

KeeFit



Model no.: IR118B

Smart Activity and Sleep Tracker

Instruction manual

This product has been created by our professional team and according to the European regulation. For a better use of your new device, we recommend you to read carefully this user manual and keep it for record.

SAFETY PRECAUTION

- 1, Only use product with confirmed power sources that follow device specifications-Do not use questionable third party chargers. Even though specifications may comply with device, third party chargers could damage and destabilize device. Only use specific charging methods or reputable branded chargers that are compatible with specified device specifications.
- 2, Do not use product beside or in close proximity to a heat source such as a ventilation heat vent, convection heater, burner, and etc..
- 3, Do not expose product to any excess moisture and liquids-avoid using device near faucets, showers, bathtubs, and etc..
- 4, Avoid dropping or applying excessive shock and force to device.
5. Avoid carrying with small metallic objects-unintended metal scraps may enter device and short device.
- 6, Do not use device in a confined space where airflow is restricted-insufficient airflow will put device at risk of overheating.
- 7, Avoid touching metal prongs when plugging and unplugging device from power source.
8. Do not use harsh chemicals to clean device. Use a damp cloth with warm water to wipe off any dirty, only clean the device when unplugging from any power source.
- 9, Do not force incompatible connectors into any ports.
- 10, Do not attempt to disassemble the device-Any attempts to do so would void all warranties on this product.
- 11, Internal batteries are designed specifically for device only, do not attempt to salvage batteries for other purposes.
- 12, Upon the event where the device may be broken, shattered, or in any way physically compromised, do not use device.
- 13, Avoid using third party cable . Supplied cables have gone through rigorous testing to ensure compatibility.
14. Do not disassemble, crush, short-circuit or incinerate the battery as it may cause fire, injury, burns, or other hazards.
- 15 The product is built with an internal rechargeable battery: do not expose the product to excessive heat such as sunshine, fire or the like.
16. Battery contains materials which are hazardous and harmful for the environment.
17. When disposed the battery, do not short circuit the + and - terminals of the battery
18. Please return them to a suitable collection facility for environmentally friendly disposal.
19. The rating plate is located at the inner side of the unit.

PACKAGE CONTENTS

1 x Smart Activity and Sleep Tracker

1 x Cable for charging the Tracker (13cm)

FEATURES

Water resistant – in pool or shower **IPX6 (not support diving)**

2-3 hours charge, play time up to 3-5 days

Smarter activity and sleep tracker;

Monitor your sleep quality and wake up silently with a vibration alarm

24 hours to track user's activity and workouts

Remind you to move when you 've been inactive for a long time

Motivate you to get your desired goal

TECHNICAL SPECIFICATION

- Compatibility

- BT 4.0 compatible with iOS 7.0 and Android 4.3 version and above

- iOS Version

 - iPhone 4S and newer

 - iPod touch 5th Gen and newer

 - iPad Mini, iPad Mini with Retina display, iPad Air, and news

- Android Phones (Android 4.3 Version and above)

 - Samsung S3/S4/S5, Samsung Note 2, Note 3 or selected smartphone

-3.5mm USB input : 5 V/0.5A

- Battery Capacity : 3.7V/35 mAh

-Charging time : ~ Environ 3 heures 45 minutes

-Product dimensions : 80 (L) * 68 (W) * 13 (H) mm

Product Overview

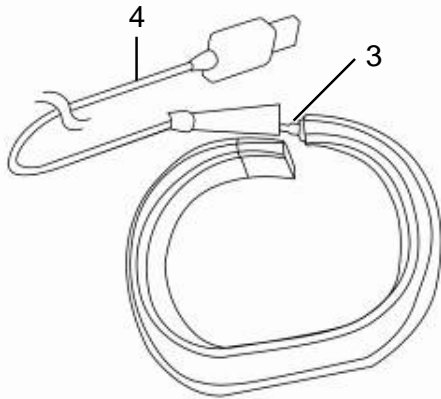
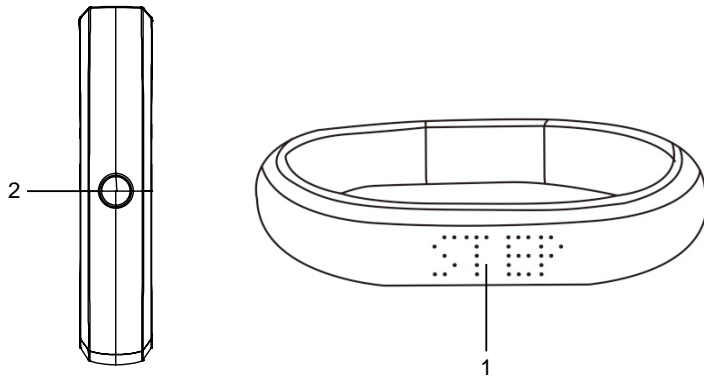

- 1. LED display
- 2. Operation button :
- 3. 3.5mm plug
- 4. Charging cable

INSTALLATION AND MAINTENANCE

Operation Instruction

Charging your IR118B

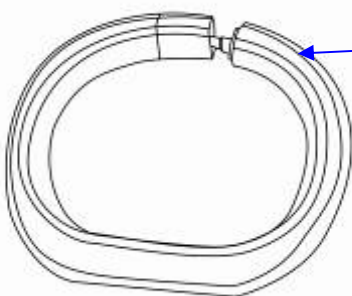

Pull out the mouth here to show the 3.5mm jack. The mouth is closed in the silver section.

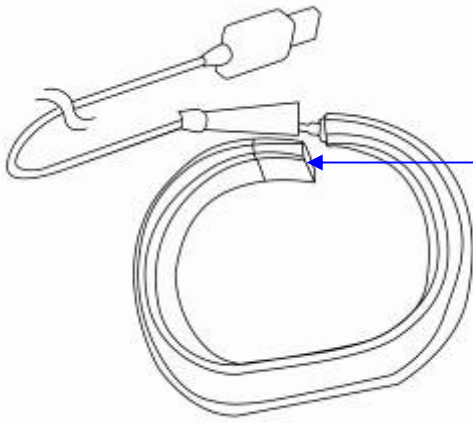

Put the 3.5mm jack into the USB cable.

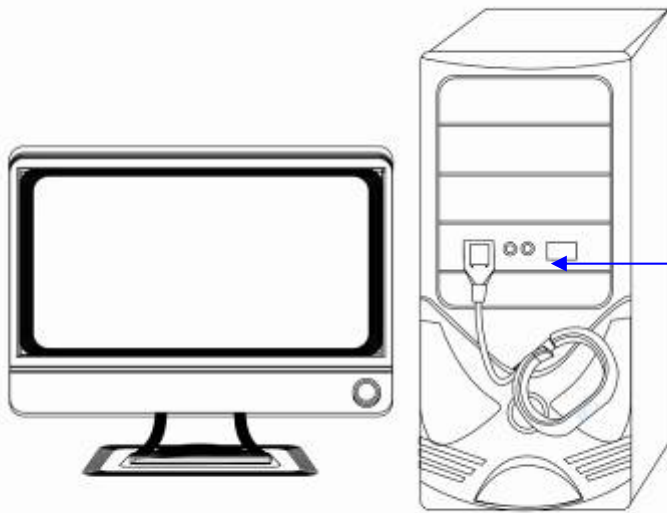

Put the USB port to charge via your computer or USB charger

IR118B is charging now. You will see the charging icon in the LED display.

Noted:

- Battery is charging automatically when the device is connecting to your computer or USB power source
- On/Off button does not control the charging via micro USB. It only controls the when charging the iPhone5/5S.
- Recommended temperature for battery charging is 0°C to 35°C
- Fully charge your IR118B at least 6 hours approximately especially for first time use, or it has not been use for a long period
- The battery could be over discharged if the device is not being used for a long time (over 3 months). To avoid over discharge, fully charge the device every 2 months.

Switch On/Off the product

Swith On the product: Press "Main button" for 5 seconds, the LED display will show 

Swith Off the product: Press "Main button" for 5 seconds, the LED display will show 

Quick Start Guide

APP/APK installation

Please search and download the APP from "iTunes" and "Google play". The APP name is **keefit2**.



APP/APK setting

Please follow the steps to control your IR118B

Step 1: Click the Keefit2 icon on your devices

Step 2: Enter the APP user interface, click "My profile" in the "Settings" manual.



Step 3: Select your gender, height, weight and age.

Remark: Select Metric or Imperial to change the "CM to Feet" and "Kg to lbs".

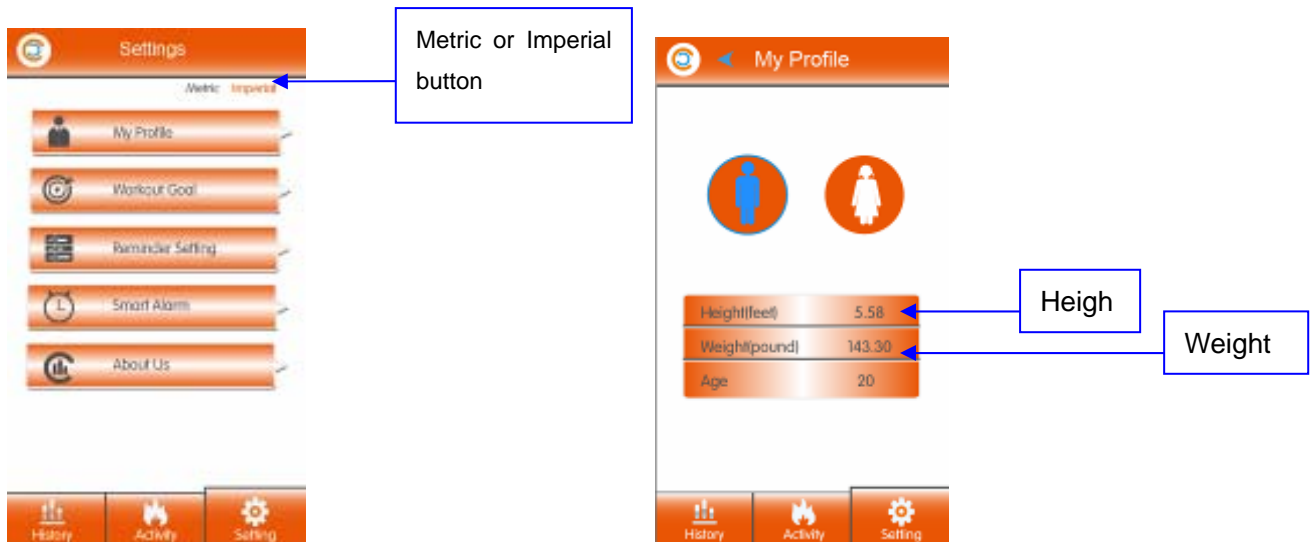

When complete the "My Profile", please click  to "Setting" page.

Remark: Your personal data has been Selected and Saved in the APP and APK.

Step 4: Data Synchronization

Make sure to switch On your IR118B.

Press the Sync button  in the APP/APK.

Press the Operation button  for 1 second in the IR118B.

The personal data in APP/APK has been transferred to your IR118B, when you can see the message “Bluetooth connect successfully” in the APP/APK.



The IR118B is ready to use now

Other APK/APP setting

IR118B is able to Select: Daily Workout Goal, Reminder and Smart Alarm.

Workout Goal

1. Click “Workout Goal” to set your daily sport goals. Choose the daily goal listed in the options and click “OK”.

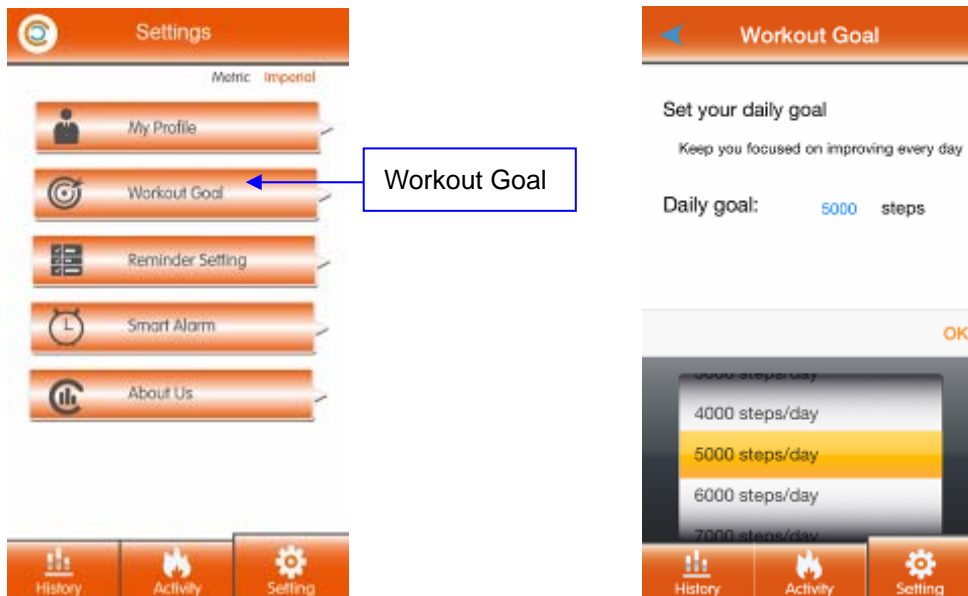

When complete the “Workout Goal”, please click  to “Setting” page.

Press the Sync button to transfer the data to your IR118B.

Remark: the Goal will be indicated in % start from 0 to 100% in the Activity Manual, Data more than 100% is meaning of your

goals has been reached and over



Reminder

The IR118B is able to remind you for your important things

Going to the "Reminder Setting" page in the "Setting" manuel.

Set the Starting, Ending Hour and Interval of your reminded.

Switch on:

to set activity reminder function.

During interval time, if user have no obviously active behavior, the bracelet will vibrate twice and show SPOT to remind you to exercise.

Remarks: If you want to set the reminder setting, please click "ON" to Orange color, and setting. When OFF/ON in gery, means close, settings doesn't work.



Smart Alarm

Click "Smart Alarm" to enter alarm setting interface. After alarm setting, click "Save" or "OK" to store information in your IR118B. The IR118B will wake you up silently (vibrate) at the time that leaves you feeling most refreshed

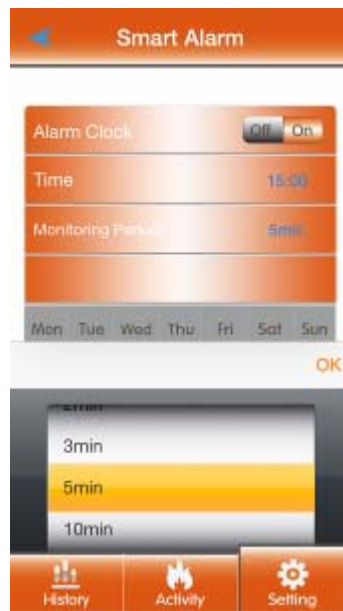

About US

Click "About US" to check related version information about the device.



Important reminder:

1. No matter what settings you put or change, you have to sync the bracelet with your devices via the Bluetooth, in order

to sync the setting done to IR118B. Press , then click  to save

Data Synchronization After use

The data storage time of the bracelet is 3 days. Please sync your bracelet within 3 days.

After charging and having the "My profile" setting, you can take the wristband on hand and doing exercise, like walking, running.

After you complete the exercise, and get ready for data synchronization.

IR118B is calculating the distance of the working steps, not including the distance of driving or taking bus.

Press the button  on wristband in short time, then the LED screen will light on.

Click the Bluetooth connecting icon  to connect with bracelet, it will show sync interface, the number of Steps, Distance, Burn and target goals that have completed will be showed outside the APP/APK.



Other Operation

In Sleep mode, press 2 times button, can change it to Sport mode. The bracelet vibrate, and display will show STEP.
1.Sport mode

Six types of parameter display on LED screen under sport mode: TIME (current time synced with your phone's), STEPS(steps covered); DIST (distance); CALS (Calories) ;GOAL(goal percentage that completed); battery power quantity.



Press  button continuously and speedily to switch among above parameters, 2 seconds pause to review each parameter.

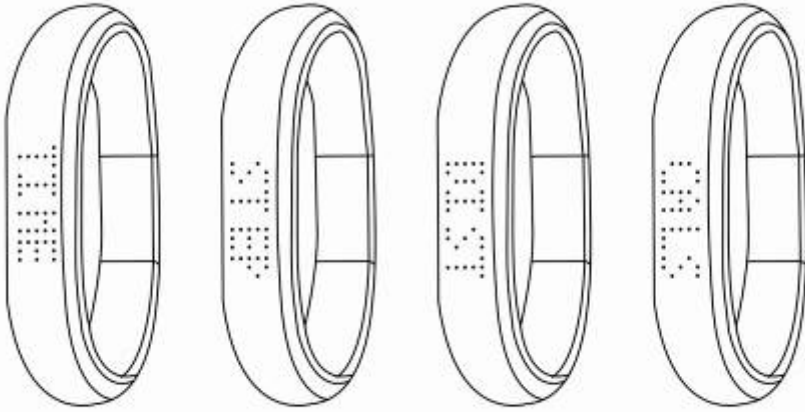

2.Sleep mode

- 1) Press button 2 times speedily, shift from sports mode to sleep mode, Wristband vibrate and show sleep icon SLEP.
- 2) In sleep mode, you can also review current time by pressing button speedily
- 3) When user wake up in morning, wristband will detect user's sports situation and shift from sleep mode to sport mode automatically.
- 4) After sync wristband with phone ,user can review sleep situation yesterday ,or previous sleep situation per day, month or year.

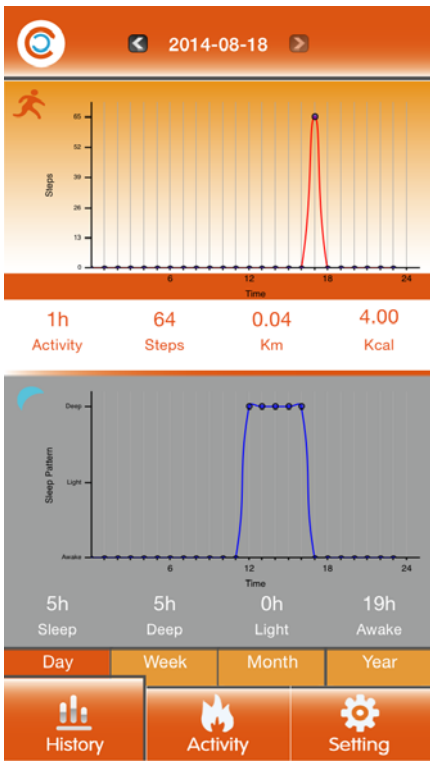
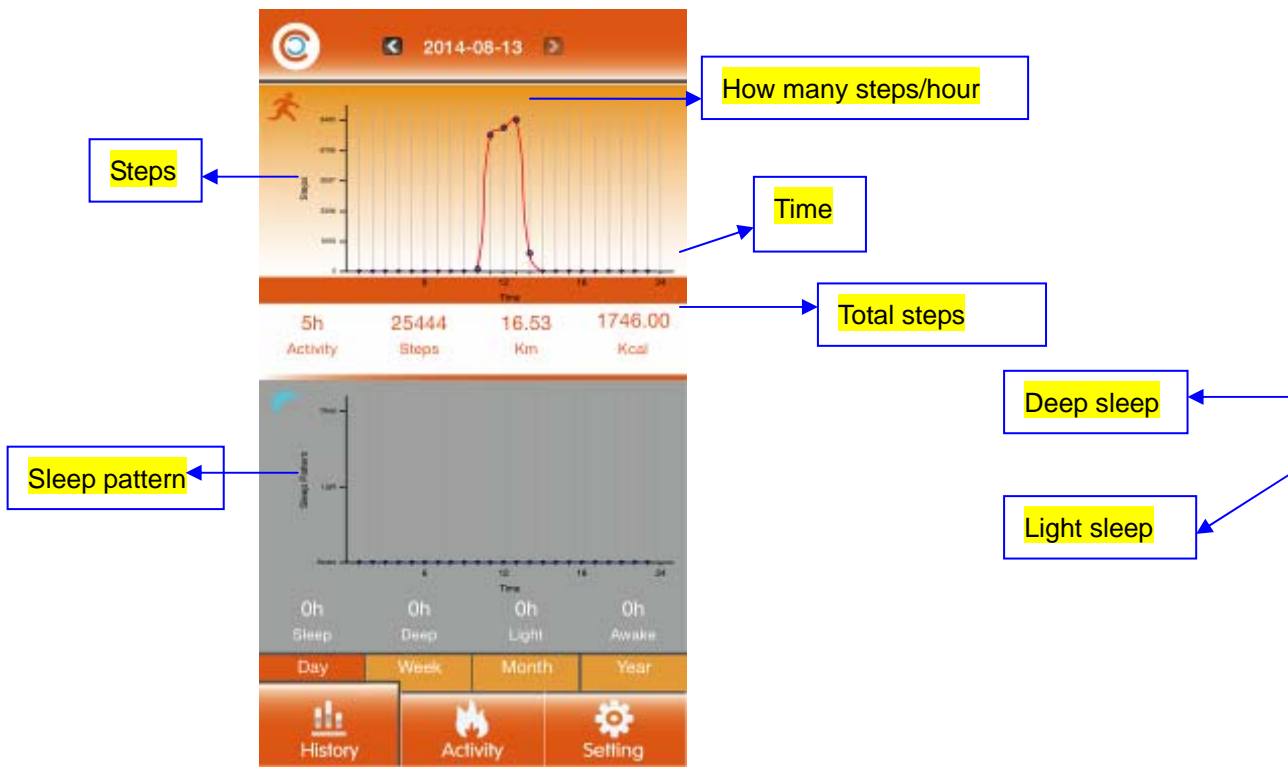

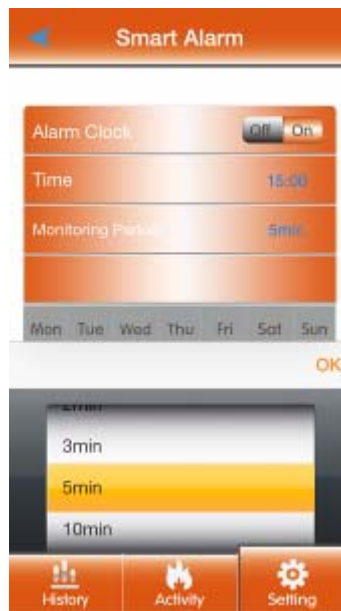
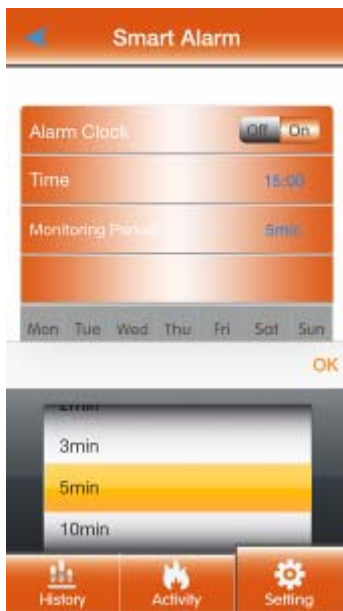

3. Smart Alarm

User can set up clock alarm time on phone and sync with wristband, wristband will vibrate 10 times as per setting time, meantime show CLCK to wake up user. At this moment, press button one time can turn off clock.





POWER ON/OFF

1. POWER OFF

In ON mode, press  5 seconds, bracelet vibrate and display ;

2. POWER ON

In OFF mode, press  5 seconds, bracelet vibrate and display ;

TRADEMARK

KeeFit is a registered trademark of Shenzhen Adition Audio Science & Technology Co. Ltd..All other company names are trademarks, registered trademarks or service marks of their respective owners.

RECYCLING

This product bears the selective sorting symbol for Waste electrical and electronic equipment (WEEE). This means that this product must be handled pursuant to European directive 2002/96/EC in order to be recycled or dismantled to minimize its impact on the environment.

User has the choice to give his product to a competent recycling organization or to the retailer when he buys a new electrical or electronic equipment.

For further information, please contact your local or regional authorities.



Net weight: 36.5g (including the cable)



FCC Statement

Changes or modifications not expressly approved by the party responsible for compliance could void the user's authority to operate the equipment.

This equipment has been tested and found to comply with the limits for a Class B digital device, pursuant to Part 15 of the FCC Rules. These limits are designed to provide reasonable protection against harmful interference in a residential installation. This equipment generates uses and can radiate radio frequency energy and, if not installed and used in accordance with the instructions, may cause harmful interference to radio communications. However, there is no guarantee that interference will not occur in a particular installation. If this equipment does cause harmful interference to radio or television reception, which can be determined by turning the equipment off and on, the user is encouraged to try to correct the interference by one or more of the following measures:

- Reorient or relocate the receiving antenna.
- Increase the separation between the equipment and receiver.
- Connect the equipment into an outlet on a circuit different from that to which the receiver is connected.
- Consult the dealer or an experienced radio/TV technician for help

This device complies with part 15 of the FCC rules. Operation is subject to the following two conditions (1) this device may not cause harmful interference, and (2) this device must accept any interference received, including interference that may cause undesired operation