

TEST REPORT

FCC ID: ZRR-BS503B

Product: Sound Boom Bluetooth Speaker

Model No.: BS503B

Additional Model No.: N/A

Trade Mark: N/A

Report No.: TCT170523E014

Issued Date: Jun. 09, 2017

Issued for:

Shenzhen Adition Audio Science & Technology Co.,Ltd
Mingzhuo Industry Park, Guangming Main Street, Guangming New District,
Shenzhen, China

Issued By:

Shenzhen Tongce Testing Lab.
1F, Leinuo Watch Building, Fuyong Town, Baoan Dist, Shenzhen, China
TEL: +86-755-27673339
FAX: +86-755-27673332

Note: This report shall not be reproduced except in full, without the written approval of Shenzhen Tongce Testing Lab.

This document may be altered or revised by Shenzhen Tongce Testing Lab. personnel only, and shall be noted in the revision section of the document. The test results in the report only apply to the tested sample.

TABLE OF CONTENTS

1. Test Certification..... 3

2. Test Result Summary..... 4

3. EUT Description..... 5

4. General Information..... 6

 4.1. Test environment and mode..... 6

 4.2. Description of Support Units..... 6

5. Facilities and Accreditations..... 7

 5.1. Facilities..... 7

 5.2. Location..... 7

 5.3. Measurement Uncertainty..... 7

6. Test Results and Measurement Data..... 8

 6.1. Antenna requirement..... 8

 6.2. Conducted Emission..... 9

 6.3. Conducted Output Power..... 13

 6.4. 20dB Occupancy Bandwidth..... 17

 6.5. Carrier Frequencies Separation..... 21

 6.6. Hopping Channel Number..... 25

 6.7. Dwell Time..... 28

 6.8. Pseudorandom Frequency Hopping Sequence..... 32

 6.9. Conducted Band Edge Measurement..... 33

 6.10. Conducted Spurious Emission Measurement..... 36

 6.11. Radiated Spurious Emission Measurement..... 39

Appendix A: Photographs of Test Setup

Appendix B: Photographs of EUT

1. Test Certification

| | |
|------------------------------|--|
| Product: | Sound Boom Bluetooth Speaker |
| Model No.: | BS503B |
| Additional Model: | N/A |
| Applicant: | Shenzhen Adition Audio Science & Technology Co., Ltd |
| Address: | Mingzhuo Industry Park, Guangming Main Street, Guangming New District, Shenzhen, China |
| Manufacturer: | Shenzhen Adition Audio Science & Technology Co., Ltd |
| Address: | Mingzhuo Industry Park, Guangming Main Street, Guangming New District, Shenzhen, China |
| Date of Test: | May 25 – Jun. 09, 2017 |
| Applicable Standards: | FCC CFR Title 47 Part 15 Subpart C Section 15.247 |

The above equipment has been tested by Shenzhen Tongce Testing Lab. and found compliance with the requirements set forth in the technical standards mentioned above. The results of testing in this report apply only to the product/system, which was tested. Other similar equipment will not necessarily produce the same results due to production tolerance and measurement uncertainties.

Tested By:



Brews Xu

Date:

Jun. 08, 2017

Reviewed By:



Joe Zhou

Date:

Jun. 09, 2017

Approved By:



Tomsin

Date:

Jun. 09, 2017

2. Test Result Summary

| Requirement | CFR 47 Section | Result |
|----------------------------------|-------------------------------------|--------|
| Antenna Requirement | §15.203/§15.247 (c) | PASS |
| AC Power Line Conducted Emission | §15.207 | PASS |
| Conducted Peak Output Power | §15.247 (b)(1) §2.1046 | PASS |
| 20dB Occupied Bandwidth | §15.247 (a)(1) §2.1049 | PASS |
| Carrier Frequencies Separation | §15.247 (a)(1) | PASS |
| Hopping Channel Number | §15.247 (a)(1) | PASS |
| Dwell Time | §15.247 (a)(1) | PASS |
| Radiated Emission | §15.205/§15.209 §2.1053, §2.1057 | PASS |
| Band Edge | §15.247(d) §2.1051, §2.1057 | PASS |

Note:

1. PASS: Test item meets the requirement.
2. Fail: Test item does not meet the requirement.
3. N/A: Test case does not apply to the test object.
4. The test result judgment is decided by the limit of test standard.

3. EUT Description

| | |
|-------------------------------|------------------------------------|
| Product Name: | Sound Boom Bluetooth Speaker |
| Model : | BS503B |
| Additional Model: | N/A |
| Trade Mark: | N/A |
| Bluetooth version: | V2.1 |
| Operation Frequency: | 2402MHz~2480MHz |
| Transfer Rate: | 1/2 Mbits/s |
| Number of Channel: | 79 |
| Modulation Type: | GFSK, $\pi/4$ -DQPSK |
| Modulation Technology: | FHSS |
| Antenna Type: | PCB Antenna |
| Antenna Gain: | 2dBi |
| Power Supply: | Rechargeable Li-ion Battery DC3.7V |

Operation Frequency each of channel for GFSK, $\pi/4$ -DQPSK

| Channel | Frequency | Channel | Frequency | Channel | Frequency | Channel | Frequency |
|---------|-----------|---------|-----------|---------|-----------|---------|-----------|
| 0 | 2402MHz | 20 | 2422MHz | 40 | 2442MHz | 60 | 2462MHz |
| 1 | 2403MHz | 21 | 2423MHz | 41 | 2443MHz | 61 | 2463MHz |
| ... | ... | ... | ... | ... | ... | ... | ... |
| 10 | 2412MHz | 30 | 2432MHz | 50 | 2452MHz | 70 | 2472MHz |
| 11 | 2413MHz | 31 | 2433MHz | 51 | 2453MHz | 71 | 2473MHz |
| ... | ... | ... | ... | ... | ... | ... | ... |
| 18 | 2420MHz | 38 | 2440MHz | 58 | 2460MHz | 78 | 2480MHz |
| 19 | 2421MHz | 39 | 2441MHz | 59 | 2461MHz | | - |

Remark: Channel 0, 39 & 78 have been tested for GFSK, $\pi/4$ -DQPSK modulation mode.

4. Genera Information

4.1. Test environment and mode

| Operating Environment: | |
|--|--|
| Temperature: | 25.0 °C |
| Humidity: | 56 % RH |
| Atmospheric Pressure: | 1010 mbar |
| Test Mode: | |
| Engineering mode: | Keep the EUT in continuous transmitting by select channel and modulations with Fully-charged battery |
| <p>The sample was placed 0.8m & 1.5m for the measurement below & above 1GHz above the ground plane of 3m chamber. Measurements in both horizontal and vertical polarities were performed. During the test, each emission was maximized by: having the EUT continuously working, investigated all operating modes, rotated about all 3 axis (X, Y & Z) and considered typical configuration to obtain worst position, manipulating interconnecting cables, rotating the turntable, varying antenna height from 1m to 4m in both horizontal and vertical polarizations. The emissions worst-case are shown in Test Results of the following pages.</p> | |

4.2. Description of Support Units

The EUT has been tested as an independent unit together with other necessary accessories or support units. The following support units or accessories were used to form a representative test configuration during the tests.

| Equipment | Model No. | Serial No. | FCC ID | Trade Name |
|-----------|-----------------|------------|--------|------------|
| Adapter | XC-0501000-06-B | / | / | ADAPTER |

Note:

1. All the equipment/cables were placed in the worst-case configuration to maximize the emission during the test.
2. Grounding was established in accordance with the manufacturer's requirements and conditions for the intended use.
3. For conducted measurements (Output Power, 20dB Occupied Bandwidth, Carrier Frequencies Separation, Hopping Channel Number, Dwell Time, Spurious Emissions), the antenna of EUT is connected to the test equipment via temporary antenna connector, the antenna connector is soldered on the antenna port of EUT, and the temporary antenna connector is listed in the Test Instruments.

5. Facilities and Accreditations

5.1. Facilities

The test facility is recognized, certified, or accredited by the following organizations:

- FCC - Registration No.: 572331

Shenzhen Tongce Testing Lab

The 3m Semi-anechoic chamber has been registered and fully described in a report with the (FCC) Federal Communications Commission. The acceptance letter from the FCC is maintained in our files.

- IC - Registration No.: 10668A-1

The 3m Semi-anechoic chamber of Shenzhen TCT Testing Technology Co., Ltd. has been registered by Certification and Engineering Bureau of Industry Canada for radio equipment testing.

5.2. Location

Shenzhen Tongce Testing Lab

Address: 1F, Leinuo Watch Building, Fuyong Town, Baoan Dist, Shenzhen, China

Tel: +86-755-27673339

5.3. Measurement Uncertainty

The reported uncertainty of measurement $y \pm U$, where expanded uncertainty U is based on a standard uncertainty multiplied by a coverage factor of $k=2$, providing a level of confidence of approximately 95 %.

| No. | Item | MU |
|-----|-------------------------------|-------------------------|
| 1 | Conducted Emission | $\pm 2.56\text{dB}$ |
| 2 | RF power, conducted | $\pm 0.12\text{dB}$ |
| 3 | Spurious emissions, conducted | $\pm 0.11\text{dB}$ |
| 4 | All emissions, radiated(<1G) | $\pm 3.92\text{dB}$ |
| 5 | All emissions, radiated(>1G) | $\pm 4.28\text{dB}$ |
| 6 | Temperature | $\pm 0.1^\circ\text{C}$ |
| 7 | Humidity | $\pm 1.0\%$ |

6. Test Results and Measurement Data

6.1. Antenna requirement

| | |
|------------------------------|-------------------------------------|
| Standard requirement: | FCC Part15 C Section 15.203 /247(c) |
|------------------------------|-------------------------------------|

15.203 requirement:

An intentional radiator shall be designed to ensure that no antenna other than that furnished by the responsible party shall be used with the device. The use of a permanently attached antenna or of an antenna that uses a unique coupling to the intentional radiator, the manufacturer may design the unit so that a broken antenna can be replaced by the user, but the use of a standard antenna jack or electrical connector is prohibited.

15.247(c) (1)(i) requirement:

(i) Systems operating in the 2400-2483.5 MHz band that is used exclusively for fixed. Point-to-point operations may employ transmitting antennas with directional gain greater than 6dBi provided the maximum conducted output power of the intentional radiator is reduced by 1 dB for every 3 dB that the directional gain of the antenna exceeds 6dBi.

| | |
|-----------------------|--|
| E.U.T Antenna: | |
|-----------------------|--|

The Bluetooth antenna is a PCB antenna which permanently attached, and the best case gain of the antenna is 2dBi.

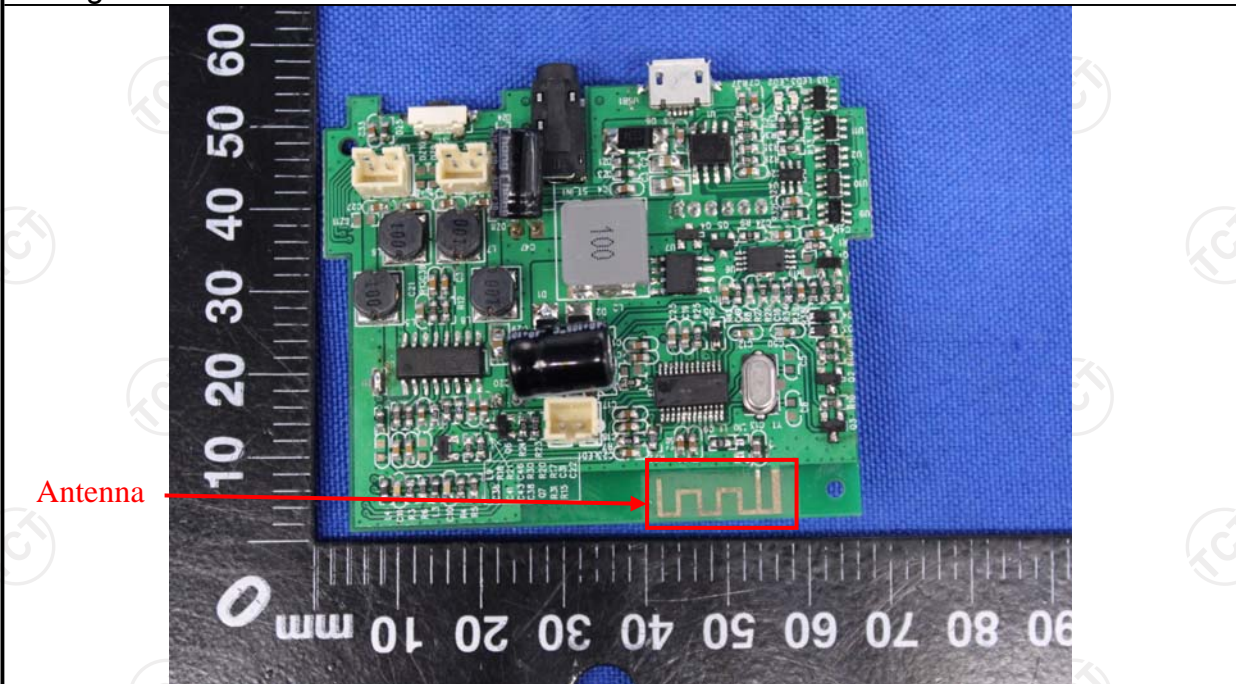

6.2. Conducted Emission

6.2.1. Test Specification

| | | | |
|--------------------------|--|--------------|-----------|
| Test Requirement: | FCC Part15 C Section 15.207 | | |
| Test Method: | ANSI C63.10:2013 | | |
| Frequency Range: | 150 kHz to 30 MHz | | |
| Receiver setup: | RBW=9 kHz, VBW=30 kHz, Sweep time=auto | | |
| Limits: | Frequency range (MHz) | Limit (dBuV) | |
| | | Quasi-peak | Average |
| | 0.15-0.5 | 66 to 56* | 56 to 46* |
| | 0.5-5 | 56 | 46 |
| | 5-30 | 60 | 50 |
| Test Setup: | <p><i>Remark</i> E.U.T: Equipment Under Test LISN: Line Impedance Stabilization Network Test table height=0.8m</p> | | |
| Test Mode: | Refer to item 4.1 | | |
| Test Procedure: | <ol style="list-style-type: none"> 1. The E.U.T is connected to an adapter through a line impedance stabilization network (L.I.S.N.). This provides a 50ohm/50uH coupling impedance for the measuring equipment. 2. The peripheral devices are also connected to the main power through a LISN that provides a 50ohm/50uH coupling impedance with 50ohm termination. (Please refer to the block diagram of the test setup and photographs). 3. Both sides of A.C. line are checked for maximum conducted interference. In order to find the maximum emission, the relative positions of equipment and all of the interface cables must be changed according to ANSI C63.10:2013 on conducted measurement. | | |
| Test Result: | PASS | | |

6.2.2. Test Instruments

| Conducted Emission Shielding Room Test Site (843) | | | | |
|---|-----------------------|-----------|---------------|-----------------|
| Equipment | Manufacturer | Model | Serial Number | Calibration Due |
| EMI Test Receiver | R&S | ESCS30 | 100139 | Aug. 11, 2017 |
| LISN | Schwarzbeck | NSLK 8126 | 8126453 | Aug. 16, 2017 |
| Coax cable (9KHz-40GHz) | TCT | CE-05 | N/A | Aug. 11, 2017 |
| EMI Test Software | Shurple Technology | EZ-EMC | N/A | N/A |

Note: The calibration interval of the above test instruments is 12 months and the calibrations are traceable to international system unit (SI).

6.2.3. Test data

Please refer to following diagram for individual
Conducted Emission on Line Terminal of the power line (150 kHz to 30MHz)

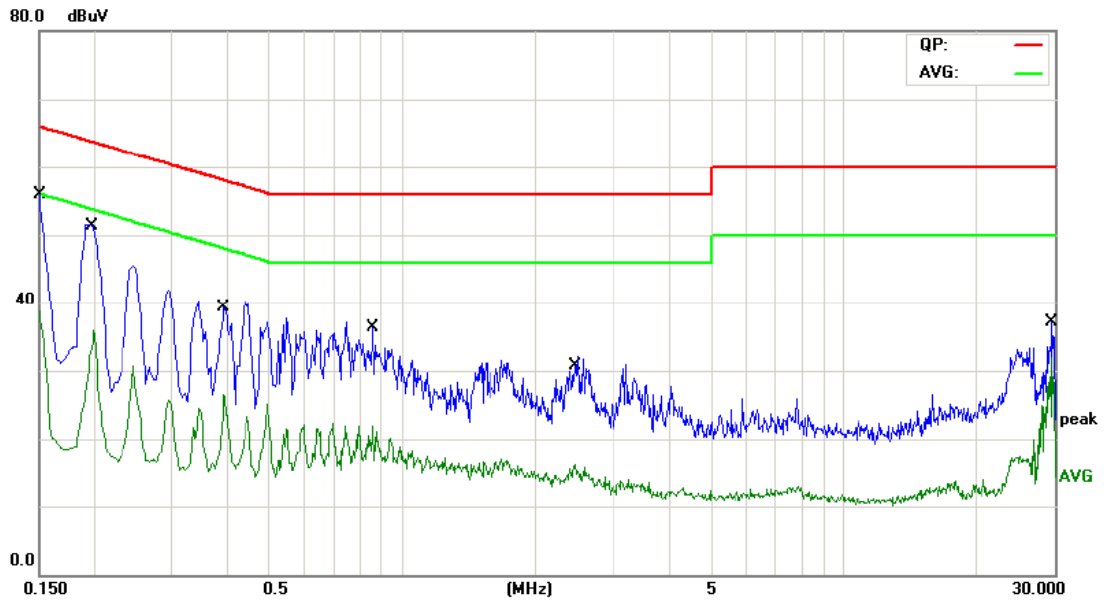

Site Chamber Phase: **L** Temperature: 26 (C)
Limit: FCC Part 15B Class B Conduction(QP) Power: AC 120V/60Hz Humidity: 60 %

| No. | Mk. | Freq. MHz | Reading Level dBuV | Correct Factor dB | Measure- ment dBuV | Limit dBuV | Over dB | Detector | Comment |
|-----|-----|--------------|--------------------------|-------------------------|--------------------------|---------------|------------|----------|---------|
| 1 | * | 0.1500 | 42.51 | 11.47 | 53.98 | 65.99 | -12.01 | QP | |
| 2 | | 0.1500 | 27.29 | 11.47 | 38.76 | 55.99 | -17.23 | AVG | |
| 3 | | 0.1995 | 38.02 | 11.45 | 49.47 | 63.63 | -14.16 | QP | |
| 4 | | 0.1995 | 24.43 | 11.45 | 35.88 | 53.63 | -17.75 | AVG | |
| 5 | | 0.3930 | 28.02 | 11.35 | 39.37 | 58.00 | -18.63 | QP | |
| 6 | | 0.3930 | 15.20 | 11.35 | 26.55 | 48.00 | -21.45 | AVG | |
| 7 | | 0.8608 | 25.16 | 11.21 | 36.37 | 56.00 | -19.63 | QP | |
| 8 | | 0.8608 | 10.59 | 11.21 | 21.80 | 46.00 | -24.20 | AVG | |
| 9 | | 2.4539 | 20.57 | 11.52 | 32.09 | 56.00 | -23.91 | QP | |
| 10 | | 2.4539 | 4.64 | 11.52 | 16.16 | 46.00 | -29.84 | AVG | |
| 11 | | 29.6655 | 26.49 | 10.60 | 37.09 | 60.00 | -22.91 | QP | |
| 12 | | 29.6655 | 21.34 | 10.60 | 31.94 | 50.00 | -18.06 | AVG | |

Note:

Freq. = Emission frequency in MHz

Reading level (dBuV) = Receiver reading

Corr. Factor (dB) = Antenna factor + Cable loss

Measurement (dBuV) = Reading level (dBuV) + Corr. Factor (dB)

Limit (dBuV) = Limit stated in standard

Margin (dB) = Measurement (dBuV) – Limits (dBuV)

Q.P. =Quasi-Peak

AVG =average

* is meaning the worst frequency has been tested in the frequency range 150 kHz to 30MHz

Conducted Emission on Neutral Terminal of the power line (150 kHz to 30MHz)

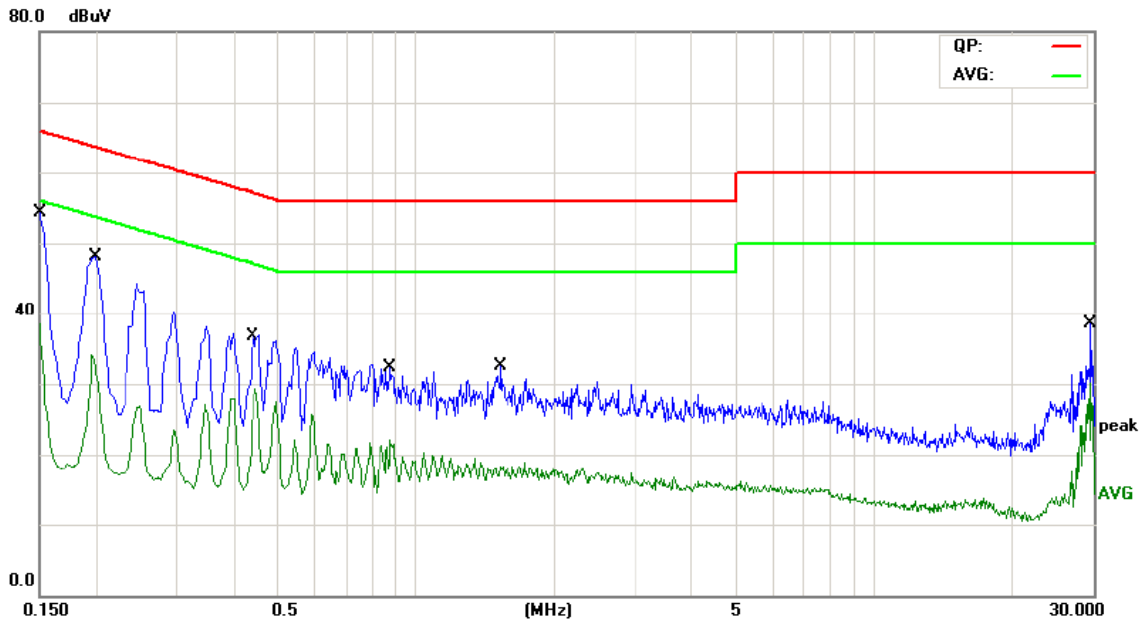

Site Chamber Phase: **N** Temperature: 26 (C)
 Limit: FCC Part 15B Class B Conduction(QP) Power: AC 120V/60Hz Humidity: 60 %

| No. | Mk. | Freq. MHz | Reading Level dBuV | Correct Factor dB | Measure- ment dBuV | Limit dBuV | Over dB | Detector | Comment |
|-----|-----|--------------|--------------------------|-------------------------|--------------------------|---------------|------------|----------|---------|
| 1 | * | 0.1500 | 42.85 | 11.47 | 54.32 | 65.99 | -11.67 | QP | |
| 2 | | 0.1500 | 27.01 | 11.47 | 38.48 | 55.99 | -17.51 | AVG | |
| 3 | | 0.1949 | 36.60 | 11.45 | 48.05 | 63.82 | -15.77 | QP | |
| 4 | | 0.1949 | 22.71 | 11.45 | 34.16 | 53.82 | -19.66 | AVG | |
| 5 | | 0.4425 | 25.52 | 11.33 | 36.85 | 57.01 | -20.16 | QP | |
| 6 | | 0.4425 | 17.99 | 11.33 | 29.32 | 47.01 | -17.69 | AVG | |
| 7 | | 0.8789 | 21.09 | 11.21 | 32.30 | 56.00 | -23.70 | QP | |
| 8 | | 0.8789 | 10.97 | 11.21 | 22.18 | 46.00 | -23.82 | AVG | |
| 9 | | 1.5224 | 21.05 | 11.46 | 32.51 | 56.00 | -23.49 | QP | |
| 10 | | 1.5224 | 6.89 | 11.46 | 18.35 | 46.00 | -27.65 | AVG | |
| 11 | | 29.6655 | 27.83 | 10.60 | 38.43 | 60.00 | -21.57 | QP | |
| 12 | | 29.6655 | 19.43 | 10.60 | 30.03 | 50.00 | -19.97 | AVG | |

Note1:

Freq. = Emission frequency in MHz

Reading level (dBuV) = Receiver reading

Corr. Factor (dB) = Antenna factor + Cable loss

Measurement (dBuV) = Reading level (dBuV) + Corr. Factor (dB)

Limit (dBuV) = Limit stated in standard

Margin (dB) = Measurement (dBuV) – Limits (dBuV)

Q.P. =Quasi-Peak AVG =average

* is meaning the worst frequency has been tested in the frequency range 150 kHz to 30MHz.

Note2:

Measurements were conducted in all three channels (high, middle, low) and three modulation (GFSK, Pi/4 DQPSK), and the worst case Mode (Lowest channel and GFSK) was submitted only.

6.3.3. Test Data

| GFSK mode | | | |
|--------------|-------------------------|-------------|--------|
| Test channel | Peak Output Power (dBm) | Limit (dBm) | Result |
| Lowest | 1.01 | 21.00 | PASS |
| Middle | 0.08 | 21.00 | PASS |
| Highest | -0.94 | 21.00 | PASS |

| Pi/4DQPSK mode | | | |
|----------------|-------------------------|-------------|--------|
| Test channel | Peak Output Power (dBm) | Limit (dBm) | Result |
| Lowest | 0.72 | 21.00 | PASS |
| Middle | -0.21 | 21.00 | PASS |
| Highest | -1.23 | 21.00 | PASS |

Test plots as follows:



Lowest channel

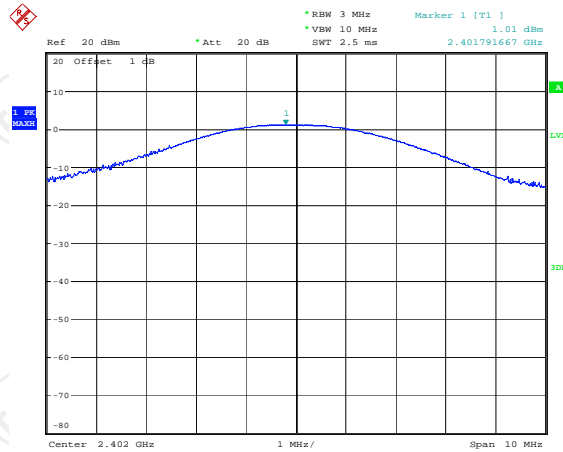

Date: 8.JUN.2017 16:26:23

Middle channel

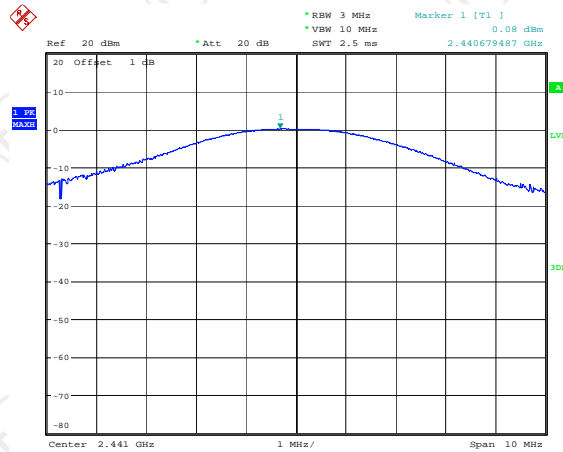

Date: 8.JUN.2017 16:25:29

Highest channel

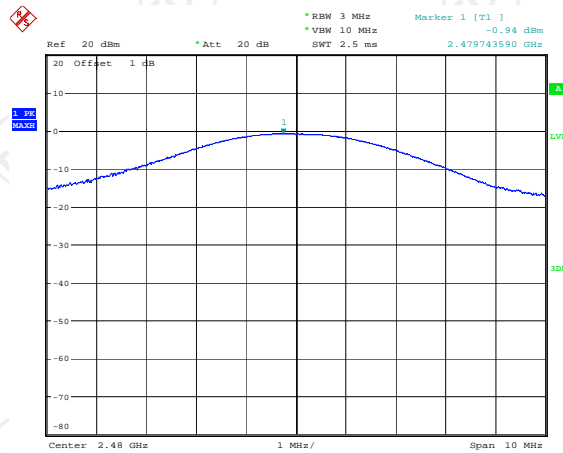

Date: 8.JUN.2017 16:24:32

Lowest channel

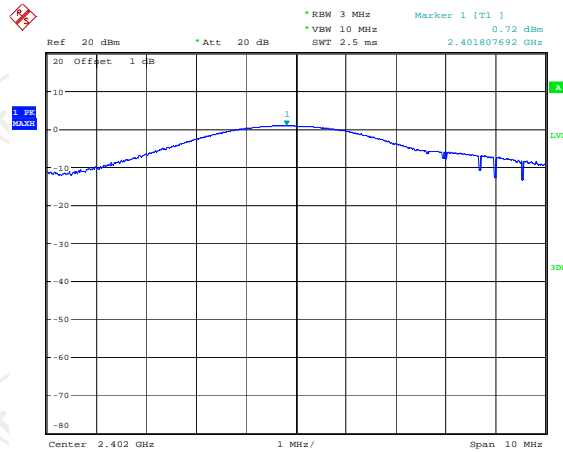

Date: 8.JUN.2017 16:20:27

Middle channel

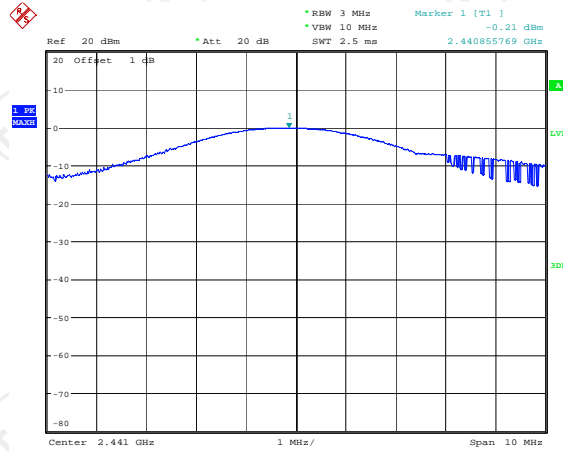

Date: 8.JUN.2017 16:22:04

Highest channel

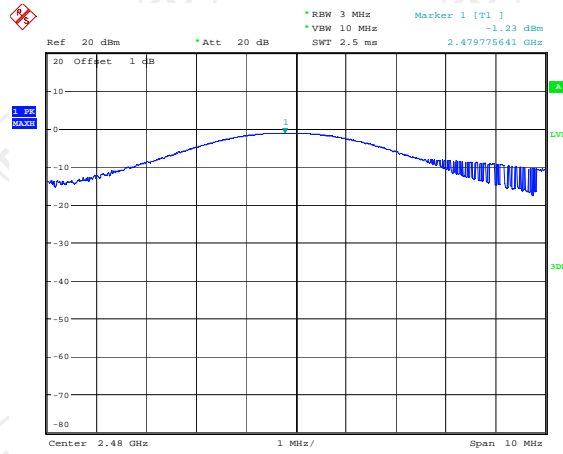

Date: 8.JUN.2017 16:23:15

6.4.3. Test data

| Test channel | 20dB Occupy Bandwidth (kHz) | | |
|--------------|-----------------------------|----------------|------------|
| | GFSK | $\pi/4$ -DQPSK | Conclusion |
| Lowest | 1105.77 | 1326.92 | PASS |
| Middle | 1105.77 | 1322.12 | PASS |
| Highest | 1105.77 | 1322.12 | PASS |

Test plots as follows:

Lowest channel

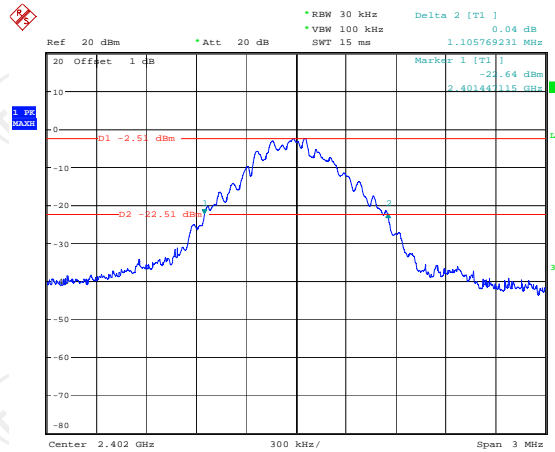

Date: 8.JUN.2017 16:09:03

Middle channel

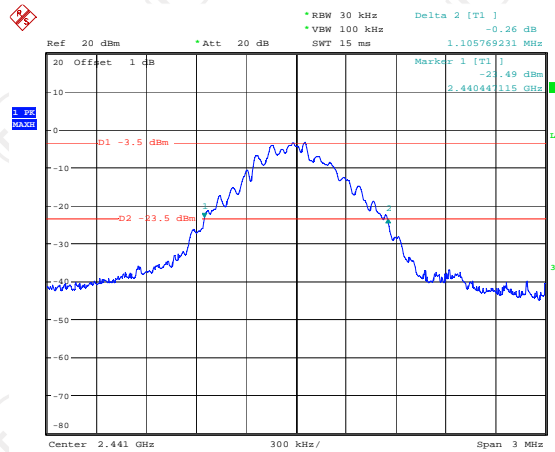

Date: 8.JUN.2017 16:10:21

Highest channel

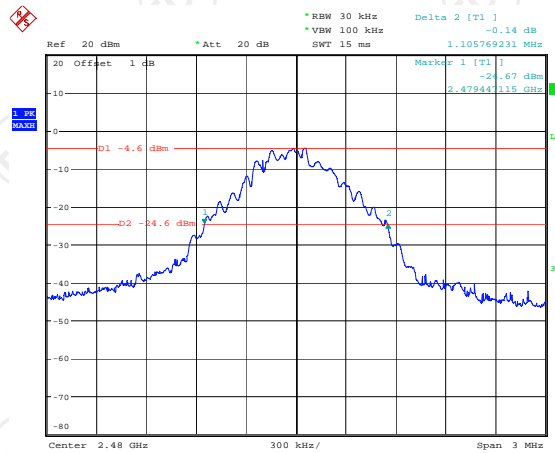

Date: 8.JUN.2017 16:11:20

Lowest channel

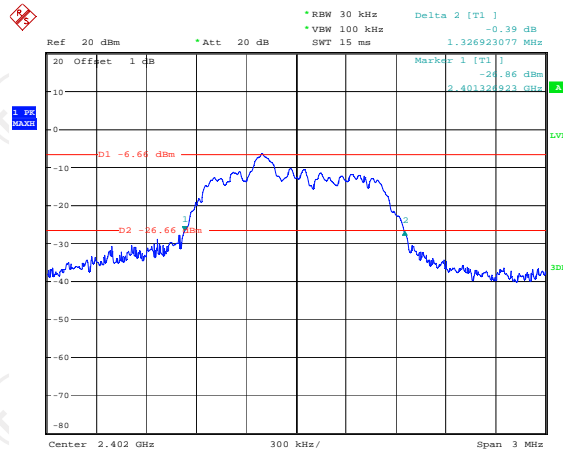

Date: 8.JUN.2017 16:17:15

Middle channel

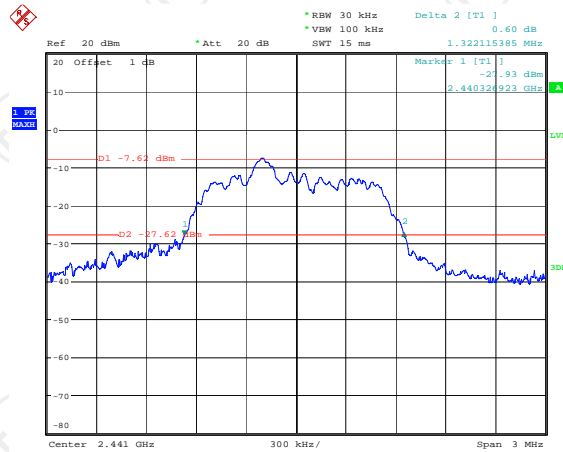

Date: 8.JUN.2017 16:15:44

Highest channel

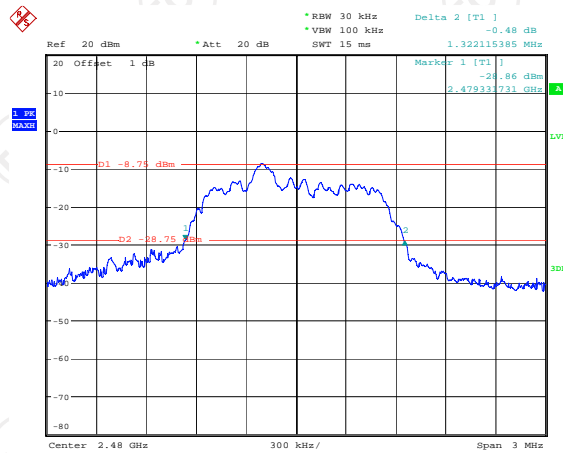

Date: 8.JUN.2017 16:13:09

6.5.3. Test data

| GFSK mode | | | |
|--------------|--------------------------------------|-------------|--------|
| Test channel | Carrier Frequencies Separation (kHz) | Limit (kHz) | Result |
| Lowest | 1000 | 737.18 | PASS |
| Middle | 1000 | 737.18 | PASS |
| Highest | 1006.4 | 737.18 | PASS |

| Pi/4 DQPSK mode | | | |
|-----------------|--------------------------------------|-------------|--------|
| Test channel | Carrier Frequencies Separation (kHz) | Limit (kHz) | Result |
| Lowest | 1003.2 | 884.61 | PASS |
| Middle | 1003.2 | 884.41 | PASS |
| Highest | 1000 | 884.41 | PASS |

Note: According to section 6.4

| Mode | 20dB bandwidth (kHz) (worse case) | Limit (kHz) (Carrier Frequencies Separation) |
|----------------|--------------------------------------|---|
| GFSK | 1105.77 | 737.18 |
| $\pi/4$ -DQPSK | 1322.12 | 884.41 |

Test plots as follows:

Lowest channel

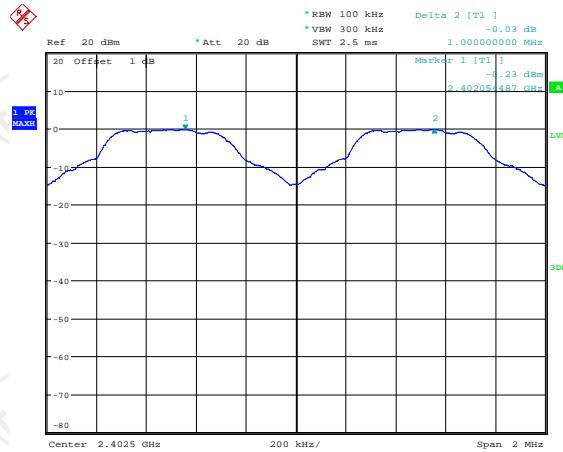

Date: 8.JUN.2017 15:22:41

Middle channel

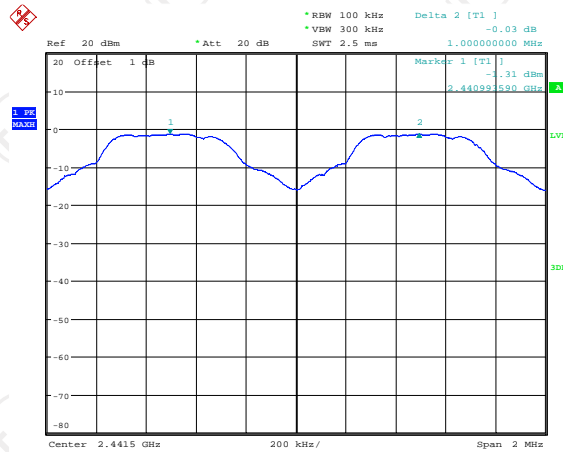

Date: 8.JUN.2017 15:23:53

Highest channel

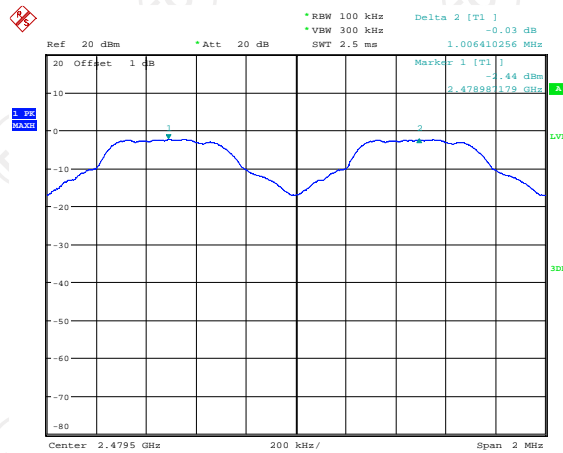

Date: 8.JUN.2017 15:25:15

Lowest channel

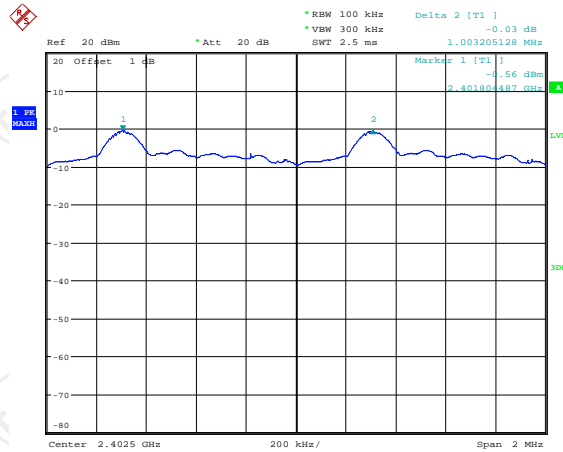

Date: 8.JUN.2017 15:30:45

Middle channel

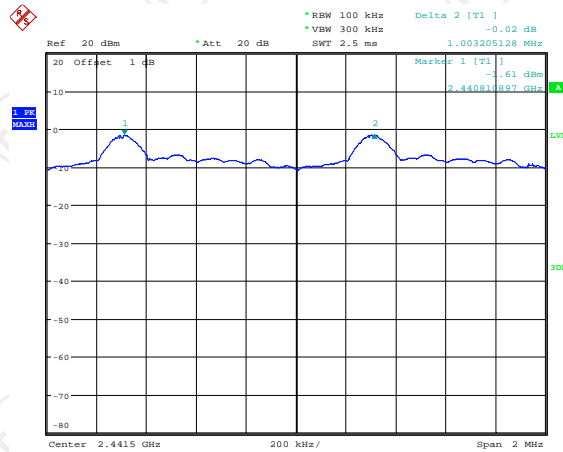

Date: 8.JUN.2017 15:29:28

Highest channel

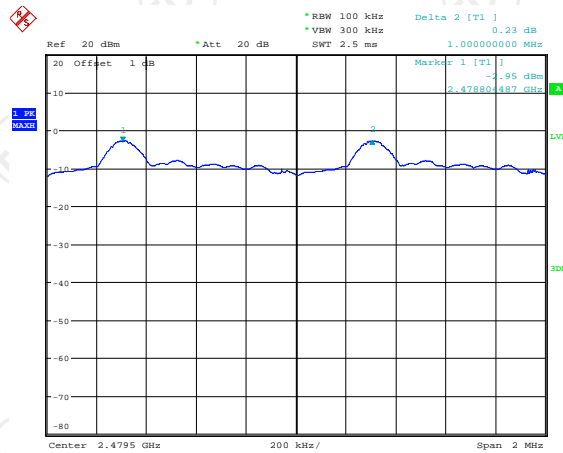

Date: 8.JUN.2017 15:27:48

6.6. Hopping Channel Number

6.6.1. Test Specification

| | |
|--------------------------|--|
| Test Requirement: | FCC Part15 C Section 15.247 (a)(1) |
| Test Method: | ANSI C63.10:2013 |
| Limit: | Frequency hopping systems in the 2400-2483.5 MHz band shall use at least 15 channels. |
| Test Setup: |  <p style="text-align: center;">Spectrum Analyzer EUT</p> |
| Test Mode: | Hopping mode |
| Test Procedure: | <ol style="list-style-type: none"> 1. The testing follows ANSI C63.10:2013 Measurement Guidelines. 2. The RF output of EUT was connected to the spectrum analyzer by RF cable and attenuator. The path loss was compensated to the results for each measurement. 3. Set to the maximum power setting and enable the EUT transmit continuously. 4. Enable the EUT hopping function. 5. Use the following spectrum analyzer settings: Span = the frequency band of operation; set the RBW to less than 30% of the channel spacing or the 20 dB bandwidth, whichever is smaller; VBW\geqRBW; Sweep = auto; Detector function = peak; Trace = max hold. 6. The number of hopping frequency used is defined as the number of total channel. 7. Record the measurement data in report. |
| Test Result: | PASS |

6.6.2. Test Instruments

| RF Test Room | | | | |
|--------------------------|--------------|--------|---------------|-----------------|
| Equipment | Manufacturer | Model | Serial Number | Calibration Due |
| Spectrum Analyzer | R&S | FSU | 200054 | Aug. 11, 2017 |
| RF Cable (9KHz-40GHz) | TCT | RE-06 | N/A | Aug. 12, 2017 |
| Antenna Connector | TCT | RFC-01 | N/A | Aug. 12, 2017 |

Note: The calibration interval of the above test instruments is 12 months and the calibrations are traceable to international system unit (SI).

6.6.3. Test data

| Mode | Hopping channel numbers | Limit | Result |
|-----------------|-------------------------|-------|--------|
| GFSK, P/4-DQPSK | 79 | 15 | PASS |

Test plots as follows:



GFSK

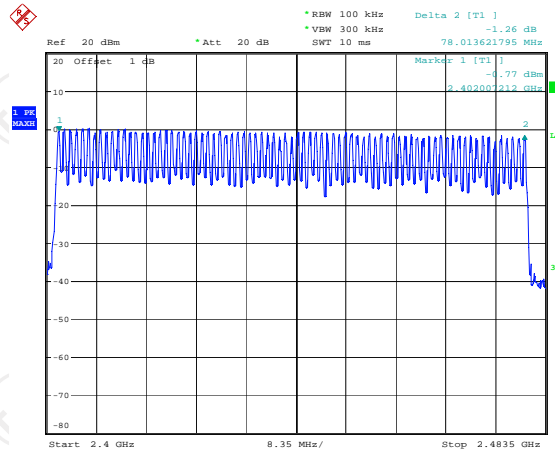

Date: 8.JUN.2017 16:28:23

Pi/4DQPSK

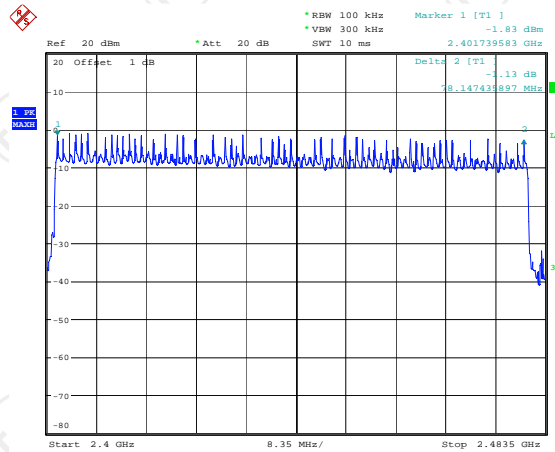

Date: 8.JUN.2017 16:32:59

6.7.3. Test Data

| Mode | Packet | Hops Over Occupancy Time (hops) | Package Transfer Time (ms) | Dwell time (second) | Limit (second) | Result |
|------------|--------|---------------------------------|----------------------------|---------------------|----------------|--------|
| GFSK | DH1 | 320 | 0.364 | 0.116 | 0.4 | PASS |
| GFSK | DH3 | 160 | 1.726 | 0.276 | 0.4 | PASS |
| GFSK | DH5 | 106.67 | 2.995 | 0.319 | 0.4 | PASS |
| Pi/4 DQPSK | 2-DH1 | 320 | 0.364 | 0.116 | 0.4 | PASS |
| Pi/4 DQPSK | 2-DH3 | 160 | 1.676 | 0.268 | 0.4 | PASS |
| Pi/4 DQPSK | 2-DH5 | 106.67 | 2.937 | 0.313 | 0.4 | PASS |

Note: 1. In normal mode, hopping rate is 1600 hops/s with 6 slots in 79 hopping channels.

For DH1, With channel hopping rate $(1600 / 2 / 79)$ in Occupancy Time Limit (0.4×79) (s), Hops Over Occupancy Time comes to $(1600 / 2 / 79) \times (0.4 \times 79) = 320$ hops

For DH3, With channel hopping rate $(1600 / 6 / 79)$ in Occupancy Time Limit (0.4×79) (s), Hops Over Occupancy Time comes to $(1600 / 4 / 79) \times (0.4 \times 79) = 160$ hops

For DH5, With channel hopping rate $(1600 / 6 / 79)$ in Occupancy Time Limit (0.4×79) (s), Hops Over Occupancy Time comes to $(1600 / 6 / 79) \times (0.4 \times 79) = 106.67$ hops

2. Dwell Time(s) = Hops Over Occupancy Time (hops) x Package Transfer Time

Test plots as follows:

**GFSK
DH1**

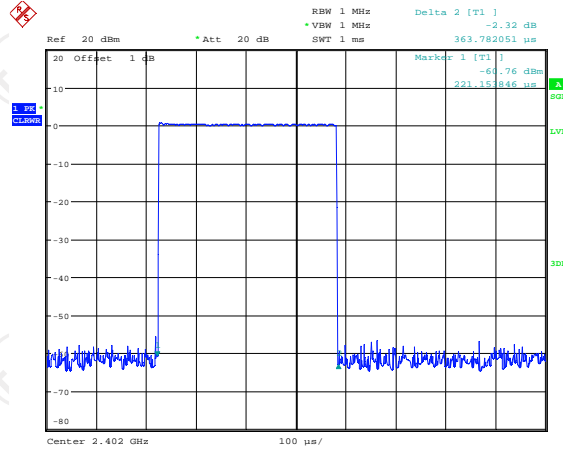

Date: 8.JUN.2017 15:49:43

DH3

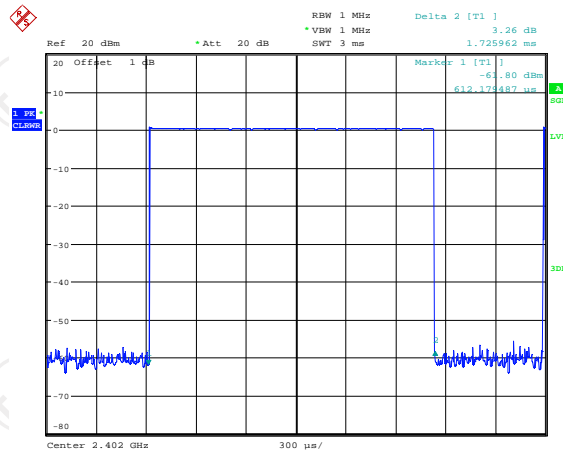

Date: 8.JUN.2017 15:49:08

DH5

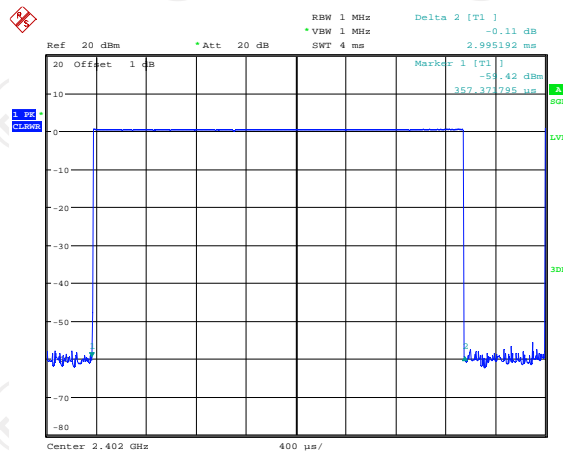

Date: 8.JUN.2017 15:44:47

Pi/4DQPSK
2-DH1

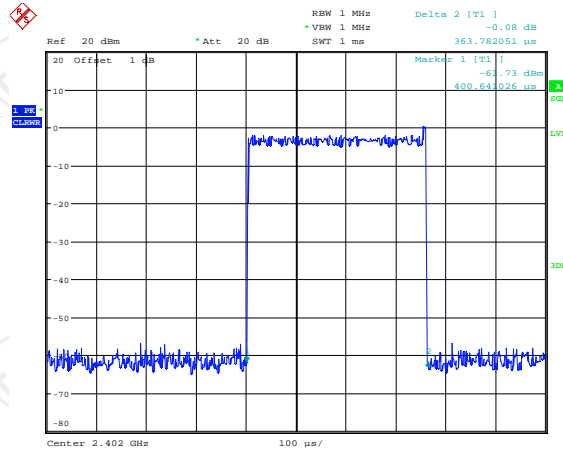

Date: 8.JUN.2017 15:42:20

2-DH3

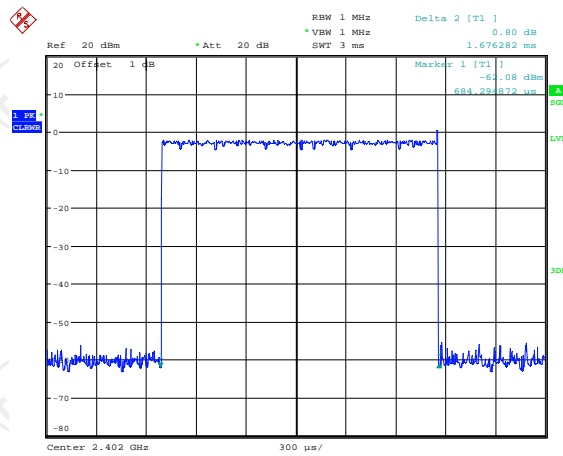

Date: 8.JUN.2017 15:43:47

2-DH5

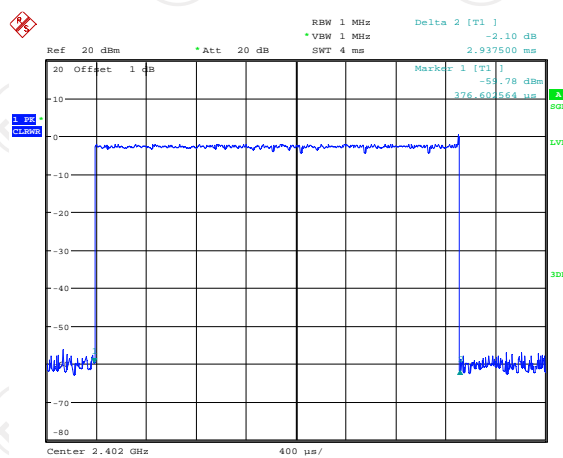

Date: 8.JUN.2017 15:44:19

6.8. Pseudorandom Frequency Hopping Sequence

Test Requirement: FCC Part15 C Section 15.247 (a)(1) requirement:

Frequency hopping systems shall have hopping channel carrier frequencies separated by a minimum of 25 kHz or the 20 dB bandwidth of the hopping channel, whichever is greater.

Alternatively. Frequency hopping systems operating in the 2400-2483.5 MHz band may have hopping channel carrier frequencies that are separated by 25 kHz or two-thirds of the 20 dB bandwidth of the hopping channel, whichever is greater, provided the systems operate with an output power no greater than 125 mW. The system shall hop to channel frequencies that are selected at the system hopping rate from a Pseudorandom ordered list of hopping frequencies. Each frequency must be used equally on the average by each transmitter. The system receivers shall have input bandwidths that match the hopping channel bandwidths of their corresponding transmitters and shall shift frequencies in synchronization with the transmitted signals.

EUT Pseudorandom Frequency Hopping Sequence

The pseudorandom sequence may be generated in a nine-stage shift register whose 5th and 9th stage outputs are added in a modulo-two addition stage. And the result is fed back to the input of the first stage. The sequence begins with the first one of 9 consecutive ones; i.e. the shift register is initialized with nine ones.

- Number of shift register stages: 9
- Length of pseudo-random sequence: $2^9 - 1 = 511$ bits
- Longest sequence of zeros: 8 (non-inverted signal)

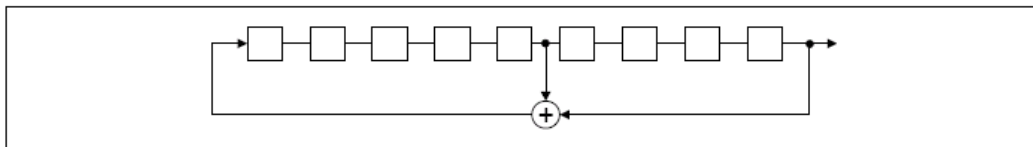

Linear Feedback Shift Register for Generation of the PRBS sequence

An example of Pseudorandom Frequency Hopping Sequence as follow:

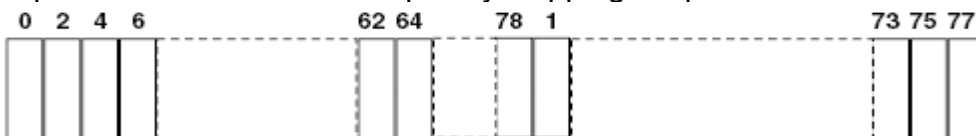

Each frequency used equally on the average by each transmitter. The system receivers have input bandwidths that match the hopping channel bandwidths of their corresponding transmitters and shift frequencies in synchronization with the transmitted signals.

6.9. Conducted Band Edge Measurement

6.9.1. Test Specification

| | |
|--------------------------|---|
| Test Requirement: | FCC Part15 C Section 15.247 (d) |
| Test Method: | ANSI C63.10:2013 |
| Limit: | In any 100 kHz bandwidth outside the intentional radiation frequency band, the radio frequency power shall be at least 20 dB below the highest level of the radiated power. In addition, radiated emissions which fall in the restricted bands must also comply with the radiated emission limits. |
| Test Setup: |  <p style="text-align: center;">Spectrum Analyzer EUT</p> |
| Test Mode: | Transmitting mode with modulation |
| Test Procedure: | <ol style="list-style-type: none"> 1. The testing follows the guidelines in Band-edge Compliance of RF Conducted Emissions of ANSI C63.10:2013 Measurement Guidelines. 2. Set to the maximum power setting and enable the EUT transmit continuously. 3. Set RBW = 100 kHz ($\geq 1\%$ span=10MHz), VBW = 300 kHz (\geqRBW). Band edge emissions must be at least 20 dB down from the highest emission level within the authorized band as measured with a 100kHz RBW. The attenuation shall be 30 dB instead of 20 dB when RMS conducted output power procedure is used. 4. Enable hopping function of the EUT and then repeat step 2 and 3. 5. Measure and record the results in the test report. |
| Test Result: | PASS |

6.9.2. Test Instruments

| RF Test Room | | | | |
|--------------------------|--------------|--------|---------------|-----------------|
| Equipment | Manufacturer | Model | Serial Number | Calibration Due |
| Spectrum Analyzer | R&S | FSU | 200054 | Aug. 11, 2017 |
| RF Cable (9KHz-40GHz) | TCT | RE-06 | N/A | Aug. 12, 2017 |
| Antenna Connector | TCT | RFC-01 | N/A | Aug. 12, 2017 |

Note: The calibration interval of the above test instruments is 12 months and the calibrations are traceable to international system unit (SI).

6.9.3. Test Data

GFSK Modulation

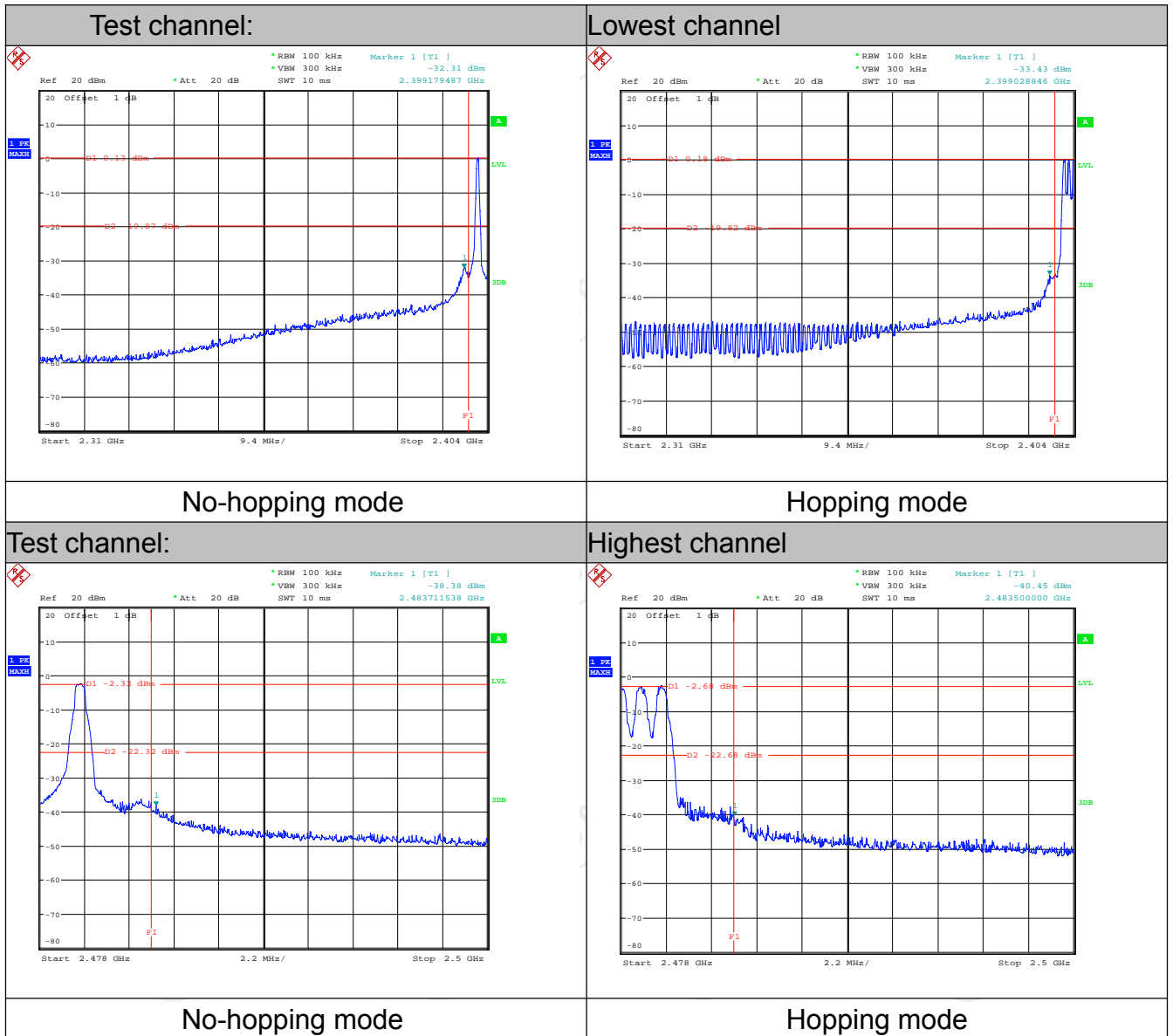

Pi/4DQPSK Modulation

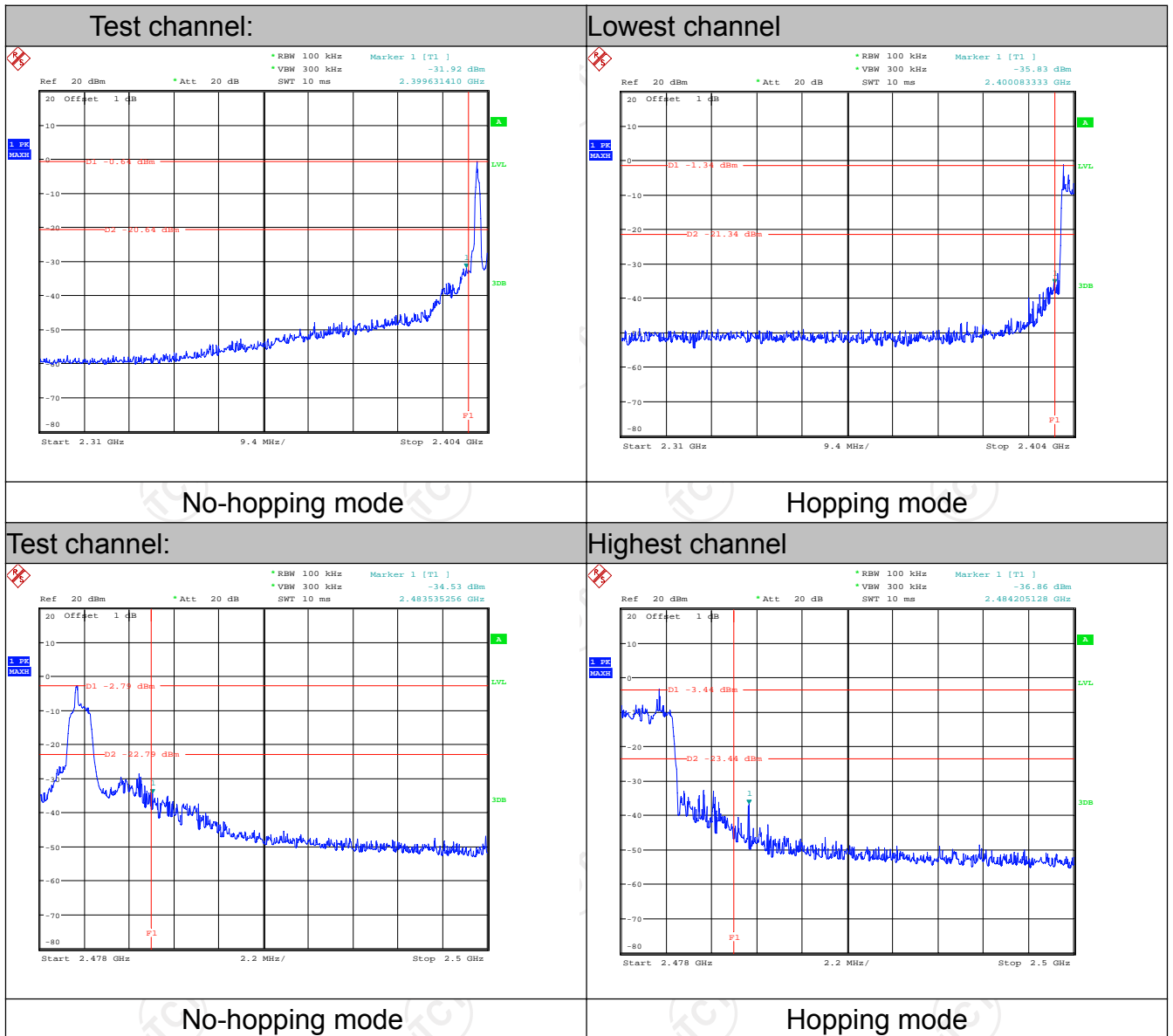

6.10. Conducted Spurious Emission Measurement

6.10.1. Test Specification

| | |
|--------------------------|---|
| Test Requirement: | FCC Part15 C Section 15.247 (d) |
| Test Method: | ANSI C63.10:2013 |
| Limit: | In any 100 kHz bandwidth outside the intentional radiation frequency band, the radio frequency power shall be at least 20 dB below the highest level of the radiated power. In addition, radiated emissions which fall in the restricted bands must also comply with the radiated emission limits. |
| Test Setup: |  <p style="text-align: center;">Spectrum Analyzer EUT</p> |
| Test Mode: | Transmitting mode with modulation |
| Test Procedure: | <ol style="list-style-type: none"> 1. The testing follows the guidelines in Spurious RF Conducted Emissions of ANSI C63.10:2013 Measurement Guidelines 2. The RF output of EUT was connected to the spectrum analyzer by RF cable and attenuator. The path loss was compensated to the results for each measurement. 3. Set to the maximum power setting and enable the EUT transmit continuously. 4. Set RBW = 100 kHz, VBW = 300kHz, scan up through 10th harmonic. All harmonics / spurs must be at least 20 dB down from the highest emission level within the authorized band as measured with a 100 kHz RBW. 5. Measure and record the results in the test report. 6. The RF fundamental frequency should be excluded against the limit line in the operating frequency band. |
| Test Result: | PASS |

6.10.2. Test Instruments

| RF Test Room | | | | |
|--------------------------|--------------|--------|---------------|-----------------|
| Equipment | Manufacturer | Model | Serial Number | Calibration Due |
| Spectrum Analyzer | Agilent | N9020A | MY49100060 | Aug. 12, 2017 |
| RF Cable (9KHz-40GHz) | TCT | RE-06 | N/A | Aug. 12, 2017 |
| Antenna Connector | TCT | RFC-01 | N/A | Aug. 12, 2017 |

Note: The calibration interval of the above test instruments is 12 months and the calibrations are traceable to international system unit (SI).

6.10.3. Test Data

GFSK mode

Lowest Channel

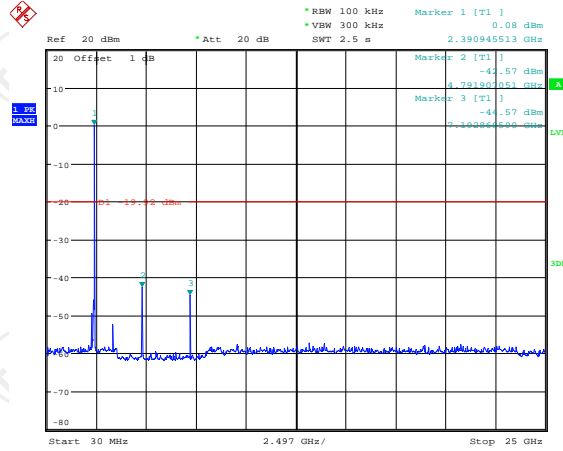

Date: 8.JUN.2017 16:23:05

Middle Channel

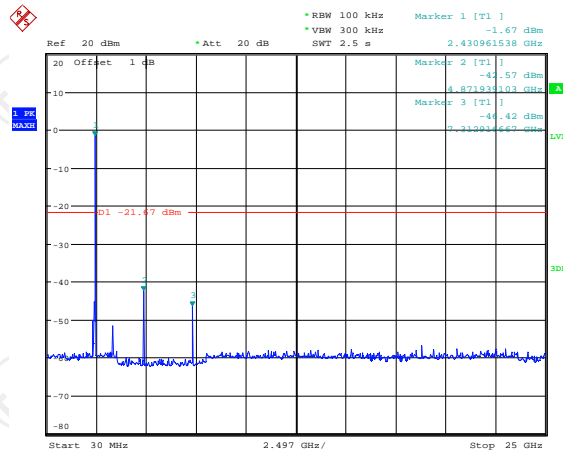

Date: 8.JUN.2017 16:24:19

Highest Channel

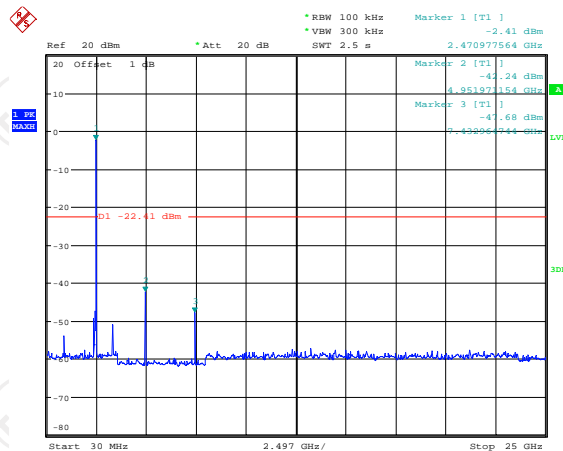

Date: 8.JUN.2017 16:26:23

Pi/4DQPSK mode

Lowest Channel

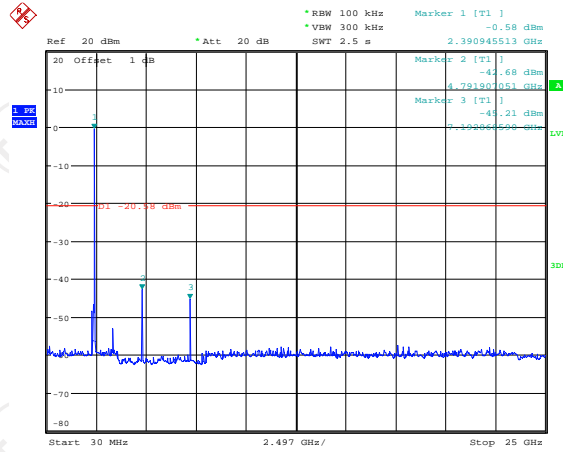

Date: 8.JUN.2017 16:30:26

Middle Channel

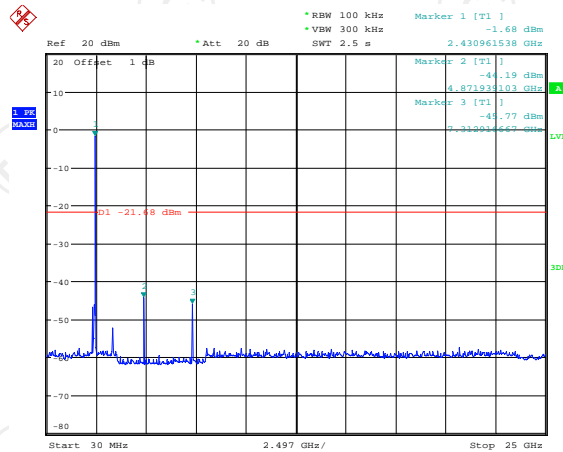

Date: 8.JUN.2017 16:29:44

Highest Channel

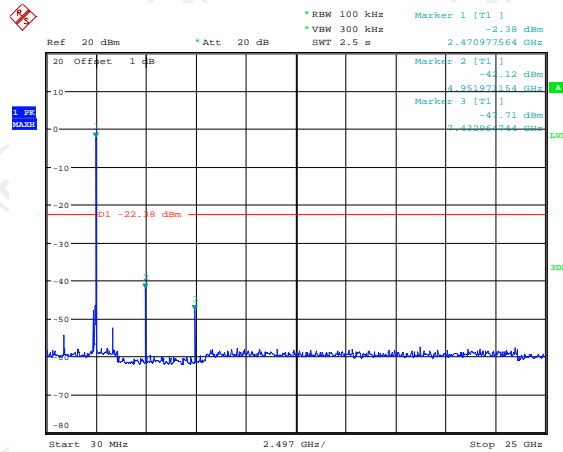

Date: 8.JUN.2017 16:28:04

6.11. Radiated Spurious Emission Measurement

6.11.1. Test Specification

| | | | | | | |
|------------------------------|---|------------|-----------------------------------|--------|-------------------------------|----------|
| Test Requirement: | FCC Part15 C Section 15.209 | | | | | |
| Test Method: | ANSI C63.10:2013 | | | | | |
| Frequency Range: | 9 kHz to 25 GHz | | | | | |
| Measurement Distance: | 3 m | | | | | |
| Antenna Polarization: | Horizontal & Vertical | | | | | |
| Receiver Setup: | Frequency | Detector | RBW | VBW | Remark | |
| | 9kHz- 150kHz | Quasi-peak | 200Hz | 1kHz | Quasi-peak Value | |
| | 150kHz- 30MHz | Quasi-peak | 9kHz | 30kHz | Quasi-peak Value | |
| | 30MHz-1GHz | Quasi-peak | 100KHz | 300KHz | Quasi-peak Value | |
| | Above 1GHz | Peak | 1MHz | 3MHz | Peak Value | |
| | | Peak | 1MHz | 10Hz | Average Value | |
| Limit: | Frequency | | Field Strength (microvolts/meter) | | Measurement Distance (meters) | |
| | 0.009-0.490 | | 2400/F(KHz) | | 300 | |
| | 0.490-1.705 | | 24000/F(KHz) | | 30 | |
| | 1.705-30 | | 30 | | 30 | |
| | 30-88 | | 100 | | 3 | |
| | 88-216 | | 150 | | 3 | |
| | 216-960 | | 200 | | 3 | |
| | Above 960 | | 500 | | 3 | |
| | Frequency | | Field Strength (microvolts/meter) | | Measurement Distance (meters) | Detector |
| | Above 1GHz | | 500 | | 3 | Average |
| | | 5000 | | 3 | Peak | |
| Test setup: | For radiated emissions below 30MHz | | | | | |
| | <p>Distance = 3m</p> <p>EUT</p> <p>Turn table</p> <p>Ground Plane</p> <p>Computer</p> <p>Pre -Amplifier</p> <p>Receiver</p> | | | | | |
| 30MHz to 1GHz | | | | | | |

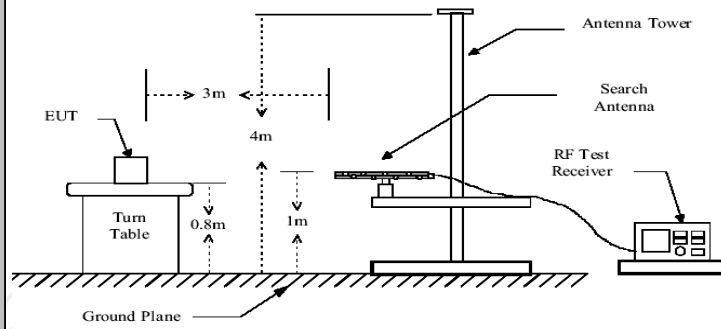

Above 1GHz

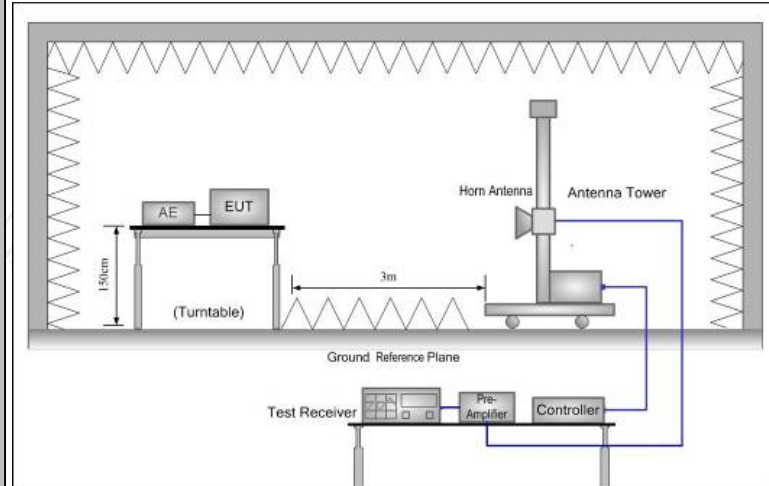

Test Mode:

Transmitting mode with modulation

Test Procedure:

1. The testing follows the guidelines in Spurious Radiated Emissions of ANSI C63.10:2013 Measurement Guidelines.
2. For the radiated emission test below 1GHz:
The EUT was placed on a turntable with 0.8 meter above ground. The EUT was set 3 meters from the interference receiving antenna, which was mounted on the top of a variable height antenna tower. The EUT was arranged to its worst case and then tune the antenna tower (from 1 m to 4 m) and turntable (from 0 degree to 360 degrees) to find the maximum reading. A pre-amp and a high PASS filter are used for the test in order to get better signal level.
- For the radiated emission test above 1GHz:
Place the measurement antenna on a turntable with 1.5 meter above ground, which is away from each area of the EUT determined to be a source of emissions at the specified measurement distance, while keeping the measurement antenna aimed at the source of emissions at each frequency of significant emissions, with polarization oriented for maximum response. The measurement antenna may have to be higher or lower than the EUT,

| | |
|----------------------|--|
| | <p>depending on the radiation pattern of the emission and staying aimed at the emission source for receiving the maximum signal. The final measurement antenna elevation shall be that which maximizes the emissions. The measurement antenna elevation for maximum emissions shall be restricted to a range of heights of from 1 m to 4 m above the ground or reference ground plane.</p> <p>3. Set to the maximum power setting and enable the EUT transmit continuously.</p> <p>4. Use the following spectrum analyzer settings:</p> <p>(1) Span shall wide enough to fully capture the emission being measured;</p> <p>(2) Set RBW=100 kHz for $f < 1$ GHz, RBW=1MHz for $f > 1$GHz ; VBW\geqRBW; Sweep = auto; Detector function = peak; Trace = max hold for peak</p> <p>(3) For average measurement: use duty cycle correction factor method per 15.35(c). Duty cycle = On time/100 milliseconds On time = $N_1 * L_1 + N_2 * L_2 + \dots + N_{n-1} * L_{n-1} + N_n * L_n$ Where N_1 is number of type 1 pulses, L_1 is length of type 1 pulses, etc. Average Emission Level = Peak Emission Level + $20 * \log(\text{Duty cycle})$</p> <p>Corrected Reading: Antenna Factor + Cable Loss + Read Level - Preamp Factor = Level</p> |
| Test results: | PASS |

6.11.2. Test Instruments

| Radiated Emission Test Site (966) | | | | |
|-----------------------------------|------------------------------------|------------|---------------|-----------------|
| Name of Equipment | Manufacturer | Model | Serial Number | Calibration Due |
| ESPI Test Receiver | ROHDE&SCHWARZ | ESVD | 100008 | Aug. 11, 2017 |
| Spectrum Analyzer | ROHDE&SCHWARZ | FSEM | 848597/001 | Aug. 11, 2017 |
| Spectrum Analyzer | Agilent | N9020A | MY49100060 | Aug. 12, 2017 |
| Pre-amplifier | EM Electronics Corporation CO.,LTD | EM30265 | 07032613 | Aug. 11, 2017 |
| Pre-amplifier | HP | 8447D | 2727A05017 | Aug. 11, 2017 |
| Loop antenna | ZHINAN | ZN30900A | 12024 | Aug. 13, 2017 |
| Broadband Antenna | Schwarzbeck | VULB9163 | 340 | Aug. 13, 2017 |
| Horn Antenna | Schwarzbeck | BBHA 9120D | 631 | Aug. 13, 2017 |
| Horn Antenna | Schwarzbeck | BBHA 9170 | 373 | Aug. 13, 2017 |
| Antenna Mast | CCS | CC-A-4M | N/A | N/A |
| Coax cable (9KHz-40GHz) | TCT | RE-low-01 | N/A | Aug. 11, 2017 |
| Coax cable (9KHz-40GHz) | TCT | RE-high-02 | N/A | Aug. 11, 2017 |
| Coax cable (9KHz-40GHz) | TCT | RE-low-03 | N/A | Aug. 11, 2017 |
| Coax cable (9KHz-40GHz) | TCT | RE-high-04 | N/A | Aug. 11, 2017 |
| EMI Test Software | Shurple Technology | EZ-EMC | N/A | N/A |

Note: The calibration interval of the above test instruments is 12 months and the calibrations are traceable to international system unit (SI).

6.11.3. Test Data

Duty cycle correction factor for average measurement

DH5 on time (One Pulse) Plot on Channel 00

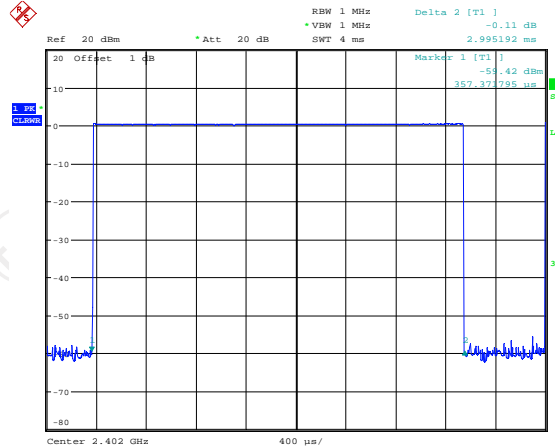

Date: 8.JUN.2017 15:44:47

DH5 on time (Count Pulses) Plot on Channel 00

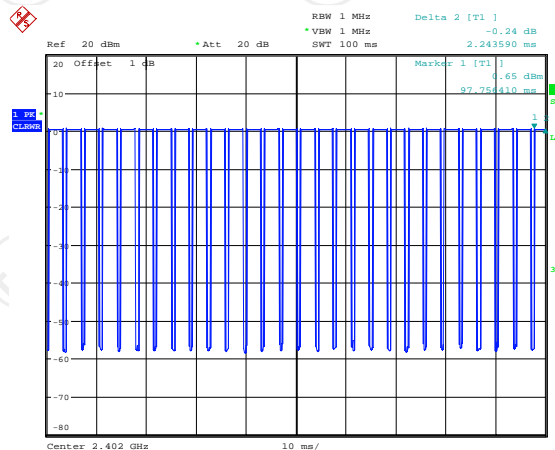

Date: 8.JUN.2017 15:52:02

Note:

1. Worst case Duty cycle = on time/100 milliseconds = $(2.995 \times 27 + 2.244) / 100 = 0.77$
2. Worst case Duty cycle correction factor = $20 \times \log(\text{Duty cycle}) = -1.61\text{dB}$
3. DH5 has the highest duty cycle worst case and is reported.
4. The average levels were calculated from the peak level corrected with duty cycle correction factor (-2.27dB) derived from $20 \log(\text{dwell time}/100\text{ms})$. This correction is only for signals that hop with the fundamental signal, such as band-edge and harmonic. Other spurious signals that are independent of the hopping signal would not use this correction.

Please refer to following diagram for individual

Below 1GHz

Horizontal:

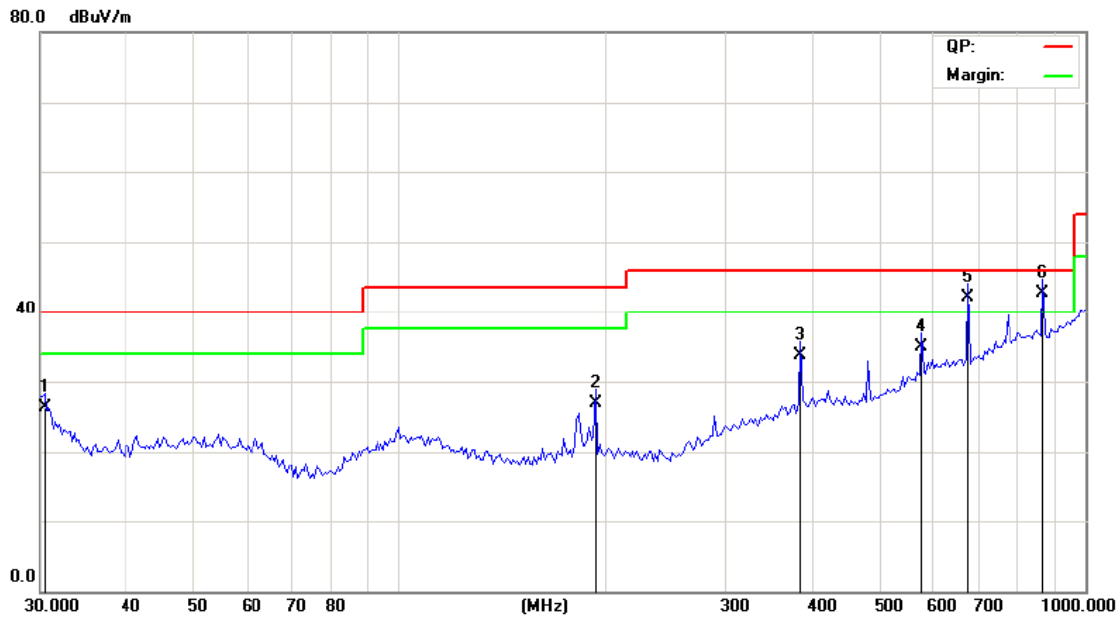

Site Chamber

Polarization: **Horizontal**

Temperature: 25 (C)

Limit: FCC Part 15B Class B 3M Radiation

Power: AC 120V/60Hz

Humidity: 55 %

| No. | Mk. | Freq. MHz | Reading Level dBuV | Correct Factor dB | Measure- ment dBuV/m | Limit dBuV/m | Over dB | Detector | Comment |
|-----|-----|--------------|--------------------------|-------------------------|----------------------------|-----------------|------------|----------|---------|
| 1 | | 30.4246 | 34.21 | -7.98 | 26.23 | 40.00 | -13.77 | QP | |
| 2 | | 193.1365 | 36.06 | -9.25 | 26.81 | 43.50 | -16.69 | QP | |
| 3 | | 384.5447 | 35.71 | -2.05 | 33.66 | 46.00 | -12.34 | QP | |
| 4 | | 578.0359 | 33.52 | 1.45 | 34.97 | 46.00 | -11.03 | QP | |
| 5 | ! | 674.6768 | 38.79 | 3.33 | 42.12 | 46.00 | -3.88 | QP | |
| 6 | * | 868.8858 | 36.19 | 6.58 | 42.77 | 46.00 | -3.23 | QP | |

Above 1GHz

| Modulation Type: GFSK | | | | | | | | | |
|-----------------------|---------------|---------------------------|-------------------------|--------------------------|---------------------|-------------------|---------------------------|-------------------------|-------------|
| Low channel: 2402 MHz | | | | | | | | | |
| Frequency (MHz) | Ant. Pol. H/V | Peak reading (dB μ V) | AV reading (dB μ V) | Correction Factor (dB/m) | Emission Level | | Peak limit (dB μ V/m) | AV limit (dB μ V/m) | Margin (dB) |
| | | | | | Peak (dB μ V/m) | AV (dB μ V/m) | | | |
| 2390 | H | 45.94 | --- | -8.27 | 37.67 | --- | 74 | 54 | -16.33 |
| 4804 | H | 50.34 | --- | 0.66 | 51.00 | --- | 74 | 54 | -3.00 |
| 7206 | H | 39.78 | --- | 9.50 | 49.28 | --- | 74 | 54 | -4.72 |
| --- | H | --- | --- | --- | --- | --- | --- | --- | --- |
| 2390 | V | 46.12 | --- | -8.27 | 37.85 | --- | 74 | 54 | -16.15 |
| 4804 | V | 49.57 | --- | 0.66 | 50.23 | --- | 74 | 54 | -3.77 |
| 7206 | V | 39.24 | --- | 9.50 | 48.74 | --- | 74 | 54 | -5.26 |
| --- | V | --- | --- | --- | --- | --- | --- | --- | --- |

| Middle channel: 2441 MHz | | | | | | | | | |
|--------------------------|---------------|---------------------------|-------------------------|--------------------------|---------------------|-------------------|---------------------------|-------------------------|-------------|
| Frequency (MHz) | Ant. Pol. H/V | Peak reading (dB μ V) | AV reading (dB μ V) | Correction Factor (dB/m) | Emission Level | | Peak limit (dB μ V/m) | AV limit (dB μ V/m) | Margin (dB) |
| | | | | | Peak (dB μ V/m) | AV (dB μ V/m) | | | |
| 4882 | H | 48.67 | --- | 0.99 | 49.66 | --- | 74 | 54 | -4.34 |
| 7323 | H | 40.27 | --- | 9.87 | 50.14 | --- | 74 | 54 | -3.86 |
| --- | H | --- | --- | --- | --- | --- | --- | --- | --- |
| 4882 | V | 49.31 | --- | 0.99 | 50.30 | --- | 74 | 54 | -3.70 |
| 7323 | V | 40.17 | --- | 9.87 | 50.04 | --- | 74 | 54 | -3.96 |
| --- | V | --- | --- | --- | --- | --- | --- | --- | --- |

| High channel: 2480 MHz | | | | | | | | | |
|------------------------|---------------|---------------------------|-------------------------|--------------------------|---------------------|-------------------|---------------------------|-------------------------|-------------|
| Frequency (MHz) | Ant. Pol. H/V | Peak reading (dB μ V) | AV reading (dB μ V) | Correction Factor (dB/m) | Emission Level | | Peak limit (dB μ V/m) | AV limit (dB μ V/m) | Margin (dB) |
| | | | | | Peak (dB μ V/m) | AV (dB μ V/m) | | | |
| 2483.5 | H | 47.34 | --- | -7.83 | 39.51 | --- | 74 | 54 | -14.49 |
| 4960 | H | 49.52 | --- | 1.33 | 50.85 | --- | 74 | 54 | -3.15 |
| 7440 | H | 39.33 | --- | 10.22 | 49.55 | --- | 74 | 54 | -4.45 |
| --- | H | --- | --- | --- | --- | --- | --- | --- | --- |
| 2483.5 | V | 46.89 | --- | -7.83 | 39.06 | --- | 74 | 54 | -14.94 |
| 4960 | V | 49.43 | --- | 1.33 | 50.76 | --- | 74 | 54 | -3.24 |
| 7440 | V | 39.62 | --- | 10.22 | 49.84 | --- | 74 | 54 | -4.16 |
| --- | V | --- | --- | --- | --- | --- | --- | --- | --- |

Note:

1. Emission Level=Peak Reading + Correction Factor; Correction Factor= Antenna Factor + Cable loss – Pre-amplifier
2. Margin (dB) = Emission Level (Peak) (dB μ V/m)-Average limit (dB μ V/m)
3. The emission levels of other frequencies are very lower than the limit and not show in test report.
4. Measurements were conducted from 1 GHz to the 10th harmonic of highest fundamental frequency.
5. Data of measurement shown "----" in the above table mean that the reading of emissions is attenuated more than 20 dB below the limits or the field strength is too small to be measured.
6. Measurements were conducted in all three modulation (GFSK, Pi/4 DQPSK), and the worst case Mode (GFSK) was submitted only.

Appendix A: Photographs of Test Setup

Product: Sound Boom Bluetooth Speaker

Model: BS503B

Radiated Emission

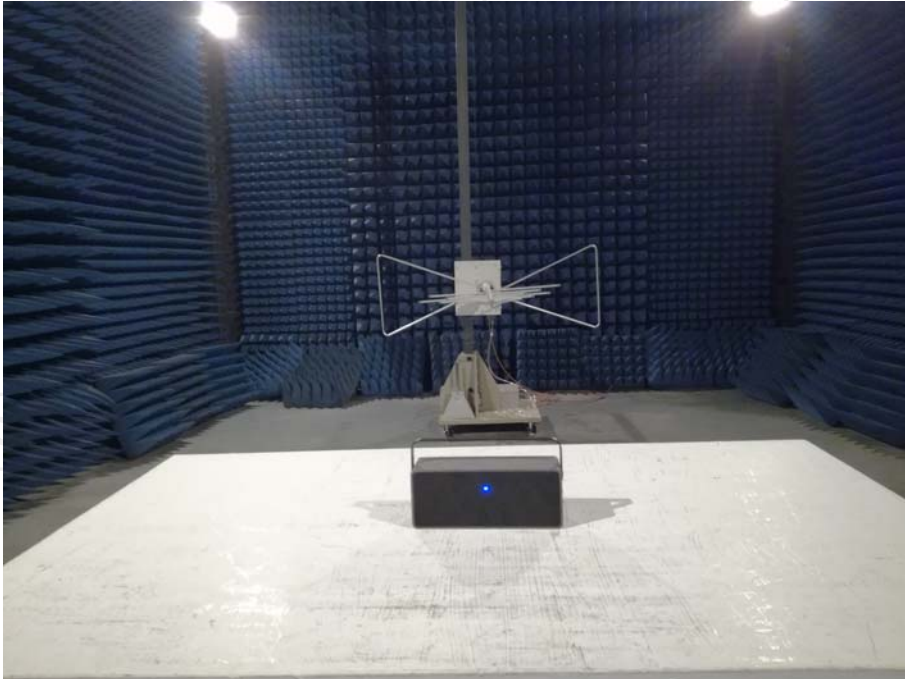

Conducted Emission



Appendix B: Photographs of EUT
Product: Sound Boom Bluetooth Speaker
Model: BS503B
External Photos

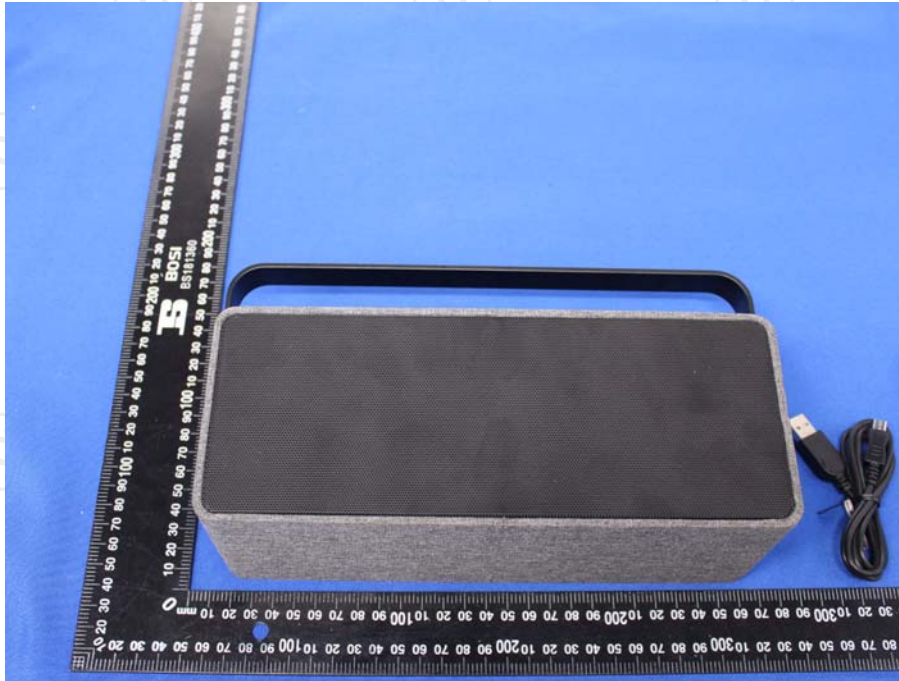

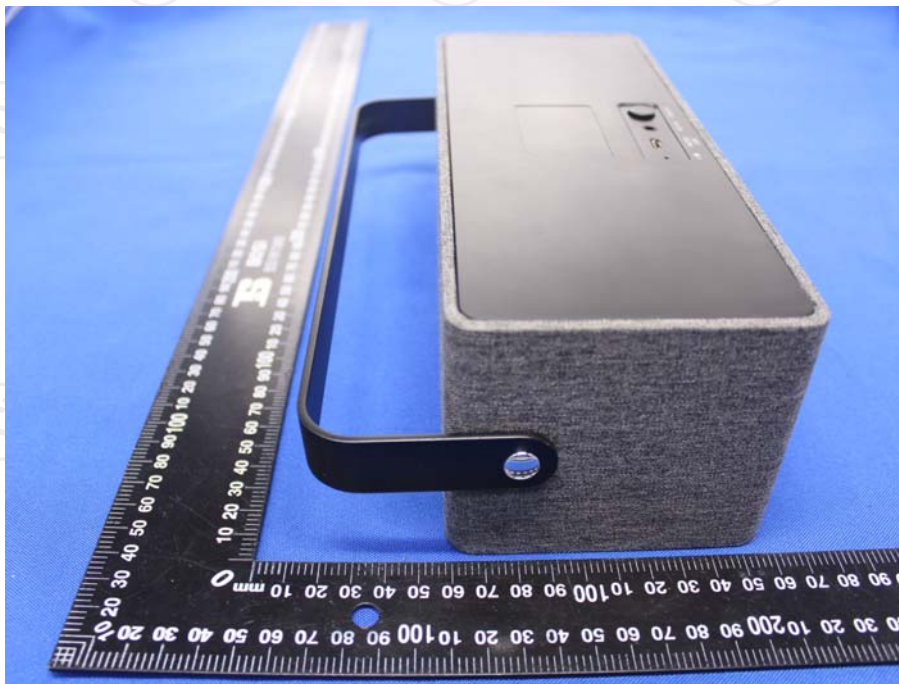

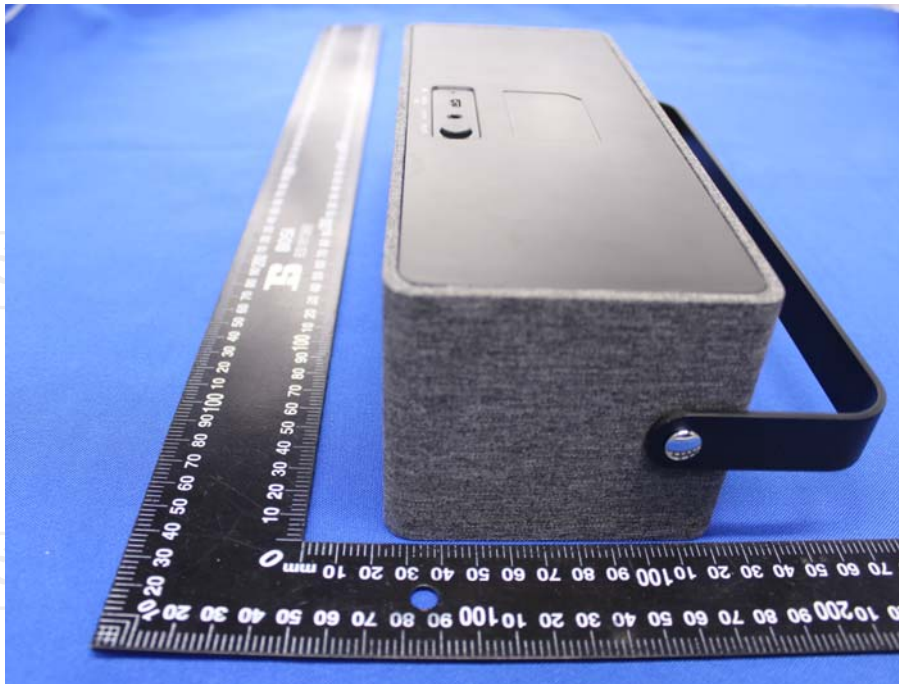

Model: BS503B
Internal Photos

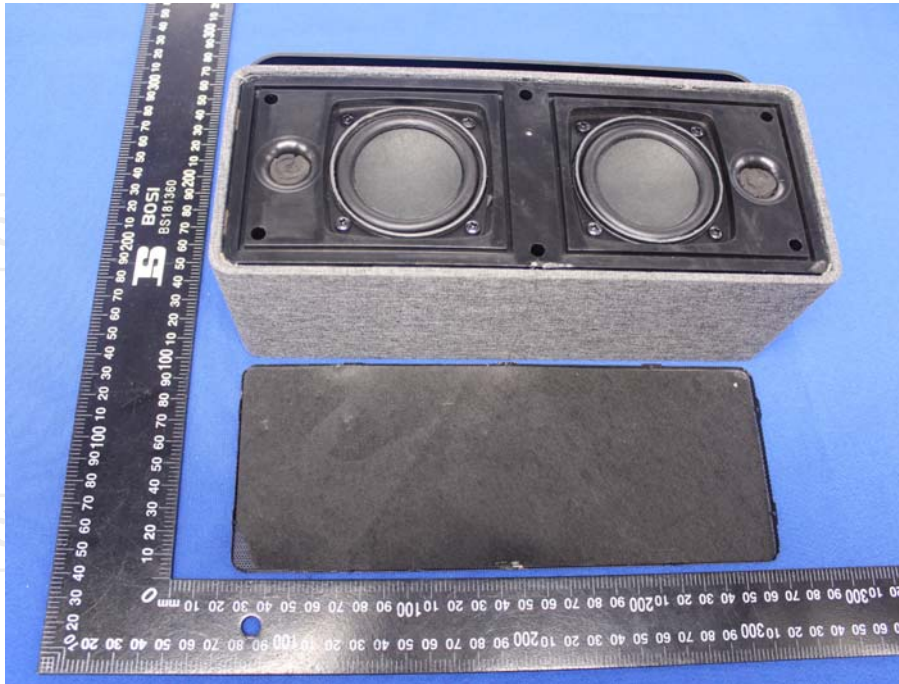

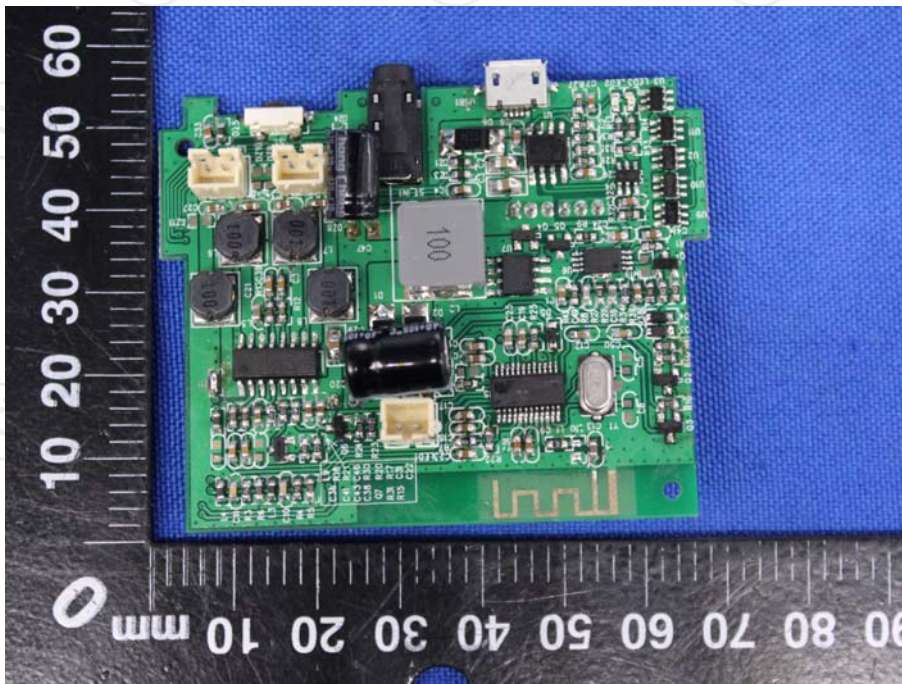

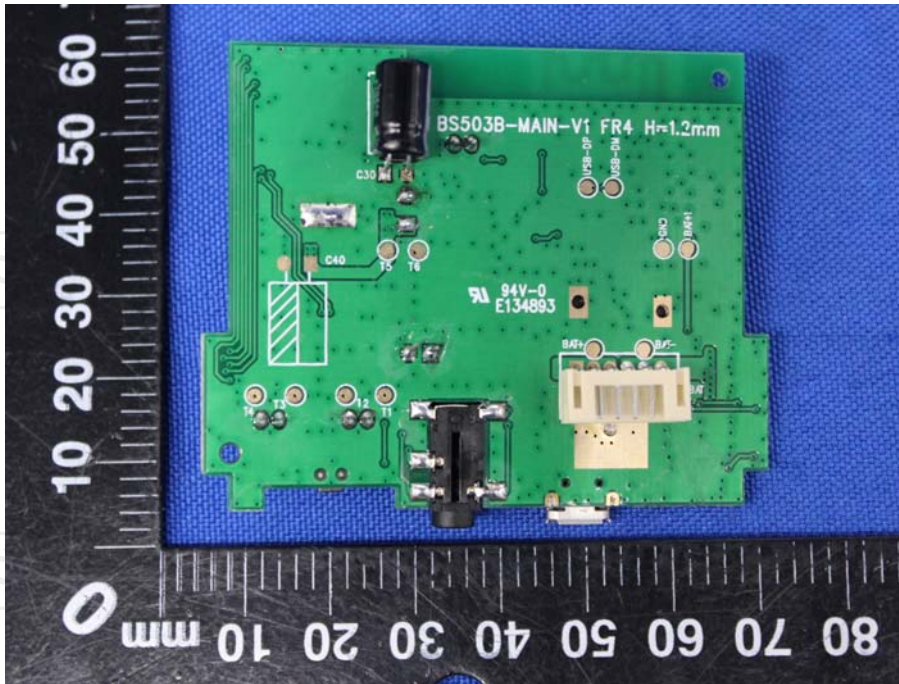

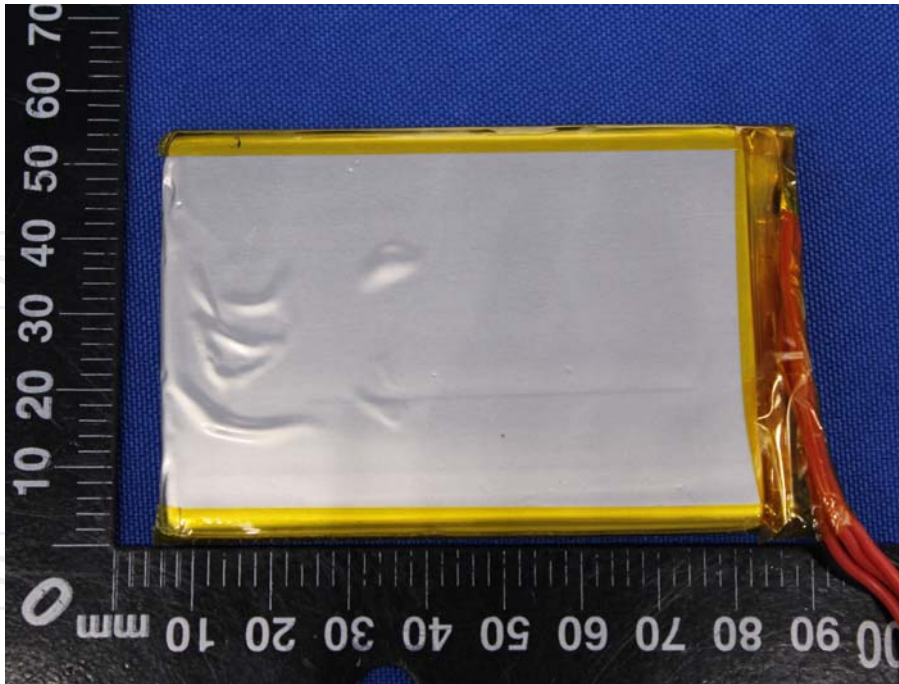

*******END OF REPORT*******