



EMC TEST REPORT

According to

47 CFR, Part 15B, CISPR PUB. 22

Applicant : Suzhou Switek Electronics&Technology Co, Ltd.
Address : No.86, South WuSong Road, Luzhi Town, Wuzhong
District, Suzhou City.
Equipment : Desktop kvm switch
Model No. : AS-41UA , AS-21UA
FCC ID : ZQXAS-41UA

I HEREBY CERTIFY THAT :

The sample was received on Mar. 14, 2019 and the testing was carried out on Apr. 05, 2019 at CerpPASS Technology Corp. The test result refers exclusively to the test presented test model / sample. Without written approval of CerpPASS Technology Corp., the test report shall not be reproduced except in full.

Approved by:

Miro Chueh
EMC/RF B.U. Manager



EMC TEST REPORT

Issued by:

CerpPASS Technology (Suzhou) Co.,Ltd

No.66,Tangzhuang Road, Suzhou Industrial Park, Jiangsu 215006, China

Tel:+86-512-6917-5888

Fax:+86-512-6917-5666

The test record, data evaluation & Equipment. Under Test configurations represented herein are true and accurate accounts of the measurements of the samples EMC characteristics under the conditions specified in this report.



Contents

1. Summary of Test Procedure and Test Result.....	5
1.1. Applicable Standards	5
2. Test Configuration of Equipment under Test	6
2.1. Feature of Equipment under Test.....	6
2.2. Test Manner	7
2.3. Description of Test System.....	8
2.4. Connection Diagram of Test System.....	9
2.5. General Information of Test.....	10
2.6. Measurement Uncertainty	11
3. Test of Conducted Emission.....	12
3.1. Test Limit	12
3.2. Test Procedures	12
3.3. Typical test Setup.....	13
3.4. Measurement Equipment.....	14
3.5. Test Result and Data.....	15
4. Test of Radiated Emission	23
4.1. Test Limit	23
4.2. Test Procedures	24
4.3. Typical test Setup.....	26
4.4. Measurement Equipment.....	27
4.5. Test Result and Data (30MHz~1GHz).....	28
4.6. Test Result and Data (1GHz ~18GHz).....	36



1. Summary of Test Procedure and Test Result

1.1. Applicable Standards

The measurements shown in this test report were made in accordance with the procedures given in ANSI C63.4 – 2014 and the energy emitted by this equipment was passed 47 CFR, Part 15B, CISPR PUB. 22.

The energy emitted by this equipment was passed both Radiated and Conducted Emissions Class B limits.

Test Item	Normative References	Test Result
Conducted Emission	ANSI C63.4-2014 FCC Part 15 Subpart B	PASS
Radiated Emission	ANSI C63.4-2014 FCC Part 15 Subpart B	PASS



2. Test Configuration of Equipment under Test

2.1. Feature of Equipment under Test

Product Name:	Desktop kvm switch
Model Name:	AS-41UA · AS-21UA
Remark:	They are similar except for model name and the number of ports.

Note: Please refer to user manual.



2.2. Test Manner

- a. During testing, the interface cables and equipment positions were varied according to ANSI C63.4.
- b. Turn on the power of all equipment.
- c. The complete test system included PC, USB Keyboard, USB Mouse, Monitor, Earphone, U disk and EUT for EMI test.
- d. The test mode as follow:
 - Mode 1 Full system work signal from PORT1 for AS-41UA with Adapter (120V/60Hz)
 - Mode 2 Full system work signal from PORT2 for AS-41UA with Adapter (120V/60Hz)
 - Mode 3 Full system work signal from PORT3 for AS-41UA with Adapter (120V/60Hz)
 - Mode 4 Full system work signal from PORT4 for AS-41UA with Adapter (120V/60Hz)
 - Mode 5 Full system work signal from PORT1 for AS-41UA (120V/60Hz)
 - Mode 6 Full system work signal from PORT2 for AS-41UA (120V/60Hz)
 - Mode 7 Full system work signal from PORT3 for AS-41UA (120V/60Hz)
 - Mode 8 Full system work signal from PORT4 for AS-41UA (120V/60Hz)The “Test Mode 5, 6,7,8” were reported as final data.
- e. The maximum operating frequency is above 108MHz, the test frequency range is from 30MHz to 18GHz.



2.3. Description of Test System

No.	Device	Manufacturer	Model No.	Description
1	PC	HP	HP Compaq Elite 8200 MTPC	Non-Shielded ,1.8m
2	USB Keyboard	DELL	SK-8115	T3A002
3	USB Mouse	DELL	G0K02XYK	R41108
4	Monitor	Philips	BDM3275UP	N/A
5	Earphone	SALAR	V18	N/A
6	U disk	Kingston	N/A	N/A



2.4. Connection Diagram of Test System

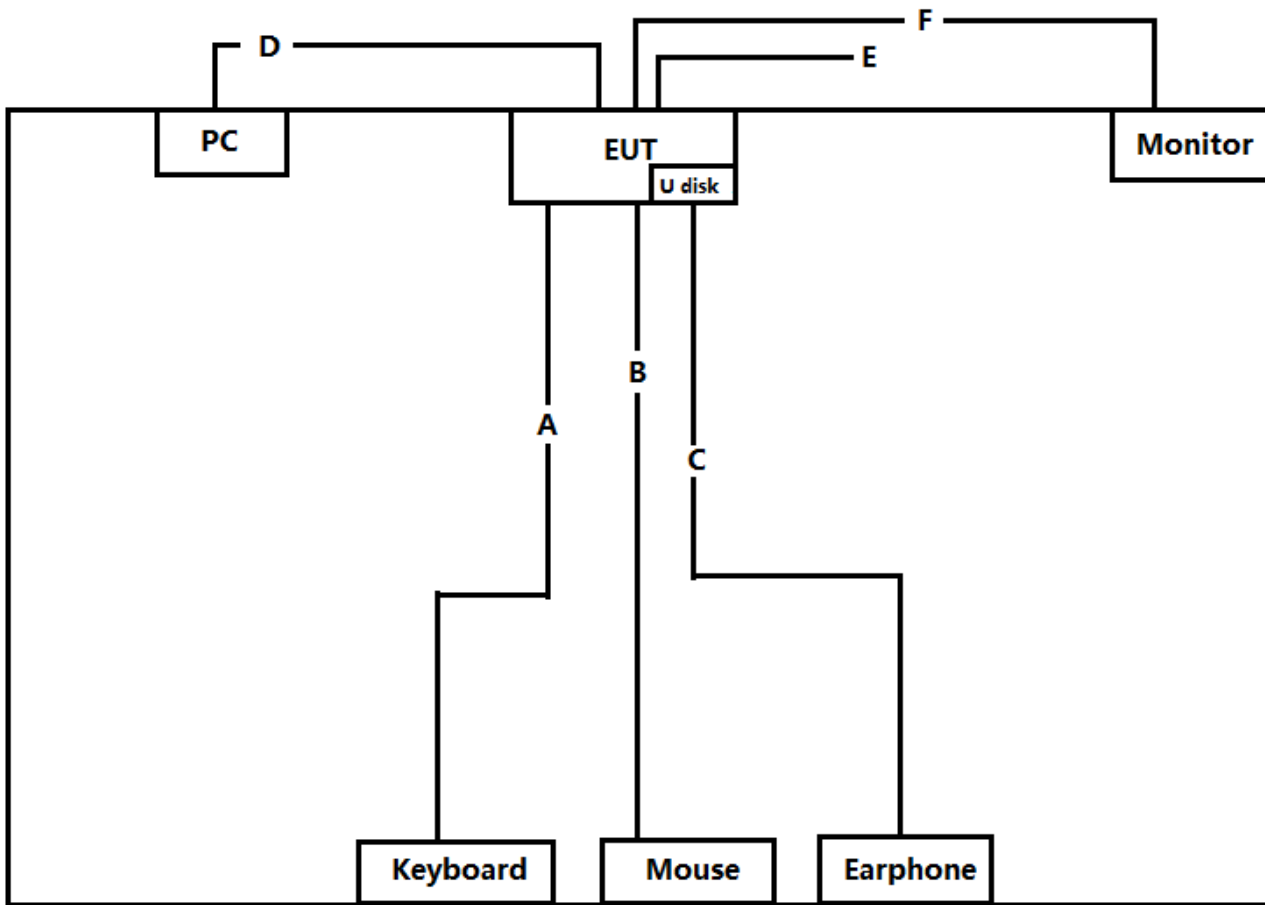

Use Cable:

No	Cable	Quantity	Description
A	USB Cable	1	Non-Shielded, 1.5m
B	USB Cable	1	Non-Shielded, 1.8m
C	Audio Cable	1	Non-Shielded, 1.5m
D	VGA Cable	1	Non-Shielded, 1.8m
E	VGA Cable	3	Non-Shielded, 1.8m
F	VGA Cable	1	Non-Shielded, 1.8m



2.5. General Information of Test

<input checked="" type="checkbox"/> Test Site	CerpPASS Technology (Suzhou) Co.,Ltd Address: No.66,Tangzhuang Road, Suzhou Industrial Park, Jiangsu 215006, China Tel: +86-512-6917-5888 Fax: +86-512-6917-5666	
	CNAS	L5515
	FCC	CN1243
	A2LA	4981.01
	IC	7920A-1, 7920A-2
	VCCI	T-1945 for Telecommunication Test C-2919 for Conducted emission test R-2670 for Radiated emission test G-227 for radiated disturbance above 1GHz



2.6. Measurement Uncertainty

Where relevant, the following measurement uncertainty levels have been estimated for tests performed on the EUT as specified in CISPR 16-4-2:

Measurement	Frequency	Uncertainty
Conducted emissions(LINE)	9KHz-30MHz	+/- 0.6847dB
Conducted emissions(NEUTRAL)	9KHz-30MHz	+/- 0.6763dB

Measurement	Polarity	Frequency	Uncertainty
Radiated emissions (below 1GHz)	H	30MHz ~ 200MHz	+/- 4.0702dB
		200MHz ~1000MHz	+/- 3.9158dB
	V	30MHz ~ 200MHz	+/- 4.0704dB
		200MHz ~1000MHz	+/- 3.9167dB
Radiated emissions (above 1GHz)	H	1000MHz ~18000MHz	+/- 3.8864dB
		18000MHz ~40000MHz	+/-3.9314dB
	V	1000MHz ~18000MHz	+/- 3.8896dB
		18000MHz ~40000MHz	+/- 3.8766dB

This uncertainty represents an expanded uncertainty expressed at approximately the 95% confidence level using a coverage factor of k=2.



3. Test of Conducted Emission

3.1. Test Limit

Conducted Emissions were measured from 150 kHz to 30 MHz with a bandwidth of 9 KHz on the 120 VAC power and return leads of the EUT according to the methods defined in ANSI C63.4-2014. The EUT was placed on a nonmetallic stand in a shielded room 0.8 meters above the ground plane as shown in ANSI C63.4-2014. The interface cables and equipment positioning were varied within limits of reasonable applications to determine the position produced maximum conducted emissions.

Conducted Emission Limits:

Frequency (MHz)	Quasi Peak (dB μ V)	Average (dB μ V)
0.15 – 0.5	66-56*	56-46*
0.5 – 5.0	56	46
5.0 – 30.0	60	50

3.2. Test Procedures

- a. The EUT was placed 0.4 meter from the conducting wall of the shielding room was kept at least 80 centimeters from any other grounded conducting surface.
- b. Connect EUT to the power mains through a line impedance stabilization network (LISN).
- c. All the support units are connecting to the other LISN.
- d. The LISN provides 50 ohm coupling impedance for the measuring instrument.
- e. The FCC states that a 50 ohm, 50 micro-Henry LISN should be used.
- f. Both sides of AC line were checked for maximum conducted interference.
- g. The frequency range from 150 kHz to 30 MHz was searched.
- h. Set the test-receiver system to Peak Detect Function and Specified Bandwidth with Maximum Hold Mode.



3.3. Typical test Setup

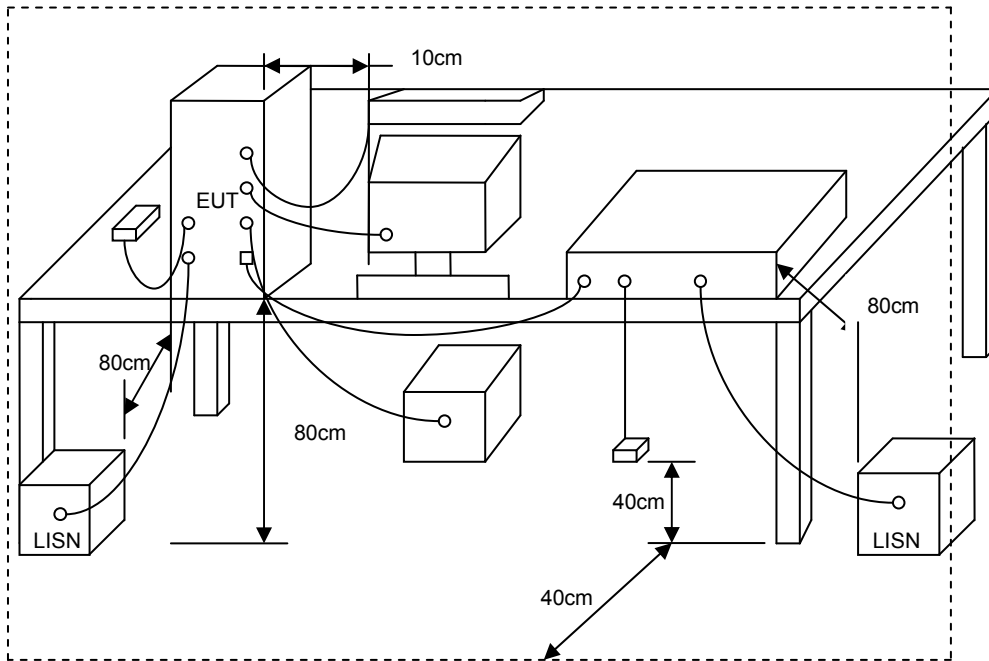



3.4. Measurement Equipment

Instrument/Ancillary	Manufacturer	Model No.	Serial No.	Calibration Date	Valid Date.
Test Receiver	R&S	ESCI	100565	2018.07.18	2019.07.17
AMN	R&S	ESH2-Z5	100182	2018.08.25	2019.08.24
ISN	FCC	FCC-TLISN-T2-02	20379	2019.03.11	2020.03.10
ISN	FCC	FCC-TLISN-T4-02	20380	2018.06.14	2019.06.13
ISN	SCHWARZBECK	T8 CAT6	173	2018.07.18	2019.07.17
ISN	TESEQ	ISN ST08	30175	2018.08.25	2019.08.24
ISN	TESEQ	ISN S751	31531	2018.08.25	2019.08.24
LISN	FCC	FCC-LISN-50-200-2-02	112087	2018.08.25	2019.08.24
LISN	SCHWARZBECK	NSLK 8127	8127-920	2018.08.25	2019.08.24
LISN	R&S	ENV216	100325	2018.08.25	2019.08.24
Current Probe	R&S	EZ-17	100303	2019.03.17	2020.03.16
Passive Voltage Probe	R&S	ESH2-Z3	100026	2019.03.17	2020.03.16
Pulse Limiter	R&S	ESH3-Z2	100529	2019.03.11	2020.03.10
Temperature/ Humidity Meter	Zhicheng	ZC1-11	CEP-TH-004	2019.03.17	2020.03.16
EZ-EMC	Fala	Ver CT3A1	N/A	N/A	N/A



3.5. Test Result and Data

Test Mode :	Mode 5: Full system work signal from PORT1 for AS-41UA (120V/60Hz)		
AC Power :	AC 120V/60Hz	Phase :	LINE
Temperature :	25°C	Humidity :	52%
Pressure(mbar) :	1002	Date:	2019/04/03

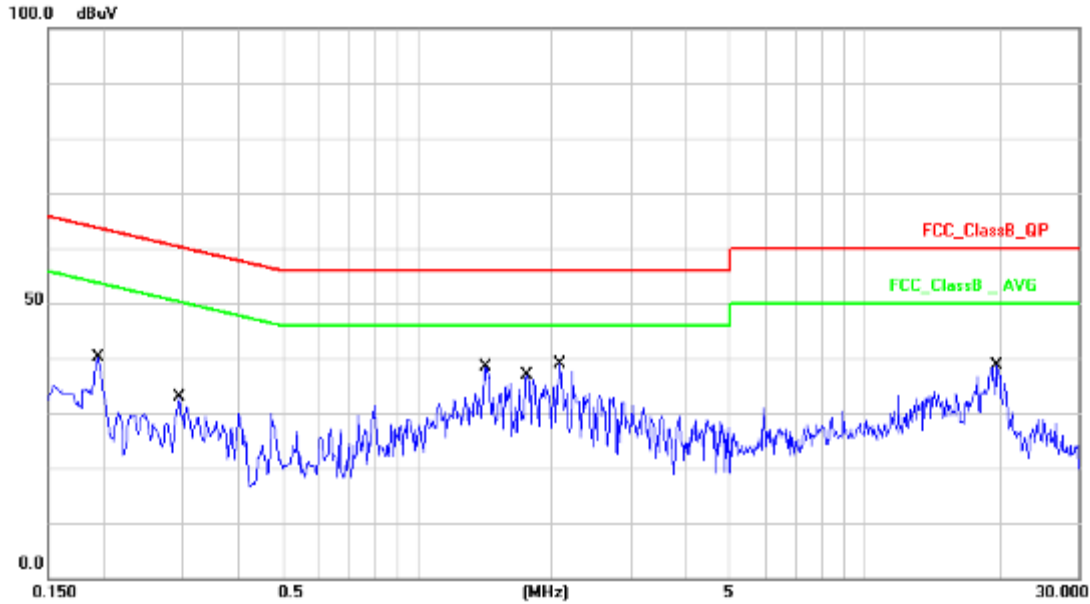

No.	Frequency (MHz)	Factor (dB)	Reading (dBuV)	Level (dBuV)	Limit (dBuV)	Margin (dB)	Detector
1	0.1944	10.13	27.38	37.51	63.84	-26.33	QP
2	0.1944	10.13	23.41	33.54	53.84	-20.30	AVG
3	0.2939	10.14	12.31	22.45	60.41	-37.96	QP
4	0.2939	10.14	5.51	15.65	50.41	-34.76	AVG
5	1.4256	10.17	8.48	18.65	56.00	-37.35	QP
6	1.4256	10.17	1.50	11.67	46.00	-34.33	AVG
7	1.7529	10.18	8.96	19.14	56.00	-36.86	QP
8	1.7529	10.18	1.82	12.00	46.00	-34.00	AVG
9	2.0878	10.18	10.99	21.17	56.00	-34.83	QP
10	2.0878	10.18	7.41	17.59	46.00	-28.41	AVG
11	19.7396	10.38	18.77	29.15	60.00	-30.85	QP
12	19.7396	10.38	8.47	18.85	50.00	-31.15	AVG

Note: Measurement Level = Reading Level + Correct Factor



Test Mode :	Mode 5: Full system work signal from PORT1 for AS-41UA (120V/60Hz)		
AC Power :	AC 120V/60Hz	Phase :	NEUTRAL
Temperature :	25°C	Humidity :	52%
Pressure(mbar) :	1002	Date:	2019/04/03

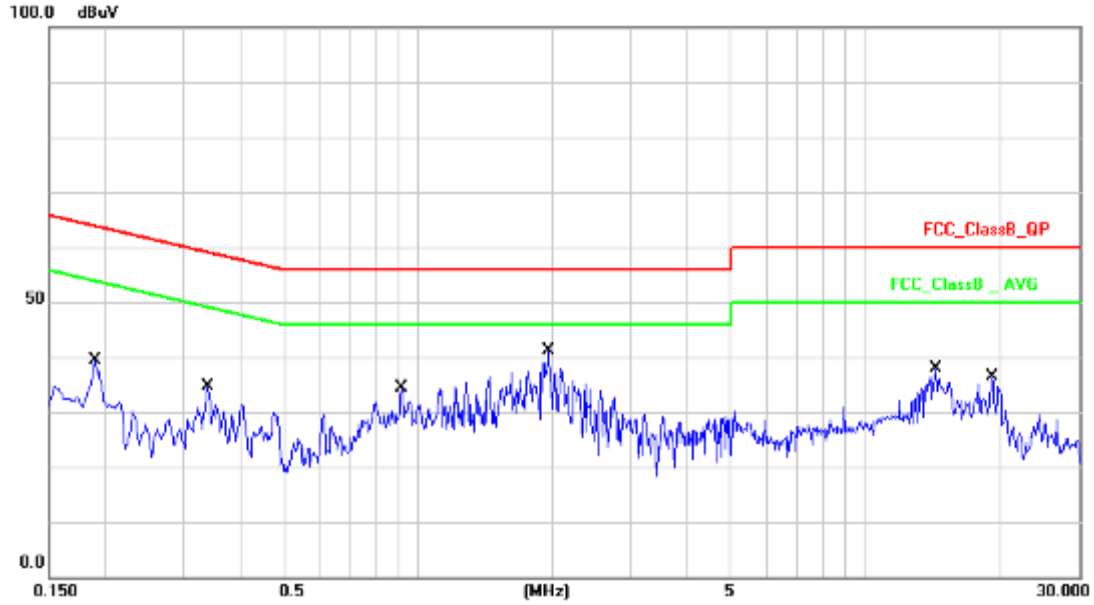

No.	Frequency (MHz)	Factor (dB)	Reading (dBuV)	Level (dBuV)	Limit (dBuV)	Margin (dB)	Detector
1	0.1893	10.13	26.36	36.49	64.06	-27.57	QP
2	0.1893	10.13	22.41	32.54	54.06	-21.52	AVG
3	0.3391	10.14	12.39	22.53	59.22	-36.69	QP
4	0.3391	10.14	7.55	17.69	49.22	-31.53	AVG
5	0.9184	10.16	15.35	25.51	56.00	-30.49	QP
6	0.9184	10.16	13.92	24.08	46.00	-21.92	AVG
7	1.9489	10.18	17.63	27.81	56.00	-28.19	QP
8	1.9489	10.18	9.45	19.63	46.00	-26.37	AVG
9	14.2881	10.52	10.90	21.42	60.00	-38.58	QP
10	14.2881	10.52	4.21	14.73	50.00	-35.27	AVG
11	19.1220	10.41	19.20	29.61	60.00	-30.39	QP
12	19.1220	10.41	8.09	18.50	50.00	-31.50	AVG

Note: Measurement Level = Reading Level + Correct Factor



Test Mode :	Mode 6: Full system work signal from PORT2 for AS-41UA (120V/60Hz)		
AC Power :	AC 120V/60Hz	Phase :	LINE
Temperature :	25°C	Humidity :	52%
Pressure(mbar) :	1002	Date:	2019/04/03

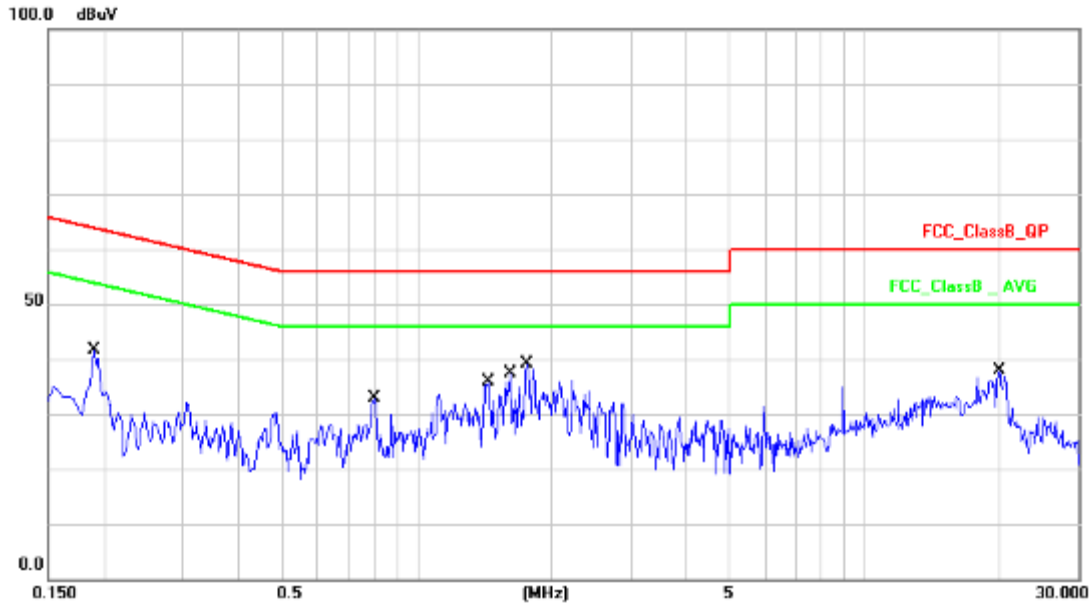

No.	Frequency (MHz)	Factor (dB)	Reading (dBuV)	Level (dBuV)	Limit (dBuV)	Margin (dB)	Detector
1	0.1901	10.13	27.67	37.80	64.03	-26.23	QP
2	0.1901	10.13	23.72	33.85	54.03	-20.18	AVG
3	0.8002	10.16	9.50	19.66	56.00	-36.34	QP
4	0.8002	10.16	5.49	15.65	46.00	-30.35	AVG
5	1.4408	10.17	13.64	23.81	56.00	-32.19	QP
6	1.4408	10.17	10.46	20.63	46.00	-25.37	AVG
7	1.6189	10.18	17.30	27.48	56.00	-28.52	QP
8	1.6189	10.18	10.62	20.80	46.00	-25.20	AVG
9	1.7621	10.18	12.15	22.33	56.00	-33.67	QP
10	1.7621	10.18	2.26	12.44	46.00	-33.56	AVG
11	19.9498	10.37	17.06	27.43	60.00	-32.57	QP
12	19.9498	10.37	8.08	18.45	50.00	-31.55	AVG

Note: Measurement Level = Reading Level + Correct Factor



Test Mode :	Mode 6: Full system work signal from PORT2 for AS-41UA (120V/60Hz)		
AC Power :	AC 120V/60Hz	Phase :	NEUTRAL
Temperature :	25°C	Humidity :	52%
Pressure(mbar) :	1002	Date:	2019/04/03

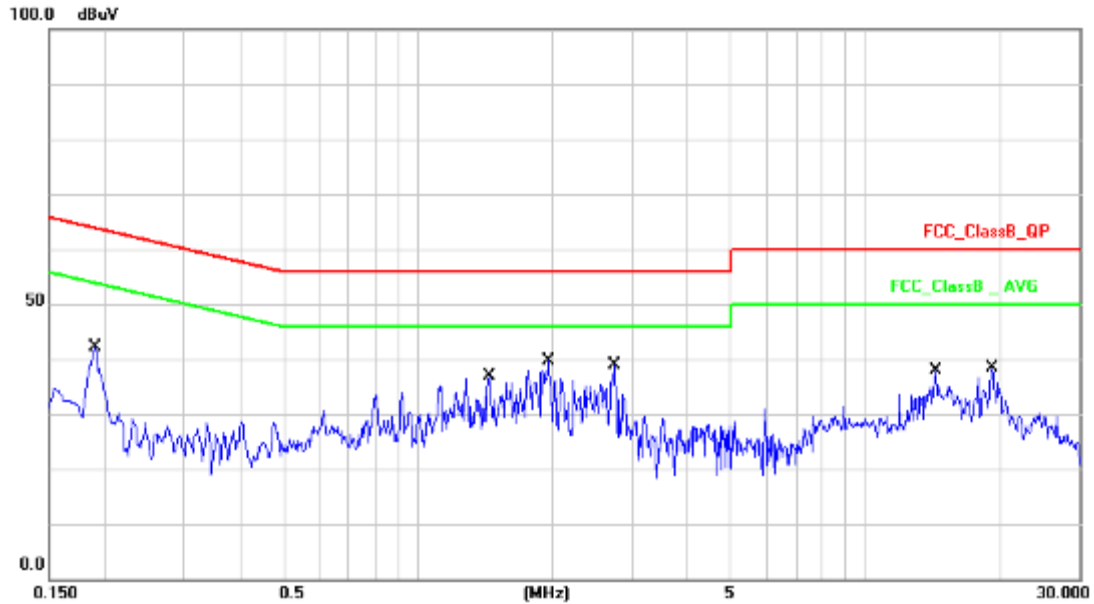

No.	Frequency (MHz)	Factor (dB)	Reading (dBuV)	Level (dBuV)	Limit (dBuV)	Margin (dB)	Detector
1	0.1901	10.13	27.68	37.81	64.03	-26.22	QP
2	0.1901	10.13	23.72	33.85	54.03	-20.18	AVG
3	1.4408	10.17	13.55	23.72	56.00	-32.28	QP
4	1.4408	10.17	10.38	20.55	46.00	-25.45	AVG
5	1.9489	10.18	17.91	28.09	56.00	-27.91	QP
6	1.9489	10.18	9.47	19.65	46.00	-26.35	AVG
7	2.7501	10.20	16.22	26.42	56.00	-29.58	QP
8	2.7501	10.20	10.27	20.47	46.00	-25.53	AVG
9	14.2881	10.52	10.81	21.33	60.00	-38.67	QP
10	14.2881	10.52	4.20	14.72	50.00	-35.28	AVG
11	19.1219	10.41	19.44	29.85	60.00	-30.15	QP
12	19.1219	10.41	8.19	18.60	50.00	-31.40	AVG

Note: Measurement Level = Reading Level + Correct Factor



Test Mode :	Mode 7: Full system work signal from PORT3 for AS-41UA (120V/60Hz)		
AC Power :	AC 120V/60Hz	Phase :	LINE
Temperature :	25°C	Humidity :	52%
Pressure(mbar) :	1002	Date:	2019/04/03

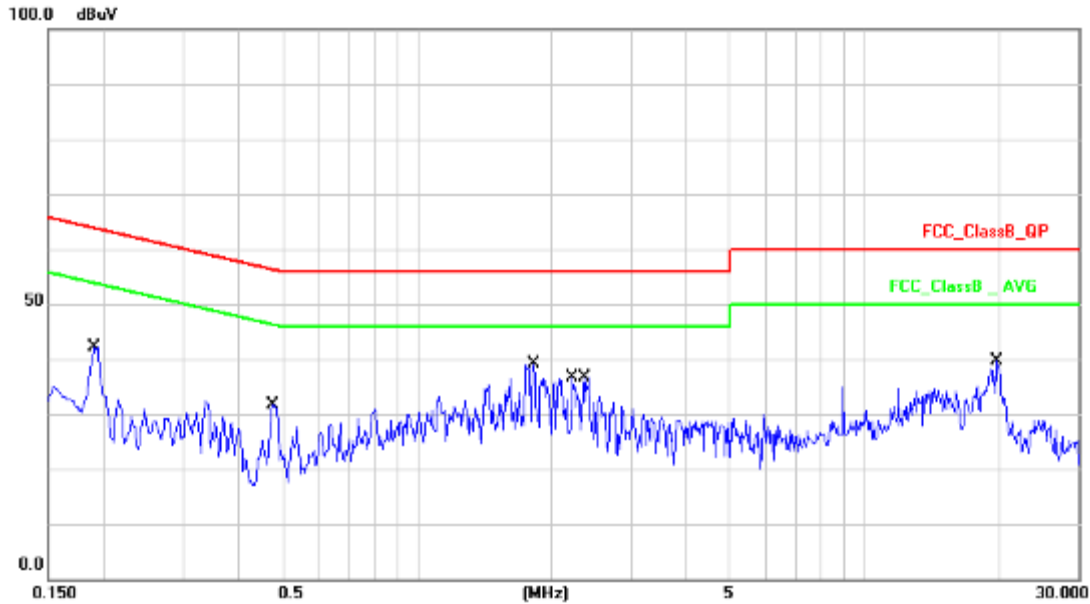

No.	Frequency (MHz)	Factor (dB)	Reading (dBuV)	Level (dBuV)	Limit (dBuV)	Margin (dB)	Detector
1	0.1901	10.13	27.66	37.79	64.03	-26.24	QP
2	0.1901	10.13	23.69	33.82	54.03	-20.21	AVG
3	0.4761	10.16	4.92	15.08	56.41	-41.33	QP
4	0.4761	10.16	-0.13	10.03	46.41	-36.38	AVG
5	1.8189	10.18	18.68	28.86	56.00	-27.14	QP
6	1.8189	10.18	15.48	25.66	46.00	-20.34	AVG
7	2.2248	10.18	7.42	17.60	56.00	-38.40	QP
8	2.2248	10.18	2.53	12.71	46.00	-33.29	AVG
9	2.3584	10.20	4.74	14.94	56.00	-41.06	QP
10	2.3584	10.20	-1.10	9.10	46.00	-36.90	AVG
11	19.7394	10.38	18.57	28.95	60.00	-31.05	QP
12	19.7394	10.38	7.82	18.20	50.00	-31.80	AVG

Note: Measurement Level = Reading Level + Correct Factor



Test Mode :	Mode 7: Full system work signal from PORT3 for AS-41UA (120V/60Hz)		
AC Power :	AC 120V/60Hz	Phase :	NEUTRAL
Temperature :	25°C	Humidity :	52%
Pressure(mbar) :	1002	Date:	2019/04/03

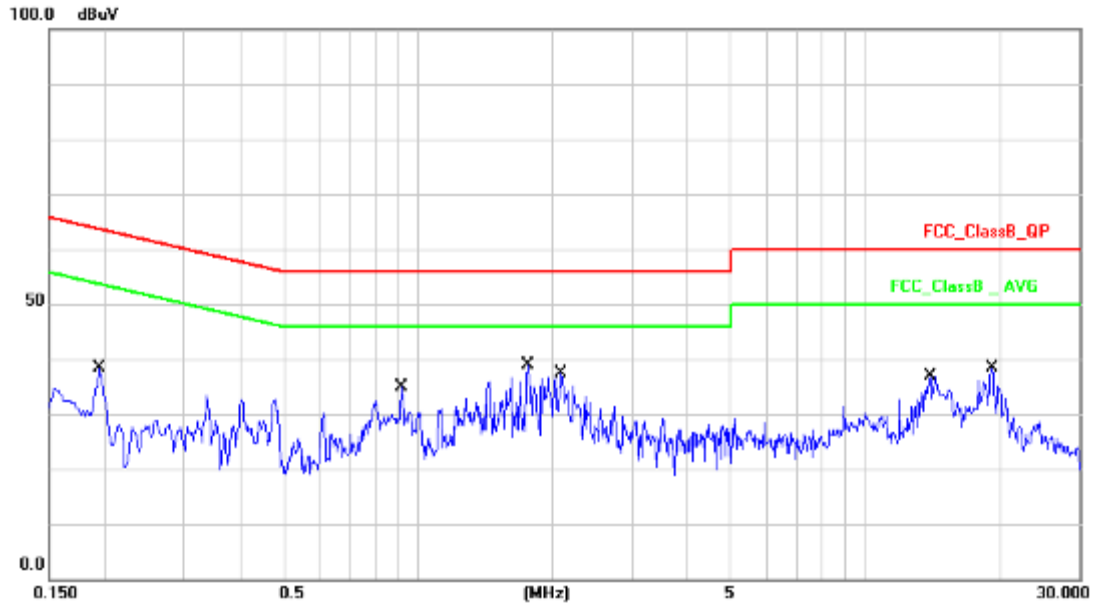

No.	Frequency (MHz)	Factor (dB)	Reading (dBuV)	Level (dBuV)	Limit (dBuV)	Margin (dB)	Detector
1	0.1932	10.13	28.56	38.69	63.89	-25.20	QP
2	0.1932	10.13	24.57	34.70	53.89	-19.19	AVG
3	0.9183	10.16	15.43	25.59	56.00	-30.41	QP
4	0.9183	10.16	14.02	24.18	46.00	-21.82	AVG
5	1.7527	10.18	9.09	19.27	56.00	-36.73	QP
6	1.7527	10.18	1.91	12.09	46.00	-33.91	AVG
7	2.0878	10.18	10.84	21.02	56.00	-34.98	QP
8	2.0878	10.18	7.23	17.41	46.00	-28.59	AVG
9	13.9146	10.50	11.29	21.79	60.00	-38.21	QP
10	13.9146	10.50	4.35	14.85	50.00	-35.15	AVG
11	19.1219	10.41	19.36	29.77	60.00	-30.23	QP
12	19.1219	10.41	8.28	18.69	50.00	-31.31	AVG

Note: Measurement Level = Reading Level + Correct Factor



Test Mode :	Mode 8: Full system work signal from PORT4 for AS-41UA (120V/60Hz)		
AC Power :	AC 120V/60Hz	Phase :	LINE
Temperature :	25°C	Humidity :	52%
Pressure(mbar) :	1002	Date:	2019/04/03

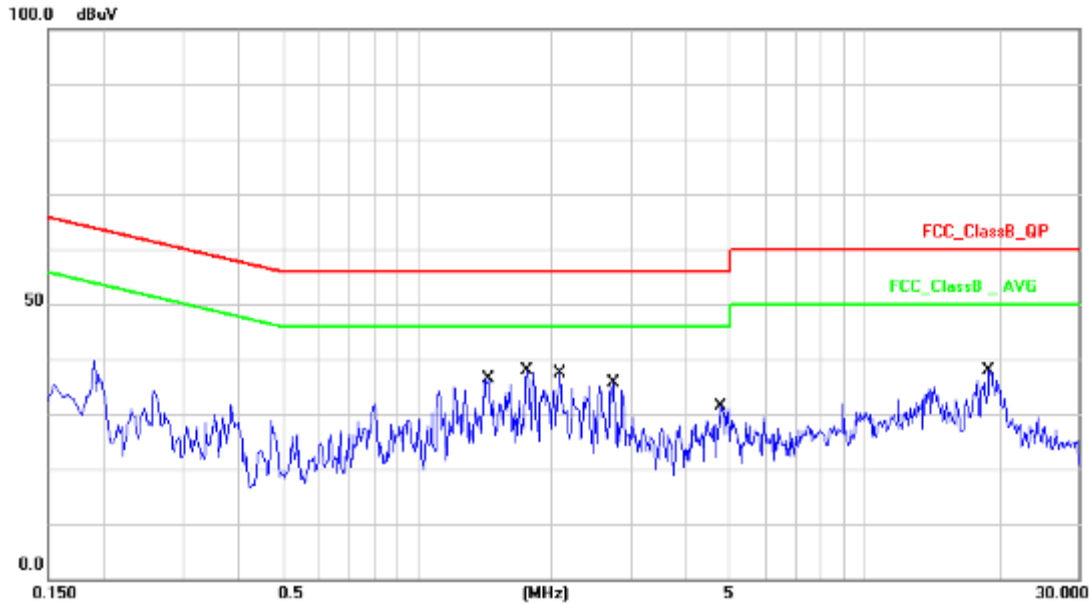

No.	Frequency (MHz)	Factor (dB)	Reading (dBuV)	Level (dBuV)	Limit (dBuV)	Margin (dB)	Detector
1	1.4408	10.17	13.64	23.81	56.00	-32.19	QP
2	1.4408	10.17	10.37	20.54	46.00	-25.46	AVG
3	1.7526	10.18	9.24	19.42	56.00	-36.58	QP
4	1.7526	10.18	1.98	12.16	46.00	-33.84	AVG
5	2.0878	10.18	10.78	20.96	56.00	-35.04	QP
6	2.0878	10.18	7.16	17.34	46.00	-28.66	AVG
7	2.7355	10.20	10.33	20.53	56.00	-35.47	QP
8	2.7355	10.20	6.81	17.01	46.00	-28.99	AVG
9	4.7713	10.26	5.88	16.14	56.00	-39.86	QP
10	4.7713	10.26	1.67	11.93	46.00	-34.07	AVG
11	18.9204	10.42	14.57	24.99	60.00	-35.01	QP
12	18.9204	10.42	5.37	15.79	50.00	-34.21	AVG

Note: Measurement Level = Reading Level + Correct Factor



Test Mode :	Mode 8: Full system work signal from PORT4 for AS-41UA (120V/60Hz)		
AC Power :	AC 120V/60Hz	Phase :	NEUTRAL
Temperature :	25°C	Humidity :	52%
Pressure(mbar) :	1002	Date:	2019/04/03

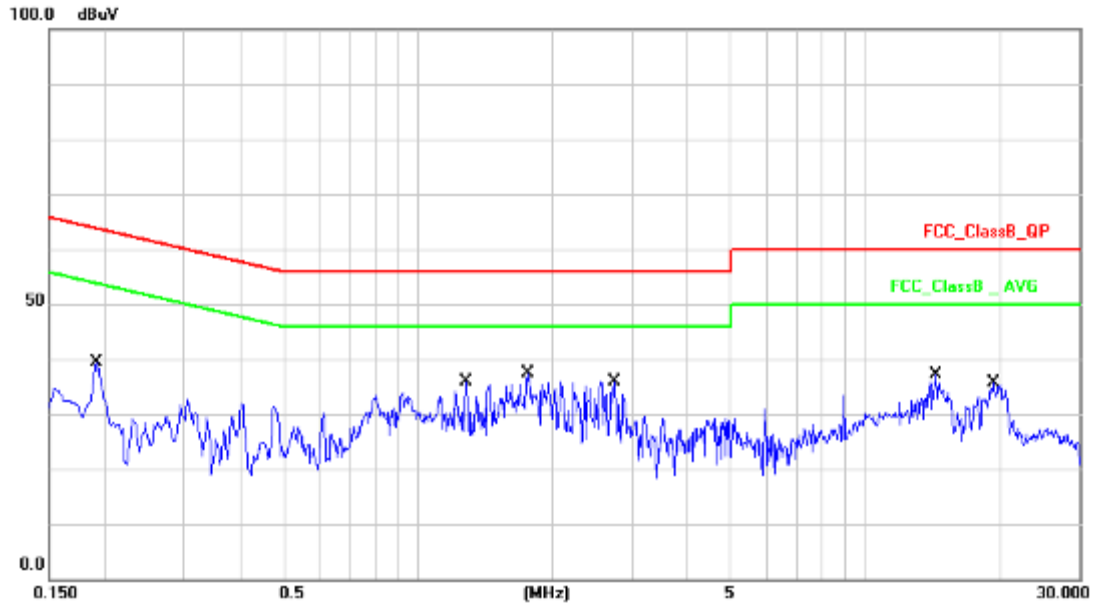

No.	Frequency (MHz)	Factor (dB)	Reading (dBuV)	Level (dBuV)	Limit (dBuV)	Margin (dB)	Detector
1	0.1912	10.13	28.65	38.78	63.98	-25.20	QP
2	0.1912	10.13	24.62	34.75	53.98	-19.23	AVG
3	1.2755	10.17	10.30	20.47	56.00	-35.53	QP
4	1.2755	10.17	1.71	11.88	46.00	-34.12	AVG
5	1.7526	10.18	9.44	19.62	56.00	-36.38	QP
6	1.7526	10.18	2.02	12.20	46.00	-33.80	AVG
7	2.7501	10.20	14.87	25.07	56.00	-30.93	QP
8	2.7501	10.20	10.87	21.07	46.00	-24.93	AVG
9	14.3640	10.53	9.71	20.24	60.00	-39.76	QP
10	14.3640	10.53	3.25	13.78	50.00	-36.22	AVG
11	19.2236	10.40	18.12	28.52	60.00	-31.48	QP
12	19.2236	10.40	7.72	18.12	50.00	-31.88	AVG

Note: Measurement Level = Reading Level + Correct Factor

Test engineer: Vare Xta



4. Test of Radiated Emission

4.1. Test Limit

Below 1GHz (for digital device)

For unintentional device, according to CISPR PUB.22, for Class B digital devices, the general requirement of field strength of radiated emissions from intentional radiators at a distance of 10 meters shall not exceed the below table.

FREQUENCY (MHz)	dBuV/m (At 10m)	
	Class A	Class B
30 ~ 230	40	30
230 ~ 1000	47	37

Limit tables for non-digital device:

Class A Radiated Emission limit at 10m (for others)

Frequency (MHz)	Field Strength Limit (uV/m)Q.P.	Field Strength Limit (dBuV/m)Q.P.
30 - 88	90	39
88 - 216	150	43.5
216 – 960	210	46.4
Above 960	300	49.5

Class B Radiated Emission limit at 3m (for others)

Frequency (MHz)	Field Strength Limit (uV/m)Q.P.	Field Strength Limit (dBuV/m)Q.P.
30 - 88	100	40
88 - 216	150	43.5
216 – 960	200	46
Above 960	500	54

Above 1GHz(for all device)

Frequency (MHz)	Class A (dBuV/m) (At 10m)		Class B (dBuV/m) (At 3m)	
	Average	Peak	Average	Peak
Above 1000	49.5	69.5	54	74

- NOTE:** (1) The lower limit shall apply at the transition frequencies.
 (2) Emission level (dBuV/m) = 20 log Emission level (uV/m).
 (3) The measurement above 1GHz is at close-in distances 3m, and determine the limit L2 corresponding to the close-in distance d2 by applying the following relation: $L2 = L1 (d1/d2)$, where L1 is the specified limit in microvolts per metre (uV/m) at the distance d1 (10m), L2 is the new limit for distance d2 (3m).
 So the new Class A limit above 1GHz at 3m is as following table:



Frequency (MHZ)	Class A (dBuV/m) (At 3m)	
	Average	Peak
Above 1000	60	80

According to FCC Part 15.33 (b), for an unintentional radiator, including a digital device, the spectrum shall be investigated from the lowest radio frequency signal generated or used in the device, without going below the lowest frequency for which a radiated emission limit is specified, up to the frequency shown in the following table:

Highest frequency generated or used in the device or on which the device operates or tunes (MHz)	Upper frequency of measurement range (MHz)
Below 1.75	30
1.75-108	1000
108-500	2000
500-1000	5000
Above 1000	5 th harmonic of the highest frequency or 40GHz, whichever is lower

4.2. Test Procedures

Procedure of Preliminary Test

- The EUT was set up as per the test configuration to simulate typical usage per the user’s manual. The EUT was placed on a Turn table top 0.8 meter above ground.
- Support equipment, if needed, was placed as per ANSI C63.4.
- All I/O cables were positioned to simulate typical usage as per ANSI C63.4.
- The EUT received AC 120VAC/60Hz power source from the outlet socket under the turntable. All support equipment power received from another socket under the turntable.
- The antenna was placed at 3 or 10 meter away from the EUT as stated in ANSI C63.4. The antenna connected to the Spectrum Analyzer via a cable and at times a pre-amplifier would be used.
- The Analyzer / Receiver quickly scanned from 30MHz to 40GHz. The EUT test program was started. Emissions were scanned and measured rotating the EUT to 360 degrees and positioning the antenna 1 to 4 meters above the ground plane, in both the vertical and the horizontal polarization, to maximize the emission reading level.
- Set the spectrum analyzer/ Receiver in the following setting as:
 Below 1GHz:
 RBW=120KHz / VBW=300KHz / Sweep=AUTO
 Above 1GHz:



Peak: RBW=1MHz, VBW=3MHz / Sweep=AUTO
Average: RBW=1MHz / VBW=1.6Hz / Sweep=AUTO

- The worst configuration of EUT and cable of the above highest emission level were recorded for reference of the final test.

Procedure of Final Test

- EUT and support equipment were set up on the turntable as per the configuration with highest emission level in the preliminary test.
- The Analyzer / Receiver scanned from 30MHz to 40GHz. Emissions were scanned and measured rotating the EUT to 360 degrees, varying cable placement and positioning the antenna 1 or 1 to 4 meters above the ground plane, in both the vertical and the horizontal polarization, to maximize the emission reading level.
- Recording at least the six highest emissions. Emission frequency, amplitude, antenna position, polarization and turntable position were recorded into a computer in which correction factors were used to calculate the emission level and compare reading to the applicable limit. Below 1GHz the Q.P. reading and above 1GHz the Peak and Average reading are presented.
- The test data of the worst-case condition(s) was recorded.



4.3. Typical test Setup

Below 1GHz Test Setup

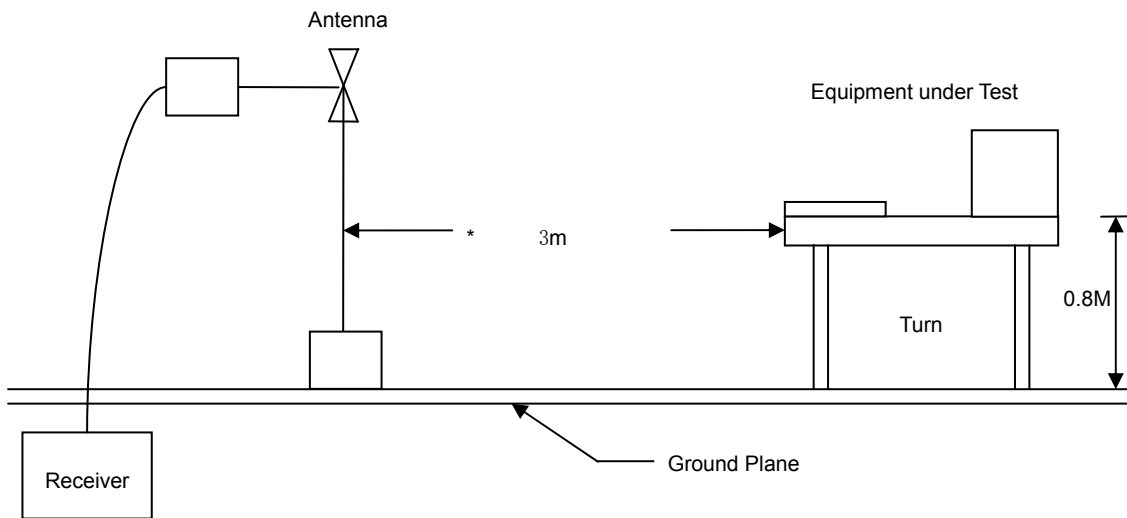

Above 1GHz Test Setup

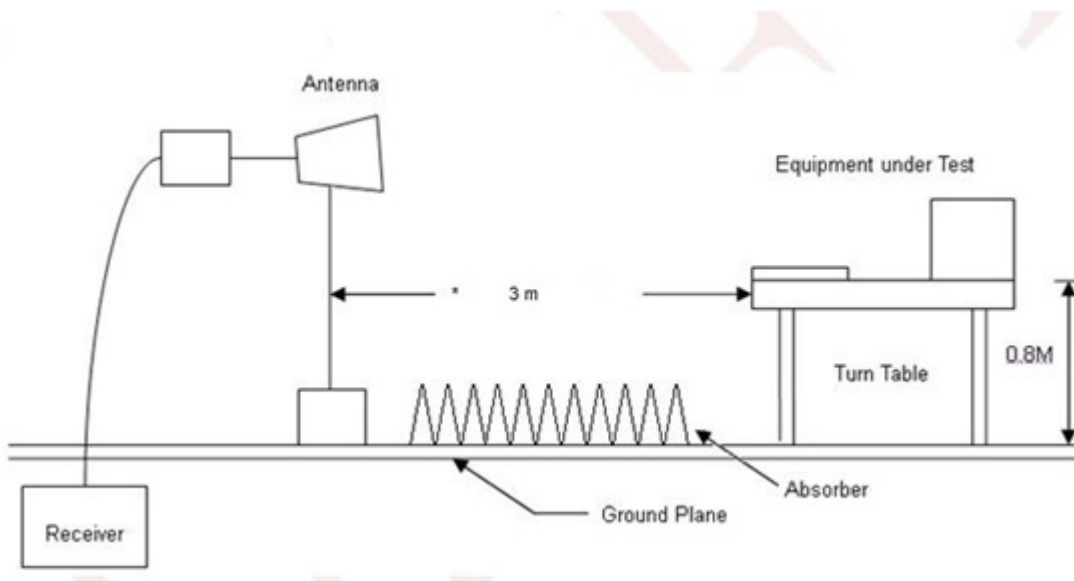



4.4. Measurement Equipment

Instrument/Ancillary	Manufacturer	Model No.	Serial No.	Calibration Date	Valid Date.
EMI Test Receiver	R&S	ESC17	100968	2018.08.25	2019.08.24
Preamplifier	EMCI	EMCI030-00-3230	SN016723	2019.03.11	2020.03.10
Preamplifier	Agilent	8449B	3008A02342	2019.03.11	2020.03.10
Bilog Antenna	Sunol Science	JB1	A072414-2	2018.07.20	2019.07.19
Broad-Band Horn Antenna	Schwarzbeck	BBHA9120D	9120D-618	2018.04.21	2019.04.20
Spectrum Analyzer	R&S	FSP40	100324	2018.08.23	2019.08.22
Temperature/ Humidity Meter	Zhicheng	ZC1-11	CEP-TH-001	2019.03.17	2020.03.16
EZ-EMC	Fala	Ver CT3A1	N/A	N/A	N/A



4.5. Test Result and Data (30MHz~1GHz)

Test Mode :	Mode 5: Full system work signal from PORT1 for AS-41UA (120V/60Hz)		
AC Power :	AC 120V/60HZ	Ant. Polarization:	Horizontal
Temp :	25°C	Humidity :	52° C
Pressure(mbar) :	1002	Date:	2019/04/03

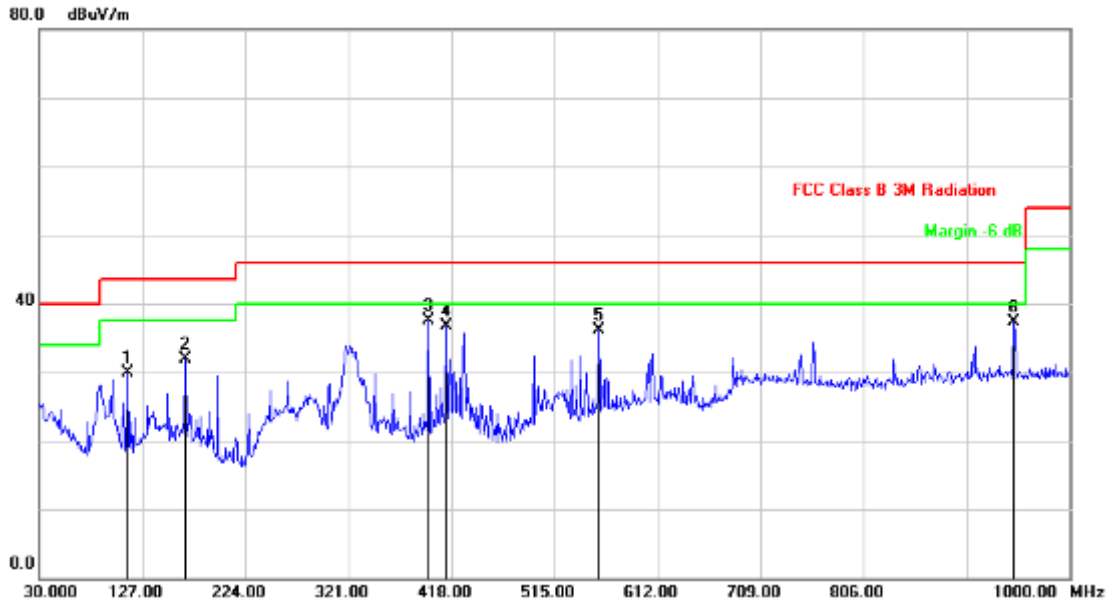

No.	Frequency (MHz)	Factor (dB/m)	Reading (dBuV)	Level (dBuV/m)	Limit (dBuV/m)	Margin (dB)	Det.	Height (cm)	Azimuth (deg)
1	113.4200	-12.81	42.78	29.97	43.50	-13.53	peak	100	0
2	167.7400	-12.55	44.41	31.86	43.50	-11.64	peak	100	0
3	396.6600	-5.95	43.55	37.60	46.00	-8.40	peak	200	325
4	413.1500	-4.12	40.77	36.65	46.00	-9.35	peak	200	111
5	556.7100	-3.42	39.49	36.07	46.00	-9.93	peak	100	33
6	947.6200	2.53	34.70	37.23	46.00	-8.77	peak	100	45

Note: Measurement Level = Reading Level + Correct Factor



Test Mode :	Mode 5: Full system work signal from PORT1 for AS-41UA (120V/60Hz)		
AC Power :	AC 120V/60HZ	Ant. Polarization:	Vertical
Temp :	25°C	Humidity :	52° C
Pressure(mbar) :	1002	Date:	2019/04/03

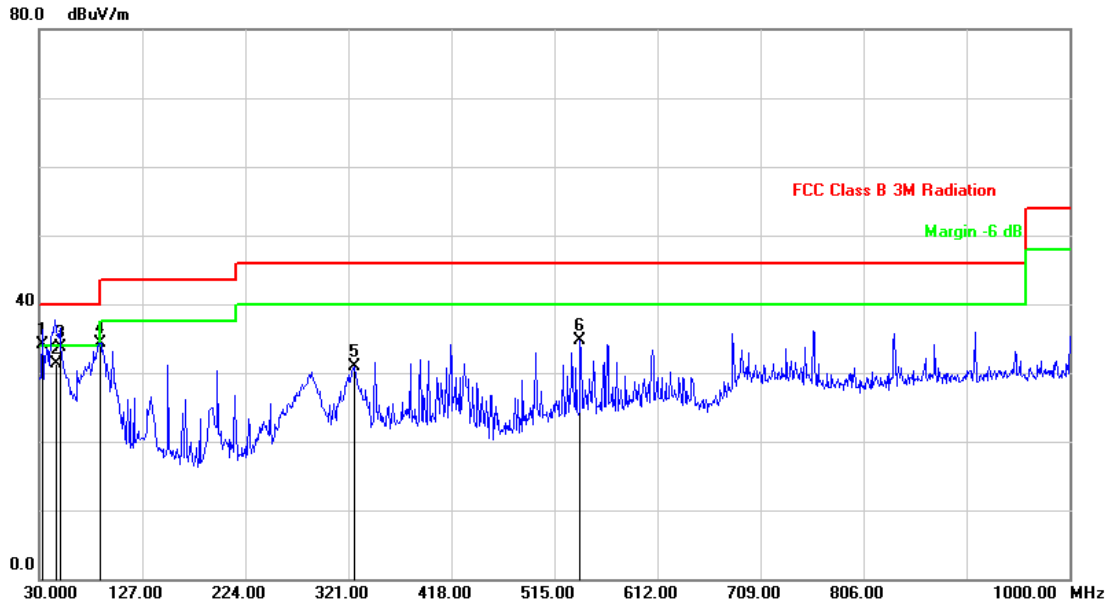

No.	Frequency (MHz)	Factor (dB/m)	Reading (dBuV)	Level (dBuV/m)	Limit (dBuV/m)	Margin (dB)	Det.	Height (cm)	Azimuth (deg)
1	33.0099	-3.61	37.77	34.16	40.00	-5.84	QP	200	173
2	45.5900	-8.89	40.28	31.39	40.00	-8.61	QP	200	209
3	49.5000	-10.74	44.40	33.66	40.00	-6.34	QP	200	192
4	87.2300	-15.45	49.72	34.27	40.00	-5.73	peak	200	194
5	326.8199	-6.36	37.25	30.89	46.00	-15.11	peak	200	266
6	539.2500	-4.04	38.71	34.67	46.00	-11.33	peak	200	301

Note: Measurement Level = Reading Level + Correct Factor



Test Mode :	Mode 6: Full system work signal from PORT2 for AS-41UA (120V/60Hz)		
AC Power :	AC 120V/60HZ	Ant. Polarization:	Horizontal
Temp :	25°C	Humidity :	52° C
Pressure(mbar) :	1002	Date:	2019/04/03

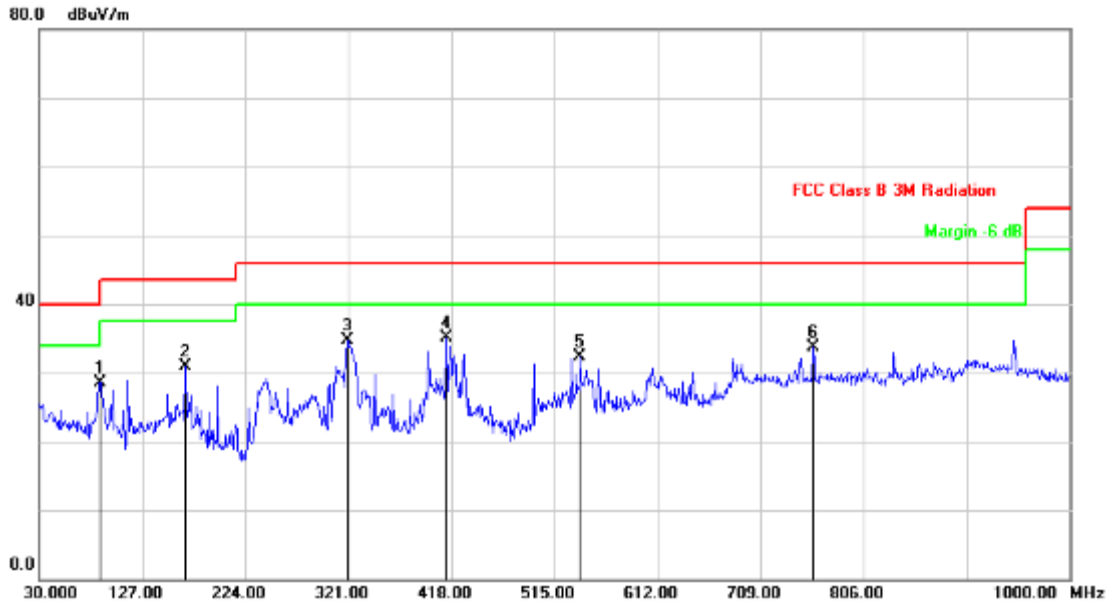

No.	Frequency (MHz)	Factor (dB/m)	Reading (dBuV)	Level (dBuV/m)	Limit (dBuV/m)	Margin (dB)	Det.	Height (cm)	Azimuth (deg)
1	87.2300	-15.45	43.98	28.53	40.00	-11.47	peak	100	167
2	167.7400	-12.55	43.41	30.86	43.50	-12.64	peak	200	305
3	320.0298	-6.24	41.00	34.76	46.00	-11.24	peak	200	156
4	413.1499	-4.12	39.27	35.15	46.00	-10.85	peak	200	229
5	539.2500	-4.04	36.38	32.34	46.00	-13.66	peak	200	38
6	758.4699	1.17	32.56	33.73	46.00	-12.27	peak	200	255

Note: Measurement Level = Reading Level + Correct Factor



Test Mode :	Mode 6: Full system work signal from PORT2 for AS-41UA (120V/60Hz)		
AC Power :	AC 120V/60HZ	Ant. Polarization:	Vertical
Temp :	25°C	Humidity :	52° C
Pressure(mbar) :	1002	Date:	2019/04/03

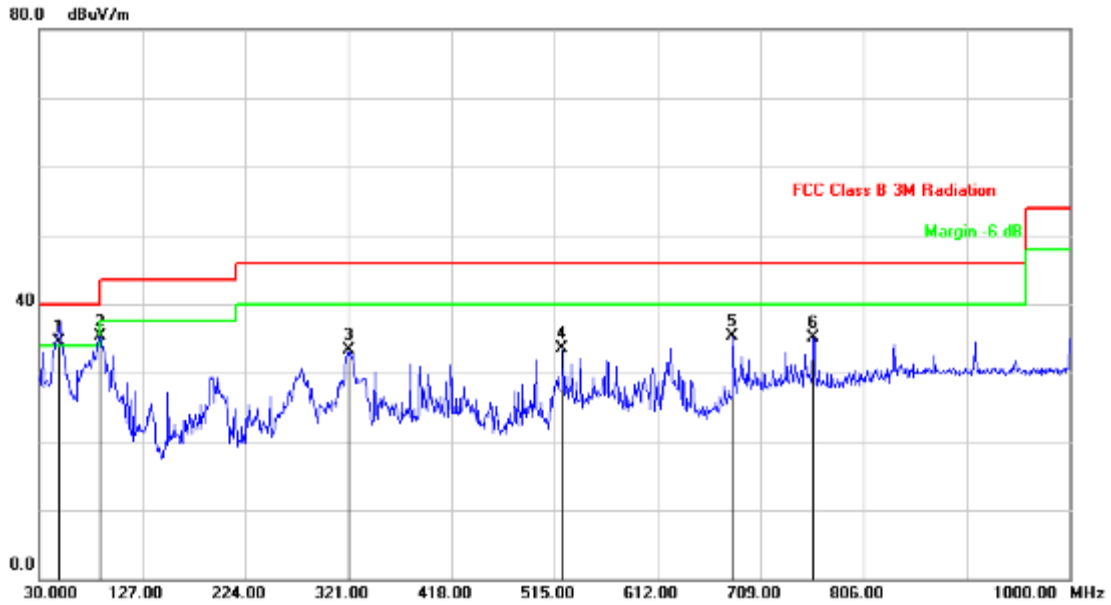

No.	Frequency (MHz)	Factor (dB/m)	Reading (dBuV)	Level (dBuV/m)	Limit (dBuV/m)	Margin (dB)	Det.	Height (cm)	Azimuth (deg)
1	49.3998	-10.70	45.21	34.51	40.00	-5.49	QP	100	29
2	87.2300	-15.45	50.72	35.27	40.00	-4.73	peak	100	168
3	321.9700	-6.27	39.49	33.22	46.00	-12.78	peak	100	244
4	522.7599	-4.38	37.96	33.58	46.00	-12.42	peak	100	230
5	682.8096	-0.49	35.72	35.23	46.00	-10.77	peak	100	172
6	758.4699	1.17	33.89	35.06	46.00	-10.94	peak	100	350

Note: Measurement Level = Reading Level + Correct Factor



Test Mode :	Mode 7: Full system work signal from PORT3 for AS-41UA (120V/60Hz)		
AC Power :	AC 120V/60HZ	Ant. Polarization:	Horizontal
Temp :	25°C	Humidity :	52° C
Pressure(mbar) :	1002	Date:	2019/04/03

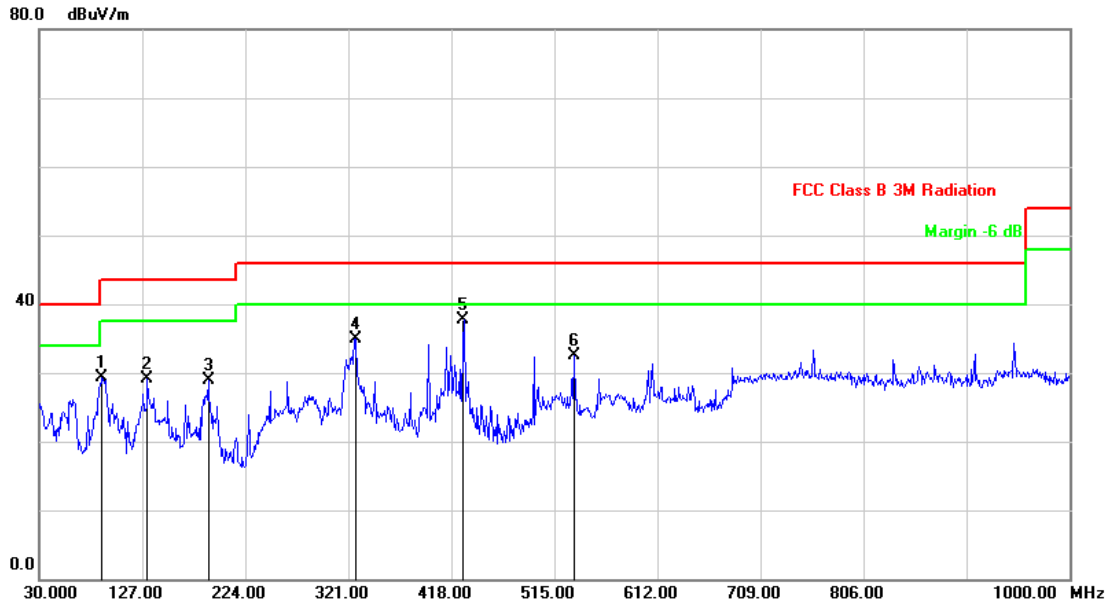

No.	Frequency (MHz)	Factor (dB/m)	Reading (dBuV)	Level (dBuV/m)	Limit (dBuV/m)	Margin (dB)	Det.	Height (cm)	Azimuth (deg)
1	89.1700	-15.29	44.69	29.40	43.50	-14.10	peak	100	273
2	131.8497	-12.83	42.01	29.18	43.50	-14.32	peak	200	190
3	189.0800	-12.56	41.42	28.86	43.50	-14.64	peak	100	82
4	327.7900	-6.37	41.29	34.92	46.00	-11.08	peak	200	112
5	429.6399	-4.30	41.96	37.66	46.00	-8.34	peak	200	59
6	533.4298	-4.16	36.65	32.49	46.00	-13.51	peak	200	308

Note: Measurement Level = Reading Level + Correct Factor



Test Mode :	Mode 7: Full system work signal from PORT3 for AS-41UA (120V/60Hz)		
AC Power :	AC 120V/60HZ	Ant. Polarization:	Vertical
Temp :	25°C	Humidity :	52° C
Pressure(mbar) :	1002	Date:	2019/04/03

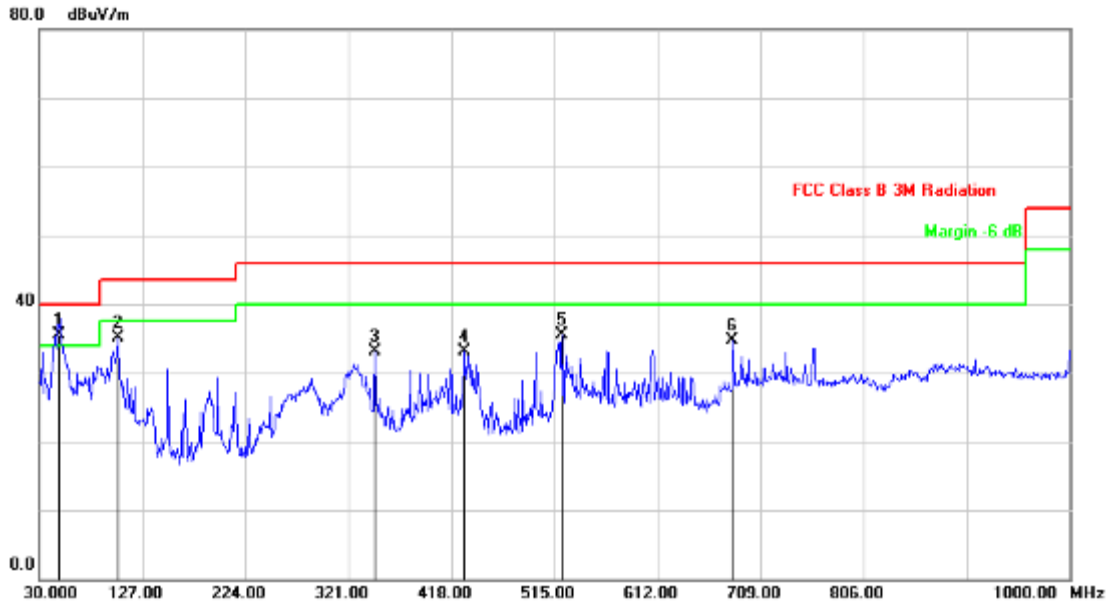

No.	Frequency (MHz)	Factor (dB/m)	Reading (dBuV)	Level (dBuV/m)	Limit (dBuV/m)	Margin (dB)	Det.	Height (cm)	Azimuth (deg)
1	49.3998	-10.70	46.20	35.50	40.00	-4.50	QP	100	199
2	104.6898	-12.80	47.95	35.15	43.50	-8.35	peak	100	274
3	346.2200	-6.66	39.71	33.05	46.00	-12.95	peak	100	320
4	430.6100	-4.41	37.42	33.01	46.00	-12.99	peak	100	145
5	522.7599	-4.38	39.96	35.58	46.00	-10.42	peak	200	97
6	682.8096	-0.49	35.22	34.73	46.00	-11.27	peak	100	216

Note: Measurement Level = Reading Level + Correct Factor



Test Mode :	Mode 8: Full system work signal from PORT4 for AS-41UA (120V/60Hz)		
AC Power :	AC 120V/60HZ	Ant. Polarization:	Horizontal
Temp :	25°C	Humidity :	52° C
Pressure(mbar) :	1002	Date:	2019/04/03

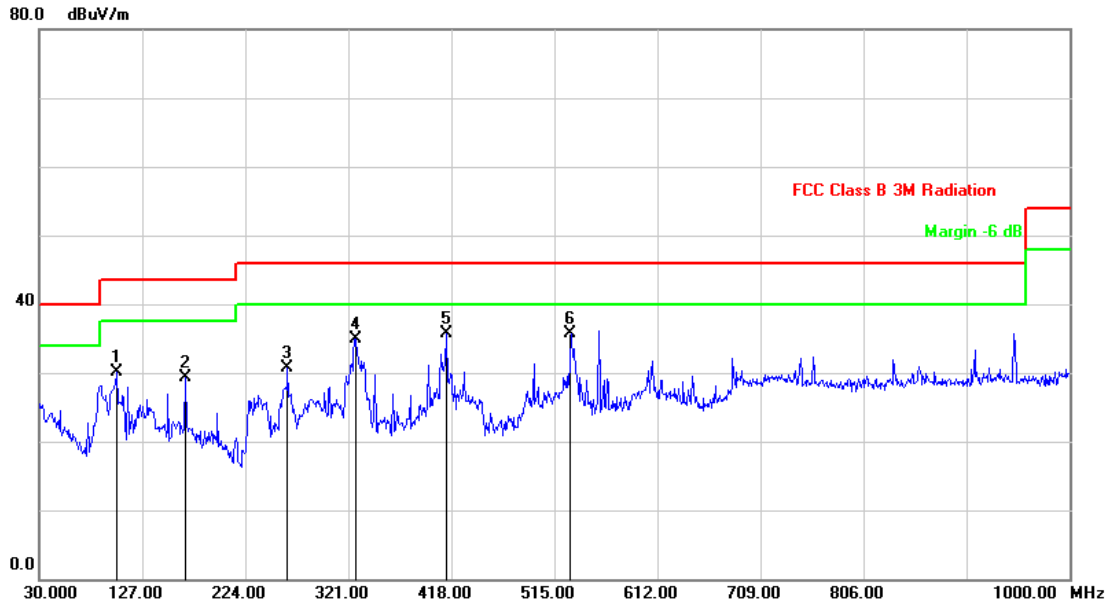

No.	Frequency (MHz)	Factor (dB/m)	Reading (dBuV)	Level (dBuV/m)	Limit (dBuV/m)	Margin (dB)	Det.	Height (cm)	Azimuth (deg)
1	102.7500	-12.79	42.81	30.02	43.50	-13.48	peak	200	218
2	167.7400	-12.55	41.91	29.36	43.50	-14.14	peak	200	302
3	263.7699	-9.93	40.69	30.76	46.00	-15.24	peak	100	154
4	327.7900	-6.37	41.29	34.92	46.00	-11.08	peak	200	49
5	413.1499	-4.12	39.77	35.65	46.00	-10.35	peak	100	166
6	530.5198	-4.22	40.02	35.80	46.00	-10.20	peak	200	266

Note: Measurement Level = Reading Level + Correct Factor



Test Mode :	Mode 8: Full system work signal from PORT4 for AS-41UA (120V/60Hz)		
AC Power :	AC 120V/60HZ	Ant. Polarization:	Vertical
Temp :	25°C	Humidity :	52° C
Pressure(mbar) :	1002	Date:	2019/04/03

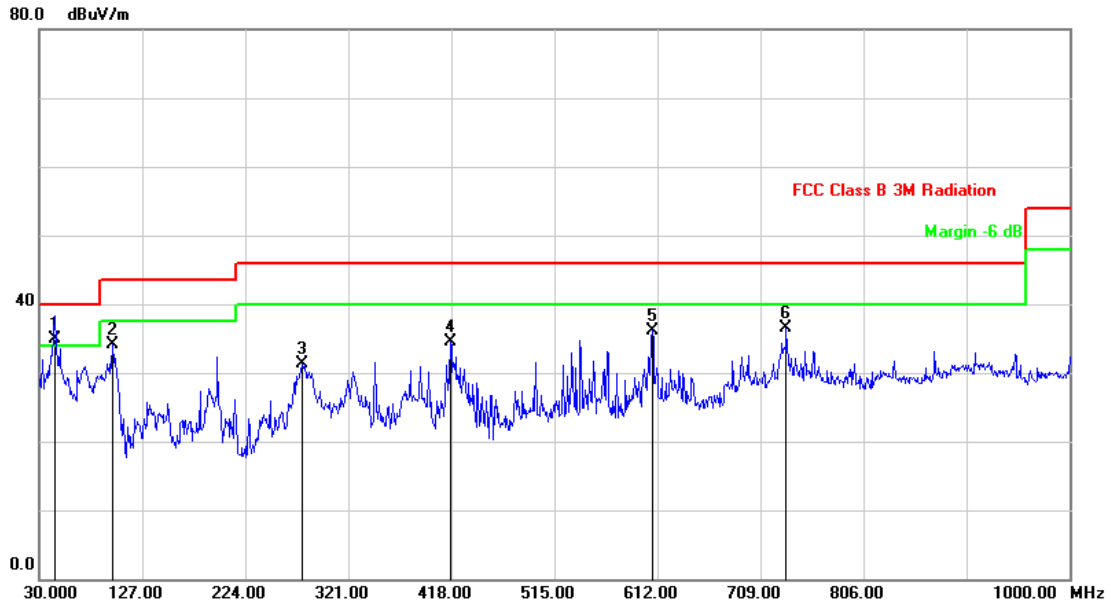

No.	Frequency (MHz)	Factor (dB/m)	Reading (dBuV)	Level (dBuV/m)	Limit (dBuV/m)	Margin (dB)	Det.	Height (cm)	Azimuth (deg)
1	44.5499	-8.40	43.28	34.88	40.00	-5.12	QP	100	128
2	98.8700	-13.06	47.15	34.09	43.50	-9.41	peak	100	117
3	277.3500	-9.14	40.36	31.22	46.00	-14.78	peak	100	213
4	417.0298	-3.65	38.23	34.58	46.00	-11.42	peak	100	300
5	607.1499	-1.73	37.93	36.20	46.00	-9.80	peak	100	187
6	733.2500	1.55	34.91	36.46	46.00	-9.54	peak	100	94

Note: Measurement Level = Reading Level + Correct Factor



4.6. Test Result and Data (1GHz ~18GHz)

Test Mode :	Mode 5: Full system work signal from PORT1 for AS-41UA (120V/60Hz)		
AC Power :	AC 120V/60HZ	Ant. Polarization:	Horizontal
Temp :	25°C	Humidity :	52° C
Pressure(mbar) :	1002	Date:	2019/04/03

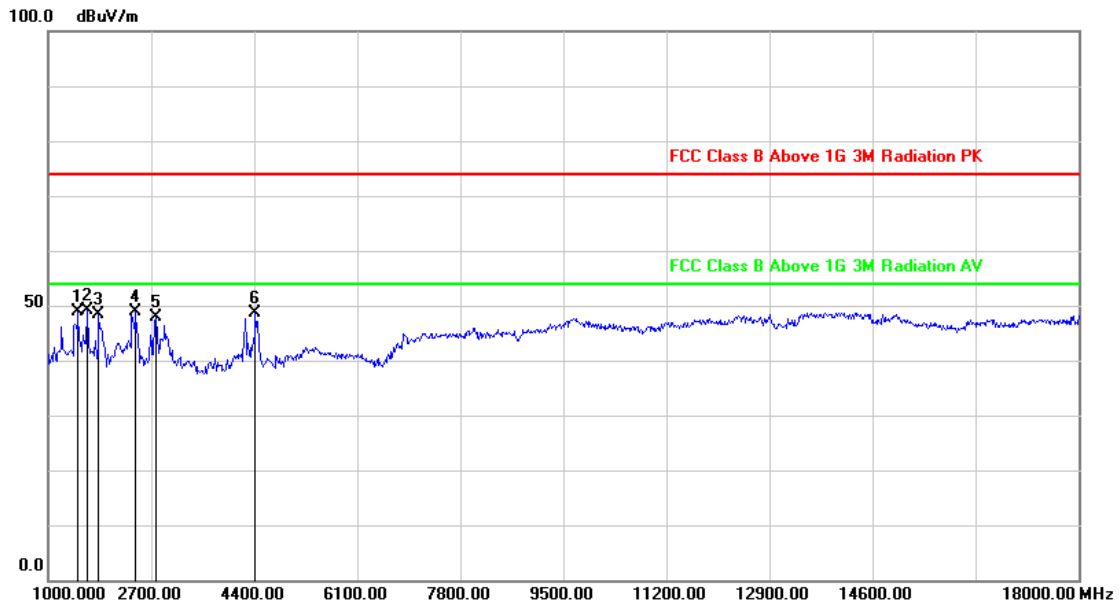

No.	Frequency (MHz)	Factor (dB/m)	Reading (dBuV)	Level (dBuV/m)	Limit (dBuV/m)	Margin (dB)	Det.	Height (cm)	Azimuth (deg)
1	1493.000	-5.83	54.62	48.79	74.00	-25.21	peak	200	187
2	1646.000	-5.17	54.35	49.18	74.00	-24.82	peak	200	309
3	1833.000	-4.39	52.83	48.44	74.00	-25.56	peak	200	128
4	2445.000	-2.04	50.87	48.83	74.00	-25.17	peak	200	155
5	2785.000	-1.48	49.33	47.85	74.00	-26.15	peak	200	219
6	4417.000	2.81	45.74	48.55	74.00	-25.45	peak	200	49

Note: Measurement Level = Reading Level + Correct Factor



Test Mode :	Mode 5: Full system work signal from PORT1 for AS-41UA (120V/60Hz)		
AC Power :	AC 120V/60HZ	Ant. Polarization:	Vertical
Temp :	25°C	Humidity :	52° C
Pressure(mbar) :	1002	Date:	2019/04/03

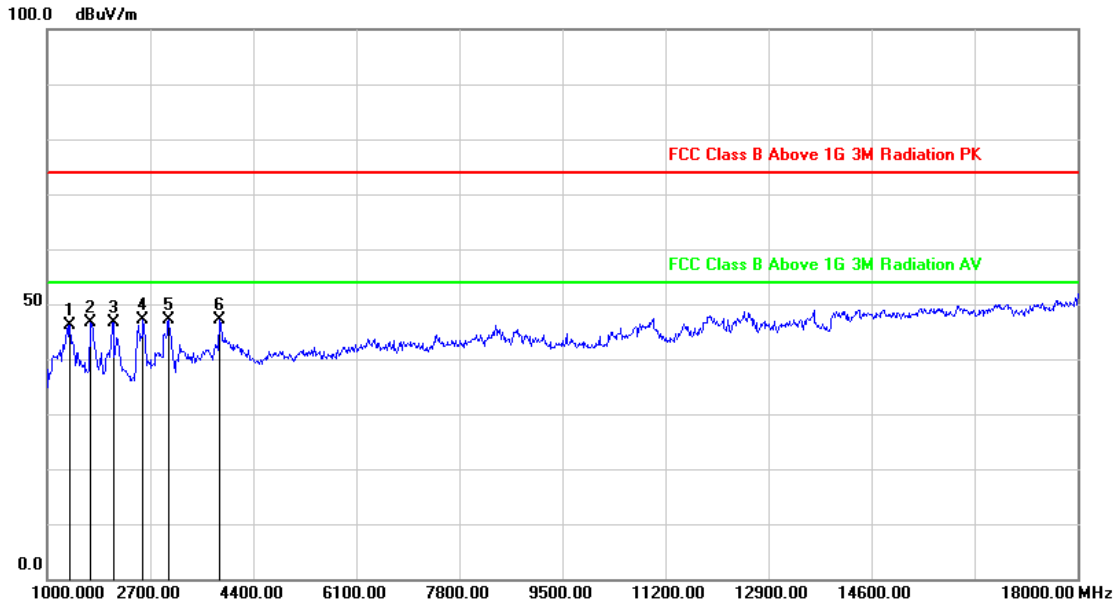

No.	Frequency (MHz)	Factor (dB/m)	Reading (dBuV)	Level (dBuV/m)	Limit (dBuV/m)	Margin (dB)	Det.	Height (cm)	Azimuth (deg)
1	1374.000	-6.78	52.98	46.20	74.00	-27.80	peak	100	276
2	1714.000	-4.88	51.40	46.52	74.00	-27.48	peak	100	269
3	2088.000	-3.37	49.90	46.53	74.00	-27.47	peak	100	15
4	2581.000	-1.73	48.81	47.08	74.00	-26.92	peak	200	300
5	3006.000	-1.19	48.25	47.06	74.00	-26.94	peak	100	162
6	3839.000	2.84	44.18	47.02	74.00	-26.98	peak	100	48

Note: Measurement Level = Reading Level + Correct Factor



Test Mode :	Mode 6: Full system work signal from PORT2 for AS-41UA (120V/60Hz)		
AC Power :	AC 120V/60HZ	Ant. Polarization:	Horizontal
Temp :	25°C	Humidity :	52° C
Pressure(mbar) :	1002	Date:	2019/04/03

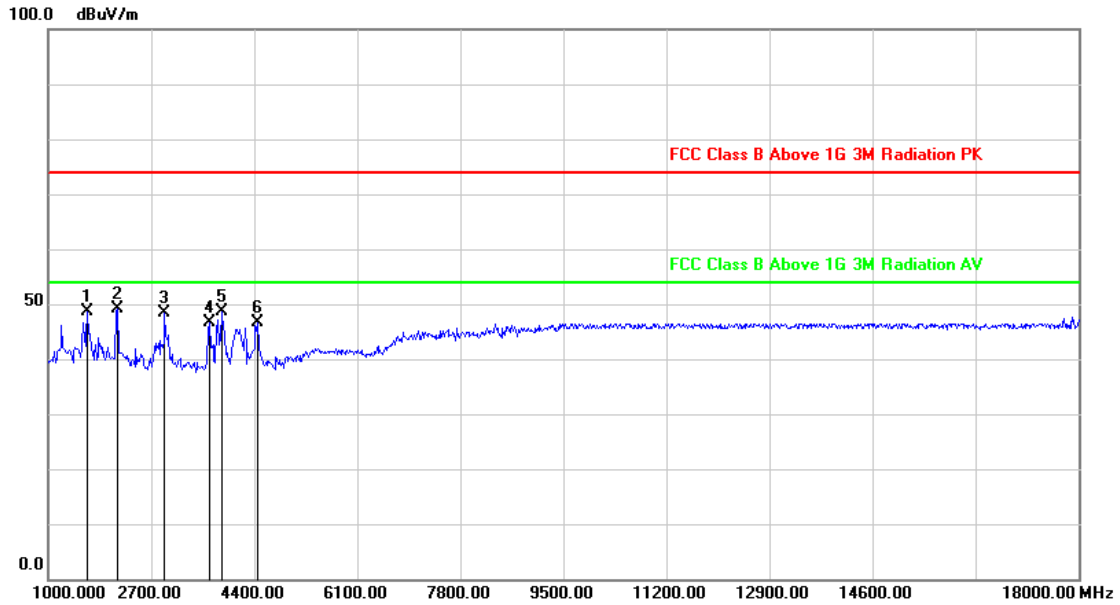

No.	Frequency (MHz)	Factor (dB/m)	Reading (dBuV)	Level (dBuV/m)	Limit (dBuV/m)	Margin (dB)	Det.	Height (cm)	Azimuth (deg)
1	1646.000	-5.17	53.85	48.68	74.00	-25.32	peak	200	264
2	2139.000	-3.18	52.35	49.17	74.00	-24.83	peak	100	189
3	2921.000	-1.32	49.81	48.49	74.00	-25.51	peak	200	302
4	3669.000	2.20	44.39	46.59	74.00	-27.41	peak	200	33
5	3856.000	2.91	45.68	48.59	74.00	-25.41	peak	200	166
6	4451.000	2.76	43.78	46.54	74.00	-27.46	peak	200	48

Note: Measurement Level = Reading Level + Correct Factor



Test Mode :	Mode 6: Full system work signal from PORT2 for AS-41UA (120V/60Hz)		
AC Power :	AC 120V/60HZ	Ant. Polarization:	Vertical
Temp :	25°C	Humidity :	52° C
Pressure(mbar) :	1002	Date:	2019/04/03

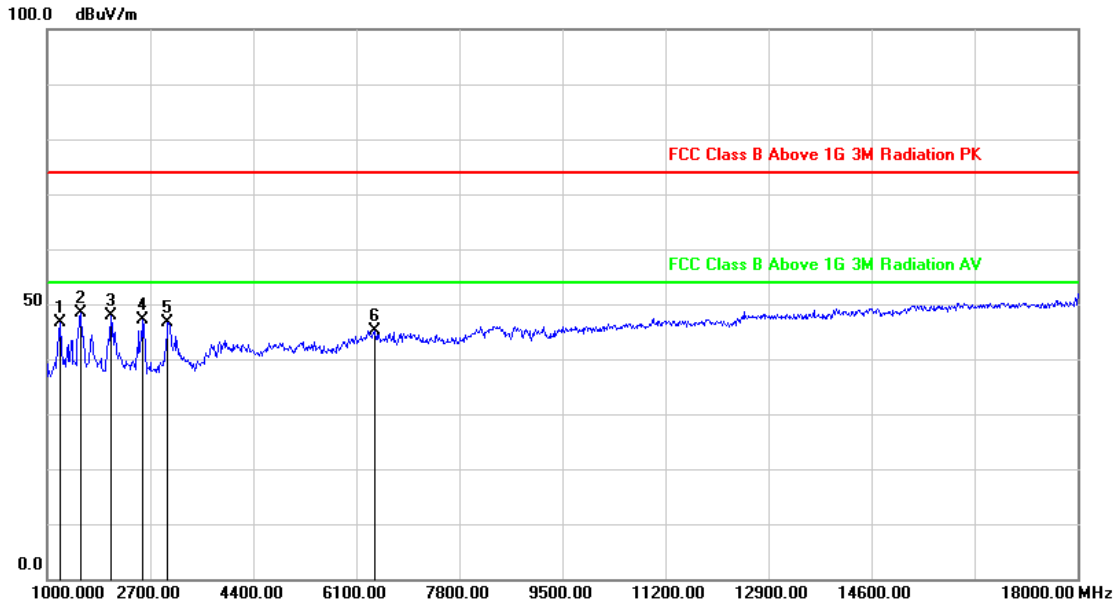

No.	Frequency (MHz)	Factor (dB/m)	Reading (dBuV)	Level (dBuV/m)	Limit (dBuV/m)	Margin (dB)	Det.	Height (cm)	Azimuth (deg)
1	1221.000	-8.00	54.59	46.59	74.00	-27.41	peak	100	302
2	1544.000	-5.59	54.04	48.45	74.00	-25.55	peak	100	188
3	2054.000	-3.50	51.26	47.76	74.00	-26.24	peak	200	162
4	2581.000	-1.73	48.81	47.08	74.00	-26.92	peak	200	179
5	2989.000	-1.23	47.85	46.62	74.00	-27.38	peak	100	48
6	6406.000	6.38	38.82	45.20	74.00	-28.80	peak	100	24

Note: Measurement Level = Reading Level + Correct Factor



Test Mode :	Mode 7: Full system work signal from PORT3 for AS-41UA (120V/60Hz)		
AC Power :	AC 120V/60HZ	Ant. Polarization:	Horizontal
Temp :	25°C	Humidity :	52° C
Pressure(mbar) :	1002	Date:	2019/04/03

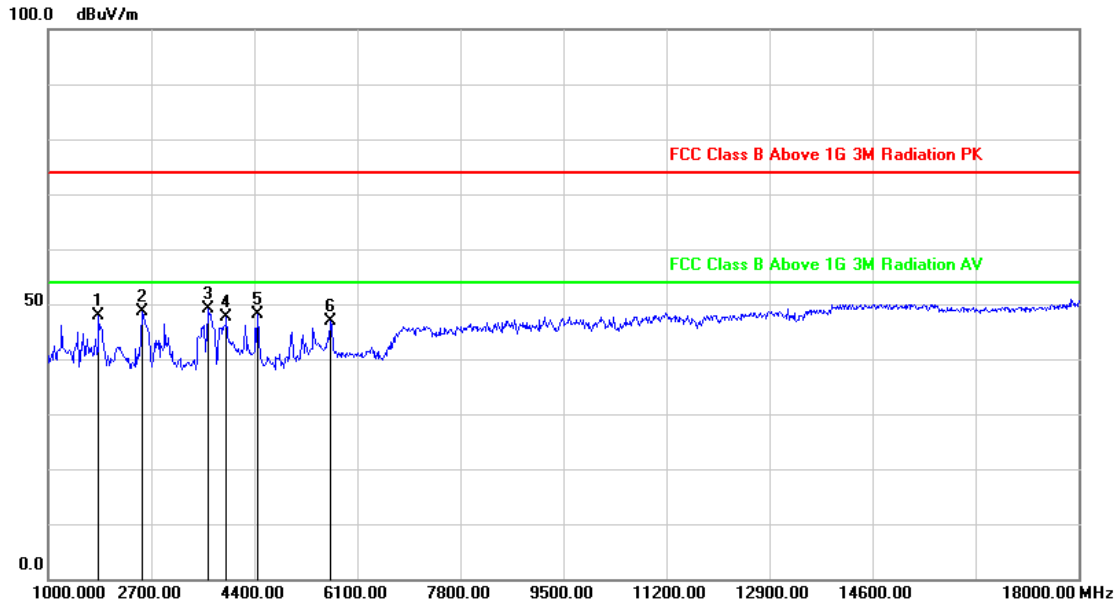

No.	Frequency (MHz)	Factor (dB/m)	Reading (dBuV)	Level (dBuV/m)	Limit (dBuV/m)	Margin (dB)	Det.	Height (cm)	Azimuth (deg)
1	1833.000	-4.39	52.33	47.94	74.00	-26.06	peak	200	49
2	2547.000	-1.77	50.32	48.55	74.00	-25.45	peak	100	288
3	3635.000	2.07	47.10	49.17	74.00	-24.83	peak	200	301
4	3941.000	3.23	44.43	47.66	74.00	-26.34	peak	200	244
5	4451.000	2.76	45.28	48.04	74.00	-25.96	peak	200	219
6	5658.000	5.27	41.53	46.80	74.00	-27.20	peak	200	163

Note: Measurement Level = Reading Level + Correct Factor



Test Mode :	Mode 7: Full system work signal from PORT3 for AS-41UA (120V/60Hz)		
AC Power :	AC 120V/60HZ	Ant. Polarization:	Vertical
Temp :	25°C	Humidity :	52° C
Pressure(mbar) :	1002	Date:	2019/04/03

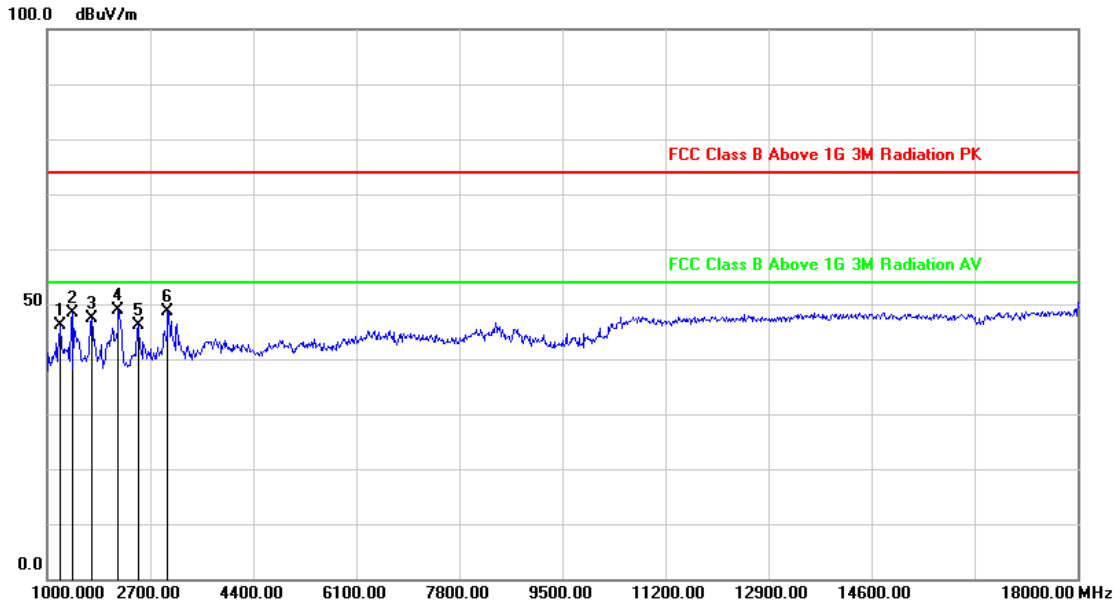

No.	Frequency (MHz)	Factor (dB/m)	Reading (dBuV)	Level (dBuV/m)	Limit (dBuV/m)	Margin (dB)	Det.	Height (cm)	Azimuth (deg)
1	1221.000	-8.00	54.09	46.09	74.00	-27.91	peak	100	154
2	1408.000	-6.51	54.89	48.38	74.00	-25.62	peak	100	59
3	1731.000	-4.81	52.30	47.49	74.00	-26.51	peak	100	177
4	2173.000	-3.05	51.84	48.79	74.00	-25.21	peak	100	168
5	2513.000	-1.81	47.86	46.05	74.00	-27.95	peak	100	289
6	2989.000	-1.23	49.85	48.62	74.00	-25.38	peak	100	302

Note: Measurement Level = Reading Level + Correct Factor



Test Mode :	Mode 8: Full system work signal from PORT4 for AS-41UA (120V/60Hz)		
AC Power :	AC 120V/60HZ	Ant. Polarization:	Horizontal
Temp :	25°C	Humidity :	52° C
Pressure(mbar) :	1002	Date:	2019/04/03

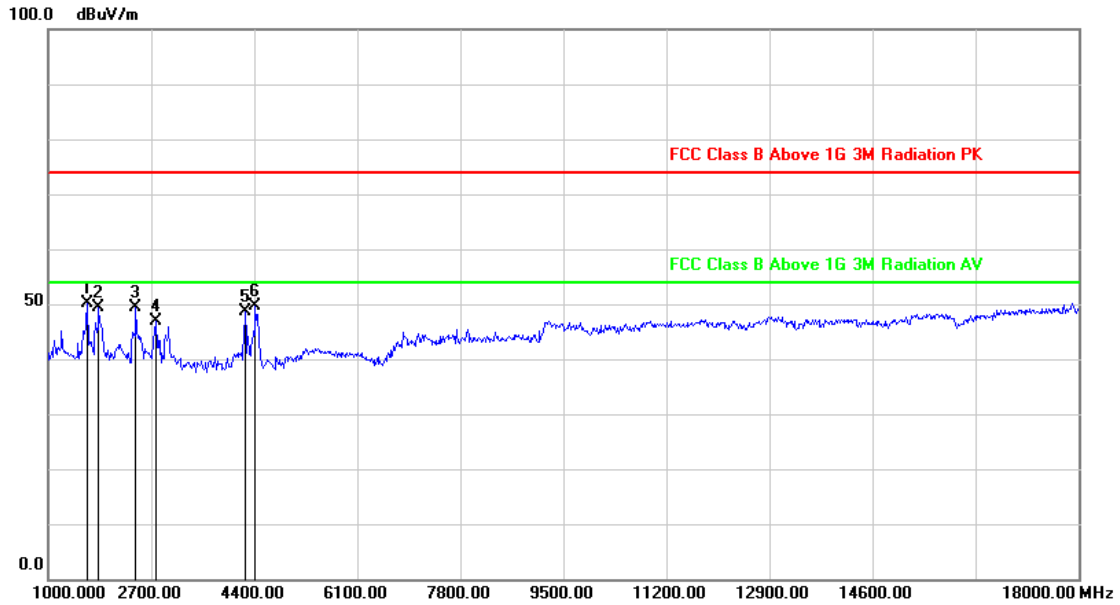

No.	Frequency (MHz)	Factor (dB/m)	Reading (dBuV)	Level (dBuV/m)	Limit (dBuV/m)	Margin (dB)	Det.	Height (cm)	Azimuth (deg)
1	1646.000	-5.17	55.35	50.18	74.00	-23.82	peak	200	93
2	1833.000	-4.39	53.83	49.44	74.00	-24.56	peak	200	158
3	2445.000	-2.04	51.37	49.33	74.00	-24.67	peak	200	187
4	2785.000	-1.48	48.33	46.85	74.00	-27.15	peak	100	60
5	4247.000	3.07	45.64	48.71	74.00	-25.29	peak	100	328
6	4417.000	2.81	46.74	49.55	74.00	-24.45	peak	200	299

Note: Measurement Level = Reading Level + Correct Factor



Test Mode :	Mode 8: Full system work signal from PORT4 for AS-41UA (120V/60Hz)		
AC Power :	AC 120V/60HZ	Ant. Polarization:	Vertical
Temp :	25°C	Humidity :	52° C
Pressure(mbar) :	1002	Date:	2019/04/03

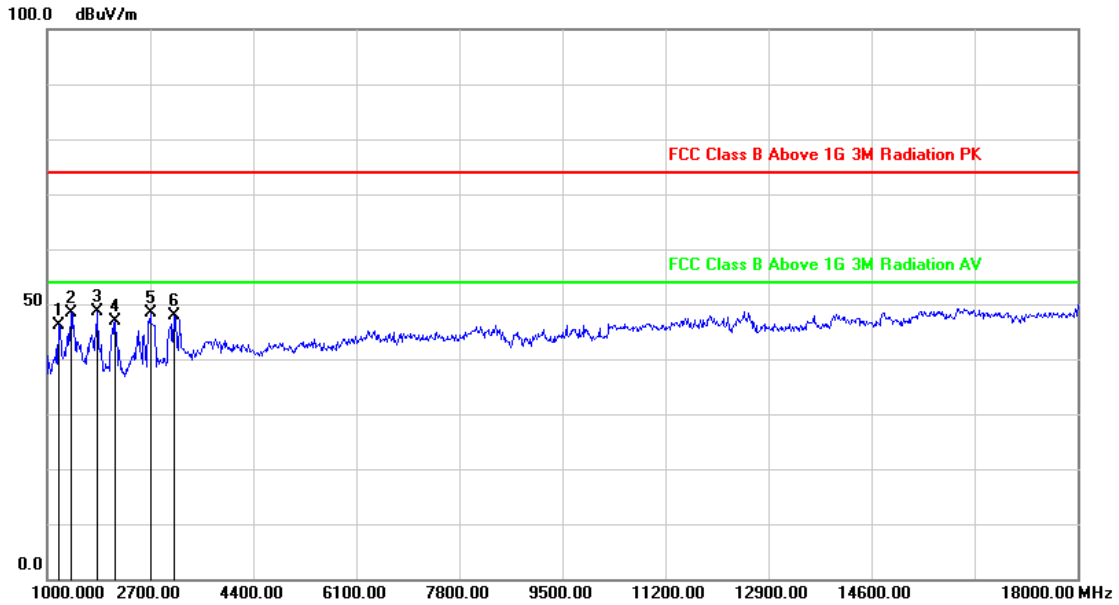

No.	Frequency (MHz)	Factor (dB/m)	Reading (dBuV)	Level (dBuV/m)	Limit (dBuV/m)	Margin (dB)	Det.	Height (cm)	Azimuth (deg)
1	1187.000	-8.27	54.50	46.23	74.00	-27.77	peak	100	329
2	1391.000	-6.64	55.09	48.45	74.00	-25.55	peak	200	155
3	1833.000	-4.39	53.05	48.66	74.00	-25.34	peak	100	176
4	2122.000	-3.24	50.21	46.97	74.00	-27.03	peak	200	302
5	2700.000	-1.59	49.86	48.27	74.00	-25.73	peak	100	84
6	3091.000	-0.72	48.53	47.81	74.00	-26.19	peak	100	99

Note: Measurement Level = Reading Level + Correct Factor

Vane Xta

Test engineer:_____