

Variant FCC Test Report

Report No.: RF150401C19I-4

FCC ID: ZQAT30

Test Model: A0013

Received Date: Jun. 08, 2018

Test Date: Jul. 20, 2018

Issued Date: Jul. 27, 2018

Applicant: Nest Labs Inc

Address: 3400 Hillview Ave. Palo Alto California, United States 94304

Issued By: Bureau Veritas Consumer Products Services (H.K.) Ltd., Taoyuan Branch

Lab Address: No. 47-2, 14th Ling, Chia Pau Vil., Lin Kou Dist., New Taipei City, Taiwan
(R.O.C)

Test Location: No. 19, Hwa Ya 2nd Rd, Wen Hwa Tsuen, Kwei Shan Hsiang, Taoyuan
Hsien 333, Taiwan, R.O.C.

**FCC Registration /
Designation Number:** 788550 / TW0003



This report is for your exclusive use. Any copying or replication of this report to or for any other person or entity, or use of our name or trademark, is permitted only with our prior written permission. This report sets forth our findings solely with respect to the test samples identified herein. The results set forth in this report are not indicative or representative of the quality or characteristics of the lot from which a test sample was taken or any similar or identical product unless specifically and expressly noted. Our report includes all of the tests requested by you and the results thereof based upon the information that you provided to us. You have 60 days from date of issuance of this report to notify us of any material error or omission caused by our negligence, provided, however, that such notice shall be in writing and shall specifically address the issue you wish to raise. A failure to raise such issue within the prescribed time shall constitute your unqualified acceptance of the completeness of this report, the tests conducted and the correctness of the report contents. Unless specific mention, the uncertainty of measurement has been explicitly taken into account to declare the compliance or non-compliance to the specification. The report must not be used by the client to claim product certification, approval, or endorsement by TAF or any government agencies.

Table of Contents

Release Control Record	3
1 Certificate of Conformity	4
2 Summary of Test Results.....	5
2.1 Measurement Uncertainty.....	5
2.2 Modification Record	5
3 General Information	6
3.1 General Description of EUT	6
3.2 Description of Test Modes.....	7
3.2.1 Test Mode Applicability and Tested Channel Detail.....	9
3.3 Description of Support Units	10
3.3.1 Configuration of System under Test	10
3.4 General Description of Applied Standards.....	10
4 Test Types and Results	11
4.1 Radiated Emission and Bandedge Measurement	11
4.1.1 Limits of Radiated Emission and Bandedge Measurement	11
4.1.2 Limits of Unwanted Emission Out of the Restricted Bands.....	12
4.1.3 Test Instruments	13
4.1.4 Test Procedures.....	14
4.1.5 Deviation from Test Standard	15
4.1.6 Test Setup.....	15
4.1.7 EUT Operating Conditions.....	16
4.1.8 Test Results	17
5 Pictures of Test Arrangements.....	47
Appendix – Information on the Testing Laboratories	48

Release Control Record

Issue No.	Description	Date Issued
RF150401C19I-4	Original Release	Jul. 27, 2018

1 Certificate of Conformity

Product: Nest Learning Thermostat

Test Model: A0013

Sample Status: Production Unit

Applicant: Nest Labs Inc

Test Date: Jul. 20, 2018

Standards: 47 CFR FCC Part 15, Subpart E (Section 15.407)
ANSI C63.10:2013

This report is issued as a supplementary report to BV ADT report no.: RF150401C19-2 R1. This report shall be used by combining with its original report.

Prepared by : Evonne Liu , **Date:** Jul. 27, 2018
Evonne Liu / Specialist

Approved by : Dylan Chiou , **Date:** Jul. 27, 2018
Dylan Chiou / Project Engineer

2 Summary of Test Results

47 CFR FCC Part 15, Subpart E (Section 15.407)			
FCC Clause	Test Item	Result	Remarks
15.407(b)(6)	AC Power Conducted Emissions	N/A	Refer to Note
15.407(b) (1/2/3/4(i/ii)/6)	Radiated Emissions & Band Edge Measurement	Pass	Meet the requirement of limit. Minimum passing margin is -0.57 dB at 5145.8 MHz.
15.407(a)(1/2/3)	Max Average Transmit Power	N/A	Refer to Note
---	Occupied Bandwidth Measurement	N/A	Refer to Note
15.407(a)(1/2/3)	Peak Power Spectral Density	N/A	Refer to Note
15.407(e)	6 dB Bandwidth	N/A	Refer to Note
15.407(g)	Frequency Stability	N/A	Refer to Note
15.203	Antenna Requirement	N/A	Refer to Note

Note: Only Radiated Emissions were performed for this report. Refer to original report for other test data.

2.1 Measurement Uncertainty

Where relevant, the following measurement uncertainty levels have been estimated for tests performed on the EUT as specified in CISPR 16-4-2:

Measurement	Frequency	Expanded Uncertainty (k=2) (±)
Radiated Emissions up to 1 GHz	30 MHz ~ 200 MHz	2.93 dB
	200 MHz ~ 1000 MHz	2.95 dB
Radiated Emissions above 1 GHz	1 GHz ~ 18 GHz	2.26 dB
	18 GHz ~ 40 GHz	1.94 dB

2.2 Modification Record

There were no modifications required for compliance.

3 General Information

3.1 General Description of EUT

Product	Nest Learning Thermostat
Test Model	A0013
Status of EUT	Production Unit
Power Supply Rating	5.0Vdc (Adapter)
Modulation Type	64QAM, 16QAM, QPSK, BPSK
Modulation Technology	OFDM
Transfer Rate	802.11a: 54.0/ 48.0/ 36.0/ 24.0/ 18.0/ 12.0/ 9.0/ 6.0 Mbps 802.11n: up to 150.0 Mbps
Operating Frequency	5180 ~ 5240 MHz, 5260 ~ 5320 MHz, 5500 ~ 5700 MHz, 5745 ~ 5825 MHz
Number of Channel	5180 ~ 5240 MHz: 4 for 802.11a, 802.11n (HT20) 2 for 802.11n (HT40) 5260 ~ 5320 MHz: 4 for 802.11a, 802.11n (HT20) 2 for 802.11n (HT40) 5500 ~ 5700 MHz: 11 for 802.11a, 802.11n (HT20) 5 for 802.11n (HT40) 5745 ~ 5825 MHz: 5 for 802.11a, 802.11n (HT20) 2 for 802.11n (HT40)
Antenna Type	Loop antenna with 1.9 dBi gain
Antenna Connector	N/A
Accessory Device	Refer to Note as below
Data Cable Supplied	Refer to Note as below

Note:

1. This report is issued as a supplementary report to BV ADT report no. RF150401C19-2 R1. The difference compared with original report is adding material of baking painting. Therefore, only Radiated Emissions was verified and recorded in this report.
2. The EUT contains following accessory devices.

Product	Brand	Model	Description
Adapter	Nest	A0017	I/P: 100-240Vac, 50/60Hz, 0.35A O/P: 5Vdc, 2.5A
USB Cable	Nest	NA	2.0m shielded cable w/o core
Stand	Nest	Stand	--

3. This device has 3 configurations as below.

Mode	Description
A	Polish steel
B	Mirror black
C	Brushed brass

4. The above EUT information is declared by manufacturer and for more detailed features description, please refers to the manufacturer's specifications or user's manual.

3.2 Description of Test Modes

For 5180 ~ 5240 MHz

4 channels are provided for 802.11a, 802.11n (HT20):

Channel	Frequency (MHz)	Channel	Frequency (MHz)
36	5180	44	5220
40	5200	48	5240

2 channels are provided for 802.11n (HT40):

Channel	Frequency (MHz)	Channel	Frequency (MHz)
38	5190	46	5230

For 5260 ~ 5320 MHz

4 channels are provided for 802.11a, 802.11n (HT20):

Channel	Frequency (MHz)	Channel	Frequency (MHz)
52	5260	60	5300
56	5280	64	5320

2 channels are provided for 802.11n (HT40):

Channel	Frequency (MHz)	Channel	Frequency (MHz)
54	5270	62	5310

For 5500 ~ 5700 MHz

11 channels are provided for 802.11a, 802.11n (HT20):

Channel	Frequency (MHz)	Channel	Frequency (MHz)
100	5500	124	5620
104	5520	128	5640
108	5540	132	5660
112	5560	136	5680
116	5580	140	5700
120	5600		

5 channels are provided for 802.11n (HT40):

Channel	Frequency (MHz)	Channel	Frequency (MHz)
102	5510	126	5630
110	5550	134	5670
118	5590		

For 5745 ~ 5825 MHz:

5 channels are provided for 802.11a, 802.11n (HT20):

Channel	Frequency (MHz)	Channel	Frequency (MHz)
149	5745	161	5805
153	5765	165	5825
157	5785		

2 channels are provided for 802.11n (HT40):

Channel	Frequency (MHz)	Channel	Frequency (MHz)
151	5755	159	5795

3.2.1 Test Mode Applicability and Tested Channel Detail

EUT Configure Mode	Applicable To		Description
	RE \geq 1G	RE<1G	
A	√	√	-
B	√	√	-
C	√	√	-

Where **RE \geq 1G**: Radiated Emission above 1 GHz **RE<1G**: Radiated Emission below 1 GHz

NOTE: 1. The EUT had been pre-tested on the positioned of each 3 axis. The worst case was found when positioned on **X-plane** for 5180-5240 and **Z-plane** for 5260-5825 mode A, B, C.

Radiated Emission Test (Above 1 GHz):

Pre-Scan has been conducted to determine the worst-case mode from all possible combinations between available modulations, data rates and antenna ports (if EUT with antenna diversity architecture).

Following channel(s) was (were) selected for the final test as listed below.

EUT Configure Mode	Frequency Band (MHz)	Mode	Available Channel	Tested Channel	Modulation Technology	Modulation Type	Data Rate (Mbps)
A, B, C	5180-5240	802.11n (HT40)	38 to 46	38	OFDM	BPSK	13.5
	5260-5320	802.11n (HT40)	54 to 62	62	OFDM	BPSK	13.5
	5500-5700	802.11n (HT20)	100 to 140	140	OFDM	BPSK	6.5
	5745-5825	802.11a	149 to 165	149	OFDM	BPSK	6.0

Radiated Emission Test (Below 1 GHz):

Pre-Scan has been conducted to determine the worst-case mode from all possible combinations between available modulations, data rates and antenna ports (if EUT with antenna diversity architecture).

Following channel(s) was (were) selected for the final test as listed below.

EUT Configure Mode	Frequency Band (MHz)	Mode	Available Channel	Tested Channel	Modulation Technology	Modulation Type	Data Rate (Mbps)
A, B, C	5180-5240	802.11n (HT40)	38 to 46	38	OFDM	BPSK	13.5

Test Condition:

Applicable To	Environmental Conditions	Input Power	Tested by
RE \geq 1G	25 deg. C, 65 % RH	120 Vac, 60 Hz	Jisyong Wang
RE<1G	25 deg. C, 65 % RH	120 Vac, 60 Hz	Jisyong Wang

3.3 Description of Support Units

The EUT has been tested as an independent unit together with other necessary accessories or support units.

3.3.1 Configuration of System under Test

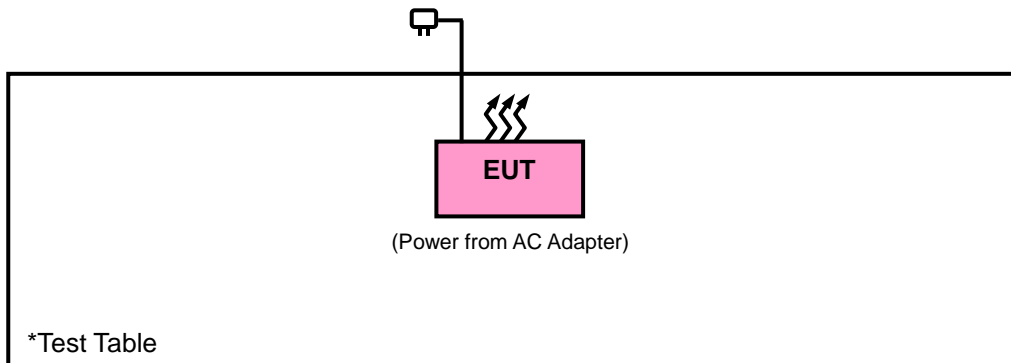

3.4 General Description of Applied Standards

The EUT is a RF Product. According to the specifications of the manufacturer, it must comply with the requirements of the following standards:

FCC Part 15, Subpart E (15.407)

KDB 789033 D02 General UNII Test Procedures New Rules v02r01

ANSI C63.10-2013

All test items have been performed and recorded as per the above standards.

4 Test Types and Results

4.1 Radiated Emission and Bandedge Measurement

4.1.1 Limits of Radiated Emission and Bandedge Measurement

Radiated emissions which fall in the restricted bands must comply with the radiated emission limits specified as below table. Other emissions shall be at least 20 dB below the highest level of the desired power:

Frequencies (MHz)	Field Strength (microvolts/meter)	Measurement Distance (meters)
0.009 ~ 0.490	2400/F (kHz)	300
0.490 ~ 1.705	24000/F (kHz)	30
1.705 ~ 30.0	30	30
30 ~ 88	100	3
88 ~ 216	150	3
216 ~ 960	200	3
Above 960	500	3

Note:

1. The lower limit shall apply at the transition frequencies.
2. Emission level (dBuV/m) = 20 log Emission level (uV/m).
3. For frequencies above 1000 MHz, the field strength limits are based on average detector, however, the peak field strength of any emission shall not exceed the maximum permitted average limits, specified above by more than 20 dB under any condition of modulation.

4.1.2 Limits of Unwanted Emission Out of the Restricted Bands

Applicable To		Limit	
789033 D02 General UNII Test Procedures New Rules v02r01		Field Strength at 3 m	
		PK: 74 (dBµV/m)	AV: 54 (dBµV/m)
Frequency Band	Applicable To	EIRP Limit	Equivalent Field Strength at 3 m
5150~5250 MHz	15.407(b)(1)	PK: -27 (dBm/MHz)	PK: 68.2 (dBµV/m)
5250~5350 MHz	15.407(b)(2)		
5470~5725 MHz	15.407(b)(3)		
5725~5850 MHz	15.407(b)(4)(i)	PK:-27 (dBm/MHz) ^{*1} PK:10 (dBm/MHz) ^{*2} PK:15.6 (dBm/MHz) ^{*3} PK:27 (dBm/MHz) ^{*4}	PK: 68.2 (dBµV/m) ^{*1} PK:105.2 (dBµV/m) ^{*2} PK: 110.8 (dBµV/m) ^{*3} PK:122.2 (dBµV/m) ^{*4}
	15.407(b)(4)(ii)	Emission limits in section 15.247(d)	
^{*1} beyond 75 MHz or more above of the band edge. ^{*2} below the band edge increasing linearly to 10 dBm/MHz at 25 MHz above. ^{*3} below the band edge increasing linearly to a level of 15.6 dBm/MHz at 5 MHz above. ^{*4} from 5 MHz above or below the band edge increasing linearly to a level of 27 dBm/MHz at the band edge.			

Note:

The following formula is used to convert the equipment isotropic radiated power (eirp) to field strength:

$$E = \frac{1000000\sqrt{30P}}{3} \mu\text{V/m, where } P \text{ is the eirp (Watts).}$$

4.1.3 Test Instruments

Description & Manufacturer	Model No.	Serial No.	Date of Calibration	Due Date of Calibration
Test Receiver ROHDE & SCHWARZ	ESCI	100424	Oct. 17, 2017	Oct. 16, 2018
Spectrum Analyzer Agilent	N9010A	MY52220207	Dec. 07, 2017	Dec. 06, 2018
Spectrum Analyzer ROHDE & SCHWARZ	FSP40	100041	Dec. 12, 2017	Dec. 11, 2018
BILOG Antenna SCHWARZBECK	VULB9168	9168-171	Dec. 11, 2017	Dec. 10, 2018
HORN Antenna SCHWARZBECK	9120D	209	Dec. 13, 2017	Dec. 12, 2018
HORN Antenna SCHWARZBECK	BBHA 9170	BBHA9170241	Dec. 01, 2017	Nov. 30, 2018
Fixed Attenuator Mini-Circuits	BW-N4W5+	PAD-ATT4-01	Jan. 29, 2018	Jan. 28, 2019
Loop Antenna	EM-6879	269	Aug. 11, 2017	Aug. 10, 2018
Preamplifier EMCI	EMC001340	980201	Nov. 01, 2017	Oct. 31, 2018
Preamplifier EMCI	EMC 012645	980115	Oct. 20, 2017	Oct. 19, 2018
Preamplifier EMCI	EMC 184045	980116	Oct. 20, 2017	Oct. 19, 2018
Preamplifier EMCI	EMC 330H	980112	Oct. 20, 2017	Oct. 19, 2018
Power Meter Anritsu	ML2495A	1012010	Aug. 15, 2017	Aug. 14, 2018
Power Sensor Anritsu	MA2411B	1315050	Aug. 15, 2017	Aug. 14, 2018
RF Coaxial Cable	8D-FB	Cable-RF3-04	Oct. 19, 2017	Oct. 18, 2018
RF signal cable HUBER+SUHNER	SUCOFLEX 104	230129/4	Oct. 19, 2017	Oct. 18, 2018
RF signal cable HUBER+SUHNER	SUCOFLEX 104	250723/4	Oct. 19, 2017	Oct. 18, 2018
Software BV ADT	E3 6.120103	NA	NA	NA
Antenna Tower MF	MFA-440H	NA	NA	NA
Turn Table MF	MFT-201SS	NA	NA	NA
Antenna Tower & Turn Table Controller MF	MF-7802	NA	NA	NA

- Note: 1. The calibration interval of the above test instruments is 12 months and the calibrations are traceable to NML/ROC and NIST/USA.
2. The test was performed in HwaYa Chamber 10.
3. The horn antenna and preamplifier (model: EMC 184045) are used only for the measurement of emission frequency above 1 GHz if tested.
4. The IC Site Registration No. is IC7450F-10.

4.1.4 Test Procedures

For Radiated Emission below 30 MHz

- a. The EUT was placed on the top of a rotating table 0.8 meters above the ground at a 3 meter chamber room. The table was rotated 360 degrees to determine the position of the highest radiation.
- b. The EUT was set 3 meters away from the interference-receiving antenna, which was mounted on the top of a variable-height antenna tower.
- c. Both Parallel, perpendicular, and ground-parallel orientations of the antenna are set to make the measurement.
- d. For each suspected emission, the EUT was arranged to its worst case and the rotatable table was turned from 0 degrees to 360 degrees to find the maximum reading.
- e. The test-receiver system was set to Quasi-Peak Detect Function and Specified Bandwidth with Maximum Hold Mode.

Note:

1. The resolution bandwidth and video bandwidth of test receiver/spectrum analyzer is 9 kHz at frequency below 30 MHz.

For Radiated Emission above 30 MHz

- a. The EUT was placed on the top of a rotating table 0.8 meters (for 30 MHz ~ 1 GHz) / 1.5 meters (for above 1 GHz) above the ground at 3 meter chamber room for test. The table was rotated 360 degrees to determine the position of the highest radiation.
- b. The EUT was set 3 meters away from the interference-receiving antenna, which was mounted on the top of a variable-height antenna tower.
- c. The height of antenna is varied from one meter to four meters above the ground to determine the maximum value of the field strength. Both horizontal and vertical polarizations of the antenna are set to make the measurement.
- d. For each suspected emission, the EUT was arranged to its worst case and then the antenna was tuned to heights from 1 meter to 4 meters and the rotatable table was turned from 0 degrees to 360 degrees to find the maximum reading.
- e. The test-receiver system was set to quasi-peak detect function and specified bandwidth with maximum hold mode when the test frequency is below 1 GHz.
- f. The test-receiver system was set to peak and average detected function and specified bandwidth with maximum hold mode when the test frequency is above 1 GHz. If the peak reading value also meets average limit, measurement with the average detector is unnecessary.

Note:

1. The resolution bandwidth and video bandwidth of test receiver/spectrum analyzer is 120 kHz for Quasi-peak detection (QP) at frequency below 1 GHz.
2. The resolution bandwidth of test receiver/spectrum analyzer is 1 MHz and the video bandwidth is 3 MHz for Peak detection (PK) at frequency above 1 GHz.
3. The resolution bandwidth of test receiver/spectrum analyzer is 1 MHz and the video bandwidth is $\geq 1/T$ (Duty cycle < 98 %) or 10 Hz (Duty cycle ≥ 98 %) for Average detection (AV) at frequency above 1 GHz.
(11a: RBW = 1 MHz, VBW = 1 kHz ; 11n (HT20): RBW = 1 MHz, VBW = 1 kHz ;
11n (HT40): RBW = 1 MHz, VBW = 1 kHz ; 11ac (VHT80): RBW = 1 MHz, VBW = 1 kHz)
4. All modes of operation were investigated and the worst-case emissions are reported.

4.1.5 Deviation from Test Standard

No deviation.

4.1.6 Test Setup

<Radiated Emission below 30 MHz>

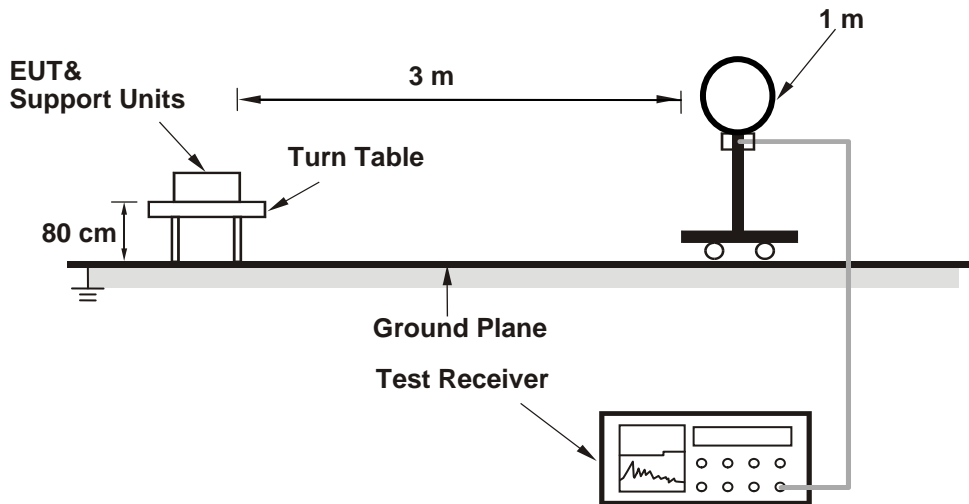

<Radiated Emission 30 MHz to 1 GHz>

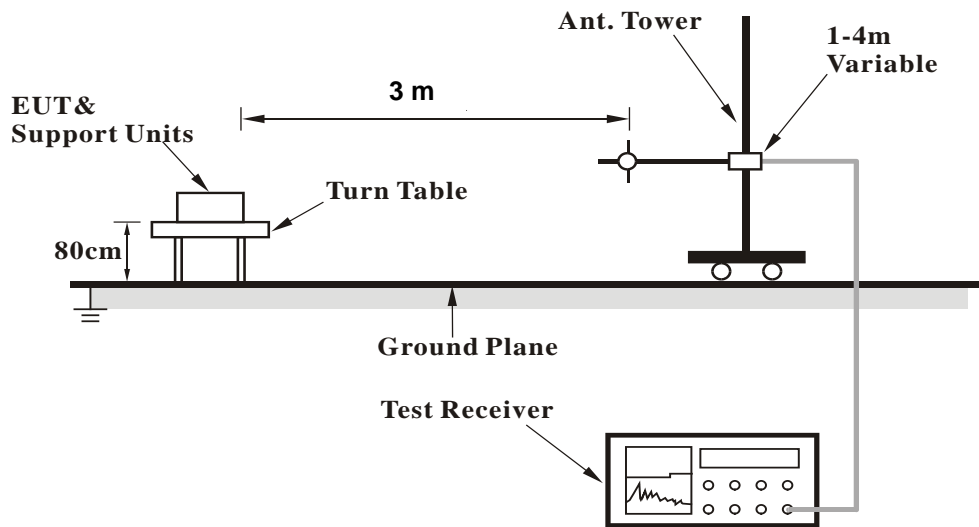

<Radiated Emission above 1 GHz>

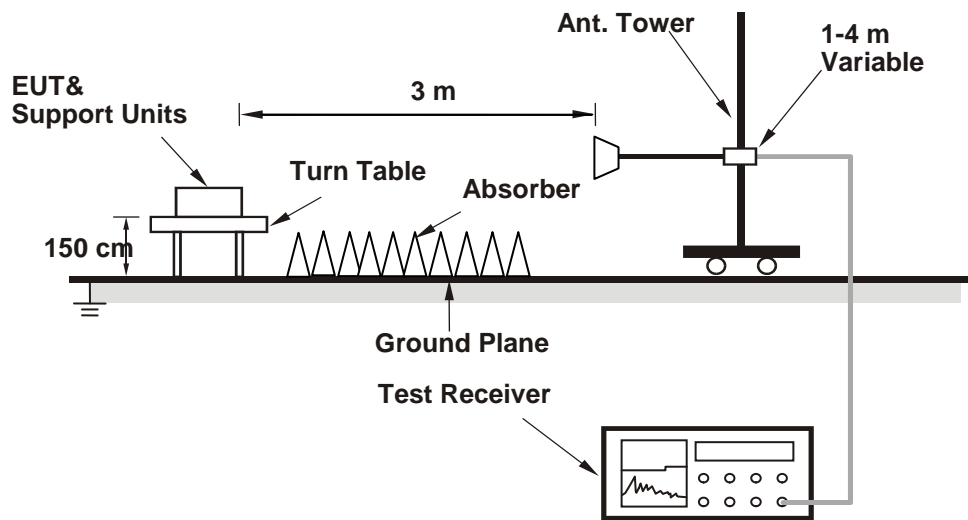

For the actual test configuration, please refer to the attached file (Test Setup Photo).

4.1.7 EUT Operating Conditions

- Placed the EUT on a testing table.
- Use the software to control the EUT under transmission condition continuously at specific channel frequency.

4.1.8 Test Results
 Above 1 GHz Data :
 Mode A
 802.11a

EUT Test Condition		Measurement Detail	
Channel	Channel 149	Frequency Range	1 GHz ~ 40 GHz
Input Power	120 Vac, 60 Hz	Detector Function	Peak (PK) Average (AV)
Environmental Conditions	25 deg. C, 65 % RH	Tested By	Jisyong Wang

Horizontal

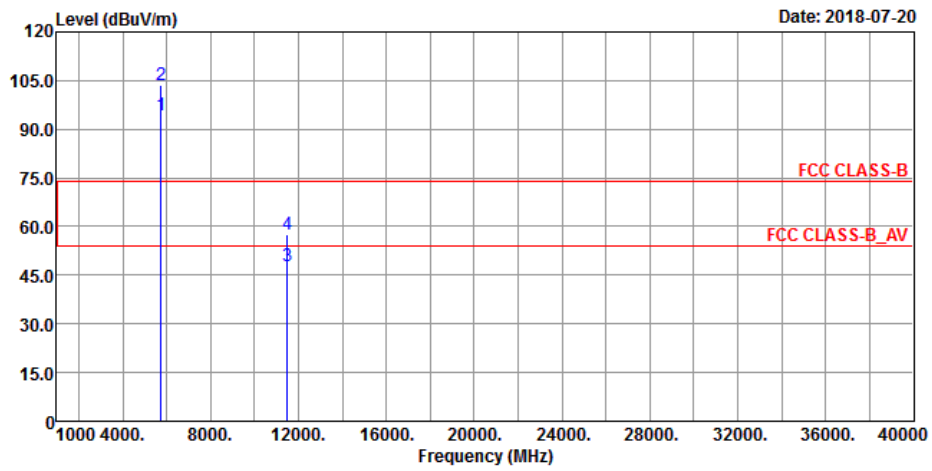

Vertical

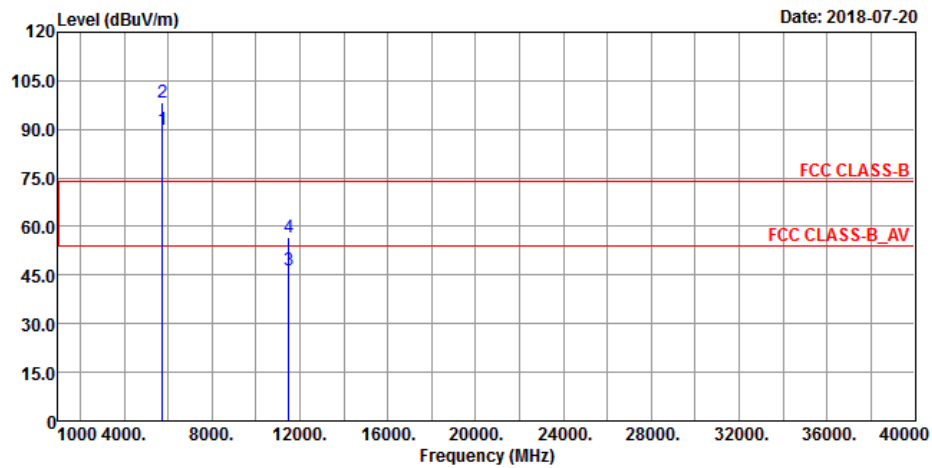

<Spurious Emission>

Antenna Polarity & Test Distance: Horizontal at 3 m										
Frequency (MHz)	Emission Level (dBuV/m)	Read Level (dBuV)	Limit (dBuV/m)	Margin (dB)	Antenna Factor (dB/m)	Cable Loss (dB)	Preamp Factor (dB)	Antenna Height (cm)	Table Angle (Degree)	Remark
5745	96.43	96.31			31.99	5.6	37.47	126	64	Average
5745	107.51	107.39			31.99	5.6	37.47	126	64	Peak
11490	51.07	54.94	68.2	-17.13	39.91	9.05	52.83	152	231	Peak
Antenna Polarity & Test Distance: Vertical at 3 m										
Frequency (MHz)	Emission Level (dBuV/m)	Read Level (dBuV)	Limit (dBuV/m)	Margin (dB)	Antenna Factor (dB/m)	Cable Loss (dB)	Preamp Factor (dB)	Antenna Height (cm)	Table Angle (Degree)	Remark
5745	93.91	93.79			31.99	5.6	37.47	100	327	Average
5745	102.47	102.35			31.99	5.6	37.47	100	327	Peak
11490	50.29	54.16	68.2	-17.91	39.91	9.05	52.83	265	251	Peak

<Out of Band Emission (OOBE)>

Antenna Polarity & Test Distance: Horizontal at 3 m										
Frequency (MHz)	Emission Level (dBuV/m)	Read Level (dBuV)	Limit (dBuV/m)	Margin (dB)	Antenna Factor (dB/m)	Cable Loss (dB)	Preamp Factor (dB)	Antenna Height (cm)	Table Angle (Degree)	Remark
5562.825	51.73	50.33	68.2	-16.47	31.89	6.63	37.12	154	54	Peak
5654.025	50.4	48.97	71.19	-20.79	32.06	6.71	37.34	154	54	Peak
5923.35	50.82	48.94	69.42	-18.6	32.52	6.86	37.5	154	54	Peak
5991.275	51.98	49.97	68.2	-16.22	32.63	6.89	37.51	154	54	Peak
Antenna Polarity & Test Distance: Vertical at 3 m										
Frequency (MHz)	Emission Level (dBuV/m)	Read Level (dBuV)	Limit (dBuV/m)	Margin (dB)	Antenna Factor (dB/m)	Cable Loss (dB)	Preamp Factor (dB)	Antenna Height (cm)	Table Angle (Degree)	Remark
5647.375	51.25	49.79	68.2	-16.95	32.04	6.7	37.28	105	160	Peak
5655.45	50.72	49.29	72.25	-21.53	32.06	6.71	37.34	105	160	Peak
5920.975	51.31	49.46	71.17	-19.86	32.49	6.86	37.5	105	160	Peak
6018.35	52.53	50.46	68.2	-15.67	32.67	6.9	37.5	105	160	Peak

Remarks:

1. Emission Level = Read Level + Antenna Factor + Cable Loss - Preamp Factor
Margin value = Emission level – Limit value
2. 5745 MHz: Fundamental Frequency
3. *: Out of Restricted Band
4. The emission levels of other frequencies were very low against the limit

802.11n (HT20)

EUT Test Condition		Measurement Detail	
Channel	Channel 140	Frequency Range	1 GHz ~ 40 GHz
Input Power	120 Vac, 60 Hz	Detector Function	Peak (PK) Average (AV)
Environmental Conditions	25 deg. C, 65 % RH	Tested By	Jisyong Wang

Horizontal

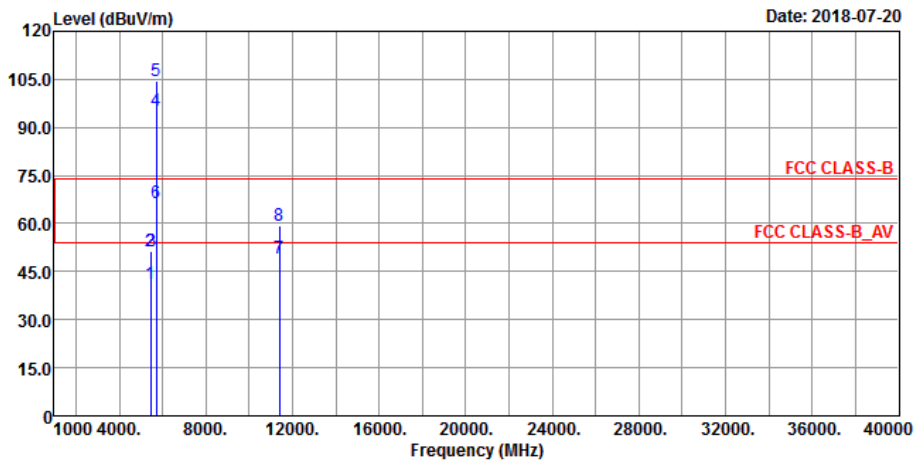

Vertical

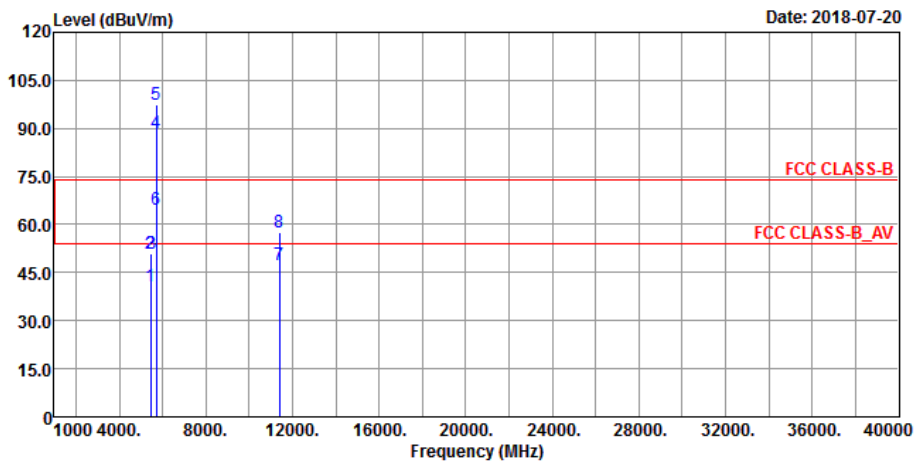

Antenna Polarity & Test Distance: Horizontal at 3 m

Frequency (MHz)	Emission Level (dBuV/m)	Read Level (dBuV)	Limit (dBuV/m)	Margin (dB)	Antenna Factor (dB/m)	Cable Loss (dB)	Preamp Factor (dB)	Antenna Height (cm)	Table Angle (Degree)	Remark
5436	60.08	60.24	68.2	-8.12	31.55	5.42	37.13	120	242	Peak
5470	57.63	57.69	68.2	-10.57	31.57	5.45	37.08	120	242	Peak
5700	90.93	90.86			31.9	5.57	37.4	120	242	Average
5700	100.57	100.5			31.9	5.57	37.4	120	242	Peak
5725	60.28	60.16	68.2	-7.92	31.96	5.59	37.43	120	242	Peak
11400	51.32	54.54	68.2	-16.88	39.96	8.95	52.13	152	265	Peak

Antenna Polarity & Test Distance: Vertical at 3 m

Frequency (MHz)	Emission Level (dBuV/m)	Read Level (dBuV)	Limit (dBuV/m)	Margin (dB)	Antenna Factor (dB/m)	Cable Loss (dB)	Preamp Factor (dB)	Antenna Height (cm)	Table Angle (Degree)	Remark
5436	60.08	60.24	68.2	-8.12	31.55	5.42	37.13	120	242	Peak
5470	57.63	57.69	68.2	-10.57	31.57	5.45	37.08	120	242	Peak
5700	90.93	90.86			31.9	5.57	37.4	120	242	Average
5700	100.57	100.5			31.9	5.57	37.4	120	242	Peak
5725	60.28	60.16	68.2	-7.92	31.96	5.59	37.43	120	242	Peak
11400	51.32	54.54	68.2	-16.88	39.96	8.95	52.13	152	265	Peak

Remarks:

- Emission Level = Read Level + Antenna Factor + Cable Loss - Preamp Factor
Margin value = Emission level – Limit value
- 5700 MHz: Fundamental Frequency
- *: Out of Restricted Band
- The emission levels of other frequencies were very low against the limit

802.11n (HT40)

EUT Test Condition		Measurement Detail	
Channel	Channel 38	Frequency Range	1 GHz ~ 40 GHz
Input Power	120 Vac, 60 Hz	Detector Function	Peak (PK) Average (AV)
Environmental Conditions	25 deg. C, 65 % RH	Tested By	Jisyong Wang

Horizontal

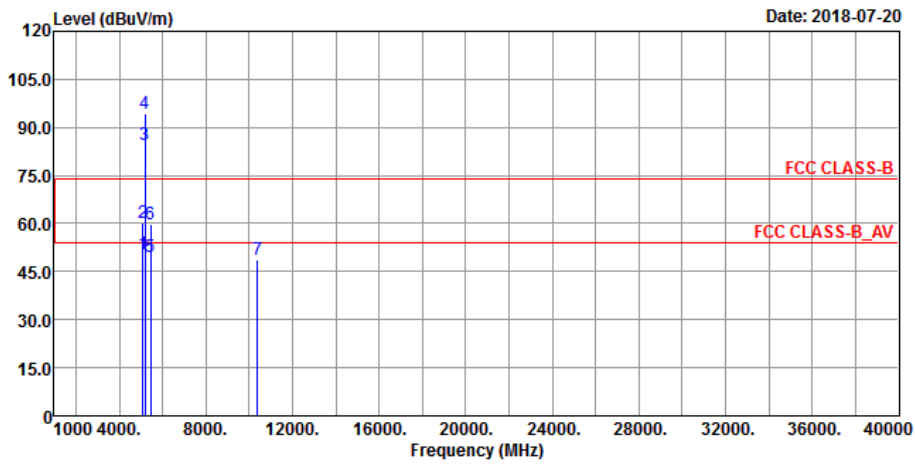

Vertical

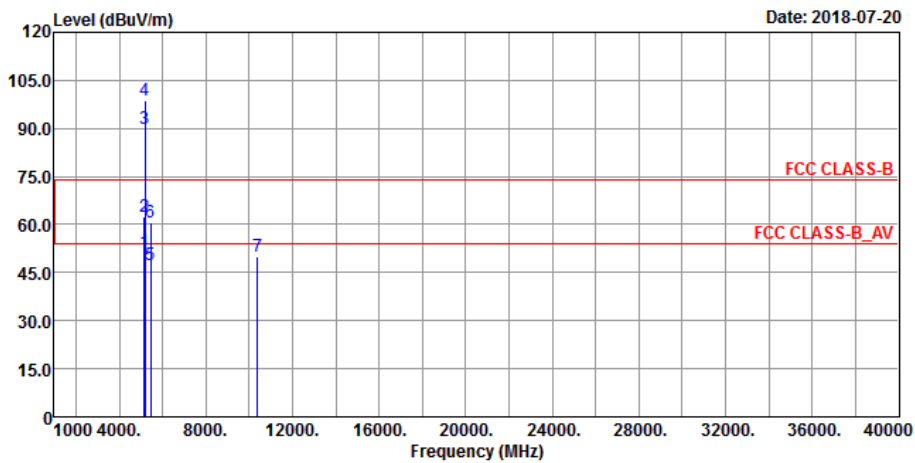

Antenna Polarity & Test Distance: Horizontal at 3 m

Frequency (MHz)	Emission Level (dBuV/m)	Read Level (dBuV)	Limit (dBuV/m)	Margin (dB)	Antenna Factor (dB/m)	Cable Loss (dB)	Preamp Factor (dB)	Antenna Height (cm)	Table Angle (Degree)	Remark
5110	60.39	61.11	68.2	-7.81	31.29	5.27	37.28	126	224	Peak
5190	84.46	85.13			31.35	5.32	37.34	126	224	Average
5190	94.15	94.82			31.35	5.32	37.34	126	224	Peak
5452	59.77	59.85	68.2	-8.43	31.56	5.44	37.08	126	224	Peak
10380	48.85	53.75	68.2	-19.35	39.21	8.14	52.25	251	152	Peak

Antenna Polarity & Test Distance: Vertical at 3 m

Frequency (MHz)	Emission Level (dBuV/m)	Read Level (dBuV)	Limit (dBuV/m)	Margin (dB)	Antenna Factor (dB/m)	Cable Loss (dB)	Preamp Factor (dB)	Antenna Height (cm)	Table Angle (Degree)	Remark
5150	62.58	63.29	68.2	-5.62	31.32	5.29	37.32	123	14	Peak
5190	89.84	90.51			31.35	5.32	37.34	123	14	Average
5190	98.61	99.28			31.35	5.32	37.34	123	14	Peak
5444	60.5	60.64	68.2	-7.7	31.55	5.44	37.13	123	14	Peak
10380	50.02	54.92	68.2	-18.18	39.21	8.14	52.25	256	321	Peak

Remarks:

- Emission Level = Read Level + Antenna Factor + Cable Loss - Preamp Factor
Margin value = Emission level – Limit value
- 5190 MHz: Fundamental Frequency
- *: Out of Restricted Band
- The emission levels of other frequencies were very low against the limit

EUT Test Condition		Measurement Detail	
Channel	Channel 62	Frequency Range	1 GHz ~ 40 GHz
Input Power	120 Vac, 60 Hz	Detector Function	Peak (PK) Average (AV)
Environmental Conditions	25 deg. C, 65 % RH	Tested By	Jisyong Wang

Horizontal

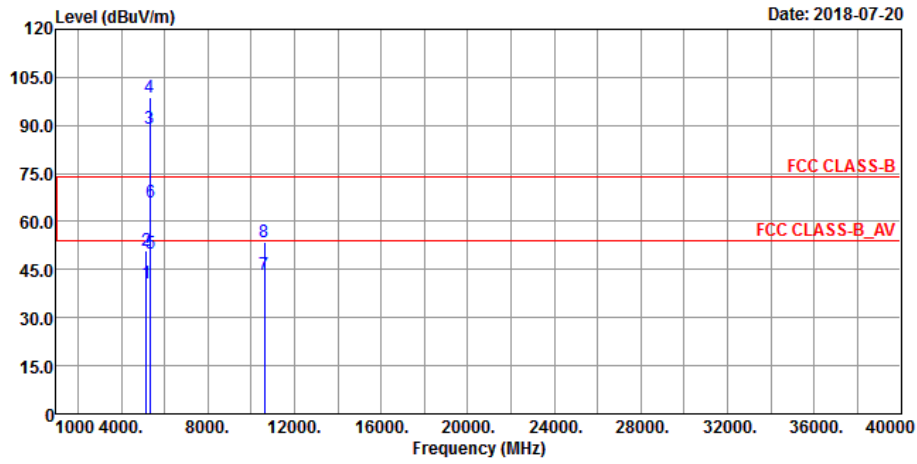

Vertical

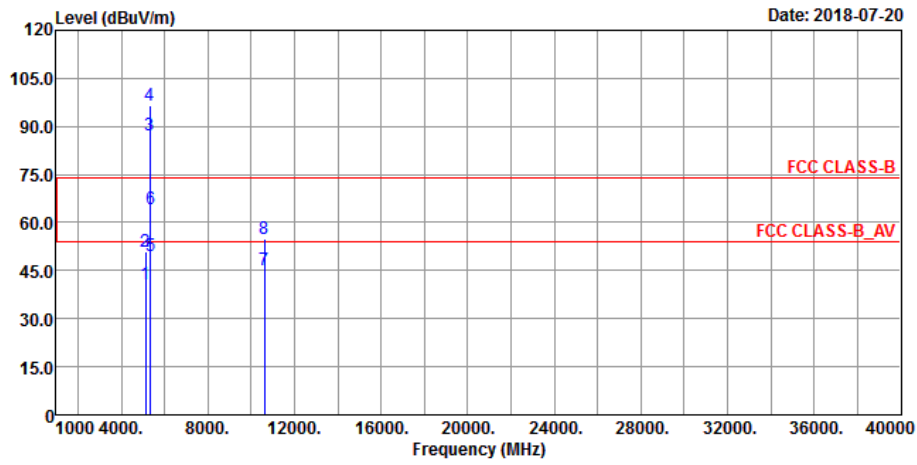

Antenna Polarity & Test Distance: Horizontal at 3 m

Frequency (MHz)	Emission Level (dBuV/m)	Read Level (dBuV)	Limit (dBuV/m)	Margin (dB)	Antenna Factor (dB/m)	Cable Loss (dB)	Preamp Factor (dB)	Antenna Height (cm)	Table Angle (Degree)	Remark
5008	59.65	60.45	68.2	-8.55	31.21	5.22	37.23	110	176	Peak
5310	88.89	89.26			31.45	5.37	37.19	110	176	Average
5310	98.54	98.91			31.45	5.37	37.19	110	176	Peak
5352	66.89	67.2	68.2	-1.31	31.48	5.39	37.18	110	176	Peak
10620	49.64	54.09	68.2	-18.56	39.59	8.3	52.34	152	265	Peak

Antenna Polarity & Test Distance: Vertical at 3 m

Frequency (MHz)	Emission Level (dBuV/m)	Read Level (dBuV)	Limit (dBuV/m)	Margin (dB)	Antenna Factor (dB/m)	Cable Loss (dB)	Preamp Factor (dB)	Antenna Height (cm)	Table Angle (Degree)	Remark
5088	60.04	60.77	68.2	-8.16	31.27	5.27	37.27	101	19	Peak
5310	89.93	90.3			31.45	5.37	37.19	101	19	Average
5310	99.9	100.27			31.45	5.37	37.19	101	19	Peak
5352	66.57	66.88	68.2	-1.63	31.48	5.39	37.18	101	19	Peak
10620	50.24	54.69	68.2	-17.96	39.59	8.3	52.34	265	147	Peak

Remarks:

1. Emission Level = Read Level + Antenna Factor + Cable Loss - Preamp Factor
Margin value = Emission level – Limit value
2. 5310 MHz: Fundamental Frequency
3. *: Out of Restricted Band
4. The emission levels of other frequencies were very low against the limit

Mode B
802.11a

EUT Test Condition		Measurement Detail	
Channel	Channel 149	Frequency Range	1 GHz ~ 40 GHz
Input Power	120 Vac, 60 Hz	Detector Function	Peak (PK) Average (AV)
Environmental Conditions	25 deg. C, 65 % RH	Tested By	Jisyong Wang

Horizontal

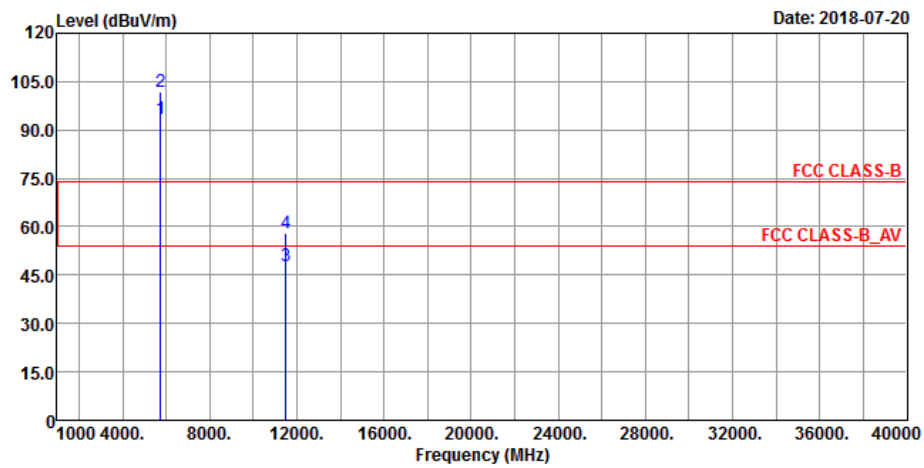

Vertical

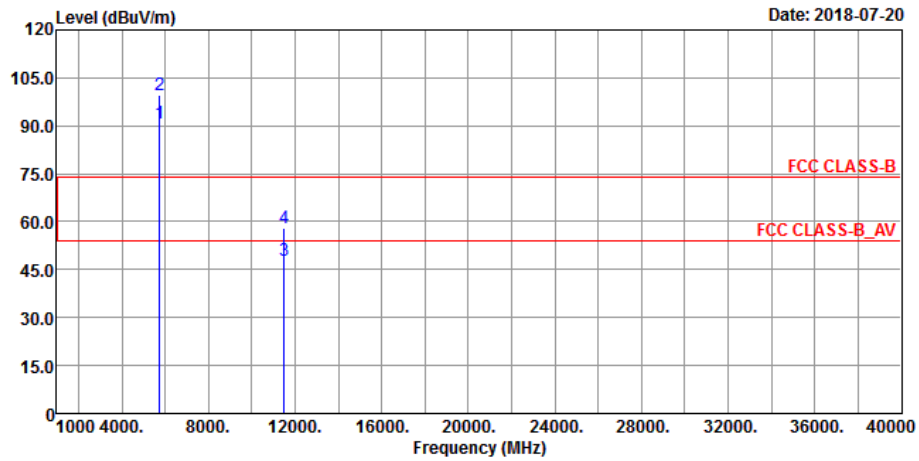

<Spurious Emission>

Antenna Polarity & Test Distance: Horizontal at 3 m										
Frequency (MHz)	Emission Level (dBuV/m)	Read Level (dBuV)	Limit (dBuV/m)	Margin (dB)	Antenna Factor (dB/m)	Cable Loss (dB)	Preamp Factor (dB)	Antenna Height (cm)	Table Angle (Degree)	Remark
5745	93.82	92.3			32.21	6.78	37.47	149	65	Average
5745	102.93	101.41			32.21	6.78	37.47	149	65	Peak
11490	54.94	57.78	68.2	-13.26	40.25	9.69	52.78	137	233	Peak
Antenna Polarity & Test Distance: Vertical at 3 m										
Frequency (MHz)	Emission Level (dBuV/m)	Read Level (dBuV)	Limit (dBuV/m)	Margin (dB)	Antenna Factor (dB/m)	Cable Loss (dB)	Preamp Factor (dB)	Antenna Height (cm)	Table Angle (Degree)	Remark
5745	92.14	90.62			32.21	6.78	37.47	155	346	Average
5745	100.86	99.34			32.21	6.78	37.47	155	346	Peak
11490	54.73	57.57	68.2	-13.47	40.25	9.69	52.78	124	304	Peak

<Out of Band Emission (OOBE)>

Antenna Polarity & Test Distance: Horizontal at 3 m										
Frequency (MHz)	Emission Level (dBuV/m)	Read Level (dBuV)	Limit (dBuV/m)	Margin (dB)	Antenna Factor (dB/m)	Cable Loss (dB)	Preamp Factor (dB)	Antenna Height (cm)	Table Angle (Degree)	Remark
5626	52.37	50.89	68.2	-15.83	32.01	6.69	37.22	149	65	Peak
5657.35	51.21	49.78	73.66	-22.45	32.06	6.71	37.34	149	65	Peak
5918.6	51.08	49.23	72.92	-21.84	32.49	6.86	37.5	149	65	Peak
5976.55	51.86	49.89	68.2	-16.34	32.6	6.88	37.51	149	65	Peak
Antenna Polarity & Test Distance: Vertical at 3 m										
Frequency (MHz)	Emission Level (dBuV/m)	Read Level (dBuV)	Limit (dBuV/m)	Margin (dB)	Antenna Factor (dB/m)	Cable Loss (dB)	Preamp Factor (dB)	Antenna Height (cm)	Table Angle (Degree)	Remark
5608.425	51.27	49.83	68.2	-16.93	31.98	6.68	37.22	155	346	Peak
5659.725	50.12	48.69	75.42	-25.3	32.06	6.71	37.34	155	346	Peak
5922.875	50.08	48.2	69.77	-19.69	32.52	6.86	37.5	155	346	Peak
5975.125	51.77	49.8	68.2	-16.43	32.6	6.88	37.51	155	346	Peak

Remarks:

1. Emission Level = Read Level + Antenna Factor + Cable Loss - Preamp Factor
Margin value = Emission level – Limit value
2. 5745 MHz: Fundamental Frequency
3. *: Out of Restricted Band
4. The emission levels of other frequencies were very low against the limit

802.11n (HT20)

EUT Test Condition		Measurement Detail	
Channel	Channel 140	Frequency Range	1 GHz ~ 40 GHz
Input Power	120 Vac, 60 Hz	Detector Function	Peak (PK) Average (AV)
Environmental Conditions	25 deg. C, 65 % RH	Tested By	Jisyong Wang

Horizontal

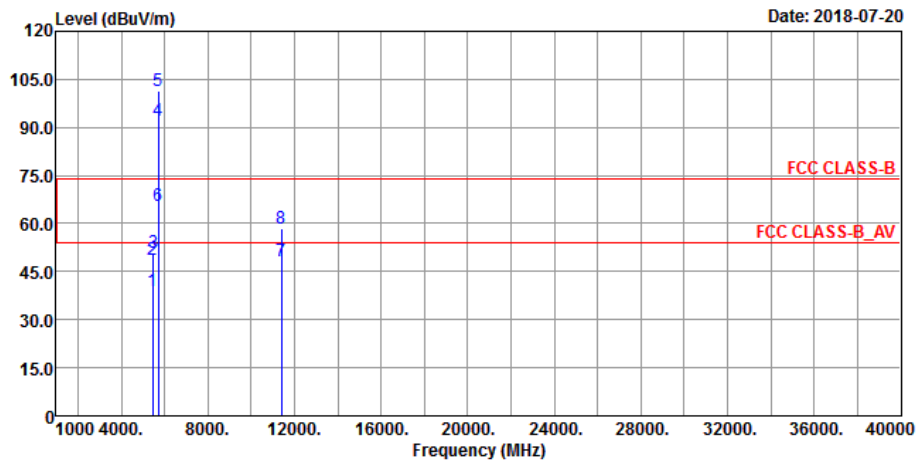

Vertical

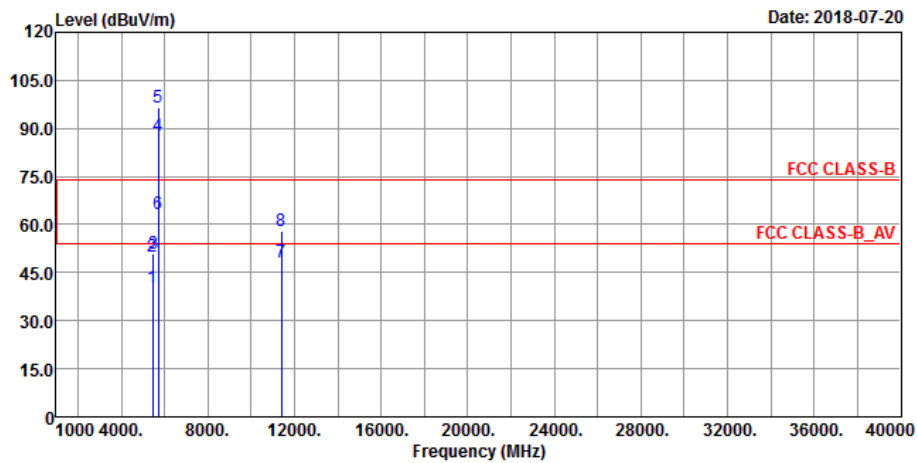

Antenna Polarity & Test Distance: Horizontal at 3 m

Frequency (MHz)	Emission Level (dBuV/m)	Read Level (dBuV)	Limit (dBuV/m)	Margin (dB)	Antenna Factor (dB/m)	Cable Loss (dB)	Preamp Factor (dB)	Antenna Height (cm)	Table Angle (Degree)	Remark
5459.12	50.91	49.71	68.2	-17.29	31.77	6.51	37.08	121	184	Peak
5700	91.9	90.45			32.12	6.73	37.4	121	184	Average
5700	101.36	99.91			32.12	6.73	37.4	121	184	Peak
5725.08	67.09	65.58	68.2	-1.11	32.18	6.76	37.43	121	184	Peak
11400	54.92	56.82	68.2	-13.28	40.33	10.47	52.7	133	219	Peak

Antenna Polarity & Test Distance: Vertical at 3 m

Frequency (MHz)	Emission Level (dBuV/m)	Read Level (dBuV)	Limit (dBuV/m)	Margin (dB)	Antenna Factor (dB/m)	Cable Loss (dB)	Preamp Factor (dB)	Antenna Height (cm)	Table Angle (Degree)	Remark
5419.28	51.09	50.04	68.2	-17.11	31.75	6.48	37.18	170	346	Peak
5700	89.68	88.23			32.12	6.73	37.4	170	346	Average
5700	97.75	96.3			32.12	6.73	37.4	170	346	Peak
5725.16	65.74	64.23	68.2	-2.46	32.18	6.76	37.43	170	346	Peak
11400	56.3	58.2	68.2	-11.9	40.33	10.47	52.7	155	47	Peak

Remarks:

- Emission Level = Read Level + Antenna Factor + Cable Loss - Preamp Factor
Margin value = Emission level – Limit value
- 5700 MHz: Fundamental Frequency
- *: Out of Restricted Band
- The emission levels of other frequencies were very low against the limit

802.11n (HT40)

EUT Test Condition		Measurement Detail	
Channel	Channel 38	Frequency Range	1 GHz ~ 40 GHz
Input Power	120 Vac, 60 Hz	Detector Function	Peak (PK) Average (AV)
Environmental Conditions	25 deg. C, 65 % RH	Tested By	Jisyong Wang

Horizontal

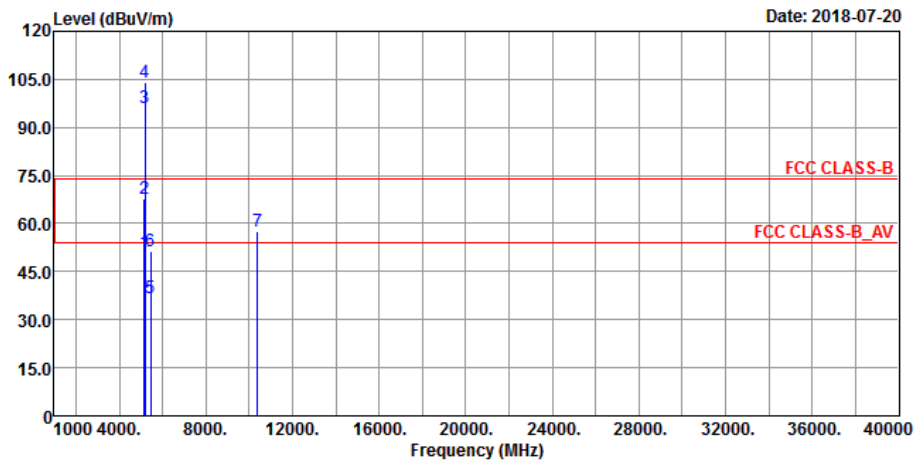

Vertical

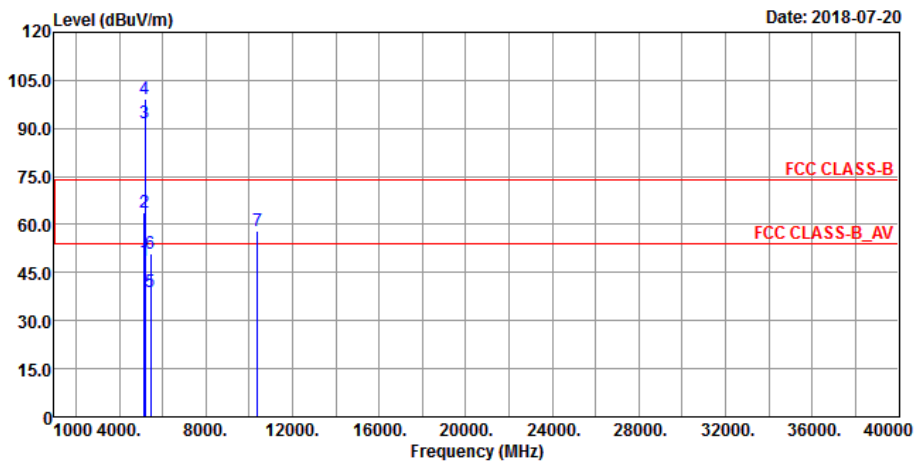

Antenna Polarity & Test Distance: Horizontal at 3 m

Frequency (MHz)	Emission Level (dBuV/m)	Read Level (dBuV)	Limit (dBuV/m)	Margin (dB)	Antenna Factor (dB/m)	Cable Loss (dB)	Preamp Factor (dB)	Antenna Height (cm)	Table Angle (Degree)	Remark
5146.16	67.28	66.7	68.2	-0.92	31.56	6.34	37.32	132	234	Peak
5190	93.23	92.6			31.59	6.38	37.34	132	234	Average
5190	102.12	101.49			31.59	6.38	37.34	132	234	Peak
5431.51	52.06	50.94	68.2	-16.14	31.76	6.49	37.13	132	234	Peak
10380	51.97	55.8	68.2	-16.23	39.5	9.12	52.45	155	200	Peak

Antenna Polarity & Test Distance: Vertical at 3 m

Frequency (MHz)	Emission Level (dBuV/m)	Read Level (dBuV)	Limit (dBuV/m)	Margin (dB)	Antenna Factor (dB/m)	Cable Loss (dB)	Preamp Factor (dB)	Antenna Height (cm)	Table Angle (Degree)	Remark
5146.88	67.08	66.5	68.2	-1.12	31.56	6.34	37.32	105	57	Peak
5190	91.83	91.2			31.59	6.38	37.34	105	57	Average
5190	99.19	98.56			31.59	6.38	37.34	105	57	Peak
5381.13	50.29	49.27	68.2	-17.91	31.73	6.47	37.18	105	57	Peak
10380	52.82	56.65	68.2	-15.38	39.5	9.12	52.45	118	224	Peak

Remarks:

- Emission Level = Read Level + Antenna Factor + Cable Loss - Preamp Factor
Margin value = Emission level – Limit value
- 5190 MHz: Fundamental Frequency
- *: Out of Restricted Band
- The emission levels of other frequencies were very low against the limit

EUT Test Condition		Measurement Detail	
Channel	Channel 62	Frequency Range	1 GHz ~ 40 GHz
Input Power	120 Vac, 60 Hz	Detector Function	Peak (PK) Average (AV)
Environmental Conditions	25 deg. C, 65 % RH	Tested By	Jisyong Wang

Horizontal

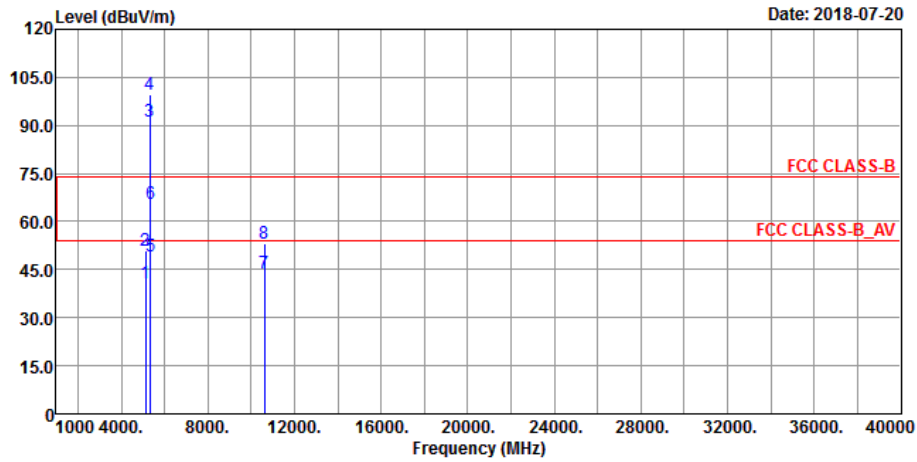

Vertical

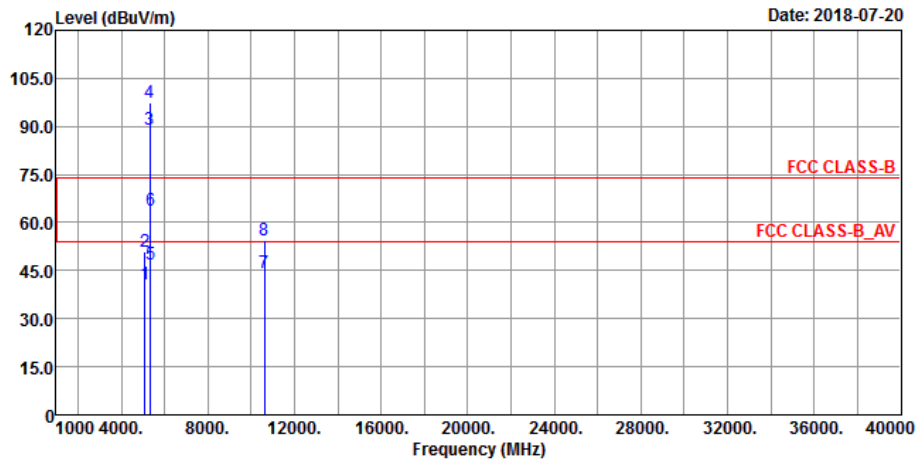

Antenna Polarity & Test Distance: Horizontal at 3 m

Frequency (MHz)	Emission Level (dBuV/m)	Read Level (dBuV)	Limit (dBuV/m)	Margin (dB)	Antenna Factor (dB/m)	Cable Loss (dB)	Preamp Factor (dB)	Antenna Height (cm)	Table Angle (Degree)	Remark
5116.64	51.01	50.44	68.2	-17.19	31.54	6.31	37.28	176	212	Peak
5310	92.18	91.23			31.68	6.46	37.19	176	212	Average
5310	100.43	99.48			31.68	6.46	37.19	176	212	Peak
5350	66.26	65.27	68.2	-1.94	31.7	6.47	37.18	176	212	Peak
10620	53.85	56.66	68.2	-14.35	39.89	10.39	53.09	156	227	Peak

Antenna Polarity & Test Distance: Vertical at 3 m

Frequency (MHz)	Emission Level (dBuV/m)	Read Level (dBuV)	Limit (dBuV/m)	Margin (dB)	Antenna Factor (dB/m)	Cable Loss (dB)	Preamp Factor (dB)	Antenna Height (cm)	Table Angle (Degree)	Remark
5097.2	51.69	51.15	68.2	-16.51	31.53	6.29	37.28	100	50	Peak
5310	90.37	89.42			31.68	6.46	37.19	100	50	Average
5310	99.14	98.19			31.68	6.46	37.19	100	50	Peak
5350.11	62.66	61.67	68.2	-5.54	31.7	6.47	37.18	100	50	Peak
10620	53.49	56.3	68.2	-14.71	39.89	10.39	53.09	119	81	Peak

Remarks:

- Emission Level = Read Level + Antenna Factor + Cable Loss - Preamp Factor
Margin value = Emission level – Limit value
- 5310 MHz: Fundamental Frequency
- *: Out of Restricted Band
- The emission levels of other frequencies were very low against the limit

Mode C
802.11a

EUT Test Condition		Measurement Detail	
Channel	Channel 149	Frequency Range	1 GHz ~ 40 GHz
Input Power	120 Vac, 60 Hz	Detector Function	Peak (PK) Average (AV)
Environmental Conditions	25 deg. C, 65 % RH	Tested By	Jisyong Wang

Horizontal

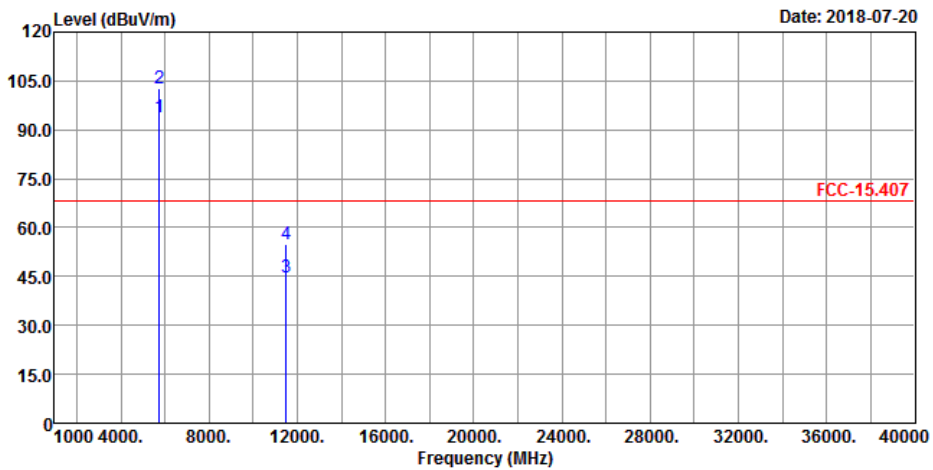

Vertical

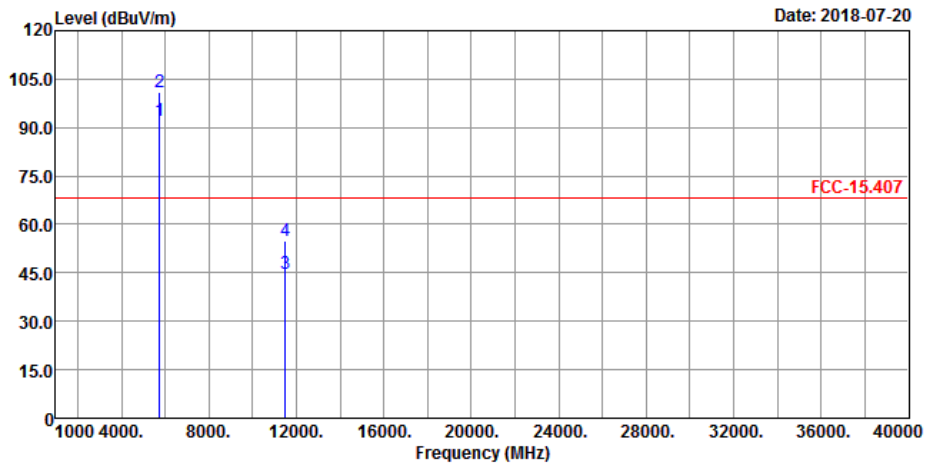

<Spurious Emission>

Antenna Polarity & Test Distance: Horizontal at 3 m										
Frequency (MHz)	Emission Level (dBuV/m)	Read Level (dBuV)	Limit (dBuV/m)	Margin (dB)	Antenna Factor (dB/m)	Cable Loss (dB)	Preamp Factor (dB)	Antenna Height (cm)	Table Angle (Degree)	Remark
5745	93.43	91.91			32.21	6.78	37.47	130	179	Average
5745	101.81	100.29			32.21	6.78	37.47	130	179	Peak
11490	58.02	59.89	68.2	-10.18	40.25	10.66	52.78	130	147	Peak
Antenna Polarity & Test Distance: Vertical at 3 m										
Frequency (MHz)	Emission Level (dBuV/m)	Read Level (dBuV)	Limit (dBuV/m)	Margin (dB)	Antenna Factor (dB/m)	Cable Loss (dB)	Preamp Factor (dB)	Antenna Height (cm)	Table Angle (Degree)	Remark
5745	90.61	89.09			32.21	6.78	37.47	100	119	Average
5745	99.7	98.18			32.21	6.78	37.47	100	119	Peak
11490	57.84	59.71	68.2	-10.36	40.25	10.66	52.78	137	228	Peak

<Out of Band Emission (OOBE)>

Antenna Polarity & Test Distance: Horizontal at 3 m										
Frequency (MHz)	Emission Level (dBuV/m)	Read Level (dBuV)	Limit (dBuV/m)	Margin (dB)	Antenna Factor (dB/m)	Cable Loss (dB)	Preamp Factor (dB)	Antenna Height (cm)	Table Angle (Degree)	Remark
5639.775	51.65	50.19	68.2	-16.55	32.04	6.7	37.28	130	179	Peak
5653.075	51.84	50.35	70.49	-18.65	32.06	6.71	37.28	130	179	Peak
5922.875	51.26	49.38	69.77	-18.51	32.52	6.86	37.5	130	179	Peak
6012.65	52.49	50.42	68.2	-15.71	32.67	6.9	37.5	130	179	Peak
Antenna Polarity & Test Distance: Vertical at 3 m										
Frequency (MHz)	Emission Level (dBuV/m)	Read Level (dBuV)	Limit (dBuV/m)	Margin (dB)	Antenna Factor (dB/m)	Cable Loss (dB)	Preamp Factor (dB)	Antenna Height (cm)	Table Angle (Degree)	Remark
5636.925	50.91	49.45	68.2	-17.29	32.04	6.7	37.28	100	119	Peak
5660.2	51.57	50.14	75.77	-24.2	32.06	6.71	37.34	100	119	Peak
5916.7	51.28	49.43	74.32	-23.04	32.49	6.86	37.5	100	119	Peak
6004.1	52.21	50.2	68.2	-15.99	32.63	6.89	37.51	100	119	Peak

Remarks:

- Emission Level = Read Level + Antenna Factor + Cable Loss - Preamp Factor
Margin value = Emission level – Limit value
- 5745 MHz: Fundamental Frequency
- *: Out of Restricted Band
- The emission levels of other frequencies were very low against the limit

802.11n (HT20)

EUT Test Condition		Measurement Detail	
Channel	Channel 140	Frequency Range	1 GHz ~ 40 GHz
Input Power	120 Vac, 60 Hz	Detector Function	Peak (PK) Average (AV)
Environmental Conditions	25 deg. C, 65 % RH	Tested By	Jisyong Wang

Horizontal

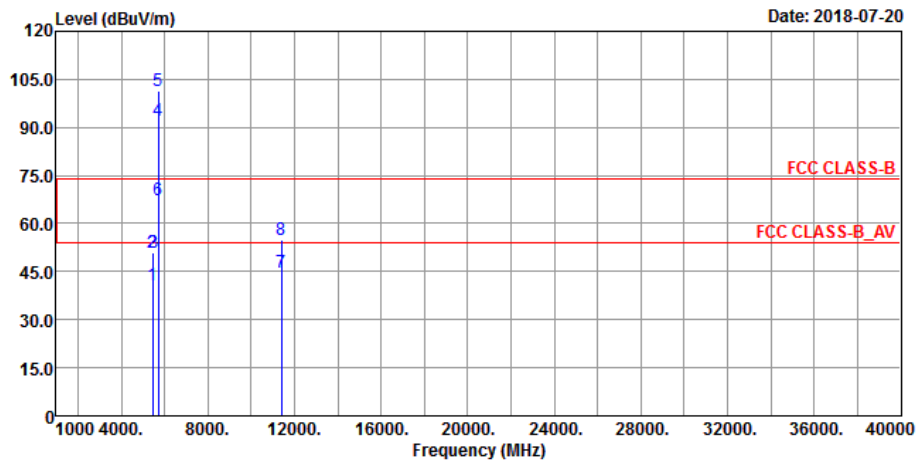

Vertical

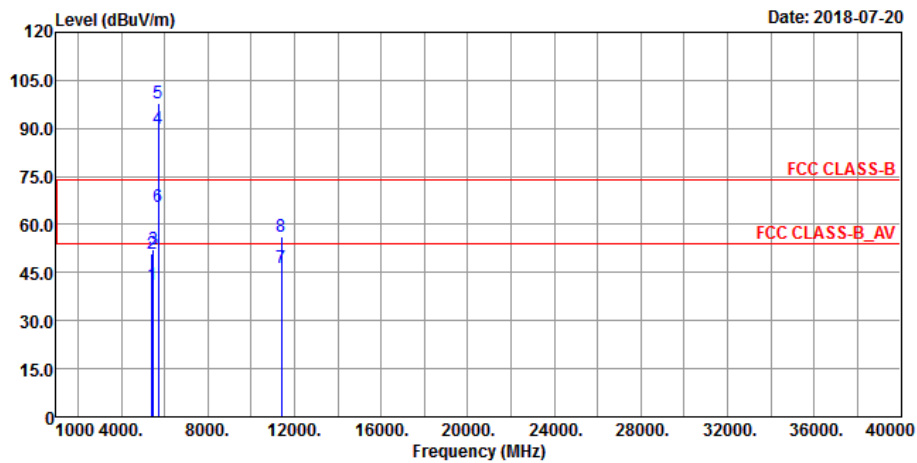

Antenna Polarity & Test Distance: Horizontal at 3 m

Frequency (MHz)	Emission Level (dBuV/m)	Read Level (dBuV)	Limit (dBuV/m)	Margin (dB)	Antenna Factor (dB/m)	Cable Loss (dB)	Preamp Factor (dB)	Antenna Height (cm)	Table Angle (Degree)	Remark
5434.16	50.83	49.71	68.2	-17.37	31.76	6.49	37.13	132	178	Peak
5700	92.31	90.86			32.12	6.73	37.4	132	178	Average
5700	101.37	99.92			32.12	6.73	37.4	132	178	Peak
5725	65.43	63.92	68.2	-2.77	32.18	6.76	37.43	132	178	Peak
11400	58.4	60.3	68.2	-9.8	40.33	10.47	52.7	119	97	Peak

Antenna Polarity & Test Distance: Vertical at 3 m

Frequency (MHz)	Emission Level (dBuV/m)	Read Level (dBuV)	Limit (dBuV/m)	Margin (dB)	Antenna Factor (dB/m)	Cable Loss (dB)	Preamp Factor (dB)	Antenna Height (cm)	Table Angle (Degree)	Remark
5425.52	51.13	50.02	68.2	-17.07	31.75	6.49	37.13	100	134	Peak
5700	87.63	86.18			32.12	6.73	37.4	100	134	Average
5700	96.34	94.89			32.12	6.73	37.4	100	134	Peak
5726.92	63.46	61.95	68.2	-4.74	32.18	6.76	37.43	100	134	Peak
11400	58.1	60	68.2	-10.1	40.33	10.47	52.7	157	231	Peak

Remarks:

- Emission Level = Read Level + Antenna Factor + Cable Loss - Preamp Factor
Margin value = Emission level – Limit value
- 5700 MHz: Fundamental Frequency
- *: Out of Restricted Band
- The emission levels of other frequencies were very low against the limit

802.11n (HT40)

EUT Test Condition		Measurement Detail	
Channel	Channel 38	Frequency Range	1 GHz ~ 40 GHz
Input Power	120 Vac, 60 Hz	Detector Function	Peak (PK) Average (AV)
Environmental Conditions	25 deg. C, 65 % RH	Tested By	Jisyong Wang

Horizontal

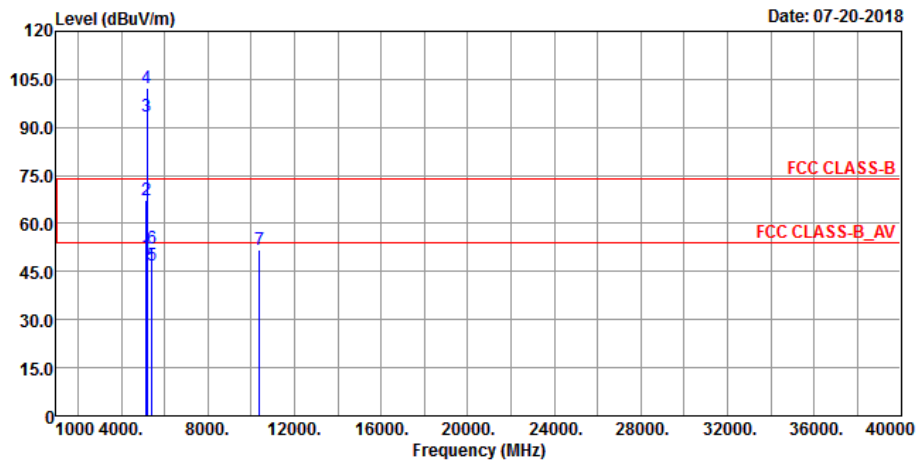

Vertical

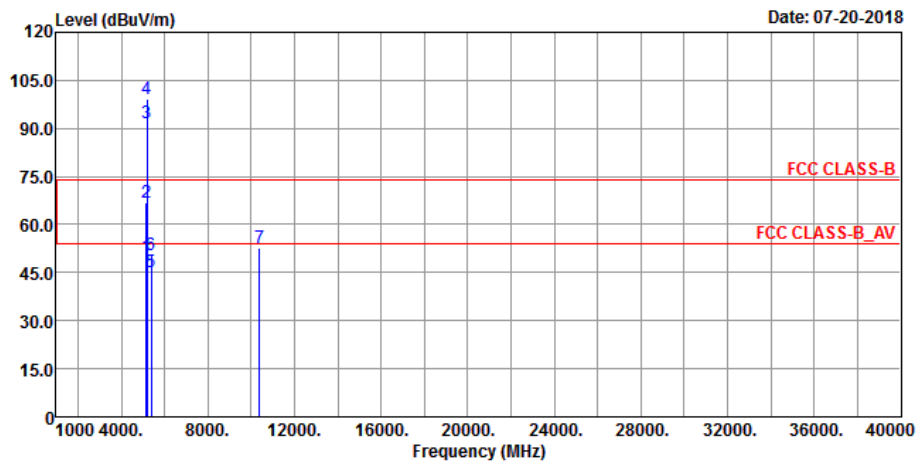

Antenna Polarity & Test Distance: Horizontal at 3 m

Frequency (MHz)	Emission Level (dBuV/m)	Read Level (dBuV)	Limit (dBuV/m)	Margin (dB)	Antenna Factor (dB/m)	Cable Loss (dB)	Preamp Factor (dB)	Antenna Height (cm)	Table Angle (Degree)	Remark
5145.8	67.63	67.05	68.2	-0.57	31.56	6.34	37.32	213	228	Peak
5190	96.22	95.59			31.59	6.38	37.34	213	228	Average
5190	104.16	103.53			31.59	6.38	37.34	213	228	Peak
5438.99	51.34	50.21	68.2	-16.86	31.76	6.5	37.13	213	228	Peak
10380	56.36	59.1	68.2	-11.84	39.5	10.21	52.45	163	312	Peak

Antenna Polarity & Test Distance: Vertical at 3 m

Frequency (MHz)	Emission Level (dBuV/m)	Read Level (dBuV)	Limit (dBuV/m)	Margin (dB)	Antenna Factor (dB/m)	Cable Loss (dB)	Preamp Factor (dB)	Antenna Height (cm)	Table Angle (Degree)	Remark
5144.36	63.91	63.34	68.2	-4.29	31.56	6.33	37.32	104	60	Peak
5190	91.51	90.88			31.59	6.38	37.34	104	60	Average
5190	99.3	98.67			31.59	6.38	37.34	104	60	Peak
5440.2	51.09	49.96	68.2	-17.11	31.76	6.5	37.13	104	60	Peak
10380	56.25	58.99	68.2	-11.95	39.5	10.21	52.45	137	226	Peak

Remarks:

1. Emission Level = Read Level + Antenna Factor + Cable Loss - Preamp Factor
Margin value = Emission level – Limit value
2. 5190 MHz: Fundamental Frequency
3. *: Out of Restricted Band
4. The emission levels of other frequencies were very low against the limit

EUT Test Condition		Measurement Detail	
Channel	Channel 62	Frequency Range	1 GHz ~ 40 GHz
Input Power	120 Vac, 60 Hz	Detector Function	Peak (PK) Average (AV)
Environmental Conditions	25 deg. C, 65 % RH	Tested By	Jisyong Wang

Horizontal

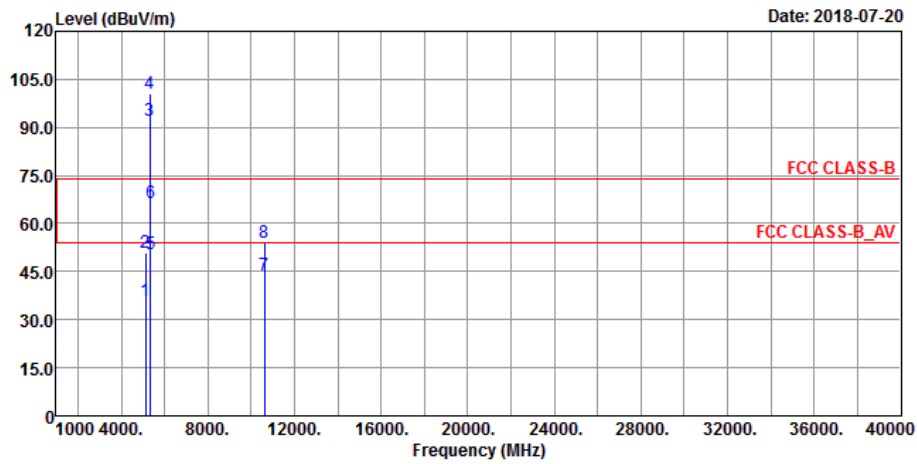

Vertical

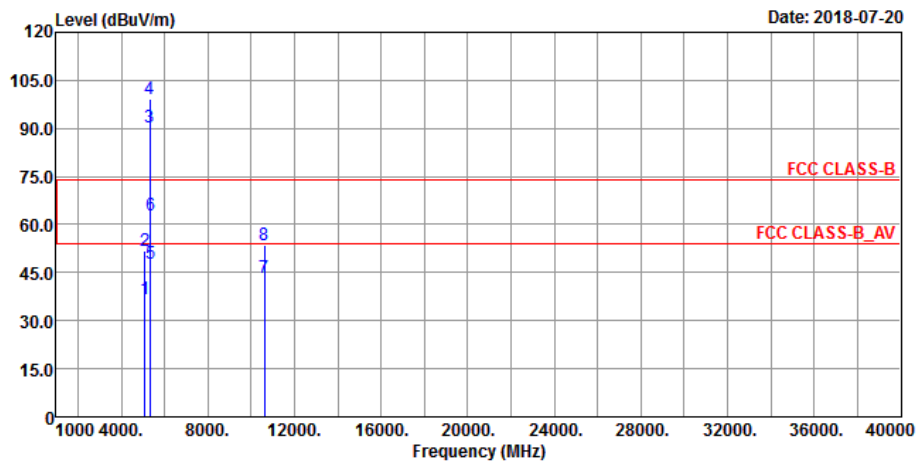

Antenna Polarity & Test Distance: Horizontal at 3 m

Frequency (MHz)	Emission Level (dBuV/m)	Read Level (dBuV)	Limit (dBuV/m)	Margin (dB)	Antenna Factor (dB/m)	Cable Loss (dB)	Preamp Factor (dB)	Antenna Height (cm)	Table Angle (Degree)	Remark
5135.36	50.96	50.38	68.2	-17.24	31.55	6.33	37.3	203	222	Peak
5310	91.01	90.06			31.68	6.46	37.19	203	222	Average
5310	99.66	98.71			31.68	6.46	37.19	203	222	Peak
5350.11	65.68	64.69	68.2	-2.52	31.7	6.47	37.18	203	222	Peak
10620	53.34	56.15	68.2	-14.86	39.89	10.39	53.09	121	224	Peak

Antenna Polarity & Test Distance: Vertical at 3 m

Frequency (MHz)	Emission Level (dBuV/m)	Read Level (dBuV)	Limit (dBuV/m)	Margin (dB)	Antenna Factor (dB/m)	Cable Loss (dB)	Preamp Factor (dB)	Antenna Height (cm)	Table Angle (Degree)	Remark
5087.3	50.93	50.4	68.2	-17.27	31.52	6.28	37.27	110	60	Peak
5310	88.85	87.9			31.68	6.46	37.19	110	60	Average
5310	97.59	96.64			31.68	6.46	37.19	110	60	Peak
5350.11	63.61	62.62	68.2	-4.59	31.7	6.47	37.18	110	60	Peak
10620	54.46	57.27	68.2	-13.74	39.89	10.39	53.09	211	83	Peak

Remarks:

- Emission Level = Read Level + Antenna Factor + Cable Loss - Preamp Factor
Margin value = Emission level – Limit value
- 5310 MHz: Fundamental Frequency
- *: Out of Restricted Band
- The emission levels of other frequencies were very low against the limit

9 kHz ~ 30 MHz Data:

The amplitude of spurious emissions attenuated more than 20 dB below the permissible value is not required to be report.

30 MHz ~ 1 GHz Worst-Case Data:

Mode A

802.11n (HT40)

EUT Test Condition		Measurement Detail	
Channel	Channel 38	Frequency Range	30 MHz ~ 1 GHz
Input Power	120 Vac, 60 Hz	Detector Function	Peak (PK) Quasi-peak (QP)
Environmental Conditions	25 deg. C, 65 % RH	Tested By	Jisyong Wang

Horizontal

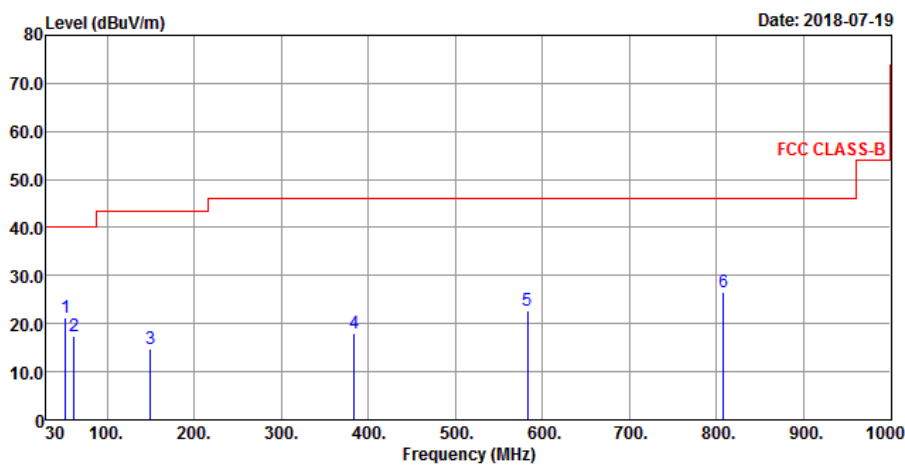

Vertical

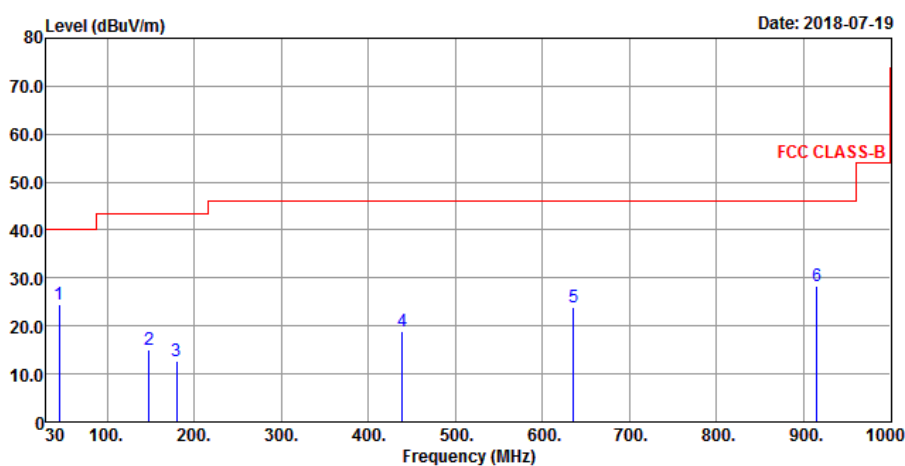

Antenna Polarity & Test Distance: Horizontal at 3 m

Frequency (MHz)	Emission Level (dBuV/m)	Read Level (dBuV)	Limit (dBuV/m)	Margin (dB)	Antenna Factor (dB/m)	Cable Loss (dB)	Preamp Factor (dB)	Antenna Height (cm)	Table Angle (Degree)	Remark
52.31	21.24	39.26	40	-18.76	12.76	0.54	31.32	152	111	Peak
62.01	17.41	36.56	40	-22.59	11.71	0.59	31.45	236	251	Peak
149.31	14.71	32.66	43.5	-28.79	12.68	0.98	31.61	185	265	Peak
384.05	18.06	33.07	46	-27.94	14.96	2.02	31.99	111	145	Peak
582.9	22.84	32.93	46	-23.16	19.21	2.83	32.13	202	251	Peak
807.94	26.46	31.88	46	-19.54	22.33	3.7	31.45	132	256	Peak

Antenna Polarity & Test Distance: Vertical at 3 m

Frequency (MHz)	Emission Level (dBuV/m)	Read Level (dBuV)	Limit (dBuV/m)	Margin (dB)	Antenna Factor (dB/m)	Cable Loss (dB)	Preamp Factor (dB)	Antenna Height (cm)	Table Angle (Degree)	Remark
44.55	24.55	41.58	40	-15.45	13.6	0.51	31.14	152	231	Peak
148.34	15.09	33.1	43.5	-28.41	12.64	0.97	31.62	165	295	Peak
179.38	12.62	32.5	43.5	-30.88	10.83	1.12	31.83	147	285	Peak
439.34	18.84	32.5	46	-27.16	16.12	2.22	32	132	214	Peak
635.28	24.01	33.04	46	-21.99	20.03	3.05	32.11	165	245	Peak
915.61	28.31	32.62	46	-17.69	23.6	4.11	32.02	132	251	Peak

Remarks:

1. Emission Level = Read Level + Antenna Factor + Cable Loss - Preamp Factor
Margin value = Emission level – Limit value
2. The emission levels of other frequencies were very low against the limit

Mode B

EUT Test Condition		Measurement Detail	
Channel	Channel 38	Frequency Range	30 MHz ~ 1 GHz
Input Power	120 Vac, 60 Hz	Detector Function	Peak (PK) Quasi-peak (QP)
Environmental Conditions	25 deg. C, 65 % RH	Tested By	Jisyong Wang

Horizontal

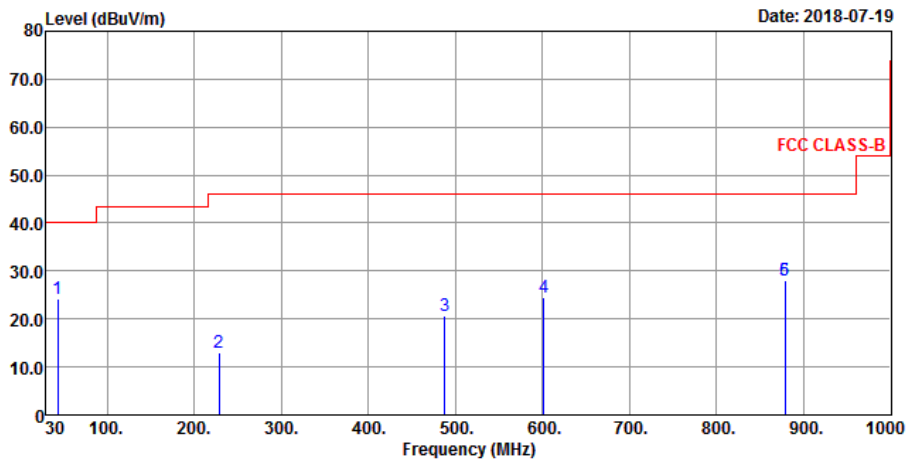

Vertical

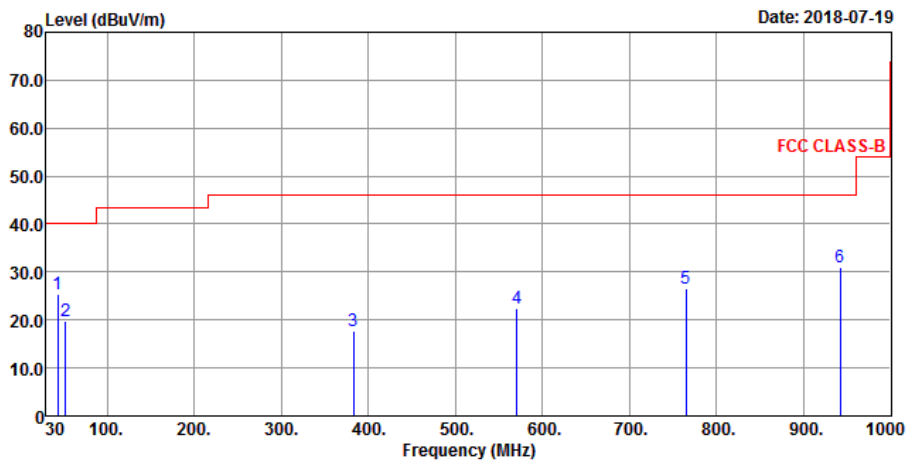

Antenna Polarity & Test Distance: Horizontal at 3 m

Frequency (MHz)	Emission Level (dBuV/m)	Read Level (dBuV)	Limit (dBuV/m)	Margin (dB)	Antenna Factor (dB/m)	Cable Loss (dB)	Preamp Factor (dB)	Antenna Height (cm)	Table Angle (Degree)	Remark
36.79	15.35	32.81	40	-24.65	13.09	0.48	31.03	152	111	Peak
155.13	15.35	33.37	43.5	-28.15	12.72	1	31.74	165	231	Peak
218.18	12.8	33.04	46	-33.2	10.13	1.32	31.69	111	195	Peak
408.3	18.24	32.64	46	-27.76	15.5	2.12	32.02	205	214	Peak
639.16	23.07	32.03	46	-22.93	20.08	3.06	32.1	174	132	Peak
932.1	29.3	33.42	46	-16.7	23.69	4.17	31.98	111	1165	Peak

Antenna Polarity & Test Distance: Vertical at 3 m

Frequency (MHz)	Emission Level (dBuV/m)	Read Level (dBuV)	Limit (dBuV/m)	Margin (dB)	Antenna Factor (dB/m)	Cable Loss (dB)	Preamp Factor (dB)	Antenna Height (cm)	Table Angle (Degree)	Remark
53.28	18.79	36.91	40	-21.21	12.66	0.55	31.33	152	231	Peak
172.59	13.89	33.1	43.5	-29.61	11.47	1.08	31.76	111	165	Peak
381.14	17.73	32.79	46	-28.27	14.89	2.01	31.96	132	256	Peak
786.6	26.9	32.65	46	-19.1	22.04	3.62	31.41	185	295	Peak
848.68	27.61	32.79	46	-18.39	22.85	3.83	31.86	147	152	Peak
975.75	29.24	32.75	54	-24.76	23.93	4.35	31.79	132	214	Peak

Remarks:

- Emission Level = Read Level + Antenna Factor + Cable Loss - Preamp Factor
Margin value = Emission level – Limit value
- The emission levels of other frequencies were very low against the limit

Mode C

EUT Test Condition		Measurement Detail	
Channel	Channel 38	Frequency Range	30 MHz ~ 1 GHz
Input Power	120 Vac, 60 Hz	Detector Function	Peak (PK) Quasi-peak (QP)
Environmental Conditions	25 deg. C, 65 % RH	Tested By	Jisyong Wang

Horizontal

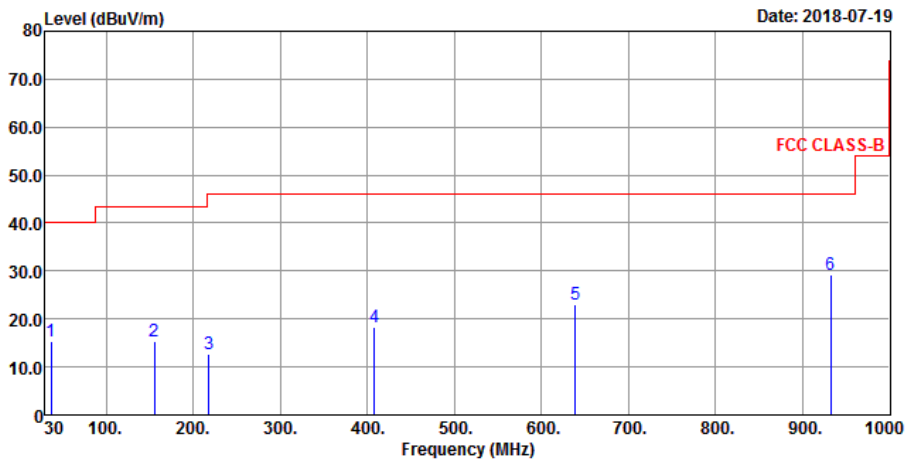

Vertical

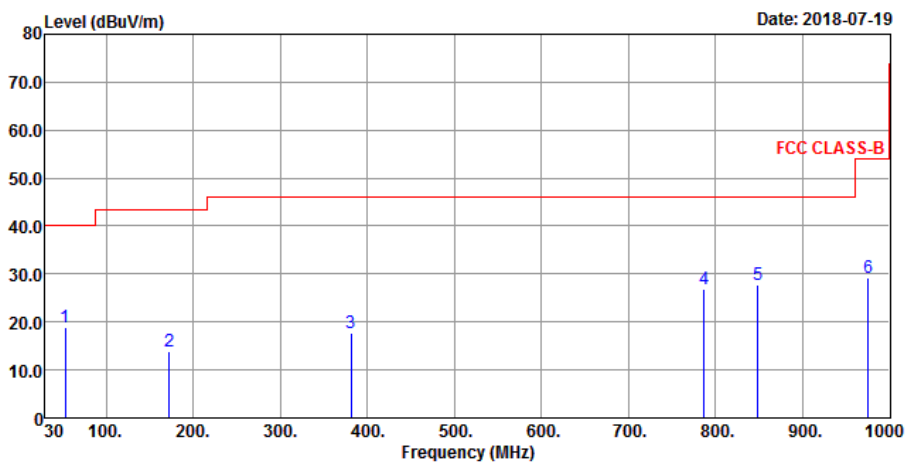

Antenna Polarity & Test Distance: Horizontal at 3 m

Frequency (MHz)	Emission Level (dBuV/m)	Read Level (dBuV)	Limit (dBuV/m)	Margin (dB)	Antenna Factor (dB/m)	Cable Loss (dB)	Preamp Factor (dB)	Antenna Height (cm)	Table Angle (Degree)	Remark
43.58	24.3	41.32	40	-15.7	13.59	0.5	31.11	152	231	Peak
228.85	12.93	32.83	46	-33.07	10.58	1.37	31.85	165	231	Peak
487.84	20.73	33	46	-25.27	17.08	2.44	31.79	111	147	Peak
601.33	24.46	34.16	46	-21.54	19.62	2.91	32.23	205	265	Peak
878.75	27.96	32.74	46	-18.04	23.24	3.96	31.98	132	214	Peak
878.75	27.96	32.74	46	-18.04	23.24	3.96	31.98	165	251	Peak

Antenna Polarity & Test Distance: Vertical at 3 m

Frequency (MHz)	Emission Level (dBuV/m)	Read Level (dBuV)	Limit (dBuV/m)	Margin (dB)	Antenna Factor (dB/m)	Cable Loss (dB)	Preamp Factor (dB)	Antenna Height (cm)	Table Angle (Degree)	Remark
43.58	25.25	42.27	40	-14.75	13.59	0.5	31.11	132	251	Peak
52.31	19.82	37.84	40	-20.18	12.76	0.54	31.32	165	251	Peak
383.08	17.85	32.88	46	-28.15	14.94	2.01	31.98	132	251	Peak
570.29	22.45	32.83	46	-23.55	18.92	2.78	32.08	201	251	Peak
765.26	26.59	32.67	46	-19.41	21.74	3.56	31.38	231	152	Peak
941.8	31.05	35.03	46	-14.95	23.74	4.19	31.91	132	251	Peak

Remarks:

1. Emission Level = Read Level + Antenna Factor + Cable Loss - Preamp Factor
Margin value = Emission level – Limit value
2. The emission levels of other frequencies were very low against the limit

5 Pictures of Test Arrangements

Please refer to the attached file (Test Setup Photo).

Appendix – Information on the Testing Laboratories

We, Bureau Veritas Consumer Products Services (H.K.) Ltd., Taoyuan Branch, were founded in 1988 to provide our best service in EMC, Radio, Telecom and Safety consultation. Our laboratories are FCC recognized accredited test firms and accredited according to ISO/IEC 17025.

If you have any comments, please feel free to contact us at the following:

Linko EMC/RF Lab

Tel: 886-2-26052180

Fax: 886-2-26051924

Hsin Chu EMC/RF/Telecom Lab

Tel: 886-3-6668565

Fax: 886-3-6668323

Hwa Ya EMC/RF/Safety

Tel: 886-3-3183232

Fax: 886-3-3270892

Email: service.adt@tw.bureauveritas.com

Web Site: www.bureauveritas-adt.com

The address and road map of all our labs can be found in our web site also.

--- END ---