

Variant FCC Test Report

Report No.: RF150401C19E

FCC ID: ZQAT30

Test Model: A0013

Received Date: Jul. 01, 2016

Test Date: Jul. 12, 2016 ~ Aug. 15, 2016

Issued Date: Aug. 18, 2016

Applicant: Nest Labs Inc

Address: 3400 Hillview Ave. Palo Alto California, United States 94304

Issued By: Bureau Veritas Consumer Products Services (H.K.) Ltd., Taoyuan Branch

Lab Address: No. 47-2, 14th Ling, Chia Pau Vil., Lin Kou Dist., New Taipei City, Taiwan (R.O.C)

Test Location: No. 19, Hwa Ya 2nd Rd, Wen Hwa Tsuen, Kwei Shan Hsiang, Taoyuan Hsien 333, Taiwan, R.O.C.



This report is for your exclusive use. Any copying or replication of this report to or for any other person or entity, or use of our name or trademark, is permitted only with our prior written permission. This report sets forth our findings solely with respect to the test samples identified herein. The results set forth in this report are not indicative or representative of the quality or characteristics of the lot from which a test sample was taken or any similar or identical product unless specifically and expressly noted. Our report includes all of the tests requested by you and the results thereof based upon the information that you provided to us. You have 60 days from date of issuance of this report to notify us of any material error or omission caused by our negligence, provided, however, that such notice shall be in writing and shall specifically address the issue you wish to raise. A failure to raise such issue within the prescribed time shall constitute your unqualified acceptance of the completeness of this report, the tests conducted and the correctness of the report contents. Unless specifically mentioned, the uncertainty of measurement has been explicitly taken into account to declare the compliance or non-compliance to the specification.

Table of Contents

Release Control Record	3
1 Certificate of Conformity	4
2 Summary of Test Results.....	5
2.1 Measurement Uncertainty.....	5
2.2 Modification Record	5
3 General Information	6
3.1 General Description of EUT	6
3.2 Description of Test Modes.....	7
3.2.1 Test Mode Applicability and Tested Channel Detail.....	8
3.3 Description of Support Units	9
3.3.1 Configuration of System under Test	9
3.4 General Description of Applied Standards.....	9
4 Test Types and Results	10
4.1 Radiated Emission and Bandedge Measurement	10
4.1.1 Limits of Radiated Emission and Bandedge Measurement	10
4.1.2 Test Instruments	11
4.1.3 Test Procedures.....	12
4.1.4 Deviation from Test Standard	12
4.1.5 Test Set Up	13
4.1.6 EUT Operating Conditions.....	13
4.1.7 Test Results	14
5 Pictures of Test Arrangements.....	22
Appendix – Information on the Testing Laboratories	23

Release Control Record

Issue No.	Description	Date Issued
RF150401C19E	Original Release	Aug. 18, 2016

1 Certificate of Conformity

Product: Nest Learning Thermostat

Test Model: A0013

Sample Status: Production Unit

Applicant: Nest Labs Inc

Test Date: Jul. 12, 2016 ~ Aug. 15, 2016

Standards: 47 CFR FCC Part 15, Subpart C (Section 15.247)
ANSI C63.10:2013

This report is issued as a supplementary report to BV ADT report no.: RF150401C19 R1. This report shall be used by combining with its original report.

Prepared by : Evonne Liu , **Date:** Aug. 18, 2016
Evonne Liu / Specialist

Approved by : Stanley Wu , **Date:** Aug. 18, 2016
Stanley Wu / Assistant Manager

2 Summary of Test Results

47 CFR FCC Part 15, Subpart C (Section 15.247)			
FCC Clause	Test Item	Result	Remarks
15.207	AC Power Conducted Emission	NA	Refer to Note
15.205 & 209	Radiated Emissions	Pass	Meet the requirement of limit. Minimum passing margin is -11.55 dB at 2484 MHz.
15.247(d)	Band Edge Measurement	NA	Refer to Note
15.247(d)	Antenna Port Emission	NA	Refer to Note
15.247(a)(2)	6 dB Bandwidth	NA	Refer to Note
15.247(b)	Conducted power	NA	Refer to Note
15.247(e)	Power Spectral Density	NA	Refer to Note
15.203	Antenna Requirement	NA	Refer to Note

Note: Only Radiated Emissions test was performed for this addendum. Refer to original report for other test data.

2.1 Measurement Uncertainty

Where relevant, the following measurement uncertainty levels have been estimated for tests performed on the EUT:

The listed uncertainties are the worst case uncertainty for the entire range of measurement. Please note that the uncertainty values are provided for informational purposes only and are not used in determining the PASS/FAIL results.

Measurement	Frequency	Expanded Uncertainty (k=2) (±)
Radiated Emissions up to 1 GHz	30 MHz ~ 200 MHz	2.93 dB
	200 MHz ~1000 MHz	2.95 dB
Radiated Emissions above 1 GHz	1 GHz ~ 18 GHz	2.26 dB
	18 GHz ~ 40 GHz	1.94 dB

2.2 Modification Record

There were no modifications required for compliance.

3 General Information

3.1 General Description of EUT

Product	Nest Learning Thermostat
Test Model	A0013
Status of EUT	Production Unit
Power Supply Rating	5.0Vac (Adapter)
Modulation Type	GFSK
Transfer Rate	1 Mbps
Operating Frequency	2402 ~ 2480 MHz
Number of Channel	40
Antenna Type	Chip antenna with -1.4 dBi gain
Antenna Connector	N/A
Accessory Device	Refer to Note as below
Data Cable Supplied	Refer to Note as below

Note:

1. This report is issued as a supplementary report to BV ADT report no. RF150401C19 R1. The difference compared with original report is adding material of outer casing. Therefore, only Radiated Emissions was verified and recorded in this report.
2. The EUT contains following accessory devices.

Product	Brand	Model	Description
Adapter	Nest	A0017	I/P: 100-240Vac, 50/60Hz, 0.35A O/P: 5Vdc, 2.5A
USB Cable	Nest	NA	2.0m shielded cable w/o core
Stand	Nest	Stand	--

3. The device has 3 configurations as below.
 - Main sample (A): Material of outer casing for DLC
 - 2nd sample (B): Material of outer casing for Copper
 - 3rd sample (C): Material of outer casing for Ceramic
4. The above EUT information is declared by manufacturer and for more detailed features description, please refer to the manufacturer's specifications or User's Manual.

3.2 Description of Test Modes

40 channels are provided to this EUT:

Channel	Freq. (MHz)	Channel	Freq. (MHz)	Channel	Freq. (MHz)	Channel	Freq. (MHz)
0	2402	10	2422	20	2442	30	2462
1	2404	11	2424	21	2444	31	2464
2	2406	12	2426	22	2446	32	2466
3	2408	13	2428	23	2448	33	2468
4	2410	14	2430	24	2450	34	2470
5	2412	15	2432	25	2452	35	2472
6	2414	16	2434	26	2454	36	2474
7	2416	17	2436	27	2456	37	2476
8	2418	18	2438	28	2458	38	2478
9	2420	19	2440	29	2460	39	2480

3.2.1 Test Mode Applicability and Tested Channel Detail

EUT Configure Mode	Applicable To		Description
	RE \geq 1G	RE $<$ 1G	
A	√	-	Sample A: DLC
B	√	-	Sample B: Copper
C	√	√	Sample C: Ceramic

Where **RE \geq 1G**: Radiated Emission above 1 GHz **RE $<$ 1G**: Radiated Emission below 1 GHz

NOTE: 1. The EUT had been pre-tested on the positioned of each 3 axis. The worst case was found when positioned on **Z-plane** for mode A/B, **X-plane** for mode C.

2. "-" means no effect.

Radiated Emission Test (Above 1 GHz):

- Pre-Scan has been conducted to determine the worst-case mode from all possible combinations between available modulations, data rates and antenna ports (if EUT with antenna diversity architecture).
- Following channel(s) was (were) selected for the final test as listed below.

EUT Configure Mode	Available Channel	Tested Channel	Modulation Type	Data Rate (Mbps)
A, B, C	0 to 39	39	GFSK	1

Radiated Emission Test (Below 1 GHz):

- Pre-Scan has been conducted to determine the worst-case mode from all possible combinations between available modulations, data rates and antenna ports (if EUT with antenna diversity architecture).
- Following channel(s) was (were) selected for the final test as listed below.

EUT Configure Mode	Available Channel	Tested Channel	Modulation Type	Data Rate (Mbps)
C	0 to 39	39	GFSK	1

Test Condition:

Applicable To	Environmental Conditions	Input Power	Tested by
RE \geq 1G	25 deg. C, 65 % RH	120 Vac, 60 Hz	Gavin Wu
RE $<$ 1G	25 deg. C, 65 % RH	120 Vac, 60 Hz	Gavin Wu

3.3 Description of Support Units

The EUT has been tested as an independent unit together with other necessary accessories or support units.

3.3.1 Configuration of System under Test

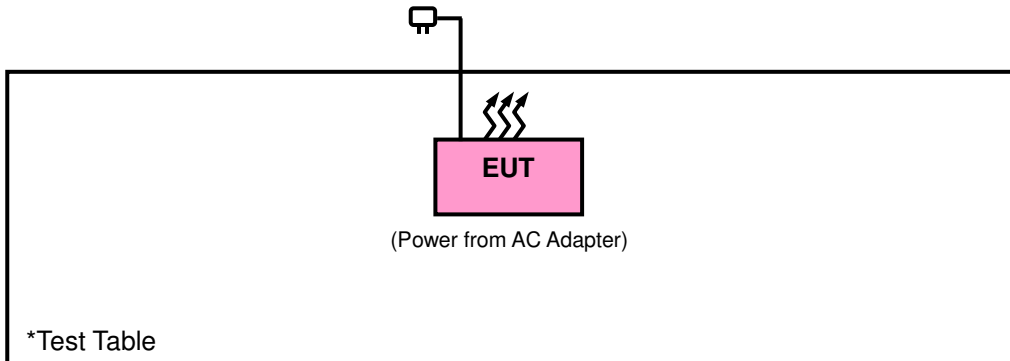

3.4 General Description of Applied Standards

The EUT is a RF Product. According to the specifications of the manufacturer, it must comply with the requirements of the following standards:

FCC Part 15, Subpart C (15.247)

558074 D01 DTS Meas Guidance v03r05

ANSI C63.10-2013

All test items have been performed and recorded as per the above standards.

NOTE: The EUT has been verified to comply with the requirements of FCC Part 15, Subpart B, Class B (DoC).
The test report has been issued separately.

4 Test Types and Results

4.1 Radiated Emission and Bandedge Measurement

4.1.1 Limits of Radiated Emission and Bandedge Measurement

Radiated emissions which fall in the restricted bands must comply with the radiated emission limits specified as below table. Other emissions shall be at least 20 dB below the highest level of the desired power:

Frequencies (MHz)	Field Strength (microvolts/meter)	Measurement Distance (meters)
0.009 ~ 0.490	2400/F (kHz)	300
0.490 ~ 1.705	24000/F (kHz)	30
1.705 ~ 30.0	30	30
30 ~ 88	100	3
88 ~ 216	150	3
216 ~ 960	200	3
Above 960	500	3

NOTE:

1. The lower limit shall apply at the transition frequencies.
2. Emission level (dBuV/m) = 20 log Emission level (uV/m).
3. For frequencies above 1000 MHz, the field strength limits are based on average detector, however, the peak field strength of any emission shall not exceed the maximum permitted average limits, specified above by more than 20 dB under any condition of modulation.

4.1.2 Test Instruments

Description & Manufacturer	Model No.	Serial No.	Date of Calibration	Due Date of Calibration
Test Receiver Agilent	N9038A	MY51210203	Jan. 21, 2016	Jan. 20, 2017
Spectrum Analyzer Agilent	N9010A	MY52220314	Sep.03, 2015	Sep. 02, 2016
BILOG Antenna SCHWARZBECK	VULB9168	9168-472	Jan. 07, 2016	Jan. 06, 2017
HORN Antenna SCHWARZBECK	BBHA 9120 D	9120D-969	Jan. 04, 2016	Jan. 03, 2017
HORN Antenna SCHWARZBECK	BBHA 9170	9170-480	Jan. 08, 2016	Jan. 07, 2017
Loop Antenna	LPA600	270	Aug. 20, 2015	Aug. 19, 2017
Agilent Communications Tester-Wireless	8960 Series 10	MY53201073	Jul. 03, 2015	Jul. 02, 2017
Preamplifier EMCI	EMC 012645	980115	Dec. 21, 2015	Dec. 20, 2016
Preamplifier EMCI	EMC 184045	980116	Dec. 21, 2015	Dec. 20, 2016
Preamplifier EMCI	EMC 330H	980112	Dec. 28, 2015	Dec. 27, 2016
RF signal cable HUBER+SUHNNER	SUCOFLEX 104	309219/4 2950114	Oct. 12, 2015	Oct. 11, 2016
RF signal cable HUBER+SUHNNER	SUCOFLEX 104	250130/4	Oct. 12, 2015	Oct. 11, 2016
RF Coaxial Cable Worken	8D-FB	Cable-Ch10-01	Oct. 12, 2015	Oct. 11, 2016
Software BV ADT	E3 6.120103	NA	NA	NA
Antenna Tower MF	MFA-440H	NA	NA	NA
Turn Table MF	MFT-201SS	NA	NA	NA
Antenna Tower & Turn Table Controller MF	MF-7802	NA	NA	NA

- Note: 1. The calibration interval of the above test instruments is 12 months and the calibrations are traceable to NML/ROC and NIST/USA.
2. The test was performed in HwaYa Chamber 10.
3. The horn antenna and preamplifier (model: EMC 184045) are used only for the measurement of emission frequency above 1GHz if tested.
4. The FCC Site Registration No. is 690701.
5. The IC Site Registration No. is IC7450F-10.

4.1.3 Test Procedures

- a. The EUT was placed on the top of a rotating table 0.8 meters (for below 1 GHz) / 1.5 meters (for above 1 GHz) above the ground at 3 meter chamber room for test. The table was rotated 360 degrees to determine the position of the highest radiation.
- b. The EUT was set 3 meters away from the interference-receiving antenna, which was mounted on the top of a variable-height antenna tower.
- c. The height of antenna is varied from one meter to four meters above the ground to determine the maximum value of the field strength. Both horizontal and vertical polarizations of the antenna are set to make the measurement.
- d. For each suspected emission, the EUT was arranged to its worst case and then the antenna was tuned to heights from 1 meter to 4 meters and the rotatable table was turned from 0 degrees to 360 degrees to find the maximum reading.
- e. The test-receiver system was set to quasi-peak detect function and specified bandwidth with maximum hold mode when the test frequency is below 1 GHz.
- f. The test-receiver system was set to peak and average detected function and specified bandwidth with maximum hold mode when the test frequency is above 1 GHz. If the peak reading value also meets average limit, measurement with the average detector is unnecessary.

Note:

1. The resolution bandwidth and video bandwidth of test receiver/spectrum analyzer is 120 kHz for Quasi-peak detection (QP) at frequency below 1 GHz.
2. The resolution bandwidth of test receiver/spectrum analyzer is 1 MHz and the video bandwidth is 3 MHz for Peak detection (PK) at frequency above 1 GHz.
3. The resolution bandwidth of test receiver/spectrum analyzer is 1 MHz and the video bandwidth is 1/T for RMS Average (Duty cycle < 98 %) for Peak detection at frequency above 1 GHz.
4. The resolution bandwidth of test receiver/spectrum analyzer is 1 MHz and the video bandwidth is 10 Hz (Duty cycle ≥ 98 %) for Average detection (AV) at frequency above 1 GHz.
5. All modes of operation were investigated and the worst-case emissions are reported.

4.1.4 Deviation from Test Standard

No deviation.

4.1.5 Test Set Up

<Frequency Range below 1 GHz>

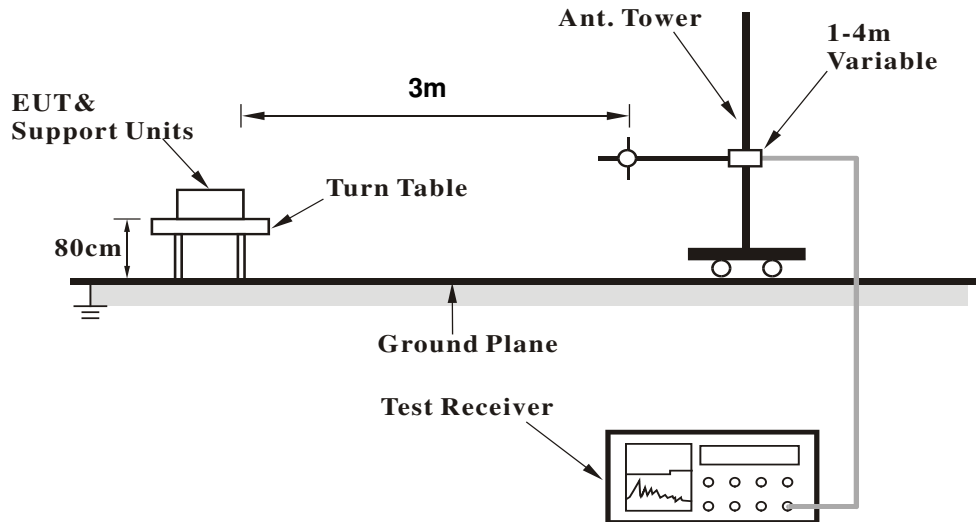

<Frequency Range above 1 GHz>

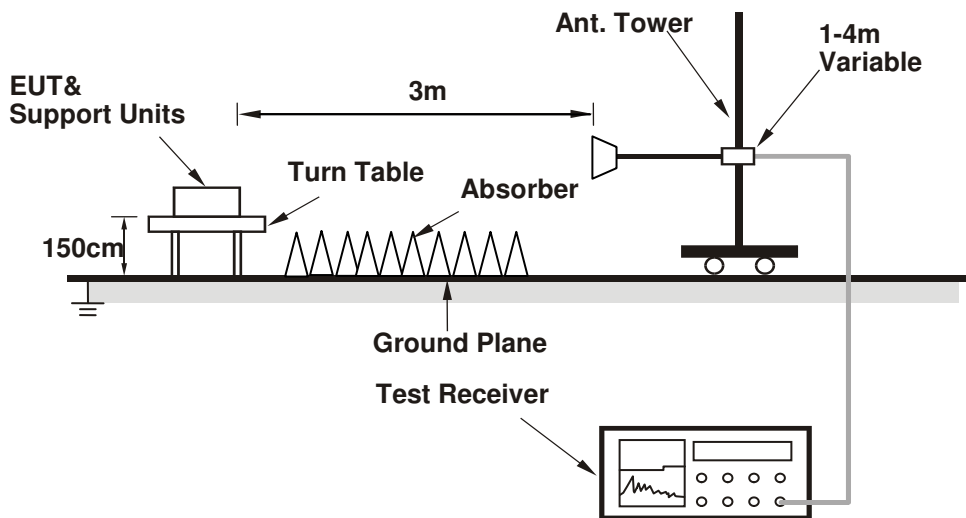

For the actual test configuration, please refer to the attached file (Test Setup Photo).

4.1.6 EUT Operating Conditions

- a. Placed the EUT on the testing table.
- b. Set the EUT under transmission condition continuously at specific channel frequency.

4.1.7 Test Results

ABOVE 1 GHz DATA :

Mode A (Peak power = 8.84 dBm)

EUT Test Condition		Measurement Detail	
Channel	Channel 39	Frequency Range	1 GHz ~ 25 GHz
Input Power	120 Vac, 60 Hz	Detector Function	Peak (PK) RBW : 1MHz , VBW : 3MHz Average (AV) RBW : 1MHz , VBW : 3KHz
Environmental Conditions	25 deg. C, 65 % RH	Tested By	Gavin Wu

Horizontal

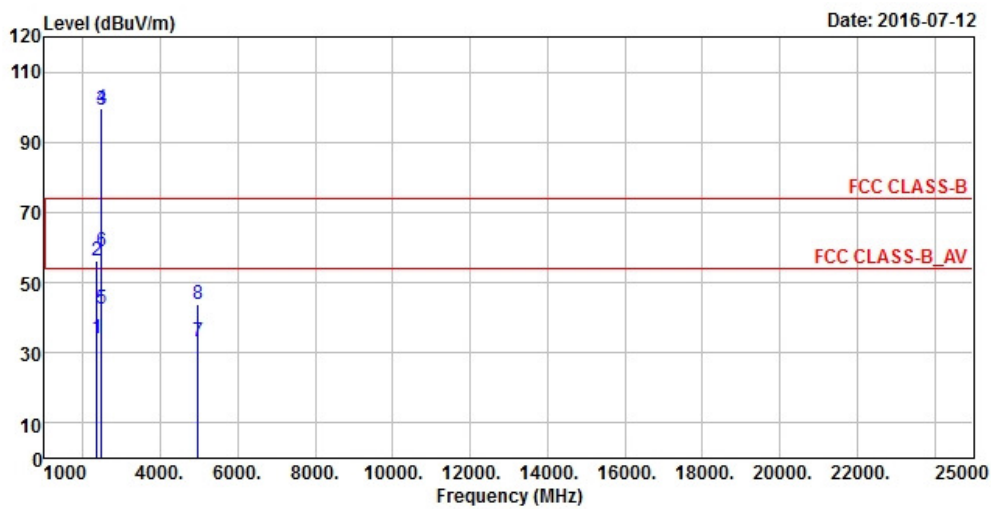

Vertical

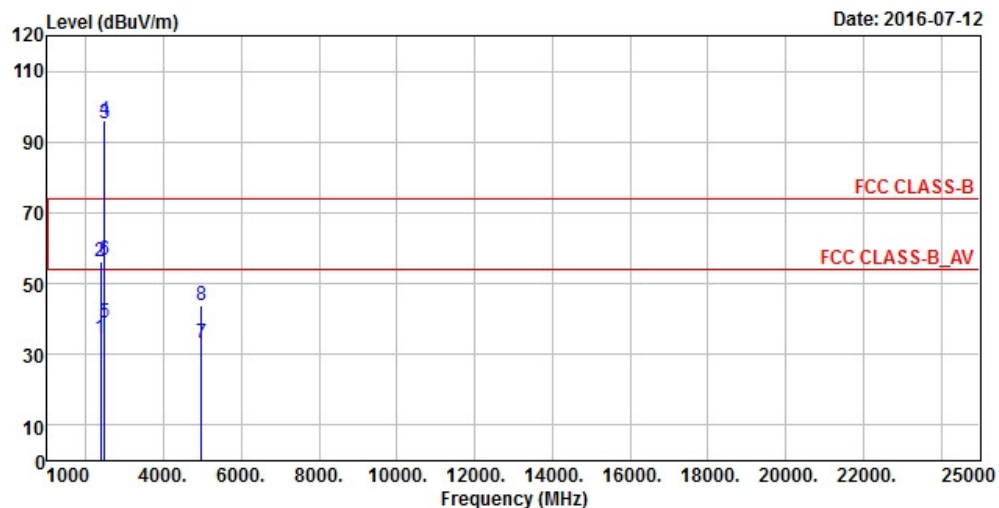

Antennal Polarity & Test Distance: Horizontal at 3 m

Frequency (MHz)	Emission Level (dBuV/m)	Read Level (dBuV)	Limit (dBuV/m)	Margin (dB)	Antenna Factor (dB/m)	Cable Loss (dB)	Preamp Factor (dB)	Antenna Height (cm)	Table Angle (Degree)	Remark
2356	34.29	40.92	54	-19.71	26.81	4.05	37.49	100	264	Average
2356	56.25	62.88	74	-17.75	26.81	4.05	37.49	100	264	Peak
2480	98.99	105.01			27.15	4.15	37.32	100	264	Average
2480	99.6	105.62			27.15	4.15	37.32	100	264	Peak
2484	42.45	48.47	54	-11.55	27.15	4.15	37.32	100	264	Average
2484	58.85	64.87	74	-15.15	27.15	4.15	37.32	100	264	Peak
4960	33.36	48.33	54	-20.64	31.16	6.91	53.04	124	341	Average
4960	43.88	58.85	74	-30.12	31.16	6.91	53.04	124	341	Peak

Antennal Polarity & Test Distance: Vertical at 3 m

Frequency (MHz)	Emission Level (dBuV/m)	Read Level (dBuV)	Limit (dBuV/m)	Margin (dB)	Antenna Factor (dB/m)	Cable Loss (dB)	Preamp Factor (dB)	Antenna Height (cm)	Table Angle (Degree)	Remark
2380	34.37	40.93	54	-19.63	26.86	4.08	37.5	100	4	Average
2380	56.1	62.66	74	-17.9	26.86	4.08	37.5	100	4	Peak
2480	95.42	101.44			27.15	4.15	37.32	100	4	Average
2480	96.26	102.28			27.15	4.15	37.32	100	4	Peak
2484	39.14	45.16	54	-14.86	27.15	4.15	37.32	100	4	Average
2484	56.78	62.8	74	-17.22	27.15	4.15	37.32	100	4	Peak
4965	33.13	48.1	54	-20.87	31.16	6.91	53.04	105	332	Average
4965	44.03	59	74	-29.97	31.16	6.91	53.04	105	332	Peak

Remarks:

- Emission Level = Read Level + Antenna Factor + Cable Loss - Preamp Factor
Margin value = Emission level – Limit value
- 2480 MHz: Fundamental frequency.

Mode B (Peak power = 8.84 dBm)

EUT Test Condition		Measurement Detail	
Channel	Channel 39	Frequency Range	1 GHz ~ 25 GHz
Input Power	120 Vac, 60 Hz	Detector Function	Peak (PK) RBW : 1MHz , VBW : 3MHz Average (AV) RBW : 1MHz , VBW : 3KHz
Environmental Conditions	25 deg. C, 65 % RH	Tested By	Gavin Wu

Horizontal

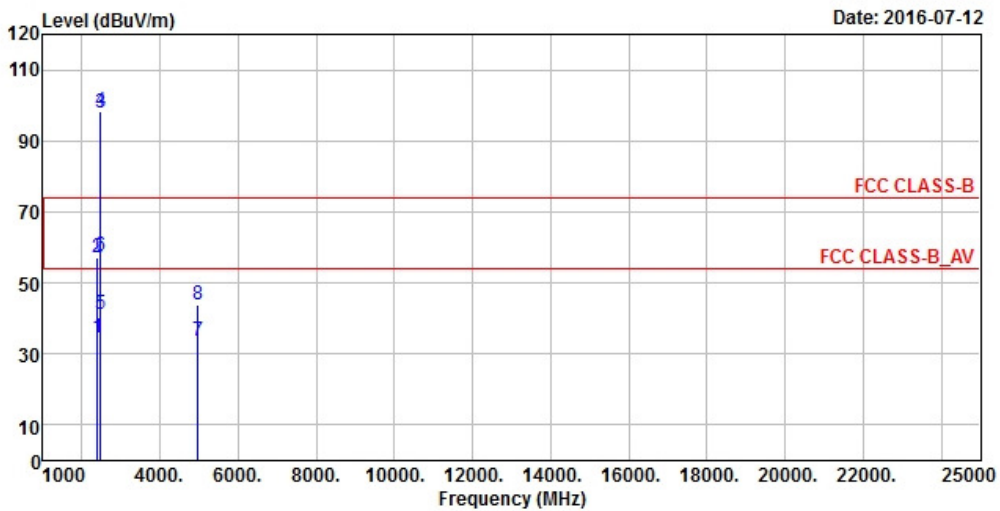

Vertical

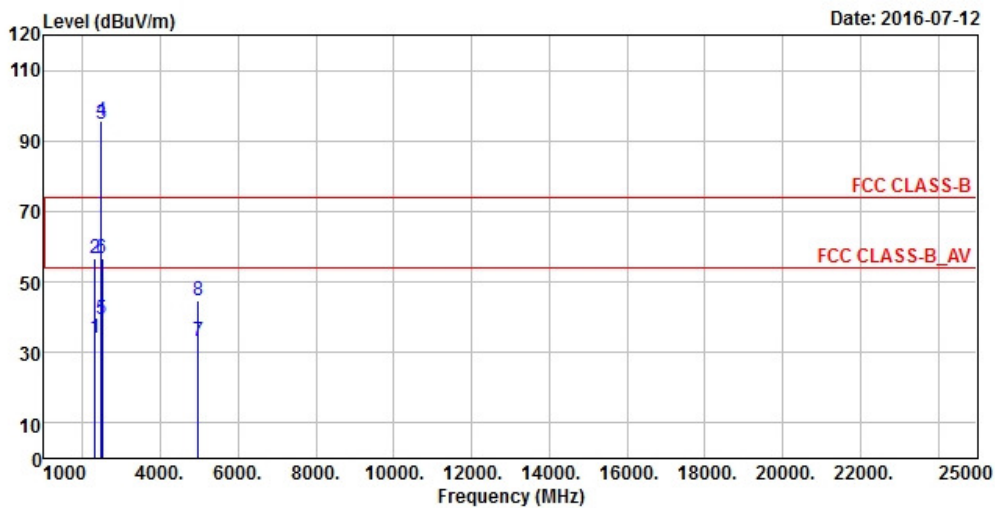

Antennal Polarity & Test Distance: Horizontal at 3 m

Frequency (MHz)	Emission Level (dBuV/m)	Read Level (dBuV)	Limit (dBuV/m)	Margin (dB)	Antenna Factor (dB/m)	Cable Loss (dB)	Preamp Factor (dB)	Antenna Height (cm)	Table Angle (Degree)	Remark
2384	34.52	41.08	54	-19.48	26.86	4.08	37.5	176	65	Average
2384	57.23	63.79	74	-16.77	26.86	4.08	37.5	176	65	Peak
2480	97.79	103.81			27.15	4.15	37.32	176	65	Average
2480	98.43	104.45			27.15	4.15	37.32	176	65	Peak
2484	41.32	47.34	54	-12.68	27.15	4.15	37.32	176	65	Average
2484	57.44	63.46	74	-16.56	27.15	4.15	37.32	176	65	Peak
4960	33.51	48.48	54	-20.49	31.16	6.91	53.04	129	57	Average
4960	43.94	58.91	74	-30.06	31.16	6.91	53.04	129	57	Peak

Antennal Polarity & Test Distance: Vertical at 3 m

Frequency (MHz)	Emission Level (dBuV/m)	Read Level (dBuV)	Limit (dBuV/m)	Margin (dB)	Antenna Factor (dB/m)	Cable Loss (dB)	Preamp Factor (dB)	Antenna Height (cm)	Table Angle (Degree)	Remark
2316	34.24	41.01	54	-19.76	26.67	4.03	37.47	229	318	Average
2316	56.46	63.23	74	-17.54	26.67	4.03	37.47	229	318	Peak
2480	94.76	100.78			27.15	4.15	37.32	229	318	Average
2480	95.58	101.6			27.15	4.15	37.32	229	318	Peak
2488	39.54	45.5	54	-14.46	27.2	4.16	37.32	229	318	Average
2488	56.51	62.47	74	-17.49	27.2	4.16	37.32	229	318	Peak
4960	33.04	48.01	54	-20.96	31.16	6.91	53.04	109	298	Average
4960	44.67	59.64	74	-29.33	31.16	6.91	53.04	109	298	Peak

Remarks:

- Emission Level = Read Level + Antenna Factor + Cable Loss - Preamp Factor
Margin value = Emission level – Limit value
- 2480 MHz: Fundamental frequency.

Mode C (Peak power = 8.84 dBm)

EUT Test Condition		Measurement Detail	
Channel	Channel 39	Frequency Range	1 GHz ~ 25 GHz
Input Power	120 Vac, 60 Hz	Detector Function	Peak (PK) RBW : 1MHz , VBW : 3MHz Average (AV) RBW : 1MHz , VBW : 3KHz
Environmental Conditions	25 deg. C, 65 % RH	Tested By	Gavin Wu

Horizontal

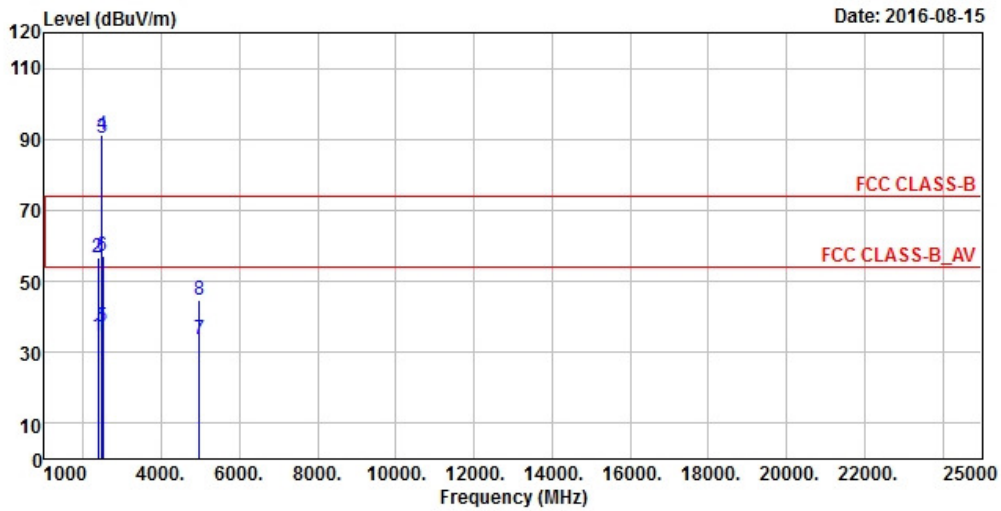

Vertical

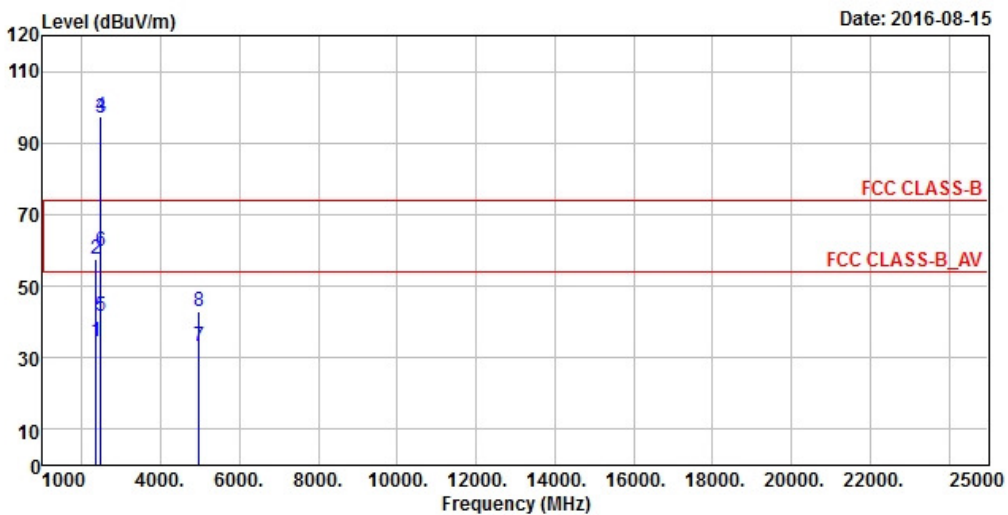

Antennal Polarity & Test Distance: Horizontal at 3 m

Frequency (MHz)	Emission Level (dBuV/m)	Read Level (dBuV)	Limit (dBuV/m)	Margin (dB)	Antenna Factor (dB/m)	Cable Loss (dB)	Preamp Factor (dB)	Antenna Height (cm)	Table Angle (Degree)	Remark
2378	34.69	41.26	54	-19.31	26.86	4.07	37.5	196	248	Average
2378	56.63	63.2	74	-17.37	26.86	4.07	37.5	196	248	Peak
2480	90.51	96.53			27.15	4.15	37.32	196	248	Average
2480	91.22	97.24			27.15	4.15	37.32	196	248	Peak
2498	37.31	43.2	54	-16.69	27.2	4.16	37.25	196	248	Average
2498	57.18	63.07	74	-16.82	27.2	4.16	37.25	196	248	Peak
4960	33.61	48.58	54	-20.39	31.16	6.91	53.04	106	212	Average
4960	44.55	59.52	74	-29.45	31.16	6.91	53.04	106	212	Peak

Antennal Polarity & Test Distance: Vertical at 3 m

Frequency (MHz)	Emission Level (dBuV/m)	Read Level (dBuV)	Limit (dBuV/m)	Margin (dB)	Antenna Factor (dB/m)	Cable Loss (dB)	Preamp Factor (dB)	Antenna Height (cm)	Table Angle (Degree)	Remark
2354	34.64	41.27	54	-19.36	26.81	4.05	37.49	174	9	Average
2354	57.45	64.08	74	-16.55	26.81	4.05	37.49	174	9	Peak
2480	96.89	102.91			27.15	4.15	37.32	174	9	Average
2480	97.57	103.59			27.15	4.15	37.32	174	9	Peak
2484	41.44	47.46	54	-12.56	27.15	4.15	37.32	174	9	Average
2484	59.72	65.74	74	-14.28	27.15	4.15	37.32	174	9	Peak
4960	33.15	48.12	54	-20.85	31.16	6.91	53.04	100	131	Average
4960	43.13	58.1	74	-30.87	31.16	6.91	53.04	100	131	Peak

Remarks:

- Emission Level = Read Level + Antenna Factor + Cable Loss - Preamp Factor
Margin value = Emission level – Limit value
- 2480 MHz: Fundamental frequency.

9 kHz ~ 30 MHz DATA:

The amplitude of spurious emissions attenuated more than 20 dB below the permissible value is not required to be report.

30 MHz ~ 1 GHz WORST-CASE DATA:

Mode C (Peak power = 8.84 dBm)

EUT Test Condition		Measurement Detail	
Channel	Channel 39	Frequency Range	30 MHz ~ 1 GHz
Input Power	120 Vac, 60 Hz	Detector Function	Peak (PK) RBW : 120KHz , VBW : 360KHz Quasi-peak (QP)
Environmental Conditions	25 deg. C, 65 % RH	Tested By	Gavin Wu

Horizontal

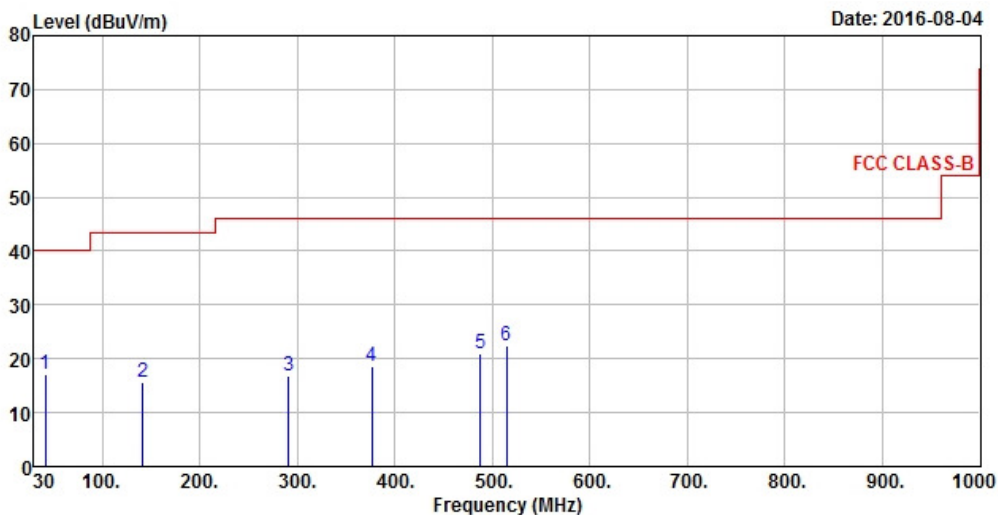

Vertical

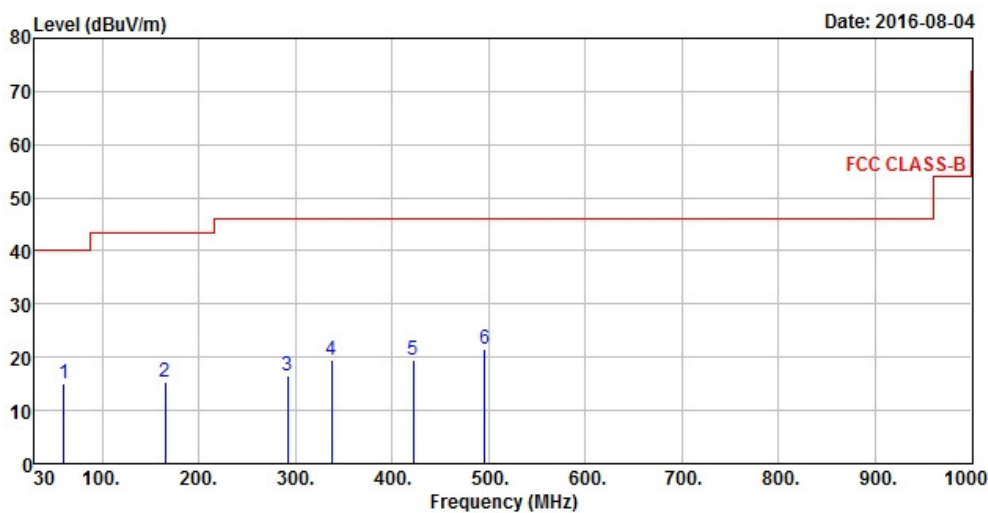

Antennal Polarity & Test Distance: Horizontal at 3 m										
Frequency (MHz)	Emission Level (dBuV/m)	Read Level (dBuV)	Limit (dBuV/m)	Margin (dB)	Antenna Factor (dB/m)	Cable Loss (dB)	Preamp Factor (dB)	Antenna Height (cm)	Table Angle (Degree)	Remark
41.64	17.24	34.07	40	-22.76	13.56	0.66	31.05	136	4	Peak
141.55	15.72	33.78	43.5	-27.78	12.41	1.16	31.63	105	37	Peak
290.93	16.8	34.2	46	-29.2	12.68	1.61	31.69	104	100	Peak
376.29	18.63	33.95	46	-27.37	14.77	1.85	31.94	111	24	Peak
487.84	21.01	33.65	46	-24.99	17.08	2.07	31.79	108	135	Peak
515	22.43	34.23	46	-23.57	17.66	2.12	31.58	130	225	Peak
Antennal Polarity & Test Distance: Vertical at 3 m										
Frequency (MHz)	Emission Level (dBuV/m)	Read Level (dBuV)	Limit (dBuV/m)	Margin (dB)	Antenna Factor (dB/m)	Cable Loss (dB)	Preamp Factor (dB)	Antenna Height (cm)	Table Angle (Degree)	Remark
60.07	14.92	33.53	40	-25.08	11.94	0.81	31.36	127	262	Peak
164.83	15.47	33.91	43.5	-28.03	12.25	1.12	31.81	136	134	Peak
291.9	16.46	33.84	46	-29.54	12.71	1.61	31.7	106	157	Peak
337.49	19.59	35.84	46	-26.41	13.84	1.73	31.82	133	255	Peak
421.88	19.36	33.69	46	-26.64	15.77	1.94	32.04	105	6	Peak
495.6	21.61	33.99	46	-24.39	17.23	2.08	31.69	103	156	Peak

Remarks:

- Emission Level = Read Level + Antenna Factor + Cable Loss - Preamp Factor
Margin value = Emission level – Limit value

5 Pictures of Test Arrangements

Please refer to the attached file (Test Setup Photo).

Appendix – Information on the Testing Laboratories

We, Bureau Veritas Consumer Products Services (H.K.) Ltd., Taoyuan Branch, were founded in 1988 to provide our best service in EMC, Radio, Telecom and Safety consultation. Our laboratories are accredited and approved according to ISO/IEC 17025.

If you have any comments, please feel free to contact us at the following:

Linko EMC/RF Lab

Tel: 886-2-26052180

Fax: 886-2-26051924

Hsin Chu EMC/RF/Telecom Lab

Tel: 886-3-6668565

Fax: 886-3-6668323

Hwa Ya EMC/RF/Safety

Tel: 886-3-3183232

Fax: 886-3-3270892

Email: service.adt@tw.bureauveritas.com

Web Site: www.bureauveritas-adt.com

The address and road map of all our labs can be found in our web site also.

--- END ---