



nest

Learning Thermostat™
Installation Guide

WE TAKE YOUR PRIVACY SERIOUSLY

We're committed to being open and honest about how we use data. We'll always ask for permission before sharing personally identifiable information like your email address, and we keep your data safe with industry standard security tools. To learn more about our Privacy Policy, go to nest.com/privacy

Compatibility

Based on Nest's online compatibility checker data, the Nest Thermostat works with most 24V systems, including gas, electric, oil, forced air, variable speed, heat pump, and radiant. It can control:

- Heating: one, two, and three stages (W1, W2, W3)
- Cooling: one and two stages (Y1, Y2)
- Heat pump: with auxiliary and emergency heat (O/B, AUX, E)
- Fan (G)
- Power (C, RH, RC)
- Humidifier or dehumidifier (HUM, DEHUM)

The Nest Thermostat's * connector can accept only one of these wires: W3, E, HUM or DEHUM.

The Nest Thermostat is designed to work even if your home doesn't have a common (C) wire. Rarely, installing a new C wire may be required.

Professional installation recommended for:

- Dual fuel systems (heat pump with furnace)
- Whole-home humidifiers and dehumidifiers

Watch the video

To see how it's done, watch our installation video at support.nest.com/thermostat

Contents

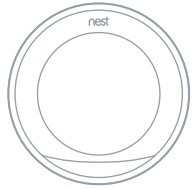

Display

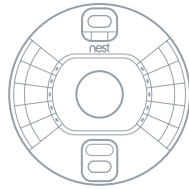

Base



Screwdriver

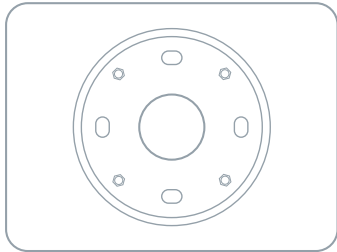

Optional trim plate

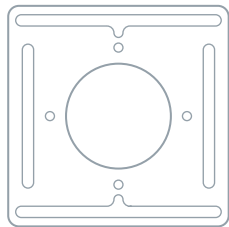

Optional steel plate



Wall screws



Optional steel plate screws

1. Switch off power

This protects you and avoids blowing a fuse in your equipment. Adjust the temperature on your old thermostat to make sure your system is off.

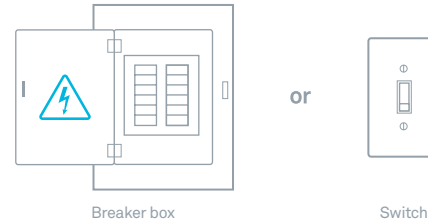

3. Check your system

If your old thermostat is labeled 120V or 240V or has thick wires with wire nuts, your system is high voltage. Not sure? Contact support.

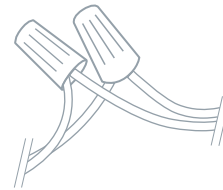

CAUTION: Do not connect Nest to high voltage wires.

2. Remove cover

Some covers pop off, while others need to be unscrewed.

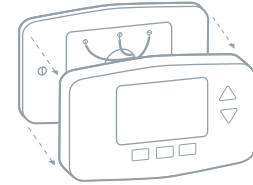

4. Remove any jumper wires

Jumper wires are short wires between two connectors. You won't need them. An R wire can go into either RC or RH.

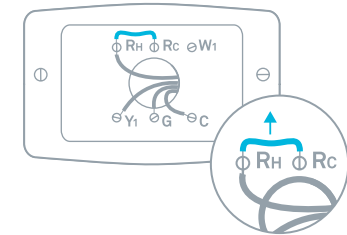

5. Label wires

Peel off the labels below and attach them to the thermostat's matching wires.

Use the white labels for any W3, E, HUM or DEHUM wires. The * connector can only connect to one of these wires.

See two names for each connector on your old thermostat's backplate? Visit nest.com/2labels for help.

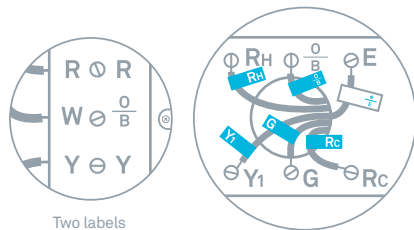

Two labels



Tip: Take a picture of the wires on your old thermostat to help you remember.

6. Disconnect wires and remove base

After removing the base, we recommend gently wrapping the wires around a pen or pencil to ensure they don't fall back into the hole in the wall.

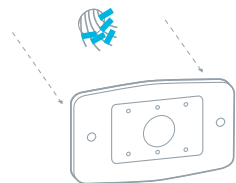

⚠ Remember, the power to your HVAC system must be off to avoid blowing a fuse in your equipment.

7. Mark where screws will go

Use the bubble level to make sure the Nest Thermostat is level.

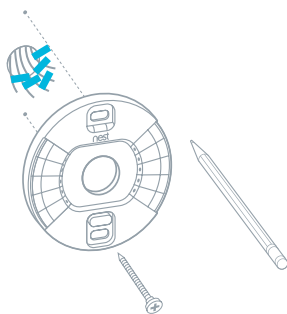

Optional in most homes

Use trim plate if needed

You can cover up holes or marks left by your old thermostat with the optional trim plate.

Snap the base and trim plate together, then screw them to the wall.

You'll find the trim plate in the bottom of the box.

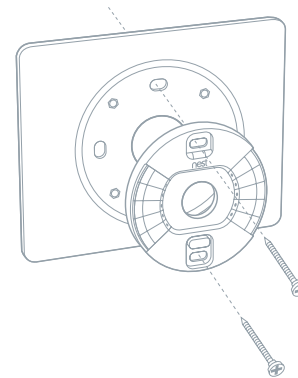

Optional in most homes

Mounting on an electrical box

Electrical boxes aren't common, but if you have one, secure the steel plate to the electrical box with two of the short steel plate screws. Insert the screws into the long slots on the steel plate.

Use the other two short screws to attach the Nest base and trim plate to the steel plate.

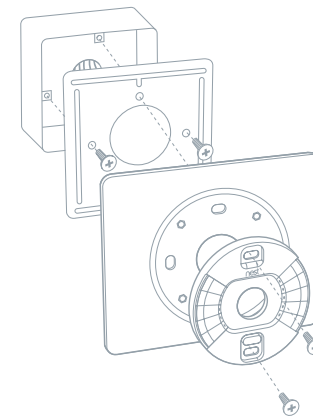

8. Attach the Nest base

Pull the wires through the center of the base, then attach it to the wall with the screws.

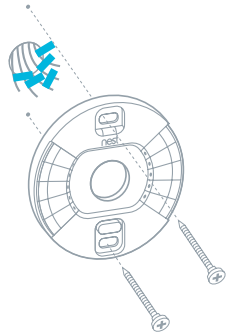

9. Connect wires

After all the wires are securely connected, push them down to make sure they're flush with the base.

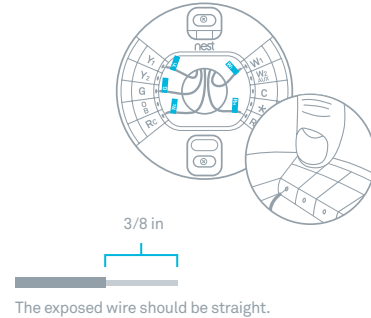

12. Setup and Nest Account

The Nest Thermostat will turn on and walk you through setup. Just turn the ring and press to select. During setup, you can connect the thermostat to Wi-Fi.

Go to nest.com/account or download the Nest app to create a Nest Account. The app will show you how to connect your Nest Account and thermostat.



10. Attach the display

Press the display onto the base until it clicks.

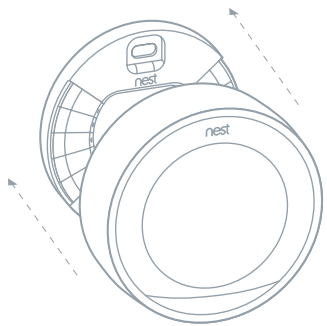

11. Switch the power back on

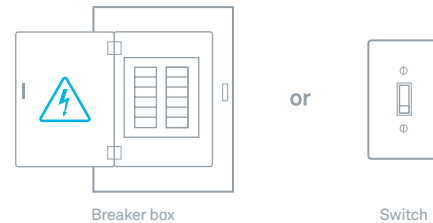

Remember, you can download the free Nest app from the iTunes App Store™ or Google Play™.

Questions about adding a thermostat to your Nest Account? Visit nest.com/pair

Nest Labs, Inc. Limited Warranty Learning Thermostat™



For more information, visit nest.com

You can also find answers in the Nest Community at nest.com/community

For FCC Compliance Statement, visit nest.com/legal/fcc-compliance-notice



Please recycle Nest's 100% recyclable packaging.

RECYCLING AND DISPOSAL
Visit nest.com/recycle

THIS LIMITED WARRANTY CONTAINS IMPORTANT INFORMATION ABOUT YOUR RIGHTS AND OBLIGATIONS, AS WELL AS LIMITATIONS AND EXCLUSIONS THAT MAY APPLY TO YOU.

1. WHAT THIS LIMITED WARRANTY COVERS; PERIOD OF COVERAGE

Nest Labs, Inc. ("Nest Labs"), 3400 Hillview Avenue, Palo Alto, California USA, warrants to the owner of the enclosed product that the product contained in this box ("Product") will be free from defects in materials and workmanship for a period of two (2) years from the date of delivery following the original retail purchase (the "Warranty Period"). If the Product fails to conform to this Limited Warranty during the Warranty Period, Nest Labs will, at its sole discretion, either (a) repair or replace any defective Product or component; or (b) accept the return of the Product and refund the money actually paid by the original purchaser for the Product. Repair or replacement may be made with a new or refurbished product or components, at Nest Labs' sole discretion. If the Product or a component incorporated within it is no longer available, Nest Labs may, at Nest Labs' sole discretion, replace the Product with a similar product of similar function. This is your sole and exclusive remedy for breach of this Limited Warranty. Any Product that has either been repaired or replaced under this Limited Warranty will be covered by the terms of this Limited Warranty for the longer of (a) ninety (90) days from the date of delivery of the repaired Product or replacement Product, or (b) the remaining Warranty Period. This Limited Warranty is transferable from the original purchaser to subsequent owners, but the Warranty Period will not be extended in duration or expanded in coverage for any such transfer.

2. TOTAL SATISFACTION RETURN POLICY

If you are the original purchaser of the Product and you are not satisfied with this Product for any reason, you may return it in its original condition within thirty (30) days of the original purchase and receive a full refund.

3. WARRANTY CONDITIONS; HOW TO GET SERVICE IF YOU WANT TO CLAIM UNDER THIS LIMITED WARRANTY

Before making a claim under this Limited Warranty, the owner of the Product must (a) notify Nest Labs of the intention to claim by visiting nest.com/support during the Warranty Period and providing a description of the alleged failure, and (b) comply with Nest Labs' return shipping instructions. Nest Labs will have no warranty obligations with respect to a returned Product if it determines, in its reasonable discretion after examination of the returned Product, that the Product is an Ineligible Product

(defined below). Nest Labs will bear all costs of return shipping to owner and will reimburse any shipping costs incurred by the owner, except with respect to any Ineligible Product, for which owner will bear all shipping costs.

4. WHAT THIS LIMITED WARRANTY DOES NOT COVER

This Limited Warranty does not cover the following (collectively "Ineligible Products"): Products marked as "sample" or "Not for Sale", or sold "AS IS"; or Products that have been subject to: (a) modifications, alterations, tampering, or improper maintenance or repairs; (b) handling, storage, installation, testing, or use not in accordance with the User's Guide or other instructions provided by Nest Labs; (c) abuse or misuse of the Product; (d) breakdowns, fluctuations, or interruptions in electric power or the telecommunications network; or (e) Acts of God, including but not limited to lightning, flood, tornado, earthquake, or hurricane. This Limited Warranty does not cover consumable parts, including batteries, unless damage is due to defects in materials or workmanship of the Product, or software (even if packaged or sold with the product). Nest Labs recommends that you use only authorized service providers for maintenance or repair. Unauthorized use of the Product or software can impair the Product's performance and may invalidate this Limited Warranty.

5. DISCLAIMER OF WARRANTIES

EXCEPT AS STATED ABOVE IN THIS LIMITED WARRANTY, AND TO THE MAXIMUM EXTENT PERMITTED BY APPLICABLE LAW, NEST LABS DISCLAIMS ALL EXPRESS, IMPLIED, AND STATUTORY WARRANTIES AND CONDITIONS WITH RESPECT TO THE PRODUCT, INCLUDING THE IMPLIED WARRANTIES OF MERCHANTABILITY AND FITNESS FOR A PARTICULAR PURPOSE. TO THE MAXIMUM EXTENT PERMITTED BY APPLICABLE LAW, NEST LABS ALSO LIMITS THE DURATION OF ANY APPLICABLE IMPLIED WARRANTIES OR CONDITIONS TO THE DURATION OF THIS LIMITED WARRANTY.

6. LIMITATION OF DAMAGES

IN ADDITION TO THE ABOVE WARRANTY DISCLAIMERS, IN NO EVENT WILL NEST LABS BE LIABLE FOR ANY CONSEQUENTIAL, INCIDENTAL, EXEMPLARY, OR SPECIAL DAMAGES, INCLUDING ANY DAMAGES FOR LOST DATA OR LOST PROFITS, ARISING FROM OR RELATING TO THIS LIMITED WARRANTY OR THE PRODUCT, AND NEST LABS' TOTAL CUMULATIVE LIABILITY ARISING FROM OR RELATED TO THIS LIMITED WARRANTY OR THE PRODUCT WILL NOT EXCEED THE AMOUNT ACTUALLY PAID FOR THE PRODUCT BY THE ORIGINAL PURCHASER.

7. LIMITATION OF LIABILITY

THE NEST LABS ONLINE SERVICES ("SERVICES") PROVIDE YOU INFORMATION ("PRODUCT INFORMATION") REGARDING YOUR NEST PRODUCTS OR OTHER PERIPHERALS CONNECTED TO YOUR PRODUCTS ("PRODUCT PERIPHERALS"). THE TYPE OF PRODUCT PERIPHERALS THAT MAY BE CONNECTED TO YOUR PRODUCT MAY CHANGE FROM TIME TO TIME. WITHOUT LIMITING THE GENERALITY OF THE DISCLAIMERS ABOVE, ALL PRODUCT INFORMATION IS PROVIDED FOR YOUR CONVENIENCE. "AS IS", AND "AS AVAILABLE". NEST LABS DOES NOT REPRESENT, WARRANT, OR GUARANTEE THAT PRODUCT INFORMATION WILL BE AVAILABLE, ACCURATE, OR RELIABLE OR THAT PRODUCT INFORMATION OR USE OF THE SERVICES OR PRODUCT WILL PROVIDE SAFETY IN YOUR HOME. YOU USE ALL PRODUCT INFORMATION, THE SERVICES, AND THE PRODUCT AT YOUR OWN DISCRETION AND RISK. YOU WILL BE SOLELY RESPONSIBLE FOR (AND NEST LABS DISCLAIMS) ANY AND ALL LOSS, LIABILITY, OR DAMAGES, INCLUDING TO YOUR WIRING, FIXTURES, ELECTRICITY, HOME, PRODUCT, PRODUCT PERIPHERALS, COMPUTER, MOBILE DEVICE, AND ALL OTHER ITEMS AND PETS IN YOUR HOME, RESULTING FROM YOUR USE OF THE PRODUCT INFORMATION, SERVICES, OR PRODUCT. PRODUCT INFORMATION PROVIDED BY THE SERVICES IS NOT INTENDED AS A SUBSTITUTE FOR DIRECT MEANS OF OBTAINING THE INFORMATION. FOR EXAMPLE, A NOTIFICATION PROVIDED THROUGH THE SERVICE IS NOT INTENDED AS A SUBSTITUTE FOR AUDIBLE AND VISIBLE INDICATIONS IN THE HOME AND ON THE PRODUCT, NOR FOR A THIRD PARTY MONITORING SERVICE THAT MONITORS ALARM STATE.

8. YOUR RIGHTS AND THIS LIMITED WARRANTY

This Limited Warranty gives you specific legal rights. You may also have other legal rights that vary by state, province, or jurisdiction. Likewise, some of the limitations in this Limited Warranty may not apply in certain states. The terms of this Limited Warranty will apply to the extent permitted by applicable law. For a full description of your legal rights you should refer to the laws applicable in your jurisdiction and you may wish to contact a relevant consumer advisory service.

64-30-0032-ES

FCC Regulatory Statement

This device complies with part 15 of the FCC rules. Operation is subject to the following two conditions: (1) This Device may not cause harmful interference; and (2) this Device must accept any interference received, including interference that may cause undesired operation.

This equipment has been tested and found to comply with the limits for a Class B digital device, pursuant to part 15 of the FCC rules. These limits are designed to provide reasonable protection against harmful interference in a residential installation. This Device generates, uses and can radiate radio frequency energy and, if not installed and used in accordance with the instructions, may cause harmful interference to radio communications. However, there is no guarantee that interference will not occur in a particular installation. If this Device does cause harmful interference to radio or television reception, which can be determined by turning the equipment off and on, the user is encouraged to try to correct the interference by one or more of the following measures:

- Reorient or relocate the receiving antenna.
- Increase the separation between the equipment and receiver.
- Connect the equipment into an outlet on a circuit different from that to which the receiver is connected.
- Consult the dealer or an experienced radio/TV technician for help.

Changes or modifications not expressly approved by the party responsible for compliance could void the user's authority to operate the equipment.

This equipment complies with FCC radiation exposure limits set fourth for an uncontrolled environment. This equipment should be installed and operated with minimum distance of 20 cm from all persons.

IC Regulatory Statement

This device complies with Industry Canada license-exempt RSS standard(s).

Operation is subject to the following two conditions:

- (1) this device may not cause interference, and
- (2) this device must accept any interference, including interference that may cause undesired operation of the device.

Le présent appareil est conforme aux CNR d'Industrie Canada applicables aux appareils radio exempts de licence. L'exploitation est autorisée aux deux conditions suivantes:

- (1) l'appareil ne doit pas produire de brouillage, et
- (2) l'utilisateur de l'appareil doit accepter tout brouillage radioélectrique subi, même si le brouillage est susceptible d'en compromettre le fonctionnement."

This Class B digital apparatus complies with Canadian ICES-003.
Cet appareil numérique de la classe B est conforme à la norme NMB-003 du Canada.

Restrictions:

- (i) the device for operation in the band 5150-5250 MHz is only for indoor use to reduce the potential for harmful interference to co-channel mobile satellite systems;
 - (ii) the maximum antenna gain permitted for devices in the bands 5250-5350 MHz and 5470-5725 MHz shall comply with the e.i.r.p. limit; and
 - (iii) the maximum antenna gain permitted for devices in the band 5725-5825 MHz shall comply with the e.i.r.p. limits specified for point-to-point and non point-to-point operation as appropriate.
- High-power radars are allocated as primary users (i.e. priority users) of the bands 5250-5350 MHz and 5650-5850 MHz and that these radars could cause interference and/or damage to LE-LAN devices.

Le guide d'utilisation des dispositifs pour réseaux locaux doit inclure des instructions précises sur les restrictions susmentionnées, notamment :

- (i) les dispositifs fonctionnant dans la bande 5 150-5 250 MHz sont réservés uniquement pour une utilisation à l'intérieur afin de réduire les risques de brouillage préjudiciable aux systèmes de satellites mobiles utilisant les mêmes canaux;
- (ii) le gain maximal d'antenne permis pour les dispositifs utilisant les bandes 5 250-5 350 MHz et 5 470-5 725 MHz doit se conformer à la limite de p.i.r.e.;
- (iii) le gain maximal d'antenne permis (pour les dispositifs utilisant la bande 5 725-5 825 MHz) doit se conformer à la limite de p.i.r.e. spécifiée pour l'exploitation point à point et non point à point, selon le cas.
- (iv) les radars de haute puissance sont désignés utilisateurs principaux (c.-à-d., qu'ils ont la priorité) pour les bandes 5 250-5 350 MHz et 5 650-5 850 MHz. Ces radars pourraient causer du brouillage et/ou des dommages aux dispositifs LAN-EL.

This equipment complies with IC RSS-102 radiation exposure limits set fourth for an uncontrolled environment. This equipment should be installed and operated with minimum distance of 20 cm from all persons.

Cet appareil est conforme au seuil d'exposition aux rayonnements CNR-102 établi par l'IC en ce qui concerne les environnements non contrôlés. Cet appareil doit être installé et utilisé à une distance minimale de 20 cm de toute personne.