



FCC TEST REPORT (15.247)

REPORT NO.: RF150401C19-1 R1
MODEL NO.: A0013
FCC ID: ZQAT30
RECEIVED: Apr. 01, 2015
TESTED: Apr. 07, 2015 ~ May 09, 2015
ISSUED: May 11, 2015

APPLICANT: Nest Labs Inc.

ADDRESS: 3400 Hillview Ave. Palo Alto California, United States 94304

ISSUED BY: Bureau Veritas Consumer Products Services (H.K.)
Ltd., Taoyuan Branch

LAB ADDRESS: No. 47-2, 14th Ling, Chia Pau Vil., Lin Kou Dist., New
Taipei City, Taiwan (R.O.C)

TEST LOCATION: No.19, Hwa Ya 2nd Rd., Wen Hwa Vil., Kwei Shan
Dist., Taoyuan City 33383, TAIWAN (R.O.C.)

This report should not be used by the client to claim
product certification, approval, or endorsement by
TAF or any government agencies.



This report is for your exclusive use. Any copying or replication of this report to or for any other person or entity, or use of our name or trademark, is permitted only with our prior written permission. This report sets forth our findings solely with respect to the test samples identified herein. The results set forth in this report are not indicative or representative of the quality or characteristics of the lot from which a test sample was taken or any similar or identical product unless specifically and expressly noted. Our report includes all of the tests requested by you and the results thereof based upon the information that you provided to us. You have 60 days from date of issuance of this report to notify us of any material error or omission caused by our negligence, provided, however, that such notice shall be in writing and shall specifically address the issue you wish to raise. A failure to raise such issue within the prescribed time shall constitute your unqualified acceptance of the completeness of this report, the tests conducted and the correctness of the report contents. Unless specific mention, the uncertainty of measurement has been explicitly taken into account to declare the compliance or non-compliance to the specification.



TABLE OF CONTENTS

- RELEASE CONTROL RECORD 4
- 1. CERTIFICATION 5
- 2. SUMMARY OF TEST RESULTS 6
 - 2.1 MEASUREMENT UNCERTAINTY 6
- 3. GENERAL INFORMATION 7
 - 3.1 GENERAL DESCRIPTION OF EUT 7
 - 3.2 DESCRIPTION OF TEST MODES 8
 - 3.2.1 TEST MODE APPLICABILITY AND TESTED CHANNEL DETAIL 9
 - 3.3 DESCRIPTION OF SUPPORT UNITS 11
 - 3.3.1 CONFIGURATION OF SYSTEM UNDER TEST 12
 - 3.4 DUTY CYCLE TEST SIGNAL 14
 - 3.5 GENERAL DESCRIPTION OF APPLIED STANDARDS 14
- 4. TEST TYPES AND RESULTS (FOR 2.4GHz BAND) 15
 - 4.1 RADIATED EMISSION AND BANDEDGE MEASUREMENT 15
 - 4.1.1 LIMITS OF RADIATED EMISSION AND BANDEDGE MEASUREMENT 15
 - 4.1.2 TEST INSTRUMENTS 16
 - 4.1.3 TEST PROCEDURES 17
 - 4.1.4 DEVIATION FROM TEST STANDARD 17
 - 4.1.5 TEST SETUP 18
 - 4.1.6 EUT OPERATING CONDITIONS 18
 - 4.1.7 TEST RESULTS 19
 - 4.2 CONDUCTED EMISSION MEASUREMENT 31
 - 4.2.1 LIMITS OF CONDUCTED EMISSION MEASUREMENT 31
 - 4.2.2 TEST INSTRUMENTS 31
 - 4.2.3 TEST PROCEDURES 32
 - 4.2.4 DEVIATION FROM TEST STANDARD 32
 - 4.2.5 TEST SETUP 33
 - 4.2.6 EUT OPERATING CONDITIONS 33
 - 4.2.7 TEST RESULTS 34
 - 4.3 6dB BANDWIDTH MEASUREMENT 38
 - 4.3.1 LIMITS OF 6dB BANDWIDTH MEASUREMENT 38
 - 4.3.2 TEST SETUP 38
 - 4.3.3 TEST INSTRUMENTS 38
 - 4.3.4 TEST PROCEDURE 38
 - 4.3.5 DEVIATION FROM TEST STANDARD 38
 - 4.3.6 EUT OPERATING CONDITIONS 38
 - 4.3.7 TEST RESULTS 39
 - 4.4 CONDUCTED OUTPUT POWER 41
 - 4.4.1 LIMITS OF CONDUCTED OUTPUT POWER MEASUREMENT 41
 - 4.4.2 TEST SETUP 41
 - 4.4.3 TEST INSTRUMENTS 41
 - 4.4.4 TEST PROCEDURES 41
 - 4.4.5 DEVIATION FROM TEST STANDARD 41
 - 4.4.6 EUT OPERATING CONDITIONS 41
 - 4.4.7 TEST RESULTS 42
 - 4.5 POWER SPECTRAL DENSITY MEASUREMENT 43
 - 4.5.1 LIMITS OF POWER SPECTRAL DENSITY MEASUREMENT 43
 - 4.5.2 TEST SETUP 43
 - 4.5.3 TEST INSTRUMENTS 43
 - 4.5.4 TEST PROCEDURE 43
 - 4.5.5 DEVIATION FROM TEST STANDARD 43



A D T

4.5.6	EUT OPERATING CONDITION.....	43
4.5.7	TEST RESULTS.....	44
4.6	CONDUCTED OUT OF BAND EMISSION MEASUREMENT	46
4.6.1	LIMITS OF CONDUCTED OUT OF BAND EMISSION MEASUREMENT.....	46
4.6.2	TEST SETUP	46
4.6.3	TEST INSTRUMENTS	46
4.6.4	TEST PROCEDURE	46
4.6.5	DEVIATION FROM TEST STANDARD	46
4.6.6	EUT OPERATING CONDITION.....	46
4.6.7	TEST RESULTS.....	47
5.	PHOTOGRAPHS OF THE TEST CONFIGURATION.....	53
6.	INFORMATION ON THE TESTING LABORATORIES	54
7.	APPENDIX A – MODIFICATIONS RECORDERS FOR ENGINEERING CHANGES TO THE EUT BY THE LAB	55



A D T

RELEASE CONTROL RECORD

ISSUE NO.	REASON FOR CHANGE	DATE ISSUED
RF150401C19-1	Original release	Apr. 22, 2015
RF150401C19-1 R1	Update model name	May 11, 2015



1. CERTIFICATION

PRODUCT: Wireless Device
MODEL NO.: A0013
APPLICANT: Nest Labs Inc.
TESTED: Apr. 07, 2015 ~ May 09, 2015
TEST SAMPLE: Identical Prototype
STANDARDS: **FCC Part 15, Subpart C (Section 15.247)**
ANSI C63.10-2009

The above equipment (model: A0013) has been tested by **Bureau Veritas Consumer Products Services (H.K.) Ltd., Taoyuan Branch**, and found compliance with the requirement of the above standards. The test record, data evaluation & Equipment Under Test (EUT) configurations represented herein are true and accurate accounts of the measurements of the sample's EMC characteristics under the conditions specified in this report.

PREPARED BY : Evonne Liu , **DATE :** May 11, 2015
Evonne Liu / Specialist

APPROVED BY : Sam Chen , **DATE :** May 11, 2015
Sam Chen / Senior Project Engineer

2. SUMMARY OF TEST RESULTS

The EUT has been tested according to the following specifications:

APPLIED STANDARD: FCC PART 15, SUBPART C (SECTION 15.247)			
STANDARD SECTION	TEST TYPE	RESULT	REMARK
15.207	AC Power Conducted Emission	PASS	Meet the requirement of limit. Minimum passing margin is -12.30dB at 0.15391MHz.
15.205 & 15.209	Radiated Emissions	PASS	Meet the requirement of limit. Minimum passing margin is -4.35dB at 2386MHz.
15.247(d)	Band Edge Measurement	PASS	Meet the requirement of limit.
15.247(d)	Antenna Port Emission	PASS	Meet the requirement of limit.
15.247(a)(2)	6dB bandwidth	PASS	Meet the requirement of limit.
15.247(b)	Conducted power	PASS	Meet the requirement of limit.
15.247(e)	Power Spectral Density	PASS	Meet the requirement of limit.
15.203	Antenna Requirement	PASS	No antenna connector is used.

2.1 MEASUREMENT UNCERTAINTY

Where relevant, the following measurement uncertainty levels have been estimated for tests performed on the EUT as specified in CISPR 16-4-2:

MEASUREMENT	FREQUENCY	UNCERTAINTY
Conducted emissions	9kHz~30MHz	2.44 dB
Radiated emissions	30MHz ~ 200MHz	2.93 dB
	200MHz ~1000MHz	2.95 dB
	1GHz ~ 18GHz	2.26 dB
	18GHz ~ 40GHz	1.94 dB

This uncertainty represents an expanded uncertainty expressed at approximately the 95% confidence level using a coverage factor of $k = 2$.

3. GENERAL INFORMATION

3.1 GENERAL DESCRIPTION OF EUT

EUT	Wireless Device
MODEL NO.	A0013
POWER SUPPLY RATING	24Vac (Adapter) 3.8Vdc (battery) 5.0Vdc (host equipment)
MODULATION TYPE	CCK, DQPSK, DBPSK for DSSS 64QAM, 16QAM, QPSK, BPSK for OFDM
MODULATION TECHNOLOGY	DSSS, OFDM
TRANSFER RATE	802.11b: 11.0 / 5.5 / 2.0 / 1.0 Mbps 802.11g: 54.0 / 48.0 / 36.0 / 24.0 / 18.0 / 12.0 / 9.0 / 6.0 Mbps 802.11n: up to MCS7
OPERATING FREQUENCY	2412 ~ 2462MHz
NUMBER OF CHANNEL	11 for 802.11b, 802.11g, 802.11n (20MHz)
OUTPUT POWER	277.33mW
ANTENNA TYPE / PEAK GAIN	Loop antenna with 1.1dBi gain
ANTENNA CONNECTOR	NA
DATA CABLE	Refer to Note as below
I/O PORTS	Refer to user's manual
ACCESSORY DEVICES	Refer to Note as below

NOTE:

1. The EUT provides one completed transmitter and one receiver.

MODULATION MODE	TX FUNCTION
802.11b	1TX
802.11g	1TX
802.11n (20MHz)	1TX
802.11n (40MHz)	1TX

2. The above EUT information is declared by the manufacturer and for more detailed features description, please refer to the manufacturer's specifications or User's Manual.
3. Testing for radiated emissions above 1GHz was performed with the EUT elevated at 1.5m instead of 0.8m. 1.5m is the required height in ANSI C63.10:2013 as referenced by RSS GEN issue 4. This test height has been permitted by FCC as discussed in FCC/TCB conference call in December 2014.



A D T

3.2 DESCRIPTION OF TEST MODES

FOR 2.4GHz:

11 channels are provided for 802.11b, 802.11g and 802.11n (20MHz):

CHANNEL	FREQUENCY	CHANNEL	FREQUENCY
1	2412MHz	7	2442MHz
2	2417MHz	8	2447MHz
3	2422MHz	9	2452MHz
4	2427MHz	10	2457MHz
5	2432MHz	11	2462MHz
6	2437MHz		

3.2.1 TEST MODE APPLICABILITY AND TESTED CHANNEL DETAIL

WLAN 2.4GHz:

EUT CONFIGURE MODE	APPLICABLE TO				DESCRIPTION
	RE≥1G	RE<1G	PLC	APCM	
A	√	√	-	√	Battery Mode
B	-	√	√	-	Notebook Mode
C	-	√	√	-	Taco Box Mode

Where **RE≥1G**: Radiated Emission above 1GHz **RE<1G**: Radiated Emission below 1GHz
PLC: Power Line Conducted Emission **APCM**: Antenna Port Conducted Measurement

NOTE: The EUT had been pre-tested on the positioned of each 3 axis. The worst case was found when positioned on **Z-plane**.

RADIATED EMISSION TEST (ABOVE 1GHz):

Pre-Scan has been conducted to determine the worst-case mode from all possible combinations between available modulations, data rates and antenna ports (if EUT with antenna diversity architecture).

Following channel(s) was (were) selected for the final test as listed below.

EUT CONFIGURE MODE	MODE	AVAILABLE CHANNEL	TESTED CHANNEL	MODULATION TECHNOLOGY	MODULATION TYPE	DATA RATE (Mbps)
A	802.11b	1 to 11	1, 6, 11	DSSS	DBPSK	1.0
	802.11g	1 to 11	1, 6, 11	OFDM	BPSK	6.0
	802.11n (20MHz)	1 to 11	1, 6, 11	OFDM	BPSK	MCS0

RADIATED EMISSION TEST (BELOW 1GHz):

Pre-Scan has been conducted to determine the worst-case mode from all possible combinations between available modulations, data rates and antenna ports (if EUT with antenna diversity architecture).

Following channel(s) was (were) selected for the final test as listed below.

EUT CONFIGURE MODE	MODE	AVAILABLE CHANNEL	TESTED CHANNEL	MODULATION TECHNOLOGY	MODULATION TYPE	DATA RATE (Mbps)
A, B, C	802.11b	1 to 11	1	OFDM	BPSK	MCS0

POWER LINE CONDUCTED EMISSION TEST:

Pre-Scan has been conducted to determine the worst-case mode from all possible combinations between available modulations, data rates and antenna ports (if EUT with antenna diversity architecture).

Following channel(s) was (were) selected for the final test as listed below.

EUT CONFIGURE MODE	MODE	AVAILABLE CHANNEL	TESTED CHANNEL	MODULATION TECHNOLOGY	MODULATION TYPE	DATA RATE (Mbps)
B, C	802.11b	1 to 11	1	OFDM	BPSK	MCS0



A D T

BANDEDGE MEASUREMENT:

- Pre-Scan has been conducted to determine the worst-case mode from all possible combinations between available modulations, data rates and antenna ports (if EUT with antenna diversity architecture).
- Following channel(s) was (were) selected for the final test as listed below.

EUT CONFIGURE MODE	MODE	AVAILABLE CHANNEL	TESTED CHANNEL	MODULATION TECHNOLOGY	MODULATION TYPE	DATA RATE (Mbps)
A	802.11b	1 to 11	1, 6, 11	DSSS	DBPSK	1.0
	802.11g	1 to 11	1, 6, 11	OFDM	BPSK	6.0
	802.11n (20MHz)	1 to 11	1, 6, 11	OFDM	BPSK	MCS0

ANTENNA PORT CONDUCTED MEASUREMENT:

- This item includes all test value of each mode, but only includes spectrum plot of worst value of each mode.
- Pre-Scan has been conducted to determine the worst-case mode from all possible combinations between available modulations, data rates and antenna ports (if EUT with antenna diversity architecture).
- Following channel(s) was (were) selected for the final test as listed below.

EUT CONFIGURE MODE	MODE	AVAILABLE CHANNEL	TESTED CHANNEL	MODULATION TECHNOLOGY	MODULATION TYPE	DATA RATE (Mbps)
A	802.11b	1 to 11	1, 6, 11	DSSS	DBPSK	1.0
	802.11g	1 to 11	1, 6, 11	OFDM	BPSK	6.0
	802.11n (20MHz)	1 to 11	1, 6, 11	OFDM	BPSK	MCS0

TEST CONDITION:

APPLICABLE TO	ENVIRONMENTAL CONDITIONS	INPUT POWER	TESTED BY
RE≥1G	25deg. C, 65%RH	120Vac, 60Hz	Gavin Wu
RE<1G	25deg. C, 65%RH	120Vac, 60Hz	Gavin Wu
PLC	25deg. C, 65%RH	120Vac, 60Hz	Toby Tian
APCM	25deg. C, 65%RH	3.8Vdc	Dylan Yang



A D T

3.3 DESCRIPTION OF SUPPORT UNITS

The EUT has been tested as an independent unit together with other necessary accessories or support units. The following support units or accessories were used to form a representative test configuration during the tests.

NO.	PRODUCT	BRAND	MODEL NO.	SERIAL NO.	FCC ID
1	Taco box	N/A	N/A	N/A	N/A
2	Notebook	N/A	N/A	N/A	N/A

NO.	SIGNAL CABLE DESCRIPTION OF THE ABOVE SUPPORT UNITS
1	N/A
2	N/A

- NOTE:** 1. All power cords of the above support units are non shielded (1.8m).
2. Item 1 was provided by client.

3.3.1 CONFIGURATION OF SYSTEM UNDER TEST

For Radiation

MODE A

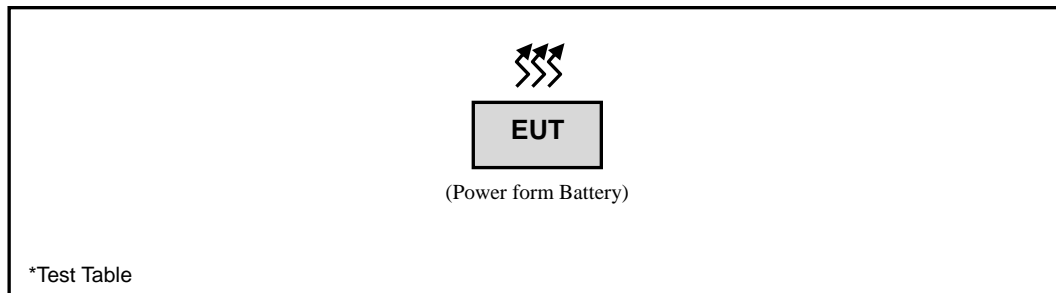

MODE B

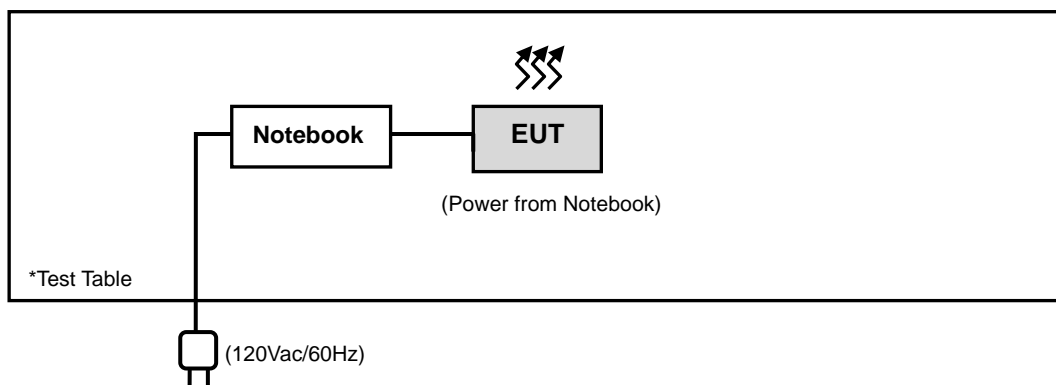

MODE C

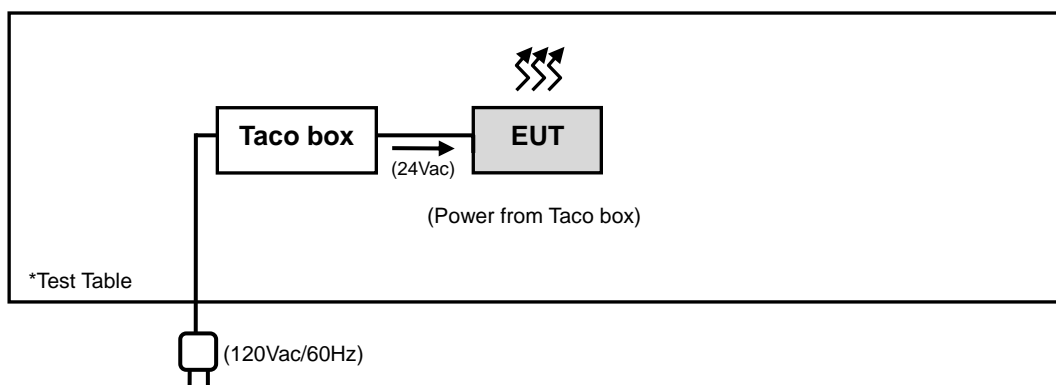

For Conduction

MODE B

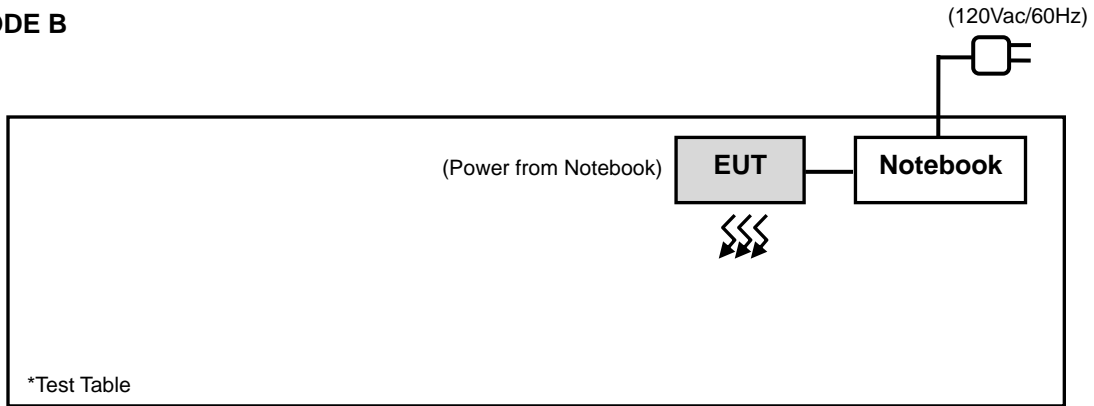

MODE C

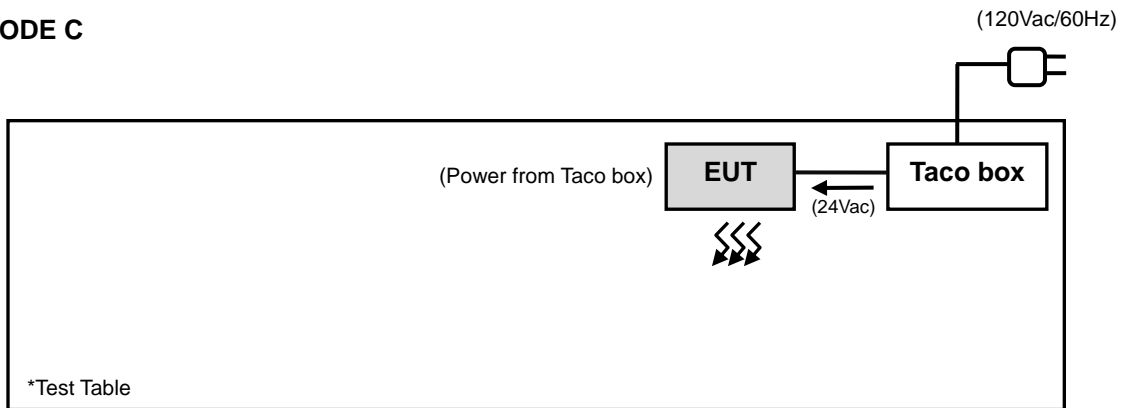

3.4 DUTY CYCLE TEST SIGNAL

WLAN 2.4GHz

If duty cycle is < 98%

802.11b: Duty cycle = $4.035/4.290 = 0.940$, Duty factor = $10 * \log(1/0.940) = 0.26$

802.11g: Duty cycle = $650/908 = 0.715$, Duty factor = $10 * \log(1/0.715) = 1.45$

802.11n (20MHz): Duty cycle = $620/880 = 0.704$, Duty factor = $10 * \log(1/0.704) = 1.52$

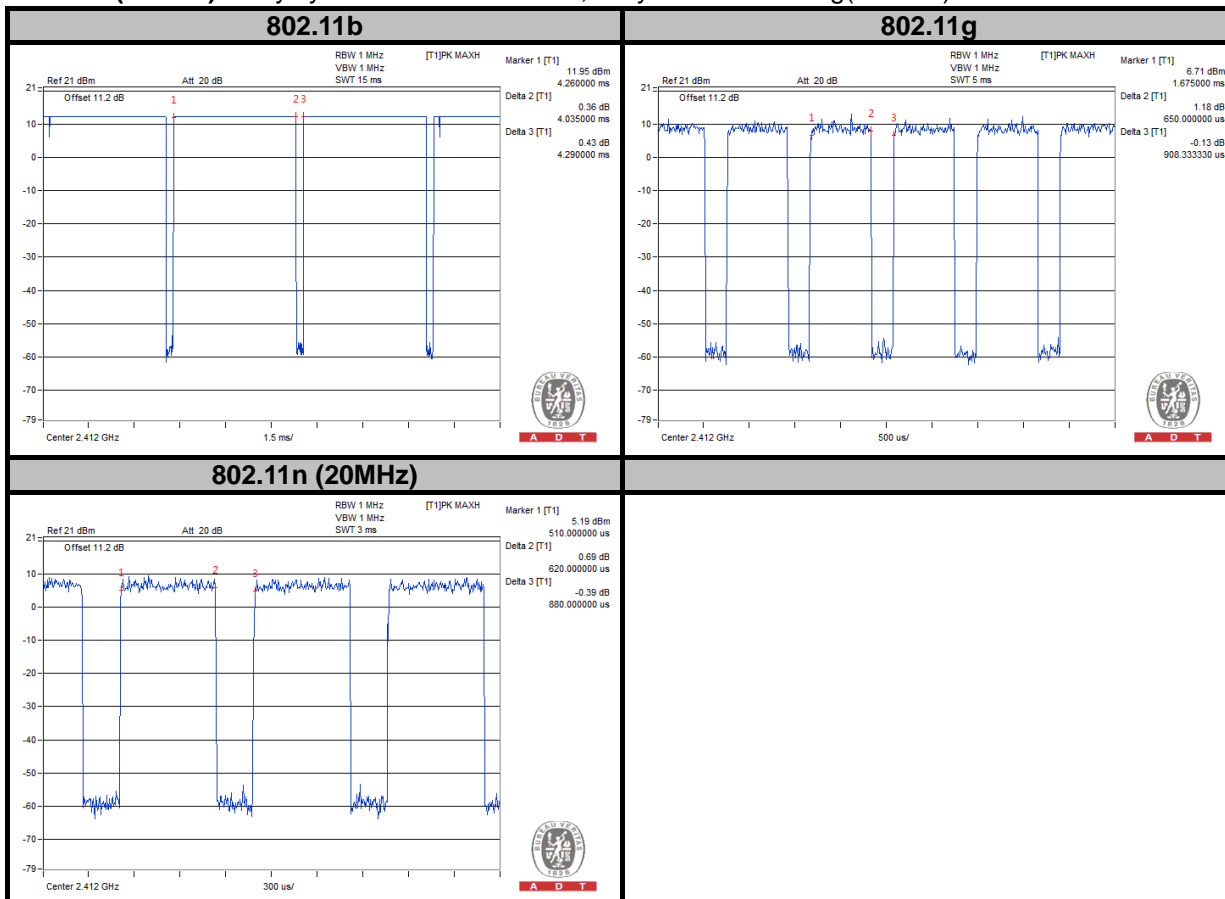

3.5 GENERAL DESCRIPTION OF APPLIED STANDARDS

The EUT is a RF Product. According to the specifications of the manufacturer, it must comply with the requirements of the following standards:

FCC Part 15, Subpart C (15.247)

558074 D01 DTS Meas Guidance v03r02

ANSI C63.10-2009

All test items have been performed and recorded as per the above standards.

NOTE: The EUT has been verified to comply with the requirements of FCC Part 15, Subpart B, Class B (DoC). The test report has been issued separately.

4. TEST TYPES AND RESULTS (FOR 2.4GHz BAND)

4.1 RADIATED EMISSION AND BANDEDGE MEASUREMENT

4.1.1 LIMITS OF RADIATED EMISSION AND BANDEDGE MEASUREMENT

Radiated emissions which fall in the restricted bands must comply with the radiated emission limits specified as below table. Other emissions shall be at least 20dB below the highest level of the desired power:

FREQUENCIES (MHz)	FIELD STRENGTH (microvolts/meter)	MEASUREMENT DISTANCE (meters)
0.009 ~ 0.490	2400/F(kHz)	300
0.490 ~ 1.705	24000/F(kHz)	30
1.705 ~ 30.0	30	30
30 ~ 88	100	3
88 ~ 216	150	3
216 ~ 960	200	3
Above 960	500	3

NOTE:

1. The lower limit shall apply at the transition frequencies.
2. Emission level (dBuV/m) = 20 log Emission level (uV/m).
3. For frequencies above 1000MHz, the field strength limits are based on average detector, however, the peak field strength of any emission shall not exceed the maximum permitted average limits, specified above by more than 20dB under any condition of modulation.



A D T

4.1.2 TEST INSTRUMENTS

DESCRIPTION & MANUFACTURER	MODEL NO.	SERIAL NO.	DATE OF CALIBRATION	DUE DATE OF CALIBRATION
Test Receiver Agilent	N9038A	MY52260177	May 19, 2014	May 18, 2015
Spectrum Analyzer Agilent	N9010A	MY52220314	Sep. 03, 2014	Sep. 02, 2015
Spectrum Analyzer ROHDE & SCHWARZ	FSU43	101261	Dec. 10, 2014	Dec. 09, 2015
BILOG Antenna SCHWARZBECK	VULB9168	9168-472	Feb. 05, 2015	Feb. 04, 2016
HORN Antenna SCHWARZBECK	BBHA 9120 D	9120D-969	Feb. 10, 2015	Feb. 09, 2016
HORN Antenna SCHWARZBECK	BBHA 9170	9170-480	Aug. 27, 2014	Aug. 26, 2015
Loop Antenna	EM-6879	269	Aug.13, 2014	Aug.12, 2015
Preamplifier EMCI	EMC 012645	980115	Dec. 12, 2014	Dec. 11, 2015
Preamplifier EMCI	EMC 184045	980116	Jan. 09, 2015	Jan. 08, 2016
Preamplifier EMCI	EMC 330H	980112	Dec. 27, 2014	Dec. 26, 2015
Power Meter Anritsu	ML2495A	1232002	Sep. 17, 2014	Sep. 16, 2015
Power Sensor Anritsu	MA2411B	1207325	Sep. 17, 2014	Sep. 16, 2015
RF signal cable HUBER+SUHNNER	SUCOFLEX 104	309219/4 2950114	Oct. 18, 2014	Oct. 17, 2015
RF signal cable HUBER+SUHNNER	SUCOFLEX 104	250130/4	Oct. 18, 2014	Oct. 17, 2015
RF Coaxial Cable Worken	8D-FB	Cable-Ch10-01	Nov. 07, 2014	Nov. 06, 2015
Software BV ADT	E3 6.120103	NA	NA	NA
Antenna Tower MF	MFA-440H	NA	NA	NA
Turn Table MF	MFT-201SS	NA	NA	NA
Antenna Tower & Turn Table Controller MF	MF-7802	NA	NA	NA
Power Meter	ML2495A	1232002	Sep. 17, 2014	Sep. 16, 2015
Power Sensor	MA2411B	1207325	Sep. 17, 2014	Sep. 16, 2015



A D T

- NOTE:**
1. The calibration interval of the above test instruments is 12 months and the calibrations are traceable to NML/ROC and NIST/USA.
 2. The calibration interval of the loop antenna is 24 months and the calibrations are traceable to NML/ROC and NIST/USA.
 3. The test was performed in HwaYa Chamber 10.
 4. The horn antenna and HP preamplifier (model: 8449B) are used only for the measurement of emission frequency above 1GHz if tested.
 5. The FCC Site Registration No. is 690701.
 6. The IC Site Registration No. is IC 7450F-10.

4.1.3 TEST PROCEDURES

- a. The EUT was placed on the top of a rotating table 0.8 meters above the ground at a 3 meters semi-anechoic chamber. The table was rotated 360 degrees to determine the position of the highest radiation.
- b. The EUT was set 3 meters away from the interference-receiving antenna, which was mounted on the top of a variable-height antenna tower.
- c. Height of receiving antenna is varied from one meter to four meters above the ground to determine the maximum value of the field strength. Both horizontal and vertical polarizations of the antenna are set to make the measurement.
- d. For each suspected emission, the EUT was arranged to its worst case and then the antenna was tuned to heights from 1 meter to 4 meters and the rotatable table was turned from 0 degrees to 360 degrees to find the maximum reading.
- e. The test-receiver system was set to Peak Detect Function and Specified Bandwidth with Maximum Hold Mode.
- f. If the emission level of the EUT in peak mode was lower than the limit specified, then testing could be stopped and the peak values of the EUT would be reported. Otherwise the emissions would be re-tested one by one using peak, quasi-peak or average method as specified and then reported in a data sheet.

NOTE:

1. For emission measurements above 1 GHz, the EUT shall be placed at a height of 1.5 m above the ground at 3 meter chamber room for test
2. The resolution bandwidth and video bandwidth of test receiver/spectrum analyzer is 120kHz for Quasi-peak detection at frequency below 1GHz.
3. The resolution bandwidth of test receiver/spectrum analyzer is 1MHz and video bandwidth is 3MHz for Peak detection at frequency above 1GHz.
4. The resolution bandwidth of test receiver/spectrum analyzer is 1MHz and the video bandwidth is 3kHz (Duty cycle < 98%) or 10Hz (Duty cycle > 98%) for Average detection (AV) at frequency above 1GHz.
5. All modes of operation were investigated and the worst-case emissions are reported.

4.1.4 DEVIATION FROM TEST STANDARD

No deviation.

4.1.5 TEST SETUP

Frequency Range 30MHz ~ 1GHz

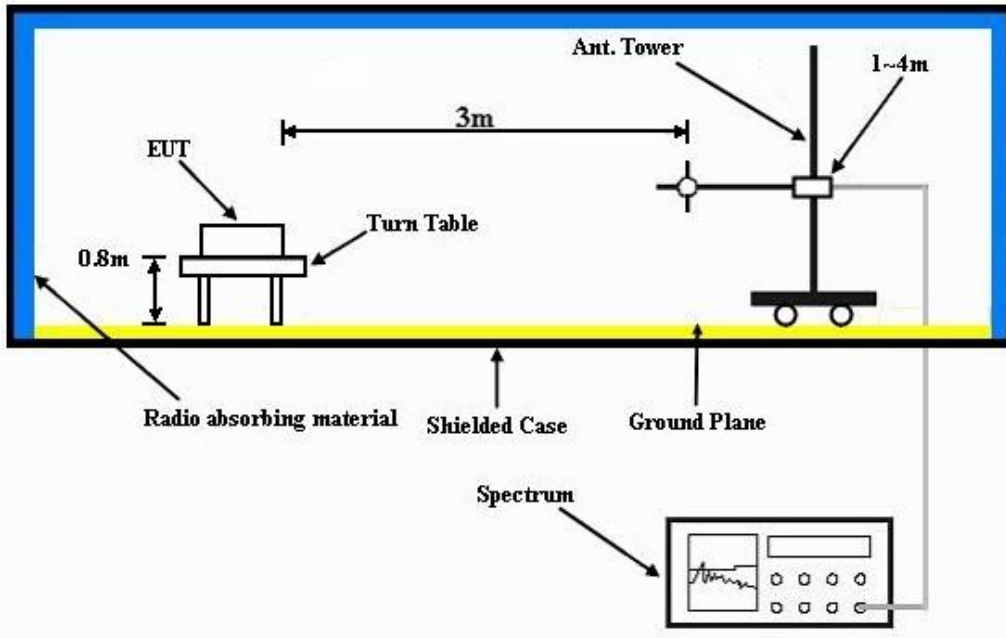

Frequency Range above 1GHz

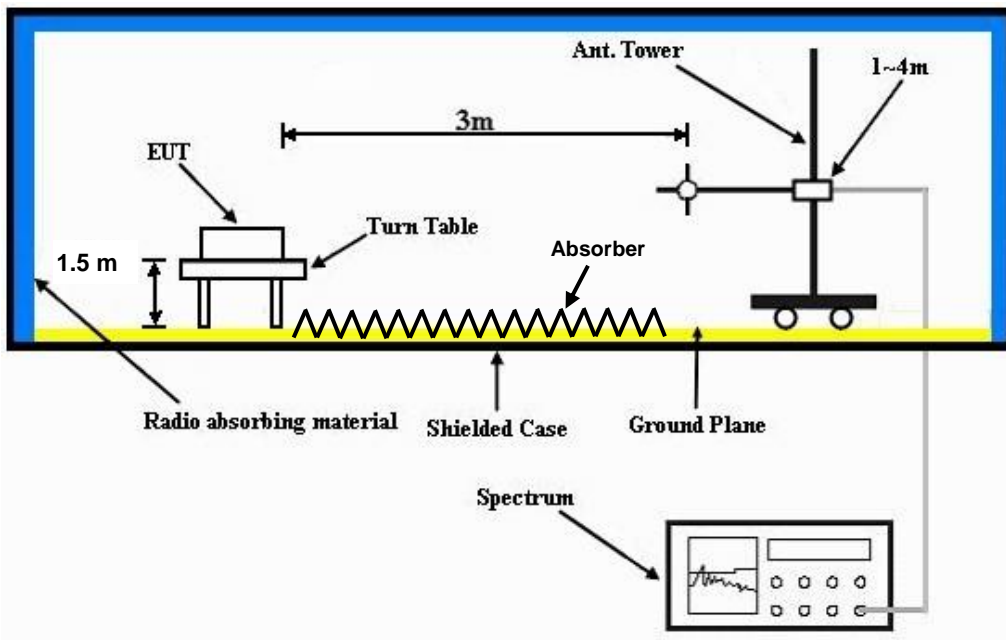

For the actual test configuration, please refer to the attached file (Test Setup Photo).

4.1.6 EUT OPERATING CONDITIONS

- a. Placed the EUT on a testing table.
- b. Use the software to control the EUT under transmission condition continuously at specific channel frequency.



A D T

4.1.7 TEST RESULTS

ABOVE 1GHz WORST-CASE DATA

MODE A

802.11b

EUT TEST CONDITION		MEASUREMENT DETAIL	
CHANNEL	Channel 1	FREQUENCY RANGE	1GHz ~ 25GHz
INPUT POWER	120Vac, 60 Hz	DETECTOR FUNCTION	Peak (PK) Average (AV)
ENVIRONMENTAL CONDITIONS	25deg. C, 65%RH	TESTED BY	Gavin Wu

ANTENNA POLARITY & TEST DISTANCE: HORIZONTAL AT 3 M

FREQ. (MHz)	EMISSION LEVEL (dBuV/m)	READ LEVEL (dBuV)	LIMIT (dBuV/m)	MARGIN (dB)	ANTENNA FACTOR (dB/m)	CABLE LOSS (dB)	PREAMP FACTOR (dB)	ANTENNA HEIGHT (cm)	TABLE ANGLE (Degree)	REMARK
2386	49.65	56.72	54	-4.35	26.91	3.52	37.5	134	45	Average
2386	58.83	65.9	74	-15.17	26.91	3.52	37.5	134	45	Peak
2412	101.42	108.44			26.96	3.54	37.52	134	45	Average
2412	105.16	112.18			26.96	3.54	37.52	134	45	Peak
2498	34.63	41.06	54	-19.37	27.2	3.62	37.25	134	45	Average
2498	56.58	63.01	74	-17.42	27.2	3.62	37.25	134	45	Peak
4824	28.89	45.21	54	-25.11	30.99	5.77	53.08	124	354	Average
4824	40.12	56.44	74	-33.88	30.99	5.77	53.08	124	354	Peak

ANTENNA POLARITY & TEST DISTANCE: VERTICAL AT 3 M

FREQ. (MHz)	EMISSION LEVEL (dBuV/m)	READ LEVEL (dBuV)	LIMIT (dBuV/m)	MARGIN (dB)	ANTENNA FACTOR (dB/m)	CABLE LOSS (dB)	PREAMP FACTOR (dB)	ANTENNA HEIGHT (cm)	TABLE ANGLE (Degree)	REMARK
2386	48.64	55.71	54	-5.36	26.91	3.52	37.5	152	16	Average
2386	58.35	65.42	74	-15.65	26.91	3.52	37.5	152	16	Peak
2412	99.63	106.65			26.96	3.54	37.52	152	16	Average
2412	103.37	110.39			26.96	3.54	37.52	152	16	Peak
2494	34.74	41.17	54	-19.26	27.2	3.62	37.25	152	16	Average
2494	55.36	61.79	74	-18.64	27.2	3.62	37.25	152	16	Peak
4824	28.71	45.03	54	-25.29	30.99	5.77	53.08	105	185	Average
4824	40.17	56.49	74	-33.83	30.99	5.77	53.08	105	185	Peak

REMARKS:

- Emission Level = Read Level + Antenna Factor + Cable Loss - Preamp Factor
Margin value = Emission level – Limit value
- 2412MHz: Fundamental frequency.



A D T

EUT TEST CONDITION		MEASUREMENT DETAIL	
CHANNEL	Channel 6	FREQUENCY RANGE	1GHz ~ 25GHz
INPUT POWER	120Vac, 60 Hz	DETECTOR FUNCTION	Peak (PK) Average (AV)
ENVIRONMENTAL CONDITIONS	25deg. C, 65%RH	TESTED BY	Gavin Wu

ANTENNA POLARITY & TEST DISTANCE: HORIZONTAL AT 3 M

FREQ. (MHz)	EMISSION LEVEL (dBuV/m)	READ LEVEL (dBuV)	LIMIT (dBuV/m)	MARGIN (dB)	ANTENNA FACTOR (dB/m)	CABLE LOSS (dB)	PREAMP FACTOR (dB)	ANTENNA HEIGHT (cm)	TABLE ANGLE (Degree)	REMARK
2380	34.36	41.48	54	-19.64	26.86	3.52	37.5	103	43	Average
2380	55.73	62.85	74	-18.27	26.86	3.52	37.5	103	43	Peak
2437	101.63	108.47			27.06	3.56	37.46	103	43	Average
2437	105.25	112.09			27.06	3.56	37.46	103	43	Peak
2486	36.37	42.94	54	-17.63	27.15	3.6	37.32	103	43	Average
2486	55.78	62.35	74	-18.22	27.15	3.6	37.32	103	43	Peak
4874	28.98	45.17	54	-25.02	31.06	5.8	53.05	114	346	Average
4874	40.21	56.4	74	-33.79	31.06	5.8	53.05	114	346	Peak

ANTENNA POLARITY & TEST DISTANCE: VERTICAL AT 3 M

FREQ. (MHz)	EMISSION LEVEL (dBuV/m)	READ LEVEL (dBuV)	LIMIT (dBuV/m)	MARGIN (dB)	ANTENNA FACTOR (dB/m)	CABLE LOSS (dB)	PREAMP FACTOR (dB)	ANTENNA HEIGHT (cm)	TABLE ANGLE (Degree)	REMARK
2334	33.88	41.15	54	-20.12	26.72	3.48	37.47	121	19	Average
2334	55.76	63.03	74	-18.24	26.72	3.48	37.47	121	19	Peak
2437	99.22	106.06			27.06	3.56	37.46	121	19	Average
2437	102.88	109.72			27.06	3.56	37.46	121	19	Peak
2494	35.25	41.68	54	-18.75	27.2	3.62	37.25	121	19	Average
2494	56.02	62.45	74	-17.98	27.2	3.62	37.25	121	19	Peak
4874	28.81	45	54	-25.19	31.06	5.8	53.05	107	202	Average
4874	39.77	55.96	74	-34.23	31.06	5.8	53.05	107	202	Peak

REMARKS:

- Emission Level = Read Level + Antenna Factor + Cable Loss - Preamp Factor
Margin value = Emission level – Limit value
- 2437MHz: Fundamental frequency.



A D T

EUT TEST CONDITION		MEASUREMENT DETAIL	
CHANNEL	Channel 11	FREQUENCY RANGE	1GHz ~ 25GHz
INPUT POWER	120Vac, 60 Hz	DETECTOR FUNCTION	Peak (PK) Average (AV)
ENVIRONMENTAL CONDITIONS	25deg. C, 65%RH	TESTED BY	Gavin Wu

ANTENNA POLARITY & TEST DISTANCE: HORIZONTAL AT 3 M

FREQ. (MHz)	EMISSION LEVEL (dBuV/m)	READ LEVEL (dBuV)	LIMIT (dBuV/m)	MARGIN (dB)	ANTENNA FACTOR (dB/m)	CABLE LOSS (dB)	PREAMP FACTOR (dB)	ANTENNA HEIGHT (cm)	TABLE ANGLE (Degree)	REMARK
2382	33.7	40.82	54	-20.3	26.86	3.52	37.5	103	43	Average
2382	56.2	63.32	74	-17.8	26.86	3.52	37.5	103	43	Peak
2462	101.16	107.87			27.1	3.58	37.39	103	43	Average
2462	105.06	111.77			27.1	3.58	37.39	103	43	Peak
2488	48.54	55.04	54	-5.46	27.2	3.62	37.32	103	43	Average
2488	59.85	66.35	74	-14.15	27.2	3.62	37.32	103	43	Peak
4924	29.12	45.2	54	-24.88	31.12	5.83	53.03	122	352	Average
4924	39.91	55.99	74	-34.09	31.12	5.83	53.03	122	352	Peak

ANTENNA POLARITY & TEST DISTANCE: VERTICAL AT 3 M

FREQ. (MHz)	EMISSION LEVEL (dBuV/m)	READ LEVEL (dBuV)	LIMIT (dBuV/m)	MARGIN (dB)	ANTENNA FACTOR (dB/m)	CABLE LOSS (dB)	PREAMP FACTOR (dB)	ANTENNA HEIGHT (cm)	TABLE ANGLE (Degree)	REMARK
2386	33.46	40.53	54	-20.54	26.91	3.52	37.5	146	18	Average
2386	57.17	64.24	74	-16.83	26.91	3.52	37.5	146	18	Peak
2462	99.16	105.87			27.1	3.58	37.39	146	18	Average
2462	102.79	109.5			27.1	3.58	37.39	146	18	Peak
2488	45.26	51.76	54	-8.74	27.2	3.62	37.32	146	18	Average
2488	57.77	64.27	74	-16.23	27.2	3.62	37.32	146	18	Peak
4924	28.92	45	54	-25.08	31.12	5.83	53.03	104	195	Average
4924	40.34	56.42	74	-33.66	31.12	5.83	53.03	104	195	Peak

REMARKS:

- Emission Level = Read Level + Antenna Factor + Cable Loss - Preamp Factor
Margin value = Emission level – Limit value
- 2462MHz: Fundamental frequency.



A D T

802.11g

EUT TEST CONDITION		MEASUREMENT DETAIL	
CHANNEL	Channel 1	FREQUENCY RANGE	1GHz ~ 25GHz
INPUT POWER	120Vac, 60 Hz	DETECTOR FUNCTION	Peak (PK) Average (AV)
ENVIRONMENTAL CONDITIONS	25deg. C, 65%RH	TESTED BY	Gavin Wu

ANTENNA POLARITY & TEST DISTANCE: HORIZONTAL AT 3 M

FREQ. (MHz)	EMISSION LEVEL (dBuV/m)	READ LEVEL (dBuV)	LIMIT (dBuV/m)	MARGIN (dB)	ANTENNA FACTOR (dB/m)	CABLE LOSS (dB)	PREAMP FACTOR (dB)	ANTENNA HEIGHT (cm)	TABLE ANGLE (Degree)	REMARK
2390	47.8	54.87	54	-6.2	26.91	3.54	37.52	102	137	Average
2390	69.51	76.58	74	-4.49	26.91	3.54	37.52	102	137	Peak
2412	92.8	99.82			26.96	3.54	37.52	102	137	Average
2412	102.87	109.89			26.96	3.54	37.52	102	137	Peak
2494	35.26	41.69	54	-18.74	27.2	3.62	37.25	102	137	Average
2494	55.95	62.38	74	-18.05	27.2	3.62	37.25	102	137	Peak
4824	29.56	45.88	54	-24.44	30.99	5.77	53.08	114	350	Average
4824	39.98	56.3	74	-34.02	30.99	5.77	53.08	114	350	Peak

ANTENNA POLARITY & TEST DISTANCE: VERTICAL AT 3 M

FREQ. (MHz)	EMISSION LEVEL (dBuV/m)	READ LEVEL (dBuV)	LIMIT (dBuV/m)	MARGIN (dB)	ANTENNA FACTOR (dB/m)	CABLE LOSS (dB)	PREAMP FACTOR (dB)	ANTENNA HEIGHT (cm)	TABLE ANGLE (Degree)	REMARK
2390	47.37	54.44	54	-6.63	26.91	3.54	37.52	100	17	Average
2390	67.03	74.1	74	-6.97	26.91	3.54	37.52	100	17	Peak
2412	91.75	98.77			26.96	3.54	37.52	100	17	Average
2412	102.02	109.04			26.96	3.54	37.52	100	17	Peak
2492	35.36	41.79	54	-18.64	27.2	3.62	37.25	100	17	Average
2492	56.38	62.81	74	-17.62	27.2	3.62	37.25	100	17	Peak
4824	29.26	45.58	54	-24.74	30.99	5.77	53.08	109	208	Average
4824	40.3	56.62	74	-33.7	30.99	5.77	53.08	109	208	Peak

REMARKS:

- Emission Level = Read Level + Antenna Factor + Cable Loss - Preamp Factor
Margin value = Emission level – Limit value
- 2412MHz: Fundamental frequency.



A D T

EUT TEST CONDITION		MEASUREMENT DETAIL	
CHANNEL	Channel 6	FREQUENCY RANGE	1GHz ~ 25GHz
INPUT POWER	120Vac, 60 Hz	DETECTOR FUNCTION	Peak (PK) Average (AV)
ENVIRONMENTAL CONDITIONS	25deg. C, 65%RH	TESTED BY	Gavin Wu

ANTENNA POLARITY & TEST DISTANCE: HORIZONTAL AT 3 M

FREQ. (MHz)	EMISSION LEVEL (dBuV/m)	READ LEVEL (dBuV)	LIMIT (dBuV/m)	MARGIN (dB)	ANTENNA FACTOR (dB/m)	CABLE LOSS (dB)	PREAMP FACTOR (dB)	ANTENNA HEIGHT (cm)	TABLE ANGLE (Degree)	REMARK
2380	38.49	45.61	54	-15.51	26.86	3.52	37.5	130	47	Average
2380	56.52	63.64	74	-17.48	26.86	3.52	37.5	130	47	Peak
2437	92.23	99.07			27.06	3.56	37.46	130	47	Average
2437	102.59	109.43			27.06	3.56	37.46	130	47	Peak
2486	40.93	47.5	54	-13.07	27.15	3.6	37.32	130	47	Average
2486	56.89	63.46	74	-17.11	27.15	3.6	37.32	130	47	Peak
4874	28.57	44.76	54	-25.43	31.06	5.8	53.05	102	359	Average
4874	39.12	55.31	74	-34.88	31.06	5.8	53.05	102	359	Peak

ANTENNA POLARITY & TEST DISTANCE: VERTICAL AT 3 M

FREQ. (MHz)	EMISSION LEVEL (dBuV/m)	READ LEVEL (dBuV)	LIMIT (dBuV/m)	MARGIN (dB)	ANTENNA FACTOR (dB/m)	CABLE LOSS (dB)	PREAMP FACTOR (dB)	ANTENNA HEIGHT (cm)	TABLE ANGLE (Degree)	REMARK
2390	38.53	45.6	54	-15.47	26.91	3.54	37.52	122	354	Average
2390	57.09	64.16	74	-16.91	26.91	3.54	37.52	122	354	Peak
2437	90.87	97.71			27.06	3.56	37.46	122	354	Average
2437	101.43	108.27			27.06	3.56	37.46	122	354	Peak
2484	40.87	47.44	54	-13.13	27.15	3.6	37.32	122	354	Average
2484	59.15	65.72	74	-14.85	27.15	3.6	37.32	122	354	Peak
4874	28.38	44.57	54	-25.62	31.06	5.8	53.05	113	214	Average
4874	38.49	54.68	74	-35.51	31.06	5.8	53.05	113	214	Peak

REMARKS:

- Emission Level = Read Level + Antenna Factor + Cable Loss - Preamp Factor
Margin value = Emission level – Limit value
- 2437MHz: Fundamental frequency.



A D T

EUT TEST CONDITION		MEASUREMENT DETAIL	
CHANNEL	Channel 11	FREQUENCY RANGE	1GHz ~ 25GHz
INPUT POWER	120Vac, 60 Hz	DETECTOR FUNCTION	Peak (PK) Average (AV)
ENVIRONMENTAL CONDITIONS	25deg. C, 65%RH	TESTED BY	Gavin Wu

ANTENNA POLARITY & TEST DISTANCE: HORIZONTAL AT 3 M

FREQ. (MHz)	EMISSION LEVEL (dBuV/m)	READ LEVEL (dBuV)	LIMIT (dBuV/m)	MARGIN (dB)	ANTENNA FACTOR (dB/m)	CABLE LOSS (dB)	PREAMP FACTOR (dB)	ANTENNA HEIGHT (cm)	TABLE ANGLE (Degree)	REMARK
2388	34.28	41.33	54	-19.72	26.91	3.54	37.5	103	43	Average
2388	55.53	62.58	74	-18.47	26.91	3.54	37.5	103	43	Peak
2462	93.02	99.73			27.1	3.58	37.39	103	43	Average
2462	103.61	110.32			27.1	3.58	37.39	103	43	Peak
2484	48.77	55.34	54	-5.23	27.15	3.6	37.32	103	43	Average
2484	68.98	75.55	74	-5.02	27.15	3.6	37.32	103	43	Peak
4924	28.47	44.55	54	-25.53	31.12	5.83	53.03	112	350	Average
4924	38.35	54.43	74	-35.65	31.12	5.83	53.03	112	350	Peak

ANTENNA POLARITY & TEST DISTANCE: VERTICAL AT 3 M

FREQ. (MHz)	EMISSION LEVEL (dBuV/m)	READ LEVEL (dBuV)	LIMIT (dBuV/m)	MARGIN (dB)	ANTENNA FACTOR (dB/m)	CABLE LOSS (dB)	PREAMP FACTOR (dB)	ANTENNA HEIGHT (cm)	TABLE ANGLE (Degree)	REMARK
2354	33.61	40.79	54	-20.39	26.81	3.5	37.49	122	357	Average
2354	55.75	62.93	74	-18.25	26.81	3.5	37.49	122	357	Peak
2462	92.24	98.95			27.1	3.58	37.39	122	357	Average
2462	102.26	108.97			27.1	3.58	37.39	122	357	Peak
2484	47.8	54.37	54	-6.2	27.15	3.6	37.32	122	357	Average
2484	64.91	71.48	74	-9.09	27.15	3.6	37.32	122	357	Peak
4924	28.32	44.4	54	-25.68	31.12	5.83	53.03	106	194	Average
4924	38.6	54.68	74	-35.4	31.12	5.83	53.03	106	194	Peak

REMARKS:

- Emission Level = Read Level + Antenna Factor + Cable Loss - Preamp Factor
Margin value = Emission level – Limit value
- 2462MHz: Fundamental frequency.



A D T

802.11n (20MHz)

EUT TEST CONDITION		MEASUREMENT DETAIL	
CHANNEL	Channel 1	FREQUENCY RANGE	1GHz ~ 25GHz
INPUT POWER	120Vac, 60 Hz	DETECTOR FUNCTION	Peak (PK) Average (AV)
ENVIRONMENTAL CONDITIONS	25deg. C, 65%RH	TESTED BY	Gavin Wu

ANTENNA POLARITY & TEST DISTANCE: HORIZONTAL AT 3 M										
FREQ. (MHz)	EMISSION LEVEL (dBuV/m)	READ LEVEL (dBuV)	LIMIT (dBuV/m)	MARGIN (dB)	ANTENNA FACTOR (dB/m)	CABLE LOSS (dB)	PREAMP FACTOR (dB)	ANTENNA HEIGHT (cm)	TABLE ANGLE (Degree)	REMARK
2390	44.89	51.96	54	-9.11	26.91	3.54	37.52	106	43	Average
2390	67.61	74.68	74	-6.39	26.91	3.54	37.52	106	43	Peak
2412	91.86	98.88			26.96	3.54	37.52	106	43	Average
2412	102.39	109.41			26.96	3.54	37.52	106	43	Peak
2492	35.46	41.89	54	-18.54	27.2	3.62	37.25	106	43	Average
2492	56.03	62.46	74	-17.97	27.2	3.62	37.25	106	43	Peak
4824	29.42	45.74	54	-24.58	30.99	5.77	53.08	114	348	Average
4824	40.81	57.13	74	-33.19	30.99	5.77	53.08	114	348	Peak
ANTENNA POLARITY & TEST DISTANCE: VERTICAL AT 3 M										
FREQ. (MHz)	EMISSION LEVEL (dBuV/m)	READ LEVEL (dBuV)	LIMIT (dBuV/m)	MARGIN (dB)	ANTENNA FACTOR (dB/m)	CABLE LOSS (dB)	PREAMP FACTOR (dB)	ANTENNA HEIGHT (cm)	TABLE ANGLE (Degree)	REMARK
2390	43.47	50.54	54	-10.53	26.91	3.54	37.52	100	16	Average
2390	65.52	72.59	74	-8.48	26.91	3.54	37.52	100	16	Peak
2412	89.47	96.49			26.96	3.54	37.52	100	16	Average
2412	100.61	107.63			26.96	3.54	37.52	100	16	Peak
2496	35.16	41.59	54	-18.84	27.2	3.62	37.25	100	16	Average
2496	55.7	62.13	74	-18.3	27.2	3.62	37.25	100	16	Peak
4824	29.12	45.44	54	-24.88	30.99	5.77	53.08	102	216	Average
4824	39.29	55.61	74	-34.71	30.99	5.77	53.08	102	216	Peak

REMARKS:

- Emission Level = Read Level + Antenna Factor + Cable Loss - Preamp Factor
Margin value = Emission level – Limit value
- 2412MHz: Fundamental frequency.



A D T

EUT TEST CONDITION		MEASUREMENT DETAIL	
CHANNEL	Channel 6	FREQUENCY RANGE	1GHz ~ 25GHz
INPUT POWER	120Vac, 60 Hz	DETECTOR FUNCTION	Peak (PK) Average (AV)
ENVIRONMENTAL CONDITIONS	25deg. C, 65%RH	TESTED BY	Gavin Wu

ANTENNA POLARITY & TEST DISTANCE: HORIZONTAL AT 3 M

FREQ. (MHz)	EMISSION LEVEL (dBuV/m)	READ LEVEL (dBuV)	LIMIT (dBuV/m)	MARGIN (dB)	ANTENNA FACTOR (dB/m)	CABLE LOSS (dB)	PREAMP FACTOR (dB)	ANTENNA HEIGHT (cm)	TABLE ANGLE (Degree)	REMARK
2330	37.84	45.11	54	-16.16	26.72	3.48	37.47	133	48	Average
2330	56.38	63.65	74	-17.62	26.72	3.48	37.47	133	48	Peak
2437	90.75	97.59			27.06	3.56	37.46	133	48	Average
2437	101.33	108.17			27.06	3.56	37.46	133	48	Peak
2484	38.99	45.56	54	-15.01	27.15	3.6	37.32	133	48	Average
2484	57.52	64.09	74	-16.48	27.15	3.6	37.32	133	48	Peak
4874	28.54	44.73	54	-25.46	31.06	5.8	53.05	103	358	Average
4874	39.4	55.59	74	-34.6	31.06	5.8	53.05	103	358	Peak

ANTENNA POLARITY & TEST DISTANCE: VERTICAL AT 3 M

FREQ. (MHz)	EMISSION LEVEL (dBuV/m)	READ LEVEL (dBuV)	LIMIT (dBuV/m)	MARGIN (dB)	ANTENNA FACTOR (dB/m)	CABLE LOSS (dB)	PREAMP FACTOR (dB)	ANTENNA HEIGHT (cm)	TABLE ANGLE (Degree)	REMARK
2380	36.36	43.48	54	-17.64	26.86	3.52	37.5	125	355	Average
2380	55.62	62.74	74	-18.38	26.86	3.52	37.5	125	355	Peak
2437	89.65	96.49			27.06	3.56	37.46	125	355	Average
2437	100.08	106.92			27.06	3.56	37.46	125	355	Peak
2484	38.36	44.93	54	-15.64	27.15	3.6	37.32	125	355	Average
2484	57.01	63.58	74	-16.99	27.15	3.6	37.32	125	355	Peak
4874	28.13	44.32	54	-25.87	31.06	5.8	53.05	125	183	Average
4874	38.74	54.93	74	-35.26	31.06	5.8	53.05	125	183	Peak

REMARKS:

- Emission Level = Read Level + Antenna Factor + Cable Loss - Preamp Factor
Margin value = Emission level – Limit value
- 2437MHz: Fundamental frequency.



A D T

EUT TEST CONDITION		MEASUREMENT DETAIL	
CHANNEL	Channel 11	FREQUENCY RANGE	1GHz ~ 25GHz
INPUT POWER	120Vac, 60 Hz	DETECTOR FUNCTION	Peak (PK) Average (AV)
ENVIRONMENTAL CONDITIONS	25deg. C, 65%RH	TESTED BY	Gavin Wu

ANTENNA POLARITY & TEST DISTANCE: HORIZONTAL AT 3 M

FREQ. (MHz)	EMISSION LEVEL (dBuV/m)	READ LEVEL (dBuV)	LIMIT (dBuV/m)	MARGIN (dB)	ANTENNA FACTOR (dB/m)	CABLE LOSS (dB)	PREAMP FACTOR (dB)	ANTENNA HEIGHT (cm)	TABLE ANGLE (Degree)	REMARK
2388	34.04	41.09	54	-19.96	26.91	3.54	37.5	103	40	Average
2388	56.37	63.42	74	-17.63	26.91	3.54	37.5	103	40	Peak
2462	91.56	98.27			27.1	3.58	37.39	103	40	Average
2462	101.93	108.64			27.1	3.58	37.39	103	40	Peak
2484	45.72	52.29	54	-8.28	27.15	3.6	37.32	103	40	Average
2484	68.58	75.15	74	-5.42	27.15	3.6	37.32	103	40	Peak
4924	28.41	44.49	54	-25.59	31.12	5.83	53.03	100	347	Average
4924	39.15	55.23	74	-34.85	31.12	5.83	53.03	100	347	Peak

ANTENNA POLARITY & TEST DISTANCE: VERTICAL AT 3 M

FREQ. (MHz)	EMISSION LEVEL (dBuV/m)	READ LEVEL (dBuV)	LIMIT (dBuV/m)	MARGIN (dB)	ANTENNA FACTOR (dB/m)	CABLE LOSS (dB)	PREAMP FACTOR (dB)	ANTENNA HEIGHT (cm)	TABLE ANGLE (Degree)	REMARK
2378	33.35	40.47	54	-20.65	26.86	3.52	37.5	177	357	Average
2378	57.26	64.38	74	-16.74	26.86	3.52	37.5	177	357	Peak
2462	89.89	96.6			27.1	3.58	37.39	177	357	Average
2462	100.4	107.11			27.1	3.58	37.39	177	357	Peak
2484	44.23	50.8	54	-9.77	27.15	3.6	37.32	177	357	Average
2484	65.49	72.06	74	-8.51	27.15	3.6	37.32	177	357	Peak
4924	28.15	44.23	54	-25.85	31.12	5.83	53.03	111	181	Average
4924	37.69	53.77	74	-36.31	31.12	5.83	53.03	111	181	Peak

REMARKS:

- Emission Level = Read Level + Antenna Factor + Cable Loss - Preamp Factor
Margin value = Emission level – Limit value
- 2462MHz: Fundamental frequency.



A D T

BELOW 1GHz WORST-CASE DATA:

MODE A

EUT TEST CONDITION		MEASUREMENT DETAIL	
CHANNEL	Channel 1	FREQUENCY RANGE	30MHz ~ 1GHz
INPUT POWER	120Vac, 60 Hz	DETECTOR FUNCTION	Peak (PK) Average (AV)
ENVIRONMENTAL CONDITIONS	25deg. C, 65%RH	TESTED BY	Gavin Wu

ANTENNA POLARITY & TEST DISTANCE: HORIZONTAL AT 3 M

FREQ. (MHz)	EMISSION LEVEL (dBuV/m)	READ LEVEL (dBuV)	LIMIT (dBuV/m)	MARGIN (dB)	ANTENNA FACTOR (dB/m)	CABLE LOSS (dB)	PREAMP FACTOR (dB)	ANTENNA HEIGHT (cm)	TABLE ANGLE (Degree)	REMARK
175.26	28.21	47.65	43.5	-15.29	11.19	1.16	31.79	124	296	Peak
196.86	30.21	51.1	43.5	-13.29	9.57	1.28	31.74	128	228	Peak
261.12	30.07	48.63	46	-15.93	11.79	1.52	31.87	123	84	Peak
340.6	36.41	52.58	46	-9.59	13.91	1.74	31.82	101	192	Peak
360.2	31.75	47.54	46	-14.25	14.38	1.8	31.97	121	293	Peak
379.8	25.47	40.69	46	-20.53	14.87	1.86	31.95	124	298	Peak

ANTENNA POLARITY & TEST DISTANCE: VERTICAL AT 3 M

FREQ. (MHz)	EMISSION LEVEL (dBuV/m)	READ LEVEL (dBuV)	LIMIT (dBuV/m)	MARGIN (dB)	ANTENNA FACTOR (dB/m)	CABLE LOSS (dB)	PREAMP FACTOR (dB)	ANTENNA HEIGHT (cm)	TABLE ANGLE (Degree)	REMARK
197.13	24.61	45.5	43.5	-18.89	9.57	1.28	31.74	140	28	Peak
260.31	22.38	40.94	46	-23.62	11.77	1.52	31.85	121	58	Peak
291.36	26.41	43.81	46	-19.59	12.68	1.61	31.69	132	286	Peak
300.7	23.06	40.32	46	-22.94	12.96	1.63	31.85	107	15	Peak
339.2	26.29	42.49	46	-19.71	13.89	1.73	31.82	139	321	Peak
360.9	23.92	39.69	46	-22.08	14.4	1.8	31.97	140	165	Peak

REMARKS: Emission Level = Read Level + Antenna Factor + Cable Loss - Preamp Factor

Margin value = Emission level – Limit value



A D T

MODE B

EUT TEST CONDITION		MEASUREMENT DETAIL	
CHANNEL	Channel 1	FREQUENCY RANGE	30MHz ~ 1GHz
INPUT POWER	120Vac, 60 Hz	DETECTOR FUNCTION	Peak (PK) Average (AV)
ENVIRONMENTAL CONDITIONS	25deg. C, 65%RH	TESTED BY	Gavin Wu

ANTENNA POLARITY & TEST DISTANCE: HORIZONTAL AT 3 M										
FREQ. (MHz)	EMISSION LEVEL (dBuV/m)	READ LEVEL (dBuV)	LIMIT (dBuV/m)	MARGIN (dB)	ANTENNA FACTOR (dB/m)	CABLE LOSS (dB)	PREAMP FACTOR (dB)	ANTENNA HEIGHT (cm)	TABLE ANGLE (Degree)	REMARK
177.44	32.15	51.76	43.5	-11.35	11.01	1.19	31.81	129	134	Peak
248.25	28.41	47.44	46	-17.59	11.4	1.48	31.91	103	158	Peak
304.51	33.73	50.91	46	-12.27	13.06	1.65	31.89	127	295	Peak
360.77	33.44	49.21	46	-12.56	14.4	1.8	31.97	111	148	Peak
480.08	29.91	42.78	46	-16.09	16.93	2.05	31.85	130	164	Peak
722.58	33.98	42	46	-12.02	21.13	2.49	31.64	102	256	Peak

ANTENNA POLARITY & TEST DISTANCE: VERTICAL AT 3 M										
FREQ. (MHz)	EMISSION LEVEL (dBuV/m)	READ LEVEL (dBuV)	LIMIT (dBuV/m)	MARGIN (dB)	ANTENNA FACTOR (dB/m)	CABLE LOSS (dB)	PREAMP FACTOR (dB)	ANTENNA HEIGHT (cm)	TABLE ANGLE (Degree)	REMARK
239.52	33.1	52.4	46	-12.9	11.03	1.45	31.78	102	153	Peak
305.48	32.37	49.54	46	-13.63	13.08	1.65	31.9	103	69	Peak
480.08	28.5	41.37	46	-17.5	16.93	2.05	31.85	135	256	Peak
597.45	32.13	42.56	46	-13.87	19.54	2.25	32.22	118	263	Peak
671.17	32.89	41.83	46	-13.11	20.47	2.4	31.81	126	176	Peak
724.52	33.02	41	46	-12.98	21.16	2.49	31.63	125	312	Peak

REMARKS: Emission Level = Read Level + Antenna Factor + Cable Loss - Preamp Factor
 Margin value = Emission level – Limit value



A D T

MODE C

EUT TEST CONDITION		MEASUREMENT DETAIL	
CHANNEL	Channel 1	FREQUENCY RANGE	30MHz ~ 1GHz
INPUT POWER	120Vac, 60 Hz	DETECTOR FUNCTION	Peak (PK) Average (AV)
ENVIRONMENTAL CONDITIONS	25deg. C, 65%RH	TESTED BY	Gavin Wu

ANTENNA POLARITY & TEST DISTANCE: HORIZONTAL AT 3 M

FREQ. (MHz)	EMISSION LEVEL (dBuV/m)	READ LEVEL (dBuV)	LIMIT (dBuV/m)	MARGIN (dB)	ANTENNA FACTOR (dB/m)	CABLE LOSS (dB)	PREAMP FACTOR (dB)	ANTENNA HEIGHT (cm)	TABLE ANGLE (Degree)	REMARK
42.96	29.21	46.01	40	-10.79	13.58	0.7	31.08	128	37	Peak
56.73	22.35	40.64	40	-17.65	12.25	0.81	31.35	117	60	Peak
136.92	15.85	34.14	43.5	-27.65	12.14	1.28	31.71	129	312	Peak
351.1	18.49	33.94	46	-27.51	14.17	2.23	31.85	139	248	Peak
463.1	20.42	33.14	46	-25.58	16.58	2.66	31.96	131	105	Peak
563.2	23.32	33.63	46	-22.68	18.77	2.99	32.07	101	65	Peak

ANTENNA POLARITY & TEST DISTANCE: VERTICAL AT 3 M

FREQ. (MHz)	EMISSION LEVEL (dBuV/m)	READ LEVEL (dBuV)	LIMIT (dBuV/m)	MARGIN (dB)	ANTENNA FACTOR (dB/m)	CABLE LOSS (dB)	PREAMP FACTOR (dB)	ANTENNA HEIGHT (cm)	TABLE ANGLE (Degree)	REMARK
43.5	28.22	45.03	40	-11.78	13.59	0.71	31.11	136	290	Peak
57	22.37	40.66	40	-17.63	12.25	0.81	31.35	120	215	Peak
97.77	12.52	34.51	43.5	-30.98	8.91	1.06	31.96	121	316	Peak
383.3	18.6	33.28	46	-27.4	14.94	2.36	31.98	102	51	Peak
432.3	19.73	33.21	46	-26.27	15.98	2.55	32.01	116	52	Peak
508.6	22.43	33.71	46	-23.57	17.51	2.81	31.6	139	326	Peak

REMARKS: Emission Level = Read Level + Antenna Factor + Cable Loss - Preamp Factor

Margin value = Emission level – Limit value

4.2 CONDUCTED EMISSION MEASUREMENT

4.2.1 LIMITS OF CONDUCTED EMISSION MEASUREMENT

FREQUENCY OF EMISSION (MHz)	CONDUCTED LIMIT (dB μ V)	
	Quasi-peak	Average
0.15 ~ 0.5	66 to 56	56 to 46
0.5 ~ 5	56	46
5 ~ 30	60	50

- NOTE:**
1. The lower limit shall apply at the transition frequencies.
 2. The limit decreases in line with the logarithm of the frequency in the range of 0.15 to 0.50MHz.
 3. All emanations from a class A/B digital device or system, including any network of conductors and apparatus connected thereto, shall not exceed the level of field strengths specified above.

4.2.2 TEST INSTRUMENTS

DESCRIPTION & MANUFACTURER	MODEL NO.	SERIAL NO.	DATE OF CALIBRATION	DUE DATE OF CALIBRATION
Test Receiver ROHDE & SCHWARZ	ESCI	100612	Sep. 30, 2014	Sep. 29, 2015
RF signal cable Woken	5D-FB	Cable-HYC01-01	Dec. 26, 2014	Dec. 25, 2015
LISN ROHDE & SCHWARZ (EUT)	ESH3-Z5	835239/001	Mar. 02, 2015	Mar. 01, 2016
LISN ROHDE & SCHWARZ (Peripheral)	ESH3-Z5	100311	Jul. 21, 2014	Jul. 20, 2015
Software ADT	BV ADT_Cond_ V7.3.7.3	NA	NA	NA

- NOTE:**
1. The calibration interval of the above test instruments is 12 months and the calibrations are traceable to NML/ROC and NIST/USA.
 2. The test was performed in HwaYa Shielded Room 1.
 3. The VCCI Site Registration No. is C-2040.
 4. Test Date: Feb. 11, 2015.

4.2.3 TEST PROCEDURES

- a. The EUT was placed 0.4 meters from the conducting wall of the shielded room with EUT being connected to the power mains through a line impedance stabilization network (LISN). Other support units were connected to the power mains through another LISN. The two LISNs provide 50 ohm/ 50uH of coupling impedance for the measuring instrument.
- b. Both lines of the power mains connected to the EUT were checked for maximum conducted interference.
- c. The frequency range from 150kHz to 30MHz was searched. Emission levels under (Limit - 20dB) was not recorded.

NOTE: All modes of operation were investigated and the worst-case emissions are reported.

4.2.4 DEVIATION FROM TEST STANDARD

No deviation.

4.2.5 TEST SETUP

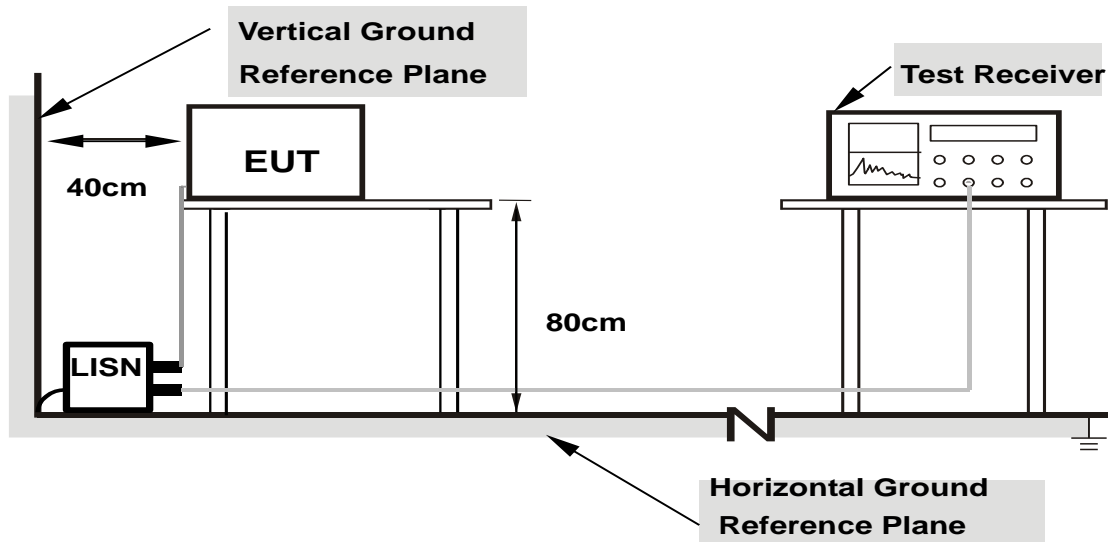

- Note: 1.Support units were connected to second LISN.**
2.Both of LISNs (AMN) are 80 cm from EUT and at least 80 from other units and other metal planes

For the actual test configuration, please refer to the attached file (Test Setup Photo).

4.2.6 EUT OPERATING CONDITIONS

Same as section 4.1.6.



A D T

4.2.7 TEST RESULTS

MODE B

Frequency Range	150kHz ~ 30MHz	Detector Function & Resolution Bandwidth	Quasi-Peak (QP) / Average (AV), 9kHz
Input Power	120Vac, 60Hz	Environmental Conditions	25°C, 65%RH
Tested by	Toby Tian	Test Date	2015/4/14

Phase Of Power : Line (L)										
No	Frequency (MHz)	Correction Factor (dB)	Reading Value (dBuV)		Emission Level (dBuV)		Limit (dBuV)		Margin (dB)	
			Q.P.	AV.	Q.P.	AV.	Q.P.	AV.	Q.P.	AV.
1	0.16173	0.05	52.42	34.37	52.47	34.42	65.37	55.37	-12.90	-20.95
2	0.19717	0.06	47.58	32.44	47.64	32.50	63.73	53.73	-16.09	-21.23
3	0.25948	0.06	39.86	25.61	39.92	25.67	61.45	51.45	-21.53	-25.78
4	0.29858	0.06	34.83	22.28	34.89	22.34	60.28	50.28	-25.39	-27.94
5	0.41197	0.06	30.97	19.21	31.03	19.27	57.61	47.61	-26.58	-28.34
6	1.55369	0.10	28.18	21.11	28.28	21.21	56.00	46.00	-27.72	-24.79

Remarks:

1. Q.P. and AV. are abbreviations of quasi-peak and average individually.
2. The emission levels of other frequencies were very low against the limit.
3. Margin value = Emission level – Limit value
4. Correction factor = Insertion loss + Cable loss
5. Emission Level = Correction Factor + Reading Value

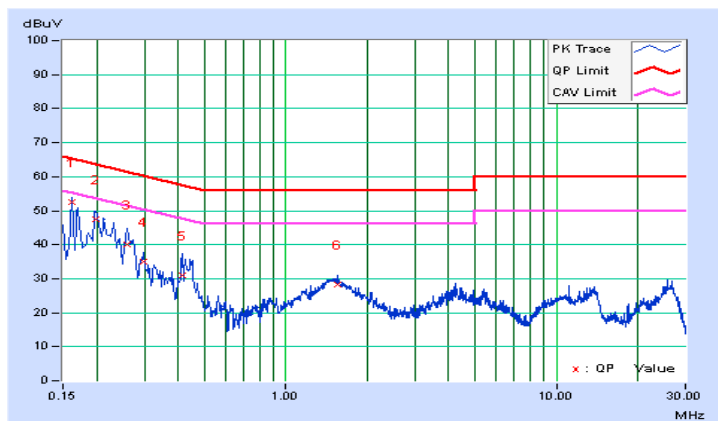



A D T

Frequency Range	150kHz ~ 30MHz	Detector Function & Resolution Bandwidth	Quasi-Peak (QP) / Average (AV), 9kHz
Input Power	120Vac, 60Hz	Environmental Conditions	25°C, 65%RH
Tested by	Toby Tian	Test Date	2015/4/14

Phase Of Power : Neutral (N)										
No	Frequency (MHz)	Correction Factor (dB)	Reading Value (dBuV)		Emission Level (dBuV)		Limit (dBuV)		Margin (dB)	
			Q.P.	AV.	Q.P.	AV.	Q.P.	AV.	Q.P.	AV.
1	0.15391	0.05	53.44	34.58	53.49	34.63	65.79	55.79	-12.30	-21.16
2	0.17346	0.05	51.19	35.10	51.24	35.15	64.79	54.79	-13.55	-19.64
3	0.20783	0.05	47.15	32.34	47.20	32.39	63.29	53.29	-16.09	-20.90
4	0.27903	0.05	37.91	25.95	37.96	26.00	60.84	50.84	-22.88	-24.84
5	0.40800	0.06	25.95	12.69	26.01	12.75	57.69	47.69	-31.68	-34.94
6	1.48722	0.09	27.44	20.56	27.53	20.65	56.00	46.00	-28.47	-25.35

Remarks:

1. Q.P. and AV. are abbreviations of quasi-peak and average individually.
2. The emission levels of other frequencies were very low against the limit.
3. Margin value = Emission level – Limit value
4. Correction factor = Insertion loss + Cable loss
5. Emission Level = Correction Factor + Reading Value

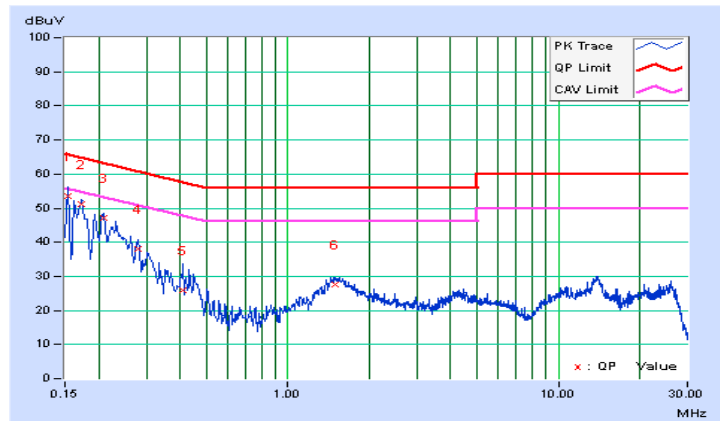



A D T

MODE C

Frequency Range	150kHz ~ 30MHz	Detector Function & Resolution Bandwidth	Quasi-Peak (QP) / Average (AV), 9kHz
Input Power	120Vac, 60Hz	Environmental Conditions	25°C, 65%RH
Tested by	Toby Tian	Test Date	2015/5/9

Phase Of Power : Line (L)										
No	Frequency (MHz)	Correction Factor (dB)	Reading Value (dBuV)		Emission Level (dBuV)		Limit (dBuV)		Margin (dB)	
			Q.P.	AV.	Q.P.	AV.	Q.P.	AV.	Q.P.	AV.
1	0.15391	0.05	32.91	33.17	32.96	33.22	65.79	55.79	-32.83	-22.57
2	0.18508	0.06	7.36	0.63	7.42	0.69	64.25	54.25	-56.84	-53.57
3	0.23094	0.06	13.59	13.39	13.65	13.45	62.42	52.42	-48.77	-38.97
4	0.27120	0.06	8.28	-0.96	8.34	-0.90	61.08	51.08	-52.74	-51.98
5	0.46280	0.06	3.63	1.58	3.69	1.64	56.64	46.64	-52.95	-45.00
6	3.75111	0.18	3.89	-0.37	4.07	-0.19	56.00	46.00	-51.93	-46.19

Remarks:

1. Q.P. and AV. are abbreviations of quasi-peak and average individually.
2. The emission levels of other frequencies were very low against the limit.
3. Margin value = Emission level – Limit value
4. Correction factor = Insertion loss + Cable loss
5. Emission Level = Correction Factor + Reading Value

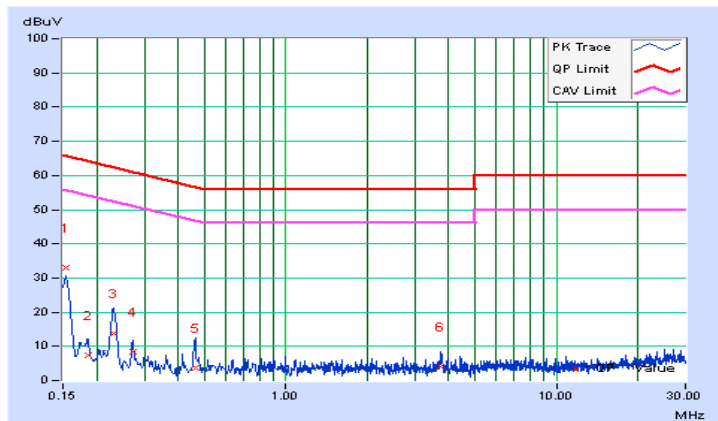



A D T

Frequency Range	150kHz ~ 30MHz	Detector Function & Resolution Bandwidth	Quasi-Peak (QP) / Average (AV), 9kHz
Input Power	120Vac, 60Hz	Environmental Conditions	25°C, 65%RH
Tested by	Toby Tian	Test Date	2015/5/9

Phase Of Power : Neutral (N)										
No	Frequency (MHz)	Correction Factor (dB)	Reading Value (dBuV)		Emission Level (dBuV)		Limit (dBuV)		Margin (dB)	
			Q.P.	AV.	Q.P.	AV.	Q.P.	AV.	Q.P.	AV.
1	0.15391	0.05	28.06	28.31	28.11	28.36	65.79	55.79	-37.68	-27.43
2	0.18508	0.05	8.59	3.82	8.64	3.87	64.25	54.25	-55.61	-50.38
3	0.23155	0.05	18.87	18.95	18.92	19.00	62.39	52.39	-43.47	-33.39
4	0.30640	0.06	3.63	0.83	3.69	0.89	60.07	50.07	-56.38	-49.18
5	0.45937	0.06	7.48	4.75	7.54	4.81	56.70	46.70	-49.16	-41.89
6	4.43536	0.21	1.89	-2.00	2.10	-1.79	56.00	46.00	-53.90	-47.79

Remarks:

1. Q.P. and AV. are abbreviations of quasi-peak and average individually.
2. The emission levels of other frequencies were very low against the limit.
3. Margin value = Emission level – Limit value
4. Correction factor = Insertion loss + Cable loss
5. Emission Level = Correction Factor + Reading Value

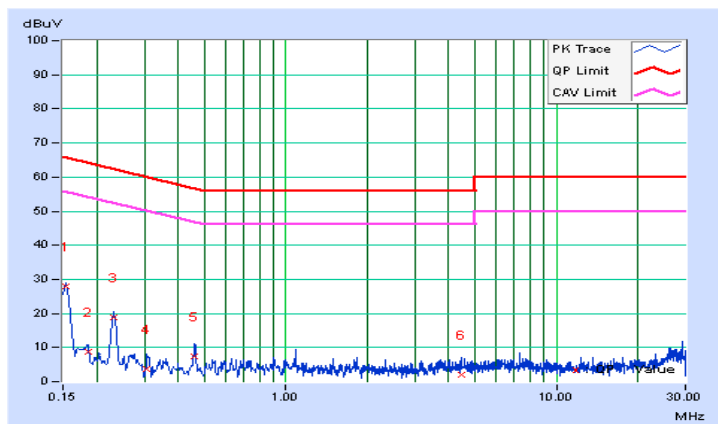

4.3 6dB BANDWIDTH MEASUREMENT

4.3.1 LIMITS OF 6dB BANDWIDTH MEASUREMENT

The minimum of 6dB Bandwidth Measurement is 0.5 MHz.

4.3.2 TEST SETUP

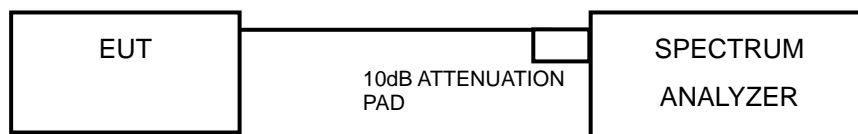

4.3.3 TEST INSTRUMENTS

Refer to section 4.1.2 to get information of above instrument.

4.3.4 TEST PROCEDURE

- Set resolution bandwidth (RBW) = 100kHz
- Set the video bandwidth (VBW) $\geq 3 \times$ RBW, Detector = Peak.
- Trace mode = max hold.
- Sweep = auto couple.
- Measure the maximum width of the emission that is constrained by the frequencies associated with the two amplitude points (upper and lower) that are attenuated by 6 dB relative to the maximum level measured in the fundamental emission

4.3.5 DEVIATION FROM TEST STANDARD

No deviation.

4.3.6 EUT OPERATING CONDITIONS

The software provided by client to enable the EUT under transmission condition continuously at lowest, middle and highest channel frequencies individually.



A D T

4.3.7 TEST RESULTS

802.11b

CHANNEL	FREQUENCY (MHz)	6dB BANDWIDTH (MHz)	MINIMUM LIMIT (MHz)	PASS / FAIL
1	2412	8.09	0.5	PASS
6	2437	8.10	0.5	PASS
11	2462	8.10	0.5	PASS

802.11g

CHANNEL	FREQUENCY (MHz)	6dB BANDWIDTH (MHz)	MINIMUM LIMIT (MHz)	PASS / FAIL
1	2412	15.13	0.5	PASS
6	2437	15.15	0.5	PASS
11	2462	15.16	0.5	PASS

802.11n (20MHz)

CHANNEL	FREQUENCY (MHz)	6dB BANDWIDTH (MHz)	MINIMUM LIMIT (MHz)	PASS / FAIL
1	2412	15.13	0.5	PASS
6	2437	15.15	0.5	PASS
11	2462	15.16	0.5	PASS



A D T

SPECTRUM PLOT OF WORST VALUE

802.11b

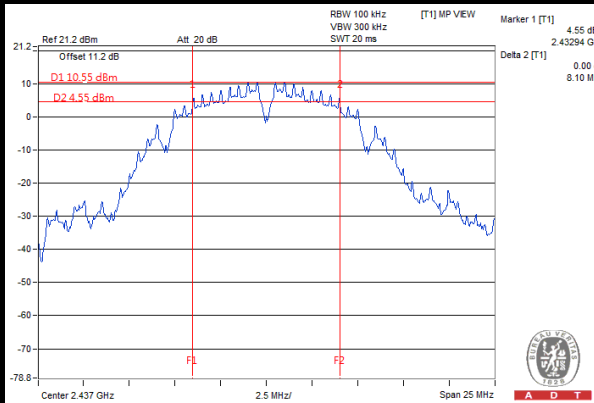

802.11g

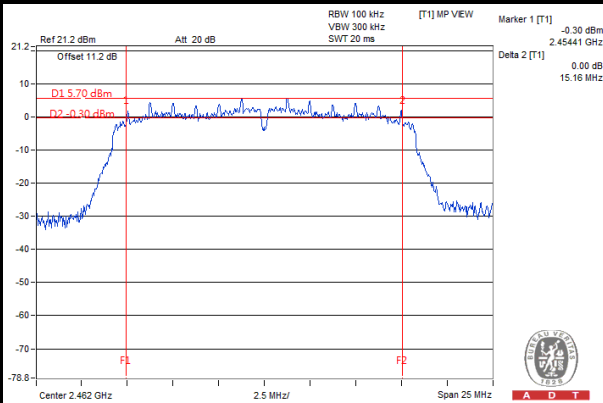

802.11n (20MHz)

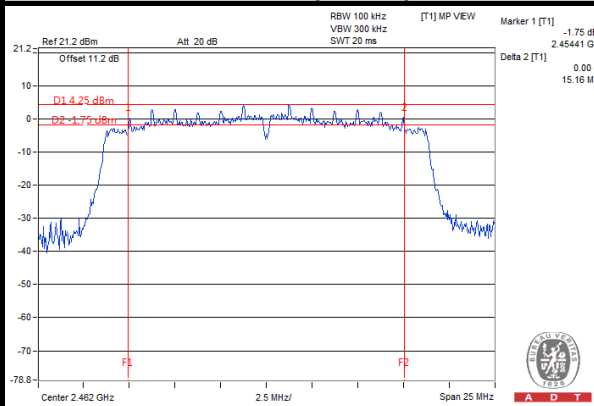

4.4 CONDUCTED OUTPUT POWER

4.4.1 LIMITS OF CONDUCTED OUTPUT POWER MEASUREMENT

For systems using digital modulation in the 2400–2483.5 MHz bands: 1 Watt (30dBm)

4.4.2 TEST SETUP

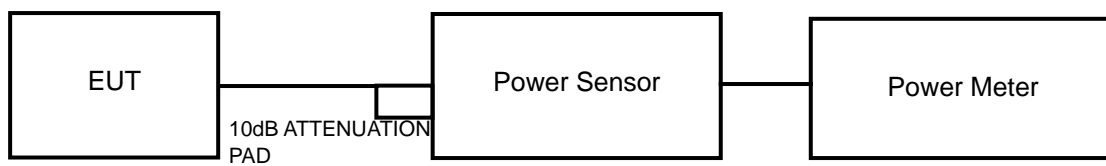

4.4.3 TEST INSTRUMENTS

Refer to section 4.1.2 to get information of above instrument.

4.4.4 TEST PROCEDURES

A peak power sensor was used on the output port of the EUT. A power meter was used to read the response of the peak power sensor. Record the peak power level.

4.4.5 DEVIATION FROM TEST STANDARD

No deviation.

4.4.6 EUT OPERATING CONDITIONS

Same as section 4.3.6.



A D T

4.4.7 TEST RESULTS

802.11b

CHANNEL	FREQUENCY (MHz)	PEAK POWER (mW)	PEAK POWER (dBm)	LIMIT (dBm)	PASS / FAIL
1	2412	156.68	21.95	30	PASS
6	2437	157.76	21.98	30	PASS
11	2462	154.88	21.90	30	PASS

802.11g

CHANNEL	FREQUENCY (MHz)	PEAK POWER (mW)	PEAK POWER (dBm)	LIMIT (dBm)	PASS / FAIL
1	2412	273.53	24.37	30	PASS
6	2437	277.33	24.43	30	PASS
11	2462	270.40	24.32	30	PASS

802.11n (20MHz)

CHANNEL	FREQUENCY (MHz)	PEAK POWER (mW)	PEAK POWER (dBm)	LIMIT (dBm)	PASS / FAIL
1	2412	264.85	24.23	30	PASS
6	2437	267.92	24.28	30	PASS
11	2462	257.63	24.11	30	PASS



A D T

4.5 POWER SPECTRAL DENSITY MEASUREMENT

4.5.1 LIMITS OF POWER SPECTRAL DENSITY MEASUREMENT

The Maximum of Power Spectral Density Measurement is 8dBm.

4.5.2 TEST SETUP

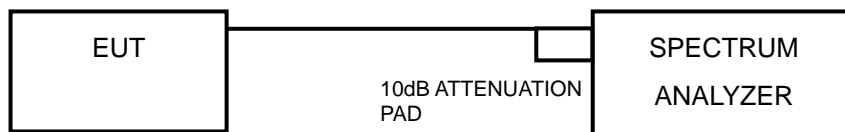

4.5.3 TEST INSTRUMENTS

Refer to section 4.1.2 to get information of above instrument.

4.5.4 TEST PROCEDURE

Set the RBW = 3 kHz, VBW = 10 kHz, Detector = peak.

- Sweep time = auto couple, Trace mode = max hold, allow trace to fully stabilize.
- Use the peak marker function to determine the maximum power level in any 100 kHz band segment within the fundamental EBW.

4.5.5 DEVIATION FROM TEST STANDARD

No deviation.

4.5.6 EUT OPERATING CONDITION

Same as section 4.3.6.



A D T

4.5.7 TEST RESULTS

802.11b

CHANNEL	FREQUENCY (MHz)	PSD (dBm/3kHz)	LIMIT (dBm/3kHz)	PASS / FAIL
1	2412	-3.84	8	PASS
6	2437	-3.58	8	PASS
11	2462	-3.77	8	PASS

802.11g

CHANNEL	FREQUENCY (MHz)	PSD (dBm/3kHz)	LIMIT (dBm/3kHz)	PASS / FAIL
1	2412	-9.45	8	PASS
6	2437	-8.99	8	PASS
11	2462	-9.01	8	PASS

802.11n (20MHz)

CHANNEL	FREQUENCY (MHz)	PSD (dBm/3kHz)	LIMIT (dBm/3kHz)	PASS / FAIL
1	2412	-10.47	8	PASS
6	2437	-10.58	8	PASS
11	2462	-10.63	8	PASS



A D T

SPECTRUM PLOT OF WORST VALUE

802.11b

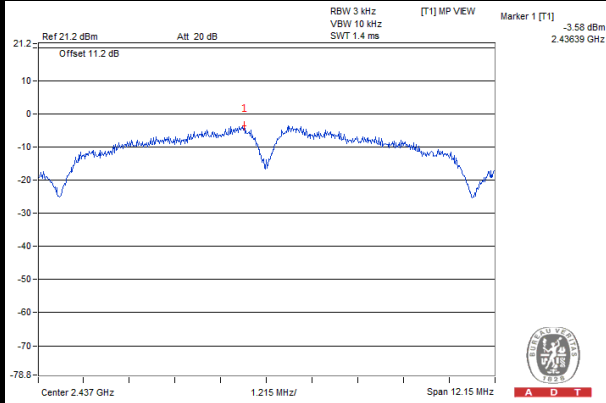

802.11g

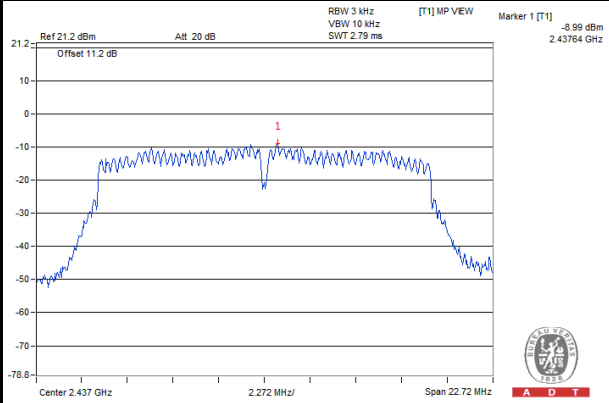

802.11n (20MHz)

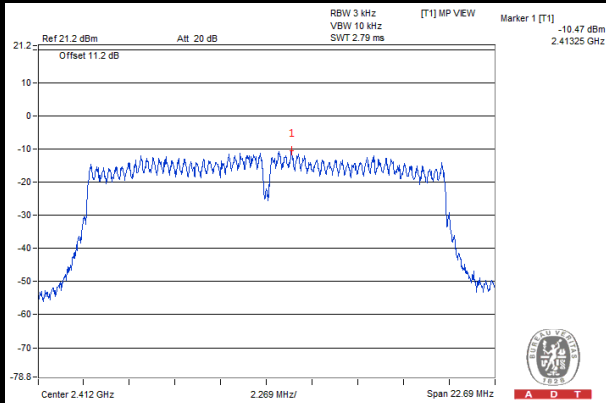

4.6 CONDUCTED OUT OF BAND EMISSION MEASUREMENT

4.6.1 LIMITS OF CONDUCTED OUT OF BAND EMISSION MEASUREMENT

Below -20dB of the highest emission level of operating band (in 100kHz Resolution Bandwidth).

4.6.2 TEST SETUP

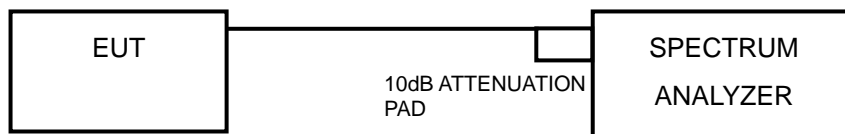

4.6.3 TEST INSTRUMENTS

Refer to section 4.1.2 to get information of above instrument.

4.6.4 TEST PROCEDURE

MEASUREMENT PROCEDURE REF

1. Set the RBW = 100 kHz.
2. Set the VBW \geq 300 kHz.
3. Detector = peak.
4. Sweep time = auto couple.
5. Trace mode = max hold.
6. Allow trace to fully stabilize.
7. Use the peak marker function to determine the maximum power level in any 100 kHz band segment within the fundamental EBW.

MEASUREMENT PROCEDURE OOB

1. Set RBW = 100 kHz.
2. Set VBW \geq 300 kHz.
3. Detector = peak.
4. Sweep = auto couple.
5. Trace Mode = max hold.
6. Allow trace to fully stabilize.
7. Use the peak marker function to determine the maximum amplitude level.

4.6.5 DEVIATION FROM TEST STANDARD

No deviation.

4.6.6 EUT OPERATING CONDITION

Same as section 4.3.6.



A D T

4.6.7 TEST RESULTS

The spectrum plots are attached on the following images. D1 line indicates the highest level, and D2 line indicates the 20dB offset below D1. It shows compliance with the requirement.

802.11b

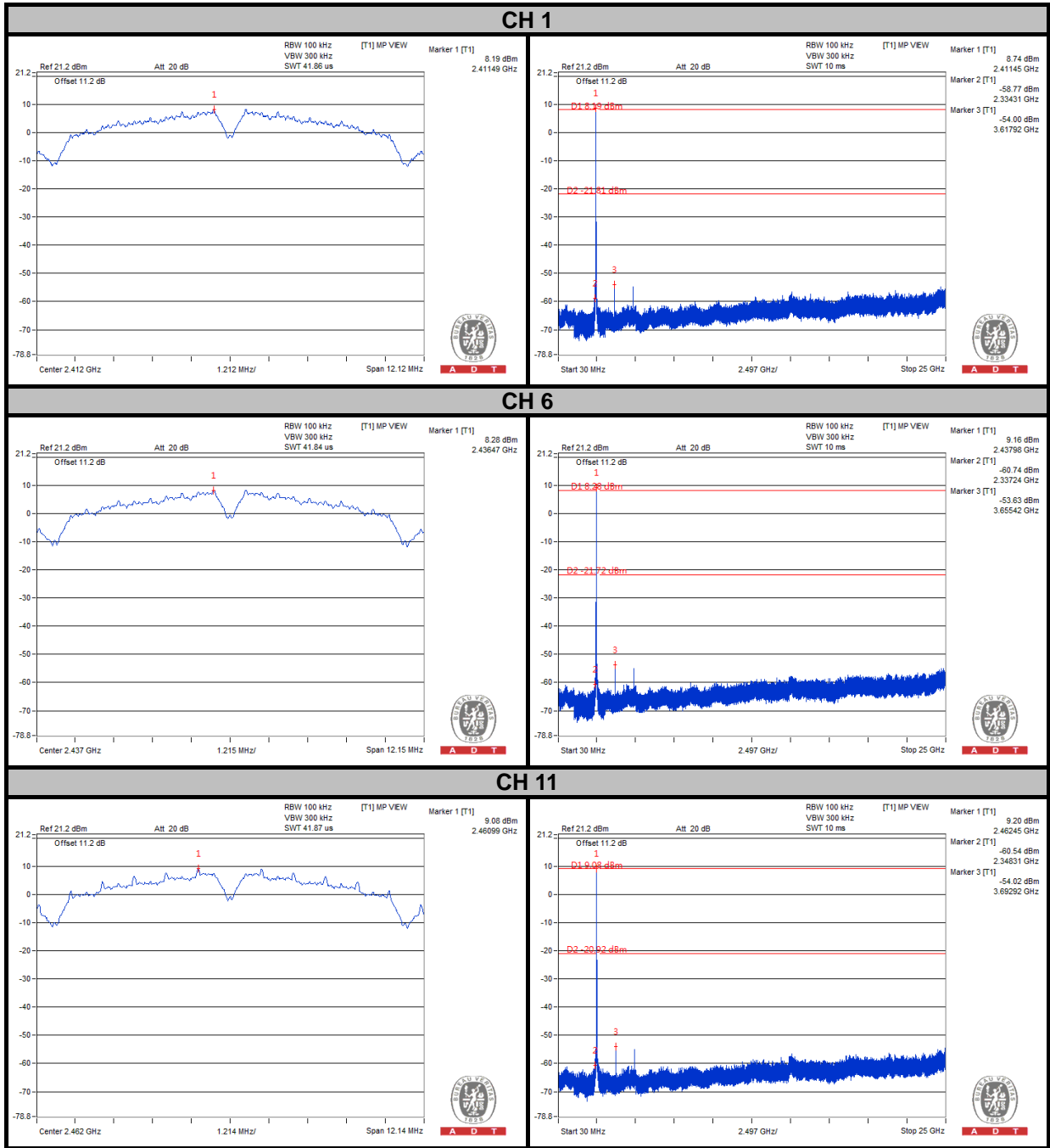



A D T

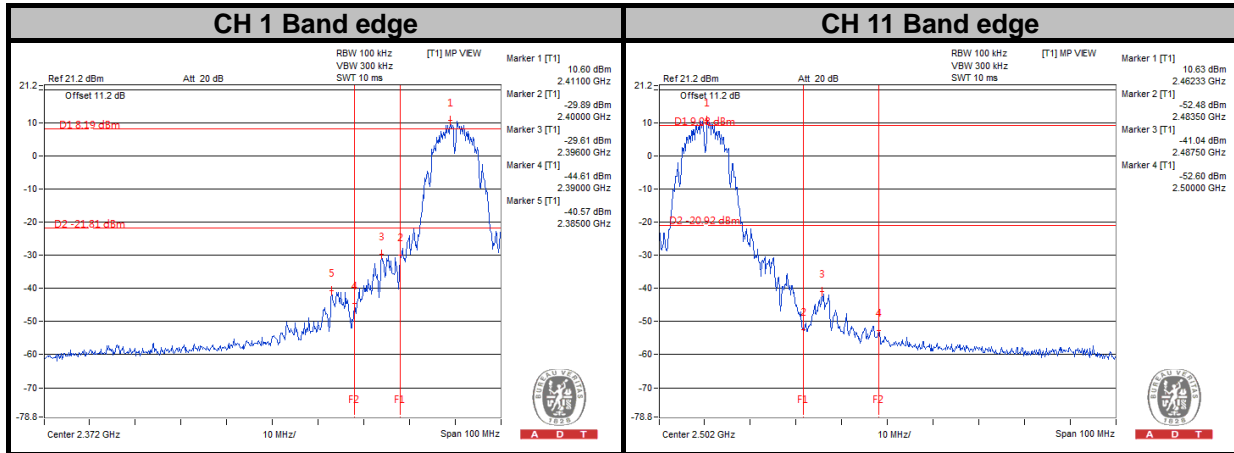



A D T

802.11g

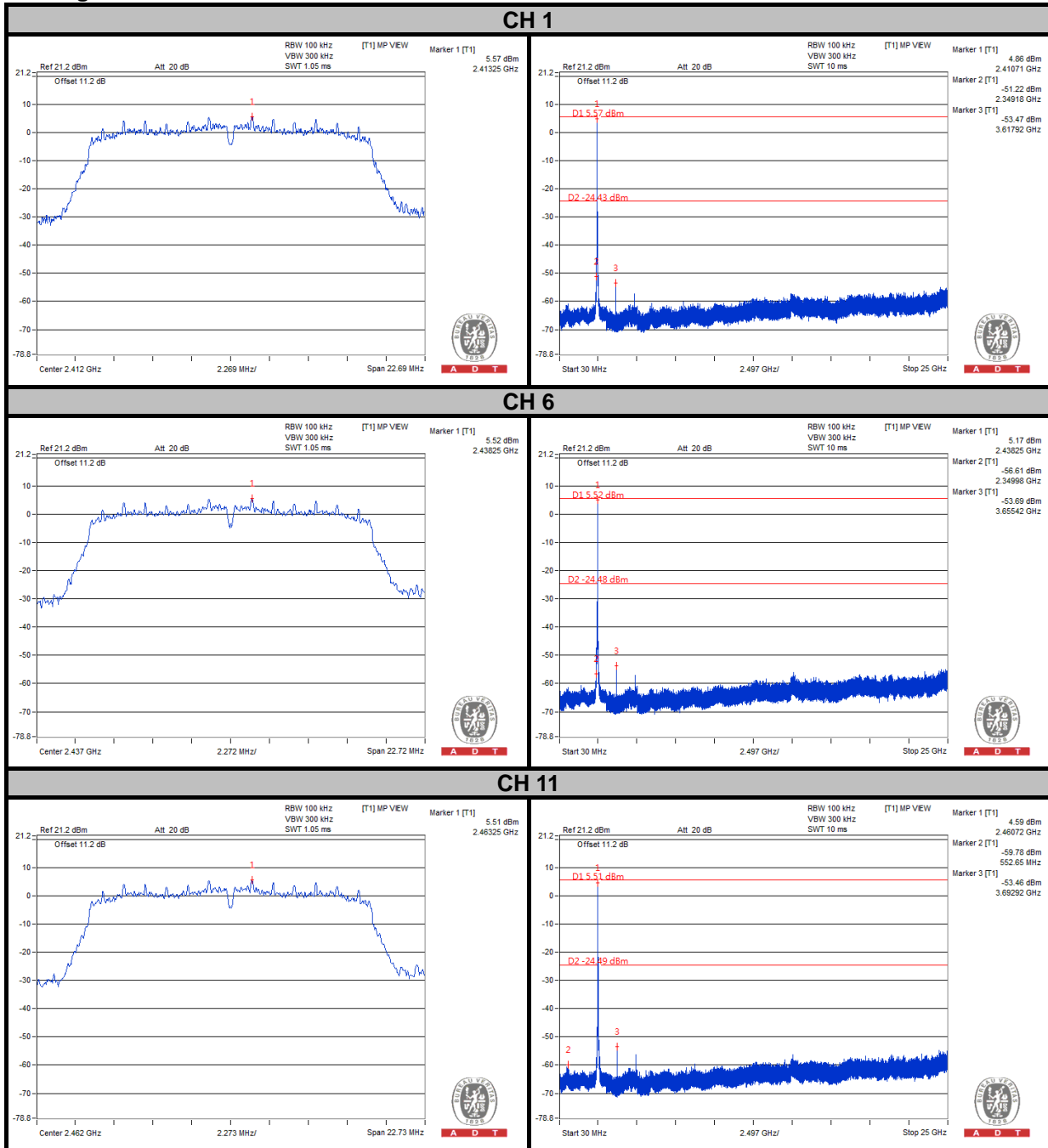



A D T

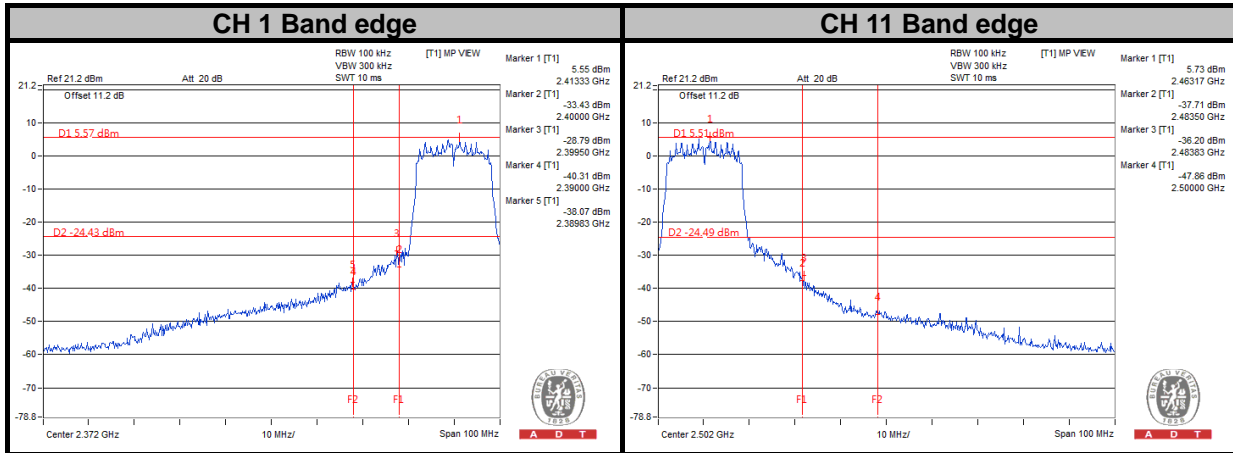



A D T

802.11n (20MHz)

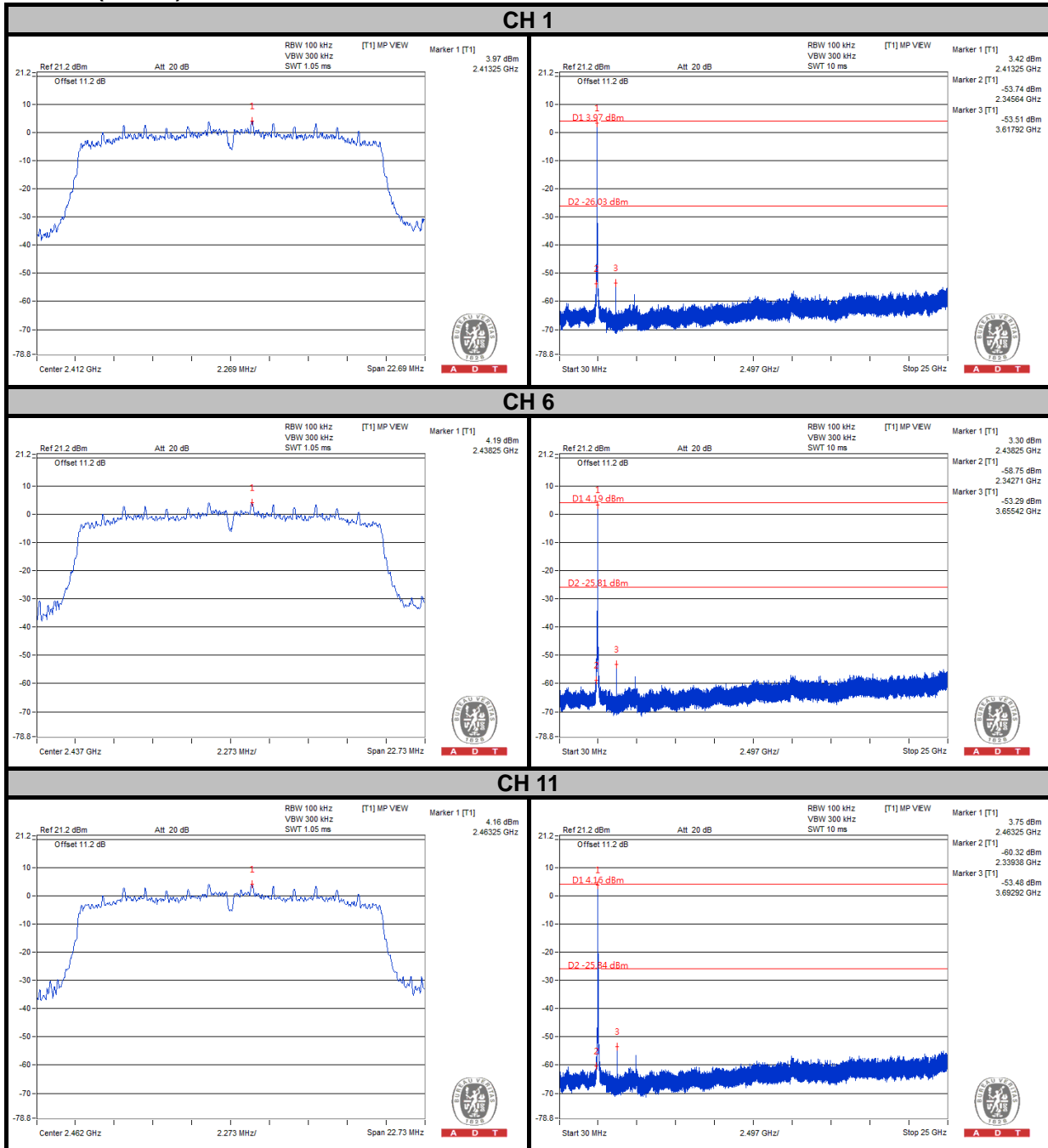



A D T

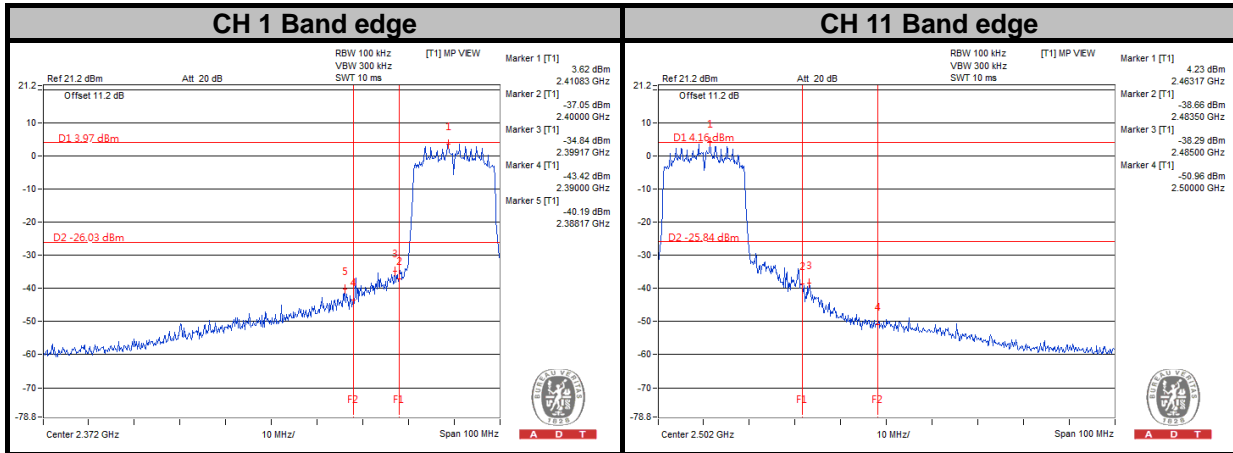



A D T

5. PHOTOGRAPHS OF THE TEST CONFIGURATION

Please refer to the attached file (Test Setup Photo).



6. INFORMATION ON THE TESTING LABORATORIES

We, Bureau Veritas Consumer Products Services (H.K.) Ltd., Taoyuan Branch, were founded in 1988 to provide our best service in EMC, Radio, Telecom and Safety consultation. Our laboratories are accredited and approved according to ISO/IEC 17025.

If you have any comments, please feel free to contact us at the following:

Linko EMC/RF Lab:

Tel: 886-2-26052180

Fax: 886-2-26051924

Hsin Chu EMC/RF/Telecom Lab:

Tel: 886-3-5935343

Fax: 886-3-5935342

Hwa Ya EMC/RF/Safety Lab:

Tel: 886-3-3183232

Fax: 886-3-3270892

Email: service.adt@tw.bureauveritas.com

Web Site: www.bureauveritas-adt.com

The address and road map of all our labs can be found in our web site also.



A D T

7. APPENDIX A – MODIFICATIONS RECORDERS FOR ENGINEERING CHANGES TO THE EUT BY THE LAB

No any modifications are made to the EUT by the lab during the test.

---END---