



FCC RF Test Report

APPLICANT : Nest Labs Inc.
EQUIPMENT : Nest Hello
MODEL NAME : A0077
FCC ID : ZQANC51
STANDARD : FCC Part 15 Subpart E §15.407
CLASSIFICATION : (NII) Unlicensed National Information Infrastructure

The product was completed on Oct. 25, 2017. We, SPORTON INTERNATIONAL INC., would like to declare that the tested sample has been evaluated in accordance with the test procedures and has been in compliance with the applicable technical standards.

The test results in this report apply exclusively to the tested model / sample. Without written approval of SPORTON INTERNATIONAL INC., the test report shall not be reproduced except in full.

Reviewed by: Joseph Lin / Supervisor

Approved by: Jones Tsai / Manager



SPORTON INTERNATIONAL INC.

No. 52, Hwa Ya 1st Rd., Hwa Ya Technology Park, Kwei-Shan District, Tao Yuan City, Taiwan, R.O.C.

SPORTON INTERNATIONAL INC.

TEL : 886-3-327-3456

FAX : 886-3-328-4978

FCC ID : ZQANC51

Page Number : 1 of 30

Report Issued Date : Nov. 09, 2017

Report Version : Rev. 02

Report Template No.: BU5-FR15EWLB4 AC MA Version 2.0



TABLE OF CONTENTS

REVISION HISTORY.....3

SUMMARY OF TEST RESULT4

1 GENERAL DESCRIPTION5

 1.1 Applicant5

 1.2 Product Feature of Equipment Under Test.....5

 1.3 Modification of EUT5

 1.4 Testing Location6

 1.5 Applicable Standards.....6

2 TEST CONFIGURATION OF EQUIPMENT UNDER TEST7

 2.1 Carrier Frequency and Channel7

 2.2 Test Mode.....8

 2.3 Connection Diagram of Test System.....9

 2.4 EUT Operation Test Setup10

 2.5 Measurement Results Explanation Example.....10

3 TEST RESULT11

 3.1 6dB and 26dB and 99% Occupied Bandwidth Measurement11

 3.2 Maximum Conducted Output Power Measurement14

 3.3 Power Spectral Density Measurement15

 3.4 Unwanted Emissions Measurement18

 3.5 AC Conducted Emission Measurement.....23

 3.6 Frequency Stability Measurement25

 3.7 Automatically Discontinue Transmission26

 3.8 Antenna Requirements28

4 LIST OF MEASURING EQUIPMENT29

5 UNCERTAINTY OF EVALUATION30

APPENDIX A. CONDUCTED TEST RESULTS

APPENDIX B. AC CONDUCTED EMISSION TEST RESULT

APPENDIX C. RADIATED SPURIOUS EMISSION

APPENDIX D. RADIATED SPURIOUS EMISSION PLOTS

APPENDIX E. DUTY CYCLE PLOTS



SUMMARY OF TEST RESULT

Report Section	FCC Rule	Description	Limit	Result
3.1	15.403(i)	6dB, 26dB and 99% Occupied Bandwidth	> 500kHz	Pass
3.2	15.407(a)	Maximum Conducted Output Power	≤ 30 dBm	Pass
3.3	15.407(a)	Power Spectral Density	≤ 30 dBm/500kHz	Pass
3.4	15.407(b)	Unwanted Emissions	15.407(b)(4)(i) & 15.209(a)	Pass
3.5	15.207	AC Conducted Emission	15.207(a)	Pass
3.6	15.407(g)	Frequency Stability	Within Operation Band	Pass
3.7	15.407(c)	Automatically Discontinue Transmission	Discontinue Transmission	Pass
3.8	15.203 & 15.407(a)	Antenna Requirement	N/A	Pass



1 General Description

1.1 Applicant

Nest Labs Inc.

3400 Hillview Ave.Palo Alto, CA 94304 USA

1.2 Product Feature of Equipment Under Test

Bluetooth, Wi-Fi 2.4GHz 802.11b/g/n/ac, Wi-Fi 5GHz 802.11a/n/ac and Zigbee

Product Specification subjective to this standard	
Antenna Type	WLAN: IFA Antenna Bluetooth: IFA Antenna Zigbee: IFA Antenna

1.3 Modification of EUT

No modifications are made to the EUT during all test items.



1.4 Testing Location

Sporton Lab is accredited to ISO 17025 by Taiwan Accreditation Foundation (TAF code : 1190) and the FCC designation No. TW1190 and TW0007 under the FCC 2.948(e) by Mutual Recognition Agreement (MRA) in FCC Test.

Test Site	SPORTON INTERNATIONAL INC.	
Test Site Location	No. 52, Hwa Ya 1 st Rd., Hwa Ya Technology Park, Kwei-Shan District, Tao Yuan City, Taiwan, R.O.C. TEL: +886-3-327-3456 FAX: +886-3-328-4978	
Test Site No.	Sporton Site No.	
	TH05-HY	CO05-HY

Note: The test site complies with ANSI C63.4 2014 requirement.

Test Site	SPORTON INTERNATIONAL INC.	
Test Site Location	No.58, Aly. 75, Ln. 564, Wenhua 3rd Rd. Guishan Dist, Taoyuan City, Taiwan (R.O.C.) TEL: +886-3-327-0868 FAX: +886-3-327-0855	
Test Site No.	Sporton Site No.	
	03CH11-HY	

Note: The test site complies with ANSI C63.4 2014 requirement.

1.5 Applicable Standards

According to the specifications of the manufacturer, the EUT must comply with the requirements of the following standards:

- ♦ FCC Part 15 Subpart E
- ♦ FCC KDB 789033 D02 General UNII Test Procedures New Rules v01r04.
- ♦ FCC KDB 662911 D01 Multiple Transmitter Output v02r01.
- ♦ ANSI C63.10-2013

Remark: All test items were verified and recorded according to the standards and without any deviation during the test.



2 Test Configuration of Equipment Under Test

- a. The EUT has been associated with peripherals and configuration operated in a manner tended to maximize its emission characteristics in a typical application. Frequency range investigated: conduction emission (150 kHz to 30 MHz), radiation emission (9 kHz to the 10th harmonic of the highest fundamental frequency or to 40 GHz, whichever is lower). For radiated measurement, pre-scanned in three orthogonal panels, X, Y, Z. The worst cases (X plane) were recorded in this report.
- b. AC power line Conducted Emission was tested under maximum output power.

2.1 Carrier Frequency and Channel

Frequency Band	Channel	Freq. (MHz)	Channel	Freq. (MHz)
5725-5850 MHz Band 4 (U-NII-3)	149	5745	157	5785
	151*	5755	159*	5795
	153	5765	161	5805
	155#	5775	165	5825

Note:

- 1. The above Frequency and Channel in "*" were 802.11n HT40 and 802.11ac VHT40.
- 2. The above Frequency and Channel in "#n" were 802.11ac VHT80.



2.2 Test Mode

Final test mode of conducted test items and radiated spurious emissions are considering the modulation and worse data rates as below table.

MIMO Antenna

Modulation	Data Rate
802.11a	6 Mbps
802.11n HT20	MCS0
802.11n HT40	MCS0
802.11ac VHT20	MCS0
802.11ac VHT40	MCS0
802.11ac VHT80	MCS0

Test Cases	
AC Conducted Emission	Mode 1 : WLAN On + BLE On + Zigbee On + Sensor On + LED On + IR LED On + Speaker On + Camera + AC to AC transformer
Remark: The MIMO conducted total power has larger 3dB than SISO conducted power, the RSE test with MIMO condition can also cover the SISO condition.	

Ch. #		Band IV : 5725-5850 MHz		
		802.11a	802.11n HT20	802.11n HT40
L	Low	149	149	151
M	Middle	157	157	-
H	High	165	165	159

Ch. #		Band IV : 5725-5850 MHz		
		802.11ac VHT20	802.11ac VHT40	802.11ac VHT80
L	Low	149	151	-
M	Middle	157	-	155
H	High	165	159	-

2.3 Connection Diagram of Test System

<WLAN Tx Mode>

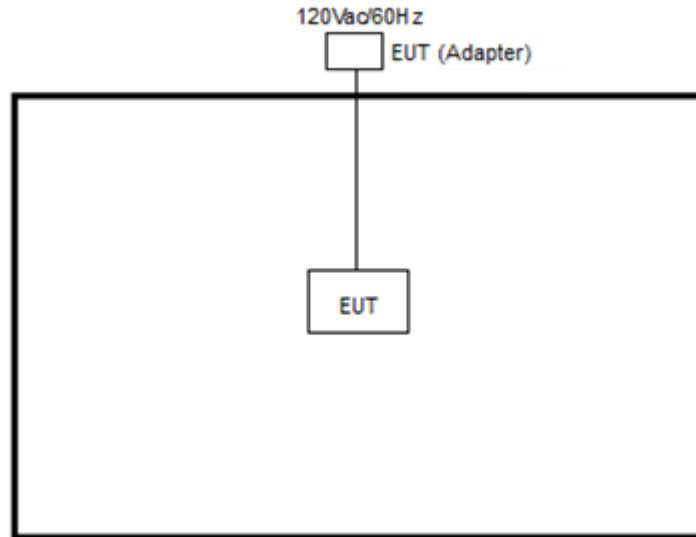

<AC Conducted Emission Mode>

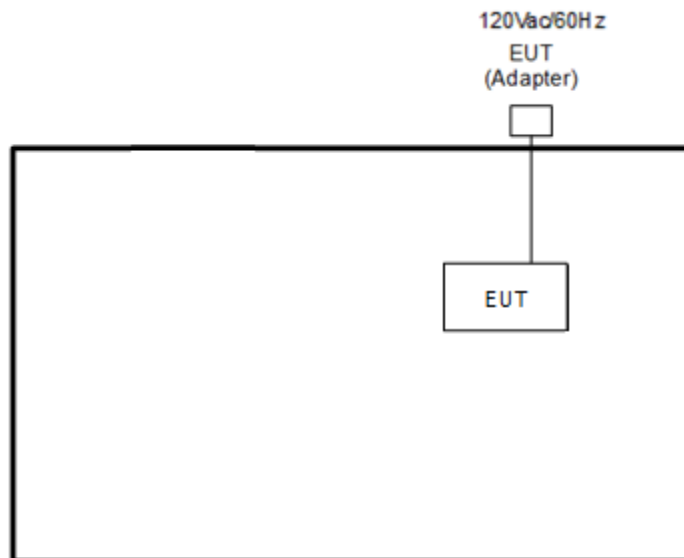



2.4 EUT Operation Test Setup

The RF test items, programmed RF utility, “tera term” installed in the notebook make the EUT provide functions like channel selection and power level for continuous transmitting and receiving signals.

2.5 Measurement Results Explanation Example

For all conducted test items:

The offset level is set in the spectrum analyzer to compensate the RF cable loss and attenuator factor between EUT conducted output port and spectrum analyzer. With the offset compensation, the spectrum analyzer reading level is exactly the EUT RF output level.

Example :

The spectrum analyzer offset is derived from RF cable loss and attenuator factor.

Offset = RF cable loss + attenuator factor.

Following shows an offset computation example with cable loss 4.2 dB and 10dB attenuator.

$$\begin{aligned} \text{Offset(dB)} &= \text{RF cable loss(dB)} + \text{attenuator factor(dB)}. \\ &= 4.2 + 10 = 14.2 \text{ (dB)} \end{aligned}$$

3 Test Result

3.1 6dB and 26dB and 99% Occupied Bandwidth Measurement

3.1.1 Description of 6dB and 26dB and 99% Occupied Bandwidth

The minimum 6 dB bandwidth shall be at least 500 kHz.

26dB and 99% Occupied bandwidth are reporting only.

3.1.2 Measuring Instruments

The measuring equipment is listed in the section 4 of this test report.

3.1.3 Test Procedures

1. The testing follows FCC KDB 789033 D02 General UNII Test Procedures New Rules v01r04.
Section C) Emission bandwidth for the band 5.725-5.85GHz
2. Set RBW = 100kHz.
3. Set the VBW $\geq 3 \times$ RBW.
4. Detector = Peak.
5. Trace mode = max hold
6. Measure the maximum width of the emission that is 6 dB down from the peak of the emission.
7. Measure and record the results in the test report.

3.1.4 Test Setup

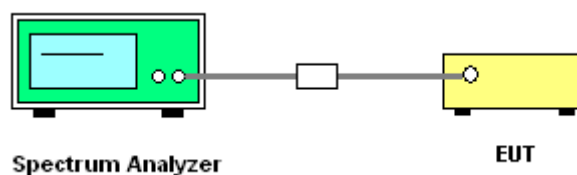

3.1.5 Test Result of 6dB Bandwidth

Please refer to Appendix A.

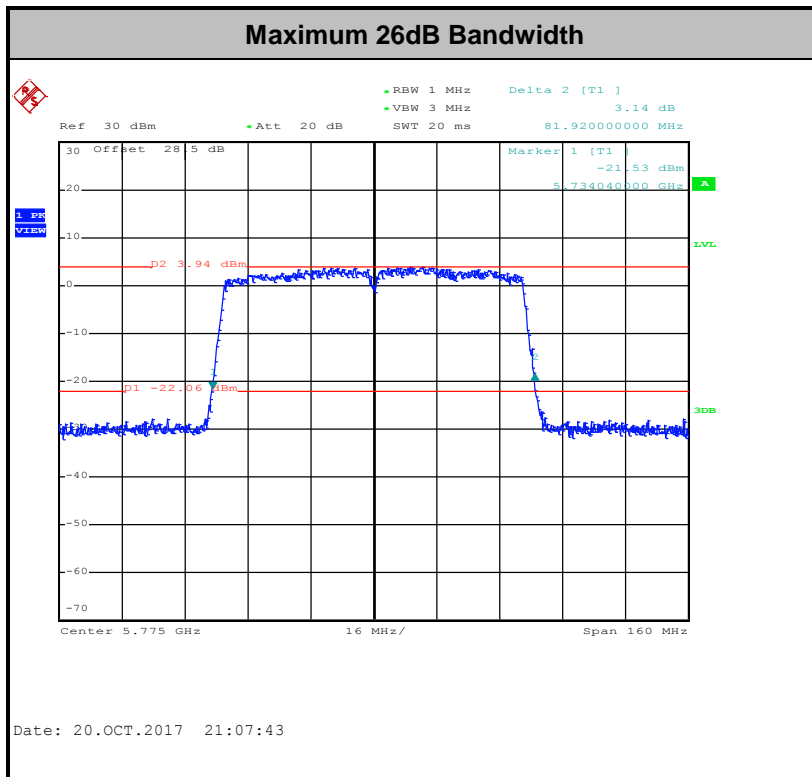
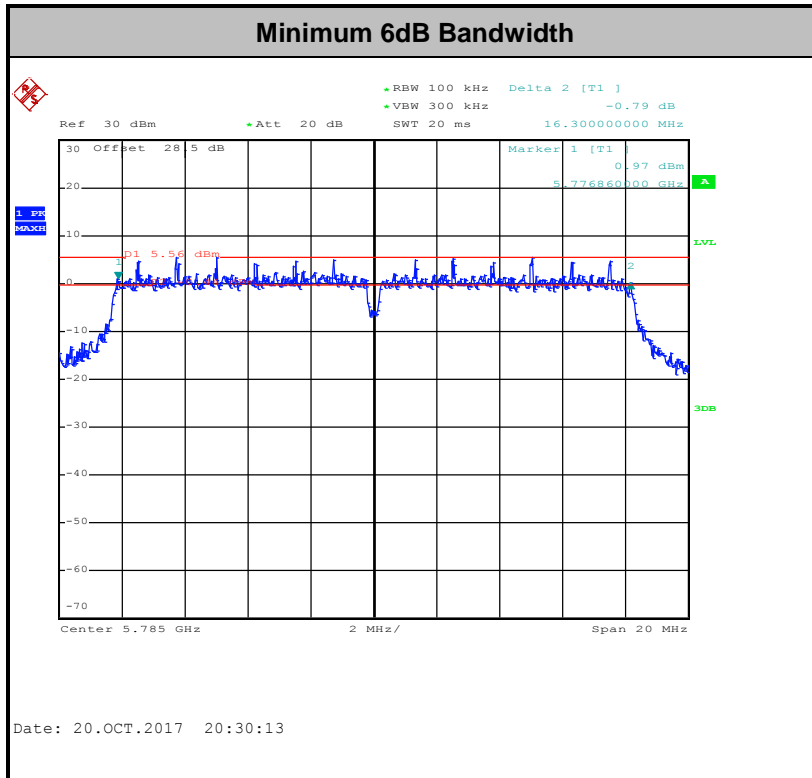

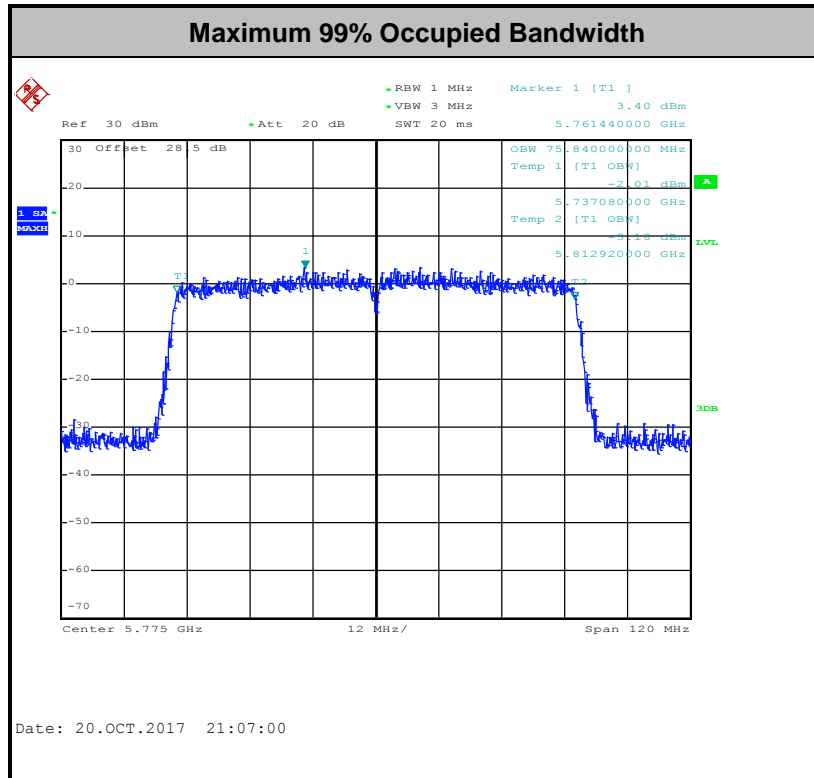

Note: The occupied channel bandwidth is maintained within the band of operation for all of the modulations.

3.2 Maximum Conducted Output Power Measurement

3.2.1 Limit of Maximum Conducted Output Power

For the band 5.725–5.85 GHz, the maximum conducted output power over the frequency band of operation shall not exceed 1 W.

If transmitting antennas of directional gain greater than 6 dBi are used, the peak output power shall be reduced by the amount in dB that the directional gain of the antenna exceeds 6 dBi.

3.2.2 Measuring Instruments

The measuring equipment is listed in the section 4 of this test report.

3.2.3 Test Procedures

The testing follows Method PM of FCC KDB 789033 D02 General UNII Test Procedures New Rules v01r04.

Method PM (Measurement using an RF average power meter):

1. Measurement is performed using a wideband RF power meter.
2. The EUT is configured to transmit continuously with a consistent duty cycle at its maximum power control level.
3. Measure the average power of the transmitter, and the average power is corrected with duty factor, $10 \log(1/x)$, where x is the duty cycle.

3.2.4 Test Setup

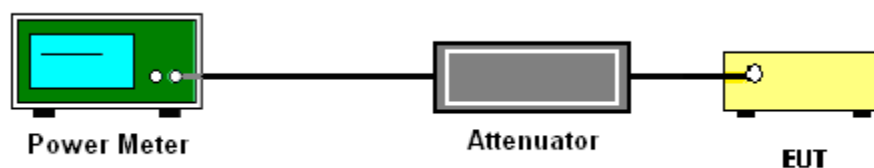

3.2.5 Test Result of Maximum Conducted Output Power

Please refer to Appendix A.



3.3 Power Spectral Density Measurement

3.3.1 Limit of Power Spectral Density

For the band 5.725–5.85 GHz, the maximum power spectral density shall not exceed 30 dBm in any 500-kHz band.

If transmitting antennas of directional gain greater than 6 dBi are used, the peak output power shall be reduced by the amount in dB that the directional gain of the antenna exceeds 6 dBi.

3.3.2 Measuring Instruments

The measuring equipment is listed in the section 4 of this test report.

3.3.3 Test Procedures

The testing follows FCC KDB 789033 D02 General UNII Test Procedures New Rules v01r04. Section F) Maximum power spectral density.

Method SA-2

(trace averaging across on and off times of the EUT transmissions, followed by duty cycle correction).

- Measure the duty cycle.
- Set span to encompass the entire emission bandwidth (EBW) of the signal.
- Set RBW = 300 kHz.
- Set VBW \geq 1 MHz.
- Number of points in sweep \geq 2 Span / RBW.
- Sweep time = auto.
- Detector = RMS
- Trace average at least 100 traces in power averaging mode.
- Add $10 \log(500\text{kHz}/\text{RBW})$ to the test result.
- Add $10 \log(1/x)$, where x is the duty cycle, to the measured power in order to compute the average power during the actual transmission times. For example, add $10 \log(1/0.25) = 6$ dB if the duty cycle is 25 percent.

1. The RF output of EUT was connected to the spectrum analyzer by a low loss cable.
2. Each plot has already offset with cable loss, and attenuator loss. Measure the PPSD and record it.
3. For MIMO mode, calculation method follows FCC KDB 662911 D01 Multiple Transmitter Output v02r01.

Method (c): Measure and add $10 \log(N_{\text{ANT}})$ dB.

With this technique, spectrum measurements are performed at each output of the device, but rather than summing the spectra or the spectral peaks across the outputs, the quantity $10 \log(N_{\text{ANT}})$ dB is added to each spectrum value before comparing to the emission limit. The addition of $10 \log(N_{\text{ANT}})$ dB serves to apportion the emission limit among the N_{ANT} outputs so that each output is permitted to contribute no more than $1/N_{\text{ANT}}^{\text{th}}$ of the PSD limit.

3.3.4 Test Setup

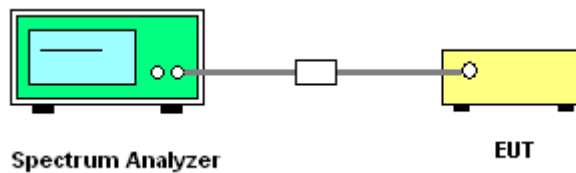

3.3.5 Test Result of Power Spectral Density

Please refer to Appendix A.



Worst Case Power Density (dBm/300kHz) for MIMO Ant. 1

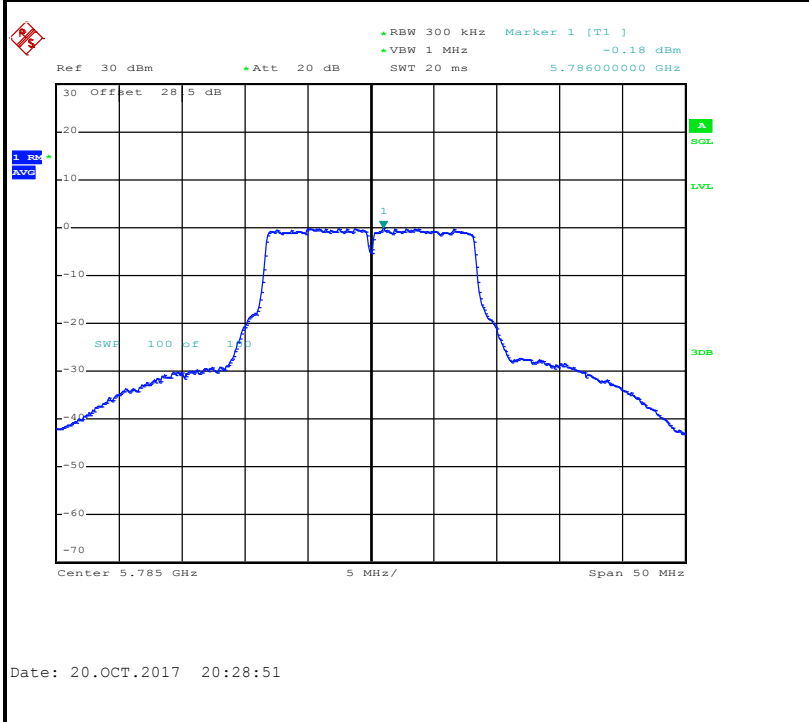

Worst Case Power Density (dBm/300kHz) for MIMO Ant. 2





3.4 Unwanted Emissions Measurement

This section is to measure unwanted emissions through radiated measurement for band edge spurious emissions and out of band emissions measurement.

3.4.1 Limit of Unwanted Emissions

- (1) For transmitters operating in the 5.725-5.85 GHz band:
15.407(b)(4)(i) All emissions shall be limited to a level of -27 dBm/MHz at 75 MHz or more above or below the band edge increasing linearly to 10 dBm/MHz at 25 MHz above or below the band edge, and from 25 MHz above or below the band edge increasing linearly to a level of 15.6 dBm/MHz at 5 MHz above or below the band edge, and from 5 MHz above or below the band edge increasing linearly to a level of 27 dBm/MHz at the band edge.
- (2) Unwanted spurious emissions fallen in restricted bands shall comply with the general field strength limits as below table.

Frequency (MHz)	Field Strength (microvolts/meter)	Measurement Distance (meters)
0.009 – 0.490	2400/F(kHz)	300
0.490 – 1.705	24000/F(kHz)	30
1.705 – 30.0	30	30
30 – 88	100	3
88 – 216	150	3
216 - 960	200	3
Above 960	500	3

Note: The following formula is used to convert the EIRP to field strength.

$$E = \frac{1000000\sqrt{30P}}{3} \mu\text{V/m, where P is the eirp (Watts)}$$



EIRP (dBm)	Field Strength at 3m (dBµV/m)
-17	78.3
- 27	68.3

(3) KDB789033 D02 v01r04 G)2)c)

- (i) Sections 15.407(b)(1) to (b)(3) specify the unwanted emission limits for the U-NII-1 and U-NII-2 bands. As specified, emissions above 1000 MHz that are outside of the restricted bands are subject to a peak emission limit of -27 dBm/MHz.³
- (ii) Section 15.407(b)(4) specifies the unwanted emission limit for the U-NII-3 band. A band emissions mask is specified in Section 15.407(b)(4)(i). The emission limits are in terms of a Peak detector. An alternative to the band emissions mask is specified in Section 15.407(b)(4)(ii). The alternative limits are based on the highest antenna gain specified in the filing. There are also marketing and importation restrictions for the devices using the alternative limit.⁴

Note 3: An out-of-band emission that complies with both the average and peak limits of Section 15.209 is not required to satisfy the -27 dBm/MHz peak emission limit.

Note 4: Only devices with antenna gains of 10 dBi or less may be approved using the emission limits specified in Section 15.247(d) till March 2, 2018; all other devices operating in this band must use the mask specified in Section 15.407(b)(4)(i).

3.4.2 Measuring Instruments

The measuring equipment is listed in the section 4 of this test report.

3.4.3 Test Procedures

1. The testing follows FCC KDB 789033 D02 General UNII Test Procedures New Rules v01r04. Section G) Unwanted emissions measurement.
 - (1) Procedure for Unwanted Emissions Measurements Below 1000MHz
 - RBW = 120 kHz
 - VBW = 300 kHz
 - Detector = Peak
 - Trace mode = max hold



(2) Procedure for Peak Unwanted Emissions Measurements Above 1000 MHz

- RBW = 1 MHz
- VBW \geq 3 MHz
- Detector = Peak
- Sweep time = auto
- Trace mode = max hold

(3) Procedures for Average Unwanted Emissions Measurements Above 1000MHz

- RBW = 1 MHz
- VBW = 10 Hz, when duty cycle is no less than 98 percent.
- VBW \geq 1/T, when duty cycle is less than 98 percent where T is the minimum transmission duration over which the transmitter is on and is transmitting at its maximum power control level for the tested mode of operation.

2. The EUT was placed on a turntable with 0.8 meter for frequency below 1GHz and 1.5 meter for frequency above 1GHz respectively above ground.
3. The EUT was set 3 meters from the interference receiving antenna which was mounted on the top of a variable height antenna tower.
4. The antenna is a broadband antenna and its height is adjusted between one meter and four meters above ground to find the maximum value of the field strength for both horizontal polarization and vertical polarization of the antenna.
5. For each suspected emission, the EUT was arranged to its worst case and then adjust the antenna tower (from 1 m to 4 m) and turntable (from 0 degree to 360 degrees) to find the maximum reading.
6. For testing below 1GHz, if the emission level of the EUT in peak mode was 3 dB lower than the limit specified, then peak values of EUT will be reported, otherwise, the emissions will be repeated one by one using the CISPR quasi-peak method and reported.
7. For testing above 1GHz, the emission level of the EUT in peak mode was 20dB lower than average limit (that means the emission level in average mode also complies with the limit in average mode), then peak values of EUT will be reported, otherwise, the emissions will be measured in average mode again and reported.

3.4.4 Test Setup

For radiated emissions below 30MHz

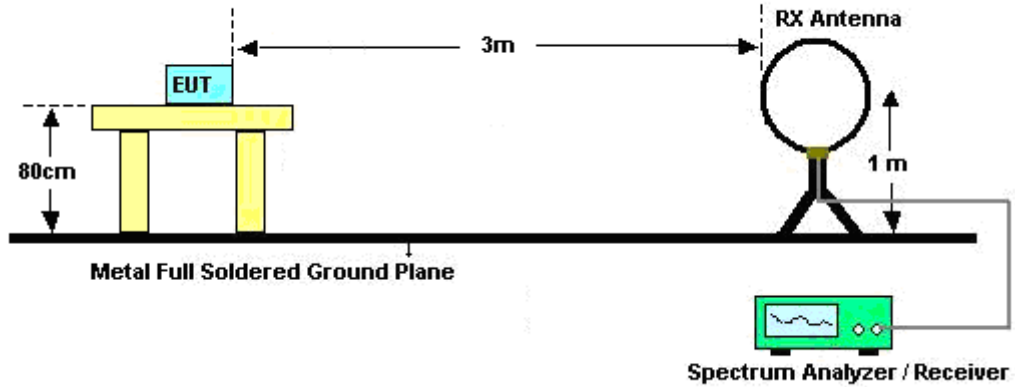

For radiated emissions from 30MHz to 1GHz

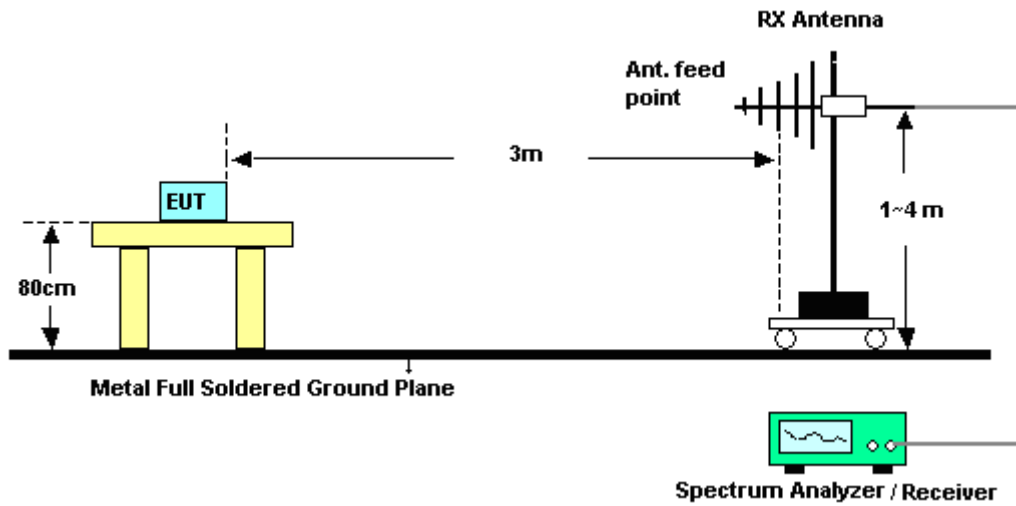

For radiated emissions above 1GHz

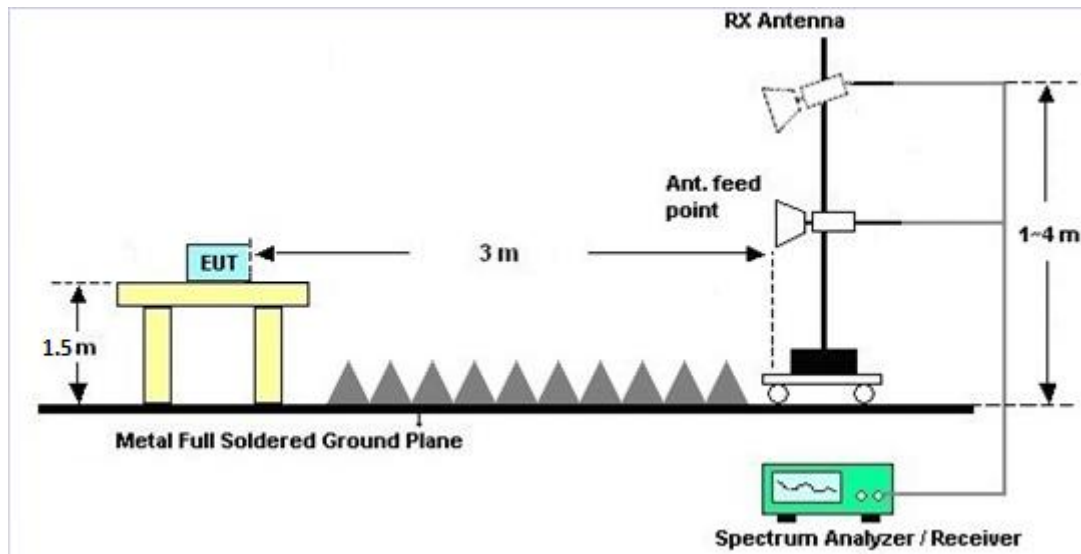

3.4.5 Test Results of Radiated Spurious Emissions (9 kHz ~ 30 MHz)

The low frequency, which started from 9 kHz to 30MHz, was pre-scanned and the result which was 20dB lower than the limit line was not reported.

There is a comparison data of both open-field test site and semi-Anechoic chamber, and the result came out very similar.

3.4.6 Test Result of Radiated Spurious at Band Edges

Please refer to Appendix C and D.

3.4.7 Duty Cycle

Please refer to Appendix E.

3.4.8 Test Result of Radiated Spurious Emissions (30MHz ~ 10th Harmonic)

Please refer to Appendix C and D.



3.5 AC Conducted Emission Measurement

3.5.1 Limit of AC Conducted Emission

For equipment that is designed to be connected to the public utility (AC) power line, the radio frequency voltage that is conducted back onto the AC power line on any frequency or frequencies within the band 150 kHz to 30 MHz shall not exceed the limits in the following table.

Frequency of emission (MHz)	Conducted limit (dBµV)	
	Quasi-peak	Average
0.15-0.5	66 to 56*	56 to 46*
0.5-5	56	46
5-30	60	50

*Decreases with the logarithm of the frequency.

3.5.2 Measuring Instruments

The measuring equipment is listed in the section 4 of this test report.

3.5.3 Test Procedures

1. The EUT was placed 0.4 meter from the conducting wall of the shielding room was kept at least 80 centimeters from any other grounded conducting surface.
2. Connect EUT to the power mains through a line impedance stabilization network (LISN).
3. All the support units are connecting to the other LISN.
4. The LISN provides 50 ohm coupling impedance for the measuring instrument.
5. The FCC states that a 50 ohm, 50 microhenry LISN should be used.
6. Both sides of AC line were checked for maximum conducted interference.
7. The frequency range from 150 kHz to 30 MHz was searched.
8. Set the test-receiver system to Peak Detect Function and specified bandwidth with Maximum Hold Mode.

3.5.4 Test Setup

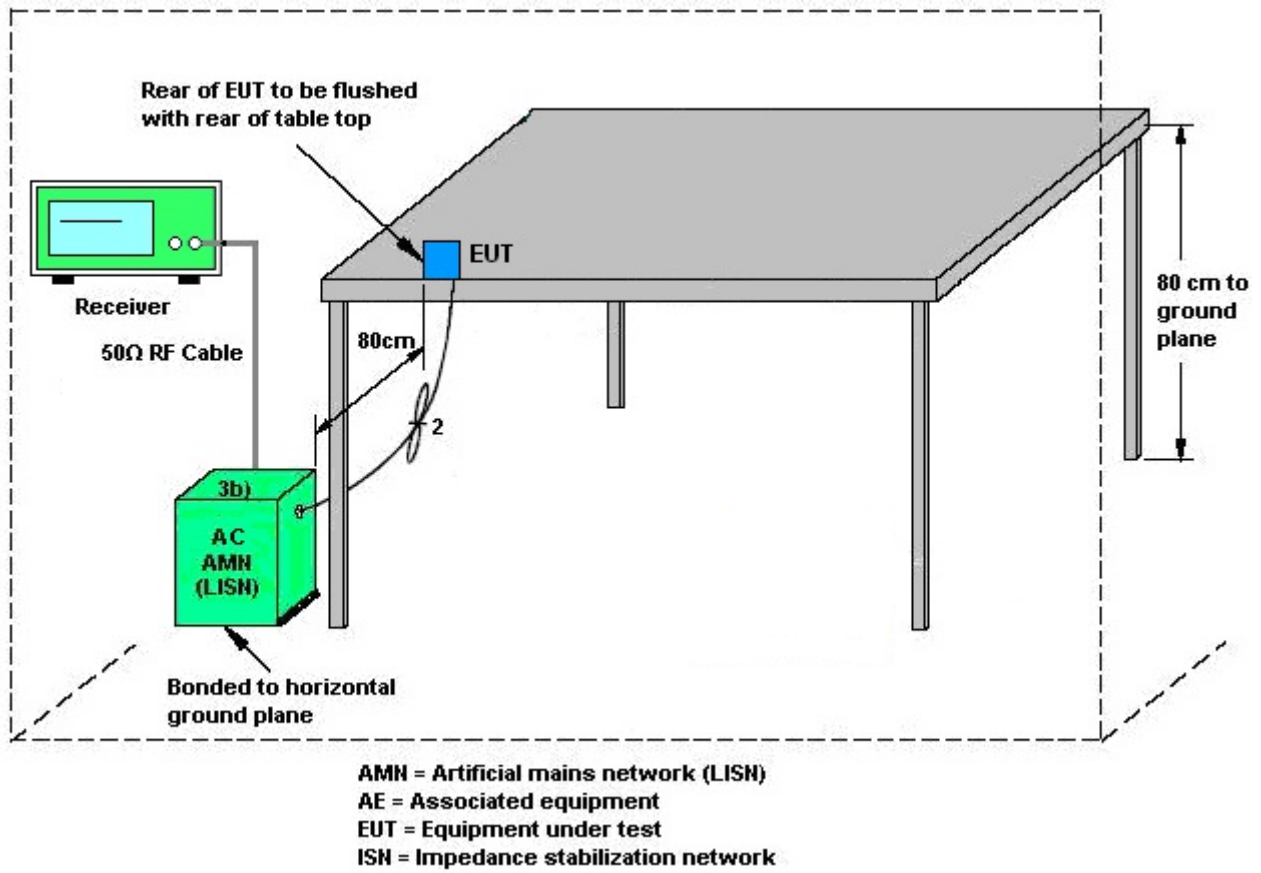

3.5.5 Test Result of AC Conducted Emission

Please refer to Appendix B.

3.6 Frequency Stability Measurement

3.6.1 Limit of Frequency Stability

Manufacturers of U-NII devices are responsible for ensuring frequency stability such that an emission is maintained within the band of operation under all conditions of normal operation as specified in the user's manual.

3.6.2 Measuring Instruments

The measuring equipment is listed in the section 4 of this test report.

3.6.3 Test Procedures

1. To ensure emission at the band edge is maintained within the authorized band, those values shall be measured by radiation emissions at upper and lower frequency points, and finally compensated by frequency deviation as procedures below.
2. The EUT was operated at the maximum output power, and connected to the spectrum analyzer, which is set to maximum hold function and peak detector. The peak value of the power envelope was measured and noted. The upper and lower frequency points were respectively measured relatively 10dB lower than the measured peak value.
3. The frequency deviation was calculated by adding the upper frequency point and the lower frequency point divided by two. Those detailed values of frequency deviation are provided in table below.

3.6.4 Test Setup

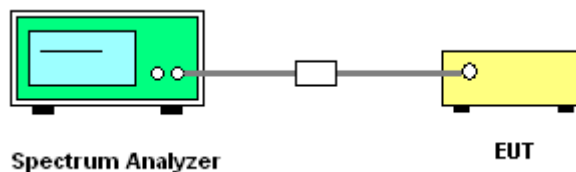

3.6.5 Test Result of Frequency Stability

Please refer to Appendix A.



3.7 Automatically Discontinue Transmission

3.7.1 Limit of Automatically Discontinue Transmission

The device shall automatically discontinue transmission in case of either absence of information to transmit or operational failure. These provisions are not intended to preclude the transmission of control or signaling information or the use of repetitive codes used by certain digital technologies to complete frame or burst intervals. Applicants shall include in their application for equipment authorization to describe how this requirement is met.

3.7.2 Measuring Instruments

The measuring equipment is listed in the section 4 of this test report.

3.7.3 Test Result of Automatically Discontinue Transmission

EUT is verified this characteristic during the function check of normal sample associated with an access point:

- A. Information start: make EUT supply information to the access point.
- B. Information stop: stop supplying information to the access point.

While the EUT is not transmitting any information, the EUT can automatically discontinue transmission and become standby mode for power saving.

- C. Information start: make EUT supply information to the access point again.

The EUT can detect the controlling signal of ACK message transmitting from remote device and verify whether it shall resend or discontinue transmission.

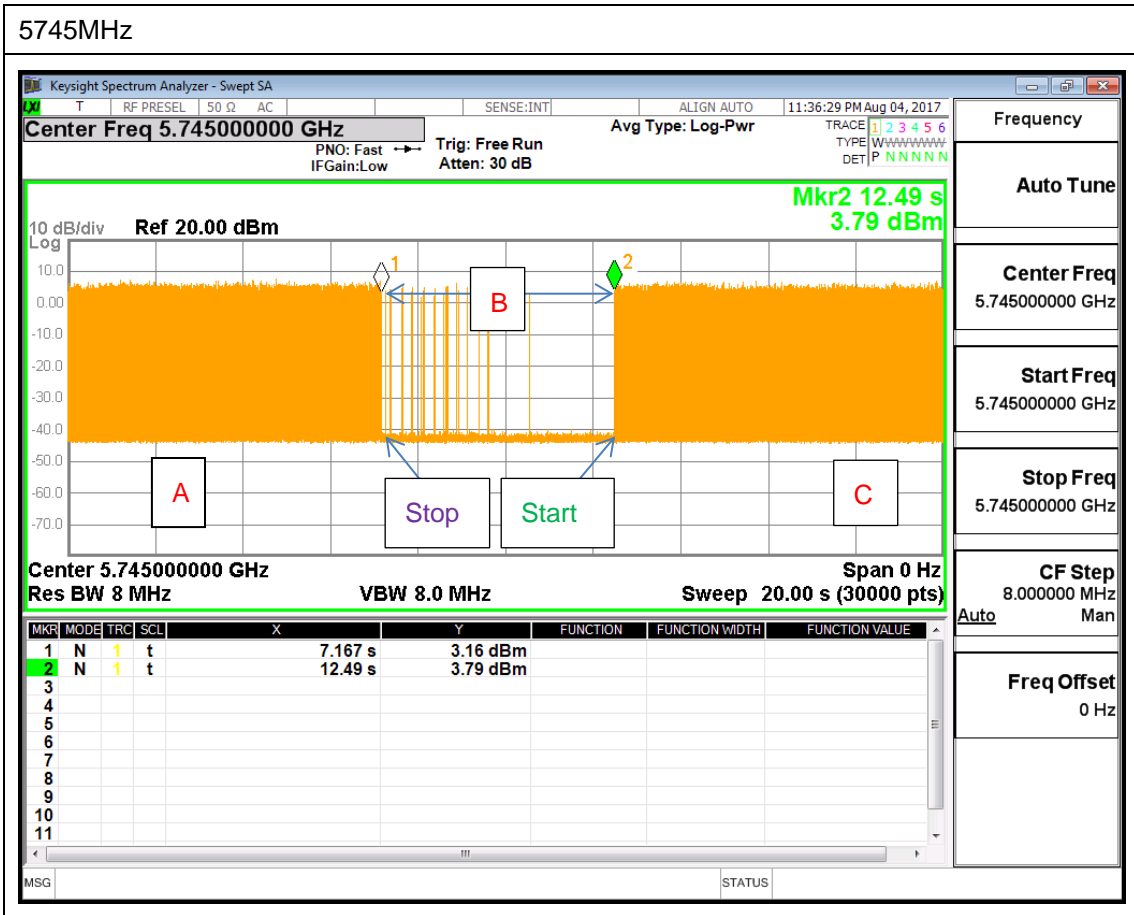

Note : The control / signalling information during the period B is precluded.



3.8 Antenna Requirements

3.8.1 Standard Applicable

If transmitting antenna directional gain is greater than 6 dBi, both the peak transmit power and the peak power spectral density shall be reduced by the amount in dB that the directional gain of the antenna exceeds 6 dBi.

3.8.2 Antenna Anti-Replacement Construction

An embedded-in antenna design is used.

3.8.3 Antenna Gain

FCC KDB 662911 D01 Multiple Transmitter Output v02r01

For CDD transmissions, directional gain is calculated as

Directional gain = $G_{ANT} + \text{Array Gain}$, where Array Gain is as follows.

For power spectral density (PSD) measurements on all devices,

Array Gain = $10 \log(N_{ANT}/N_{SS}=1)$ dB.

For power measurements on IEEE 802.11 devices,

Array Gain = 0 dB (i.e., no array gain) for $N_{ANT} \leq 4$.

Directional gain may be calculated by using the formulas applicable to equal gain antennas with G_{ANT} set equal to the gain of the antenna having the highest gain;

The EUT supports CDD mode.

For power, the directional gain G_{ANT} is set equal to the antenna having the highest gain, i.e., F)2)f)i).

For PSD, the directional gain calculation is following F)2)f)ii) of KDB 662911 D01 v02r01.

The power and PSD limit should be modified if the directional gain of EUT is over 6 dBi,

The directional gain "DG" is calculated as following table.

	Ant 1 (dBi)	Ant 2 (dBi)	DG for Power (dBi)	DG for PSD (dBi)	Power Limit Reduction (dB)	PSD Limit Reduction (dB)
Band IV	1.83	2.12	2.12	4.99	0.00	0.00

Power limit reduction = Composite gain – 6dBi, (min = 0)

PSD limit reduction = Composite gain + PSD Array gain – 6dBi, (min = 0)



4 List of Measuring Equipment

Instrument	Manufacturer	Model No.	Serial No.	Characteristics	Calibration Date	Test Date	Due Date	Remark
AC Power Source	AC POWER	AFC-500W	F104070011	50Hz~60Hz	Dec. 01, 2016	Oct. 06, 2017 ~ Oct. 25, 2017	Nov. 30, 2017	Conducted (TH05-HY)
Power Meter	Anritsu	ML2495A	1132003	N/A	Aug. 09, 2017	Oct. 06, 2017 ~ Oct. 25, 2017	Aug. 08, 2018	Conducted (TH05-HY)
Power Sensor	Anritsu	MA2411B	1126017	300MHz~40GHz	Aug. 09, 2017	Oct. 06, 2017 ~ Oct. 25, 2017	Aug. 08, 2018	Conducted (TH05-HY)
Spectrum Analyzer	Rohde & Schwarz	FSP40	100057	9kHz-40GHz	Nov. 25, 2016	Oct. 06, 2017 ~ Oct. 25, 2017	Nov. 24, 2017	Conducted (TH05-HY)
Temperature Chamber	ESPEC	SU-241	92003713	-30°C ~95°C	Jun. 05, 2017	Oct. 06, 2017 ~ Oct. 25, 2017	Jun. 04, 2018	Conducted (TH05-HY)
AC Power Source	ChainTek	APC-1000W	N/A	N/A	N/A	Jul. 22, 2017	N/A	Conduction (CO05-HY)
EMI Test Receiver	Rohde & Schwarz	ESCI 7	100724	9kHz~7GHz	Aug. 30, 2016	Jul. 22, 2017	Aug. 29, 2017	Conduction (CO05-HY)
LISN	Rohde & Schwarz	ENV216	100080	9kHz~30MHz	Nov. 29, 2016	Jul. 22, 2017	Nov. 28, 2017	Conduction (CO05-HY)
Preamplifier	MITEQ	TTA1840-35-HG	1887435	18GHz~40GHz	Oct. 13, 2016	July. 01, 2017~ July. 25, 2017	Oct. 12, 2017	Radiation (03CH11-HY)
Amplifier	MITEQ	TTA1840-35-HG	1871923	18GHz~40GHz, VSWR : 2.5:1 max	Jul. 18, 2017	July. 26, 2017~ Oct. 20, 2017	Jul. 17, 2018	Radiation (03CH11-HY)
Amplifier	SONOMA	310N	187312	9kHz~1GHz	Nov. 10, 2016	July. 01, 2017~ Oct. 20, 2017	Nov. 09, 2017	Radiation (03CH11-HY)
Loop Antenna	Rohde & Schwarz	HFH2-Z2	100488	9 kHz~30 MHz	Oct. 20, 2016	July. 01, 2017~ Oct. 20, 2017	Oct. 19, 2018	Radiation (03CH11-HY)
Preamplifier	Keysight	83017A	MY53270080	1GHz~26.5GHz	Nov. 10, 2016	July. 01, 2017~ Oct. 20, 2017	Nov. 09, 2017	Radiation (03CH11-HY)
Preamplifier	MITEQ	AMF-7D-0010 1800-30-10P	1902247	1GHz~18GHz	Jun. 23, 2017	July. 01, 2017~ Oct. 0, 2017	Jun. 22, 2018	Radiation (03CH11-HY)
Antenna Mast	EMEC	AM-BS-4500-B	N/A	1~4m	N/A	July. 01, 2017~ Oct. 20, 2017	N/A	Radiation (03CH11-HY)
Turn Table	EMEC	TT 2000	N/A	0~360 Degree	N/A	July. 01, 2017~ Oct. 20, 2017	N/A	Radiation (03CH11-HY)
Bilog Antenna	TESEQ	CBL6111D&00 800N1D01N-06	41912&05	30MHz to 1GHz	Jan. 07, 2017	July. 01, 2017~ Oct. 20, 2017	Jan. 06, 2018	Radiation (03CH11-HY)
SHF-EHF Horn Antenna	SCHWARZBECK	BBHA 9170	BBHA9170584	18GHz- 40GHz	Nov. 08, 2016	July. 01, 2017~ Oct. 20, 2017	Nov. 07, 2017	Radiation (03CH11-HY)
EMI Test Receiver	Agilent	N9038A(MXE)	MY53290053	20Hz to 26.5GHz	Jan. 12, 2017	July. 01, 2017~ Oct. 20, 2017	Jan. 11, 2018	Radiation (03CH11-HY)
Horn Antenna	SCHWARZBECK	BBHA 9120 D	9120D-1522	1G~18GHz	Mar. 17, 2017	July. 01, 2017~ Oct. 20, 2017	Mar. 16, 2018	Radiation (03CH11-HY)
Signal Analyzer	Rohde & Schwarz	FSV 30	100895	9kHz~30GHz	Apr. 25, 2017	July. 01, 2017~ Oct. 20, 2017	Apr. 24, 2018	Radiation (03CH11-HY)



5 Uncertainty of Evaluation

Uncertainty of Conducted Emission Measurement (150kHz ~ 30MHz)

Measuring Uncertainty for a Level of Confidence of 95% ($U = 2Uc(y)$)	2.70
---	------

Uncertainty of Radiated Emission Measurement (30 MHz ~ 1000 MHz)

Measuring Uncertainty for a Level of Confidence of 95% ($U = 2Uc(y)$)	5.20
---	------

Uncertainty of Radiated Emission Measurement (1000 MHz ~ 18000 MHz)

Measuring Uncertainty for a Level of Confidence of 95% ($U = 2Uc(y)$)	5.50
---	------

Uncertainty of Radiated Emission Measurement (18000 MHz ~ 40000 MHz)

Measuring Uncertainty for a Level of Confidence of 95% ($U = 2Uc(y)$)	5.20
---	------

Appendix A. Test Result of Conducted Test Items

Test Engineer:	Aking chang	Temperature:	21~25	°C
Test Date:	2017/10/06~2017/10/25	Relative Humidity:	51~54	%

TEST RESULTS DATA
6dB and 26dB EBW and 99% OBW

Band IV													
Mod.	Data Rate	NTX	CH.	Freq. (MHz)	99% Bandwidth (MHz)		26dB Bandwidth (MHz)		6 dB Bandwidth (MHz)		6 dB Bandwidth Min. Limit (MHz)		Pass/Fail
					Ant 1	Ant 2	Ant 1	Ant 2	Ant 1	Ant 2	Ant 1	Ant 2	
11a	6Mbps	2	149	5745	18.55	17.95	30.25	22.90	16.32	16.32	0.5		Pass
11a	6Mbps	2	157	5785	17.90	18.30	31.00	26.00	16.30	16.32	0.5		Pass
11a	6Mbps	2	165	5825	18.55	18.15	33.95	23.90	16.30	16.30	0.5		Pass
HT20	MCS0	2	149	5745	19.35	19.15	31.70	23.30	17.50	17.56	0.5		Pass
HT20	MCS0	2	157	5785	19.15	19.00	37.15	29.10	17.30	17.56	0.5		Pass
HT20	MCS0	2	165	5825	19.30	18.90	38.65	26.15	17.56	17.56	0.5		Pass
HT40	MCS0	2	151	5755	36.90	36.50	68.49	49.23	36.00	36.32	0.5		Pass
HT40	MCS0	2	159	5795	37.10	36.90	71.10	60.66	36.32	36.28	0.5		Pass
VHT80	MCS0	2	155	5775	75.84	75.84	81.92	81.28	75.28	75.76	0.5		Pass

TEST RESULTS DATA
Average Power Table

Band IV														
Mod.	Data Rate	NTX	CH.	Freq. (MHz)	Duty Factor (dB)		Average Conducted Power (dBm)			FCC Conducted Power Limit (dBm)		DG (dBi)		Pass/Fail
					Ant 1	Ant 2	Ant 1	Ant 2	SUM	Ant 1	Ant 2	Ant 1	Ant 2	
11a	6Mbps	1	149	5745	0.32	0.32	16.27	15.07		30.00	30.00	1.83	2.12	Pass
11a	6Mbps	1	157	5785	0.32	0.32	16.77	15.03		30.00	30.00	1.83	2.12	Pass
11a	6Mbps	1	165	5825	0.32	0.32	16.84	14.97		30.00	30.00	1.83	2.12	Pass
HT20	MCS0	1	149	5745	0.31	0.00	16.50	15.28		30.00	30.00	1.83	2.12	Pass
HT20	MCS0	1	157	5785	0.31	0.00	17.06	15.34		30.00	30.00	1.83	2.12	Pass
HT20	MCS0	1	165	5825	0.31	0.00	16.80	14.94		30.00	30.00	1.83	2.12	Pass
HT40	MCS0	1	151	5755	0.72	0.67	16.87	15.42		30.00	30.00	1.83	2.12	Pass
HT40	MCS0	1	159	5795	0.72	0.67	16.72	15.09		30.00	30.00	1.83	2.12	Pass
VHT20	MCS0	1	149	5745	0.10	0.10	16.25	15.02		30.00	30.00	1.83	2.12	Pass
VHT20	MCS0	1	157	5785	0.10	0.10	16.80	15.05		30.00	30.00	1.83	2.12	Pass
VHT20	MCS0	1	165	5825	0.10	0.10	16.57	14.65		30.00	30.00	1.83	2.12	Pass
VHT40	MCS0	1	151	5755	0.67	0.67	16.82	15.32		30.00	30.00	1.83	2.12	Pass
VHT40	MCS0	1	159	5795	0.67	0.67	16.67	15.02		30.00	30.00	1.83	2.12	Pass
VHT80	MCS0	1	155	5775	1.20	1.14	12.90	11.49		30.00	30.00	1.83	2.12	Pass
11a	6Mbps	2	149	5745	0.29	0.32	16.29	15.10	18.75	30.00		2.12		Pass
11a	6Mbps	2	157	5785	0.29	0.32	16.79	15.06	19.02	30.00		2.12		Pass
11a	6Mbps	2	165	5825	0.29	0.32	16.87	14.99	19.04	30.00		2.12		Pass
HT20	MCS0	2	149	5745	0.34	0.35	16.53	15.29	18.96	30.00		2.12		Pass
HT20	MCS0	2	157	5785	0.34	0.35	17.09	15.37	19.32	30.00		2.12		Pass
HT20	MCS0	2	165	5825	0.34	0.35	16.83	14.97	19.01	30.00		2.12		Pass
HT40	MCS0	2	151	5755	0.60	0.61	16.89	15.43	19.23	30.00		2.12		Pass
HT40	MCS0	2	159	5795	0.60	0.61	16.73	15.13	19.02	30.00		2.12		Pass
VHT20	MCS0	2	149	5745	0.10	0.10	16.29	15.04	18.72	30.00		2.12		Pass
VHT20	MCS0	2	157	5785	0.10	0.10	16.85	15.12	19.08	30.00		2.12		Pass
VHT20	MCS0	2	165	5825	0.10	0.10	16.59	14.72	18.77	30.00		2.12		Pass
VHT40	MCS0	2	151	5755	0.60	0.66	16.85	15.36	19.18	30.00		2.12		Pass
VHT40	MCS0	2	159	5795	0.60	0.66	16.70	15.06	18.97	30.00		2.12		Pass
VHT80	MCS0	2	155	5775	1.20	1.20	12.94	11.55	15.31	30.00		2.12		Pass

TEST RESULTS DATA
Power Spectral Density

Band IV																
Mod.	Data Rate	NTX	CH.	Freq. (MHz)	Duty Factor (dB)		10log (500kHz /RBW) Factor (dB)		Average Power Density (dBm/500kHz)			Average PSD Limit (dBm/500kHz)		DG (dBi)		Pass /Fail
					Ant 1	Ant 2	Ant 1	Ant 2	Ant 1	Ant 2	SUM	Ant 1	Ant 2	Ant 1	Ant 2	
11a	6Mbps	2	149	5745	0.29	0.32	2.22		1.82	-1.77	4.83	30.00		4.99		Pass
11a	6Mbps	2	157	5785	0.29	0.32	2.22		2.33	-1.65	5.34	30.00		4.99		Pass
11a	6Mbps	2	165	5825	0.29	0.32	2.22		2.00	-1.80	5.01	30.00		4.99		Pass
HT20	MCS0	2	149	5745	0.34	0.35	2.22		1.67	-1.86	4.68	30.00		4.99		Pass
HT20	MCS0	2	157	5785	0.34	0.35	2.22		2.03	-1.86	5.04	30.00		4.99		Pass
HT20	MCS0	2	165	5825	0.34	0.35	2.22		1.89	-1.98	4.90	30.00		4.99		Pass
HT40	MCS0	2	151	5755	0.60	0.61	2.22		-0.81	-4.28	2.20	30.00		4.99		Pass
HT40	MCS0	2	159	5795	0.60	0.61	2.22		-1.09	-4.49	1.92	30.00		4.99		Pass
VHT80	MCS0	2	155	5775	1.20	1.20	2.22		-7.10	-10.69	-4.09	30.00		4.99		Pass

Note: PSD Sum = Max PSD(Ant. 1, Ant. 2) + 10 log (n)

TEST RESULTS DATA
Frequency Stability

Band IV										
Mod.	Data Rate	NTX	CH.	Freq. (MHz)	Center Frequency (MHz)	Frequency Deviation (MHz)	Frequency Stability (ppm)	Temperature (°C)	Voltage (V)	Note
11a	6Mbps	1	149	5745	5745.000	0.000	0.00	50	20	0 Min
11a	6Mbps	1	149	5745	5745.000	0.000	0.00	50	20	2 Min
11a	6Mbps	1	149	5745	5745.000	0.000	0.00	50	20	5 Min
11a	6Mbps	1	149	5745	5745.000	0.000	0.00	50	20	10 Min
11a	6Mbps	1	149	5745	5745.000	0.000	0.00	-30	20	0 Min
11a	6Mbps	1	149	5745	5745.000	0.000	0.00	-30	20	2 Min
11a	6Mbps	1	149	5745	5745.000	0.000	0.00	-30	20	5 Min
11a	6Mbps	1	149	5745	5745.000	0.000	0.00	-30	20	10 Min
11a	6Mbps	1	149	5745	5745.000	0.000	0.00	20	24	0 Min
11a	6Mbps	1	149	5745	5745.000	0.000	0.00	20	24	2 Min
11a	6Mbps	1	149	5745	5745.000	0.000	0.00	20	24	5 Min
11a	6Mbps	1	149	5745	5745.000	0.000	0.00	20	24	10 Min
11a	6Mbps	1	149	5745	5745.000	0.000	0.00	20	16	0 Min
11a	6Mbps	1	149	5745	5745.000	0.000	0.00	20	16	2 Min
11a	6Mbps	1	149	5745	5745.000	0.000	0.00	20	16	5 Min
11a	6Mbps	1	149	5745	5745.000	0.000	0.00	20	16	10 Min
11a	6Mbps	1	149	5745	5745.000	0.000	0.00	20	20	0 Min
11a	6Mbps	1	149	5745	5745.000	0.000	0.00	20	20	2 Min
11a	6Mbps	1	149	5745	5745.000	0.000	0.00	20	20	5 Min
11a	6Mbps	1	149	5745	5745.000	0.000	0.00	20	20	10 Min



Appendix B. AC Conducted Emission Test Results

Test Engineer :	Kai-Chun Chu	Temperature :	22~25°C
		Relative Humidity :	52~55%

EUT Information

Report NO : 733120-01
 Test Mode : Mode 1
 Test Voltage : 120Vac/60Hz
 Phase : Line

ENV216 Auto Test FCC Power Bar - L

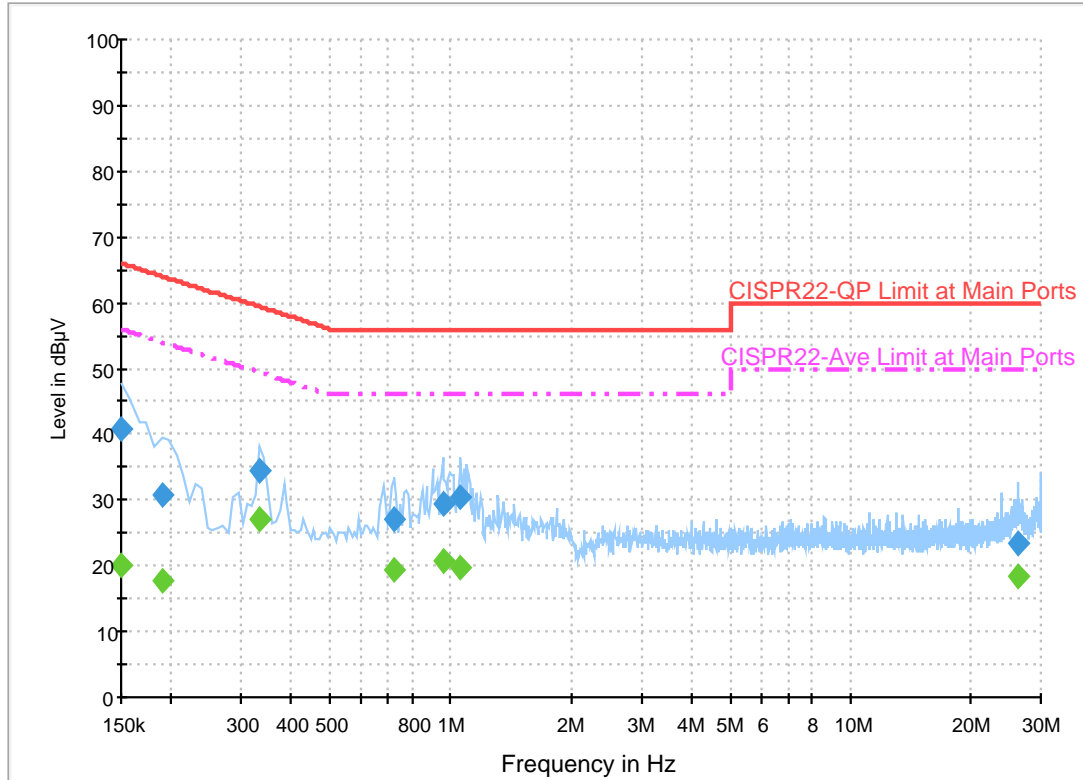

Final Result 1

Frequency (MHz)	QuasiPeak (dBµV)	Filter	Line	Corr. (dB)	Margin (dB)	Limit (dBµV)
0.150000	40.9	Off	L1	19.6	25.1	66.0
0.190000	30.7	Off	L1	19.6	33.3	64.0
0.334000	34.5	Off	L1	19.6	24.9	59.4
0.726000	27.1	Off	L1	19.6	28.9	56.0
0.958000	29.6	Off	L1	19.6	26.4	56.0
1.062000	30.3	Off	L1	19.6	25.7	56.0
26.342000	23.3	Off	L1	20.9	36.7	60.0

Final Result 2

Frequency (MHz)	Average (dBµV)	Filter	Line	Corr. (dB)	Margin (dB)	Limit (dBµV)
0.150000	20.2	Off	L1	19.6	35.8	56.0
0.190000	17.6	Off	L1	19.6	36.4	54.0
0.334000	27.2	Off	L1	19.6	22.2	49.4
0.726000	19.3	Off	L1	19.6	26.7	46.0
0.958000	20.8	Off	L1	19.6	25.2	46.0
1.062000	19.8	Off	L1	19.6	26.2	46.0
26.342000	18.4	Off	L1	20.9	31.6	50.0

EUT Information

Report NO : 733120-01
 Test Mode : Mode 1
 Test Voltage : 120Vac/60Hz
 Phase : Neutral

ENV216 Auto Test FCC Power Bar - N

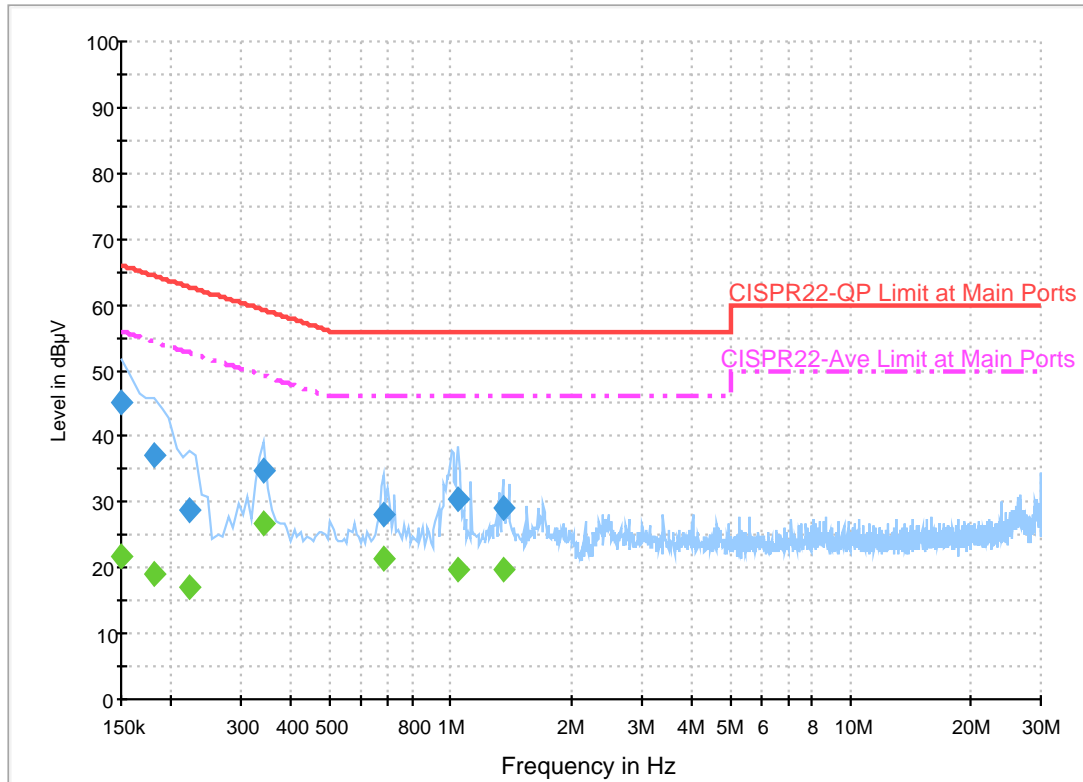

Final Result 1

Frequency (MHz)	QuasiPeak (dBµV)	Filter	Line	Corr. (dB)	Margin (dB)	Limit (dBµV)
0.150000	45.3	Off	N	19.5	20.7	66.0
0.182000	37.0	Off	N	19.5	27.4	64.4
0.222000	28.6	Off	N	19.5	34.1	62.7
0.342000	34.8	Off	N	19.5	24.4	59.2
0.678000	28.0	Off	N	19.5	28.0	56.0
1.046000	30.3	Off	N	19.6	25.7	56.0
1.350000	29.2	Off	N	19.6	26.8	56.0

Final Result 2

Frequency (MHz)	Average (dBµV)	Filter	Line	Corr. (dB)	Margin (dB)	Limit (dBµV)
0.150000	21.7	Off	N	19.5	34.3	56.0
0.182000	18.9	Off	N	19.5	35.5	54.4
0.222000	17.0	Off	N	19.5	35.7	52.7
0.342000	26.6	Off	N	19.5	22.6	49.2
0.678000	21.4	Off	N	19.5	24.6	46.0
1.046000	19.9	Off	N	19.6	26.1	46.0
1.350000	19.8	Off	N	19.6	26.2	46.0



Appendix B. Radiated Spurious Emission

Test Engineer :	Hao Hsu, Jacky Hung and Ken Wu	Temperature :	20-25°C
		Relative Humidity :	50-55%

Band 4 - 5725~5850MHz

WIFI 802.11a (Band Edge @ 3m)

WIFI Ant.	Note	Frequency (MHz)	Level (dBμV/m)	Over Limit (dB)	Limit Line (dBμV/m)	Read Level (dBμV)	Antenna Factor (dB/m)	Cable Loss (dB)	Preamp Factor (dB)	Ant Pos (cm)	Table Pos (deg)	Peak Avg. (P/A)	Pol. (H/V)	
802.11a CH 149 5745MHz		5648.4	59.03	-9.17	68.2	49.46	33.06	9.61	33.1	238	34	P	H	
		5698.6	75.1	-29.07	104.17	65.39	33.08	9.75	33.12	238	34	P	H	
		5720	83.21	-27.59	110.8	73.44	33.09	9.81	33.13	238	34	P	H	
		5724.4	95.24	-25.59	120.83	85.47	33.09	9.81	33.13	238	34	P	H	
	*	5745	120.2	-	-	110.37	33.1	9.88	33.15	238	34	P	H	
	*	5745	109.25	-	-	99.42	33.1	9.88	33.15	238	34	A	H	
														H
														H
			5641	55.94	-12.26	68.2	46.37	33.06	9.61	33.1	357	274	P	V
			5699.2	68.64	-35.97	104.61	58.93	33.08	9.75	33.12	357	274	P	V
			5716.4	75.28	-34.51	109.79	65.52	33.08	9.81	33.13	357	274	P	V
			5722	82.79	-32.57	115.36	73.02	33.09	9.81	33.13	357	274	P	V
	*		5745	114.19	-	-	104.36	33.1	9.88	33.15	357	274	P	V
	*		5745	102.81	-	-	92.98	33.1	9.88	33.15	357	274	A	V
														V
														V



WIFI Ant. 1+2	Note	Frequency (MHz)	Level (dBμV/m)	Over Limit (dB)	Limit Line (dBμV/m)	Read Level (dBμV)	Antenna Factor (dB/m)	Cable Loss (dB)	Preamp Factor (dB)	Ant Pos (cm)	Table Pos (deg)	Peak Avg. (P/A)	Pol. (H/V)	
802.11a CH 157 5785MHz		5638.4	57.2	-11	68.2	47.63	33.06	9.61	33.1	237	27	P	H	
		5689.4	58.04	-39.34	97.38	48.33	33.08	9.75	33.12	237	27	P	H	
		5720	61.9	-48.9	110.8	52.13	33.09	9.81	33.13	237	27	P	H	
		5724.2	63.95	-56.43	120.38	54.18	33.09	9.81	33.13	237	27	P	H	
	*	5785	118.92	-	-	108.97	33.11	10.01	33.17	237	27	P	H	
	*	5785	108.43	-	-	98.48	33.11	10.01	33.17	237	27	A	H	
		5851	61.73	-58.19	119.92	51.76	33.14	10.02	33.19	237	27	P	H	
		5857.8	60.09	-49.92	110.01	50.14	33.14	10.02	33.21	237	27	P	H	
		5893.6	58.3	-33.1	91.4	48.34	33.16	10.02	33.22	237	27	P	H	
		5947.2	57.67	-10.53	68.2	47.71	33.18	10.02	33.24	237	27	P	H	
														H
														H
			5643.8	55.77	-12.43	68.2	46.2	33.06	9.61	33.1	357	275	P	V
			5700	56.89	-48.31	105.2	47.18	33.08	9.75	33.12	357	275	P	V
			5716.8	58.24	-51.67	109.91	48.48	33.08	9.81	33.13	357	275	P	V
			5723.2	58.42	-59.68	118.1	48.65	33.09	9.81	33.13	357	275	P	V
	*		5785	113.17	-	-	103.22	33.11	10.01	33.17	357	275	P	V
	*		5785	102.44	-	-	92.49	33.11	10.01	33.17	357	275	A	V
			5852.2	56.94	-60.24	117.18	46.97	33.14	10.02	33.19	357	275	P	V
			5857	57.29	-52.95	110.24	47.32	33.14	10.02	33.19	357	275	P	V
		5903.4	57.04	-27.11	84.15	47.08	33.16	10.02	33.22	357	275	P	V	
		5932.2	56.27	-11.93	68.2	46.31	33.17	10.02	33.23	357	275	P	V	
													V	
													V	



WiFi Ant. 1+2	Note	Frequency (MHz)	Level (dBµV/m)	Over Limit (dB)	Limit Line (dBµV/m)	Read Level (dBµV)	Antenna Factor (dB/m)	Cable Loss (dB)	Preamp Factor (dB)	Ant Pos (cm)	Table Pos (deg)	Peak Avg. (P/A)	Pol. (H/V)	
802.11a CH 165 5825MHz	*	5825	119.24	-	-	109.27	33.13	10.02	33.18	238	49	P	H	
	*	5825	108.42	-	-	98.45	33.13	10.02	33.18	238	49	A	H	
		5850	79.62	-42.58	122.2	69.65	33.14	10.02	33.19	238	49	P	H	
		5855.2	76.93	-33.81	110.74	66.96	33.14	10.02	33.19	238	49	P	H	
		5875.8	63.32	-41.29	104.61	53.36	33.15	10.02	33.21	238	49	P	H	
		5948.4	58.6	-9.6	68.2	48.64	33.18	10.02	33.24	238	49	P	H	
														H
														H
	*	5825	112.69	-	-	102.72	33.13	10.02	33.18	315	277	P	V	
	*	5825	101.92	-	-	91.95	33.13	10.02	33.18	315	277	A	V	
		5851	74.07	-45.85	119.92	64.1	33.14	10.02	33.19	315	277	P	V	
		5855.6	71	-39.63	110.63	61.03	33.14	10.02	33.19	315	277	P	V	
		5875.6	59	-45.75	104.75	49.04	33.15	10.02	33.21	315	277	P	V	
		5931.4	56.35	-11.85	68.2	46.39	33.17	10.02	33.23	315	277	P	V	
														V
														V
														V
	Remark	1. No other spurious found. 2. All results are PASS against Peak and Average limit line.												



Band 4 5725~5850MHz
WIFI 802.11a (Harmonic @ 3m)

WIFI Ant. 1+2	Note	Frequency (MHz)	Level (dBμV/m)	Over Limit (dB)	Limit Line (dBμV/m)	Read Level (dBμV)	Antenna Factor (dB/m)	Cable Loss (dB)	Preamp Factor (dB)	Ant Pos (cm)	Table Pos (deg)	Peak Avg. (P/A)	Pol. (H/V)
802.11a CH 149 5745MHz		11490	57.09	-16.91	74	64.42	39.98	15.44	63.03	178	233	P	H
		11490	42.72	-11.28	54	50.05	39.98	15.44	63.03	178	233	A	H
		17235	57.33	-10.87	68.2	57.66	41.14	19.24	61.07	100	0	P	H
													H
		11490	55.81	-18.19	74	63.14	39.98	15.44	63.03	392	187	P	V
		11490	42.29	-11.71	54	49.62	39.98	15.44	63.03	392	187	A	V
		17235	60.13	-8.07	68.2	60.46	41.14	19.24	61.07	100	0	P	V
802.11a CH 157 5785MHz		11570	56.85	-17.15	74	64.18	39.82	15.49	62.92	249	230	P	H
		11570	42.95	-11.05	54	50.28	39.82	15.49	62.92	249	230	A	H
		17355	57.45	-10.75	68.2	56.81	41.21	19.31	60.25	100	0	P	H
													H
		11570	57.38	-16.62	74	64.71	39.82	15.49	62.92	296	114	P	V
		11570	43.27	-10.73	54	50.6	39.82	15.49	62.92	296	114	A	V
		17355	57.18	-11.02	68.2	56.54	41.21	19.31	60.25	100	0	P	V
802.11a CH 165 5825MHz		11650	56.8	-17.2	74	64.15	39.64	15.56	62.83	246	232	P	H
		11650	42.38	-11.62	54	49.73	39.64	15.56	62.83	246	232	A	H
		17475	59.66	-8.54	68.2	58.06	41.28	19.37	59.43	100	0	P	H
													H
		11650	57.42	-16.58	74	64.77	39.64	15.56	62.83	294	115	P	V
		11650	43.62	-10.38	54	50.97	39.64	15.56	62.83	294	115	A	V
		17475	58.24	-9.96	68.2	56.64	41.28	19.37	59.43	100	0	P	V
Remark	1. No other spurious found. 2. All results are PASS against Peak and Average limit line.												



Band 4 5725~5850MHz
WIFI 802.11n HT20 (Band Edge @ 3m)

WIFI Ant. 1+2	Note	Frequency (MHz)	Level (dBμV/m)	Over Limit (dB)	Limit Line (dBμV/m)	Read Level (dBμV)	Antenna Factor (dB/m)	Cable Loss (dB)	Preamp Factor (dB)	Ant Pos (cm)	Table Pos (deg)	Peak Avg. (P/A)	Pol. (H/V)	
802.11n HT20 CH 149 5745MHz		5650	59.4	-8.8	68.2	49.83	33.06	9.61	33.1	242	51	P	H	
		5699.6	68.7	-36.21	104.91	58.99	33.08	9.75	33.12	242	51	P	H	
		5719.6	84.41	-26.28	110.69	74.64	33.09	9.81	33.13	242	51	P	H	
		5724.8	93.33	-28.41	121.74	83.56	33.09	9.81	33.13	242	51	P	H	
	*	5745	118.7	-	-	108.87	33.1	9.88	33.15	242	51	P	H	
	*	5745	108.06	-	-	98.23	33.1	9.88	33.15	242	51	A	H	
														H
														H
			5648.8	56.11	-12.09	68.2	46.54	33.06	9.61	33.1	361	275	P	V
			5698.4	64.09	-39.93	104.02	54.38	33.08	9.75	33.12	361	275	P	V
			5720	75.05	-35.75	110.8	65.28	33.09	9.81	33.13	361	275	P	V
			5723.8	87.26	-32.2	119.46	77.49	33.09	9.81	33.13	361	275	P	V
	*		5745	112.13	-	-	102.3	33.1	9.88	33.15	361	275	P	V
	*		5745	101.22	-	-	91.39	33.1	9.88	33.15	361	275	A	V
														V
														V



WIFI Ant. 1+2	Note	Frequency (MHz)	Level (dBμV/m)	Over Limit (dB)	Limit Line (dBμV/m)	Read Level (dBμV)	Antenna Factor (dB/m)	Cable Loss (dB)	Preamp Factor (dB)	Ant Pos (cm)	Table Pos (deg)	Peak Avg. (P/A)	Pol. (H/V)	
802.11n HT20 CH 157 5785MHz		5624.4	57.57	-10.63	68.2	48.05	33.05	9.55	33.08	237	51	P	H	
		5700	60.78	-44.42	105.2	51.07	33.08	9.75	33.12	237	51	P	H	
		5714.2	62.85	-46.33	109.18	53.09	33.08	9.81	33.13	237	51	P	H	
		5724.6	64.04	-57.25	121.29	54.27	33.09	9.81	33.13	237	51	P	H	
	*	5785	118.84	-	-	108.89	33.11	10.01	33.17	237	51	P	H	
	*	5785	107.84	-	-	97.89	33.11	10.01	33.17	237	51	A	H	
		5854.6	61.35	-50.36	111.71	51.38	33.14	10.02	33.19	237	51	P	H	
		5857	61.65	-48.59	110.24	51.68	33.14	10.02	33.19	237	51	P	H	
		5903.4	58.63	-25.52	84.15	48.67	33.16	10.02	33.22	237	51	P	H	
		5942	57.84	-10.36	68.2	47.88	33.18	10.02	33.24	237	51	P	H	
														H
														H
			5631.6	55.32	-12.88	68.2	45.76	33.05	9.61	33.1	357	277	P	V
			5692.4	56.25	-43.35	99.6	46.54	33.08	9.75	33.12	357	277	P	V
			5714.2	57.18	-52	109.18	47.42	33.08	9.81	33.13	357	277	P	V
			5721.2	58.07	-55.47	113.54	48.3	33.09	9.81	33.13	357	277	P	V
	*		5785	112.59	-	-	102.64	33.11	10.01	33.17	357	277	P	V
	*		5785	101.4	-	-	91.45	33.11	10.01	33.17	357	277	A	V
			5851	57.12	-62.8	119.92	47.15	33.14	10.02	33.19	357	277	P	V
			5870.8	57.33	-49.04	106.37	47.37	33.15	10.02	33.21	357	277	P	V
		5907	56.96	-24.52	81.48	46.99	33.17	10.02	33.22	357	277	P	V	
		5942	56.65	-11.55	68.2	46.69	33.18	10.02	33.24	357	277	P	V	
													V	
													V	



WIFI Ant. 1+2	Note	Frequency (MHz)	Level (dBμV/m)	Over Limit (dB)	Limit Line (dBμV/m)	Read Level (dBμV)	Antenna Factor (dB/m)	Cable Loss (dB)	Preamp Factor (dB)	Ant Pos (cm)	Table Pos (deg)	Peak Avg. (P/A)	Pol. (H/V)	
802.11n HT20 CH 165 5825MHz	*	5825	118.88	-	-	108.91	33.13	10.02	33.18	239	52	P	H	
	*	5825	107.88	-	-	97.91	33.13	10.02	33.18	239	52	A	H	
		5850	88.02	-34.18	122.2	78.05	33.14	10.02	33.19	239	52	P	H	
		5857.8	76.21	-33.8	110.01	66.26	33.14	10.02	33.21	239	52	P	H	
		5875.2	64.79	-40.26	105.05	54.83	33.15	10.02	33.21	239	52	P	H	
		5943	58.49	-9.71	68.2	48.53	33.18	10.02	33.24	239	52	P	H	
														H
														H
	*	5825	112.34	-	-	102.37	33.13	10.02	33.18	369	275	P	V	
	*	5825	100.83	-	-	90.86	33.13	10.02	33.18	369	275	A	V	
		5850.6	77.87	-42.96	120.83	67.9	33.14	10.02	33.19	369	275	P	V	
		5856.2	68.44	-42.02	110.46	58.47	33.14	10.02	33.19	369	275	P	V	
		5882.4	58.27	-41.43	99.7	48.31	33.15	10.02	33.21	369	275	P	V	
		5946.8	56.71	-11.49	68.2	46.75	33.18	10.02	33.24	369	275	P	V	
														V
														V
Remark	1. No other spurious found. 2. All results are PASS against Peak and Average limit line.													



Band 4 5725~5850MHz
WIFI 802.11n HT20 (Harmonic @ 3m)

WIFI Ant. 1+2	Note	Frequency (MHz)	Level (dBμV/m)	Over Limit (dB)	Limit Line (dBμV/m)	Read Level (dBμV)	Antenna Factor (dB/m)	Cable Loss (dB)	Preamp Factor (dB)	Ant Pos (cm)	Table Pos (deg)	Peak Avg. (P/A)	Pol. (H/V)
802.11n HT20 CH 149 5745MHz		11490	53.95	-20.05	74	62.74	38.52	15.44	63.03	200	126	P	H
		11490	42.79	-11.21	54	51.58	38.52	15.44	63.03	200	126	A	H
		17235	53.76	-14.44	68.2	54.47	40.76	19.24	61.07	100	0	P	H
													H
		11490	56.92	-17.08	74	65.71	38.52	15.44	63.03	200	29	P	V
		11490	46.27	-7.73	54	55.06	38.52	15.44	63.03	200	29	A	V
		17235	52.98	-15.22	68.2	53.69	40.76	19.24	61.07	100	0	P	V
													V
802.11n HT20 CH 157 5785MHz		11570	56.34	-17.66	74	64.93	38.56	15.49	62.92	200	126	P	H
		11570	45.16	-8.84	54	53.75	38.56	15.49	62.92	200	126	A	H
		17355	56.68	-11.52	68.2	56.56	40.69	19.31	60.25	100	0	P	H
													H
		11570	59.4	-14.6	74	67.99	38.56	15.49	62.92	200	27	P	V
		11570	47.85	-6.15	54	56.44	38.56	15.49	62.92	200	27	A	V
		17355	56.56	-11.64	68.2	56.44	40.69	19.31	60.25	100	0	P	V
													V
802.11n HT20 CH 165 5825MHz		11650	58.11	-15.89	74	66.49	38.61	15.56	62.83	197	127	P	H
		11650	45.16	-8.84	54	53.54	38.61	15.56	62.83	197	127	A	H
		17475	56.32	-11.88	68.2	55.38	40.62	19.37	59.43	100	0	P	H
													H
		11650	58.41	-15.59	74	66.79	38.61	15.56	62.83	100	242	P	V
		11650	45.18	-8.82	54	53.56	38.61	15.56	62.83	100	242	A	V
		17475	55.94	-12.26	68.2	55	40.62	19.37	59.43	100	0	P	V
													V
Remark	1. No other spurious found. 2. All results are PASS against Peak and Average limit line.												



**Band 4 5725~5850MHz
WIFI 802.11n HT40 (Band Edge @ 3m)**

WIFI Ant. 1+2	Note	Frequency (MHz)	Level (dBμV/m)	Over Limit (dB)	Limit Line (dBμV/m)	Read Level (dBμV)	Antenna Factor (dB/m)	Cable Loss (dB)	Preamp Factor (dB)	Ant Pos (cm)	Table Pos (deg)	Peak Avg. (P/A)	Pol. (H/V)
		5642.6	65.41	-2.79	68.2	55.84	33.06	9.61	33.1	241	51	P	H
		5698.6	77.75	-26.42	104.17	68.04	33.08	9.75	33.12	241	51	P	H
		5719	91.46	-19.06	110.52	81.69	33.09	9.81	33.13	241	51	P	H
		5722	92.73	-22.63	115.36	82.96	33.09	9.81	33.13	241	51	P	H
	*	5755	116.33	-	-	106.5	33.1	9.88	33.15	241	51	P	H
	*	5755	105.47	-	-	95.64	33.1	9.88	33.15	241	51	A	H
		5851.2	68.75	-50.71	119.46	58.78	33.14	10.02	33.19	241	51	P	H
		5856.8	63.96	-46.34	110.3	53.99	33.14	10.02	33.19	241	51	P	H
		5876.8	62.48	-41.38	103.86	52.52	33.15	10.02	33.21	241	51	P	H
		5936.4	58.03	-10.17	68.2	48.08	33.17	10.02	33.24	241	51	P	H
													H
													H
802.11n HT40 CH 151 5755MHz		5637	60	-8.2	68.2	50.43	33.06	9.61	33.1	360	276	P	V
		5697.6	70.68	-32.75	103.43	60.97	33.08	9.75	33.12	360	276	P	V
		5717.6	84.69	-25.44	110.13	74.92	33.09	9.81	33.13	360	276	P	V
		5722.2	85.84	-29.98	115.82	76.07	33.09	9.81	33.13	360	276	P	V
	*	5755	109.53	-	-	99.7	33.1	9.88	33.15	360	276	P	V
	*	5755	99.16	-	-	89.33	33.1	9.88	33.15	360	276	A	V
		5851.4	63.61	-55.4	119.01	53.64	33.14	10.02	33.19	360	276	P	V
		5856.4	58.6	-51.81	110.41	48.63	33.14	10.02	33.19	360	276	P	V
		5881	57.62	-43.12	100.74	47.66	33.15	10.02	33.21	360	276	P	V
		5942.2	56.56	-11.64	68.2	46.6	33.18	10.02	33.24	360	276	P	V
													V
													V



WIFI Ant. 1+2	Note	Frequency (MHz)	Level (dBμV/m)	Over Limit (dB)	Limit Line (dBμV/m)	Read Level (dBμV)	Antenna Factor (dB/m)	Cable Loss (dB)	Preamp Factor (dB)	Ant Pos (cm)	Table Pos (deg)	Peak Avg. (P/A)	Pol. (H/V)	
802.11n HT40 CH 159 5795MHz		5649.4	62.75	-5.45	68.2	53.18	33.06	9.61	33.1	232	50	P	H	
		5689.8	68.69	-28.99	97.68	58.98	33.08	9.75	33.12	232	50	P	H	
		5718.8	72.88	-37.58	110.46	63.11	33.09	9.81	33.13	232	50	P	H	
		5724.2	74.73	-45.65	120.38	64.96	33.09	9.81	33.13	232	50	P	H	
	*	5795	116.19	-	-	106.23	33.12	10.01	33.17	232	50	P	H	
	*	5795	105.37	-	-	95.41	33.12	10.01	33.17	232	50	A	H	
		5852.2	76.35	-40.83	117.18	66.38	33.14	10.02	33.19	232	50	P	H	
		5863.4	75.28	-33.17	108.45	65.33	33.14	10.02	33.21	232	50	P	H	
		5877.2	69.84	-33.73	103.57	59.88	33.15	10.02	33.21	232	50	P	H	
		5925.4	60.48	-7.72	68.2	50.52	33.17	10.02	33.23	232	50	P	H	
														H
														H
			5646.6	56.72	-11.48	68.2	47.15	33.06	9.61	33.1	306	274	P	V
			5698.4	62.1	-41.92	104.02	52.39	33.08	9.75	33.12	306	274	P	V
			5716	65.38	-44.3	109.68	55.62	33.08	9.81	33.13	306	274	P	V
			5723.4	66.7	-51.85	118.55	56.93	33.09	9.81	33.13	306	274	P	V
	*		5795	108.78	-	-	98.82	33.12	10.01	33.17	306	274	P	V
	*		5795	98.42	-	-	88.46	33.12	10.01	33.17	306	274	A	V
			5850.8	72.55	-47.83	120.38	62.58	33.14	10.02	33.19	306	274	P	V
			5855.4	71.08	-39.61	110.69	61.11	33.14	10.02	33.19	306	274	P	V
		5876	63.46	-41	104.46	53.5	33.15	10.02	33.21	306	274	P	V	
		5929.2	56.99	-11.21	68.2	47.03	33.17	10.02	33.23	306	274	P	V	
													V	
													V	
Remark	<ol style="list-style-type: none"> No other spurious found. All results are PASS against Peak and Average limit line. 													



Band 4 5725~5850MHz
WIFI 802.11n HT40 (Harmonic @ 3m)

WIFI Ant. 1+2	Note	Frequency (MHz)	Level (dBµV/m)	Over Limit (dB)	Limit Line (dBµV/m)	Read Level (dBµV)	Antenna Factor (dB/m)	Cable Loss (dB)	Preamp Factor (dB)	Ant Pos (cm)	Table Pos (deg)	Peak Avg. (P/A)	Pol. (H/V)
802.11n HT40 CH 151 5755MHz		11510	55.6	-18.4	74	64.37	38.5	15.45	63	100	60	P	H
		11510	42.76	-11.24	54	51.53	38.5	15.45	63	100	60	A	H
		17265	52.83	-15.37	68.2	53.3	40.74	19.26	60.83	100	0	P	H
													H
		11510	55.99	-18.01	74	64.76	38.5	15.45	63	100	239	P	V
		11510	43.52	-10.48	54	52.29	38.5	15.45	63	100	239	A	V
		17265	52.53	-15.67	68.2	53	40.74	19.26	60.83	100	0	P	V
802.11n HT40 CH 159 5795MHz		11590	53.58	-20.42	74	62.12	38.57	15.51	62.9	121	358	P	H
		11590	41.5	-12.5	54	50.04	38.57	15.51	62.9	121	358	A	H
		17385	51.27	-16.93	68.2	50.93	40.67	19.32	60.02	100	0	P	H
													H
		11590	56.47	-17.53	74	65.01	38.57	15.51	62.9	100	239	P	V
		11590	43.87	-10.13	54	52.41	38.57	15.51	62.9	100	239	A	V
		17385	50.36	-17.84	68.2	50.02	40.67	19.32	60.02	100	0	P	V
Remark	1. No other spurious found. 2. All results are PASS against Peak and Average limit line.												



**Band 4 5725~5850MHz
WIFI 802.11ac VHT80 (Band Edge @ 3m)**

WIFI Ant. 1+2	Note	Frequency (MHz)	Level (dBμV/m)	Over Limit (dB)	Limit Line (dBμV/m)	Read Level (dBμV)	Antenna Factor (dB/m)	Cable Loss (dB)	Preamp Factor (dB)	Ant Pos (cm)	Table Pos (deg)	Peak Avg. (P/A)	Pol. (H/V)	
		5647.6	67.16	-1.04	68.2	57.59	33.06	9.61	33.1	235	50	P	H	
		5699	74.97	-29.49	104.46	65.26	33.08	9.75	33.12	235	50	P	H	
		5719	77.39	-33.13	110.52	67.62	33.09	9.81	33.13	235	50	P	H	
		5720	74.75	-36.05	110.8	64.98	33.09	9.81	33.13	235	50	P	H	
	*	5775	109.37	-	-	99.47	33.11	9.95	33.16	235	50	P	H	
	*	5775	100.25	-	-	90.35	33.11	9.95	33.16	235	50	A	H	
		5850.6	73.24	-47.59	120.83	63.27	33.14	10.02	33.19	235	50	P	H	
		5860.2	72.28	-37.06	109.34	62.33	33.14	10.02	33.21	235	50	P	H	
		5877.4	69.5	-33.92	103.42	59.54	33.15	10.02	33.21	235	50	P	H	
		5932.6	59.8	-8.4	68.2	49.84	33.17	10.02	33.23	235	50	P	H	
802.11ac VHT80 CH 155 5775MHz													H	
													H	
			5643.6	62.66	-5.54	68.2	53.09	33.06	9.61	33.1	324	276	P	V
			5687.4	66.83	-29.08	95.91	57.12	33.08	9.75	33.12	324	276	P	V
			5718.4	68.21	-42.14	110.35	58.44	33.09	9.81	33.13	324	276	P	V
			5722.8	68.68	-48.5	117.18	58.91	33.09	9.81	33.13	324	276	P	V
		*	5775	102.83	-	-	92.93	33.11	9.95	33.16	324	276	P	V
		*	5775	93.57	-	-	83.67	33.11	9.95	33.16	324	276	A	V
			5850.6	67.64	-53.19	120.83	57.67	33.14	10.02	33.19	324	276	P	V
			5861.2	66.26	-42.8	109.06	56.31	33.14	10.02	33.21	324	276	P	V
			5875.8	63.1	-41.51	104.61	53.14	33.15	10.02	33.21	324	276	P	V
			5929.4	57.54	-10.66	68.2	47.58	33.17	10.02	33.23	324	276	P	V
														V
														V
	Remark	1. No other spurious found.												
		2. All results are PASS against Peak and Average limit line.												



Band 4 5725~5850MHz
WIFI 802.11ac VHT80 (Harmonic @ 3m)

WIFI Ant. 1+2	Note	Frequency (MHz)	Level (dBμV/m)	Over Limit (dB)	Limit Line (dBμV/m)	Read Level (dBμV)	Antenna Factor (dB/m)	Cable Loss (dB)	Preamp Factor (dB)	Ant Pos (cm)	Table Pos (deg)	Peak Avg. (P/A)	Pol. (H/V)	
802.11ac VHT80 CH 155 5775MHz		11550	48.84	-25.16	74	57.48	38.54	15.48	62.94	100	0	P	H	
		17325	50.59	-17.61	68.2	50.7	40.71	19.29	60.48	100	0	P	H	
													H	
													H	
			11550	54.12	-19.88	74	62.76	38.54	15.48	62.94	102	243	P	V
			11550	43.16	-10.84	54	51.8	38.54	15.48	62.94	102	243	A	V
			17325	50.72	-17.48	68.2	50.83	40.71	19.29	60.48	100	0	P	V
													V	
Remark	1. No other spurious found. 2. All results are PASS against Peak and Average limit line.													



Emission below 1GHz

5GHz WIFI 802.11ac VHT80 (LF @ 3m)

WIFI	Note	Frequency	Level	Over	Limit	Read	Antenna	Cable	Preamp	Ant	Table	Peak	Pol.	
Ant.				Limit	Line	Level	Factor	Loss	Factor	Pos	Pos	Avg.		
1+2		(MHz)	(dBμV/m)	(dB)	(dBμV/m)	(dBμV)	(dB/m)	(dB)	(dB)	(cm)	(deg)	(P/A)	(H/V)	
5GHz 802.11ac VHT80 LF		242.22	35.42	-10.58	46	48.23	17.55	1.95	32.38	-	-	P	H	
		255.18	37.16	-8.84	46	48.2	19.18	2.09	32.38	250	196	P	H	
		294.87	34.47	-11.53	46	45.43	19.09	2.22	32.37	-	-	P	H	
		314	30.79	-15.21	46	41.36	19.4	2.31	32.36	-	-	P	H	
		699.7	31.35	-14.65	46	33.68	26.66	3.35	32.47	-	-	P	H	
		957.3	34.85	-11.15	46	30.82	31.1	3.9	31.14	-	-	P	H	
														H
														H
														H
														H
														H
														V
			31.89	30.22	-9.78	40	38.54	23.33	0.82	32.49	-	-	P	V
			37.02	27.55	-12.45	40	38.4	20.82	0.82	32.49	-	-	P	V
			61.32	31.73	-8.27	40	51.45	11.73	1.02	32.49	140	280	P	V
			470.8	28.6	-17.4	46	34.58	23.58	2.77	32.37	-	-	P	V
			619.9	33.69	-12.31	46	36.85	26.06	3.15	32.46	-	-	P	V
			941.2	35.47	-10.53	46	32.35	30.41	3.82	31.28	-	-	P	V
													V	
													V	
													V	
													V	
													V	
Remark	1. No other spurious found. 2. All results are PASS against limit line.													



Note symbol

*	Fundamental Frequency which can be ignored. However, the level of any unwanted emissions shall not exceed the level of the fundamental frequency.
!	Test result is over limit line.
P/A	Peak or Average
H/V	Horizontal or Vertical



A calculation example for radiated spurious emission is shown as below:

WIFI	Note	Frequency	Level	Over	Limit	Read	Antenna	Cable	Preamp	Ant	Table	Peak	Pol.
Ant.				Limit	Line	Level	Factor	Loss	Factor	Pos	Pos	Avg.	
1		(MHz)	(dBμV/m)	(dB)	(dBμV/m)	(dBμV)	(dB/m)	(dB)	(dB)	(cm)	(deg)	(P/A)	(H/V)
802.11b		2390	55.45	-18.55	74	54.51	32.22	4.58	35.86	103	308	P	H
CH 01													
2412MHz		2390	43.54	-10.46	54	42.6	32.22	4.58	35.86	103	308	A	H

- Level(dBμV/m) =
Antenna Factor(dB/m) + Cable Loss(dB) + Read Level(dBμV) - Preamp Factor(dB)
- Over Limit(dB) = Level(dBμV/m) – Limit Line(dBμV/m)

For Peak Limit @ 2390MHz:

- Level(dBμV/m)
= Antenna Factor(dB/m) + Cable Loss(dB) + Read Level(dBμV) - Preamp Factor(dB)
= 32.22(dB/m) + 4.58(dB) + 54.51(dBμV) – 35.86 (dB)
= 55.45 (dBμV/m)
- Over Limit(dB)
= Level(dBμV/m) – Limit Line(dBμV/m)
= 55.45(dBμV/m) – 74(dBμV/m)
= -18.55(dB)

For Average Limit @ 2390MHz:

- Level(dBμV/m)
= Antenna Factor(dB/m) + Cable Loss(dB) + Read Level(dBμV) - Preamp Factor(dB)
= 32.22(dB/m) + 4.58(dB) + 42.6(dBμV) – 35.86 (dB)
= 43.54 (dBμV/m)
- Over Limit(dB)
= Level(dBμV/m) – Limit Line(dBμV/m)
= 43.54(dBμV/m) – 54(dBμV/m)
= -10.46(dB)

Both peak and average measured complies with the limit line, so test result is “PASS”.



Appendix D. Radiated Spurious Emission Plots

Test Engineer :	Hao Hsu, Jacky Hung and Ken Wu	Temperature :	20-25°C
		Relative Humidity :	50-55%

Note symbol

-L	Low channel location
-R	High channel location



Band 4 - 5725~5850MHz
WIFI 802.11a (Band Edge @ 3m)

WIFI	Band 4 5725~5850MHz Band Edge @ 3m	
ANT	802.11a CH149 5745MHz	
1+2	Horizontal	Fundamental
Peak	<p>Site : 03CH11-HY Condition : PEAK BE(84) 16-24 3m HORN 9120D-HF HORIZONTAL</p>	<p>Site : 03CH11-HY Condition : PEAK:UNB1 3m HORN 9120D-HF HORIZONTAL</p>



WIFI	Band 4 5725~5850MHz Band Edge @ 3m	
ANT	802.11a CH149 5745MHz	
1+2	Vertical	Fundamental
Peak	<p>Site : 03CH114Y Condition : PEAK BE(B4) 16.24 3m HORN 9120D-HF VERTICAL</p>	<p>Site : 03CH114Y Condition : PEAK(U) 57.92 3m HORN 9120D-HF VERTICAL</p>



WIFI	Band 4 5725~5850MHz Band Edge @ 3m	
ANT	802.11a CH157 5785MHz	
1+2	Horizontal	Fundamental
Peak	<p>Site : 03CH11-HY Condition : PEAK_BE(B4)_16-24 3m HORN 9120D-HF HORIZONTAL</p>	<p>Site : 03CH11-HY Condition : PEAK(UNII) 3m HORN 9120D-HF HORIZONTAL</p>
Peak	<p>Site : 03CH11-HY Condition : PEAK_BE(B4)_16-24 3m HORN 9120D-HF HORIZONTAL</p>	Left blank



WIFI	Band 4 5725~5850MHz Band Edge @ 3m	
ANT	802.11a CH157 5785MHz	
1+2	Vertical	Fundamental
Peak	<p>Site : 03CH11-HY Condition : PEAK_BE(B4) 16-24 3m HORN 9120D-HF VERTICAL</p>	<p>Site : 03CH11-HY Condition : PEAK(UNII) 3m HORN 9120D-HF VERTICAL</p>
Peak	<p>Site : 03CH11-HY Condition : PEAK_BE(B4) 16-24 3m HORN 9120D-HF VERTICAL</p>	Left blank



WIFI	Band 4 5725~5850MHz Band Edge @ 3m	
ANT	802.11a CH165 5825MHz	
1+2	Horizontal	Fundamental
Peak	<p>Site : 03CHE1-14Y Condition : PEAK BE(B4) 16-24 3m HORN 9120D-HF HORIZONTAL</p>	<p>Site : 03CHE1-14Y Condition : PEAK(UINII) 3m HORN 9120D-HF HORIZONTAL</p>



WIFI	Band 4 5725~5850MHz Band Edge @ 3m	
ANT	802.11a CH165 5825MHz	
1+2	Vertical	Fundamental
Peak	<p>Site : 03CH114Y Condition : PEAK BE(B4) 16.24 3m HORN 9120D-HF VERTICAL</p>	<p>Site : 03CH114Y Condition : PEAK(UINII) 3m HORN 9120D-HF VERTICAL</p>



Band 4 5725~5850MHz
WIFI 802.11n HT20 (Band Edge @ 3m)

WIFI	Band 4 5725~5850MHz Band Edge @ 3m	
ANT	802.11n HT20 CH149 5745MHz	
1+2	Horizontal	Fundamental
Peak	<p>Site : 03CH11-HY Condition : PEAK_BE(B4) 16-24 3m HORN 9120D-HF HORIZONTAL</p>	<p>Site : 03CH11-HY Condition : PEAK(LINB) 3m HORN 9120D-HF HORIZONTAL</p>



WIFI	Band 4 5725~5850MHz Band Edge @ 3m	
ANT	802.11n HT20 CH149 5745MHz	
1+2	Vertical	Fundamental
Peak	<p>Site : 03CH11-14Y Condition : PEAK BE(B4) 16-24 3m HORN 9120D-HF VERTICAL</p>	<p>Site : 03CH11-14Y Condition : PEAK(U)III 3m HORN 9120D-HF VERTICAL</p>



WIFI	Band 4 5725~5850MHz Band Edge @ 3m	
ANT	802.11n HT20 CH157 5785MHz	
1+2	Horizontal	Fundamental
Peak	<p>Site : 03CH11-HY Condition : PEAK_BE(B4) 16-24 3m HORN 9120D-HF HORIZONTAL</p>	<p>Site : 03CH11-HY Condition : PEAK(UNII) 3m HORN 9120D-HF HORIZONTAL</p>
Peak	<p>Site : 03CH11-HY Condition : PEAK_BE(B4) 16-24 3m HORN 9120D-HF HORIZONTAL</p>	Left blank



WIFI	Band 4 5725~5850MHz Band Edge @ 3m	
ANT	802.11n HT20 CH157 5785MHz	
1+2	Vertical	Fundamental
Peak	<p>Site : 03CH11-HY Condition : PEAK_BE(B4) 16-24 3m HORN 9120D-HF VERTICAL</p>	<p>Site : 03CH11-HY Condition : PEAK(UNII) 3m HORN 9120D-HF VERTICAL</p>
Peak	<p>Site : 03CH11-HY Condition : PEAK_BE(B4) 16-24 3m HORN 9120D-HF VERTICAL</p>	Left blank

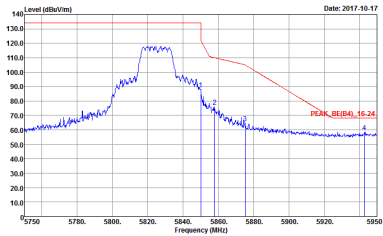
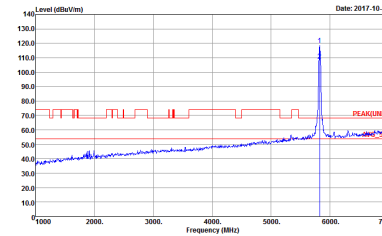

WIFI	Band 4 5725~5850MHz Band Edge @ 3m	
ANT	802.11n HT20 CH165 5825MHz	
1+2	Horizontal	Fundamental
Peak	 <p>Site : 03CH11-14Y Condition : PEAK BE(B4) 16-24 3m HORN 9120D-HF HORIZONTAL</p>	 <p>Site : 03CH11-14Y Condition : PEAK(UINII) 3m HORN 9120D-HF HORIZONTAL</p>

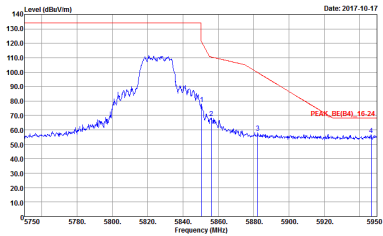
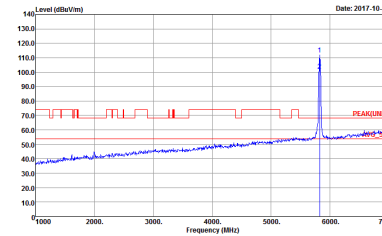

WIFI	Band 4 5725~5850MHz Band Edge @ 3m	
ANT	802.11n HT20 CH165 5825MHz	
1+2	Vertical	Fundamental
Peak	 <p>Site : 03CH11-14Y Condition : PEAK BE(B4) 16-24 3m HORN 9120D-HF VERTICAL</p>	 <p>Site : 03CH11-14Y Condition : PEAK(UINII) 3m HORN 9120D-HF VERTICAL</p>



**Band 4 5725~5850MHz
WIFI 802.11n HT40 (Band Edge @ 3m)**

WIFI	Band 4 5725~5850MHz Band Edge @ 3m	
ANT	802.11n HT40 CH151 5755MHz	
1+2	Horizontal	Fundamental
Peak	<p>Site : 03CH11-HY Condition : PEAK_BE(B4) 16-24 3m HORN 9120D-HF HORIZONTAL</p>	<p>Site : 03CH11-HY Condition : PEAK(LINB) 3m HORN 9120D-HF HORIZONTAL</p>
Peak	<p>Site : 03CH11-HY Condition : PEAK_BE(B4) 16-24 3m HORN 9120D-HF HORIZONTAL</p>	Left blank

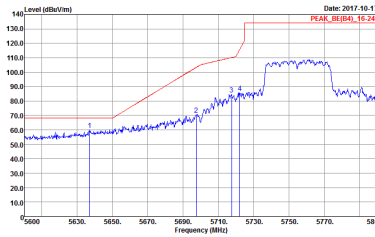
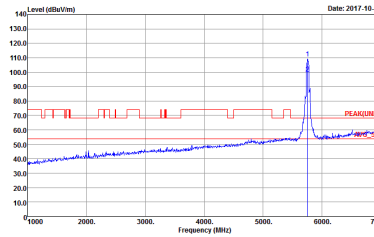
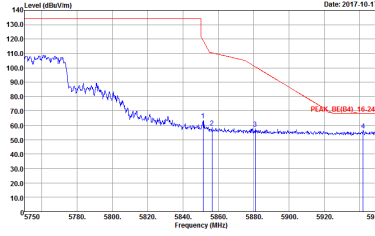

WIFI	Band 4 5725~5850MHz Band Edge @ 3m	
ANT	802.11n HT40 CH151 5755MHz	
1+2	Vertical	Fundamental
<p>Peak</p>	 <p>Site : 03CH11-HY Condition : PEAK_BE(B4) 16-24 3m HORN 9120D-HF VERTICAL</p>	 <p>Site : 03CH11-HY Condition : PEAK(UNII) 3m HORN 9120D-HF VERTICAL</p>
<p>Peak</p>	 <p>Site : 03CH11-HY Condition : PEAK_BE(B4) 16-24 3m HORN 9120D-HF VERTICAL</p>	<p>Left blank</p>



WIFI	Band 4 5725~5850MHz Band Edge @ 3m	
ANT	802.11n HT40 CH159 5795MHz	
1+2	Horizontal	Fundamental
Peak	<p>Site : 03CH11-HY Condition : PEAK_BE(B4) 16-24 3m HORN 9120D-HF HORIZONTAL</p>	<p>Site : 03CH11-HY Condition : PEAK(UNII) 3m HORN 9120D-HF HORIZONTAL</p>
Peak	<p>Site : 03CH11-HY Condition : PEAK_BE(B4) 16-24 3m HORN 9120D-HF HORIZONTAL</p>	Left blank



WIFI	Band 4 5725~5850MHz Band Edge @ 3m	
ANT	802.11n HT40 CH159 5795MHz	
1+2	Vertical	Fundamental
Peak	<p>Site : 03CH11-HY Condition : PEAK_BE(B4) 16-24 3m HORN 9120D-HF VERTICAL</p>	<p>Site : 03CH11-HY Condition : PEAK(UNII) 3m HORN 9120D-HF VERTICAL</p>
Peak	<p>Site : 03CH11-HY Condition : PEAK_BE(B4) 16-24 3m HORN 9120D-HF VERTICAL</p>	Left blank



**Band 4 5725~5850MHz
WIFI 802.11ac VHT80 (Band Edge @ 3m)**

WIFI	Band 4 5725~5850MHz Band Edge @ 3m	
ANT	802.11ac VHT80 CH155 5775MHz	
1+2	Horizontal	Fundamental
Peak	<p>Site : 03CH11-HY Condition : PEAK_BE(B4) 16-24 3m HORN 9120D-HF HORIZONTAL</p>	<p>Site : 03CH11-HY Condition : PEAK(LINB) 3m HORN 9120D-HF HORIZONTAL</p>
Peak	<p>Site : 03CH11-HY Condition : PEAK_BE(B4) 16-24 3m HORN 9120D-HF HORIZONTAL</p>	Left blank



WIFI	Band 4 5725~5850MHz Band Edge @ 3m	
ANT	802.11ac VHT80 CH155 5775MHz	
1+2	Vertical	Fundamental
Peak	<p>Site : 03CH11-HY Condition : PEAK_BE(B4) 16-24 3m HORN 9120D-HF VERTICAL</p>	<p>Site : 03CH11-HY Condition : PEAK(FUN) 3m HORN 9120D-HF VERTICAL</p>
Peak	<p>Site : 03CH11-HY Condition : PEAK_BE(B4) 16-24 3m HORN 9120D-HF VERTICAL</p>	Left blank



Band 4 - 5725~5850MHz
WIFI 802.11a (Harmonic @ 3m)

WIFI	Band 4 5725~5850MHz Harmonic @ 3m	
ANT	802.11a CH149 5745MHz	
1+2	Horizontal	Vertical
Peak Avg.	<p>Site : 03CH11-HY Condition : PEAK(LINE1) 3m HORN 9120D-1HF HORIZONTAL</p>	<p>Site : 03CH11-HY Condition : PEAK(LINE1) 3m HORN 9120D-1HF VERTICAL</p>



WIFI	Band 4 5725~5850MHz Harmonic @ 3m	
ANT	802.11a CH157 5785MHz	
1+2	Horizontal	Vertical
Peak Avg.	<p>Site : 03CHE1-4Y Condition : PEAK(UNII) 3m HORN 9120D-HF HORIZONTAL</p>	<p>Site : 03CHE1-4Y Condition : PEAK(UNII) 3m HORN 9120D-HF VERTICAL</p>



WIFI	Band 4 5725~5850MHz Harmonic @ 3m	
ANT	802.11a CH165 5825MHz	
1+2	Horizontal	Vertical
Peak Avg.	<p>Site : 03CHE1-14Y Condition : PEAK(UIN1) 3m HORN 9120D-HF HORIZONTAL</p>	<p>Site : 03CHE1-14Y Condition : PEAK(UIN1) 3m HORN 9120D-HF VERTICAL</p>



Band 4 5725~5850MHz
WIFI 802.11n HT20 (Harmonic @ 3m)

WIFI	Band 4 5725~5850MHz Harmonic @ 3m	
ANT	802.11n HT20 CH149 5745MHz	
1+2	Horizontal	Vertical
Peak Avg.	<p>Site : 03CH11-HY Condition : PEAK(UNII) 3m HORN 9120D-HF HORIZONTAL</p>	<p>Site : 03CH11-HY Condition : PEAK(UNII) 3m HORN 9120D-HF VERTICAL</p>



WIFI	Band 4 5725~5850MHz Harmonic @ 3m	
ANT	802.11n HT20 CH157 5785MHz	
1+2	Horizontal	Vertical
Peak Avg.	<p>Site : 03CHEL14Y Condition : PEA(KUNII) 3m HORN 9120D-HF HORIZONTAL</p>	<p>Site : 03CHEL14Y Condition : PEA(KUNII) 3m HORN 9120D-HF VERTICAL</p>



WIFI	Band 4 5725~5850MHz Harmonic @ 3m	
ANT	802.11n HT20 CH165 5825MHz	
1+2	Horizontal	Vertical
Peak Avg.	<p>Site : 03CHEL14Y Condition : PEAK(UNII) 3m HORN 9120D-HF HORIZONTAL</p>	<p>Site : 03CHEL14Y Condition : PEAK(UNII) 3m HORN 9120D-HF VERTICAL</p>



Band 4 5725~5850MHz
WIFI 802.11n HT40 (Harmonic @ 3m)

Table with 3 columns: WIFI, ANT, 1+2. It contains two spectral plots: Horizontal and Vertical. Each plot shows Level (dBm/100) vs Frequency (MHz) with peak and average markers.



WIFI	Band 4 5725~5850MHz Harmonic @ 3m	
ANT	802.11n HT40 CH159 5795MHz	
1+2	Horizontal	Vertical
Peak Avg.	<p>Site : 03CHEL-HY Condition : PEAK(UNII) 3m HORN 9120D-HF HORIZONTAL</p>	<p>Site : 03CHEL-HY Condition : PEAK(UNII) 3m HORN 9120D-HF VERTICAL</p>



**Band 4 5725~5850MHz
WIFI 802.11ac VHT80 (Harmonic @ 3m)**

WIFI	Band 4 5725~5850MHz Harmonic @ 3m	
ANT	802.11ac VHT80 CH155 5775MHz	
1+2	Horizontal	Vertical
Peak Avg.	<p>Site : 03CHI1-HY Condition : PEAK(UNII) 3m HORN 9120D-HF HORIZONTAL</p>	<p>Site : 03CHI1-HY Condition : PEAK(UNII) 3m HORN 9120D-HF VERTICAL</p>



Band 4 5725~5850MHz

Emission below 1GHz

5GHz WIFI 802.11ac VHT80 (LF)

WIFI	5GHz 5725~5850MHz	
ANT	802.11ac VHT80 LF	
1+2	Horizontal	Vertical
QP / Peak	<p>Site : 03CH11-HY Condition : QP-3m-BU-LOG-6111D-LF ETC HORIZONTAL</p>	<p>Site : 03CH11-HY Condition : QP-3m-BU-LOG-6111D-LF ETC VERTICAL</p>



Appendix E. Duty Cycle Plots

Antenna	Band	Duty Cycle(%)	T(us)	1/T(kHz)	VBW Setting	Duty Factor(dB)
1	802.11a	92.83	1425	0.70	1kHz	0.32
2	802.11a	92.86	1430	0.70		0.32
1+2	802.11a for Ant. 1	93.51	1440	0.70		0.29
1+2	802.11a for Ant. 2	92.83	1425	0.70		0.32
1	5GHz 802.11n HT20	93.06	1340	0.75	1kHz	0.31
2	5GHz 802.11n HT20	92.41	1340	0.75		0.34
1+2	5GHz 802.11n HT20 Ant. 1	92.41	1340	0.75		0.34
1+2	5GHz 802.11n HT20 Ant. 2	92.36	1330	0.75		0.35
1	5GHz 802.11n HT40	84.81	670	1.49	3kHz	0.72
2	5GHz 802.11n HT40	85.71	660	1.52		0.67
1+2	5GHz 802.11n HT40 Ant. 1	87.01	670	1.49		0.60
1+2	5GHz 802.11n HT40 Ant. 2	86.84	660	1.52		0.61
1	5GHz 802.11ac VHT20	97.71	5120	0.20	300Hz	0.10
2	5GHz 802.11ac VHT20	97.71	5120	0.20		0.10
1+2	5GHz 802.11ac VHT20 Ant. 1	97.69	5080	0.20		0.10
1+2	5GHz 802.11ac VHT20 Ant. 2	97.71	5120	0.20		0.10
1	5GHz 802.11ac VHT40	85.71	660	1.52	3kHz	0.67
2	5GHz 802.11ac VHT40	85.71	660	1.52		0.67
1+2	5GHz 802.11ac VHT40 Ant. 1	87.01	670	1.49		0.60
1+2	5GHz 802.11ac VHT40 Ant. 2	85.90	670	1.49		0.66
1	5GHz 802.11ac VHT80	75.93	328	3.05	10kHz	1.20
2	5GHz 802.11ac VHT80	76.85	332	3.01		1.14
1+2	5GHz 802.11ac VHT80 Ant. 1	75.93	328	3.05		1.20
1+2	5GHz 802.11ac VHT80 Ant. 2	75.93	328	3.05		1.20



<Ant. 1>

802.11a

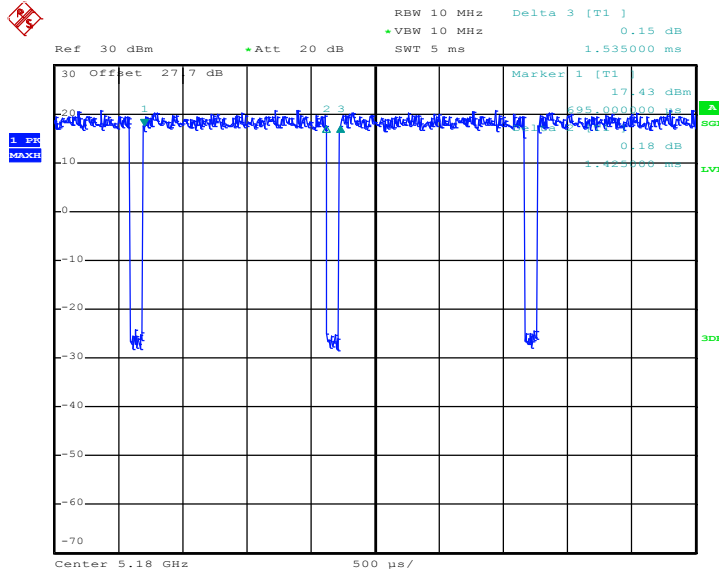

Date: 23.OCT.2017 10:00:29

802.11n HT20

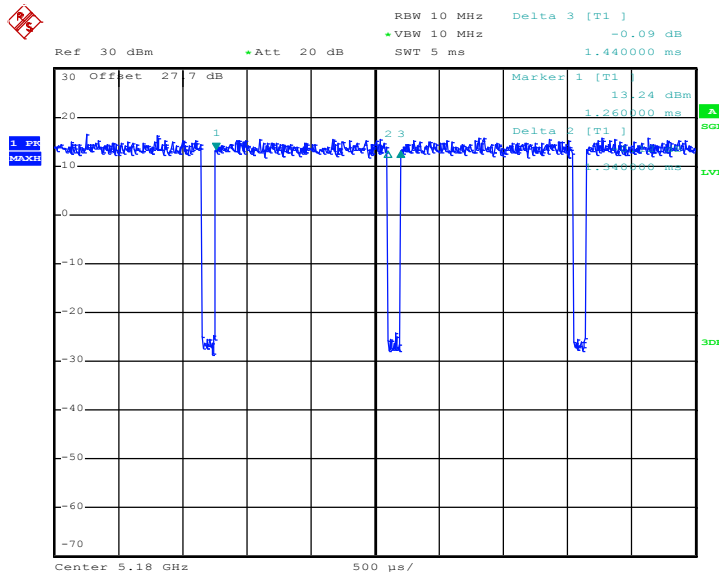

Date: 23.OCT.2017 10:40:09



802.11n HT40

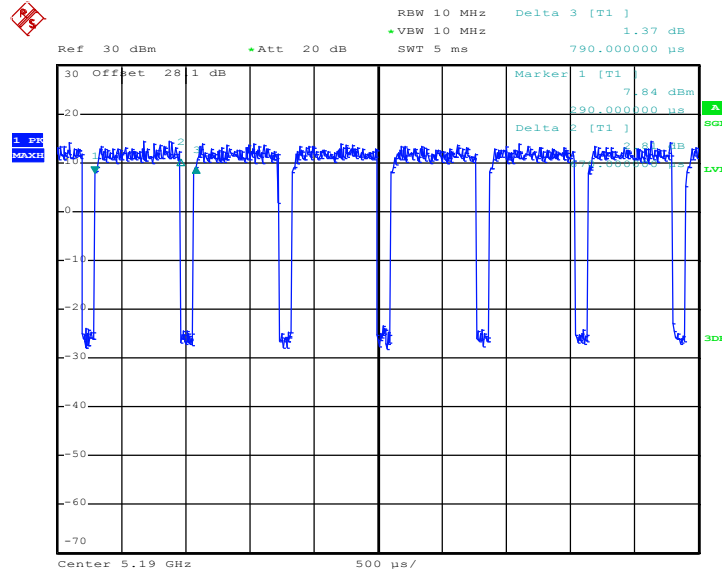

Date: 6.OCT.2017 20:28:49

802.11ac VHT20

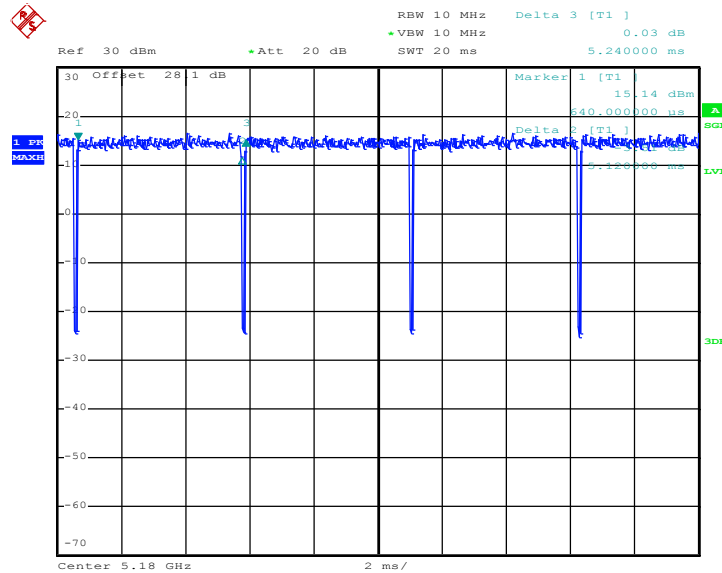

Date: 24.OCT.2017 23:34:04



802.11ac VHT40

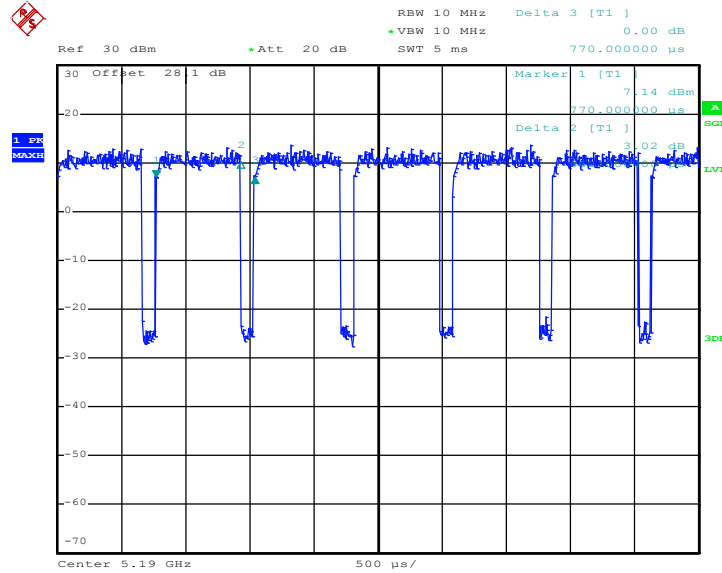

Date: 24.OCT.2017 23:38:08

802.11ac VHT80

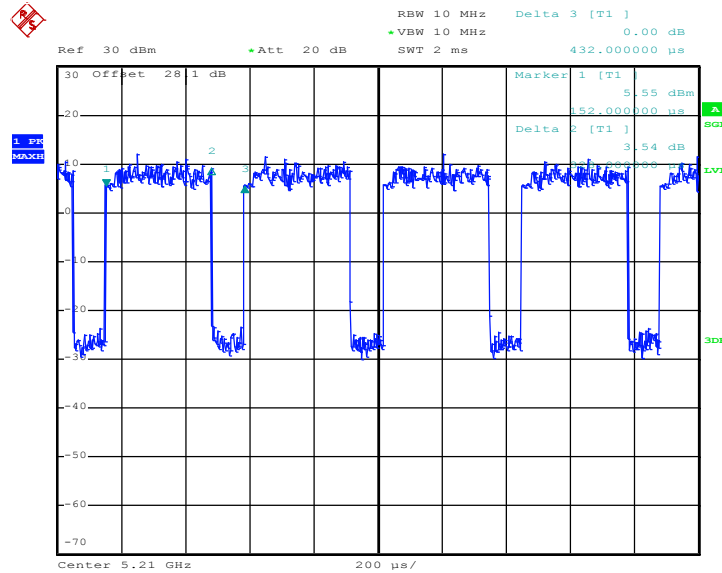

Date: 6.OCT.2017 19:51:10



<Ant. 2>

802.11a

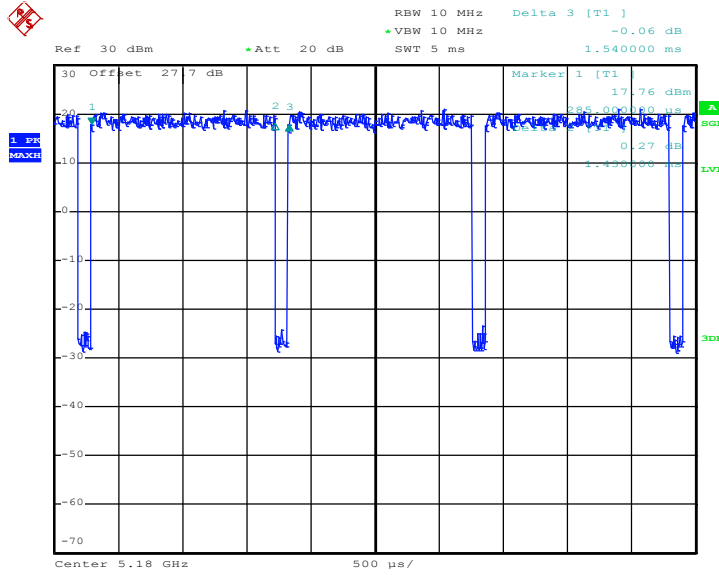

Date: 23.OCT.2017 10:01:32

802.11n HT20

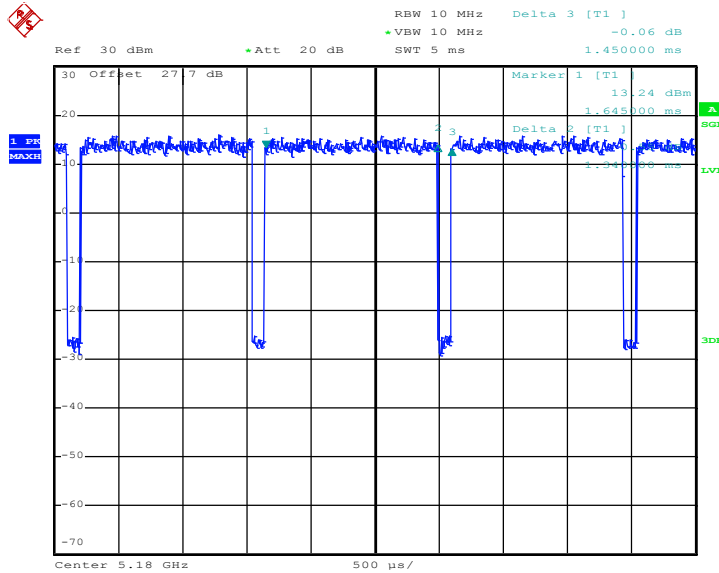

Date: 23.OCT.2017 10:40:44



802.11n HT40

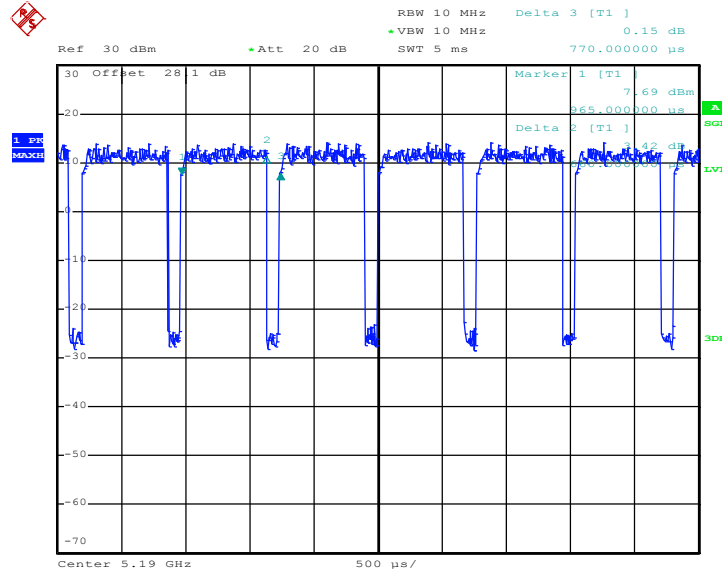

Date: 6.OCT.2017 20:30:05



802.11ac VHT20

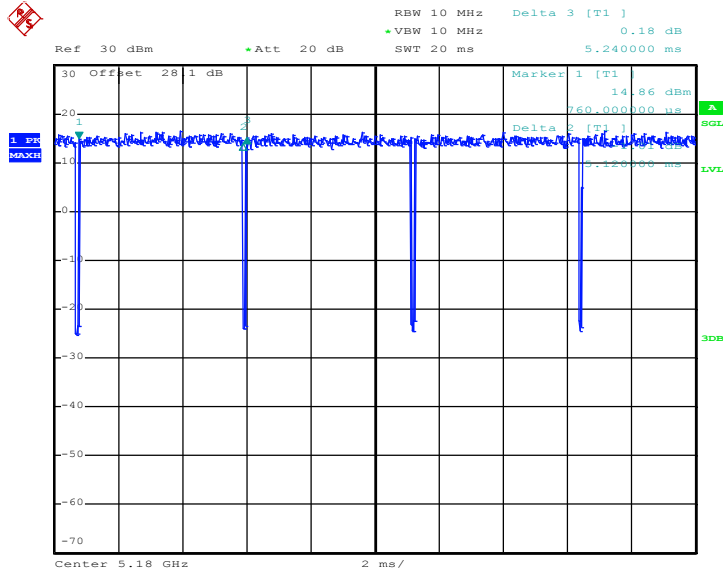

Date: 24.OCT.2017 23:35:30



802.11ac VHT40

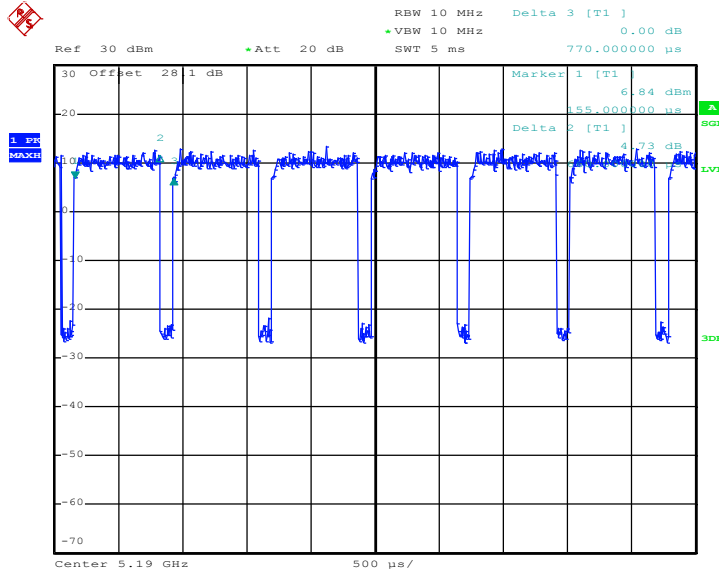

Date: 24.OCT.2017 23:38:52

802.11ac VHT80

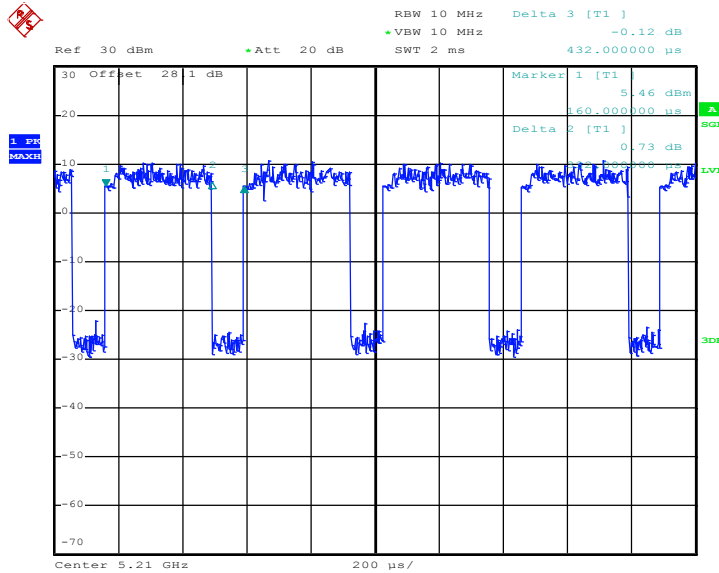

Date: 6.OCT.2017 19:56:21



MIMO <Ant. 1>

802.11a

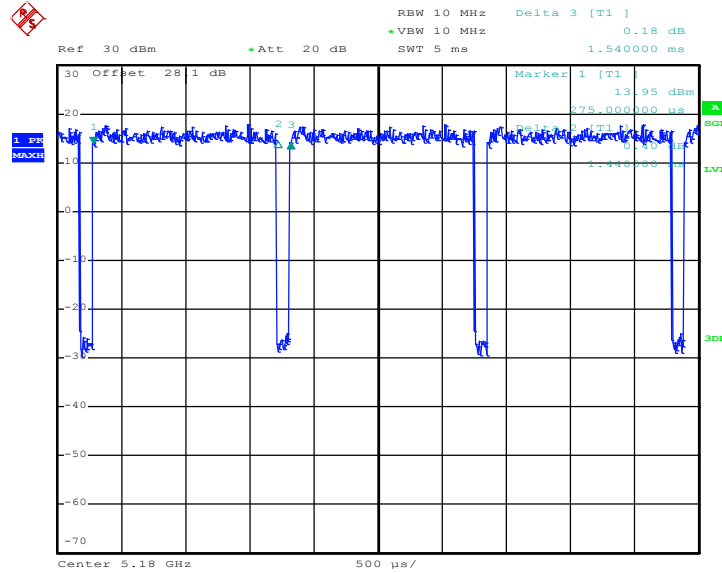

Date: 18.OCT.2017 20:57:59

802.11n HT20

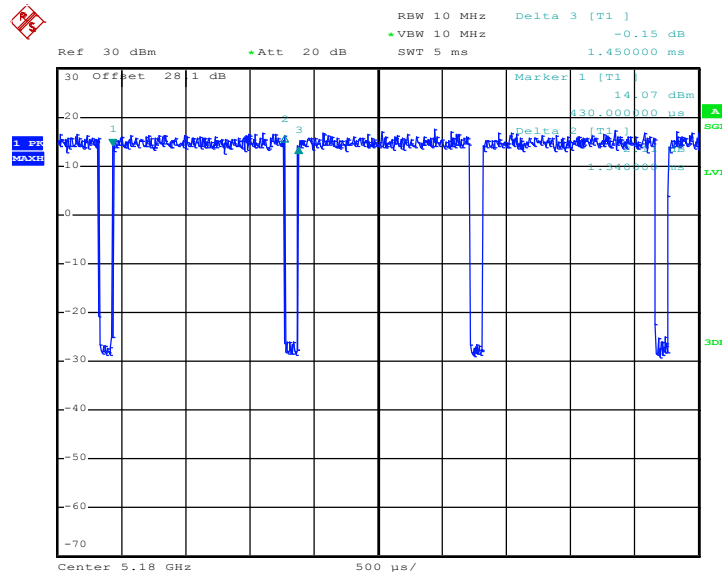

Date: 18.OCT.2017 22:21:48



802.11n HT40

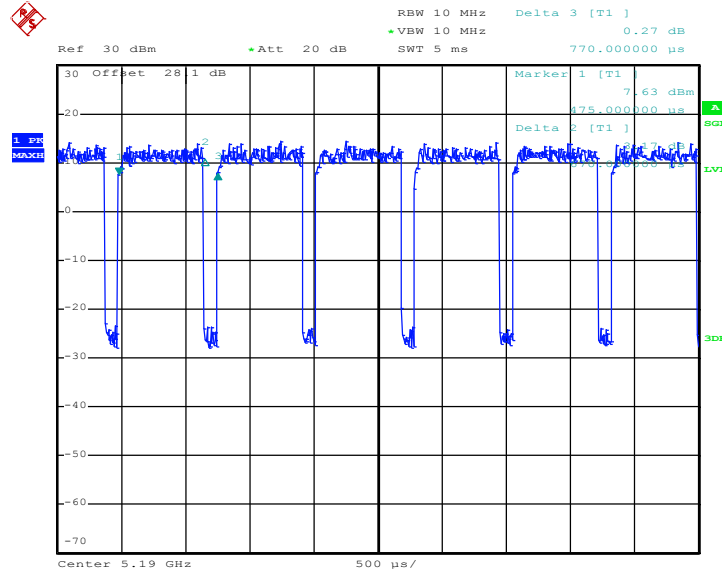

Date: 6.OCT.2017 20:31:35

802.11ac VHT20

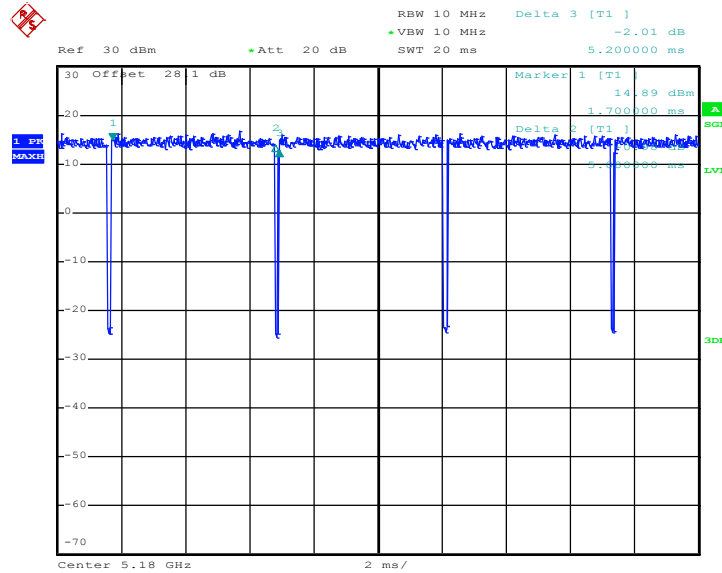

Date: 24.OCT.2017 23:36:13



802.11ac VHT40

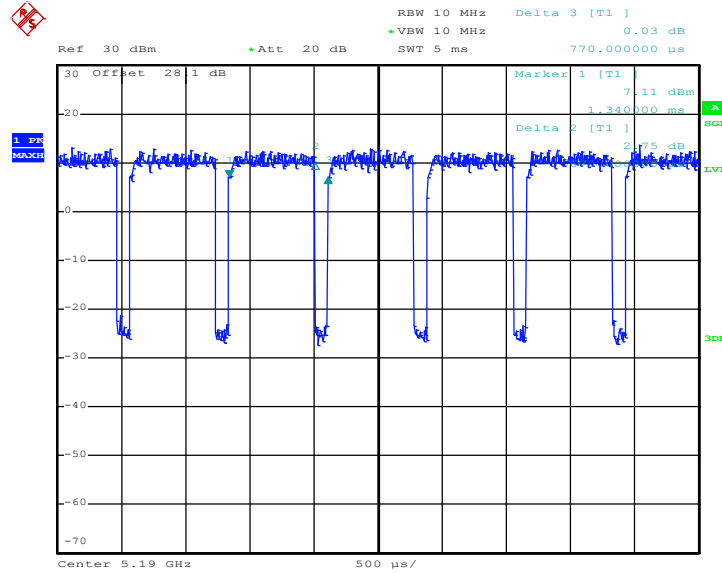

Date: 24.OCT.2017 23:39:35

802.11ac VHT80

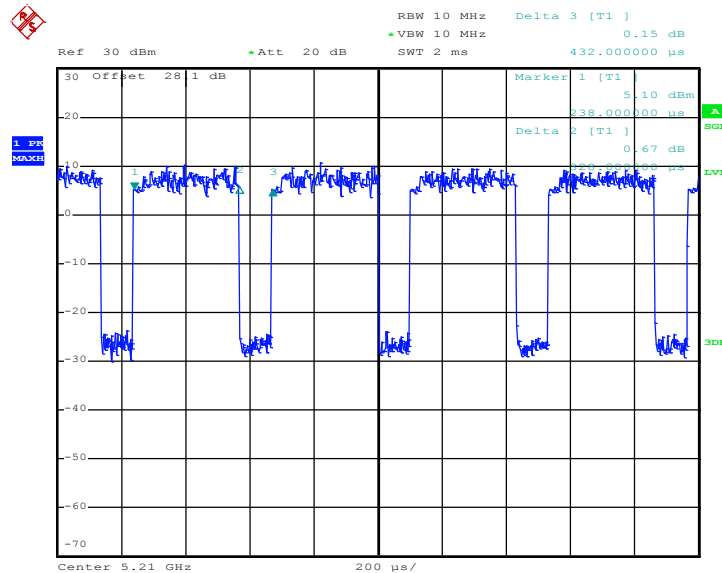

Date: 6.OCT.2017 19:59:14



MIMO <Ant. 2>

802.11a

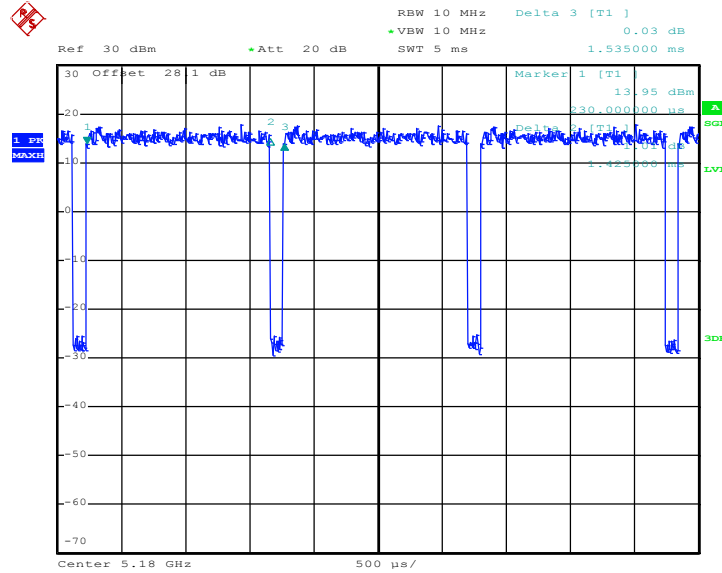

Date: 18.OCT.2017 20:58:40

802.11n HT20

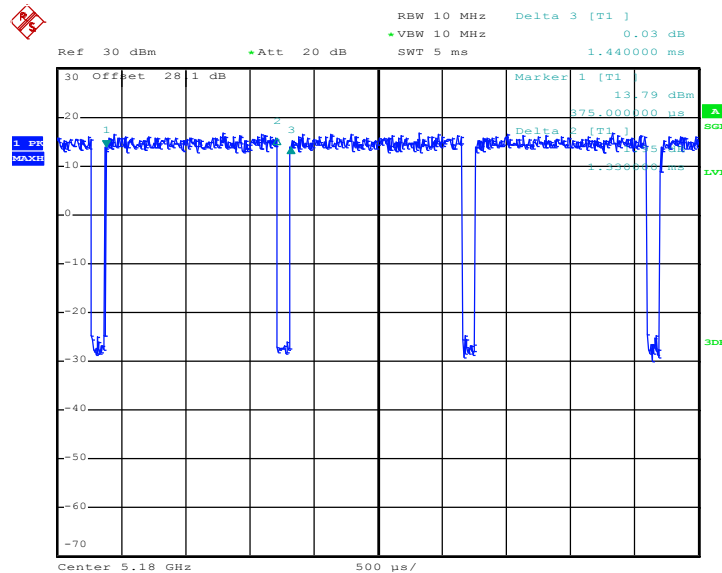

Date: 18.OCT.2017 22:22:16



802.11n HT40

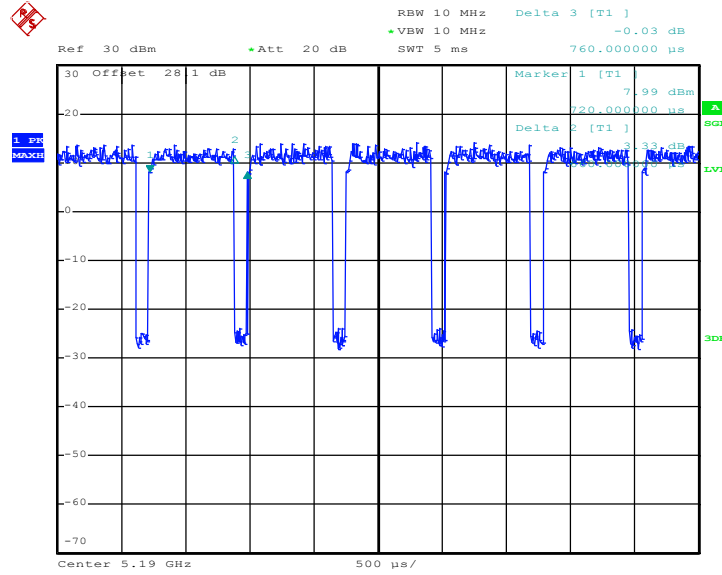

Date: 6.OCT.2017 20:32:18

802.11ac VHT20

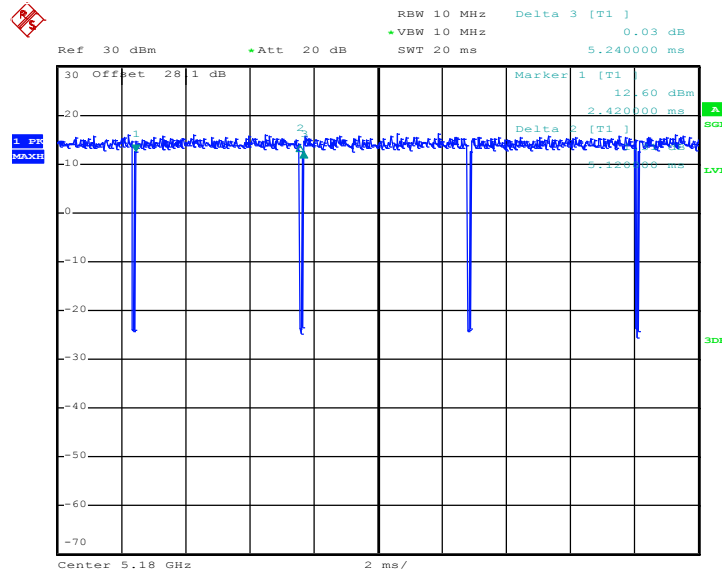

Date: 24.OCT.2017 23:36:44



802.11ac VHT40

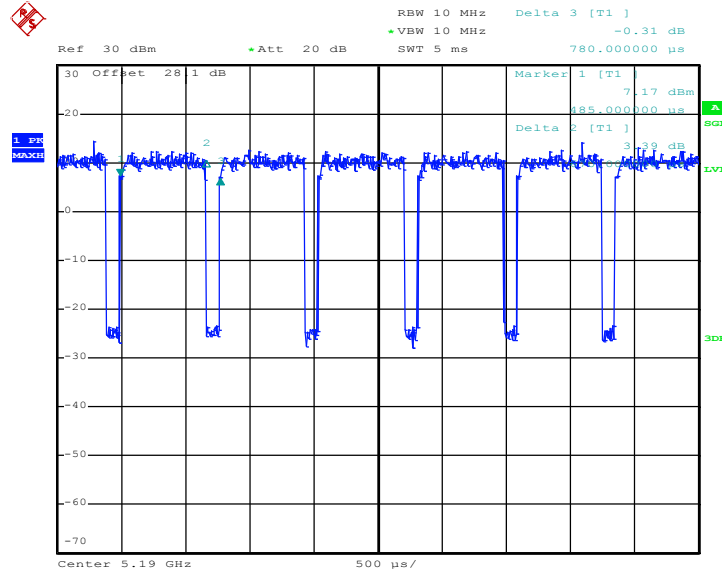

Date: 24.OCT.2017 23:40:03

802.11ac VHT80

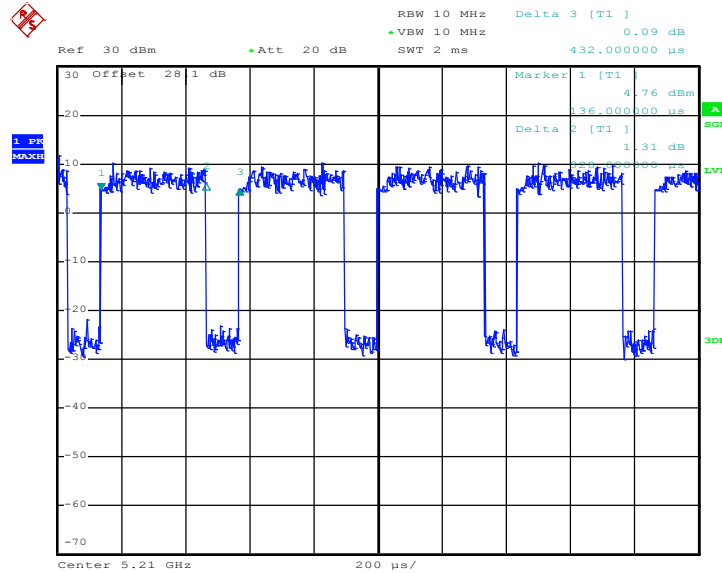

Date: 6.OCT.2017 20:00:15