



A D T

FCC TEST REPORT (15.407)

REPORT NO.: RF150127C26-2 R1

MODEL NO.: A00005

FCC ID: ZQANC11

RECEIVED: Jan. 27, 2015

TESTED: Feb. 05, 2015 ~ Feb. 13, 2015

ISSUED: Mar. 09, 2015

APPLICANT: Nest Labs Inc.

ADDRESS: 3400 Hillview Ave. Palo Alto California, United States 94304

ISSUED BY: Bureau Veritas Consumer Products Services (H.K.)
Ltd., Taoyuan Branch

LAB ADDRESS: No. 47-2, 14th Ling, Chia Pau Vil., Lin Kou Dist.,
New Taipei City, Taiwan (R.O.C)

TEST LOCATION: No.19, Hwa Ya 2nd Rd., Wen Hwa Vil., Kwei Shan
Dist., Taoyuan City 33383, TAIWAN (R.O.C.)

This report should not be used by the client to claim product certification, approval, or endorsement by TAF or any government agencies.



This report is for your exclusive use. Any copying or replication of this report to or for any other person or entity, or use of our name or trademark, is permitted only with our prior written permission. This report sets forth our findings solely with respect to the test samples identified herein. The results set forth in this report are not indicative or representative of the quality or characteristics of the lot from which a test sample was taken or any similar or identical product unless specifically and expressly noted. Our report includes all of the tests requested by you and the results thereof based upon the information that you provided to us. You have 60 days from date of issuance of this report to notify us of any material error or omission caused by our negligence, provided, however, that such notice shall be in writing and shall specifically address the issue you wish to raise. A failure to raise such issue within the prescribed time shall constitute your unqualified acceptance of the completeness of this report, the tests conducted and the correctness of the report contents. Unless specific mention, the uncertainty of measurement has been explicitly taken into account to declare the compliance or non-compliance to the specification.



TABLE OF CONTENTS

- RELEASE CONTROL RECORD4
- 1. CERTIFICATION.....5
- 2. SUMMARY OF TEST RESULTS6
 - 2.1 MEASUREMENT UNCERTAINTY.....6
- 3. GENERAL INFORMATION7
 - 3.1 GENERAL DESCRIPTION OF EUT7
 - 3.2 DESCRIPTION OF TEST MODES8
 - 3.2.1 TEST MODE APPLICABILITY AND TESTED CHANNEL DETAIL 10
 - 3.3 DESCRIPTION OF SUPPORT UNITS 13
 - 3.3.1 CONFIGURATION OF SYSTEM UNDER TEST 13
 - 3.4 DUTY CYCLE TEST SIGNAL 14
 - 3.5 GENERAL DESCRIPTION OF APPLIED STANDARDS 17
- 4. TEST TYPES AND RESULTS 18
 - 4.1 RADIATED EMISSION AND BANDEDGE MEASUREMENT 18
 - 4.1.1 LIMITS OF RADIATED EMISSION AND BANDEDGE MEASUREMENT 18
 - 4.1.2 LIMITS OF UNWANTED EMISSION OUT OF THE RESTRICTED BANDS 18
 - 4.1.3 TEST INSTRUMENTS 19
 - 4.1.4 TEST PROCEDURES 20
 - 4.1.5 DEVIATION FROM TEST STANDARD 20
 - 4.1.6 TEST SETUP 21
 - 4.1.7 EUT OPERATING CONDITIONS 21
 - 4.1.8 TEST RESULTS..... 22
 - 4.2 CONDUCTED EMISSION MEASUREMENT 56
 - 4.2.1 LIMITS OF CONDUCTED EMISSION MEASUREMENT 56
 - 4.2.2 TEST INSTRUMENTS 56
 - 4.2.3 TEST PROCEDURES 57
 - 4.2.4 DEVIATION FROM TEST STANDARD 57
 - 4.2.5 TEST SETUP 58
 - 4.2.6 EUT OPERATING CONDITIONS 58
 - 4.2.7 TEST RESULTS..... 59
 - 4.3 TRANSMIT POWER MEASUREMENT 61
 - 4.3.1 LIMITS OF TRANSMIT POWER MEASUREMENT 61
 - 4.3.2 TEST SETUP 61
 - 4.3.3 TEST INSTRUMENTS 61
 - 4.3.4 TEST PROCEDURE 62
 - 4.3.5 DEVIATION FROM TEST STANDARD 62
 - 4.3.6 EUT OPERATING CONDITIONS 62
 - 4.3.7 TEST RESULTS..... 63
 - 4.4 PEAK POWER SPECTRAL DENSITY MEASUREMENT 72
 - 4.4.1 LIMITS OF PEAK POWER SPECTRAL DENSITY MEASUREMENT 72
 - 4.4.2 TEST SETUP 72
 - 4.4.3 TEST INSTRUMENTS 72
 - 4.4.4 TEST PROCEDURES 72
 - 4.4.5 DEVIATION FROM TEST STANDARD 73
 - 4.4.6 EUT OPERATING CONDITIONS 73
 - 4.4.7 TEST RESULTS..... 74
 - 4.5 FREQUENCY STABILITY 78
 - 4.5.1 LIMITS OF FREQUENCY STABILITY MEASUREMENT 78
 - 4.5.2 TEST SETUP 78
 - 4.5.3 TEST INSTRUMENTS 78
 - 4.5.4 TEST PROCEDURE 79



4.5.5	DEVIATION FROM TEST STANDARD	79
4.5.6	EUT OPERATING CONDITION.....	79
4.5.7	TEST RESULTS.....	80
4.6	6dB BANDWIDTH MEASUREMENT	81
4.6.1	LIMITS OF 6dB BANDWIDTH MEASUREMENT	81
4.6.2	TEST SETUP	81
4.6.3	TEST INSTRUMENTS	81
4.6.4	TEST PROCEDURE	81
4.6.5	DEVIATION FROM TEST STANDARD	81
4.6.6	EUT OPERATING CONDITIONS	81
4.6.7	TEST RESULTS.....	82
5.	PHOTOGRAPHS OF THE TEST CONFIGURATION.....	84
6.	INFORMATION ON THE TESTING LABORATORIES	85
7.	APPENDIX A - MODIFICATIONS RECORDERS FOR ENGINEERING CHANGES TO THE EUT BY THE LAB	86



A D T

RELEASE CONTROL RECORD

ISSUE NO.	REASON FOR CHANGE	DATE ISSUED
RF150127C26-2	Original release	Feb. 26, 2015
RF150127C26-2 R1	Revise antenna gain and add occupied bandwidth data for 5GHz Band I	Mar. 09, 2015



A D T

1. CERTIFICATION

PRODUCT: Wireless Camera

MODEL NO.: A00005

APPLICANT: Nest Labs Inc.

TESTED: Feb. 05, 2015 ~ Feb. 13, 2015

TEST SAMPLE: Identical Prototype

STANDARDS: **FCC Part 15, Subpart E (Section 15.407)**

ANSI C63.10-2009

The above equipment (model: A00005) has been tested by **Bureau Veritas Consumer Products Services (H.K.) Ltd., Taoyuan Branch**, and found compliance with the requirement of the above standards. The test record, data evaluation & Equipment Under Test (EUT) configurations represented herein are true and accurate accounts of the measurements of the sample's EMC characteristics under the conditions specified in this report.

PREPARED BY : Vera Huang , **DATE :** Mar. 09, 2015

Vera Huang / Specialist

APPROVED BY : Sam Chen , **DATE :** Mar. 09, 2015

Sam Chen / Senior Project Engineer

2. SUMMARY OF TEST RESULTS

The EUT has been tested according to the following specifications:

APPLIED STANDARD: FCC PART 15, SUBPART E (SECTION 15.407, Under New Rule)			
STANDARD SECTION	TEST TYPE	RESULT	REMARK
15.407(b)(6)	AC Power Conducted Emission	PASS	Meet the requirement of limit. Minimum passing margin is -12.87dB at 0.15000MHz.
15.407(b/1/2/3) (b)(6)	Radiated Emissions	PASS	Meet the requirement of limit. Minimum passing margin is -1.03dB at 11400MHz.
15.407(a/1/2/3)	Max Average Transmit Power	PASS	Meet the requirement of limit.
15.407(a)(6)	Peak Power Excursion	PASS	Meet the requirement of limit.
15.407(a/1/2/3)	Peak Power Spectral Density	PASS	Meet the requirement of limit.
15.407(e)	6dB bandwidth	PASS	Meet the requirement of limit. (U-NII-3 Band only)
15.407(g)	Frequency Stability	PASS	Meet the requirement of limit.
15.203	Antenna Requirement	PASS	No antenna connector is used.

2.1 MEASUREMENT UNCERTAINTY

Where relevant, the following measurement uncertainty levels have been estimated for tests performed on the EUT as specified in CISPR 16-4-2:

MEASUREMENT	FREQUENCY	UNCERTAINTY
Conducted emissions	9kHz~30MHz	2.44 dB
Radiated emissions	30MHz ~ 200MHz	2.93 dB
	200MHz ~1000MHz	2.95 dB
	1GHz ~ 18GHz	2.26 dB
	18GHz ~ 40GHz	1.94 dB

This uncertainty represents an expanded uncertainty expressed at approximately the 95% confidence level using a coverage factor of $k = 2$.



3. GENERAL INFORMATION

3.1 GENERAL DESCRIPTION OF EUT

EUT	Wireless Camera
MODEL NO.	A00005
MODULATION TYPE	64QAM, 16QAM, QPSK, BPSK
MODULATION TECHNOLOGY	OFDM
TRANSFER RATE	802.11a: 54.0/ 48.0/ 36.0/ 24.0/ 18.0/ 12.0/ 9.0/ 6.0Mbps 802.11n: up to MCS7
OPERATING FREQUENCY	5180 ~ 5240MHz, 5260 ~ 5320MHz, 5500 ~ 5700MHz, 5745 ~ 5825MHz
NUMBER OF CHANNEL	5180 ~ 5240MHz: 4 for 802.11a, 802.11n (20MHz) 2 for 802.11n (40MHz) 5260 ~ 5320MHz: 4 for 802.11a, 802.11n (20MHz) 2 for 802.11n (40MHz) 5500 ~ 5700MHz: 8 for 802.11a, 802.11n (20MHz) 3 for 802.11n (40MHz) 5745 ~ 5825MHz: 5 for 802.11a, 802.11n (20MHz) 2 for 802.11n (40MHz)
OUTPUT POWER	38.99mW for 5180 ~ 5240MHz 33.73mW for 5260 ~ 5320MHz 60.53mW for 5500 ~ 5700MHz 55.85mW for 5745 ~ 5825MHz
ANTENNA TYPE / PEAK GAIN	Integral antenna with -1.5dBi gain (5180 ~ 5240MHz) Integral antenna with -1.5dBi gain (5260 ~ 5320MHz) Integral antenna with -1.5dBi gain (5500 ~ 5700MHz) Integral antenna with -1.5dBi gain (5745 ~ 5825MHz)
ANTENNA CONNECTOR	NA
DATA CABLE	Refer to Note as below
I/O PORTS	Refer to user's manual
ACCESSORY DEVICES	Refer to Note as below

NOTE:

1. The EUT provides one completed transmitter and one receiver.

MODULATION MODE	TX FUNCTION
802.11b	1TX
802.11g	1TX
802.11a	1TX
802.11n (20MHz)	1TX
802.11n (40MHz)	1TX

2. The above EUT information is declared by the manufacturer and for more detailed features description, please refer to the manufacturer's specifications or User's Manual.

3.2 DESCRIPTION OF TEST MODES

WLAN 5180 ~ 5240MHz

4 channels are provided for 802.11a, 802.11n (20MHz):

CHANNEL	FREQUENCY	CHANNEL	FREQUENCY
36	5180 MHz	44	5220 MHz
40	5200 MHz	48	5240 MHz

2 channels are provided for 802.11n (40MHz):

CHANNEL	FREQUENCY	CHANNEL	FREQUENCY
38	5190 MHz	46	5230 MHz

FOR 5260 ~ 5320MHz

4 channels are provided for 802.11a, 802.11n (20MHz):

CHANNEL	FREQUENCY	CHANNEL	FREQUENCY
52	5260 MHz	60	5300 MHz
56	5280 MHz	64	5320 MHz

2 channels are provided for 802.11n (40MHz):

CHANNEL	FREQUENCY	CHANNEL	FREQUENCY
54	5270 MHz	62	5310 MHz

**WLAN 5500 ~ 5700MHz**

8 channels are provided for 802.11a, 802.11n (20MHz):

CHANNEL	FREQUENCY	CHANNEL	FREQUENCY
100	5500MHz	116	5580MHz
104	5520MHz	132	5660MHz
108	5540MHz	136	5680MHz
112	5560MHz	140	5700MHz

3 channels are provided for 802.11n (40MHz):

CHANNEL	FREQUENCY	CHANNEL	FREQUENCY
102	5510MHz	134	5670MHz
110	5550MHz		

FOR 5.0GHz (5745 ~ 5825MHz):

5 channels are provided for 802.11a, 802.11n (20MHz):

CHANNEL	FREQUENCY	CHANNEL	FREQUENCY
149	5745MHz	161	5805MHz
153	5765MHz	165	5825MHz
157	5785MHz		

2 channels are provided for 802.11n (40MHz):

CHANNEL	FREQUENCY	CHANNEL	FREQUENCY
151	5755MHz	159	5795MHz



3.2.1 TEST MODE APPLICABILITY AND TESTED CHANNEL DETAIL

EUT CONFIGURE MODE	APPLICABLE TO				DESCRIPTION
	RE \geq 1G	RE $<$ 1G	PLC	APCM	
-	√	√	√	√	-

Where **RE \geq 1G**: Radiated Emission above 1GHz **RE $<$ 1G**: Radiated Emission below 1GHz
PLC: Power Line Conducted Emission **APCM**: Antenna Port Conducted Measurement

NOTE: The EUT had been pre-tested on the positioned of each 3 axis. The worst case was found when positioned on **Z-plane**.

RADIATED EMISSION TEST (ABOVE 1GHz):

Pre-Scan has been conducted to determine the worst-case mode from all possible combinations between available modulations, data rates and antenna ports (if EUT with antenna diversity architecture).

Following channel(s) was (were) selected for the final test as listed below.

EUT CONFIGURE MODE	MODE	FREQ. BAND (MHz)	AVAILABLE CHANNEL	TESTED CHANNEL	MODULATION TECHNOLOGY	MODULATION TYPE	DATA RATE (Mbps)
-	802.11a	5180-5240	36 to 48	36, 44, 48	OFDM	BPSK	6.0
	802.11n (20MHz)		36 to 48	36, 44, 48	OFDM	BPSK	MCS0
	802.11n (40MHz)		38 to 46	38, 46	OFDM	BPSK	MCS0
-	802.11a	5260-5320	52 to 64	52, 60, 64	OFDM	BPSK	6.0
	802.11n (20MHz)		52 to 64	52, 60, 64	OFDM	BPSK	MCS0
	802.11n (40MHz)		54 to 62	54, 62	OFDM	BPSK	MCS0
-	802.11a	5500-5700	100 to 140	100, 116, 140	OFDM	BPSK	6.0
	802.11n (20MHz)		100 to 140	100, 116, 140	OFDM	BPSK	MCS0
	802.11n (40MHz)		102 to 134	102, 110, 134	OFDM	BPSK	MCS0
-	802.11a	5745-5825	149 to 161	149, 157, 165	OFDM	BPSK	6.0
	802.11n (20MHz)		149 to 161	149, 157, 165	OFDM	BPSK	MCS0
	802.11n (40MHz)		151 to 159	151, 159	OFDM	BPSK	MCS0

RADIATED EMISSION TEST (BELOW 1GHz):

Pre-Scan has been conducted to determine the worst-case mode from all possible combinations between available modulations, data rates and antenna ports (if EUT with antenna diversity architecture).

Following channel(s) was (were) selected for the final test as listed below.

EUT CONFIGURE MODE	MODE	FREQ. BAND (MHz)	AVAILABLE CHANNEL	TESTED CHANNEL	MODULATION TECHNOLOGY	MODULATION TYPE	DATA RATE (Mbps)
-	802.11a	5500-5700	100 to 140	140	OFDM	BPSK	6.0



POWER LINE CONDUCTED EMISSION TEST:

EUT CONFIGURE MODE	MODE	FREQ. BAND (MHz)	AVAILABLE CHANNEL	TESTED CHANNEL	MODULATION TECHNOLOGY	MODULATION TYPE	DATA RATE (Mbps)
-	802.11a	5500-5700	100 to 140	140	OFDM	BPSK	6.0

BANDEDGE MEASUREMENT:

Pre-Scan has been conducted to determine the worst-case mode from all possible combinations between available modulations, data rates and antenna ports (if EUT with antenna diversity architecture).

Following channel(s) was (were) selected for the final test as listed below.

EUT CONFIGURE MODE	MODE	FREQ. BAND (MHz)	AVAILABLE CHANNEL	TESTED CHANNEL	MODULATION TECHNOLOGY	MODULATION TYPE	DATA RATE (Mbps)
-	802.11a	5180-5240	36 to 48	36, 44, 48	OFDM	BPSK	6.0
	802.11n (20MHz)		36 to 48	36, 44, 48	OFDM	BPSK	MCS0
	802.11n (40MHz)		38 to 46	38, 46	OFDM	BPSK	MCS0
-	802.11a	5260-5320	52 to 64	52, 60, 64	OFDM	BPSK	6.0
	802.11n (20MHz)		52 to 64	52, 60, 64	OFDM	BPSK	MCS0
	802.11n (40MHz)		54 to 62	54, 62	OFDM	BPSK	MCS0
-	802.11a	5500-5700	100 to 140	100, 116, 140	OFDM	BPSK	6.0
	802.11n (20MHz)		100 to 140	100, 116, 140	OFDM	BPSK	MCS0
	802.11n (40MHz)		102 to 134	102, 110, 134	OFDM	BPSK	MCS0
-	802.11a	5745-5825	149 to 161	149, 157, 165	OFDM	BPSK	6.0
	802.11n (20MHz)		149 to 161	149, 157, 165	OFDM	BPSK	MCS0
	802.11n (40MHz)		151 to 159	151, 159	OFDM	BPSK	MCS0



ANTENNA PORT CONDUCTED MEASUREMENT:

- This item includes all test value of each mode, but only includes spectrum plot of worst value of each mode.
- Pre-Scan has been conducted to determine the worst-case mode from all possible combinations between available modulations, data rates and antenna ports (if EUT with antenna diversity architecture).
- Following channel(s) was (were) selected for the final test as listed below.

EUT CONFIGURE MODE	MODE	FREQ. BAND (MHz)	AVAILABLE CHANNEL	TESTED CHANNEL	MODULATION TECHNOLOGY	MODULATION TYPE	DATA RATE (Mbps)
-	802.11a	5180-5240	36 to 48	36, 44, 48	OFDM	BPSK	6.0
	802.11n (20MHz)		36 to 48	36, 44, 48	OFDM	BPSK	MCS0
	802.11n (40MHz)		38 to 46	38, 46	OFDM	BPSK	MCS0
-	802.11a	5260-5320	52 to 64	52, 60, 64	OFDM	BPSK	6.0
	802.11n (20MHz)		52 to 64	52, 60, 64	OFDM	BPSK	MCS0
	802.11n (40MHz)		54 to 62	54, 62	OFDM	BPSK	MCS0
-	802.11a	5500-5700	100 to 140	100, 116, 140	OFDM	BPSK	6.0
	802.11n (20MHz)		100 to 140	100, 116, 140	OFDM	BPSK	MCS0
	802.11n (40MHz)		102 to 134	102, 110, 134	OFDM	BPSK	MCS0
-	802.11a	5745-5825	149 to 161	149, 157, 165	OFDM	BPSK	6.0
	802.11n (20MHz)		149 to 161	149, 157, 165	OFDM	BPSK	MCS0
	802.11n (40MHz)		151 to 159	151, 159	OFDM	BPSK	MCS0

Test CONDITION:

APPLICABLE TO	ENVIRONMENTAL CONDITIONS	INPUT POWER	TESTED BY
RE≥1G	25deg. C, 65%RH	120Vac, 60Hz	Gavin Wu
RE<1G	25deg. C, 65%RH	120Vac, 60Hz	Gavin Wu
PLC	25deg. C, 65%RH	120Vac, 60Hz	Anson Lin
APCM	25deg. C, 65%RH	120Vac, 60Hz	Dylan Yang

3.3 DESCRIPTION OF SUPPORT UNITS

The EUT has been tested as an independent unit together with other necessary accessories or support units. The following support units or accessories were used to form a representative test configuration during the tests.

NO.	PRODUCT	MODEL NO.	SERIAL NO.	FCC ID
1	Adapter	KSAPK0110500200FU	N/A	FCC Doc Approved
2	USB Cable	N/A	N/A	N/A

NO.	SIGNAL CABLE DESCRIPTION OF THE ABOVE SUPPORT UNITS
1	N/A
2	N/A

NOTE:

1. All power cords of the above support units are non shielded (1.8m).
2. Items 1-2 were provided by client.

3.3.1 CONFIGURATION OF SYSTEM UNDER TEST

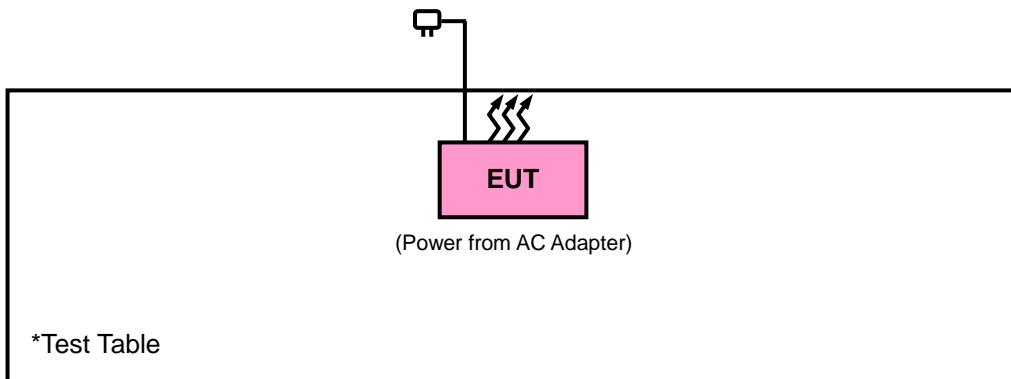

3.4 DUTY CYCLE TEST SIGNAL

MODULATION TYPE: BPSK

If duty cycle is < 98%

802.11a: Duty cycle = $2.051/2.099 = 0.977$, Duty factor = $10 * \log(1/0.977) = 0.10$

802.11n (20MHz): Duty cycle = $1.915/1.955 = 0.980$, Duty factor = $10 * \log(1/0.980) = 0.09$

802.11n (40MHz): Duty cycle = $905.44/969.55 = 0.934$, Duty factor = $10 * \log(1/0.934) = 0.30$

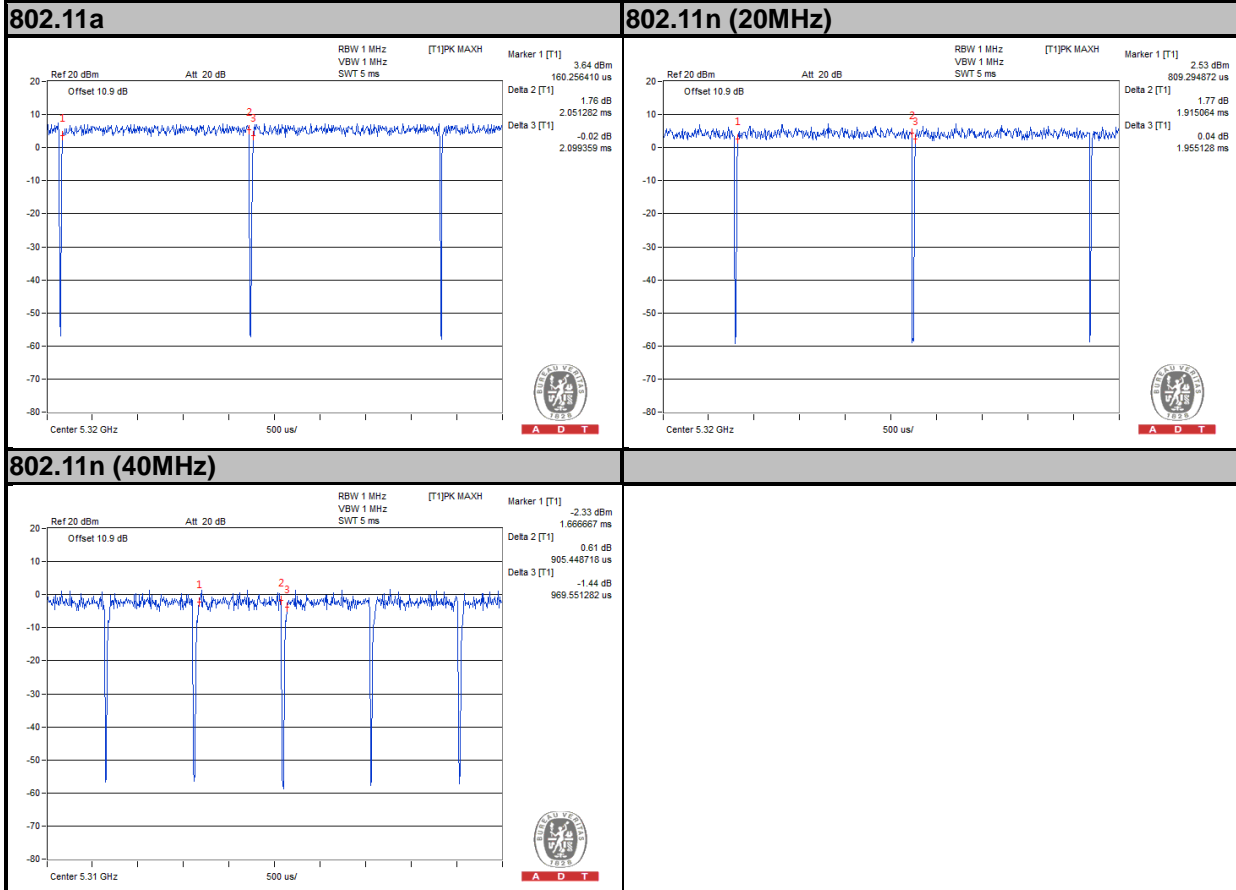



A D T

MODULATION TYPE: QPSK

If duty cycle is < 98%

802.11a: Duty cycle = 1.041/1.081 = 0.963, Duty factor = $10 * \log(1/0.963) = 0.16$

802.11n (20MHz): Duty cycle = 0.977/1.009 = 0.968, Duty factor = $10 * \log(1/0.968) = 0.14$

802.11n (40MHz): Duty cycle = 461.53/525.64 = 0.878, Duty factor = $10 * \log(1/0.878) = 0.57$

802.11a

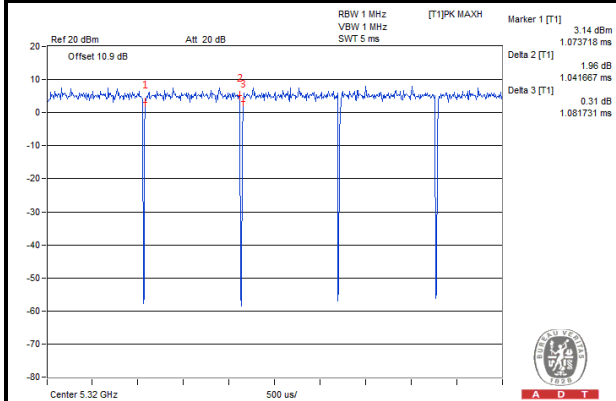

802.11n (20MHz)

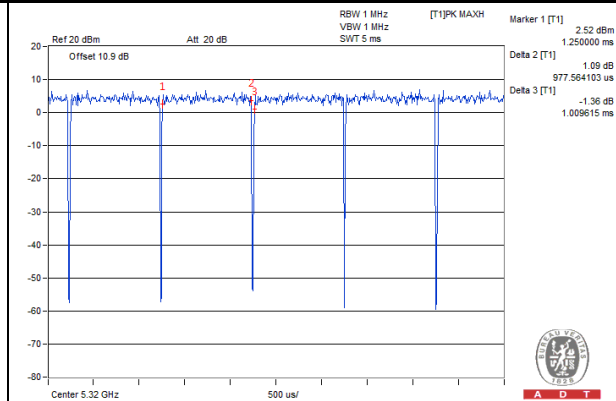

802.11n (40MHz)

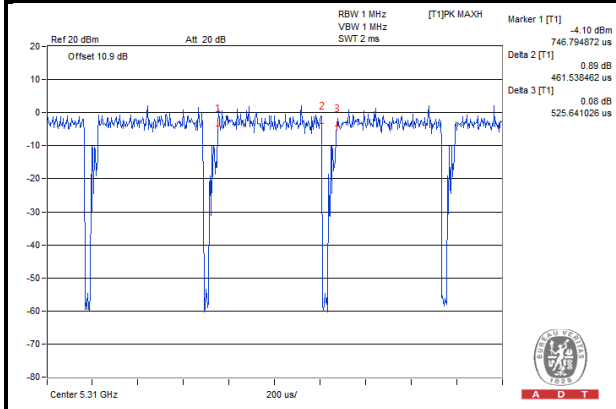



A D T

MODULATION TYPE: 16QAM

If duty cycle is < 98%

802.11a: Duty cycle = $522.43/562.50 = 0.929$, Duty factor = $10 * \log(1/0.929) = 0.32$

802.11n (20MHz): Duty cycle = $501.60/538.46 = 0.932$, Duty factor = $10 * \log(1/0.932) = 0.31$

802.11n (40MHz): Duty cycle = $232.37/294.87 = 0.788$, Duty factor = $10 * \log(1/0.788) = 1.03$

802.11a

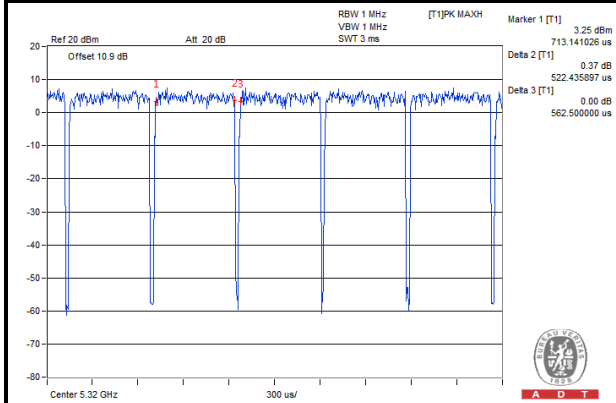

802.11n (20MHz)

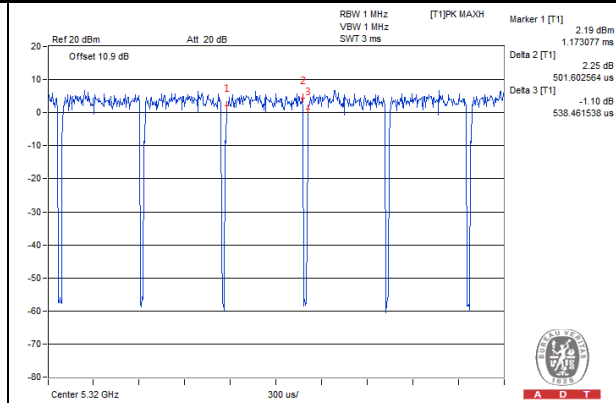

802.11n (40MHz)

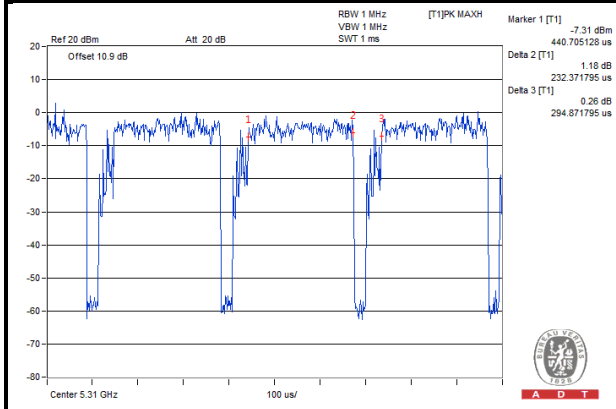

MODULATION TYPE: 64QAM

If duty cycle is < 98%

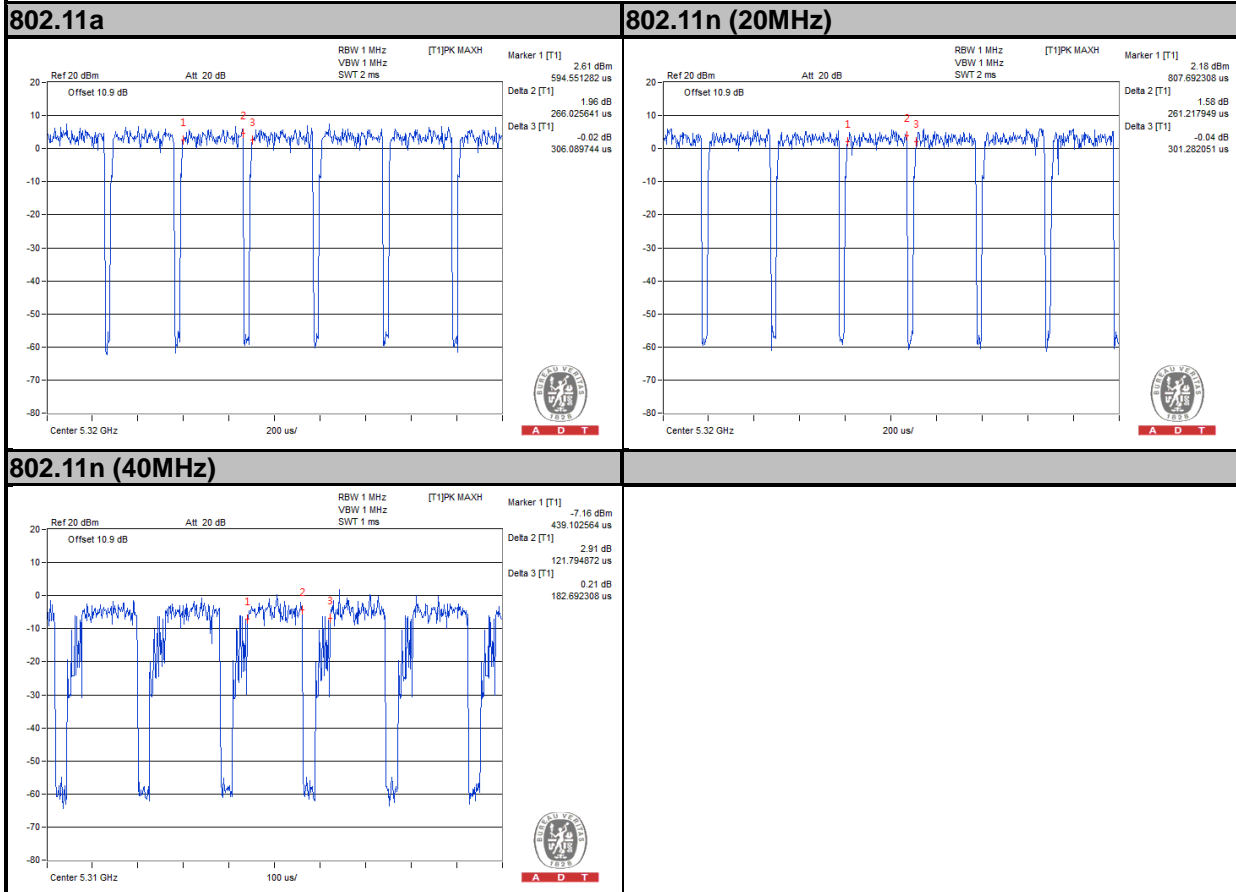
802.11a: Duty cycle = $266.02/306.08 = 0.869$, Duty factor = $10 * \log(1/0.869) = 0.61$
802.11n (20MHz): Duty cycle = $261.21/301.28 = 0.867$, Duty factor = $10 * \log(1/0.867) = 0.62$
802.11n (40MHz): Duty cycle = $121.79/182.69 = 0.667$, Duty factor = $10 * \log(1/0.667) = 1.76$

3.5 GENERAL DESCRIPTION OF APPLIED STANDARDS

The EUT is a RF Product. According to the specifications of the manufacturer, it must comply with the requirements of the following standards:

FCC Part 15, Subpart E (15.407)
789033 D02 General UNII Test Procedures New Rules v01
644545 D01 Guidance for IEEE 802 11ac v01r02

ANSI C63.10-2009

All test items have been performed and recorded as per the above standards.

NOTE: The EUT has been verified to comply with the requirements of FCC Part 15, Subpart B, Class B (DoC). The test report has been issued separately.

4. TEST TYPES AND RESULTS

4.1 RADIATED EMISSION AND BANDEDGE MEASUREMENT

4.1.1 LIMITS OF RADIATED EMISSION AND BANDEDGE MEASUREMENT

Radiated emissions which fall in the restricted bands must comply with the radiated emission limits specified as below table:

FREQUENCIES (MHz)	FIELD STRENGTH (microvolts/meter)	MEASUREMENT DISTANCE (meters)
0.009 ~ 0.490	2400/F(kHz)	300
0.490 ~ 1.705	24000/F(kHz)	30
1.705 ~ 30.0	30	30
30 ~ 88	100	3
88 ~ 216	150	3
216 ~ 960	200	3
Above 960	500	3

NOTE:

1. The lower limit shall apply at the transition frequencies.
2. Emission level (dBuV/m) = 20 log Emission level (uV/m).
3. For frequencies above 1000MHz, the field strength limits are based on average detector, however, the peak field strength of any emission shall not exceed the maximum permitted average limits, specified above by more than 20dB under any condition of modulation.

4.1.2 LIMITS OF UNWANTED EMISSION OUT OF THE RESTRICTED BANDS

APPLICABLE TO	LIMIT	
789033 D02 General UNII Test Procedures New Rules v01	FIELD STRENGTH AT 3m	
	PK: 74 (dBµV/m)	AV: 54 (dBµV/m)
APPLICABLE TO	EIRP LIMIT	EQUIVALENT FIELD STRENGTH AT 3m
15.407(b)(1)	PK: -27 (dBm/MHz)	PK: 68.2 (dBµV/m)
15.407(b)(2)		
15.407(b)(3)		
15.407(b)(4)	PK: -27 (dBm/MHz) ^{*1} PK: -17 (dBm/MHz) ^{*2}	PK: 68.2 (dBµV/m) ^{*1} PK: 78.2 (dBµV/m) ^{*2}

NOTE: ^{*1} beyond 10MHz of the band edge ^{*2} within 10 MHz of band edge

The following formula is used to convert the equipment isotropic radiated power (eirp) to field strength:

$$E = \frac{1000000\sqrt{30P}}{3} \mu\text{V/m, where P is the eirp (Watts).}$$



A D T

4.1.3 TEST INSTRUMENTS

DESCRIPTION & MANUFACTURER	MODEL NO.	SERIAL NO.	DATE OF CALIBRATION	DUE DATE OF CALIBRATION
Test Receiver Agilent	N9038A	MY52260177	May 19, 2014	May 18, 2015
Spectrum Analyzer Agilent	N9010A	MY52220314	Sep. 03, 2014	Sep. 02, 2015
Spectrum Analyzer ROHDE & SCHWARZ	FSU43	101261	Dec. 10, 2014	Dec. 09, 2015
BILOG Antenna SCHWARZBECK	VULB9168	9168-472	Feb. 27, 2014	Feb. 26, 2015
HORN Antenna SCHWARZBECK	BBHA 9120 D	9120D-969	Feb. 19, 2014	Feb. 18, 2015
HORN Antenna SCHWARZBECK	BBHA 9170	9170-480	Aug. 27, 2014	Aug. 26, 2015
Loop Antenna	EM-6879	269	Aug.13, 2014	Aug.12, 2015
Preamplifier EMCI	EMC 012645	980115	Dec. 12, 2014	Dec. 11, 2015
Preamplifier EMCI	EMC 184045	980116	Jan. 09, 2015	Jan. 08, 2016
Preamplifier EMCI	EMC 330H	980112	Dec. 27, 2014	Dec. 26, 2015
Power Meter Anritsu	ML2495A	1232002	Sep. 17, 2014	Sep. 16, 2015
Power Sensor Anritsu	MA2411B	1207325	Sep. 17, 2014	Sep. 16, 2015
RF signal cable HUBER+SUHNNER	SUCOFLEX 104	309219/4 2950114	Oct. 18, 2014	Oct. 17, 2015
RF signal cable HUBER+SUHNNER	SUCOFLEX 104	250130/4	Oct. 18, 2014	Oct. 17, 2015
RF Coaxial Cable Worken	8D-FB	Cable-Ch10-01	Nov. 07, 2014	Nov. 06, 2015
Software BV ADT	E3 6.120103	NA	NA	NA
Antenna Tower MF	MFA-440H	NA	NA	NA
Turn Table MF	MFT-201SS	NA	NA	NA
Antenna Tower & Turn Table Controller MF	MF-7802	NA	NA	NA
Power Meter	ML2495A	1232002	Sep. 17, 2014	Sep. 16, 2015
Power Sensor	MA2411B	1207325	Sep. 17, 2014	Sep. 16, 2015



A D T

- NOTE:**
1. The calibration interval of the above test instruments is 12 months and the calibrations are traceable to NML/ROC and NIST/USA.
 2. The calibration interval of the loop antenna is 24 months and the calibrations are traceable to NML/ROC and NIST/USA.
 3. The test was performed in HwaYa Chamber 10.
 4. The horn antenna and HP preamplifier (model: 8449B) are used only for the measurement of emission frequency above 1GHz if tested.
 5. The FCC Site Registration No. is 690701.
 6. The IC Site Registration No. is IC 7450F-10.

4.1.4 TEST PROCEDURES

- a. The EUT was placed on the top of a rotating table 0.8 meters above the ground at a 3 meters semi-anechoic chamber. The table was rotated 360 degrees to determine the position of the highest radiation.
- b. The EUT was set 3 meters away from the interference-receiving antenna, which was mounted on the top of a variable-height antenna tower.
- c. The antenna is a broadband antenna, and its height is varied from one meter to four meters above the ground to determine the maximum value of the field strength. Both horizontal and vertical polarizations of the antenna are set to make the measurement.
- d. For each suspected emission, the EUT was arranged to its worst case and then the antenna was tuned to heights from 1 meter to 4 meters and the rotatable table was turned from 0 degrees to 360 degrees to find the maximum reading.
- e. The test-receiver system was set to Peak Detect Function and Specified Bandwidth with Maximum Hold Mode.
- f. If the emission level of the EUT in peak mode was 10dB lower than the limit specified, then testing could be stopped and the peak values of the EUT would be reported. Otherwise the emissions that did not have 10dB margin would be re-tested one by one using peak, quasi-peak or average method as specified and then reported in a data sheet.

NOTE:

1. For emission measurements above 1 GHz, the EUT shall be placed at a height of 1.5 m above the ground at 3 meter chamber room for test
2. The resolution bandwidth and video bandwidth of test receiver/spectrum analyzer is 120kHz for Peak detection (PK) and Quasi-peak detection (QP) at frequency below 1GHz.
3. The resolution bandwidth of test receiver/spectrum analyzer is 1MHz and video bandwidth is 3MHz for Peak detection at frequency above 1GHz.
4. The resolution bandwidth of test receiver/spectrum analyzer is 1MHz and the video bandwidth is 1kHz (Duty cycle < 98%) or 10Hz (Duty cycle > 98%) for Average detection (AV) at frequency above 1GHz.
5. All modes of operation were investigated and the worst-case emissions are reported.

4.1.5 DEVIATION FROM TEST STANDARD

No deviation.

4.1.6 TEST SETUP

Frequency Range 30MHz ~ 1GHz

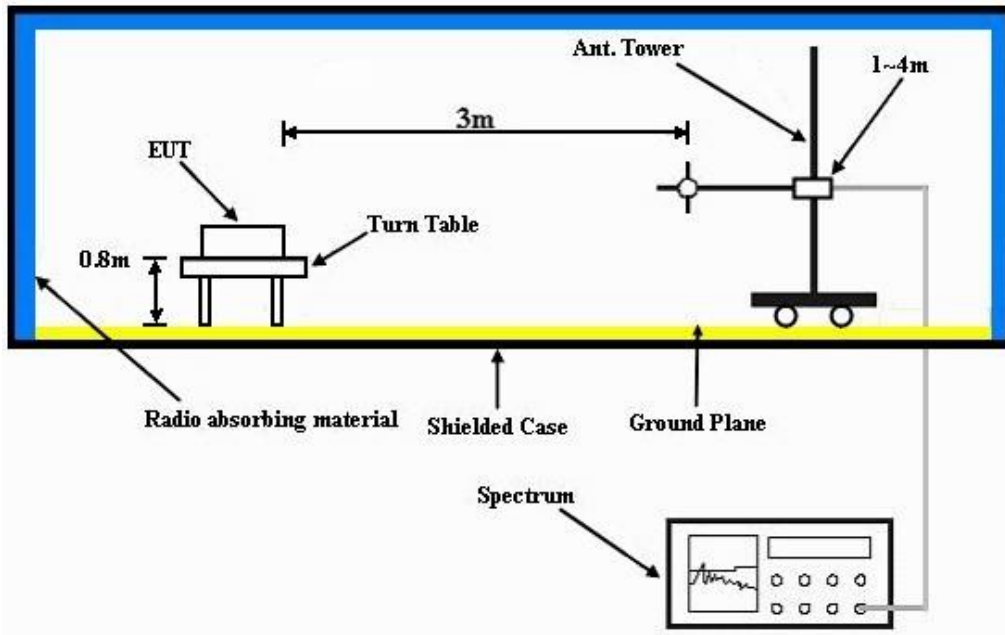

Frequency Range above 1GHz

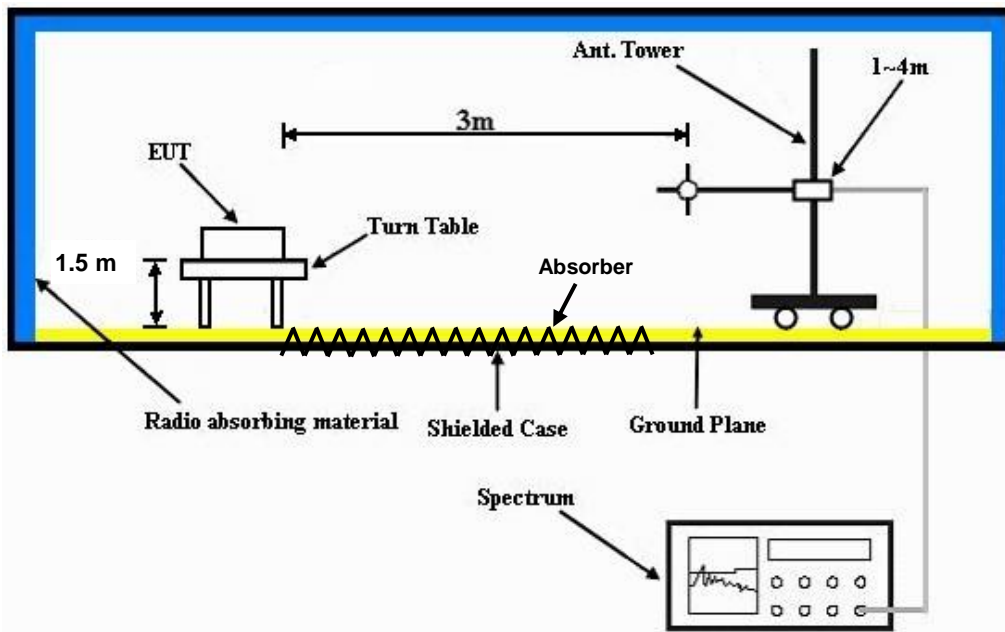

For the actual test configuration, please refer to the attached file (Test Setup Photo).

4.1.7 EUT OPERATING CONDITIONS

- Placed the EUT on a testing table.
- Use the software to control the EUT under transmission condition continuously at specific channel frequency.



4.1.8 TEST RESULTS

ABOVE 1GHz WORST-CASE DATA

802.11a

EUT TEST CONDITION		MEASUREMENT DETAIL	
CHANNEL	Channel 36	FREQUENCY RANGE	1GHz ~ 40GHz
INPUT POWER	120Vac, 60 Hz	DETECTOR FUNCTION	Peak (PK) Average (AV)
ENVIRONMENTAL CONDITIONS	25deg. C, 65%RH	TESTED BY	Gavin Wu

ANTENNA POLARITY & TEST DISTANCE: HORIZONTAL AT 3 M

FREQ. (MHz)	EMISSION LEVEL (dBuV/m)	READ LEVEL (dBuV)	LIMIT (dBuV/m)	MARGIN (dB)	ANTENNA FACTOR (dB/m)	CABLE LOSS (dB)	PREAMP FACTOR (dB)	ANTENNA HEIGHT (cm)	TABLE ANGLE (Degree)	REMARK
5150	43.51	44.22	54	-10.49	31.32	5.29	37.32	105	355	Average
5150	60.96	61.67	74	-13.04	31.32	5.29	37.32	105	355	Peak
5180	96.01	96.69			31.35	5.31	37.34	105	355	Average
5180	105.12	105.8			31.35	5.31	37.34	105	355	Peak
5396	37.82	38.07	54	-16.18	31.52	5.41	37.18	105	355	Average
5396	59.64	59.89	74	-14.36	31.52	5.41	37.18	105	355	Peak
10360	63.11	67.93	68.2	-5.09	39.19	8.13	52.14	117	344	Peak

ANTENNA POLARITY & TEST DISTANCE: VERTICAL AT 3 M

FREQ. (MHz)	EMISSION LEVEL (dBuV/m)	READ LEVEL (dBuV)	LIMIT (dBuV/m)	MARGIN (dB)	ANTENNA FACTOR (dB/m)	CABLE LOSS (dB)	PREAMP FACTOR (dB)	ANTENNA HEIGHT (cm)	TABLE ANGLE (Degree)	REMARK
5122	39.53	40.26	54	-14.47	31.29	5.28	37.3	109	334	Average
5122	59.45	60.18	74	-14.55	31.29	5.28	37.3	109	334	Peak
5180	90.99	91.67			31.35	5.31	37.34	109	334	Average
5180	100.32	101			31.35	5.31	37.34	109	334	Peak
5416	39.22	39.45	54	-14.78	31.53	5.42	37.18	109	334	Average
5416	60.02	60.25	74	-13.98	31.53	5.42	37.18	109	334	Peak
10360	59.91	64.73	68.2	-8.29	39.19	8.13	52.14	101	70	Peak

REMARKS:

- Emission Level = Read Level + Antenna Factor + Cable Loss - Preamp Factor
Margin value = Emission level – Limit value
- 5180MHz: Fundamental frequency.
- 10360MHz: Out of restricted band



A D T

EUT TEST CONDITION		MEASUREMENT DETAIL	
CHANNEL	Channel 44	FREQUENCY RANGE	1GHz ~ 40GHz
INPUT POWER	120Vac, 60 Hz	DETECTOR FUNCTION	Peak (PK) Average (AV)
ENVIRONMENTAL CONDITIONS	25deg. C, 65%RH	TESTED BY	Gavin Wu

ANTENNA POLARITY & TEST DISTANCE: HORIZONTAL AT 3 M										
FREQ. (MHz)	EMISSION LEVEL (dBuV/m)	READ LEVEL (dBuV)	LIMIT (dBuV/m)	MARGIN (dB)	ANTENNA FACTOR (dB/m)	CABLE LOSS (dB)	PREAMP FACTOR (dB)	ANTENNA HEIGHT (cm)	TABLE ANGLE (Degree)	REMARK
5110	39	39.72	54	-15	31.29	5.27	37.28	103	352	Average
5110	59.78	60.5	74	-14.22	31.29	5.27	37.28	103	352	Peak
5220	96.24	96.9			31.37	5.33	37.36	103	352	Average
5220	105.33	105.99			31.37	5.33	37.36	103	352	Peak
5440	39.11	39.25	54	-14.89	31.55	5.44	37.13	103	352	Average
5440	59.6	59.74	74	-14.4	31.55	5.44	37.13	103	352	Peak
10440	64.99	69.99	68.2	-3.21	39.29	8.19	52.48	116	344	Peak
ANTENNA POLARITY & TEST DISTANCE: VERTICAL AT 3 M										
FREQ. (MHz)	EMISSION LEVEL (dBuV/m)	READ LEVEL (dBuV)	LIMIT (dBuV/m)	MARGIN (dB)	ANTENNA FACTOR (dB/m)	CABLE LOSS (dB)	PREAMP FACTOR (dB)	ANTENNA HEIGHT (cm)	TABLE ANGLE (Degree)	REMARK
5026	37.56	38.33	54	-16.44	31.23	5.24	37.24	111	336	Average
5026	60.06	60.83	74	-13.94	31.23	5.24	37.24	111	336	Peak
5220	91.45	92.11			31.37	5.33	37.36	111	336	Average
5220	100.92	101.58			31.37	5.33	37.36	111	336	Peak
5456	39.15	39.23	54	-14.85	31.56	5.44	37.08	111	336	Average
5456	60.14	60.22	74	-13.86	31.56	5.44	37.08	111	336	Peak
10440	60.96	65.96	68.2	-7.24	39.29	8.19	52.48	100	69	Peak

REMARKS:

- Emission Level = Read Level + Antenna Factor + Cable Loss - Preamp Factor
Margin value = Emission level – Limit value
- 5220MHz: Fundamental frequency.
- 10440MHz: Out of restricted band



A D T

EUT TEST CONDITION		MEASUREMENT DETAIL	
CHANNEL	Channel 48	FREQUENCY RANGE	1GHz ~ 40GHz
INPUT POWER	120Vac, 60 Hz	DETECTOR FUNCTION	Peak (PK) Average (AV)
ENVIRONMENTAL CONDITIONS	25deg. C, 65%RH	TESTED BY	Gavin Wu

ANTENNA POLARITY & TEST DISTANCE: HORIZONTAL AT 3 M										
FREQ. (MHz)	EMISSION LEVEL (dBuV/m)	READ LEVEL (dBuV)	LIMIT (dBuV/m)	MARGIN (dB)	ANTENNA FACTOR (dB/m)	CABLE LOSS (dB)	PREAMP FACTOR (dB)	ANTENNA HEIGHT (cm)	TABLE ANGLE (Degree)	REMARK
5090	38.43	39.15	54	-15.57	31.28	5.27	37.27	104	351	Average
5090	59.53	60.25	74	-14.47	31.28	5.27	37.27	104	351	Peak
5240	94.69	95.28			31.39	5.34	37.32	104	351	Average
5240	104.06	104.65			31.39	5.34	37.32	104	351	Peak
5374	38.16	38.45	54	-15.84	31.49	5.4	37.18	104	351	Average
5374	60.26	60.55	74	-13.74	31.49	5.4	37.18	104	351	Peak
10480	64.77	69.91	68.2	-3.43	39.37	8.2	52.71	110	345	Peak
ANTENNA POLARITY & TEST DISTANCE: VERTICAL AT 3 M										
FREQ. (MHz)	EMISSION LEVEL (dBuV/m)	READ LEVEL (dBuV)	LIMIT (dBuV/m)	MARGIN (dB)	ANTENNA FACTOR (dB/m)	CABLE LOSS (dB)	PREAMP FACTOR (dB)	ANTENNA HEIGHT (cm)	TABLE ANGLE (Degree)	REMARK
5126	37.57	38.28	54	-16.43	31.31	5.28	37.3	134	336	Average
5126	59.47	60.18	74	-14.53	31.31	5.28	37.3	134	336	Peak
5240	91.08	91.67			31.39	5.34	37.32	134	336	Average
5240	100.44	101.03			31.39	5.34	37.32	134	336	Peak
5384	38.74	39.01	54	-15.26	31.51	5.4	37.18	134	336	Average
5384	60.17	60.44	74	-13.83	31.51	5.4	37.18	134	336	Peak
10480	62.06	67.2	68.2	-6.14	39.37	8.2	52.71	101	16	Peak

REMARKS:

- Emission Level = Read Level + Antenna Factor + Cable Loss - Preamp Factor
Margin value = Emission level – Limit value
- 5240MHz: Fundamental frequency.
- 10480MHz: Out of restricted band



A D T

EUT TEST CONDITION		MEASUREMENT DETAIL	
CHANNEL	Channel 52	FREQUENCY RANGE	1GHz ~ 40GHz
INPUT POWER	120Vac, 60 Hz	DETECTOR FUNCTION	Peak (PK) Average (AV)
ENVIRONMENTAL CONDITIONS	25deg. C, 65%RH	TESTED BY	Gavin Wu

ANTENNA POLARITY & TEST DISTANCE: HORIZONTAL AT 3 M										
FREQ. (MHz)	EMISSION LEVEL (dBuV/m)	READ LEVEL (dBuV)	LIMIT (dBuV/m)	MARGIN (dB)	ANTENNA FACTOR (dB/m)	CABLE LOSS (dB)	PREAMP FACTOR (dB)	ANTENNA HEIGHT (cm)	TABLE ANGLE (Degree)	REMARK
5058	38.27	39.02	54	-15.73	31.25	5.25	37.25	103	346	Average
5058	59.06	59.81	74	-14.94	31.25	5.25	37.25	103	346	Peak
5260	93.77	94.29			31.41	5.34	37.27	103	346	Average
5260	102.92	103.44			31.41	5.34	37.27	103	346	Peak
5360	39.29	39.6	54	-14.71	31.48	5.39	37.18	103	346	Average
5360	60.01	60.32	74	-13.99	31.48	5.39	37.18	103	346	Peak
10520	52.26	57.43	54	-1.74	39.43	8.23	52.83	118	339	Average
10520	64.21	69.38	74	-9.79	39.43	8.23	52.83	118	339	Peak

ANTENNA POLARITY & TEST DISTANCE: VERTICAL AT 3 M										
FREQ. (MHz)	EMISSION LEVEL (dBuV/m)	READ LEVEL (dBuV)	LIMIT (dBuV/m)	MARGIN (dB)	ANTENNA FACTOR (dB/m)	CABLE LOSS (dB)	PREAMP FACTOR (dB)	ANTENNA HEIGHT (cm)	TABLE ANGLE (Degree)	REMARK
5148	37.57	38.28	54	-16.43	31.32	5.29	37.32	138	69	Average
5148	60.67	61.38	74	-13.33	31.32	5.29	37.32	138	69	Peak
5260	93.06	93.58			31.41	5.34	37.27	138	69	Average
5260	102.35	102.87			31.41	5.34	37.27	138	69	Peak
5350	39.24	39.55	54	-14.76	31.48	5.39	37.18	138	69	Average
5350	60.46	60.77	74	-13.54	31.48	5.39	37.18	138	69	Peak
10520	50.21	55.38	54	-3.79	39.43	8.23	52.83	100	336	Average
10520	61.82	66.99	74	-12.18	39.43	8.23	52.83	100	336	Peak

REMARKS:

- Emission Level = Read Level + Antenna Factor + Cable Loss - Preamp Factor
Margin value = Emission level – Limit value
- 5260MHz: Fundamental frequency.



A D T

EUT TEST CONDITION		MEASUREMENT DETAIL	
CHANNEL	Channel 60	FREQUENCY RANGE	1GHz ~ 40GHz
INPUT POWER	120Vac, 60 Hz	DETECTOR FUNCTION	Peak (PK) Average (AV)
ENVIRONMENTAL CONDITIONS	25deg. C, 65%RH	TESTED BY	Gavin Wu

ANTENNA POLARITY & TEST DISTANCE: HORIZONTAL AT 3 M										
FREQ. (MHz)	EMISSION LEVEL (dBuV/m)	READ LEVEL (dBuV)	LIMIT (dBuV/m)	MARGIN (dB)	ANTENNA FACTOR (dB/m)	CABLE LOSS (dB)	PREAMP FACTOR (dB)	ANTENNA HEIGHT (cm)	TABLE ANGLE (Degree)	REMARK
5112	37.33	38.05	54	-16.67	31.29	5.27	37.28	102	344	Average
5112	59.96	60.68	74	-14.04	31.29	5.27	37.28	102	344	Peak
5300	92.15	92.53			31.44	5.37	37.19	102	344	Average
5300	101.31	101.69			31.44	5.37	37.19	102	344	Peak
5398	39.09	39.34	54	-14.91	31.52	5.41	37.18	102	344	Average
5398	59.38	59.63	74	-14.62	31.52	5.41	37.18	102	344	Peak
10600	52.72	57.28	54	-1.28	39.57	8.28	52.41	116	340	Average
10600	64.34	68.9	74	-9.66	39.57	8.28	52.41	116	340	Peak

ANTENNA POLARITY & TEST DISTANCE: VERTICAL AT 3 M										
FREQ. (MHz)	EMISSION LEVEL (dBuV/m)	READ LEVEL (dBuV)	LIMIT (dBuV/m)	MARGIN (dB)	ANTENNA FACTOR (dB/m)	CABLE LOSS (dB)	PREAMP FACTOR (dB)	ANTENNA HEIGHT (cm)	TABLE ANGLE (Degree)	REMARK
5040	37.25	38	54	-16.75	31.24	5.25	37.24	128	65	Average
5040	59.64	60.39	74	-14.36	31.24	5.25	37.24	128	65	Peak
5300	91.22	91.6			31.44	5.37	37.19	128	65	Average
5300	100.61	100.99			31.44	5.37	37.19	128	65	Peak
5420	39	39.23	54	-15	31.53	5.42	37.18	128	65	Average
5420	59.99	60.22	74	-14.01	31.53	5.42	37.18	128	65	Peak
10600	51.63	56.19	54	-2.37	39.57	8.28	52.41	100	341	Average
10600	62.81	67.37	74	-11.19	39.57	8.28	52.41	100	341	Peak

REMARKS:

- Emission Level = Read Level + Antenna Factor + Cable Loss - Preamp Factor
Margin value = Emission level – Limit value
- 5300MHz: Fundamental frequency.



A D T

EUT TEST CONDITION		MEASUREMENT DETAIL	
CHANNEL	Channel 64	FREQUENCY RANGE	1GHz ~ 40GHz
INPUT POWER	120Vac, 60 Hz	DETECTOR FUNCTION	Peak (PK) Average (AV)
ENVIRONMENTAL CONDITIONS	25deg. C, 65%RH	TESTED BY	Gavin Wu

ANTENNA POLARITY & TEST DISTANCE: HORIZONTAL AT 3 M										
FREQ. (MHz)	EMISSION LEVEL (dBuV/m)	READ LEVEL (dBuV)	LIMIT (dBuV/m)	MARGIN (dB)	ANTENNA FACTOR (dB/m)	CABLE LOSS (dB)	PREAMP FACTOR (dB)	ANTENNA HEIGHT (cm)	TABLE ANGLE (Degree)	REMARK
5046	37.4	38.16	54	-16.6	31.24	5.25	37.25	112	342	Average
5046	59.85	60.61	74	-14.15	31.24	5.25	37.25	112	342	Peak
5320	92.48	92.84			31.45	5.38	37.19	112	342	Average
5320	101.9	102.26			31.45	5.38	37.19	112	342	Peak
5364	39.88	40.17	54	-14.12	31.49	5.4	37.18	112	342	Average
5364	60.45	60.74	74	-13.55	31.49	5.4	37.18	112	342	Peak
10640	52.94	57.27	54	-1.06	39.62	8.32	52.27	102	338	Average
10640	63.88	68.21	74	-10.12	39.62	8.32	52.27	102	338	Peak

ANTENNA POLARITY & TEST DISTANCE: VERTICAL AT 3 M										
FREQ. (MHz)	EMISSION LEVEL (dBuV/m)	READ LEVEL (dBuV)	LIMIT (dBuV/m)	MARGIN (dB)	ANTENNA FACTOR (dB/m)	CABLE LOSS (dB)	PREAMP FACTOR (dB)	ANTENNA HEIGHT (cm)	TABLE ANGLE (Degree)	REMARK
5078	37.27	38.01	54	-16.73	31.27	5.26	37.27	126	60	Average
5078	58.35	59.09	74	-15.65	31.27	5.26	37.27	126	60	Peak
5320	91.59	91.95			31.45	5.38	37.19	126	60	Average
5320	101.09	101.45			31.45	5.38	37.19	126	60	Peak
5386	39.8	40.07	54	-14.2	31.51	5.4	37.18	126	60	Average
5386	58.89	59.16	74	-15.11	31.51	5.4	37.18	126	60	Peak
10640	51.63	55.96	54	-2.37	39.62	8.32	52.27	100	329	Average
10640	62.82	67.15	74	-11.18	39.62	8.32	52.27	100	329	Peak

REMARKS:

- Emission Level = Read Level + Antenna Factor + Cable Loss - Preamp Factor
Margin value = Emission level – Limit value
- 5320MHz: Fundamental frequency.



A D T

EUT TEST CONDITION		MEASUREMENT DETAIL	
CHANNEL	Channel 100	FREQUENCY RANGE	1GHz ~ 40GHz
INPUT POWER	120Vac, 60 Hz	DETECTOR FUNCTION	Peak (PK) Average (AV)
ENVIRONMENTAL CONDITIONS	25deg. C, 65%RH	TESTED BY	Gavin Wu

ANTENNA POLARITY & TEST DISTANCE: HORIZONTAL AT 3 M										
FREQ. (MHz)	EMISSION LEVEL (dBuV/m)	READ LEVEL (dBuV)	LIMIT (dBuV/m)	MARGIN (dB)	ANTENNA FACTOR (dB/m)	CABLE LOSS (dB)	PREAMP FACTOR (dB)	ANTENNA HEIGHT (cm)	TABLE ANGLE (Degree)	REMARK
5446	38.36	38.49	54	-15.64	31.56	5.44	37.13	110	24	Average
5446	59.3	59.43	74	-14.7	31.56	5.44	37.13	110	24	Peak
5470	59.13	59.19	68.2	-9.07	31.57	5.45	37.08	110	24	Peak
5500	91.2	91.17			31.6	5.46	37.03	110	24	Average
5500	100.73	100.7			31.6	5.46	37.03	110	24	Peak
5725	58.2	58.08	68.2	-10	31.96	5.59	37.43	110	24	Peak
11000	46.78	51.47	54	-7.22	40.2	8.56	53.45	120	305	Average
11000	56.66	61.35	74	-17.34	40.2	8.56	53.45	120	305	Peak

ANTENNA POLARITY & TEST DISTANCE: VERTICAL AT 3 M										
FREQ. (MHz)	EMISSION LEVEL (dBuV/m)	READ LEVEL (dBuV)	LIMIT (dBuV/m)	MARGIN (dB)	ANTENNA FACTOR (dB/m)	CABLE LOSS (dB)	PREAMP FACTOR (dB)	ANTENNA HEIGHT (cm)	TABLE ANGLE (Degree)	REMARK
5414	38.85	39.08	54	-15.15	31.53	5.42	37.18	124	52	Average
5414	59.73	59.96	74	-14.27	31.53	5.42	37.18	124	52	Peak
5470	60.57	60.63	68.2	-7.63	31.57	5.45	37.08	124	52	Peak
5500	94.44	94.41			31.6	5.46	37.03	124	52	Average
5500	103.56	103.53			31.6	5.46	37.03	124	52	Peak
5725	59.13	59.01	68.2	-9.07	31.96	5.59	37.43	124	52	Peak
11000	44.76	49.45	54	-9.24	40.2	8.56	53.45	105	66	Average
11000	55.25	59.94	74	-18.75	40.2	8.56	53.45	105	66	Peak

REMARKS:

- Emission Level = Read Level + Antenna Factor + Cable Loss - Preamp Factor
Margin value = Emission level – Limit value
- 5500MHz: Fundamental frequency.
- 5470MHz & 5725MHz: Out of restricted band



A D T

EUT TEST CONDITION		MEASUREMENT DETAIL	
CHANNEL	Channel 116	FREQUENCY RANGE	1GHz ~ 40GHz
INPUT POWER	120Vac, 60 Hz	DETECTOR FUNCTION	Peak (PK) Average (AV)
ENVIRONMENTAL CONDITIONS	25deg. C, 65%RH	TESTED BY	Gavin Wu

ANTENNA POLARITY & TEST DISTANCE: HORIZONTAL AT 3 M										
FREQ. (MHz)	EMISSION LEVEL (dBuV/m)	READ LEVEL (dBuV)	LIMIT (dBuV/m)	MARGIN (dB)	ANTENNA FACTOR (dB/m)	CABLE LOSS (dB)	PREAMP FACTOR (dB)	ANTENNA HEIGHT (cm)	TABLE ANGLE (Degree)	REMARK
5372	38.16	38.45	54	-15.84	31.49	5.4	37.18	109	22	Average
5372	60.88	61.17	74	-13.12	31.49	5.4	37.18	109	22	Peak
5470	57.83	57.89	68.2	-10.37	31.57	5.45	37.08	109	22	Peak
5580	94.09	94.04			31.71	5.5	37.16	109	22	Average
5580	103.92	103.87			31.71	5.5	37.16	109	22	Peak
5725	58.88	58.76	68.2	-9.32	31.96	5.59	37.43	109	22	Peak
11160	51.46	56.04	54	-2.54	40.1	8.71	53.39	108	337	Average
11160	61.77	66.35	74	-12.23	40.1	8.71	53.39	108	337	Peak

ANTENNA POLARITY & TEST DISTANCE: VERTICAL AT 3 M										
FREQ. (MHz)	EMISSION LEVEL (dBuV/m)	READ LEVEL (dBuV)	LIMIT (dBuV/m)	MARGIN (dB)	ANTENNA FACTOR (dB/m)	CABLE LOSS (dB)	PREAMP FACTOR (dB)	ANTENNA HEIGHT (cm)	TABLE ANGLE (Degree)	REMARK
5428	38.67	38.85	54	-15.33	31.53	5.42	37.13	123	52	Average
5428	59.53	59.71	74	-14.47	31.53	5.42	37.13	123	52	Peak
5470	58.31	58.37	68.2	-9.89	31.57	5.45	37.08	123	52	Peak
5580	95.74	95.69			31.71	5.5	37.16	123	52	Average
5580	105.4	105.35			31.71	5.5	37.16	123	52	Peak
5725	59.9	59.78	68.2	-8.3	31.96	5.59	37.43	123	52	Peak
11160	51.61	56.19	54	-2.39	40.1	8.71	53.39	111	68	Average
11160	62.67	67.25	74	-11.33	40.1	8.71	53.39	111	68	Peak

REMARKS:

- Emission Level = Read Level + Antenna Factor + Cable Loss - Preamp Factor
Margin value = Emission level – Limit value
- 5580MHz: Fundamental frequency.
- 5470MHz & 5725MHz: Out of restricted band



A D T

EUT TEST CONDITION		MEASUREMENT DETAIL	
CHANNEL	Channel 140	FREQUENCY RANGE	1GHz ~ 40GHz
INPUT POWER	120Vac, 60 Hz	DETECTOR FUNCTION	Peak (PK) Average (AV)
ENVIRONMENTAL CONDITIONS	25deg. C, 65%RH	TESTED BY	Gavin Wu

ANTENNA POLARITY & TEST DISTANCE: HORIZONTAL AT 3 M

FREQ. (MHz)	EMISSION LEVEL (dBuV/m)	READ LEVEL (dBuV)	LIMIT (dBuV/m)	MARGIN (dB)	ANTENNA FACTOR (dB/m)	CABLE LOSS (dB)	PREAMP FACTOR (dB)	ANTENNA HEIGHT (cm)	TABLE ANGLE (Degree)	REMARK
5460	38.15	38.23	54	-15.85	31.56	5.44	37.08	106	22	Average
5460	60.06	60.14	74	-13.94	31.56	5.44	37.08	106	22	Peak
5470	58.85	58.91	68.2	-9.35	31.57	5.45	37.08	106	22	Peak
5700	93.94	93.87			31.9	5.57	37.4	106	22	Average
5700	103.68	103.61			31.9	5.57	37.4	106	22	Peak
5725	62.05	61.93	68.2	-6.15	31.96	5.59	37.43	106	22	Peak
11400	52.87	56.09	54	-1.13	39.96	8.95	52.13	106	346	Average
11400	63.06	66.28	74	-10.94	39.96	8.95	52.13	106	346	Peak

ANTENNA POLARITY & TEST DISTANCE: VERTICAL AT 3 M

FREQ. (MHz)	EMISSION LEVEL (dBuV/m)	READ LEVEL (dBuV)	LIMIT (dBuV/m)	MARGIN (dB)	ANTENNA FACTOR (dB/m)	CABLE LOSS (dB)	PREAMP FACTOR (dB)	ANTENNA HEIGHT (cm)	TABLE ANGLE (Degree)	REMARK
5430	38.34	38.5	54	-15.66	31.55	5.42	37.13	124	340	Average
5430	59.97	60.13	74	-14.03	31.55	5.42	37.13	124	340	Peak
5470	58.87	58.93	68.2	-9.33	31.57	5.45	37.08	124	340	Peak
5700	96.2	96.13			31.9	5.57	37.4	124	340	Average
5700	105.95	105.88			31.9	5.57	37.4	124	340	Peak
5725	65.7	65.58	68.2	-2.5	31.96	5.59	37.43	124	340	Peak
11400	52.97	56.19	54	-1.03	39.96	8.95	52.13	150	64	Average
11400	63.98	67.2	74	-10.02	39.96	8.95	52.13	150	64	Peak

REMARKS:

- Emission Level = Read Level + Antenna Factor + Cable Loss - Preamp Factor
Margin value = Emission level – Limit value
- 5700MHz: Fundamental frequency.
- 5470MHz & 5725MHz: Out of restricted band



A D T

EUT TEST CONDITION		MEASUREMENT DETAIL	
CHANNEL	Channel 149	FREQUENCY RANGE	1GHz ~ 40GHz
INPUT POWER	120Vac, 60 Hz	DETECTOR FUNCTION	Peak (PK) Average (AV)
ENVIRONMENTAL CONDITIONS	25deg. C, 65%RH	TESTED BY	Gavin Wu

ANTENNA POLARITY & TEST DISTANCE: HORIZONTAL AT 3 M

FREQ. (MHz)	EMISSION LEVEL (dBuV/m)	READ LEVEL (dBuV)	LIMIT (dBuV/m)	MARGIN (dB)	ANTENNA FACTOR (dB/m)	CABLE LOSS (dB)	PREAMP FACTOR (dB)	ANTENNA HEIGHT (cm)	TABLE ANGLE (Degree)	REMARK
5714	63.71	63.62	68.2	-4.49	31.93	5.59	37.43	115	16	Peak
5725	72.52	72.4	78.2	-5.68	31.96	5.59	37.43	115	16	Peak
5745	94.21	94.09			31.99	5.6	37.47	115	16	Average
5745	103.61	103.49			31.99	5.6	37.47	115	16	Peak
5850	58.87	58.57	78.2	-19.33	32.15	5.66	37.51	115	16	Peak
5861	58.01	57.67	68.2	-10.19	32.18	5.66	37.5	115	16	Peak
11490	52.94	56.81	54	-1.06	39.91	9.05	52.83	110	356	Average
11490	65.53	69.4	74	-8.47	39.91	9.05	52.83	110	356	Peak

ANTENNA POLARITY & TEST DISTANCE: VERTICAL AT 3 M

FREQ. (MHz)	EMISSION LEVEL (dBuV/m)	READ LEVEL (dBuV)	LIMIT (dBuV/m)	MARGIN (dB)	ANTENNA FACTOR (dB/m)	CABLE LOSS (dB)	PREAMP FACTOR (dB)	ANTENNA HEIGHT (cm)	TABLE ANGLE (Degree)	REMARK
5714	63.32	63.23	68.2	-4.88	31.93	5.59	37.43	110	344	Peak
5725	74.4	74.28	78.2	-3.8	31.96	5.59	37.43	110	344	Peak
5745	94.91	94.79			31.99	5.6	37.47	110	344	Average
5745	104.33	104.21			31.99	5.6	37.47	110	344	Peak
5850	59.15	58.85	78.2	-19.05	32.15	5.66	37.51	110	344	Peak
5861	58.49	58.15	68.2	-9.71	32.18	5.66	37.5	110	344	Peak
11490	48.45	52.32	54	-5.55	39.91	9.05	52.83	101	27	Average
11490	61.64	65.51	74	-12.36	39.91	9.05	52.83	101	27	Peak

REMARKS:

- Emission Level = Read Level + Antenna Factor + Cable Loss - Preamp Factor
Margin value = Emission level – Limit value
- 5745MHz: Fundamental frequency.
- 5714MHz & 5725MHz & 5850MHz & 5861MHz: Out of restricted band



A D T

EUT TEST CONDITION		MEASUREMENT DETAIL	
CHANNEL	Channel 157	FREQUENCY RANGE	1GHz ~ 40GHz
INPUT POWER	120Vac, 60 Hz	DETECTOR FUNCTION	Peak (PK) Average (AV)
ENVIRONMENTAL CONDITIONS	25deg. C, 65%RH	TESTED BY	Gavin Wu

ANTENNA POLARITY & TEST DISTANCE: HORIZONTAL AT 3 M

FREQ. (MHz)	EMISSION LEVEL (dBuV/m)	READ LEVEL (dBuV)	LIMIT (dBuV/m)	MARGIN (dB)	ANTENNA FACTOR (dB/m)	CABLE LOSS (dB)	PREAMP FACTOR (dB)	ANTENNA HEIGHT (cm)	TABLE ANGLE (Degree)	REMARK
5714	59.04	58.95	68.2	-9.16	31.93	5.59	37.43	114	16	Peak
5724	59.83	59.71	78.2	-18.37	31.96	5.59	37.43	114	16	Peak
5785	94.77	94.65			32.04	5.62	37.54	114	16	Average
5785	104.07	103.95			32.04	5.62	37.54	114	16	Peak
5850	58.77	58.47	78.2	-19.43	32.15	5.66	37.51	114	16	Peak
5861	59.15	58.81	68.2	-9.05	32.18	5.66	37.5	114	16	Peak
11570	52.63	57.09	54	-1.37	39.78	9.09	53.33	108	356	Average
11570	63.56	68.02	74	-10.44	39.78	9.09	53.33	108	356	Peak

ANTENNA POLARITY & TEST DISTANCE: VERTICAL AT 3 M

FREQ. (MHz)	EMISSION LEVEL (dBuV/m)	READ LEVEL (dBuV)	LIMIT (dBuV/m)	MARGIN (dB)	ANTENNA FACTOR (dB/m)	CABLE LOSS (dB)	PREAMP FACTOR (dB)	ANTENNA HEIGHT (cm)	TABLE ANGLE (Degree)	REMARK
5714	60	59.91	68.2	-8.2	31.93	5.59	37.43	109	345	Peak
5724	58.96	58.84	78.2	-19.24	31.96	5.59	37.43	109	345	Peak
5785	94.28	94.16			32.04	5.62	37.54	109	345	Average
5785	103.63	103.51			32.04	5.62	37.54	109	345	Peak
5850	58.85	58.55	78.2	-19.35	32.15	5.66	37.51	109	345	Peak
5861	60.9	60.56	68.2	-7.3	32.18	5.66	37.5	109	345	Peak
11570	48.72	53.18	54	-5.28	39.78	9.09	53.33	116	54	Average
11570	60.47	64.93	74	-13.53	39.78	9.09	53.33	116	54	Peak

REMARKS:

- Emission Level = Read Level + Antenna Factor + Cable Loss - Preamp Factor
Margin value = Emission level – Limit value
- 5785MHz: Fundamental frequency.
- 5714MHz & 5725MHz & 5850MHz & 5861MHz: Out of restricted band



A D T

EUT TEST CONDITION		MEASUREMENT DETAIL	
CHANNEL	Channel 165	FREQUENCY RANGE	1GHz ~ 40GHz
INPUT POWER	120Vac, 60 Hz	DETECTOR FUNCTION	Peak (PK) Average (AV)
ENVIRONMENTAL CONDITIONS	25deg. C, 65%RH	TESTED BY	Gavin Wu

ANTENNA POLARITY & TEST DISTANCE: HORIZONTAL AT 3 M

FREQ. (MHz)	EMISSION LEVEL (dBuV/m)	READ LEVEL (dBuV)	LIMIT (dBuV/m)	MARGIN (dB)	ANTENNA FACTOR (dB/m)	CABLE LOSS (dB)	PREAMP FACTOR (dB)	ANTENNA HEIGHT (cm)	TABLE ANGLE (Degree)	REMARK
5714	58.88	58.79	68.2	-9.32	31.93	5.59	37.43	104	15	Peak
5724	57.83	57.71	78.2	-20.37	31.96	5.59	37.43	104	15	Peak
5825	93.81	93.58			32.12	5.64	37.53	104	15	Average
5825	103.08	102.85			32.12	5.64	37.53	104	15	Peak
5850	59.43	59.13	78.2	-18.77	32.15	5.66	37.51	104	15	Peak
5861	58.59	58.25	68.2	-9.61	32.18	5.66	37.5	104	15	Peak
11650	52.23	56.81	54	-1.77	39.65	9.12	53.35	102	356	Average
11650	64.36	68.94	74	-9.64	39.65	9.12	53.35	102	356	Peak

ANTENNA POLARITY & TEST DISTANCE: VERTICAL AT 3 M

FREQ. (MHz)	EMISSION LEVEL (dBuV/m)	READ LEVEL (dBuV)	LIMIT (dBuV/m)	MARGIN (dB)	ANTENNA FACTOR (dB/m)	CABLE LOSS (dB)	PREAMP FACTOR (dB)	ANTENNA HEIGHT (cm)	TABLE ANGLE (Degree)	REMARK
5714	58.9	58.81	68.2	-9.3	31.93	5.59	37.43	109	342	Peak
5724	58.85	58.73	78.2	-19.35	31.96	5.59	37.43	109	342	Peak
5825	91.55	91.32			32.12	5.64	37.53	109	342	Average
5825	100.93	100.7			32.12	5.64	37.53	109	342	Peak
5850	59.81	59.51	78.2	-18.39	32.15	5.66	37.51	109	342	Peak
5861	58.42	58.08	68.2	-9.78	32.18	5.66	37.5	109	342	Peak
11650	48.11	52.69	54	-5.89	39.65	9.12	53.35	116	51	Average
11650	59.95	64.53	74	-14.05	39.65	9.12	53.35	116	51	Peak

REMARKS:

- Emission Level = Read Level + Antenna Factor + Cable Loss - Preamp Factor
Margin value = Emission level – Limit value
- 5825MHz: Fundamental frequency.
- 5714MHz & 5724MHz & 5850MHz & 5861MHz: Out of restricted band



A D T

802.11n (20MHz)

EUT TEST CONDITION		MEASUREMENT DETAIL	
CHANNEL	Channel 36	FREQUENCY RANGE	1GHz ~ 40GHz
INPUT POWER	120Vac, 60 Hz	DETECTOR FUNCTION	Peak (PK) Average (AV)
ENVIRONMENTAL CONDITIONS	25deg. C, 65%RH	TESTED BY	Gavin Wu

ANTENNA POLARITY & TEST DISTANCE: HORIZONTAL AT 3 M

FREQ. (MHz)	EMISSION LEVEL (dBuV/m)	READ LEVEL (dBuV)	LIMIT (dBuV/m)	MARGIN (dB)	ANTENNA FACTOR (dB/m)	CABLE LOSS (dB)	PREAMP FACTOR (dB)	ANTENNA HEIGHT (cm)	TABLE ANGLE (Degree)	REMARK
5112	40.49	41.21	54	-13.51	31.29	5.27	37.28	105	353	Average
5112	59.98	60.7	74	-14.02	31.29	5.27	37.28	105	353	Peak
5180	93.1	93.78			31.35	5.31	37.34	105	353	Average
5180	102.64	103.32			31.35	5.31	37.34	105	353	Peak
5420	38.01	38.24	54	-15.99	31.53	5.42	37.18	105	353	Average
5420	60.09	60.32	74	-13.91	31.53	5.42	37.18	105	353	Peak
10360	61.69	66.51	68.2	-6.51	39.19	8.13	52.14	110	339	Peak

ANTENNA POLARITY & TEST DISTANCE: VERTICAL AT 3 M

FREQ. (MHz)	EMISSION LEVEL (dBuV/m)	READ LEVEL (dBuV)	LIMIT (dBuV/m)	MARGIN (dB)	ANTENNA FACTOR (dB/m)	CABLE LOSS (dB)	PREAMP FACTOR (dB)	ANTENNA HEIGHT (cm)	TABLE ANGLE (Degree)	REMARK
5076	38.3	39.04	54	-15.7	31.27	5.26	37.27	110	333	Average
5076	60.51	61.25	74	-13.49	31.27	5.26	37.27	110	333	Peak
5180	88.77	89.45			31.35	5.31	37.34	110	333	Average
5180	98.71	99.39			31.35	5.31	37.34	110	333	Peak
5452	39.21	39.29	54	-14.79	31.56	5.44	37.08	110	333	Average
5452	60.08	60.16	74	-13.92	31.56	5.44	37.08	110	333	Peak
10360	57.1	61.92	68.2	-11.1	39.19	8.13	52.14	113	70	Peak

REMARKS:

- Emission Level = Read Level + Antenna Factor + Cable Loss - Preamp Factor
Margin value = Emission level – Limit value
- 5180MHz: Fundamental frequency.
- 10360MHz: Out of restricted band



A D T

EUT TEST CONDITION		MEASUREMENT DETAIL	
CHANNEL	Channel 44	FREQUENCY RANGE	1GHz ~ 40GHz
INPUT POWER	120Vac, 60 Hz	DETECTOR FUNCTION	Peak (PK) Average (AV)
ENVIRONMENTAL CONDITIONS	25deg. C, 65%RH	TESTED BY	Gavin Wu

ANTENNA POLARITY & TEST DISTANCE: HORIZONTAL AT 3 M										
FREQ. (MHz)	EMISSION LEVEL (dBuV/m)	READ LEVEL (dBuV)	LIMIT (dBuV/m)	MARGIN (dB)	ANTENNA FACTOR (dB/m)	CABLE LOSS (dB)	PREAMP FACTOR (dB)	ANTENNA HEIGHT (cm)	TABLE ANGLE (Degree)	REMARK
5044	37.98	38.74	54	-16.02	31.24	5.25	37.25	103	352	Average
5044	60.02	60.78	74	-13.98	31.24	5.25	37.25	103	352	Peak
5220	92.47	93.13			31.37	5.33	37.36	103	352	Average
5220	102.02	102.68			31.37	5.33	37.36	103	352	Peak
5428	38.07	38.25	54	-15.93	31.53	5.42	37.13	103	352	Average
5428	59.8	59.98	74	-14.2	31.53	5.42	37.13	103	352	Peak
10440	60.82	65.82	68.2	-7.38	39.29	8.19	52.48	116	344	Peak
ANTENNA POLARITY & TEST DISTANCE: VERTICAL AT 3 M										
FREQ. (MHz)	EMISSION LEVEL (dBuV/m)	READ LEVEL (dBuV)	LIMIT (dBuV/m)	MARGIN (dB)	ANTENNA FACTOR (dB/m)	CABLE LOSS (dB)	PREAMP FACTOR (dB)	ANTENNA HEIGHT (cm)	TABLE ANGLE (Degree)	REMARK
5120	37.62	38.35	54	-16.38	31.29	5.28	37.3	111	335	Average
5120	59.65	60.38	74	-14.35	31.29	5.28	37.3	111	335	Peak
5220	88.82	89.48			31.37	5.33	37.36	111	335	Average
5220	98.2	98.86			31.37	5.33	37.36	111	335	Peak
5432	38.31	38.47	54	-15.69	31.55	5.42	37.13	111	335	Average
5432	59.48	59.64	74	-14.52	31.55	5.42	37.13	111	335	Peak
10440	56.94	61.94	68.2	-11.26	39.29	8.19	52.48	112	70	Peak

REMARKS:

- Emission Level = Read Level + Antenna Factor + Cable Loss - Preamp Factor
Margin value = Emission level – Limit value
- 5220MHz: Fundamental frequency.
- 10440MHz: Out of restricted band



A D T

EUT TEST CONDITION		MEASUREMENT DETAIL	
CHANNEL	Channel 48	FREQUENCY RANGE	1GHz ~ 40GHz
INPUT POWER	120Vac, 60 Hz	DETECTOR FUNCTION	Peak (PK) Average (AV)
ENVIRONMENTAL CONDITIONS	25deg. C, 65%RH	TESTED BY	Gavin Wu

ANTENNA POLARITY & TEST DISTANCE: HORIZONTAL AT 3 M										
FREQ. (MHz)	EMISSION LEVEL (dBuV/m)	READ LEVEL (dBuV)	LIMIT (dBuV/m)	MARGIN (dB)	ANTENNA FACTOR (dB/m)	CABLE LOSS (dB)	PREAMP FACTOR (dB)	ANTENNA HEIGHT (cm)	TABLE ANGLE (Degree)	REMARK
5086	37.85	38.59	54	-16.15	31.27	5.26	37.27	103	352	Average
5086	59.02	59.76	74	-14.98	31.27	5.26	37.27	103	352	Peak
5240	92.64	93.23			31.39	5.34	37.32	103	352	Average
5240	102.17	102.76			31.39	5.34	37.32	103	352	Peak
5404	38	38.25	54	-16	31.52	5.41	37.18	103	352	Average
5404	59.71	59.96	74	-14.29	31.52	5.41	37.18	103	352	Peak
10480	60.83	65.97	68.2	-7.37	39.37	8.2	52.71	116	344	Peak
ANTENNA POLARITY & TEST DISTANCE: VERTICAL AT 3 M										
FREQ. (MHz)	EMISSION LEVEL (dBuV/m)	READ LEVEL (dBuV)	LIMIT (dBuV/m)	MARGIN (dB)	ANTENNA FACTOR (dB/m)	CABLE LOSS (dB)	PREAMP FACTOR (dB)	ANTENNA HEIGHT (cm)	TABLE ANGLE (Degree)	REMARK
5150	37.39	38.1	54	-16.61	31.32	5.29	37.32	100	337	Average
5150	60.38	61.09	74	-13.62	31.32	5.29	37.32	100	337	Peak
5240	88.73	89.32			31.39	5.34	37.32	100	337	Average
5240	98.27	98.86			31.39	5.34	37.32	100	337	Peak
5410	38.07	38.32	54	-15.93	31.52	5.41	37.18	100	337	Average
5410	59.99	60.24	74	-14.01	31.52	5.41	37.18	100	337	Peak
10480	59.77	64.91	68.2	-8.43	39.37	8.2	52.71	112	68	Peak

REMARKS:

- Emission Level = Read Level + Antenna Factor + Cable Loss - Preamp Factor
Margin value = Emission level – Limit value
- 5240MHz: Fundamental frequency.
- 10480MHz: Out of restricted band



A D T

EUT TEST CONDITION		MEASUREMENT DETAIL	
CHANNEL	Channel 52	FREQUENCY RANGE	1GHz ~ 40GHz
INPUT POWER	120Vac, 60 Hz	DETECTOR FUNCTION	Peak (PK) Average (AV)
ENVIRONMENTAL CONDITIONS	25deg. C, 65%RH	TESTED BY	Gavin Wu

ANTENNA POLARITY & TEST DISTANCE: HORIZONTAL AT 3 M										
FREQ. (MHz)	EMISSION LEVEL (dBuV/m)	READ LEVEL (dBuV)	LIMIT (dBuV/m)	MARGIN (dB)	ANTENNA FACTOR (dB/m)	CABLE LOSS (dB)	PREAMP FACTOR (dB)	ANTENNA HEIGHT (cm)	TABLE ANGLE (Degree)	REMARK
5130	38.13	38.84	54	-15.87	31.31	5.28	37.3	103	342	Average
5130	59.96	60.67	74	-14.04	31.31	5.28	37.3	103	342	Peak
5260	90.42	90.94			31.41	5.34	37.27	103	342	Average
5260	99.62	100.14			31.41	5.34	37.27	103	342	Peak
5448	39.11	39.24	54	-14.89	31.56	5.44	37.13	103	342	Average
5448	59.14	59.27	74	-14.86	31.56	5.44	37.13	103	342	Peak
10520	47.72	52.89	54	-6.28	39.43	8.23	52.83	129	349	Average
10520	61.24	66.41	74	-12.76	39.43	8.23	52.83	129	349	Peak

ANTENNA POLARITY & TEST DISTANCE: VERTICAL AT 3 M										
FREQ. (MHz)	EMISSION LEVEL (dBuV/m)	READ LEVEL (dBuV)	LIMIT (dBuV/m)	MARGIN (dB)	ANTENNA FACTOR (dB/m)	CABLE LOSS (dB)	PREAMP FACTOR (dB)	ANTENNA HEIGHT (cm)	TABLE ANGLE (Degree)	REMARK
5038	37.28	38.03	54	-16.72	31.24	5.25	37.24	127	68	Average
5038	59.4	60.15	74	-14.6	31.24	5.25	37.24	127	68	Peak
5260	89.39	89.91			31.41	5.34	37.27	127	68	Average
5260	98.86	99.38			31.41	5.34	37.27	127	68	Peak
5418	38.8	39.03	54	-15.2	31.53	5.42	37.18	127	68	Average
5418	59.22	59.45	74	-14.78	31.53	5.42	37.18	127	68	Peak
10520	46.67	51.84	54	-7.33	39.43	8.23	52.83	100	343	Average
10520	60.58	65.75	74	-13.42	39.43	8.23	52.83	100	343	Peak

REMARKS:

- Emission Level = Read Level + Antenna Factor + Cable Loss - Preamp Factor
Margin value = Emission level – Limit value
- 5260MHz: Fundamental frequency.



A D T

EUT TEST CONDITION		MEASUREMENT DETAIL	
CHANNEL	Channel 60	FREQUENCY RANGE	1GHz ~ 40GHz
INPUT POWER	120Vac, 60 Hz	DETECTOR FUNCTION	Peak (PK) Average (AV)
ENVIRONMENTAL CONDITIONS	25deg. C, 65%RH	TESTED BY	Gavin Wu

ANTENNA POLARITY & TEST DISTANCE: HORIZONTAL AT 3 M										
FREQ. (MHz)	EMISSION LEVEL (dBuV/m)	READ LEVEL (dBuV)	LIMIT (dBuV/m)	MARGIN (dB)	ANTENNA FACTOR (dB/m)	CABLE LOSS (dB)	PREAMP FACTOR (dB)	ANTENNA HEIGHT (cm)	TABLE ANGLE (Degree)	REMARK
5062	37.48	38.23	54	-16.52	31.25	5.25	37.25	102	341	Average
5062	59.64	60.39	74	-14.36	31.25	5.25	37.25	102	341	Peak
5300	89.72	90.1			31.44	5.37	37.19	102	341	Average
5300	99.11	99.49			31.44	5.37	37.19	102	341	Peak
5422	39.19	39.42	54	-14.81	31.53	5.42	37.18	102	341	Average
5422	59.41	59.64	74	-14.59	31.53	5.42	37.18	102	341	Peak
10600	51.28	55.84	54	-2.72	39.57	8.28	52.41	116	341	Average
10600	64.05	68.61	74	-9.95	39.57	8.28	52.41	116	341	Peak

ANTENNA POLARITY & TEST DISTANCE: VERTICAL AT 3 M										
FREQ. (MHz)	EMISSION LEVEL (dBuV/m)	READ LEVEL (dBuV)	LIMIT (dBuV/m)	MARGIN (dB)	ANTENNA FACTOR (dB/m)	CABLE LOSS (dB)	PREAMP FACTOR (dB)	ANTENNA HEIGHT (cm)	TABLE ANGLE (Degree)	REMARK
5022	37.24	38.01	54	-16.76	31.23	5.24	37.24	126	66	Average
5022	59.07	59.84	74	-14.93	31.23	5.24	37.24	126	66	Peak
5300	89.35	89.73			31.44	5.37	37.19	126	66	Average
5300	98.67	99.05			31.44	5.37	37.19	126	66	Peak
5444	39.04	39.18	54	-14.96	31.55	5.44	37.13	126	66	Average
5444	59.55	59.69	74	-14.45	31.55	5.44	37.13	126	66	Peak
10600	48.05	52.61	54	-5.95	39.57	8.28	52.41	100	322	Average
10600	59.87	64.43	74	-14.13	39.57	8.28	52.41	100	322	Peak

REMARKS:

- Emission Level = Read Level + Antenna Factor + Cable Loss - Preamp Factor
Margin value = Emission level – Limit value
- 5300MHz: Fundamental frequency.



A D T

EUT TEST CONDITION		MEASUREMENT DETAIL	
CHANNEL	Channel 64	FREQUENCY RANGE	1GHz ~ 40GHz
INPUT POWER	120Vac, 60 Hz	DETECTOR FUNCTION	Peak (PK) Average (AV)
ENVIRONMENTAL CONDITIONS	25deg. C, 65%RH	TESTED BY	Gavin Wu

ANTENNA POLARITY & TEST DISTANCE: HORIZONTAL AT 3 M										
FREQ. (MHz)	EMISSION LEVEL (dBuV/m)	READ LEVEL (dBuV)	LIMIT (dBuV/m)	MARGIN (dB)	ANTENNA FACTOR (dB/m)	CABLE LOSS (dB)	PREAMP FACTOR (dB)	ANTENNA HEIGHT (cm)	TABLE ANGLE (Degree)	REMARK
5100	37.69	38.42	54	-16.31	31.28	5.27	37.28	102	343	Average
5100	58.57	59.3	74	-15.43	31.28	5.27	37.28	102	343	Peak
5320	90.1	90.46			31.45	5.38	37.19	102	343	Average
5320	99.63	99.99			31.45	5.38	37.19	102	343	Peak
5438	39.84	39.98	54	-14.16	31.55	5.44	37.13	102	343	Average
5438	59.82	59.96	74	-14.18	31.55	5.44	37.13	102	343	Peak
10640	51.2	55.53	54	-2.8	39.62	8.32	52.27	122	339	Average
10640	64.62	68.95	74	-9.38	39.62	8.32	52.27	122	339	Peak

ANTENNA POLARITY & TEST DISTANCE: VERTICAL AT 3 M										
FREQ. (MHz)	EMISSION LEVEL (dBuV/m)	READ LEVEL (dBuV)	LIMIT (dBuV/m)	MARGIN (dB)	ANTENNA FACTOR (dB/m)	CABLE LOSS (dB)	PREAMP FACTOR (dB)	ANTENNA HEIGHT (cm)	TABLE ANGLE (Degree)	REMARK
5060	37.29	38.04	54	-16.71	31.25	5.25	37.25	125	65	Average
5060	57.73	58.48	74	-16.27	31.25	5.25	37.25	125	65	Peak
5320	89.93	90.29			31.45	5.38	37.19	125	65	Average
5320	98.99	99.35			31.45	5.38	37.19	125	65	Peak
5402	39.23	39.48	54	-14.77	31.52	5.41	37.18	125	65	Average
5402	58.71	58.96	74	-15.29	31.52	5.41	37.18	125	65	Peak
10640	48.86	53.19	54	-5.14	39.62	8.32	52.27	100	333	Average
10640	61.77	66.1	74	-12.23	39.62	8.32	52.27	100	333	Peak

REMARKS:

- Emission Level = Read Level + Antenna Factor + Cable Loss - Preamp Factor
Margin value = Emission level – Limit value
- 5320MHz: Fundamental frequency.



A D T

EUT TEST CONDITION		MEASUREMENT DETAIL	
CHANNEL	Channel 100	FREQUENCY RANGE	1GHz ~ 40GHz
INPUT POWER	120Vac, 60 Hz	DETECTOR FUNCTION	Peak (PK) Average (AV)
ENVIRONMENTAL CONDITIONS	25deg. C, 65%RH	TESTED BY	Gavin Wu

ANTENNA POLARITY & TEST DISTANCE: HORIZONTAL AT 3 M										
FREQ. (MHz)	EMISSION LEVEL (dBuV/m)	READ LEVEL (dBuV)	LIMIT (dBuV/m)	MARGIN (dB)	ANTENNA FACTOR (dB/m)	CABLE LOSS (dB)	PREAMP FACTOR (dB)	ANTENNA HEIGHT (cm)	TABLE ANGLE (Degree)	REMARK
5394	38.41	38.67	54	-15.59	31.51	5.41	37.18	122	4	Average
5394	60.57	60.83	74	-13.43	31.51	5.41	37.18	122	4	Peak
5470	58.55	58.61	68.2	-9.65	31.57	5.45	37.08	122	4	Peak
5500	89.87	89.84			31.6	5.46	37.03	122	4	Average
5500	99.53	99.5			31.6	5.46	37.03	122	4	Peak
5725	62.9	62.78	68.2	-5.3	31.96	5.59	37.43	122	4	Peak
11000	44.38	49.07	54	-9.62	40.2	8.56	53.45	121	309	Average
11000	56.07	60.76	74	-17.93	40.2	8.56	53.45	121	309	Peak

ANTENNA POLARITY & TEST DISTANCE: VERTICAL AT 3 M										
FREQ. (MHz)	EMISSION LEVEL (dBuV/m)	READ LEVEL (dBuV)	LIMIT (dBuV/m)	MARGIN (dB)	ANTENNA FACTOR (dB/m)	CABLE LOSS (dB)	PREAMP FACTOR (dB)	ANTENNA HEIGHT (cm)	TABLE ANGLE (Degree)	REMARK
5412	39.18	39.42	54	-14.82	31.53	5.41	37.18	122	63	Average
5412	60.94	61.18	74	-13.06	31.53	5.41	37.18	122	63	Peak
5470	58.96	59.02	68.2	-9.24	31.57	5.45	37.08	122	63	Peak
5500	92.46	92.43			31.6	5.46	37.03	122	63	Average
5500	101.87	101.84			31.6	5.46	37.03	122	63	Peak
5725	59.79	59.67	68.2	-8.41	31.96	5.59	37.43	122	63	Peak
11000	43.43	48.12	54	-10.57	40.2	8.56	53.45	105	63	Average
11000	54.89	59.58	74	-19.11	40.2	8.56	53.45	105	63	Peak

REMARKS:

- Emission Level = Read Level + Antenna Factor + Cable Loss - Preamp Factor
Margin value = Emission level – Limit value
- 5500MHz: Fundamental frequency.
- 5470MHz & 5725MHz: Out of restricted band



A D T

EUT TEST CONDITION		MEASUREMENT DETAIL	
CHANNEL	Channel 116	FREQUENCY RANGE	1GHz ~ 40GHz
INPUT POWER	120Vac, 60 Hz	DETECTOR FUNCTION	Peak (PK) Average (AV)
ENVIRONMENTAL CONDITIONS	25deg. C, 65%RH	TESTED BY	Gavin Wu

ANTENNA POLARITY & TEST DISTANCE: HORIZONTAL AT 3 M										
FREQ. (MHz)	EMISSION LEVEL (dBuV/m)	READ LEVEL (dBuV)	LIMIT (dBuV/m)	MARGIN (dB)	ANTENNA FACTOR (dB/m)	CABLE LOSS (dB)	PREAMP FACTOR (dB)	ANTENNA HEIGHT (cm)	TABLE ANGLE (Degree)	REMARK
5430	38.09	38.25	54	-15.91	31.55	5.42	37.13	108	23	Average
5430	59.99	60.15	74	-14.01	31.55	5.42	37.13	108	23	Peak
5470	58.46	58.52	68.2	-9.74	31.57	5.45	37.08	108	23	Peak
5580	91.92	91.87			31.71	5.5	37.16	108	23	Average
5580	101.69	101.64			31.71	5.5	37.16	108	23	Peak
5725	58.8	58.68	68.2	-9.4	31.96	5.59	37.43	108	23	Peak
11160	49.21	53.79	54	-4.79	40.1	8.71	53.39	114	338	Average
11160	61.61	66.19	74	-12.39	40.1	8.71	53.39	114	338	Peak

ANTENNA POLARITY & TEST DISTANCE: VERTICAL AT 3 M										
FREQ. (MHz)	EMISSION LEVEL (dBuV/m)	READ LEVEL (dBuV)	LIMIT (dBuV/m)	MARGIN (dB)	ANTENNA FACTOR (dB/m)	CABLE LOSS (dB)	PREAMP FACTOR (dB)	ANTENNA HEIGHT (cm)	TABLE ANGLE (Degree)	REMARK
5412	38.41	38.65	54	-15.59	31.53	5.41	37.18	122	51	Average
5412	59.41	59.65	74	-14.59	31.53	5.41	37.18	122	51	Peak
5470	58.38	58.44	68.2	-9.82	31.57	5.45	37.08	122	51	Peak
5580	93.44	93.39			31.71	5.5	37.16	122	51	Average
5580	103.14	103.09			31.71	5.5	37.16	122	51	Peak
5725	58.2	58.08	68.2	-10	31.96	5.59	37.43	122	51	Peak
11160	47.81	52.39	54	-6.19	40.1	8.71	53.39	111	69	Average
11160	59.19	63.77	74	-14.81	40.1	8.71	53.39	111	69	Peak

REMARKS:

- Emission Level = Read Level + Antenna Factor + Cable Loss - Preamp Factor
Margin value = Emission level – Limit value
- 5580MHz: Fundamental frequency.
- 5470MHz & 5725MHz: Out of restricted band



A D T

EUT TEST CONDITION		MEASUREMENT DETAIL	
CHANNEL	Channel 140	FREQUENCY RANGE	1GHz ~ 40GHz
INPUT POWER	120Vac, 60 Hz	DETECTOR FUNCTION	Peak (PK) Average (AV)
ENVIRONMENTAL CONDITIONS	25deg. C, 65%RH	TESTED BY	Gavin Wu

ANTENNA POLARITY & TEST DISTANCE: HORIZONTAL AT 3 M										
FREQ. (MHz)	EMISSION LEVEL (dBuV/m)	READ LEVEL (dBuV)	LIMIT (dBuV/m)	MARGIN (dB)	ANTENNA FACTOR (dB/m)	CABLE LOSS (dB)	PREAMP FACTOR (dB)	ANTENNA HEIGHT (cm)	TABLE ANGLE (Degree)	REMARK
5374	37.83	38.12	54	-16.17	31.49	5.4	37.18	107	22	Average
5374	59.83	60.12	74	-14.17	31.49	5.4	37.18	107	22	Peak
5470	57.98	58.04	68.2	-10.22	31.57	5.45	37.08	107	22	Peak
5700	92.31	92.24			31.9	5.57	37.4	107	22	Average
5700	101.9	101.83			31.9	5.57	37.4	107	22	Peak
5725	63.19	63.07	68.2	-5.01	31.96	5.59	37.43	107	22	Peak
11400	50.37	53.59	54	-3.63	39.96	8.95	52.13	106	345	Average
11400	61.94	65.16	74	-12.06	39.96	8.95	52.13	106	345	Peak

ANTENNA POLARITY & TEST DISTANCE: VERTICAL AT 3 M										
FREQ. (MHz)	EMISSION LEVEL (dBuV/m)	READ LEVEL (dBuV)	LIMIT (dBuV/m)	MARGIN (dB)	ANTENNA FACTOR (dB/m)	CABLE LOSS (dB)	PREAMP FACTOR (dB)	ANTENNA HEIGHT (cm)	TABLE ANGLE (Degree)	REMARK
5454	37.96	38.04	54	-16.04	31.56	5.44	37.08	124	342	Average
5454	59.8	59.88	74	-14.2	31.56	5.44	37.08	124	342	Peak
5470	58.96	59.02	68.2	-9.24	31.57	5.45	37.08	124	342	Peak
5700	94	93.93			31.9	5.57	37.4	124	342	Average
5700	103.74	103.67			31.9	5.57	37.4	124	342	Peak
5725	61.87	61.75	68.2	-6.33	31.96	5.59	37.43	124	342	Peak
11400	50.36	53.58	54	-3.64	39.96	8.95	52.13	150	65	Average
11400	62.87	66.09	74	-11.13	39.96	8.95	52.13	150	65	Peak

REMARKS:

- Emission Level = Read Level + Antenna Factor + Cable Loss - Preamp Factor
Margin value = Emission level – Limit value
- 5700MHz: Fundamental frequency.
- 5470MHz & 5725MHz: Out of restricted band



A D T

EUT TEST CONDITION		MEASUREMENT DETAIL	
CHANNEL	Channel 149	FREQUENCY RANGE	1GHz ~ 40GHz
INPUT POWER	120Vac, 60 Hz	DETECTOR FUNCTION	Peak (PK) Average (AV)
ENVIRONMENTAL CONDITIONS	25deg. C, 65%RH	TESTED BY	Gavin Wu

ANTENNA POLARITY & TEST DISTANCE: HORIZONTAL AT 3 M

FREQ. (MHz)	EMISSION LEVEL (dBuV/m)	READ LEVEL (dBuV)	LIMIT (dBuV/m)	MARGIN (dB)	ANTENNA FACTOR (dB/m)	CABLE LOSS (dB)	PREAMP FACTOR (dB)	ANTENNA HEIGHT (cm)	TABLE ANGLE (Degree)	REMARK
5714	58.17	58.08	68.2	-10.03	31.93	5.59	37.43	116	22	Peak
5725	65.56	65.44	78.2	-12.64	31.96	5.59	37.43	116	22	Peak
5745	91.53	91.41			31.99	5.6	37.47	116	22	Average
5745	101.2	101.08			31.99	5.6	37.47	116	22	Peak
5850	58.86	58.56	78.2	-19.34	32.15	5.66	37.51	116	22	Peak
5861	58.61	58.27	68.2	-9.59	32.18	5.66	37.5	116	22	Peak
11490	48.19	52.06	54	-5.81	39.91	9.05	52.83	100	347	Average
11490	59.97	63.84	74	-14.03	39.91	9.05	52.83	100	347	Peak

ANTENNA POLARITY & TEST DISTANCE: VERTICAL AT 3 M

FREQ. (MHz)	EMISSION LEVEL (dBuV/m)	READ LEVEL (dBuV)	LIMIT (dBuV/m)	MARGIN (dB)	ANTENNA FACTOR (dB/m)	CABLE LOSS (dB)	PREAMP FACTOR (dB)	ANTENNA HEIGHT (cm)	TABLE ANGLE (Degree)	REMARK
5714	58.09	58	68.2	-10.11	31.93	5.59	37.43	100	339	Peak
5725	67.18	67.06	78.2	-11.02	31.96	5.59	37.43	100	339	Peak
5745	92.74	92.62			31.99	5.6	37.47	100	339	Average
5745	101.9	101.78			31.99	5.6	37.47	100	339	Peak
5850	58.18	57.88	78.2	-20.02	32.15	5.66	37.51	100	339	Peak
5861	58.42	58.08	68.2	-9.78	32.18	5.66	37.5	100	339	Peak
11490	49.49	53.36	54	-4.51	39.91	9.05	52.83	151	62	Average
11490	61.79	65.66	74	-12.21	39.91	9.05	52.83	151	62	Peak

REMARKS:

- Emission Level = Read Level + Antenna Factor + Cable Loss - Preamp Factor
Margin value = Emission level – Limit value
- 5745MHz: Fundamental frequency.
- 5714MHz & 5725MHz & 5850MHz & 5861MHz: Out of restricted band



A D T

EUT TEST CONDITION		MEASUREMENT DETAIL	
CHANNEL	Channel 157	FREQUENCY RANGE	1GHz ~ 40GHz
INPUT POWER	120Vac, 60 Hz	DETECTOR FUNCTION	Peak (PK) Average (AV)
ENVIRONMENTAL CONDITIONS	25deg. C, 65%RH	TESTED BY	Gavin Wu

ANTENNA POLARITY & TEST DISTANCE: HORIZONTAL AT 3 M

FREQ. (MHz)	EMISSION LEVEL (dBuV/m)	READ LEVEL (dBuV)	LIMIT (dBuV/m)	MARGIN (dB)	ANTENNA FACTOR (dB/m)	CABLE LOSS (dB)	PREAMP FACTOR (dB)	ANTENNA HEIGHT (cm)	TABLE ANGLE (Degree)	REMARK
5714	57.63	57.54	68.2	-10.57	31.93	5.59	37.43	114	37	Peak
5725	58.53	58.41	78.2	-19.67	31.96	5.59	37.43	114	37	Peak
5785	91.83	91.71			32.04	5.62	37.54	114	37	Average
5785	101.04	100.92			32.04	5.62	37.54	114	37	Peak
5850	58.8	58.5	78.2	-19.4	32.15	5.66	37.51	114	37	Peak
5861	58.92	58.58	68.2	-9.28	32.18	5.66	37.5	114	37	Peak
11570	49.44	53.9	54	-4.56	39.78	9.09	53.33	102	353	Average
11570	61.98	66.44	74	-12.02	39.78	9.09	53.33	102	353	Peak

ANTENNA POLARITY & TEST DISTANCE: VERTICAL AT 3 M

FREQ. (MHz)	EMISSION LEVEL (dBuV/m)	READ LEVEL (dBuV)	LIMIT (dBuV/m)	MARGIN (dB)	ANTENNA FACTOR (dB/m)	CABLE LOSS (dB)	PREAMP FACTOR (dB)	ANTENNA HEIGHT (cm)	TABLE ANGLE (Degree)	REMARK
5714	57.88	57.79	68.2	-10.32	31.93	5.59	37.43	100	340	Peak
5725	58.99	58.87	78.2	-19.21	31.96	5.59	37.43	100	340	Peak
5785	93.26	93.14			32.04	5.62	37.54	100	340	Average
5785	102.65	102.53			32.04	5.62	37.54	100	340	Peak
5850	57.35	57.05	78.2	-20.85	32.15	5.66	37.51	100	340	Peak
5861	59.34	59	68.2	-8.86	32.18	5.66	37.5	100	340	Peak
11570	46.8	51.26	54	-7.2	39.78	9.09	53.33	101	351	Average
11570	58.81	63.27	74	-15.19	39.78	9.09	53.33	101	351	Peak

REMARKS:

- Emission Level = Read Level + Antenna Factor + Cable Loss - Preamp Factor
Margin value = Emission level – Limit value
- 5785MHz: Fundamental frequency.
- 5714MHz & 5725MHz & 5850MHz & 5861MHz: Out of restricted band



A D T

EUT TEST CONDITION		MEASUREMENT DETAIL	
CHANNEL	Channel 165	FREQUENCY RANGE	1GHz ~ 40GHz
INPUT POWER	120Vac, 60 Hz	DETECTOR FUNCTION	Peak (PK) Average (AV)
ENVIRONMENTAL CONDITIONS	25deg. C, 65%RH	TESTED BY	Gavin Wu

ANTENNA POLARITY & TEST DISTANCE: HORIZONTAL AT 3 M

FREQ. (MHz)	EMISSION LEVEL (dBuV/m)	READ LEVEL (dBuV)	LIMIT (dBuV/m)	MARGIN (dB)	ANTENNA FACTOR (dB/m)	CABLE LOSS (dB)	PREAMP FACTOR (dB)	ANTENNA HEIGHT (cm)	TABLE ANGLE (Degree)	REMARK
5714	58.31	58.22	68.2	-9.89	31.93	5.59	37.43	114	38	Peak
5725	57.24	57.12	78.2	-20.96	31.96	5.59	37.43	114	38	Peak
5825	91.61	91.38			32.12	5.64	37.53	114	38	Average
5825	100.85	100.62			32.12	5.64	37.53	114	38	Peak
5850	57.78	57.48	78.2	-20.42	32.15	5.66	37.51	114	38	Peak
5861	58.06	57.72	68.2	-10.14	32.18	5.66	37.5	114	38	Peak
11650	49.06	53.64	54	-4.94	39.65	9.12	53.35	103	357	Average
11650	61.52	66.1	74	-12.48	39.65	9.12	53.35	103	357	Peak

ANTENNA POLARITY & TEST DISTANCE: VERTICAL AT 3 M

FREQ. (MHz)	EMISSION LEVEL (dBuV/m)	READ LEVEL (dBuV)	LIMIT (dBuV/m)	MARGIN (dB)	ANTENNA FACTOR (dB/m)	CABLE LOSS (dB)	PREAMP FACTOR (dB)	ANTENNA HEIGHT (cm)	TABLE ANGLE (Degree)	REMARK
5714	59.34	59.25	68.2	-8.86	31.93	5.59	37.43	122	342	Peak
5725	59.85	59.73	78.2	-18.35	31.96	5.59	37.43	122	342	Peak
5825	92.45	92.22			32.12	5.64	37.53	122	342	Average
5825	101.99	101.76			32.12	5.64	37.53	122	342	Peak
5850	60.89	60.59	78.2	-17.31	32.15	5.66	37.51	122	342	Peak
5861	59.99	59.65	68.2	-8.21	32.18	5.66	37.5	122	342	Peak
11650	48.45	53.03	54	-5.55	39.65	9.12	53.35	142	77	Average
11650	59.26	63.84	74	-14.74	39.65	9.12	53.35	142	77	Peak

REMARKS:

- Emission Level = Read Level + Antenna Factor + Cable Loss - Preamp Factor
Margin value = Emission level – Limit value
- 5825MHz: Fundamental frequency.
- 5714MHz & 5725MHz & 5850MHz & 5861MHz: Out of restricted band



A D T

802.11n (40MHz)

EUT TEST CONDITION		MEASUREMENT DETAIL	
CHANNEL	Channel 38	FREQUENCY RANGE	1GHz ~ 40GHz
INPUT POWER	120Vac, 60 Hz	DETECTOR FUNCTION	Peak (PK) Average (AV)
ENVIRONMENTAL CONDITIONS	25deg. C, 65%RH	TESTED BY	Gavin Wu

ANTENNA POLARITY & TEST DISTANCE: HORIZONTAL AT 3 M

FREQ. (MHz)	EMISSION LEVEL (dBuV/m)	READ LEVEL (dBuV)	LIMIT (dBuV/m)	MARGIN (dB)	ANTENNA FACTOR (dB/m)	CABLE LOSS (dB)	PREAMP FACTOR (dB)	ANTENNA HEIGHT (cm)	TABLE ANGLE (Degree)	REMARK
5148	45.11	45.82	54	-8.89	31.32	5.29	37.32	105	353	Average
5148	63.01	63.72	74	-10.99	31.32	5.29	37.32	105	353	Peak
5190	90.88	91.55			31.35	5.32	37.34	105	353	Average
5190	100.23	100.9			31.35	5.32	37.34	105	353	Peak
5440	38.2	38.34	54	-15.8	31.55	5.44	37.13	105	353	Average
5440	60.03	60.17	74	-13.97	31.55	5.44	37.13	105	353	Peak
10380	57.89	62.79	68.2	-10.31	39.21	8.14	52.25	110	344	Peak

ANTENNA POLARITY & TEST DISTANCE: VERTICAL AT 3 M

FREQ. (MHz)	EMISSION LEVEL (dBuV/m)	READ LEVEL (dBuV)	LIMIT (dBuV/m)	MARGIN (dB)	ANTENNA FACTOR (dB/m)	CABLE LOSS (dB)	PREAMP FACTOR (dB)	ANTENNA HEIGHT (cm)	TABLE ANGLE (Degree)	REMARK
5150	40.75	41.46	54	-13.25	31.32	5.29	37.32	109	334	Average
5150	59.89	60.6	74	-14.11	31.32	5.29	37.32	109	334	Peak
5190	86.69	87.36			31.35	5.32	37.34	109	334	Average
5190	95.84	96.51			31.35	5.32	37.34	109	334	Peak
5400	39.01	39.26	54	-14.99	31.52	5.41	37.18	109	334	Average
5400	60.83	61.08	74	-13.17	31.52	5.41	37.18	109	334	Peak
10380	55.54	60.44	68.2	-12.66	39.21	8.14	52.25	100	69	Peak

REMARKS:

- Emission Level = Read Level + Antenna Factor + Cable Loss - Preamp Factor
Margin value = Emission level – Limit value
- 5190MHz: Fundamental frequency.
- 10380MHz: Out of restricted band



A D T

EUT TEST CONDITION		MEASUREMENT DETAIL	
CHANNEL	Channel 46	FREQUENCY RANGE	1GHz ~ 40GHz
INPUT POWER	120Vac, 60 Hz	DETECTOR FUNCTION	Peak (PK) Average (AV)
ENVIRONMENTAL CONDITIONS	25deg. C, 65%RH	TESTED BY	Gavin Wu

ANTENNA POLARITY & TEST DISTANCE: HORIZONTAL AT 3 M										
FREQ. (MHz)	EMISSION LEVEL (dBuV/m)	READ LEVEL (dBuV)	LIMIT (dBuV/m)	MARGIN (dB)	ANTENNA FACTOR (dB/m)	CABLE LOSS (dB)	PREAMP FACTOR (dB)	ANTENNA HEIGHT (cm)	TABLE ANGLE (Degree)	REMARK
5140	38.06	38.75	54	-15.94	31.32	5.29	37.3	103	354	Average
5140	59.39	60.08	74	-14.61	31.32	5.29	37.3	103	354	Peak
5230	89.85	90.45			31.39	5.33	37.32	103	354	Average
5230	99.25	99.85			31.39	5.33	37.32	103	354	Peak
5380	37.87	38.14	54	-16.13	31.51	5.4	37.18	103	354	Average
5380	60.07	60.34	74	-13.93	31.51	5.4	37.18	103	354	Peak
10460	58.48	63.57	68.2	-9.72	39.32	8.19	52.6	116	344	Peak
ANTENNA POLARITY & TEST DISTANCE: VERTICAL AT 3 M										
FREQ. (MHz)	EMISSION LEVEL (dBuV/m)	READ LEVEL (dBuV)	LIMIT (dBuV/m)	MARGIN (dB)	ANTENNA FACTOR (dB/m)	CABLE LOSS (dB)	PREAMP FACTOR (dB)	ANTENNA HEIGHT (cm)	TABLE ANGLE (Degree)	REMARK
5044	37.89	38.65	54	-16.11	31.24	5.25	37.25	109	334	Average
5044	59.83	60.59	74	-14.17	31.24	5.25	37.25	109	334	Peak
5230	87.19	87.79			31.39	5.33	37.32	109	334	Average
5230	96.39	96.99			31.39	5.33	37.32	109	334	Peak
5458	38.85	38.93	54	-15.15	31.56	5.44	37.08	109	334	Average
5458	60.16	60.24	74	-13.84	31.56	5.44	37.08	109	334	Peak
10460	54.96	60.05	68.2	-13.24	39.32	8.19	52.6	100	69	Peak

REMARKS:

- Emission Level = Read Level + Antenna Factor + Cable Loss - Preamp Factor
Margin value = Emission level – Limit value
- 5230MHz: Fundamental frequency.
- 10460MHz: Out of restricted band



A D T

EUT TEST CONDITION		MEASUREMENT DETAIL	
CHANNEL	Channel 54	FREQUENCY RANGE	1GHz ~ 40GHz
INPUT POWER	120Vac, 60 Hz	DETECTOR FUNCTION	Peak (PK) Average (AV)
ENVIRONMENTAL CONDITIONS	25deg. C, 65%RH	TESTED BY	Gavin Wu

ANTENNA POLARITY & TEST DISTANCE: HORIZONTAL AT 3 M										
FREQ. (MHz)	EMISSION LEVEL (dBuV/m)	READ LEVEL (dBuV)	LIMIT (dBuV/m)	MARGIN (dB)	ANTENNA FACTOR (dB/m)	CABLE LOSS (dB)	PREAMP FACTOR (dB)	ANTENNA HEIGHT (cm)	TABLE ANGLE (Degree)	REMARK
5032	37.87	38.64	54	-16.13	31.23	5.24	37.24	102	341	Average
5032	58.95	59.72	74	-15.05	31.23	5.24	37.24	102	341	Peak
5270	87.28	87.79			31.41	5.35	37.27	102	341	Average
5270	96.26	96.77			31.41	5.35	37.27	102	341	Peak
5412	38.94	39.18	54	-15.06	31.53	5.41	37.18	102	341	Average
5412	60.21	60.45	74	-13.79	31.53	5.41	37.18	102	341	Peak
10540	47.1	52.08	54	-6.9	39.46	8.25	52.69	100	347	Average
10540	57.89	62.87	74	-16.11	39.46	8.25	52.69	100	347	Peak

ANTENNA POLARITY & TEST DISTANCE: VERTICAL AT 3 M										
FREQ. (MHz)	EMISSION LEVEL (dBuV/m)	READ LEVEL (dBuV)	LIMIT (dBuV/m)	MARGIN (dB)	ANTENNA FACTOR (dB/m)	CABLE LOSS (dB)	PREAMP FACTOR (dB)	ANTENNA HEIGHT (cm)	TABLE ANGLE (Degree)	REMARK
5078	37.73	38.47	54	-16.27	31.27	5.26	37.27	116	68	Average
5078	58.74	59.48	74	-15.26	31.27	5.26	37.27	116	68	Peak
5270	86.24	86.75			31.41	5.35	37.27	116	68	Average
5270	95.36	95.87			31.41	5.35	37.27	116	68	Peak
5382	38.66	38.93	54	-15.34	31.51	5.4	37.18	116	68	Average
5382	59.72	59.99	74	-14.28	31.51	5.4	37.18	116	68	Peak
10540	46.61	51.59	54	-7.39	39.46	8.25	52.69	100	346	Average
10540	56.53	61.51	74	-17.47	39.46	8.25	52.69	100	346	Peak

REMARKS:

- Emission Level = Read Level + Antenna Factor + Cable Loss - Preamp Factor
Margin value = Emission level – Limit value
- 5270MHz: Fundamental frequency.



A D T

EUT TEST CONDITION		MEASUREMENT DETAIL	
CHANNEL	Channel 62	FREQUENCY RANGE	1GHz ~ 40GHz
INPUT POWER	120Vac, 60 Hz	DETECTOR FUNCTION	Peak (PK) Average (AV)
ENVIRONMENTAL CONDITIONS	25deg. C, 65%RH	TESTED BY	Gavin Wu

ANTENNA POLARITY & TEST DISTANCE: HORIZONTAL AT 3 M										
FREQ. (MHz)	EMISSION LEVEL (dBuV/m)	READ LEVEL (dBuV)	LIMIT (dBuV/m)	MARGIN (dB)	ANTENNA FACTOR (dB/m)	CABLE LOSS (dB)	PREAMP FACTOR (dB)	ANTENNA HEIGHT (cm)	TABLE ANGLE (Degree)	REMARK
5076	37.85	38.59	54	-16.15	31.27	5.26	37.27	102	343	Average
5076	59.94	60.68	74	-14.06	31.27	5.26	37.27	102	343	Peak
5310	88.18	88.55			31.45	5.37	37.19	102	343	Average
5310	97.26	97.63			31.45	5.37	37.19	102	343	Peak
5350	45.43	45.74	54	-8.57	31.48	5.39	37.18	102	343	Average
5350	63.32	63.63	74	-10.68	31.48	5.39	37.18	102	343	Peak
10620	50.38	54.83	54	-3.62	39.59	8.3	52.34	123	340	Average
10620	61.11	65.56	74	-12.89	39.59	8.3	52.34	123	340	Peak

ANTENNA POLARITY & TEST DISTANCE: VERTICAL AT 3 M										
FREQ. (MHz)	EMISSION LEVEL (dBuV/m)	READ LEVEL (dBuV)	LIMIT (dBuV/m)	MARGIN (dB)	ANTENNA FACTOR (dB/m)	CABLE LOSS (dB)	PREAMP FACTOR (dB)	ANTENNA HEIGHT (cm)	TABLE ANGLE (Degree)	REMARK
5108	37.73	38.45	54	-16.27	31.29	5.27	37.28	125	67	Average
5108	58.79	59.51	74	-15.21	31.29	5.27	37.28	125	67	Peak
5310	87.78	88.15			31.45	5.37	37.19	125	67	Average
5310	96.75	97.12			31.45	5.37	37.19	125	67	Peak
5350	45.08	45.39	54	-8.92	31.48	5.39	37.18	125	67	Average
5350	61.09	61.4	74	-12.91	31.48	5.39	37.18	125	67	Peak
10620	48.44	52.89	54	-5.56	39.59	8.3	52.34	100	342	Average
10620	59.15	63.6	74	-14.85	39.59	8.3	52.34	100	342	Peak

REMARKS:

- Emission Level = Read Level + Antenna Factor + Cable Loss - Preamp Factor
Margin value = Emission level – Limit value
- 5310MHz: Fundamental frequency.



A D T

EUT TEST CONDITION		MEASUREMENT DETAIL	
CHANNEL	Channel 102	FREQUENCY RANGE	1GHz ~ 40GHz
INPUT POWER	120Vac, 60 Hz	DETECTOR FUNCTION	Peak (PK) Average (AV)
ENVIRONMENTAL CONDITIONS	25deg. C, 65%RH	TESTED BY	Gavin Wu

ANTENNA POLARITY & TEST DISTANCE: HORIZONTAL AT 3 M										
FREQ. (MHz)	EMISSION LEVEL (dBuV/m)	READ LEVEL (dBuV)	LIMIT (dBuV/m)	MARGIN (dB)	ANTENNA FACTOR (dB/m)	CABLE LOSS (dB)	PREAMP FACTOR (dB)	ANTENNA HEIGHT (cm)	TABLE ANGLE (Degree)	REMARK
5444	40.61	40.75	54	-13.39	31.55	5.44	37.13	121	4	Average
5444	59.71	59.85	74	-14.29	31.55	5.44	37.13	121	4	Peak
5470	64.97	65.03	68.2	-3.23	31.57	5.45	37.08	121	4	Peak
5510	87.97	87.97			31.6	5.46	37.06	121	4	Average
5510	97.4	97.4			31.6	5.46	37.06	121	4	Peak
5725	59.43	59.31	68.2	-8.77	31.96	5.59	37.43	121	4	Peak
11020	45.62	50.34	54	-8.38	40.19	8.58	53.49	146	307	Average
11020	57.39	62.11	74	-16.61	40.19	8.58	53.49	146	307	Peak

ANTENNA POLARITY & TEST DISTANCE: VERTICAL AT 3 M										
FREQ. (MHz)	EMISSION LEVEL (dBuV/m)	READ LEVEL (dBuV)	LIMIT (dBuV/m)	MARGIN (dB)	ANTENNA FACTOR (dB/m)	CABLE LOSS (dB)	PREAMP FACTOR (dB)	ANTENNA HEIGHT (cm)	TABLE ANGLE (Degree)	REMARK
5404	41.74	41.99	54	-12.26	31.52	5.41	37.18	125	53	Average
5404	59.51	59.76	74	-14.49	31.52	5.41	37.18	125	53	Peak
5470	65.52	65.58	68.2	-2.68	31.57	5.45	37.08	125	53	Peak
5510	89.73	89.73			31.6	5.46	37.06	125	53	Average
5510	98.89	98.89			31.6	5.46	37.06	125	53	Peak
5725	58.97	58.85	68.2	-9.23	31.96	5.59	37.43	125	53	Peak
11020	43.94	48.66	54	-10.06	40.19	8.58	53.49	105	64	Average
11020	56.13	60.85	74	-17.87	40.19	8.58	53.49	105	64	Peak

REMARKS:

- Emission Level = Read Level + Antenna Factor + Cable Loss - Preamp Factor
Margin value = Emission level – Limit value
- 5510MHz: Fundamental frequency.
- 5470MHz & 5725MHz: Out of restricted band



A D T

EUT TEST CONDITION		MEASUREMENT DETAIL	
CHANNEL	Channel 110	FREQUENCY RANGE	1GHz ~ 40GHz
INPUT POWER	120Vac, 60 Hz	DETECTOR FUNCTION	Peak (PK) Average (AV)
ENVIRONMENTAL CONDITIONS	25deg. C, 65%RH	TESTED BY	Gavin Wu

ANTENNA POLARITY & TEST DISTANCE: HORIZONTAL AT 3 M										
FREQ. (MHz)	EMISSION LEVEL (dBuV/m)	READ LEVEL (dBuV)	LIMIT (dBuV/m)	MARGIN (dB)	ANTENNA FACTOR (dB/m)	CABLE LOSS (dB)	PREAMP FACTOR (dB)	ANTENNA HEIGHT (cm)	TABLE ANGLE (Degree)	REMARK
5444	38.41	38.55	54	-15.59	31.55	5.44	37.13	108	22	Average
5444	59.76	59.9	74	-14.24	31.55	5.44	37.13	108	22	Peak
5470	59.47	59.53	68.2	-8.73	31.57	5.45	37.08	108	22	Peak
5550	89.14	89.06			31.68	5.49	37.09	108	22	Average
5550	98.7	98.62			31.68	5.49	37.09	108	22	Peak
5725	58.23	58.11	68.2	-9.97	31.96	5.59	37.43	108	22	Peak
11100	46.79	51.6	54	-7.21	40.14	8.66	53.61	109	338	Average
11100	58.11	62.92	74	-15.89	40.14	8.66	53.61	109	338	Peak

ANTENNA POLARITY & TEST DISTANCE: VERTICAL AT 3 M										
FREQ. (MHz)	EMISSION LEVEL (dBuV/m)	READ LEVEL (dBuV)	LIMIT (dBuV/m)	MARGIN (dB)	ANTENNA FACTOR (dB/m)	CABLE LOSS (dB)	PREAMP FACTOR (dB)	ANTENNA HEIGHT (cm)	TABLE ANGLE (Degree)	REMARK
5370	38.74	39.03	54	-15.26	31.49	5.4	37.18	117	342	Average
5370	59.28	59.57	74	-14.72	31.49	5.4	37.18	117	342	Peak
5470	59.08	59.14	68.2	-9.12	31.57	5.45	37.08	117	342	Peak
5550	89.88	89.8			31.68	5.49	37.09	117	342	Average
5550	99.44	99.36			31.68	5.49	37.09	117	342	Peak
5725	58.96	58.84	68.2	-9.24	31.96	5.59	37.43	117	342	Peak
11100	44.88	49.69	54	-9.12	40.14	8.66	53.61	118	70	Average
11100	55.42	60.23	74	-18.58	40.14	8.66	53.61	118	70	Peak

REMARKS:

- Emission Level = Read Level + Antenna Factor + Cable Loss - Preamp Factor
Margin value = Emission level – Limit value
- 5550MHz: Fundamental frequency.
- 5470MHz & 5725MHz: Out of restricted band



A D T

EUT TEST CONDITION		MEASUREMENT DETAIL	
CHANNEL	Channel 134	FREQUENCY RANGE	1GHz ~ 40GHz
INPUT POWER	120Vac, 60 Hz	DETECTOR FUNCTION	Peak (PK) Average (AV)
ENVIRONMENTAL CONDITIONS	25deg. C, 65%RH	TESTED BY	Gavin Wu

ANTENNA POLARITY & TEST DISTANCE: HORIZONTAL AT 3 M										
FREQ. (MHz)	EMISSION LEVEL (dBuV/m)	READ LEVEL (dBuV)	LIMIT (dBuV/m)	MARGIN (dB)	ANTENNA FACTOR (dB/m)	CABLE LOSS (dB)	PREAMP FACTOR (dB)	ANTENNA HEIGHT (cm)	TABLE ANGLE (Degree)	REMARK
5446	38.23	38.36	54	-15.77	31.56	5.44	37.13	108	23	Average
5446	59.49	59.62	74	-14.51	31.56	5.44	37.13	108	23	Peak
5470	60.03	60.09	68.2	-8.17	31.57	5.45	37.08	108	23	Peak
5670	89.33	89.23			31.88	5.56	37.34	108	23	Average
5670	98.58	98.48			31.88	5.56	37.34	108	23	Peak
5725	59.2	59.08	68.2	-9	31.96	5.59	37.43	108	23	Peak
11340	48.76	52.37	54	-5.24	40	8.9	52.51	100	349	Average
11340	59.12	62.73	74	-14.88	40	8.9	52.51	100	349	Peak

ANTENNA POLARITY & TEST DISTANCE: VERTICAL AT 3 M										
FREQ. (MHz)	EMISSION LEVEL (dBuV/m)	READ LEVEL (dBuV)	LIMIT (dBuV/m)	MARGIN (dB)	ANTENNA FACTOR (dB/m)	CABLE LOSS (dB)	PREAMP FACTOR (dB)	ANTENNA HEIGHT (cm)	TABLE ANGLE (Degree)	REMARK
5402	38.1	38.35	54	-15.9	31.52	5.41	37.18	124	341	Average
5402	59.45	59.7	74	-14.55	31.52	5.41	37.18	124	341	Peak
5470	58.11	58.17	68.2	-10.09	31.57	5.45	37.08	124	341	Peak
5670	90.82	90.72			31.88	5.56	37.34	124	341	Average
5670	100.61	100.51			31.88	5.56	37.34	124	341	Peak
5725	59.35	59.23	68.2	-8.85	31.96	5.59	37.43	124	341	Peak
11340	48.14	51.75	54	-5.86	40	8.9	52.51	139	66	Average
11340	59.12	62.73	74	-14.88	40	8.9	52.51	139	66	Peak

REMARKS:

- Emission Level = Read Level + Antenna Factor + Cable Loss - Preamp Factor
Margin value = Emission level – Limit value
- 5670MHz: Fundamental frequency.
- 5470MHz & 5725MHz: Out of restricted band



A D T

EUT TEST CONDITION		MEASUREMENT DETAIL	
CHANNEL	Channel 151	FREQUENCY RANGE	1GHz ~ 40GHz
INPUT POWER	120Vac, 60 Hz	DETECTOR FUNCTION	Peak (PK) Average (AV)
ENVIRONMENTAL CONDITIONS	25deg. C, 65%RH	TESTED BY	Gavin Wu

ANTENNA POLARITY & TEST DISTANCE: HORIZONTAL AT 3 M

FREQ. (MHz)	EMISSION LEVEL (dBuV/m)	READ LEVEL (dBuV)	LIMIT (dBuV/m)	MARGIN (dB)	ANTENNA FACTOR (dB/m)	CABLE LOSS (dB)	PREAMP FACTOR (dB)	ANTENNA HEIGHT (cm)	TABLE ANGLE (Degree)	REMARK
5714	63.32	63.23	68.2	-4.88	31.93	5.59	37.43	124	36	Peak
5725	68.26	68.14	78.2	-9.94	31.96	5.59	37.43	124	36	Peak
5755	89.82	89.68			32.01	5.6	37.47	124	36	Average
5755	99.6	99.46			32.01	5.6	37.47	124	36	Peak
5850	58.82	58.52	78.2	-19.38	32.15	5.66	37.51	124	36	Peak
5861	58.4	58.06	68.2	-9.8	32.18	5.66	37.5	124	36	Peak
11510	51.25	55.37	54	-2.75	39.9	9.05	53.07	105	356	Average
11510	61.03	65.15	74	-12.97	39.9	9.05	53.07	105	356	Peak

ANTENNA POLARITY & TEST DISTANCE: VERTICAL AT 3 M

FREQ. (MHz)	EMISSION LEVEL (dBuV/m)	READ LEVEL (dBuV)	LIMIT (dBuV/m)	MARGIN (dB)	ANTENNA FACTOR (dB/m)	CABLE LOSS (dB)	PREAMP FACTOR (dB)	ANTENNA HEIGHT (cm)	TABLE ANGLE (Degree)	REMARK
5714	66.69	66.6	68.2	-1.51	31.93	5.59	37.43	122	341	Peak
5725	70.81	70.69	78.2	-7.39	31.96	5.59	37.43	122	341	Peak
5755	91.18	91.04			32.01	5.6	37.47	122	341	Average
5755	100.72	100.58			32.01	5.6	37.47	122	341	Peak
5850	58.31	58.01	78.2	-19.89	32.15	5.66	37.51	122	341	Peak
5861	57.11	56.77	68.2	-11.09	32.18	5.66	37.5	122	341	Peak
11510	50.25	54.37	54	-3.75	39.9	9.05	53.07	151	60	Average
11510	59.94	64.06	74	-14.06	39.9	9.05	53.07	151	60	Peak

REMARKS:

- Emission Level = Read Level + Antenna Factor + Cable Loss - Preamp Factor
Margin value = Emission level – Limit value
- 5755MHz: Fundamental frequency.
- 5714MHz & 5725MHz & 5850MHz & 5861MHz: Out of restricted band



A D T

EUT TEST CONDITION		MEASUREMENT DETAIL	
CHANNEL	Channel 159	FREQUENCY RANGE	1GHz ~ 40GHz
INPUT POWER	120Vac, 60 Hz	DETECTOR FUNCTION	Peak (PK) Average (AV)
ENVIRONMENTAL CONDITIONS	25deg. C, 65%RH	TESTED BY	Gavin Wu

ANTENNA POLARITY & TEST DISTANCE: HORIZONTAL AT 3 M

FREQ. (MHz)	EMISSION LEVEL (dBuV/m)	READ LEVEL (dBuV)	LIMIT (dBuV/m)	MARGIN (dB)	ANTENNA FACTOR (dB/m)	CABLE LOSS (dB)	PREAMP FACTOR (dB)	ANTENNA HEIGHT (cm)	TABLE ANGLE (Degree)	REMARK
5714	58.95	58.86	68.2	-9.25	31.93	5.59	37.43	114	38	Peak
5725	58.54	58.42	78.2	-19.66	31.96	5.59	37.43	114	38	Peak
5795	88.7	88.54			32.07	5.63	37.54	114	38	Average
5795	98.14	97.98			32.07	5.63	37.54	114	38	Peak
5850	59.2	58.9	78.2	-19	32.15	5.66	37.51	114	38	Peak
5861	58.64	58.3	68.2	-9.56	32.18	5.66	37.5	114	38	Peak
11590	47.02	51.51	54	-6.98	39.74	9.1	53.33	120	358	Average
11590	57.06	61.55	74	-16.94	39.74	9.1	53.33	120	358	Peak

ANTENNA POLARITY & TEST DISTANCE: VERTICAL AT 3 M

FREQ. (MHz)	EMISSION LEVEL (dBuV/m)	READ LEVEL (dBuV)	LIMIT (dBuV/m)	MARGIN (dB)	ANTENNA FACTOR (dB/m)	CABLE LOSS (dB)	PREAMP FACTOR (dB)	ANTENNA HEIGHT (cm)	TABLE ANGLE (Degree)	REMARK
5714	57.35	57.26	68.2	-10.85	31.93	5.59	37.43	100	339	Peak
5725	56.36	56.24	78.2	-21.84	31.96	5.59	37.43	100	339	Peak
5795	90.05	89.89			32.07	5.63	37.54	100	339	Average
5795	99.15	98.99			32.07	5.63	37.54	100	339	Peak
5850	58.4	58.1	78.2	-19.8	32.15	5.66	37.51	100	339	Peak
5861	57.76	57.42	68.2	-10.44	32.18	5.66	37.5	100	339	Peak
11590	46.18	50.67	54	-7.82	39.74	9.1	53.33	150	60	Average
11590	55.98	60.47	74	-18.02	39.74	9.1	53.33	150	60	Peak

REMARKS:

- Emission Level = Read Level + Antenna Factor + Cable Loss - Preamp Factor
Margin value = Emission level – Limit value
- 5795MHz: Fundamental frequency.
- 5714MHz & 5725MHz & 5850MHz & 5861MHz: Out of restricted band



BELOW 1GHz WORST-CASE DATA:

802.11a

EUT TEST CONDITION		MEASUREMENT DETAIL	
CHANNEL	Channel 140	FREQUENCY RANGE	30MHz ~ 1GHz
INPUT POWER	120Vac, 60 Hz	DETECTOR FUNCTION	Peak (PK) Quasi-peak (QP)
ENVIRONMENTAL CONDITIONS	25deg. C, 65%RH	TESTED BY	Gavin Wu

ANTENNA POLARITY & TEST DISTANCE: HORIZONTAL AT 3 M

FREQ. (MHz)	EMISSION LEVEL (dBuV/m)	READ LEVEL (dBuV)	LIMIT (dBuV/m)	MARGIN (dB)	ANTENNA FACTOR (dB/m)	CABLE LOSS (dB)	PREAMP FACTOR (dB)	ANTENNA HEIGHT (cm)	TABLE ANGLE (Degree)	REMARK
131.85	28.75	47.52	43.5	-14.75	11.81	1.25	31.83	135	197	Peak
185.2	27.38	47.23	43.5	-16.12	10.39	1.52	31.76	124	302	Peak
221.09	32.21	51.97	46	-13.79	10.26	1.7	31.72	103	148	Peak
270.56	33.69	51.7	46	-12.31	12.08	1.92	32.01	129	280	Peak
395.69	32.42	46.86	46	-13.58	15.24	2.41	32.09	123	330	Peak
565.44	31.24	41.51	46	-14.76	18.81	2.99	32.07	129	28	Peak

ANTENNA POLARITY & TEST DISTANCE: VERTICAL AT 3 M

FREQ. (MHz)	EMISSION LEVEL (dBuV/m)	READ LEVEL (dBuV)	LIMIT (dBuV/m)	MARGIN (dB)	ANTENNA FACTOR (dB/m)	CABLE LOSS (dB)	PREAMP FACTOR (dB)	ANTENNA HEIGHT (cm)	TABLE ANGLE (Degree)	REMARK
30.97	31.98	50.39	40	-8.02	12.14	0.57	31.12	121	20	Peak
131.85	26.02	44.79	43.5	-17.48	11.81	1.25	31.83	117	307	Peak
221.09	26.9	46.66	46	-19.1	10.26	1.7	31.72	123	64	Peak
270.56	29.02	47.03	46	-16.98	12.08	1.92	32.01	102	196	Peak
418	27.66	41.51	46	-18.34	15.7	2.49	32.04	132	93	Peak
589.69	34.13	43.84	46	-11.87	19.37	3.06	32.14	129	76	Peak

REMARKS: Emission Level = Read Level + Antenna Factor + Cable Loss - Preamp Factor

Margin value = Emission level – Limit value



4.2 CONDUCTED EMISSION MEASUREMENT

4.2.1 LIMITS OF CONDUCTED EMISSION MEASUREMENT

FREQUENCY OF EMISSION (MHz)	CONDUCTED LIMIT (dBµV)	
	Quasi-peak	Average
0.15 ~ 0.5	66 to 56	56 to 46
0.5 ~ 5	56	46
5 ~ 30	60	50

NOTE:

1. The lower limit shall apply at the transition frequencies.
2. The limit decreases in line with the logarithm of the frequency in the range of 0.15 to 0.50MHz.
3. All emanations from a class A/B digital device or system, including any network of conductors and apparatus connected thereto, shall not exceed the level of field strengths specified above.

4.2.2 TEST INSTRUMENTS

DESCRIPTION & MANUFACTURER	MODEL NO.	SERIAL NO.	DATE OF CALIBRATION	DUE DATE OF CALIBRATION
Test Receiver ROHDE & SCHWARZ	ESCI	100612	Sep. 30, 2014	Sep. 29, 2015
RF signal cable Woken	5D-FB	Cable-HYC01-01	Dec. 26, 2014	Dec. 25, 2015
LISN ROHDE & SCHWARZ (EUT)	ESH3-Z5	835239/001	Feb. 13, 2014	Feb. 12, 2015
LISN ROHDE & SCHWARZ (Peripheral)	ESH3-Z5	100311	Jul. 21, 2014	Jul. 20, 2015
Software ADT	BV ADT_Cond_ V7.3.7.3	NA	NA	NA

- NOTE:**
1. The calibration interval of the above test instruments is 12 months and the calibrations are traceable to NML/ROC and NIST/USA.
 2. The test was performed in HwaYa Shielded Room 1.
 3. The VCCI Site Registration No. is C-2040.
 4. Test Date: Feb. 11, 2015.



4.2.3 TEST PROCEDURES

- a. The EUT was placed 0.4 meters from the conducting wall of the shielded room with EUT being connected to the power mains through a line impedance stabilization network (LISN). Other support units were connected to the power mains through another LISN. The two LISNs provide 50 ohm/ 50uH of coupling impedance for the measuring instrument.
- b. Both lines of the power mains connected to the EUT were checked for maximum conducted interference.
- c. The frequency range from 150kHz to 30MHz was searched. Emission levels under (Limit - 20dB) was not recorded.

NOTE: All modes of operation were investigated and the worst-case emissions are reported.

4.2.4 DEVIATION FROM TEST STANDARD

No deviation.

4.2.5 TEST SETUP

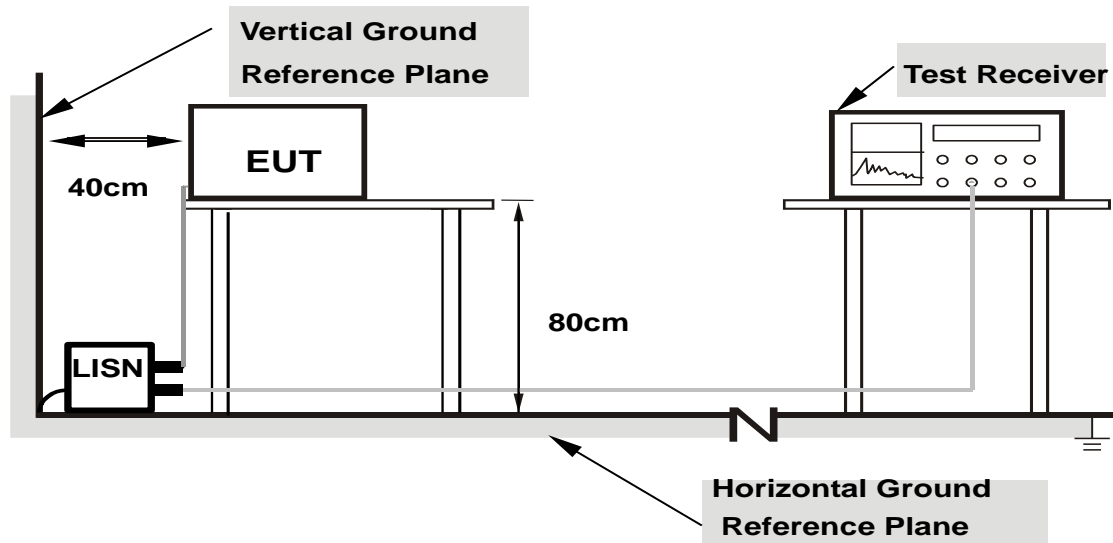

- Note:**
1. Support units were connected to second LISN.
 2. Both of LISNs (AMN) are 80 cm from EUT and at least 80 from other units and other metal planes

For the actual test configuration, please refer to the attached file (Test Setup Photo).

4.2.6 EUT OPERATING CONDITIONS

Same as section 4.1.6.

4.2.7 TEST RESULTS

Frequency Range	150kHz ~ 30MHz	Detector Function & Resolution Bandwidth	Quasi-Peak (QP), 9kHz Average (AV), 9kHz
Input Power	120Vac, 60Hz	Environmental Conditions	25°C, 65%RH
Tested by	Anson Lin	Test Date	2015/2/11

Phase Of Power : Line (L)										
No	Frequency (MHz)	Correction Factor (dB)	Reading Value (dBuV)		Emission Level (dBuV)		Limit (dBuV)		Margin (dB)	
			Q.P.	AV.	Q.P.	AV.	Q.P.	AV.	Q.P.	AV.
1	0.15000	0.08	52.45	39.72	52.53	39.80	66.00	56.00	-13.47	-16.20
2	0.19717	0.07	48.69	35.54	48.76	35.61	63.73	53.73	-14.97	-18.12
3	0.24601	0.07	44.54	31.38	44.61	31.45	61.89	51.89	-17.28	-20.44
4	0.29740	0.07	41.39	28.22	41.46	28.29	60.32	50.32	-18.85	-22.02
5	0.34926	0.08	38.18	24.84	38.26	24.92	58.98	48.98	-20.72	-24.06
6	0.61920	0.09	36.17	26.26	36.26	26.35	56.00	46.00	-19.74	-19.65

Remarks:

1. Q.P. and AV. are abbreviations of quasi-peak and average individually.
2. The emission levels of other frequencies were very low against the limit.
3. Margin value = Emission level – Limit value
4. Correction factor = Insertion loss + Cable loss
5. Emission Level = Correction Factor + Reading Value

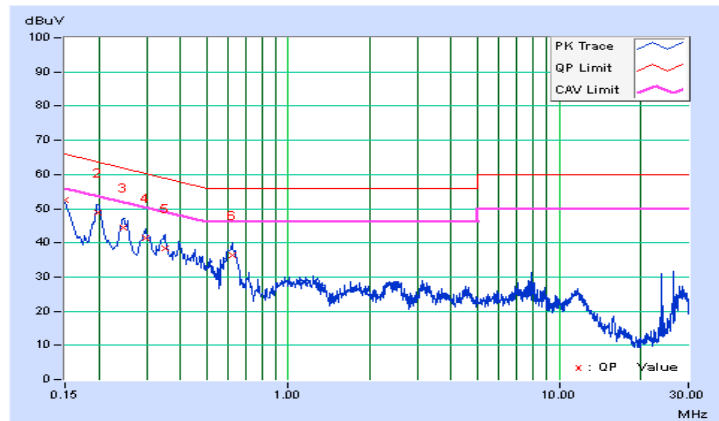



A D T

Frequency Range	150kHz ~ 30MHz	Detector Function & Resolution Bandwidth	Quasi-Peak (QP), 9kHz Average (AV), 9kHz
Input Power	120Vac, 60Hz	Environmental Conditions	25°C, 65%RH
Tested by	Anson Lin	Test Date	2015/2/11

Phase Of Power : Neutral (N)										
No	Frequency (MHz)	Correction Factor (dB)	Reading Value (dBuV)		Emission Level (dBuV)		Limit (dBuV)		Margin (dB)	
			Q.P.	AV.	Q.P.	AV.	Q.P.	AV.	Q.P.	AV.
1	0.15000	0.05	53.08	39.74	53.13	39.79	66.00	56.00	-12.87	-16.21
2	0.20084	0.05	48.41	34.50	48.46	34.55	63.58	53.58	-15.12	-19.03
3	0.24775	0.05	45.39	31.82	45.44	31.87	61.83	51.83	-16.39	-19.96
4	0.30374	0.06	39.21	24.96	39.27	25.02	60.14	50.14	-20.87	-25.12
5	0.39635	0.07	36.61	21.93	36.68	22.00	57.93	47.93	-21.25	-25.93
6	0.61543	0.08	35.67	21.22	35.75	21.30	56.00	46.00	-20.25	-24.70

Remarks:

1. Q.P. and AV. are abbreviations of quasi-peak and average individually.
2. The emission levels of other frequencies were very low against the limit.
3. Margin value = Emission level – Limit value
4. Correction factor = Insertion loss + Cable loss
5. Emission Level = Correction Factor + Reading Value

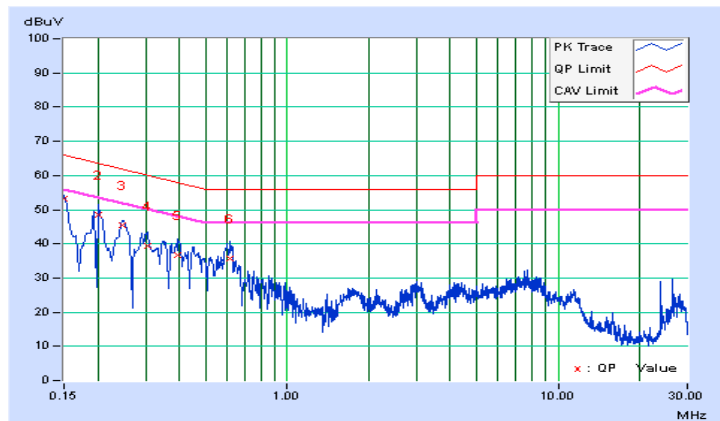

4.3 TRANSMIT POWER MEASUREMENT

4.3.1 LIMITS OF TRANSMIT POWER MEASUREMENT

OPERATION BAND	EUT CATEGORY		LIMIT
U-NII-1		Outdoor Access Point	1 Watt (30 dBm) (Max. e.i.r.p \leq 125mW(21 dBm) at any elevation angle above 30 degrees as measured from the horizon)
		Fixed point-to-point Access Point	1 Watt (30 dBm)
		Indoor Access Point	1 Watt (30 dBm)
	√	Mobile and Portable client device	250mW (24 dBm)
U-NII-2A	√	---	250mW (24 dBm) or 11 dBm+10 log B*
U-NII-2C	√	---	250mW (24 dBm) or 11 dBm+10 log B*
U-NII-3	√	---	1 Watt (30 dBm)

NOTE: Where B is the 26dB emission bandwidth in MHz.

4.3.2 TEST SETUP

FOR POWER OUTPUT MEASUREMENT

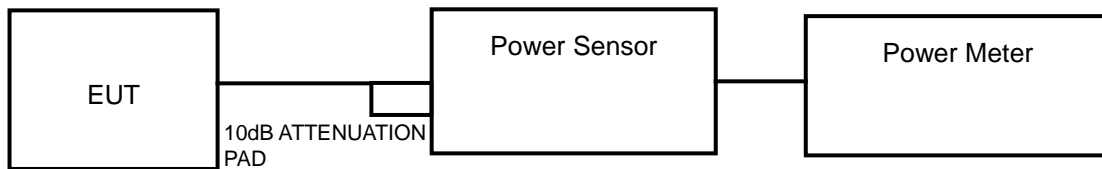

FOR 26dB BANDWIDTH AND OCCUPIED BANDWIDTH

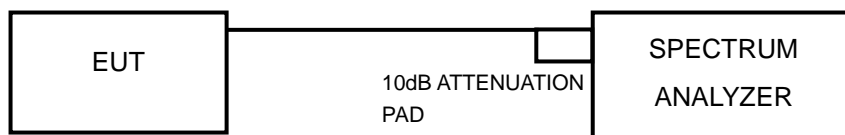

4.3.3 TEST INSTRUMENTS

Refer to section 4.1.3 to get information of above instrument.

4.3.4 TEST PROCEDURE

FOR AVERAGE POWER MEASUREMENT

Method PM is used to perform output power measurement, trigger and gating function of wide band power meter is enabled to measure max output power of TX on burst. Duty factor is not added to measured value.

FOR 26dB BANDWIDTH

- 1) Set RBW = approximately 1% of the emission bandwidth.
- 2) Set the VBW > RBW.
- 3) Detector = Peak.
- 4) Trace mode = max hold.
- 5) Measure the maximum width of the emission that is 26 dB down from the peak of the emission.
Compare this with the RBW setting of the analyzer. Readjust RBW and repeat measurement as needed until the RBW/EBW ratio is approximately 1%.

FOR OCCUPIED BANDWIDTH

The transmitter output was connected to the spectrum analyzer through an attenuator. The bandwidth of the fundamental frequency was measured by spectrum analyzer with RBW = 1% to 5% of the OBW and VBW $\geq 3 \times$ RBW.

The width of a frequency band such that, below the lower and above the upper frequency limits, the mean powers emitted are each equal to a specified percentage 0.5 % of the total mean power of a given emission.

4.3.5 DEVIATION FROM TEST STANDARD

No deviation.

4.3.6 EUT OPERATING CONDITIONS

The software provided by client to enable the EUT under transmission condition continuously at specific channel frequencies individually.



4.3.7 TEST RESULTS

POWER OUTPUT

802.11a

CHANNEL	CHANNEL FREQUENCY (MHz)	MAX. CONDUCTED POWER (mW)	MAX. CONDUCTED POWER (dBm)	POWER LIMIT (dBm)	PASS/FAIL
36	5180	35.97	15.56	24	PASS
44	5220	37.67	15.76	24	PASS
48	5240	38.99	15.91	24	PASS
52	5260	33.73	15.28	24	PASS
60	5300	29.17	14.65	24	PASS
64	5320	29.99	14.77	24	PASS
100	5500	37.50	15.74	24	PASS
116	5580	60.53	17.82	24	PASS
140	5700	46.56	16.68	24	PASS
149	5745	55.85	17.47	30	PASS
157	5785	36.56	15.63	30	PASS
165	5825	26.67	14.26	30	PASS

NOTE:**For U-NII-2A, U-NII-2C Band:**

1. $11\text{dBm} + 10\log(37.06) = 26.69\text{ dBm} > 24\text{dBm}$.
2. $11\text{dBm} + 10\log(26.09) = 25.16\text{ dBm} > 24\text{dBm}$.
3. $11\text{dBm} + 10\log(26.67) = 25.26\text{ dBm} > 24\text{dBm}$.
4. $11\text{dBm} + 10\log(37.70) = 26.76\text{ dBm} > 24\text{dBm}$.
5. $11\text{dBm} + 10\log(38.12) = 26.81\text{ dBm} > 24\text{dBm}$.
6. $11\text{dBm} + 10\log(37.70) = 26.76\text{ dBm} > 24\text{dBm}$.



A D T

802.11n (20MHz)

CHANNEL	CHANNEL FREQUENCY (MHz)	MAX. CONDUCTED POWER (mW)	MAX. CONDUCTED POWER (dBm)	POWER LIMIT (dBm)	PASS/FAIL
36	5180	20.23	13.06	24	PASS
44	5220	20.61	13.14	24	PASS
48	5240	21.28	13.28	24	PASS
52	5260	25.35	14.04	24	PASS
60	5300	28.71	14.58	24	PASS
64	5320	28.12	14.49	24	PASS
100	5500	23.66	13.74	24	PASS
116	5580	31.48	14.98	24	PASS
140	5700	28.64	14.57	24	PASS
149	5745	31.12	14.93	30	PASS
157	5785	26.67	14.26	30	PASS
165	5825	22.80	13.58	30	PASS

NOTE:

For U-NII-2A, U-NII-2C Band:

1. $11\text{dBm} + 10\log(23.94) = 24.79\text{ dBm} > 24\text{dBm}$.
2. $11\text{dBm} + 10\log(24.27) = 24.85\text{ dBm} > 24\text{dBm}$.
3. $11\text{dBm} + 10\log(26.07) = 25.16\text{ dBm} > 24\text{dBm}$.
4. $11\text{dBm} + 10\log(25.58) = 25.08\text{ dBm} > 24\text{dBm}$.
5. $11\text{dBm} + 10\log(24.63) = 24.91\text{ dBm} > 24\text{dBm}$.
6. $11\text{dBm} + 10\log(24.30) = 24.86\text{ dBm} > 24\text{dBm}$.



A D T

802.11n (40MHz)

CHANNEL	CHANNEL FREQUENCY (MHz)	MAX. CONDUCTED POWER (mW)	MAX. CONDUCTED POWER (dBm)	POWER LIMIT (dBm)	PASS/FAIL
38	5190	20.32	13.08	24	PASS
46	5230	22.18	13.46	24	PASS
54	5270	27.04	14.32	24	PASS
62	5310	30.34	14.82	24	PASS
102	5510	28.64	14.57	24	PASS
110	5550	33.57	15.26	24	PASS
134	5670	33.34	15.23	24	PASS
151	5755	33.73	15.28	30	PASS
159	5795	25.41	14.05	30	PASS

NOTE:

For U-NII-2A, U-NII-2C Band:

1. $11\text{dBm} + 10\log(55.90) = 28.47\text{ dBm} > 24\text{dBm}$.
2. $11\text{dBm} + 10\log(63.82) = 29.05\text{ dBm} > 24\text{dBm}$.
3. $11\text{dBm} + 10\log(67.12) = 29.27\text{ dBm} > 24\text{dBm}$.
4. $11\text{dBm} + 10\log(71.27) = 29.53\text{ dBm} > 24\text{dBm}$.
5. $11\text{dBm} + 10\log(65.58) = 29.17\text{ dBm} > 24\text{dBm}$.



A D T

26dB BANDWIDTH

802.11a

CHANNEL	CHANNEL FREQUENCY (MHz)	26dBc BANDWIDTH (MHz)	PASS / FAIL
52	5260	37.06	PASS
60	5300	26.09	PASS
64	5320	26.67	PASS
100	5500	37.70	PASS
116	5580	38.12	PASS
140	5700	37.70	PASS

802.11n (20MHz)

CHANNEL	CHANNEL FREQUENCY (MHz)	26dBc BANDWIDTH (MHz)	PASS / FAIL
52	5260	23.94	PASS
60	5300	24.27	PASS
64	5320	26.07	PASS
100	5500	25.58	PASS
116	5580	24.63	PASS
140	5700	24.30	PASS

802.11n (40MHz)

CHANNEL	CHANNEL FREQUENCY (MHz)	26dBc BANDWIDTH (MHz)	PASS / FAIL
54	5270	55.90	PASS
62	5310	63.82	PASS
102	5510	67.12	PASS
110	5550	71.27	PASS
134	5670	65.58	PASS



A D T

SPECTRUM PLOT OF WORST VALUE

802.11a

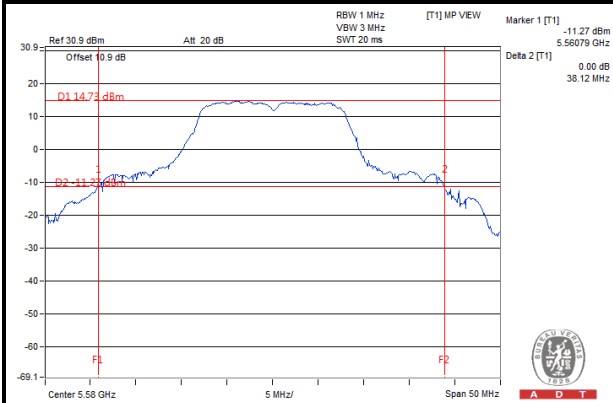

802.11n (20MHz)

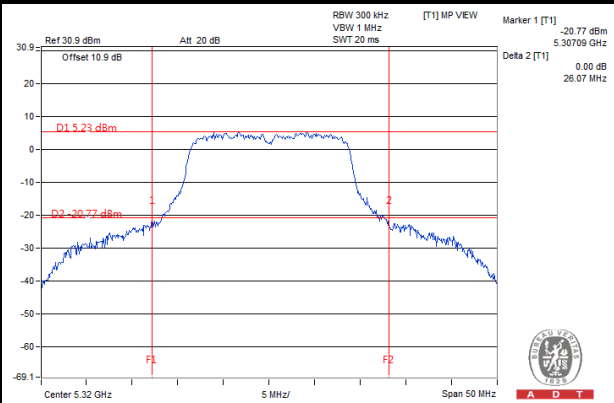

802.11n (40MHz)

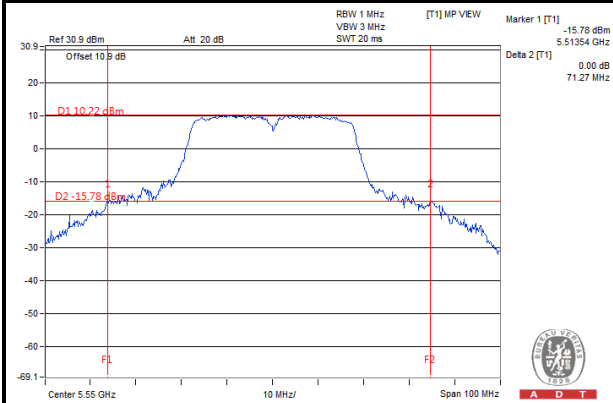



A D T

OCCUPIED BANDWIDTH

802.11a

CHANNEL	CHANNEL FREQUENCY (MHz)	OCCUPIED BANDWIDTH (MHz)	PASS / FAIL
36	5180	16.87	PASS
44	5220	16.87	PASS
48	5240	16.92	PASS

802.11n (20MHz)

CHANNEL	CHANNEL FREQUENCY (MHz)	OCCUPIED BANDWIDTH (MHz)	PASS / FAIL
36	5180	17.88	PASS
44	5220	17.88	PASS
48	5240	18.08	PASS

802.11n (40MHz)

CHANNEL	CHANNEL FREQUENCY (MHz)	OCCUPIED BANDWIDTH (MHz)	PASS / FAIL
38	5190	37.44	PASS
46	5230	38.21	PASS



A D T

802.11a

Channel 36

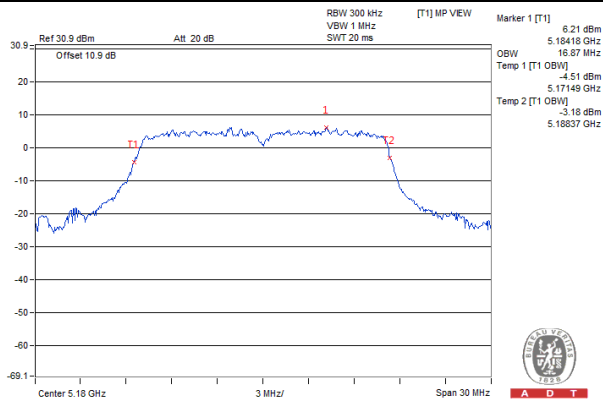

Channel 44

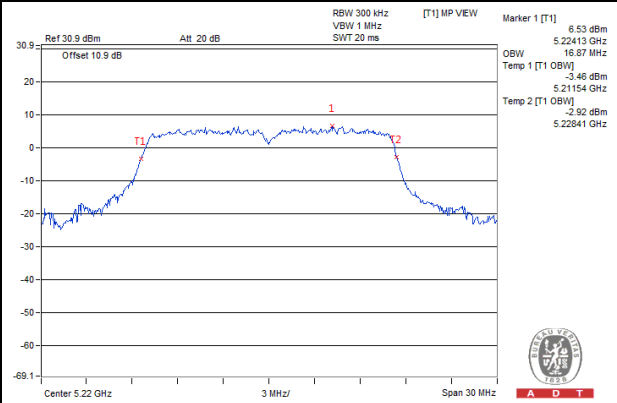

Channel 48

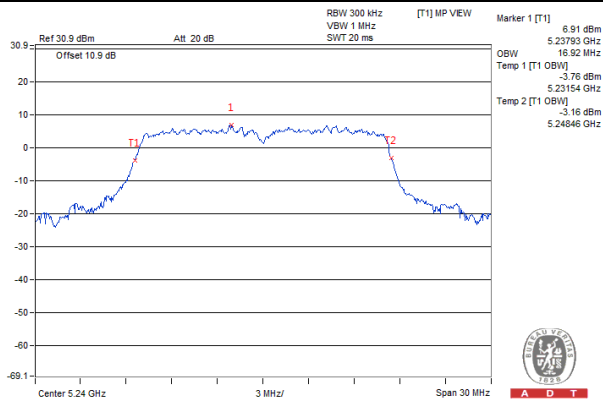



A D T

802.11n (20MHz)

Channel 36

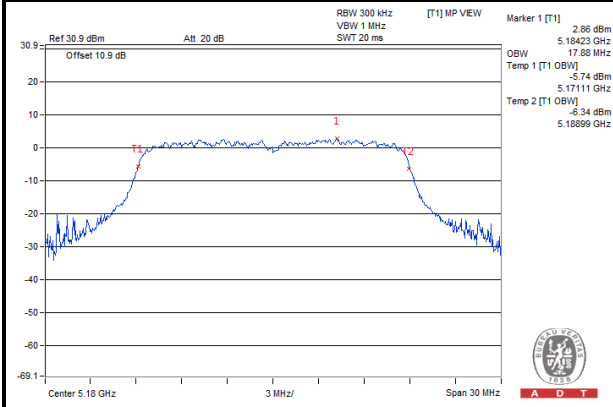

Channel 44

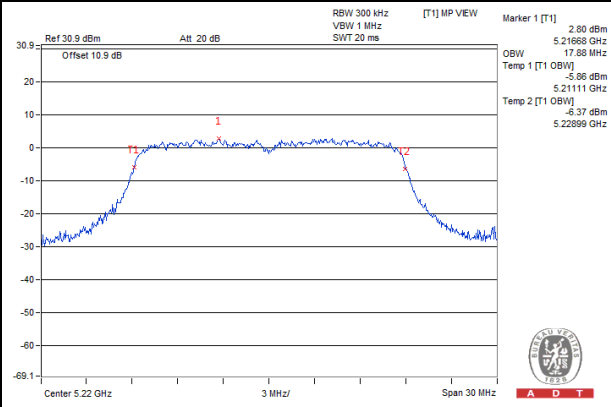

Channel 48

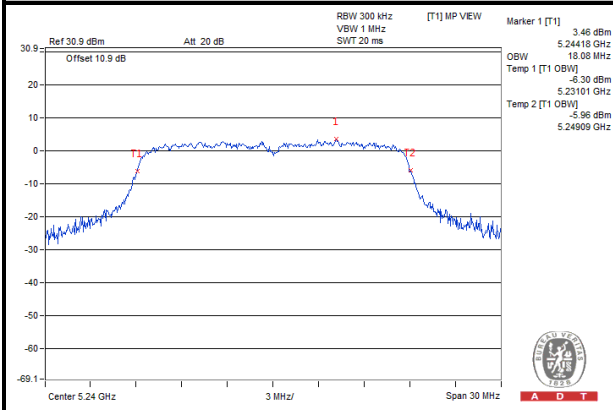



A D T

802.11n (40MHz)

Channel 38

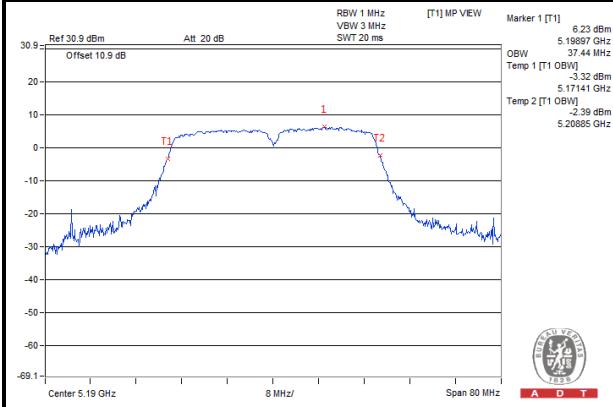

Channel 46

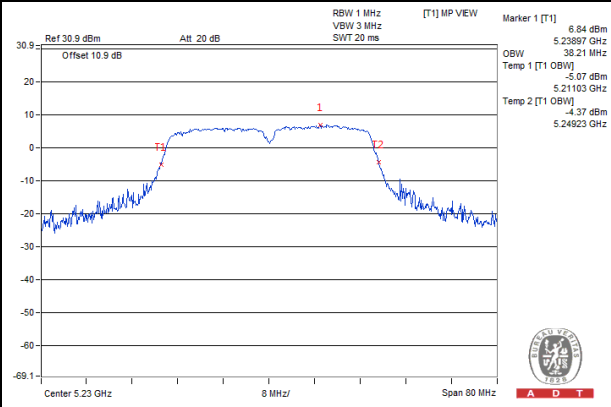

4.4 PEAK POWER SPECTRAL DENSITY MEASUREMENT

4.4.1 LIMITS OF PEAK POWER SPECTRAL DENSITY MEASUREMENT

Operation Band	EUT Category		LIMIT
U-NII-1		Outdoor Access Point	17dBm/ MHz
		Fixed point-to-point Access Point	
		Indoor Access Point	
	√	Mobile and Portable client device	11dBm/ MHz
U-NII-2A	√	---	11dBm/ MHz
U-NII-2C	√	---	11dBm/ MHz
U-NII-3	√	---	30dBm/ 500kHz

4.4.2 TEST SETUP

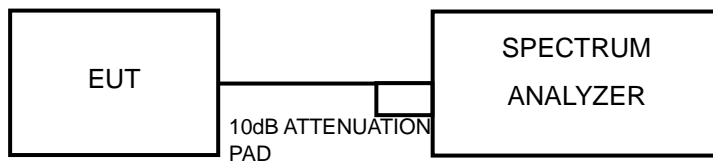

4.4.3 TEST INSTRUMENTS

Refer to section 4.1.3 to get information of above instrument.

4.4.4 TEST PROCEDURES

For U-NII-1, U-NII-2A, U-NII-2C band:

Using method SA-1 alternative

- 1) Set span to encompass the entire emission bandwidth (EBW) of the signal.
- 2) Set RBW = 30 kHz, Set VBW \geq 1 MHz, Detector = RMS
- 3) Set Channel power measure = 1MHz
- 4) Sweep time = 4 second.
- 5) Perform a single sweep.
- 6) Record the max value

Using method SA-2 alternative

- 1) Set span to encompass the entire emission bandwidth (EBW) of the signal.
- 2) Set RBW = 30 kHz, Set VBW \geq 1 MHz, Detector = RMS
- 3) Set Channel power measure = 1MHz
- 4) Sweep time = 4 second.
- 5) Perform a single sweep.
- 6) Record the max value and add 10 log (1/duty cycle)

For U-NII-3 band:

- 1) Set span to encompass the entire emission bandwidth (EBW) of the signal.
- 2) Set RBW = 500 kHz, Set VBW \geq 3 RBW, Detector = RMS
- 3) Sweep time = auto, trigger set to "free run".
- 4) Trace average at least 100 traces in power averaging mode.
- 5) Record the max value and add 10 log (1/duty cycle)

4.4.5 DEVIATION FROM TEST STANDARD

No deviation.

4.4.6 EUT OPERATING CONDITIONS

Same as Item 4.3.6.



4.4.7 TEST RESULTS

For U-NII-1, U-NII-2A, U-NII-2C Band

802.11a

CHANNEL	FREQUENCY (MHz)	PSD W/O DUTY FACTOR (dBm)	DUTY FACTOR	PSD WITH DUTY FACTOR (dBm)	MAXIMUM LIMIT (dBm)	PASS/FAIL
36	5180	2.66	0.10	2.76	11	PASS
44	5220	3.13	0.10	3.23	11	PASS
48	5240	3.35	0.10	3.45	11	PASS
52	5260	3.99	0.10	4.09	11	PASS
60	5300	3.55	0.10	3.65	11	PASS
64	5320	3.75	0.10	3.85	11	PASS
100	5500	5.37	0.10	5.47	11	PASS
116	5580	6.02	0.10	6.12	11	PASS
140	5700	5.21	0.10	5.31	11	PASS

NOTE: Refer to section 3.3 for duty cycle spectrum plot.

802.11n (20MHz)

CHANNEL	FREQUENCY (MHz)	PSD W/O DUTY FACTOR (dBm)	DUTY FACTOR	PSD WITH DUTY FACTOR (dBm)	MAXIMUM LIMIT (dBm)	PASS/FAIL
36	5180	-0.03	0.09	0.06	11	PASS
44	5220	-0.01	0.09	0.08	11	PASS
48	5240	0.23	0.09	0.32	11	PASS
52	5260	1.69	0.09	1.78	11	PASS
60	5300	1.97	0.09	2.06	11	PASS
64	5320	2.30	0.09	2.39	11	PASS
100	5500	3.34	0.09	3.43	11	PASS
116	5580	3.78	0.09	3.87	11	PASS
140	5700	3.00	0.09	3.09	11	PASS

NOTE: Refer to section 3.3 for duty cycle spectrum plot.



A D T

802.11n (40MHz)

CHANNEL	FREQUENCY (MHz)	PSD W/O DUTY FACTOR (dBm)	DUTY FACTOR	PSD WITH DUTY FACTOR (dBm)	MAXIMUM LIMIT (dBm)	PASS/FAIL
38	5190	-2.26	0.30	-1.96	11	PASS
46	5230	-1.74	0.30	-1.44	11	PASS
54	5270	-0.66	0.30	-0.36	11	PASS
62	5310	-0.66	0.30	-0.36	11	PASS
102	5510	1.00	0.30	1.30	11	PASS
110	5550	1.60	0.30	1.90	11	PASS
134	5670	0.64	0.30	0.94	11	PASS

NOTE: Refer to section 3.3 for duty cycle spectrum plot.

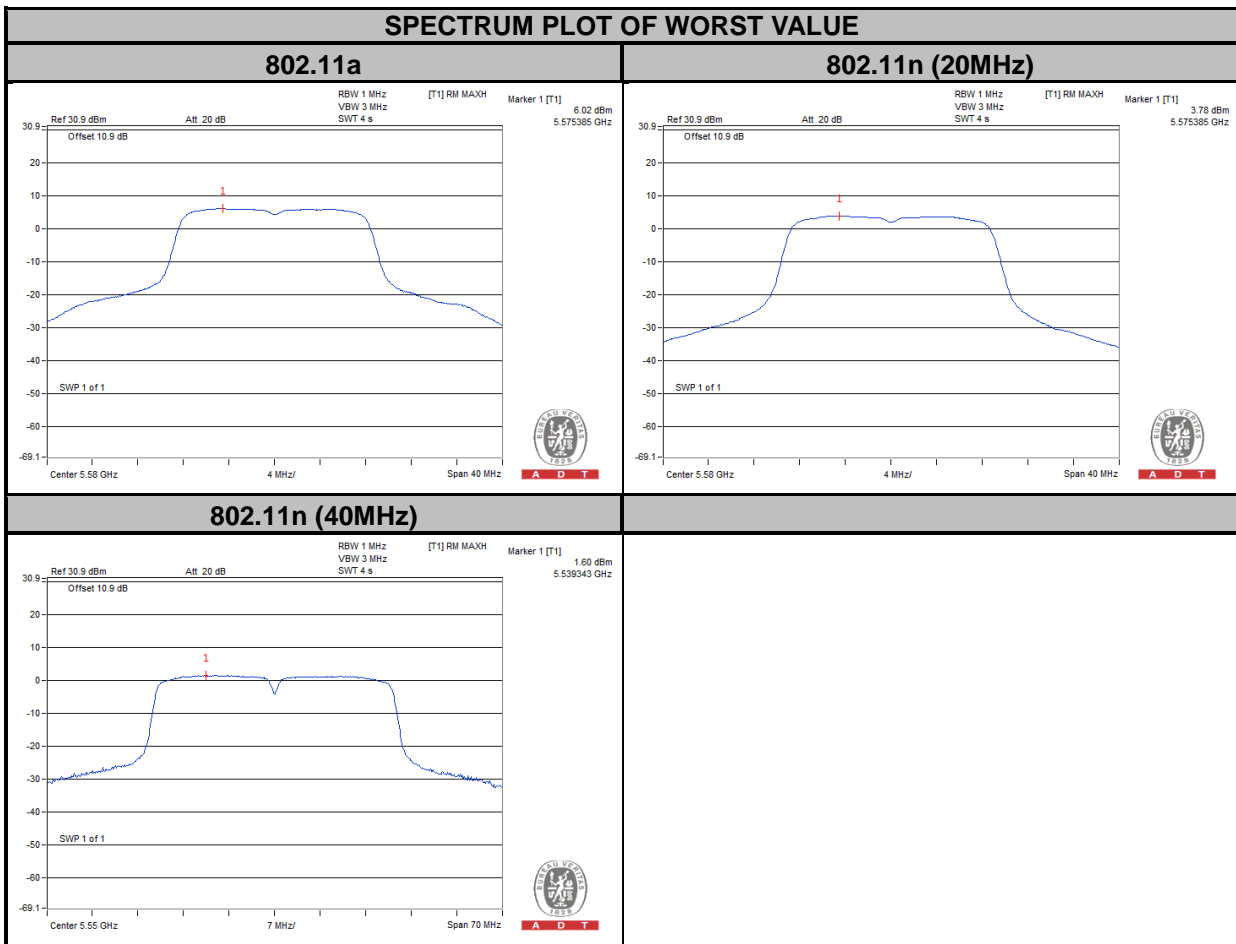

**A D T****For U-NII-3 Band****802.11a**

CHANNEL	FREQUENCY (MHz)	PSD W/O DUTY FACTOR (dBm)	DUTY FACTOR	PSD WITH DUTY FACTOR (dBm)	LIMIT (dBm/500kHz)	PASS/FAIL
149	5745	2.49	0.10	2.59	30	PASS
157	5785	1.18	0.10	1.28	30	PASS
165	5825	0.03	0.10	0.13	30	PASS

802.11n (20MHz)

CHANNEL	FREQUENCY (MHz)	PSD W/O DUTY FACTOR (dBm)	DUTY FACTOR	PSD WITH DUTY FACTOR (dBm)	LIMIT (dBm/500kHz)	PASS/FAIL
149	5745	-0.25	0.09	-0.16	30	PASS
157	5785	-0.73	0.09	-0.64	30	PASS
165	5825	-0.97	0.09	-0.88	30	PASS

802.11n (40MHz)

CHANNEL	FREQUENCY (MHz)	PSD W/O DUTY FACTOR (dBm)	DUTY FACTOR	PSD WITH DUTY FACTOR (dBm)	LIMIT (dBm/500kHz)	PASS/FAIL
151	5755	-2.97	0.30	-2.67	30	PASS
159	5795	-3.31	0.30	-3.01	30	PASS



A D T

SPECTRUM PLOT OF WORST VALUE

802.11a

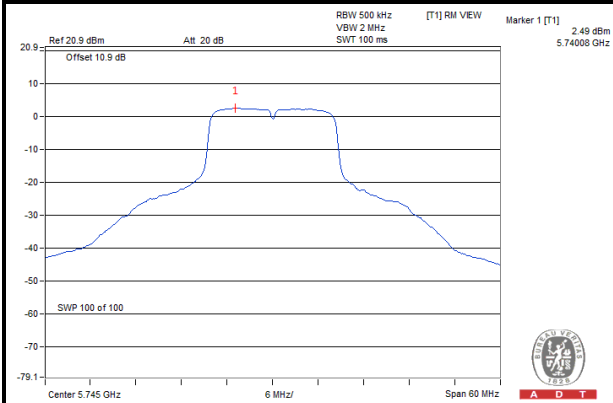

802.11n (20MHz)

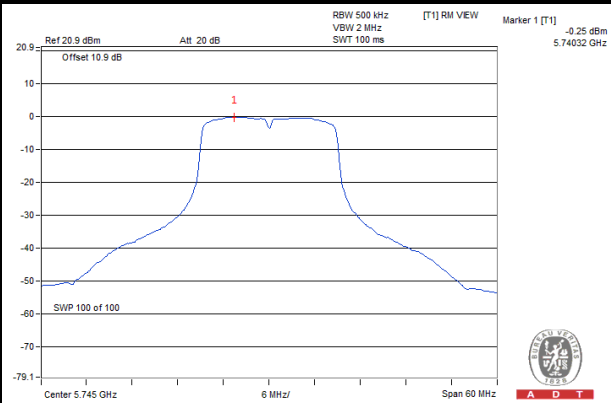

802.11n (40MHz)

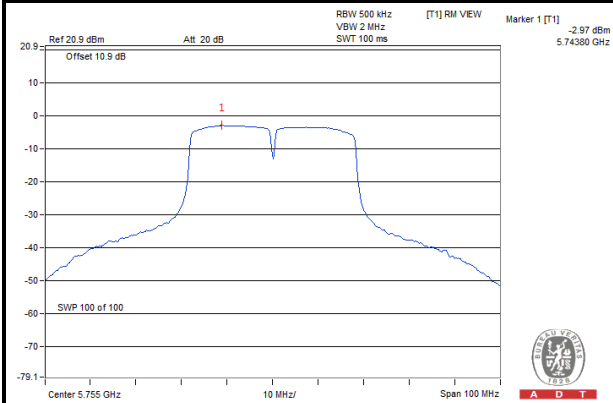

4.5 FREQUENCY STABILITY

4.5.1 LIMITS OF FREQUENCY STABILITY MEASUREMENT

The frequency of the carrier signal shall be maintained within band of operation.

4.5.2 TEST SETUP

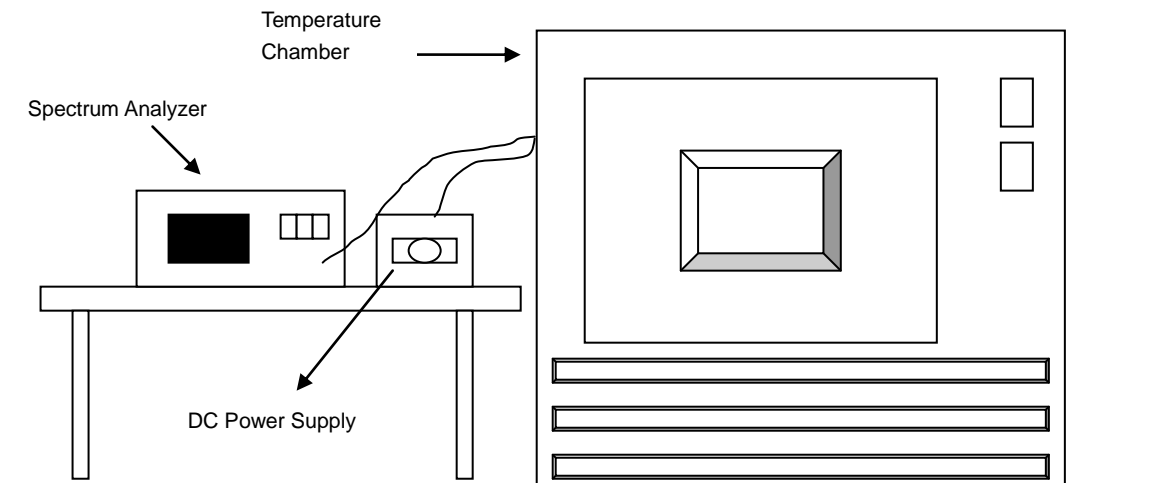

4.5.3 TEST INSTRUMENTS

Refer to section 4.1.3 to get information of above instrument.



4.5.4 TEST PROCEDURE

- a. To ensure emission at the band edge is maintained within the authorized band, those values shall be measured by radiation emissions at upper and lower frequency points, and finally compensated by frequency deviation as procedures below.
- b. The EUT was operated at the maximum output power, and connected to the spectrum analyzer, which is set to maximum hold function and peak detector. The peak value of the power envelope was measured and noted. The upper and lower frequency points were respectively measured relatively 10dB lower than the measured peak value.
- c. The frequency deviation was calculated by adding the upper frequency point and the lower frequency point divided by two. Those detailed values of frequency deviation are provided in table below.

4.5.5 DEVIATION FROM TEST STANDARD

No deviation.

4.5.6 EUT OPERATING CONDITION

Set the EUT transmit at un-modulation mode to test frequency stability.



A D T

4.5.7 TEST RESULTS

FREQUENCY STABILITY VERSUS TEMP.									
OPERATING FREQUENCY: 5320MHz									
TEMP. (°C)	POWER SUPPLY (Vdc)	0 MINUTE		2 MINUTE		5 MINUTE		10 MINUTE	
		Measured Frequency (MHz)	Frequency Drift (ppm)	Measured Frequency (MHz)	Frequency Drift (ppm)	Measured Frequency (MHz)	Frequency Drift (ppm)	Measured Frequency (MHz)	Frequency Drift (ppm)
50	5.0	5320.079823	15.004	5320.095041	17.865	5320.095211	17.897	5320.094997	17.857
40	5.0	5320.080176	15.071	5320.095043	17.865	5320.095564	17.963	5320.095198	17.894
30	5.0	5320.081669	15.351	5320.097113	18.254	5320.097077	18.248	5320.096749	18.186
20	5.0	5320.068928	12.956	5320.069244	13.016	5320.068870	12.945	5320.068530	12.882
10	5.0	5320.084988	15.975	5320.100208	18.836	5320.099793	18.758	5320.100038	18.804
0	5.0	5320.083180	15.635	5320.098400	18.496	5320.098390	18.494	5320.098083	18.437
-10	5.0	5320.081011	15.228	5320.096343	18.110	5320.096528	18.144	5320.095708	17.990
-20	5.0	5320.080683	15.166	5320.095699	17.989	5320.095717	17.992	5320.095966	18.039
-30	5.0	5320.080386	15.110	5320.095941	18.034	5320.095897	18.026	5320.095789	18.005

FREQUENCY STABILITY VERSUS VOLTAGE									
OPERATING FREQUENCY: 5320MHz									
TEMP. (°C)	POWER SUPPLY (Vdc)	0 MINUTE		2 MINUTE		5 MINUTE		10 MINUTE	
		Measured Frequency (MHz)	Frequency Drift (ppm)	Measured Frequency (MHz)	Frequency Drift (ppm)	Measured Frequency (MHz)	Frequency Drift (ppm)	Measured Frequency (MHz)	Frequency Drift (ppm)
20	4.75	5320.068696	12.913	5320.068281	12.835	5320.068407	12.858	5320.067808	12.746
	5.0	5320.068928	12.956	5320.069244	13.016	5320.068870	12.945	5320.068530	12.882
	5.25	5320.068857	12.943	5320.069505	13.065	5320.069109	12.990	5320.069212	13.010

4.6 6dB BANDWIDTH MEASUREMENT

4.6.1 LIMITS OF 6dB BANDWIDTH MEASUREMENT

The minimum of 6dB Bandwidth Measurement is 0.5MHz.

4.6.2 TEST SETUP

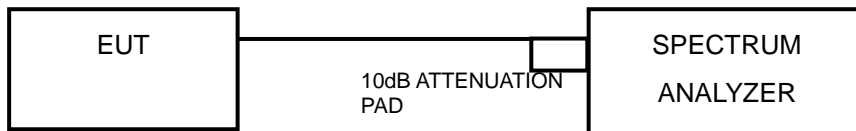

4.6.3 TEST INSTRUMENTS

Refer to section 4.1.3 to get information of above instrument.

4.6.4 TEST PROCEDURE

- Set resolution bandwidth (RBW) = 100kHz
- Set the video bandwidth (VBW) $\geq 3 \times$ RBW, Detector = Peak.
- Trace mode = max hold.
- Sweep = auto couple.
- Measure the maximum width of the emission that is constrained by the frequencies associated with the two amplitude points (upper and lower) that are attenuated by 6 dB relative to the maximum level measured in the fundamental emission.

4.6.5 DEVIATION FROM TEST STANDARD

No deviation.

4.6.6 EUT OPERATING CONDITIONS

The software provided by client to enable the EUT under transmission condition continuously at lowest, middle and highest channel frequencies individually.



A D T

4.6.7 TEST RESULTS

802.11a

CHANNEL	FREQUENCY (MHz)	6dB BANDWIDTH (MHz)	MINIMUM LIMIT (MHz)	PASS / FAIL
149	5745	15.82	0.5	PASS
157	5785	15.87	0.5	PASS
165	5825	16.09	0.5	PASS

802.11n (20MHz)

CHANNEL	FREQUENCY (MHz)	6dB BANDWIDTH (MHz)	MINIMUM LIMIT (MHz)	PASS / FAIL
149	5745	16.86	0.5	PASS
157	5785	16.98	0.5	PASS
165	5825	16.86	0.5	PASS

802.11n (40MHz)

CHANNEL	FREQUENCY (MHz)	6dB BANDWIDTH (MHz)	MINIMUM LIMIT (MHz)	PASS / FAIL
151	5755	35.49	0.5	PASS
159	5795	35.43	0.5	PASS



A D T

SPECTRUM PLOT OF WORST VALUE

802.11a

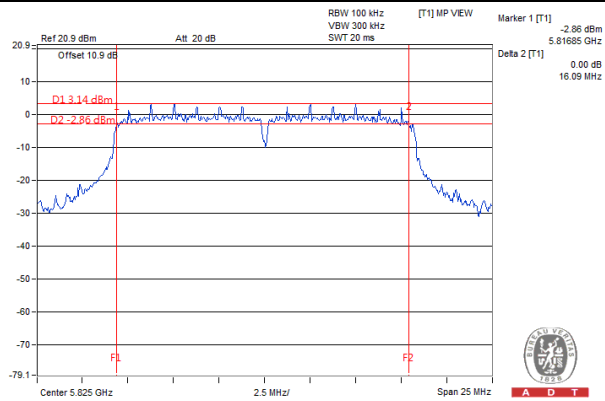

802.11n (20MHz)

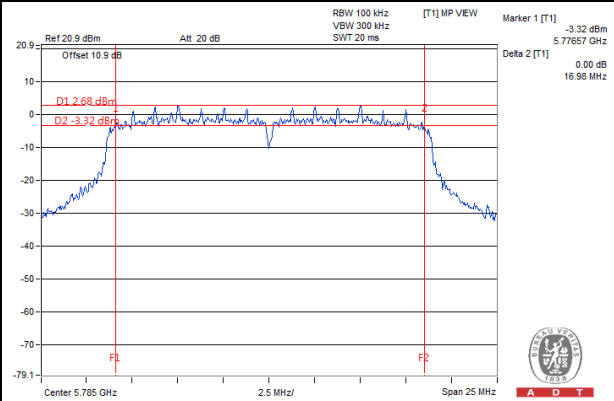

802.11n (40MHz)

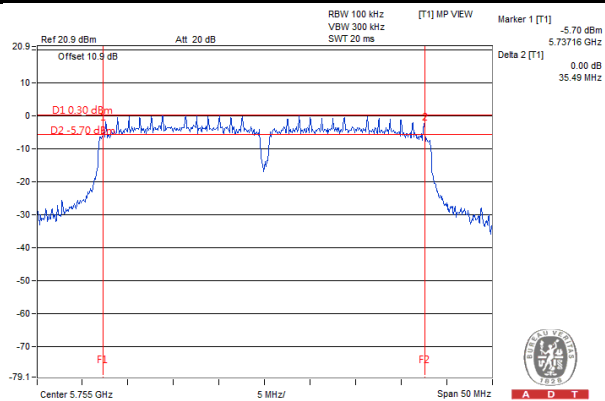



A D T

5. PHOTOGRAPHS OF THE TEST CONFIGURATION

Please refer to the attached file (Test Setup Photo).



A D T

6. INFORMATION ON THE TESTING LABORATORIES

We, Bureau Veritas Consumer Products Services (H.K.) Ltd., Taoyuan Branch, were founded in 1988 to provide our best service in EMC, Radio, Telecom and Safety consultation. Our laboratories are accredited and approved according to ISO/IEC 17025.

If you have any comments, please feel free to contact us at the following:

Linko EMC/RF Lab:

Tel: 886-2-26052180

Fax: 886-2-26051924

Hsin Chu EMC/RF/Telecom Lab:

Tel: 886-3-5935343

Fax: 886-3-5935342

Hwa Ya EMC/RF/Safety Lab:

Tel: 886-3-3183232

Fax: 886-3-3270892

Email: service.adt@tw.bureauveritas.com

Web Site: www.bureauveritas-adt.com

The address and road map of all our labs can be found in our web site also.



7. APPENDIX A - MODIFICATIONS RECORDERS FOR ENGINEERING CHANGES TO THE EUT BY THE LAB

No any modifications are made to the EUT by the lab during the test.

---END---