

## FCC Test Report

**Report No.:** RF170103C26-2

**FCC ID:** ZQAH10

**Test Model:** A0024

**Received Date:** Jan. 03, 2017

**Test Date:** Jan. 25, 2017 ~ Mar. 23, 2017

**Issued Date:** Apr. 28, 2017

**Applicant:** Nest Labs Inc.

**Address:** 3400 Hillview Ave. Palo Alto California, United States 94304

**Issued By:** Bureau Veritas Consumer Products Services (H.K.) Ltd., Taoyuan Branch

**Lab Address:** No. 47-2, 14th Ling, Chia Pau Vil., Lin Kou Dist., New Taipei City, Taiwan  
( R.O.C )

**Test Location:** No.19, Hwa Ya 2nd Rd., Wen Hwa Vil., Kwei Shan Dist., Taoyuan City  
33383, Taiwan, R.O.C.



This report is for your exclusive use. Any copying or replication of this report to or for any other person or entity, or use of our name or trademark, is permitted only with our prior written permission. This report sets forth our findings solely with respect to the test samples identified herein. The results set forth in this report are not indicative or representative of the quality or characteristics of the lot from which a test sample was taken or any similar or identical product unless specifically and expressly noted. Our report includes all of the tests requested by you and the results thereof based upon the information that you provided to us. You have 60 days from date of issuance of this report to notify us of any material error or omission caused by our negligence, provided, however, that such notice shall be in writing and shall specifically address the issue you wish to raise. A failure to raise such issue within the prescribed time shall constitute your unqualified acceptance of the completeness of this report, the tests conducted and the correctness of the report contents. Unless specific mention, the uncertainty of measurement has been explicitly taken into account to declare the compliance or non-compliance to the specification. The report must not be used by the client to claim product certification, approval, or endorsement by TAF or any government agencies.

## Table of Contents

<b>Release Control Record</b> .....	<b>4</b>
<b>1 Certificate of Conformity</b> .....	<b>5</b>
<b>2 Summary of Test Results</b> .....	<b>6</b>
2.1 Measurement Uncertainty.....	6
2.2 Modification Record .....	6
<b>3 General Information</b> .....	<b>7</b>
3.1 General Description of EUT .....	7
3.2 Description of Test Modes.....	8
3.2.1 Test Mode Applicability and Tested Channel Detail.....	9
3.3 Duty Cycle of Test Signal .....	11
3.4 Description of Support Units .....	12
3.4.1 Configuration of System under Test .....	12
3.5 General Description of Applied Standards.....	12
<b>4 Test Types and Results</b> .....	<b>13</b>
4.1 Radiated Emission and Bandedge Measurement .....	13
4.1.1 Limits of Radiated Emission and Bandedge Measurement .....	13
4.1.2 Limits of Unwanted Emission Out of the Restricted Bands .....	14
4.1.3 Test Instruments .....	15
4.1.4 Test Procedures.....	16
4.1.5 Deviation from Test Standard .....	16
4.1.6 Test Set Up .....	17
4.1.7 EUT Operating Conditions.....	18
4.1.8 Test Results .....	19
4.2 Conducted Emission Measurement.....	90
4.2.1 Limits of Conducted Emission Measurement .....	90
4.2.2 Test Instruments .....	90
4.2.3 Test Procedures.....	91
4.2.4 Deviation from Test Standard .....	91
4.2.5 Test Setup.....	91
4.2.6 EUT Operating Conditions.....	91
4.2.7 Test Results .....	92
4.3 Transmit Power Measurement.....	94
4.3.1 Limits of Transmit Power Measurement .....	94
4.3.2 Test Setup.....	94
4.3.3 Test Instruments .....	95
4.3.4 Test Procedure .....	95
4.3.5 Deviation from Test Standard .....	95
4.3.6 EUT Operating Conditions.....	95
4.3.7 Test Result .....	96
4.4 Peak Power Spectral Density Measurement .....	100
4.4.1 Limits of Peak Power Spectral Density Measurement .....	100
4.4.2 Test Setup.....	100
4.4.3 Test Instruments .....	100
4.4.4 Test Procedures.....	100
4.4.5 Deviation from Test Standard .....	101
4.4.6 EUT Operating Conditions.....	101
4.4.7 Test Results .....	102
4.5 Frequency Stability .....	105
4.5.1 Limit of Frequency Stability Measurement .....	105
4.5.2 Test Setup.....	105
4.5.3 Test Instruments .....	105
4.5.4 Test Procedure .....	105
4.5.5 Deviation from Test Standard .....	105

4.5.6 EUT Operating Condition .....	105
4.5.7 Test Results .....	106
4.6 6 dB Bandwidth Measurement.....	108
4.6.1 Limits of 6 dB Bandwidth Measurement.....	108
4.6.2 Test Setup.....	108
4.6.3 Test Instruments .....	108
4.6.4 Test Procedure .....	108
4.6.5 Deviation from Test Standard .....	108
4.6.6 EUT Operating Condition .....	108
4.6.7 Test Results .....	109
<b>5 Pictures of Test Arrangements.....</b>	<b>110</b>
<b>Annex A- Radiated Bandedge Plots.....</b>	<b>111</b>
<b>Appendix – Information on the Testing Laboratories .....</b>	<b>117</b>

### Release Control Record

Issue No.	Description	Date Issued
RF170103C26-2	Original Release	Apr. 28, 2017

## 1 Certificate of Conformity

**Product:** Home security device

**Brand:** Nest Guard

**Test Model:** A0024

**Sample Status:** Identical Prototype

**Applicant:** Nest Labs Inc.

**Test Date:** Jan. 25, 2017 ~ Mar. 23, 2017

**Standards:** 47 CFR FCC Part 15, Subpart E (Section 15.407)  
ANSI C63.10:2013

The above equipment has been tested by **Bureau Veritas Consumer Products Services (H.K.) Ltd., Taoyuan Branch**, and found compliance with the requirement of the above standards. The test record, data evaluation & Equipment Under Test (EUT) configurations represented herein are true and accurate accounts of the measurements of the sample's EMC characteristics under the conditions specified in this report.

**Prepared by :** Rona Chen, **Date:** Apr. 28, 2017  
Rona Chen / Specialist

**Approved by :** David Huang, **Date:** Apr. 28, 2017  
David Huang / Project Engineer

## 2 Summary of Test Results

47 CFR FCC Part 15, Subpart E (Section 15.407)			
FCC Clause	Test Item	Result	Remarks
15.407(b)(6)	AC Power Conducted Emissions	Pass	Meet the requirement of limit. Minimum passing margin is -12.03 dB at 0.61138 MHz.
15.407(b) (1/2/3/4(i/ii)/6)	Radiated Emissions & Band Edge Measurement	Pass	Meet the requirement of limit. Minimum passing margin is -1.17 dB at 5350.33 MHz.
15.407(a)(1/2/3)	Max Average Transmit Power	Pass	Meet the requirement of limit.
15.407(a)(1/2/3)	Peak Power Spectral Density	Pass	Meet the requirement of limit.
15.407(e)	6 dB Bandwidth	Pass	Meet the requirement of limit. (U-NII-3 Band only)
15.407(g)	Frequency Stability	Pass	Meet the requirement of limit.
15.203	Antenna Requirement	Pass	No antenna connector is used.

\*For U-NII-3 band compliance with rule part 15.407(b)(4)(i), the OOB test plots were recorded in Section 4.1.8.

### 2.1 Measurement Uncertainty

Where relevant, the following measurement uncertainty levels have been estimated for tests performed on the EUT as specified in CISPR 16-4-2:

Measurement	Frequency	Expanded Uncertainty (k=2) (±)
Conducted Emissions at mains ports	150 kHz ~ 30 MHz	2.44 dB
Radiated Emissions up to 1 GHz	30 MHz ~ 200 MHz	2.93 dB
	200 MHz ~ 1000 MHz	2.95 dB
Radiated Emissions above 1 GHz	1 GHz ~ 18 GHz	2.26 dB
	18 GHz ~ 40 GHz	1.94 dB

### 2.2 Modification Record

There were no modifications required for compliance.

### 3 General Information

#### 3.1 General Description of EUT

<b>Product</b>	Home security device
<b>Brand</b>	Nest Guard
<b>Test Model</b>	A0024
<b>Status of EUT</b>	Identical Prototype
<b>Power Supply Rating</b>	5.0 Vdc (adapter or host equipment) 3.7 Vdc (Li-ion battery)
<b>Modulation Type</b>	64QAM, 16QAM, QPSK, BPSK
<b>Modulation Technology</b>	OFDM
<b>Transfer Rate</b>	802.11a: 54.0/ 48.0/ 36.0/ 24.0/ 18.0/ 12.0/ 9.0/ 6.0 Mbps 802.11n: up to MCS7
<b>Operating Frequency</b>	5180 ~ 5240 MHz, 5260 ~ 5320 MHz, 5500 ~ 5700 MHz, 5745 ~ 5825 MHz
<b>Number of Channel</b>	5180 ~ 5240 MHz: 4 for 802.11a, 802.11n (HT20) 5260 ~ 5320 MHz: 4 for 802.11a, 802.11n (HT20) 5500 ~ 5700 MHz: 11 for 802.11a, 802.11n (HT20) 5745 ~ 5825 MHz: 5 for 802.11a, 802.11n (HT20)
<b>Output Power</b>	92.897 mW for 5180 ~ 5240 MHz 80.724 mW for 5260 ~ 5320 MHz 72.111 mW for 5500 ~ 5700 MHz 79.068 mW for 5745 ~ 5825 MHz
<b>Antenna Type</b>	Monopole Type antenna with 3.06 dBi gain (5180 ~ 5240 MHz) Monopole Type antenna with 3.21 dBi gain (5260 ~ 5320 MHz) Monopole Type antenna with 1.90 dBi gain (5500 ~ 5700 MHz) Monopole Type antenna with 2.56 dBi gain (5745 ~ 5825 MHz)
<b>Antenna Connector</b>	N/A
<b>Accessory Device</b>	Refer to Note as below
<b>Data Cable Supplied</b>	Refer to Note as below

**Note:**

- The EUT provides 1 completed transmitter and 1 receiver.

Modulation Mode	Tx Function
802.11a	1TX
802.11n (HT20)	1TX

- The EUT contains following accessory devices.

Product	Brand	Model	Description
Adapter	Nest	A0017	I/P: 100-240 Vac, 50/60 Hz, 0.35 A O/P: 5 Vdc, 2.5 A
Battery	Nest	N/A	3.7 Vdc, 2850 mAh
USB Cable	Nest	N/A	1.9 meter shielded cable without core

- The above EUT information is declared by manufacturer and for more detailed features description, please refer to the manufacturer's specifications or user's manual.

### 3.2 Description of Test Modes

#### For 5180 ~ 5240 MHz

4 channels are provided for 802.11a, 802.11n (HT20):

Channel	Frequency (MHz)	Channel	Frequency (MHz)
36	5180	44	5220
40	5200	48	5240

#### For 5260 ~ 5320 MHz

4 channels are provided for 802.11a, 802.11n (HT20):

Channel	Frequency (MHz)	Channel	Frequency (MHz)
52	5260	60	5300
56	5280	64	5320

#### For 5500 ~ 5700 MHz

11 channels are provided for 802.11a, 802.11n (HT20):

Channel	Frequency (MHz)	Channel	Frequency (MHz)
100	5500	124	5620
104	5520	128	5640
108	5540	132	5660
112	5560	136	5680
116	5580	140	5700
120	5600		

#### For 5745 ~ 5825 MHz:

5 channels are provided for 802.11a, 802.11n (HT20):

Channel	Frequency (MHz)	Channel	Frequency (MHz)
149	5745	161	5805
153	5765	165	5825
157	5785		



### 3.2.1 Test Mode Applicability and Tested Channel Detail

EUT Configure Mode	Applicable To				Description
	RE $\geq$ 1G	RE $<$ 1G	PLC	APCM	
-	√	√	√	√	-

Where **RE $\geq$ 1G**: Radiated Emission above 1 GHz      **RE $<$ 1G**: Radiated Emission below 1 GHz  
**PLC**: Power Line Conducted Emission      **APCM**: Antenna Port Conducted Measurement

**Note:** 1. The EUT had been pre-tested on the positioned of each 3 axis. The worst case was found when positioned on **Z-plane**.

#### **Radiated Emission Test (Above 1 GHz):**

- Pre-Scan has been conducted to determine the worst-case mode from all possible combinations between available modulations, data rates and antenna ports (if EUT with antenna diversity architecture).
- Following channel(s) was (were) selected for the final test as listed below.

EUT Configure Mode	Frequency Band (MHz)	Mode	Available Channel	Tested Channel	Modulation Technology	Modulation Type	Data Rate (Mbps)
-	5180-5240	802.11a	36 to 48	36, 44, 48	OFDM	BPSK	6.0
-		802.11n (HT20)	36 to 48	36, 44, 48	OFDM	BPSK	MCS0
-	5260-5320	802.11a	52 to 64	52, 60, 64	OFDM	BPSK	6.0
-		802.11n (HT20)	52 to 64	52, 60, 64	OFDM	BPSK	MCS0
-	5500-5700	802.11a	100 to 140	100, 116, 140	OFDM	BPSK	6.0
-		802.11n (HT20)	100 to 140	100, 116, 140	OFDM	BPSK	MCS0
-	5745-5825	802.11a	149 to 165	149, 157, 165	OFDM	BPSK	6.0
-		802.11n (HT20)	149 to 165	149, 157, 165	OFDM	BPSK	MCS0

#### **Radiated Emission Test (Below 1 GHz):**

- Pre-Scan has been conducted to determine the worst-case mode from all possible combinations between available modulations, data rates and antenna ports (if EUT with antenna diversity architecture).
- Following channel(s) was (were) selected for the final test as listed below.

EUT Configure Mode	Frequency Band (MHz)	Mode	Available Channel	Tested Channel	Modulation Technology	Modulation Type	Data Rate (Mbps)
-	5180-5240	802.11a	36 to 48	36	OFDM	BPSK	6.0
-	5260-5320	802.11a	52 to 64	60	OFDM	BPSK	6.0
-	5500-5700	802.11n (HT20)	100 to 140	140	OFDM	BPSK	MCS0
-	5745-5825	802.11a	149 to 165	149	OFDM	BPSK	6.0

- The Low Frequency, which started from 9kHz to 30MHz, was pre-scanned and the result which was 20 dB lower than the limit line was not reported.

#### **Power Line Conducted Emission Test:**

- Pre-Scan has been conducted to determine the worst-case mode from all possible combinations between available modulations, data rates and antenna ports (if EUT with antenna diversity architecture).
- Following channel(s) was (were) selected for the final test as listed below.

EUT Configure Mode	Frequency Band (MHz)	Mode	Available Channel	Tested Channel	Modulation Technology	Modulation Type	Data Rate (Mbps)
-	5180-5320	802.11a	36 to 64	60	OFDM	BPSK	6.0

### **Antenna Port Conducted Measurement:**

- This item includes all test value of each mode, but only includes spectrum plot of worst value of each mode.
- Pre-Scan has been conducted to determine the worst-case mode from all possible combinations between available modulations, data rates and antenna ports (if EUT with antenna diversity architecture).
- Following channel(s) was (were) selected for the final test as listed below.

EUT Configure Mode	Frequency Band (MHz)	Mode	Available Channel	Tested Channel	Modulation Technology	Modulation Type	Data Rate (Mbps)
-	5180-5240	802.11a	36 to 48	36, 44, 48	OFDM	BPSK	6.0
-		802.11n (HT20)	36 to 48	36, 44, 48	OFDM	BPSK	MCS0
-	5260-5320	802.11a	52 to 64	52, 60, 64	OFDM	BPSK	6.0
-		802.11n (HT20)	52 to 64	52, 60, 64	OFDM	BPSK	MCS0
-	5500-5700	802.11a	100 to 140	100, 116, 140	OFDM	BPSK	6.0
-		802.11n (HT20)	100 to 140	100, 116, 140	OFDM	BPSK	MCS0
-	5745-5825	802.11a	149 to 165	149, 157, 165	OFDM	BPSK	6.0
-		802.11n (HT20)	149 to 165	149, 157, 165	OFDM	BPSK	MCS0

### **Test Condition:**

Applicable To	Environmental Conditions	Input Power	Tested by
RE $\geq$ 1G	25 deg. C, 65 % RH	120 Vac, 60 Hz	Gavin Wu
RE<1G	25 deg. C, 65 % RH	120 Vac, 60 Hz	Gavin Wu
PLC	25 deg. C, 65 % RH	120 Vac, 60 Hz	Getaz Yang
APCM	25 deg. C, 65 % RH	3.7 Vdc	Taylor Liu

### 3.3 Duty Cycle of Test Signal

#### MODULATION TYPE: BPSK

Duty cycle of test signal is < 98 %, duty factor is required.

**802.11a:** Duty cycle =  $1.434/1.683 = 0.852$ , Duty factor =  $10 * \log(1/0.852) = 0.69$

**802.11n (HT20):** Duty cycle =  $1.338/1.587 = 0.843$ , Duty factor =  $10 * \log(1/0.843) = 0.74$

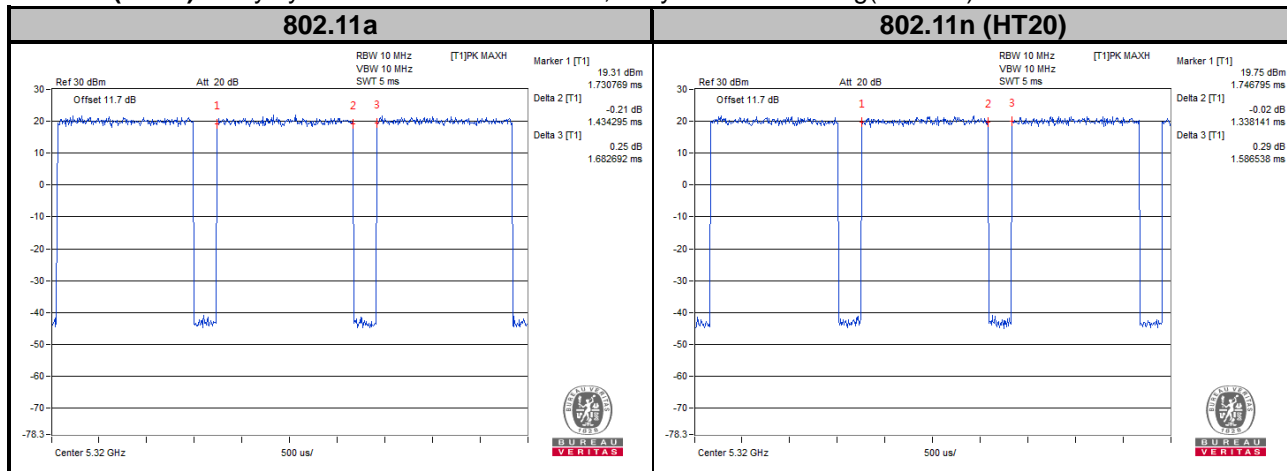

### 3.4 Description of Support Units

The EUT has been tested as an independent unit together with other necessary accessories or support units.

#### 3.4.1 Configuration of System under Test

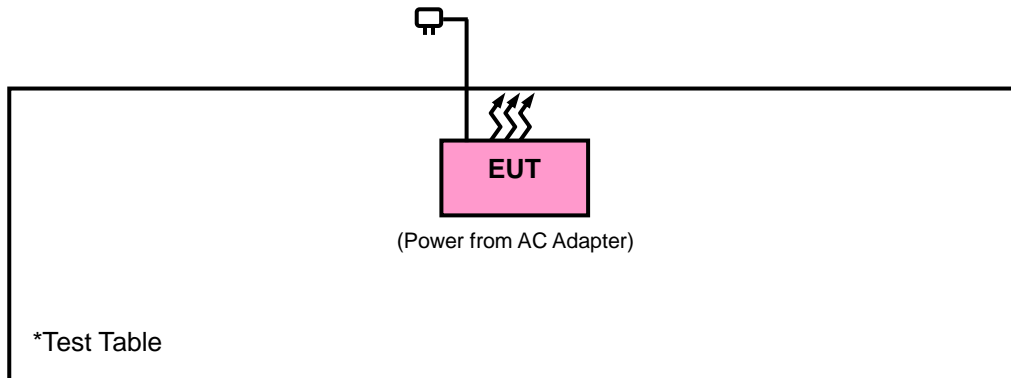

### 3.5 General Description of Applied Standards

The EUT is a RF Product. According to the specifications of the manufacturer, it must comply with the requirements of the following standards:

**FCC Part 15, Subpart E (15.407)**

**789033 D02 General UNII Test Procedures New Rules v01r04**

ANSI C63.10-2013

All test items have been performed and recorded as per the above standards.

## 4 Test Types and Results

### 4.1 Radiated Emission and Bandedge Measurement

#### 4.1.1 Limits of Radiated Emission and Bandedge Measurement

Radiated emissions which fall in the restricted bands must comply with the radiated emission limits specified as below table. Other emissions shall be at least 20 dB below the highest level of the desired power:

Frequencies (MHz)	Field Strength (microvolts/meter)	Measurement Distance (meters)
0.009 ~ 0.490	2400/F (kHz)	300
0.490 ~ 1.705	24000/F (kHz)	30
1.705 ~ 30.0	30	30
30 ~ 88	100	3
88 ~ 216	150	3
216 ~ 960	200	3
Above 960	500	3

**Note:**

1. The lower limit shall apply at the transition frequencies.
2. Emission level (dBuV/m) = 20 log Emission level (uV/m).
3. For frequencies above 1000 MHz, the field strength limits are based on average detector, however, the peak field strength of any emission shall not exceed the maximum permitted average limits, specified above by more than 20 dB under any condition of modulation.

#### 4.1.2 Limits of Unwanted Emission Out of the Restricted Bands

Applicable To		Limit	
789033 D02 General UNII Test Procedures New Rules v01r04		Field Strength at 3 m	
		PK: 74 (dBµV/m)	AV: 54 (dBµV/m)
Frequency Band	Applicable To	EIRP Limit	Equivalent Field Strength at 3 m
5150~5250 MHz	15.407(b)(1)	PK: -27 (dBm/MHz)	PK: 68.2 (dBµV/m)
5250~5350 MHz	15.407(b)(2)		
5470~5725 MHz	15.407(b)(3)		
5725~5850 MHz	15.407(b)(4)(i)	PK:-27 (dBm/MHz) <sup>*1</sup> PK:10 (dBm/MHz) <sup>*2</sup> PK:15.6 (dBm/MHz) <sup>*3</sup> PK:27 (dBm/MHz) <sup>*4</sup>	PK: 68.2 (dBµV/m) <sup>*1</sup> PK:105.2 (dBµV/m) <sup>*2</sup> PK: 110.8 (dBµV/m) <sup>*3</sup> PK:122.2 (dBµV/m) <sup>*4</sup>
	15.407(b)(4)(ii)	Emission limits in section 15.247(d)	

<sup>\*1</sup> beyond 75 MHz or more above of the band edge.

<sup>\*2</sup> below the band edge increasing linearly to 10 dBm/MHz at 25 MHz above.

<sup>\*3</sup> below the band edge increasing linearly to a level of 15.6 dBm/MHz at 5 MHz above.

<sup>\*4</sup> from 5 MHz above or below the band edge increasing linearly to a level of 27 dBm/MHz at the band edge.

**Note:**

The following formula is used to convert the equipment isotropic radiated power (eirp) to field strength:

$$E = \frac{1000000\sqrt{30P}}{3} \mu\text{V/m, where P is the eirp (Watts).}$$

## 4.1.3 Test Instruments

Description & Manufacturer	Model No.	Serial No.	Date of Calibration	Due Date of Calibration
Test Receiver Agilent	N9038A	MY52260177	Jun. 21, 2016	Jun. 20, 2017
		MY51210203	Feb. 17, 2017	Feb. 16, 2018
Spectrum Analyzer Agilent	N9010A	MY52220314	Dec. 16, 2016	Dec. 15, 2017
Spectrum Analyzer ROHDE & SCHWARZ	FSU43	101261	Dec. 13, 2016	Dec. 12, 2017
BILOG Antenna SCHWARZBECK	VULB9168	9168-472	Dec. 26, 2016	Dec. 27, 2017
HORN Antenna SCHWARZBECK	BBHA 9120 D	9120D-969	Dec. 12, 2016	Dec. 13, 2017
HORN Antenna SCHWARZBECK	BBHA 9170	9170-480	Dec. 14, 2016	Dec. 13, 2017
Fixed Attenuator Mini-Circuits	BW-N10W5+	NA	Jul. 08, 2016	Jul. 07, 2017
Loop Antenna	EM-6879	269	Aug. 11, 2016	Aug. 10, 2017
Preamplifier EMCI	EMC 012645	980115	Oct. 21, 2016	Oct. 20, 2017
Preamplifier EMCI	EMC 184045	980116	Oct. 21, 2016	Oct. 20, 2017
Preamplifier EMCI	EMC 330H	980112	Oct. 21, 2016	Oct. 20, 2017
Power Meter Anritsu	ML2495A	1232002	Sep. 08, 2016	Sep. 07, 2017
Power Sensor Anritsu	MA2411B	1207325	Sep. 08, 2016	Sep. 07, 2017
RF signal cable HUBER+SUHNNER	SUCOFLEX 104	309219/4 2950114	Oct. 21, 2016	Oct. 20, 2017
RF signal cable HUBER+SUHNNER	SUCOFLEX 104	250130/4	Oct. 21, 2016	Oct. 20, 2017
RF Coaxial Cable Worken	8D-FB	Cable-Ch10-01	Oct. 21, 2016	Oct. 20, 2017
Software BV ADT	E3 6.120103	NA	NA	NA
Antenna Tower MF	MFA-440H	NA	NA	NA
Turn Table MF	MFT-201SS	NA	NA	NA
Antenna Tower & Turn Table Controller MF	MF-7802	NA	NA	NA
Temperature & Humidity Chamber	GTH-120-40-CP-AR	MAA1306-019	Sep. 02, 2016	Sep. 01, 2017
DC Power Supply Topward	33010D	807748	Oct. 25, 2016	Oct. 24, 2017
Digital Multimeter Fluke	87-III	70360742	Jul. 01, 2016	Jun. 30, 2017

- Note:
1. The calibration interval of the above test instruments is 12 months and the calibrations are traceable to NML/ROC and NIST/USA.
  2. The test was performed in HwaYa Chamber 10.
  3. The horn antenna and preamplifier (model: EMC 184045) are used only for the measurement of emission frequency above 1 GHz if tested.
  4. The FCC Designation Number is TW0003. The number will be varied with the Lab location and scope as attached.
  5. The IC Site Registration No. is IC7450F-10.

#### 4.1.4 Test Procedures

- a. The EUT was placed on the top of a rotating table 0.8 meters (for below 1 GHz) / 1.5 meters (for above 1 GHz) above the ground at 3 meter chamber room for test. The table was rotated 360 degrees to determine the position of the highest radiation.
- b. The EUT was set 3 meters away from the interference-receiving antenna, which was mounted on the top of a variable-height antenna tower.
- c. The height of antenna is varied from one meter to four meters above the ground to determine the maximum value of the field strength. Both horizontal and vertical polarizations of the antenna are set to make the measurement.
- d. For each suspected emission, the EUT was arranged to its worst case and then the antenna was tuned to heights from 1 meter to 4 meters and the rotatable table was turned from 0 degrees to 360 degrees to find the maximum reading.
- e. The test-receiver system was set to quasi-peak detect function and specified bandwidth with maximum hold mode when the test frequency is below 1 GHz.
- f. The test-receiver system was set to peak and average detected function and specified bandwidth with maximum hold mode when the test frequency is above 1 GHz. If the peak reading value also meets average limit, measurement with the average detector is unnecessary.

**Note:**

1. The resolution bandwidth and video bandwidth of test receiver/spectrum analyzer is 120 kHz & 360 kHz for Quasi-peak detection (QP) at frequency below 1 GHz.
2. The resolution bandwidth of test receiver/spectrum analyzer is 1 MHz and the video bandwidth is 3 MHz for Peak detection (PK) at frequency above 1 GHz.
3. The resolution bandwidth of test receiver/spectrum analyzer is 1 MHz and the video bandwidth is 1/T for Average (Duty cycle < 98 %) for Average detection at frequency above 1 GHz.
4. The resolution bandwidth of test receiver/spectrum analyzer is 1 MHz and the video bandwidth is 10 Hz (Duty cycle ≥ 98 %) for Average detection (AV) at frequency above 1 GHz.
5. All modes of operation were investigated and the worst-case emissions are reported.

Test Setting			
Bandedge Emissions	RBW / VBW		
(Non-restricted Band)	100k / 300k		
(Restricted Band)	802.11a	Average: 1M / 1k	Peak: 1M / 3M
	802.11n (20MHz)		

#### 4.1.5 Deviation from Test Standard

No deviation.



4.1.6 Test Set Up

<Radiated emission below 30MHz>

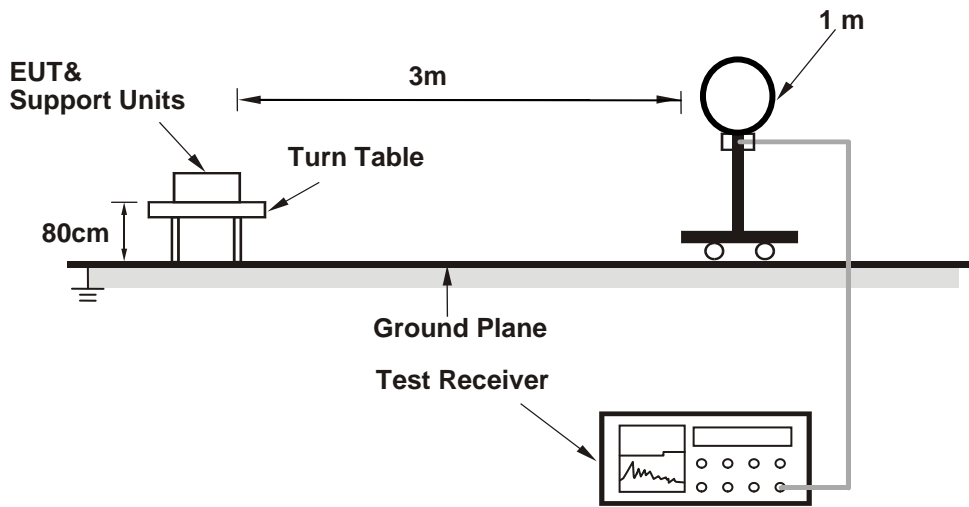

<Frequency Range below 1 GHz>

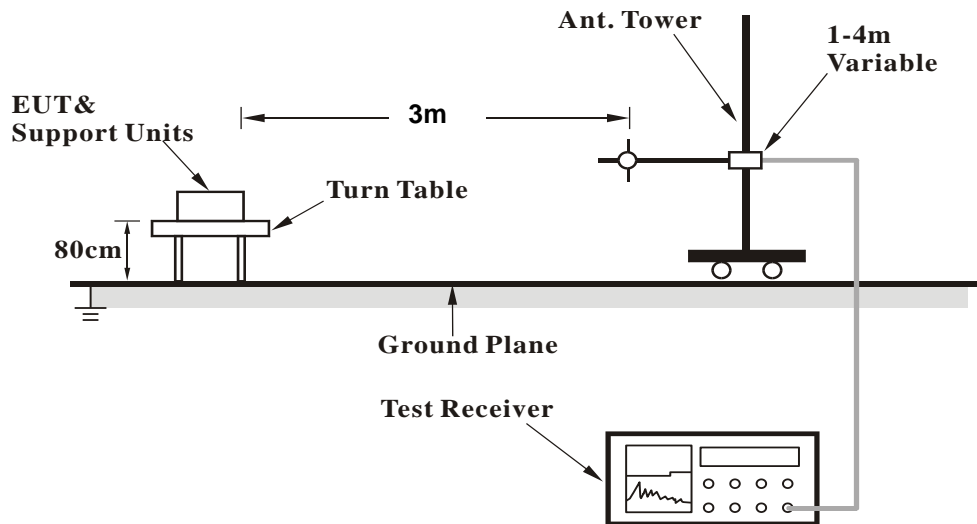

<Frequency Range above 1 GHz>

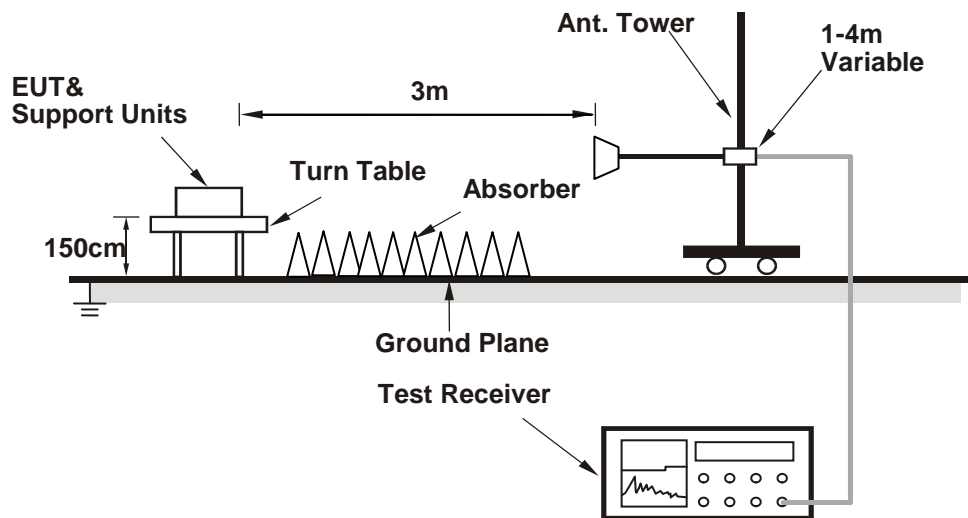

For the actual test configuration, please refer to the attached file (Test Setup Photo).

#### 4.1.7 EUT Operating Conditions

- Placed the EUT on a testing table.
- Use the software to control the EUT under transmission condition continuously at specific channel frequency.

#### 4.1.8 Test Results

No non-compliance noted:

#### **KDB 414788 D01 OATS and Chamber Correlation Justification**

- Base on FCC 15.31 (f) (2): measurements may be performed at a distance closer than that specified in the regulations; however, an attempt should be made to avoid making measurements in the near field.
- OATs and chamber correlation testing had been performed and chamber measured test result is the worst case test result.

**Above 1 GHz Data :**  
**802.11a**

EUT Test Condition		Measurement Detail	
Channel	Channel 36	Frequency Range	1 GHz ~ 40 GHz
Input Power	120 Vac, 60 Hz	Detector Function	Peak (PK) Average (AV)
Environmental Conditions	25 deg. C, 65 % RH	Tested By	Gavin Wu

**Horizontal**

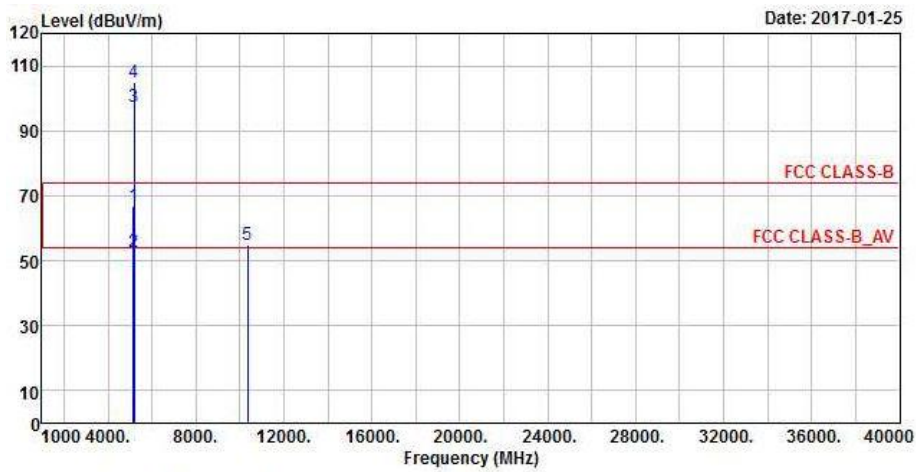

**Vertical**

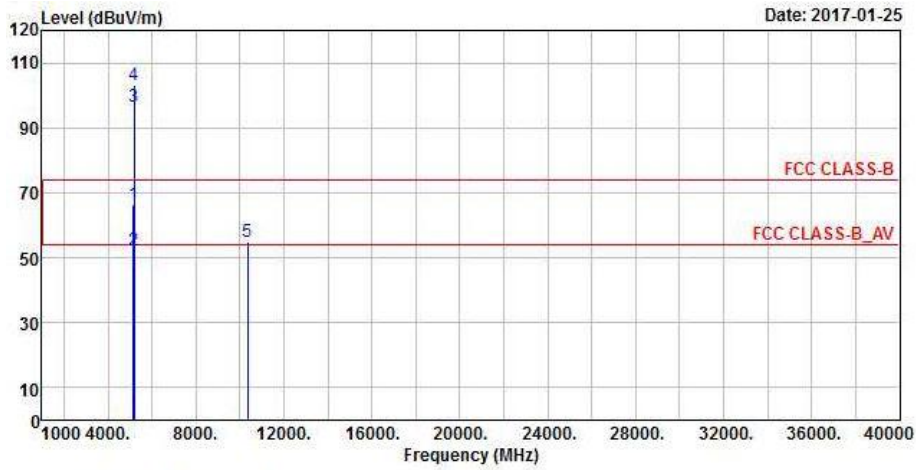

**Antenna Polarity & Test Distance: Horizontal at 3 m**

Frequency (MHz)	Emission Level (dBuV/m)	Read Level (dBuV)	Limit (dBuV/m)	Margin (dB)	Antenna Factor (dB/m)	Cable Loss (dB)	Preamp Factor (dB)	Antenna Height (cm)	Table Angle (Degree)	Remark
5149.7	66.77	66.57	74	-7.23	31.32	6.2	37.32	198	173	Peak
5149.85	52.78	52.58	54	-1.22	31.32	6.2	37.32	198	173	Average
5180	97.64	97.41			31.35	6.22	37.34	198	173	Average
5180	104.81	104.58			31.35	6.22	37.34	198	173	Peak
*10360	55.09	58.99	68.2	-13.11	39.19	9.05	52.14	100	184	Peak

**Antenna Polarity & Test Distance: Vertical at 3 m**

Frequency (MHz)	Emission Level (dBuV/m)	Read Level (dBuV)	Limit (dBuV/m)	Margin (dB)	Antenna Factor (dB/m)	Cable Loss (dB)	Preamp Factor (dB)	Antenna Height (cm)	Table Angle (Degree)	Remark
5147.9	66.58	66.38	74	-7.42	31.32	6.2	37.32	190	165	Peak
5149.55	52.08	51.88	54	-1.92	31.32	6.2	37.32	190	165	Average
5180	96.37	96.14			31.35	6.22	37.34	190	165	Average
5180	103.35	103.12			31.35	6.22	37.34	190	165	Peak
*10360	55.06	58.96	68.2	-13.14	39.19	9.05	52.14	100	113	Peak

## Remarks:

- Emission Level = Read Level + Antenna Factor + Cable Loss - Preamp Factor  
Margin value = Emission level – Limit value
- 5180 MHz: Fundamental Frequency
- \*: Out of Restricted Band

EUT Test Condition		Measurement Detail	
Channel	Channel 44	Frequency Range	1 GHz ~ 40 GHz
Input Power	120 Vac, 60 Hz	Detector Function	Peak (PK) Average (AV)
Environmental Conditions	25 deg. C, 65 % RH	Tested By	Gavin Wu

### Horizontal

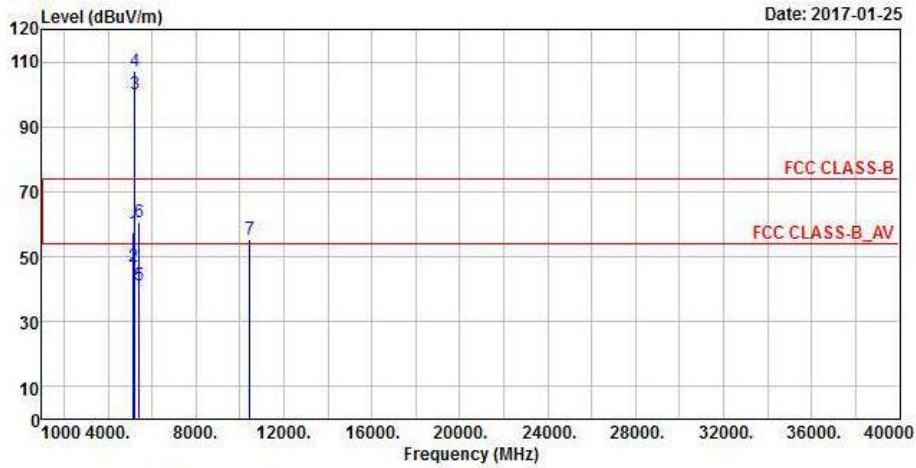

### Vertical

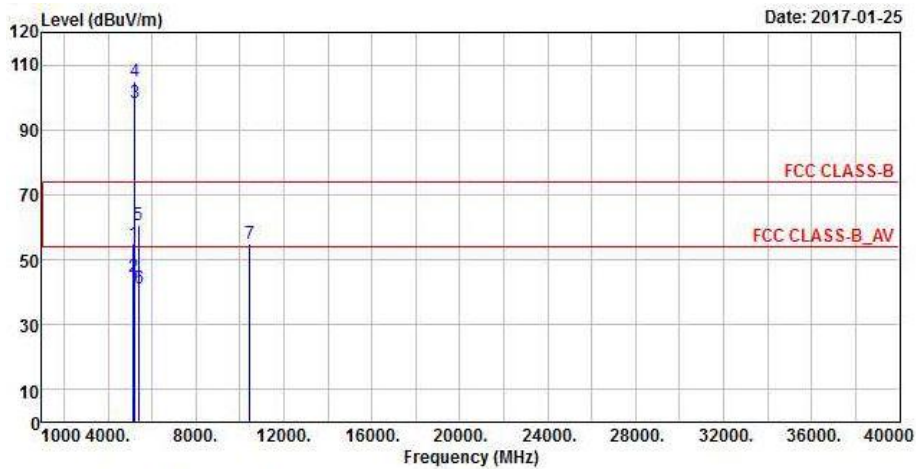

**Antenna Polarity & Test Distance: Horizontal at 3 m**

Frequency (MHz)	Emission Level (dBuV/m)	Read Level (dBuV)	Limit (dBuV/m)	Margin (dB)	Antenna Factor (dB/m)	Cable Loss (dB)	Preamp Factor (dB)	Antenna Height (cm)	Table Angle (Degree)	Remark
5149.4	57.56	57.36	74	-16.44	31.32	6.2	37.32	197	181	Peak
5149.85	46.79	46.59	54	-7.21	31.32	6.2	37.32	197	181	Average
5220	100	99.75			31.37	6.24	37.36	197	181	Average
5220	107.34	107.09			31.37	6.24	37.36	197	181	Peak
5417.43	41.36	40.69	54	-12.64	31.53	6.32	37.18	197	181	Average
5420.29	60.84	60.17	74	-13.16	31.53	6.32	37.18	197	181	Peak
*10440	55.17	59.27	68.2	-13.03	39.29	9.09	52.48	100	166	Peak

**Antenna Polarity & Test Distance: Vertical at 3 m**

Frequency (MHz)	Emission Level (dBuV/m)	Read Level (dBuV)	Limit (dBuV/m)	Margin (dB)	Antenna Factor (dB/m)	Cable Loss (dB)	Preamp Factor (dB)	Antenna Height (cm)	Table Angle (Degree)	Remark
5148.95	55.13	54.93	74	-18.87	31.32	6.2	37.32	183	173	Peak
5149.85	44.78	44.58	54	-9.22	31.32	6.2	37.32	183	173	Average
5220	98.37	98.12			31.37	6.24	37.36	183	173	Average
5220	104.78	104.53			31.37	6.24	37.36	183	173	Peak
5389.6	60.47	59.83	74	-13.53	31.51	6.31	37.18	183	173	Peak
5416.99	41.11	40.44	54	-12.89	31.53	6.32	37.18	183	173	Average
*10440	54.73	58.83	68.2	-13.47	39.29	9.09	52.48	100	208	Peak

Remarks:

- Emission Level = Read Level + Antenna Factor + Cable Loss - Preamp Factor  
Margin value = Emission level – Limit value
- 5220 MHz: Fundamental Frequency
- \*: Out of Restricted Band

EUT Test Condition		Measurement Detail	
Channel	Channel 48	Frequency Range	1 GHz ~ 40 GHz
Input Power	120 Vac, 60 Hz	Detector Function	Peak (PK) Average (AV)
Environmental Conditions	25 deg. C, 65 % RH	Tested By	Gavin Wu

### Horizontal

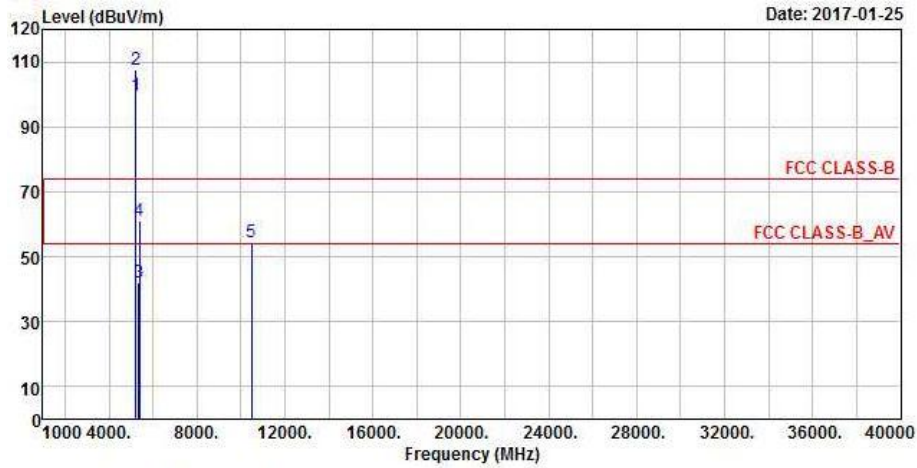

### Vertical

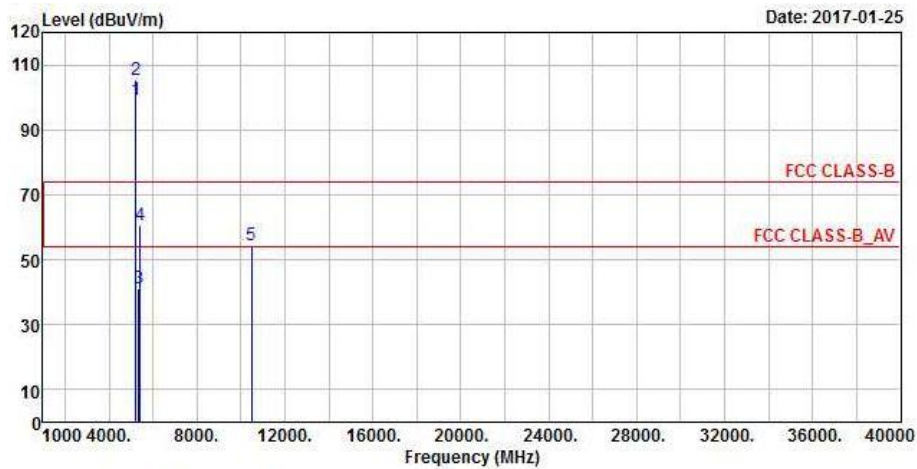



**Antenna Polarity & Test Distance: Horizontal at 3 m**

Frequency (MHz)	Emission Level (dBuV/m)	Read Level (dBuV)	Limit (dBuV/m)	Margin (dB)	Antenna Factor (dB/m)	Cable Loss (dB)	Preamp Factor (dB)	Antenna Height (cm)	Table Angle (Degree)	Remark
5240	99.84	99.52			31.39	6.25	37.32	195	185	Average
5240	107.5	107.18			31.39	6.25	37.32	195	185	Peak
5351.65	41.96	41.37	54	-12.04	31.48	6.29	37.18	195	185	Average
5388.06	60.99	60.35	74	-13.01	31.51	6.31	37.18	195	185	Peak
*10480	54.56	58.81	68.2	-13.64	39.37	9.09	52.71	100	102	Peak

**Antenna Polarity & Test Distance: Vertical at 3 m**

Frequency (MHz)	Emission Level (dBuV/m)	Read Level (dBuV)	Limit (dBuV/m)	Margin (dB)	Antenna Factor (dB/m)	Cable Loss (dB)	Preamp Factor (dB)	Antenna Height (cm)	Table Angle (Degree)	Remark
5240	99.01	98.69			31.39	6.25	37.32	184	174	Average
5240	105.57	105.25			31.39	6.25	37.32	184	174	Peak
5356.6	41.37	40.78	54	-12.63	31.48	6.29	37.18	184	174	Average
5427.99	60.87	60.15	74	-13.13	31.53	6.32	37.13	184	174	Peak
*10480	54.28	58.53	68.2	-13.92	39.37	9.09	52.71	100	115	Peak

Remarks:

- Emission Level = Read Level + Antenna Factor + Cable Loss - Preamp Factor  
Margin value = Emission level – Limit value
- 5240 MHz: Fundamental Frequency
- \*: Out of Restricted Band

EUT Test Condition		Measurement Detail	
Channel	Channel 52	Frequency Range	1 GHz ~ 40 GHz
Input Power	120 Vac, 60 Hz	Detector Function	Peak (PK) Average (AV)
Environmental Conditions	25 deg. C, 65 % RH	Tested By	Gavin Wu

### Horizontal

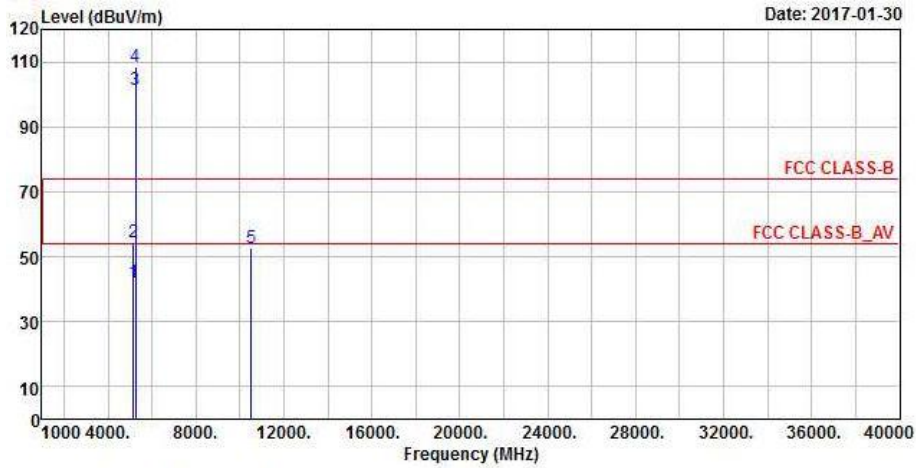

### Vertical

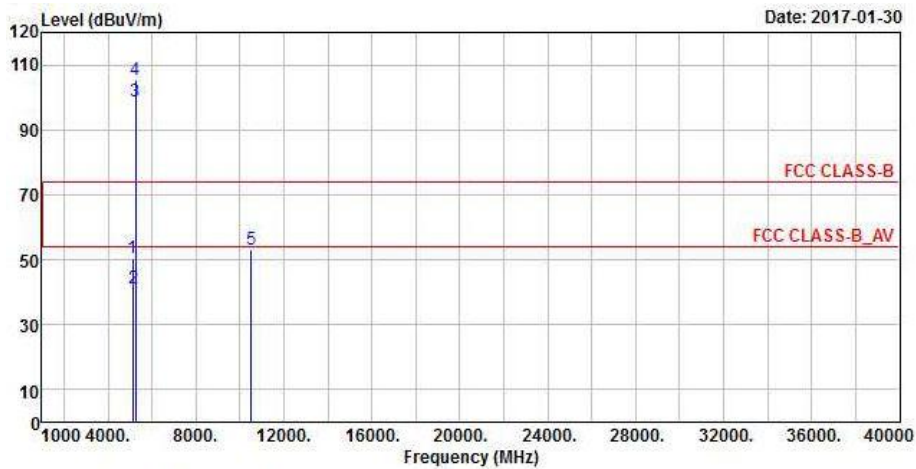

**Antenna Polarity & Test Distance: Horizontal at 3 m**

Frequency (MHz)	Emission Level (dBuV/m)	Read Level (dBuV)	Limit (dBuV/m)	Margin (dB)	Antenna Factor (dB/m)	Cable Loss (dB)	Preamp Factor (dB)	Antenna Height (cm)	Table Angle (Degree)	Remark
5148.65	42.17	41.97	54	-11.83	31.32	6.2	37.32	176	358	Average
5150	54.48	54.28	74	-19.52	31.32	6.2	37.32	176	358	Peak
5260	101.51	101.12			31.41	6.25	37.27	176	358	Average
5260	108.43	108.04			31.41	6.25	37.27	176	358	Peak
*10520	52.79	57.07	68.2	-15.41	39.43	9.12	52.83	110	333	Peak

**Antenna Polarity & Test Distance: Vertical at 3 m**

Frequency (MHz)	Emission Level (dBuV/m)	Read Level (dBuV)	Limit (dBuV/m)	Margin (dB)	Antenna Factor (dB/m)	Cable Loss (dB)	Preamp Factor (dB)	Antenna Height (cm)	Table Angle (Degree)	Remark
5138.45	50.59	50.38	74	-23.41	31.31	6.2	37.3	101	360	Peak
5149.4	41.22	41.02	54	-12.78	31.32	6.2	37.32	101	360	Average
5260	98.61	98.22			31.41	6.25	37.27	101	360	Average
5260	105.24	104.85			31.41	6.25	37.27	101	360	Peak
*10520	53.34	57.62	68.2	-14.86	39.43	9.12	52.83	105	88	Peak

## Remarks:

- Emission Level = Read Level + Antenna Factor + Cable Loss - Preamp Factor  
Margin value = Emission level – Limit value
- 5260 MHz: Fundamental Frequency
- \*: Out of Restricted Band

EUT Test Condition		Measurement Detail	
Channel	Channel 60	Frequency Range	1 GHz ~ 40 GHz
Input Power	120 Vac, 60 Hz	Detector Function	Peak (PK) Average (AV)
Environmental Conditions	25 deg. C, 65 % RH	Tested By	Gavin Wu

### Horizontal

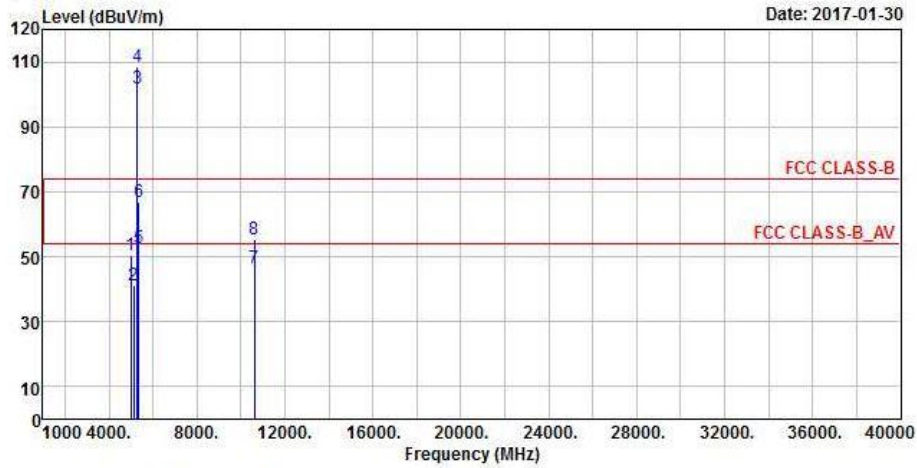

### Vertical

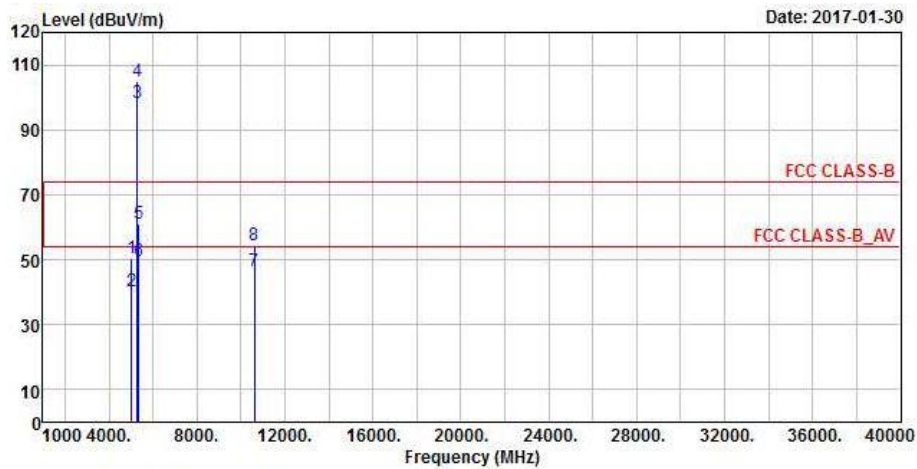

**Antenna Polarity & Test Distance: Horizontal at 3 m**

Frequency (MHz)	Emission Level (dBuV/m)	Read Level (dBuV)	Limit (dBuV/m)	Margin (dB)	Antenna Factor (dB/m)	Cable Loss (dB)	Preamp Factor (dB)	Antenna Height (cm)	Table Angle (Degree)	Remark
5001.2	50.29	50.19	74	-23.71	31.2	6.13	37.23	175	360	Peak
5131.7	41.09	40.88	54	-12.91	31.31	6.2	37.3	175	360	Average
5300	101.75	101.23			31.44	6.27	37.19	175	360	Average
5300	108.36	107.84			31.44	6.27	37.19	175	360	Peak
<b>5350.33</b>	<b>52.83</b>	<b>52.24</b>	<b>54</b>	<b>-1.17</b>	<b>31.48</b>	<b>6.29</b>	<b>37.18</b>	<b>175</b>	<b>360</b>	<b>Average</b>
5356.38	66.91	66.32	74	-7.09	31.48	6.29	37.18	175	360	Peak
10600	46.67	50.35	54	-7.33	39.57	9.16	52.41	123	355	Average
10600	55.26	58.94	74	-18.74	39.57	9.16	52.41	123	355	Peak

**Antenna Polarity & Test Distance: Vertical at 3 m**

Frequency (MHz)	Emission Level (dBuV/m)	Read Level (dBuV)	Limit (dBuV/m)	Margin (dB)	Antenna Factor (dB/m)	Cable Loss (dB)	Preamp Factor (dB)	Antenna Height (cm)	Table Angle (Degree)	Remark
5017.1	50.36	50.24	74	-23.64	31.21	6.15	37.24	129	358	Peak
5020.4	40.33	40.21	54	-13.67	31.21	6.15	37.24	129	358	Average
5300	98.29	97.77			31.44	6.27	37.19	129	358	Average
5300	104.97	104.45			31.44	6.27	37.19	129	358	Peak
5350.44	61.11	60.52	74	-12.89	31.48	6.29	37.18	129	358	Peak
5350.99	49.63	49.04	54	-4.37	31.48	6.29	37.18	129	358	Average
10600	46.64	50.32	54	-7.36	39.57	9.16	52.41	149	90	Average
10600	54.53	58.21	74	-19.47	39.57	9.16	52.41	149	90	Peak

Remarks:

- Emission Level = Read Level + Antenna Factor + Cable Loss - Preamp Factor  
Margin value = Emission level – Limit value
- 5300 MHz: Fundamental Frequency
- \*: Out of Restricted Band

EUT Test Condition		Measurement Detail	
Channel	Channel 64	Frequency Range	1 GHz ~ 40 GHz
Input Power	120 Vac, 60 Hz	Detector Function	Peak (PK) Average (AV)
Environmental Conditions	25 deg. C, 65 % RH	Tested By	Gavin Wu

### Horizontal

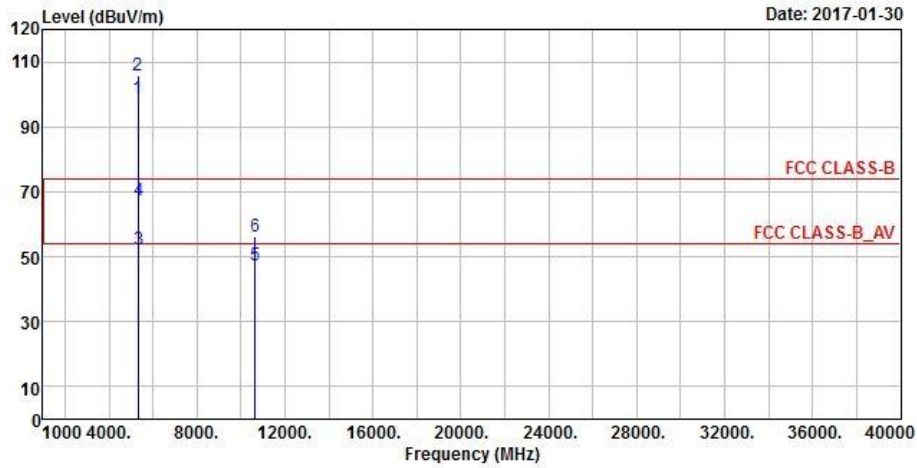

### Vertical

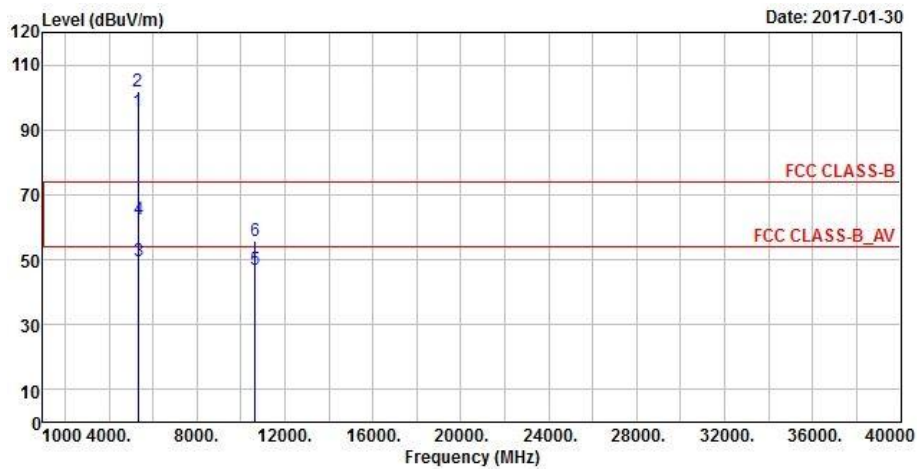

**Antenna Polarity & Test Distance: Horizontal at 3 m**

Frequency (MHz)	Emission Level (dBuV/m)	Read Level (dBuV)	Limit (dBuV/m)	Margin (dB)	Antenna Factor (dB/m)	Cable Loss (dB)	Preamp Factor (dB)	Antenna Height (cm)	Table Angle (Degree)	Remark
5320	98.93	98.38			31.45	6.29	37.19	194	357	Average
5320	105.67	105.12			31.45	6.29	37.19	194	357	Peak
5350.22	52.22	51.63	54	-1.78	31.48	6.29	37.18	194	357	Average
5353.52	67.17	66.58	74	-6.83	31.48	6.29	37.18	194	357	Peak
10640	47.41	50.86	54	-6.59	39.62	9.2	52.27	121	350	Average
10640	56.37	59.82	74	-17.63	39.62	9.2	52.27	121	350	Peak

**Antenna Polarity & Test Distance: Vertical at 3 m**

Frequency (MHz)	Emission Level (dBuV/m)	Read Level (dBuV)	Limit (dBuV/m)	Margin (dB)	Antenna Factor (dB/m)	Cable Loss (dB)	Preamp Factor (dB)	Antenna Height (cm)	Table Angle (Degree)	Remark
5320	95.83	95.28			31.45	6.29	37.19	144	358	Average
5320	101.77	101.22			31.45	6.29	37.19	144	358	Peak
5350.11	49.69	49.1	54	-4.31	31.48	6.29	37.18	144	358	Average
5353.63	62.23	61.64	74	-11.77	31.48	6.29	37.18	144	358	Peak
10640	47.01	50.46	54	-6.99	39.62	9.2	52.27	150	78	Average
10640	55.82	59.27	74	-18.18	39.62	9.2	52.27	150	78	Peak

## Remarks:

- Emission Level = Read Level + Antenna Factor + Cable Loss - Preamp Factor  
Margin value = Emission level – Limit value
- 5320 MHz: Fundamental Frequency
- \*: Out of Restricted Band

EUT Test Condition		Measurement Detail	
Channel	Channel 100	Frequency Range	1 GHz ~ 40 GHz
Input Power	120 Vac, 60 Hz	Detector Function	Peak (PK) Average (AV)
Environmental Conditions	25 deg. C, 65 % RH	Tested By	Gavin Wu

### Horizontal

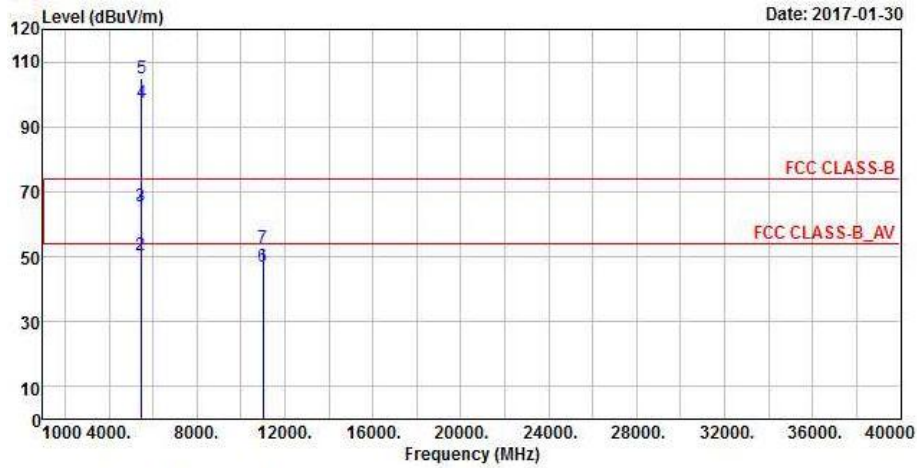

### Vertical

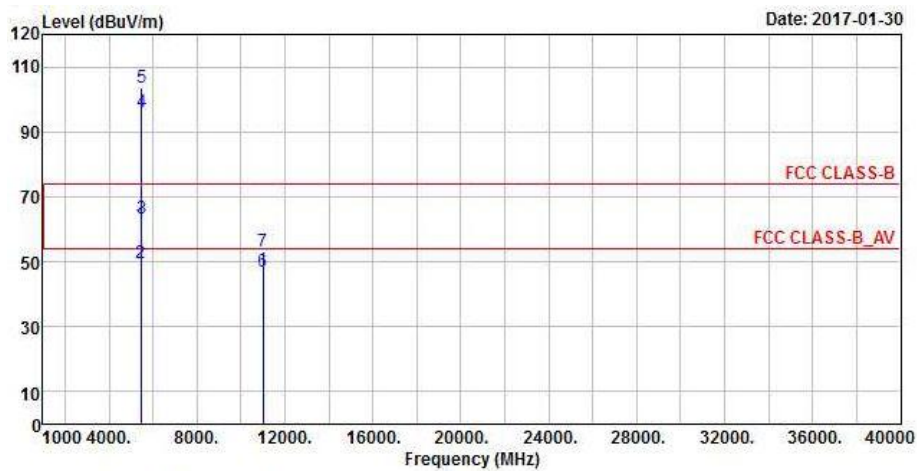



**Antenna Polarity & Test Distance: Horizontal at 3 m**

Frequency (MHz)	Emission Level (dBuV/m)	Read Level (dBuV)	Limit (dBuV/m)	Margin (dB)	Antenna Factor (dB/m)	Cable Loss (dB)	Preamp Factor (dB)	Antenna Height (cm)	Table Angle (Degree)	Remark
5451.6	63.78	62.96	74	-10.22	31.56	6.34	37.08	196	1	Peak
5460.08	50.48	49.66	54	-3.52	31.56	6.34	37.08	196	1	Average
*5468.4	65.62	64.79	68.2	-2.58	31.57	6.34	37.08	196	1	Peak
5500	97.42	96.49			31.6	6.36	37.03	196	1	Average
5500	104.8	103.87			31.6	6.36	37.03	196	1	Peak
11000	47.05	50.95	54	-6.95	40.2	9.35	53.45	140	50	Average
11000	52.6	56.5	74	-21.4	40.2	9.35	53.45	140	50	Peak

**Antenna Polarity & Test Distance: Vertical at 3 m**

Frequency (MHz)	Emission Level (dBuV/m)	Read Level (dBuV)	Limit (dBuV/m)	Margin (dB)	Antenna Factor (dB/m)	Cable Loss (dB)	Preamp Factor (dB)	Antenna Height (cm)	Table Angle (Degree)	Remark
5451.28	61.44	60.62	74	-12.56	31.56	6.34	37.08	198	307	Peak
5458.8	49.81	48.99	54	-4.19	31.56	6.34	37.08	198	307	Average
*5470.48	63.31	62.48	68.2	-4.89	31.57	6.34	37.08	198	307	Peak
5500	96.21	95.28			31.6	6.36	37.03	198	307	Average
5500	103.44	102.51			31.6	6.36	37.03	198	307	Peak
11000	46.85	50.75	54	-7.15	40.2	9.35	53.45	102	249	Average
11000	53.06	56.96	74	-20.94	40.2	9.35	53.45	102	249	Peak

Remarks:

- Emission Level = Read Level + Antenna Factor + Cable Loss - Preamp Factor  
Margin value = Emission level – Limit value
- 5500 MHz: Fundamental Frequency
- \*: Out of Restricted Band

EUT Test Condition		Measurement Detail	
Channel	Channel 116	Frequency Range	1 GHz ~ 40 GHz
Input Power	120 Vac, 60 Hz	Detector Function	Peak (PK) Average (AV)
Environmental Conditions	25 deg. C, 65 % RH	Tested By	Gavin Wu

### Horizontal

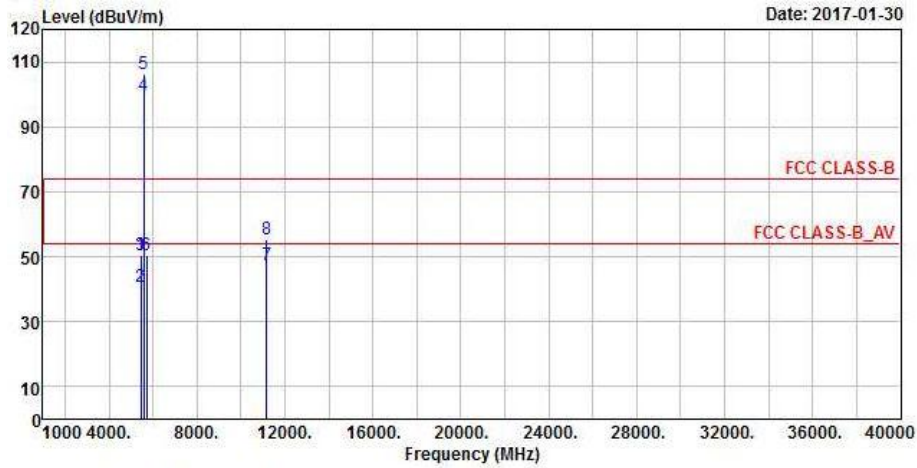

### Vertical

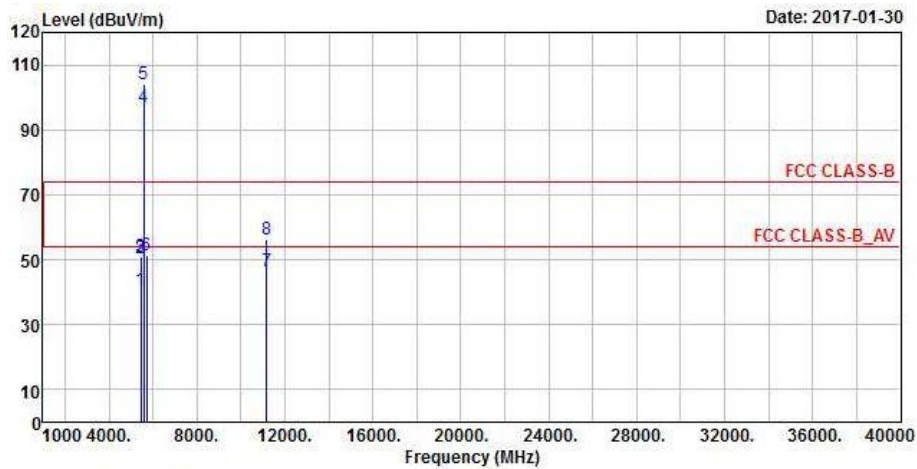

**Antenna Polarity & Test Distance: Horizontal at 3 m**

Frequency (MHz)	Emission Level (dBuV/m)	Read Level (dBuV)	Limit (dBuV/m)	Margin (dB)	Antenna Factor (dB/m)	Cable Loss (dB)	Preamp Factor (dB)	Antenna Height (cm)	Table Angle (Degree)	Remark
5445.52	50.67	49.9	74	-23.33	31.56	6.34	37.13	206	4	Peak
5455.6	40.79	39.97	54	-13.21	31.56	6.34	37.08	206	4	Average
*5468.88	50.65	49.82	68.2	-17.55	31.57	6.34	37.08	206	4	Peak
5580	99.76	98.72			31.71	6.49	37.16	206	4	Average
5580	106.49	105.45			31.71	6.49	37.16	206	4	Peak
*5724.84	50.62	49.4	68.2	-17.58	31.96	6.69	37.43	206	4	Peak
11160	47.3	51.02	54	-6.7	40.1	9.57	53.39	139	48	Average
11160	55.53	59.25	74	-18.47	40.1	9.57	53.39	139	48	Peak

**Antenna Polarity & Test Distance: Vertical at 3 m**

Frequency (MHz)	Emission Level (dBuV/m)	Read Level (dBuV)	Limit (dBuV/m)	Margin (dB)	Antenna Factor (dB/m)	Cable Loss (dB)	Preamp Factor (dB)	Antenna Height (cm)	Table Angle (Degree)	Remark
5443.6	40.69	39.93	54	-13.31	31.55	6.34	37.13	200	307	Average
5446.48	50.69	49.92	74	-23.31	31.56	6.34	37.13	200	307	Peak
*5469.36	50.96	50.13	68.2	-17.24	31.57	6.34	37.08	200	307	Peak
5580	97.07	96.03			31.71	6.49	37.16	200	307	Average
5580	104.08	103.04			31.71	6.49	37.16	200	307	Peak
*5724.68	51.58	50.36	68.2	-16.62	31.96	6.69	37.43	200	307	Peak
11160	46.62	50.34	54	-7.38	40.1	9.57	53.39	101	251	Average
11160	56.29	60.01	74	-17.71	40.1	9.57	53.39	101	251	Peak

## Remarks:

- Emission Level = Read Level + Antenna Factor + Cable Loss - Preamp Factor  
Margin value = Emission level – Limit value
- 5580 MHz: Fundamental Frequency
- \*: Out of Restricted Band

EUT Test Condition		Measurement Detail	
Channel	Channel 140	Frequency Range	1 GHz ~ 40 GHz
Input Power	120 Vac, 60 Hz	Detector Function	Peak (PK) Average (AV)
Environmental Conditions	25 deg. C, 65 % RH	Tested By	Gavin Wu

### Horizontal

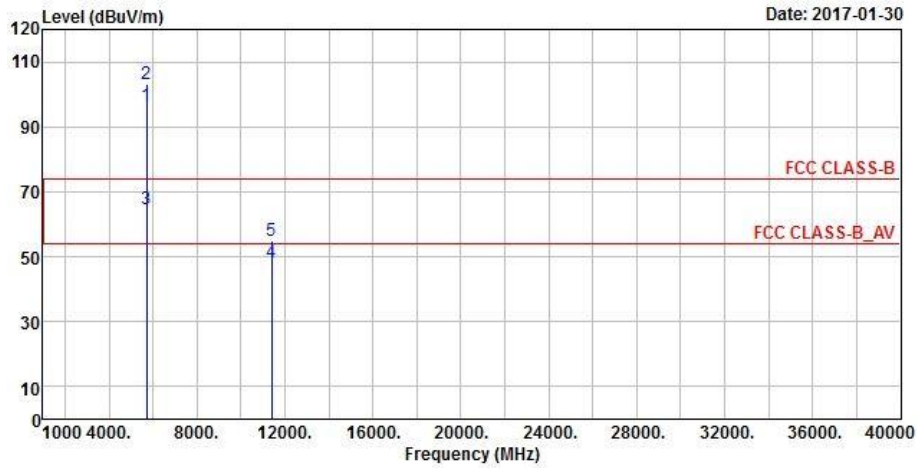

### Vertical

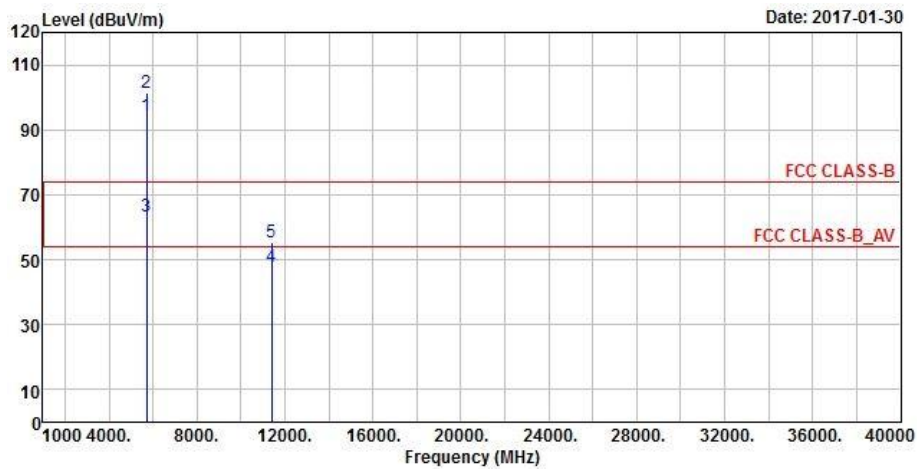

**Antenna Polarity & Test Distance: Horizontal at 3 m**

Frequency (MHz)	Emission Level (dBuV/m)	Read Level (dBuV)	Limit (dBuV/m)	Margin (dB)	Antenna Factor (dB/m)	Cable Loss (dB)	Preamp Factor (dB)	Antenna Height (cm)	Table Angle (Degree)	Remark
5700	96.63	95.44			31.9	6.69	37.4	207	2	Average
5700	103.33	102.14			31.9	6.69	37.4	207	2	Peak
*5724.92	64.73	63.51	68.2	-3.47	31.96	6.69	37.43	207	2	Peak
11400	48.1	50.36	54	-5.9	39.96	9.91	52.13	152	69	Average
11400	54.93	57.19	74	-19.07	39.96	9.91	52.13	152	69	Peak

**Antenna Polarity & Test Distance: Vertical at 3 m**

Frequency (MHz)	Emission Level (dBuV/m)	Read Level (dBuV)	Limit (dBuV/m)	Margin (dB)	Antenna Factor (dB/m)	Cable Loss (dB)	Preamp Factor (dB)	Antenna Height (cm)	Table Angle (Degree)	Remark
5700	94.25	93.06			31.9	6.69	37.4	204	307	Average
5700	101.48	100.29			31.9	6.69	37.4	204	307	Peak
*5726.04	63.24	61.96	68.2	-4.96	31.96	6.75	37.43	204	307	Peak
11400	47.9	50.16	54	-6.1	39.96	9.91	52.13	103	248	Average
11400	55.33	57.59	74	-18.67	39.96	9.91	52.13	103	248	Peak

## Remarks:

- Emission Level = Read Level + Antenna Factor + Cable Loss - Preamp Factor  
Margin value = Emission level – Limit value
- 5700 MHz: Fundamental Frequency
- \*: Out of Restricted Band

EUT Test Condition		Measurement Detail	
Channel	Channel 149	Frequency Range	1 GHz ~ 40 GHz
Input Power	120 Vac, 60 Hz	Detector Function	Peak (PK) Average (AV)
Environmental Conditions	25 deg. C, 65 % RH	Tested By	Gavin Wu

**<Spurious Emission>  
Horizontal**

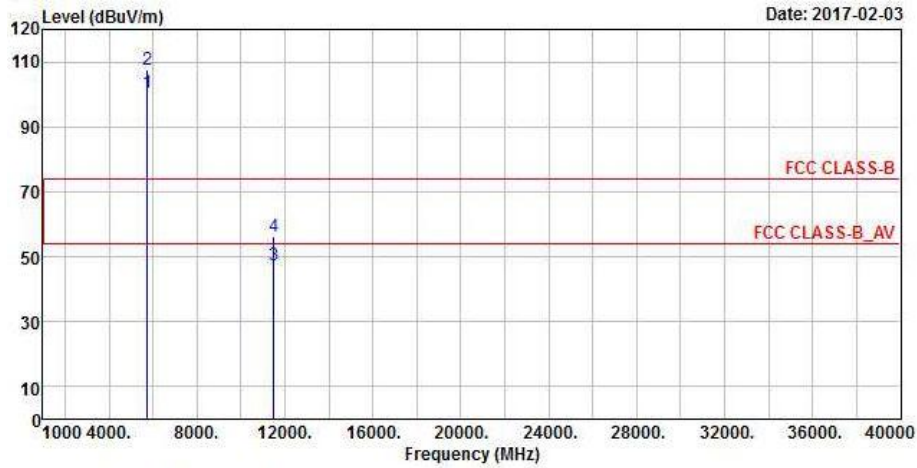

**Vertical**

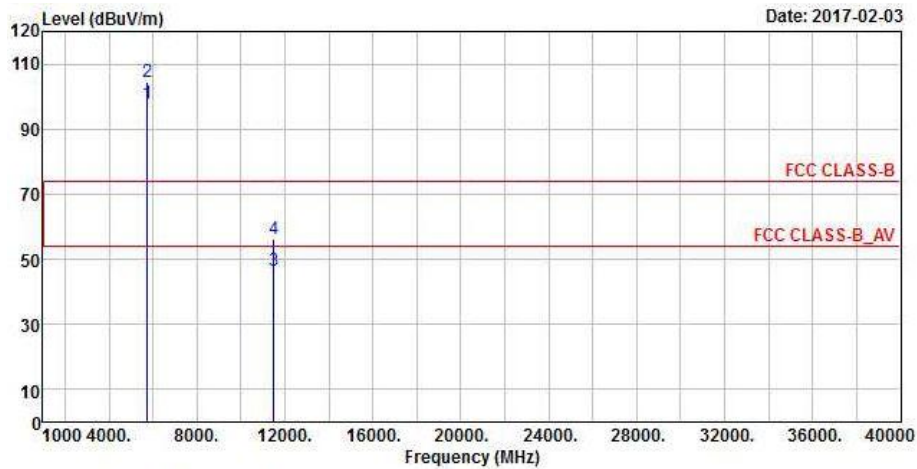

**<Out of Band Emission (OOBE)>  
Horizontal**

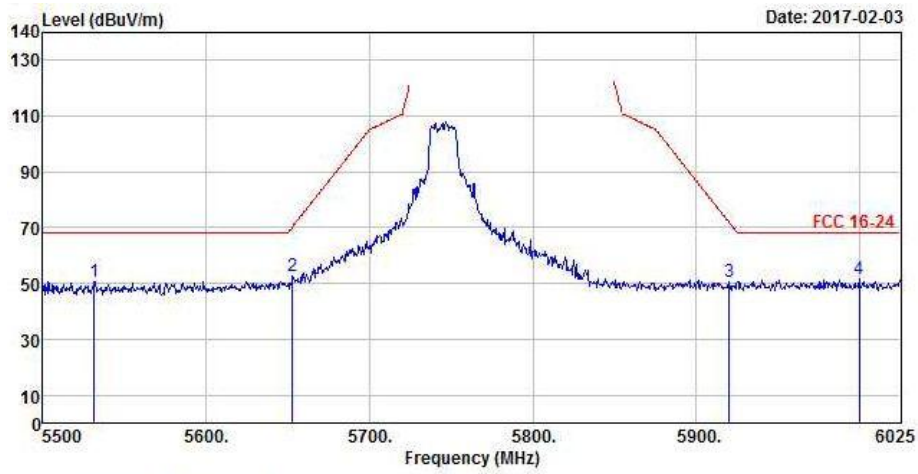

**Vertical**

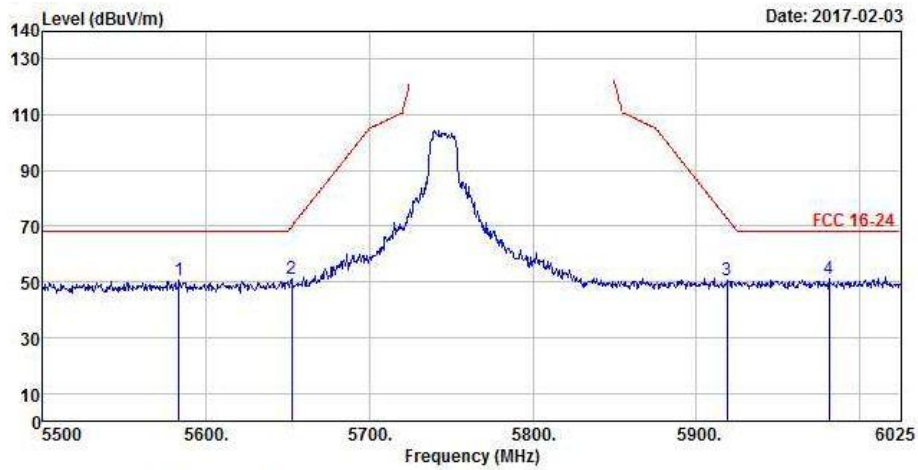

**<Spurious Emission>**

Antenna Polarity & Test Distance: Horizontal at 3 m										
Frequency (MHz)	Emission Level (dBuV/m)	Read Level (dBuV)	Limit (dBuV/m)	Margin (dB)	Antenna Factor (dB/m)	Cable Loss (dB)	Preamp Factor (dB)	Antenna Height (cm)	Table Angle (Degree)	Remark
5745	100.4	99.13			31.99	6.75	37.47	200	300	Average
5745	107.47	106.2			31.99	6.75	37.47	200	300	Peak
11490	47.52	50.41	54	-6.48	39.91	10.03	52.83	169	62	Average
11490	56.13	59.02	74	-17.87	39.91	10.03	52.83	169	62	Peak
Antenna Polarity & Test Distance: Vertical at 3 m										
Frequency (MHz)	Emission Level (dBuV/m)	Read Level (dBuV)	Limit (dBuV/m)	Margin (dB)	Antenna Factor (dB/m)	Cable Loss (dB)	Preamp Factor (dB)	Antenna Height (cm)	Table Angle (Degree)	Remark
5745	98.04	96.77			31.99	6.75	37.47	221	282	Average
5745	104.68	103.41			31.99	6.75	37.47	221	282	Peak
11490	46.46	49.35	54	-7.54	39.91	10.03	52.83	185	149	Average
11490	56.25	59.14	74	-17.75	39.91	10.03	52.83	185	149	Peak

**<Out of Band Emission (OOBE)>**

Antenna Polarity & Test Distance: Horizontal at 3 m										
Frequency (MHz)	Emission Level (dBuV/m)	Read Level (dBuV)	Limit (dBuV/m)	Margin (dB)	Antenna Factor (dB/m)	Cable Loss (dB)	Preamp Factor (dB)	Antenna Height (cm)	Table Angle (Degree)	Remark
*5531.5	50.65	49.66	68.2	-17.55	31.66	6.42	37.09	200	300	Peak
5652.775	52.88	51.69	70.26	-17.38	31.85	6.62	37.28	200	300	Peak
5920	50.57	48.8	71.89	-21.32	32.26	7.01	37.5	200	300	Peak
*5999.8	51.76	49.73	68.2	-16.44	32.4	7.14	37.51	200	300	Peak
Antenna Polarity & Test Distance: Vertical at 3 m										
Frequency (MHz)	Emission Level (dBuV/m)	Read Level (dBuV)	Limit (dBuV/m)	Margin (dB)	Antenna Factor (dB/m)	Cable Loss (dB)	Preamp Factor (dB)	Antenna Height (cm)	Table Angle (Degree)	Remark
*5583.475	50.41	49.34	68.2	-17.79	31.74	6.49	37.16	221	282	Peak
5652.25	51.24	50.05	69.87	-18.63	31.85	6.62	37.28	221	282	Peak
5918.95	50.58	48.81	72.66	-22.08	32.26	7.01	37.5	221	282	Peak
*5981.425	51.36	49.42	68.2	-16.84	32.37	7.08	37.51	221	282	Peak

Remarks:

- Emission Level = Read Level + Antenna Factor + Cable Loss - Preamp Factor  
Margin value = Emission level – Limit value
- 5745 MHz: Fundamental Frequency
- \*: Out of Restricted Band



EUT Test Condition		Measurement Detail	
Channel	Channel 157	Frequency Range	1 GHz ~ 40 GHz
Input Power	120 Vac, 60 Hz	Detector Function	Peak (PK) Average (AV)
Environmental Conditions	25 deg. C, 65 % RH	Tested By	Gavin Wu

**<Spurious Emission>  
Horizontal**

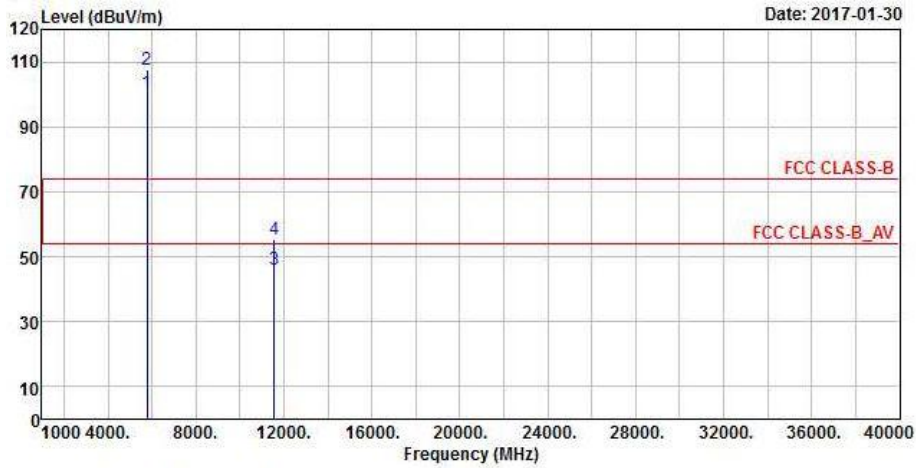

**Vertical**

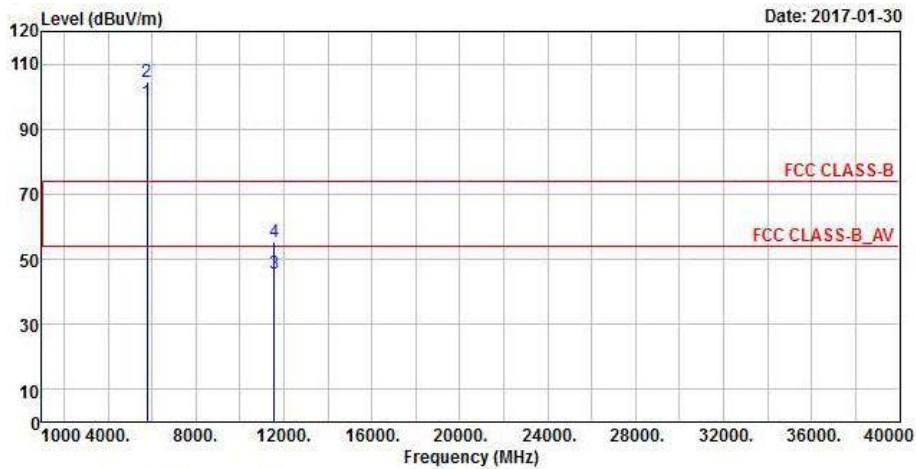

<Out of Band Emission (OOBE)>  
Horizontal

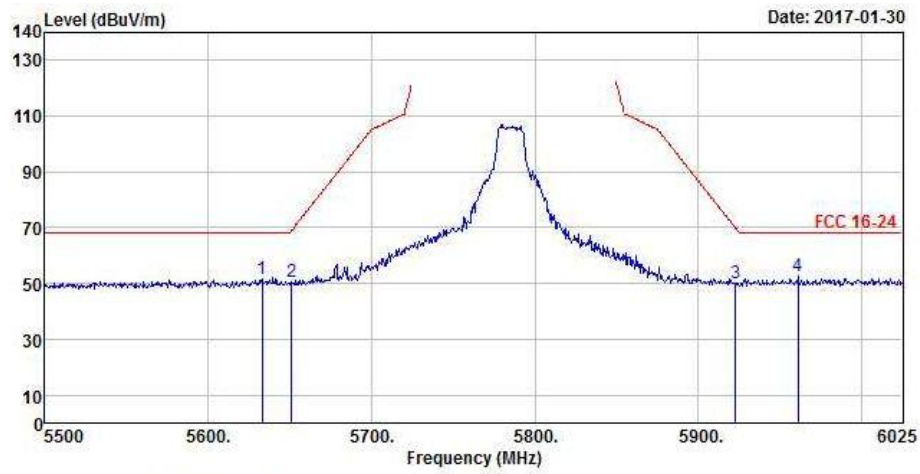

Vertical

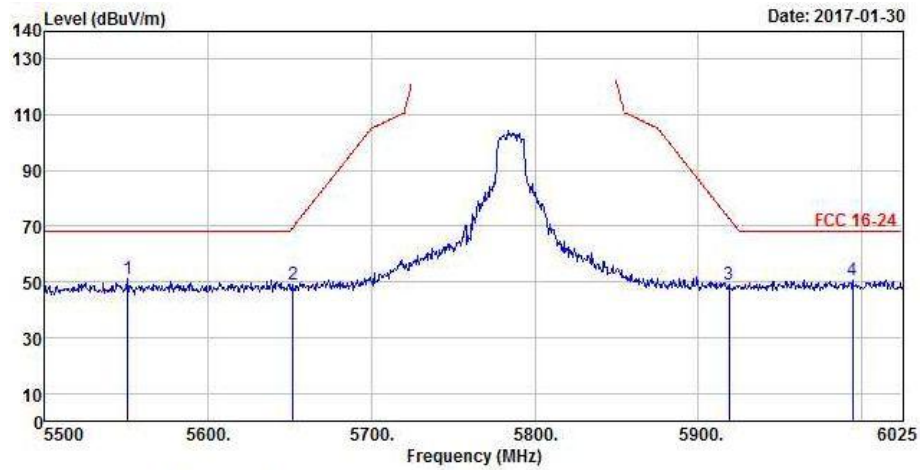

**<Spurious Emission>**

Antenna Polarity & Test Distance: Horizontal at 3 m										
Frequency (MHz)	Emission Level (dBuV/m)	Read Level (dBuV)	Limit (dBuV/m)	Margin (dB)	Antenna Factor (dB/m)	Cable Loss (dB)	Preamp Factor (dB)	Antenna Height (cm)	Table Angle (Degree)	Remark
5785	100.51	99.19			32.04	6.82	37.54	199	301	Average
5785	107.48	106.16			32.04	6.82	37.54	199	301	Peak
11570	46.17	49.63	54	-7.83	39.78	10.09	53.33	168	67	Average
11570	55.33	58.79	74	-18.67	39.78	10.09	53.33	168	67	Peak
Antenna Polarity & Test Distance: Vertical at 3 m										
Frequency (MHz)	Emission Level (dBuV/m)	Read Level (dBuV)	Limit (dBuV/m)	Margin (dB)	Antenna Factor (dB/m)	Cable Loss (dB)	Preamp Factor (dB)	Antenna Height (cm)	Table Angle (Degree)	Remark
5785	98.11	96.79			32.04	6.82	37.54	220	279	Average
5785	104.5	103.18			32.04	6.82	37.54	220	279	Peak
11570	45.59	49.05	54	-8.41	39.78	10.09	53.33	138	179	Average
11570	55.37	58.83	74	-18.63	39.78	10.09	53.33	138	179	Peak

**<Out of Band Emission (OOBE)>**

Antenna Polarity & Test Distance: Horizontal at 3 m										
Frequency (MHz)	Emission Level (dBuV/m)	Read Level (dBuV)	Limit (dBuV/m)	Margin (dB)	Antenna Factor (dB/m)	Cable Loss (dB)	Preamp Factor (dB)	Antenna Height (cm)	Table Angle (Degree)	Remark
*5632.825	51.53	50.43	68.2	-16.67	31.82	6.56	37.28	199	301	Peak
5651.2	50.47	49.28	69.09	-18.62	31.85	6.62	37.28	199	301	Peak
5922.625	50.3	48.5	69.95	-19.65	32.29	7.01	37.5	199	301	Peak
*5960.95	52.85	50.94	68.2	-15.35	32.34	7.08	37.51	199	301	Peak
Antenna Polarity & Test Distance: Vertical at 3 m										
Frequency (MHz)	Emission Level (dBuV/m)	Read Level (dBuV)	Limit (dBuV/m)	Margin (dB)	Antenna Factor (dB/m)	Cable Loss (dB)	Preamp Factor (dB)	Antenna Height (cm)	Table Angle (Degree)	Remark
*5550.925	50.94	49.93	68.2	-17.26	31.68	6.42	37.09	220	279	Peak
5651.725	49.2	48.01	69.48	-20.28	31.85	6.62	37.28	220	279	Peak
5918.95	49.31	47.54	72.66	-23.35	32.26	7.01	37.5	220	279	Peak
*5994.55	50.53	48.5	68.2	-17.67	32.4	7.14	37.51	220	279	Peak

Remarks:

- Emission Level = Read Level + Antenna Factor + Cable Loss - Preamp Factor  
Margin value = Emission level – Limit value
- 5785 MHz: Fundamental Frequency
- \*: Out of Restricted Band

EUT Test Condition		Measurement Detail	
Channel	Channel 165	Frequency Range	1 GHz ~ 40 GHz
Input Power	120 Vac, 60 Hz	Detector Function	Peak (PK) Average (AV)
Environmental Conditions	25 deg. C, 65 % RH	Tested By	Gavin Wu

**<Spurious Emission>  
Horizontal**

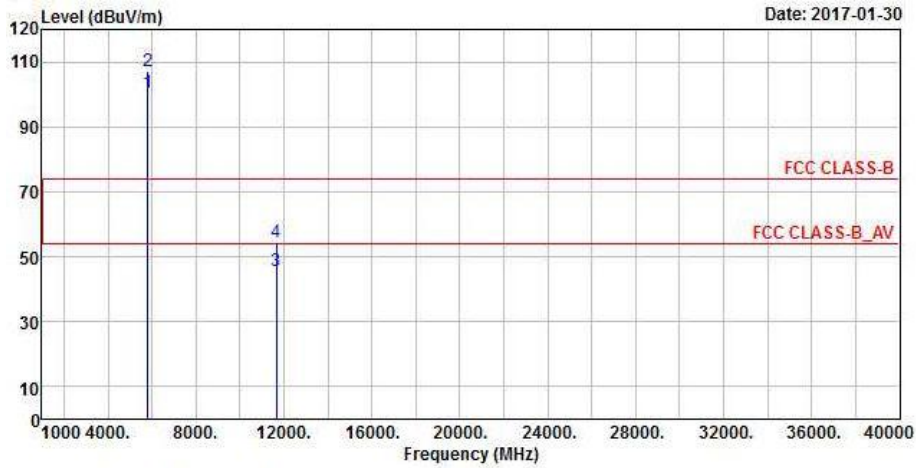

**Vertical**

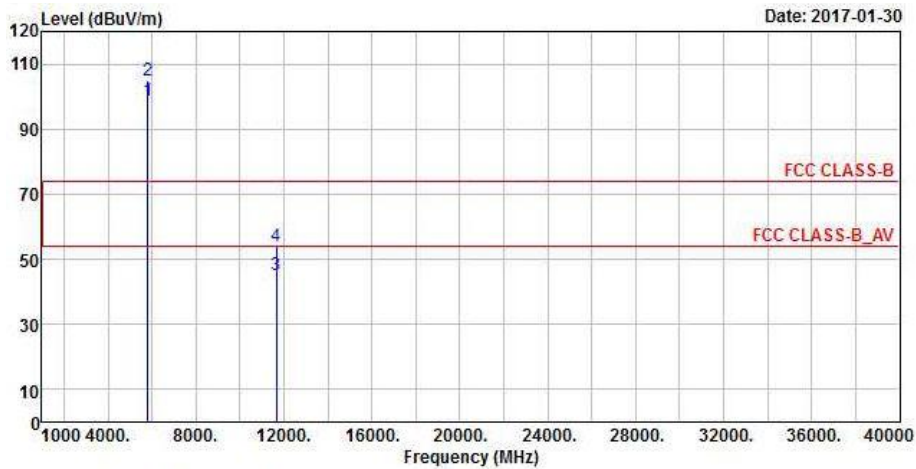

<Out of Band Emission (OOBE)>  
Horizontal

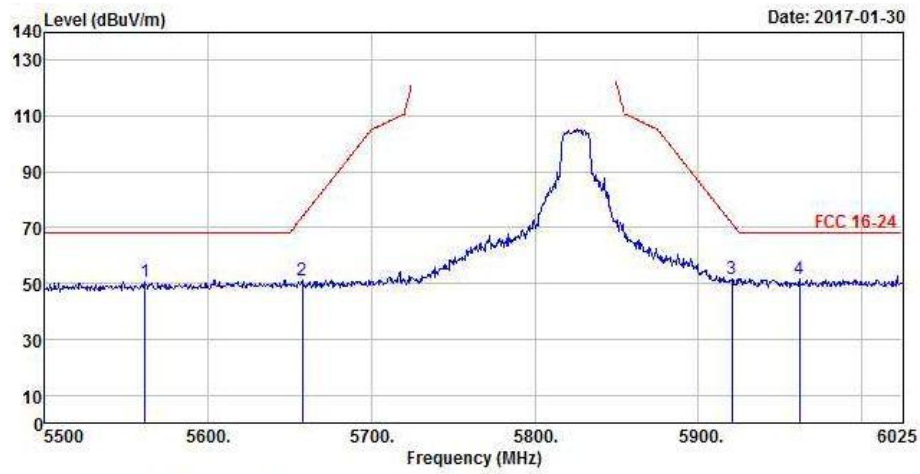

Vertical

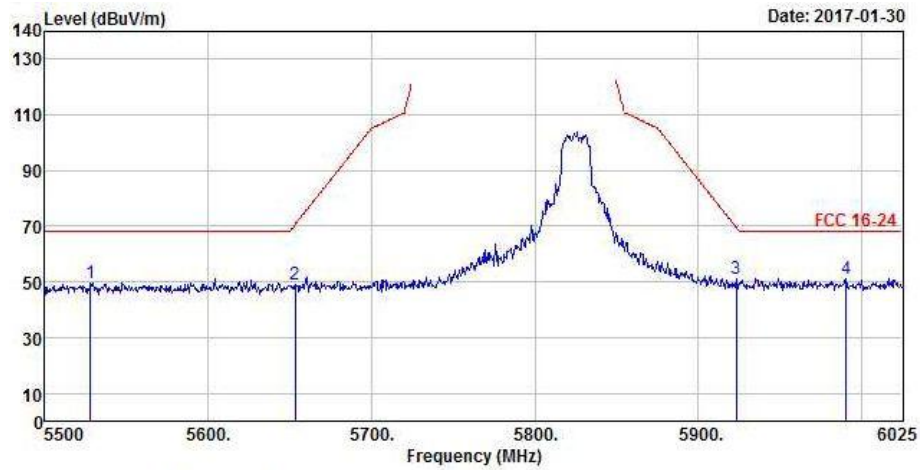

**<Spurious Emission>**

Antenna Polarity & Test Distance: Horizontal at 3 m										
Frequency (MHz)	Emission Level (dBuV/m)	Read Level (dBuV)	Limit (dBuV/m)	Margin (dB)	Antenna Factor (dB/m)	Cable Loss (dB)	Preamp Factor (dB)	Antenna Height (cm)	Table Angle (Degree)	Remark
5825	100.35	98.88			32.12	6.88	37.53	201	299	Average
5825	107.36	105.89			32.12	6.88	37.53	201	299	Peak
11650	45.61	49.16	54	-8.39	39.65	10.15	53.35	172	78	Average
11650	54.24	57.79	74	-19.76	39.65	10.15	53.35	172	78	Peak
Antenna Polarity & Test Distance: Vertical at 3 m										
Frequency (MHz)	Emission Level (dBuV/m)	Read Level (dBuV)	Limit (dBuV/m)	Margin (dB)	Antenna Factor (dB/m)	Cable Loss (dB)	Preamp Factor (dB)	Antenna Height (cm)	Table Angle (Degree)	Remark
5825	98.6	97.13			32.12	6.88	37.53	217	283	Average
5825	104.82	103.35			32.12	6.88	37.53	217	283	Peak
11650	45.33	48.88	54	-8.67	39.65	10.15	53.35	191	133	Average
11650	54.24	57.79	74	-19.76	39.65	10.15	53.35	191	133	Peak

**<Out of Band Emission (OOBE)>**

Antenna Polarity & Test Distance: Horizontal at 3 m										
Frequency (MHz)	Emission Level (dBuV/m)	Read Level (dBuV)	Limit (dBuV/m)	Margin (dB)	Antenna Factor (dB/m)	Cable Loss (dB)	Preamp Factor (dB)	Antenna Height (cm)	Table Angle (Degree)	Remark
*5561.425	50.41	49.36	68.2	-17.79	31.68	6.49	37.12	201	299	Peak
5657.5	51.27	50.14	73.77	-22.5	31.85	6.62	37.34	201	299	Peak
5920.525	51.56	49.79	71.5	-19.94	32.26	7.01	37.5	201	299	Peak
*5962	51.43	49.52	68.2	-16.77	32.34	7.08	37.51	201	299	Peak
Antenna Polarity & Test Distance: Vertical at 3 m										
Frequency (MHz)	Emission Level (dBuV/m)	Read Level (dBuV)	Limit (dBuV/m)	Margin (dB)	Antenna Factor (dB/m)	Cable Loss (dB)	Preamp Factor (dB)	Antenna Height (cm)	Table Angle (Degree)	Remark
*5527.825	49.64	48.68	68.2	-18.56	31.63	6.42	37.09	217	283	Peak
5653.3	48.9	47.71	70.65	-21.75	31.85	6.62	37.28	217	283	Peak
5923.15	50.97	49.17	69.56	-18.59	32.29	7.01	37.5	217	283	Peak
*5990.35	51.24	49.21	68.2	-16.96	32.4	7.14	37.51	217	283	Peak

Remarks:

- Emission Level = Read Level + Antenna Factor + Cable Loss - Preamp Factor  
Margin value = Emission level – Limit value
- 5825 MHz: Fundamental Frequency
- \*: Out of Restricted Band

802.11n (HT20)

EUT Test Condition		Measurement Detail	
Channel	Channel 36	Frequency Range	1 GHz ~ 40 GHz
Input Power	120 Vac, 60 Hz	Detector Function	Peak (PK) Average (AV)
Environmental Conditions	25 deg. C, 65 % RH	Tested By	Gavin Wu

Horizontal

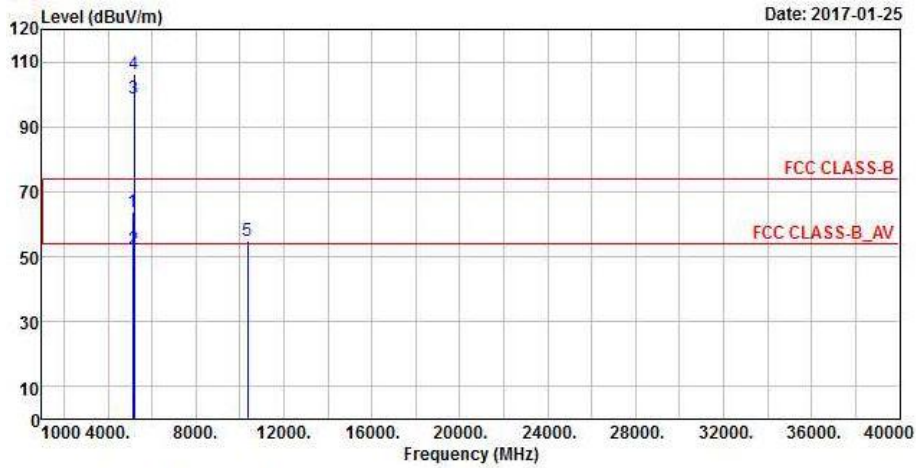

Vertical

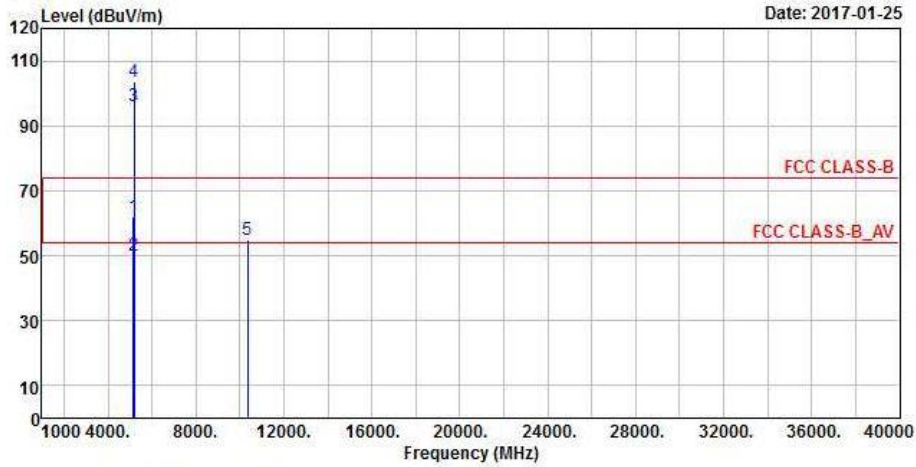

**Antenna Polarity & Test Distance: Horizontal at 3 m**

Frequency (MHz)	Emission Level (dBuV/m)	Read Level (dBuV)	Limit (dBuV/m)	Margin (dB)	Antenna Factor (dB/m)	Cable Loss (dB)	Preamp Factor (dB)	Antenna Height (cm)	Table Angle (Degree)	Remark
5124.05	63.65	63.45	74	-10.35	31.31	6.19	37.3	200	182	Peak
5150	52.06	51.86	54	-1.94	31.32	6.2	37.32	200	182	Average
5180	98.65	98.42			31.35	6.22	37.34	200	182	Average
5180	106.23	106			31.35	6.22	37.34	200	182	Peak
*10360	55.08	58.98	68.2	-13.12	39.19	9.05	52.14	102	126	Peak

**Antenna Polarity & Test Distance: Vertical at 3 m**

Frequency (MHz)	Emission Level (dBuV/m)	Read Level (dBuV)	Limit (dBuV/m)	Margin (dB)	Antenna Factor (dB/m)	Cable Loss (dB)	Preamp Factor (dB)	Antenna Height (cm)	Table Angle (Degree)	Remark
5148.05	62.04	61.84	74	-11.96	31.32	6.2	37.32	184	173	Peak
5150	50.12	49.92	54	-3.88	31.32	6.2	37.32	184	173	Average
5180	96.05	95.82			31.35	6.22	37.34	184	173	Average
5180	103.44	103.21			31.35	6.22	37.34	184	173	Peak
*10360	54.71	58.61	68.2	-13.49	39.19	9.05	52.14	100	117	Peak

Remarks:

- Emission Level = Read Level + Antenna Factor + Cable Loss - Preamp Factor  
Margin value = Emission level – Limit value
- 5180 MHz: Fundamental Frequency
- \*: Out of Restricted Band



EUT Test Condition		Measurement Detail	
Channel	Channel 44	Frequency Range	1 GHz ~ 40 GHz
Input Power	120 Vac, 60 Hz	Detector Function	Peak (PK) Average (AV)
Environmental Conditions	25 deg. C, 65 % RH	Tested By	Gavin Wu

### Horizontal

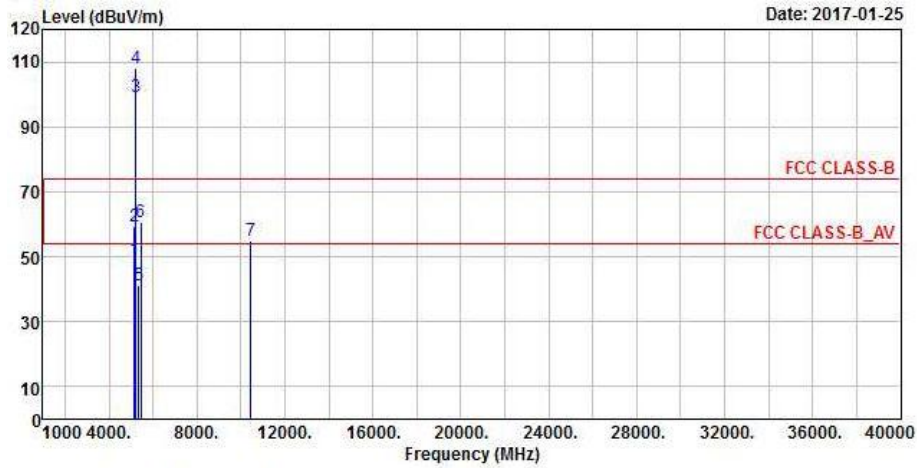

### Vertical

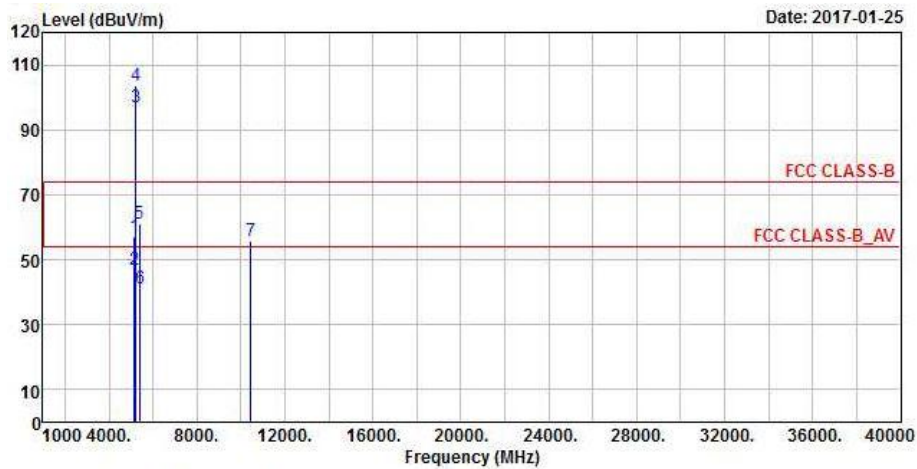

Antenna Polarity & Test Distance: Horizontal at 3 m										
Frequency (MHz)	Emission Level (dBuV/m)	Read Level (dBuV)	Limit (dBuV/m)	Margin (dB)	Antenna Factor (dB/m)	Cable Loss (dB)	Preamp Factor (dB)	Antenna Height (cm)	Table Angle (Degree)	Remark
5149.85	49.33	49.13	54	-4.67	31.32	6.2	37.32	197	182	Average
5149.85	59.36	59.16	74	-14.64	31.32	6.2	37.32	197	182	Peak
5220	99.21	98.96			31.37	6.24	37.36	197	182	Average
5220	107.86	107.61			31.37	6.24	37.36	197	182	Peak
5361.55	41.25	40.63	54	-12.75	31.49	6.31	37.18	197	182	Average
5447.57	60.79	60.02	74	-13.21	31.56	6.34	37.13	197	182	Peak
*10440	54.97	59.07	68.2	-13.23	39.29	9.09	52.48	104	144	Peak
Antenna Polarity & Test Distance: Vertical at 3 m										
Frequency (MHz)	Emission Level (dBuV/m)	Read Level (dBuV)	Limit (dBuV/m)	Margin (dB)	Antenna Factor (dB/m)	Cable Loss (dB)	Preamp Factor (dB)	Antenna Height (cm)	Table Angle (Degree)	Remark
5148.2	57.06	56.86	74	-16.94	31.32	6.2	37.32	173	173	Peak
5150	47.05	46.85	54	-6.95	31.32	6.2	37.32	173	173	Average
5220	96.88	96.63			31.37	6.24	37.36	173	173	Average
5220	103.8	103.55			31.37	6.24	37.36	173	173	Peak
5398.51	61.08	60.42	74	-12.92	31.52	6.32	37.18	173	173	Peak
5417.32	41.02	40.35	54	-12.98	31.53	6.32	37.18	173	173	Average
*10440	55.75	59.85	68.2	-12.45	39.29	9.09	52.48	100	128	Peak

Remarks:

- Emission Level = Read Level + Antenna Factor + Cable Loss - Preamp Factor  
Margin value = Emission level – Limit value
- 5220 MHz: Fundamental Frequency
- \*: Out of Restricted Band

EUT Test Condition		Measurement Detail	
Channel	Channel 48	Frequency Range	1 GHz ~ 40 GHz
Input Power	120 Vac, 60 Hz	Detector Function	Peak (PK) Average (AV)
Environmental Conditions	25 deg. C, 65 % RH	Tested By	Gavin Wu

### Horizontal

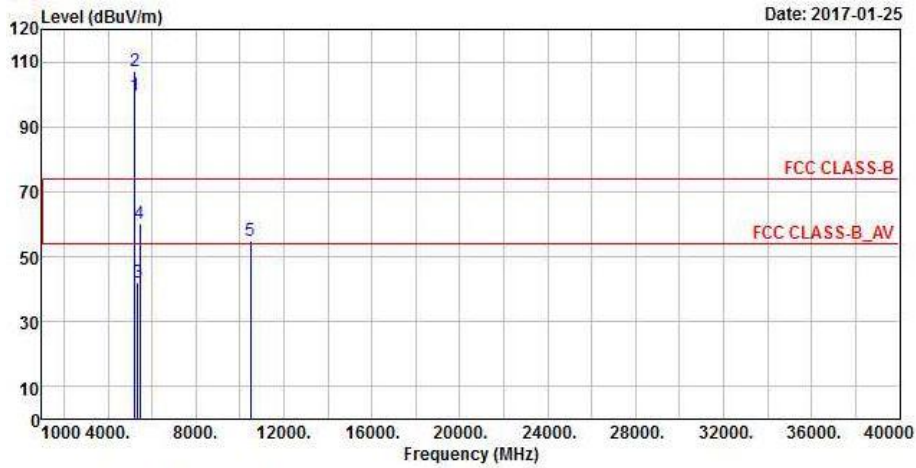

### Vertical

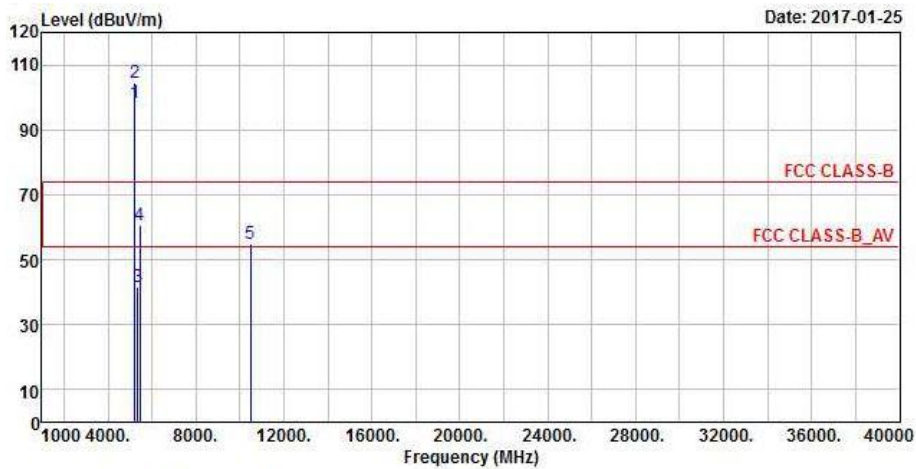

**Antenna Polarity & Test Distance: Horizontal at 3 m**

Frequency (MHz)	Emission Level (dBuV/m)	Read Level (dBuV)	Limit (dBuV/m)	Margin (dB)	Antenna Factor (dB/m)	Cable Loss (dB)	Preamp Factor (dB)	Antenna Height (cm)	Table Angle (Degree)	Remark
5240	99.81	99.49			31.39	6.25	37.32	196	188	Average
5240	107.17	106.85			31.39	6.25	37.32	196	188	Peak
5353.08	42.04	41.45	54	-11.96	31.48	6.29	37.18	196	188	Average
5443.17	60.41	59.65	74	-13.59	31.55	6.34	37.13	196	188	Peak
*10480	54.95	59.2	68.2	-13.25	39.37	9.09	52.71	100	115	Peak

**Antenna Polarity & Test Distance: Vertical at 3 m**

Frequency (MHz)	Emission Level (dBuV/m)	Read Level (dBuV)	Limit (dBuV/m)	Margin (dB)	Antenna Factor (dB/m)	Cable Loss (dB)	Preamp Factor (dB)	Antenna Height (cm)	Table Angle (Degree)	Remark
5240	98.12	97.8			31.39	6.25	37.32	168	173	Average
5240	104.72	104.4			31.39	6.25	37.32	168	173	Peak
5350.44	41.65	41.06	54	-12.35	31.48	6.29	37.18	168	173	Average
5453.29	60.67	59.85	74	-13.33	31.56	6.34	37.08	168	173	Peak
*10480	54.96	59.21	68.2	-13.24	39.37	9.09	52.71	100	162	Peak

## Remarks:

- Emission Level = Read Level + Antenna Factor + Cable Loss - Preamp Factor  
Margin value = Emission level – Limit value
- 5240 MHz: Fundamental Frequency
- \*: Out of Restricted Band

EUT Test Condition		Measurement Detail	
Channel	Channel 52	Frequency Range	1 GHz ~ 40 GHz
Input Power	120 Vac, 60 Hz	Detector Function	Peak (PK) Average (AV)
Environmental Conditions	25 deg. C, 65 % RH	Tested By	Gavin Wu

### Horizontal

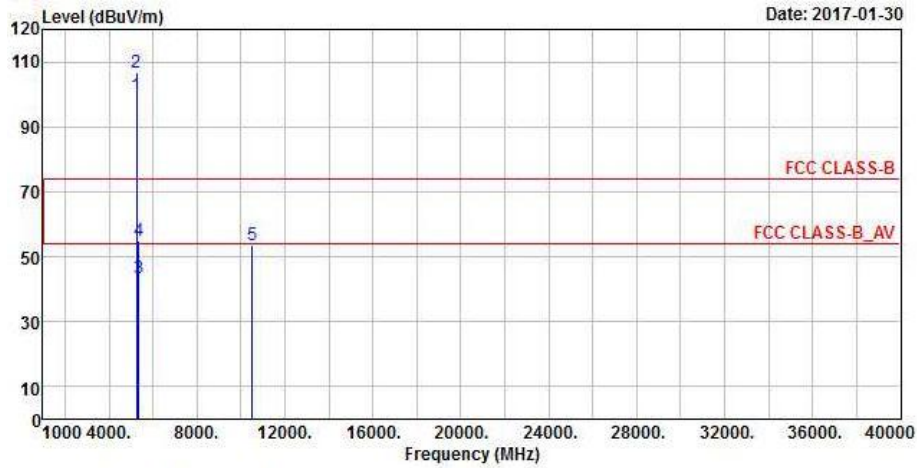

### Vertical

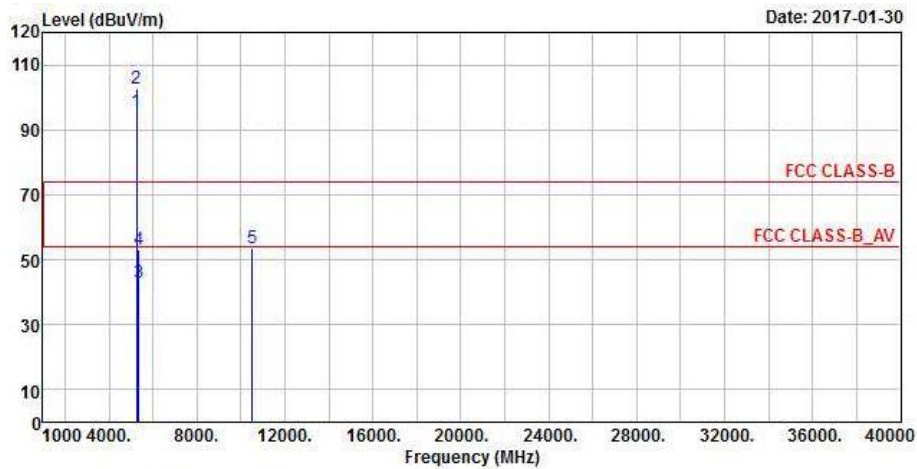

**Antenna Polarity & Test Distance: Horizontal at 3 m**

Frequency (MHz)	Emission Level (dBuV/m)	Read Level (dBuV)	Limit (dBuV/m)	Margin (dB)	Antenna Factor (dB/m)	Cable Loss (dB)	Preamp Factor (dB)	Antenna Height (cm)	Table Angle (Degree)	Remark
5260	99.55	99.16			31.41	6.25	37.27	211	358	Average
5260	106.54	106.15			31.41	6.25	37.27	211	358	Peak
5350.11	43.37	42.78	54	-10.63	31.48	6.29	37.18	211	358	Average
5351.21	54.8	54.21	74	-19.2	31.48	6.29	37.18	211	358	Peak
*10520	53.36	57.64	68.2	-14.84	39.43	9.12	52.83	111	321	Peak

**Antenna Polarity & Test Distance: Vertical at 3 m**

Frequency (MHz)	Emission Level (dBuV/m)	Read Level (dBuV)	Limit (dBuV/m)	Margin (dB)	Antenna Factor (dB/m)	Cable Loss (dB)	Preamp Factor (dB)	Antenna Height (cm)	Table Angle (Degree)	Remark
5260	95.55	95.16			31.41	6.25	37.27	200	281	Average
5260	102.74	102.35			31.41	6.25	37.27	200	281	Peak
5350.55	43.03	42.44	54	-10.97	31.48	6.29	37.18	200	281	Average
5352.64	53.23	52.64	74	-20.77	31.48	6.29	37.18	200	281	Peak
*10520	53.51	57.79	68.2	-14.69	39.43	9.12	52.83	107	88	Peak

## Remarks:

1. Emission Level = Read Level + Antenna Factor + Cable Loss - Preamp Factor  
Margin value = Emission level – Limit value
2. 5260 MHz: Fundamental Frequency
3. \*: Out of Restricted Band

EUT Test Condition		Measurement Detail	
Channel	Channel 60	Frequency Range	1 GHz ~ 40 GHz
Input Power	120 Vac, 60 Hz	Detector Function	Peak (PK) Average (AV)
Environmental Conditions	25 deg. C, 65 % RH	Tested By	Gavin Wu

### Horizontal

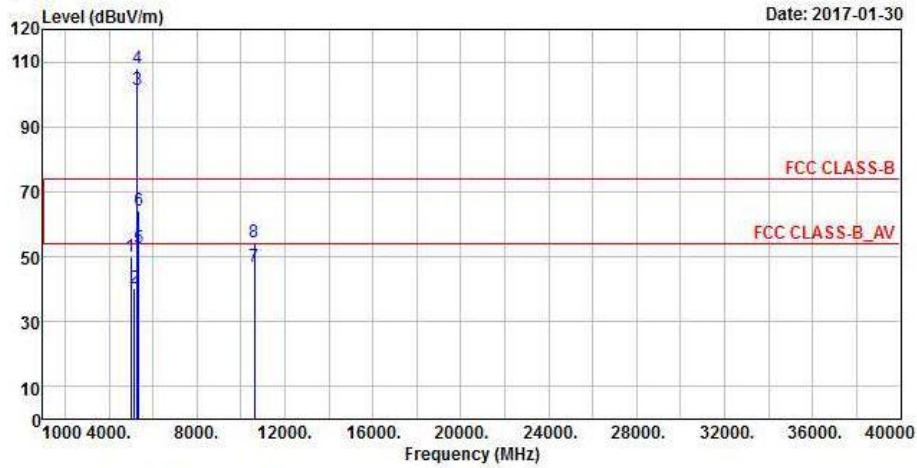

### Vertical

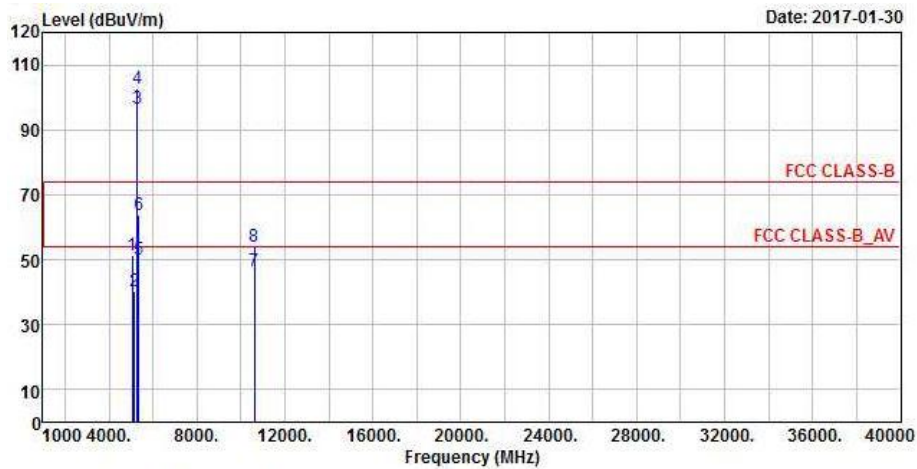

**Antenna Polarity & Test Distance: Horizontal at 3 m**

Frequency (MHz)	Emission Level (dBuV/m)	Read Level (dBuV)	Limit (dBuV/m)	Margin (dB)	Antenna Factor (dB/m)	Cable Loss (dB)	Preamp Factor (dB)	Antenna Height (cm)	Table Angle (Degree)	Remark
5002.1	50.11	50.01	74	-23.89	31.2	6.13	37.23	211	360	Peak
5143.55	40.44	40.22	54	-13.56	31.32	6.2	37.3	211	360	Average
5300	101.46	100.94			31.44	6.27	37.19	211	360	Average
5300	107.89	107.37			31.44	6.27	37.19	211	360	Peak
5351.65	52.66	52.07	54	-1.34	31.48	6.29	37.18	211	360	Average
5356.05	64.02	63.43	74	-9.98	31.48	6.29	37.18	211	360	Peak
10600	47.07	50.75	54	-6.93	39.57	9.16	52.41	133	351	Average
10600	54.47	58.15	74	-19.53	39.57	9.16	52.41	133	351	Peak

**Antenna Polarity & Test Distance: Vertical at 3 m**

Frequency (MHz)	Emission Level (dBuV/m)	Read Level (dBuV)	Limit (dBuV/m)	Margin (dB)	Antenna Factor (dB/m)	Cable Loss (dB)	Preamp Factor (dB)	Antenna Height (cm)	Table Angle (Degree)	Remark
5057.3	51.24	51.07	74	-22.76	31.25	6.17	37.25	200	281	Peak
5149.7	40.4	40.2	54	-13.6	31.32	6.2	37.32	200	281	Average
5300	96.47	95.95			31.44	6.27	37.19	200	281	Average
5300	102.88	102.36			31.44	6.27	37.19	200	281	Peak
5350.55	50	49.41	54	-4	31.48	6.29	37.18	200	281	Average
5356.82	63.58	62.99	74	-10.42	31.48	6.29	37.18	200	281	Peak
10600	46.68	50.36	54	-7.32	39.57	9.16	52.41	151	88	Average
10600	54.12	57.8	74	-19.88	39.57	9.16	52.41	151	88	Peak

Remarks:

- Emission Level = Read Level + Antenna Factor + Cable Loss - Preamp Factor  
Margin value = Emission level – Limit value
- 5300 MHz: Fundamental Frequency
- \*: Out of Restricted Band



EUT Test Condition		Measurement Detail	
Channel	Channel 64	Frequency Range	1 GHz ~ 40 GHz
Input Power	120 Vac, 60 Hz	Detector Function	Peak (PK) Average (AV)
Environmental Conditions	25 deg. C, 65 % RH	Tested By	Gavin Wu

### Horizontal

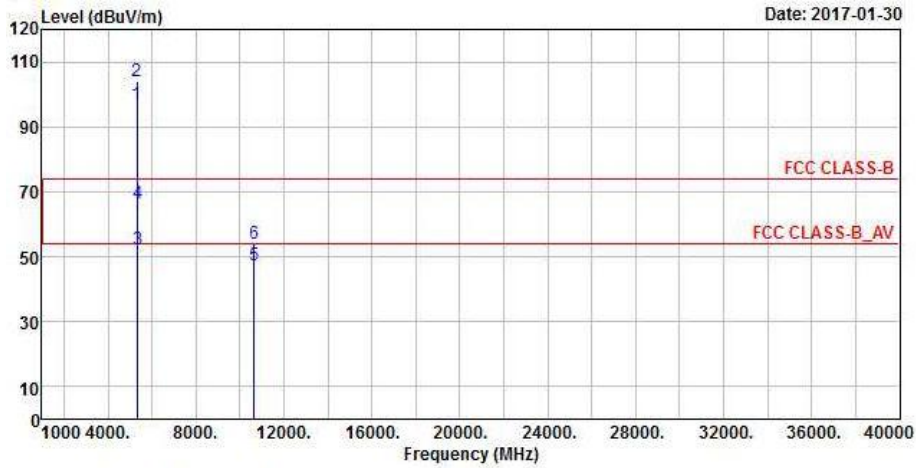

### Vertical

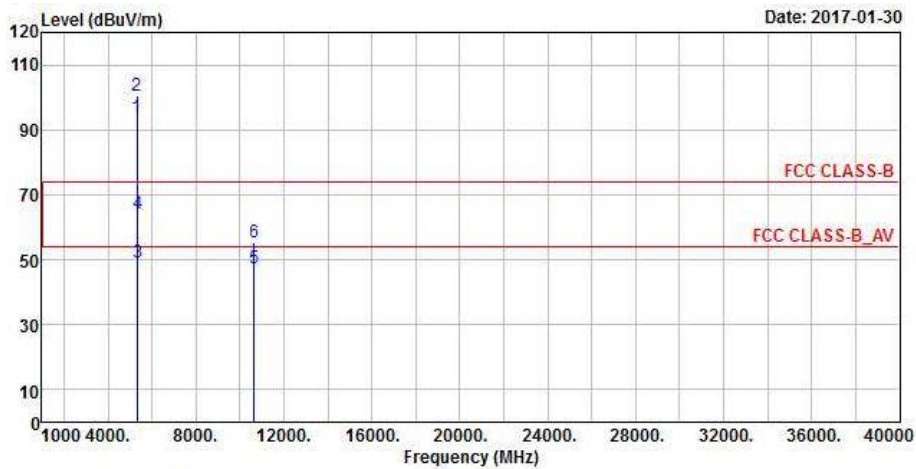

**Antenna Polarity & Test Distance: Horizontal at 3 m**

Frequency (MHz)	Emission Level (dBuV/m)	Read Level (dBuV)	Limit (dBuV/m)	Margin (dB)	Antenna Factor (dB/m)	Cable Loss (dB)	Preamp Factor (dB)	Antenna Height (cm)	Table Angle (Degree)	Remark
5320	97.01	96.46			31.45	6.29	37.19	211	360	Average
5320	104.03	103.48			31.45	6.29	37.19	211	360	Peak
5350.11	52.33	51.74	54	-1.67	31.48	6.29	37.18	211	360	Average
5351.65	66.22	65.63	74	-7.78	31.48	6.29	37.18	211	360	Peak
10640	47.4	50.85	54	-6.6	39.62	9.2	52.27	118	349	Average
10640	54.01	57.46	74	-19.99	39.62	9.2	52.27	118	349	Peak

**Antenna Polarity & Test Distance: Vertical at 3 m**

Frequency (MHz)	Emission Level (dBuV/m)	Read Level (dBuV)	Limit (dBuV/m)	Margin (dB)	Antenna Factor (dB/m)	Cable Loss (dB)	Preamp Factor (dB)	Antenna Height (cm)	Table Angle (Degree)	Remark
5320	93.68	93.13			31.45	6.29	37.19	200	281	Average
5320	100.62	100.07			31.45	6.29	37.19	200	281	Peak
5350	49.15	48.56	54	-4.85	31.48	6.29	37.18	200	281	Average
5354.73	64.07	63.48	74	-9.93	31.48	6.29	37.18	200	281	Peak
10640	47.2	50.65	54	-6.8	39.62	9.2	52.27	149	77	Average
10640	55.19	58.64	74	-18.81	39.62	9.2	52.27	149	77	Peak

## Remarks:

- Emission Level = Read Level + Antenna Factor + Cable Loss - Preamp Factor  
Margin value = Emission level – Limit value
- 5320 MHz: Fundamental Frequency
- \*: Out of Restricted Band

EUT Test Condition		Measurement Detail	
Channel	Channel 100	Frequency Range	1 GHz ~ 40 GHz
Input Power	120 Vac, 60 Hz	Detector Function	Peak (PK) Average (AV)
Environmental Conditions	25 deg. C, 65 % RH	Tested By	Gavin Wu

**Horizontal**

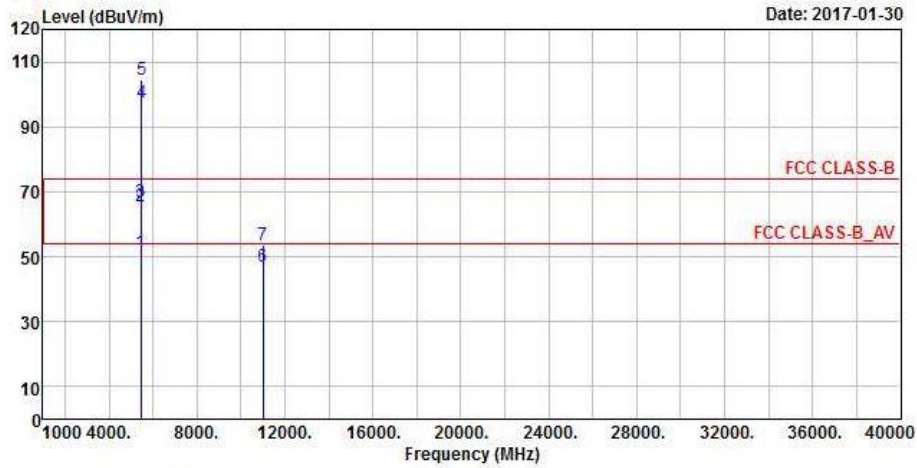

**Vertical**

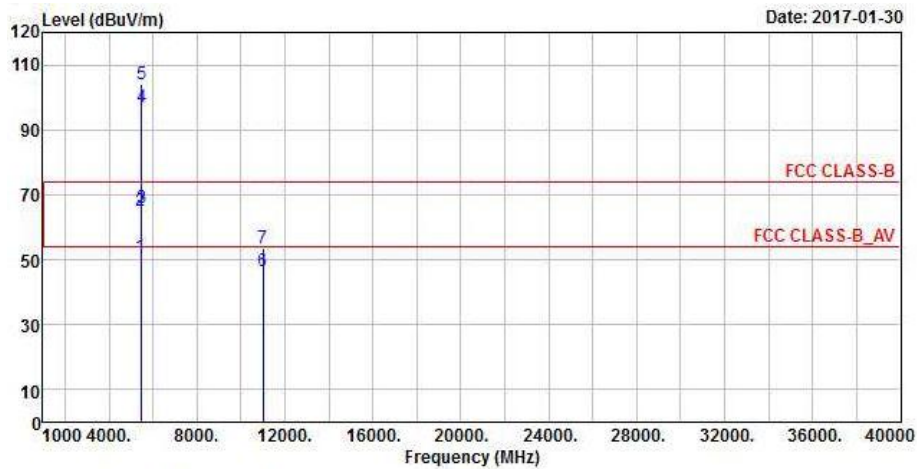

Antenna Polarity & Test Distance: Horizontal at 3 m										
Frequency (MHz)	Emission Level (dBuV/m)	Read Level (dBuV)	Limit (dBuV/m)	Margin (dB)	Antenna Factor (dB/m)	Cable Loss (dB)	Preamp Factor (dB)	Antenna Height (cm)	Table Angle (Degree)	Remark
5458.16	51.48	50.66	54	-2.52	31.56	6.34	37.08	206	4	Average
5460.08	65.4	64.58	74	-8.6	31.56	6.34	37.08	206	4	Peak
*5469.04	66.98	66.15	68.2	-1.22	31.57	6.34	37.08	206	4	Peak
5500	97.49	96.56			31.6	6.36	37.03	206	4	Average
5500	104.36	103.43			31.6	6.36	37.03	206	4	Peak
11000	46.96	50.86	54	-7.04	40.2	9.35	53.45	144	77	Average
11000	53.43	57.33	74	-20.57	40.2	9.35	53.45	144	77	Peak
Antenna Polarity & Test Distance: Vertical at 3 m										
Frequency (MHz)	Emission Level (dBuV/m)	Read Level (dBuV)	Limit (dBuV/m)	Margin (dB)	Antenna Factor (dB/m)	Cable Loss (dB)	Preamp Factor (dB)	Antenna Height (cm)	Table Angle (Degree)	Remark
5459.92	51.05	50.23	54	-2.95	31.56	6.34	37.08	204	306	Average
5459.92	64.92	64.1	74	-9.08	31.56	6.34	37.08	204	306	Peak
*5470.16	65.77	64.94	68.2	-2.43	31.57	6.34	37.08	204	306	Peak
5500	96.77	95.84			31.6	6.36	37.03	204	306	Average
5500	103.89	102.96			31.6	6.36	37.03	204	306	Peak
11000	46.55	50.45	54	-7.45	40.2	9.35	53.45	102	244	Average
11000	53.67	57.57	74	-20.33	40.2	9.35	53.45	102	244	Peak

Remarks:

- Emission Level = Read Level + Antenna Factor + Cable Loss - Preamp Factor  
Margin value = Emission level – Limit value
- 5500 MHz: Fundamental Frequency
- \*: Out of Restricted Band

EUT Test Condition		Measurement Detail	
Channel	Channel 116	Frequency Range	1 GHz ~ 40 GHz
Input Power	120 Vac, 60 Hz	Detector Function	Peak (PK) Average (AV)
Environmental Conditions	25 deg. C, 65 % RH	Tested By	Gavin Wu

### Horizontal

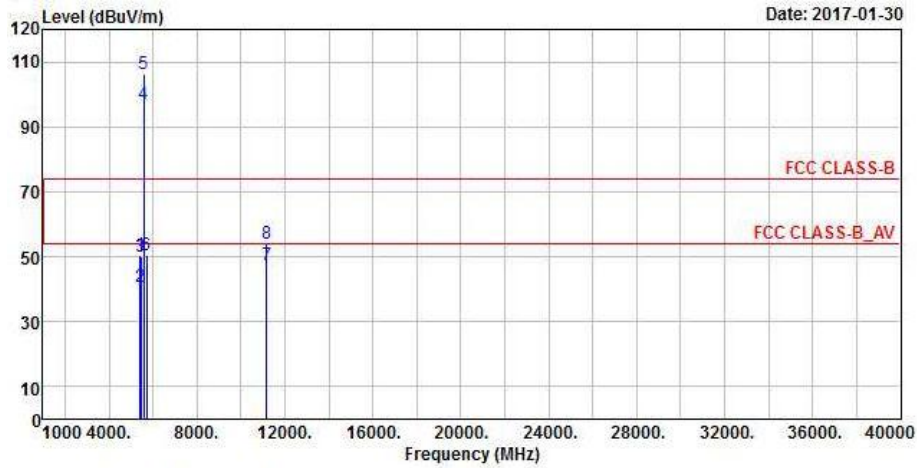

### Vertical

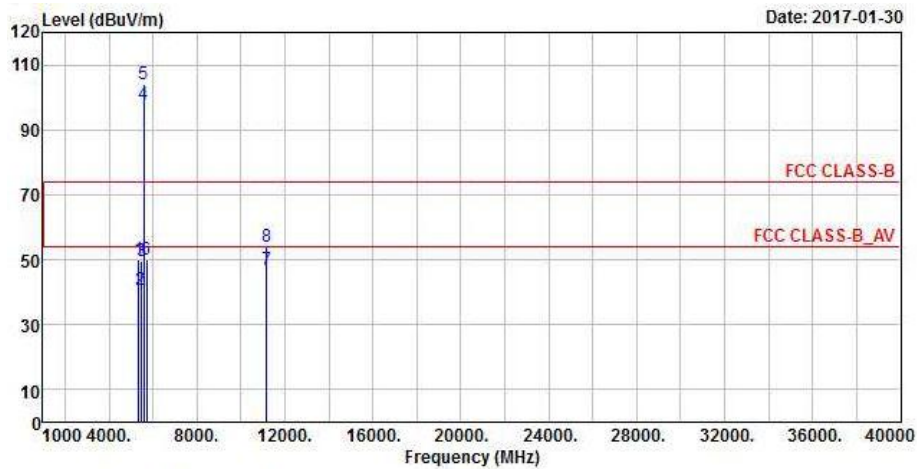

**Antenna Polarity & Test Distance: Horizontal at 3 m**

Frequency (MHz)	Emission Level (dBuV/m)	Read Level (dBuV)	Limit (dBuV/m)	Margin (dB)	Antenna Factor (dB/m)	Cable Loss (dB)	Preamp Factor (dB)	Antenna Height (cm)	Table Angle (Degree)	Remark
5432.4	50.49	49.75	74	-23.51	31.55	6.32	37.13	206	4	Peak
5457.84	40.84	40.02	54	-13.16	31.56	6.34	37.08	206	4	Average
*5469.36	50.07	49.24	68.2	-18.13	31.57	6.34	37.08	206	4	Peak
5580	96.95	95.91			31.71	6.49	37.16	206	4	Average
5580	106.41	105.37			31.71	6.49	37.16	206	4	Peak
*5724.52	50.59	49.37	68.2	-17.61	31.96	6.69	37.43	206	4	Peak
11160	47.28	51	54	-6.72	40.1	9.57	53.39	144	47	Average
11160	54.21	57.93	74	-19.79	40.1	9.57	53.39	144	47	Peak

**Antenna Polarity & Test Distance: Vertical at 3 m**

Frequency (MHz)	Emission Level (dBuV/m)	Read Level (dBuV)	Limit (dBuV/m)	Margin (dB)	Antenna Factor (dB/m)	Cable Loss (dB)	Preamp Factor (dB)	Antenna Height (cm)	Table Angle (Degree)	Remark
5362.96	50.23	49.61	74	-23.77	31.49	6.31	37.18	202	306	Peak
5457.36	40.75	39.93	54	-13.25	31.56	6.34	37.08	202	306	Average
*5470.48	49.67	48.84	68.2	-18.53	31.57	6.34	37.08	202	306	Peak
5580	97.66	96.62			31.71	6.49	37.16	202	306	Average
5580	104.19	103.15			31.71	6.49	37.16	202	306	Peak
*5724.84	50.17	48.95	68.2	-18.03	31.96	6.69	37.43	202	306	Peak
11160	47.03	50.75	54	-6.97	40.1	9.57	53.39	103	242	Average
11160	54.02	57.74	74	-19.98	40.1	9.57	53.39	103	242	Peak

Remarks:

- Emission Level = Read Level + Antenna Factor + Cable Loss - Preamp Factor  
Margin value = Emission level – Limit value
- 5580 MHz: Fundamental Frequency
- \*: Out of Restricted Band

EUT Test Condition		Measurement Detail	
Channel	Channel 140	Frequency Range	1 GHz ~ 40 GHz
Input Power	120 Vac, 60 Hz	Detector Function	Peak (PK) Average (AV)
Environmental Conditions	25 deg. C, 65 % RH	Tested By	Gavin Wu

### Horizontal

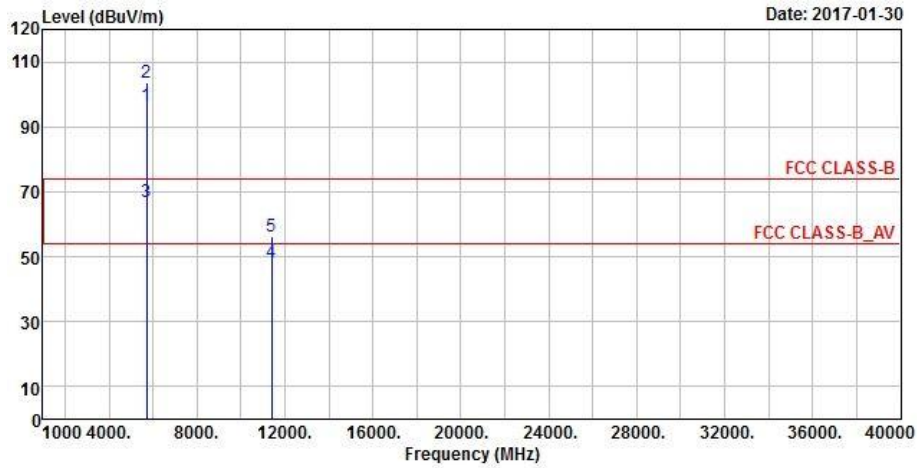

### Vertical

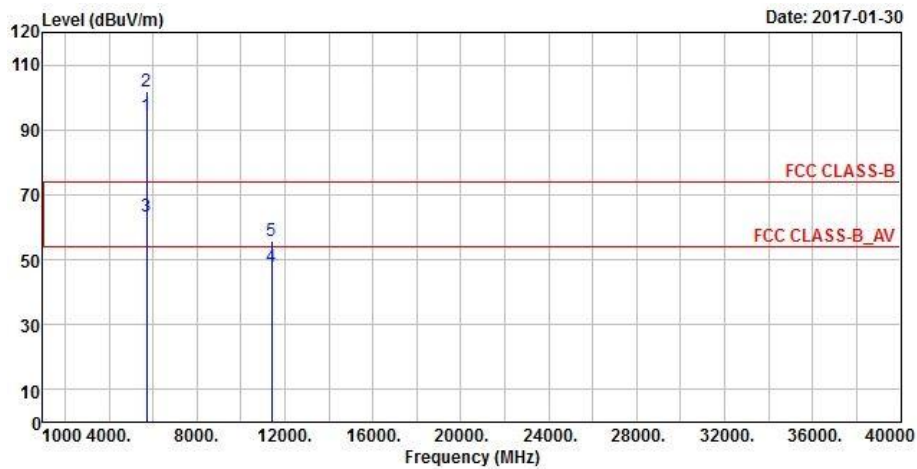

**Antenna Polarity & Test Distance: Horizontal at 3 m**

Frequency (MHz)	Emission Level (dBuV/m)	Read Level (dBuV)	Limit (dBuV/m)	Margin (dB)	Antenna Factor (dB/m)	Cable Loss (dB)	Preamp Factor (dB)	Antenna Height (cm)	Table Angle (Degree)	Remark
5700	96.38	95.19			31.9	6.69	37.4	206	4	Average
5700	103.71	102.52			31.9	6.69	37.4	206	4	Peak
*5724.76	66.92	65.7	68.2	-1.28	31.96	6.69	37.43	206	4	Peak
11400	48.11	50.37	54	-5.89	39.96	9.91	52.13	141	56	Average
11400	56.04	58.3	74	-17.96	39.96	9.91	52.13	141	56	Peak

**Antenna Polarity & Test Distance: Vertical at 3 m**

Frequency (MHz)	Emission Level (dBuV/m)	Read Level (dBuV)	Limit (dBuV/m)	Margin (dB)	Antenna Factor (dB/m)	Cable Loss (dB)	Preamp Factor (dB)	Antenna Height (cm)	Table Angle (Degree)	Remark
5700	94.31	93.12			31.9	6.69	37.4	203	307	Average
5700	101.93	100.74			31.9	6.69	37.4	203	307	Peak
*5725	63.31	62.03	74	-10.69	31.96	6.75	37.43	203	307	Peak
11400	47.87	50.13	54	-6.13	39.96	9.91	52.13	103	253	Average
11400	55.79	58.05	74	-18.21	39.96	9.91	52.13	103	253	Peak

Remarks:

- Emission Level = Read Level + Antenna Factor + Cable Loss - Preamp Factor  
Margin value = Emission level – Limit value
- 5700 MHz: Fundamental Frequency
- \*: Out of Restricted Band



EUT Test Condition		Measurement Detail	
Channel	Channel 149	Frequency Range	1 GHz ~ 40 GHz
Input Power	120 Vac, 60 Hz	Detector Function	Peak (PK) Average (AV)
Environmental Conditions	25 deg. C, 65 % RH	Tested By	Gavin Wu

**<Spurious Emission>  
Horizontal**

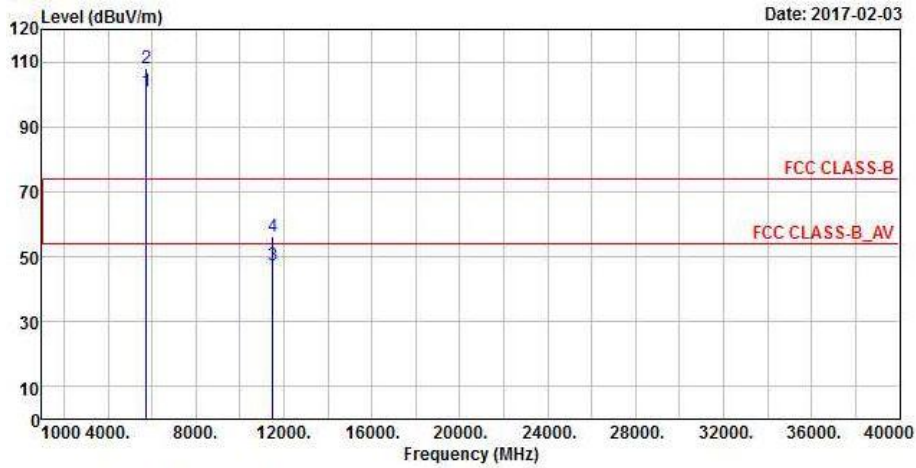

**Vertical**

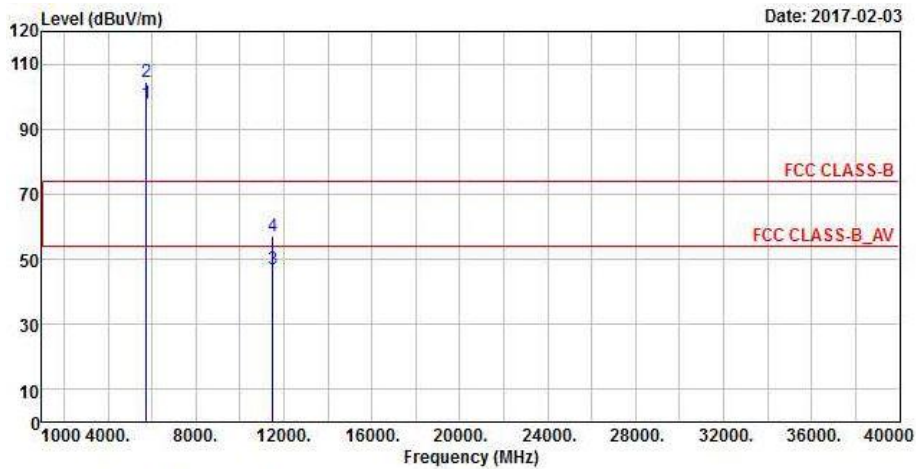

**<Out of Band Emission (OOBE)>  
Horizontal**

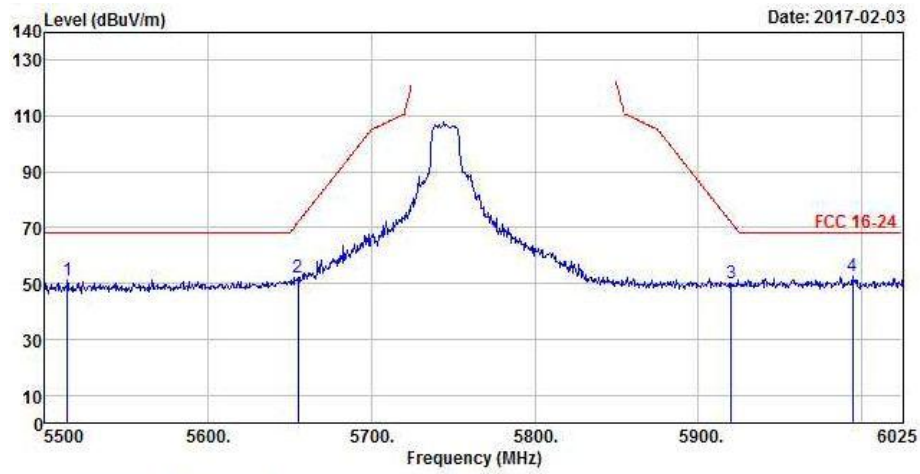

**Vertical**

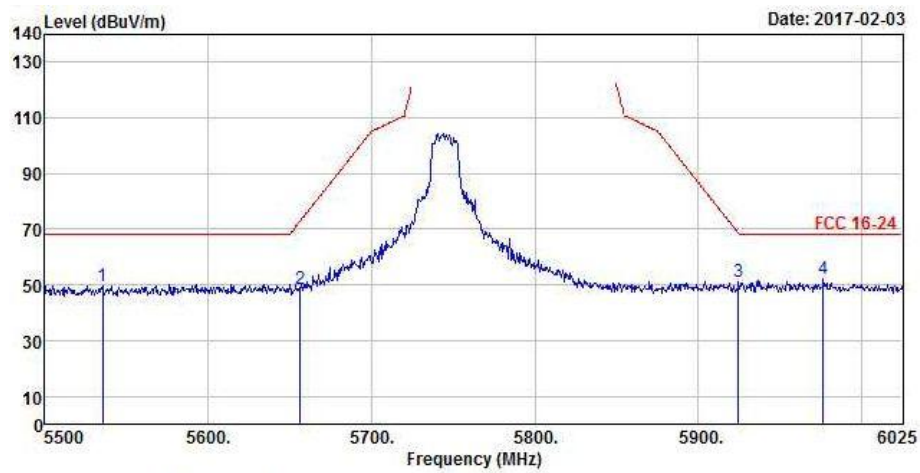

**<Spurious Emission>**

Antenna Polarity & Test Distance: Horizontal at 3 m										
Frequency (MHz)	Emission Level (dBuV/m)	Read Level (dBuV)	Limit (dBuV/m)	Margin (dB)	Antenna Factor (dB/m)	Cable Loss (dB)	Preamp Factor (dB)	Antenna Height (cm)	Table Angle (Degree)	Remark
5745	100.79	99.52			31.99	6.75	37.47	200	298	Average
5745	107.91	106.64			31.99	6.75	37.47	200	298	Peak
11490	47.51	50.4	54	-6.49	39.91	10.03	52.83	162	69	Average
11490	56.37	59.26	74	-17.63	39.91	10.03	52.83	162	69	Peak
Antenna Polarity & Test Distance: Vertical at 3 m										
Frequency (MHz)	Emission Level (dBuV/m)	Read Level (dBuV)	Limit (dBuV/m)	Margin (dB)	Antenna Factor (dB/m)	Cable Loss (dB)	Preamp Factor (dB)	Antenna Height (cm)	Table Angle (Degree)	Remark
5745	98.08	96.81			31.99	6.75	37.47	220	282	Average
5745	104.57	103.3			31.99	6.75	37.47	220	282	Peak
11490	47.02	49.91	54	-6.98	39.91	10.03	52.83	182	143	Average
11490	56.96	59.85	74	-17.04	39.91	10.03	52.83	182	143	Peak

**<Out of Band Emission (OOBE)>**

Antenna Polarity & Test Distance: Horizontal at 3 m										
Frequency (MHz)	Emission Level (dBuV/m)	Read Level (dBuV)	Limit (dBuV/m)	Margin (dB)	Antenna Factor (dB/m)	Cable Loss (dB)	Preamp Factor (dB)	Antenna Height (cm)	Table Angle (Degree)	Remark
*5513.65	51.1	50.17	68.2	-17.1	31.63	6.36	37.06	200	298	Peak
5654.875	52.09	50.96	71.82	-19.73	31.85	6.62	37.34	200	298	Peak
5920	50.13	48.36	71.89	-21.76	32.26	7.01	37.5	200	298	Peak
*5994.55	52.71	50.68	68.2	-15.49	32.4	7.14	37.51	200	298	Peak
Antenna Polarity & Test Distance: Vertical at 3 m										
Frequency (MHz)	Emission Level (dBuV/m)	Read Level (dBuV)	Limit (dBuV/m)	Margin (dB)	Antenna Factor (dB/m)	Cable Loss (dB)	Preamp Factor (dB)	Antenna Height (cm)	Table Angle (Degree)	Remark
*5535.175	49.68	48.69	68.2	-18.52	31.66	6.42	37.09	220	282	Peak
5656.45	48.62	47.49	72.99	-24.37	31.85	6.62	37.34	220	282	Peak
5924.725	50.96	49.16	68.4	-17.44	32.29	7.01	37.5	220	282	Peak
*5976.7	51.98	50.04	68.2	-16.22	32.37	7.08	37.51	220	282	Peak

Remarks:

- Emission Level = Read Level + Antenna Factor + Cable Loss - Preamp Factor  
Margin value = Emission level – Limit value
- 5745 MHz: Fundamental Frequency
- \*: Out of Restricted Band

EUT Test Condition		Measurement Detail	
Channel	Channel 157	Frequency Range	1 GHz ~ 40 GHz
Input Power	120 Vac, 60 Hz	Detector Function	Peak (PK) Average (AV)
Environmental Conditions	25 deg. C, 65 % RH	Tested By	Gavin Wu

**<Spurious Emission>  
Horizontal**

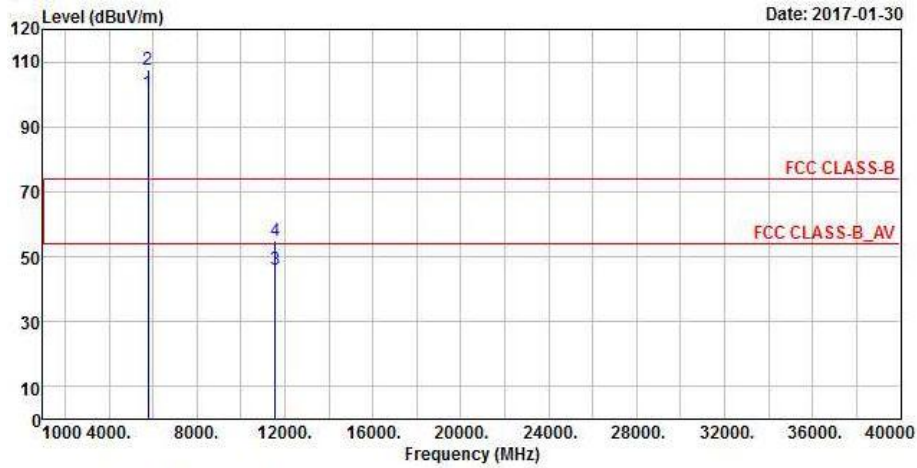

**Vertical**

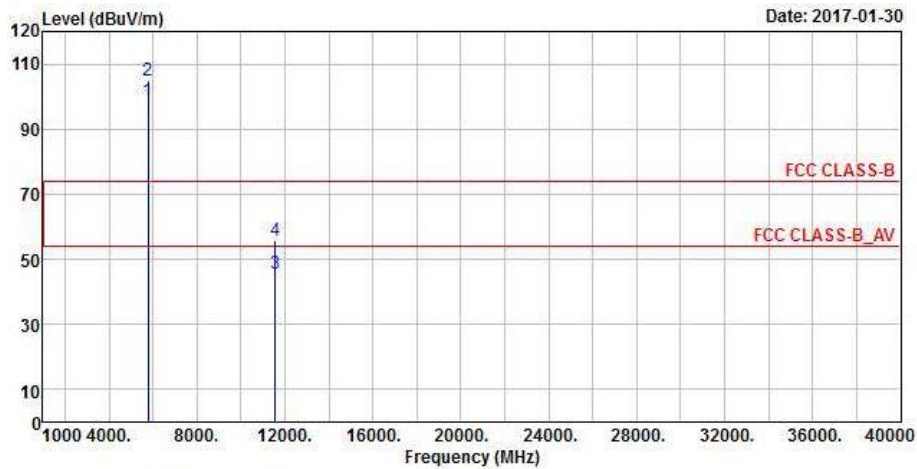

**<Out of Band Emission (OOBE)>  
Horizontal**

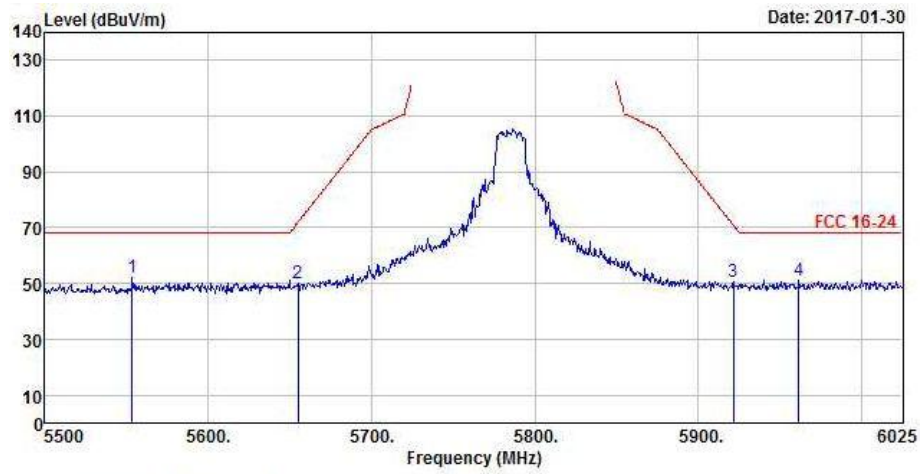

**Vertical**

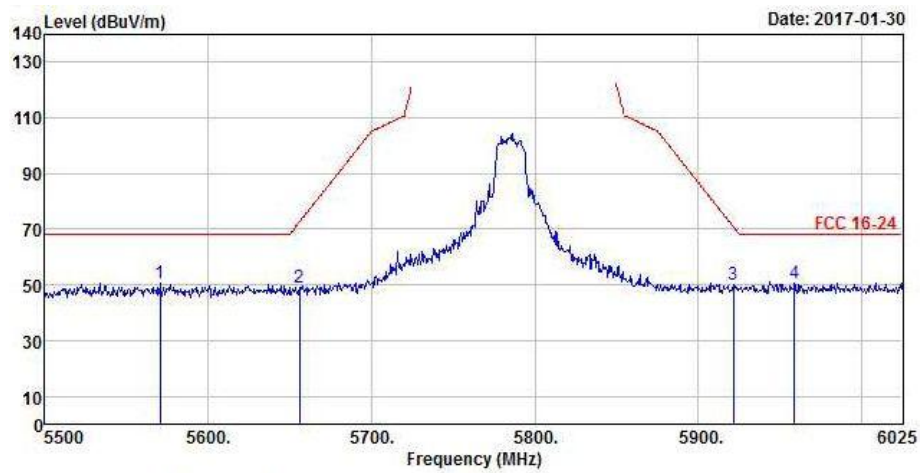

**<Spurious Emission>**

Antenna Polarity & Test Distance: Horizontal at 3 m										
Frequency (MHz)	Emission Level (dBuV/m)	Read Level (dBuV)	Limit (dBuV/m)	Margin (dB)	Antenna Factor (dB/m)	Cable Loss (dB)	Preamp Factor (dB)	Antenna Height (cm)	Table Angle (Degree)	Remark
5785	100.35	99.03			32.04	6.82	37.54	200	298	Average
5785	107.56	106.24			32.04	6.82	37.54	200	298	Peak
11570	46.05	49.51	54	-7.95	39.78	10.09	53.33	154	72	Average
11570	55.09	58.55	74	-18.91	39.78	10.09	53.33	154	72	Peak
Antenna Polarity & Test Distance: Vertical at 3 m										
Frequency (MHz)	Emission Level (dBuV/m)	Read Level (dBuV)	Limit (dBuV/m)	Margin (dB)	Antenna Factor (dB/m)	Cable Loss (dB)	Preamp Factor (dB)	Antenna Height (cm)	Table Angle (Degree)	Remark
5785	98.72	97.4			32.04	6.82	37.54	220	279	Average
5785	104.97	103.65			32.04	6.82	37.54	220	279	Peak
11570	45.57	49.03	54	-8.43	39.78	10.09	53.33	176	141	Average
11570	55.66	59.12	74	-18.34	39.78	10.09	53.33	176	141	Peak

**<Out of Band Emission (OOBE)>**

Antenna Polarity & Test Distance: Horizontal at 3 m										
Frequency (MHz)	Emission Level (dBuV/m)	Read Level (dBuV)	Limit (dBuV/m)	Margin (dB)	Antenna Factor (dB/m)	Cable Loss (dB)	Preamp Factor (dB)	Antenna Height (cm)	Table Angle (Degree)	Remark
*5553.55	52.29	51.31	68.2	-15.91	31.68	6.42	37.12	200	298	Peak
5654.875	50.12	48.99	71.82	-21.7	31.85	6.62	37.34	200	298	Peak
5921.575	50.37	48.57	70.72	-20.35	32.29	7.01	37.5	200	298	Peak
*5961.475	51.35	49.44	68.2	-16.85	32.34	7.08	37.51	200	298	Peak
Antenna Polarity & Test Distance: Vertical at 3 m										
Frequency (MHz)	Emission Level (dBuV/m)	Read Level (dBuV)	Limit (dBuV/m)	Margin (dB)	Antenna Factor (dB/m)	Cable Loss (dB)	Preamp Factor (dB)	Antenna Height (cm)	Table Angle (Degree)	Remark
*5570.35	50.74	49.66	68.2	-17.46	31.71	6.49	37.12	220	279	Peak
5655.925	49.29	48.16	72.6	-23.31	31.85	6.62	37.34	220	279	Peak
5921.575	50.15	48.35	70.72	-20.57	32.29	7.01	37.5	220	279	Peak
*5958.85	50.66	48.74	68.2	-17.54	32.34	7.08	37.5	220	279	Peak

## Remarks:

- Emission Level = Read Level + Antenna Factor + Cable Loss - Preamp Factor  
Margin value = Emission level – Limit value
- 5785 MHz: Fundamental Frequency
- \*: Out of Restricted Band

EUT Test Condition		Measurement Detail	
Channel	Channel 165	Frequency Range	1 GHz ~ 40 GHz
Input Power	120 Vac, 60 Hz	Detector Function	Peak (PK) Average (AV)
Environmental Conditions	25 deg. C, 65 % RH	Tested By	Gavin Wu

**<Spurious Emission>  
Horizontal**

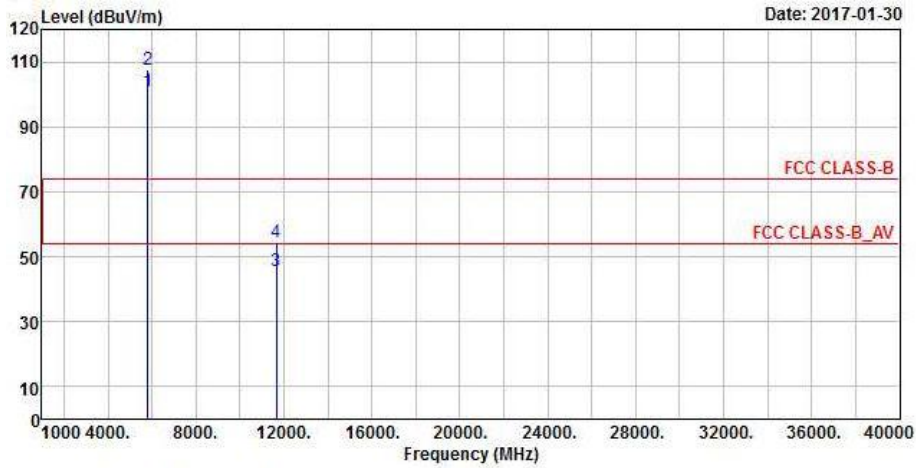

**Vertical**

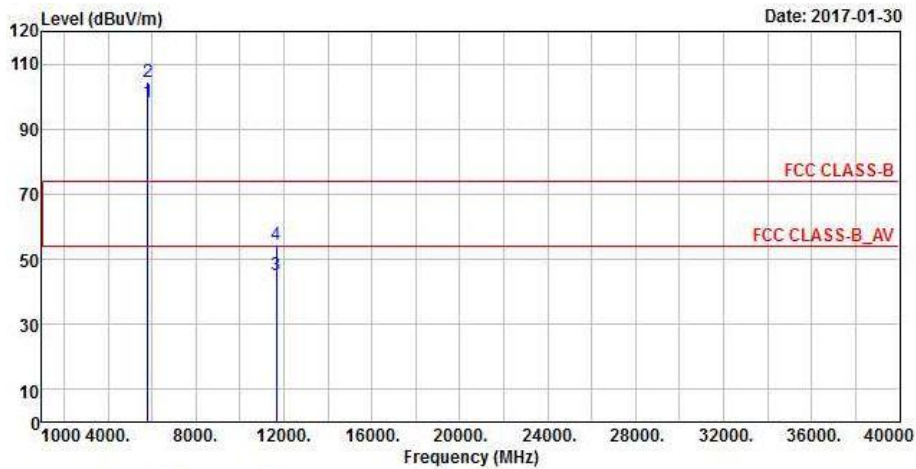

<Out of Band Emission (OOBE)>  
Horizontal

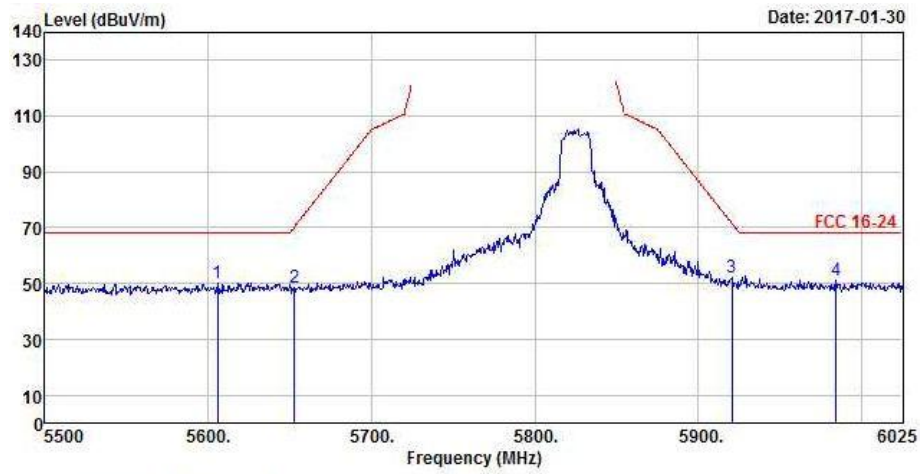

Vertical

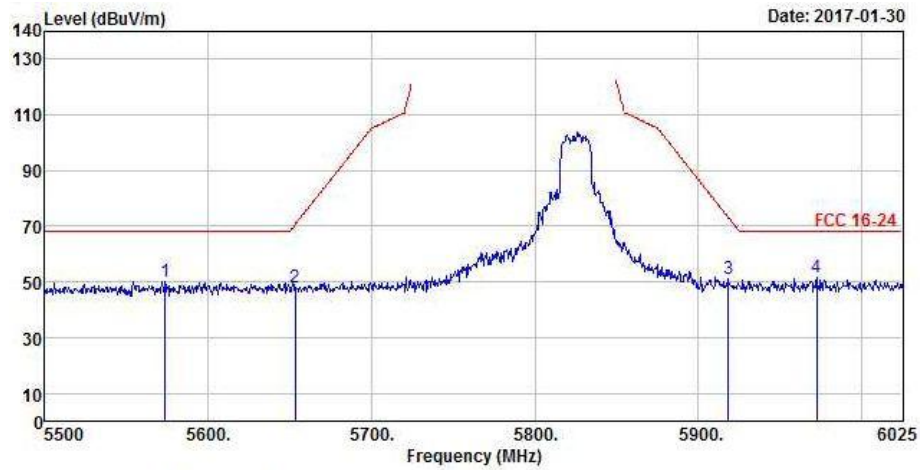



**<Spurious Emission>**

Antenna Polarity & Test Distance: Horizontal at 3 m										
Frequency (MHz)	Emission Level (dBuV/m)	Read Level (dBuV)	Limit (dBuV/m)	Margin (dB)	Antenna Factor (dB/m)	Cable Loss (dB)	Preamp Factor (dB)	Antenna Height (cm)	Table Angle (Degree)	Remark
5825	100.82	99.35			32.12	6.88	37.53	200	296	Average
5825	107.71	106.24			32.12	6.88	37.53	200	296	Peak
11650	45.71	49.26	54	-8.29	39.65	10.15	53.35	161	66	Average
11650	54.3	57.85	74	-19.7	39.65	10.15	53.35	161	66	Peak
Antenna Polarity & Test Distance: Vertical at 3 m										
Frequency (MHz)	Emission Level (dBuV/m)	Read Level (dBuV)	Limit (dBuV/m)	Margin (dB)	Antenna Factor (dB/m)	Cable Loss (dB)	Preamp Factor (dB)	Antenna Height (cm)	Table Angle (Degree)	Remark
5825	98.3	96.83			32.12	6.88	37.53	218	285	Average
5825	104.48	103.01			32.12	6.88	37.53	218	285	Peak
11650	45.37	48.92	54	-8.63	39.65	10.15	53.35	184	139	Average
11650	54.68	58.23	74	-19.32	39.65	10.15	53.35	184	139	Peak

**<Out of Band Emission (OOBE)>**

Antenna Polarity & Test Distance: Horizontal at 3 m										
Frequency (MHz)	Emission Level (dBuV/m)	Read Level (dBuV)	Limit (dBuV/m)	Margin (dB)	Antenna Factor (dB/m)	Cable Loss (dB)	Preamp Factor (dB)	Antenna Height (cm)	Table Angle (Degree)	Remark
*5605.525	49.97	48.86	68.2	-18.23	31.77	6.56	37.22	200	296	Peak
5652.775	48.62	47.43	70.26	-21.64	31.85	6.62	37.28	200	296	Peak
5920.525	52.03	50.26	71.5	-19.47	32.26	7.01	37.5	200	296	Peak
*5984.575	50.97	48.97	68.2	-17.23	32.37	7.14	37.51	200	296	Peak
Antenna Polarity & Test Distance: Vertical at 3 m										
Frequency (MHz)	Emission Level (dBuV/m)	Read Level (dBuV)	Limit (dBuV/m)	Margin (dB)	Antenna Factor (dB/m)	Cable Loss (dB)	Preamp Factor (dB)	Antenna Height (cm)	Table Angle (Degree)	Remark
*5573.5	50.36	49.28	68.2	-17.84	31.71	6.49	37.12	218	285	Peak
5653.3	48.16	46.97	70.65	-22.49	31.85	6.62	37.28	218	285	Peak
5918.425	51.04	49.27	73.05	-22.01	32.26	7.01	37.5	218	285	Peak
*5972.5	51.62	49.71	68.2	-16.58	32.34	7.08	37.51	218	285	Peak

Remarks:

- Emission Level = Read Level + Antenna Factor + Cable Loss - Preamp Factor  
Margin value = Emission level – Limit value
- 5825 MHz: Fundamental Frequency
- \*: Out of Restricted Band

<For Reference>

802.11a

EUT Test Condition		Measurement Detail	
Channel	Channel 40	Frequency Range	5 GHz ~ 7 GHz
Input Power	120 Vac, 60 Hz	Detector Function	Peak (PK) Average (AV)
Environmental Conditions	25 deg. C, 65 % RH	Tested By	Gavin Wu

Horizontal

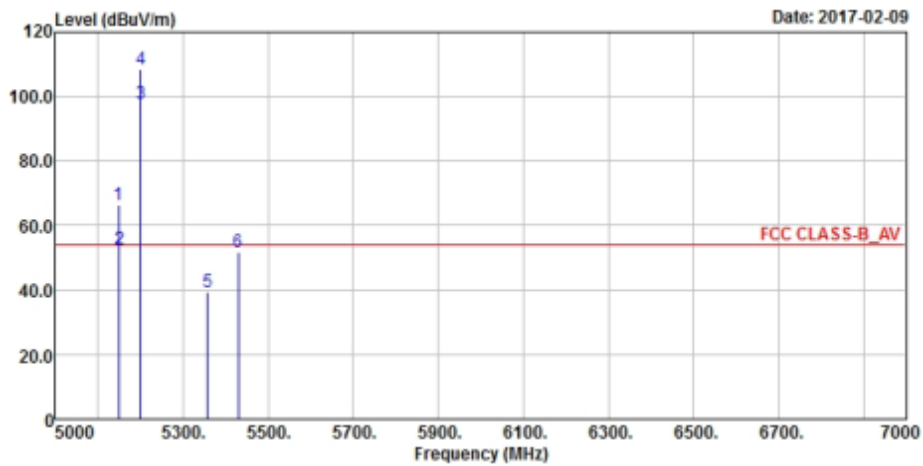

Vertical

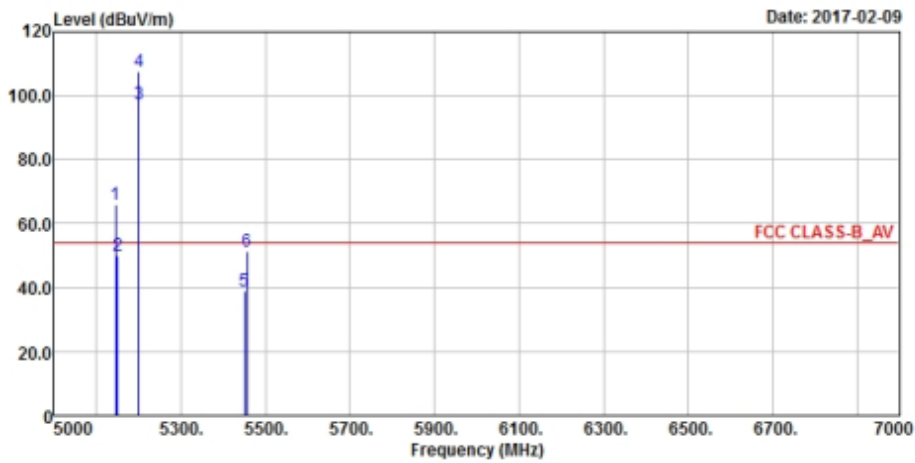

**Antenna Polarity & Test Distance: Horizontal at 3 m**

Frequency (MHz)	Emission Level (dBuV/m)	Read Level (dBuV)	Limit (dBuV/m)	Margin (dB)	Antenna Factor (dB/m)	Cable Loss (dB)	Preamp Factor (dB)	Antenna Height (cm)	Table Angle (Degree)	Remark
5147.45	66.33	65.99	74	-7.67	31.32	6.34	37.32	123	184	Peak
5150	52.77	52.43	54	-1.23	31.32	6.34	37.32	123	184	Average
5200	97.75	97.36			31.36	6.39	37.36	123	184	Average
5200	108.59	108.2			31.36	6.39	37.36	123	184	Peak
5358.14	39.25	38.48	54	-14.75	31.48	6.47	37.18	123	184	Average
5428.87	51.83	50.92	74	-22.17	31.55	6.49	37.13	123	184	Peak
5147.45	66.33	65.99	74	-7.67	31.32	6.34	37.32	123	184	Peak

**Antenna Polarity & Test Distance: Vertical at 3 m**

Frequency (MHz)	Emission Level (dBuV/m)	Read Level (dBuV)	Limit (dBuV/m)	Margin (dB)	Antenna Factor (dB/m)	Cable Loss (dB)	Preamp Factor (dB)	Antenna Height (cm)	Table Angle (Degree)	Remark
5145.35	66.09	65.75	74	-7.91	31.32	6.34	37.32	101	113	Peak
5150	50.19	49.85	54	-3.81	31.32	6.34	37.32	101	113	Average
5200	97.63	97.24			31.36	6.39	37.36	101	113	Average
5200	107.67	107.28			31.36	6.39	37.36	101	113	Peak
5449	39	38.07	54	-15	31.56	6.5	37.13	101	113	Average
5455.71	51.41	50.42	74	-22.59	31.56	6.51	37.08	101	113	Peak
5145.35	66.09	65.75	74	-7.91	31.32	6.34	37.32	101	113	Peak

Remarks:

- Emission Level = Read Level + Antenna Factor + Cable Loss - Preamp Factor  
Margin value = Emission level – Limit value
- 5200 MHz: Fundamental Frequency
- \*: Out of Restricted Band

EUT Test Condition		Measurement Detail	
Channel	Channel 136	Frequency Range	5 GHz ~ 7 GHz
Input Power	120 Vac, 60 Hz	Detector Function	Peak (PK) Average (AV)
Environmental Conditions	25 deg. C, 65 % RH	Tested By	Gavin Wu

### Horizontal

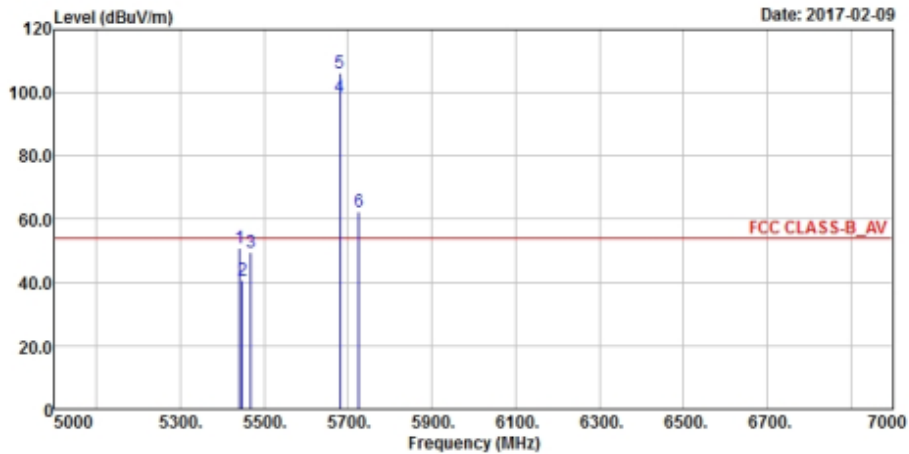

### Vertical

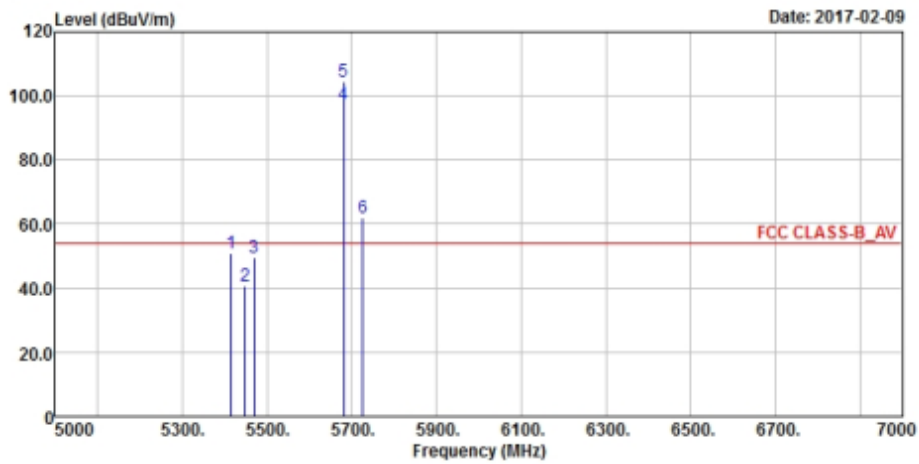

**Antenna Polarity & Test Distance: Horizontal at 3 m**

Frequency (MHz)	Emission Level (dBuV/m)	Read Level (dBuV)	Limit (dBuV/m)	Margin (dB)	Antenna Factor (dB/m)	Cable Loss (dB)	Preamp Factor (dB)	Antenna Height (cm)	Table Angle (Degree)	Remark
5441.04	50.95	50.19	74	-23.05	31.55	6.34	37.13	249	180	Peak
5448.56	40.82	40.05	54	-13.18	31.56	6.34	37.13	249	180	Average
5468.08	49.78	48.95	74	-24.22	31.57	6.34	37.08	249	180	Peak
5680	98.74	97.64			31.88	6.62	37.4	249	180	Average
5680	106.23	105.13			31.88	6.62	37.4	249	180	Peak
5725.32	62.54	61.26	74	-11.46	31.96	6.75	37.43	249	180	Peak

**Antenna Polarity & Test Distance: Vertical at 3 m**

Frequency (MHz)	Emission Level (dBuV/m)	Read Level (dBuV)	Limit (dBuV/m)	Margin (dB)	Antenna Factor (dB/m)	Cable Loss (dB)	Preamp Factor (dB)	Antenna Height (cm)	Table Angle (Degree)	Remark
5415.12	50.84	50.17	74	-23.16	31.53	6.32	37.18	201	120	Peak
5448.56	40.82	40.05	54	-13.18	31.56	6.34	37.13	201	120	Average
5469.36	49.57	48.74	74	-24.43	31.57	6.34	37.08	201	120	Peak
5680	97.42	96.32			31.88	6.62	37.4	201	120	Average
5680	104.43	103.33			31.88	6.62	37.4	201	120	Peak
5725.32	61.86	60.58	74	-12.14	31.96	6.75	37.43	201	120	Peak

**Remarks:**

- Emission Level = Read Level + Antenna Factor + Cable Loss - Preamp Factor  
Margin value = Emission level – Limit value
- 5680 MHz: Fundamental Frequency
- \*: Out of Restricted Band

### 802.11n (HT20)

EUT Test Condition		Measurement Detail	
Channel	Channel 40	Frequency Range	5 GHz ~ 7 GHz
Input Power	120 Vac, 60 Hz	Detector Function	Peak (PK) Average (AV)
Environmental Conditions	25 deg. C, 65 % RH	Tested By	Gavin Wu

#### Horizontal

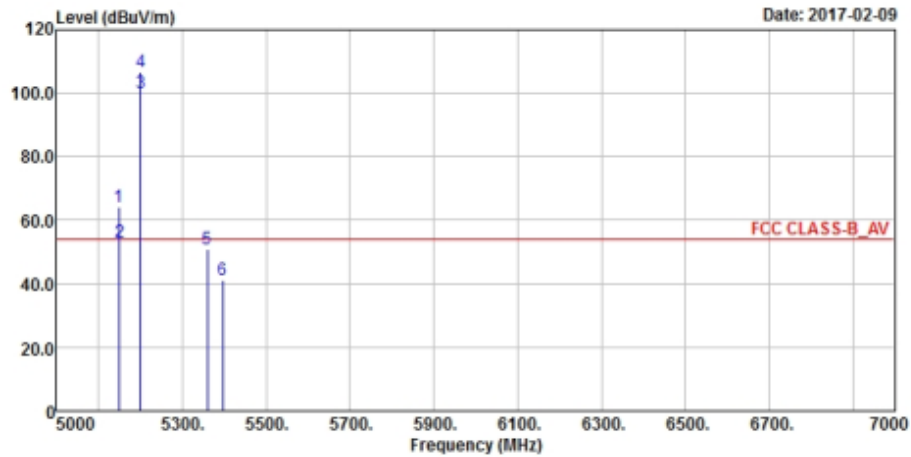

#### Vertical

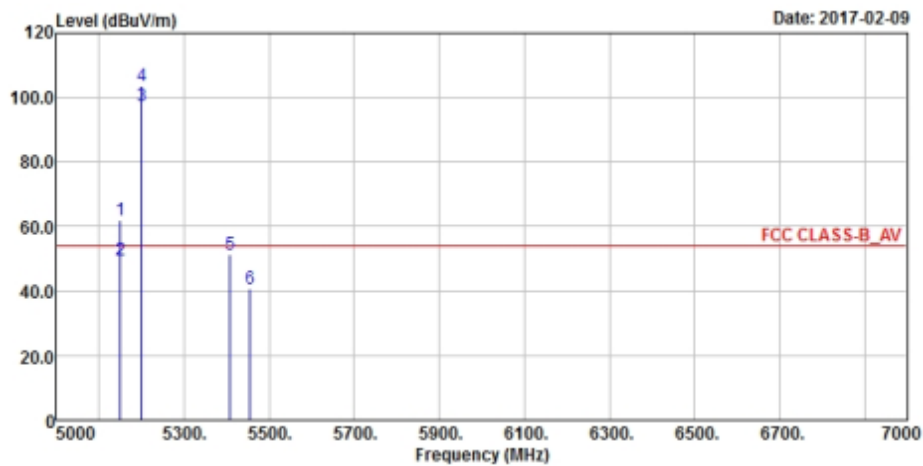

**Antenna Polarity & Test Distance: Horizontal at 3 m**

Frequency (MHz)	Emission Level (dBuV/m)	Read Level (dBuV)	Limit (dBuV/m)	Margin (dB)	Antenna Factor (dB/m)	Cable Loss (dB)	Preamp Factor (dB)	Antenna Height (cm)	Table Angle (Degree)	Remark
5148.2	64.42	64.22	74	-9.58	31.32	6.2	37.32	190	180	Peak
5149.4	53.18	52.98	54	-0.82	31.32	6.2	37.32	190	180	Average
5200	99.95	99.73			31.36	6.22	37.36	190	180	Average
5200	106.88	106.66			31.36	6.22	37.36	190	180	Peak
5359.46	51.02	50.41	74	-22.98	31.48	6.31	37.18	190	180	Peak
5396.31	41.12	40.47	54	-12.88	31.52	6.31	37.18	190	180	Average
5148.2	64.42	64.22	74	-9.58	31.32	6.2	37.32	190	180	Peak

**Antenna Polarity & Test Distance: Vertical at 3 m**

Frequency (MHz)	Emission Level (dBuV/m)	Read Level (dBuV)	Limit (dBuV/m)	Margin (dB)	Antenna Factor (dB/m)	Cable Loss (dB)	Preamp Factor (dB)	Antenna Height (cm)	Table Angle (Degree)	Remark
5148.95	61.97	61.77	74	-12.03	31.32	6.2	37.32	107	185	Peak
5149.85	49.65	49.45	54	-4.35	31.32	6.2	37.32	107	185	Average
5200	97.27	97.05			31.36	6.22	37.36	107	185	Average
5200	103.47	103.25			31.36	6.22	37.36	107	185	Peak
5408.41	51.33	50.67	74	-22.67	31.52	6.32	37.18	107	185	Peak
5453.95	40.91	40.09	54	-13.09	31.56	6.34	37.08	107	185	Average
5148.95	61.97	61.77	74	-12.03	31.32	6.2	37.32	107	185	Peak

Remarks:

- Emission Level = Read Level + Antenna Factor + Cable Loss - Preamp Factor  
Margin value = Emission level – Limit value
- 5200 MHz: Fundamental Frequency
- \*: Out of Restricted Band

EUT Test Condition		Measurement Detail	
Channel	Channel 136	Frequency Range	5 GHz ~ 7 GHz
Input Power	120 Vac, 60 Hz	Detector Function	Peak (PK) Average (AV)
Environmental Conditions	25 deg. C, 65 % RH	Tested By	Gavin Wu

### Horizontal

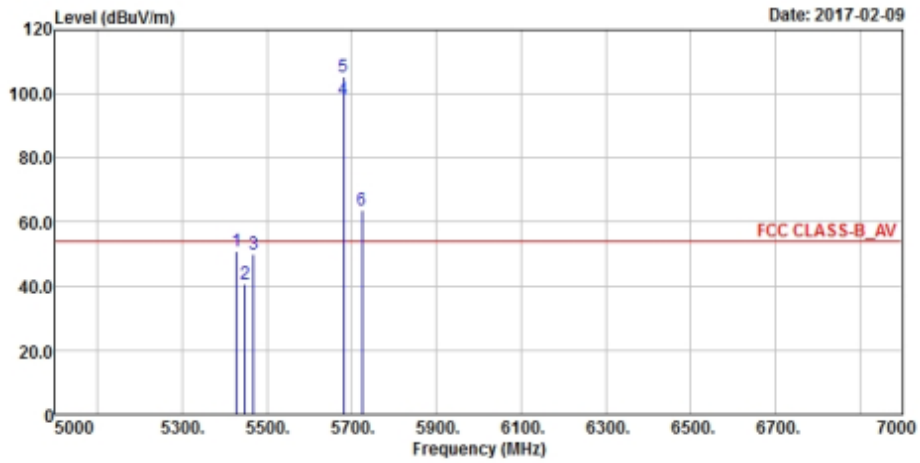

### Vertical

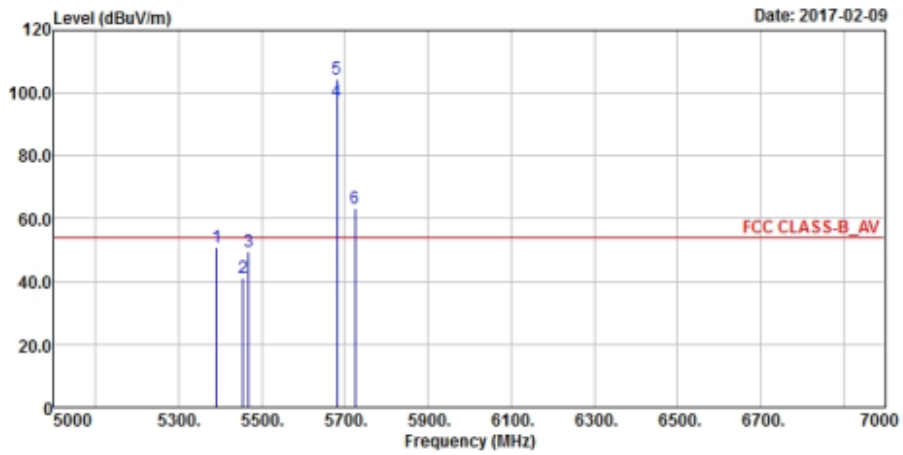



**Antenna Polarity & Test Distance: Horizontal at 3 m**

Frequency (MHz)	Emission Level (dBuV/m)	Read Level (dBuV)	Limit (dBuV/m)	Margin (dB)	Antenna Factor (dB/m)	Cable Loss (dB)	Preamp Factor (dB)	Antenna Height (cm)	Table Angle (Degree)	Remark
5427.28	50.73	50.01	74	-23.27	31.53	6.32	37.13	248	180	Peak
5448.56	40.95	40.18	54	-13.05	31.56	6.34	37.13	248	180	Average
5468.24	50.1	49.27	74	-23.9	31.57	6.34	37.08	248	180	Peak
5680	98.52	97.42			31.88	6.62	37.4	248	180	Average
5680	105.53	104.43			31.88	6.62	37.4	248	180	Peak
5725.16	63.94	62.66	74	-10.06	31.96	6.75	37.43	248	180	Peak

**Antenna Polarity & Test Distance: Vertical at 3 m**

Frequency (MHz)	Emission Level (dBuV/m)	Read Level (dBuV)	Limit (dBuV/m)	Margin (dB)	Antenna Factor (dB/m)	Cable Loss (dB)	Preamp Factor (dB)	Antenna Height (cm)	Table Angle (Degree)	Remark
5391.12	51.02	50.38	74	-22.98	31.51	6.31	37.18	201	117	Peak
5455.28	41.02	40.2	54	-12.98	31.56	6.34	37.08	201	117	Average
5468.4	49.47	48.64	74	-24.53	31.57	6.34	37.08	201	117	Peak
5680	97.62	96.52			31.88	6.62	37.4	201	117	Average
5680	104.33	103.23			31.88	6.62	37.4	201	117	Peak
5725	63.35	62.07	54	9.35	31.96	6.75	37.43	201	117	Peak

## Remarks:

- Emission Level = Read Level + Antenna Factor + Cable Loss - Preamp Factor  
Margin value = Emission level – Limit value
- 5680 MHz: Fundamental Frequency
- \*: Out of Restricted Band

**9 kHz ~ 30 MHz DATA:**

The amplitude of spurious emissions attenuated more than 20 dB below the permissible value is not required to be report.

The Low Frequency, which started from 9KHz to 30MHz, was pre-scanned and the result which was 20 dB lower than the limit line was not reported.

**30 MHz ~ 1 GHz WORST-CASE DATA:**

**802.11a**

EUT Test Condition		Measurement Detail	
Channel	Channel 36	Frequency Range	30 MHz ~ 1 GHz
Input Power	120 Vac, 60 Hz	Detector Function	Peak (PK) Quasi-peak (QP)
Environmental Conditions	25 deg. C, 65 % RH	Tested By	Gavin Wu

**Horizontal**

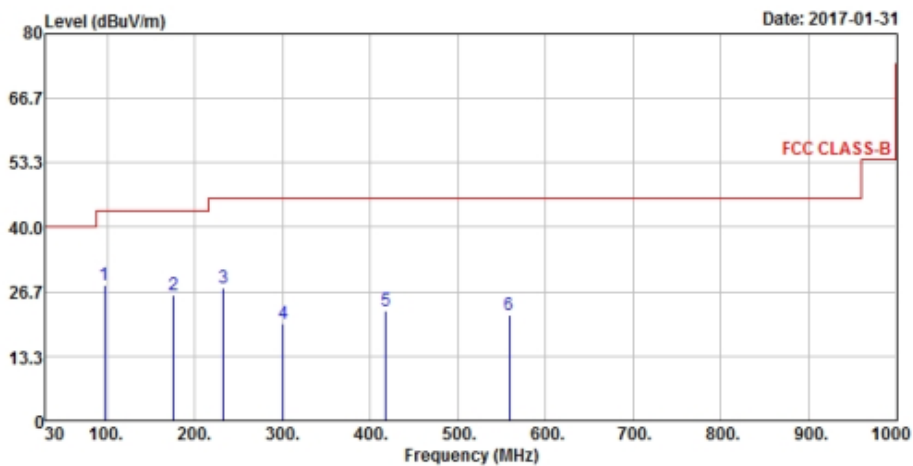

**Vertical**

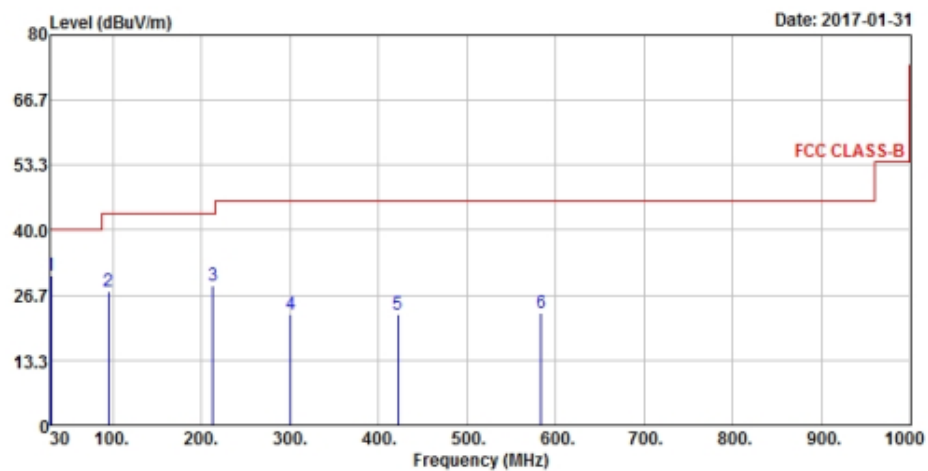

**Antenna Polarity & Test Distance: Horizontal at 3 m**

Frequency (MHz)	Emission Level (dBuV/m)	Read Level (dBuV)	Limit (dBuV/m)	Margin (dB)	Antenna Factor (dB/m)	Cable Loss (dB)	Preamp Factor (dB)	Antenna Height (cm)	Table Angle (Degree)	Remark
96.93	28.17	50.27	43.5	-15.33	8.83	1.03	31.96	105	168	Peak
175.5	26.06	45.5	43.5	-17.44	11.19	1.16	31.79	119	349	Peak
232.73	27.56	47.23	46	-18.44	10.75	1.42	31.84	109	310	Peak
300.63	20.13	37.39	46	-25.87	12.96	1.63	31.85	122	269	Peak
418	22.63	37.03	46	-23.37	15.7	1.94	32.04	139	248	Peak
558.65	21.88	33.08	46	-24.12	18.66	2.19	32.05	132	303	Peak

**Antenna Polarity & Test Distance: Vertical at 3 m**

Frequency (MHz)	Emission Level (dBuV/m)	Read Level (dBuV)	Limit (dBuV/m)	Margin (dB)	Antenna Factor (dB/m)	Cable Loss (dB)	Preamp Factor (dB)	Antenna Height (cm)	Table Angle (Degree)	Remark
30	30.56	49.14	40	-9.44	11.98	0.58	31.14	124	334	Peak
94.99	27.54	49.8	43.5	-15.96	8.68	1.02	31.96	122	190	Peak
213.33	28.62	48.97	43.5	-14.88	9.93	1.35	31.63	118	69	Peak
300.63	22.72	39.98	46	-23.28	12.96	1.63	31.85	122	5	Peak
421.88	22.85	37.18	46	-23.15	15.77	1.94	32.04	116	266	Peak
583.87	23.11	33.78	46	-22.89	19.23	2.23	32.13	109	20	Peak

Remarks:

- Emission Level = Read Level + Antenna Factor + Cable Loss - Preamp Factor  
Margin value = Emission level – Limit value

802.11a

EUT Test Condition		Measurement Detail	
Channel	Channel 60	Frequency Range	30 MHz ~ 1 GHz
Input Power	120 Vac, 60 Hz	Detector Function	Peak (PK) Quasi-peak (QP)
Environmental Conditions	25 deg. C, 65 % RH	Tested By	Gavin Wu

Horizontal

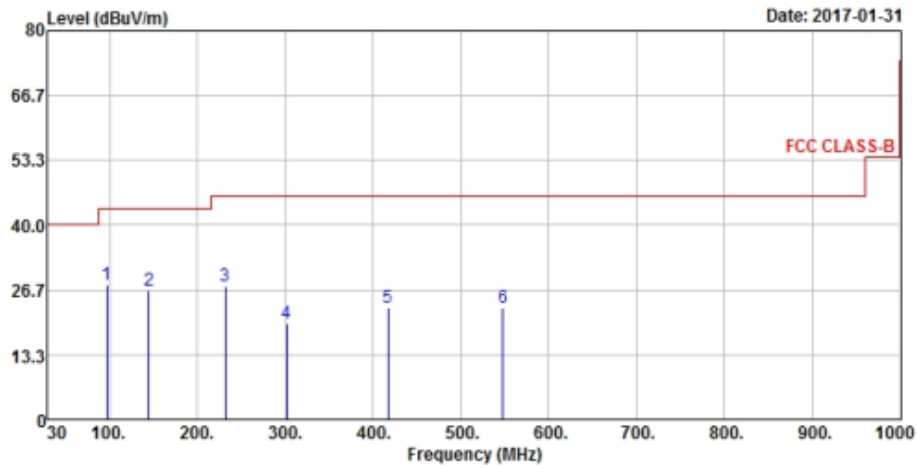

Vertical

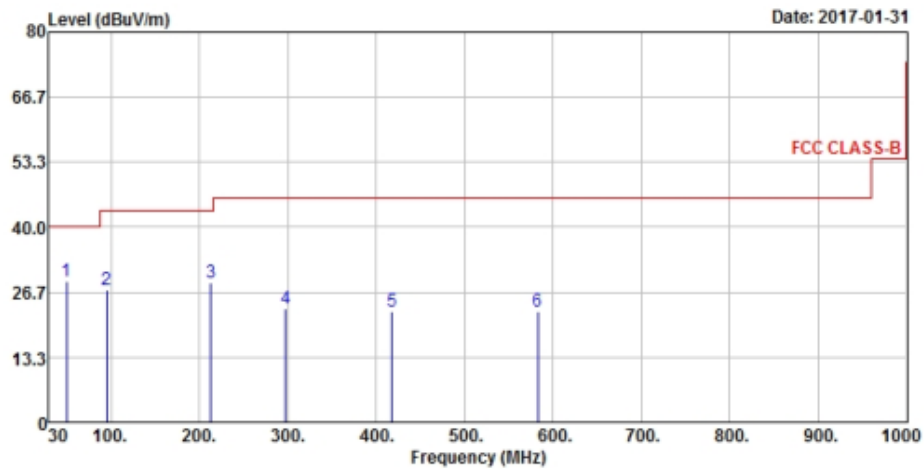

**Antenna Polarity & Test Distance: Horizontal at 3 m**

Frequency (MHz)	Emission Level (dBuV/m)	Read Level (dBuV)	Limit (dBuV/m)	Margin (dB)	Antenna Factor (dB/m)	Cable Loss (dB)	Preamp Factor (dB)	Antenna Height (cm)	Table Angle (Degree)	Remark
96.93	27.9	50	43.5	-15.6	8.83	1.03	31.96	105	71	Peak
144.46	26.63	44.59	43.5	-16.87	12.51	1.16	31.63	134	211	Peak
231.76	27.52	47.23	46	-18.48	10.71	1.42	31.84	111	197	Peak
301.6	19.67	36.9	46	-26.33	12.99	1.64	31.86	129	266	Peak
417.03	22.89	37.3	46	-23.11	15.68	1.94	32.03	124	292	Peak
547.98	22.93	34.26	46	-23.07	18.41	2.17	31.91	106	281	Peak

**Antenna Polarity & Test Distance: Vertical at 3 m**

Frequency (MHz)	Emission Level (dBuV/m)	Read Level (dBuV)	Limit (dBuV/m)	Margin (dB)	Antenna Factor (dB/m)	Cable Loss (dB)	Preamp Factor (dB)	Antenna Height (cm)	Table Angle (Degree)	Remark
49.4	29.03	46.53	40	-10.97	13.08	0.7	31.28	117	1	Peak
94.99	27.07	49.33	43.5	-16.43	8.68	1.02	31.96	136	225	Peak
213.33	28.53	48.88	43.5	-14.97	9.93	1.35	31.63	117	301	Peak
297.72	23.24	40.54	46	-22.76	12.88	1.63	31.81	118	261	Peak
418	22.66	37.06	46	-23.34	15.7	1.94	32.04	104	3	Peak
582.9	22.82	33.51	46	-23.18	19.21	2.23	32.13	100	23	Peak

Remarks:

- Emission Level = Read Level + Antenna Factor + Cable Loss - Preamp Factor  
Margin value = Emission level – Limit value

802.11n (HT20)

EUT Test Condition		Measurement Detail	
Channel	Channel 140	Frequency Range	30 MHz ~ 1 GHz
Input Power	120 Vac, 60 Hz	Detector Function	Peak (PK) Quasi-peak (QP)
Environmental Conditions	25 deg. C, 65 % RH	Tested By	Gavin Wu

Horizontal

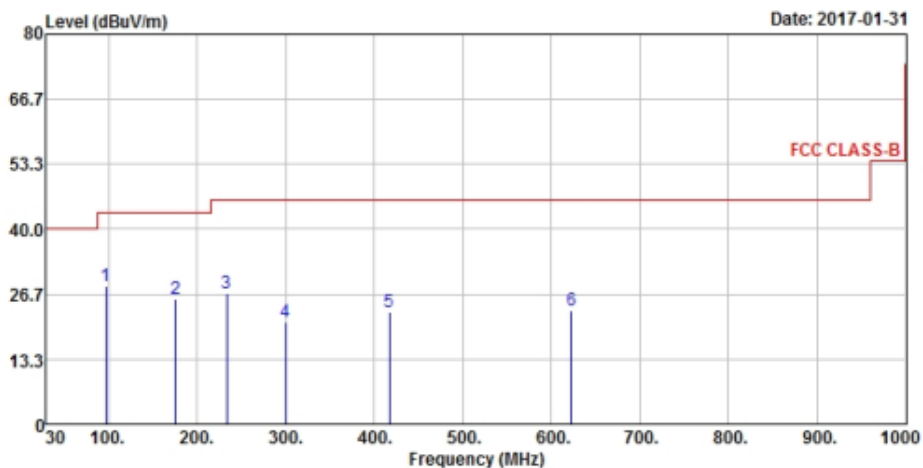

Vertical

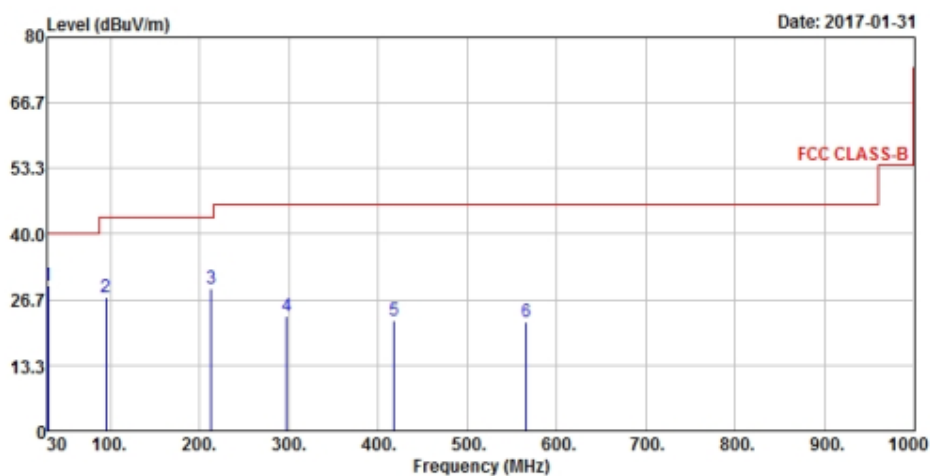

**Antenna Polarity & Test Distance: Horizontal at 3 m**

Frequency (MHz)	Emission Level (dBuV/m)	Read Level (dBuV)	Limit (dBuV/m)	Margin (dB)	Antenna Factor (dB/m)	Cable Loss (dB)	Preamp Factor (dB)	Antenna Height (cm)	Table Angle (Degree)	Remark
96.93	28.25	50.35	43.5	-15.25	8.83	1.03	31.96	120	286	Peak
175.5	25.67	45.11	43.5	-17.83	11.19	1.16	31.79	107	22	Peak
233.7	26.78	46.39	46	-19.22	10.79	1.43	31.83	126	139	Peak
299.66	20.97	38.24	46	-25.03	12.94	1.63	31.84	119	125	Peak
417.03	23.01	37.42	46	-22.99	15.68	1.94	32.03	113	288	Peak
622.67	23.26	33.24	46	-22.74	19.88	2.3	32.16	101	204	Peak

**Antenna Polarity & Test Distance: Vertical at 3 m**

Frequency (MHz)	Emission Level (dBuV/m)	Read Level (dBuV)	Limit (dBuV/m)	Margin (dB)	Antenna Factor (dB/m)	Cable Loss (dB)	Preamp Factor (dB)	Antenna Height (cm)	Table Angle (Degree)	Remark
30	29.55	48.13	40	-10.45	11.98	0.58	31.14	122	186	Peak
94.99	27.28	49.54	43.5	-16.22	8.68	1.02	31.96	110	303	Peak
213.33	28.92	49.27	43.5	-14.58	9.93	1.35	31.63	116	210	Peak
297.72	23.19	40.49	46	-22.81	12.88	1.63	31.81	118	189	Peak
418	22.54	36.94	46	-23.46	15.7	1.94	32.04	124	206	Peak
565.44	22.26	33.32	46	-23.74	18.81	2.2	32.07	131	126	Peak

Remarks:

- Emission Level = Read Level + Antenna Factor + Cable Loss - Preamp Factor  
Margin value = Emission level – Limit value

802.11a

EUT Test Condition		Measurement Detail	
Channel	Channel 149	Frequency Range	30 MHz ~ 1 GHz
Input Power	120 Vac, 60 Hz	Detector Function	Peak (PK) Quasi-peak (QP)
Environmental Conditions	25 deg. C, 65 % RH	Tested By	Gavin Wu

Horizontal

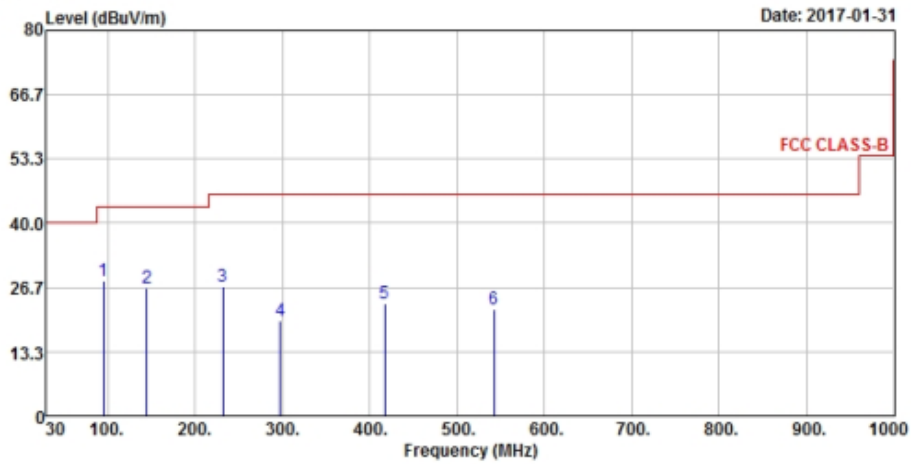

Vertical

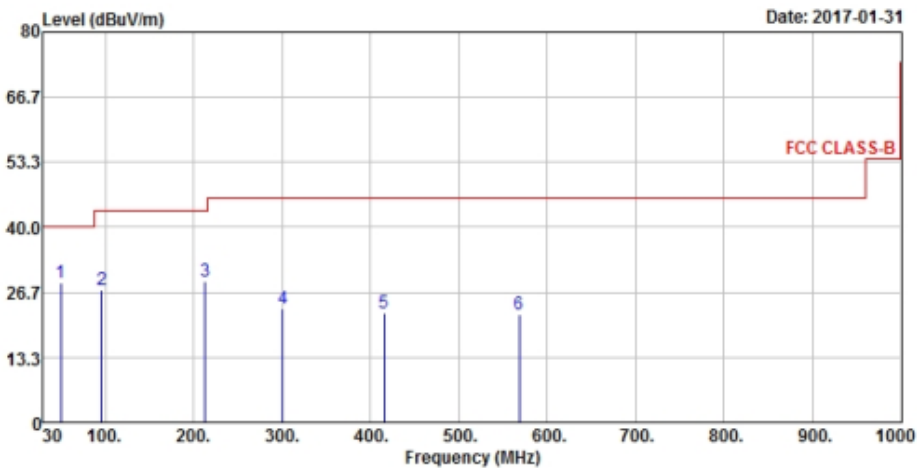



**Antenna Polarity & Test Distance: Horizontal at 3 m**

Frequency (MHz)	Emission Level (dBuV/m)	Read Level (dBuV)	Limit (dBuV/m)	Margin (dB)	Antenna Factor (dB/m)	Cable Loss (dB)	Preamp Factor (dB)	Antenna Height (cm)	Table Angle (Degree)	Remark
94.99	28.15	50.41	43.5	-15.35	8.68	1.02	31.96	112	266	Peak
144.46	26.49	44.45	43.5	-17.01	12.51	1.16	31.63	120	96	Peak
231.76	26.8	46.51	46	-19.2	10.71	1.42	31.84	133	279	Peak
297.72	19.93	37.23	46	-26.07	12.88	1.63	31.81	121	208	Peak
417.03	23.21	37.62	46	-22.79	15.68	1.94	32.03	128	140	Peak
542.16	22.22	33.55	46	-23.78	18.28	2.16	31.77	134	272	Peak

**Antenna Polarity & Test Distance: Vertical at 3 m**

Frequency (MHz)	Emission Level (dBuV/m)	Read Level (dBuV)	Limit (dBuV/m)	Margin (dB)	Antenna Factor (dB/m)	Cable Loss (dB)	Preamp Factor (dB)	Antenna Height (cm)	Table Angle (Degree)	Remark
49.4	28.74	46.24	40	-11.26	13.08	0.7	31.28	119	3	Peak
95.96	27.22	49.4	43.5	-16.28	8.76	1.02	31.96	123	97	Peak
213.33	28.96	49.31	43.5	-14.54	9.93	1.35	31.63	134	321	Peak
300.63	23.43	40.69	46	-22.57	12.96	1.63	31.85	120	275	Peak
415.09	22.41	36.85	46	-23.59	15.64	1.94	32.02	106	230	Peak
568.35	22.11	33.11	46	-23.89	18.88	2.2	32.08	140	98	Peak

Remarks:

- Emission Level = Read Level + Antenna Factor + Cable Loss - Preamp Factor  
Margin value = Emission level – Limit value

## 4.2 Conducted Emission Measurement

### 4.2.1 Limits of Conducted Emission Measurement

Frequency (MHz)	Conducted Limit (dBuV)	
	Quasi-peak	Average
0.15 - 0.5	66 - 56	56 - 46
0.50 - 5.0	56	46
5.0 - 30.0	60	50

Note: 1. The lower limit shall apply at the transition frequencies.

2. The limit decreases in line with the logarithm of the frequency in the range of 0.15 to 0.50 MHz.

### 4.2.2 Test Instruments

Description & Manufacturer	Model No.	Serial No.	Date Of Calibration	Due Date Of Calibration
Test Receiver ROHDE & SCHWARZ	ESCI	100613	Nov. 21, 2016	Nov. 20, 2017
RF signal cable (with 10dB PAD) Woken	5D-FB	Cable-cond1-01	Dec. 22, 2016	Dec. 21, 2017
LISN ROHDE & SCHWARZ (EUT)	ESH3-Z5	835239/001	Mar. 10, 2017	Mar. 09, 2018
LISN ROHDE & SCHWARZ (Peripheral)	ESH3-Z5	100311	Jul. 28, 2016	Jul. 27, 2017
Software ADT	BV ADT_Cond_ V7.3.7.3	NA	NA	NA

**NOTE:** 1. The calibration interval of the above test instruments is 12 months and the calibrations are traceable to NML/ROC and NIST/USA.

2. The test was performed in HwaYa Shielded Room 1.

3. The VCCI Site Registration No. is C-2040.

#### 4.2.3 Test Procedures

- a. The EUT was placed 0.4 meters from the conducting wall of the shielded room with EUT being connected to the power mains through a line impedance stabilization network (LISN). Other support units were connected to the power mains through another LISN. The two LISNs provide 50 ohm/ 50uH of coupling impedance for the measuring instrument.
- b. Both lines of the power mains connected to the EUT were checked for maximum conducted interference.
- c. The frequency range from 150 kHz to 30 MHz was searched. Emission levels under (Limit -20 dB) was not recorded.

**Note:** All modes of operation were investigated and the worst-case emissions are reported.

#### 4.2.4 Deviation from Test Standard

No deviation.

#### 4.2.5 Test Setup

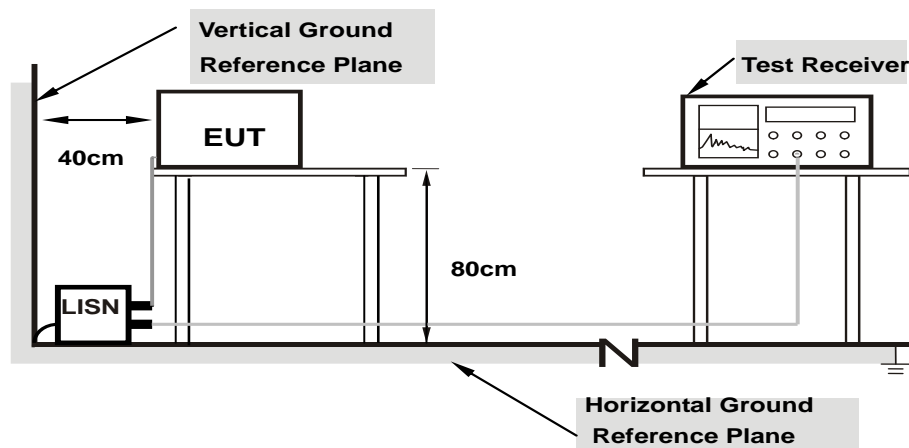

- Note:**
- 1.Support units were connected to second LISN.
  - 2.Both of LISNs (AMN) are 80 cm from EUT and at least 80 from other units and other metal planes

For the actual test configuration, please refer to the attached file (Test Setup Photo).

#### 4.2.6 EUT Operating Conditions

- a. Placed the EUT on a testing table.
- b. Use the software to control the EUT under transmission condition continuously at specific channel frequency.

#### 4.2.7 Test Results

Frequency Range	150kHz ~ 30MHz	Detector Function & Resolution Bandwidth	Quasi-Peak (QP) / Average (AV), 9kHz
Input Power	120Vac, 60Hz	Environmental Conditions	25°C, 65%RH
Tested by	Getaz Yang	Test Date	2017/3/23

Phase Of Power : Line (L)										
No	Frequency (MHz)	Correction Factor (dB)	Reading Value (dBuV)		Emission Level (dBuV)		Limit (dBuV)		Margin (dB)	
			Q.P.	AV.	Q.P.	AV.	Q.P.	AV.	Q.P.	AV.
1	0.16173	10.35	35.63	20.65	45.98	31.00	65.37	55.37	-19.39	-24.37
2	0.24775	10.38	29.71	14.88	40.09	25.26	61.83	51.83	-21.74	-26.57
3	0.46280	10.40	22.77	11.98	33.17	22.38	56.64	46.64	-23.47	-24.26
4	0.61138	10.40	30.13	18.34	40.53	28.74	56.00	46.00	-15.47	-17.26
5	12.68155	10.97	16.76	12.48	27.73	23.45	60.00	50.00	-32.27	-26.55
6	28.63044	11.63	13.94	8.04	25.57	19.67	60.00	50.00	-34.43	-30.33

Remarks:

1. Q.P. and AV. are abbreviations of quasi-peak and average individually.
2. The emission levels of other frequencies were very low against the limit.
3. Margin value = Emission level – Limit value
4. Correction factor = Insertion loss + Cable loss
5. Emission Level = Correction Factor + Reading Value

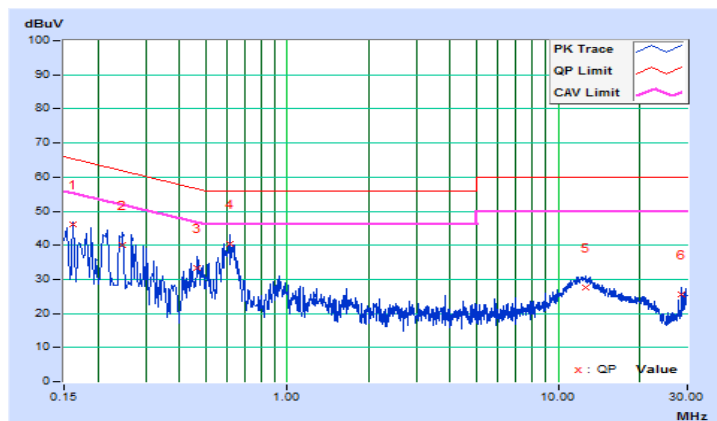

Frequency Range	150kHz ~ 30MHz	Detector Function & Resolution Bandwidth	Quasi-Peak (QP) / Average (AV), 9kHz
Input Power	120Vac, 60Hz	Environmental Conditions	25°C, 65%RH
Tested by	Getaz Yang	Test Date	2017/3/23

Phase Of Power : Neutral (N)										
No	Frequency (MHz)	Correction Factor (dB)	Reading Value (dBuV)		Emission Level (dBuV)		Limit (dBuV)		Margin (dB)	
			Q.P.	AV.	Q.P.	AV.	Q.P.	AV.	Q.P.	AV.
1	0.19665	10.14	27.16	16.17	37.30	26.31	63.75	53.75	-26.45	-27.44
2	0.26346	10.15	21.98	13.69	32.13	23.84	61.32	51.32	-29.19	-27.48
3	0.31813	10.15	16.31	8.78	26.46	18.93	59.76	49.76	-33.30	-30.83
4	0.40415	10.16	13.52	8.25	23.68	18.41	57.77	47.77	-34.09	-29.36
<b>5</b>	<b>0.61138</b>	<b>10.16</b>	<b>30.22</b>	<b>23.81</b>	<b>40.38</b>	<b>33.97</b>	<b>56.00</b>	<b>46.00</b>	<b>-15.62</b>	<b>-12.03</b>
6	29.43199	11.18	20.61	11.34	31.79	22.52	60.00	50.00	-28.21	-27.48

Remarks:

1. Q.P. and AV. are abbreviations of quasi-peak and average individually.
2. The emission levels of other frequencies were very low against the limit.
3. Margin value = Emission level – Limit value
4. Correction factor = Insertion loss + Cable loss
5. Emission Level = Correction Factor + Reading Value

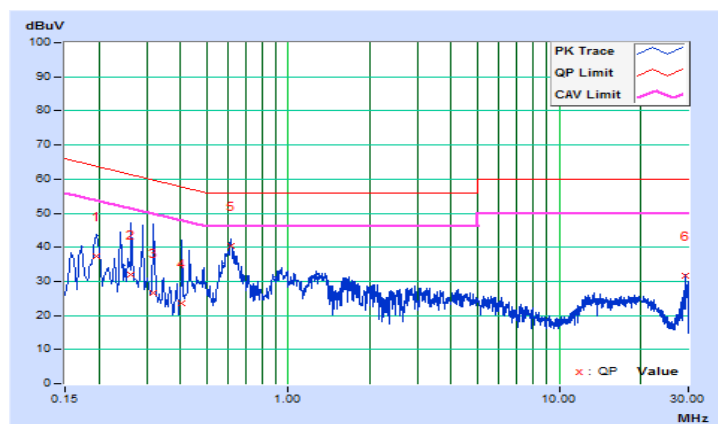

### 4.3 Transmit Power Measurement

#### 4.3.1 Limits of Transmit Power Measurement

Operation Band	EUT Category	Limit
U-NII-1	Outdoor Access Point	1 Watt (30 dBm) (Max. e.i.r.p $\leq$ 125 mW (21 dBm) at any elevation angle above 30 degrees as measured from the horizon)
	Fixed point-to-point Access Point	1 Watt (30 dBm)
	Indoor Access Point	1 Watt (30 dBm)
	√ Mobile and Portable client device	250 mW (24 dBm)
U-NII-2A	√	250 mW (24 dBm) or 11 dBm+10 log B*
U-NII-2C	√	250 mW (24 dBm) or 11 dBm+10 log B*
U-NII-3	√	1 Watt (30 dBm)

\*B is the 26 dB emission bandwidth in megahertz

Per KDB 662911 Method of conducted output power measurement on IEEE 802.11 devices,

Array Gain = 0 dB (i.e., no array gain) for  $N_{ANT} \leq 4$ ;

Array Gain = 0 dB (i.e., no array gain) for channel widths  $\geq 40$  MHz for any  $N_{ANT}$ ;

Array Gain =  $5 \log(N_{ANT}/N_{SS})$  dB or 3 dB, whichever is less for 20 MHz channel widths with  $N_{ANT} \geq 5$ .

For power measurements on all other devices: Array Gain =  $10 \log(N_{ANT}/N_{SS})$  dB.

#### 4.3.2 Test Setup

##### <Power Output Measurement>

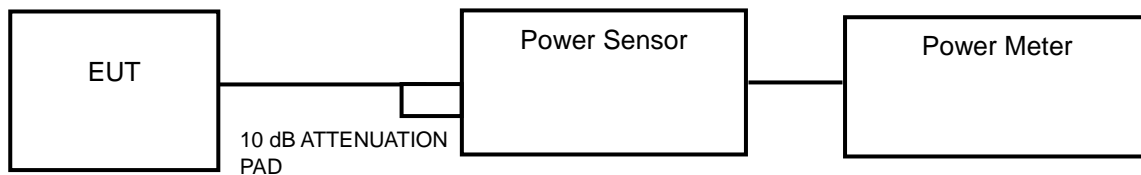

##### <26 dB Bandwidth>

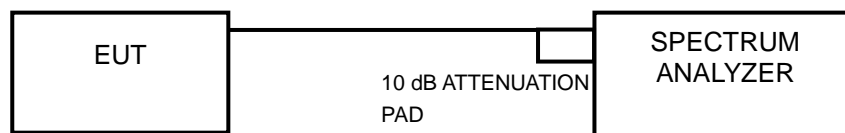

#### 4.3.3 Test Instruments

Refer to section 4.1.2 to get information of above instrument.

#### 4.3.4 Test Procedure

##### **Average Power Measurement**

Method PM is used to perform output power measurement, trigger and gating function of wide band power meter is enabled to measure max output power of TX on burst. Duty factor is not added to measured value.

##### **26 dB Bandwidth**

- 1) Set RBW = approximately 1 % of the emission bandwidth.
- 2) Set the VBW > RBW.
- 3) Detector = Peak.
- 4) Trace mode = max hold.
- 5) Measure the maximum width of the emission that is 26 dB down from the peak of the emission. Compare this with the RBW setting of the analyzer. Readjust RBW and repeat measurement as needed until the RBW/EBW ratio is approximately 1 %.

#### 4.3.5 Deviation from Test Standard

No deviation.

#### 4.3.6 EUT Operating Conditions

The software provided by client to enable the EUT under transmission condition continuously at lowest, middle and highest channel frequencies individually.

#### 4.3.7 Test Result

##### Power Output:

##### 802.11a

Channel	Frequency (MHz)	Maximum Conducted Power (mW)	Maximum Conducted Power (dBm)	Power Limit (dBm)	Pass / Fail
36	5180	55.847	17.47	24	Pass
44	5220	91.622	19.62	24	Pass
48	5240	91.411	19.61	24	Pass
52	5260	79.799	19.02	24	Pass
60	5300	80.724	19.07	24	Pass
64	5320	49.888	16.98	24	Pass
100	5500	61.518	17.89	24	Pass
116	5580	71.779	18.56	24	Pass
140	5700	39.084	15.92	24	Pass
149	5745	77.983	18.92	30	Pass
157	5785	79.068	18.98	30	Pass
165	5825	77.09	18.87	30	Pass

##### Note:

##### For U-NII-2A, U-NII-2C Band:

1.  $11 \text{ dBm} + 10\log(41.15) = 27.14 \text{ dBm} > 24 \text{ dBm}$ .
2.  $11 \text{ dBm} + 10\log(41.42) = 27.17 \text{ dBm} > 24 \text{ dBm}$ .
3.  $11 \text{ dBm} + 10\log(25.22) = 25.02 \text{ dBm} > 24 \text{ dBm}$ .
4.  $11 \text{ dBm} + 10\log(36.83) = 26.66 \text{ dBm} > 24 \text{ dBm}$ .
5.  $11 \text{ dBm} + 10\log(40.13) = 27.03 \text{ dBm} > 24 \text{ dBm}$ .
6.  $11 \text{ dBm} + 10\log(25.98) = 25.15 \text{ dBm} > 24 \text{ dBm}$ .

##### <For Reference>

Channel	Frequency (MHz)	Maximum Conducted Power (mW)	Maximum Conducted Power (dBm)	Power Limit (dBm)	Pass / Fail
40	5200	81.66	19.12	24	Pass
136	5680	70.31	18.47	24	Pass



### 802.11n (HT20)

Channel	Frequency (MHz)	Maximum Conducted Power (mW)	Maximum Conducted Power (dBm)	Power Limit (dBm)	Pass / Fail
36	5180	52.966	17.24	24	Pass
44	5220	92.897	19.68	24	Pass
48	5240	91.411	19.61	24	Pass
52	5260	73.451	18.66	24	Pass
60	5300	73.79	18.68	24	Pass
64	5320	48.306	16.84	24	Pass
100	5500	59.841	17.77	24	Pass
116	5580	72.111	18.58	24	Pass
140	5700	34.754	15.41	24	Pass
149	5745	76.384	18.83	30	Pass
157	5785	77.446	18.89	30	Pass
165	5825	66.222	18.21	30	Pass

**Note:**

**For U-NII-2A, U-NII-2C Band:**

1.  $11 \text{ dBm} + 10\log(43.38) = 27.37 \text{ dBm} > 24 \text{ dBm}$ .
2.  $11 \text{ dBm} + 10\log(40.81) = 27.11 \text{ dBm} > 24 \text{ dBm}$ .
3.  $11 \text{ dBm} + 10\log(28.50) = 25.55 \text{ dBm} > 24 \text{ dBm}$ .
4.  $11 \text{ dBm} + 10\log(41.37) = 27.17 \text{ dBm} > 24 \text{ dBm}$ .
5.  $11 \text{ dBm} + 10\log(42.28) = 27.26 \text{ dBm} > 24 \text{ dBm}$ .
6.  $11 \text{ dBm} + 10\log(25.38) = 25.04 \text{ dBm} > 24 \text{ dBm}$ .

**<For Reference>**

Channel	Frequency (MHz)	Maximum Conducted Power (mW)	Maximum Conducted Power (dBm)	Power Limit (dBm)	Pass / Fail
40	5200	91.83	19.63	24	Pass
136	5680	70.79	18.50	24	Pass

**26 dB Bandwidth:**
**802.11a**

Channel	Frequency (MHz)	26 dBc Bandwidth (MHz)
36	5180	29.80
44	5220	41.95
48	5240	41.72
52	5260	41.15
60	5300	41.42
64	5320	25.22
100	5500	36.83
116	5580	40.13
140	5700	25.98

**802.11n (HT20)**

Channel	Frequency (MHz)	26 dBc Bandwidth (MHz)
36	5180	29.02
44	5220	44.75
48	5240	42.32
52	5260	43.38
60	5300	40.81
64	5320	28.50
100	5500	41.37
116	5580	42.28
140	5700	25.38

### Spectrum Plot of Worst Value

#### 802.11a

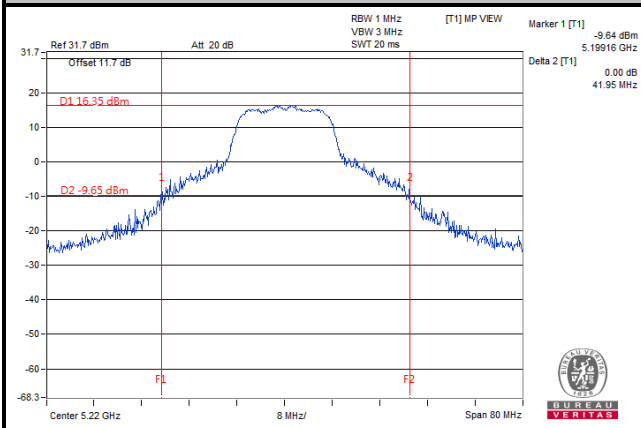

#### 802.11n (HT20)

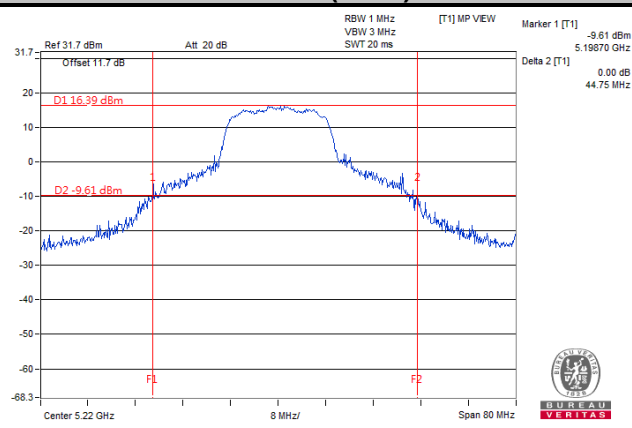

#### 4.4 Peak Power Spectral Density Measurement

##### 4.4.1 Limits of Peak Power Spectral Density Measurement

Operation Band	EUT Category		Limit
U-NII-1		Outdoor Access Point	17 dBm/MHz
		Fixed point-to-point Access Point	
		Indoor Access Point	
	√	Mobile and Portable client device	11 dBm/MHz
U-NII-2A		√	11 dBm/MHz
U-NII-2C		√	11 dBm/MHz
U-NII-3		√	30 dBm/500 kHz

##### 4.4.2 Test Setup

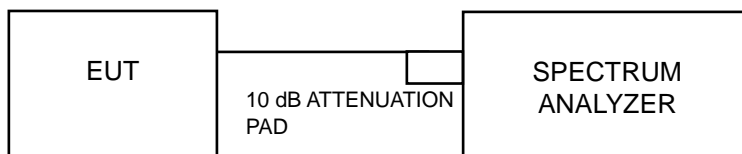

##### 4.4.3 Test Instruments

Refer to section 4.1.3 to get information of above instrument.

##### 4.4.4 Test Procedures

###### For U-NII-1, U-NII-2A, U-NII-2C band:

Using method SA-2

1. Set span to encompass the entire emission bandwidth (EBW) of the signal.
2. Set RBW = 1 MHz, Set VBW  $\geq$  3 RBW, Detector = RMS
3. Sweep time = auto, trigger set to "free run".
4. Trace average at least 100 traces in power averaging mode.
5. Record the max value and add 10 log (1/duty cycle)

###### ※For U-NII-3 band:

1. Set span to encompass the entire emission bandwidth (EBW) of the signal.
2. Set RBW = 500 kHz, Set VBW  $\geq$  3 RBW, Detector = RMS
3. Use the peak marker function to determine the maximum power level in any 500 kHz band segment within the fundamental EBW.
4. Sweep time = auto, trigger set to "free run".
5. Trace average at least 100 traces in power averaging mode.
6. Record the max value and add 10 log (1/duty cycle)

#### 4.4.5 Deviation from Test Standard

No deviation.

#### 4.4.6 EUT Operating Conditions

The software provided by client to enable the EUT under transmission condition continuously at lowest, middle and highest channel frequencies individually.

4.4.7 Test Results

For U-NII-1, U-NII-2A, U-NII-2C Band

802.11a

Channel	Frequency (MHz)	PSD w/o Duty Factor (dBm/MHz)	Duty Factor (dB)	PSD with Duty Factor (dBm/MHz)	Maximum Limit (dBm/MHz)	Pass / Fail
36	5180	5.08	0.69	5.77	11	Pass
44	5220	6.19	0.69	6.88	11	Pass
48	5240	6.19	0.69	6.88	11	Pass
52	5260	7.10	0.69	7.79	11	Pass
60	5300	7.35	0.69	8.04	11	Pass
64	5320	5.74	0.69	6.43	11	Pass
100	5500	6.69	0.69	7.38	11	Pass
116	5580	7.07	0.69	7.76	11	Pass
140	5700	3.82	0.69	4.51	11	Pass

**Note:** Refer to section 3.3 for duty cycle spectrum plot.

802.11n (HT20)

Channel	Frequency (MHz)	PSD w/o Duty Factor (dBm/MHz)	Duty Factor (dB)	PSD with Duty Factor (dBm/MHz)	Maximum Limit (dBm/MHz)	Pass / Fail
36	5180	4.74	0.74	5.48	11	Pass
44	5220	6.10	0.74	6.84	11	Pass
48	5240	6.14	0.74	6.88	11	Pass
52	5260	5.64	0.74	6.38	11	Pass
60	5300	6.04	0.74	6.78	11	Pass
64	5320	5.14	0.74	5.88	11	Pass
100	5500	5.38	0.74	6.12	11	Pass
116	5580	5.96	0.74	6.70	11	Pass
140	5700	2.92	0.74	3.66	11	Pass

**Note:** Refer to section 3.3 for duty cycle spectrum plot.

### Spectrum Plot of Worst Value

#### 802.11a

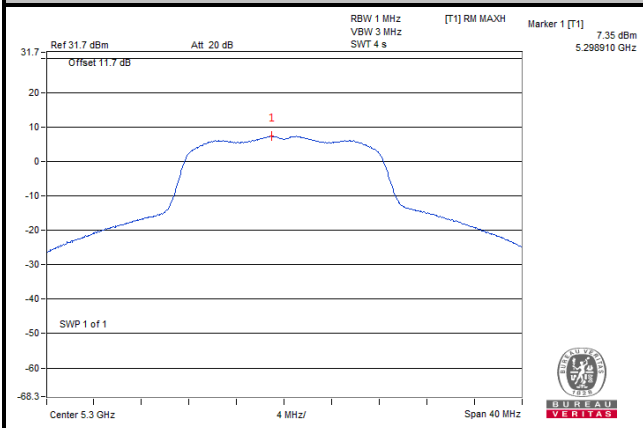

#### 802.11n (HT20)

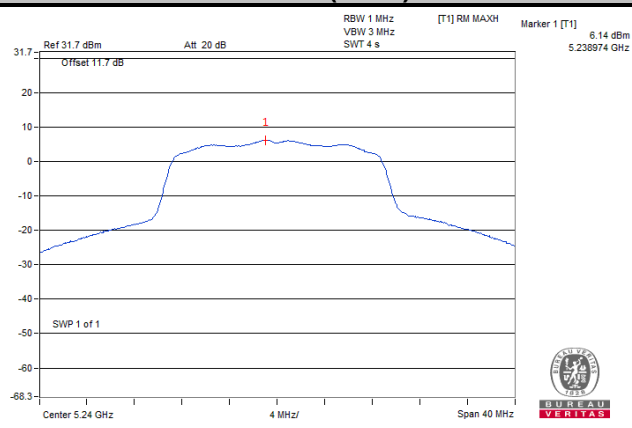

**For U-NII-3 Band**

**802.11a**

Channel	Frequency (MHz)	PSD w/o Duty Factor (dBm/500 kHz)	Duty Factor (dB)	PSD with Duty Factor (dBm/500 kHz)	Limit (dBm/500 kHz)	Pass / Fail
149	5745	3.08	0.69	3.77	30	Pass
157	5785	3.56	0.69	4.25	30	Pass
165	5825	3.79	0.69	4.48	30	Pass

**Note:** Refer to section 3.3 for duty cycle spectrum plot.

**802.11n (HT20)**

Channel	Frequency (MHz)	PSD w/o Duty Factor (dBm/500 kHz)	Duty Factor (dB)	PSD with Duty Factor (dBm/500 kHz)	Limit (dBm/500 kHz)	Pass / Fail
149	5745	3.16	0.74	3.90	30	Pass
157	5785	3.10	0.74	3.84	30	Pass
165	5825	2.93	0.74	3.67	30	Pass

**Note:** Refer to section 3.3 for duty cycle spectrum plot.

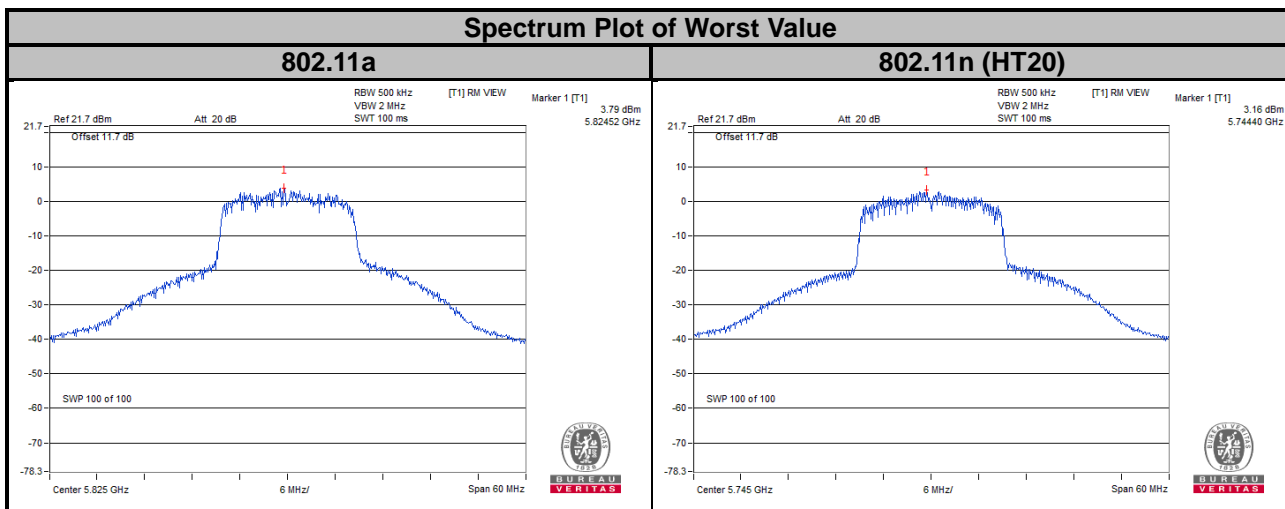



## 4.5 Frequency Stability

### 4.5.1 Limit of Frequency Stability Measurement

The frequency of the carrier signal shall be maintained within band of operation.

### 4.5.2 Test Setup

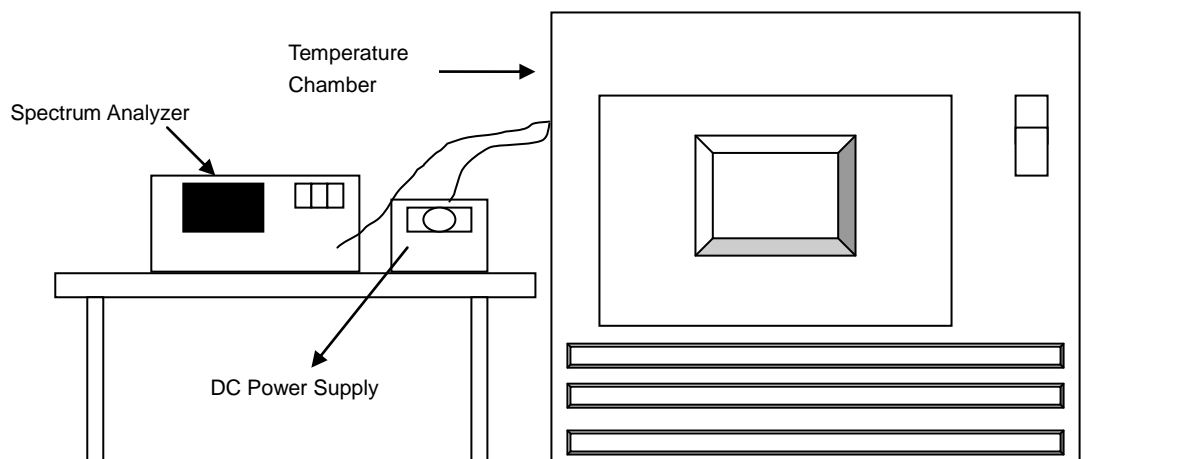

### 4.5.3 Test Instruments

Refer to section 4.1.3 to get information of above instrument.

### 4.5.4 Test Procedure

- To ensure emission at the band edge is maintained within the authorized band, those values shall be measured by radiation emissions at upper and lower frequency points, and finally compensated by frequency deviation as procedures below.
- The EUT was operated at the maximum output power, and connected to the spectrum analyzer, which is set to maximum hold function and peak detector. The peak value of the power envelope was measured and noted. The upper and lower frequency points were respectively measured relatively 10 dB lower than the measured peak value.
- The frequency deviation was calculated by adding the upper frequency point and the lower frequency point divided by two. Those detailed values of frequency deviation are provided in table below.

### 4.5.5 Deviation from Test Standard

No deviation.

### 4.5.6 EUT Operating Condition

Set the EUT transmit at un-modulation mode to test frequency stability.

4.5.7 Test Results

802.11a

Frequency Stability Versus Temp.									
Operating Frequency: 5180 MHz									
Temp. (°C)	Power Supply (Vdc)	0 Minute		2 Minute		5 Minute		10 Minute	
		Measured Frequency (MHz)	Frequency Drift (ppm)	Measured Frequency (MHz)	Frequency Drift (ppm)	Measured Frequency (MHz)	Frequency Drift (ppm)	Measured Frequency (MHz)	Frequency Drift (ppm)
55	3.7	5180.0038	0.00007	5180.0063	0.00012	5180.0051	0.00010	5180.0078	0.00015
50	3.7	5179.997	-0.00006	5179.9931	-0.00013	5179.9965	-0.00007	5179.9936	-0.00012
40	3.7	5180.0131	0.00025	5180.012	0.00023	5180.0124	0.00024	5180.0146	0.00028
30	3.7	5179.9972	-0.00005	5179.999	-0.00002	5179.9969	-0.00006	5179.9994	-0.00001
20	3.7	5180.0043	0.00008	5180.0039	0.00008	5180.0028	0.00005	5180.0051	0.00010
10	3.7	5180.0036	0.00007	5180.001	0.00002	5179.9993	-0.00001	5180.0005	0.00001
0	3.7	5180.0141	0.00027	5180.0153	0.00030	5180.0162	0.00031	5180.0152	0.00029
-10	3.7	5179.9811	-0.00036	5179.9786	-0.00041	5179.9782	-0.00042	5179.9784	-0.00042
-20	3.7	5179.984	-0.00031	5179.9846	-0.00030	5179.9853	-0.00028	5179.9829	-0.00033
-30	3.7	5180.0038	0.00007	5180.0031	0.00006	5180.004	0.00008	5180.0034	0.00007

Frequency Stability Versus Temp.									
Operating Frequency: 5180 MHz									
Temp. (°C)	Power Supply (Vdc)	0 Minute		2 Minute		5 Minute		10 Minute	
		Measured Frequency (MHz)	Frequency Drift (ppm)	Measured Frequency (MHz)	Frequency Drift (ppm)	Measured Frequency (MHz)	Frequency Drift (ppm)	Measured Frequency (MHz)	Frequency Drift (ppm)
20	5.2	5180.0039	0.00008	5180.0043	0.00008	5180.0025	0.00005	5180.006	0.00012
	3.7	5180.0043	0.00008	5180.0039	0.00008	5180.0028	0.00005	5180.0051	0.00010
	3.4	5180.0047	0.00009	5180.0048	0.00009	5180.0038	0.00007	5180.0047	0.00009

802.11n (HT20)

Frequency Stability Versus Temp.									
Operating Frequency: 5320 MHz									
Temp. (°C)	Power Supply (Vdc)	0 Minute		2 Minute		5 Minute		10 Minute	
		Measured Frequency (MHz)	Frequency Drift (ppm)	Measured Frequency (MHz)	Frequency Drift (ppm)	Measured Frequency (MHz)	Frequency Drift (ppm)	Measured Frequency (MHz)	Frequency Drift (ppm)
55	3.7	5180.0207	0.00040	5180.0184	0.00036	5180.0225	0.00043	5180.0211	0.00041
50	3.7	5180.0143	0.00028	5180.0106	0.00020	5180.0136	0.00026	5180.0116	0.00022
40	3.7	5179.9906	-0.00018	5179.9927	-0.00014	5179.9881	-0.00023	5179.9907	-0.00018
30	3.7	5180.0056	0.00011	5180.0063	0.00012	5180.0055	0.00011	5180.0046	0.00009
20	3.7	5179.9722	-0.00054	5179.9755	-0.00047	5179.9743	-0.00050	5179.9747	-0.00049
10	3.7	5180.0163	0.00031	5180.0196	0.00038	5180.0187	0.00036	5180.0186	0.00036
0	3.7	5179.9921	-0.00015	5179.9904	-0.00019	5179.9919	-0.00016	5179.9929	-0.00014
-10	3.7	5179.9779	-0.00043	5179.978	-0.00042	5179.9818	-0.00035	5179.9797	-0.00039
-20	3.7	5180.006	0.00012	5180.0077	0.00015	5180.0068	0.00013	5180.0048	0.00009
-30	3.7	5180.0094	0.00018	5180.0052	0.00010	5180.0085	0.00016	5180.0097	0.00019

Frequency Stability Versus Temp.									
Operating Frequency: 5320 MHz									
Temp. (°C)	Power Supply (Vdc)	0 Minute		2 Minute		5 Minute		10 Minute	
		Measured Frequency (MHz)	Frequency Drift (ppm)	Measured Frequency (MHz)	Frequency Drift (ppm)	Measured Frequency (MHz)	Frequency Drift (ppm)	Measured Frequency (MHz)	Frequency Drift (ppm)
20	5.2	5179.9727	-0.00053	5179.9746	-0.00049	5179.9743	-0.00050	5179.975	-0.00048
	3.7	5179.9722	-0.00054	5179.9755	-0.00047	5179.9743	-0.00050	5179.9747	-0.00049
	3.4	5179.9724	-0.00053	5179.9748	-0.00049	5179.9736	-0.00051	5179.9744	-0.00049

## 4.6 6 dB Bandwidth Measurement

### 4.6.1 Limits of 6 dB Bandwidth Measurement

The minimum of 6 dB Bandwidth Measurement is 0.5 MHz.

### 4.6.2 Test Setup

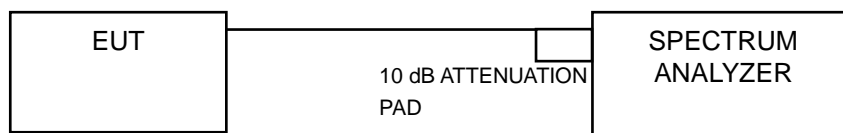

### 4.6.3 Test Instruments

Refer to section 4.1.3 to get information of above instrument.

### 4.6.4 Test Procedure

#### MEASUREMENT PROCEDURE REF

- Set resolution bandwidth (RBW) = 100 kHz
- Set the video bandwidth (VBW)  $\geq 3 \times$  RBW, Detector = Peak.
- Trace mode = max hold.
- Sweep = auto couple.
- Measure the maximum width of the emission that is constrained by the frequencies associated with the two amplitude points (upper and lower) that are attenuated by 6 dB relative to the maximum level measured in the fundamental emission

### 4.6.5 Deviation from Test Standard

No deviation.

### 4.6.6 EUT Operating Condition

The software provided by client to enable the EUT under transmission condition continuously at lowest, middle and highest channel frequencies individually.

#### 4.6.7 Test Results

##### 802.11a

Channel	Frequency (MHz)	6 dB Bandwidth (MHz)	Minimum Limit (MHz)	Pass / Fail
149	5745	15.13	0.5	Pass
157	5785	15.14	0.5	Pass
165	5825	15.13	0.5	Pass

##### 802.11n (HT20)

Channel	Frequency (MHz)	6 dB Bandwidth (MHz)	Minimum Limit (MHz)	Pass / Fail
149	5745	15.15	0.5	Pass
157	5785	15.11	0.5	Pass
165	5825	15.15	0.5	Pass

#### Spectrum Plot of Worst Value

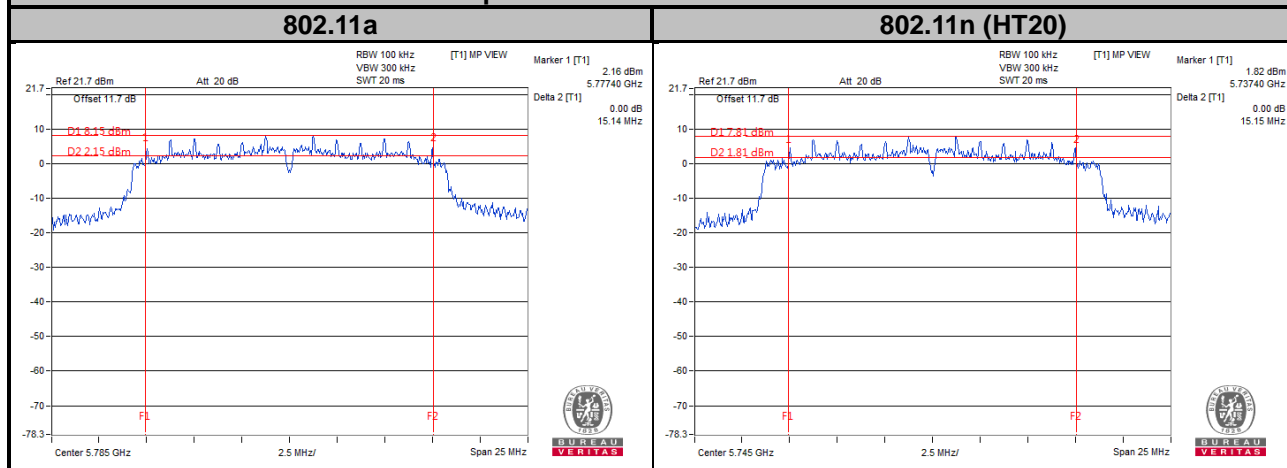

## 5 Pictures of Test Arrangements

Please refer to the attached file (Test Setup Photo).

# Annex A- Radiated Bandedge Plots

## 802.11a

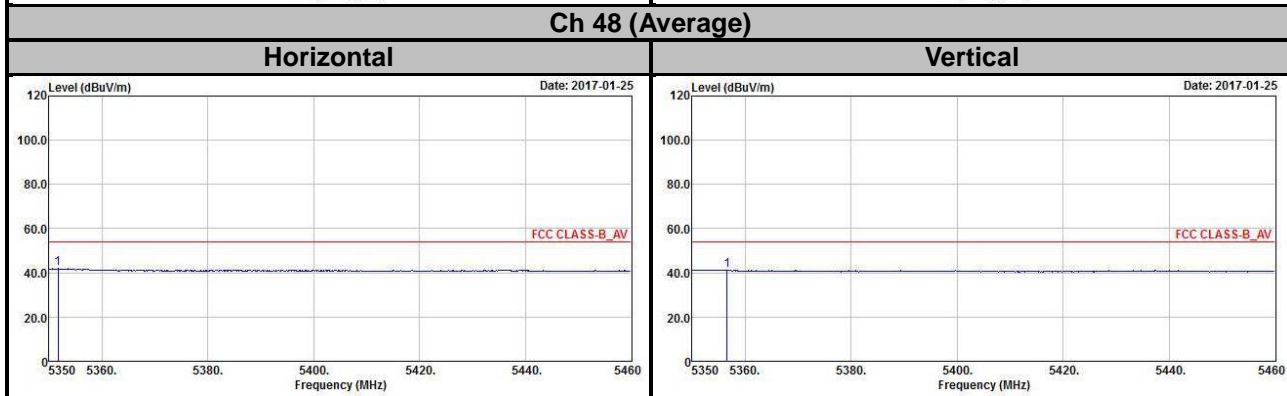
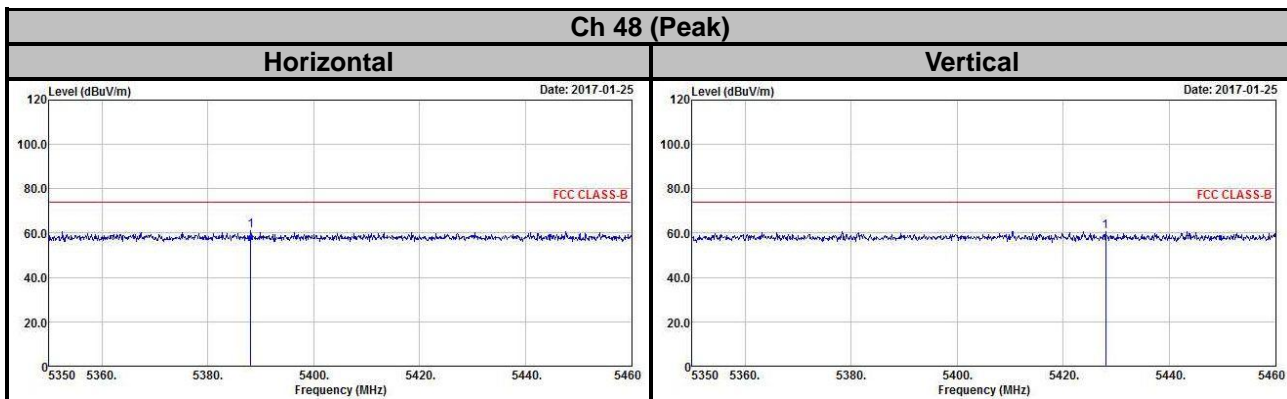
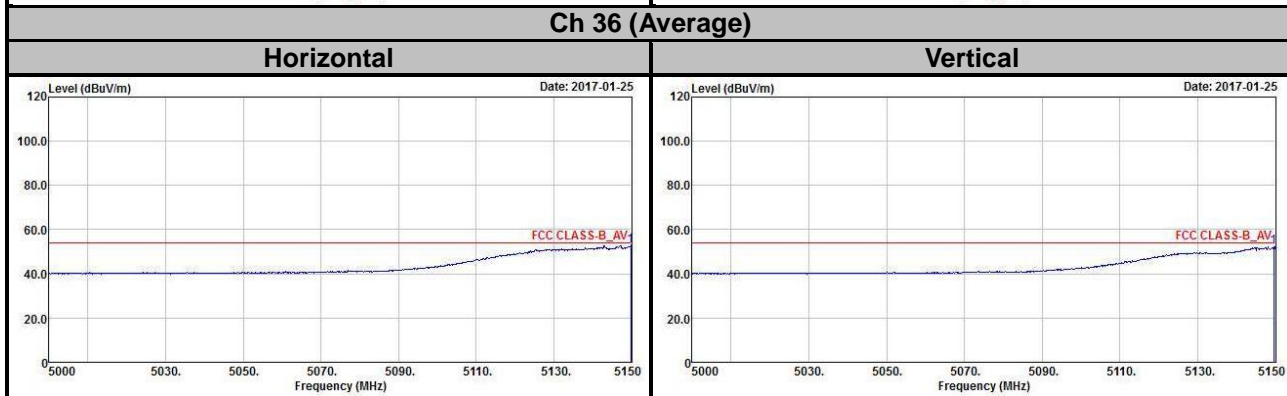
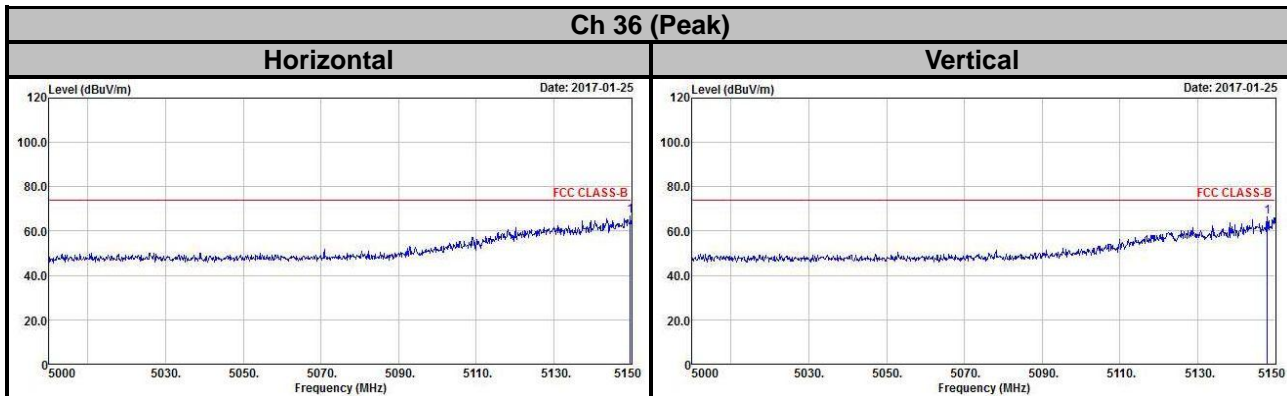

### Ch 52 (Peak)

#### Horizontal

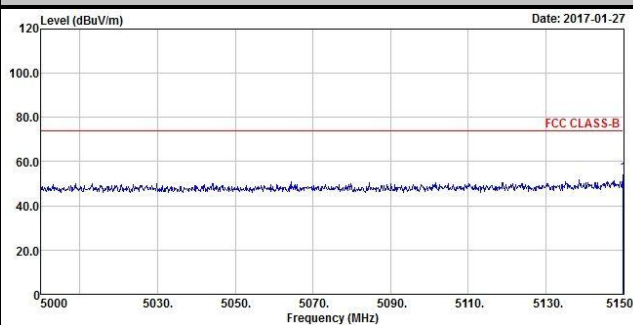

#### Vertical

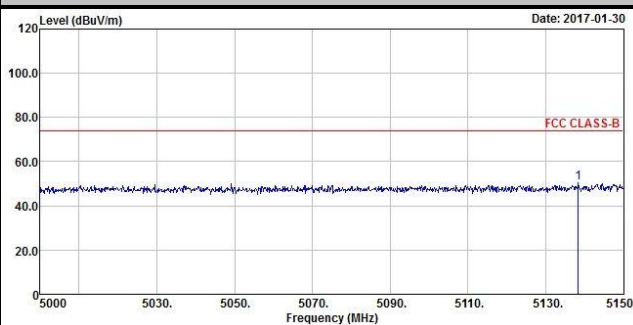

### Ch 52 (Average)

#### Horizontal

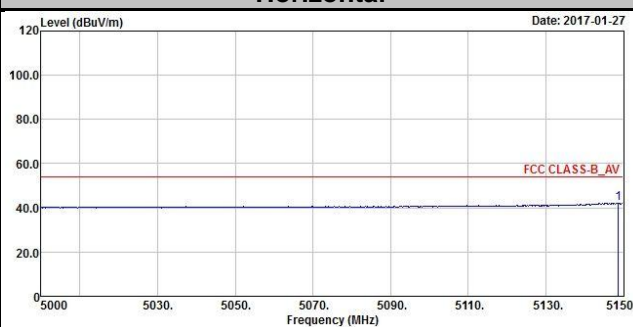

#### Vertical

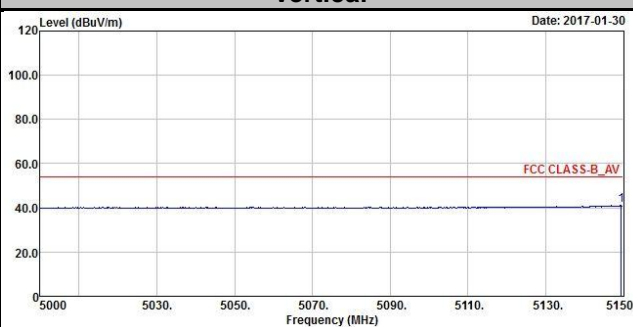

### Ch 64 (Peak)

#### Horizontal

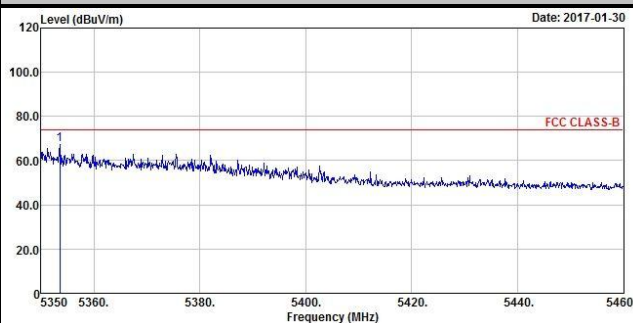

#### Vertical

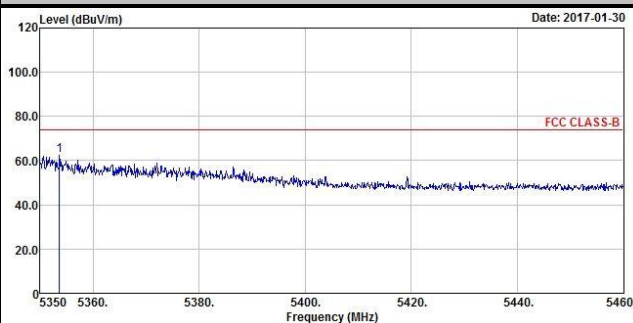

### Ch 64 (Average)

#### Horizontal

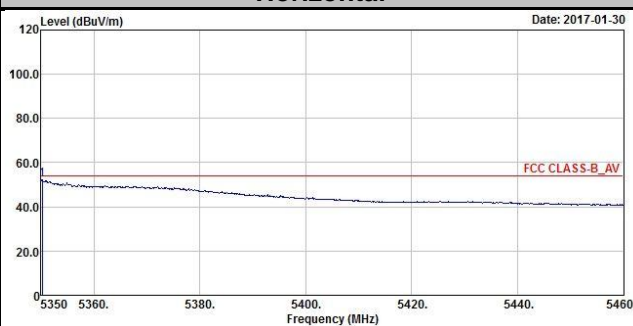

#### Vertical

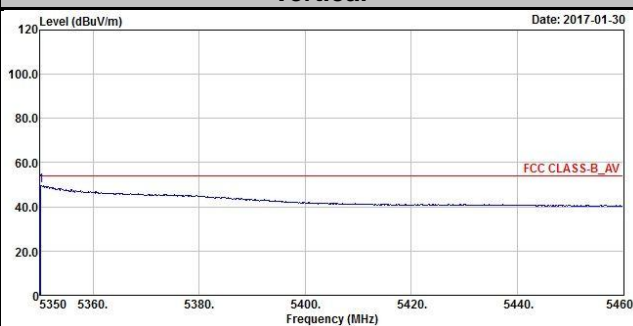



### Ch 100 (Peak)

#### Horizontal

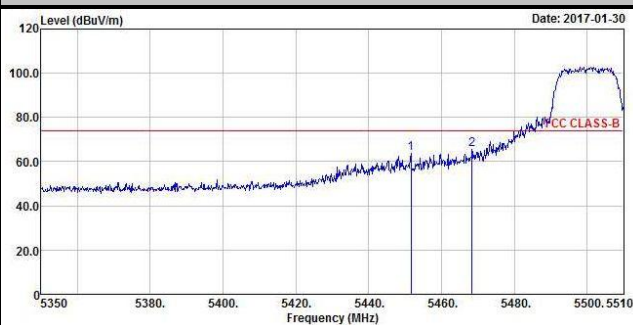

#### Vertical

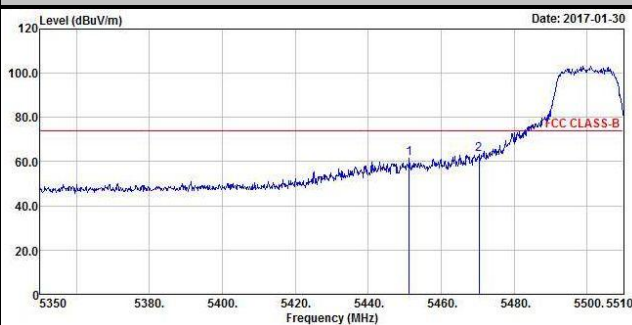

### Ch 100 (Average)

#### Horizontal

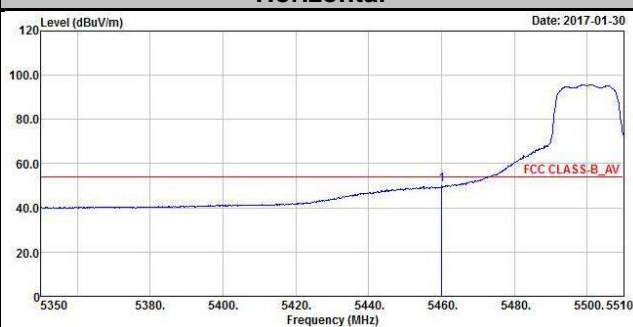

#### Vertical

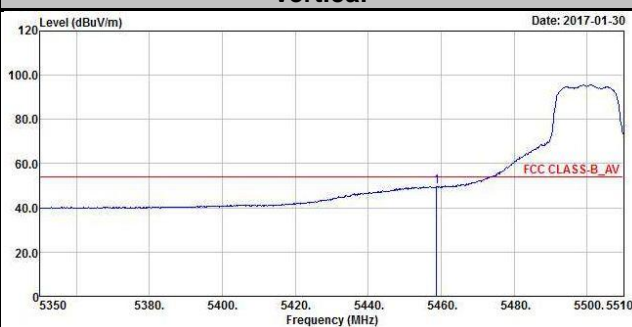

### Ch 140 (Peak)

#### Horizontal

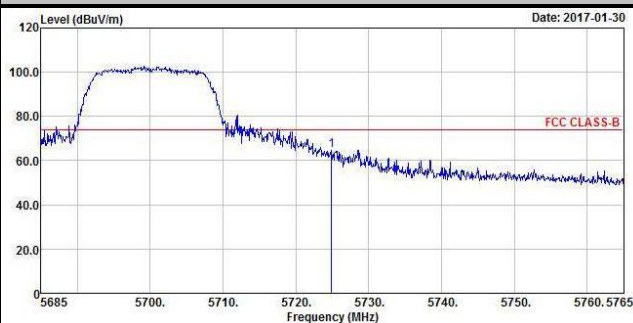

#### Vertical

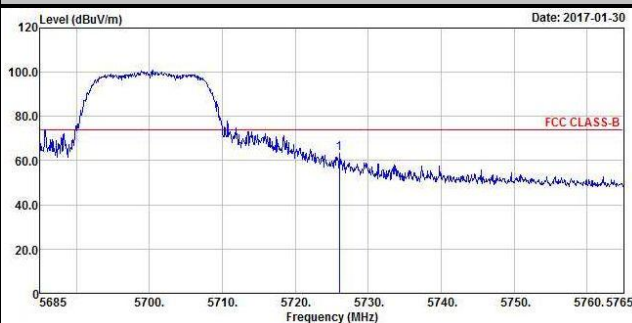

### Ch 140 (Average)

#### Horizontal

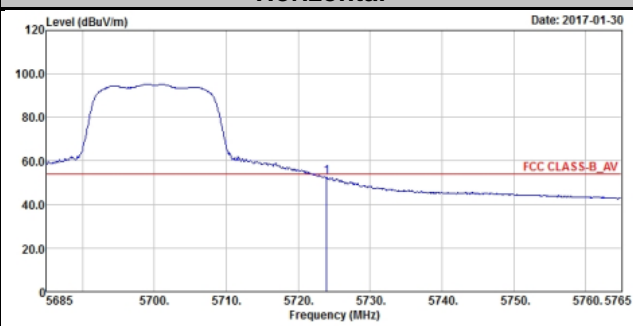

#### Vertical

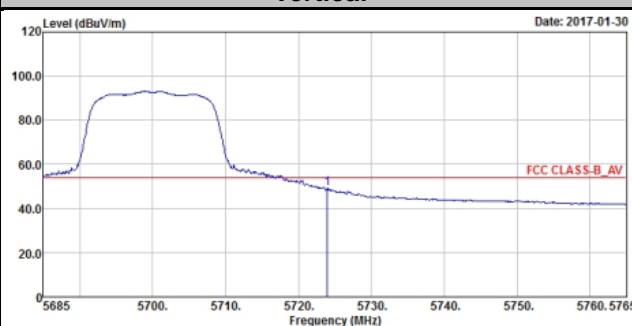

802.11n (HT20)

Ch 36 (Peak)

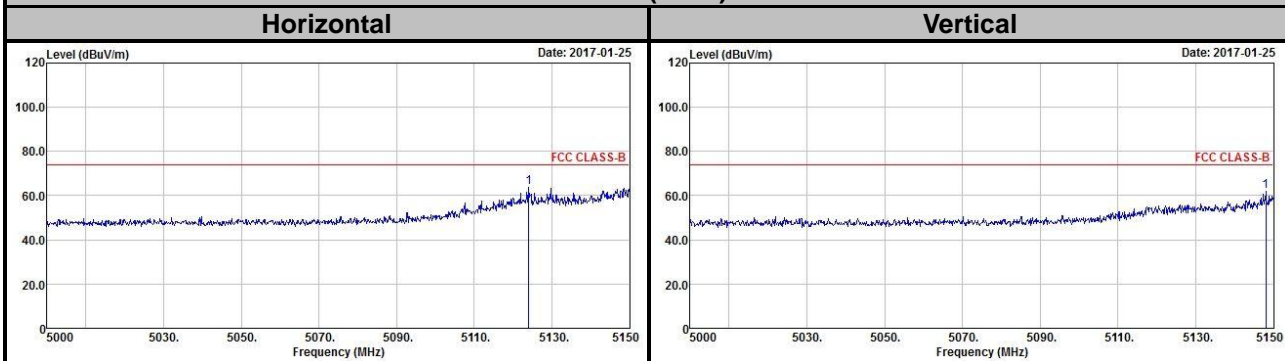

Ch 36 (Average)

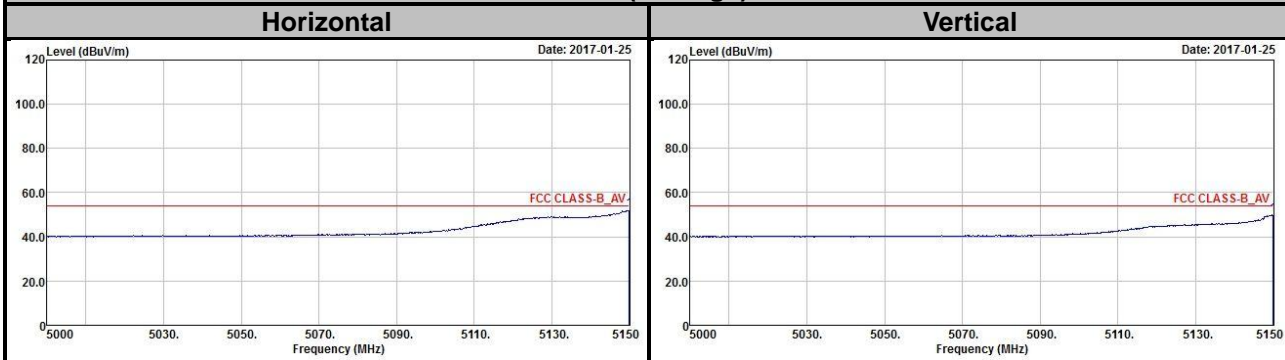

Ch 48 (Peak)

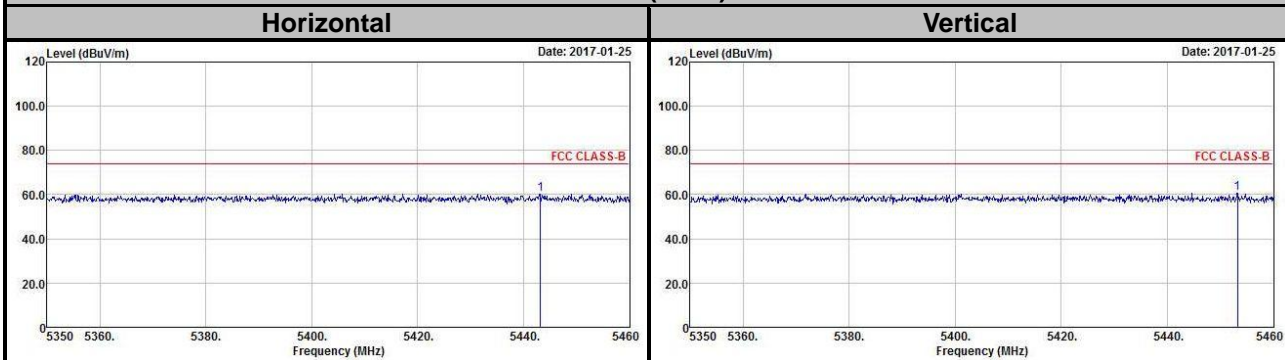

Ch 48 (Average)

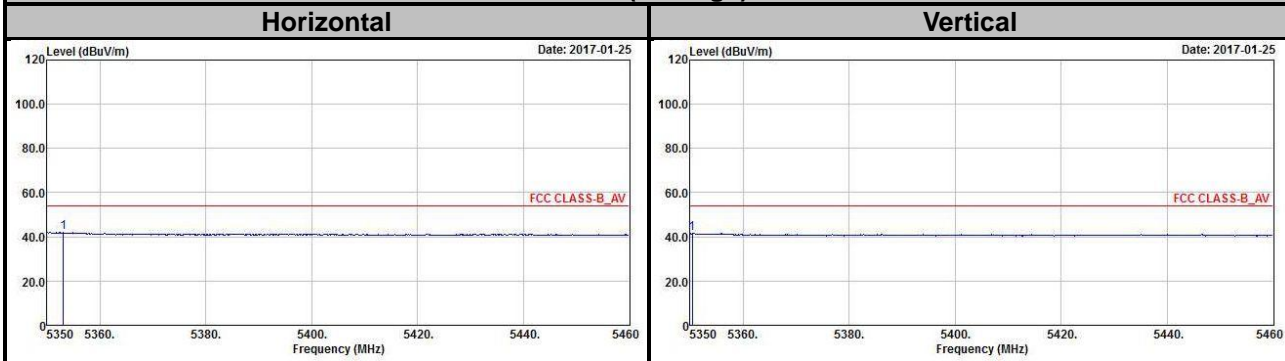

### Ch 52 (Peak)

#### Horizontal

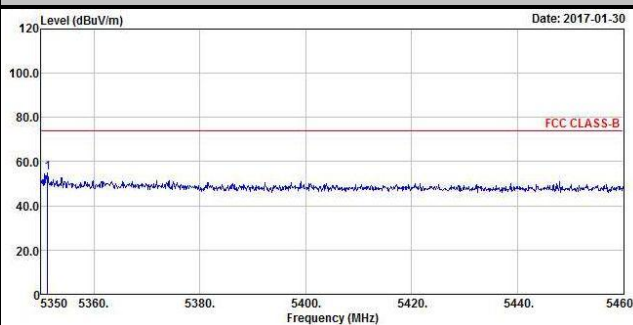

#### Vertical

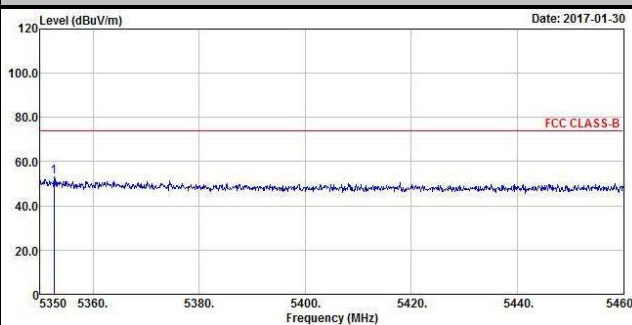

### Ch 52 (Average)

#### Horizontal

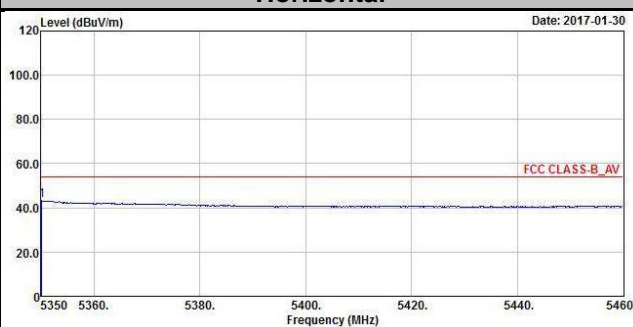

#### Vertical

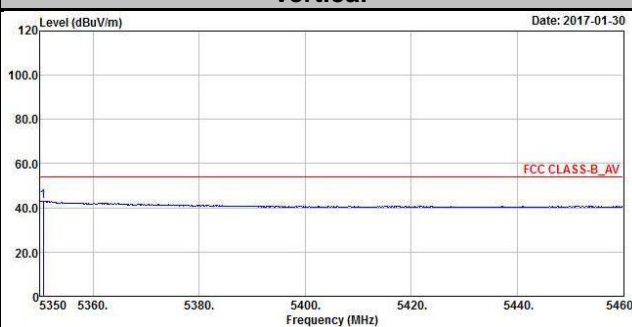

### Ch 64 (Peak)

#### Horizontal

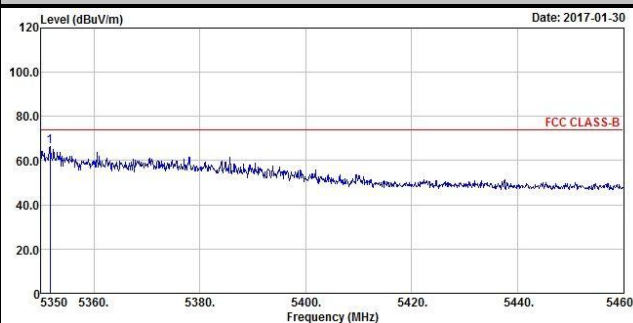

#### Vertical

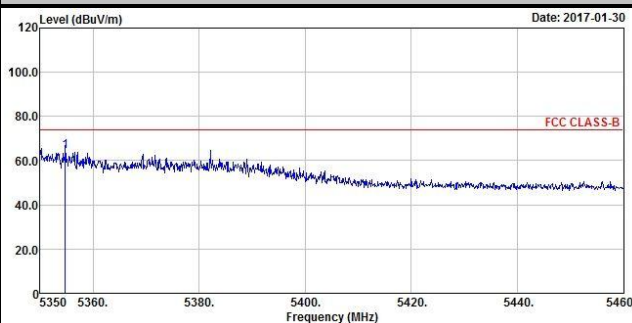

### Ch 64 (Average)

#### Horizontal

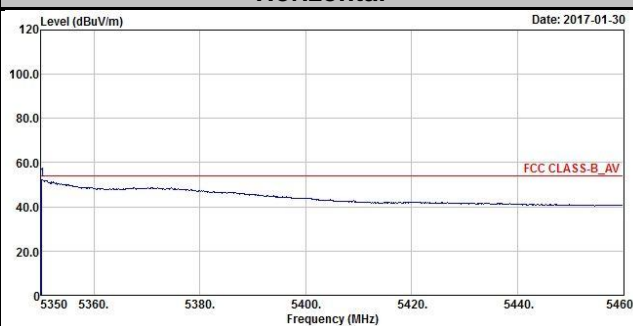

#### Vertical

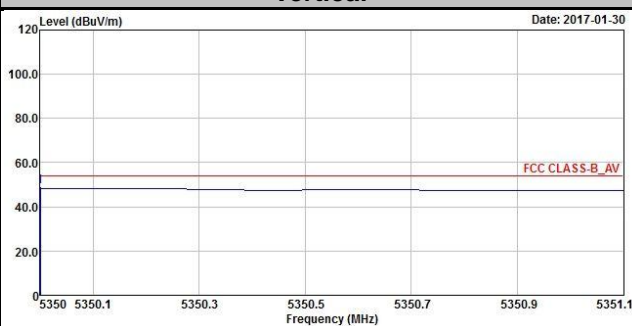

### Ch 100 (Peak)

#### Horizontal

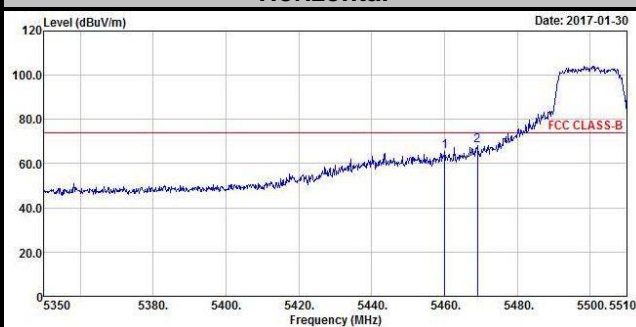

#### Vertical

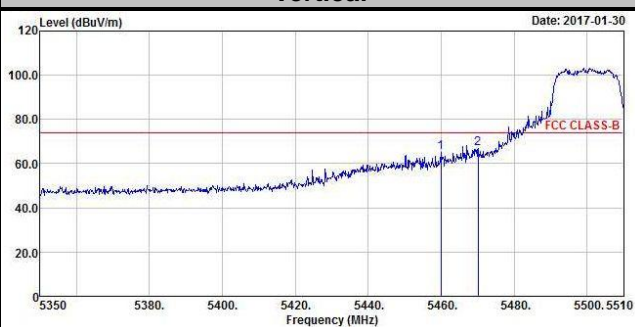

### Ch 100 (Average)

#### Horizontal

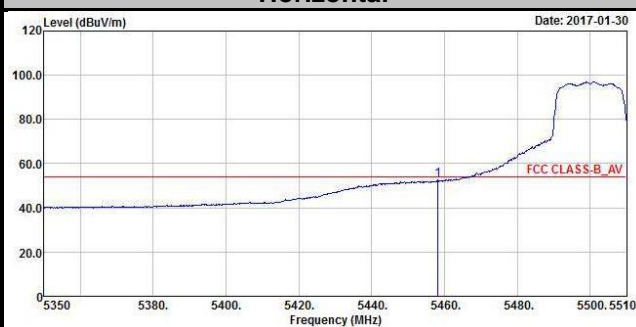

#### Vertical

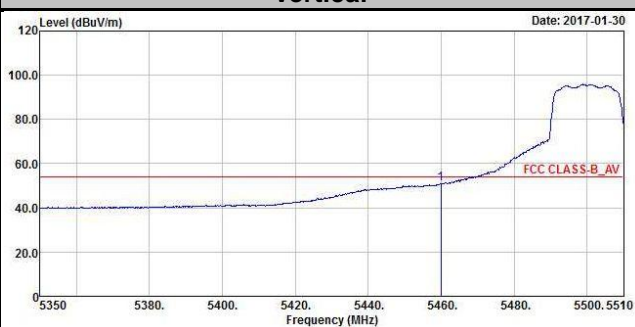

### Ch 140 (Peak)

#### Horizontal

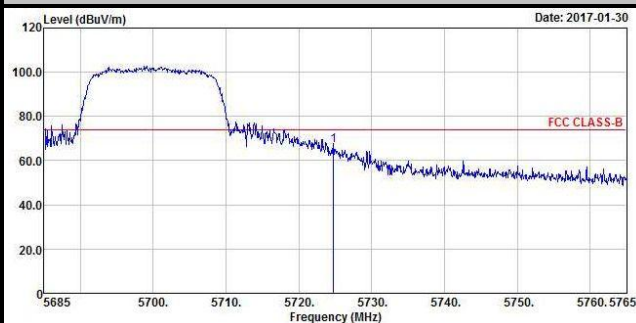

#### Vertical

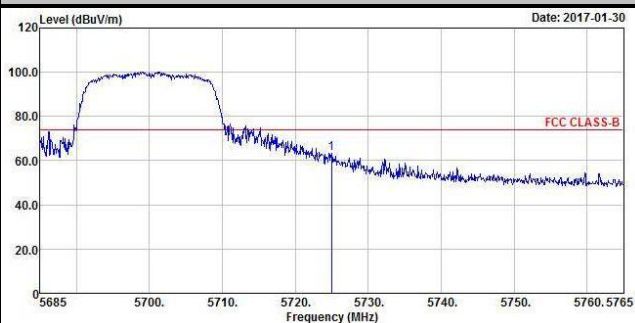

### Ch 140 (Average)

#### Horizontal

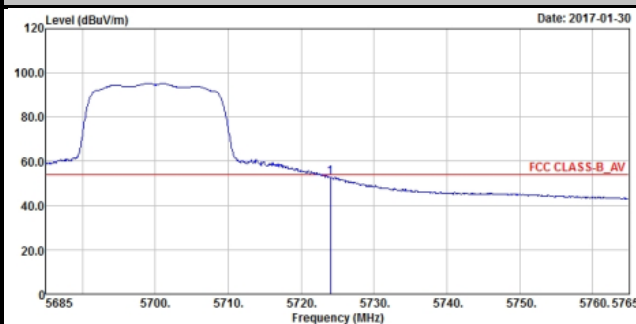

#### Vertical

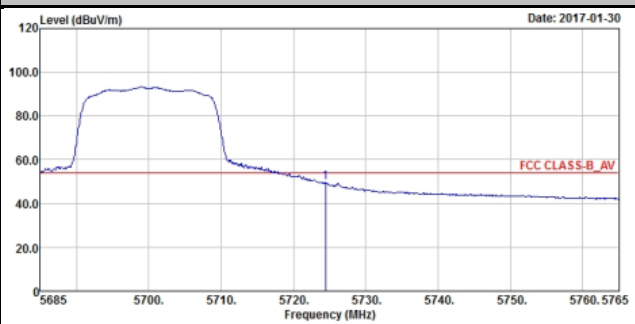

## Appendix – Information on the Testing Laboratories

We, Bureau Veritas Consumer Products Services (H.K.) Ltd., Taoyuan Branch, were founded in 1988 to provide our best service in EMC, Radio, Telecom and Safety consultation. Our laboratories are accredited and approved according to ISO/IEC 17025.

If you have any comments, please feel free to contact us at the following:

**Linko EMC/RF Lab**

Tel: 886-2-26052180

Fax: 886-2-26051924

**Hsin Chu EMC/RF/Telecom Lab**

Tel: 886-3-6668565

Fax: 886-3-6668323

**Hwa Ya EMC/RF/Safety**

Tel: 886-3-3183232

Fax: 886-3-3270892

**Email:** [service.adt@tw.bureauveritas.com](mailto:service.adt@tw.bureauveritas.com)

**Web Site:** [www.bureauveritas-adt.com](http://www.bureauveritas-adt.com)

The address and road map of all our labs can be found in our web site also.

--- END ---