

FCC Test Report

Report No.: RF170103C26

FCC ID: ZQAH10

Test Model: A0024

Received Date: Jan. 03, 2017

Test Date: Jan. 24, 2017 ~ Mar. 23, 2017

Issued Date: Apr. 28, 2017

Applicant: Nest Labs Inc.

Address: 3400 Hillview Ave. Palo Alto California, United States 94304

Issued By: Bureau Veritas Consumer Products Services (H.K.) Ltd., Taoyuan Branch

Lab Address: No. 47-2, 14th Ling, Chia Pau Vil., Lin Kou Dist., New Taipei City, Taiwan
(R.O.C)

Test Location: No.19, Hwa Ya 2nd Rd., Wen Hwa Vil., Kwei Shan Dist., Taoyuan City
33383, Taiwan, R.O.C.



This report is for your exclusive use. Any copying or replication of this report to or for any other person or entity, or use of our name or trademark, is permitted only with our prior written permission. This report sets forth our findings solely with respect to the test samples identified herein. The results set forth in this report are not indicative or representative of the quality or characteristics of the lot from which a test sample was taken or any similar or identical product unless specifically and expressly noted. Our report includes all of the tests requested by you and the results thereof based upon the information that you provided to us. You have 60 days from date of issuance of this report to notify us of any material error or omission caused by our negligence, provided, however, that such notice shall be in writing and shall specifically address the issue you wish to raise. A failure to raise such issue within the prescribed time shall constitute your unqualified acceptance of the completeness of this report, the tests conducted and the correctness of the report contents. Unless specific mention, the uncertainty of measurement has been explicitly taken into account to declare the compliance or non-compliance to the specification.

Table of Contents

Release Control Record	4
1 Certificate of Conformity	5
2 Summary of Test Results	6
2.1 Measurement Uncertainty	6
2.2 Modification Record	6
3 General Information	7
3.1 General Description of EUT	7
3.2 Description of Test Modes	8
3.2.1 Test Mode Applicability and Tested Channel Detail	9
3.3 Duty Cycle of Test Signal	11
3.4 Description of Support Units	12
3.4.1 Configuration of System under Test	12
3.5 General Description of Applied Standards	12
4 Test Types and Results	13
4.1 Radiated Emission and Bandedge Measurement	13
4.1.1 Limits of Radiated Emission and Bandedge Measurement	13
4.1.2 Test Instruments	14
4.1.3 Test Procedures	15
4.1.4 Deviation from Test Standard	15
4.1.5 Test Set Up	16
4.1.6 EUT Operating Conditions	16
4.1.7 Test Results	17
4.2 Conducted Emission Measurement	50
4.2.1 Limits of Conducted Emission Measurement	50
4.2.2 Test Instruments	50
4.2.3 Test Procedures	51
4.2.4 Deviation from Test Standard	51
4.2.5 Test Setup	51
4.2.6 EUT Operating Conditions	51
4.2.7 Test Results	52
4.3 6 dB Bandwidth Measurement	54
4.3.1 Limits of 6 dB Bandwidth Measurement	54
4.3.2 Test Setup	54
4.3.3 Test Instruments	54
4.3.4 Test Procedure	54
4.3.5 Deviation from Test Standard	54
4.3.6 EUT Operating Conditions	54
4.3.7 Test Result	55
4.4 Conducted Output Power Measurement	57
4.4.1 Limits of Conducted Output Power Measurement	57
4.4.2 Test Setup	57
4.4.3 Test Instruments	57
4.4.4 Test Procedures	57
4.4.5 Deviation from Test Standard	57
4.4.6 EUT Operating Conditions	57
4.4.7 Test Results	58
4.5 Power Spectral Density Measurement	61
4.5.1 Limits of Power Spectral Density Measurement	61
4.5.2 Test Setup	61
4.5.3 Test Instruments	61
4.5.4 Test Procedure	61
4.5.5 Deviation from Test Standard	61
4.5.6 EUT Operating Condition	61

4.5.7 Test Results	62
4.6 Conducted Out of Band Emission Measurement	64
4.6.1 Limits of Conducted Out of Band Emission Measurement.....	64
4.6.2 Test Setup.....	64
4.6.3 Test Instruments	64
4.6.4 Test Procedure	64
4.6.5 Deviation from Test Standard	64
4.6.6 EUT Operating Condition	64
4.6.7 Test Results	65
5 Pictures of Test Arrangements.....	74
Annex A- Radiated Bandedge Plots.....	75
Appendix – Information on the Testing Laboratories	78

Release Control Record

Issue No.	Description	Date Issued
RF170103C26	Original Release	Apr. 28, 2017

1 Certificate of Conformity

Product: Home security device

Brand: Nest Guard

Test Model: A0024

Sample Status: Identical Prototype

Applicant: Nest Labs Inc.

Test Date: Jan. 24, 2017 ~ Mar. 23, 2017

Standards: 47 CFR FCC Part 15, Subpart C (Section 15.247)
ANSI C63.10:2013

The above equipment has been tested by **Bureau Veritas Consumer Products Services (H.K.) Ltd., Taoyuan Branch**, and found compliance with the requirement of the above standards. The test record, data evaluation & Equipment Under Test (EUT) configurations represented herein are true and accurate accounts of the measurements of the sample's EMC characteristics under the conditions specified in this report.

Prepared by : Rona Chen, **Date:** Apr. 28, 2017
Rona Chen / Specialist

Approved by : David Huang, **Date:** Apr. 28, 2017
David Huang / Project Engineer

2 Summary of Test Results

47 CFR FCC Part 15, Subpart C (Section 15.247)			
FCC Clause	Test Item	Result	Remarks
15.207	AC Power Conducted Emission	Pass	Meet the requirement of limit. Minimum passing margin is -11.74 dB at 0.61138 MHz.
15.205 / 15.209 / 15.247(d)	Radiated Emissions and Band Edge Measurement	Pass	Meet the requirement of limit. Minimum passing margin is -1.89 dB at 2483.68 MHz.
15.247(d)	Antenna Port Emission	Pass	Meet the requirement of limit.
15.247(a)(2)	6 dB Bandwidth	Pass	Meet the requirement of limit.
15.247(b)	Conducted power	Pass	Meet the requirement of limit.
15.247(e)	Power Spectral Density	Pass	Meet the requirement of limit.
15.203	Antenna Requirement	Pass	No antenna connector is used.

2.1 Measurement Uncertainty

Where relevant, the following measurement uncertainty levels have been estimated for tests performed on the EUT:

The listed uncertainties are the worst case uncertainty for the entire range of measurement. Please note that the uncertainty values are provided for informational purposes only and are not used in determining the PASS/FAIL results.

Measurement	Frequency	Expanded Uncertainty (k=2) (\pm)
Conducted Emissions at mains ports	150 kHz ~ 30 MHz	2.44 dB
Radiated Emissions up to 1 GHz	30 MHz ~ 200 MHz	2.93 dB
	200 MHz ~ 1000 MHz	2.95 dB
Radiated Emissions above 1 GHz	1 GHz ~ 18 GHz	2.26 dB
	18 GHz ~ 40 GHz	1.94 dB

2.2 Modification Record

There were no modifications required for compliance.

3 General Information

3.1 General Description of EUT

Product	Home security device
Brand	Nest Guard
Test Model	A0024
Status of EUT	Identical Prototype
Power Supply Rating	5.0 Vdc (adapter or host equipment) 3.7 Vdc (Li-ion battery)
Modulation Type	CCK, DQPSK, DBPSK for DSSS 64QAM, 16QAM, QPSK, BPSK for OFDM
Modulation Technology	DSSS, OFDM
Transfer Rate	802.11b: 11.0 / 5.5 / 2.0 / 1.0 Mbps 802.11g: 54.0 / 48.0 / 36.0 / 24.0 / 18.0 / 12.0 / 9.0 / 6.0 Mbps 802.11n: up to MCS7
Operating Frequency	2412 ~ 2462 MHz
Number of Channel	11 for 802.11b, 802.11g, 802.11n (HT20)
Output Power	258.226 mW
Antenna Type	Monopole Type antenna with 2.95 dBi gain
Antenna Connector	N/A
Accessory Device	Refer to Note as below
Data Cable Supplied	Refer to Note as below

Note:

- The EUT provides 1 completed transmitter and 1 receiver.

Modulation Mode	TX Function
802.11b	1TX
802.11g	1TX
802.11n (HT20)	1TX

- The EUT contains following accessory devices.

Product	Brand	Model	Description
Adapter	Nest	A0017	I/P: 100-240 Vac, 50/60 Hz, 0.35 A O/P: 5 Vdc, 2.5 A
Battery	Nest	N/A	3.7 Vdc, 2850 mAh
USB Cable	Nest	N/A	1.9 meter shielded cable without core

- The above EUT information is declared by manufacturer and for more detailed features description, please refer to the manufacturer's specifications or user's manual.

3.2 Description of Test Modes

11 channels are provided for 802.11b, 802.11g and 802.11n (HT20):

Channel	Frequency (MHz)	Channel	Frequency (MHz)
1	2412	7	2442
2	2417	8	2447
3	2422	9	2452
4	2427	10	2457
5	2432	11	2462
6	2437		

3.2.1 Test Mode Applicability and Tested Channel Detail

EUT Configure Mode	Applicable To				Description
	RE \geq 1G	RE<1G	PLC	APCM	
-	√	√	√	√	-

Where **RE \geq 1G**: Radiated Emission above 1 GHz **RE<1G**: Radiated Emission below 1 GHz
PLC: Power Line Conducted Emission **APCM**: Antenna Port Conducted Measurement

NOTE: The EUT had been pre-tested on the positioned of each 3 axis. The worst case was found when positioned on **X-plane**.

Radiated Emission Test (Above 1 GHz):

- Pre-Scan has been conducted to determine the worst-case mode from all possible combinations between available modulations, data rates and antenna ports (if EUT with antenna diversity architecture).
- Following channel(s) was (were) selected for the final test as listed below.

EUT Configure Mode	Mode	Available Channel	Tested Channel	Modulation Technology	Modulation Type	Data Rate (Mbps)
-	802.11b	1 to 11	1, 6, 11	DSSS	DBPSK	1.0
-	802.11g	1 to 11	1, 6, 11	OFDM	BPSK	6.0
-	802.11n (HT20)	1 to 11	1, 6, 11	OFDM	BPSK	MCS0

Radiated Emission Test (Below 1 GHz):

- Pre-Scan has been conducted to determine the worst-case mode from all possible combinations between available modulations, data rates and antenna ports (if EUT with antenna diversity architecture).
- Following channel(s) was (were) selected for the final test as listed below.

EUT Configure Mode	Mode	Available Channel	Tested Channel	Modulation Technology	Modulation Type	Data Rate (Mbps)
-	802.11g	1 to 11	11	OFDM	BPSK	6.0

- The Low Frequency, which started from 9kHz to 30MHz, was pre-scanned and the result which was 20 dB lower than the limit line was not reported.

Power Line Conducted Emission Test:

- Pre-Scan has been conducted to determine the worst-case mode from all possible combinations between available modulations, data rates and antenna ports (if EUT with antenna diversity architecture).
- Following channel(s) was (were) selected for the final test as listed below.

EUT Configure Mode	Mode	Available Channel	Tested Channel	Modulation Technology	Modulation Type	Data Rate (Mbps)
-	802.11g	1 to 11	11	OFDM	BPSK	6.0

Bandedge Measurement:

- Pre-Scan has been conducted to determine the worst-case mode from all possible combinations between available modulations, data rates and antenna ports (if EUT with antenna diversity architecture).
- Following channel(s) was (were) selected for the final test as listed below.

EUT Configure Mode	Mode	Available Channel	Tested Channel	Modulation Technology	Modulation Type	Data Rate (Mbps)
-	802.11b	1 to 11	1, 11	DSSS	DBPSK	1.0
-	802.11g	1 to 11	1, 11	OFDM	BPSK	6.0
-	802.11n (HT20)	1 to 11	1, 11	OFDM	BPSK	MCS0

Antenna Port Conducted Measurement:

- This item includes all test value of each mode, but only includes spectrum plot of worst value of each mode.
- Pre-Scan has been conducted to determine the worst-case mode from all possible combinations between available modulations, data rates and antenna ports (if EUT with antenna diversity architecture).
- Following channel(s) was (were) selected for the final test as listed below.

EUT Configure Mode	Mode	Available Channel	Tested Channel	Modulation Technology	Modulation Type	Data Rate (Mbps)
-	802.11b	1 to 11	1, 6, 11	DSSS	DBPSK	1.0
-	802.11g	1 to 11	1, 6, 11	OFDM	BPSK	6.0
-	802.11n (HT20)	1 to 11	1, 6, 11	OFDM	BPSK	MCS0

Test Condition:

Applicable To	Environmental Conditions	Input Power	Tested by
RE \geq 1G	25 deg. C, 65 % RH	120 Vac, 60 Hz	Gavin Wu
RE<1G	25 deg. C, 65 % RH	120 Vac, 60 Hz	Gavin Wu
PLC	25 deg. C, 65 % RH	120 Vac, 60 Hz	Getaz Yang
APCM	25 deg. C, 65 % RH	3.7 Vdc	Taylor Liu

3.3 Duty Cycle of Test Signal

802.11b: Duty cycle = $8.600/8.860 = 0.971$, Duty factor = $10 * \log(1/0.971) = 0.13$

802.11g: Duty cycle = $1.425/1.675 = 0.851$, Duty factor = $10 * \log(1/0.851) = 0.70$

802.11n (HT20): Duty cycle = $1.342/1.592 = 0.843$, Duty factor = $10 * \log(1/0.843) = 0.74$



3.4 Description of Support Units

The EUT has been tested as an independent unit together with other necessary accessories or support units.

3.4.1 Configuration of System under Test

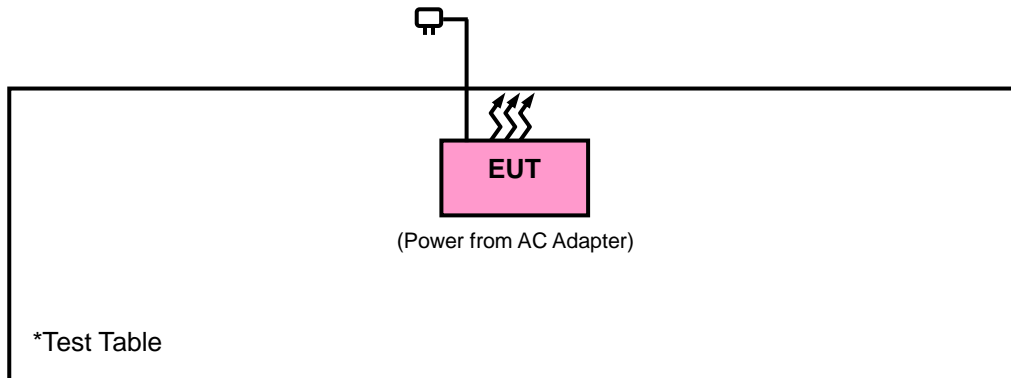

3.5 General Description of Applied Standards

The EUT is a RF Product. According to the specifications of the manufacturer, it must comply with the requirements of the following standards:

FCC Part 15, Subpart C (15.247)

558074 D01 DTS Meas Guidance v04

ANSI C63.10-2013

All test items have been performed and recorded as per the above standards.

4 Test Types and Results

4.1 Radiated Emission and Bandedge Measurement

4.1.1 Limits of Radiated Emission and Bandedge Measurement

Radiated emissions which fall in the restricted bands must comply with the radiated emission limits specified as below table. Other emissions shall be at least 20 dB below the highest level of the desired power:

Frequencies (MHz)	Field Strength (microvolts/meter)	Measurement Distance (meters)
0.009 ~ 0.490	2400/F (kHz)	300
0.490 ~ 1.705	24000/F (kHz)	30
1.705 ~ 30.0	30	30
30 ~ 88	100	3
88 ~ 216	150	3
216 ~ 960	200	3
Above 960	500	3

NOTE:

1. The lower limit shall apply at the transition frequencies.
2. Emission level (dBuV/m) = 20 log Emission level (uV/m).
3. For frequencies above 1000 MHz, the field strength limits are based on average detector, however, the peak field strength of any emission shall not exceed the maximum permitted average limits, specified above by more than 20 dB under any condition of modulation.

4.1.2 Test Instruments

Description & Manufacturer	Model No.	Serial No.	Date of Calibration	Due Date of Calibration
Test Receiver Agilent	N9038A	MY52260177	Jun. 21, 2016	Jun. 20, 2017
		MY51210203	Feb. 17, 2017	Feb. 16, 2018
Spectrum Analyzer Agilent	N9010A	MY52220314	Dec. 16, 2016	Dec. 15, 2017
Spectrum Analyzer ROHDE & SCHWARZ	FSU43	101261	Dec. 13, 2016	Dec. 12, 2017
BILOG Antenna SCHWARZBECK	VULB9168	9168-472	Dec. 26, 2016	Dec. 27, 2017
HORN Antenna SCHWARZBECK	BBHA 9120 D	9120D-969	Dec. 12, 2016	Dec. 13, 2017
HORN Antenna SCHWARZBECK	BBHA 9170	9170-480	Dec. 14, 2016	Dec. 13, 2017
Fixed Attenuator Mini-Circuits	BW-N10W5+	NA	Jul. 08, 2016	Jul. 07, 2017
Loop Antenna	EM-6879	269	Aug. 11, 2016	Aug. 10, 2017
Preamplifier EMCI	EMC 012645	980115	Oct. 21, 2016	Oct. 20, 2017
Preamplifier EMCI	EMC 184045	980116	Oct. 21, 2016	Oct. 20, 2017
Preamplifier EMCI	EMC 330H	980112	Oct. 21, 2016	Oct. 20, 2017
Power Meter Anritsu	ML2495A	1232002	Sep. 08, 2016	Sep. 07, 2017
Power Sensor Anritsu	MA2411B	1207325	Sep. 08, 2016	Sep. 07, 2017
RF signal cable HUBER+SUHNNER	SUCOFLEX 104	309219/4 2950114	Oct. 21, 2016	Oct. 20, 2017
RF signal cable HUBER+SUHNNER	SUCOFLEX 104	250130/4	Oct. 21, 2016	Oct. 20, 2017
RF Coaxial Cable Worken	8D-FB	Cable-Ch10-01	Oct. 21, 2016	Oct. 20, 2017
Software BV ADT	E3 6.120103	NA	NA	NA
Antenna Tower MF	MFA-440H	NA	NA	NA
Turn Table MF	MFT-201SS	NA	NA	NA
Antenna Tower & Turn Table Controller MF	MF-7802	NA	NA	NA

- Note: 1. The calibration interval of the above test instruments is 12 months and the calibrations are traceable to NML/ROC and NIST/USA.
2. The test was performed in HwaYa Chamber 10.
3. The horn antenna and preamplifier (model: EMC 184045) are used only for the measurement of emission frequency above 1 GHz if tested.
4. The FCC Designation Number is TW0003. The number will be varied with the Lab location and scope as attached.
5. The IC Site Registration No. is IC7450F-10.

4.1.3 Test Procedures

- a. The EUT was placed on the top of a rotating table 0.8 meters (for below 1 GHz) / 1.5 meters (for above 1 GHz) above the ground at 3 meter chamber room for test. The table was rotated 360 degrees to determine the position of the highest radiation.
- b. The EUT was set 3 meters away from the interference-receiving antenna, which was mounted on the top of a variable-height antenna tower.
- c. The height of antenna is varied from one meter to four meters above the ground to determine the maximum value of the field strength. Both horizontal and vertical polarizations of the antenna are set to make the measurement.
- d. For each suspected emission, the EUT was arranged to its worst case and then the antenna was tuned to heights from 1 meter to 4 meters and the rotatable table was turned from 0 degrees to 360 degrees to find the maximum reading.
- e. The test-receiver system was set to quasi-peak detect function and specified bandwidth with maximum hold mode when the test frequency is below 1 GHz.
- f. The test-receiver system was set to peak and average detected function and specified bandwidth with maximum hold mode when the test frequency is above 1 GHz. If the peak reading value also meets average limit, measurement with the average detector is unnecessary.

Note:

1. The resolution bandwidth and video bandwidth of test receiver/spectrum analyzer is 120 kHz & 360 KHz for Quasi-peak detection (QP) at frequency below 1 GHz.
2. The resolution bandwidth of test receiver/spectrum analyzer is 1 MHz and the video bandwidth is 3 MHz for Peak detection (PK) at frequency above 1 GHz.
3. The resolution bandwidth of test receiver/spectrum analyzer is 1 MHz and the video bandwidth is 1/T for Average (Duty cycle < 98 %) for Average detection at frequency above 1 GHz.
4. The resolution bandwidth of test receiver/spectrum analyzer is 1 MHz and the video bandwidth is 10 Hz (Duty cycle ≥ 98 %) for Average detection (AV) at frequency above 1 GHz.
5. All modes of operation were investigated and the worst-case emissions are reported.

Test Setting			
Bandedge Emissions	RBW / VBW		
(Non-restricted Band)	100k / 300k		
(Restricted Band)	802.11b	Average: 1M / 1k	Peak: 1M / 3M
	802.11g		
	802.11n (20MHz)		

4.1.4 Deviation from Test Standard

No deviation.

4.1.5 Test Set Up

<Frequency Range below 1 GHz>

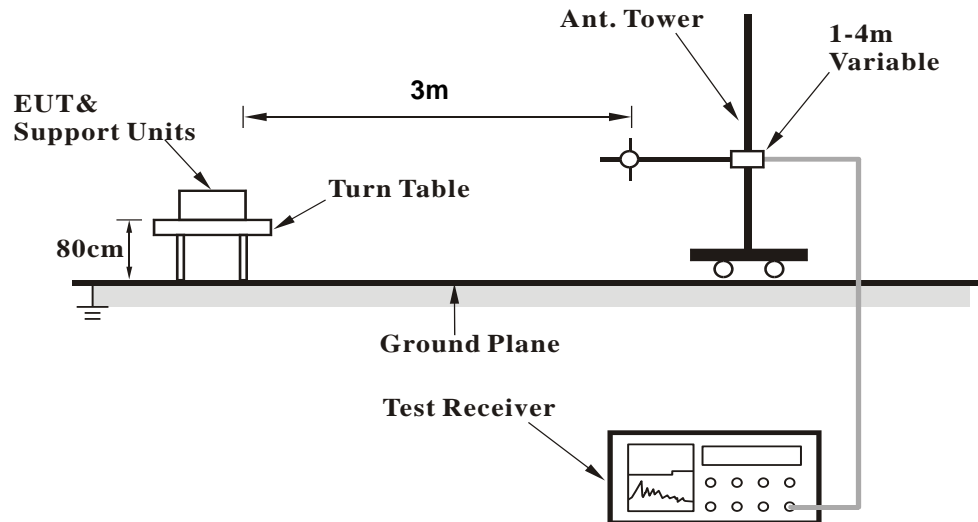

<Frequency Range above 1 GHz>

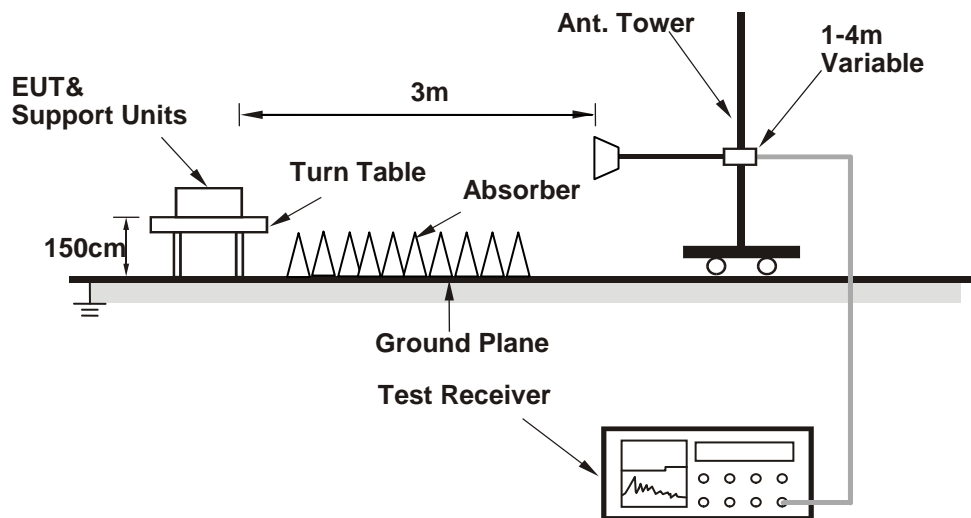

For the actual test configuration, please refer to the attached file (Test Setup Photo).

4.1.6 EUT Operating Conditions

- Placed the EUT on a testing table.
- Use the software to control the EUT under transmission condition continuously at specific channel frequency.

4.1.7 Test Results

No non-compliance noted:

KDB 414788 D01 OATS and Chamber Correlation Justification

- Base on FCC 15.31 (f) (2): measurements may be performed at a distance closer than that specified in the regulations; however, an attempt should be made to avoid making measurements in the near field.
- OATs and chamber correlation testing had been performed and chamber measured test result is the worst case test result.

Above 1 GHz Data :

802.11b

EUT Test Condition		Measurement Detail	
Channel	Channel 1	Frequency Range	1 GHz ~ 25 GHz
Input Power	120 Vac, 60 Hz	Detector Function	Peak (PK) Average (AV)
Environmental Conditions	25 deg. C, 65 % RH	Tested By	Gavin Wu

Horizontal

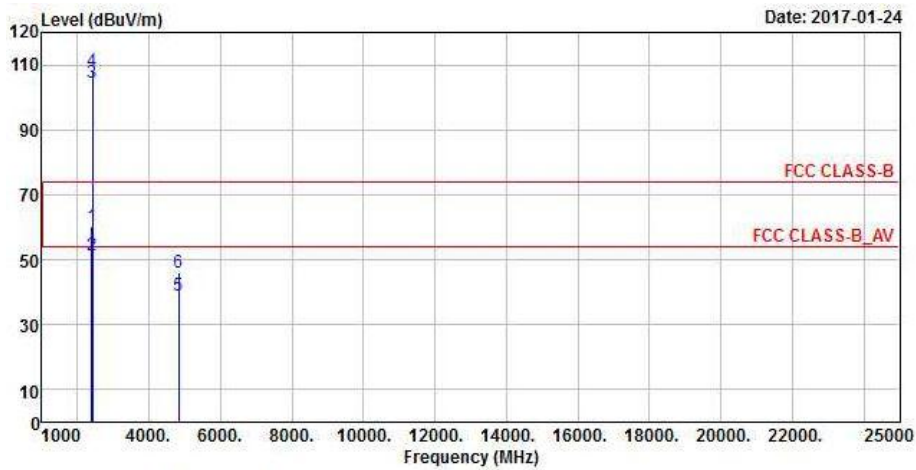

Vertical

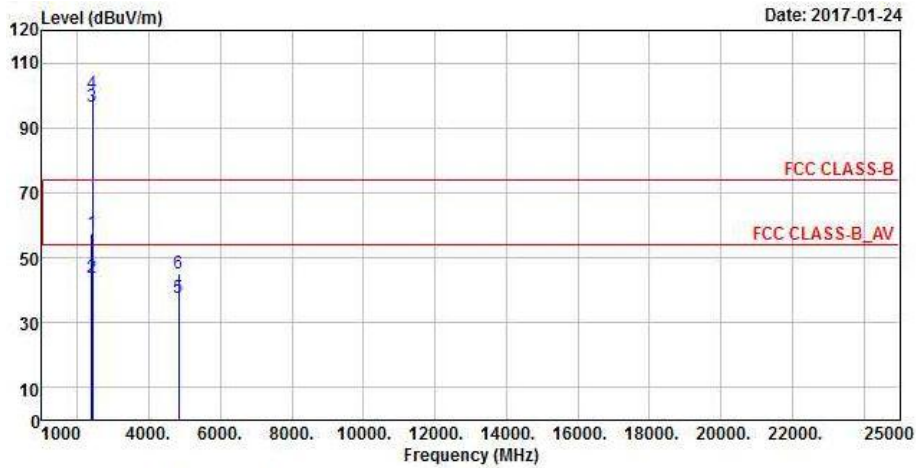

Antennal Polarity & Test Distance: Horizontal at 3 m

Frequency (MHz)	Emission Level (dBuV/m)	Read Level (dBuV)	Limit (dBuV/m)	Margin (dB)	Antenna Factor (dB/m)	Cable Loss (dB)	Preamp Factor (dB)	Antenna Height (cm)	Table Angle (Degree)	Remark
2386.05	60.32	66.83	74	-13.68	26.91	4.08	37.5	107	300	Peak
2386.32	51.46	57.97	54	-2.54	26.91	4.08	37.5	107	300	Average
2412	104.37	110.84			26.96	4.09	37.52	107	300	Average
2412	107.93	114.4			26.96	4.09	37.52	107	300	Peak
4824	39.15	54.45	54	-14.85	30.99	6.79	53.08	100	252	Average
4824	45.84	61.14	74	-28.16	30.99	6.79	53.08	100	252	Peak

Antennal Polarity & Test Distance: Vertical at 3 m

Frequency (MHz)	Emission Level (dBuV/m)	Read Level (dBuV)	Limit (dBuV/m)	Margin (dB)	Antenna Factor (dB/m)	Cable Loss (dB)	Preamp Factor (dB)	Antenna Height (cm)	Table Angle (Degree)	Remark
2385.15	57.7	64.26	74	-16.3	26.86	4.08	37.5	101	12	Peak
2386.32	43.77	50.28	54	-10.23	26.91	4.08	37.5	101	12	Average
2412	96.42	102.89			26.96	4.09	37.52	101	12	Average
2412	100.37	106.84			26.96	4.09	37.52	101	12	Peak
4824	37.82	53.12	54	-16.18	30.99	6.79	53.08	100	125	Average
4824	45.34	60.64	74	-28.66	30.99	6.79	53.08	100	125	Peak

Remarks:

- Emission Level = Read Level + Antenna Factor + Cable Loss - Preamp Factor
Margin value = Emission level – Limit value
- 2412 MHz: Fundamental frequency.

EUT Test Condition		Measurement Detail	
Channel	Channel 6	Frequency Range	1 GHz ~ 25 GHz
Input Power	120 Vac, 60 Hz	Detector Function	Peak (PK) Average (AV)
Environmental Conditions	25 deg. C, 65 % RH	Tested By	Gavin Wu

Horizontal

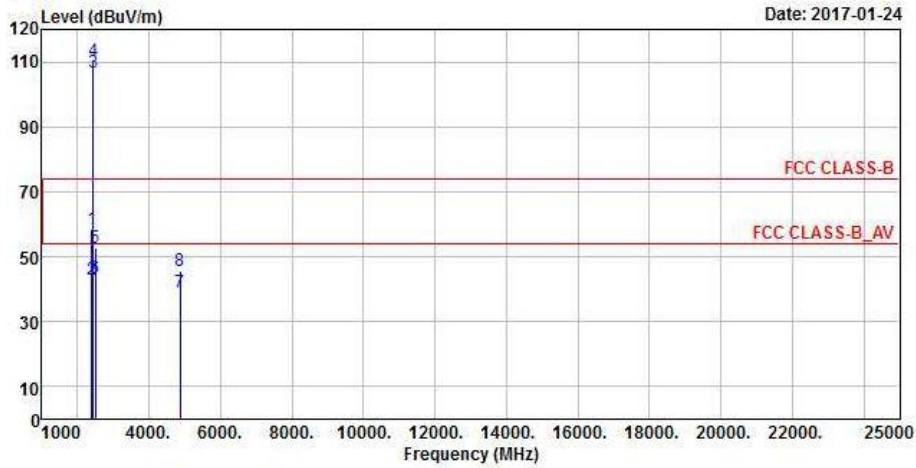

Vertical

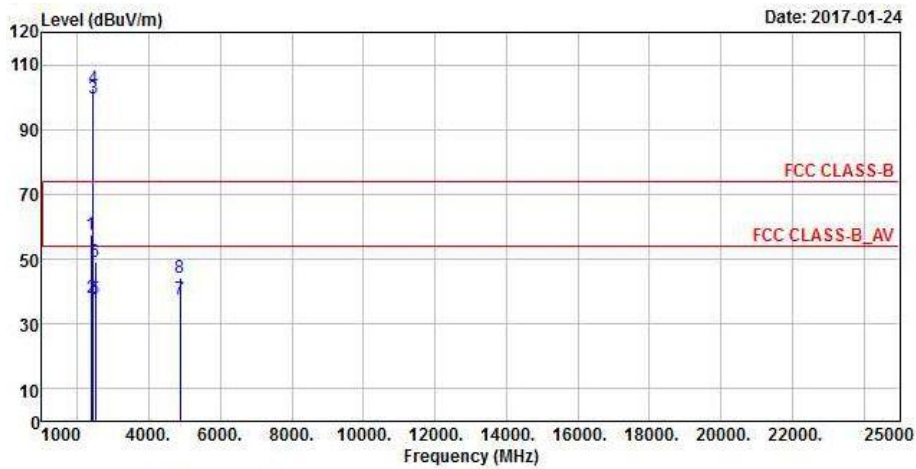

Antennal Polarity & Test Distance: Horizontal at 3 m

Frequency (MHz)	Emission Level (dBuV/m)	Read Level (dBuV)	Limit (dBuV/m)	Margin (dB)	Antenna Factor (dB/m)	Cable Loss (dB)	Preamp Factor (dB)	Antenna Height (cm)	Table Angle (Degree)	Remark
2388.66	58.37	64.88	74	-15.63	26.91	4.08	37.5	105	298	Peak
2389.29	43.17	49.68	54	-10.83	26.91	4.08	37.5	105	298	Average
2437	106.77	113.05			27.06	4.12	37.46	105	298	Average
2437	110.18	116.46			27.06	4.12	37.46	105	298	Peak
2484.72	52.55	58.57	74	-21.45	27.15	4.15	37.32	105	298	Peak
2484.88	43.31	49.33	54	-10.69	27.15	4.15	37.32	105	298	Average
4874	39.01	54.15	54	-14.99	31.06	6.85	53.05	101	211	Average
4874	45.58	60.72	74	-28.42	31.06	6.85	53.05	101	211	Peak

Antennal Polarity & Test Distance: Vertical at 3 m

Frequency (MHz)	Emission Level (dBuV/m)	Read Level (dBuV)	Limit (dBuV/m)	Margin (dB)	Antenna Factor (dB/m)	Cable Loss (dB)	Preamp Factor (dB)	Antenna Height (cm)	Table Angle (Degree)	Remark
2378.94	57.61	64.18	74	-16.39	26.86	4.07	37.5	100	12	Peak
2389.11	38.24	44.75	54	-15.76	26.91	4.08	37.5	100	12	Average
2437	99.46	105.74			27.06	4.12	37.46	100	12	Average
2437	102.83	109.11			27.06	4.12	37.46	100	12	Peak
2484.8	37.73	43.75	54	-16.27	27.15	4.15	37.32	100	12	Average
2492.48	49.17	55.06	74	-24.83	27.2	4.16	37.25	100	12	Peak
4874	37.8	52.94	54	-16.2	31.06	6.85	53.05	100	119	Average
4874	44.22	59.36	74	-29.78	31.06	6.85	53.05	100	119	Peak

Remarks:

- Emission Level = Read Level + Antenna Factor + Cable Loss - Preamp Factor
Margin value = Emission level – Limit value
- 2437 MHz: Fundamental frequency.

EUT Test Condition		Measurement Detail	
Channel	Channel 11	Frequency Range	1 GHz ~ 25 GHz
Input Power	120 Vac, 60 Hz	Detector Function	Peak (PK) Average (AV)
Environmental Conditions	25 deg. C, 65 % RH	Tested By	Gavin Wu

Horizontal

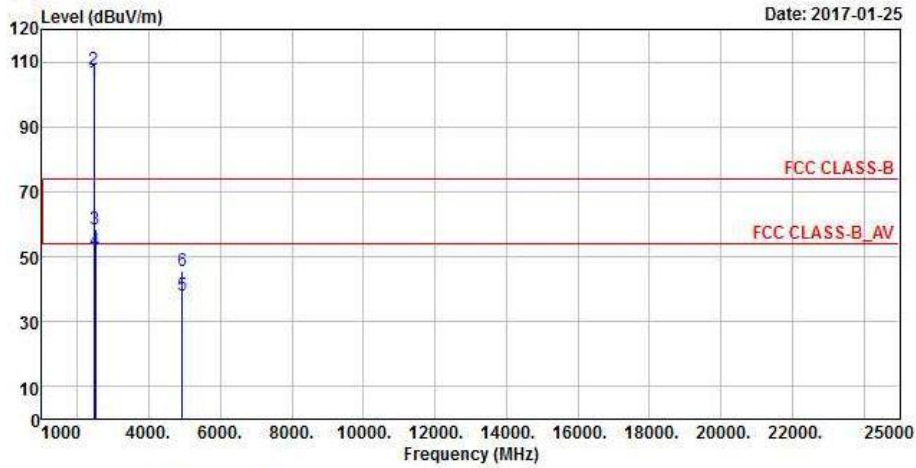

Vertical

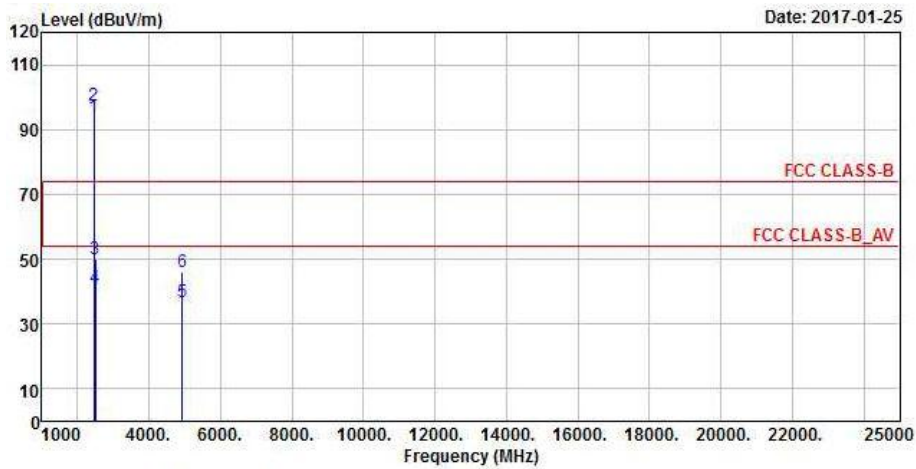

Antennal Polarity & Test Distance: Horizontal at 3 m

Frequency (MHz)	Emission Level (dBuV/m)	Read Level (dBuV)	Limit (dBuV/m)	Margin (dB)	Antenna Factor (dB/m)	Cable Loss (dB)	Preamp Factor (dB)	Antenna Height (cm)	Table Angle (Degree)	Remark
2462	103.94	110.1			27.1	4.13	37.39	104	301	Average
2462	107.51	113.67			27.1	4.13	37.39	104	301	Peak
2487.04	58.33	64.35	74	-15.67	27.15	4.15	37.32	104	301	Peak
2487.8	51.68	57.64	54	-2.32	27.2	4.16	37.32	104	301	Average
4924	38.2	53.23	54	-15.8	31.12	6.88	53.03	100	222	Average
4924	45.81	60.84	74	-28.19	31.12	6.88	53.03	100	222	Peak

Antennal Polarity & Test Distance: Vertical at 3 m

Frequency (MHz)	Emission Level (dBuV/m)	Read Level (dBuV)	Limit (dBuV/m)	Margin (dB)	Antenna Factor (dB/m)	Cable Loss (dB)	Preamp Factor (dB)	Antenna Height (cm)	Table Angle (Degree)	Remark
2462	94.01	100.17			27.1	4.13	37.39	100	11	Average
2462	97.48	103.64			27.1	4.13	37.39	100	11	Peak
2486.36	50.21	56.23	74	-23.79	27.15	4.15	37.32	100	11	Peak
2487.76	41.02	46.98	54	-12.98	27.2	4.16	37.32	100	11	Average
4924	36.82	51.85	54	-17.18	31.12	6.88	53.03	100	111	Average
4924	45.87	60.9	74	-28.13	31.12	6.88	53.03	100	111	Peak

Remarks:

- Emission Level = Read Level + Antenna Factor + Cable Loss - Preamp Factor
Margin value = Emission level – Limit value
- 2462 MHz: Fundamental frequency.

802.11g

EUT Test Condition		Measurement Detail	
Channel	Channel 1	Frequency Range	1 GHz ~ 25 GHz
Input Power	120 Vac, 60 Hz	Detector Function	Peak (PK) Average (AV)
Environmental Conditions	25 deg. C, 65 % RH	Tested By	Gavin Wu

Horizontal

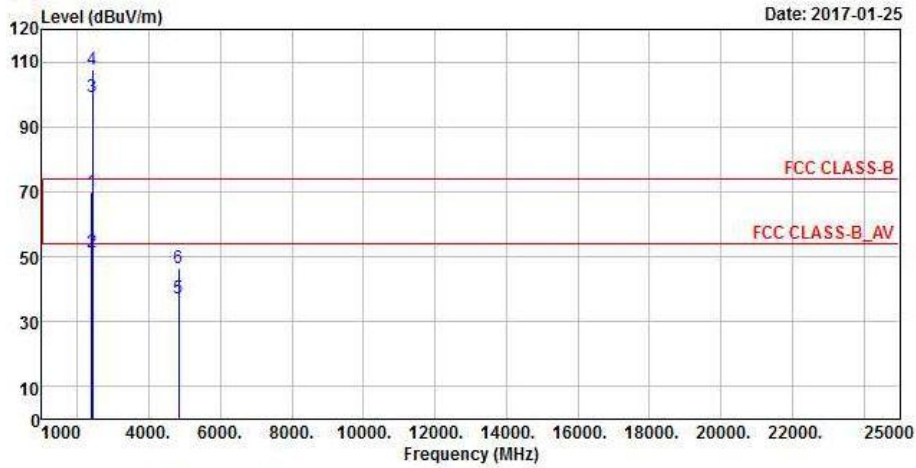

Vertical

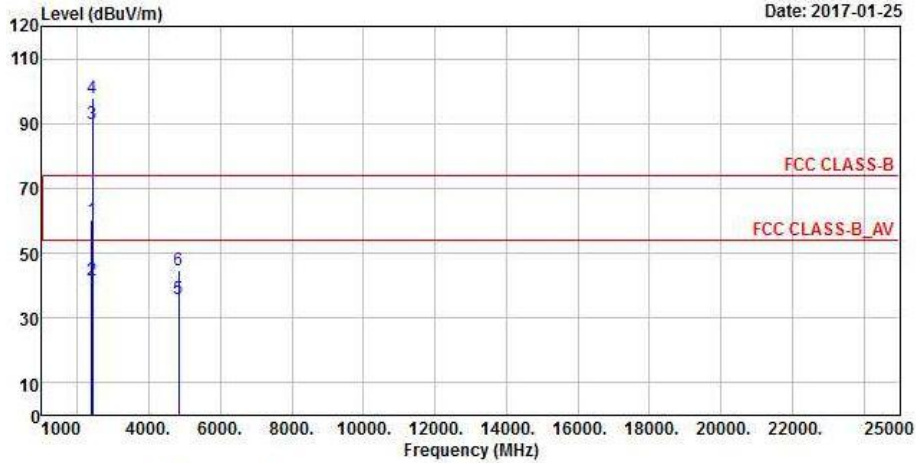

Antennal Polarity & Test Distance: Horizontal at 3 m

Frequency (MHz)	Emission Level (dBuV/m)	Read Level (dBuV)	Limit (dBuV/m)	Margin (dB)	Antenna Factor (dB/m)	Cable Loss (dB)	Preamp Factor (dB)	Antenna Height (cm)	Table Angle (Degree)	Remark
2388.75	69.81	76.32	74	-4.19	26.91	4.08	37.5	108	297	Peak
2389.92	51.43	57.96	54	-2.57	26.91	4.08	37.52	108	297	Average
2412	99.16	105.63			26.96	4.09	37.52	108	297	Average
2412	107.4	113.87			26.96	4.09	37.52	108	297	Peak
4824	37.25	52.55	54	-16.75	30.99	6.79	53.08	100	133	Average
4824	46.31	61.61	74	-27.69	30.99	6.79	53.08	100	133	Peak

Antennal Polarity & Test Distance: Vertical at 3 m

Frequency (MHz)	Emission Level (dBuV/m)	Read Level (dBuV)	Limit (dBuV/m)	Margin (dB)	Antenna Factor (dB/m)	Cable Loss (dB)	Preamp Factor (dB)	Antenna Height (cm)	Table Angle (Degree)	Remark
2385.96	60.2	66.71	74	-13.8	26.91	4.08	37.5	100	50	Peak
2389.02	41.42	47.93	54	-12.58	26.91	4.08	37.5	100	50	Average
2412	90.01	96.48			26.96	4.09	37.52	100	50	Average
2412	97.99	104.46			26.96	4.09	37.52	100	50	Peak
4824	35.89	51.19	54	-18.11	30.99	6.79	53.08	106	113	Average
4824	44.79	60.09	74	-29.21	30.99	6.79	53.08	106	113	Peak

Remarks:

- Emission Level = Read Level + Antenna Factor + Cable Loss - Preamp Factor
Margin value = Emission level – Limit value
- 2412 MHz: Fundamental frequency.

EUT Test Condition		Measurement Detail	
Channel	Channel 6	Frequency Range	1 GHz ~ 25 GHz
Input Power	120 Vac, 60 Hz	Detector Function	Peak (PK) Average (AV)
Environmental Conditions	25 deg. C, 65 % RH	Tested By	Gavin Wu

Horizontal

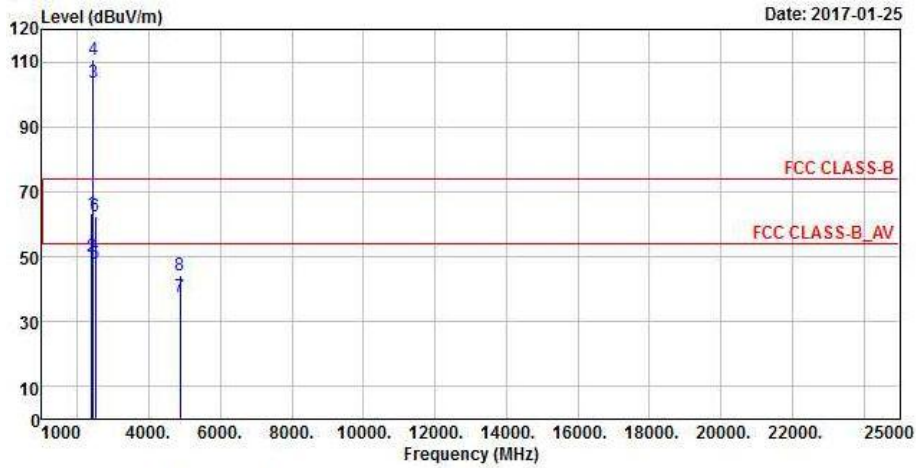

Vertical

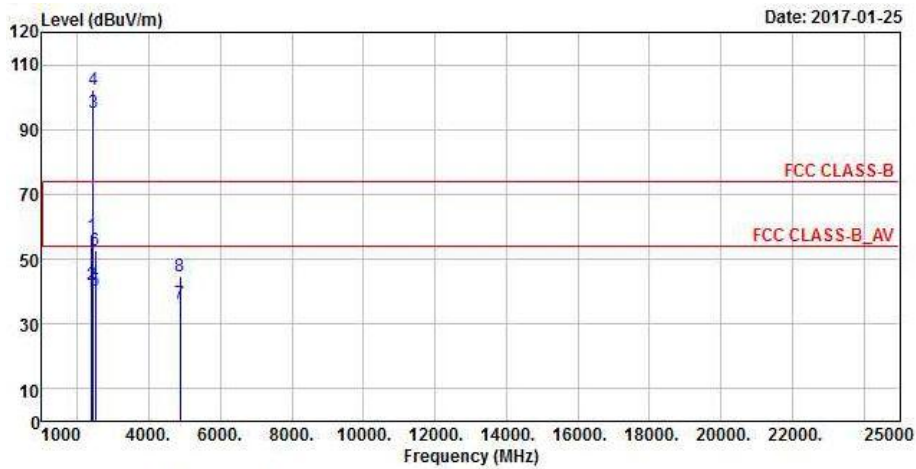

Antennal Polarity & Test Distance: Horizontal at 3 m

Frequency (MHz)	Emission Level (dBuV/m)	Read Level (dBuV)	Limit (dBuV/m)	Margin (dB)	Antenna Factor (dB/m)	Cable Loss (dB)	Preamp Factor (dB)	Antenna Height (cm)	Table Angle (Degree)	Remark
2389.56	63.31	69.82	74	-10.69	26.91	4.08	37.5	106	285	Peak
2389.92	50.04	56.57	54	-3.96	26.91	4.08	37.52	106	285	Average
2437	103.4	109.68			27.06	4.12	37.46	106	285	Average
2437	110.74	117.02			27.06	4.12	37.46	106	285	Peak
2484.56	48.04	54.06	54	-5.96	27.15	4.15	37.32	106	285	Average
2485.72	62.61	68.63	74	-11.39	27.15	4.15	37.32	106	285	Peak
4874	37.63	52.77	54	-16.37	31.06	6.85	53.05	100	219	Average
4874	44.47	59.61	74	-29.53	31.06	6.85	53.05	100	219	Peak

Antennal Polarity & Test Distance: Vertical at 3 m

Frequency (MHz)	Emission Level (dBuV/m)	Read Level (dBuV)	Limit (dBuV/m)	Margin (dB)	Antenna Factor (dB/m)	Cable Loss (dB)	Preamp Factor (dB)	Antenna Height (cm)	Table Angle (Degree)	Remark
2387.13	57.1	63.61	74	-16.9	26.91	4.08	37.5	100	44	Peak
2389.83	41.91	48.44	54	-12.09	26.91	4.08	37.52	100	44	Average
2437	95.04	101.32			27.06	4.12	37.46	100	44	Average
2437	102.08	108.36			27.06	4.12	37.46	100	44	Peak
2484.04	40.49	46.51	54	-13.51	27.15	4.15	37.32	100	44	Average
2487.32	52.57	58.58	74	-21.43	27.15	4.16	37.32	100	44	Peak
4874	36.11	51.25	54	-17.89	31.06	6.85	53.05	100	180	Average
4874	44.7	59.84	74	-29.3	31.06	6.85	53.05	100	180	Peak

Remarks:

- Emission Level = Read Level + Antenna Factor + Cable Loss - Preamp Factor
Margin value = Emission level – Limit value
- 2437 MHz: Fundamental frequency.

EUT Test Condition		Measurement Detail	
Channel	Channel 11	Frequency Range	1 GHz ~ 25 GHz
Input Power	120 Vac, 60 Hz	Detector Function	Peak (PK) Average (AV)
Environmental Conditions	25 deg. C, 65 % RH	Tested By	Gavin Wu

Horizontal

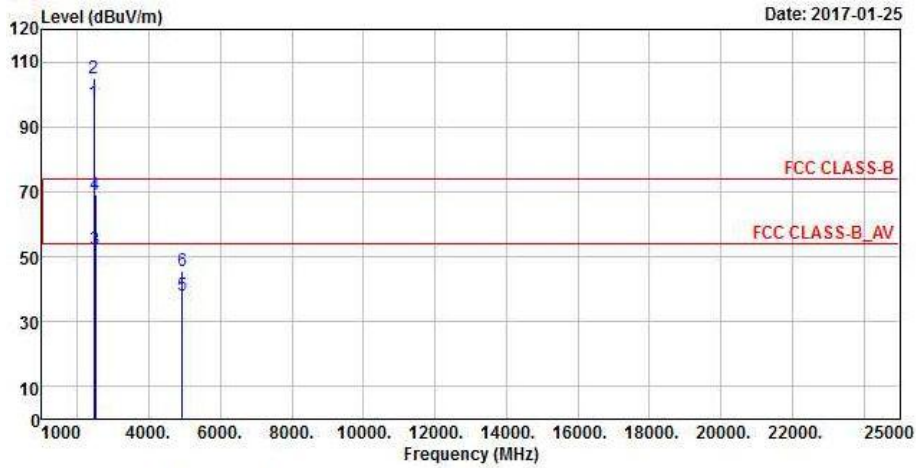

Vertical

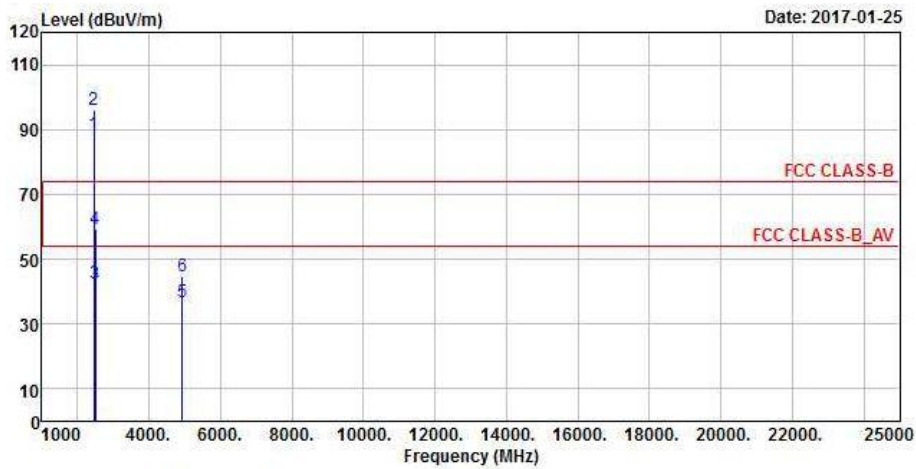

Antennal Polarity & Test Distance: Horizontal at 3 m

Frequency (MHz)	Emission Level (dBuV/m)	Read Level (dBuV)	Limit (dBuV/m)	Margin (dB)	Antenna Factor (dB/m)	Cable Loss (dB)	Preamp Factor (dB)	Antenna Height (cm)	Table Angle (Degree)	Remark
2462	97.5	103.66			27.1	4.13	37.39	118	286	Average
2462	105.14	111.3			27.1	4.13	37.39	118	286	Peak
2483.68	52.11	58.13	54	-1.89	27.15	4.15	37.32	118	286	Average
2484.04	68.98	75	74	-5.02	27.15	4.15	37.32	118	286	Peak
4924	37.93	52.96	54	-16.07	31.12	6.88	53.03	102	193	Average
4924	45.4	60.43	74	-28.6	31.12	6.88	53.03	102	193	Peak

Antennal Polarity & Test Distance: Vertical at 3 m

Frequency (MHz)	Emission Level (dBuV/m)	Read Level (dBuV)	Limit (dBuV/m)	Margin (dB)	Antenna Factor (dB/m)	Cable Loss (dB)	Preamp Factor (dB)	Antenna Height (cm)	Table Angle (Degree)	Remark
2462	88.49	94.65			27.1	4.13	37.39	100	12	Average
2462	96.02	102.18			27.1	4.13	37.39	100	12	Peak
2483.6	42.61	48.63	54	-11.39	27.15	4.15	37.32	100	12	Average
2484.28	59.5	65.52	74	-14.5	27.15	4.15	37.32	100	12	Peak
4924	36.84	51.87	54	-17.16	31.12	6.88	53.03	100	165	Average
4924	44.53	59.56	74	-29.47	31.12	6.88	53.03	100	165	Peak

Remarks:

- Emission Level = Read Level + Antenna Factor + Cable Loss - Preamp Factor
Margin value = Emission level – Limit value
- 2462 MHz: Fundamental frequency.

802.11n (HT20)

EUT Test Condition		Measurement Detail	
Channel	Channel 1	Frequency Range	1 GHz ~ 25 GHz
Input Power	120 Vac, 60 Hz	Detector Function	Peak (PK) Average (AV)
Environmental Conditions	25 deg. C, 65 % RH	Tested By	Gavin Wu

Horizontal

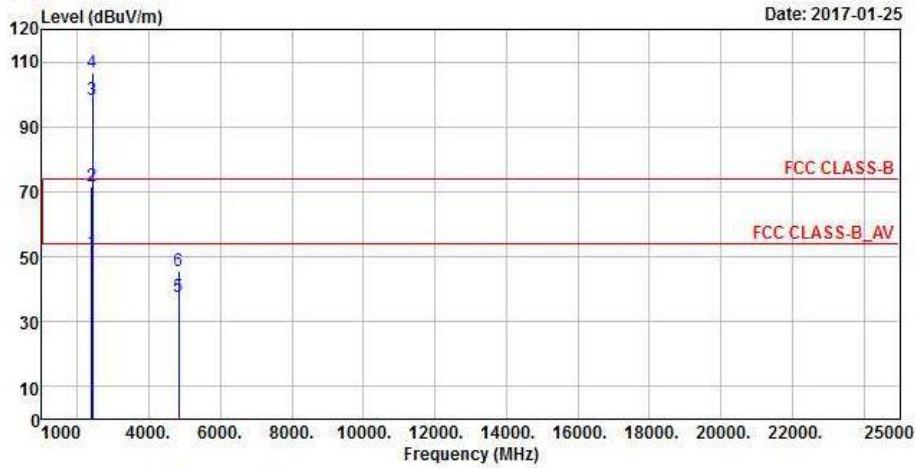

Vertical

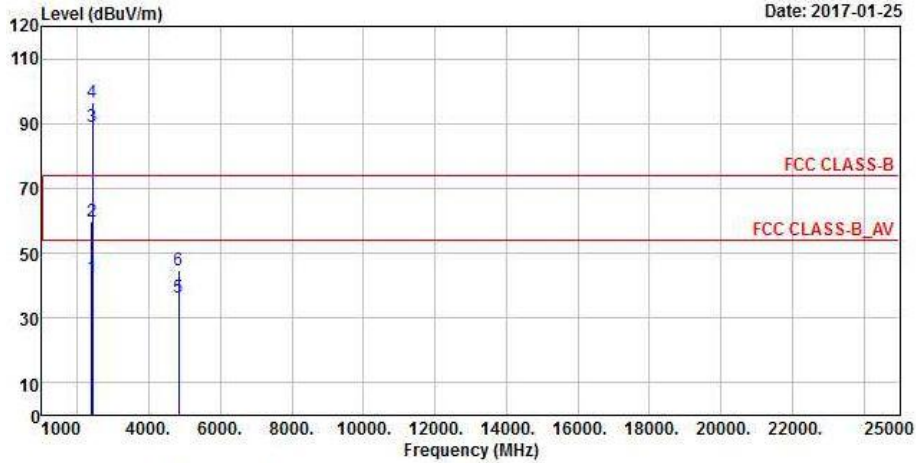

Antennal Polarity & Test Distance: Horizontal at 3 m

Frequency (MHz)	Emission Level (dBuV/m)	Read Level (dBuV)	Limit (dBuV/m)	Margin (dB)	Antenna Factor (dB/m)	Cable Loss (dB)	Preamp Factor (dB)	Antenna Height (cm)	Table Angle (Degree)	Remark
2388.57	51.36	57.87	54	-2.64	26.91	4.08	37.5	106	298	Average
2389.02	71.72	78.23	74	-2.28	26.91	4.08	37.5	106	298	Peak
2412	98.2	104.67			26.96	4.09	37.52	106	298	Average
2412	106.62	113.09			26.96	4.09	37.52	106	298	Peak
4824	37.55	52.85	54	-16.45	30.99	6.79	53.08	102	147	Average
4824	45.82	61.12	74	-28.18	30.99	6.79	53.08	102	147	Peak

Antennal Polarity & Test Distance: Vertical at 3 m

Frequency (MHz)	Emission Level (dBuV/m)	Read Level (dBuV)	Limit (dBuV/m)	Margin (dB)	Antenna Factor (dB/m)	Cable Loss (dB)	Preamp Factor (dB)	Antenna Height (cm)	Table Angle (Degree)	Remark
2388.93	42.55	49.06	54	-11.45	26.91	4.08	37.5	100	12	Average
2389.65	59.84	66.35	74	-14.16	26.91	4.08	37.5	100	12	Peak
2412	89.13	95.6			26.96	4.09	37.52	100	12	Average
2412	96.63	103.1			26.96	4.09	37.52	100	12	Peak
4824	36.25	51.55	54	-17.75	30.99	6.79	53.08	100	135	Average
4824	44.83	60.13	74	-29.17	30.99	6.79	53.08	100	135	Peak

Remarks:

- Emission Level = Read Level + Antenna Factor + Cable Loss - Preamp Factor
Margin value = Emission level – Limit value
- 2412 MHz: Fundamental frequency.

EUT Test Condition		Measurement Detail	
Channel	Channel 6	Frequency Range	1 GHz ~ 25 GHz
Input Power	120 Vac, 60 Hz	Detector Function	Peak (PK) Average (AV)
Environmental Conditions	25 deg. C, 65 % RH	Tested By	Gavin Wu

Horizontal

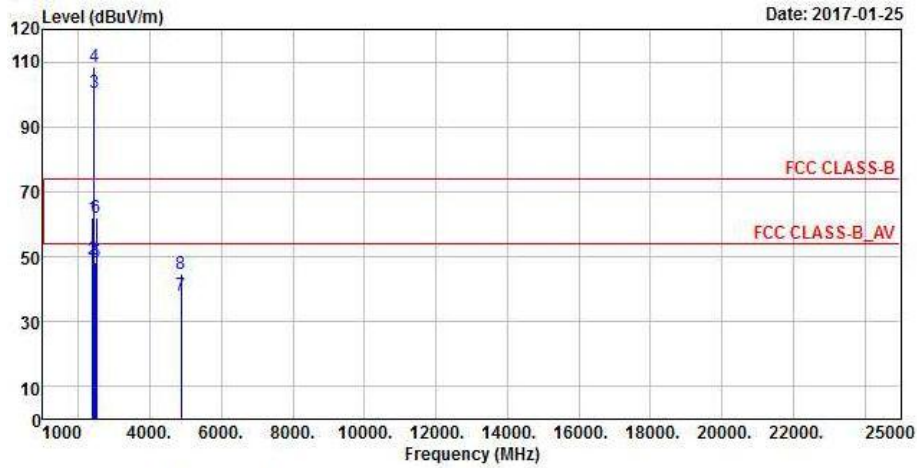

Vertical

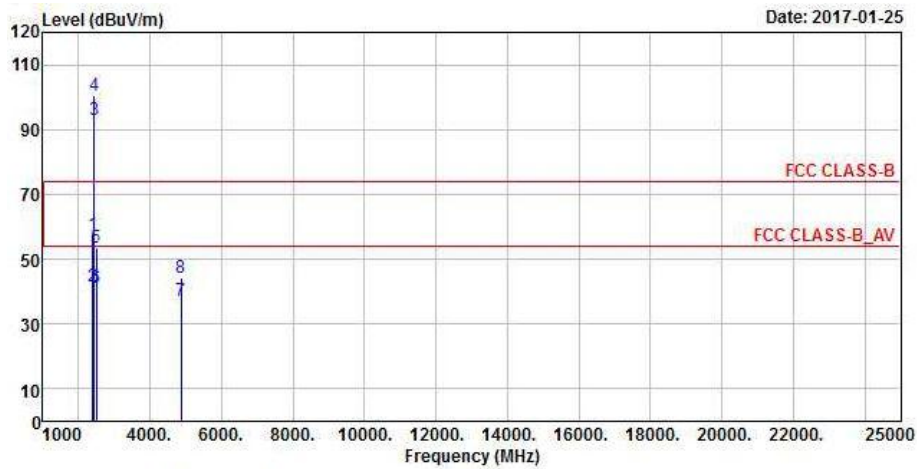

Antennal Polarity & Test Distance: Horizontal at 3 m

Frequency (MHz)	Emission Level (dBuV/m)	Read Level (dBuV)	Limit (dBuV/m)	Margin (dB)	Antenna Factor (dB/m)	Cable Loss (dB)	Preamp Factor (dB)	Antenna Height (cm)	Table Angle (Degree)	Remark
2388.57	62.07	68.58	74	-11.93	26.91	4.08	37.5	106	299	Peak
2389.83	48.98	55.51	54	-5.02	26.91	4.08	37.52	106	299	Average
2437	100.72	107			27.06	4.12	37.46	106	299	Average
2437	108.57	114.85			27.06	4.12	37.46	106	299	Peak
2483.68	48.09	54.11	54	-5.91	27.15	4.15	37.32	106	299	Average
2485.6	62.02	68.04	74	-11.98	27.15	4.15	37.32	106	299	Peak
4874	37.86	53	54	-16.14	31.06	6.85	53.05	100	177	Average
4874	44.56	59.7	74	-29.44	31.06	6.85	53.05	100	177	Peak

Antennal Polarity & Test Distance: Vertical at 3 m

Frequency (MHz)	Emission Level (dBuV/m)	Read Level (dBuV)	Limit (dBuV/m)	Margin (dB)	Antenna Factor (dB/m)	Cable Loss (dB)	Preamp Factor (dB)	Antenna Height (cm)	Table Angle (Degree)	Remark
2385.24	57.7	64.26	74	-16.3	26.86	4.08	37.5	100	7	Peak
2387.49	41.6	48.11	54	-12.4	26.91	4.08	37.5	100	7	Average
2437	92.95	99.23			27.06	4.12	37.46	100	7	Average
2437	100.38	106.66			27.06	4.12	37.46	100	7	Peak
2485	53.71	59.73	74	-20.29	27.15	4.15	37.32	100	7	Peak
2485.56	41.27	47.29	54	-12.73	27.15	4.15	37.32	100	7	Average
4874	37.29	52.43	54	-16.71	31.06	6.85	53.05	103	120	Average
4874	44.29	59.43	74	-29.71	31.06	6.85	53.05	103	120	Peak

Remarks:

- Emission Level = Read Level + Antenna Factor + Cable Loss - Preamp Factor
Margin value = Emission level – Limit value
- 2437 MHz: Fundamental frequency.

EUT Test Condition		Measurement Detail	
Channel	Channel 11	Frequency Range	1 GHz ~ 25 GHz
Input Power	120 Vac, 60 Hz	Detector Function	Peak (PK) Average (AV)
Environmental Conditions	25 deg. C, 65 % RH	Tested By	Gavin Wu

Horizontal

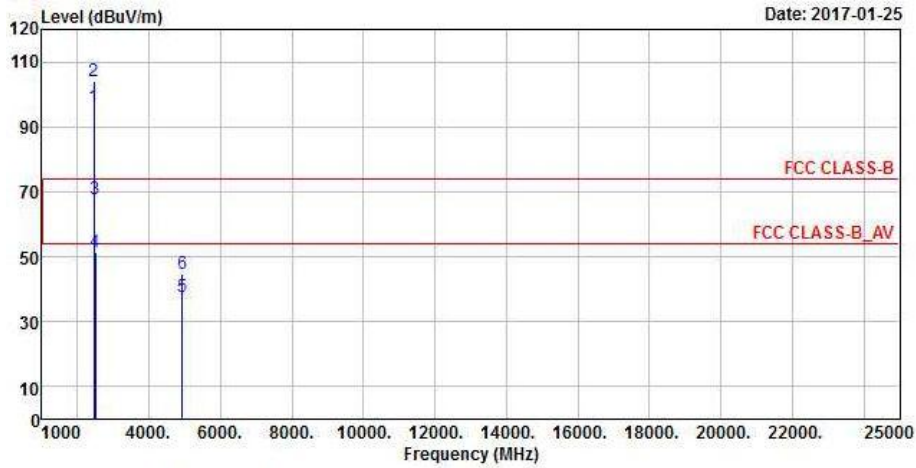

Vertical

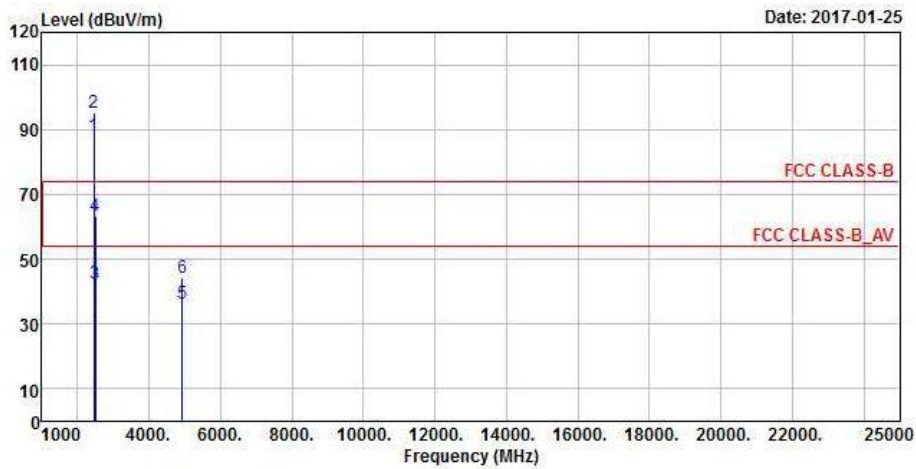

Antennal Polarity & Test Distance: Horizontal at 3 m

Frequency (MHz)	Emission Level (dBuV/m)	Read Level (dBuV)	Limit (dBuV/m)	Margin (dB)	Antenna Factor (dB/m)	Cable Loss (dB)	Preamp Factor (dB)	Antenna Height (cm)	Table Angle (Degree)	Remark
2462	96.06	102.22			27.1	4.13	37.39	104	301	Average
2462	104.17	110.33			27.1	4.13	37.39	104	301	Peak
2483.96	67.96	73.98	74	-6.04	27.15	4.15	37.32	104	301	Peak
2484.24	51.23	57.25	54	-2.77	27.15	4.15	37.32	104	301	Average
4924	37.85	52.88	54	-16.15	31.12	6.88	53.03	104	176	Average
4924	44.51	59.54	74	-29.49	31.12	6.88	53.03	104	176	Peak

Antennal Polarity & Test Distance: Vertical at 3 m

Frequency (MHz)	Emission Level (dBuV/m)	Read Level (dBuV)	Limit (dBuV/m)	Margin (dB)	Antenna Factor (dB/m)	Cable Loss (dB)	Preamp Factor (dB)	Antenna Height (cm)	Table Angle (Degree)	Remark
2462	88	94.16			27.1	4.13	37.39	100	13	Average
2462	95.19	101.35			27.1	4.13	37.39	100	13	Peak
2483.52	42.35	48.37	54	-11.65	27.15	4.15	37.32	100	13	Average
2484.48	63.11	69.13	74	-10.89	27.15	4.15	37.32	100	13	Peak
4924	36.42	51.45	54	-17.58	31.12	6.88	53.03	100	116	Average
4924	44.24	59.27	74	-29.76	31.12	6.88	53.03	100	116	Peak

Remarks:

- Emission Level = Read Level + Antenna Factor + Cable Loss - Preamp Factor
Margin value = Emission level – Limit value
- 2462 MHz: Fundamental frequency.

<For Reference>

802.11b

EUT Test Condition		Measurement Detail	
Channel	Channel 2	Frequency Range	1 GHz ~ 3 GHz
Input Power	120 Vac, 60 Hz	Detector Function	Peak (PK) Average (AV)
Environmental Conditions	25 deg. C, 65 % RH	Tested By	Gavin Wu

Horizontal

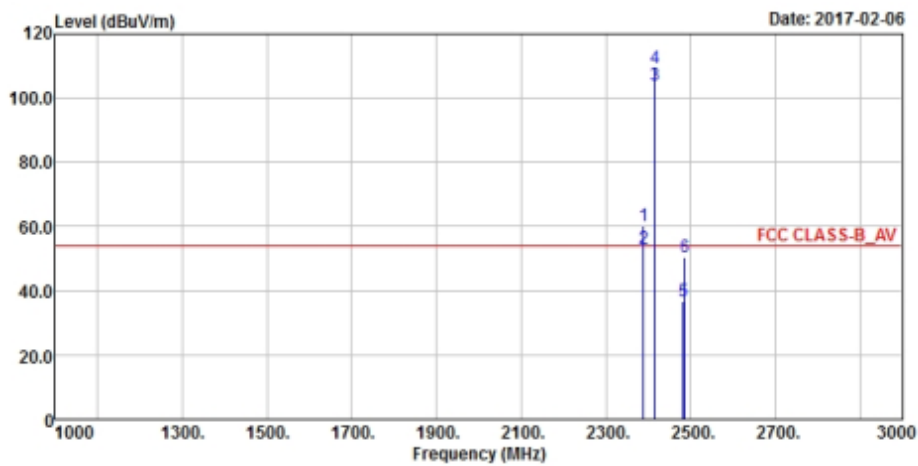

Vertical

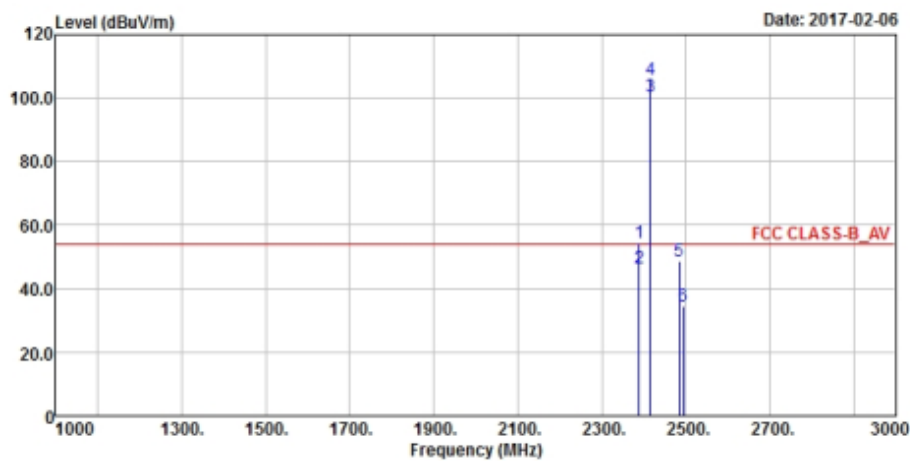

Antennal Polarity & Test Distance: Horizontal at 3 m

Frequency (MHz)	Emission Level (dBuV/m)	Read Level (dBuV)	Limit (dBuV/m)	Margin (dB)	Antenna Factor (dB/m)	Cable Loss (dB)	Preamp Factor (dB)	Antenna Height (cm)	Table Angle (Degree)	Remark
2389.74	60.05	66.28	74	-13.95	26.91	4.36	37.5	107	300	Peak
2389.92	53.36	59.61	54	-0.64	26.91	4.36	37.52	107	300	Average
2417	104.08	110.2			26.96	4.38	37.46	107	300	Average
2417	109.33	115.45			26.96	4.38	37.46	107	300	Peak
2483.84	36.61	42.35	54	-17.39	27.15	4.43	37.32	107	300	Average
2487.56	50.61	56.3	74	-23.39	27.2	4.43	37.32	107	300	Peak

Antennal Polarity & Test Distance: Vertical at 3 m

Frequency (MHz)	Emission Level (dBuV/m)	Read Level (dBuV)	Limit (dBuV/m)	Margin (dB)	Antenna Factor (dB/m)	Cable Loss (dB)	Preamp Factor (dB)	Antenna Height (cm)	Table Angle (Degree)	Remark
2389.56	54.28	60.51	74	-19.72	26.91	4.36	37.5	112	42	Peak
2389.92	46.3	52.55	54	-7.7	26.91	4.36	37.52	112	42	Average
2417	100.59	106.71			26.96	4.38	37.46	112	42	Average
2417	105.73	111.85			26.96	4.38	37.46	112	42	Peak
2484.72	48.87	54.61	74	-25.13	27.15	4.43	37.32	112	42	Peak
2495	34.62	40.23	54	-19.38	27.2	4.44	37.25	112	42	Average

Remarks:

- Emission Level = Read Level + Antenna Factor + Cable Loss - Preamp Factor
Margin value = Emission level – Limit value
- 2417 MHz: Fundamental frequency.

EUT Test Condition		Measurement Detail	
Channel	Channel 10	Frequency Range	1 GHz ~ 3 GHz
Input Power	120 Vac, 60 Hz	Detector Function	Peak (PK) Average (AV)
Environmental Conditions	25 deg. C, 65 % RH	Tested By	Gavin Wu

Horizontal

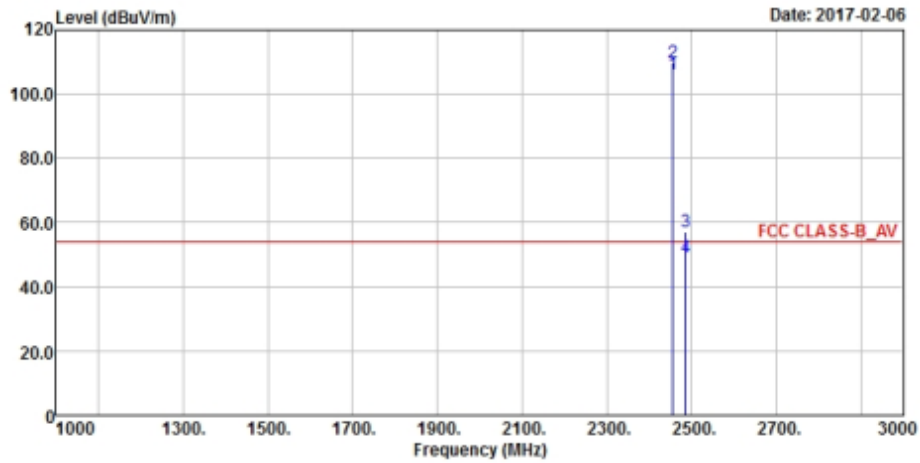

Vertical

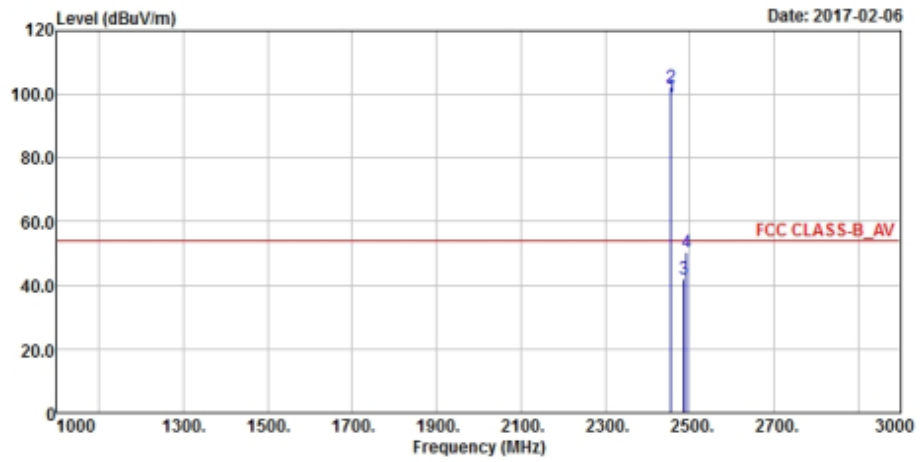

Antennal Polarity & Test Distance: Horizontal at 3 m

Frequency (MHz)	Emission Level (dBuV/m)	Read Level (dBuV)	Limit (dBuV/m)	Margin (dB)	Antenna Factor (dB/m)	Cable Loss (dB)	Preamp Factor (dB)	Antenna Height (cm)	Table Angle (Degree)	Remark
2457	106.31	112.47			27.1	4.13	37.39	120	305	Average
2457	109.66	115.82			27.1	4.13	37.39	120	305	Peak
2486.52	56.96	62.98	74	-17.04	27.15	4.15	37.32	120	305	Peak
2487.16	49.29	55.31	54	-4.71	27.15	4.15	37.32	120	305	Average

Antennal Polarity & Test Distance: Vertical at 3 m

Frequency (MHz)	Emission Level (dBuV/m)	Read Level (dBuV)	Limit (dBuV/m)	Margin (dB)	Antenna Factor (dB/m)	Cable Loss (dB)	Preamp Factor (dB)	Antenna Height (cm)	Table Angle (Degree)	Remark
2457	99.01	105.17			27.1	4.13	37.39	100	21	Average
2457	102.22	108.38			27.1	4.13	37.39	100	21	Peak
2487.2	41.97	47.98	54	-12.03	27.15	4.16	37.32	100	21	Average
2494.04	50.55	56.44	74	-23.45	27.2	4.16	37.25	100	21	Peak

Remarks:

- Emission Level = Read Level + Antenna Factor + Cable Loss - Preamp Factor
Margin value = Emission level – Limit value
- 2457 MHz: Fundamental frequency.

802.11g

EUT Test Condition		Measurement Detail	
Channel	Channel 2	Frequency Range	1 GHz ~ 3 GHz
Input Power	120 Vac, 60 Hz	Detector Function	Peak (PK) Average (AV)
Environmental Conditions	25 deg. C, 65 % RH	Tested By	Gavin Wu

Horizontal

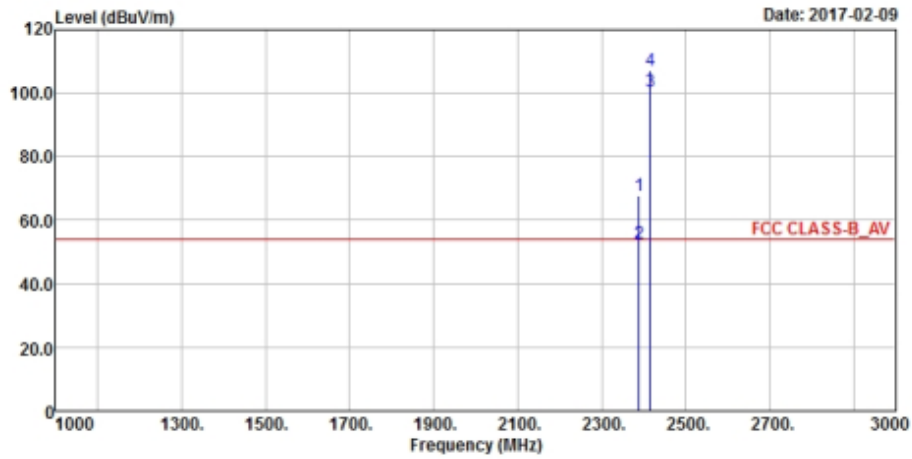

Vertical

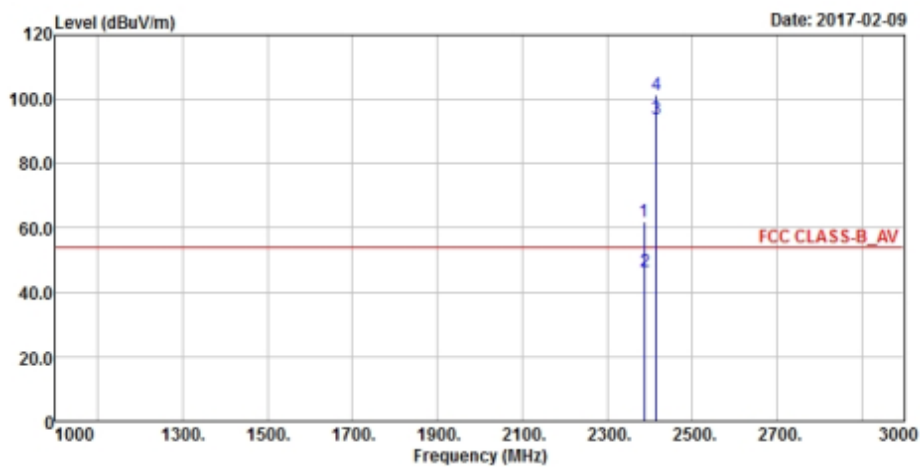

Antennal Polarity & Test Distance: Horizontal at 3 m

Frequency (MHz)	Emission Level (dBuV/m)	Read Level (dBuV)	Limit (dBuV/m)	Margin (dB)	Antenna Factor (dB/m)	Cable Loss (dB)	Preamp Factor (dB)	Antenna Height (cm)	Table Angle (Degree)	Remark
2389.2	67.55	74.06	74	-6.45	26.91	4.08	37.5	137	288	Peak
2389.38	52.75	59.26	54	-1.25	26.91	4.08	37.5	137	288	Average
2417	100.69	107.08			26.96	4.11	37.46	137	288	Average
2417	107.23	113.62			26.96	4.11	37.46	137	288	Peak

Antennal Polarity & Test Distance: Vertical at 3 m

Frequency (MHz)	Emission Level (dBuV/m)	Read Level (dBuV)	Limit (dBuV/m)	Margin (dB)	Antenna Factor (dB/m)	Cable Loss (dB)	Preamp Factor (dB)	Antenna Height (cm)	Table Angle (Degree)	Remark
2387.13	62.16	68.67	74	-11.84	26.91	4.08	37.5	100	38	Peak
2389.83	46.67	53.2	54	-7.33	26.91	4.08	37.52	100	38	Average
2417	94.08	100.47			26.96	4.11	37.46	100	38	Average
2417	101.62	108.01			26.96	4.11	37.46	100	38	Peak

Remarks:

- Emission Level = Read Level + Antenna Factor + Cable Loss - Preamp Factor
Margin value = Emission level – Limit value
- 2417 MHz: Fundamental frequency.

EUT Test Condition		Measurement Detail	
Channel	Channel 10	Frequency Range	1 GHz ~ 3 GHz
Input Power	120 Vac, 60 Hz	Detector Function	Peak (PK) Average (AV)
Environmental Conditions	25 deg. C, 65 % RH	Tested By	Gavin Wu

Horizontal

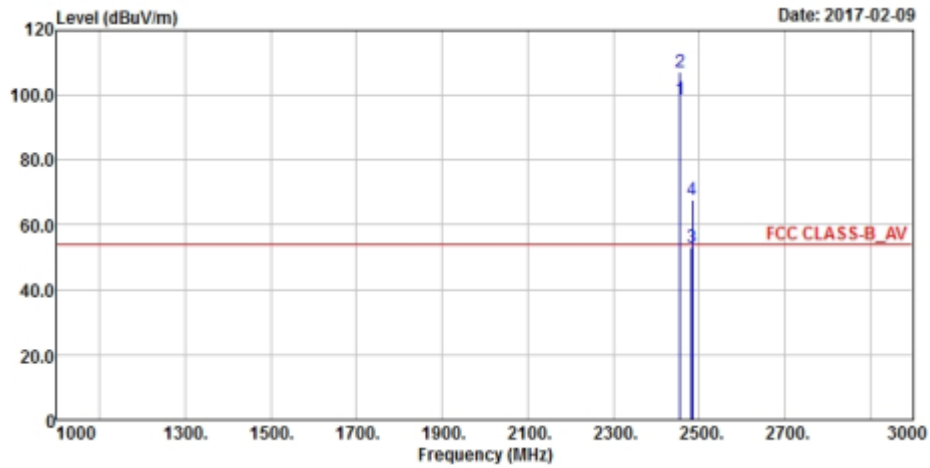

Vertical

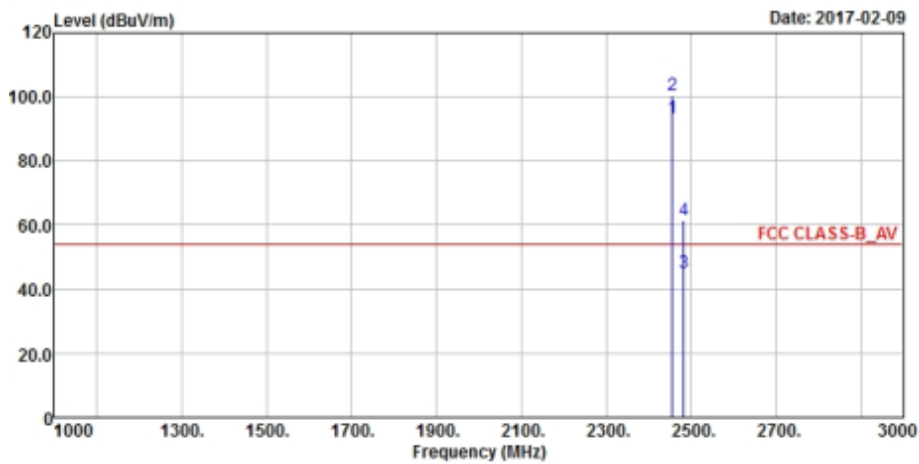

Antennal Polarity & Test Distance: Horizontal at 3 m

Frequency (MHz)	Emission Level (dBuV/m)	Read Level (dBuV)	Limit (dBuV/m)	Margin (dB)	Antenna Factor (dB/m)	Cable Loss (dB)	Preamp Factor (dB)	Antenna Height (cm)	Table Angle (Degree)	Remark
2457	98.73	104.89			27.1	4.13	37.39	134	291	Average
2457	107.36	113.52			27.1	4.13	37.39	134	291	Peak
2483.68	52.95	58.97	54	-1.05	27.15	4.15	37.32	134	291	Average
2484.92	67.71	73.73	74	-6.29	27.15	4.15	37.32	134	291	Peak

Antennal Polarity & Test Distance: Vertical at 3 m

Frequency (MHz)	Emission Level (dBuV/m)	Read Level (dBuV)	Limit (dBuV/m)	Margin (dB)	Antenna Factor (dB/m)	Cable Loss (dB)	Preamp Factor (dB)	Antenna Height (cm)	Table Angle (Degree)	Remark
2457	93.25	99.41			27.1	4.13	37.39	110	39	Average
2457	100.43	106.59			27.1	4.13	37.39	110	39	Peak
2483.52	45.34	51.36	54	-8.66	27.15	4.15	37.32	110	39	Average
2483.84	61.46	67.48	74	-12.54	27.15	4.15	37.32	110	39	Peak

Remarks:

- Emission Level = Read Level + Antenna Factor + Cable Loss - Preamp Factor
Margin value = Emission level – Limit value
- 2457 MHz: Fundamental frequency.

802.11n (HT20)

EUT Test Condition		Measurement Detail	
Channel	Channel 2	Frequency Range	1 GHz ~ 3 GHz
Input Power	120 Vac, 60 Hz	Detector Function	Peak (PK) Average (AV)
Environmental Conditions	25 deg. C, 65 % RH	Tested By	Gavin Wu

Horizontal

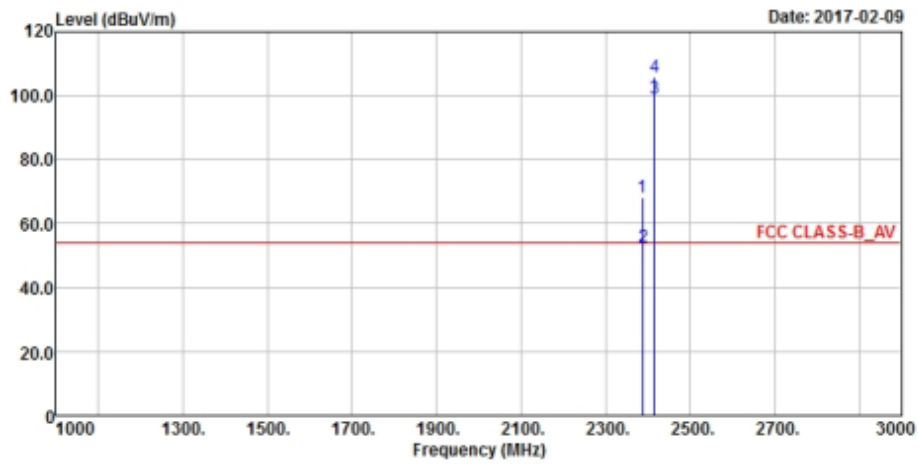

Vertical

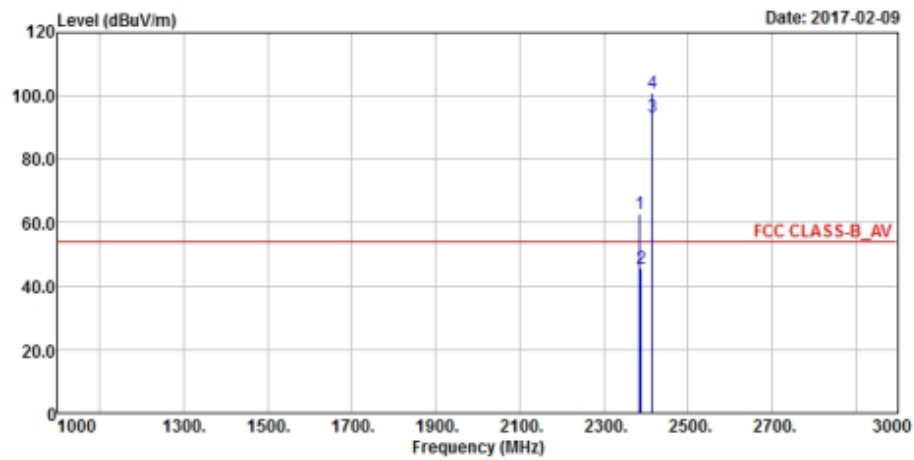

Antennal Polarity & Test Distance: Horizontal at 3 m

Frequency (MHz)	Emission Level (dBuV/m)	Read Level (dBuV)	Limit (dBuV/m)	Margin (dB)	Antenna Factor (dB/m)	Cable Loss (dB)	Preamp Factor (dB)	Antenna Height (cm)	Table Angle (Degree)	Remark
2388.3	68.35	74.86	74	-5.65	26.91	4.08	37.5	122	294	Peak
2388.75	52.84	59.35	54	-1.16	26.91	4.08	37.5	122	294	Average
2417	99.02	105.41			26.96	4.11	37.46	122	294	Average
2417	105.82	112.21			26.96	4.11	37.46	122	294	Peak

Antennal Polarity & Test Distance: Vertical at 3 m

Frequency (MHz)	Emission Level (dBuV/m)	Read Level (dBuV)	Limit (dBuV/m)	Margin (dB)	Antenna Factor (dB/m)	Cable Loss (dB)	Preamp Factor (dB)	Antenna Height (cm)	Table Angle (Degree)	Remark
2385.78	62.94	69.45	74	-11.06	26.91	4.08	37.5	114	38	Peak
2389.74	45.54	52.05	54	-8.46	26.91	4.08	37.5	114	38	Average
2417	93.45	99.84			26.96	4.11	37.46	114	38	Average
2417	100.81	107.2			26.96	4.11	37.46	114	38	Peak

Remarks:

- Emission Level = Read Level + Antenna Factor + Cable Loss - Preamp Factor
Margin value = Emission level – Limit value
- 2417 MHz: Fundamental frequency.

EUT Test Condition		Measurement Detail	
Channel	Channel 10	Frequency Range	1 GHz ~ 3 GHz
Input Power	120 Vac, 60 Hz	Detector Function	Peak (PK) Average (AV)
Environmental Conditions	25 deg. C, 65 % RH	Tested By	Gavin Wu

Horizontal

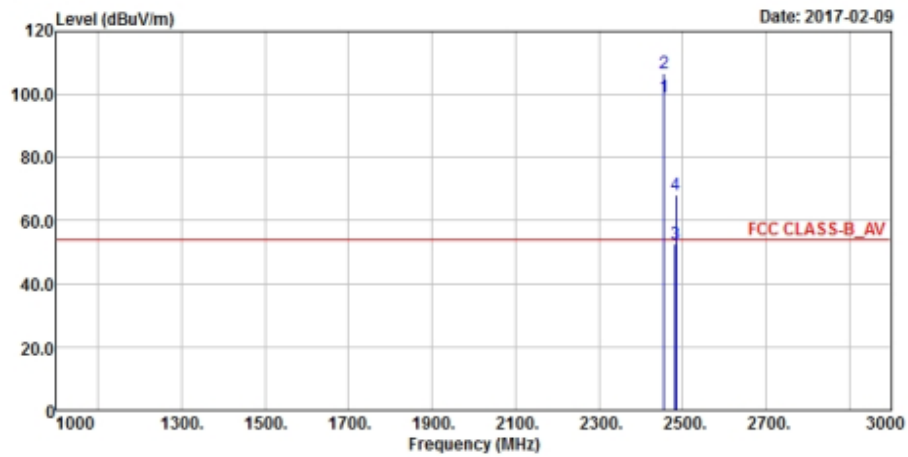

Vertical

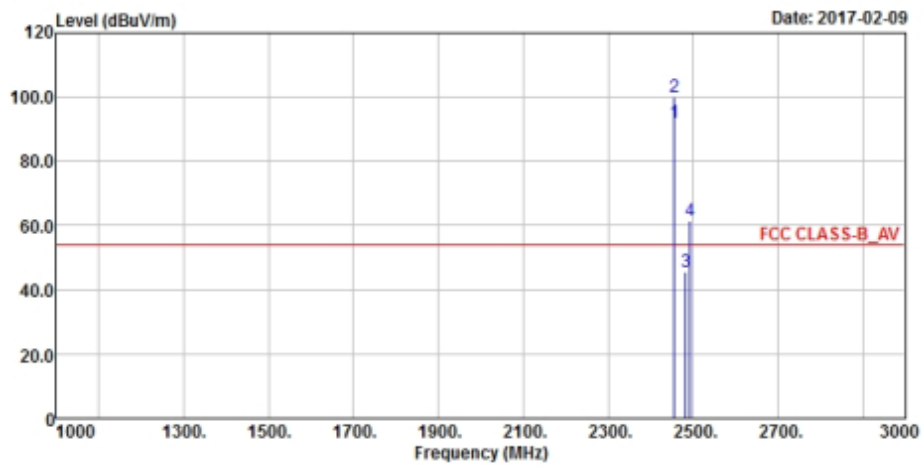

Antennal Polarity & Test Distance: Horizontal at 3 m

Frequency (MHz)	Emission Level (dBuV/m)	Read Level (dBuV)	Limit (dBuV/m)	Margin (dB)	Antenna Factor (dB/m)	Cable Loss (dB)	Preamp Factor (dB)	Antenna Height (cm)	Table Angle (Degree)	Remark
2457	99.36	105.52			27.1	4.13	37.39	119	294	Average
2457	106.55	112.71			27.1	4.13	37.39	119	294	Peak
2483.72	52.74	58.76	54	-1.26	27.15	4.15	37.32	119	294	Average
2484.64	68.2	74.22	74	-5.8	27.15	4.15	37.32	119	294	Peak

Antennal Polarity & Test Distance: Vertical at 3 m

Frequency (MHz)	Emission Level (dBuV/m)	Read Level (dBuV)	Limit (dBuV/m)	Margin (dB)	Antenna Factor (dB/m)	Cable Loss (dB)	Preamp Factor (dB)	Antenna Height (cm)	Table Angle (Degree)	Remark
2457	92.27	98.43			27.1	4.13	37.39	110	37	Average
2457	99.9	106.06			27.1	4.13	37.39	110	37	Peak
2483.56	45.41	51.43	54	-8.59	27.15	4.15	37.32	110	37	Average
2493.32	61.33	67.22	74	-12.67	27.2	4.16	37.25	110	37	Peak

Remarks:

- Emission Level = Read Level + Antenna Factor + Cable Loss - Preamp Factor
Margin value = Emission level – Limit value
- 2457 MHz: Fundamental frequency.

9 kHz ~ 30 MHz DATA:

The amplitude of spurious emissions attenuated more than 20 dB below the permissible value is not required to be report.

The Low Frequency, which started from 9KHz to 30MHz, was pre-scanned and the result which was 20 dB lower than the limit line was not reported.

30 MHz ~ 1 GHz WORST-CASE DATA:

802.11g

EUT Test Condition		Measurement Detail	
Channel	Channel 11	Frequency Range	30 MHz ~ 1 GHz
Input Power	120 Vac, 60 Hz	Detector Function	Peak (PK) Quasi-peak (QP)
Environmental Conditions	25 deg. C, 65 % RH	Tested By	Gavin Wu

Horizontal

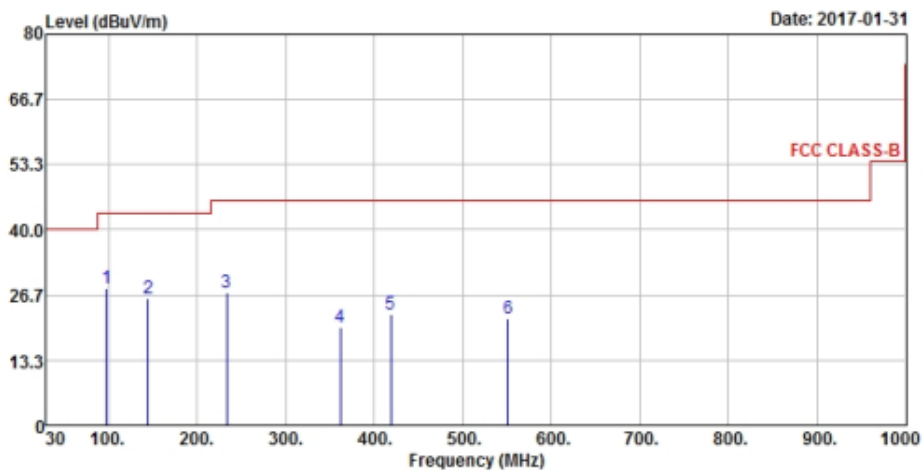

Vertical

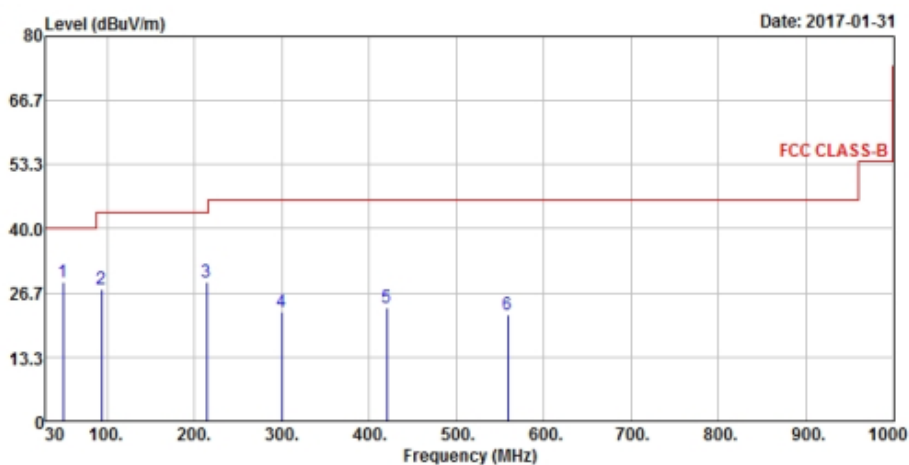

Antennal Polarity & Test Distance: Horizontal at 3 m

Frequency (MHz)	Emission Level (dBuV/m)	Read Level (dBuV)	Limit (dBuV/m)	Margin (dB)	Antenna Factor (dB/m)	Cable Loss (dB)	Preamp Factor (dB)	Antenna Height (cm)	Table Angle (Degree)	Remark
97.9	28.1	50.12	43.5	-15.4	8.91	1.03	31.96	118	201	Peak
144.46	25.95	43.91	43.5	-17.55	12.51	1.16	31.63	112	123	Peak
233.7	27.23	46.84	46	-18.77	10.79	1.43	31.83	110	82	Peak
361.74	20.07	35.8	46	-25.93	14.43	1.8	31.96	107	207	Peak
418.97	22.65	37.04	46	-23.35	15.71	1.94	32.04	116	332	Peak
550.89	21.84	33.14	46	-24.16	18.48	2.18	31.96	140	299	Peak

Antennal Polarity & Test Distance: Vertical at 3 m

Frequency (MHz)	Emission Level (dBuV/m)	Read Level (dBuV)	Limit (dBuV/m)	Margin (dB)	Antenna Factor (dB/m)	Cable Loss (dB)	Preamp Factor (dB)	Antenna Height (cm)	Table Angle (Degree)	Remark
49.4	28.91	46.41	40	-11.09	13.08	0.7	31.28	103	236	Peak
94.02	27.32	49.67	43.5	-16.18	8.6	1.01	31.96	105	242	Peak
214.3	28.86	49.18	43.5	-14.64	9.97	1.35	31.64	139	105	Peak
299.66	22.71	39.98	46	-23.29	12.94	1.63	31.84	137	191	Peak
419.94	23.48	37.86	46	-22.52	15.73	1.94	32.05	130	298	Peak
558.65	22.06	33.26	46	-23.94	18.66	2.19	32.05	123	189	Peak

Remarks:

- Emission Level = Read Level + Antenna Factor + Cable Loss - Preamp Factor
Margin value = Emission level – Limit value

4.2 Conducted Emission Measurement

4.2.1 Limits of Conducted Emission Measurement

Frequency (MHz)	Conducted Limit (dBuV)	
	Quasi-peak	Average
0.15 - 0.5	66 - 56	56 - 46
0.50 - 5.0	56	46
5.0 - 30.0	60	50

Note: 1. The lower limit shall apply at the transition frequencies.

2. The limit decreases in line with the logarithm of the frequency in the range of 0.15 to 0.50 MHz.

4.2.2 Test Instruments

Description & Manufacturer	Model No.	Serial No.	Date Of Calibration	Due Date Of Calibration
Test Receiver ROHDE & SCHWARZ	ESCI	100613	Nov. 21, 2016	Nov. 20, 2017
RF signal cable (with 10dB PAD) Woken	5D-FB	Cable-cond1-01	Dec. 22, 2016	Dec. 21, 2017
LISN ROHDE & SCHWARZ (EUT)	ESH3-Z5	835239/001	Mar. 10, 2017	Mar. 09, 2018
LISN ROHDE & SCHWARZ (Peripheral)	ESH3-Z5	100311	Jul. 28, 2016	Jul. 27, 2017
Software ADT	BV ADT_Cond_ V7.3.7.3	NA	NA	NA

NOTE: 1. The calibration interval of the above test instruments is 12 months and the calibrations are traceable to NML/ROC and NIST/USA.

2. The test was performed in HwaYa Shielded Room 1.

3. The VCCI Site Registration No. is C-2040.

4.2.3 Test Procedures

- a. The EUT was placed 0.4 meters from the conducting wall of the shielded room with EUT being connected to the power mains through a line impedance stabilization network (LISN). Other support units were connected to the power mains through another LISN. The two LISNs provide 50 ohm/50 uH of coupling impedance for the measuring instrument.
- b. Both lines of the power mains connected to the EUT were checked for maximum conducted interference.
- c. The frequency range from 150 kHz to 30 MHz was searched. Emission levels under (Limit – 20 dB) was not recorded.

NOTE: All modes of operation were investigated and the worst-case emissions are reported.

4.2.4 Deviation from Test Standard

No deviation.

4.2.5 Test Setup

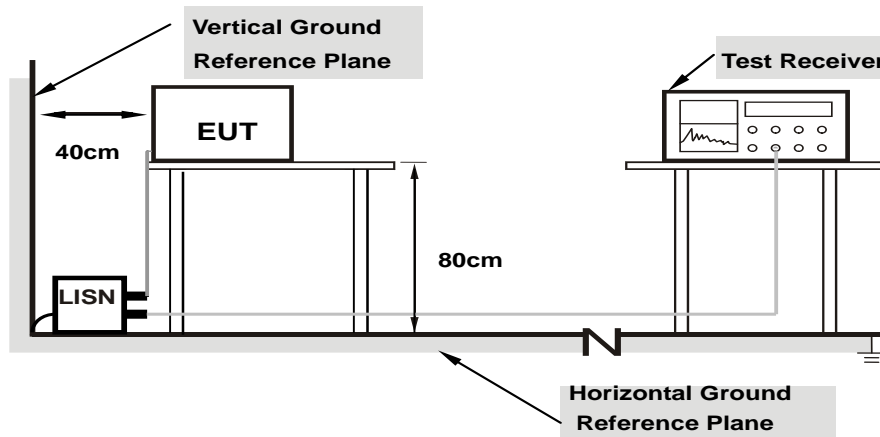

Note: 1. Support units were connected to second LISN.

For the actual test configuration, please refer to the attached file (Test Setup Photo).

4.2.6 EUT Operating Conditions

- a. Placed the EUT on a testing table.
- b. Use the software to control the EUT under transmission condition continuously at specific channel frequency.

4.2.7 Test Results

Frequency Range	150kHz ~ 30MHz	Detector Function & Resolution Bandwidth	Quasi-Peak (QP) / Average (AV), 9kHz
Input Power	120Vac, 60Hz	Environmental Conditions	25°C, 65%RH
Tested by	Getaz Yang	Test Date	2017/3/23

Phase Of Power : Line (L)										
No	Frequency (MHz)	Correction Factor (dB)	Reading Value (dBuV)		Emission Level (dBuV)		Limit (dBuV)		Margin (dB)	
			Q.P.	AV.	Q.P.	AV.	Q.P.	AV.	Q.P.	AV.
1	0.15000	10.34	34.71	19.61	45.05	29.95	66.00	56.00	-20.95	-26.05
2	0.22024	10.37	30.56	15.08	40.93	25.45	62.81	52.81	-21.88	-27.36
3	0.27512	10.38	28.07	13.62	38.45	24.00	60.96	50.96	-22.51	-26.96
4	0.61138	10.40	29.87	18.07	40.27	28.47	56.00	46.00	-15.73	-17.53
5	12.52906	10.96	16.84	12.65	27.80	23.61	60.00	50.00	-32.20	-26.39
6	29.59621	11.67	10.41	3.75	22.08	15.42	60.00	50.00	-37.92	-34.58

Remarks:

1. Q.P. and AV. are abbreviations of quasi-peak and average individually.
2. The emission levels of other frequencies were very low against the limit.
3. Margin value = Emission level – Limit value
4. Correction factor = Insertion loss + Cable loss
5. Emission Level = Correction Factor + Reading Value

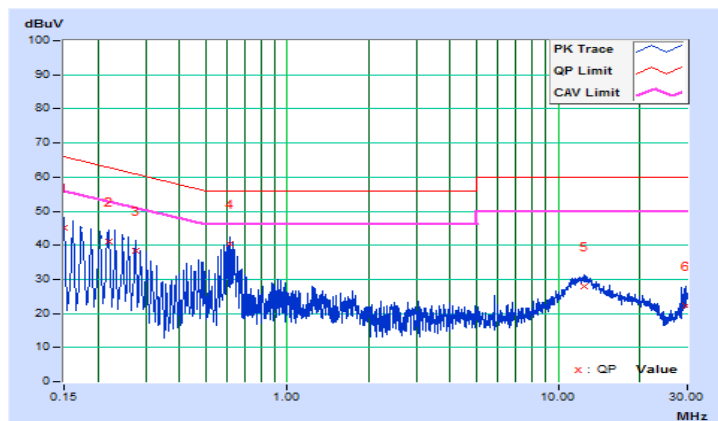

Frequency Range	150kHz ~ 30MHz	Detector Function & Resolution Bandwidth	Quasi-Peak (QP) / Average (AV), 9kHz
Input Power	120Vac, 60Hz	Environmental Conditions	25°C, 65%RH
Tested by	Getaz Yang	Test Date	2017/3/23

Phase Of Power : Neutral (N)										
No	Frequency (MHz)	Correction Factor (dB)	Reading Value (dBuV)		Emission Level (dBuV)		Limit (dBuV)		Margin (dB)	
			Q.P.	AV.	Q.P.	AV.	Q.P.	AV.	Q.P.	AV.
1	0.16967	10.12	29.29	17.56	39.41	27.68	64.98	54.98	-25.57	-27.30
2	0.22434	10.14	26.34	16.66	36.48	26.80	62.66	52.66	-26.18	-25.86
3	0.61138	10.16	30.46	24.10	40.62	34.26	56.00	46.00	-15.38	-11.74
4	1.78829	10.22	17.77	9.50	27.99	19.72	56.00	46.00	-28.01	-26.28
5	16.29439	10.81	11.24	1.51	22.05	12.32	60.00	50.00	-37.95	-37.68
6	29.43199	11.18	20.73	11.45	31.91	22.63	60.00	50.00	-28.09	-27.37

Remarks:

1. Q.P. and AV. are abbreviations of quasi-peak and average individually.
2. The emission levels of other frequencies were very low against the limit.
3. Margin value = Emission level – Limit value
4. Correction factor = Insertion loss + Cable loss
5. Emission Level = Correction Factor + Reading Value

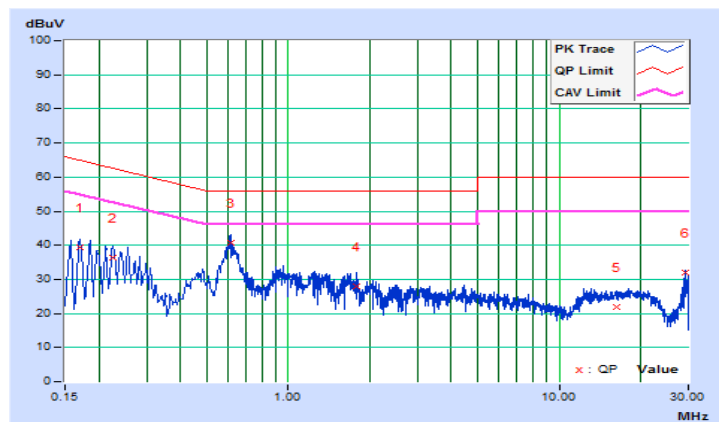

4.3 6 dB Bandwidth Measurement

4.3.1 Limits of 6 dB Bandwidth Measurement

The minimum of 6 dB Bandwidth Measurement is 0.5 MHz.

4.3.2 Test Setup

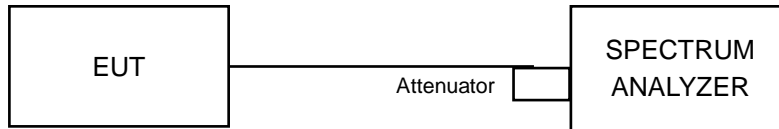

4.3.3 Test Instruments

Refer to section 4.1.2 to get information of above instrument.

4.3.4 Test Procedure

- Set resolution bandwidth (RBW) = 100 kHz
- Set the video bandwidth (VBW) $\geq 3 \times$ RBW, Detector = Peak.
- Trace mode = max hold.
- Sweep = auto couple.
- Measure the maximum width of the emission that is constrained by the frequencies associated with the two amplitude points (upper and lower) that are attenuated by 6 dB relative to the maximum level measured in the fundamental emission

4.3.5 Deviation from Test Standard

No deviation.

4.3.6 EUT Operating Conditions

The software provided by client to enable the EUT under transmission condition continuously at lowest, middle and highest channel frequencies individually.

4.3.7 Test Result

802.11b

Channel	Frequency (MHz)	6 dB Bandwidth (MHz)	Minimum Limit (MHz)	Pass / Fail
1	2412	8.07	0.5	Pass
6	2437	9.05	0.5	Pass
11	2462	8.08	0.5	Pass

802.11g

Channel	Frequency (MHz)	6 dB Bandwidth (MHz)	Minimum Limit (MHz)	Pass / Fail
1	2412	15.13	0.5	Pass
6	2437	15.15	0.5	Pass
11	2462	15.13	0.5	Pass

802.11n (HT20)

Channel	Frequency (MHz)	6 dB Bandwidth (MHz)	Minimum Limit (MHz)	Pass / Fail
1	2412	15.13	0.5	Pass
6	2437	15.14	0.5	Pass
11	2462	15.15	0.5	Pass

For Reference

Spectrum Plot of Worst Value

802.11b

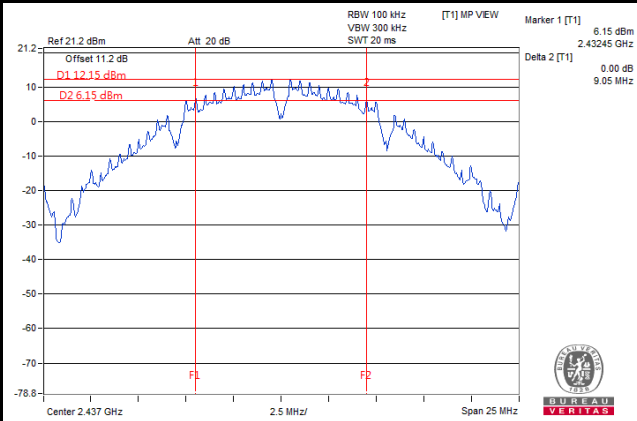

802.11g

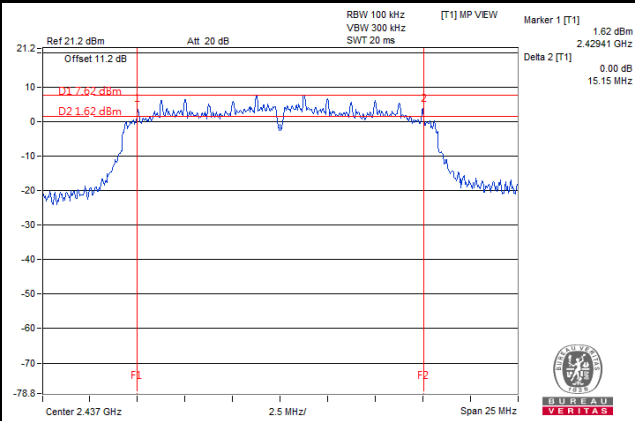

802.11n (HT20)

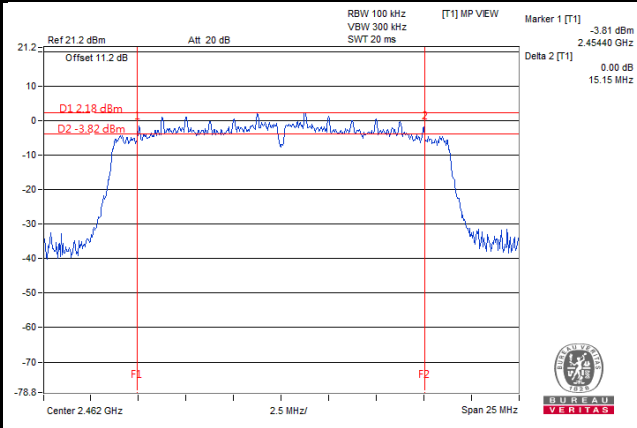

4.4 Conducted Output Power Measurement

4.4.1 Limits of Conducted Output Power Measurement

For systems using digital modulation in the 2400–2483.5 MHz bands: 1 Watt (30 dBm)

4.4.2 Test Setup

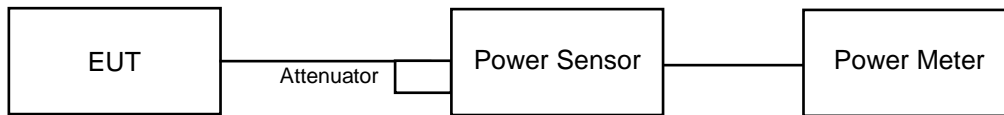

4.4.3 Test Instruments

Refer to section 4.1.2 to get information of above instrument.

4.4.4 Test Procedures

A peak power sensor was used on the output port of the EUT. A power meter was used to read the response of the peak power sensor. Record the power level.

4.4.5 Deviation from Test Standard

No deviation.

4.4.6 EUT Operating Conditions

The software provided by client to enable the EUT under transmission condition continuously at lowest, middle and highest channel frequencies individually.

4.4.7 Test Results

<Peak Power>

802.11b

Channel	Frequency (MHz)	Peak Power (mW)	Peak Power (dBm)	Limit (dBm)	Pass / Fail
1	2412	92.47	19.66	30	Pass
6	2437	218.776	23.40	30	Pass
11	2462	98.175	19.92	30	Pass

802.11g

Channel	Frequency (MHz)	Peak Power (mW)	Peak Power (dBm)	Limit (dBm)	Pass / Fail
1	2412	204.644	23.11	30	Pass
6	2437	257.632	24.11	30	Pass
11	2462	195.884	22.92	30	Pass

802.11n (HT20)

Channel	Frequency (MHz)	Peak Power (mW)	Peak Power (dBm)	Limit (dBm)	Pass / Fail
1	2412	195.884	22.92	30	Pass
6	2437	258.226	24.12	30	Pass
11	2462	173.38	22.39	30	Pass

For Reference

<Peak Power>

802.11b

Channel	Frequency (MHz)	Average Power (mW)	Average Power (dBm)	Limit (dBm)	Pass / Fail
2	2417	184.93	22.67	30	Pass
10	2457	187.50	22.73	30	Pass

802.11g

Channel	Frequency (MHz)	Average Power (mW)	Average Power (dBm)	Limit (dBm)	Pass / Fail
2	2417	225.94	23.54	30	Pass
10	2457	205.12	23.12	30	Pass

802.11n (HT20)

Channel	Frequency (MHz)	Average Power (mW)	Average Power (dBm)	Limit (dBm)	Pass / Fail
2	2417	216.27	23.35	30	Pass
10	2457	219.28	23.41	30	Pass

<Average Power>

802.11b

Channel	Frequency (MHz)	Average Power (mW)	Average Power (dBm)	Limit (dBm)	Pass / Fail
1	2412	46.026	16.63	30	Pass
2	2417	115.88	20.64	30	Pass
6	2437	135.831	21.33	30	Pass
10	2457	132.434	21.22	30	Pass
11	2462	47.643	16.78	30	Pass

802.11g

Channel	Frequency (MHz)	Average Power (mW)	Average Power (dBm)	Limit (dBm)	Pass / Fail
1	2412	27.669	14.42	30	Pass
2	2417	46.03	16.63	30	Pass
6	2437	69.343	18.41	30	Pass
10	2457	45.08	16.54	30	Pass
11	2462	22.336	13.49	30	Pass

802.11n (HT20)

Channel	Frequency (MHz)	Average Power (mW)	Average Power (dBm)	Limit (dBm)	Pass / Fail
1	2412	27.102	14.33	30	Pass
2	2417	40.64	16.09	30	Pass
6	2437	60.674	17.83	30	Pass
10	2457	39.99	16.02	30	Pass
11	2462	21.928	13.41	30	Pass

4.5 Power Spectral Density Measurement

4.5.1 Limits of Power Spectral Density Measurement

The Maximum of Power Spectral Density Measurement is 8 dBm.

4.5.2 Test Setup

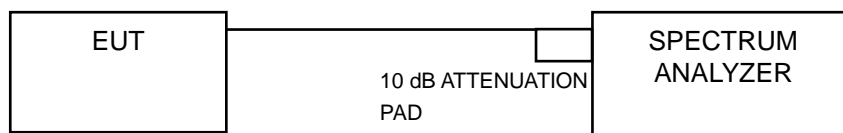

4.5.3 Test Instruments

Refer to section 4.1.2 to get information of above instrument.

4.5.4 Test Procedure

- a. Set analyzer center frequency to DTS channel center frequency.
- b. Set the span to 1.5 times the DTS bandwidth.
- c. Set the RBW to: $3 \text{ kHz} \leq \text{RBW} \leq 100 \text{ kHz}$.
- d. Set the VBW $\geq 3 \times \text{RBW}$.
- e. Detector = peak.
- f. Sweep time = auto couple.
- g. Trace mode = max hold.
- h. Allow trace to fully stabilize.
- i. Use the peak marker function to determine the maximum amplitude level within the RBW.

4.5.5 Deviation from Test Standard

No deviation.

4.5.6 EUT Operating Condition

The software provided by client to enable the EUT under transmission condition continuously at lowest, middle and highest channel frequencies individually.

4.5.7 Test Results

802.11b

Channel	Frequency (MHz)	PSD (dBm)	Limit (dBm)	Pass / Fail
1	2412	-6.39	8	Pass
6	2437	-2.04	8	Pass
11	2462	-6.48	8	Pass

802.11g

Channel	Frequency (MHz)	PSD (dBm)	Limit (dBm)	Pass / Fail
1	2412	-11.77	8	Pass
6	2437	-7.33	8	Pass
11	2462	-12.36	8	Pass

802.11n (HT20)

Channel	Frequency (MHz)	PSD (dBm)	Limit (dBm)	Pass / Fail
1	2412	-11.70	8	Pass
6	2437	-7.43	8	Pass
11	2462	-12.31	8	Pass

For Reference

Spectrum Plot of Worst Value

802.11b

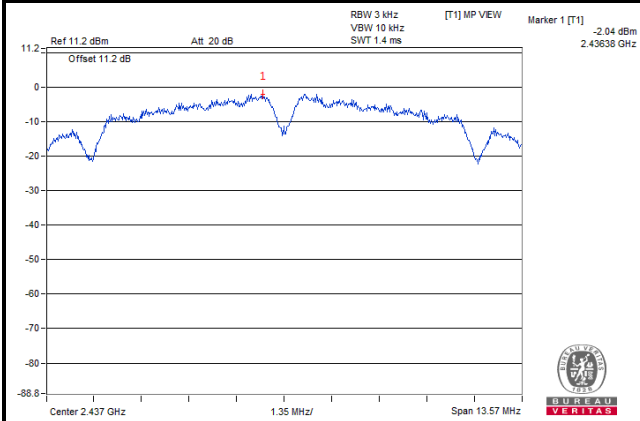

802.11g

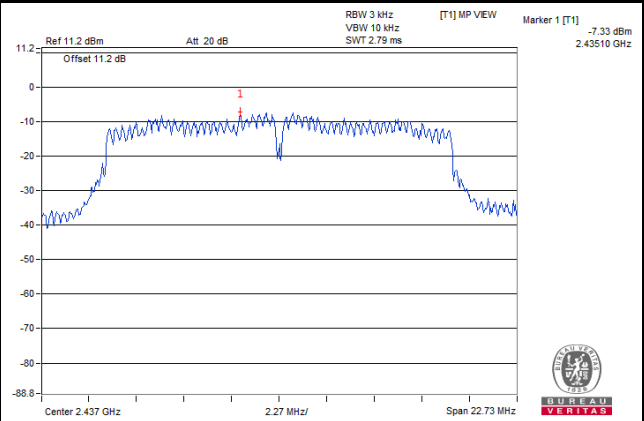

802.11n (HT20)

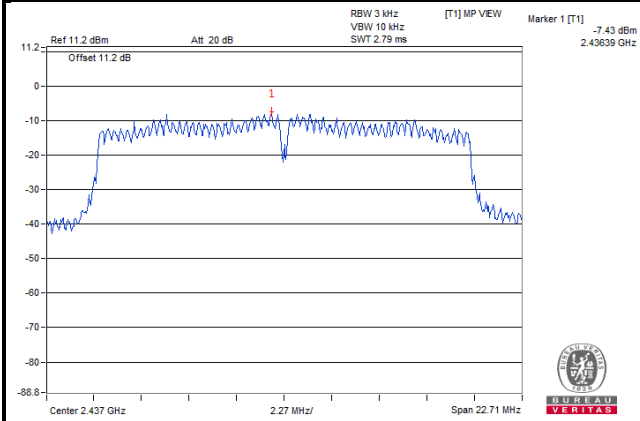

4.6 Conducted Out of Band Emission Measurement

4.6.1 Limits of Conducted Out of Band Emission Measurement

Below 20 dB of the highest emission level of operating band (in 100 kHz Resolution Bandwidth).

4.6.2 Test Setup

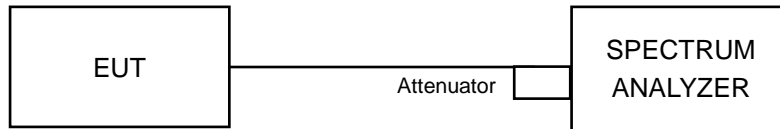

4.6.3 Test Instruments

Refer to section 4.1.2 to get information of above instrument.

4.6.4 Test Procedure

MEASUREMENT PROCEDURE REF

1. Set the RBW = 100 kHz.
2. Set the VBW \geq 300 kHz.
3. Detector = peak.
4. Sweep time = auto couple.
5. Trace mode = max hold.
6. Allow trace to fully stabilize.
7. Use the peak marker function to determine the maximum power level in any 100 kHz band segment within the fundamental EBW.

MEASUREMENT PROCEDURE OOBE

1. Set RBW = 100 kHz.
2. Set VBW \geq 300 kHz.
3. Detector = peak.
4. Sweep = auto couple.
5. Trace Mode = max hold.
6. Allow trace to fully stabilize.
7. Use the peak marker function to determine the maximum amplitude level.

4.6.5 Deviation from Test Standard

No deviation.

4.6.6 EUT Operating Condition

The software provided by client to enable the EUT under transmission condition continuously at lowest, middle and highest channel frequencies individually.

4.6.7 Test Results

The spectrum plots are attached on the following images. D1 line indicates the highest level, and D2 line indicates the 20 dB offset below D1. It shows compliance with the requirement.

802.11b

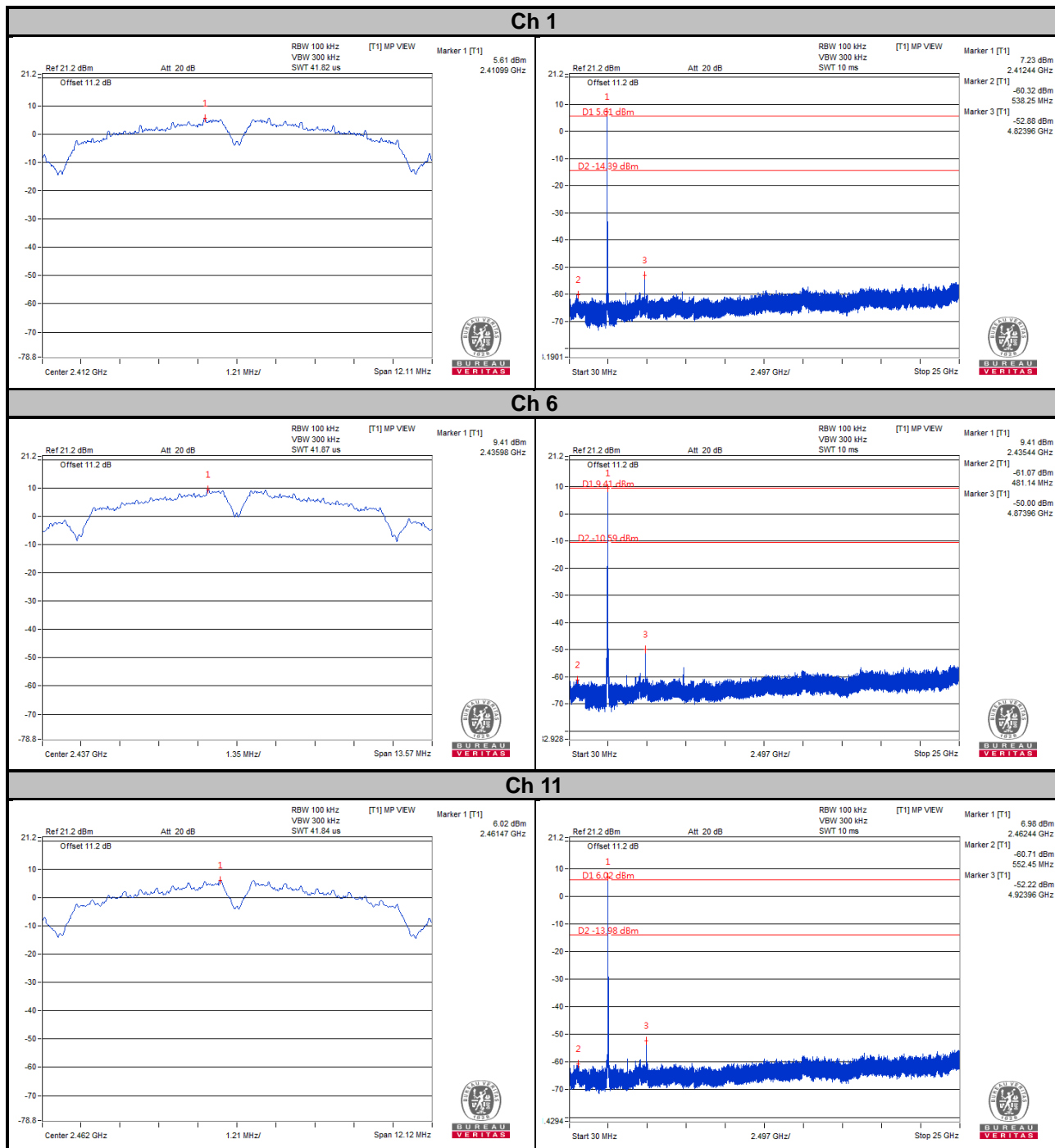

Ch 1 Band Edge

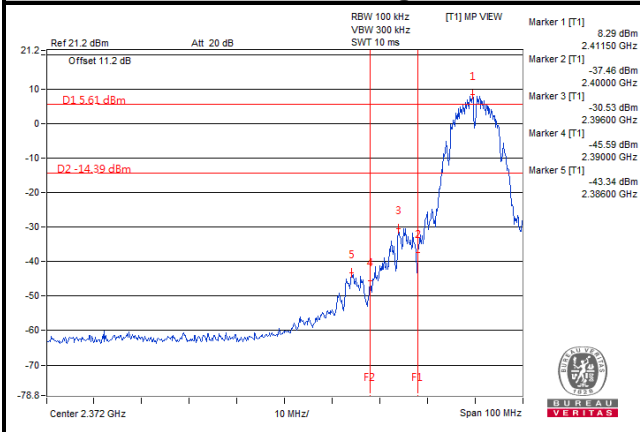

Ch 11 Band Edge

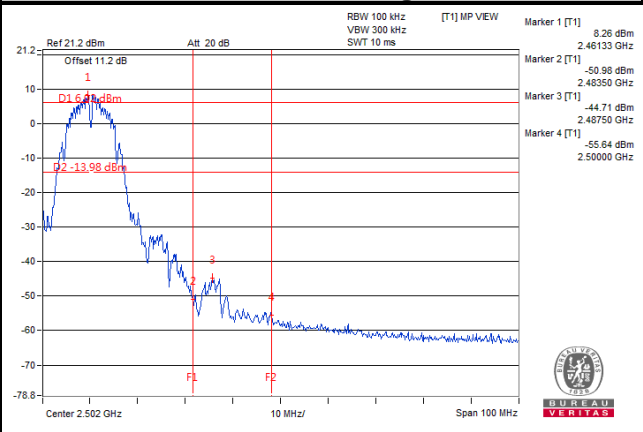

802.11g

Ch 1

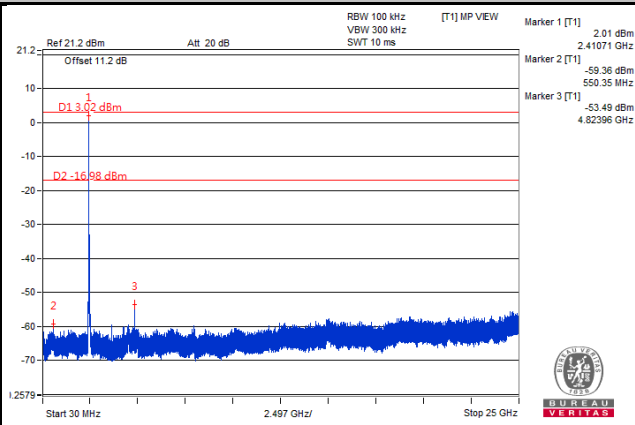
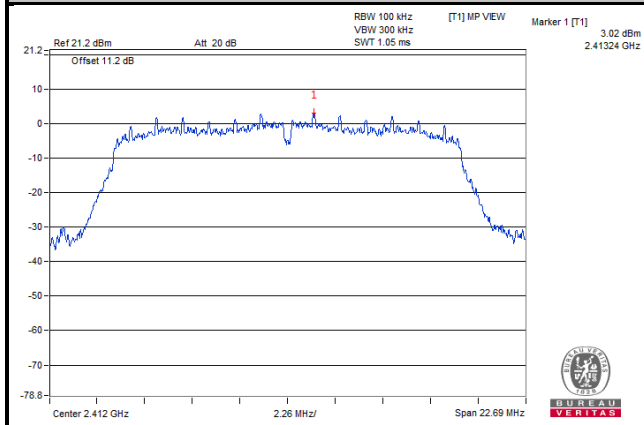

Ch 6

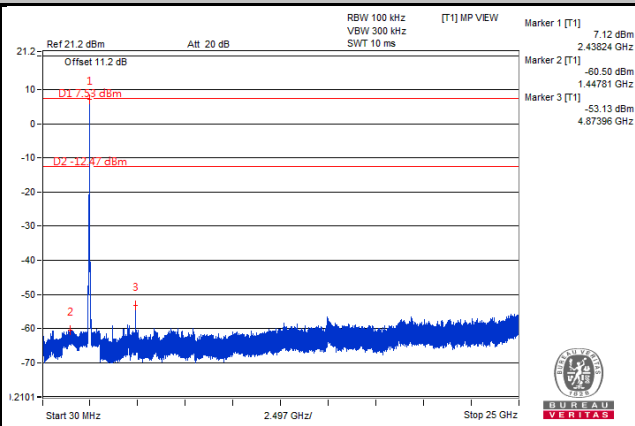
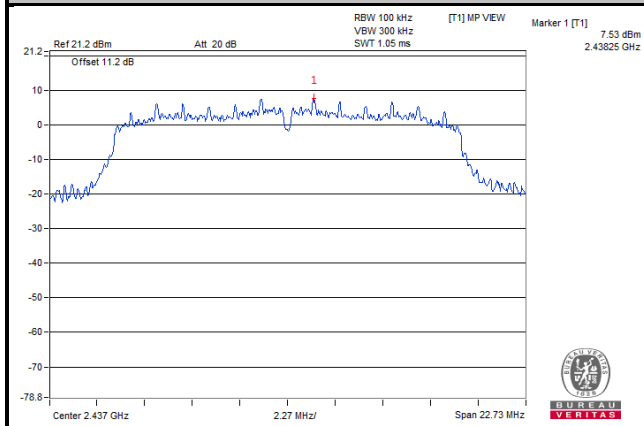

Ch 11

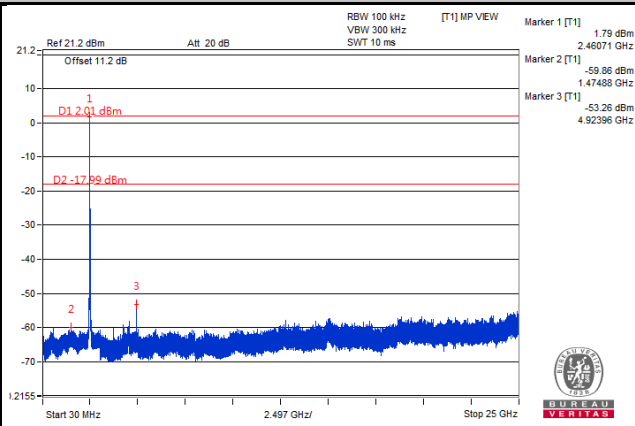
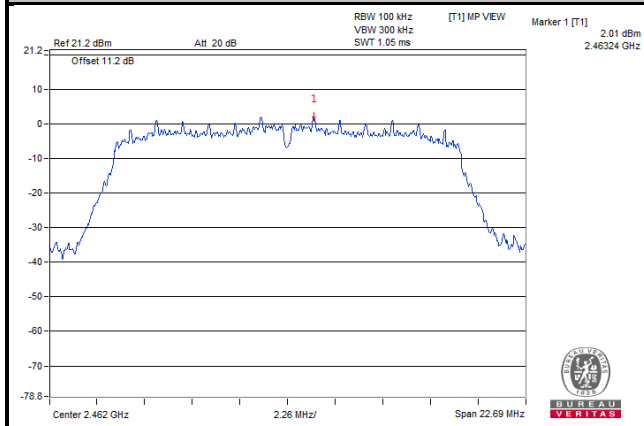

Ch 1 Band Edge

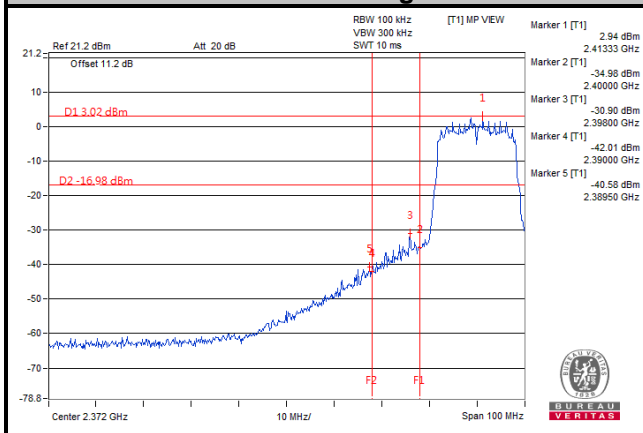

Ch 11 Band Edge

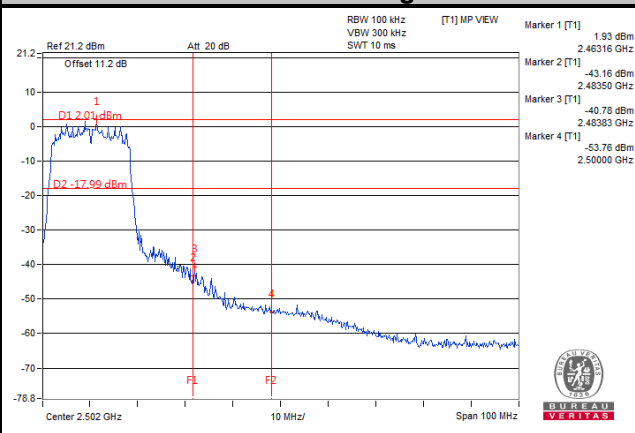

802.11n (HT20)

Ch 1

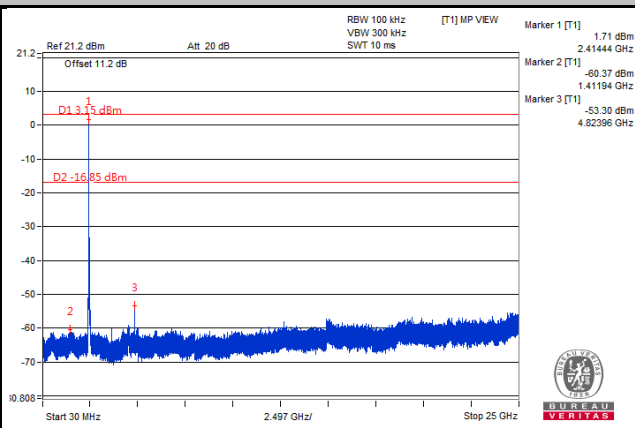
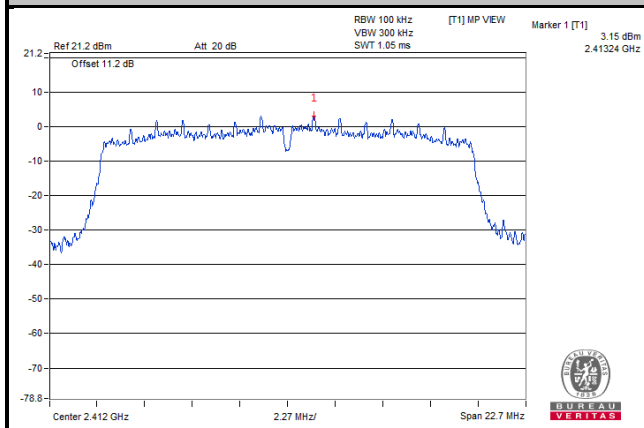

Ch 6

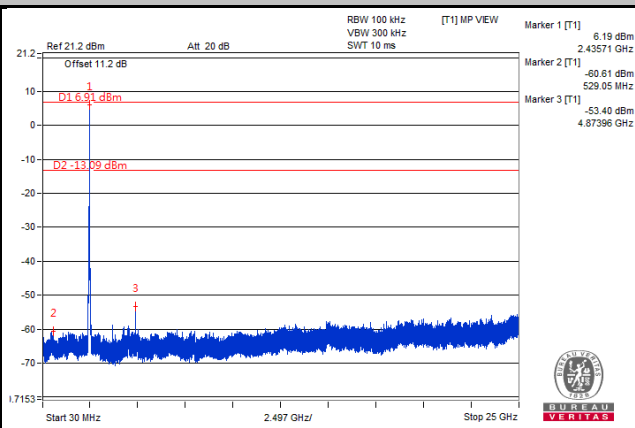
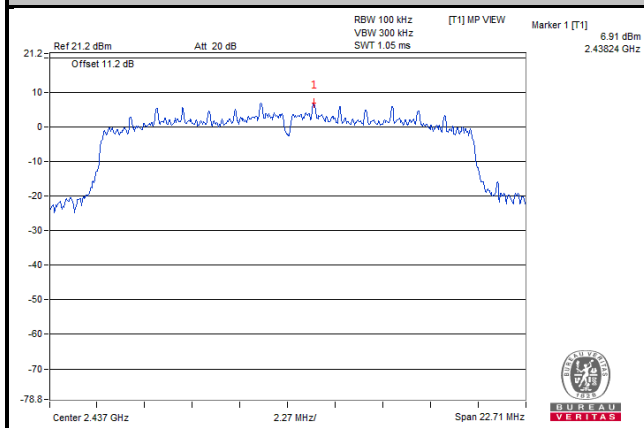

Ch 11

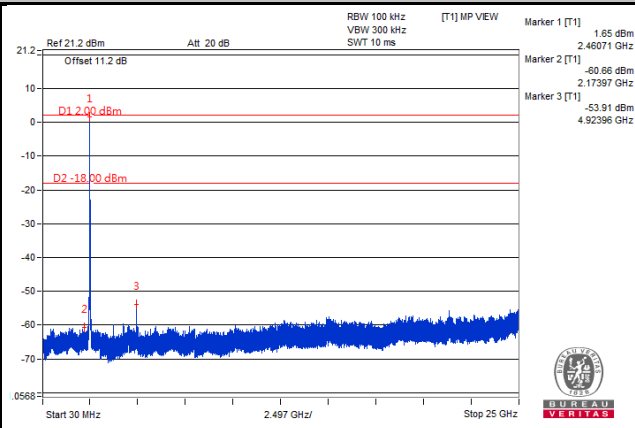
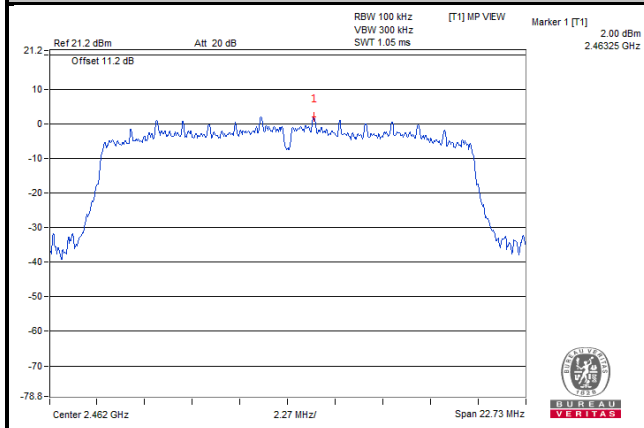

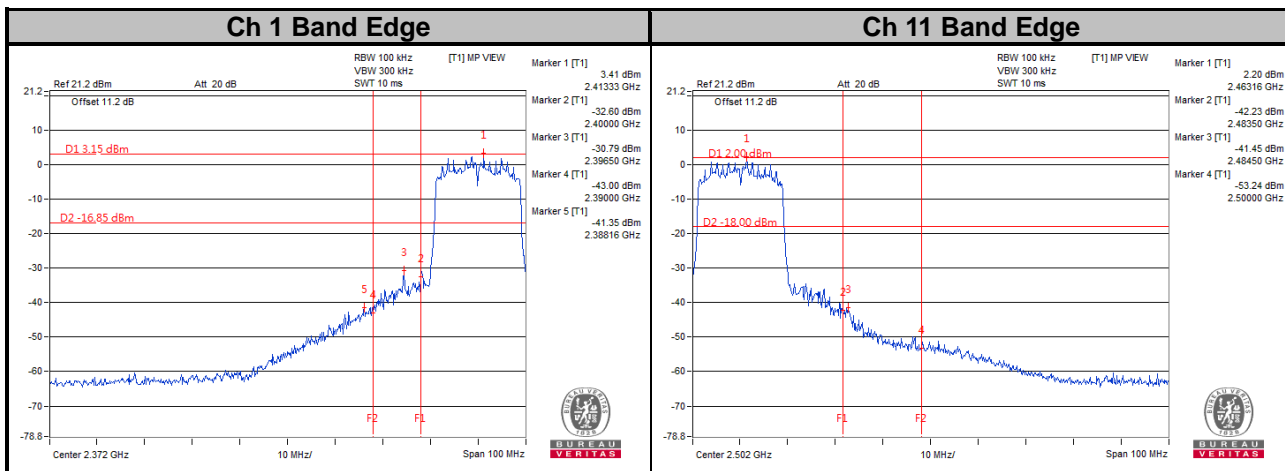

For Reference
802.11b

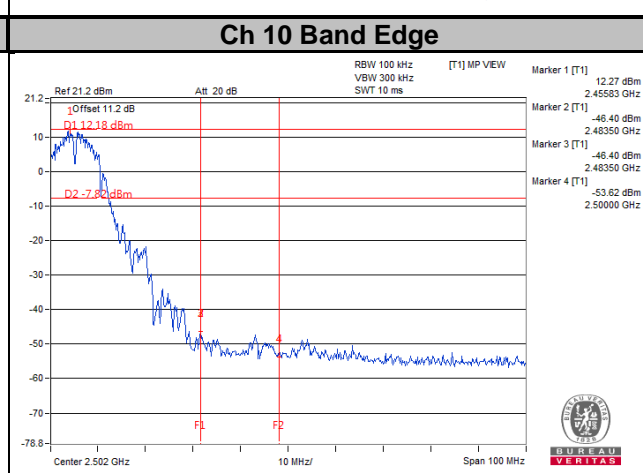
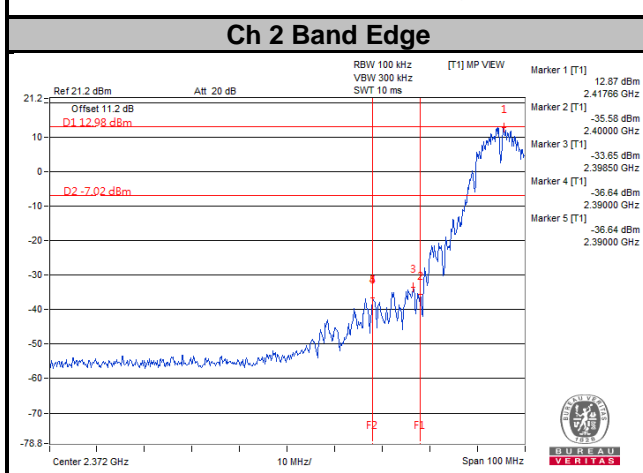
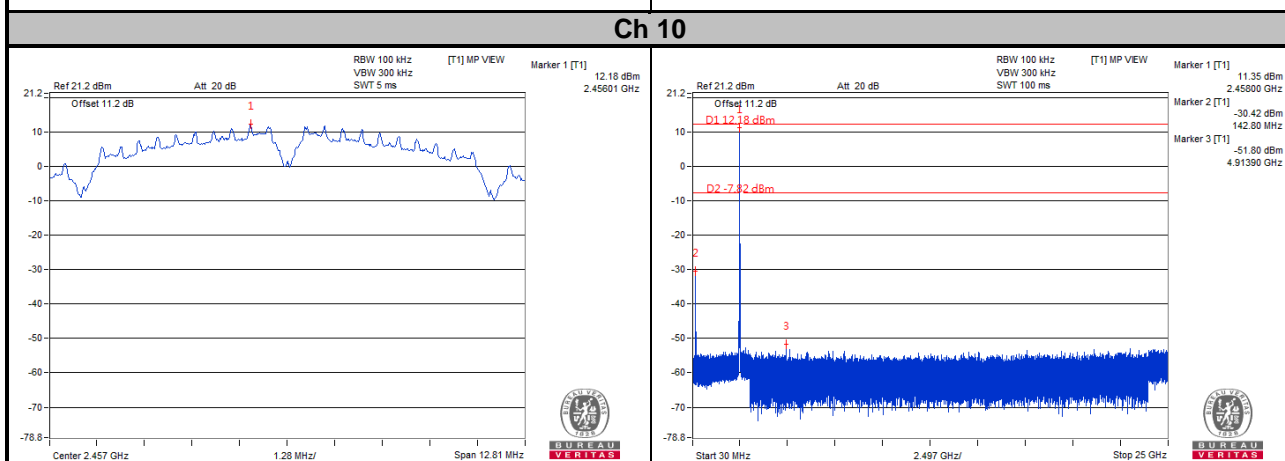
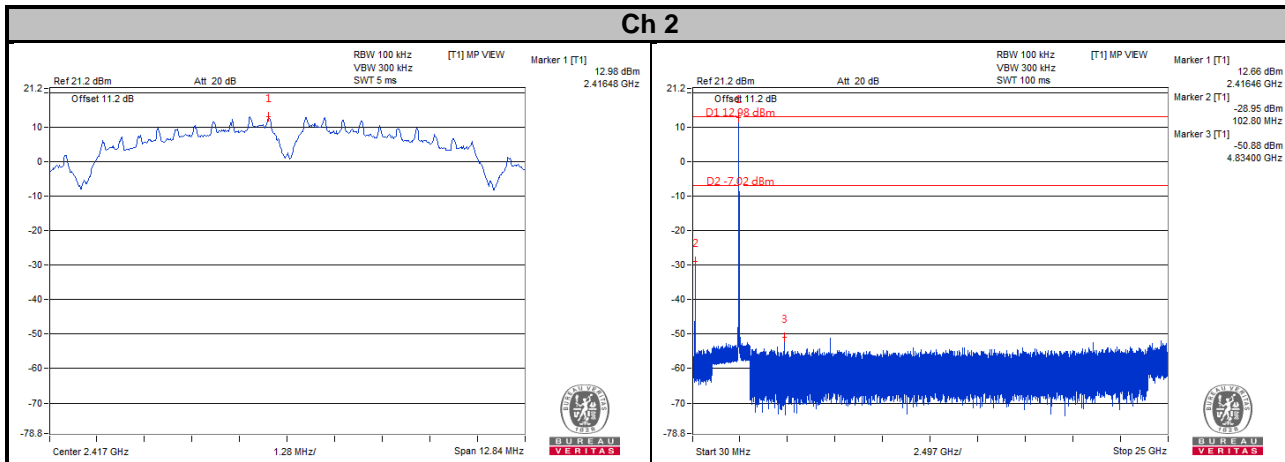

802.11g

Ch 2

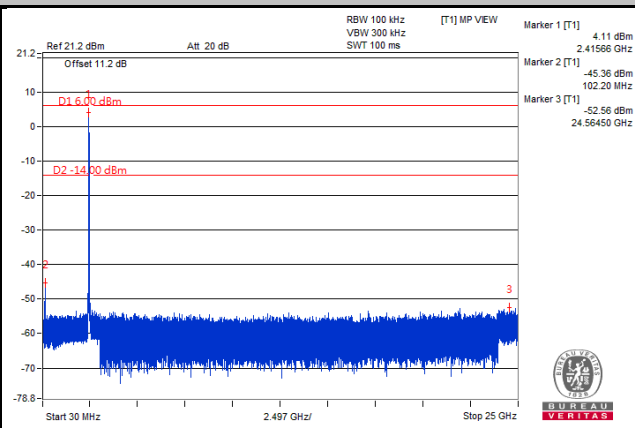
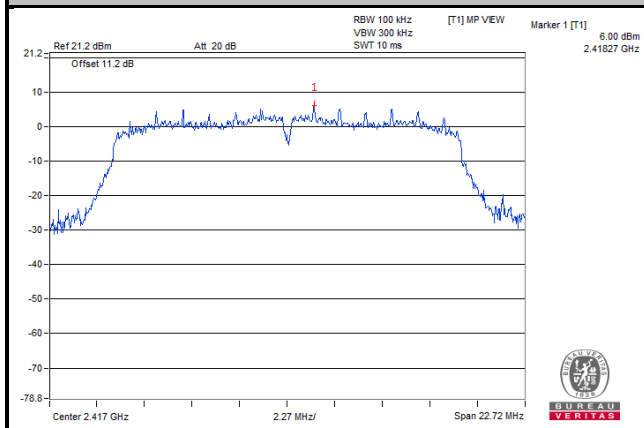

Ch 10

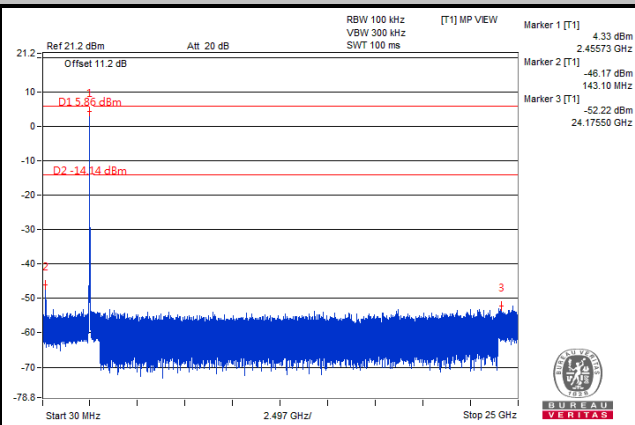
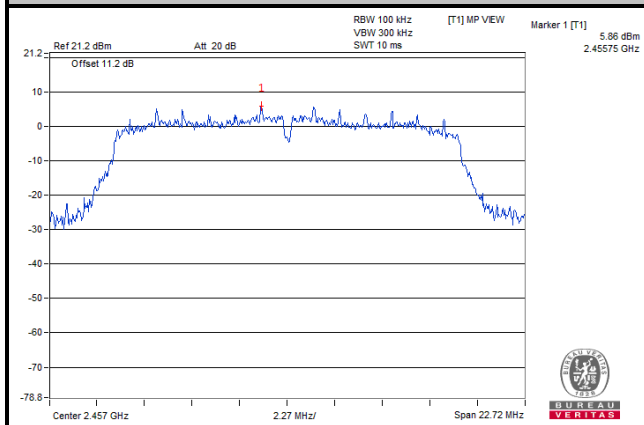

Ch 2 Band Edge

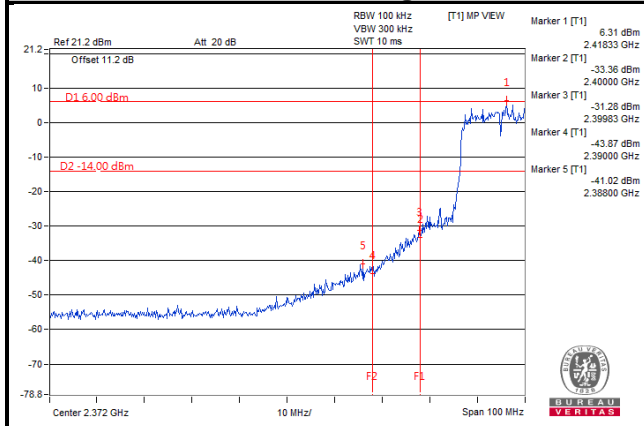

Ch 10 Band Edge

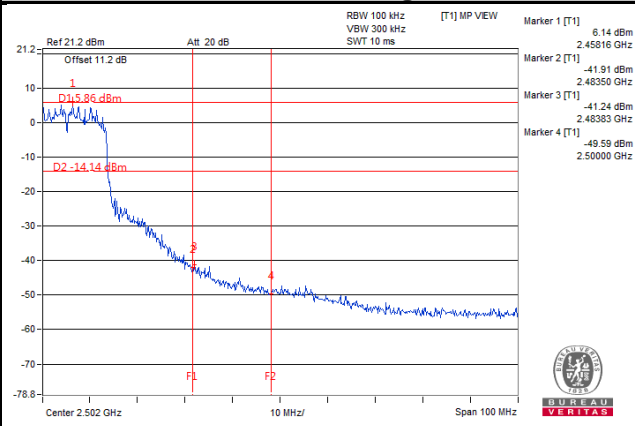

802.11n (HT20)

Ch 2

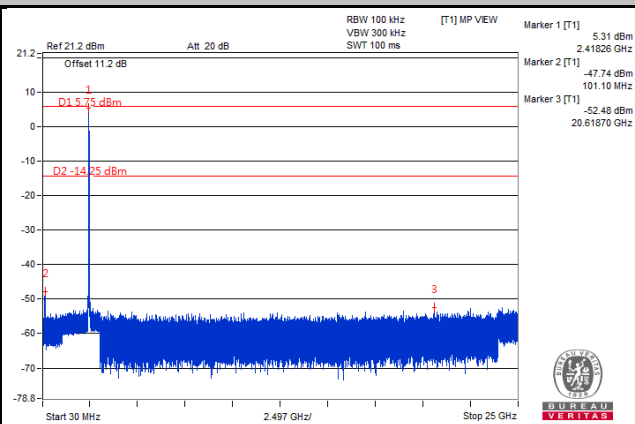
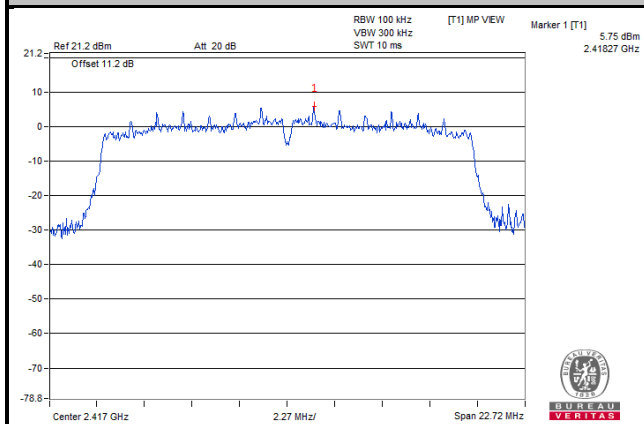

Ch 10

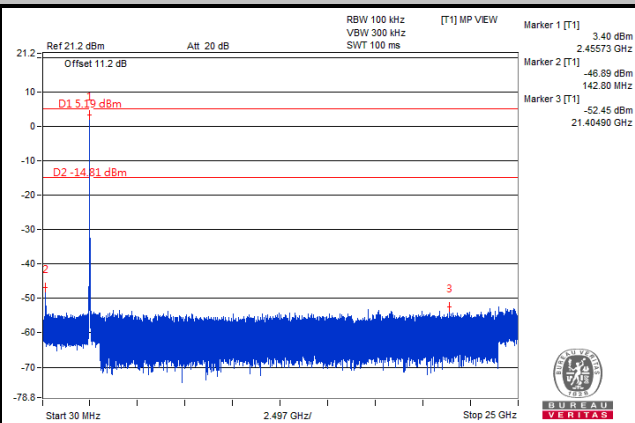
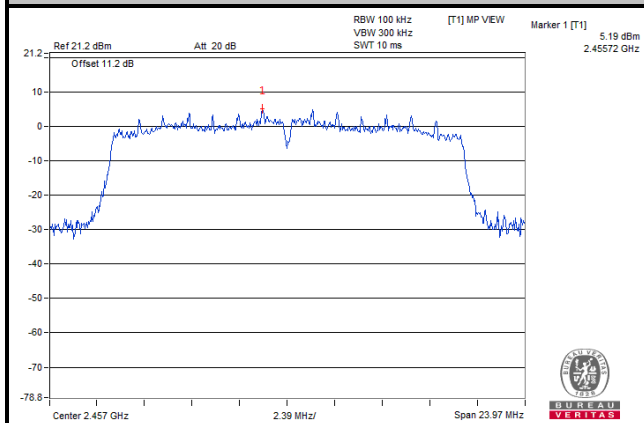

Ch 2 Band Edge

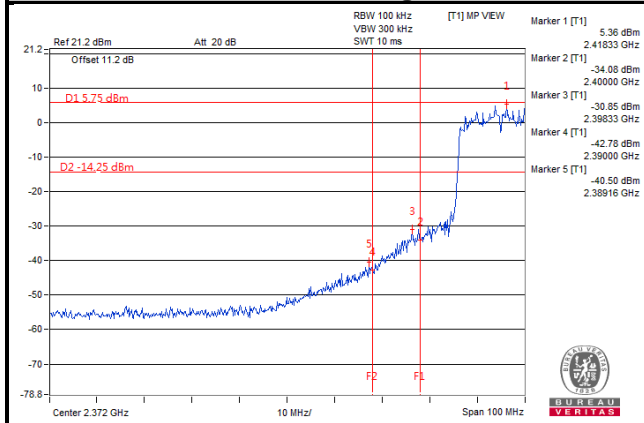

Ch 10 Band Edge

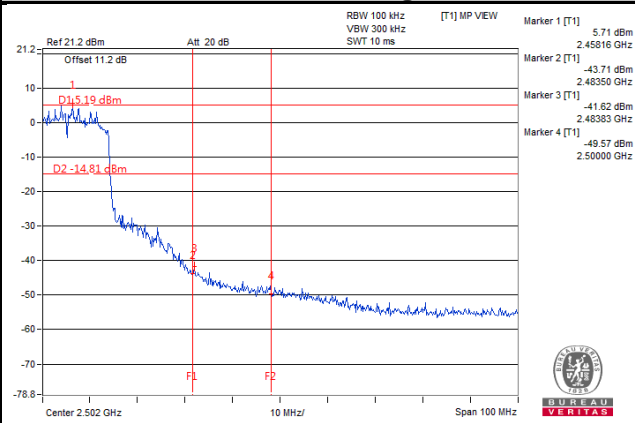

5 Pictures of Test Arrangements

Please refer to the attached file (Test Setup Photo).

Annex A- Radiated Bandedge Plots

802.11b

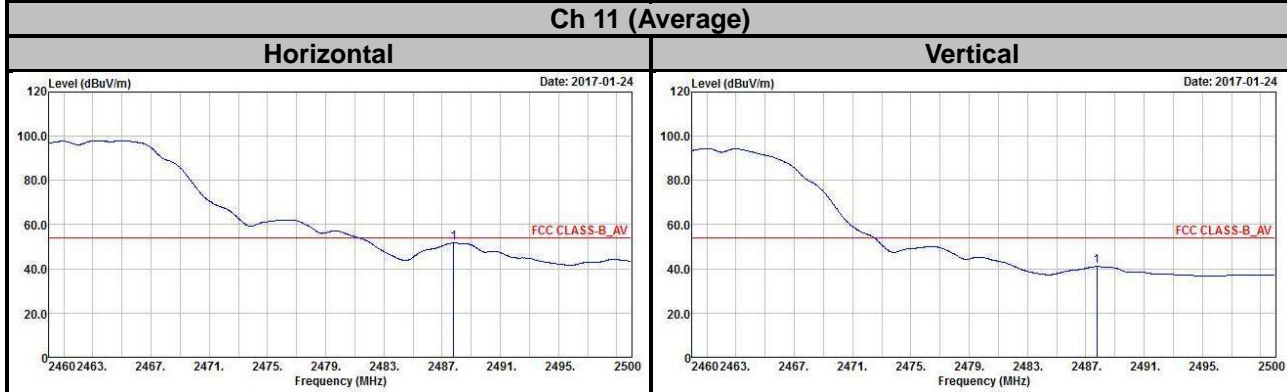
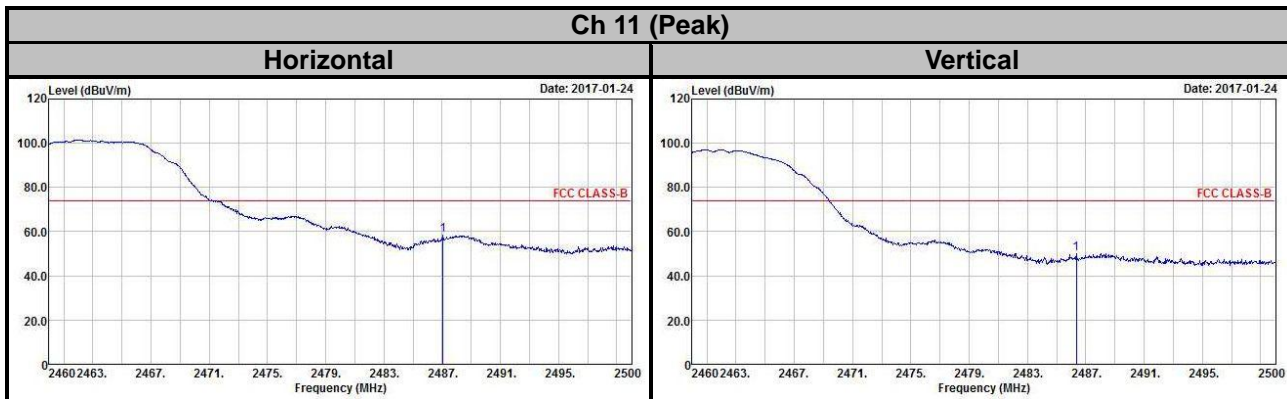
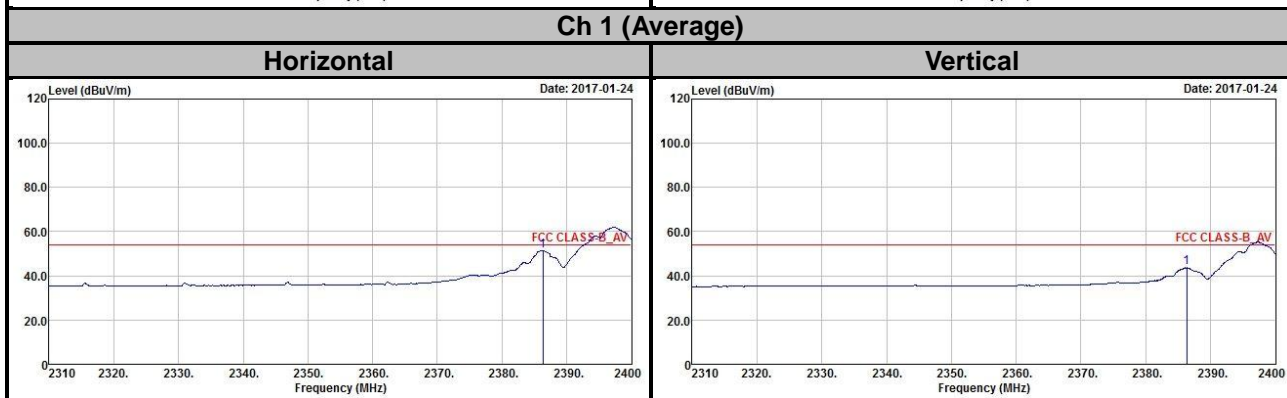
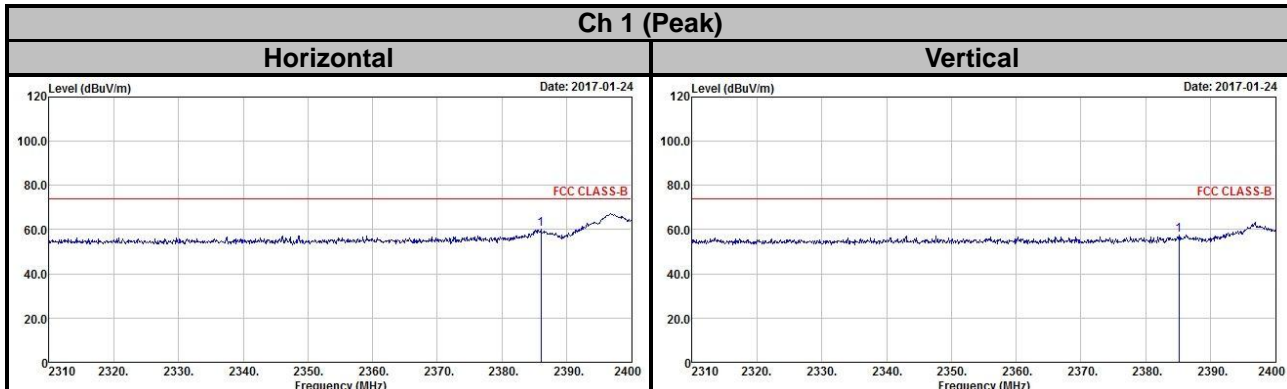

802.11g

Ch 1 (Peak)

Horizontal

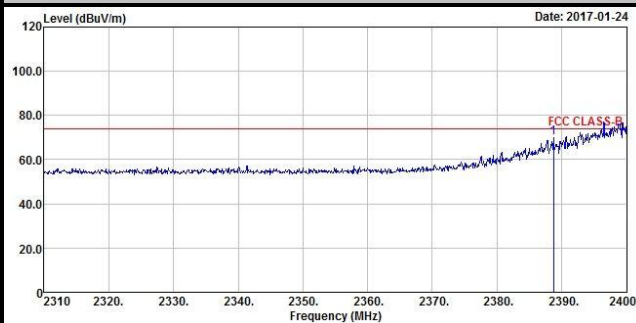

Vertical

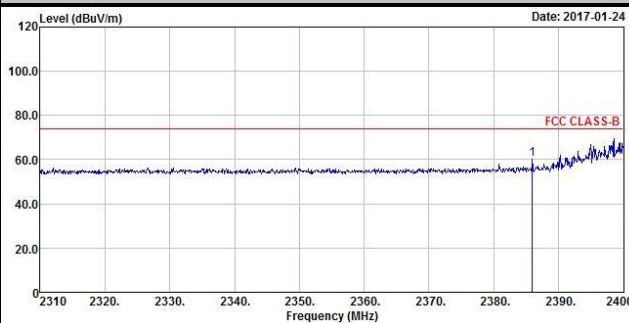

Ch 1 (Average)

Horizontal

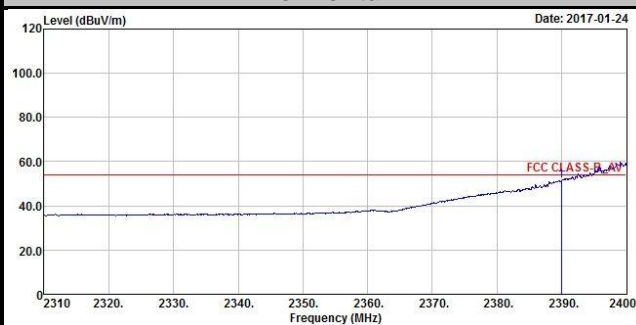

Vertical

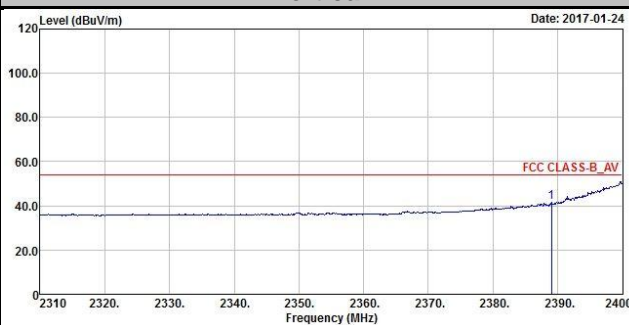

Ch 11 (Peak)

Horizontal

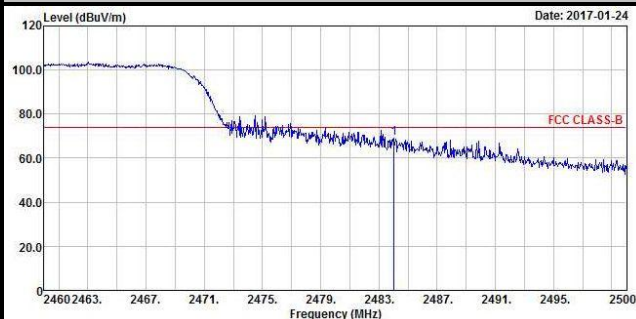

Vertical

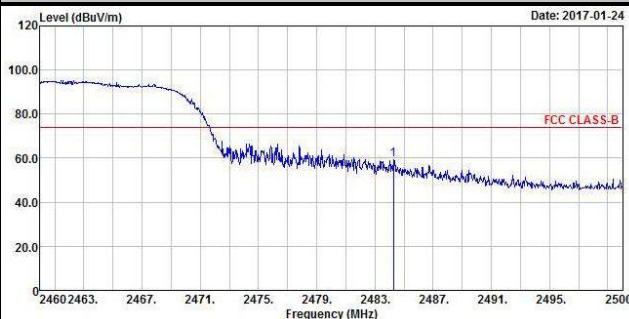

Ch 11 (Average)

Horizontal

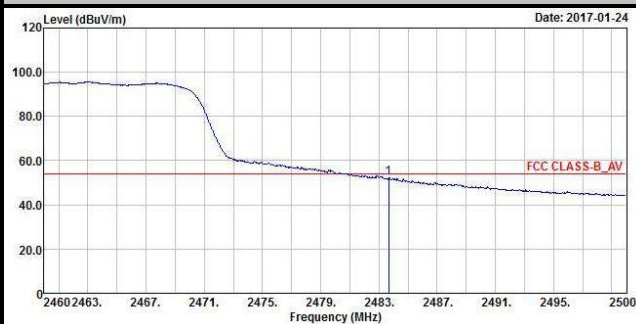

Vertical

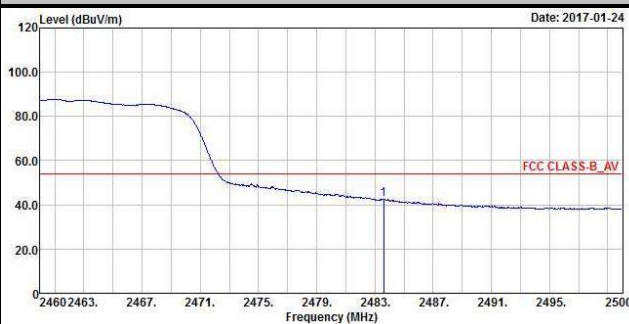

802.11n (HT20)

Ch 1 (Peak)

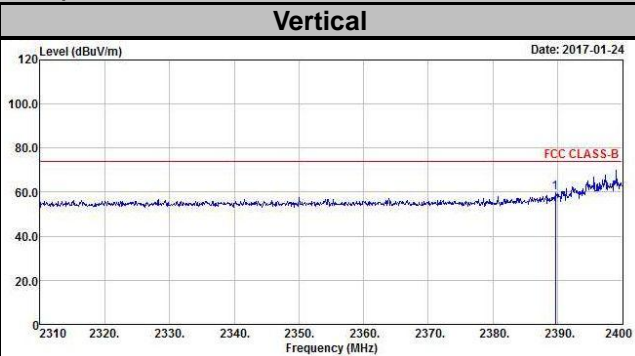
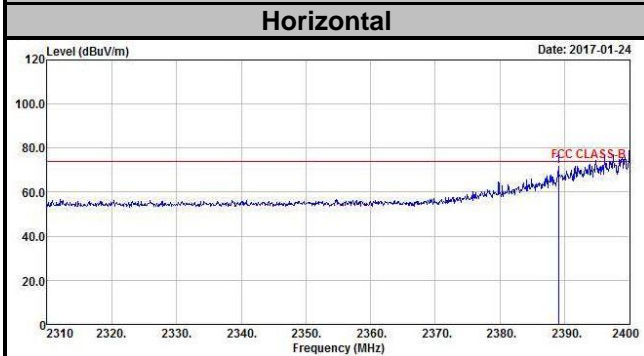

Ch 1 (Average)

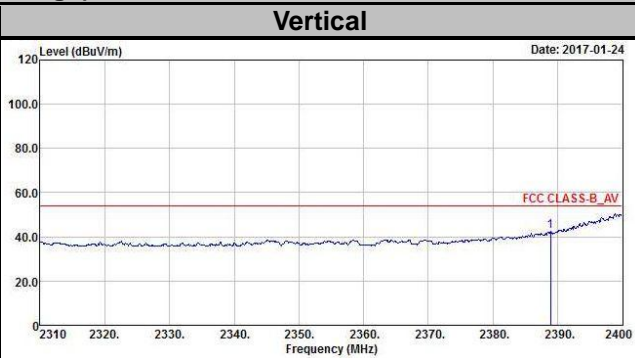
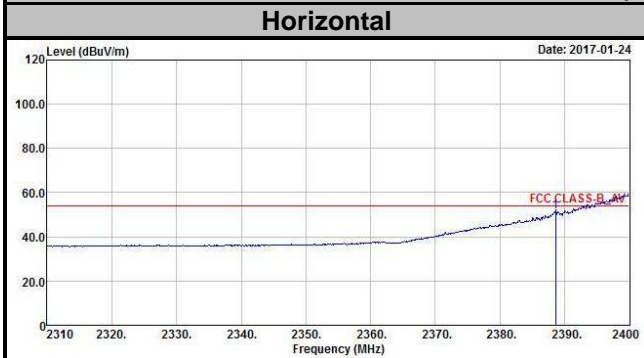

Ch 11 (Peak)

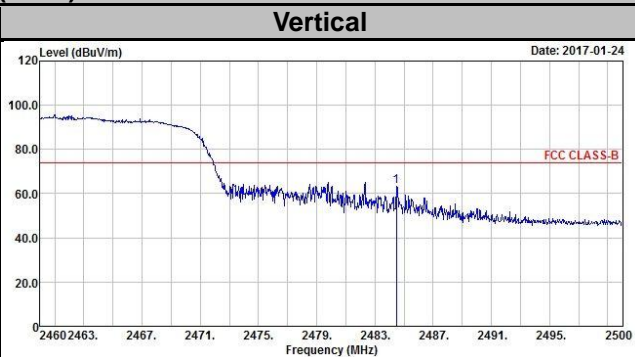
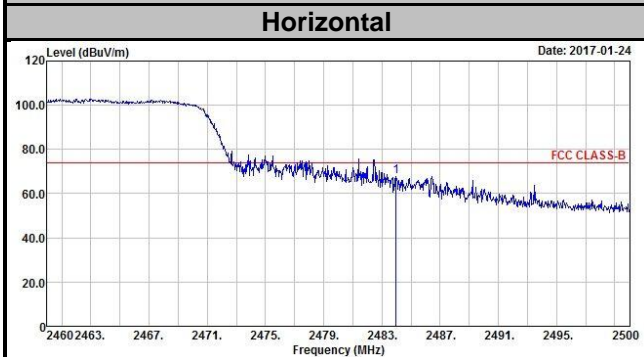

Ch 11 (Average)

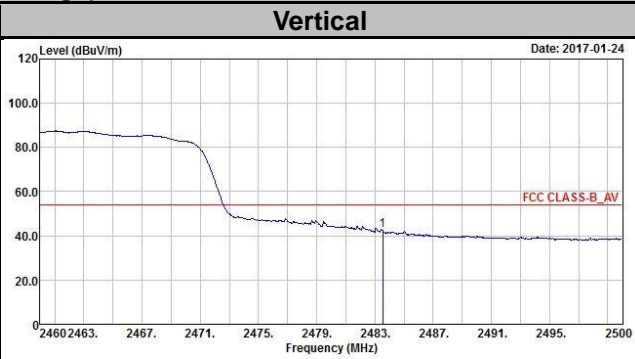
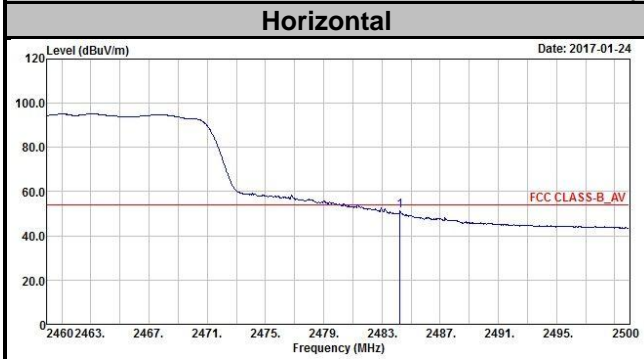

Appendix – Information on the Testing Laboratories

We, Bureau Veritas Consumer Products Services (H.K.) Ltd., Taoyuan Branch, were founded in 1988 to provide our best service in EMC, Radio, Telecom and Safety consultation. Our laboratories are accredited and approved according to ISO/IEC 17025.

If you have any comments, please feel free to contact us at the following:

Linko EMC/RF Lab

Tel: 886-2-26052180

Fax: 886-2-26051924

Hsin Chu EMC/RF/Telecom Lab

Tel: 886-3-6668565

Fax: 886-3-6668323

Hwa Ya EMC/RF/Safety Lab

Tel: 886-3-3183232

Fax: 886-3-3270892

Email: service.adt@tw.bureauveritas.com

Web Site: www.bureauveritas-adt.com

The address and road map of all our labs can be found in our web site also.

--- END ---