



# FCC TEST REPORT (15.247)

**REPORT NO.:** RF110531C15

**MODEL NO.:** WMDA-612AN\_RX

**FCC ID:** ZQ6-WMDA612ANRX

**RECEIVED:** May 31, 2011

**TESTED:** Jun. 16 ~ Jul. 08, 2011

**ISSUED:** Jul. 18, 2011

**APPLICANT:** AMPAK Technology Inc.

**ADDRESS:** No. 1 Jen Ai Road, Hsinchu Industrial Park, Hukou,  
Hsinchu, Taiwan

**ISSUED BY:** Bureau Veritas Consumer Products Services (H.K.)  
Ltd., Taoyuan Branch

**LAB ADDRESS:** No. 47, 14th Ling, Chia Pau Tsuen, Lin Kou Hsiang,  
Taipei Hsien 244, Taiwan, R.O.C.

**TEST LOCATION:** No. 19, Hwa Ya 2nd Rd, Wen Hwa Tsuen, Kwei  
Shan Hsiang, Taoyuan Hsien 333, Taiwan, R.O.C.

This test report consists of 41 pages in total. It may be duplicated completely for legal use with the approval of the applicant. It should not be reproduced except in full, without the written approval of our laboratory. The client should not use it to claim product certification, approval or endorsement by TAF or any government agency. The test results in the report only apply to the tested sample.





## TABLE OF CONTENTS

RELEASE CONTROL RECORD .....	4
1. CERTIFICATION .....	5
2. SUMMARY OF TEST RESULTS .....	6
2.1 MEASUREMENT UNCERTAINTY .....	6
3. GENERAL INFORMATION .....	7
3.1 GENERAL DESCRIPTION OF EUT .....	7
3.2 DESCRIPTION OF TEST MODES .....	9
3.2.1 CONFIGURATION OF SYSTEM UNDER TEST .....	9
3.2.2 TEST MODE APPLICABILITY AND TESTED CHANNEL DETAIL .....	10
3.3 GENERAL DESCRIPTION OF APPLIED STANDARDS .....	12
3.4 DESCRIPTION OF SUPPORT UNITS .....	12
4. TEST TYPES AND RESULTS .....	13
4.1 RADIATED EMISSION MEASUREMENT .....	13
4.1.1 LIMITS OF RADIATED EMISSION MEASUREMENT .....	13
4.1.2 TEST INSTRUMENTS .....	14
4.1.3 TEST PROCEDURES .....	15
4.1.4 DEVIATION FROM TEST STANDARD .....	15
4.1.5 TEST SETUP .....	16
4.1.6 EUT OPERATING CONDITIONS .....	16
4.1.7 TEST RESULTS .....	17
4.2 CONDUCTED EMISSION MEASUREMENT .....	20
4.2.1 LIMITS OF CONDUCTED EMISSION MEASUREMENT .....	20
4.2.2 TEST INSTRUMENTS .....	20
4.2.3 TEST PROCEDURES .....	21
4.2.4 DEVIATION FROM TEST STANDARD .....	21
4.2.5 TEST SETUP .....	22
4.2.6 EUT OPERATING CONDITIONS .....	22
4.2.7 TEST RESULTS .....	23
4.3 6dB BANDWIDTH MEASUREMENT .....	25
4.3.1 LIMITS OF 6dB BANDWIDTH MEASUREMENT .....	25
4.3.2 TEST INSTRUMENTS .....	25
4.3.3 TEST PROCEDURE .....	25
4.3.4 DEVIATION FROM TEST STANDARD .....	26
4.3.5 TEST SETUP .....	26
4.3.6 EUT OPERATING CONDITIONS .....	26
4.3.7 TEST RESULTS .....	27
4.4 MAXIMUM OUTPUT POWER .....	28
4.4.1 LIMITS OF MAXIMUM OUTPUT POWER MEASUREMENT .....	28
4.4.2 INSTRUMENTS .....	28
4.4.3 TEST PROCEDURES .....	28
4.4.4 DEVIATION FROM TEST STANDARD .....	28
4.4.5 TEST SETUP .....	29
4.4.6 EUT OPERATING CONDITIONS .....	29
4.4.7 TEST RESULTS .....	29
4.5 POWER SPECTRAL DENSITY MEASUREMENT .....	30
4.5.1 LIMITS OF POWER SPECTRAL DENSITY MEASUREMENT .....	30
4.5.2 TEST INSTRUMENTS .....	30
4.5.3 TEST PROCEDURE .....	30



A D T

4.5.4	DEVIATION FROM TEST STANDARD.....	31
4.5.5	TEST SETUP.....	31
4.5.6	EUT OPERATING CONDITION.....	31
4.5.7	TEST RESULTS .....	32
4.6	BAND EDGES MEASUREMENT .....	33
4.6.1	LIMITS OF BAND EDGES MEASUREMENT.....	33
4.6.2	TEST INSTRUMENTS.....	33
4.6.3	TEST PROCEDURE.....	34
4.6.4	DEVIATION FROM TEST STANDARD.....	35
4.6.5	EUT OPERATING CONDITION.....	35
4.6.6	TEST RESULTS .....	35
5.	PHOTOGRAPHS OF THE TEST CONFIGURATION.....	39
6.	INFORMATION ON THE TESTING LABORATORIES .....	40
7.	APPENDIX A - MODIFICATIONS RECORDERS FOR ENGINEERING CHANGES TO THE EUT BY THE LAB.....	41



A D T

## RELEASE CONTROL RECORD

ISSUE NO.	REASON FOR CHANGE	DATE ISSUED
Original release	NA	Jul. 18, 2011



## 1. CERTIFICATION

**PRODUCT:** Wireless Home Digital Interface Receiver Dongle

**MODEL:** WMDA-612AN\_RX

**APPLICANT:** AMPAK Technology Inc.

**TESTED:** Jun. 16 ~ Jul. 08, 2011

**TEST SAMPLE:** ENGINEERING SAMPLE

**STANDARDS:** **FCC Part 15, Subpart C (Section 15.247)**

ANSI C63.4-2003

ANSI C63.10-2009

The above equipment (Model: WMDA-612AN\_RX) has been tested by **Bureau Veritas Consumer Products Services (H.K.) Ltd., Taoyuan Branch**, and found compliance with the requirement of the above standards. The test record, data evaluation & Equipment Under Test (EUT) configurations represented herein are true and accurate accounts of the measurements of the sample's EMC characteristics under the conditions specified in this report.

PREPARED BY : Andrea Hsia , DATE : Jul. 18, 2011  
Andrea Hsia / Specialist

APPROVED BY : Gary Chang , DATE : Jul. 18, 2011  
Gary Chang / Assistant Manager

## 2. SUMMARY OF TEST RESULTS

The EUT has been tested according to the following specifications:

APPLIED STANDARD: FCC PART 15, SUBPART C (SECTION 15.247)			
STANDARD SECTION	TEST TYPE AND LIMIT	RESULT	REMARK
15.207	AC Power Conducted Emission	PASS	Meet the requirement of limit. Minimum passing margin is -25.54dB at 0.162MHz.
15.247(a)(2)	Spectrum Bandwidth of a Direct Sequence Spread Spectrum System Limit: min. 500kHz	PASS	Meet the requirement of limit.
15.247(b)	Maximum Output Power Limit: max. 30dBm	PASS	Meet the requirement of limit.
15.247(d)	Radiated Emissions Limit: Table 15.209	PASS	Meet the requirement of limit. Minimum passing margin is -2.1dB at 11590.00MHz.
15.247(e)	Power Spectral Density Limit: max. 8dBm	PASS	Meet the requirement of limit.
15.247(d)	Band Edge Measurement Limit: 20dB less than the peak value of fundamental frequency	PASS	Meet the requirement of limit.
15.203	Antenna Requirement	PASS	No antenna connector is used.

### 2.1 MEASUREMENT UNCERTAINTY

Where relevant, the following measurement uncertainty levels have been estimated for tests performed on the EUT as specified in CISPR 16-4-2:

MEASUREMENT	FREQUENCY	UNCERTAINTY
Conducted emissions	9kHz~30MHz	2.44 dB
Radiated emissions	30MHz ~ 200MHz	3.19 dB
	200MHz ~1000MHz	3.21 dB
	1GHz ~ 18GHz	2.26 dB
	18GHz ~ 40GHz	1.94 dB

This uncertainty represents an expanded uncertainty expressed at approximately the 95% confidence level using a coverage factor of  $k = 2$ .



### 3. GENERAL INFORMATION

#### 3.1 GENERAL DESCRIPTION OF EUT

<b>EUT</b>	Wireless Home Digital Interface Receiver Dongle
<b>MODEL NO.</b>	WMDA-612AN_RX
<b>FCC ID</b>	ZQ6-WMDA612ANRX
<b>POWER SUPPLY</b>	12Vdc
<b>MODULATION TECHNOLOGY</b>	OFDM
<b>TRANSFER RATE</b>	WHDI (40MHz): 63.0Mbps
<b>OPERATING FREQUENCY</b>	5755 ~ 5795MHz
<b>NUMBER OF CHANNEL</b>	2
<b>OUTPUT POWER</b>	151.4mW
<b>ANTENNA TYPE</b>	Refer to note as below
<b>ANTENNA CONNECTOR</b>	NA
<b>DATA CABLE</b>	1.5m shielded HDMI cable without core
<b>I/O PORTS</b>	Refer to user's manual
<b>ACCESSORY DEVICES</b>	Adapter

**NOTE:**

1. The EUT provides 1 completed transmitter and 5 receivers.

MODULATION MODE	TX FUNCTION
WHDI (40MHz)	1TX

2. The test data are separated into following test reports.

	TEST STANDARD	REFERENCE REPORT
WHDI (40MHz) (5755~5795 MHz)	FCC Part 15, Subpart C (Section 15.247)	RF110531C15
WHDI (40MHz) (5190~ 5230MHz)	FCC Part 15, Subpart E (Section 15.407)	RF110531C15-1

3. The frequency bands used in this EUT are listed as follows:

FREQUENCY BAND (MHz)	5190~5230	5755~5795
WHDI (40MHz)	√	√

4. The EUT was powered by the following adapter:

<b>BRAND:</b>	OEM
<b>MODEL:</b>	ADS0128-W
<b>INPUT:</b>	100-240Vac, 50-60Hz, 0.5A
<b>OUTPUT:</b>	12Vdc, 1A
<b>POWER LINE:</b>	1.5m non-shielded cable without core



5. The EUT used the following antennas:

ITEM	ANTENNA TYPE	ANTENNA GAIN	ANTENNA CONNECTOR
Antenna 1 (Rx)	Printed	5.50dBi for 5.0GHz 3.44dBi for 5.2GHz 5.44dBi for 5.5GHz 4.14dBi for 5.8GHz	none
Antenna 2 (Rx)	Printed	-3.78dBi for 5.0GHz 1.24dBi for 5.2GHz 0.90dBi for 5.5GHz 1.67dBi for 5.8GHz	none
Antenna 3 (Tx & Rx)	Printed	-0.90dBi for 5.0GHz 0.18dBi for 5.2GHz 3.38dBi for 5.5GHz 1.46dBi for 5.8GHz	none
Antenna 4 (Rx)	Printed	-1.89dBi for 5.0GHz 0.52dBi for 5.2GHz 2.25dBi for 5.5GHz 3.32dBi for 5.8GHz	none
Antenna 5 (Rx)	Printed	3.40dBi for 5.0GHz 2.09dBi for 5.2GHz 2.79dBi for 5.5GHz 2.96dBi for 5.8GHz	none

6. The above EUT information is declared by manufacturer and for more detailed features description, please refer to the manufacturer's specifications or user's manual.



### 3.2 DESCRIPTION OF TEST MODES

2 channels are provided for WHDI (40MHz):

CHANNEL	FREQUENCY	CHANNEL	FREQUENCY
151	5755MHz	159	5795MHz

#### 3.2.1 CONFIGURATION OF SYSTEM UNDER TEST

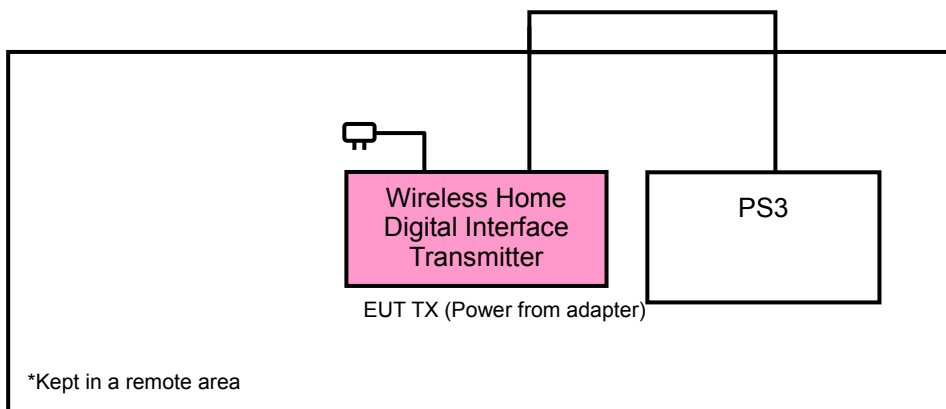
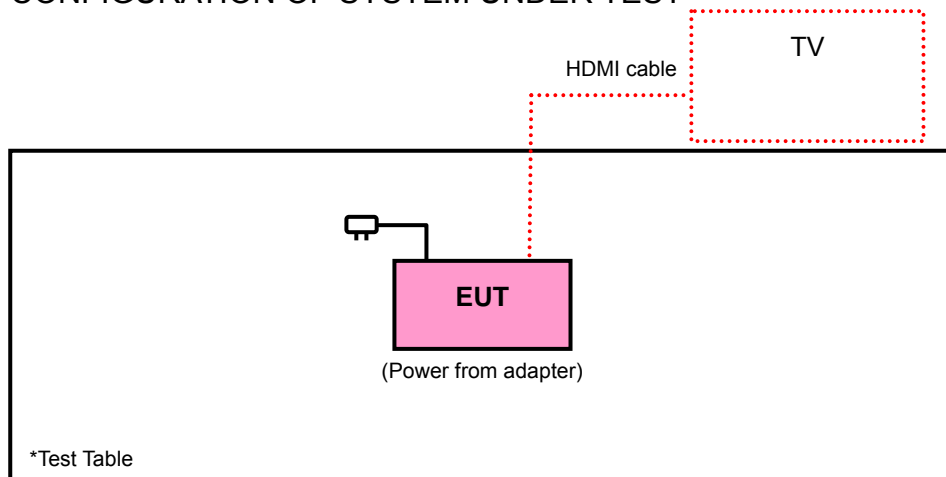



### 3.2.2 TEST MODE APPLICABILITY AND TESTED CHANNEL DETAIL

EUT CONFIGURE MODE	APPLICABLE TO				DESCRIPTION
	RE≥1G	RE<1G	PLC	APCM	
-	√	√	√	√	-

Where **PLC**: Power Line Conducted Emission      **RE<1G**: Radiated Emission below 1GHz  
**RE≥1G**: Radiated Emission above 1GHz      **APCM**: Antenna Port Conducted Measurement

#### **RADIATED EMISSION TEST (ABOVE 1GHz):**

- Pre-Scan has been conducted to determine the worst-case mode from all possible combinations between available modulations, data rates, XYZ axis and antenna ports (if EUT with antenna diversity architecture).
- Following channel(s) was (were) selected for the final test as listed below.

MODE	AVAILABLE CHANNEL	TESTED CHANNEL	MODULATION TECHNOLOGY	MODULATION TYPE	DATA RATE (Mbps)
WHDI (40MHz)	151 to 159	151, 159	OFDM	16QAM	63

#### **RADIATED EMISSION TEST (BELOW 1GHz):**

- Pre-Scan has been conducted to determine the worst-case mode from all possible combinations between available modulations, data rates, XYZ axis and antenna ports (if EUT with antenna diversity architecture).
- Following channel(s) was (were) selected for the final test as listed below.

MODE	AVAILABLE CHANNEL	TESTED CHANNEL	MODULATION TECHNOLOGY	MODULATION TYPE	DATA RATE (Mbps)
WHDI (40MHz)	151 to 159	159	OFDM	16QAM	63

#### **POWER LINE CONDUCTED EMISSION TEST:**

- Pre-Scan has been conducted to determine the worst-case mode from all possible combinations between available modulations, data rates and antenna ports (if EUT with antenna diversity architecture).
- Following channel(s) was (were) selected for the final test as listed below.

MODE	AVAILABLE CHANNEL	TESTED CHANNEL	MODULATION TECHNOLOGY	MODULATION TYPE	DATA RATE (Mbps)
WHDI (40MHz)	151 to 159	159	OFDM	16QAM	63



**BANDEDGE MEASUREMENT:**

- Pre-Scan has been conducted to determine the worst-case mode from all possible combinations between available modulations, data rates and antenna ports (if EUT with antenna diversity architecture).
- Following channel(s) was (were) selected for the final test as listed below.

MODE	AVAILABLE CHANNEL	TESTED CHANNEL	MODULATION TECHNOLOGY	MODULATION TYPE	DATA RATE (Mbps)
WHDI (40MHz)	151 to 159	151, 159	OFDM	16QAM	63

**ANTENNA PORT CONDUCTED MEASUREMENT:**

- This item includes all test value of each mode, but only includes spectrum plot of worst value of each mode.
- Pre-Scan has been conducted to determine the worst-case mode from all possible combinations between available modulations, data rates and antenna ports (if EUT with antenna diversity architecture).
- Following channel(s) was (were) selected for the final test as listed below.

MODE	AVAILABLE CHANNEL	TESTED CHANNEL	MODULATION TECHNOLOGY	MODULATION TYPE	DATA RATE (Mbps)
WHDI (40MHz)	151 to 159	151, 159	OFDM	16QAM	63

**TEST CONDITION:**

APPLICABLE TO	ENVIRONMENTAL CONDITIONS	INPUT POWER	TESTED BY
RE≥1G	26deg. C, 65%RH, 1017 hPa	120Vac, 60Hz	Frank Wang
RE<1G	25deg. C, 66%RH, 1016 hPa	120Vac, 60Hz	Frank Wang
PLC	25deg. C, 65%RH, 1014 hPa	120Vac, 60Hz	David Huang
APCM	25deg. C, 65%RH, 1015 hPa	120Vac, 60Hz	Frank Wang

### 3.3 GENERAL DESCRIPTION OF APPLIED STANDARDS

The EUT is a RF Product. According to the specifications of the manufacturer, it must comply with the requirements of the following standards:

#### FCC Part 15, Subpart C (15.247)

ANSI C63.4-2003

ANSI C63.10-2009

All test items have been performed and recorded as per the above standards.

**NOTE:** The EUT is also considered as a kind of computer peripheral, because the connection to computer is necessary for typical use. It has been verified to comply with the requirements of FCC Part 15, Subpart B, Class B (DoC). The test report has been issued separately.

### 3.4 DESCRIPTION OF SUPPORT UNITS

The EUT has been tested as an independent unit together with other necessary accessories or support units. The following support units or accessories were used to form a representative test configuration during the tests.

NO.	PRODUCT	BRAND	MODEL NO.	SERIAL NO.	FCC ID
1	TV	SANYO	SMT-32KE5	NA	NA
2	PS3	SONY	CECHA07	02-27430182-955 1173-CECHA07	NA
3	Wireless Home Digital Interface Transmitter Dongle	NA	WMDA-612AN_TX	NA	ZQ6-WMDA612ANTX

NO.	SIGNAL CABLE DESCRIPTION OF THE ABOVE SUPPORT UNITS
1	1.5m shielded HDMI cable
2	1.5m shielded HDMI cable
3	NA

**NOTE 1:** All power cords of the above support units are non-shielded (1.8m).

**NOTE 2:** Item 3 & HDMI cables were supplied from client

**NOTE 3:** Items 2~3acted as communication partners to transfer data.

**NOTE 4:** Items 1 was placed under the table.

## 4. TEST TYPES AND RESULTS

### 4.1 RADIATED EMISSION MEASUREMENT

#### 4.1.1 LIMITS OF RADIATED EMISSION MEASUREMENT

Emissions radiated outside of the specified bands, shall be according to the general radiated limits in 15.209 as following:

FREQUENCIES (MHz)	FIELD STRENGTH (microvolts/meter)	MEASUREMENT DISTANCE (meters)
0.009 ~ 0.490	2400/F(kHz)	300
0.490 ~ 1.705	24000/F(kHz)	30
1.705 ~ 30.0	30	30
30 ~ 88	100	3
88 ~ 216	150	3
216 ~ 960	200	3
Above 960	500	3

**NOTE:**

1. The lower limit shall apply at the transition frequencies.
2. Emission level (dBuV/m) = 20 log Emission level (uV/m).
3. As shown in 15.35(b), for frequencies above 1000MHz, the field strength limits are based on average detector, however, the peak field strength of any emission shall not exceed the maximum permitted average limits, specified above by more than 20dB under any condition of modulation.



#### 4.1.2 TEST INSTRUMENTS

DESCRIPTION & MANUFACTURER	MODEL NO.	SERIAL NO.	DATE OF CALIBRATION	DUE DATE OF CALIBRATION
Test Receiver ROHDE & SCHWARZ	ESI7	838496/016	Dec. 27, 2010	Dec. 26, 2011
Spectrum Analyzer ROHDE & SCHWARZ	FSU43	100115	Aug. 02, 2010	Aug. 01, 2011
BILOG Antenna SCHWARZBECK	VULB9168	9168-155	Apr. 12, 2011	Apr. 11, 2012
HORN Antenna SCHWARZBECK	BBHA 9120D	9120D-408	Jan. 06, 2011	Jan. 05, 2012
HORN Antenna SCHWARZBECK	BBHA 9170	BBHA9170243	Dec. 27, 2010	Dec. 26, 2011
Preamplifier Agilent	8449B	3008A01961	Nov. 02, 2010	Nov. 01, 2011
Preamplifier Agilent	8447D	2944A10738	Nov. 02, 2010	Nov. 01, 2011
RF signal cable HUBER+SUHNNER	SUCOFLEX 104	250792/4	Sep. 03, 2010	Sep. 02, 2011
RF signal cable HUBER+SUHNNER	SUCOFLEX 104	283397/4	Sep. 03, 2010	Sep. 02, 2011
RF signal cable HUBER+SUHNNER	SUCOFLEX 104	295012/4	Sep. 03, 2010	Sep. 02, 2011
Software ADT.	ADT_Radiated_ V7.6.15.9.2	NA	NA	NA
Antenna Tower inn-co GmbH	MA 4000	010303	NA	NA
Antenna Tower Controller inn-co GmbH	CO2000	019303	NA	NA
Turn Table ADT.	TT100.	TT93021704	NA	NA
Turn Table Controller ADT.	SC100.	SC93021704	NA	NA
26GHz ~ 40GHz Amplifier	EM26400	07026401	Aug. 25, 2010	Aug. 24, 2011

- NOTE:**
1. The calibration interval of the above test instruments is 12 months and the calibrations are traceable to NML/ROC and NIST/USA.
  2. The test was performed in HwaYa Chamber 4.
  3. The horn antenna and HP preamplifier (model: 8449B) are used only for the measurement of emission frequency above 1GHz if tested.
  4. The FCC Site Registration No. is 988962.
  5. The IC Site Registration No. is IC7450F-4.

#### 4.1.3 TEST PROCEDURES

- a. The EUT was placed on the top of a rotating table 0.8 meters above the ground at a 3 meters semi-anechoic chamber. The table was rotated 360 degrees to determine the position of the highest radiation.
- b. The EUT was set 3 meters away from the interference-receiving antenna, which was mounted on the top of a variable-height antenna tower.
- c. The antenna is a broadband antenna, and its height is varied from one meter to four meters above the ground to determine the maximum value of the field strength. Both horizontal and vertical polarizations of the antenna are set to make the measurement.
- d. For each suspected emission, the EUT was arranged to its worst case and then the antenna was tuned to heights from 1 meter to 4 meters and the rotatable table was turned from 0 degrees to 360 degrees to find the maximum reading.
- e. The test-receiver system was set to Peak Detect Function and Specified Bandwidth with Maximum Hold Mode.
- f. If the emission level of the EUT in peak mode was lower than the limit specified, then testing could be stopped and the peak values of the EUT would be reported. Otherwise the emissions would be re-tested one by one using peak, quasi-peak or average method as specified and then reported in a data sheet.

**NOTE:**

1. The resolution bandwidth and video bandwidth of test receiver/spectrum analyzer is 120kHz for Quasi-peak detection at frequency below 1GHz.
2. The resolution bandwidth of test receiver/spectrum analyzer is 100kHz and video bandwidth is 300kHz for Peak detection at frequency above 1GHz.
3. The resolution bandwidth of test receiver/spectrum analyzer is 1MHz and the video bandwidth is 1kHz for Average detection (AV) at frequency above 1GHz.
4. All modes of operation were investigated and the worst-case emissions are reported.

#### 4.1.4 DEVIATION FROM TEST STANDARD

No deviation.

#### 4.1.5 TEST SETUP

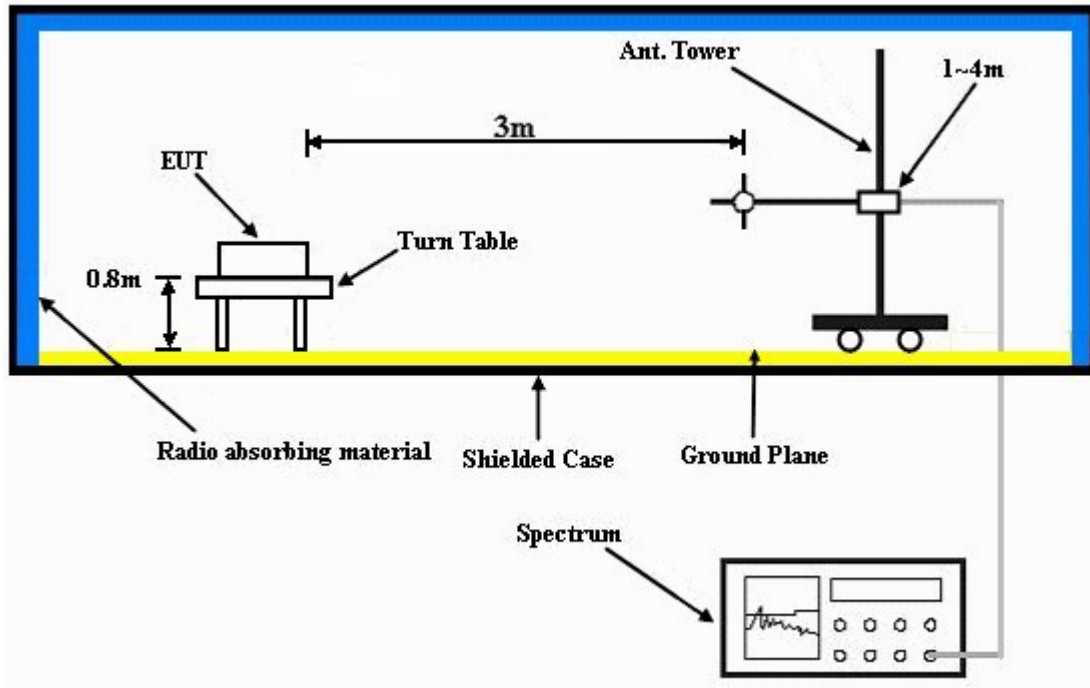

For the actual test configuration, please refer to the attached file (Test Setup Photo).

#### 4.1.6 EUT OPERATING CONDITIONS

- a. Placed the EUT on the testing table.
- b. Prepared the TV under the test table to act as a communication partners.
- c. The communication partners ran a test program (provided by manufacturer) to enable EUT under transmission condition continuously at specific channel frequency.



#### 4.1.7 TEST RESULTS

##### ABOVE 1GHz WORST-CASE DATA :

EUT TEST CONDITION		MEASUREMENT DETAIL	
CHANNEL	Channel 151	FREQUENCY RANGE	1 ~ 40GHz
INPUT POWER (SYSTEM)	120Vac, 60 Hz	DETECTOR FUNCTION	Peak (PK) Average (AV)
ENVIRONMENTAL CONDITIONS	26deg. C, 65%RH 1017 hPa	TESTED BY	Frank Wang

ANTENNA POLARITY & TEST DISTANCE: HORIZONTAL AT 3 M								
NO.	FREQ. (MHz)	EMISSION LEVEL (dBuV/m)	LIMIT (dBuV/m)	MARGIN (dB)	ANTENNA HEIGHT (m)	TABLE ANGLE (Degree)	RAW VALUE (dBuV)	CORRECTION FACTOR (dB/m)
1	#5725.00	76.5 PK	84.4	-7.9	1.25 H	77	36.00	40.50
2	#5725.00	59.8 AV	72.2	-12.4	1.25 H	77	19.30	40.50
3	*5755.00	104.4 PK			1.25 H	77	63.90	40.50
4	*5755.00	92.2 AV			1.25 H	77	51.70	40.50
5	11510.00	60.5 PK	74.0	-13.5	1.40 H	328	8.60	51.90
6	11510.00	47.2 AV	54.0	-6.8	1.40 H	328	-4.70	51.90
ANTENNA POLARITY & TEST DISTANCE: VERTICAL AT 3 M								
NO.	FREQ. (MHz)	EMISSION LEVEL (dBuV/m)	LIMIT (dBuV/m)	MARGIN (dB)	ANTENNA HEIGHT (m)	TABLE ANGLE (Degree)	RAW VALUE (dBuV)	CORRECTION FACTOR (dB/m)
1	#5725.00	70.1 PK	78.6	-8.5	1.80 V	13	29.60	40.50
2	#5725.00	53.8 AV	66.1	-12.3	1.80 V	13	13.30	40.50
3	*5755.00	98.6 PK			1.80 V	13	58.10	40.50
4	*5755.00	86.1 AV			1.80 V	13	45.60	40.50
5	11510.00	61.4 PK	74.0	-12.6	1.60 V	77	9.50	51.90
6	11510.00	51.5 AV	54.0	-2.5	1.60 V	77	-0.40	51.90

- REMARKS:**
1. Emission level (dBuV/m) = Raw Value (dBuV) + Correction Factor (dB/m).
  2. Correction Factor (dB/m) = Antenna Factor (dB/m) + Cable Factor (dB).
  3. The other emission levels were very low against the limit.
  4. Margin value = Emission level – Limit value.
  5. “ \* “: Fundamental frequency.
  6. The limit value is defined as per 15.247.
  7. “#”:The radiated frequency is out the restricted band.



A D T

EUT TEST CONDITION		MEASUREMENT DETAIL	
CHANNEL	Channel 159	FREQUENCY RANGE	1 ~ 40GHz
INPUT POWER (SYSTEM)	120Vac, 60 Hz	DETECTOR FUNCTION	Peak (PK) Average (AV)
ENVIRONMENTAL CONDITIONS	26deg. C, 65%RH 1017 hPa	TESTED BY	Frank Wang

ANTENNA POLARITY & TEST DISTANCE: HORIZONTAL AT 3 M								
NO.	FREQ. (MHz)	EMISSION LEVEL (dBuV/m)	LIMIT (dBuV/m)	MARGIN (dB)	ANTENNA HEIGHT (m)	TABLE ANGLE (Degree)	RAW VALUE (dBuV)	CORRECTION FACTOR (dB/m)
1	*5795.00	104.0 PK			1.32 H	125	63.40	40.60
2	*5795.00	92.0 AV			1.32 H	125	51.40	40.60
3	#5850.00	59.1 PK	84.0	-24.9	1.32 H	125	18.30	40.80
4	#5850.00	44.9 AV	72.0	-27.1	1.32 H	125	4.10	40.80
5	11590.00	59.5 PK	74.0	-14.5	1.36 H	104	7.60	51.90
6	11590.00	47.2 AV	54.0	-6.8	1.36 H	104	-4.70	51.90
ANTENNA POLARITY & TEST DISTANCE: VERTICAL AT 3 M								
NO.	FREQ. (MHz)	EMISSION LEVEL (dBuV/m)	LIMIT (dBuV/m)	MARGIN (dB)	ANTENNA HEIGHT (m)	TABLE ANGLE (Degree)	RAW VALUE (dBuV)	CORRECTION FACTOR (dB/m)
1	*5795.00	98.1 PK			2.12 V	197	57.50	40.60
2	*5795.00	85.6 AV			2.12 V	197	45.00	40.60
3	#5850.00	57.9 PK	78.1	-20.2	2.12 V	197	17.10	40.80
4	#5850.00	44.0 AV	65.6	-21.6	2.12 V	197	3.20	40.80
5	11590.00	61.0 PK	74.0	-13.0	1.60 V	80	9.10	51.90
6	11590.00	51.9 AV	54.0	-2.1	1.60 V	80	0.00	51.90

- REMARKS:**
1. Emission level (dBuV/m) = Raw Value (dBuV) + Correction Factor (dB/m).
  2. Correction Factor (dB/m) = Antenna Factor (dB/m) + Cable Factor (dB).
  3. The other emission levels were very low against the limit.
  4. Margin value = Emission level – Limit value.
  5. “ \* “: Fundamental frequency.
  6. The limit value is defined as per 15.247.
  7. "#":The radiated frequency is out the restricted band.



**BELOW 1GHz WORST-CASE DATA : 802.11a OFDM MODULATION**

EUT TEST CONDITION		MEASUREMENT DETAIL	
CHANNEL	Channel 159	FREQUENCY RANGE	Below 1000MHz
INPUT POWER (SYSTEM)	120Vac, 60 Hz	DETECTOR FUNCTION	Quasi-Peak
ENVIRONMENTAL CONDITIONS	26deg. C, 65%RH 1016 hPa	TESTED BY	Frank Wang

ANTENNA POLARITY & TEST DISTANCE: HORIZONTAL AT 3 M								
NO.	FREQ. (MHz)	EMISSION LEVEL (dBuV/m)	LIMIT (dBuV/m)	MARGIN (dB)	ANTENNA HEIGHT (m)	TABLE ANGLE (Degree)	RAW VALUE (dBuV)	CORRECTION FACTOR (dB/m)
1	109.62	32.3 QP	43.5	-11.2	1.50 H	298	20.40	11.90
2	199.05	30.5 QP	43.5	-13.0	2.00 H	157	18.30	12.20
3	276.82	30.5 QP	46.0	-15.5	1.00 H	55	16.00	14.50
4	319.60	31.0 QP	46.0	-15.0	1.00 H	34	15.10	15.90
5	498.47	29.2 QP	46.0	-16.8	1.00 H	64	7.90	21.30
6	801.78	30.1 QP	46.0	-15.9	1.50 H	13	2.70	27.40
ANTENNA POLARITY & TEST DISTANCE: VERTICAL AT 3 M								
NO.	FREQ. (MHz)	EMISSION LEVEL (dBuV/m)	LIMIT (dBuV/m)	MARGIN (dB)	ANTENNA HEIGHT (m)	TABLE ANGLE (Degree)	RAW VALUE (dBuV)	CORRECTION FACTOR (dB/m)
1	31.84	37.1 QP	40.0	-2.9	1.00 V	175	24.20	12.90
2	66.84	37.5 QP	40.0	-2.5	1.00 V	154	24.40	13.10
3	99.89	34.0 QP	43.5	-9.5	1.00 V	4	22.80	11.20
4	319.60	28.7 QP	46.0	-17.3	1.00 V	67	12.80	15.90
5	486.81	28.3 QP	46.0	-17.7	1.00 V	277	7.30	21.00
6	801.78	29.8 QP	46.0	-16.2	1.00 V	238	2.40	27.40

- REMARKS:**
1. Emission level (dBuV/m) = Raw Value (dBuV) + Correction Factor (dB/m).
  2. Correction Factor (dB/m) = Antenna Factor (dB/m) + Cable Factor (dB).
  3. The other emission levels were very low against the limit.
  4. Margin value = Emission level – Limit value.

## 4.2 CONDUCTED EMISSION MEASUREMENT

### 4.2.1 LIMITS OF CONDUCTED EMISSION MEASUREMENT

FREQUENCY OF EMISSION (MHz)	CONDUCTED LIMIT (dB $\mu$ V)	
	Quasi-peak	Average
0.15 ~ 0.5	66 to 56	56 to 46
0.5 ~ 5	56	46
5 ~ 30	60	50

- NOTE:** 1. The lower limit shall apply at the transition frequencies.
2. The limit decreases in line with the logarithm of the frequency in the range of 0.15 to 0.50MHz.
3. All emanations from a class A/B digital device or system, including any network of conductors and apparatus connected thereto, shall not exceed the level of field strengths specified above.

### 4.2.2 TEST INSTRUMENTS

DESCRIPTION & MANUFACTURER	MODEL NO.	SERIAL NO.	DATE OF CALIBRATION	DUE DATE OF CALIBRATION
Test Receiver ROHDE & SCHWARZ	ESCS30	100291	Nov. 30, 2010	Nov. 29, 2011
RF signal cable Woken	5D-FB	Cable-HYC01-01	Dec. 30, 2010	Dec. 29, 2011
LISN ROHDE & SCHWARZ	ESH2-Z5	100100	Jan. 06, 2011	Jan. 05, 2012
V-LISN SCHWARZBECK	NNBL 8226-2	8226-142	Jun. 30, 2011	Jun. 29, 2012
LISN ROHDE & SCHWARZ	ENV216	100072	Jun. 10, 2011	Jun. 09, 2012
Software ADT	ADT_Cond_ V7.3.7	NA	NA	NA

- NOTE:** 1. The calibration interval of the above test instruments is 12 months and the calibrations are traceable to NML/ROC and NIST/USA.
2. The test was performed in HwaYa Shielded Room 2.
3. The VCCI Site Registration No. is C-2047.

#### 4.2.3 TEST PROCEDURES

- a. The EUT was placed 0.4 meters from the conducting wall of the shielded room with EUT being connected to the power mains through a line impedance stabilization network (LISN). Other support units were connected to the power mains through another LISN. The two LISNs provide 50 ohm/ 50uH of coupling impedance for the measuring instrument.
- b. Both lines of the power mains connected to the EUT were checked for maximum conducted interference.
- c. The frequency range from 150kHz to 30MHz was searched. Emission levels under (Limit - 20dB) was not recorded.

**NOTE:** All modes of operation were investigated and the worst-case emissions are reported.

#### 4.2.4 DEVIATION FROM TEST STANDARD

No deviation.

#### 4.2.5 TEST SETUP

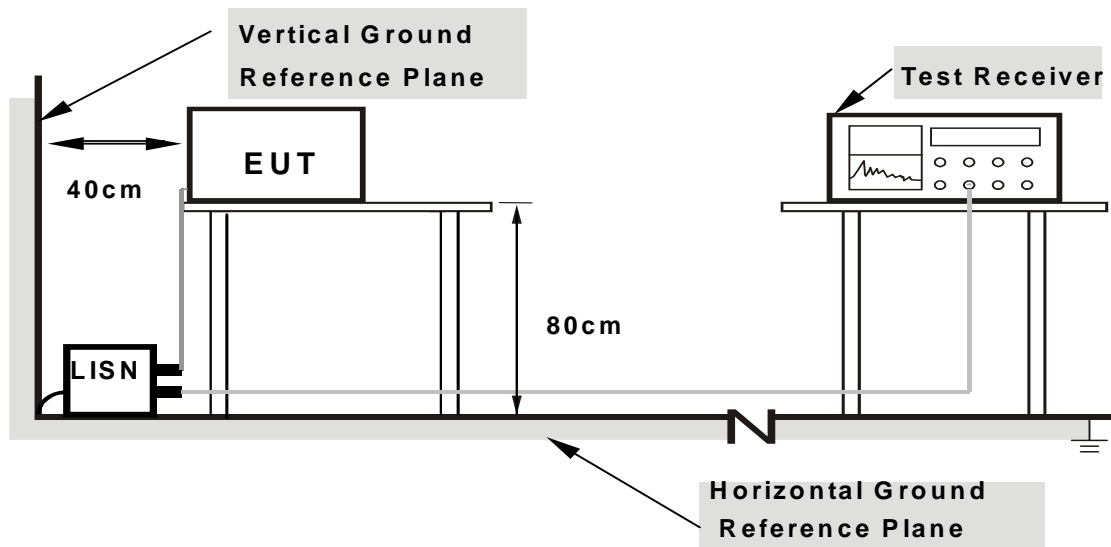

**Note: 1.Support units were connected to second LISN.**

**2.Both of LISNs (AMN) are 80 cm from EUT and at least 80 from other units and other metal planes**

For the actual test configuration, please refer to the attached file (Test Setup Photo).

#### 4.2.6 EUT OPERATING CONDITIONS

Same as 4.1.6



A D T

## 4.2.7 TEST RESULTS

### CONDUCTED WORST-CASE DATA :

PHASE	Line 1	6dB BANDWIDTH	9kHz
-------	--------	---------------	------

No	Freq.	Corr.	Reading Value		Emission Level		Limit		Margin	
	[MHz]	Factor	[dB (uV)]		[dB (uV)]		[dB (uV)]		(dB)	
		(dB)	Q.P.	AV.	Q.P.	AV.	Q.P.	AV.	Q.P.	AV.
1	0.162	0.19	39.64	-	39.83	-	65.38	55.38	-25.54	-
2	0.197	0.19	34.03	-	34.22	-	63.74	53.74	-29.52	-
3	0.392	0.20	23.98	-	24.18	-	58.02	48.02	-33.84	-
4	2.270	0.29	21.04	-	21.33	-	56.00	46.00	-34.67	-
5	7.242	0.62	25.06	-	25.68	-	60.00	50.00	-34.32	-
6	9.609	0.77	24.87	-	25.64	-	60.00	50.00	-34.36	-

- REMARKS:**
1. Q.P. and AV. are abbreviations of quasi-peak and average individually.
  2. "-": The Quasi-peak reading value also meets average limit and measurement with the average detector is unnecessary.
  3. The emission levels of other frequencies were very low against the limit.
  4. Margin value = Emission level - Limit value
  5. Correction factor = Insertion loss + Cable loss
  6. Emission Level = Correction Factor + Reading Value.

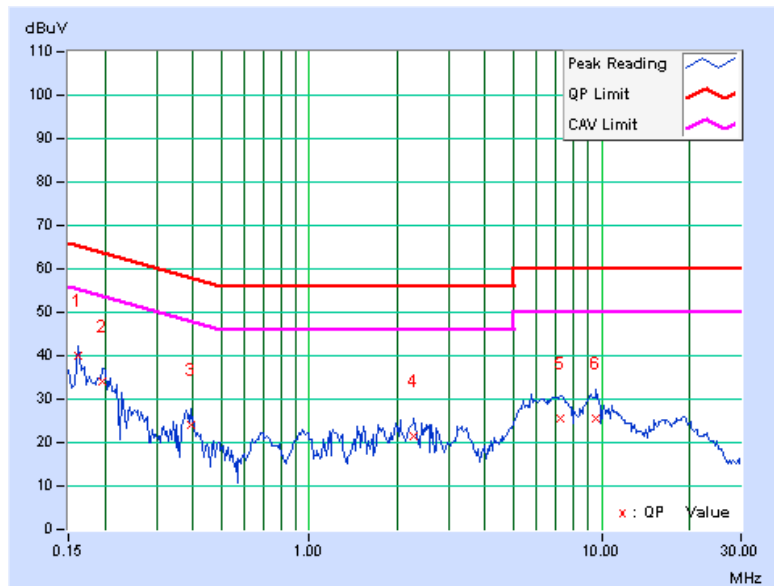



PHASE	Line 2	6dB BANDWIDTH	9kHz
-------	--------	---------------	------

No	Freq.	Corr.	Reading Value		Emission Level		Limit		Margin	
	[MHz]	Factor	[dB (uV)]		[dB (uV)]		[dB (uV)]		(dB)	
		(dB)	Q.P.	AV.	Q.P.	AV.	Q.P.	AV.	Q.P.	AV.
1	0.162	0.16	39.58	-	39.74	-	65.38	55.38	-25.64	-
2	0.201	0.16	33.20	-	33.36	-	63.58	53.58	-30.22	-
3	0.384	0.17	23.07	-	23.24	-	58.18	48.18	-34.95	-
4	1.449	0.21	19.31	-	19.52	-	56.00	46.00	-36.48	-
5	2.301	0.25	20.13	-	20.38	-	56.00	46.00	-35.62	-
6	9.438	0.64	25.91	-	26.55	-	60.00	50.00	-33.45	-

- REMARKS:**
1. Q.P. and AV. are abbreviations of quasi-peak and average individually.
  2. "-": The Quasi-peak reading value also meets average limit and measurement with the average detector is unnecessary.
  3. The emission levels of other frequencies were very low against the limit.
  4. Margin value = Emission level - Limit value
  5. Correction factor = Insertion loss + Cable loss
  6. Emission Level = Correction Factor + Reading Value.

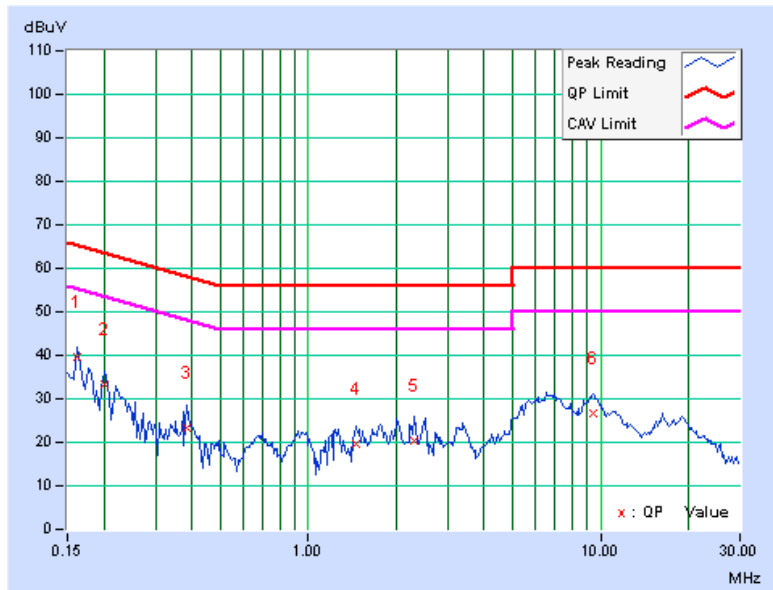





### 4.3 6dB BANDWIDTH MEASUREMENT

#### 4.3.1 LIMITS OF 6dB BANDWIDTH MEASUREMENT

The minimum of 6dB Bandwidth Measurement is 0.5MHz.

#### 4.3.2 TEST INSTRUMENTS

DESCRIPTION & MANUFACTURER	MODEL NO.	SERIAL NO.	DATE OF CALIBRATION	DUE DATE OF CALIBRATION
SPECTRUM ANALYZER R&S	FSP40	100040	Jul. 17, 2010	Jul. 16, 2011

**NOTE:** The calibration interval of the above test instruments is 12 months and the calibrations are traceable to NML/ROC and NIST/USA.

#### 4.3.3 TEST PROCEDURE

The transmitter output was connected to the spectrum analyzer through an attenuator. The bandwidth of the fundamental frequency was measured by spectrum analyzer with 100kHz RBW and 300kHz VBW. The 6dB bandwidth is defined as the total spectrum the power of which is higher than peak power minus 6dB.

#### 4.3.4 DEVIATION FROM TEST STANDARD

No deviation.

#### 4.3.5 TEST SETUP

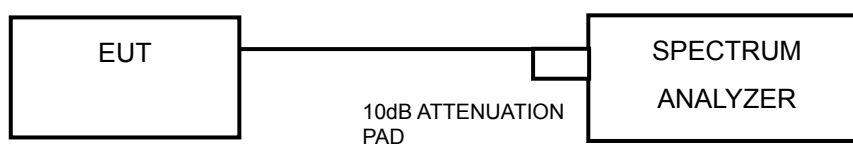

#### 4.3.6 EUT OPERATING CONDITIONS

The software provided by client to enable the EUT under transmission condition continuously at lowest, middle and highest channel frequencies individually.



A D T

### 4.3.7 TEST RESULTS

CHANNEL	CHANNEL FREQUENCY (MHz)	6dB BANDWIDTH (MHz)	MINIMUM LIMIT (MHz)	PASS / FAIL
151	5755	28.31	0.5	PASS
159	5795	37.26	0.5	PASS

#### CH 159

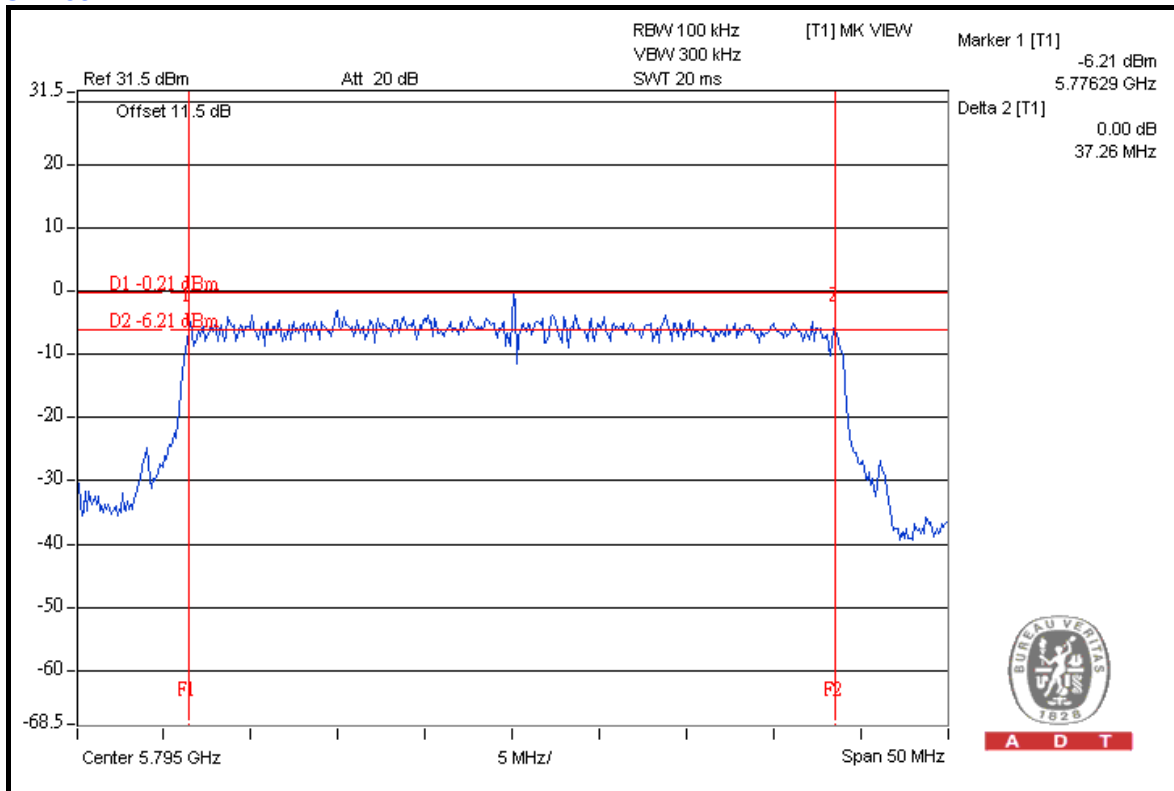



#### 4.4 MAXIMUM OUTPUT POWER

##### 4.4.1 LIMITS OF MAXIMUM OUTPUT POWER MEASUREMENT

The Maximum Output Power Measurement is 30dBm.

##### 4.4.2 INSTRUMENTS

DESCRIPTION & MANUFACTURER	MODEL NO.	SERIAL NO.	DATE OF CALIBRATION	DUE DATE OF CALIBRATION
High Speed Peak Power Meter	ML2495A	0824011	Aug. 02, 2010	Aug. 01, 2011
Power Sensor	MA2411B	0738171	Aug. 02, 2010	Aug. 01, 2011

- Note:** 1. The calibration interval of the above test instruments is 12 months and the calibrations are traceable to NML/ROC and NIST/USA.  
2. Measurement Bandwidth of ML2495A is 65MHz greater than 6dB bandwidth of emission.

##### 4.4.3 TEST PROCEDURES

A power sensor was used on the output port of the EUT. A power meter was used to read the response of the power sensor. Record the power level.

##### 4.4.4 DEVIATION FROM TEST STANDARD

No deviation.



#### 4.4.5 TEST SETUP

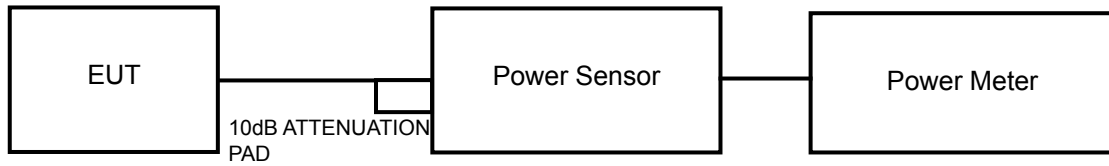

#### 4.4.6 EUT OPERATING CONDITIONS

Same as Item 5.3.6

#### 4.4.7 TEST RESULTS

CHANNEL	CHANNEL FREQUENCY (MHz)	POWER OUTPUT (mW)	POWER OUTPUT (dBm)	POWER LIMIT (dBm)	PASS/FAIL
151	5755	141.3	21.5	30	PASS
159	5795	151.4	21.8	30	PASS



## 4.5 POWER SPECTRAL DENSITY MEASUREMENT

### 4.5.1 LIMITS OF POWER SPECTRAL DENSITY MEASUREMENT

The Maximum of Power Spectral Density Measurement is 8dBm.

### 4.5.2 TEST INSTRUMENTS

DESCRIPTION & MANUFACTURER	MODEL NO.	SERIAL NO.	DATE OF CALIBRATION	DUE DATE OF CALIBRATION
SPECTRUM ANALYZER R&S	FSP40	100040	Jul. 17, 2010	Jul. 16, 2011

**NOTE:** The calibration interval of the above test instruments is 12 months and the calibrations are traceable to NML/ROC and NIST/USA.

### 4.5.3 TEST PROCEDURE

The transmitter output was connected to the spectrum analyzer through an attenuator, the bandwidth of the fundamental frequency was measured with the spectrum analyzer using 3kHz RBW and 30kHz VBW, set sweep time = span/3kHz. The power spectral density was measured and recorded.

The sweep time is allowed to be longer than span/3kHz for a full response of the mixer in the spectrum analyzer.

#### 4.5.4 DEVIATION FROM TEST STANDARD

No deviation.

#### 4.5.5 TEST SETUP

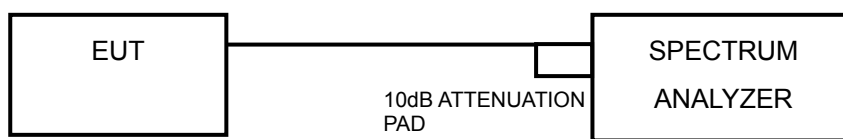

#### 4.5.6 EUT OPERATING CONDITION

Same as Item 5.3.6.



A D T

### 4.5.7 TEST RESULTS

CHAN.	CHAN. FREQ. (MHz)	RF POWER LEVEL IN 3kHz BW (dBm)	MAX. LIMIT (dBm)	PASS / FAIL
151	5755	0.1	8	PASS
159	5795	-1.0	8	PASS

#### CH 151

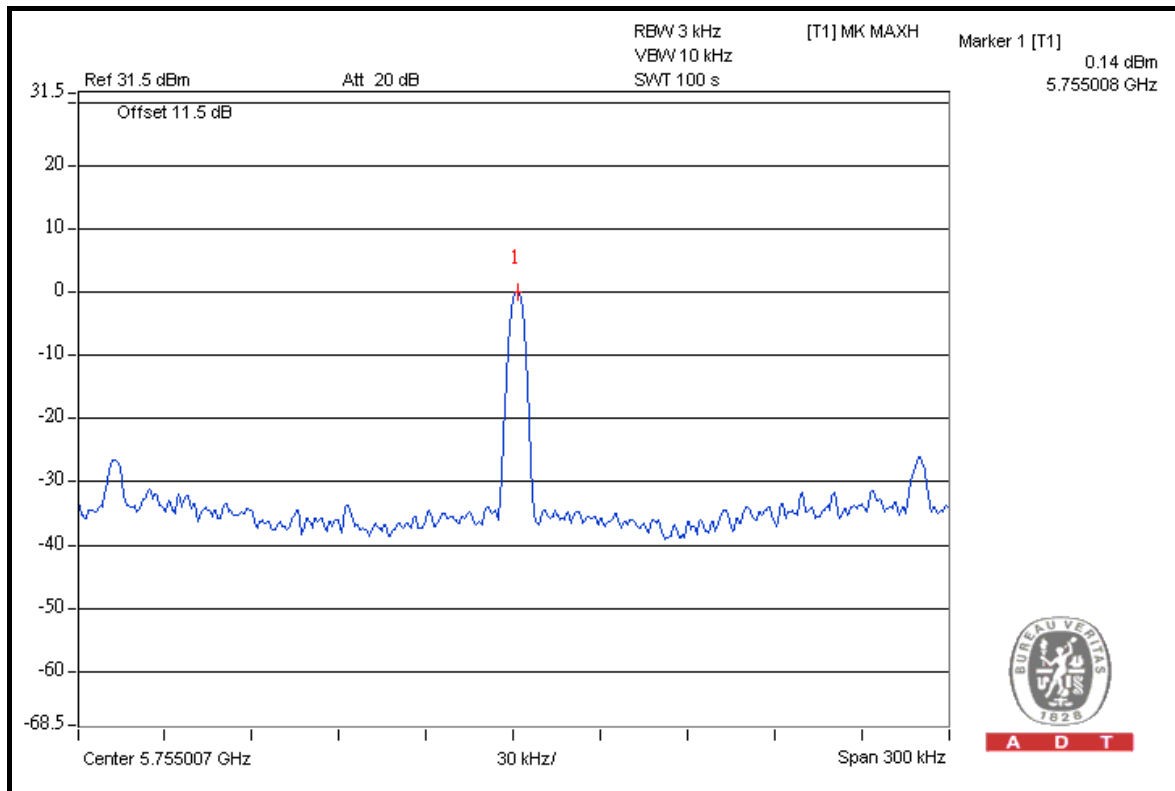





## 4.6 BAND EDGES MEASUREMENT

### 4.6.1 LIMITS OF BAND EDGES MEASUREMENT

Below  $-20\text{dB}$  of the highest emission level of operating band (in 100kHz Resolution Bandwidth).

### 4.6.2 TEST INSTRUMENTS

DESCRIPTION & MANUFACTURER	MODEL NO.	SERIAL NO.	DATE OF CALIBRATION	DUE DATE OF CALIBRATION
Test Receiver ROHDE & SCHWARZ	ESI7	838496/016	Dec. 27, 2010	Dec. 26, 2011
Spectrum Analyzer ROHDE & SCHWARZ	FSU43	100115	Aug. 02, 2010	Aug. 01, 2011
BILOG Antenna SCHWARZBECK	VULB9168	9168-155	Apr. 12, 2011	Apr. 11, 2012
HORN Antenna SCHWARZBECK	BBHA 9120D	9120D-408	Jan. 06, 2011	Jan. 05, 2012
HORN Antenna SCHWARZBECK	BBHA 9170	BBHA9170243	Dec. 27, 2010	Dec. 26, 2011
Preamplifier Agilent	8449B	3008A01961	Nov. 02, 2010	Nov. 01, 2011
Preamplifier Agilent	8447D	2944A10738	Nov. 02, 2010	Nov. 01, 2011
RF signal cable HUBER+SUHNNER	SUCOFLEX 104	250792/4	Sep. 03, 2010	Sep. 02, 2011
RF signal cable HUBER+SUHNNER	SUCOFLEX 104	283397/4	Sep. 03, 2010	Sep. 02, 2011
RF signal cable HUBER+SUHNNER	SUCOFLEX 104	295012/4	Sep. 03, 2010	Sep. 02, 2011
Software ADT.	ADT_Radiated_ V7.6.15.9.2	NA	NA	NA
Antenna Tower inn-co GmbH	MA 4000	010303	NA	NA
Antenna Tower Controller inn-co GmbH	CO2000	019303	NA	NA
Turn Table ADT.	TT100.	TT93021704	NA	NA
Turn Table Controller ADT.	SC100.	SC93021704	NA	NA
26GHz ~ 40GHz Amplifier	EM26400	07026401	Aug. 25, 2010	Aug. 24, 2011

**NOTE:** The calibration interval of the above test instruments is 12 months and the calibrations are traceable to NML/ROC and NIST/USA.

#### 4.6.3 TEST PROCEDURE

- a. The EUT was placed on the top of a rotating table 0.8 meters above the ground at a 3 meter semi-anechoic chamber. The table was rotated 360 degrees to determine the position of the highest radiation.
- b. The EUT was set 3 meters away from the interference-receiving antenna, which was mounted on the top of a variable-height antenna tower.
- c. The antenna is a broadband antenna, and its height is varied from one meter to four meters above the ground to determine the maximum value of the field strength. Both horizontal and vertical polarizations of the antenna are set to make the measurement.
- d. For each suspected emission, the EUT was arranged to its worst case and then the antenna was tuned to heights from 1 meter to 4 meters and the rotatable table was turned from 0 degrees to 360 degrees to find the maximum reading.
- e. Set both RBW and VBW of spectrum analyzer to 100kHz and 300kHz with suitable frequency span including 100MHz bandwidth from band edge. The band edges was measured and recorded.

**NOTE:** The resolution bandwidth of test receiver/spectrum analyzer is 1MHz and the video bandwidth is 1kHz for Average detection (AV) at frequency above 1GHz.



#### 4.6.4 DEVIATION FROM TEST STANDARD

No deviation.

#### 4.6.5 EUT OPERATING CONDITION

Same as Item 5.3.6.

#### 4.6.6 TEST RESULTS

The spectrum plots are attached on the following pages. D1 line indicates the highest level, D2 line indicates the 20dB offset below D1. It shows compliance with the requirement in part 15.247(d).



A D T

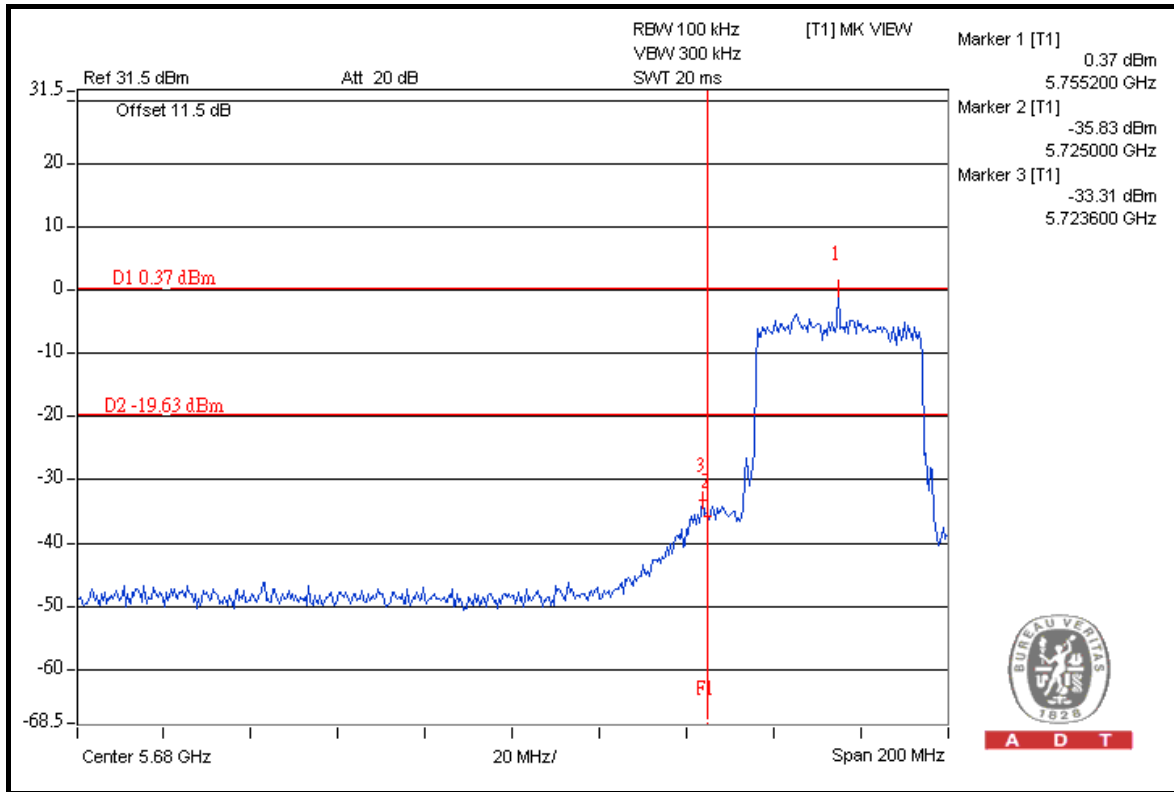

A D T

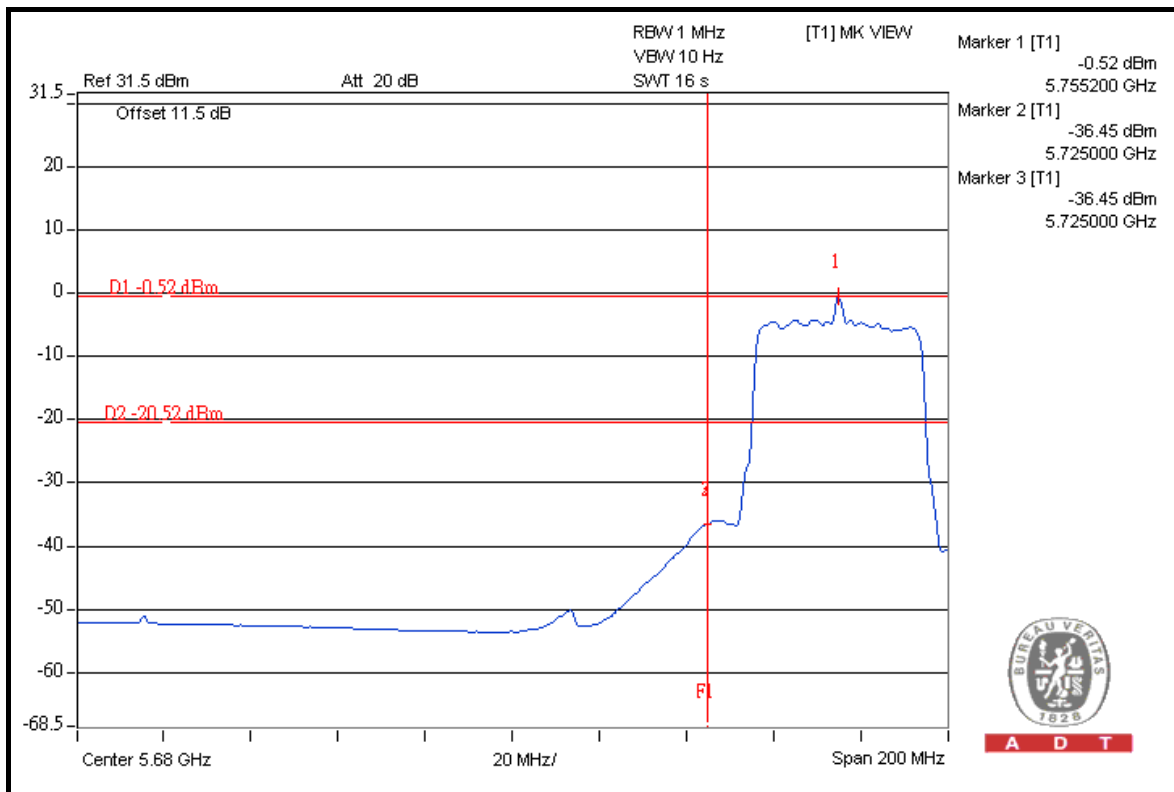

A D T



A D T

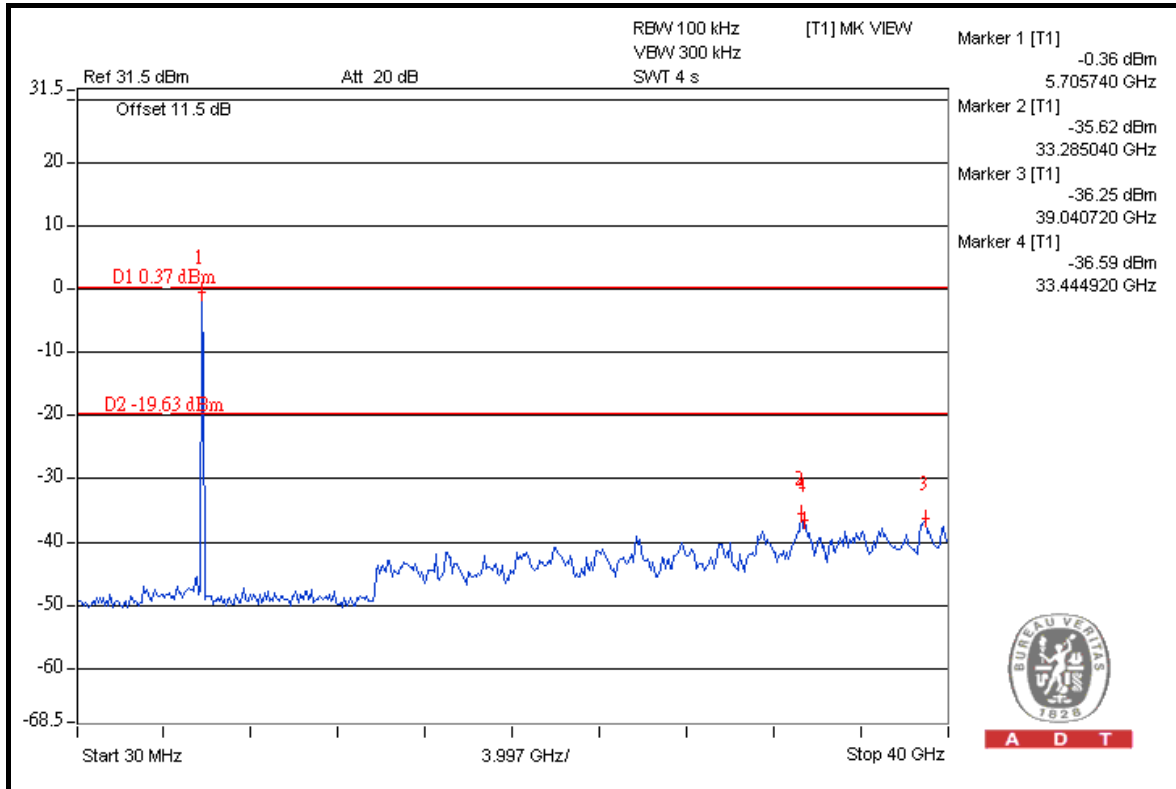

A D T

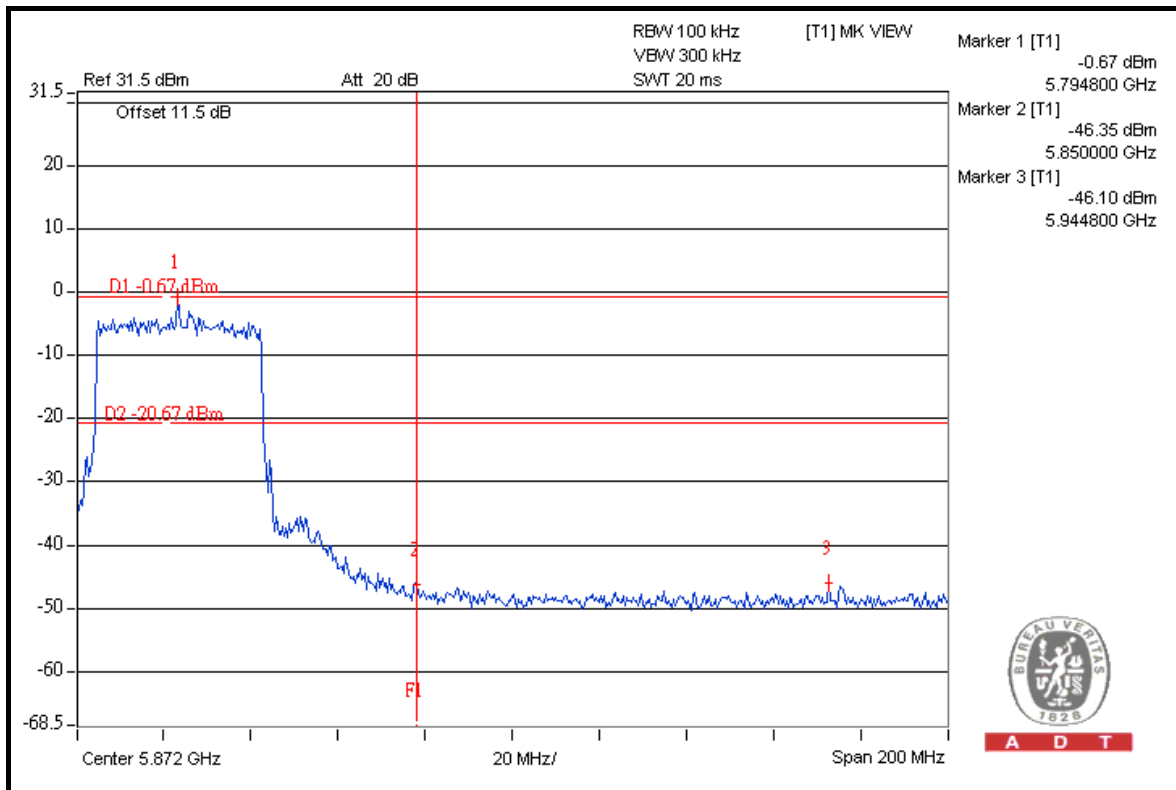

A D T



A D T

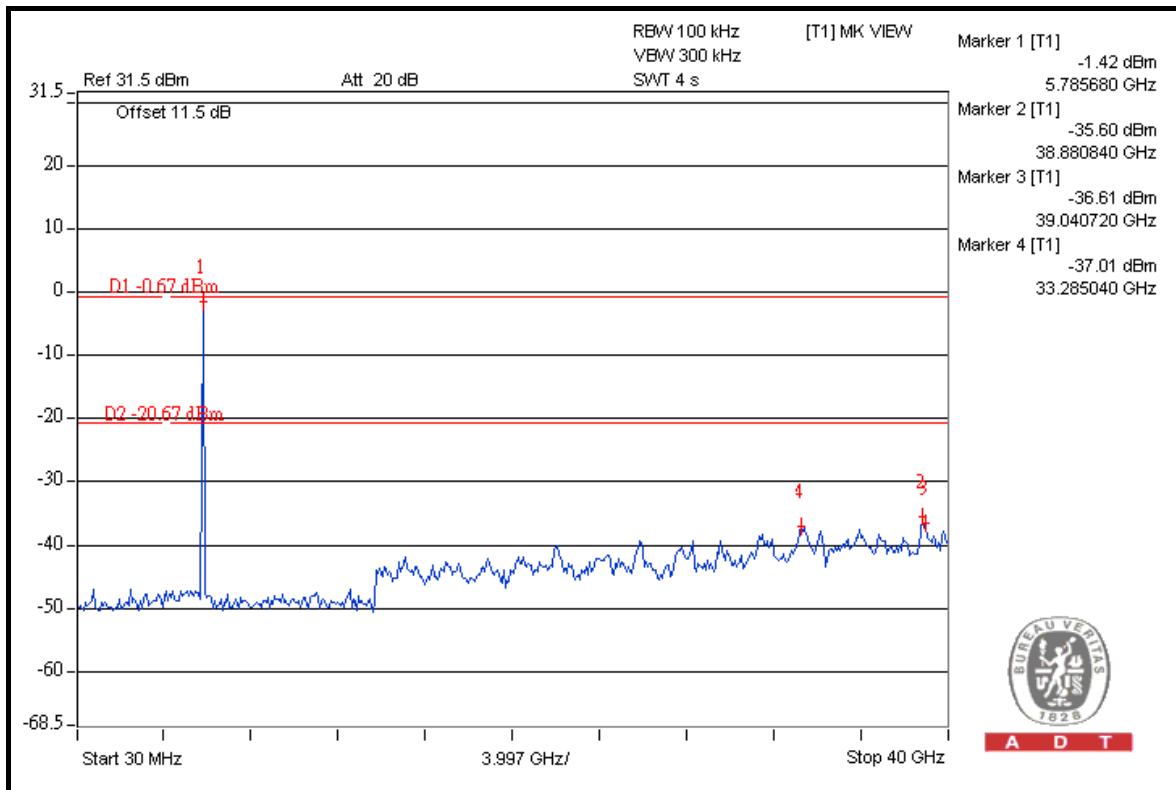
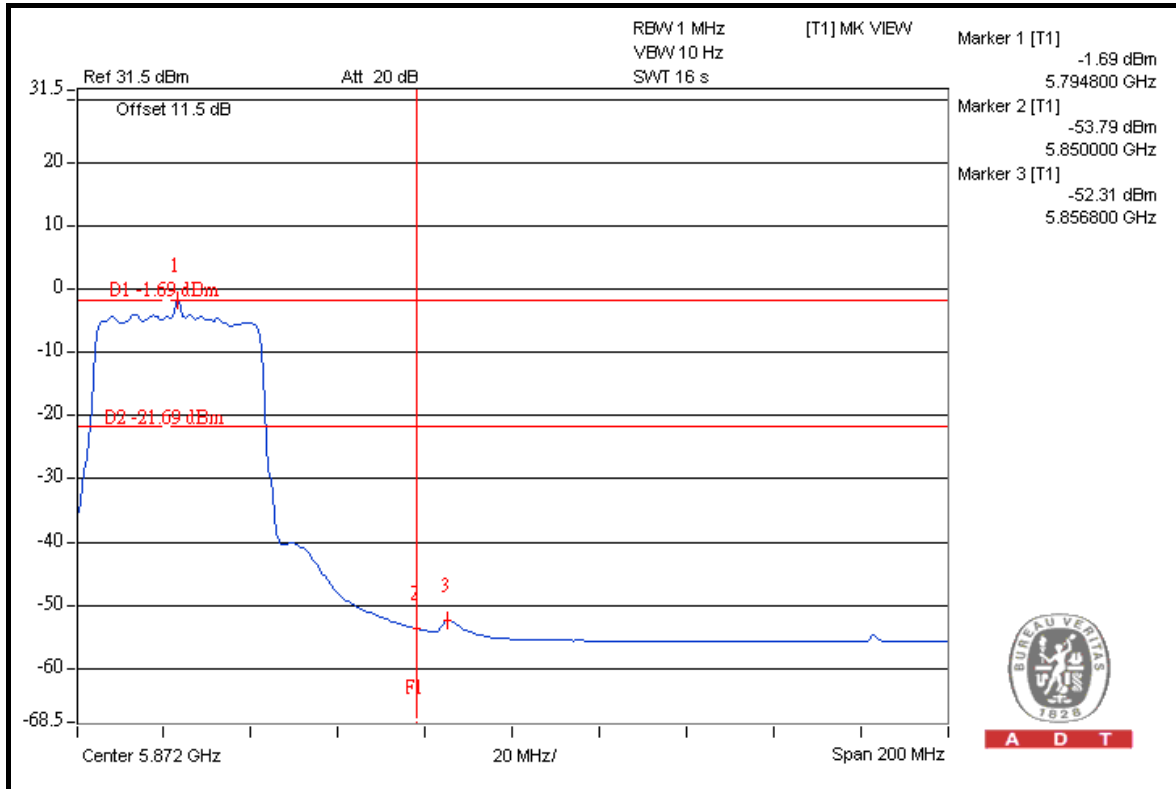



## 5. PHOTOGRAPHS OF THE TEST CONFIGURATION

Please refer to the attached file (Test Setup Photo).



## 6. INFORMATION ON THE TESTING LABORATORIES

We, Bureau Veritas Consumer Products Services (H.K.) Ltd., Taoyuan Branch, were founded in 1988 to provide our best service in EMC, Radio, Telecom and Safety consultation. Our laboratories are accredited and approved according to ISO/IEC 17025.

Copies of accreditation certificates of our laboratories obtained from approval agencies can be downloaded from our web site: [www.adt.com.tw/index.5.phtml](http://www.adt.com.tw/index.5.phtml). If you have any comments, please feel free to contact us at the following:

**Linko EMC/RF Lab:**

Tel: 886-2-26052180

Fax: 886-2-26051924

**Hsin Chu EMC/RF Lab:**

Tel: 886-3-5935343

Fax: 886-3-5935342

**Hwa Ya EMC/RF/Safety Telecom Lab:**

Tel: 886-3-3183232

Fax: 886-3-3185050

**Email:** [service.adt@tw.bureauveritas.com](mailto:service.adt@tw.bureauveritas.com)

**Web Site:** [www.adt.com.tw](http://www.adt.com.tw)

The address and road map of all our labs can be found in our web site also.





## **7. APPENDIX A - MODIFICATIONS RECORDERS FOR ENGINEERING CHANGES TO THE EUT BY THE LAB**

No any modifications are made to the EUT by the lab during the test.

**---END---**