

FCC Test Report

Report No.: RFBBZS-WTW-P21080732-3

FCC ID: ZQ6-W522A

Test Model: W522A

Received Date: Sep. 28, 2021

Test Date: Nov. 15 ~ Dec. 11, 2021

Issued Date: Mar. 14, 2022

Applicant: AMPAK Technology Inc.

Address: 3F, No.1 Jen Ai Road, Hsinchu Industrial Park, Hsinchu, Taiwan, 30352

Issued By: Bureau Veritas Consumer Products Services (H.K.) Ltd., Taoyuan Branch
Lin Kou Laboratories

Lab Address: No. 47-2, 14th Ling, Chia Pau Vil., Lin Kou Dist., New Taipei City, Taiwan

Test Location (1): No. 19, Hwa Ya 2nd Rd., Wen Hwa Vil., Kwei Shan Dist., Taoyuan City
33383, Taiwan

Test Location (2): No. 70, Wenming Rd., Guishan Dist., Taoyuan City 333, Taiwan

**FCC Registration /
Designation Number (1):** 788550 / TW0003

**FCC Registration /
Designation Number (2):** 281270 / TW0032



This report is for your exclusive use. Any copying or replication of this report to or for any other person or entity, or use of our name or trademark, is permitted only with our prior written permission. This report sets forth our findings solely with respect to the test samples identified herein. The results set forth in this report are not indicative or representative of the quality or characteristics of the lot from which a test sample was taken or any similar or identical product unless specifically and expressly noted. Our report includes all of the tests requested by you and the results thereof based upon the information that you provided to us. You have 60 days from date of issuance of this report to notify us of any material error or omission caused by our negligence, provided, however, that such notice shall be in writing and shall specifically address the issue you wish to raise. A failure to raise such issue within the prescribed time shall constitute your unqualified acceptance of the completeness of this report, the tests conducted and the correctness of the report contents. Unless specific mention, the uncertainty of measurement has been explicitly taken into account to declare the compliance or non-compliance to the specification.

Table of Contents

Release Control Record	4
1 Certificate of Conformity	5
2 Summary of Test Results	6
2.1 Measurement Uncertainty.....	6
2.2 Modification Record.....	6
3 General Information	7
3.1 General Description of EUT.....	7
3.2 Description of Test Modes.....	8
3.2.1 Test Mode Applicability and Tested Channel Detail.....	9
3.3 Duty Cycle of Test Signal.....	10
3.4 Description of Support Units.....	11
3.4.1 Configuration of System under Test.....	11
3.5 General Description of Applied Standards and References.....	11
4 Test Types and Results	12
4.1 Radiated Emission and Bandedge Measurement.....	12
4.1.1 Limits of Radiated Emission and Bandedge Measurement.....	12
4.1.2 Test Instruments.....	13
4.1.3 Test Procedures.....	14
4.1.4 Deviation from Test Standard.....	14
4.1.5 Test Setup.....	15
4.1.6 EUT Operating Conditions.....	16
4.1.7 Test Results.....	17
4.2 Conducted Emission Measurement.....	25
4.2.1 Limits of Conducted Emission Measurement.....	25
4.2.2 Test Instruments.....	25
4.2.3 Test Procedures.....	26
4.2.4 Deviation from Test Standard.....	26
4.2.5 Test Setup.....	26
4.2.6 EUT Operating Conditions.....	26
4.2.7 Test Results.....	27
4.3 6dB Bandwidth Measurement.....	29
4.3.1 Limits of 6dB Bandwidth Measurement.....	29
4.3.2 Test Setup.....	29
4.3.3 Test Instruments.....	29
4.3.4 Test Procedure.....	29
4.3.5 Deviation from Test Standard.....	29
4.3.6 EUT Operating Conditions.....	29
4.3.7 Test Result.....	30
4.4 Conducted Output Power Measurement.....	32
4.4.1 Limits of Conducted Output Power Measurement.....	32
4.4.2 Test Setup.....	32
4.4.3 Test Instruments.....	32
4.4.4 Test Procedures.....	32
4.4.5 Deviation from Test Standard.....	32
4.4.6 EUT Operating Conditions.....	32
4.4.7 Test Results.....	33
4.5 Power Spectral Density Measurement.....	34
4.5.1 Limits of Power Spectral Density Measurement.....	34
4.5.2 Test Setup.....	34
4.5.3 Test Instruments.....	34
4.5.4 Test Procedure.....	34
4.5.5 Deviation from Test Standard.....	34
4.5.6 EUT Operating Condition.....	34

4.5.7 Test Results	35
4.6 Conducted Out of Band Emission Measurement.....	37
4.6.1 Limits of Conducted Out of Band Emission Measurement	37
4.6.2 Test Setup.....	37
4.6.3 Test Instruments	37
4.6.4 Test Procedure	37
4.6.5 Deviation from Test Standard	37
4.6.6 EUT Operating Condition	37
4.6.7 Test Results	37
Annex A- Band Edge Measurement.....	40
5 Pictures of Test Arrangements.....	42
Appendix – Information of the Testing Laboratories	43



Release Control Record

Issue No.	Description	Date Issued
RFBBZS-WTW-P21080732-3	Original release	Mar. 14, 2022

1 Certificate of Conformity

Product: 1Tx/1Rx 802.11 ac/a/b/g/n Wi-Fi + BT 5.0 Module

Brand: AMPAK

Test Model: W522A

Sample Status: Engineering sample

Applicant: AMPAK Technology Inc.

Test Date: Nov. 15 ~ Dec. 11, 2021

Standards: 47 CFR FCC Part 15, Subpart C (Section 15.247)
ANSI C63.10:2013

The above equipment has been tested by **Bureau Veritas Consumer Products Services (H.K.) Ltd., Taoyuan Branch**, and found compliance with the requirement of the above standards. The test record, data evaluation & Equipment Under Test (EUT) configurations represented herein are true and accurate accounts of the measurements of the sample's RF characteristics under the conditions specified in this report.

Prepared by :

Polly Chien / Specialist

, Date:

Mar. 14, 2022

Approved by :



Jeremy Lin / Project Engineer

, Date:

Mar. 14, 2022

2 Summary of Test Results

47 CFR FCC Part 15, Subpart C (Section 15.247)			
FCC Clause	Test Item	Result	Remarks
15.207	AC Power Conducted Emission	Pass	Meet the requirement of limit. Minimum passing margin is -13.22dB at 0.46200MHz.
15.205 / 15.209 / 15.247(d)	Radiated Emissions and Band Edge Measurement	Pass	Meet the requirement of limit. Minimum passing margin is -3.91dB at 2483.50MHz.
15.247(d)	Antenna Port Emission	Pass	Meet the requirement of limit.
15.247(a)(2)	6dB bandwidth	Pass	Meet the requirement of limit.
15.247(b)	Conducted power	Pass	Meet the requirement of limit.
15.247(e)	Power Spectral Density	Pass	Meet the requirement of limit.
15.203	Antenna Requirement	Pass	Antenna connector is IPEX Female not a standard connector.

Note:

- For 2.4G band compliance with rule 15.247(d) of the band-edge items, the test plots were recorded in Annex A. Test Procedures refer to report 4.1.3.
- Determining compliance based on the results of the compliance measurement, not taking into account measurement instrumentation uncertainty.

2.1 Measurement Uncertainty

Where relevant, the following measurement uncertainty levels have been estimated for tests performed on the EUT as specified in CISPR 16-4-2:

Measurement	Frequency	Expanded Uncertainty (k=2) (\pm)
Conducted Emissions at mains ports	150kHz ~ 30MHz	2.79 dB
Radiated Emissions up to 1 GHz	9kHz ~ 30MHz	3.00 dB
	30MHz ~ 200MHz	2.91 dB
	200MHz ~ 1000MHz	2.92 dB
Radiated Emissions above 1 GHz	1GHz ~ 18GHz	1.76 dB
	18GHz ~ 40GHz	1.77 dB

2.2 Modification Record

There were no modifications required for compliance.

3 General Information

3.1 General Description of EUT

Product	1Tx/1Rx 802.11 ac/a/b/g/n Wi-Fi + BT 5.0 Module
Brand	AMPAK
Test Model	W522A
Sample Status	Engineering sample
Power Supply rating	3.3Vdc (from host equipment)
Modulation Type	GFSK
Transfer Rate	Bluetooth LE 4.0: 1Mbps Bluetooth LE 5.0: 2Mbps
Operating Frequency	2402 ~ 2480MHz
Number of Channel	40
Channel Spacing	2MHz
Output Power	Bluetooth LE 4.0: 2.570mW Bluetooth LE 5.0: 2.512mW
Antenna Type	Refer to note
Antenna Connector	Refer to note
Accessory Device	NA
Cable Supplied	NA

Note:

1. The following antennas were provided to the EUT.

Antenna Type	Connector	Gain(dBi)	
		2.4G	5G
Dipole	IPEX Female	2	3

* The above Antenna information is declared by manufacturer and for more detailed features description, please refer to the manufacturer's specifications, the laboratory shall not be held responsible.

3.2 Description of Test Modes

40 channels are provided to this EUT:

Channel	Freq. (MHz)	Channel	Freq. (MHz)	Channel	Freq. (MHz)	Channel	Freq. (MHz)
0	2402	10	2422	20	2442	30	2462
1	2404	11	2424	21	2444	31	2464
2	2406	12	2426	22	2446	32	2466
3	2408	13	2428	23	2448	33	2468
4	2410	14	2430	24	2450	34	2470
5	2412	15	2432	25	2452	35	2472
6	2414	16	2434	26	2454	36	2474
7	2416	17	2436	27	2456	37	2476
8	2418	18	2438	28	2458	38	2478
9	2420	19	2440	29	2460	39	2480

3.2.1 Test Mode Applicability and Tested Channel Detail

EUT Configure Mode	Applicable to				Description
	RE \geq 1G	RE<1G	PLC	APCM	
-	√	√	√	√	-

Where RE \geq 1G: Radiated Emission above 1GHz & Bandedge Measurement
 RE<1G: Radiated Emission below 1GHz
 PLC: Power Line Conducted Emission
 APCM: Antenna Port Conducted Measurement

Note:

1. The EUT had been pre-tested on the positioned of each 3 axis. The worst case was found when positioned on X plane.
2. For radiated emission (below 1GHz) and power line conducted emission test items chosen the worst maximum fundamental emission level channel.

Radiated Emission Test (Above 1GHz):

- Pre-Scan has been conducted to determine the worst-case mode from all possible combinations between available modulations, data rates and antenna ports (if EUT with antenna diversity architecture).
- Following channel(s) was (were) selected for the final test as listed below.

EUT Configure Mode	Available Channel	Tested Channel	Modulation Type	Data Rate (Mbps)
-	0 to 39	0, 19, 39	GFSK	1, 2

Radiated Emission Test (Below 1GHz):

- Pre-Scan has been conducted to determine the worst-case mode from all possible combinations between available modulations, data rates and antenna ports (if EUT with antenna diversity architecture).
- Following channel(s) was (were) selected for the final test as listed below.

EUT Configure Mode	Available Channel	Tested Channel	Modulation Type	Data Rate (Mbps)
-	0 to 39	39	GFSK	1

Power Line Conducted Emission Test:

- Pre-Scan has been conducted to determine the worst-case mode from all possible combinations between available modulations, data rates and antenna ports (if EUT with antenna diversity architecture).
- Following channel(s) was (were) selected for the final test as listed below.

EUT Configure Mode	Available Channel	Tested Channel	Modulation Type	Data Rate (Mbps)
-	0 to 39	39	GFSK	1

Antenna Port Conducted Measurement:

- This item includes all test value of each mode, but only includes spectrum plot of worst value of each mode.
- Pre-Scan has been conducted to determine the worst-case mode from all possible combinations between available modulations, data rates and antenna ports (if EUT with antenna diversity architecture).
- Following channel(s) was (were) selected for the final test as listed below.

EUT Configure Mode	Available Channel	Tested Channel	Modulation Type	Data Rate (Mbps)
-	0 to 39	0, 19, 39	GFSK	1, 2

Test Condition:

Applicable to	Environmental Conditions	Input Power (System)	Tested by
RE \geq 1G	23 deg. C, 68% RH	120Vac, 60Hz	Wade Huang
RE<1G	24 deg. C, 69% RH	120Vac, 60Hz,	Wade Huang
PLC	25 deg. C, 75% RH	120Vac, 60Hz,	Edison Lee
APCM	25 deg. C, 60% RH	120Vac, 60Hz	Chris Lin

3.3 Duty Cycle of Test Signal

Duty cycle of test signal is < 98%.

BT LE 4.0: Duty cycle = 0.395/1.270 = 0.311, Duty factor = 10 * log (1/0.311) = 5.07

BT LE 5.0: Duty cycle = 0.205/1.260 = 0.163, Duty factor = 10 * log (1/0.163) = 7.89

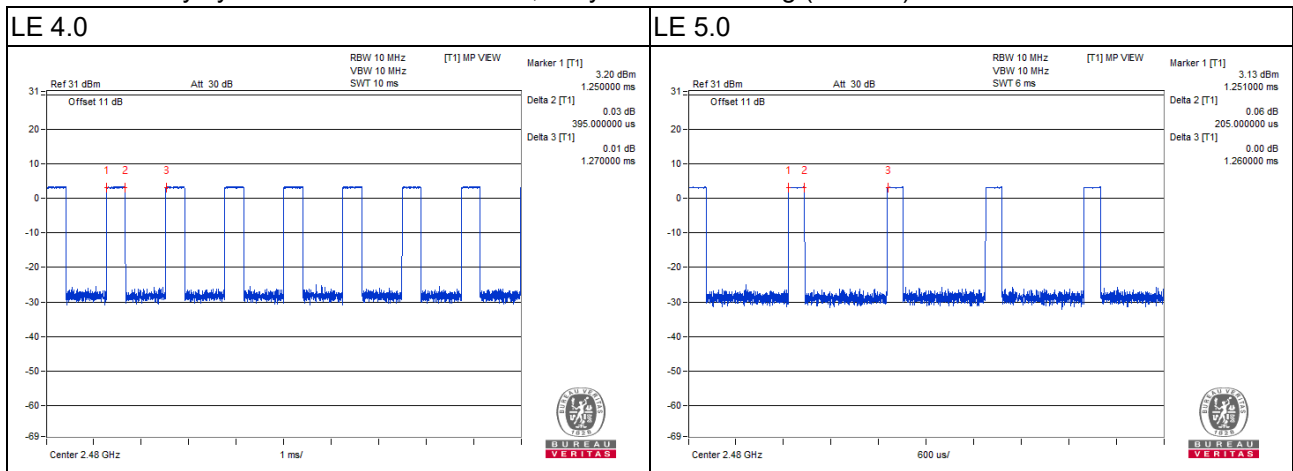

3.4 Description of Support Units

The EUT has been tested as an independent unit together with other necessary accessories or support units. The following support units or accessories were used to form a representative test configuration during the tests.

ID	Product	Brand	Model No.	Serial No.	FCC ID	Remarks
A.	Jig Board	NA	S905X_DKB	NA	NA	Provided by client
B.	Jig Board	NA	UART_V07	NA	NA	Provided by client
C.	Antenna x2	MAG.LAYERS	EDA-8709-25GR2-A7-VK	NA	NA	Provided by client
D.	Adapter	AtechOEM	ADS012T-W050200	NA	NA	Provided by client
E.	Notebook	DELL	E5420	76WNBT1	FCC DoC Approved	-

Note:

1. All power cords of the above support units are non-shielded (1.8m).
2. Items E acted as communication partners to transfer data.

ID	Descriptions	Qty.	Length (m)	Shielding (Yes/No)	Cores (Qty.)	Remarks
1.	RF cable	2	0.12	Y	0	Provided by client
2.	I/O cable	1	0.2	N	0	Provided by client
3.	I/O cable	1	0.2	N	0	Provided by client
4.	USB cable	1	1.5	Y	1	Provided by client
5.	USB cable	1	1.5	Y	0	-
6.	USB cable	1	1.8	Y	0	-

Note: The core(s) is(are) originally attached to the cable(s).

3.4.1 Configuration of System under Test

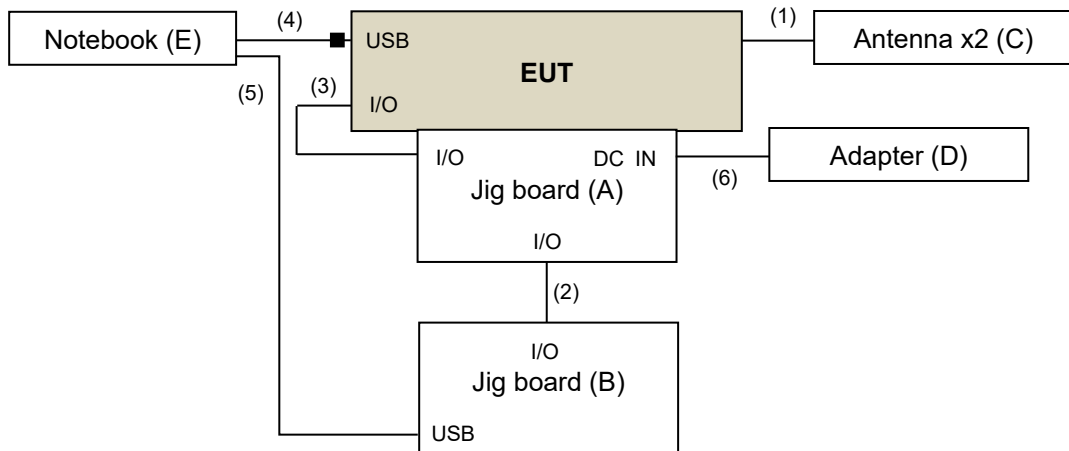

3.5 General Description of Applied Standards and References

The EUT is a RF Product. According to the specifications of the manufacturer, it must comply with the requirements of the following standards and references:

Test standard:

FCC Part 15, Subpart C (15.247)

ANSI C63.10:2013

All test items have been performed and recorded as per the above standards.

References Test Guidance:

KDB 558074 D01 15.247 Meas Guidance v05r02

All test items have been performed as a reference to the above KDB test guidance.

4 Test Types and Results

4.1 Radiated Emission and Bandedge Measurement

4.1.1 Limits of Radiated Emission and Bandedge Measurement

Radiated emissions which fall in the restricted bands must comply with the radiated emission limits specified as below table. Other emissions shall be at least 20dB below the highest level of the desired power:

Frequencies (MHz)	Field Strength (microvolts/meter)	Measurement Distance (meters)
0.009 ~ 0.490	2400/F(kHz)	300
0.490 ~ 1.705	24000/F(kHz)	30
1.705 ~ 30.0	30	30
30 ~ 88	100	3
88 ~ 216	150	3
216 ~ 960	200	3
Above 960	500	3

Note:

1. The lower limit shall apply at the transition frequencies.
2. Emission level (dBuV/m) = 20 log Emission level (uV/m).
3. For frequencies above 1000MHz, the field strength limits are based on average detector, however, the peak field strength of any emission shall not exceed the maximum permitted average limits, specified above by more than 20dB under any condition of modulation.

4.1.2 Test Instruments

Description & Manufacturer	Model No.	Serial No.	Cal. Date	Cal. Due
Test Receiver Rohde & Schwarz	ESR3	102579	Jul. 05, 2021	Jul. 04, 2022
Spectrum Analyzer KEYSIGHT	N9020B	MY60110462	Dec. 18, 2020	Dec. 17, 2021
BILOG Antenna SCHWARZBECK	VULB9168	995	Oct. 28, 2021	Oct. 27, 2022
HORN Antenna F SPIN	DRH18-E	210104A18E	Nov. 14, 2021	Nov. 13, 2022
Loop Antenna TESEQ	HLA 6121	45745	Jul. 21, 2021	Jul. 20, 2022
Preamplifier EMCI	EMC330N	980783	Jan. 19, 2021	Jan. 18, 2022
Preamplifier EMCI	EMC118A45SE	980810	Jan. 06, 2021	Jan. 05, 2022
Preamplifier EMCI	EMC184045SE	980787	Jan. 18, 2021	Jan. 17, 2022
RF signal cable EMCI	EMC104-SM-SM-(9000+2000+1000)	201230+ 201242+ 210101	Jan. 18, 2021	Jan. 17, 2022
RF signal cable EMCI	EMCCFD400-NM-NM-(9000+300+500)	201252+ 201250+ 201245	Jan. 18, 2021	Jan. 17, 2022
RF signal cable EMCI	EMC101G-KM-KM-(5000+3000+2000)	201261+201258+ 201249	Jan. 18, 2021	Jan. 17, 2022
Software BV CPS	ADT_Radiated_V7.6.15.9.5	NA	NA	NA
Turn Table Max-Full	MFT-151SS-0.5T	NA	NA	NA
Turn Table Controller Max-Full	MF-7802BS	MF780208675	NA	NA
Antenna Tower KaiTuo	NA	NA	NA	NA
Antenna Tower Controller KaiTuo	KT-2000	NA	NA	NA
Peak Power Analyzer KEYSIGHT	8990B	MY51000485	Jan. 19, 2021	Jan. 18, 2022
Wideband Power Sensor KEYSIGHT	N1923A	MY58020002	Jan. 11, 2021	Jan. 10, 2022

- Note: 1. The calibration interval of the above test instruments is 12 months and the calibrations are traceable to NML/ROC and NIST/USA.
 2. The test was performed in WM Chamber 7.
 3. Tested date: Nov. 15 ~ Nov. 30, 2021

4.1.3 Test Procedures

For Radiated emission below 30MHz

- a. The EUT was placed on the top of a rotating table 0.8 meters above the ground at a 3 meter chamber room. The table was rotated 360 degrees to determine the position of the highest radiation.
- b. The EUT was set 3 meters away from the interference-receiving antenna, which was mounted on the top of a variable-height antenna tower.
- c. Parallel, perpendicular, and ground-parallel orientations of the antenna are set to make the measurement.
- d. For each suspected emission, the EUT was arranged to its worst case and the rotatable table was turned from 0 degrees to 360 degrees to find the maximum reading.
- e. The test-receiver system was set to Quasi-Peak Detect Function and Specified Bandwidth with Maximum Hold Mode.

Note:

1. The resolution bandwidth and video bandwidth of test receiver/spectrum analyzer is 9kHz at frequency below 30MHz.

For Radiated emission above 30MHz

- a. The EUT was placed on the top of a rotating table 0.8 meters (for 30MHz ~ 1GHz) / 1.5 meters (for above 1GHz) above the ground at 3 meter chamber room for test. The table was rotated 360 degrees to determine the position of the highest radiation.
- b. The EUT was set 3 meters away from the interference-receiving antenna, which was mounted on the top of a variable-height antenna tower.
- c. The height of antenna is varied from one meter to four meters above the ground to determine the maximum value of the field strength. Both horizontal and vertical polarizations of the antenna are set to make the measurement.
- d. For each suspected emission, the EUT was arranged to its worst case and then the antenna was tuned to heights from 1 meter to 4 meters and the rotatable table was turned from 0 degrees to 360 degrees to find the maximum reading.
- e. The test-receiver system was set to quasi-peak detect function and specified bandwidth with maximum hold mode when the test frequency is below 1 GHz.
- f. The test-receiver system was set to peak and average detect function and specified bandwidth with maximum hold mode when the test frequency is above 1 GHz. If the peak reading value also meets average limit, measurement with the average detector is unnecessary.

Note:

1. The resolution bandwidth and video bandwidth of test receiver/spectrum analyzer is 120kHz for Quasi-peak detection (QP) at frequency below 1GHz.
2. The resolution bandwidth of test receiver/spectrum analyzer is 1 MHz and the video bandwidth is 3 MHz for Peak detection (PK) at frequency above 1GHz.
3. The resolution bandwidth of test receiver/spectrum analyzer is 1MHz and the video bandwidth is $\geq 1/T$ (Duty cycle < 98%) or 10Hz (Duty cycle $\geq 98\%$) for Average detection (AV) at frequency above 1GHz. (BT LE 4.0: RBW = 1MHz, VBW = 3kHz, BT LE 5.0: RBW = 1MHz, VBW = 10kHz)
4. All modes of operation were investigated and the worst-case emissions are reported.

4.1.4 Deviation from Test Standard

No deviation.

4.1.5 Test Setup

For Radiated emission below 30MHz

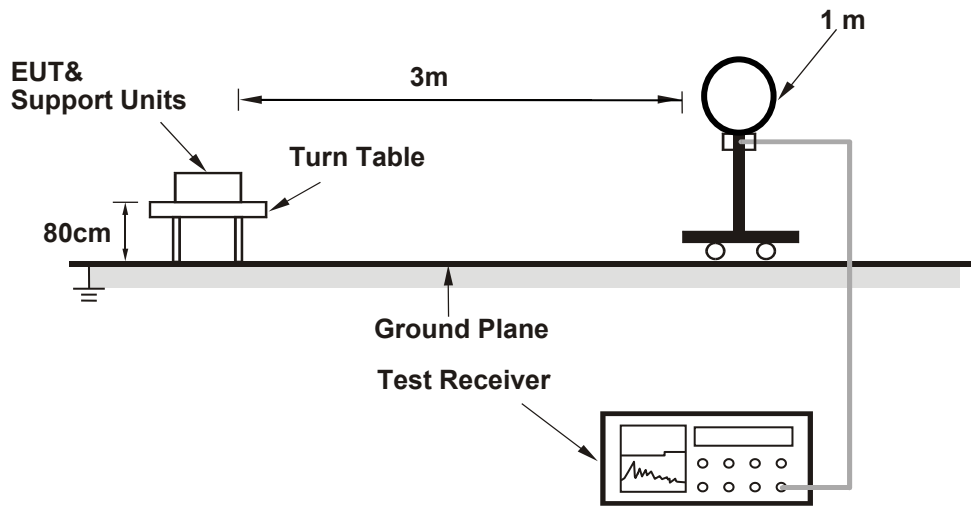

For Radiated emission 30MHz to 1GHz

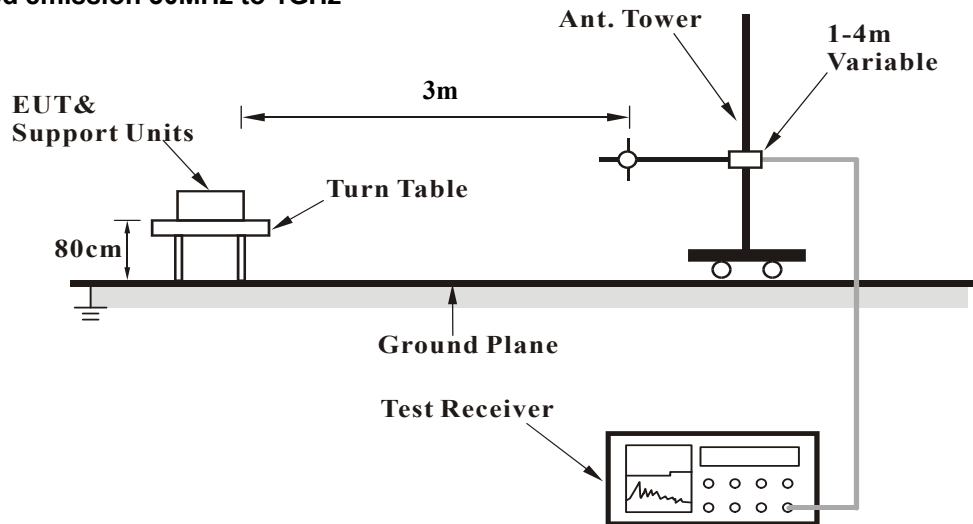

For Radiated emission above 1GHz

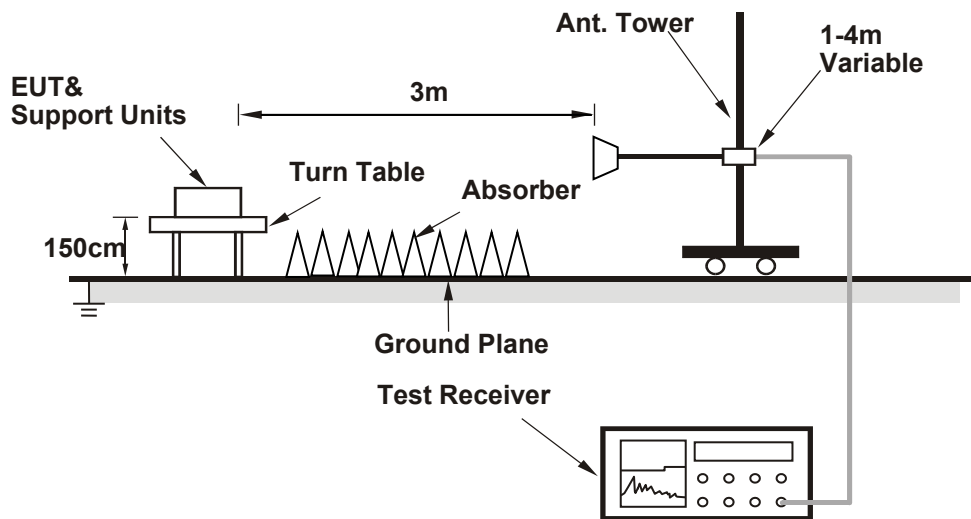

For the actual test configuration, please refer to the attached file (Test Setup Photo).

4.1.6 EUT Operating Conditions

- a. Placed the EUT on the testing table.
- b. Set the EUT under transmission condition continuously at specific channel frequency.

4.1.7 Test Results

Above 1 GHz Data:

LE 4.0

CHANNEL	TX Channel 0	DETECTOR FUNCTION	Peak (PK) Average (AV)
FREQUENCY RANGE	1GHz ~ 25GHz		

Antenna Polarity & Test Distance : Horizontal at 3 m								
No	Frequency (MHz)	Emission Level (dBuV/m)	Limit (dBuV/m)	Margin (dB)	Antenna Height (m)	Table Angle (Degree)	Raw Value (dBuV)	Correction Factor (dB/m)
1	2390.00	55.66 PK	74.00	-18.34	1.58 H	208	24.00	31.66
2	2390.00	43.96 AV	54.00	-10.04	1.58 H	208	12.30	31.66
3	*2402.00	87.38 PK			1.58 H	208	55.70	31.68
4	*2402.00	86.58 AV			1.58 H	208	54.90	31.68
5	4804.00	48.66 PK	74.00	-25.34	2.69 H	29	46.30	2.36
6	4804.00	43.36 AV	54.00	-10.64	2.69 H	29	41.00	2.36
Antenna Polarity & Test Distance : Vertical at 3m								
No	Frequency (MHz)	Emission Level (dBuV/m)	Limit (dBuV/m)	Margin (dB)	Antenna Height (m)	Table Angle (Degree)	Raw Value (dBuV)	Correction Factor (dB/m)
1	2390.00	55.86 PK	74.00	-18.14	1.64 V	176	24.20	31.66
2	2390.00	43.96 AV	54.00	-10.04	1.64 V	176	12.30	31.66
3	*2402.00	100.38 PK			1.64 V	176	68.70	31.68
4	*2402.00	99.18 AV			1.64 V	176	67.50	31.68
5	4804.00	51.86 PK	74.00	-22.14	1.60 V	346	49.50	2.36
6	4804.00	44.36 AV	54.00	-9.64	1.60 V	346	42.00	2.36

Remarks:

1. Emission Level(dBuV/m) = Raw Value(dBuV) + Correction Factor(dB/m).
2. Correction Factor(dB/m) = Antenna Factor(dB/m) + Cable Factor(dB) – Pre-Amplifier Factor(dB).
3. Margin value = Emission Level – Limit value.
4. The other emission levels were very low against the limit.
5. " * ": Fundamental frequency.

CHANNEL	TX Channel 19	DETECTOR FUNCTION	Peak (PK) Average (AV)
FREQUENCY RANGE	1GHz ~ 25GHz		

Antenna Polarity & Test Distance : Horizontal at 3 m

No	Frequency (MHz)	Emission Level (dBuV/m)	Limit (dBuV/m)	Margin (dB)	Antenna Height (m)	Table Angle (Degree)	Raw Value (dBuV)	Correction Factor (dB/m)
1	*2440.00	84.18 PK			1.66 H	224	52.40	31.78
2	*2440.00	82.78 AV			1.66 H	224	51.00	31.78
3	4880.00	48.44 PK	74.00	-25.56	2.60 H	22	45.90	2.54
4	4880.00	42.84 AV	54.00	-11.16	2.60 H	22	40.30	2.54

Antenna Polarity & Test Distance : Vertical at 3m

No	Frequency (MHz)	Emission Level (dBuV/m)	Limit (dBuV/m)	Margin (dB)	Antenna Height (m)	Table Angle (Degree)	Raw Value (dBuV)	Correction Factor (dB/m)
1	*2440.00	99.68 PK			1.66 V	168	67.90	31.78
2	*2440.00	98.68 AV			1.66 V	168	66.90	31.78
3	4880.00	53.24 PK	74.00	-20.76	1.71 V	344	50.70	2.54
4	4880.00	44.24 AV	54.00	-9.76	1.71 V	344	41.70	2.54

Remarks:

1. Emission Level(dBuV/m) = Raw Value(dBuV) + Correction Factor(dB/m).
2. Correction Factor(dB/m) = Antenna Factor(dB/m) + Cable Factor(dB) – Pre-Amplifier Factor(dB).
3. Margin value = Emission Level – Limit value.
4. The other emission levels were very low against the limit.
5. " * " : Fundamental frequency.

CHANNEL	TX Channel 39	DETECTOR FUNCTION	Peak (PK) Average (AV)
FREQUENCY RANGE	1GHz ~ 25GHz		

Antenna Polarity & Test Distance : Horizontal at 3 m								
No	Frequency (MHz)	Emission Level (dBuV/m)	Limit (dBuV/m)	Margin (dB)	Antenna Height (m)	Table Angle (Degree)	Raw Value (dBuV)	Correction Factor (dB/m)
1	*2480.00	84.38 PK			1.64 H	207	52.50	31.88
2	*2480.00	82.88 AV			1.64 H	207	51.00	31.88
3	2483.50	56.59 PK	74.00	-17.41	1.64 H	207	24.70	31.89
4	2483.50	45.89 AV	54.00	-8.11	1.64 H	207	14.00	31.89
5	4960.00	48.29 PK	74.00	-25.71	2.70 H	32	45.60	2.69
6	4960.00	42.69 AV	54.00	-11.31	2.70 H	32	40.00	2.69
Antenna Polarity & Test Distance : Vertical at 3m								
No	Frequency (MHz)	Emission Level (dBuV/m)	Limit (dBuV/m)	Margin (dB)	Antenna Height (m)	Table Angle (Degree)	Raw Value (dBuV)	Correction Factor (dB/m)
1	*2480.00	100.08 PK			1.66 V	180	68.20	31.88
2	*2480.00	99.28 AV			1.66 V	180	67.40	31.88
3	2483.50	56.59 PK	74.00	-17.41	1.66 V	180	24.70	31.89
4	2483.50	47.29 AV	54.00	-6.71	1.66 V	180	15.40	31.89
5	4960.00	53.39 PK	74.00	-20.61	1.65 V	351	50.70	2.69
6	4960.00	46.39 AV	54.00	-7.61	1.65 V	351	43.70	2.69

Remarks:

1. Emission Level(dBuV/m) = Raw Value(dBuV) + Correction Factor(dB/m).
2. Correction Factor(dB/m) = Antenna Factor(dB/m) + Cable Factor(dB) – Pre-Amplifier Factor(dB).
3. Margin value = Emission Level – Limit value.
4. The other emission levels were very low against the limit.
5. " * " : Fundamental frequency.

LE 5.0

CHANNEL	TX Channel 0	DETECTOR FUNCTION	Peak (PK) Average (AV)
FREQUENCY RANGE	1GHz ~ 25GHz		

Antenna Polarity & Test Distance : Horizontal at 3 m								
No	Frequency (MHz)	Emission Level (dBuV/m)	Limit (dBuV/m)	Margin (dB)	Antenna Height (m)	Table Angle (Degree)	Raw Value (dBuV)	Correction Factor (dB/m)
1	2390.00	55.56 PK	74.00	-18.44	1.64 H	209	23.90	31.66
2	2390.00	44.76 AV	54.00	-9.24	1.64 H	209	13.10	31.66
3	*2402.00	86.68 PK			1.64 H	209	55.00	31.68
4	*2402.00	84.38 AV			1.64 H	209	52.70	31.68
5	4804.00	48.46 PK	74.00	-25.54	2.66 H	28	46.10	2.36
6	4804.00	42.96 AV	54.00	-11.04	2.66 H	28	40.60	2.36

Antenna Polarity & Test Distance : Vertical at 3m								
No	Frequency (MHz)	Emission Level (dBuV/m)	Limit (dBuV/m)	Margin (dB)	Antenna Height (m)	Table Angle (Degree)	Raw Value (dBuV)	Correction Factor (dB/m)
1	2390.00	56.16 PK	74.00	-17.84	1.64 V	178	24.50	31.66
2	2390.00	44.36 AV	54.00	-9.64	1.64 V	178	12.70	31.66
3	*2402.00	100.38 PK			1.64 V	178	68.70	31.68
4	*2402.00	97.58 AV			1.64 V	178	65.90	31.68
5	4804.00	51.06 PK	74.00	-22.94	1.78 V	347	48.70	2.36
6	4804.00	42.56 AV	54.00	-11.44	1.78 V	347	40.20	2.36

Remarks:

1. Emission Level(dBuV/m) = Raw Value(dBuV) + Correction Factor(dB/m).
2. Correction Factor(dB/m) = Antenna Factor(dB/m) + Cable Factor(dB) – Pre-Amplifier Factor(dB).
3. Margin value = Emission Level – Limit value.
4. The other emission levels were very low against the limit.
5. " * " : Fundamental frequency.

CHANNEL	TX Channel 19	DETECTOR FUNCTION	Peak (PK) Average (AV)
FREQUENCY RANGE	1GHz ~ 25GHz		

Antenna Polarity & Test Distance : Horizontal at 3 m								
No	Frequency (MHz)	Emission Level (dBuV/m)	Limit (dBuV/m)	Margin (dB)	Antenna Height (m)	Table Angle (Degree)	Raw Value (dBuV)	Correction Factor (dB/m)
1	*2440.00	83.68 PK			1.58 H	227	51.90	31.78
2	*2440.00	80.98 AV			1.58 H	227	49.20	31.78
3	4880.00	48.24 PK	74.00	-25.76	2.59 H	26	45.70	2.54
4	4880.00	43.04 AV	54.00	-10.96	2.59 H	26	40.50	2.54
Antenna Polarity & Test Distance : Vertical at 3m								
No	Frequency (MHz)	Emission Level (dBuV/m)	Limit (dBuV/m)	Margin (dB)	Antenna Height (m)	Table Angle (Degree)	Raw Value (dBuV)	Correction Factor (dB/m)
1	*2440.00	100.08 PK			1.73 V	178	68.30	31.78
2	*2440.00	97.28 AV			1.73 V	178	65.50	31.78
3	4880.00	52.04 PK	74.00	-21.96	1.80 V	351	49.50	2.54
4	4880.00	43.04 AV	54.00	-10.96	1.80 V	351	40.50	2.54

Remarks:

1. Emission Level(dBuV/m) = Raw Value(dBuV) + Correction Factor(dB/m).
2. Correction Factor(dB/m) = Antenna Factor(dB/m) + Cable Factor(dB) – Pre-Amplifier Factor(dB).
3. Margin value = Emission Level – Limit value.
4. The other emission levels were very low against the limit.
5. " * " : Fundamental frequency.

CHANNEL	TX Channel 39	DETECTOR FUNCTION	Peak (PK) Average (AV)
FREQUENCY RANGE	1GHz ~ 25GHz		

Antenna Polarity & Test Distance : Horizontal at 3 m

No	Frequency (MHz)	Emission Level (dBuV/m)	Limit (dBuV/m)	Margin (dB)	Antenna Height (m)	Table Angle (Degree)	Raw Value (dBuV)	Correction Factor (dB/m)
1	*2480.00	85.78 PK			1.51 H	227	53.90	31.88
2	*2480.00	83.28 AV			1.51 H	227	51.40	31.88
3	2483.50	64.79 PK	74.00	-9.21	1.51 H	227	32.90	31.89
4	2483.50	46.39 AV	54.00	-7.61	1.51 H	227	14.50	31.89
5	4960.00	48.59 PK	74.00	-25.41	2.66 H	25	45.90	2.69
6	4960.00	43.59 AV	54.00	-10.41	2.66 H	25	40.90	2.69

Antenna Polarity & Test Distance : Vertical at 3m

No	Frequency (MHz)	Emission Level (dBuV/m)	Limit (dBuV/m)	Margin (dB)	Antenna Height (m)	Table Angle (Degree)	Raw Value (dBuV)	Correction Factor (dB/m)
1	*2480.00	100.28 PK			1.94 V	174	68.40	31.88
2	*2480.00	97.58 AV			1.94 V	174	65.70	31.88
3	2483.50	57.69 PK	74.00	-16.31	1.94 V	174	25.80	31.89
4	2483.50	50.09 AV	54.00	-3.91	1.94 V	174	18.20	31.89
5	4960.00	51.79 PK	74.00	-22.21	1.71 V	349	49.10	2.69
6	4960.00	43.09 AV	54.00	-10.91	1.71 V	349	40.40	2.69

Remarks:

1. Emission Level(dBuV/m) = Raw Value(dBuV) + Correction Factor(dB/m).
2. Correction Factor(dB/m) = Antenna Factor(dB/m) + Cable Factor(dB) – Pre-Amplifier Factor(dB).
3. Margin value = Emission Level – Limit value.
4. The other emission levels were very low against the limit.
5. " * " : Fundamental frequency.

Below 1GHz worst-case data:

LE 4.0

CHANNEL	TX Channel 39	DETECTOR FUNCTION	Quasi-Peak (QP)
FREQUENCY RANGE	9kHz ~ 1GHz		

ANTENNA POLARITY & TEST DISTANCE: HORIZONTAL AT 3 M								
NO.	FREQ. (MHz)	EMISSION LEVEL (dBuV/m)	LIMIT (dBuV/m)	MARGIN (dB)	ANTENNA HEIGHT (m)	TABLE ANGLE (Degree)	RAW VALUE (dBuV)	CORRECTION FACTOR (dB/m)
1	119.97	32.07 QP	43.50	-11.43	1.49 H	146	52.57	-20.50
2	143.87	32.63 QP	43.50	-10.87	1.99 H	2	50.97	-18.34
3	167.77	30.46 QP	43.50	-13.04	1.49 H	150	49.04	-18.58
4	263.36	34.16 QP	46.00	-11.84	1.01 H	154	53.49	-19.33
5	311.16	36.29 QP	46.00	-9.71	1.01 H	149	54.03	-17.74
6	479.86	31.70 QP	46.00	-14.30	1.99 H	154	45.47	-13.77

Remarks:

1. Emission Level(dBuV/m) = Raw Value(dBuV) + Correction Factor(dB/m).
2. Correction Factor(dB/m) = Antenna Factor(dB/m) + Cable Factor(dB) – Pre-Amplifier Factor(dB).
3. The other emission levels were very low against the limit of frequency range 30MHz ~ 1000MHz.
4. Margin value = Emission Level – Limit value.
5. The emission levels were very low against the limit of frequency range 9kHz ~ 30MHz: the amplitude of spurious emissions attenuated more than 20 dB below the permissible value to be report.

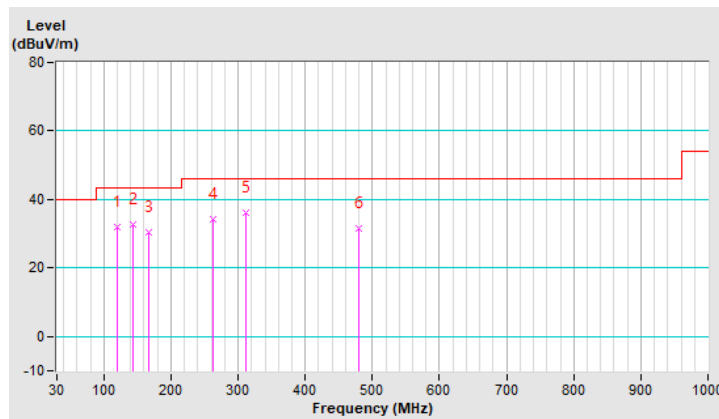

CHANNEL	TX Channel 39	DETECTOR FUNCTION	Quasi-Peak (QP)
FREQUENCY RANGE	9kHz ~ 1GHz		

ANTENNA POLARITY & TEST DISTANCE: VERTICAL AT 3 M								
NO.	FREQ. (MHz)	EMISSION LEVEL (dBuV/m)	LIMIT (dBuV/m)	MARGIN (dB)	ANTENNA HEIGHT (m)	TABLE ANGLE (Degree)	RAW VALUE (dBuV)	CORRECTION FACTOR (dB/m)
1	32.81	31.17 QP	40.00	-8.83	1.01 V	224	50.62	-19.45
2	59.52	28.60 QP	40.00	-11.40	1.51 V	75	47.44	-18.84
3	112.94	30.67 QP	43.50	-12.83	1.01 V	315	51.79	-21.12
4	143.87	28.34 QP	43.50	-15.16	1.01 V	16	46.68	-18.34
5	263.36	26.96 QP	46.00	-19.04	2.00 V	105	46.29	-19.33
6	384.26	29.52 QP	46.00	-16.48	1.51 V	156	45.38	-15.86

Remarks:

1. Emission Level(dBuV/m) = Raw Value(dBuV) + Correction Factor(dB/m).
2. Correction Factor(dB/m) = Antenna Factor(dB/m) + Cable Factor(dB) – Pre-Amplifier Factor(dB).
3. The other emission levels were very low against the limit of frequency range 30MHz ~ 1000MHz.
4. Margin value = Emission Level – Limit value.
5. The emission levels were very low against the limit of frequency range 9kHz ~ 30MHz: the amplitude of spurious emissions attenuated more than 20 dB below the permissible value to be report.

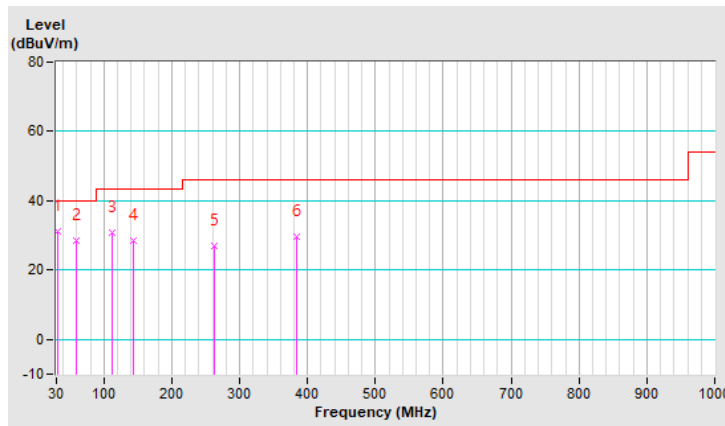

4.2 Conducted Emission Measurement

4.2.1 Limits of Conducted Emission Measurement

Frequency (MHz)	Conducted Limit (dBuV)	
	Quasi-peak	Average
0.15 - 0.5	66 - 56	56 - 46
0.50 - 5.0	56	46
5.0 - 30.0	60	50

Note: 1. The lower limit shall apply at the transition frequencies.
 2. The limit decreases in line with the logarithm of the frequency in the range of 0.15 to 0.50MHz.

4.2.2 Test Instruments

Description & Manufacturer	Model No.	Serial No.	Cal. Date	Cal. Due
Test Receiver ROHDE & SCHWARZ	ESR3	102412	Jan. 29, 2021	Jan. 28, 2022
RF signal cable (with 10dB PAD) Woken	5D-FB	Cable-cond2-01	Sep. 04, 2021	Sep. 03, 2022
LISN ROHDE & SCHWARZ (EUT)	ESH2-Z5	100100	Jan. 28, 2021	Jan. 27, 2022
LISN ROHDE & SCHWARZ (Peripheral)	ENV216	101196	Apr. 26, 2021	Apr. 25, 2022
Software ADT	BV ADT_Cond_ V7.3.7.4	NA	NA	NA

Note: 1. The calibration interval of the above test instruments is 12 months and the calibrations are traceable to NML/ROC and NIST/USA.
 2. The test was performed in HwaYa Shielded Room 2 (Conduction 2).
 3. The VCCI Site Registration No. is C-12047.
 4. Tested date: Dec. 11, 2021

4.2.3 Test Procedures

- The EUT was placed 0.4 meters from the conducting wall of the shielded room with EUT being connected to the power mains through a line impedance stabilization network (LISN). Other support units were connected to the power mains through another LISN. The two LISNs provide 50 ohm/ 50uH of coupling impedance for the measuring instrument.
- Both lines of the power mains connected to the EUT were checked for maximum conducted interference.
- The frequency range from 150kHz to 30MHz was searched. Emission levels under (Limit - 20dB) was not recorded.

Note: The resolution bandwidth and video bandwidth of test receiver is 9kHz for quasi-peak detection (QP) and average detection (AV) at frequency 0.15MHz-30MHz.

4.2.4 Deviation from Test Standard

No deviation.

4.2.5 Test Setup

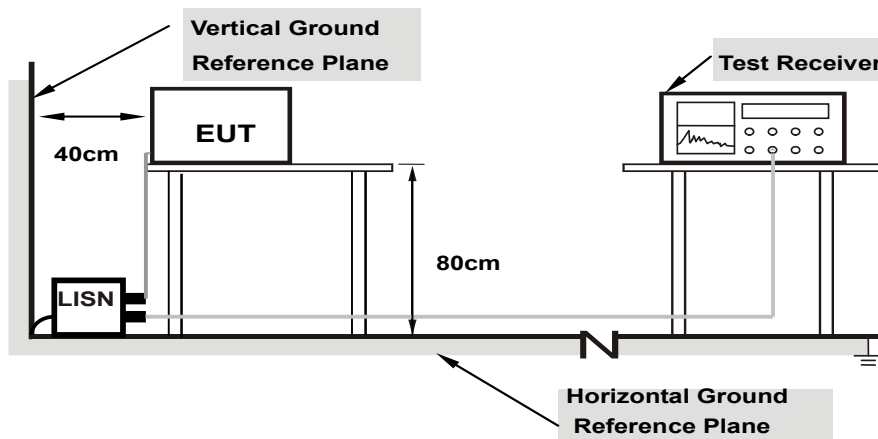

Note: 1.Support units were connected to second LISN.

For the actual test configuration, please refer to the attached file (Test Setup Photo).

4.2.6 EUT Operating Conditions

Same as 4.1.6.

4.2.7 Test Results

LE 4.0

Phase	Line (L)	Detector Function	Quasi-Peak (QP) / Average (AV)
-------	----------	-------------------	--------------------------------

No	Freq. [MHz]	Corr. Factor (dB)	Reading Value [dB (uV)]		Emission Level [dB (uV)]		Limit [dB (uV)]		Margin (dB)	
			Q.P.	AV.	Q.P.	AV.	Q.P.	AV.	Q.P.	AV.
			1	0.15400	10.11	39.66	24.57	49.77	34.68	65.78
2	0.45800	10.14	33.13	18.59	43.27	28.73	56.73	46.73	-13.46	-18.00
3	1.36200	10.18	21.96	11.79	32.14	21.97	56.00	46.00	-23.86	-24.03
4	3.49800	10.23	15.59	6.35	25.82	16.58	56.00	46.00	-30.18	-29.42
5	4.55400	10.25	12.22	3.68	22.47	13.93	56.00	46.00	-33.53	-32.07
6	14.67800	10.39	16.50	3.94	26.89	14.33	60.00	50.00	-33.11	-35.67

Remarks:

1. Q.P. and AV. are abbreviations of quasi-peak and average individually.
2. The emission levels of other frequencies were very low against the limit.
3. Margin value = Emission level - Limit value
4. Correction factor = Insertion loss + Cable loss
5. Emission Level = Correction Factor + Reading Value.

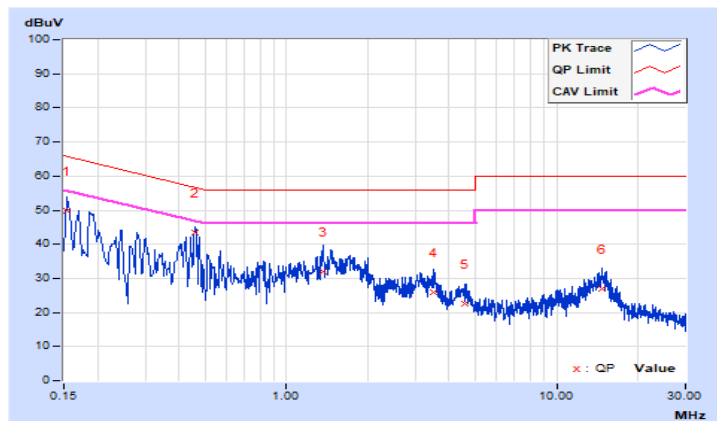

Phase	Neutral (N)	Detector Function	Quasi-Peak (QP) / Average (AV)
-------	-------------	-------------------	--------------------------------

No	Freq. [MHz]	Corr. Factor (dB)	Reading Value [dB (uV)]		Emission Level [dB (uV)]		Limit [dB (uV)]		Margin (dB)	
			Q.P.	AV.	Q.P.	AV.	Q.P.	AV.	Q.P.	AV.
			1	0.17400	10.12	39.67	29.34	49.79	39.46	64.77
2	0.27134	10.14	28.92	17.77	39.06	27.91	61.08	51.08	-22.02	-23.17
3	0.46200	10.15	33.29	18.62	43.44	28.77	56.66	46.66	-13.22	-17.89
4	1.46600	10.20	25.37	17.10	35.57	27.30	56.00	46.00	-20.43	-18.70
5	3.46200	10.26	16.02	6.94	26.28	17.20	56.00	46.00	-29.72	-28.80
6	14.68600	10.53	19.55	6.28	30.08	16.81	60.00	50.00	-29.92	-33.19

Remarks:

1. Q.P. and AV. are abbreviations of quasi-peak and average individually.
2. The emission levels of other frequencies were very low against the limit.
3. Margin value = Emission level - Limit value
4. Correction factor = Insertion loss + Cable loss
5. Emission Level = Correction Factor + Reading Value.

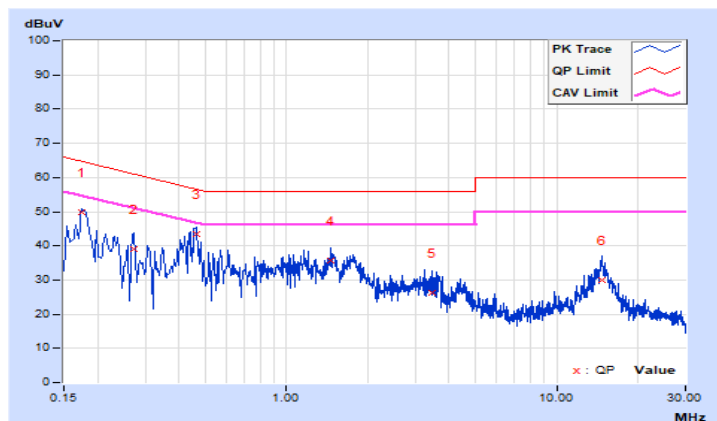

4.3 6dB Bandwidth Measurement

4.3.1 Limits of 6dB Bandwidth Measurement

The minimum of 6dB Bandwidth Measurement is 0.5 MHz.

4.3.2 Test Setup

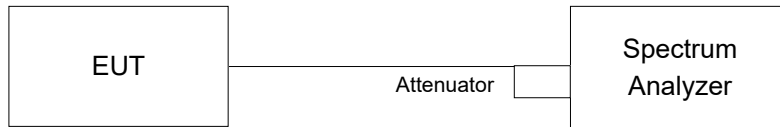

4.3.3 Test Instruments

Refer to section 4.1.2 to get information of above instrument.

4.3.4 Test Procedure

- Set resolution bandwidth (RBW) = 100kHz.
- Set the video bandwidth (VBW) $\geq 3 \times$ RBW, Detector = peak.
- Trace mode = max hold.
- Sweep = auto couple.
- Measure the maximum width of the emission that is constrained by the frequencies associated with the two amplitude points (upper and lower) that are attenuated by 6 dB relative to the maximum level measured in the fundamental emission.

4.3.5 Deviation from Test Standard

No deviation.

4.3.6 EUT Operating Conditions

The software provided by client to enable the EUT under transmission condition continuously at lowest, middle and highest channel frequencies individually.

4.3.7 Test Result

LE 4.0

Channel	Frequency (MHz)	6dB Bandwidth (MHz)	Minimum Limit (MHz)	Pass / Fail
0	2402	0.67	0.5	Pass
19	2440	0.67	0.5	Pass
39	2480	0.67	0.5	Pass

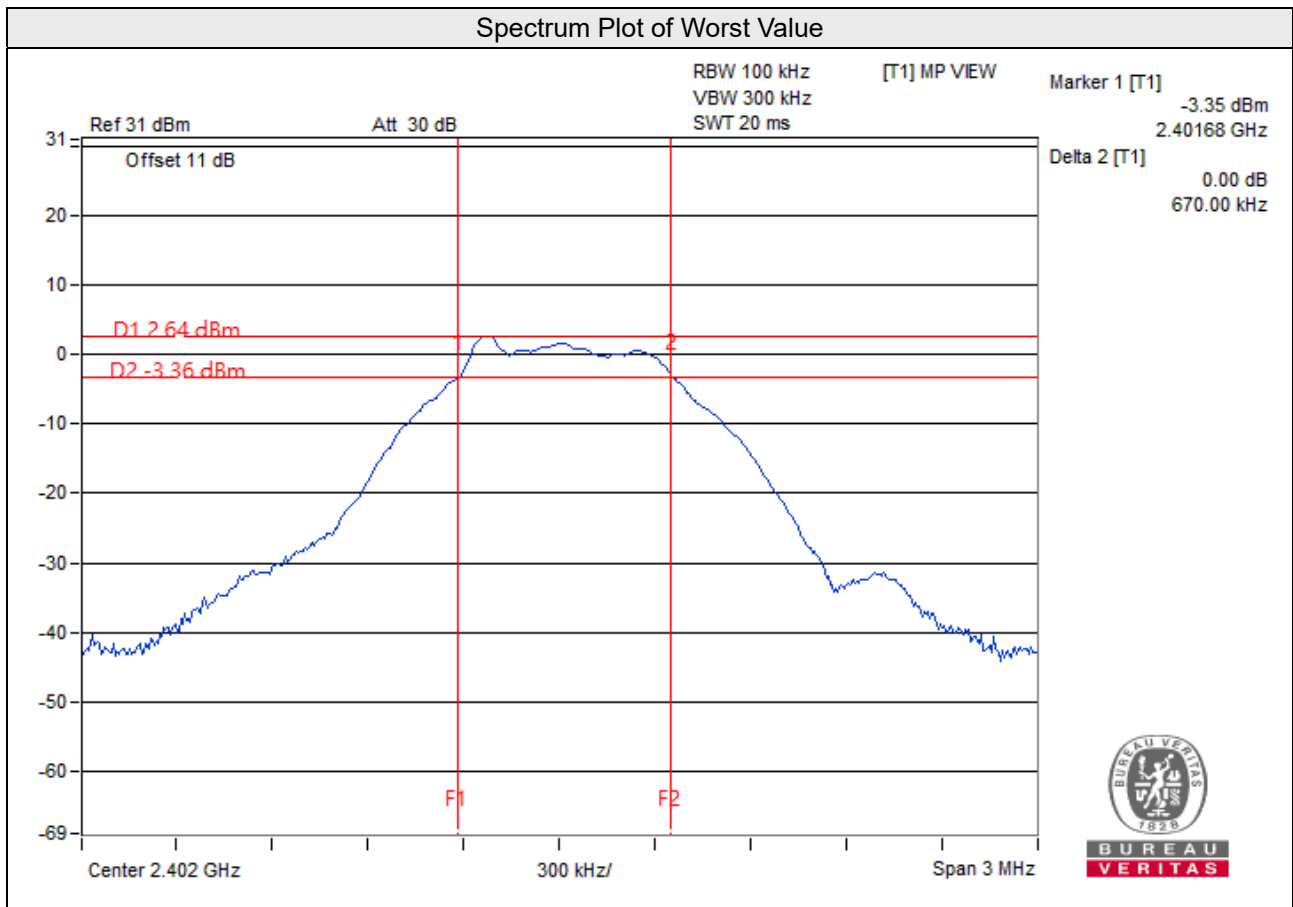

LE 5.0

Channel	Frequency (MHz)	6dB Bandwidth (MHz)	Minimum Limit (MHz)	Pass / Fail
0	2402	1.14	0.5	Pass
19	2440	1.13	0.5	Pass
39	2480	1.12	0.5	Pass

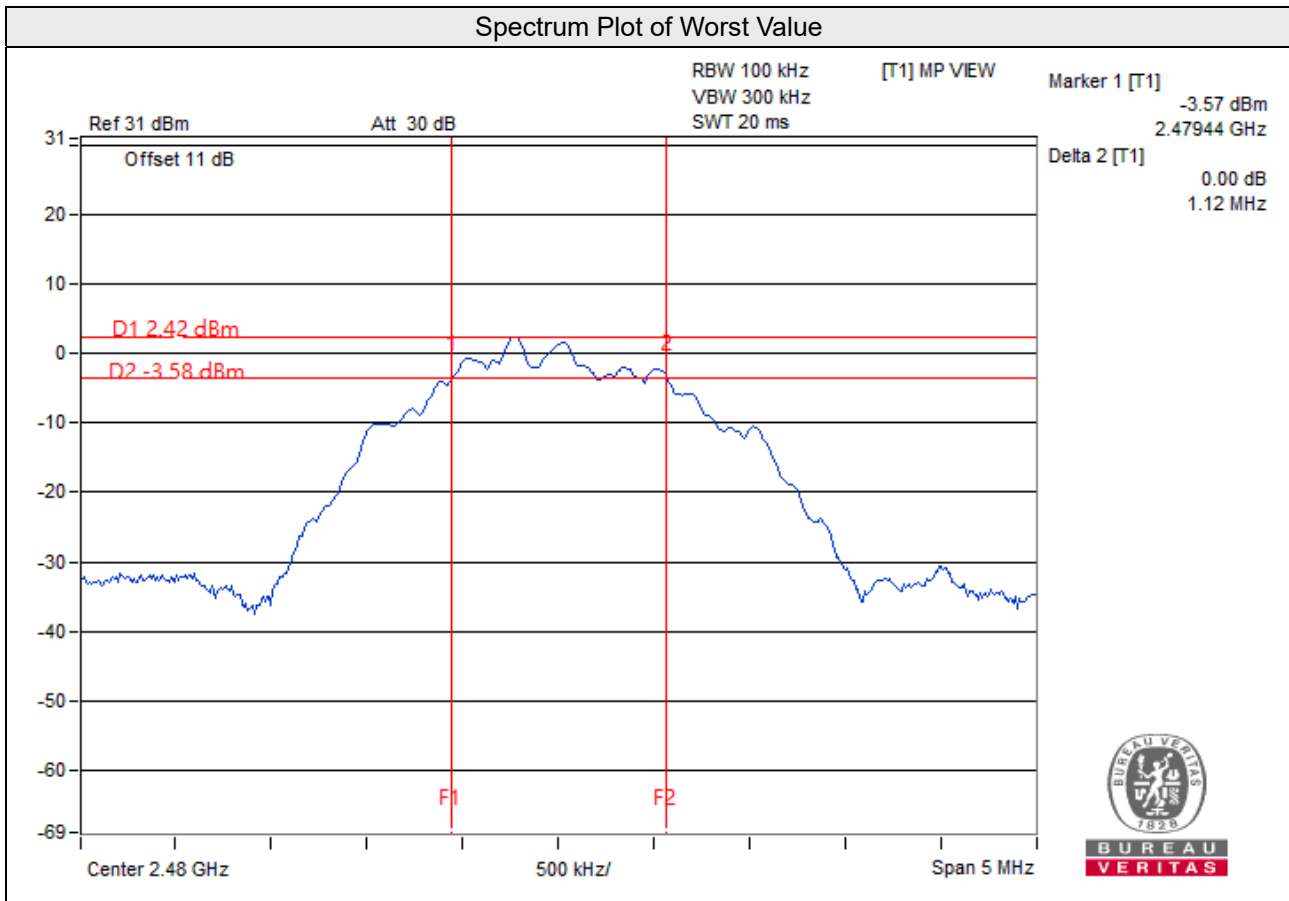

4.4 Conducted Output Power Measurement

4.4.1 Limits of Conducted Output Power Measurement

For systems using digital modulation in the 2400–2483.5 MHz bands: 1 Watt (30dBm)

4.4.2 Test Setup

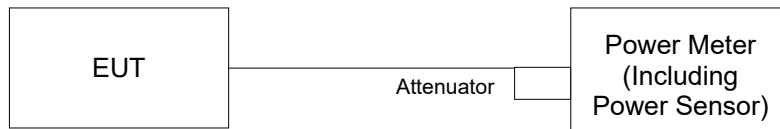

4.4.3 Test Instruments

Refer to section 4.1.2 to get information of above instrument.

4.4.4 Test Procedures

For Peak Power

A peak power sensor was used on the output port of the EUT. A power meter was used to read the response of the peak power sensor. Record the power level.

For Average Power

Average power sensor was used to perform output power measurement, trigger and gating function of wide band power meter is enabled to measure max output power of TX on burst. Duty factor is not added to measured value.

4.4.5 Deviation from Test Standard

No deviation.

4.4.6 EUT Operating Conditions

Same as item 4.3.6.

4.4.7 Test Results

Peak Power

LE 4.0

Channel	Frequency (MHz)	Peak Power (mW)	Peak Power (dBm)	Limit (dBm)	Pass/Fail
0	2402	2.344	3.70	30.00	Pass
19	2440	2.483	3.95	30.00	Pass
39	2480	2.570	4.10	30.00	Pass

LE 5.0

Channel	Frequency (MHz)	Peak Power (mW)	Peak Power (dBm)	Limit (dBm)	Pass/Fail
0	2402	2.296	3.61	30.00	Pass
19	2440	2.415	3.83	30.00	Pass
39	2480	2.512	4.00	30.00	Pass

Average Power

LE 4.0

Channel	Frequency (MHz)	Average Power (mW)	Average Power (dBm)
0	2402	1.991	2.99
19	2440	2.094	3.21
39	2480	2.183	3.39

LE 5.0

Channel	Frequency (MHz)	Average Power (mW)	Average Power (dBm)
0	2402	1.963	2.93
19	2440	2.075	3.17
39	2480	2.158	3.34

4.5 Power Spectral Density Measurement

4.5.1 Limits of Power Spectral Density Measurement

The Maximum of Power Spectral Density Measurement is 8dBm per 3kHz.

4.5.2 Test Setup

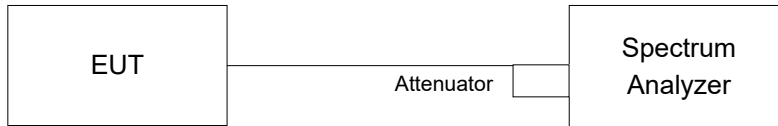

4.5.3 Test Instruments

Refer to section 4.1.2 to get information of above instrument.

4.5.4 Test Procedure

- a. Set analyzer center frequency to DTS channel center frequency.
- b. Set the span to 1.5 times the DTS bandwidth.
- c. Set the RBW to: $3 \text{ kHz} \leq \text{RBW} \leq 100 \text{ kHz}$.
- d. Set the VBW $\geq 3 \times \text{RBW}$.
- e. Detector = peak.
- f. Sweep time = auto couple.
- g. Trace mode = max hold.
- h. Allow trace to fully stabilize.
- i. Use the peak marker function to determine the maximum amplitude level within the RBW.

4.5.5 Deviation from Test Standard

No deviation.

4.5.6 EUT Operating Condition

Same as item 4.3.6

4.5.7 Test Results

LE 4.0

Channel	Freq. (MHz)	PSD (dBm/3kHz)	Limit (dBm/3kHz)	Pass / Fail
0	2402	-11.56	8.00	Pass
19	2440	-11.58	8.00	Pass
39	2480	-11.48	8.00	Pass

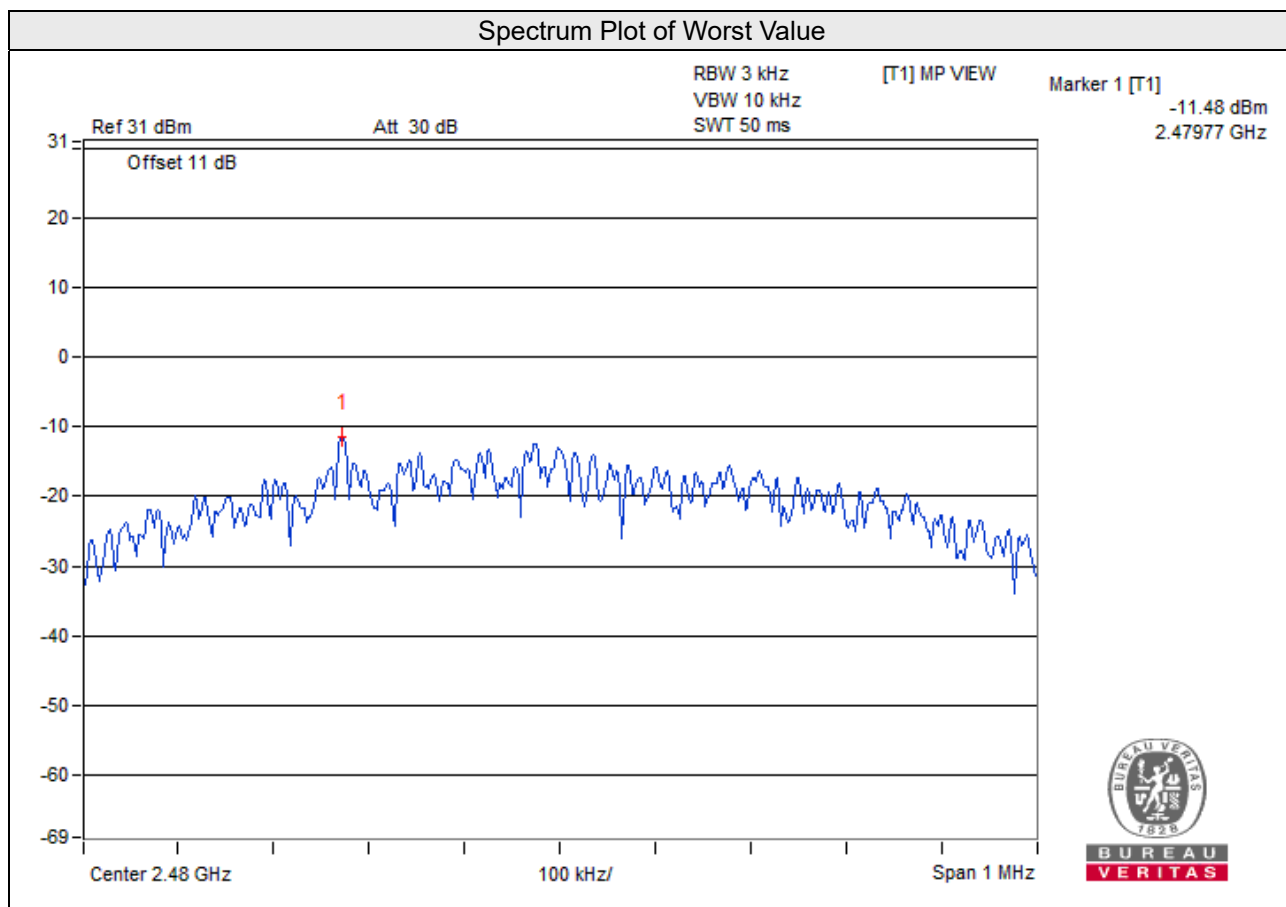

LE 5.0

Channel	Freq. (MHz)	PSD (dBm/3kHz)	Limit (dBm/3kHz)	Pass / Fail
0	2402	-15.77	8.00	Pass
19	2440	-15.69	8.00	Pass
39	2480	-15.45	8.00	Pass

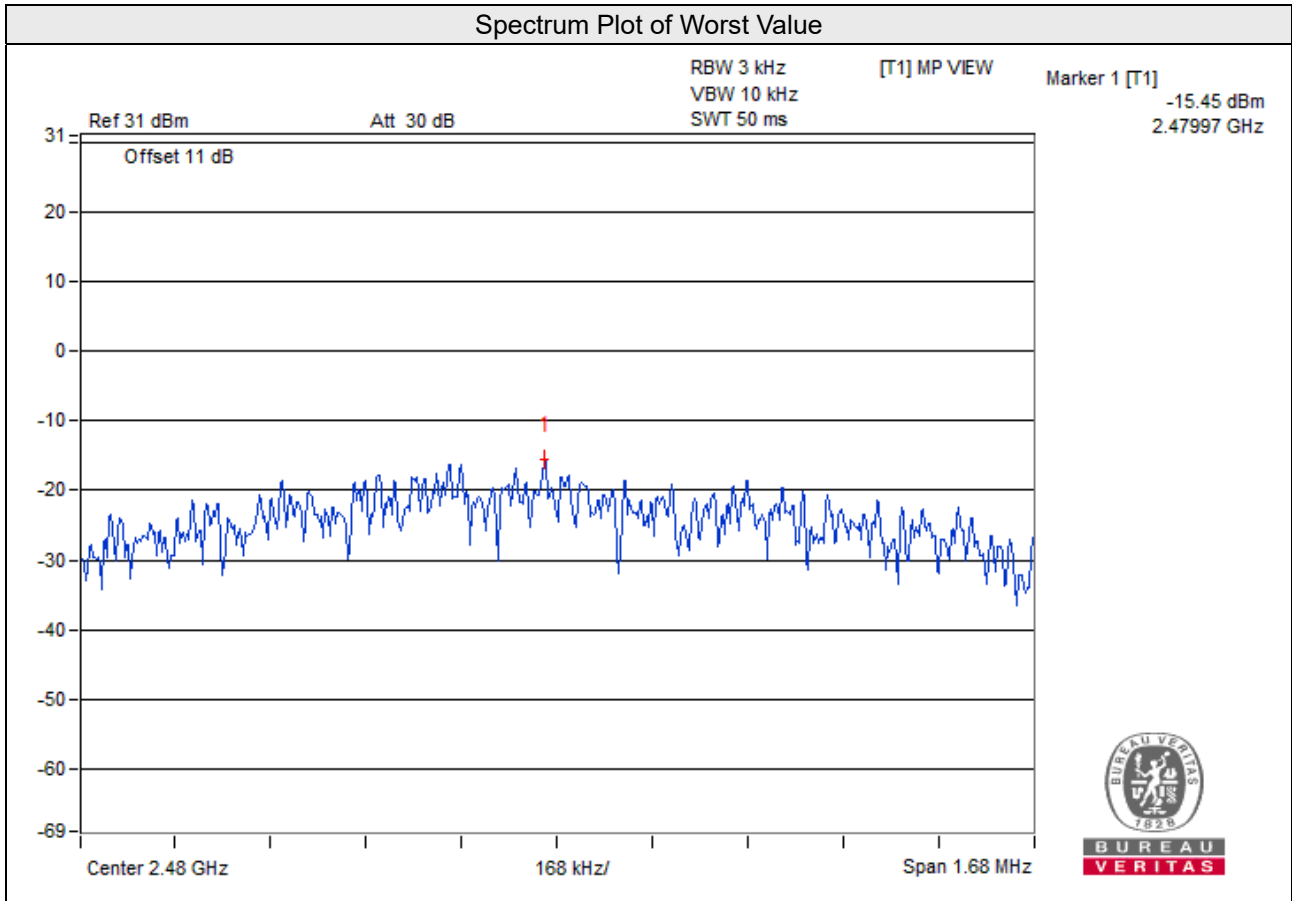

4.6 Conducted Out of Band Emission Measurement

4.6.1 Limits of Conducted Out of Band Emission Measurement

Below 20dB of the highest emission level of operating band (in 100kHz Resolution Bandwidth).

4.6.2 Test Setup

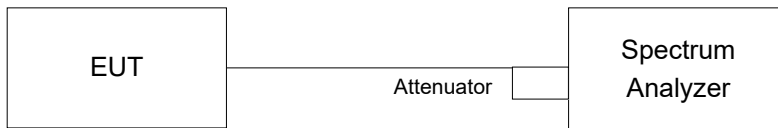

4.6.3 Test Instruments

Refer to section 4.1.2 to get information of above instrument.

4.6.4 Test Procedure

MEASUREMENT PROCEDURE REF

- Set the RBW = 100 kHz.
- Set the VBW \geq 300 kHz.
- Detector = peak.
- Sweep time = auto couple.
- Trace mode = max hold.
- Allow trace to fully stabilize.
- Use the peak marker function to determine the maximum power level in any 100 kHz band segment within the fundamental EBW.

MEASUREMENT PROCEDURE OOB

- Set RBW = 100 kHz.
- Set VBW \geq 300 kHz.
- Detector = peak.
- Sweep = auto couple.
- Trace Mode = max hold.
- Allow trace to fully stabilize.
- Use the peak marker function to determine the maximum amplitude level.

4.6.5 Deviation from Test Standard

No deviation.

4.6.6 EUT Operating Condition

Same as item 4.3.6

4.6.7 Test Results

The conducted emission test is performed on each TX port of operating mode without summing or adding 10log (N) since the limit is relative emission limit.

The spectrum plots are attached on the following pages. D1 line indicates the highest level, and D2 line indicates the 20dB offset below D1. It shows compliance with the requirement.

LE 4.0

CH 0

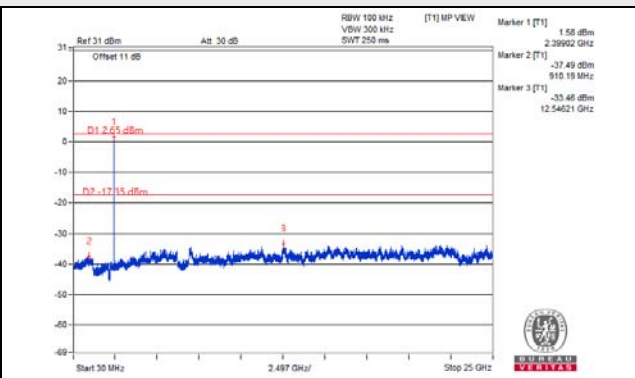
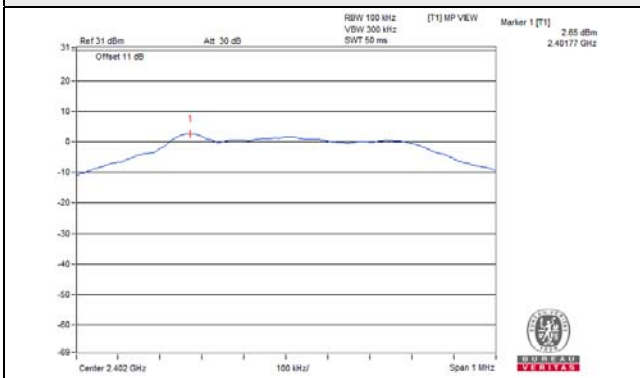

CH 19

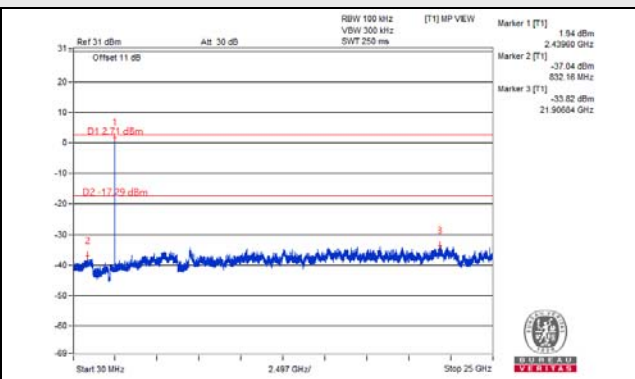
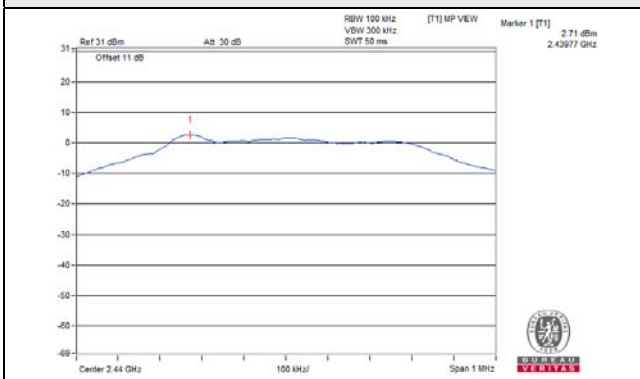

CH 39

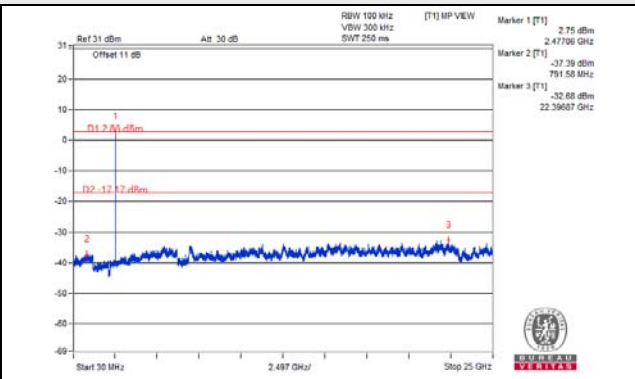
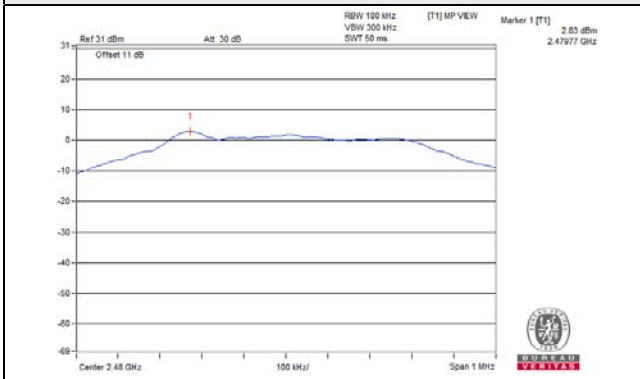

CH 0 Band edge

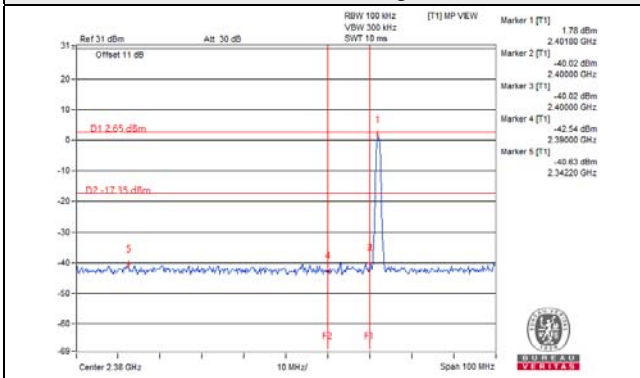

CH 39 Band edge

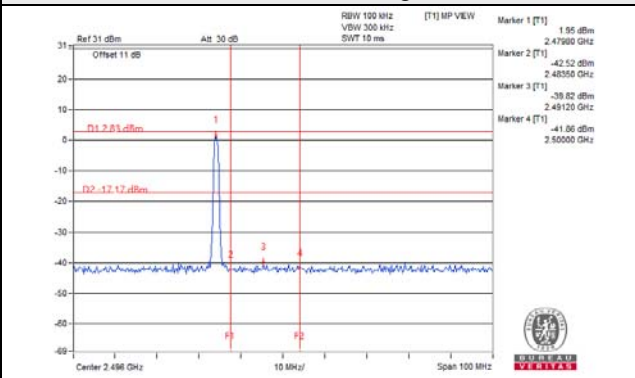

LE 5.0

CH 0

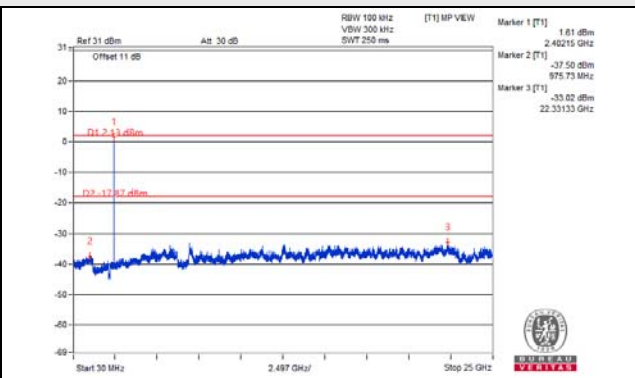
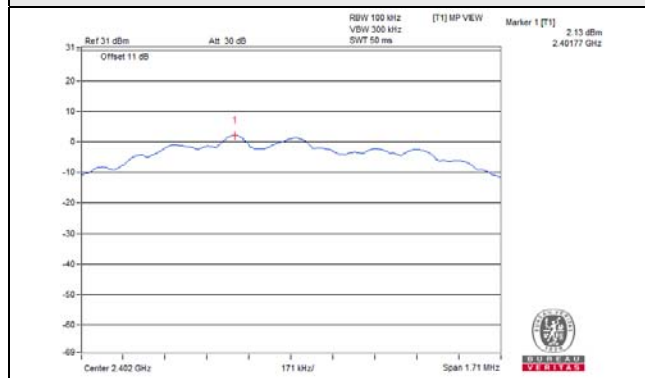

CH 19

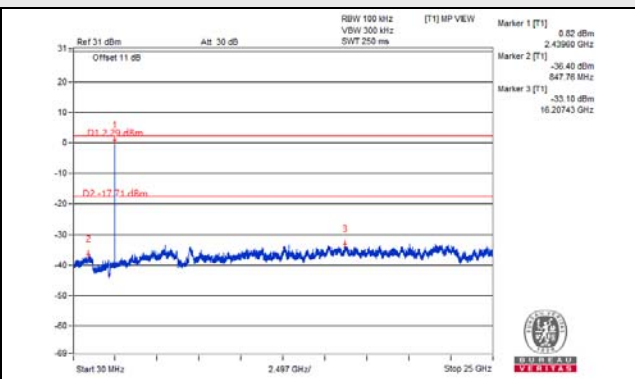
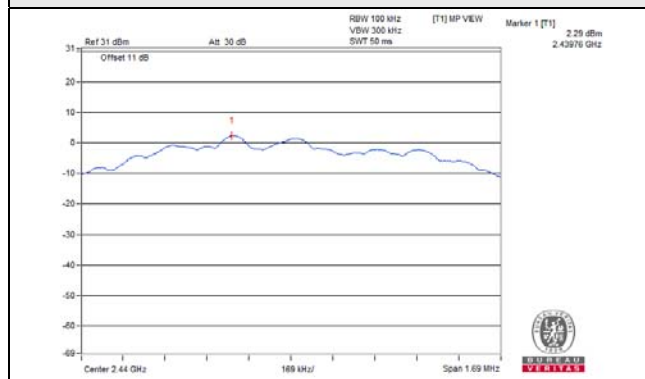

CH 39

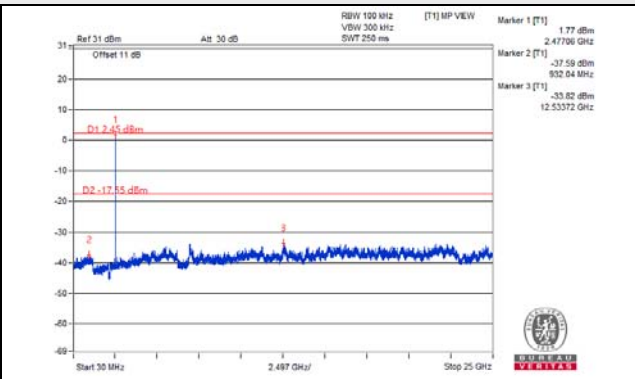
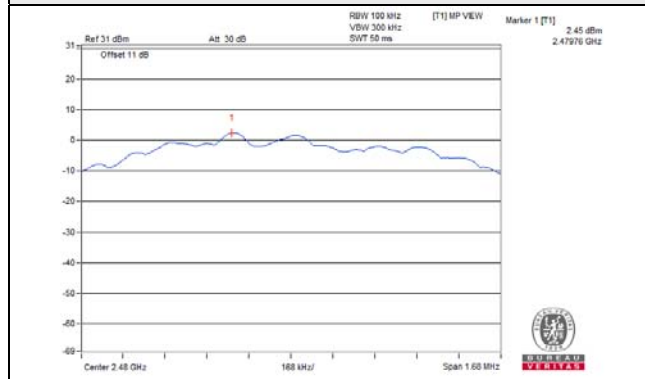

CH 0 Band edge

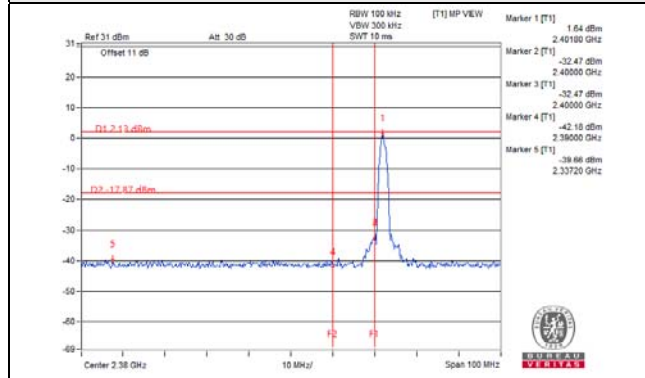

CH 39 Band edge

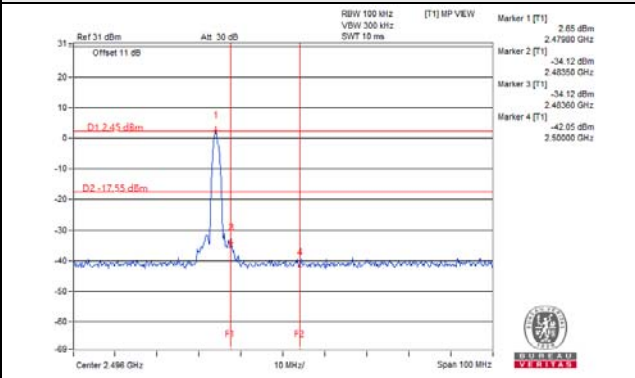

Annex A- Band Edge Measurement

LE 4.0

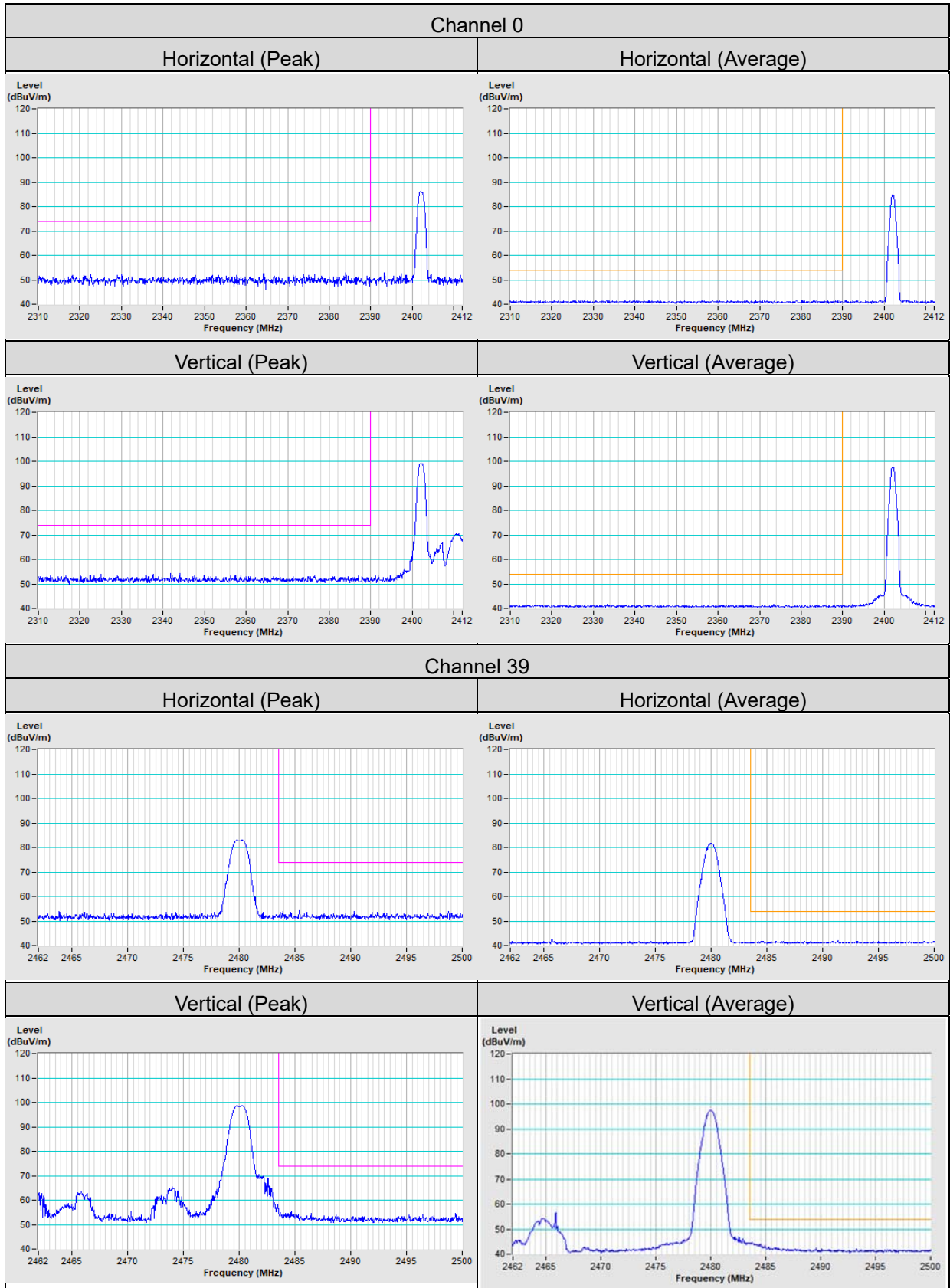

LE 5.0

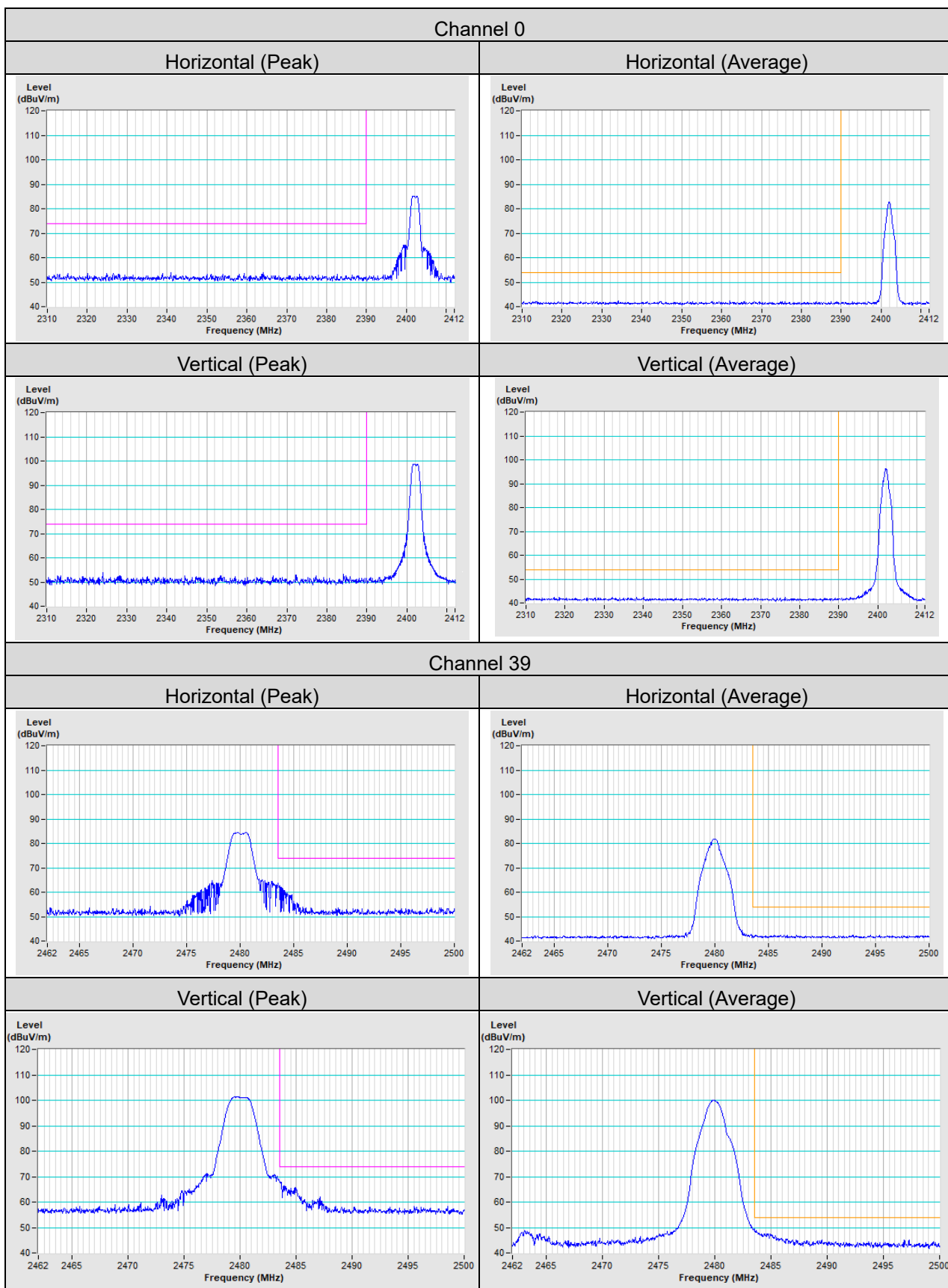

5 Pictures of Test Arrangements

Please refer to the attached file (Test Setup Photo).

Appendix – Information of the Testing Laboratories

We, Bureau Veritas Consumer Products Services (H.K.) Ltd., Taoyuan Branch, were founded in 1988 to provide our best service in EMC, Radio, Telecom and Safety consultation. Our laboratories are FCC recognized accredited test firms and accredited and approved according to ISO/IEC 17025.

If you have any comments, please feel free to contact us at the following:

Lin Kou EMC/RF Lab

Tel: 886-2-26052180

Fax: 886-2-26051924

Hsin Chu EMC/RF/Telecom Lab

Tel: 886-3-6668565

Fax: 886-3-6668323

Hwa Ya EMC/RF/Safety Lab

Tel: 886-3-3183232

Fax: 886-3-3270892

Email: service.adt@tw.bureauveritas.com

Web Site: www.bureauveritas-adt.com

The address and road map of all our labs can be found in our web site also.

--- END ---