

Prüfbericht-Nr.: <i>Test report no.:</i>	50349170 001	Auftrags-Nr.: <i>Order no.:</i>	238106182	Seite 1 von 43 Page 1 of 43	
Kunden-Referenz-Nr.: <i>Client reference no.:</i>	N/A	Auftragsdatum: <i>Order date:</i>	10-Jun-2019		
Auftraggeber: <i>Client:</i>	AMPAK Technology Inc. 3F, No. 1, Jen AI Road, Hsinchu Industrial Park, Hsinchu 30352				
Prüfgegenstand: <i>Test item:</i>	Wi-Fi and Bluetooth module				
Bezeichnung / Typ-Nr.: <i>Identification / Type no.:</i>	AP6398XU				
Auftrags-Inhalt: <i>Order content:</i>	FCC Part 15C Test report (BLE)				
Prüfgrundlage: <i>Test specification:</i>	FCC 47CFR Part 15: Subpart C Section 15.247				
Wareneingangsdatum: <i>Date of sample receipt:</i>	17-Oct-2019				
Prüfmuster-Nr.: <i>Test sample no.:</i>	A001008650-001				
Prüfzeitraum: <i>Testing period:</i>	18-Mar-2020- 22-May-2020				
Ort der Prüfung: <i>Place of testing:</i>	EMC/RF Laboratory Taipei				
Prüflaboratorium: <i>Testing laboratory:</i>	Taipei Testing laboratories				
Prüfergebnis*: <i>Test result*:</i>	Pass				
überprüft von: <i>reviewed by:</i>	genehmigt von: <i>authorized by:</i>				
atum: 23-Jun-2020 <i>Date:</i>	Mars Y.J. Lin	Datum: 23-Jun-2020 <i>Date:</i>	Ryan W.T. Chen		
Stellung / Position:	Project Engineer	Stellung / Position:	Project Manager		
Sonstiges / Other:					
Zustand des Prüfgegenstandes bei Anlieferung: <i>Condition of the test item at delivery:</i>		Prüfmuster vollständig und unbeschädigt <i>Test item complete and undamaged</i>			
* Legende:	1 = sehr gut P(ass) = entspricht o.g. Prüfgrundlage(n)	2 = gut 2 = good P(ass) = passed a.m. test specification(s)	3 = befriedigend F(ail) = entspricht nicht o.g. Prüfgrundlage(n) 3 = satisfactory F(ail) = failed a.m. test specification(s)	4 = ausreichend N/A = nicht anwendbar 4 = sufficient N/A = not applicable	5 = mangelhaft N/T = nicht getestet 5 = poor N/T = not tested
<p>Dieser Prüfbericht bezieht sich nur auf das o.g. Prüfmuster und darf ohne Genehmigung der Prüfstelle nicht auszugsweise vervielfältigt werden. Dieser Bericht berechtigt nicht zur Verwendung eines Prüfzeichens. <i>This test report only relates to the a. m. test sample. Without permission of the test center this test report is not permitted to be duplicated in extracts. This test report does not entitle to carry any test mark.</i></p>					

TEST SUMMARY

5.1.1 ANTENNA REQUIREMENT

RESULT: *Passed*

5.1.2 MAXIMUM CONDUCTED PEAK OUTPUT POWER

RESULT: *Passed*

5.1.3 6dB BANDWIDTH AND 99% BANDWIDTH

RESULT: *Passed*

5.1.4 POWER DENSITY

RESULT: *Passed*

5.1.5 CONDUCTED SPURIOUS EMISSIONS AND FREQUENCY BAND EDGE MEASURED IN 100kHz BANDWIDTH

RESULT: *Passed*

5.1.6 SPURIOUS EMISSION

RESULT: *Passed*

5.2.1 MAINS CONDUCTED EMISSIONS

RESULT: *Passed*

6.1.1 ELECTROMAGNETIC FIELDS

RESULT: *Passed*

Contents

1.	GENERAL REMARKS	5
1.1	COMPLEMENTARY MATERIALS	5
1.2	DECISION RULE OF CONFORMITY.....	5
2.	TEST SITES.....	6
2.1	TEST LABORATORY	6
2.2	TEST FACILITY	6
2.3	LIST OF TEST AND MEASUREMENT INSTRUMENTS	7
2.4	TRACEABILITY	8
2.5	CALIBRATION.....	8
2.6	MEASUREMENT UNCERTAINTY	8
3.	GENERAL PRODUCT INFORMATION	9
3.1	PRODUCT FUNCTION AND INTENDED USE.....	9
3.2	SYSTEM DETAILS AND RATINGS	9
3.3	INDEPENDENT OPERATION MODES.....	10
3.4	NOISE GENERATING AND NOISE SUPPRESSING PARTS.....	10
3.5	SUBMITTED DOCUMENTS	10
4.	TEST SET-UP AND OPERATION MODES	11
4.1	PRINCIPLE OF CONFIGURATION SELECTION.....	11
4.2	TEST OPERATION AND TEST SOFTWARE	11
4.3	SPECIAL ACCESSORIES AND AUXILIARY EQUIPMENT.....	12
4.4	COUNTERMEASURES TO ACHIEVE EMC COMPLIANCE	12
4.5	TEST SETUP DIAGRAM.....	13
5.	TEST RESULTS	16
5.1	TRANSMITTER REQUIREMENT & TEST SUITES	16
5.1.1	<i>Antenna Requirement.....</i>	<i>16</i>
5.1.2	<i>Maximum conducted Peak output power.....</i>	<i>17</i>
5.1.3	<i>6dB Bandwidth and 99% Bandwidth.....</i>	<i>18</i>
5.1.4	<i>Power Density.....</i>	<i>26</i>
5.1.5	<i>Conducted spurious emissions and Frequency Band Edge measured in 100kHz Bandwidth.....</i>	<i>30</i>
5.1.6	<i>Spurious Emission.....</i>	<i>36</i>
5.2	MAINS EMISSIONS.....	37
5.2.1	<i>Mains Conducted Emissions</i>	<i>37</i>
6.	SAFETY HUMAN EXPOSURE.....	38

Prüfbericht- Nr.: 50349170 001
*Test Report No.***Seite 4 von 43**
Page 4 of 43

6.1	RADIO FREQUENCY EXPOSURE COMPLIANCE	38
6.1.1	<i>Electromagnetic Fields</i>	<i>38</i>
7.	PHOTOGRAPHS OF THE TEST SET-UP	39
8.	LIST OF TABLES	43
9.	LIST OF PHOTOGRAPHS	43

1. General Remarks

1.1 Complementary Materials

The following attachments are integral parts of this test report:

Appendix P: Photo Documentation internal view
(File Name: 50349168 001, 50349169 001, 50349170 001, 50349171 001
Appendix P)

Appendix D: Test Result of Radiated Emissions
(File Name: 50349170 001 Appendix D)

Test Specifications

The following standards were applied.

Table 1: Applied Standard and Test Levels

Radio
FCC 47CFR Part 15: Subpart C Section 15.247 FCC 47CFR Part 2: Subpart J Section 2.1091 ANSI C63.10:2013 KDB558074 D01 DTS Meas Guidance v05r02 KDB447498 D01 General RF Exposure Guidance v06

1.2 Decision Rule of conformity

The decision rule of conformity of this test report is following the requirements of the requested standard in the quotation, and agreed among testing laboratory and manufacturer (applicant) to exclude the consideration of Measurement Uncertainty, unless it is required by the specific standard.

2. Test Sites

2.1 Test Laboratory

Taipei Testing laboratories

11F. No.758, Sec. 4, Bade Rd., Songshan Dist.
Taipei City 105
Taiwan (R.O.C.)

2.2 Test Facility

Taipei Testing laboratories

No. 458-18, Sec 2, Fenliao., Linkou Dist.
New Taipei City 244
Taiwan (R.O.C.)

FCC Registration No.: 226631
IC Canada Registration No.: 25563
TAF Accredited NCC Test Lab. No.:3567
TAF ISO17025 Certification effective period: 6th-May-2019 to 05th-May-2022



Testing Laboratory
3567

2.3 List of Test and Measurement Instruments

Table 2: List of Test and Measurement Equipment

Equipment	Manufacturer	Model No.	Serial No.	Cal. Date	Cal. Due Date
EMI Test Receiver	R&S	ESR7	102109	2020/3/30	2021/3/29
Spectrum Analyzer	R&S	FSV40	101508	2020/3/16	2021/3/15
Pre-Amplifier	Agilent	8447D	2727A05146	2020/2/17	2021/2/16
Pre-Amplifier	EMCI	EMC051845SE	980635	2020/2/11	2021/2/10
Pre-Amplifier	EMCI	EMC184045SE	980656	2020/2/11	2021/2/10
Bilog Antenna	SCHWARZBECK	VULB-9168	00950	2020/1/20	2021/1/19
Horn Antenna	ETS-Lindgren	3117	00218929	2019/11/27	2020/11/26
Horn Antenna	SCHWARZBECK	BBHA 9170	00896	2020/1/17	2021/1/16
Loop Antenna	EMCI	LPA600	287	2019/12/20	2020/12/19
Test Software	Audix	e3	Ver. 9	N/A	N/A
Test Cable	HUBER+SUHNER	SUCOFLEX 104EA	800057/4EA	2020/3/25	2021/3/24
Test Cable	HUBER+SUHNER	SUCOFLEX 104	802244/4	2020/3/25	2021/3/24
Test Cable	HUBER+SUHNER	SUCOFLEX 104	MY37203/4	2020/3/25	2021/3/24
Test Cable	HUBER+SUHNER	SUCOFLEX 102EA	800897/2EA	2020/3/25	2021/3/24
Test Cable	HUBER+SUHNER	SUCOFLEX 102EA	800902/2EA	2020/3/25	2021/3/24
Test Cable	HUBER+SUHNER	SUCOFLEX 102EA	801026/2EA	2020/3/25	2021/3/24
EMI Test Receiver	Rohde & Schwarz	ESCI 7	100797	2020/03/13	2021/03/13
Two-Line V-Network	Rohde & Schwarz	ENV216	101262	2019/07/16	2020/07/16
Telecom ISN 4 Line	Fischer Custom Communications	FFCC-TLISN-T4-02-09	101168	2020/02/03	2021/02/03
Impedance Stabilization Network	TESEQ	ISN T800	51949	2020/02/25	2021/02/25
Pulse Limiter	Rohde & Schwarz	ESH3-Z2	0357.8810.54-102102-HN	2019/07/25	2020/07/25

2.4 Traceability

All measurement equipment calibrations are traceable to NML(Taiwan)/NIST(USA) or where calibration is performed outside Taiwan, to equivalent nationally recognized standards organizations.

2.5 Calibration

Equipment requiring calibration is calibrated periodically in a suitably accredited Calibration Lab. Additionally all equipment is verified for proper performance on a regular schedule using in house standards or comparisons.

2.6 Measurement Uncertainty

The estimated combined standard uncertainty for radiated emissions and conducted emissions measurements .

Table 3: Emission Measurement Uncertainty

Parameter	Uncertainty
Radio Frequency	$\pm 1 \times 10^{-7}$
RF power, conducted	± 1.5 dB
RF power density, conducted	± 3 dB
spurious emissions, conducted	± 3 dB
all emissions, radiated	± 6 dB
Temperature	± 1 °C
Humidity	± 5 %

3. General Product Information

3.1 Product Function and Intended Use

The EUT is a Wi-Fi and Bluetooth module. It contains a bluetooth compatible module enabling the user to communicate data through a Wireless interface.

For details refer to the User Guide, Data Sheet and Circuit Diagram.

3.2 System Details and Ratings

Table 4: Basic Information of EUT

Item	EUT information
Kind of Equipment/Test Item	Wi-Fi and Bluetooth module
Type Designation	AP6398XU
FCC ID	ZQ6-AP6398XU

Table 5: Technical Specification of EUT

Technical Specification	Value
Operating Frequencies	2402~2480MHz
Channel number	40
Operation Voltage	3.3Vdc
Modulation	LE 1M:GFSK LE 2M:GFSK
Antenna gain	3.69 dBi
Transmission port	Antenna 1

3.3 Independent Operation Modes

Basic operation modes are:

- A. Transmitting
- B. Receiving

3.4 Noise Generating and Noise Suppressing Parts

Refer to the Circuit Diagram.

3.5 Submitted Documents

- Circuit Diagram
- Block Diagram
- Rating Label
- Technical Description

4. Test Set-up and Operation Modes

4.1 Principle of Configuration Selection

The test modes were adapted accordingly in reference to the instructions for use.

During testing, Channel and Power Controlling Software provided by the customer was used to control the operating channel as well as the output power level. The RF output power selection is for the setting of RF output power expected by the customer and is going to be fixed on the firmware of the final end product.

Table 6: Table for Parameters of Test Software Setting

Mode	Channel Frequency		
	2402 MHz	2440 MHz	2480 MHz
BLE 1M	Default	Default	Default
BLE 2M	Default	Default	Default

4.2 Test Operation and Test Software

Setup for testing: Test samples are provided with a USB interface which makes it possible to control them through a test software installed on a notebook computer.

This software was running on the laptop computer connected to the EUT. It was used to enable the operation modes listed in section 3.3 as appropriate.

The samples were used as follows:

A001008650-001

Full test was applied on all test modes, but only worst case was shown

Test Software	Broadcom BlueTool Version 1.9.7.4
----------------------	-----------------------------------

4.3 Special Accessories and Auxiliary Equipment

The product has been tested together with the following additional accessories:

Accessories of EUT:
 N/A

Support Unit:

Item No.	Kind of Equipment	Model Name	Serial Number	Brand Name
1	PC	N/A	N/A	DELL
2	Monitor	P2214Hb	CN-020C1Y-74261-5BL-0RL	Lenovo
3	USB Keyboard	KU-0225	762697	Lenovo
4	USB Mouse	SM-8823	8SS050L24506MT0047T3 812	N/A
5	Fixture	N/A	N/A	DELL

Item No.	Kind of Equipment	Spec
A	Mini USB Cable	1.8m
B	Mini USB Cable	1.8m
C	USB Mouse Cable	1.8m
D	USB Keyboard Cable	1.8m
E	D-Sub Cable	1.8m

4.4 Countermeasures to achieve EMC Compliance

The test sample which has been tested contained the noise suppression parts as described in the Constructional Data Form or the Technical Construction File. No additional measures were employed to achieve compliance.

4.5 Test Setup Diagram

Diagram of Measurement Configuration for Radiation Test

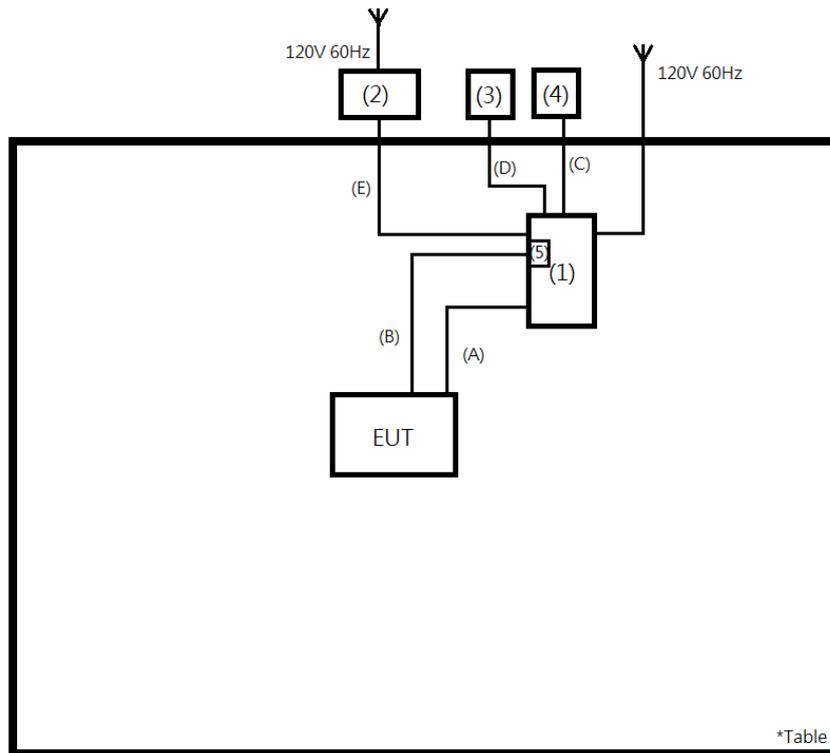

Diagram of Measurement Equipment Configuration for Mains Conduction Measurement (if applicable)

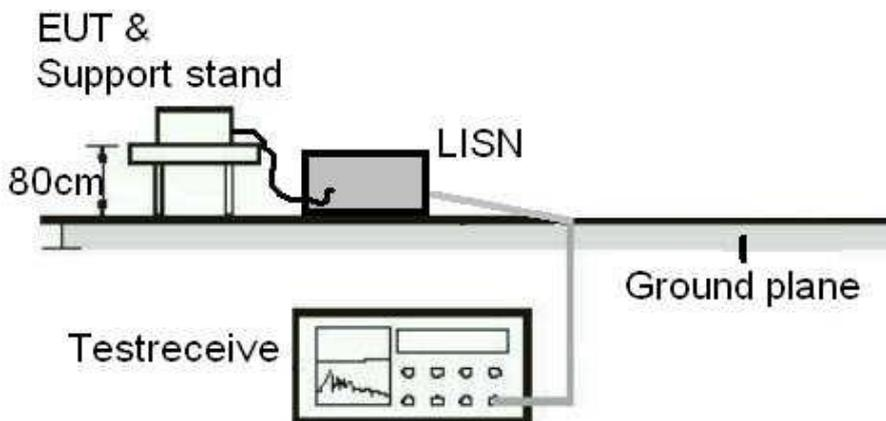
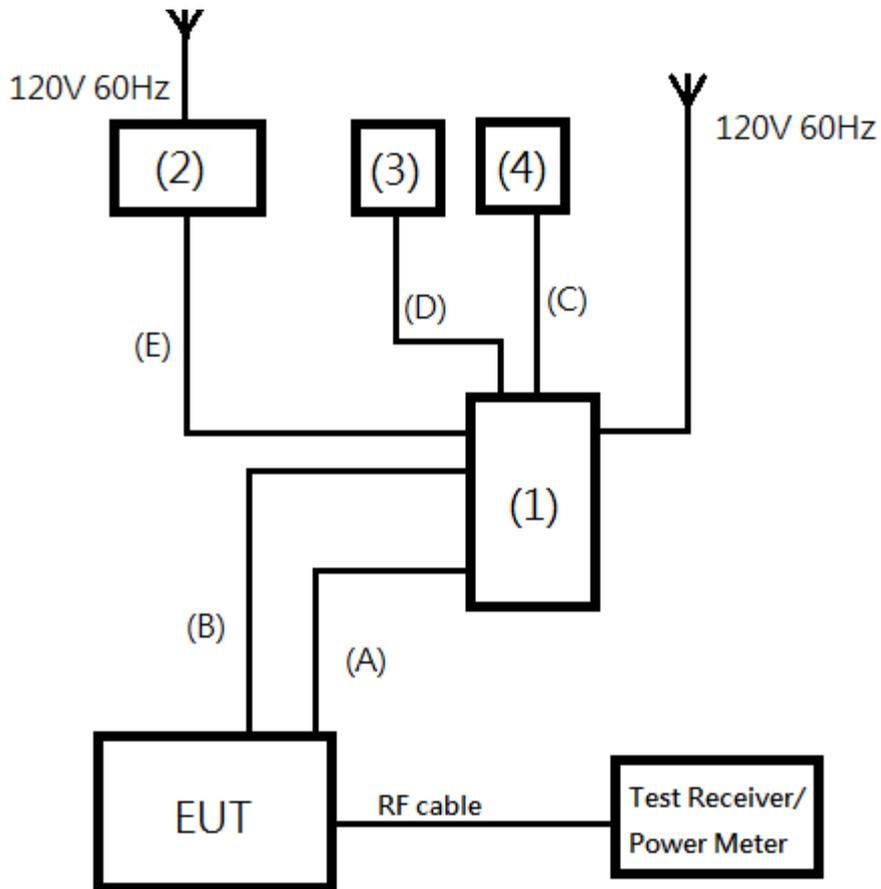

Diagram of Measurement Equipment Configuration for Conducted Transmitter Measurement

Note: The output power is measured by power meter according to 8.3.1.3 KDB558074 D01 Meas Guidance v05r02 8.3.1.3.

5. Test Results

5.1 Transmitter Requirement & Test Suites

5.1.1 Antenna Requirement

RESULT: **Passed**

Test standard : FCC Part 15.247(b)(4), Part 15.203

According to the manufacturer declaration, the EUT has an antenna with maximum directional gain of 3.69dBi. The antenna is PCB with no possibility of replacement with a non-approved antenna by the end-user. Therefore, the EUT is considered to comply with this provision.

Refer to EUT photo for details.

5.1.2 Maximum conducted Peak output power

RESULT:
Passed

Test standard : FCC Part 15.247(b)(3)
 Basic standard : ANSI C63.10:2013, KDB558074
 Limit : 1 Watt
 Kind of test site : Shielded room

Test setup

Test Channel : Low/ Middle/ High
 Operation Mode : A
 Ambient temperature : 20-24°C
 Relative humidity : 50-65%
 Atmospheric pressure : 100-103 kPa

Table 7: Test result of Maximum conducted Peak output power, BLE 1M

Channel	Channel Frequency (MHz)	Output Power		Average Output Power (W)	Limit (W)
		(dBm)	(W)		
Low Channel	2402	6.57	0.00454	0.00440	1
Middle Channel	2440	6.83	0.00482	0.00466	1
High Channel	2480	6.37	0.00434	0.00419	1

Table 8: Test result of Maximum conducted Peak output power, BLE 2M

Channel	Channel Frequency (MHz)	Output Power		Average Output Power (W)	Limit (W)
		(dBm)	(W)		
Low Channel	2402	5.82	0.00382	0.00358	1
Middle Channel	2440	6.04	0.00402	0.00378	1
High Channel	2480	5.51	0.00356	0.00336	1

5.1.3 6dB Bandwidth and 99% Bandwidth

RESULT:
Passed

Test standard : FCC Part 15.247(a)(2)
 Basic standard : ANSI C63.10:2013, KDB558074
 Kind of test site : Shielded room

Test setup

Test Channel : Low/ Middle/ High
 Operation Mode : A
 Ambient temperature : 20-24°C
 Relative humidity : 50-65%
 Atmospheric pressure : 100-103 kPa

Table 9: Test result of 6dB Bandwidth, BLE 1M

Channel	Channel Frequency (MHz)	6dB Bandwidth (kHz)	Limit (kHz)	Result
Low Channel	2402	677.3	>500	Pass
Mid Channel	2440	680.3	>500	Pass
High Channel	2480	680.3	>500	Pass

Table 10: Test result of 6dB Bandwidth, BLE 2M

Channel	Channel Frequency (MHz)	6dB Bandwidth (MHz)	Limit (kHz)	Result
Low Channel	2402	1.229	>500	Pass
Mid Channel	2440	1.233	>500	Pass
High Channel	2480	1.229	>500	Pass

Prüfbericht- Nr.: 50349170 001

Test Report No.

Seite 19 von 43

Page 19 of 43

Table 11: Test result of 99% Bandwidth, BLE 1M

Channel	Channel Frequency (MHz)	99% Bandwidth (MHz)
Low Channel	2402	1.052
Mid Channel	2440	1.052
High Channel	2480	1.055

Table 12: Test result of 99% Bandwidth, BLE 2M

Channel	Channel Frequency (MHz)	99% Bandwidth (MHz)
Low Channel	2402	2.083
Mid Channel	2440	2.083
High Channel	2480	2.083

Test Plot of 6dB Bandwidth, BLE 1M

Low Channel

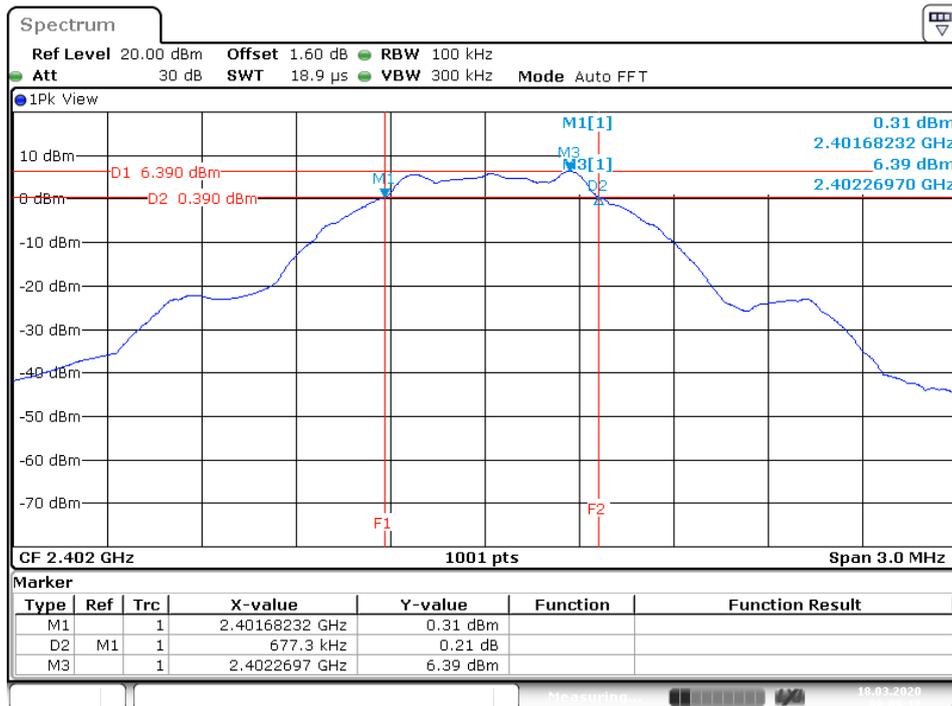

Middle Channel

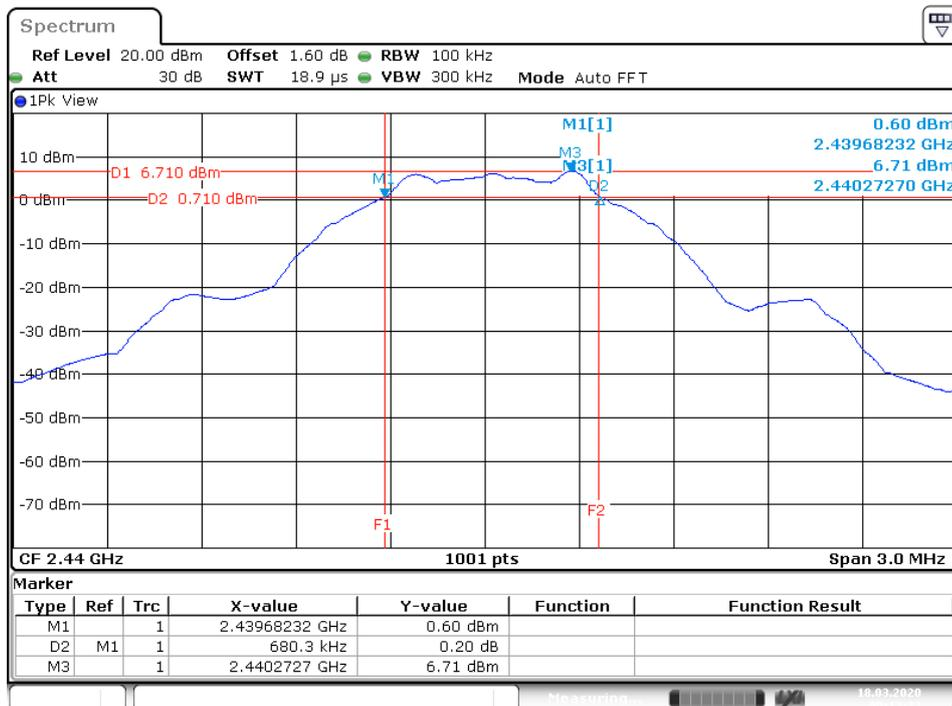

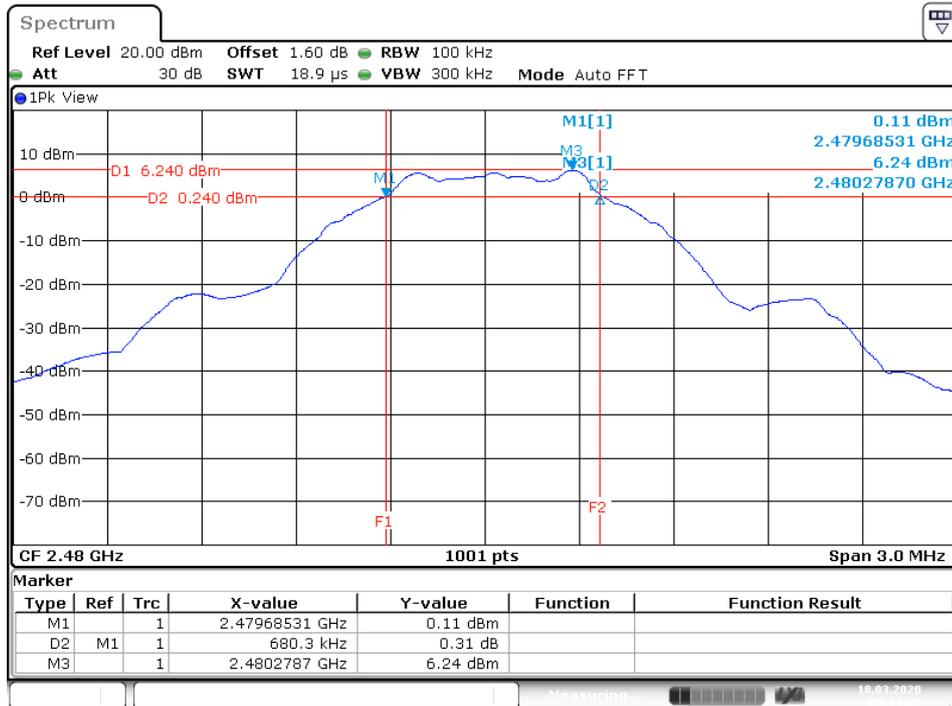
High Channel

Date: 18.MAR.2020 09:14:22

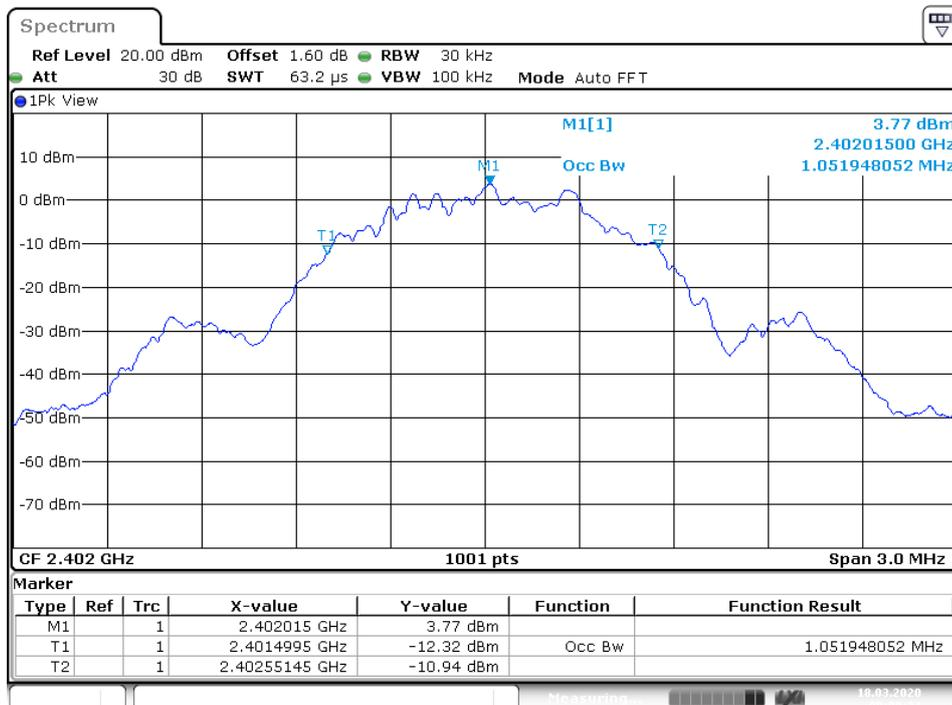
Test Plot of 99% Bandwidth, BLE 1M
Low Channel

Date: 18.MAR.2020 09:09:31

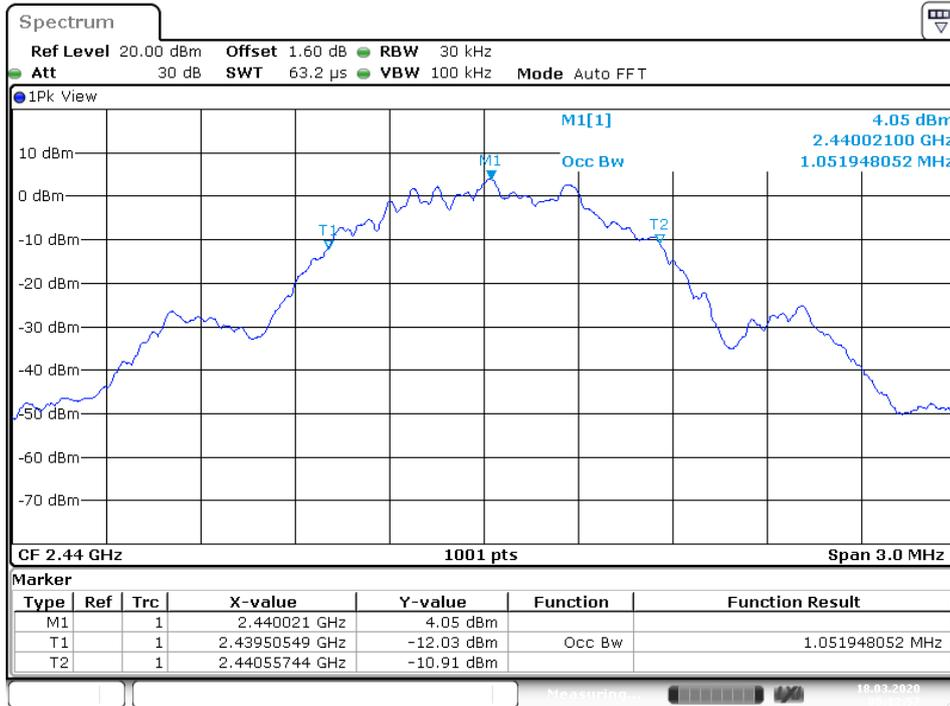
Middle Channel

Date: 18.MAR.2020 09:12:57

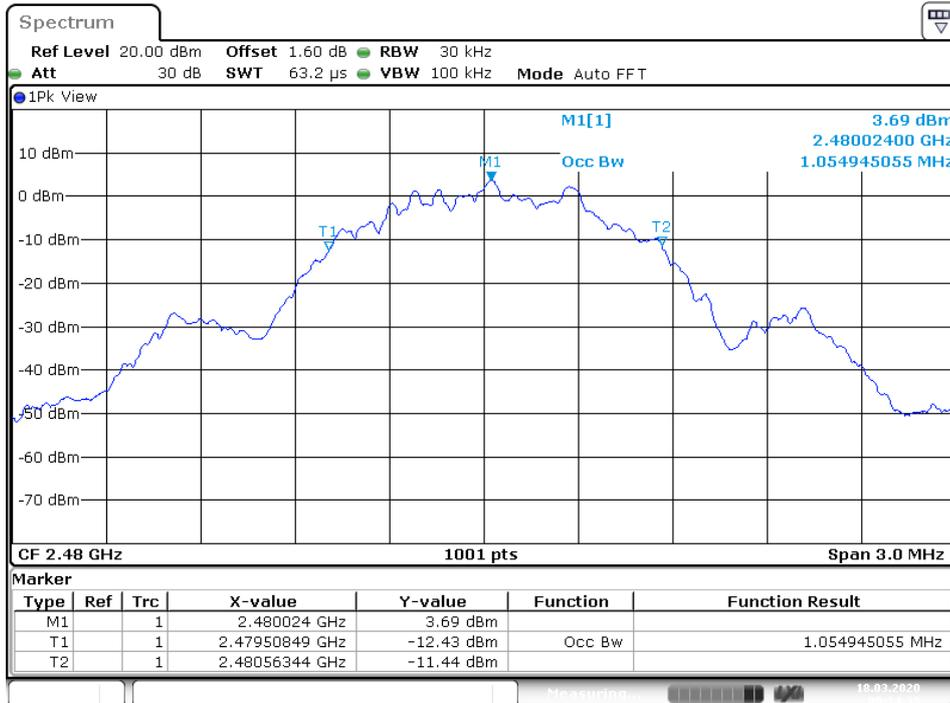
High Channel

Date: 18.MAR.2020 09:14:38

Test Plot of 6dB Bandwidth, BLE 2M

Low Channel

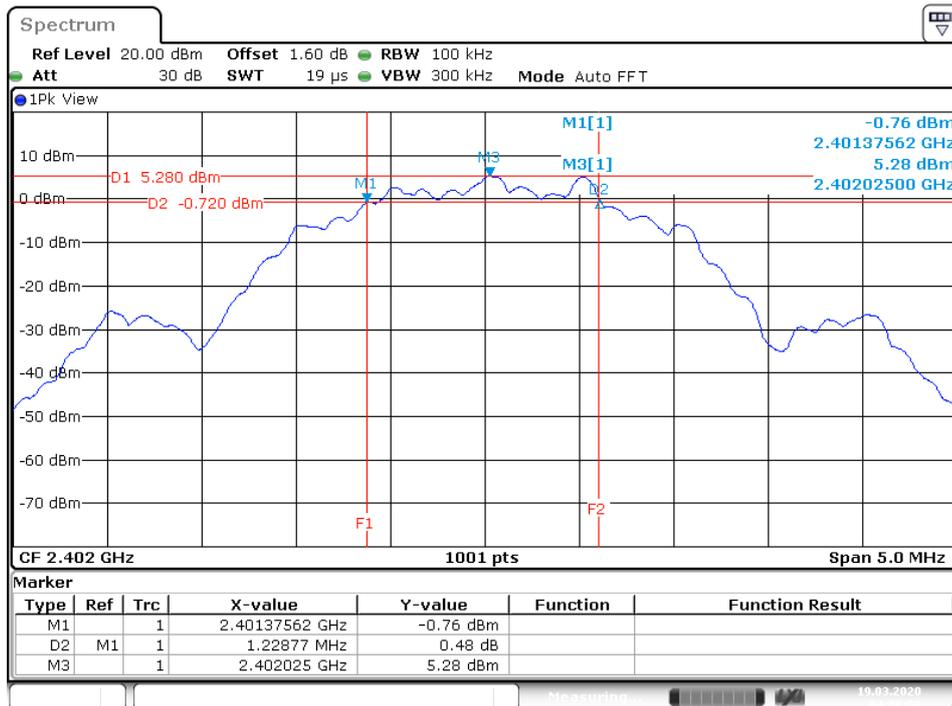

Date: 19.MAR.2020 04:30:09

Middle Channel

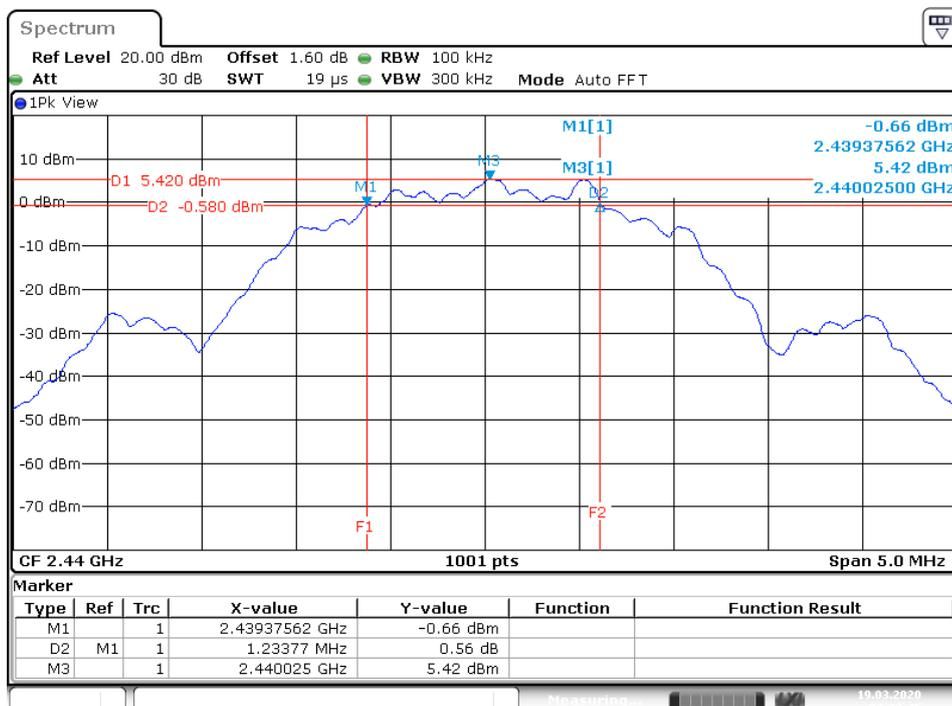

Date: 19.MAR.2020 04:32:46

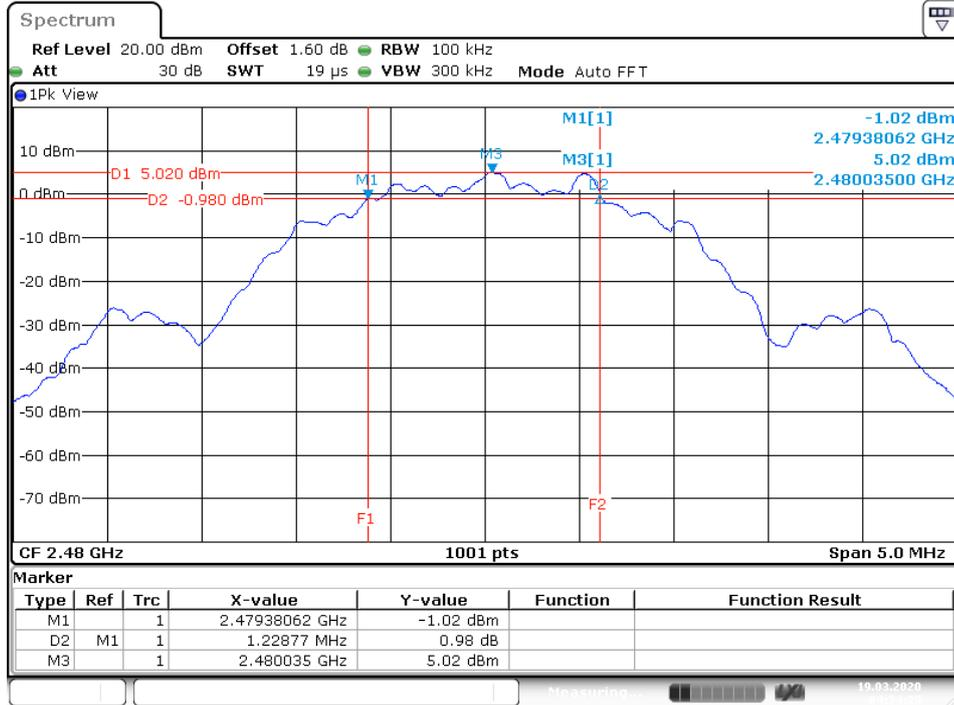
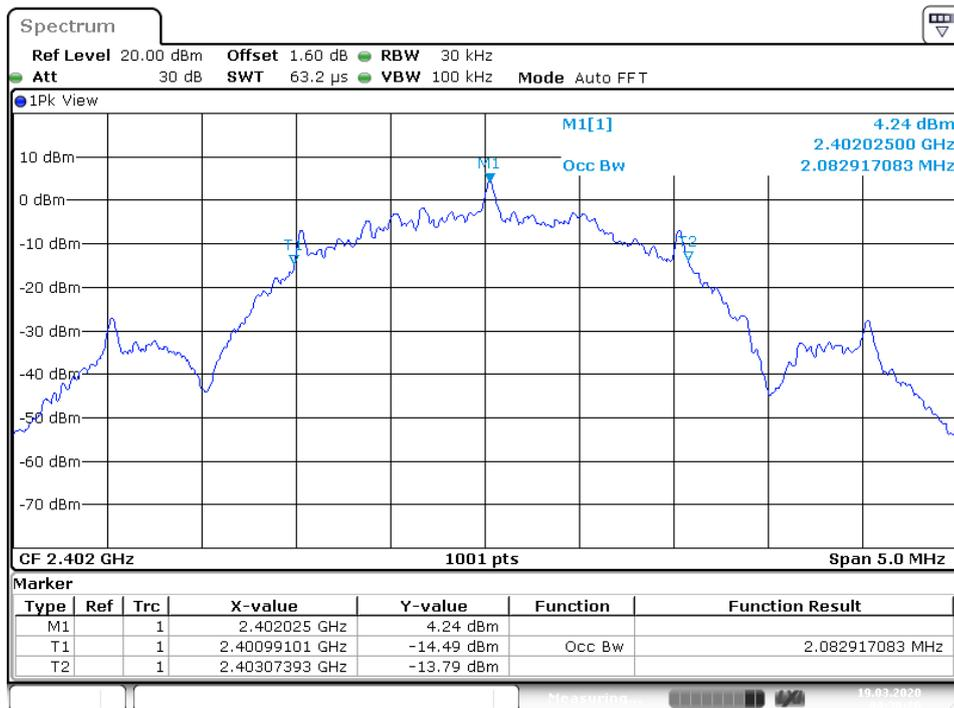
High Channel

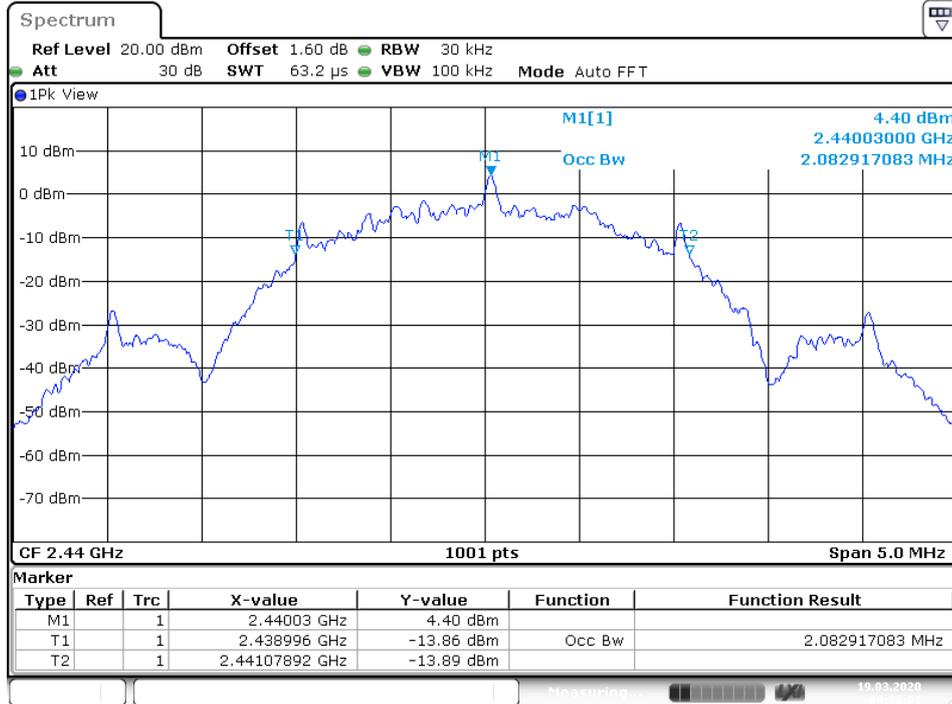
Test Plot of 99% Bandwidth, BLE 2M
Low Channel

Middle Channel

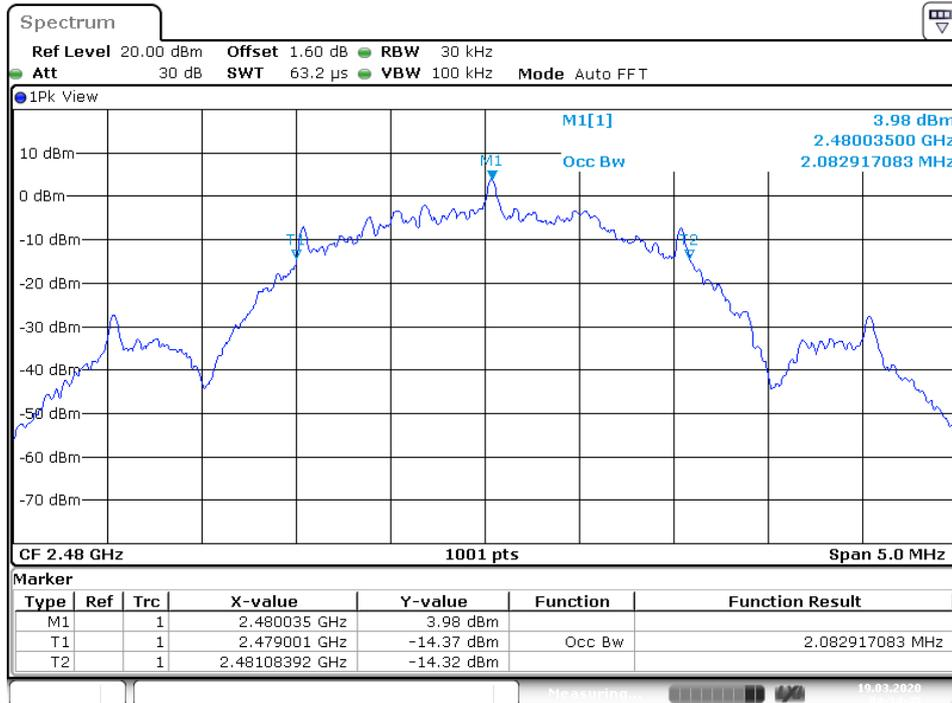
Date: 19.MAR.2020 04:33:02

High Channel

Date: 19.MAR.2020 04:34:45

5.1.4 Power Density

RESULT:
Passed

Test standard : FCC Part 15.247(e) , ISED RSS-247 5.2(b)
 Basic standard : ANSI C63.10:2013, KDB558074
 Kind of test site : Shielded room

Test setup

Test Channel : Low/ Middle/ High
 Operation Mode : A
 Ambient temperature : 20-24°C
 Relative humidity : 50-65%
 Atmospheric pressure : 100-103 kPa

Table 13: Test result of Power Density, BLE 1M

Channel	Channel Frequency (MHz)	Power Density	Limit
		(dBm)	(dBm)
Low Channel	2402	-9.65	8
Middle Channel	2440	-9.25	8
High Channel	2480	-9.65	8

Table 14: Test result of Power Density, BLE 2M

Channel	Channel Frequency (MHz)	Power Density	Limit
		(dBm)	(dBm)
Low Channel	2402	-11.06	8
Middle Channel	2440	-10.84	8
High Channel	2480	-11.35	8

Test Plot of Power Density, BLE 1M

Low Channel

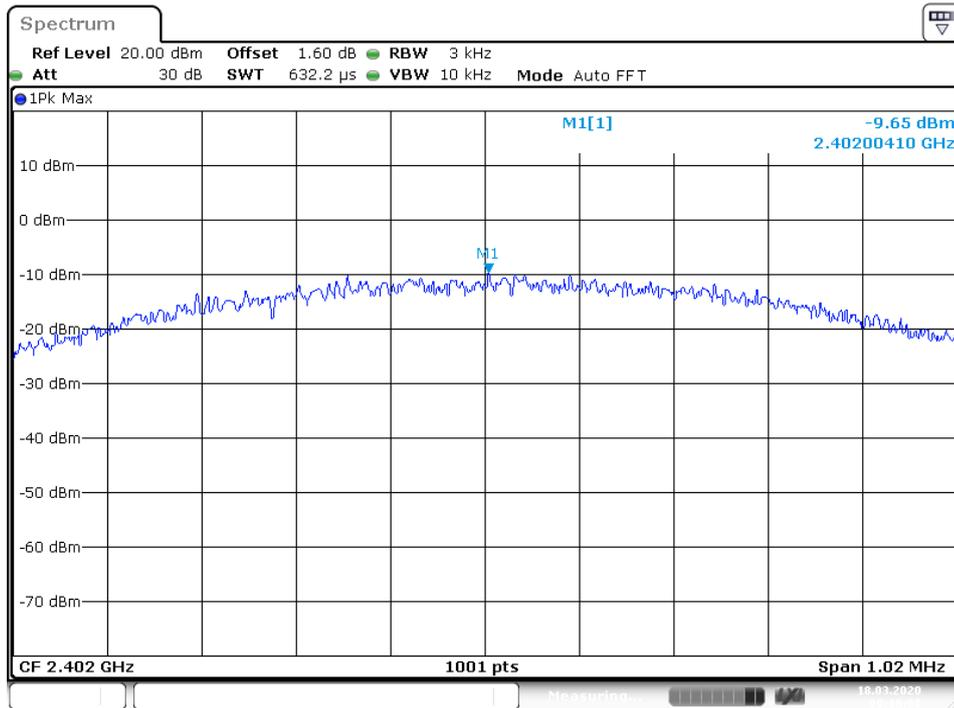

Middle Channel

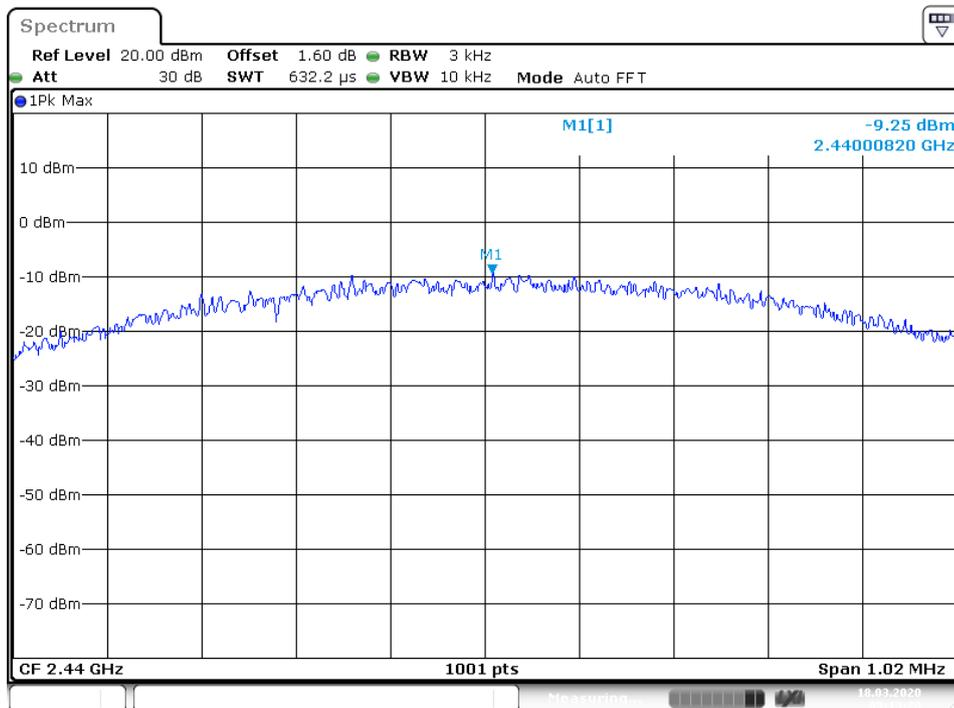

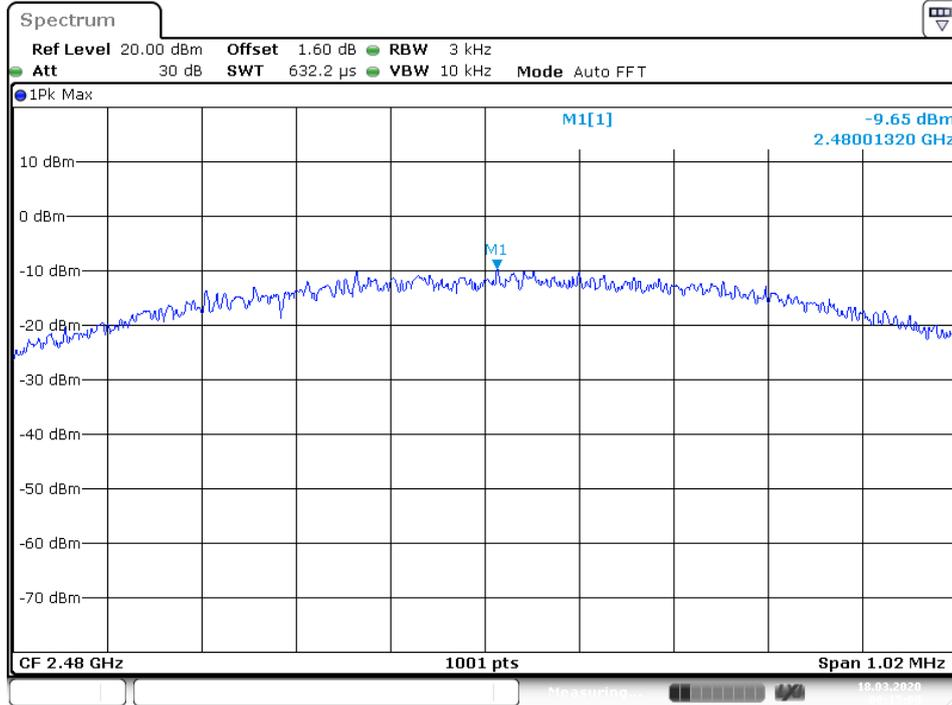
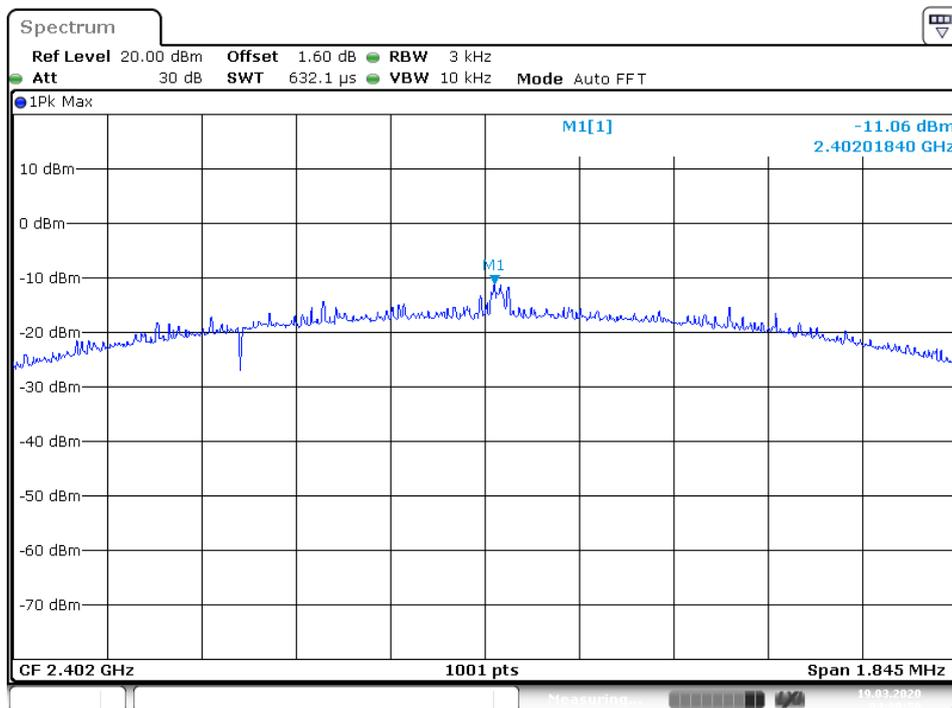
High Channel

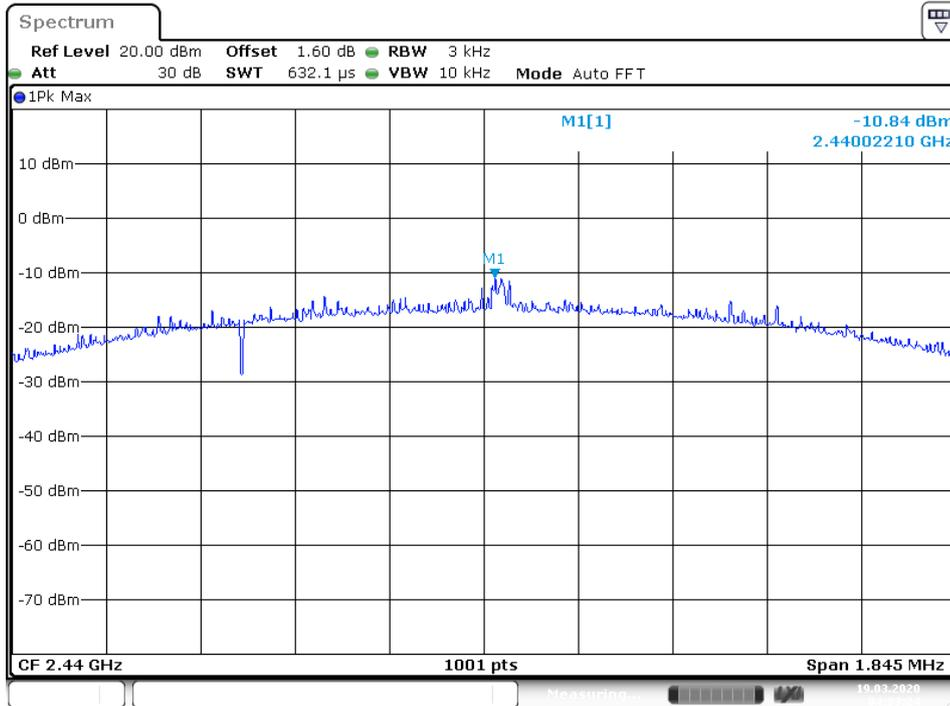
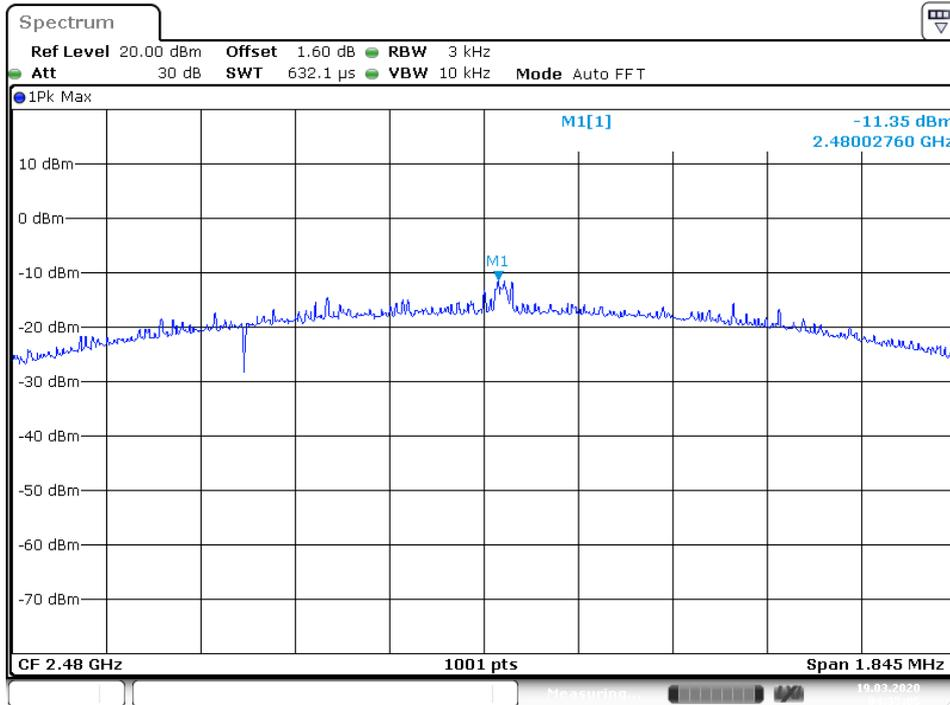
Test Plot of Power Density, BLE 2M
Low Channel

Middle Channel

High Channel

5.1.5 Conducted spurious emissions and Frequency Band Edge measured in 100kHz Bandwidth

RESULT:**Passed**

Test standard	: FCC part 15.247(d)
Basic standard	: ANSI C63.10:2013, KDB558074
Limit	: 20dB (below that in the 100kHz bandwidth within the band that contains the highest level of the desired power)
Kind of test site	: Shielded room

Test setup

Test Channel	: Low/ Mid/ High for spurious, Low/ High for Band Edge
Operation mode	: A
Ambient temperature	: 20-24°C
Relative humidity	: 50-65%
Atmospheric pressure	: 100-103 kPa

All emissions are more than 20dB below fundamental, details refer to following test plot, and compliance is achieved as well.

Due to the small size of the product and that there are no inductive components of significant size, 9kHz to 30MHz frequency range is not tested based on technical judgment.

Test Plot 100kHz Conducted Emissions, BLE 1M

Low Channel

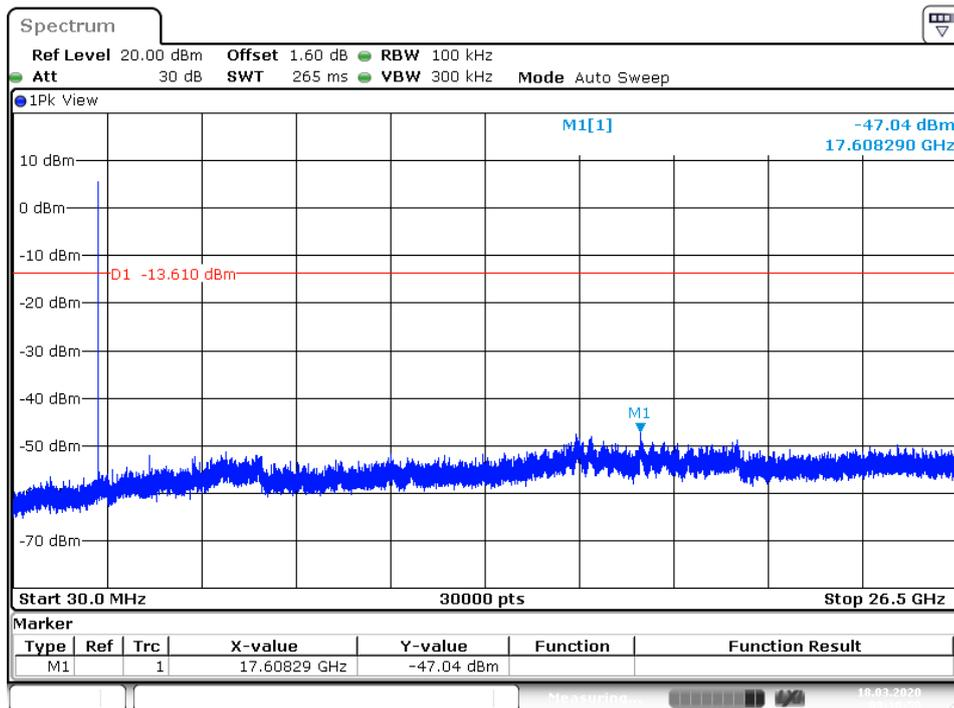

Middle Channel

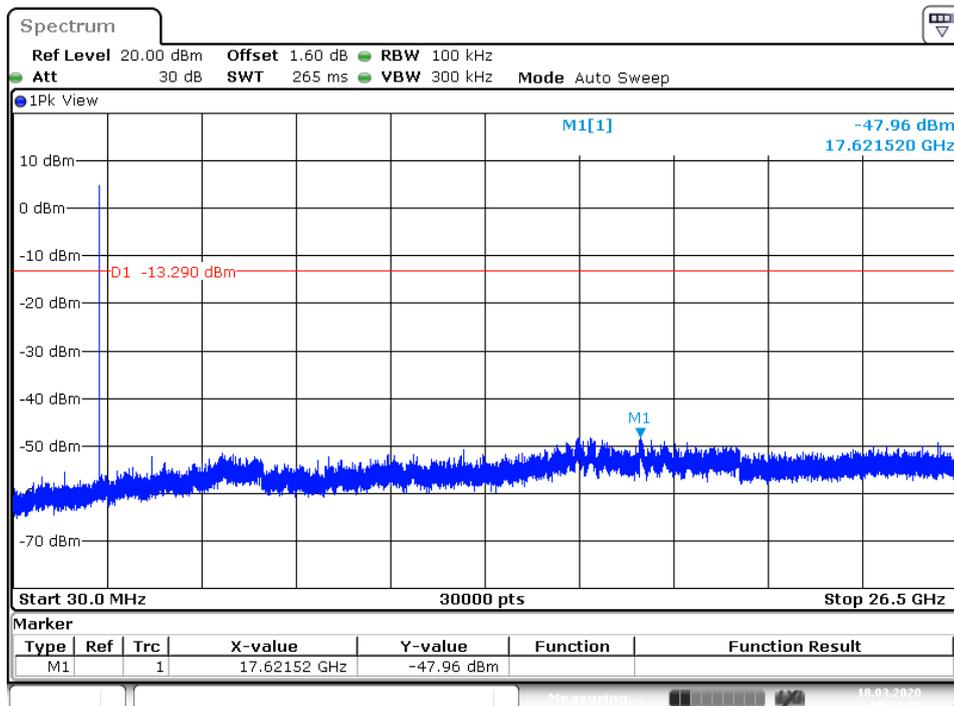

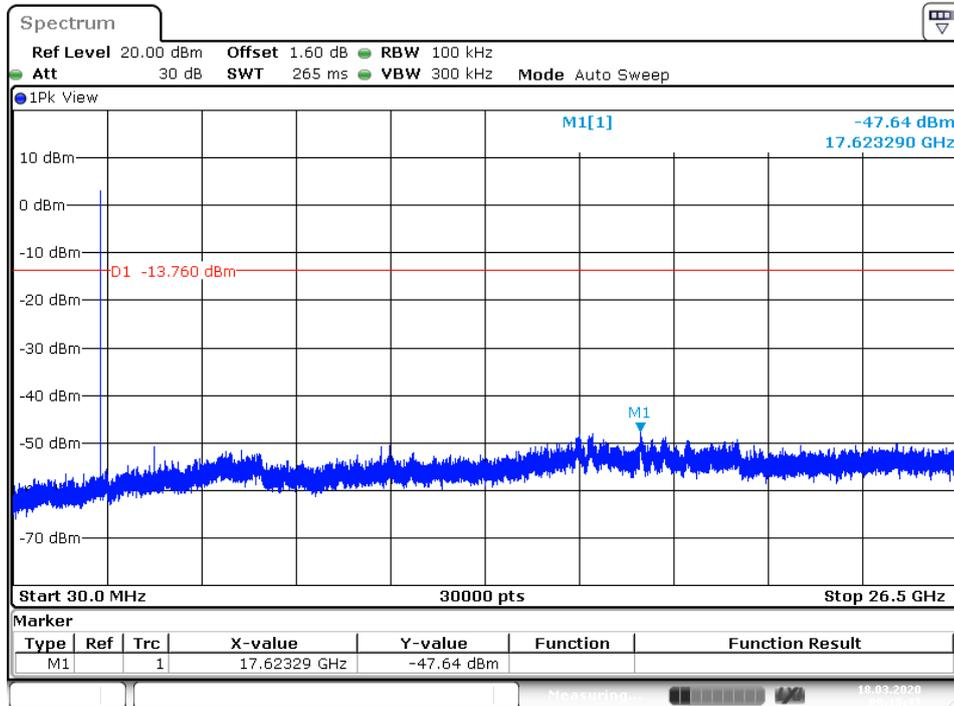
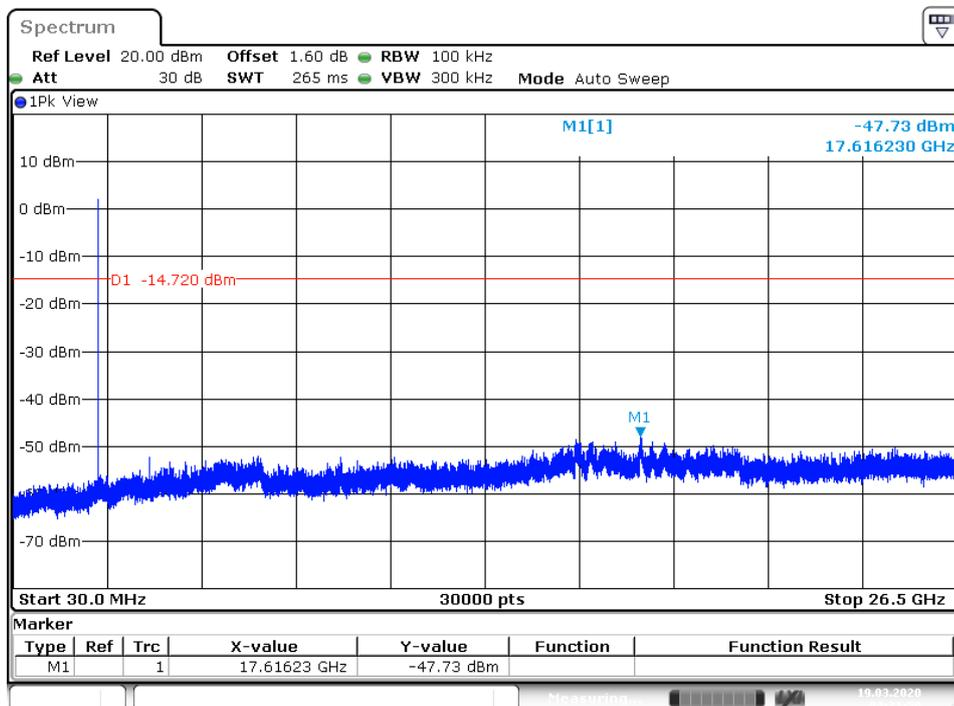
High Channel

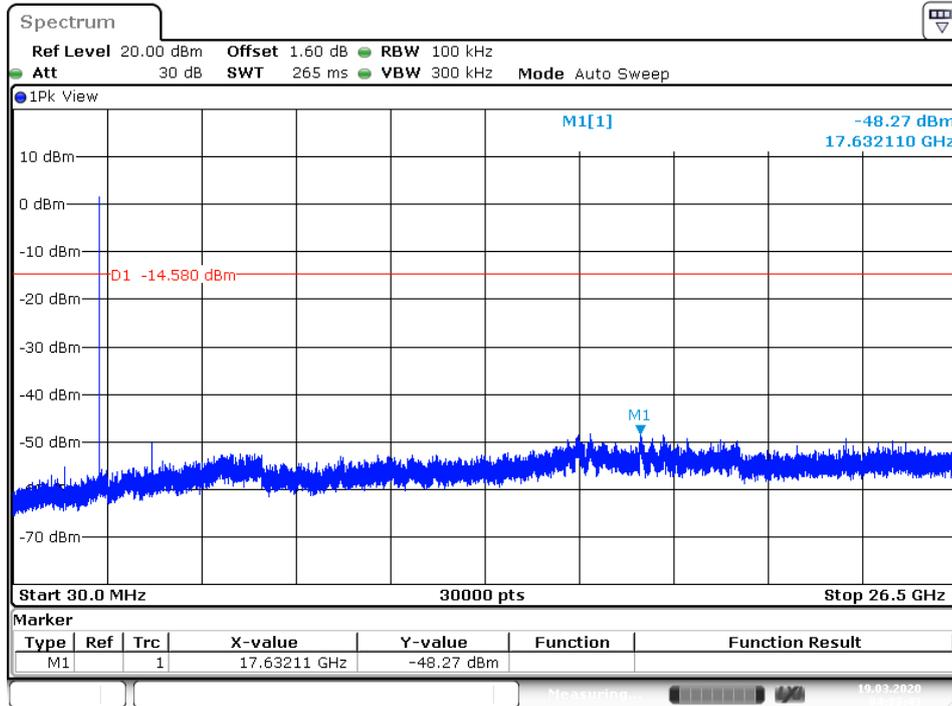
Test Plot 100kHz Conducted Emissions, BLE 2M
Low Channel

Middle Channel

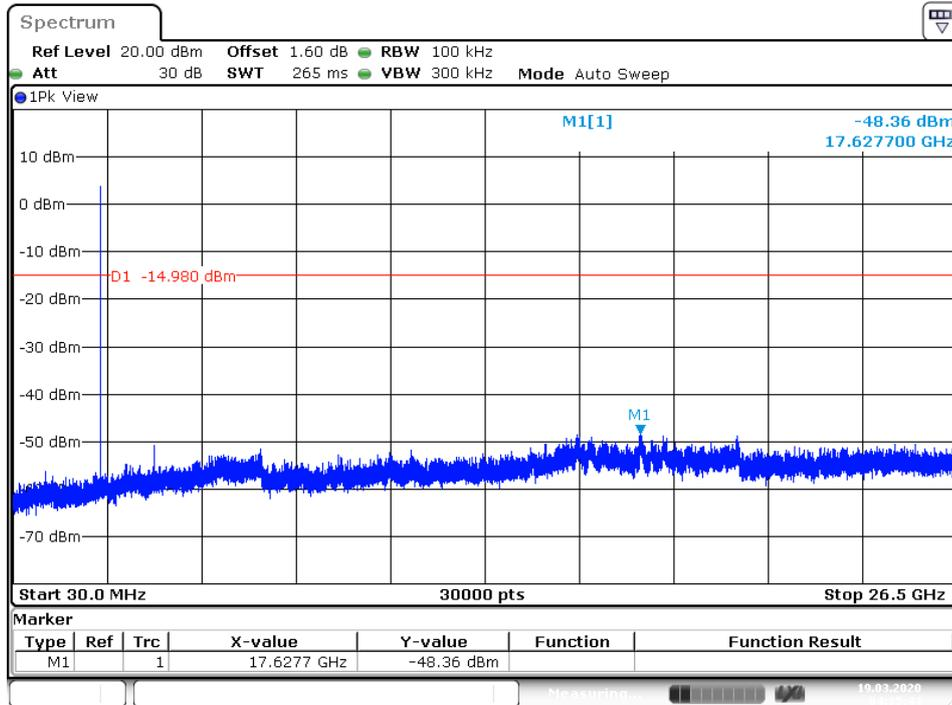
Date: 19.MAR.2020 04:33:44

High Channel

Date: 19.MAR.2020 04:35:44

Test Plot 100kHz RBW of Band Edge, BLE 1M

Low Channel

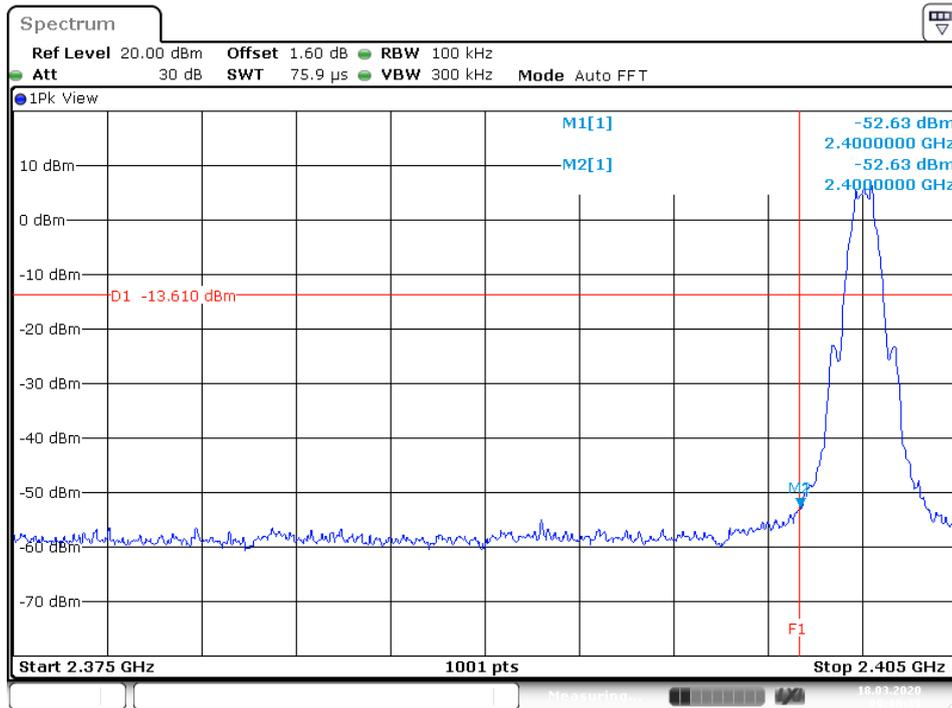

High Channel

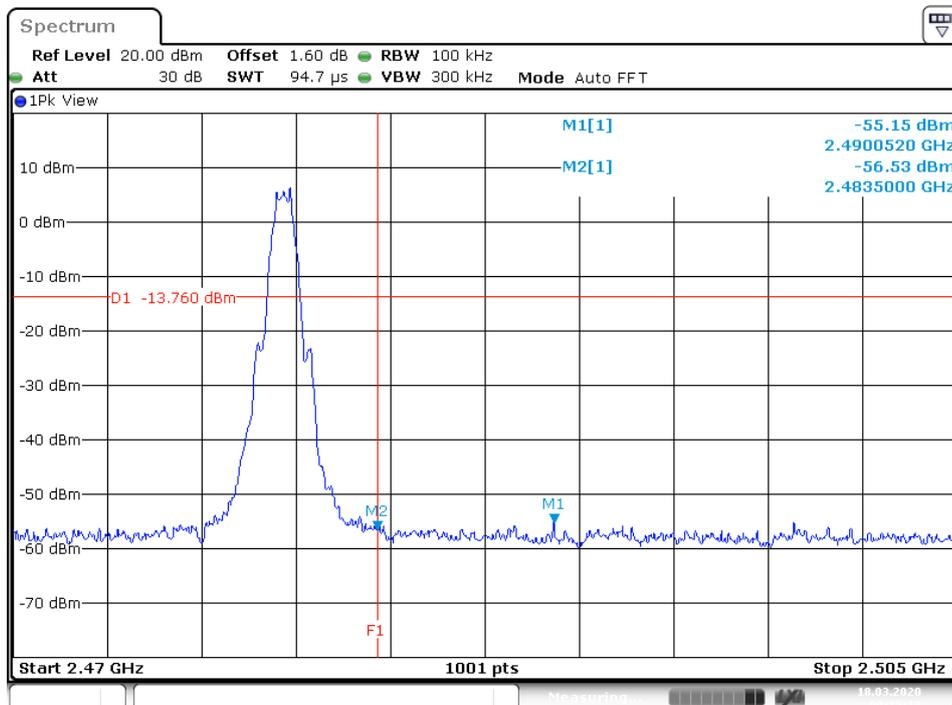

Test Plot 100kHz RBW of Band Edge, BLE 2M

Low Channel

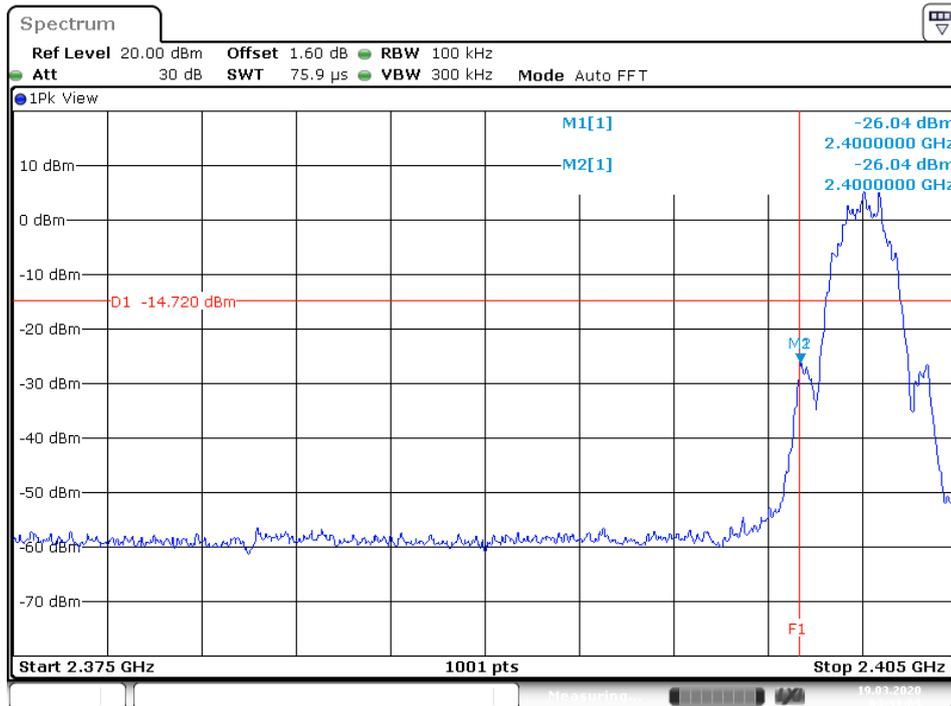

High Channel

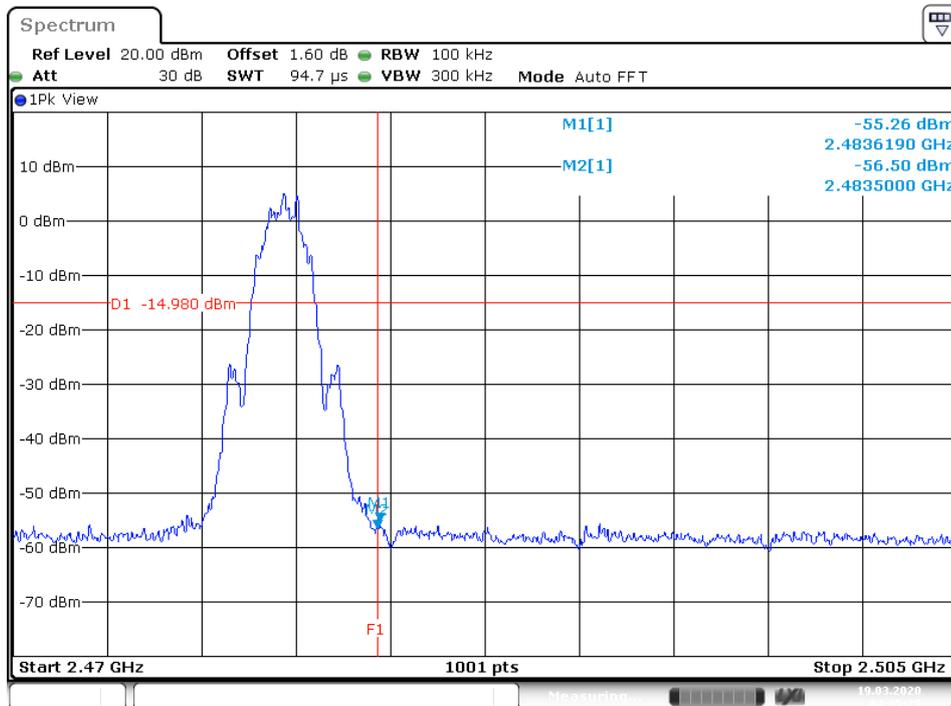

5.1.6 Spurious Emission

RESULT:**Passed**

Test standard : FCC part 15.247(d), FCC 15.205, FCC 15.209
Basic standard : ANSI C63.10: 2013
Limits : Radiated emissions which fall in the restricted bands, as defined in FCC 15.205(a) and ISSED RSS-Gen i5, 8.10 (Table 7), must comply with the radiated emission limits specified in FCC 15.209(a).
Emission radiated outside the restricted and authorized frequency bands must either comply with the radiated emission limits specified for the restricted bands or in FCC15.247(d).

Kind of test site : 3m Semi-Anechoic Chamber

Test setup

Test Channel : Refer to table 6
Operation mode : A

For details refer to Appendix D.

The Radiated Emissions testing was performed in the X, Y and Z axis orientation. The worst-case Axis orientation is recorded in this test report.

Factor (dB/m)=Antenna Factor(dB/m)+Cable loss (dB)
Level(dBuV/m)=Reading(dBuV)+ Factor(dB/m)

5.2 Mains Emissions

5.2.1 Mains Conducted Emissions

RESULT:**Passed**

Test standard	:	FCC Part 15.207 FCC Part 15.107
Limits	:	Mains Conducted emissions as defined in above test standards must comply with the mains conducted emission limits specified
Kind of test site	:	Shielded Room

Test setup

Test Channel	:	GFSK 1M, 2402MHz
Operation mode	:	A
Ambient temperature	:	20-24 °C
Relative humidity	:	50-65 %
Atmospheric pressure	:	100-103 kPa

Remark: For details refer to Appendix D.

6. Safety Human exposure

6.1 Radio Frequency Exposure Compliance

6.1.1 Electromagnetic Fields

RESULT: **Passed**

Test standard : FCC KDB Publication 447498 D01 v06
FCC CFR 47 Part 2 Subpart J Section 2.1091

Separation distance is more than 20 cm, thus mobile device exposure limits can be applied.

FCC Maximum Exposure:

Mode	Frequency (MHz)	Antenna Gain (dBi)	Antenna Gain (numeric)	Maximum Output Power (dBm)	Output Power (mW)	Power Density (S)(mW/cm ²)	Test Result
BLE 1M	2440	3.69	2.3388	6.83	4.8195	0.002244	Pass

Limit FCC: 1500-100,000 MHz 1.0 mW/cm²

7. Photographs of the Test Set-Up

Photograph 1: Set-up for Spurious Emissions (Front View 1)

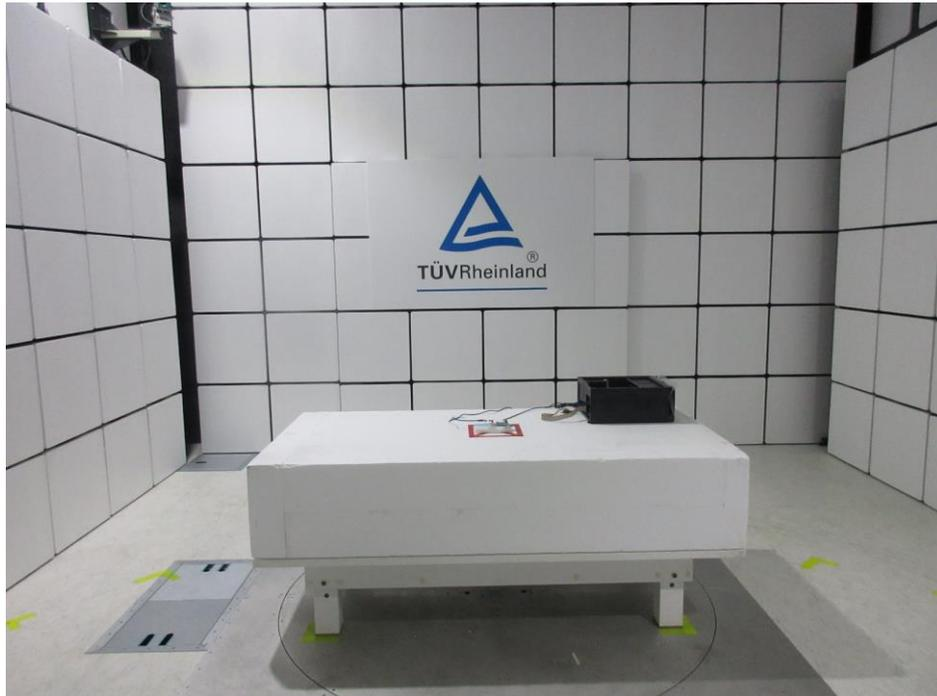

Photograph 2: Set-up for Spurious Emissions (Front View 2)



Photograph 3: Set-up for Spurious Emissions (Back View 1)

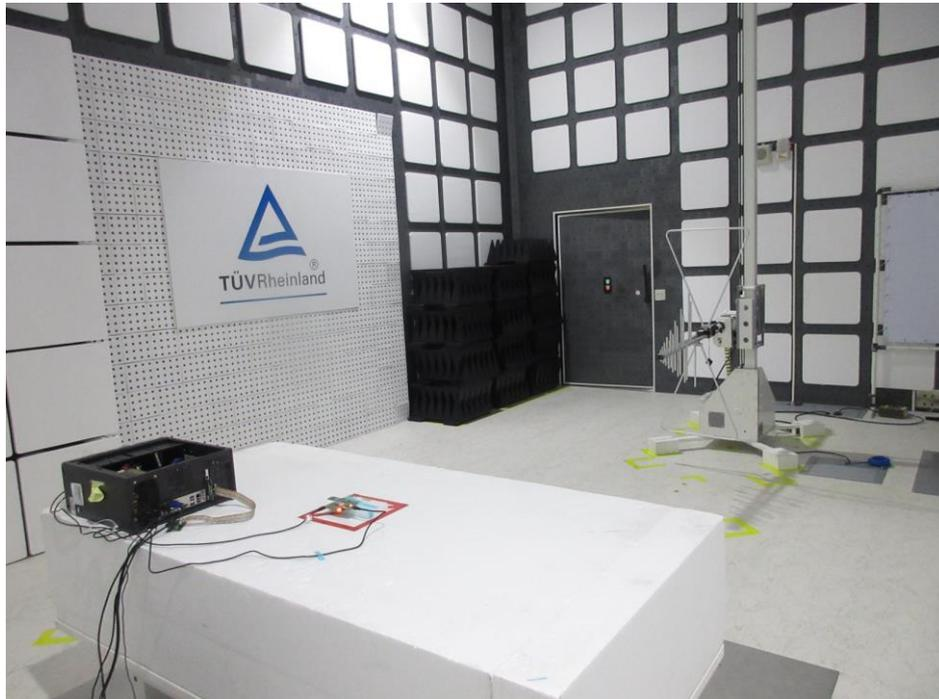

Photograph 4: Set-up for Spurious Emissions (Back View 2)



Photograph 5: Set-up for Spurious Emissions (Back View 3)

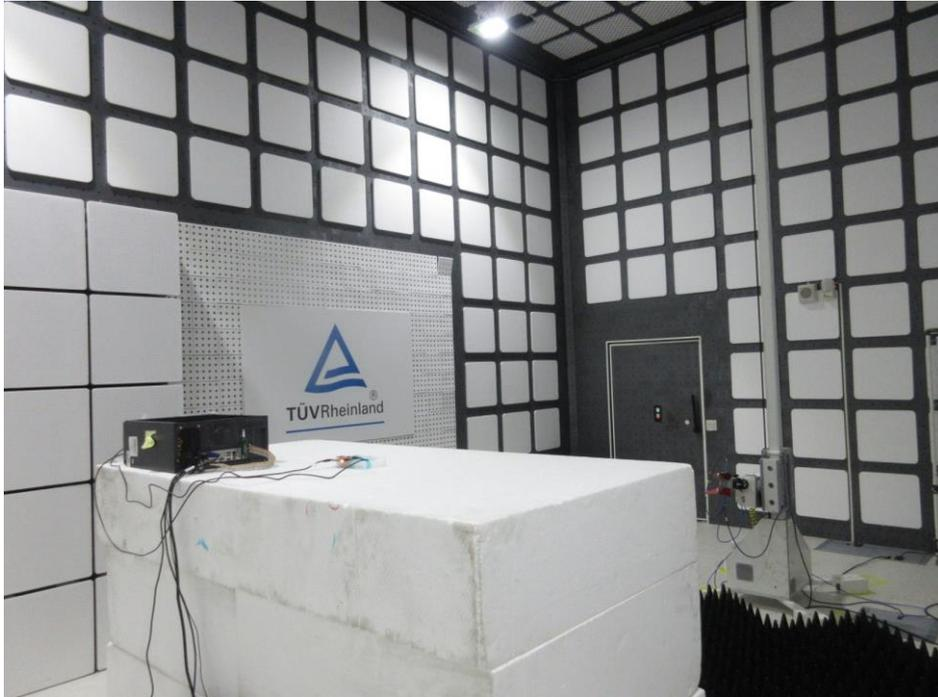

Photograph 6: Set-up for Spurious Emissions (Back View 4)

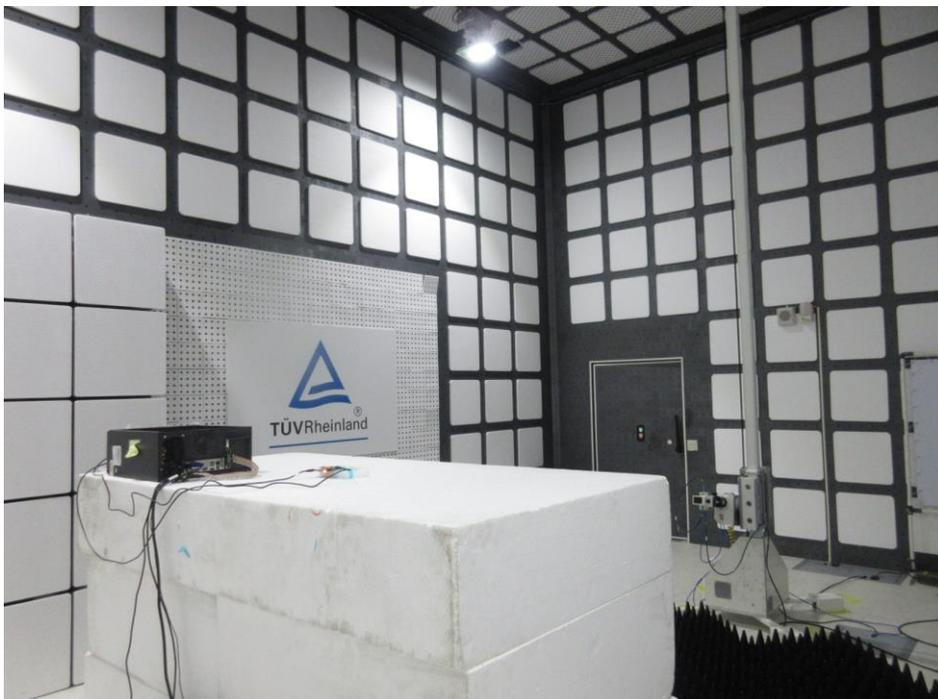

Photograph 7: Set-up for AC Mains Conducted testing (Front View)



Photograph 8: Set-up for AC Mains Conducted testing (Back View)

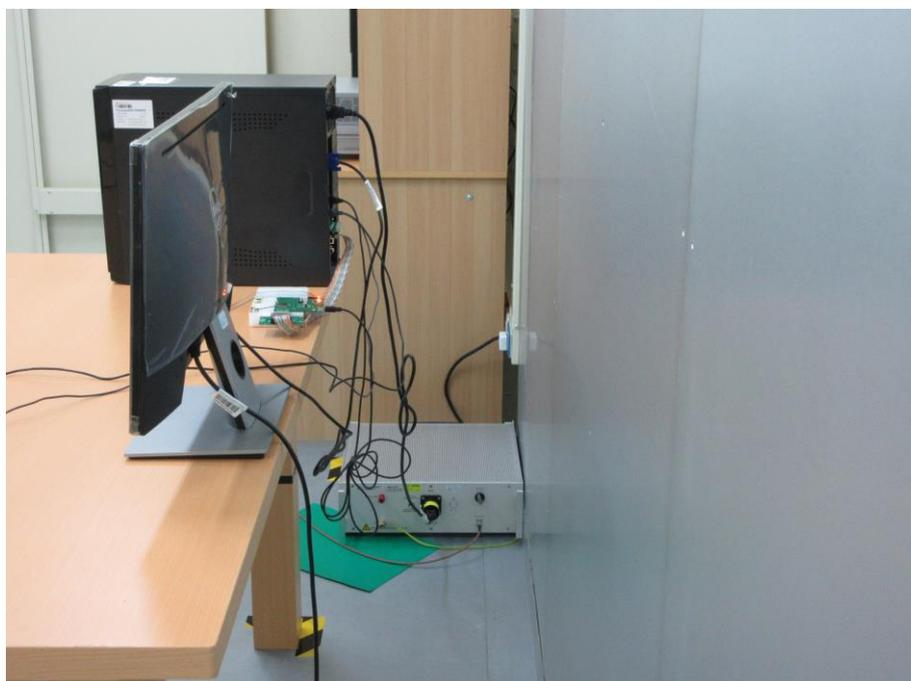

8. List of Tables

Table 1: Applied Standard and Test Levels.....	5
Table 2: List of Test and Measurement Equipment.....	7
Table 3: Emission Measurement Uncertainty	8
Table 4: Basic Information of EUT.....	9
Table 5: Technical Specification of EUT.....	9
Table 6: Table for Parameters of Test Software Setting.....	11
Table 7: Test result of Maximum conducted Peak output power, BLE 1M.....	17
Table 8: Test result of Maximum conducted Peak output power, BLE 2M.....	17
Table 9: Test result of 6dB Bandwidth, BLE 1M.....	18
Table 10: Test result of 6dB Bandwidth, BLE 2M.....	18
Table 11: Test result of 99% Bandwidth, BLE 1M.....	19
Table 12: Test result of 99% Bandwidth, BLE 2M.....	19
Table 13: Test result of Power Density, BLE 1M.....	26
Table 14: Test result of Power Density, BLE 2M.....	26

9. List of Photographs

Photograph 1: Set-up for Spurious Emissions (Front View 1).....	39
Photograph 2: Set-up for Spurious Emissions (Front View 2).....	39
Photograph 3: Set-up for Spurious Emissions (Back View 1).....	40
Photograph 4: Set-up for Spurious Emissions (Back View 2).....	40
Photograph 5: Set-up for Spurious Emissions (Back View 3).....	41
Photograph 6: Set-up for Spurious Emissions (Back View 4).....	41
Photograph 7: Set-up for AC Mains Conducted testing (Front View).....	42
Photograph 8: Set-up for AC Mains Conducted testing (Back View).....	42