

FCC Test Report

Report No.: RF150821C10I-2

FCC ID: ZQ6-AP6356SDXX

Test Model: AP6356SD, AP6356SDPB_I

Series Model: AP6356SDPB (Refer to item 3.1 for more details)

Received Date: Aug. 21, 2015

Test Date: Dec. 24, 2015 (For test mode A)

Jun. 04 ~ Jun. 06, 2018 (For test mode B)

Issued Date: Jun. 13, 2018

Applicant: AMPAK Technology Inc.

Address: 3F, No.1, Jen Ai Road, Hsinchu Industrial Park, Hsinchu, Taiwan, 30352

Issued By: Bureau Veritas Consumer Products Services (H.K.) Ltd., Taoyuan Branch

Lab Address: No. 47-2, 14th Ling, Chia Pau Vil., Lin Kou Dist., New Taipei City, Taiwan (R.O.C.)

Test Location: No. 19, Hwa Ya 2nd Rd., Wen Hwa Vil., Kwei Shan Dist., Taoyuan City 33383, TAIWAN (R.O.C.)

**FCC Registration /
Designation Number:** 788550 / TW0003



This report is for your exclusive use. Any copying or replication of this report to or for any other person or entity, or use of our name or trademark, is permitted only with our prior written permission. This report sets forth our findings solely with respect to the test samples identified herein. The results set forth in this report are not indicative or representative of the quality or characteristics of the lot from which a test sample was taken or any similar or identical product unless specifically and expressly noted. Our report includes all of the tests requested by you and the results thereof based upon the information that you provided to us. You have 60 days from date of issuance of this report to notify us of any material error or omission caused by our negligence, provided, however, that such notice shall be in writing and shall specifically address the issue you wish to raise. A failure to raise such issue within the prescribed time shall constitute your unqualified acceptance of the completeness of this report, the tests conducted and the correctness of the report contents. Unless specific mention, the uncertainty of measurement has been explicitly taken into account to declare the compliance or non-compliance to the specification. This report should not be used by the client to claim product certification, approval, or endorsement by TAF or any government agencies.

Table of Contents

Release Control Record	4
1 Certificate of Conformity	5
2 Summary of Test Results	6
2.1 Measurement Uncertainty.....	6
2.2 Modification Record.....	6
3 General Information	7
3.1 General Description of EUT.....	7
3.2 Description of Test Modes.....	8
3.2.1 Test Mode Applicability and Tested Channel Detail.....	9
3.3 Description of Support Units.....	10
3.3.1 Configuration of System under Test.....	10
3.4 General Description of Applied Standards.....	11
4 Test Types and Results	12
4.1 Radiated Emission and Bandedge Measurement.....	12
4.1.1 Limits of Radiated Emission and Bandedge Measurement.....	12
4.1.2 Test Instruments.....	13
4.1.3 Test Procedures.....	15
4.1.4 Deviation from Test Standard.....	15
4.1.5 Test Setup.....	16
4.1.6 EUT Operating Conditions.....	17
4.1.7 Test Results.....	18
4.2 Conducted Emission Measurement.....	22
4.2.1 Limits of Conducted Emission Measurement.....	22
4.2.2 Test Instruments.....	22
4.2.3 Test Procedures.....	23
4.2.4 Deviation from Test Standard.....	23
4.2.5 Test Setup.....	23
4.2.6 EUT Operating Conditions.....	23
4.2.7 Test Results.....	24
4.3 6dB Bandwidth Measurement.....	26
4.3.1 Limits of 6dB Bandwidth Measurement.....	26
4.3.2 Test Setup.....	26
4.3.3 Test Instruments.....	26
4.3.4 Test Procedure.....	26
4.3.5 Deviation from Test Standard.....	26
4.3.6 EUT Operating Conditions.....	26
4.3.7 Test Result.....	27
4.4 Conducted Output Power Measurement.....	28
4.4.1 Limits of Conducted Output Power Measurement.....	28
4.4.2 Test Setup.....	28
4.4.3 Test Instruments.....	28
4.4.4 Deviation from Test Standard.....	28
4.4.5 Test Procedures.....	28
4.4.6 EUT Operating Conditions.....	28
4.4.7 Test Results.....	28
4.5 Power Spectral Density Measurement.....	29
4.5.1 Limits of Power Spectral Density Measurement.....	29
4.5.2 Test Setup.....	29
4.5.3 Test Instruments.....	29
4.5.4 Test Procedure.....	29
4.5.5 Deviation from Test Standard.....	29
4.5.6 EUT Operating Condition.....	29
4.5.7 Test Results.....	30

4.6	Conducted Out of Band Emission Measurement.....	31
4.6.1	Limits of Conducted Out of Band Emission Measurement	31
4.6.2	Test Setup.....	31
4.6.3	Test Instruments	31
4.6.4	Test Procedure	31
4.6.5	Deviation from Test Standard	31
4.6.6	EUT Operating Condition	31
4.6.7	Test Results	31
5	Pictures of Test Arrangements.....	33
	Appendix – Information on the Testing Laboratories	34

Release Control Record

Issue No.	Description	Date Issued
RF150821C10I-2	Original release	Jun. 13, 2018

1 Certificate of Conformity

Product: WLAN module for 802.11abgn(2x2) + 11ac + BT4.1

Brand: Ampak

Test Model: AP6356SD, AP6356SDPB_I

Series Model: AP6356SDPB (Refer to item 3.1 for more details)

Sample Status: Engineering Sample

Applicant: AMPAK Technology Inc.

Test Date: Dec. 24, 2015 (For test mode A)
Jun. 04 ~ Jun. 06, 2018 (For test mode B)

Standards: 47 CFR FCC Part 15, Subpart C (Section 15.247)
ANSI C63.10:2013

The above equipment has been tested by **Bureau Veritas Consumer Products Services (H.K.) Ltd., Taoyuan Branch**, and found compliance with the requirement of the above standards. The test record, data evaluation & Equipment Under Test (EUT) configurations represented herein are true and accurate accounts of the measurements of the sample's RF characteristics under the conditions specified in this report.

Prepared by : Celine Chou , **Date:** Jun. 13, 2018
Celine Chou / Specialist

Approved by : Bruce Chen , **Date:** Jun. 13, 2018
Bruce Chen / Project Engineer

2 Summary of Test Results

47 CFR FCC Part 15, Subpart C (Section 15.247)			
FCC Clause	Test Item	Result	Remarks
15.207	AC Power Conducted Emission	Pass	Meet the requirement of limit. Minimum passing margin is -11.23dB at 0.20254MHz
15.205 / 15.209 / 15.247(d)	Radiated Emissions and Band Edge Measurement	Pass	Meet the requirement of limit. Minimum passing margin is -2.6dB at 852.56MHz.
15.247(d)	Antenna Port Emission	Pass	Meet the requirement of limit.
15.247(a)(2)	6dB bandwidth	Pass	Meet the requirement of limit.
15.247(b)	Conducted power	Pass	Meet the requirement of limit.
15.247(e)	Power Spectral Density	Pass	Meet the requirement of limit.
15.203	Antenna Requirement	Pass	Antenna connectors are IPEX and RP-SMA (M) not a standard connector.

2.1 Measurement Uncertainty

Where relevant, the following measurement uncertainty levels have been estimated for tests performed on the EUT as specified in CISPR 16-4-2:

Measurement	Frequency	Expanded Uncertainty (k=2) (±)
Conducted Emissions at mains ports	150kHz ~ 30MHz	2.94 dB
Radiated Emissions up to 1 GHz	30MHz ~ 200MHz	3.59 dB
	200MHz ~ 1000MHz	3.60 dB
Radiated Emissions above 1 GHz	1GHz ~ 18GHz	2.29 dB
	18GHz ~ 40GHz	2.29 dB

2.2 Modification Record

There were no modifications required for compliance.

3 General Information

3.1 General Description of EUT

Product	WLAN module for 802.11abgn(2x2) + 11ac + BT4.1
Brand	Ampak
Test Model	AP6356SD, AP6356SDPB_I
Series Model	AP6356SDPB
Model Difference	Refer to note
Sample Status	Engineering Sample
Power Supply Rating	5Vdc (host equipment)
Modulation Type	GFSK
Transfer Rate	1Mbps
Operating Frequency	2402 ~ 2480MHz
Number of Channel	40
Channel Spacing	2MHz
Output Power	5.309mW
Antenna Type	Refer to note
Antenna Connector	Refer to note
Accessory Device	NA
Data Cable Supplied	NA

Note:

1. This report is prepared for FCC class II permissive change, the differences compared with the original report (BV CPS report no.: RF150821C10G-2) are adding one model name, two antennas and changing EUT Category from "Indoor Access Point" to "Mobile and Portable client device". After evaluation, only the radiated emission and power line conducted emission had been an addendum test, the antenna port conducted test data was copy from original report, due to the output power of EUT is not change.
2. The following models are provided to this EUT. (New model name is marked in boldface)

Brand	Model	Description	
		Fixture	Crystal Temperature Operating Range
Ampak	AP6356SD	-	-10~65°C
	AP6356SDPB	AP12356	-10~65°C
	AP6356SDPB_I	AP12356_I	-40~85°C

* The model of the AP6356SD and AP6356SDPB_I was chosen for final test.

3. The following antennas were provided to the EUT. (New antennas are marked in boldface)

No.	Type	Connector	Gain(dBi)	
			2.4G	5G
1	PIFA	I-PEX	3.5	5.5
2	Dipole	RP-SMA (M)	3.8	5.5
3	Dipole	RP-SMA (M)	3	3

3.2 Description of Test Modes

40 channels are provided to this EUT:

Channel	Freq. (MHz)	Channel	Freq. (MHz)	Channel	Freq. (MHz)	Channel	Freq. (MHz)
0	2402	10	2422	20	2442	30	2462
1	2404	11	2424	21	2444	31	2464
2	2406	12	2426	22	2446	32	2466
3	2408	13	2428	23	2448	33	2468
4	2410	14	2430	24	2450	34	2470
5	2412	15	2432	25	2452	35	2472
6	2414	16	2434	26	2454	36	2474
7	2416	17	2436	27	2456	37	2476
8	2418	18	2438	28	2458	38	2478
9	2420	19	2440	29	2460	39	2480

3.2.1 Test Mode Applicability and Tested Channel Detail

EUT Configure Mode	Applicable to				Description
	RE \geq 1G	RE<1G	PLC	APCM	
A	-	-	-	√	Model: AP6356SD
B	√	√	√	-	Model: AP6356SDPB_I with AP12356_I Platform

Where RE \geq 1G: Radiated Emission above 1GHz & Bandedge Measurement
 RE<1G: Radiated Emission below 1GHz
 PLC: Power Line Conducted Emission
 APCM: Antenna Port Conducted Measurement

Note:

1. The EUT had been pre-tested on the positioned of each 3 axis. The worst case was found when positioned on **X-plane**.
2. "-" means no effect.

Radiated Emission Test (Above 1GHz):

- Pre-Scan has been conducted to determine the worst-case mode from all possible combinations between available modulations, data rates and antenna ports (if EUT with antenna diversity architecture).
- Following channel(s) was (were) selected for the final test as listed below.

EUT Configure Mode	Available Channel	Tested Channel	Modulation Technology	Data Rate (Mbps)
B	0 to 39	0, 19, 39	GFSK	1

Radiated Emission Test (Below 1GHz):

- Pre-Scan has been conducted to determine the worst-case mode from all possible combinations between available modulations, data rates and antenna ports (if EUT with antenna diversity architecture).
- Following channel(s) was (were) selected for the final test as listed below.

EUT Configure Mode	Available Channel	Tested Channel	Modulation Technology	Data Rate (Mbps)
B	0 to 39	39	GFSK	1

Power Line Conducted Emission Test:

- Pre-Scan has been conducted to determine the worst-case mode from all possible combinations between available modulations, data rates and antenna ports (if EUT with antenna diversity architecture).
- Following channel(s) was (were) selected for the final test as listed below.

EUT Configure Mode	Available Channel	Tested Channel	Modulation Technology	Data Rate (Mbps)
B	0 to 39	39	GFSK	1

Antenna Port Conducted Measurement:

- This item includes all test value of each mode, but only includes spectrum plot of worst value of each mode.
- Pre-Scan has been conducted to determine the worst-case mode from all possible combinations between available modulations, data rates and antenna ports (if EUT with antenna diversity architecture).
- Following channel(s) was (were) selected for the final test as listed below.

EUT Configure Mode	Available Channel	Tested Channel	Modulation Technology	Data Rate (Mbps)
A	0 to 39	0, 19, 39	GFSK	1

Test Condition:

Applicable to	Environmental Conditions	Input Power (System)	Tested by
RE \geq 1G	22 deg. C, 66% RH	120Vac, 60Hz	Han Wu
RE<1G	25 deg. C, 65% RH	120Vac, 60Hz	Greg Lin
PLC	25 deg. C, 75% RH	120Vac, 60Hz	Greg Lin
APCM	25 deg. C, 60% RH	120Vac, 60Hz	Robert Cheng

3.3 Description of Support Units

The EUT has been tested as an independent unit together with other necessary accessories or support units. The following support units or accessories were used to form a representative test configuration during the tests.

ID	Product	Brand	Model No.	Serial No.	FCC ID	Remarks
A.	PC	Ampak	AC00910	NA	NA	Provided by manufacturer
B.	Monitor	Lenovo	L215pwA	4M0373192470697	FCC DoC Approved	-
C.	Keyboard	DELL	KB4021	CN-05V23T-71581-1A K-01Q7-A01	FCC DoC Approved	-
D.	Mouse	DELL	MS111-P	CN-011D3V-71581-1C J-019A	FCC DoC Approved	-
E.	Fixture	NA	NA	NA	NA	Provided by manufacturer

Note: All power cords of the above support units are non-shielded (1.8m).

ID	Descriptions	Qty.	Length (m)	Shielding (Yes/No)	Cores (Qty.)	Remarks
1.	D-sub cable	1	1.8	Y	2	-
2.	USB cable	1	1.8	Y	0	-
3.	USB cable	1	1.8	Y	0	-
4.	Mini USB cable	2	1	Y	0	Provided by manufacturer
5.	Convertible cable	1	0.5	N	0	Provided by manufacturer

Note: The core(s) is(are) originally attached to the cable(s).

3.3.1 Configuration of System under Test

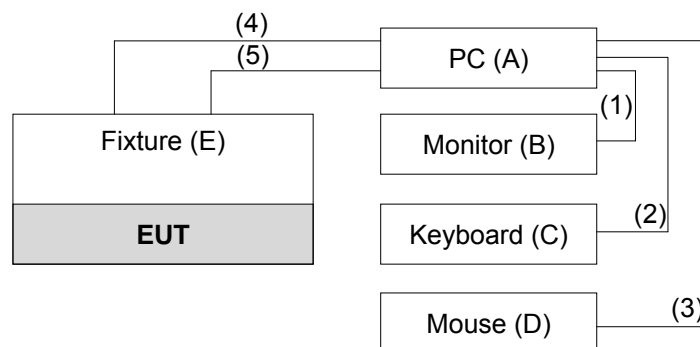

3.4 General Description of Applied Standards

The EUT is a RF Product. According to the specifications of the manufacturer, it must comply with the requirements of the following standards:

FCC Part 15, Subpart C (15.247)

KDB 558074 D01 DTS Meas Guidance v04

ANSI C63.10-2013

All test items have been performed and recorded as per the above standards.

4 Test Types and Results

4.1 Radiated Emission and Bandedge Measurement

4.1.1 Limits of Radiated Emission and Bandedge Measurement

Radiated emissions which fall in the restricted bands must comply with the radiated emission limits specified as below table. Other emissions shall be at least 30dB below the highest level of the desired power:

Frequencies (MHz)	Field Strength (microvolts/meter)	Measurement Distance (meters)
0.009 ~ 0.490	2400/F(kHz)	300
0.490 ~ 1.705	24000/F(kHz)	30
1.705 ~ 30.0	30	30
30 ~ 88	100	3
88 ~ 216	150	3
216 ~ 960	200	3
Above 960	500	3

Note:

1. The lower limit shall apply at the transition frequencies.
2. Emission level (dBuV/m) = 20 log Emission level (uV/m).
3. For frequencies above 1000MHz, the field strength limits are based on average detector, however, the peak field strength of any emission shall not exceed the maximum permitted average limits, specified above by more than 20dB under any condition of modulation.

4.1.2 Test Instruments

Test Date: Dec. 24, 2015

Description & Manufacturer	Model No.	Serial No.	Cal. Date	Cal. Due
Test Receiver ROHDE & SCHWARZ	ESCI	100424	Oct. 12, 2015	Oct. 11, 2016
Spectrum Analyzer ROHDE & SCHWARZ	FSP40	100040	Jul. 08, 2015	Jul. 07, 2016
BILOG Antenna SCHWARZBECK	VULB9168	9168-155	Feb. 06, 2015	Feb. 05, 2016
HORN Antenna SCHWARZBECK	BBHA 9120D	9120D-1170	Feb. 05, 2015	Feb. 04, 2016
HORN Antenna SCHWARZBECK	BBHA 9170	BBHA9170241	Feb. 09, 2015	Feb. 08, 2016
Loop Antenna	EM-6879	269	Aug. 11, 2015	Aug. 10, 2016
Preamplifier Agilent	8449B	3008A01960	Aug. 09, 2015	Aug. 08, 2016
Preamplifier Agilent	8447D	2944A10631	Aug. 09, 2015	Aug. 08, 2016
RF signal cable HUBER+SUHNER	SUCOFLEX 104	Cable-CH4-02(295012+309220)	Aug. 09, 2015	Aug. 08, 2016
RF signal cable HUBER+SUHNER	SUCOFLEX 104	Cable-CH4-03(250724)	Aug. 09, 2015	Aug. 08, 2016
Software BV ADT	ADT_Radiated_V7.6.15.9.4	NA	NA	NA
Antenna Tower inn-co GmbH	MA 4000	010303	NA	NA
Antenna Tower Controller BV ADT	AT100	AT93021703	NA	NA
Turn Table BV ADT	TT100	TT93021703	NA	NA
Turn Table Controller BV ADT	SC100.	SC93021703	NA	NA
High Speed Peak Power Meter	ML2495A	0824011	Jul. 09, 2015	Jul. 08, 2016
Power Sensor	MA2411B	0738171	Jul. 09, 2015	Jul. 08, 2016

- Note:
1. The calibration interval of the above test instruments is 12 months and the calibrations are traceable to NML/ROC and NIST/USA.
 2. The test was performed in HwaYa Chamber 4.
 3. The horn antenna and preamplifier (model: 8449B) are used only for the measurement of emission frequency above 1GHz if tested.
 4. The FCC Designation Number is TW0003. The number will be varied with the Lab location and scope as attached.
 5. The IC Site Registration No. is IC7450F-4.

Test Date: Jun. 04 ~ Jun. 06, 2018

Description & Manufacturer	Model No.	Serial No.	Cal. Date	Cal. Due
Test Receiver KEYSIGHT	N9038A	MY55420137	Apr. 11, 2018	Apr. 10, 2019
Spectrum Analyzer ROHDE & SCHWARZ	FSP40	100269	May 29, 2018	May 28, 2019
BILOG Antenna SCHWARZBECK	VULB9168	9168-148	Dec. 11, 2017	Dec. 10, 2018
HORN Antenna SCHWARZBECK	BBHA 9120 D	9120D-1169	Dec. 12, 2017	Dec. 11, 2018
HORN Antenna SCHWARZBECK	BBHA 9170	BBHA9170241	Dec. 01, 2017	Nov. 30, 2018
Loop Antenna EMCI	EM-6879	269	Aug. 11, 2017	Aug. 10, 2018
Preamplifier Agilent (Below 1GHz)	8447D	2944A10638	Aug. 08, 2017	Aug. 07, 2018
Preamplifier Agilent (Above 1GHz)	8449B	3008A01638	Feb. 22, 2018	Feb. 21, 2019
RF signal cable HUBER+SUHNER&EMCI	SUCOFLEX 104 & EMC104-SM-SM8000	CABLE-CH9-02 (248780+171006)	Jan. 15, 2018	Jan. 14, 2019
RF signal cable HUBER+SUHNER	SUCOFLEX 104	CABLE-CH9-(250795/4)	Aug. 08, 2017	Aug. 07, 2018
RF signal cable Woken	8D-FB	Cable-CH9-01	Aug. 01, 2017	Jul. 31, 2018
Software BV ADT	ADT_Radiated_ V7.6.15.9.5	NA	NA	NA
Antenna Tower EMCO	2070/2080	512.835.4684	NA	NA
Turn Table EMCO	2087-2.03	NA	NA	NA
Antenna Tower & Turn BV ADT	AT100	AT93021705	NA	NA
Turn Table BV ADT	TT100	TT93021705	NA	NA
Turn Table Controller BV ADT	SC100	SC93021705	NA	NA
Boresight Antenna Fixture	FBA-01	FBA-SIP01	NA	NA
High Speed Peak Power Meter	ML2495A	0824012	Aug. 18, 2017	Aug. 17, 2018
Power Sensor	MA2411B	0738171	Aug. 18, 2017	Aug. 17, 2018

- Note: 1. The calibration interval of the above test instruments is 12 months and the calibrations are traceable to NML/ROC and NIST/USA.
 2. The test was performed in HwaYa Chamber 9.
 3. The FCC Designation Number is TW0003. The number will be varied with the Lab location and scope as attached.
 4. The IC Site Registration No. is IC 7450F-9.

4.1.3 Test Procedures

For Radiated emission below 30MHz

- a. The EUT was placed on the top of a rotating table 0.8 meters above the ground at a 3 meter chamber room. The table was rotated 360 degrees to determine the position of the highest radiation.
- b. The EUT was set 3 meters away from the interference-receiving antenna, which was mounted on the top of a variable-height antenna tower.
- c. Parallel, perpendicular, and ground-parallel orientations of the antenna are set to make the measurement.
- d. For each suspected emission, the EUT was arranged to its worst case and the rotatable table was turned from 0 degrees to 360 degrees to find the maximum reading.
- e. The test-receiver system was set to Quasi-Peak Detect Function and Specified Bandwidth with Maximum Hold Mode.

Note:

1. The resolution bandwidth and video bandwidth of test receiver/spectrum analyzer is 9kHz at frequency below 30MHz.

For Radiated emission above 30MHz

- a. The EUT was placed on the top of a rotating table 0.8 meters (for 30MHz ~ 1GHz) / 1.5 meters (for above 1GHz) above the ground at 3 meter chamber room for test. The table was rotated 360 degrees to determine the position of the highest radiation.
- b. The EUT was set 3 meters away from the interference-receiving antenna, which was mounted on the top of a variable-height antenna tower.
- c. The height of antenna is varied from one meter to four meters above the ground to determine the maximum value of the field strength. Both horizontal and vertical polarizations of the antenna are set to make the measurement.
- d. For each suspected emission, the EUT was arranged to its worst case and then the antenna was tuned to heights from 1 meter to 4 meters and the rotatable table was turned from 0 degrees to 360 degrees to find the maximum reading.
- e. The test-receiver system was set to quasi-peak detect function and specified bandwidth with maximum hold mode when the test frequency is below 1 GHz.
- f. The test-receiver system was set to peak and average detect function and specified bandwidth with maximum hold mode when the test frequency is above 1 GHz. If the peak reading value also meets average limit, measurement with the average detector is unnecessary.

Note:

1. The resolution bandwidth and video bandwidth of test receiver/spectrum analyzer is 120kHz for Quasi-peak detection (QP) at frequency below 1GHz.
2. The resolution bandwidth of test receiver/spectrum analyzer is 1 MHz and the video bandwidth is 3 MHz for Peak detection (PK) at frequency above 1GHz.
3. The resolution bandwidth of test receiver/spectrum analyzer is 1 MHz and the video bandwidth is $\geq 1/T$ (Duty cycle < 98%) or 10 Hz (Duty cycle $\geq 98\%$) for Average detection (AV) frequency above 1GHz.
4. All modes of operation were investigated and the worst-case emissions are reported.

4.1.4 Deviation from Test Standard

No deviation.

4.1.5 Test Setup

For Radiated emission below 30MHz

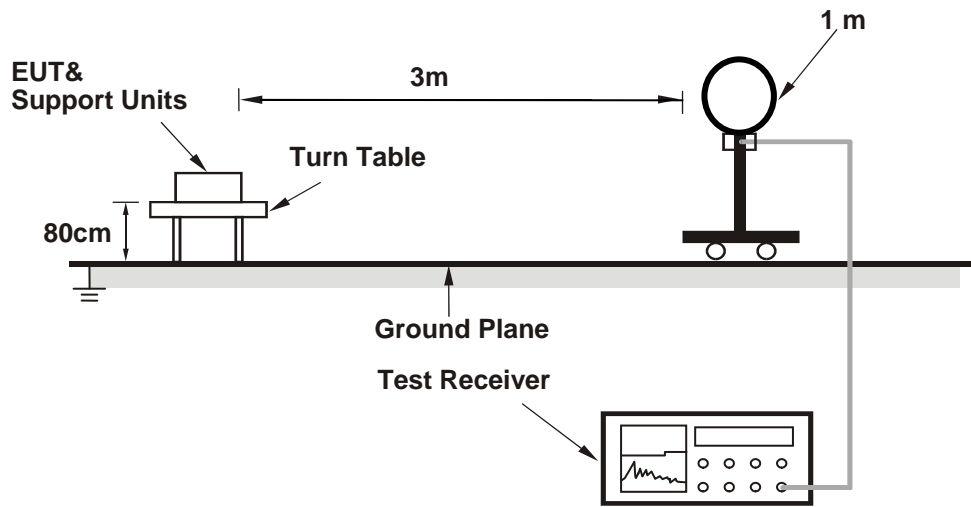

For Radiated emission 30MHz to 1GHz

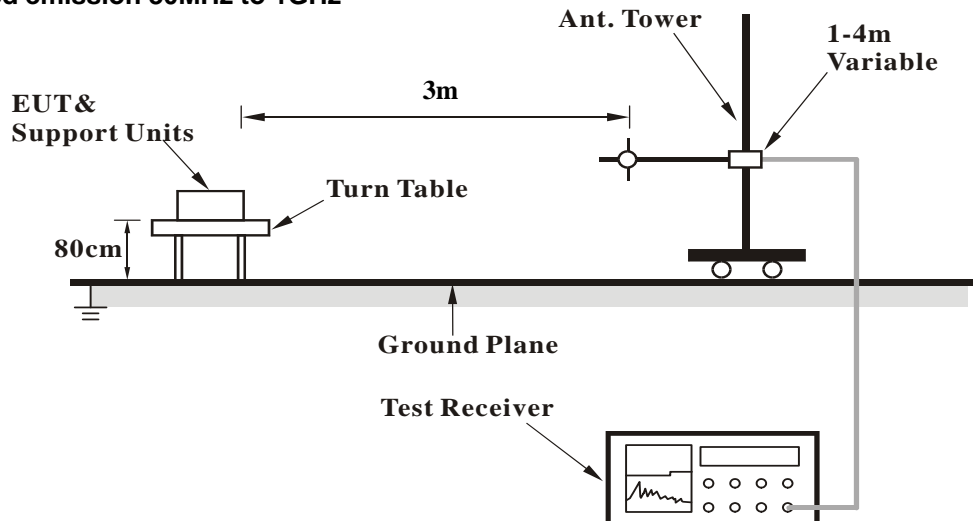

For Radiated emission above 1GHz

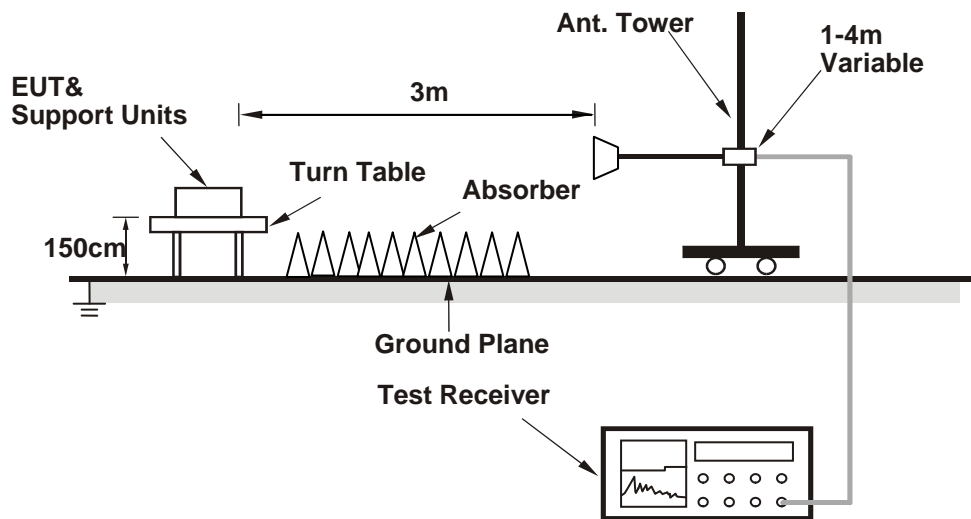

For the actual test configuration, please refer to the attached file (Test Setup Photo).

4.1.6 EUT Operating Conditions

- a. Connected EUT with PC via Convertible Board through mini USB cable.
- b. Set the EUT under transmission condition continuously at specific channel frequency.

4.1.7 Test Results

Above 1GHz worst-case data:

CHANNEL	TX Channel 0	DETECTOR FUNCTION	Peak (PK)
FREQUENCY RANGE	1GHz ~ 25GHz		Average (AV)

ANTENNA POLARITY & TEST DISTANCE: HORIZONTAL AT 3 M								
NO.	FREQ. (MHz)	EMISSION LEVEL (dBuV/m)	LIMIT (dBuV/m)	MARGIN (dB)	ANTENNA HEIGHT (m)	TABLE ANGLE (Degree)	RAW VALUE (dBuV)	CORRECTION FACTOR (dB/m)
1	2390.00	54.7 PK	74.0	-19.3	2.03 H	46	22.5	32.2
2	2390.00	45.2 AV	54.0	-8.8	2.03 H	46	13.0	32.2
3	*2402.00	97.6 PK			1.22 H	256	65.4	32.2
4	*2402.00	96.0 AV			1.22 H	256	63.8	32.2
5	4804.00	42.3 PK	74.0	-31.7	1.81 H	155	41.2	1.1
6	4804.00	31.6 AV	54.0	-22.4	1.81 H	155	30.5	1.1
ANTENNA POLARITY & TEST DISTANCE: VERTICAL AT 3 M								
NO.	FREQ. (MHz)	EMISSION LEVEL (dBuV/m)	LIMIT (dBuV/m)	MARGIN (dB)	ANTENNA HEIGHT (m)	TABLE ANGLE (Degree)	RAW VALUE (dBuV)	CORRECTION FACTOR (dB/m)
1	2390.00	54.9 PK	74.0	-19.1	2.08 V	280	22.7	32.2
2	2390.00	45.3 AV	54.0	-8.7	2.08 V	280	13.1	32.2
3	*2402.00	103.8 PK			2.04 V	282	71.6	32.2
4	*2402.00	102.8 AV			2.04 V	282	70.6	32.2
5	4804.00	42.7 PK	74.0	-31.3	1.70 V	153	41.6	1.1
6	4804.00	31.9 AV	54.0	-22.1	1.70 V	153	30.8	1.1

Remarks:

1. Emission Level(dBuV/m) = Raw Value(dBuV) + Correction Factor(dB/m)
2. Correction Factor(dB/m) = Antenna Factor(dB/m) + Cable Factor(dB) – Pre-Amplifier Factor(dB)
3. The other emission levels were very low against the limit.
4. Margin value = Emission Level – Limit value
5. " * ": Fundamental frequency.

CHANNEL	TX Channel 19	DETECTOR FUNCTION	Peak (PK)
FREQUENCY RANGE	1GHz ~ 25GHz		Average (AV)

ANTENNA POLARITY & TEST DISTANCE: HORIZONTAL AT 3 M

NO.	FREQ. (MHz)	EMISSION LEVEL (dBuV/m)	LIMIT (dBuV/m)	MARGIN (dB)	ANTENNA HEIGHT (m)	TABLE ANGLE (Degree)	RAW VALUE (dBuV)	CORRECTION FACTOR (dB/m)
1	*2440.00	97.8 PK			1.23 H	255	65.8	32.0
2	*2440.00	96.2 AV			1.23 H	255	64.2	32.0
3	4880.00	42.6 PK	74.0	-31.4	1.79 H	157	41.3	1.3
4	4880.00	31.9 AV	54.0	-22.1	1.79 H	157	30.6	1.3

ANTENNA POLARITY & TEST DISTANCE: VERTICAL AT 3 M

NO.	FREQ. (MHz)	EMISSION LEVEL (dBuV/m)	LIMIT (dBuV/m)	MARGIN (dB)	ANTENNA HEIGHT (m)	TABLE ANGLE (Degree)	RAW VALUE (dBuV)	CORRECTION FACTOR (dB/m)
1	*2440.00	103.2 PK			1.53 V	283	71.2	32.0
2	*2440.00	102.3 AV			1.53 V	283	70.3	32.0
3	4880.00	42.5 PK	74.0	-31.5	1.77 V	150	41.2	1.3
4	4880.00	31.8 AV	54.0	-22.2	1.77 V	150	30.5	1.3

Remarks:

1. Emission Level(dBuV/m) = Raw Value(dBuV) + Correction Factor(dB/m)
2. Correction Factor(dB/m) = Antenna Factor(dB/m) + Cable Factor(dB) – Pre-Amplifier Factor(dB)
3. The other emission levels were very low against the limit.
4. Margin value = Emission Level – Limit value
5. " * ": Fundamental frequency.

CHANNEL	TX Channel 39	DETECTOR FUNCTION	Peak (PK)
FREQUENCY RANGE	1GHz ~ 25GHz		Average (AV)

ANTENNA POLARITY & TEST DISTANCE: HORIZONTAL AT 3 M

NO.	FREQ. (MHz)	EMISSION LEVEL (dBuV/m)	LIMIT (dBuV/m)	MARGIN (dB)	ANTENNA HEIGHT (m)	TABLE ANGLE (Degree)	RAW VALUE (dBuV)	CORRECTION FACTOR (dB/m)
1	*2480.00	97.6 PK			1.23 H	251	65.5	32.1
2	*2480.00	95.9 AV			1.23 H	251	63.8	32.1
3	2483.50	57.1 PK	74.0	-16.9	1.28 H	255	25.0	32.1
4	2483.50	46.1 AV	54.0	-7.9	1.28 H	255	14.0	32.1
5	4960.00	43.7 PK	74.0	-30.3	2.34 H	79	41.8	1.9
6	4960.00	33.1 AV	54.0	-20.9	2.34 H	79	31.2	1.9

ANTENNA POLARITY & TEST DISTANCE: VERTICAL AT 3 M

NO.	FREQ. (MHz)	EMISSION LEVEL (dBuV/m)	LIMIT (dBuV/m)	MARGIN (dB)	ANTENNA HEIGHT (m)	TABLE ANGLE (Degree)	RAW VALUE (dBuV)	CORRECTION FACTOR (dB/m)
1	*2480.00	104.1 PK			1.88 V	262	72.0	32.1
2	*2480.00	102.3 AV			1.88 V	262	70.2	32.1
3	2483.50	57.2 PK	74.0	-16.8	1.82 V	269	25.1	32.1
4	2483.50	47.6 AV	54.0	-6.4	1.82 V	269	15.5	32.1
5	4960.00	43.6 PK	74.0	-30.4	1.79 V	144	41.7	1.9
6	4960.00	32.8 AV	54.0	-21.2	1.79 V	144	30.9	1.9

Remarks:

1. Emission Level(dBuV/m) = Raw Value(dBuV) + Correction Factor(dB/m)
2. Correction Factor(dB/m) = Antenna Factor(dB/m) + Cable Factor(dB) – Pre-Amplifier Factor(dB)
3. The other emission levels were very low against the limit.
4. Margin value = Emission Level – Limit value
5. " * ": Fundamental frequency.

Below 1GHz worst-case data:

CHANNEL	TX Channel 39	DETECTOR FUNCTION	Quasi-Peak (QP)
FREQUENCY RANGE	9kHz ~ 1GHz		

ANTENNA POLARITY & TEST DISTANCE: HORIZONTAL AT 3 M								
NO.	FREQ. (MHz)	EMISSION LEVEL (dBuV/m)	LIMIT (dBuV/m)	MARGIN (dB)	ANTENNA HEIGHT (m)	TABLE ANGLE (Degree)	RAW VALUE (dBuV)	CORRECTION FACTOR (dB/m)
1	30.00	33.8 QP	40.0	-6.2	1.00 H	79	43.9	-10.1
2	197.81	38.8 QP	43.5	-4.7	1.50 H	237	49.7	-10.9
3	266.68	39.8 QP	46.0	-6.2	1.25 H	105	48.0	-8.2
4	320.03	39.1 QP	46.0	-6.9	1.25 H	228	45.6	-6.5
5	742.95	40.1 QP	46.0	-5.9	1.00 H	290	38.6	1.5
6	852.56	43.4 QP	46.0	-2.6	1.50 H	10	40.2	3.2

ANTENNA POLARITY & TEST DISTANCE: VERTICAL AT 3 M								
NO.	FREQ. (MHz)	EMISSION LEVEL (dBuV/m)	LIMIT (dBuV/m)	MARGIN (dB)	ANTENNA HEIGHT (m)	TABLE ANGLE (Degree)	RAW VALUE (dBuV)	CORRECTION FACTOR (dB/m)
1	71.71	36.8 QP	40.0	-3.2	1.00 V	2	47.4	-10.6
2	315.18	42.2 QP	46.0	-3.8	1.25 V	123	48.9	-6.7
3	389.87	39.2 QP	46.0	-6.8	1.50 V	106	44.6	-5.4
4	486.87	40.5 QP	46.0	-5.5	1.50 V	89	44.2	-3.7
5	742.95	38.4 QP	46.0	-7.6	1.00 V	287	36.9	1.5
6	960.23	38.6 QP	54.0	-15.4	2.00 V	280	33.4	5.2

Remarks:

1. Emission Level(dBuV/m) = Raw Value(dBuV) + Correction Factor(dB/m)
2. Correction Factor(dB/m) = Antenna Factor(dB/m) + Cable Factor(dB) – Pre-Amplifier Factor(dB)
3. The other emission levels were very low against the limit of frequency range 30MHz ~ 1000MHz.
4. Margin value = Emission Level – Limit value
5. The emission levels were very low against the limit of frequency range 9kHz ~ 30MHz.

4.2 Conducted Emission Measurement

4.2.1 Limits of Conducted Emission Measurement

Frequency (MHz)	Conducted Limit (dBuV)	
	Quasi-peak	Average
0.15 - 0.5	66 - 56	56 - 46
0.50 - 5.0	56	46
5.0 - 30.0	60	50

Note: 1. The lower limit shall apply at the transition frequencies.

2. The limit decreases in line with the logarithm of the frequency in the range of 0.15 to 0.50MHz.

4.2.2 Test Instruments

Description & Manufacturer	Model No.	Serial No.	Cal. Date	Cal. Due
Test Receiver ROHDE & SCHWARZ	ESCI	100613	Nov. 23, 2017	Nov. 22, 2018
RF signal cable (with 10dB PAD) Woken	5D-FB	Cable-cond1-01	Sep. 05, 2017	Sep. 04, 2018
LISN ROHDE & SCHWARZ (EUT)	ESH3-Z5	835239/001	Mar. 06, 2018	Mar. 05, 2019
LISN ROHDE & SCHWARZ (Peripheral)	ESH3-Z5	100311	Aug. 15, 2017	Aug. 14, 2018
Software ADT	BV ADT_Cond_ V7.3.7.4	NA	NA	NA

Note: 1. The calibration interval of the above test instruments is 12 months and the calibrations are traceable to NML/ROC and NIST/USA.

2. The test was performed in HwaYa Shielded Room 1.

3. The VCCI Site Registration No. is C-2040.

4.2.3 Test Procedures

- The EUT was placed 0.4 meters from the conducting wall of the shielded room with EUT being connected to the power mains through a line impedance stabilization network (LISN). Other support units were connected to the power mains through another LISN. The two LISNs provide 50 ohm/ 50uH of coupling impedance for the measuring instrument.
- Both lines of the power mains connected to the EUT were checked for maximum conducted interference.
- The frequency range from 150kHz to 30MHz was searched. Emission levels under (Limit - 20dB) was not recorded.

Note: The resolution bandwidth and video bandwidth of test receiver is 9kHz for quasi-peak detection (QP) and average detection (AV) at frequency 0.15MHz-30MHz.

4.2.4 Deviation from Test Standard

No deviation.

4.2.5 Test Setup

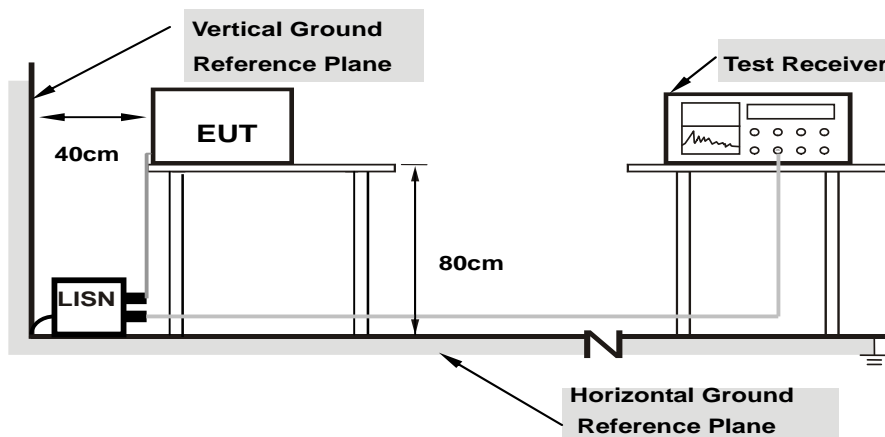

Note: 1.Support units were connected to second LISN.

For the actual test configuration, please refer to the attached file (Test Setup Photo).

4.2.6 EUT Operating Conditions

Same as 4.1.6.

4.2.7 Test Results

Phase	Line (L)	Detector Function	Quasi-Peak (QP) / Average (AV)
-------	----------	-------------------	--------------------------------

No	Freq. [MHz]	Corr. Factor (dB)	Reading Value [dB (uV)]		Emission Level [dB (uV)]		Limit [dB (uV)]		Margin (dB)	
			Q.P.	AV.	Q.P.	AV.	Q.P.	AV.	Q.P.	AV.
			1	0.15000	10.16	33.68	11.26	43.84	21.42	66.00
2	0.20201	10.15	35.62	32.03	45.77	42.18	63.53	53.53	-17.76	-11.35
3	0.33856	10.19	29.19	23.13	39.38	33.32	59.24	49.24	-19.86	-15.92
4	2.98200	10.29	18.77	3.76	29.06	14.05	56.00	46.00	-26.94	-31.95
5	12.59000	10.81	33.05	26.97	43.86	37.78	60.00	50.00	-16.14	-12.22
6	29.10600	11.42	25.86	17.94	37.28	29.36	60.00	50.00	-22.72	-20.64

Remarks:

1. Q.P. and AV. are abbreviations of quasi-peak and average individually.
2. The emission levels of other frequencies were very low against the limit.
3. Margin value = Emission level - Limit value
4. Correction factor = Insertion loss + Cable loss
5. Emission Level = Correction Factor + Reading Value.

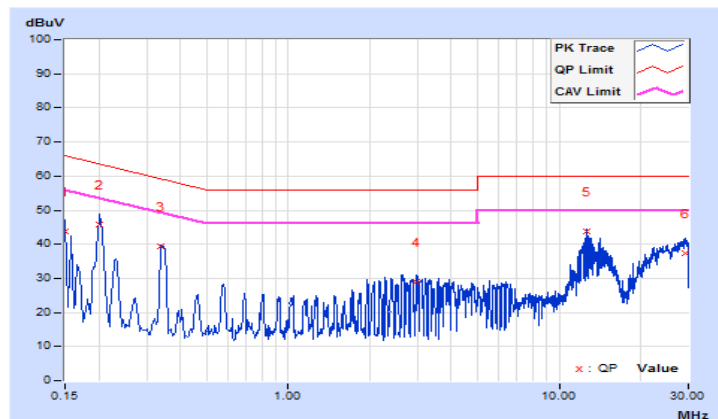

Phase	Neutral (N)	Detector Function	Quasi-Peak (QP) / Average (AV)
-------	-------------	-------------------	--------------------------------

No	Freq. [MHz]	Corr. Factor (dB)	Reading Value [dB (uV)]		Emission Level [dB (uV)]		Limit [dB (uV)]		Margin (dB)	
			Q.P.	AV.	Q.P.	AV.	Q.P.	AV.	Q.P.	AV.
			1	0.15000	10.14	33.54	11.48	43.68	21.62	66.00
2	0.20254	10.16	35.74	32.12	45.90	42.28	63.51	53.51	-17.61	-11.23
3	0.34214	10.19	29.61	27.02	39.80	37.21	59.15	49.15	-19.35	-11.94
4	2.96600	10.28	18.58	6.41	28.86	16.69	56.00	46.00	-27.14	-29.31
5	12.65800	10.69	32.60	26.62	43.29	37.31	60.00	50.00	-16.71	-12.69
6	29.78600	11.13	23.77	16.44	34.90	27.57	60.00	50.00	-25.10	-22.43

Remarks:

1. Q.P. and AV. are abbreviations of quasi-peak and average individually.
2. The emission levels of other frequencies were very low against the limit.
3. Margin value = Emission level - Limit value
4. Correction factor = Insertion loss + Cable loss
5. Emission Level = Correction Factor + Reading Value.

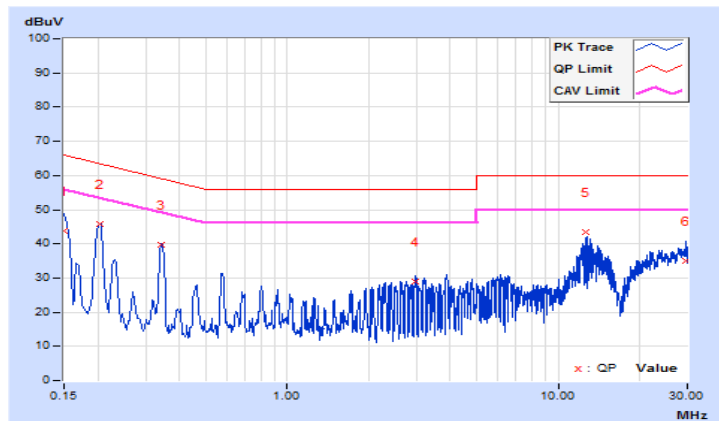

4.3 6dB Bandwidth Measurement

4.3.1 Limits of 6dB Bandwidth Measurement

The minimum of 6dB Bandwidth Measurement is 0.5 MHz.

4.3.2 Test Setup

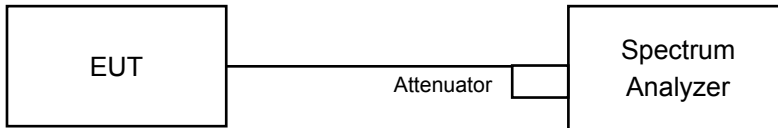

4.3.3 Test Instruments

Refer to section 4.1.2 to get information of above instrument.

4.3.4 Test Procedure

- Set resolution bandwidth (RBW) = 100kHz.
- Set the video bandwidth (VBW) $\geq 3 \times$ RBW, Detector = peak.
- Trace mode = max hold.
- Sweep = auto couple.
- Measure the maximum width of the emission that is constrained by the frequencies associated with the two amplitude points (upper and lower) that are attenuated by 6 dB relative to the maximum level measured in the fundamental emission.

4.3.5 Deviation from Test Standard

No deviation.

4.3.6 EUT Operating Conditions

The software provided by client to enable the EUT under transmission condition continuously at lowest, middle and highest channel frequencies individually.

4.3.7 Test Result

Channel	Frequency (MHz)	6dB Bandwidth (kHz)	Minimum Limit (MHz)	Pass / Fail
0	2402	718.08	0.5	Pass
19	2440	715.68	0.5	Pass
39	2480	715.16	0.5	Pass

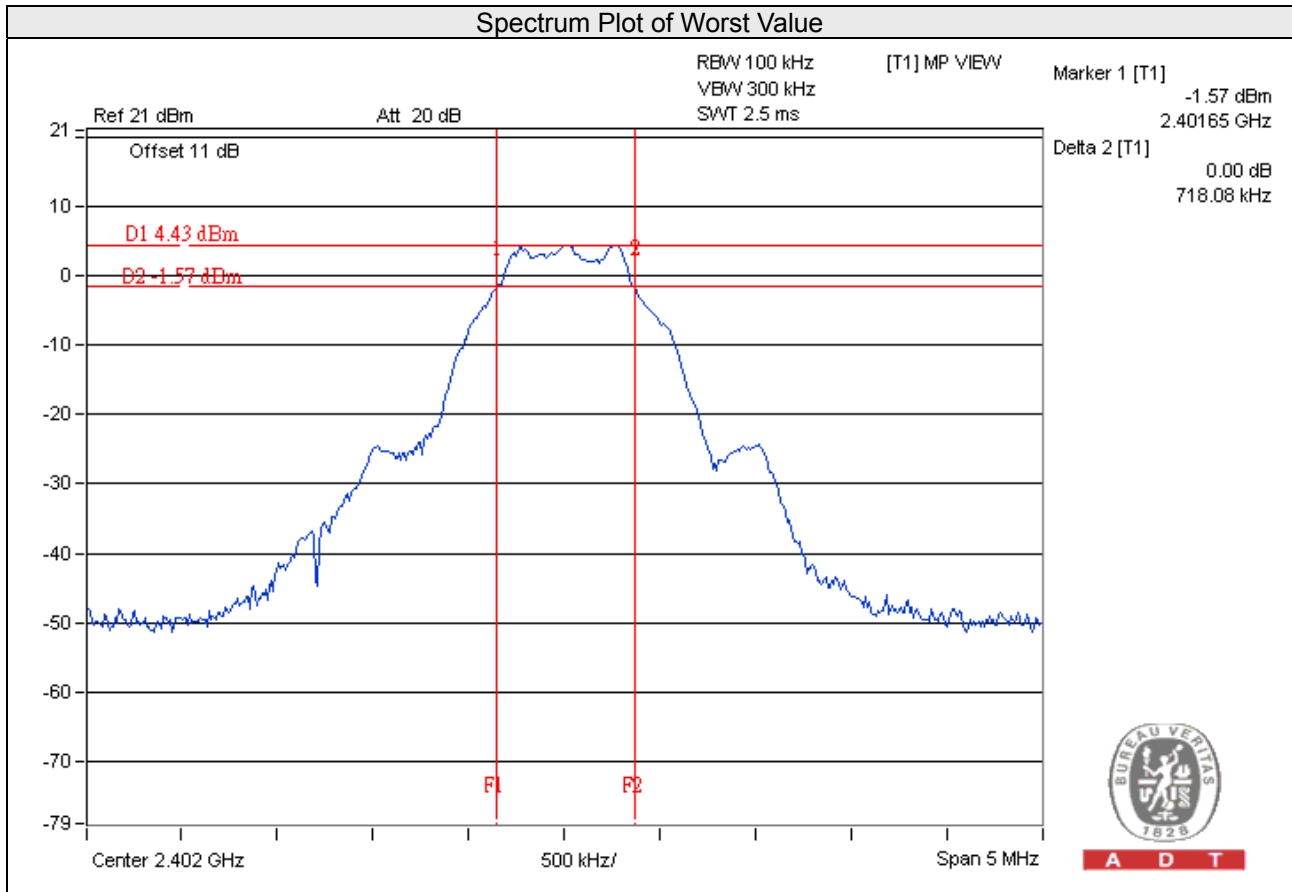

4.4 Conducted Output Power Measurement

4.4.1 Limits of Conducted Output Power Measurement

For systems using digital modulation in the 2400–2483.5 MHz bands: 1 Watt (30dBm)

4.4.2 Test Setup

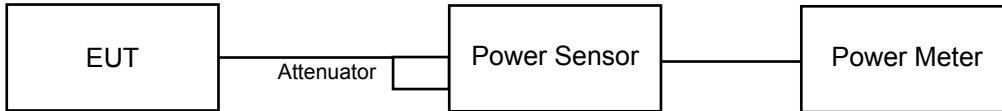

4.4.3 Test Instruments

Refer to section 4.1.2 to get information of above instrument.

4.4.4 Deviation from Test Standard

No deviation.

4.4.5 Test Procedures

A peak power sensor was used on the output port of the EUT. A power meter was used to read the response of the peak power sensor. Record the power level.

4.4.6 EUT Operating Conditions

Same as item 4.3.6.

4.4.7 Test Results

Channel	Frequency (MHz)	Peak Power (mW)	Peak Power (dBm)	Limit (dBm)	Pass/Fail
0	2402	3.828	5.83	30	Pass
19	2440	4.753	6.77	30	Pass
39	2480	5.309	7.25	30	Pass

4.5 Power Spectral Density Measurement

4.5.1 Limits of Power Spectral Density Measurement

The Maximum of Power Spectral Density Measurement is 8dBm.

4.5.2 Test Setup

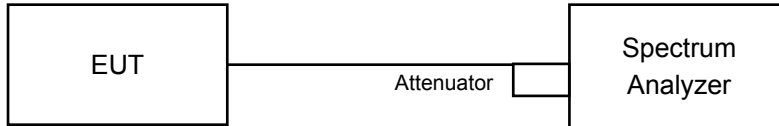

4.5.3 Test Instruments

Refer to section 4.1.2 to get information of above instrument.

4.5.4 Test Procedure

- a. Set analyzer center frequency to DTS channel center frequency.
- b. Set the span to 1.5 times the DTS bandwidth.
- c. Set the RBW to: $3 \text{ kHz} \leq \text{RBW} \leq 100 \text{ kHz}$.
- d. Set the VBW $\geq 3 \times \text{RBW}$.
- e. Detector = peak.
- f. Sweep time = auto couple.
- g. Trace mode = max hold.
- h. Allow trace to fully stabilize.
- i. Use the peak marker function to determine the maximum amplitude level within the RBW.

4.5.5 Deviation from Test Standard

No deviation.

4.5.6 EUT Operating Condition

Same as item 4.3.6

4.5.7 Test Results

Channel	Frequency (MHz)	PSD (dBm/3kHz)	Limit (dBm/3kHz)	Pass / Fail
0	2402	-9.31	8.00	Pass
19	2440	-8.34	8.00	Pass
39	2480	-8.05	8.00	Pass

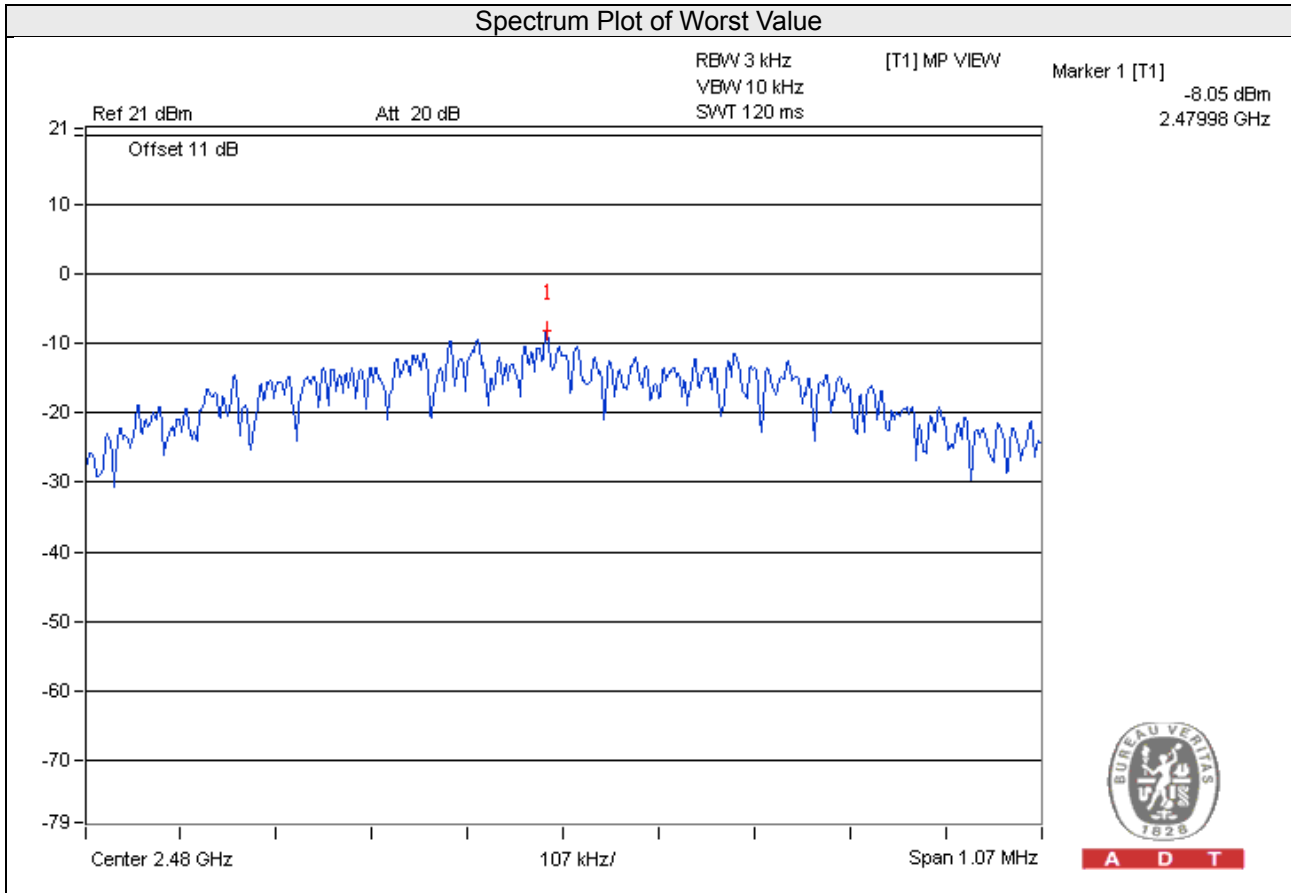

4.6 Conducted Out of Band Emission Measurement

4.6.1 Limits of Conducted Out of Band Emission Measurement

Below -20dB of the highest emission level of operating band (in 100kHz Resolution Bandwidth).

4.6.2 Test Setup

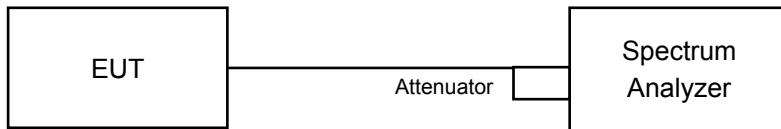

4.6.3 Test Instruments

Refer to section 4.1.2 to get information of above instrument.

4.6.4 Test Procedure

MEASUREMENT PROCEDURE REF

- Set the RBW = 100 kHz.
- Set the VBW \geq 300 kHz.
- Detector = peak.
- Sweep time = auto couple.
- Trace mode = max hold.
- Allow trace to fully stabilize.
- Use the peak marker function to determine the maximum power level in any 100 kHz band segment within the fundamental EBW.

MEASUREMENT PROCEDURE OOB

- Set RBW = 100 kHz.
- Set VBW \geq 300 kHz.
- Detector = peak.
- Sweep = auto couple.
- Trace Mode = max hold.
- Allow trace to fully stabilize.
- Use the peak marker function to determine the maximum amplitude level.

4.6.5 Deviation from Test Standard

No deviation.

4.6.6 EUT Operating Condition

Same as item 4.3.6

4.6.7 Test Results

The conducted emission test is performed on each TX port of operating mode without summing or adding 10log (N) since the limit is relative emission limit.

The spectrum plots are attached on the following pages. D1 line indicates the highest level, and D2 line indicates the 20dB offset below D1. It shows compliance with the requirement.

CH 0

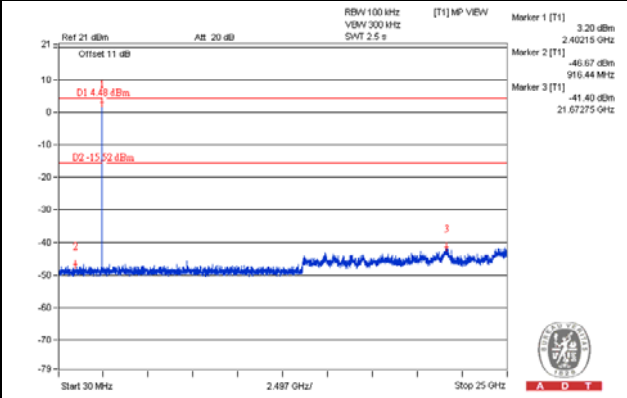
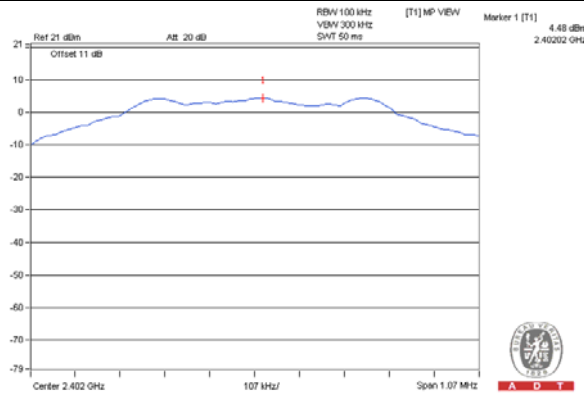

CH 19

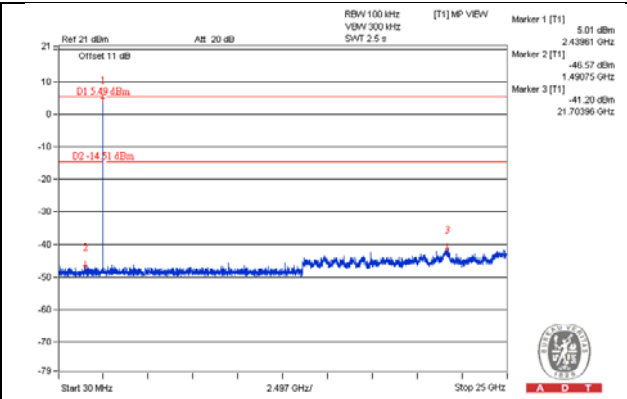
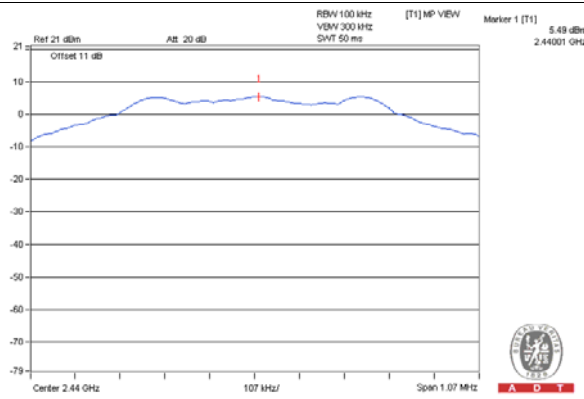

CH 39

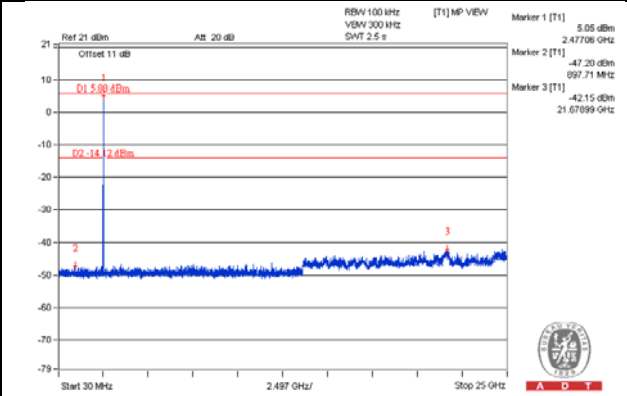
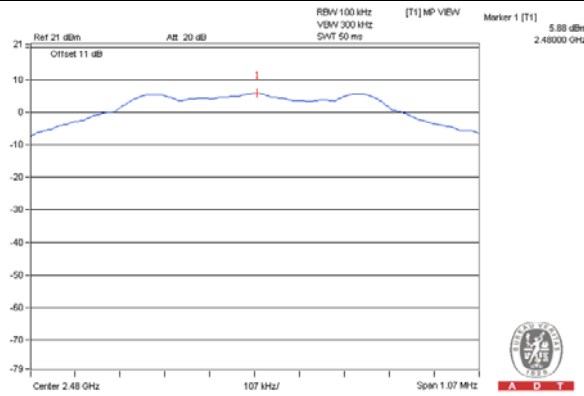

CH 0 Band edge

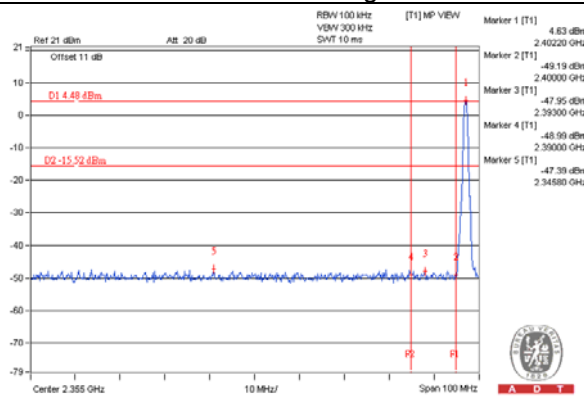

CH 39 Band edge

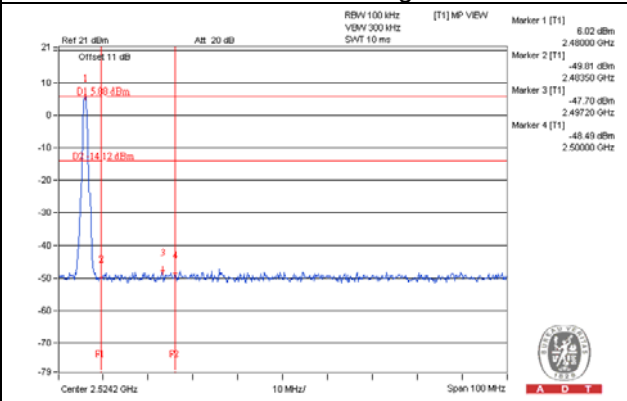

5 Pictures of Test Arrangements

Please refer to the attached file (Test Setup Photo).

Appendix – Information on the Testing Laboratories

We, Bureau Veritas Consumer Products Services (H.K.) Ltd., Taoyuan Branch, were founded in 1988 to provide our best service in EMC, Radio, Telecom and Safety consultation. Our laboratories are FCC recognized accredited test firms and accredited and approved according to ISO/IEC 17025.

If you have any comments, please feel free to contact us at the following:

Linko EMC/RF Lab

Tel: 886-2-26052180

Fax: 886-2-26051924

Hsin Chu EMC/RF/Telecom Lab

Tel: 886-3-6668565

Fax: 886-3-6668323

Hwa Ya EMC/RF/Safety Lab

Tel: 886-3-3183232

Fax: 886-3-3270892

Email: service.adt@tw.bureauveritas.com

Web Site: www.bureauveritas-adt.com

The address and road map of all our labs can be found in our web site also.

--- END ---