

FCC Test Report

Report No.: RF150821C10I-1

FCC ID: ZQ6-AP6356SDXX

Test Model: AP6356SD, AP6356SDPB_I

Series Model: AP6356SDPB (Refer to item 3.1 for more details)

Received Date: Aug. 21, 2015

Test Date: Nov. 30, 2015 (For test mode A)

Jun. 04 ~ Jun. 06, 2018 (For test mode B)

Issued Date: Jun. 13, 2018

Applicant: AMPAK Technology Inc.

Address: 3F, No.1, Jen Ai Road, Hsinchu Industrial Park, Hsinchu, Taiwan, 30352

Issued By: Bureau Veritas Consumer Products Services (H.K.) Ltd., Taoyuan Branch

Lab Address: No. 47-2, 14th Ling, Chia Pau Vil., Lin Kou Dist., New Taipei City, Taiwan (R.O.C.)

Test Location: No. 19, Hwa Ya 2nd Rd., Wen Hwa Vil., Kwei Shan Dist., Taoyuan City 33383, TAIWAN (R.O.C.)

**FCC Registration /
Designation Number:** 788550 / TW0003



This report is for your exclusive use. Any copying or replication of this report to or for any other person or entity, or use of our name or trademark, is permitted only with our prior written permission. This report sets forth our findings solely with respect to the test samples identified herein. The results set forth in this report are not indicative or representative of the quality or characteristics of the lot from which a test sample was taken or any similar or identical product unless specifically and expressly noted. Our report includes all of the tests requested by you and the results thereof based upon the information that you provided to us. You have 60 days from date of issuance of this report to notify us of any material error or omission caused by our negligence, provided, however, that such notice shall be in writing and shall specifically address the issue you wish to raise. A failure to raise such issue within the prescribed time shall constitute your unqualified acceptance of the completeness of this report, the tests conducted and the correctness of the report contents. Unless specific mention, the uncertainty of measurement has been explicitly taken into account to declare the compliance or non-compliance to the specification. This report should not be used by the client to claim product certification, approval, or endorsement by TAF or any government agencies.

Table of Contents

Release Control Record	4
1 Certificate of Conformity	5
2 Summary of Test Results	6
2.1 Measurement Uncertainty.....	6
2.2 Modification Record.....	6
3 General Information	7
3.1 General Description of EUT.....	7
3.2 Description of Test Modes.....	9
3.2.1 Test Mode Applicability and Tested Channel Detail.....	11
3.3 Duty Cycle of Test Signal.....	13
3.4 Description of Support Units.....	15
3.4.1 Configuration of System under Test.....	15
3.5 General Description of Applied Standards.....	15
4 Test Types and Results	16
4.1 Radiated Emission and Bandedge Measurement.....	16
4.1.1 Limits of Radiated Emission and Bandedge Measurement.....	16
4.1.2 Test Instruments.....	17
4.1.3 Test Procedures.....	19
4.1.4 Deviation from Test Standard.....	19
4.1.5 Test Setup.....	20
4.1.6 EUT Operating Conditions.....	21
4.1.7 Test Results.....	22
4.2 Conducted Emission Measurement.....	60
4.2.1 Limits of Conducted Emission Measurement.....	60
4.2.2 Test Instruments.....	60
4.2.3 Test Procedures.....	61
4.2.4 Deviation from Test Standard.....	61
4.2.5 Test Setup.....	61
4.2.6 EUT Operating Conditions.....	61
4.2.7 Test Results.....	62
4.3 Transmit Power Measurement.....	64
4.3.1 Limits of Transmit Power Measurement.....	64
4.3.2 Test Setup.....	64
4.3.3 Test Instruments.....	64
4.3.4 Test Procedure.....	65
4.3.5 Deviation from Test Standard.....	65
4.3.6 EUT Operating Conditions.....	65
4.3.7 Test Result.....	66
4.4 Occupied Bandwidth Measurement.....	71
4.4.1 Test Setup.....	71
4.4.2 Test Instruments.....	71
4.4.3 Test Procedure.....	71
4.4.4 Test Result.....	72
4.5 Peak Power Spectral Density Measurement.....	76
4.5.1 Limits of Peak Power Spectral Density Measurement.....	76
4.5.2 Test Setup.....	76
4.5.3 Test Instruments.....	76
4.5.4 Test Procedures.....	76
4.5.5 Deviation from Test Standard.....	77
4.5.6 EUT Operating Conditions.....	77
4.5.7 Test Results.....	78
4.6 Frequency Stability.....	83
4.6.1 Limits of Frequency Stability Measurement.....	83

4.6.2	Test Setup.....	83
4.6.3	Test Instruments	83
4.6.4	Test Procedure	83
4.6.5	Deviation from Test Standard	83
4.6.6	EUT Operating Condition	83
4.6.7	Test Results	84
4.7	6dB Bandwidth Measurement.....	85
4.7.1	Limits of 6dB Bandwidth Measurement.....	85
4.7.2	Test Setup.....	85
4.7.3	Test Instruments	85
4.7.4	Test Procedure	85
4.7.5	Deviation from Test Standard	85
4.7.6	EUT Operating Condition	85
4.7.7	Test Results	86
5	Pictures of Test Arrangements.....	88
	Annex A- Radiated Out of Band Emission (OOBE) Measurement (For U-NII-3 band).....	89
	Appendix – Information on the Testing Laboratories	92

Release Control Record

Issue No.	Description	Date Issued
RF150821C10I-1	Original release	Jun. 13, 2018

1 Certificate of Conformity

Product: WLAN module for 802.11abgn(2x2) + 11ac + BT4.1

Brand: Ampak

Test Model: AP6356SD, AP6356SDPB_I

Series Model: AP6356SDPB (Refer to item 3.1 for more details)

Sample Status: Engineering Sample

Applicant: AMPAK Technology Inc.

Test Date: Nov. 30, 2015 (For test mode A)

Jun. 04 ~ Jun. 06, 2018 (For test mode B)

Standards: 47 CFR FCC Part 15, Subpart E (Section 15.407)

ANSI C63.10:2013

The above equipment has been tested by **Bureau Veritas Consumer Products Services (H.K.) Ltd., Taoyuan Branch**, and found compliance with the requirement of the above standards. The test record, data evaluation & Equipment Under Test (EUT) configurations represented herein are true and accurate accounts of the measurements of the sample's RF characteristics under the conditions specified in this report.

Prepared by : Celine Chou , **Date:** Jun. 13, 2018
Celine Chou / Specialist

Approved by : Bruce Chen , **Date:** Jun. 13, 2018
Bruce Chen / Project Engineer

2 Summary of Test Results

47 CFR FCC Part 15, Subpart E (Section 15.407)			
FCC Clause	Test Item	Result	Remarks
15.407(b)(6)	AC Power Conducted Emissions	Pass	Meet the requirement of limit. Minimum passing margin is -11.37dB at 0.20201MHz.
15.407(b)(1/2/3/4(i/ii)/6)	Radiated Emissions & Band Edge Measurement	Pass	Meet the requirement of limit. Minimum passing margin is -2.6dB at 71.71MHz.
15.407(a)(1/2/3)	Max Average Transmit Power	Pass	Meet the requirement of limit.
---	Occupied Bandwidth Measurement	-	Reference only.
15.407(a)(1/2/3)	Peak Power Spectral Density	Pass	Meet the requirement of limit.
15.407(e)	6dB bandwidth	Pass	Meet the requirement of limit. (U-NII-3 Band only)
15.407(g)	Frequency Stability	Pass	Meet the requirement of limit.
15.203	Antenna Requirement	Pass	Antenna connectors are IPEX and RP-SMA (M) not a standard connector.

*For U-NII-3 band compliance with rule part 15.407(b)(4)(i), the OOB test plots were recorded in Annex A.

2.1 Measurement Uncertainty

Where relevant, the following measurement uncertainty levels have been estimated for tests performed on the EUT as specified in CISPR 16-4-2:

Measurement	Frequency	Expanded Uncertainty (k=2) (±)
Conducted Emissions at mains ports	150kHz ~ 30MHz	2.94 dB
Radiated Emissions up to 1 GHz	30MHz ~ 200MHz	3.59 dB
	200MHz ~ 1000MHz	3.60 dB
Radiated Emissions above 1 GHz	1GHz ~ 18GHz	2.29 dB
	18GHz ~ 40GHz	2.29 dB

2.2 Modification Record

There were no modifications required for compliance.

3 General Information

3.1 General Description of EUT

Product	WLAN module for 802.11abgn(2x2) + 11ac + BT4.1
Brand	Ampak
Test Model	AP6356SD, AP6356SDPB_I
Series Model	AP6356SDPB
Model Difference	Refer to note
Status of EUT	Engineering Sample
Power Supply Rating	5Vdc (host equipment)
Modulation Type	256QAM, 64QAM, 16QAM, QPSK, BPSK for OFDM
Modulation Technology	OFDM
Transfer Rate	802.11a: 54.0/ 48.0/ 36.0/ 24.0/ 18.0/ 12.0/ 9.0/ 6.0Mbps 802.11n: up to 150Mbps 802.11ac: up to 866.7Mbps
Operating Frequency	5180 ~ 5240MHz, 5260 ~ 5320MHz, 5500 ~ 5700MHz, 5745 ~ 5825MHz
Number of Channel	5180 ~ 5240MHz: 802.11a, 802.11n (HT20), 802.11ac (VHT20): 4 802.11n (HT40), 802.11ac (VHT40): 2 802.11ac (VHT80): 1 5260 ~ 5320MHz: 802.11a, 802.11n (HT20), 802.11ac (VHT20): 4 802.11n (HT40), 802.11ac (VHT40): 2 802.11ac (VHT80): 1 5500 ~ 5700MHz: 802.11a, 802.11n (HT20), 802.11ac (VHT20): 11, 802.11n (HT40), 802.11ac (VHT40): 5, 802.11ac (VHT80): 2 5745 ~ 5825MHz: 802.11a, 802.11n (HT20), 802.11ac (VHT20): 5 802.11n (HT40), 802.11ac (VHT40) : 2 802.11ac (VHT80): 1
Output Power	5180 ~ 5240MHz: 17.490mW 5260 ~ 5320MHz: 19.232mW 5500 ~ 5700MHz: 18.774mW 5745 ~ 5825MHz: 18.394mW
Antenna Type	Refer to note
Antenna Connector	Refer to note
Accessory Device	NA
Data Cable Supplied	NA

Note:

1. This report is prepared for FCC class II permissive change, the differences compared with the original report (BV CPS report no.: RF150821C10G-1) are adding one model name and two antennas. After evaluation, only the radiated emission and power line conducted emission had been an addendum test, the antenna port conducted test data was copy from original report, due to the output power of EUT is not change.
2. The following models are provided to this EUT. (New model name is marked in boldface)

Brand	Model	Description	
		Fixture	Crystal Temperature Operating Range
Ampak	AP6356SD	-	-10~65°C
	AP6356SDPB	AP12356	-10~65°C
	AP6356SDPB_I	AP12356_I	-40~85°C

* The model of the AP6356SD and AP6356SDPB_I was chosen for final test.

3. The EUT incorporates a MIMO function. Physically, the EUT provides two completed transmitters and two receivers.

Modulation Mode	TX Function
802.11a	2TX
802.11n (HT20)	2TX
802.11n (HT40)	2TX
802.11ac (VHT80)	2TX

* The modulation and bandwidth are similar for 802.11n mode for 20MHz/40MHz and 802.11ac mode for 20MHz/40MHz, therefore investigated worst case to representative mode in test report. (Final test mode refer section 3.2.1)

4. The following antennas were provided to the EUT. (New antennas are marked in boldface)

No.	Type	Connector	Gain(dBi)	
			2.4G	5G
1	PIFA	I-PEX	3.5	5.5
2	Dipole	RP-SMA (M)	3.8	5.5
3	Dipole	RP-SMA (M)	3	3

3.2 Description of Test Modes

For 5180 ~ 5240MHz

4 channels are provided for 802.11a, 802.11n (HT20), 802.11ac (VHT20):

Channel	Frequency	Channel	Frequency
36	5180 MHz	44	5220 MHz
40	5200 MHz	48	5240 MHz

2 channels are provided for 802.11n (HT40), 802.11ac (VHT40):

Channel	Frequency	Channel	Frequency
38	5190 MHz	46	5230 MHz

1 channel is provided for 802.11ac (VHT80):

Channel	Frequency
42	5210MHz

For 5260 ~ 5320MHz

4 channels are provided for 802.11a, 802.11n (HT20), 802.11ac (VHT20):

Channel	Frequency	Channel	Frequency
52	5260 MHz	60	5300 MHz
56	5280 MHz	64	5320 MHz

2 channels are provided for 802.11n (HT40), 802.11ac (VHT40):

Channel	Frequency	Channel	Frequency
54	5270 MHz	62	5310 MHz

1 channel is provided for 802.11ac (VHT80):

Channel	Frequency
58	5290 MHz

For 5500 ~ 5700MHz

11 channels are provided for 802.11a, 802.11n (HT20), 802.11ac (VHT20):

Channel	Frequency	Channel	Frequency
100	5500 MHz	124	5620 MHz
104	5520 MHz	128	5640 MHz
108	5540 MHz	132	5660 MHz
112	5560 MHz	136	5680 MHz
116	5580 MHz	140	5700 MHz
120	5600 MHz		

5 channels are provided for 802.11n (HT40), 802.11ac (VHT40):

Channel	Frequency	Channel	Frequency
102	5510 MHz	126	5630 MHz
110	5550 MHz	134	5670 MHz
118	5590 MHz		

2 channels are provided for 802.11ac (VHT80):

Channel	Frequency	Channel	Frequency
106	5530 MHz	122	5610 MHz

For 5745 ~ 5825MHz:

5 channels are provided for 802.11a, 802.11n (HT20), 802.11ac (VHT20):

Channel	Frequency	Channel	Frequency
149	5745MHz	161	5805MHz
153	5765MHz	165	5825MHz
157	5785MHz		

2 channels are provided for 802.11n (HT40), 802.11ac (VHT40):

Channel	Frequency	Channel	Frequency
151	5755MHz	159	5795MHz

1 channel is provided for 802.11ac (VHT80):

Channel	Frequency
155	5775MHz

3.2.1 Test Mode Applicability and Tested Channel Detail

EUT Configure Mode	Applicable to				Description
	RE \geq 1G	RE<1G	PLC	APCM	
A	-	-	-	√	Model: AP6356SD
B	√	√	√	-	Model: AP6356SDPB_I with AP12356_I Platform

Where RE \geq 1G: Radiated Emission above 1GHz & Bandedge Measurement
 RE<1G: Radiated Emission below 1GHz
 PLC: Power Line Conducted Emission
 APCM: Antenna Port Conducted Measurement

Note:

1. The EUT had been pre-tested on the positioned of each 3 axis. The worst case was found when positioned on **X-plane**.
2. "-" means no effect.

Radiated Emission Test (Above 1GHz):

- Pre-Scan has been conducted to determine the worst-case mode from all possible combinations between available modulations, data rates and antenna ports (if EUT with antenna diversity architecture).
- Following channel(s) was (were) selected for the final test as listed below.

EUT Configure Mode	Mode	Frequency Band (MHz)	Available Channel	Tested Channel	Modulation Technology	Data Rate (Mbps)
B	802.11a	5180-5240	36 to 48	36, 40, 48	OFDM	6.0
B	802.11n (HT20)		36 to 48	36, 40, 48	OFDM	6.5
B	802.11n (HT40)		38 to 46	38, 46	OFDM	13.5
B	802.11ac (VHT80)		42	42	OFDM	29.3
B	802.11a	5260-5320	52 to 64	52, 60, 64	OFDM	6.0
B	802.11n (HT20)		52 to 64	52, 60, 64	OFDM	6.5
B	802.11n (HT40)		54 to 62	54, 62	OFDM	13.5
B	802.11ac (VHT80)		58	58	OFDM	29.3
B	802.11a	5500-5700	100 to 140	100, 116, 140	OFDM	6.0
B	802.11n (HT20)		100 to 140	100, 116, 140	OFDM	6.5
B	802.11n (HT40)		102 to 134	102, 110, 134	OFDM	13.5
B	802.11ac (VHT80)		106	106	OFDM	29.3
B	802.11a	5745-5825	149 to 165	149, 157, 165	OFDM	6.0
B	802.11n (HT20)		149 to 165	149, 157, 165	OFDM	6.5
B	802.11n (HT40)		151 to 159	151, 159	OFDM	13.5
B	802.11ac (VHT80)		155	155	OFDM	29.3

Radiated Emission Test (Below 1GHz):

- Pre-Scan has been conducted to determine the worst-case mode from all possible combinations between available modulations, data rates and antenna ports (if EUT with antenna diversity architecture).
- Following channel(s) was (were) selected for the final test as listed below.

EUT Configure Mode	Mode	Frequency Band (MHz)	Available Channel	Tested Channel	Modulation Technology	Data Rate (Mbps)
B	802.11a	5180-5240	36 to 48	64	OFDM	6.0
B	802.11a	5260-5320	52 to 64		OFDM	6.0
B	802.11a	5500-5700	100 to 140		OFDM	6.0
B	802.11a	5745-5825	149 to 165		OFDM	6.0

Power Line Conducted Emission Test:

- Pre-Scan has been conducted to determine the worst-case mode from all possible combinations between available modulations, data rates and antenna ports (if EUT with antenna diversity architecture).
- Following channel(s) was (were) selected for the final test as listed below.

EUT Configure Mode	Mode	Frequency Band (MHz)	Available Channel	Tested Channel	Modulation Technology	Data Rate (Mbps)
B	802.11a	5180-5240	36 to 48	64	OFDM	6.0
B	802.11a	5260-5320	52 to 64		OFDM	6.0
B	802.11a	5500-5700	100 to 140		OFDM	6.0
B	802.11a	5745-5825	149 to 165		OFDM	6.0

Antenna Port Conducted Measurement:

- This item includes all test value of each mode, but only includes spectrum plot of worst value of each mode.
- Pre-Scan has been conducted to determine the worst-case mode from all possible combinations between available modulations, data rates and antenna ports (if EUT with antenna diversity architecture).
- Following channel(s) was (were) selected for the final test as listed below.

EUT Configure Mode	Mode	Frequency Band (MHz)	Available Channel	Tested Channel	Modulation Technology	Data Rate (Mbps)
A	802.11a	5180-5240	36 to 48	36, 40, 48	OFDM	6.0
A	802.11n (HT20)		36 to 48	36, 40, 48	OFDM	6.5
A	802.11n (HT40)		38 to 46	38, 46	OFDM	13.5
A	802.11ac (VHT80)		42	42	OFDM	29.3
A	802.11a	5260-5320	52 to 64	52, 60, 64	OFDM	6.0
A	802.11n (HT20)		52 to 64	52, 60, 64	OFDM	6.5
A	802.11n (HT40)		54 to 62	54, 62	OFDM	13.5
A	802.11ac (VHT80)		58	58	OFDM	29.3
A	802.11a	5500-5700	100 to 140	100, 116, 140	OFDM	6.0
A	802.11n (HT20)		100 to 140	100, 116, 140	OFDM	6.5
A	802.11n (HT40)		102 to 134	102, 110, 134	OFDM	13.5
A	802.11ac (VHT80)		106	106	OFDM	29.3
A	802.11a	5745-5825	149 to 165	149, 157, 165	OFDM	6.0
A	802.11n (HT20)		149 to 165	149, 157, 165	OFDM	6.5
A	802.11n (HT40)		151 to 159	151, 159	OFDM	13.5
A	802.11ac (VHT80)		155	155	OFDM	29.3

Test Condition:

Applicable to	Environmental Conditions	Input Power (System)	Tested by
RE≥1G	22 deg. C, 66% RH	120Vac, 60Hz	Han Wu
RE<1G	25 deg. C, 65% RH	120Vac, 60Hz	Greg Lin
PLC	25 deg. C, 75% RH	120Vac, 60Hz	Greg Lin
APCM	25 deg. C, 60% RH	120Vac, 60Hz	Frank Liu

3.3 Duty Cycle of Test Signal

For 5180 ~ 5240MHz, 5260 ~ 5320MHz, 5500 ~ 5700MHz

802.11a: Duty cycle of test signal is > 98%, duty factor is not required.

802.11n (HT20), 802.11n (HT40), 802.11ac (VHT80): Duty cycle of test signal is < 98 %, duty factor is required.

802.11n (HT20): Duty cycle = $1.900/1.952 = 0.973$, Duty factor = $10 * \log(1/0.973) = 0.12$

802.11n (HT40): Duty cycle = $0.939/0.979 = 0.959$, Duty factor = $10 * \log(1/0.959) = 0.18$

802.11ac (VHT80): Duty cycle = $0.448/0.493 = 0.909$, Duty factor = $10 * \log(1/0.909) = 0.42$

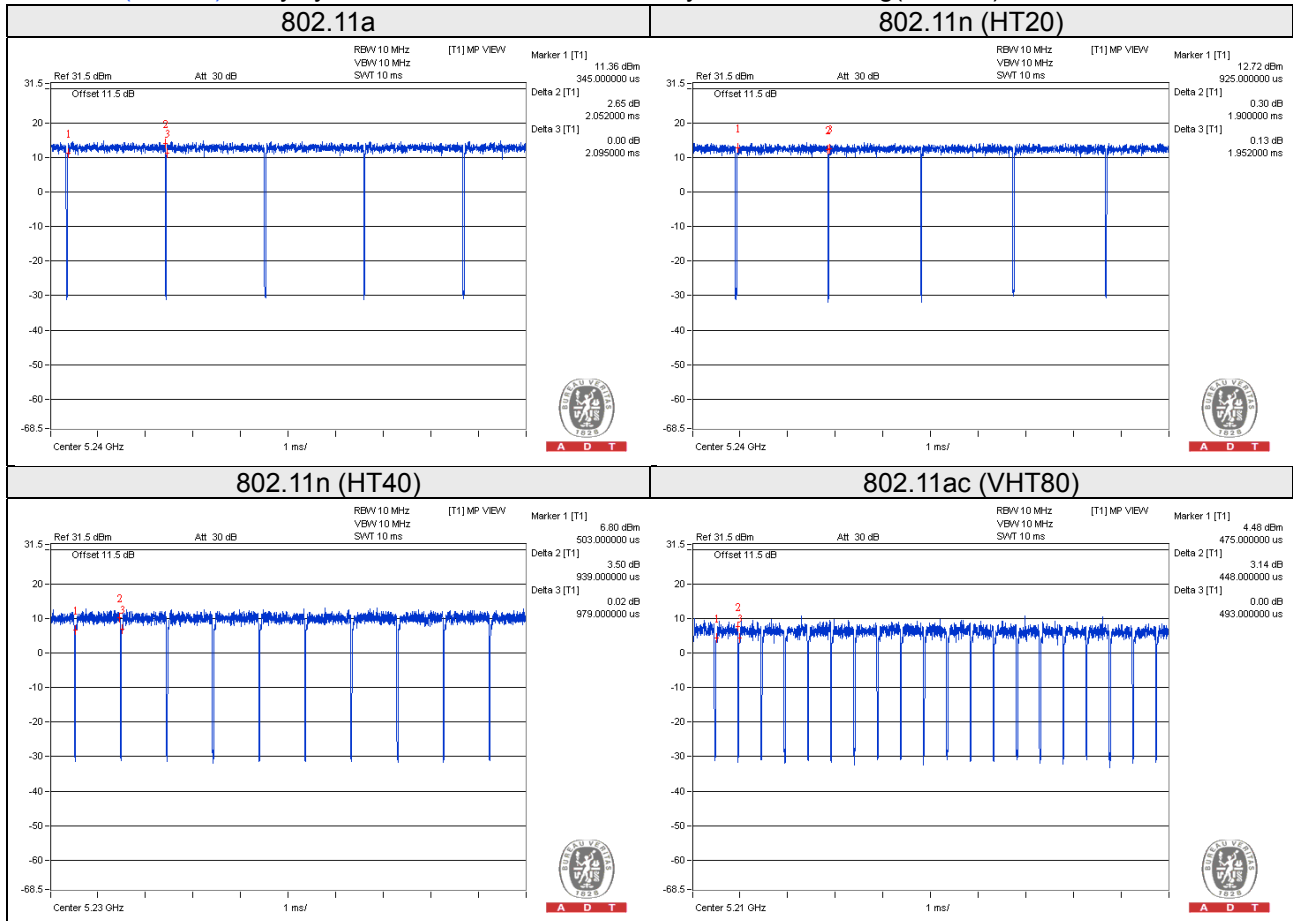

For 5745 ~ 5825MHz

Duty cycle of test signal is < 98 %, duty factor is required.

802.11a: Duty cycle = $2.013/2.175 = 0.926$, Duty factor = $10 * \log(1/0.926) = 0.34$

802.11n (HT20): Duty cycle = $1.850/1.987 = 0.931$, Duty factor = $10 * \log(1/0.931) = 0.31$

802.11n (HT40): Duty cycle = $0.936/0.988 = 0.947$, Duty factor = $10 * \log(1/0.947) = 0.23$

802.11ac (VHT80): Duty cycle = $0.459/0.488 = 0.941$, Duty factor = $10 * \log(1/0.941) = 0.27$

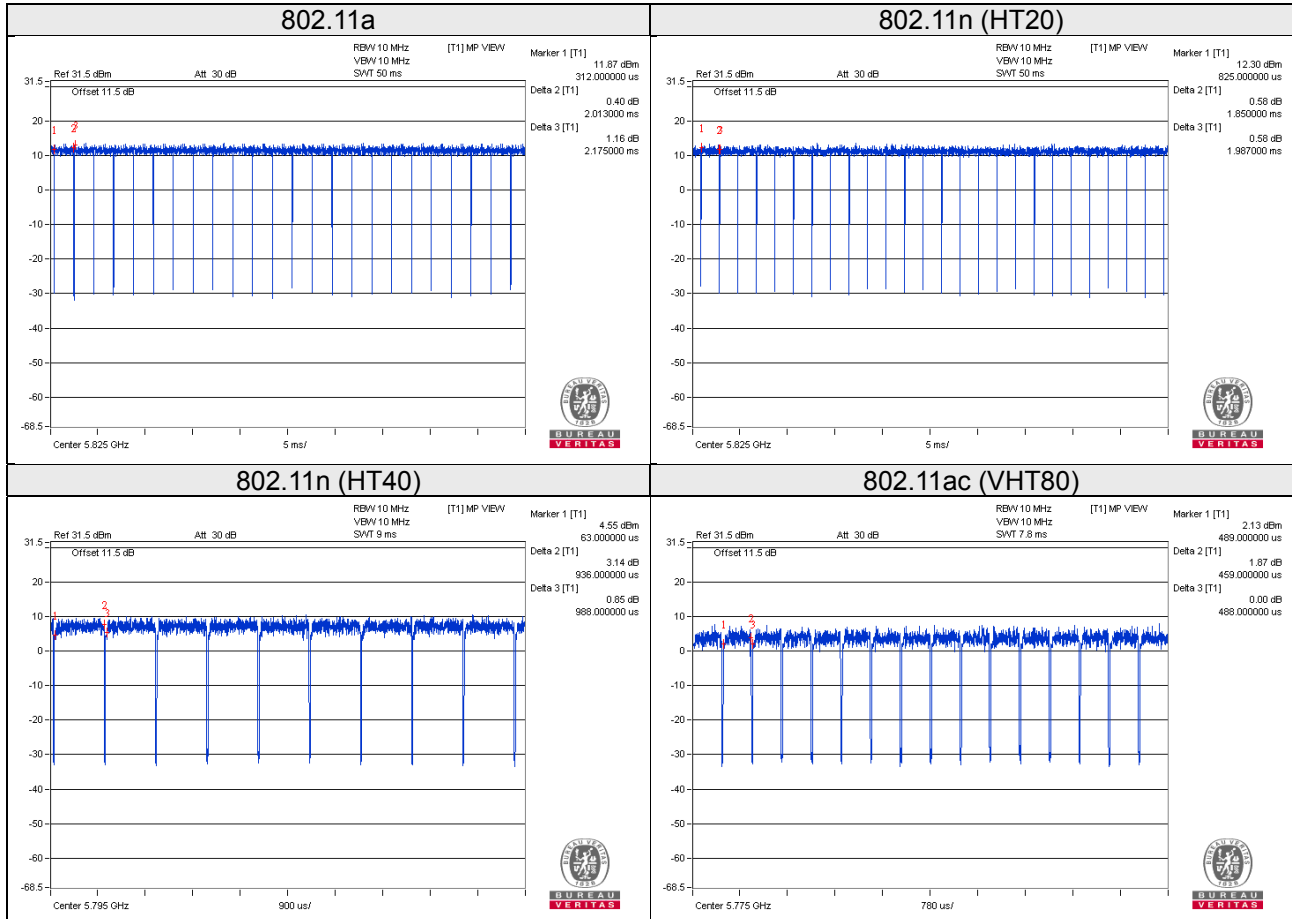

3.4 Description of Support Units

The EUT has been tested as an independent unit together with other necessary accessories or support units. The following support units or accessories were used to form a representative test configuration during the tests.

ID	Product	Brand	Model No.	Serial No.	FCC ID	Remarks
A.	PC	Ampak	AC00910	NA	NA	Provided by manufacturer
B.	Monitor	Lenovo	L215pwA	4M0373192470697	FCC DoC Approved	-
C.	Keyboard	DELL	KB4021	CN-05V23T-71581-1A K-01Q7-A01	FCC DoC Approved	-
D.	Mouse	DELL	MS111-P	CN-011D3V-71581-1C J-019A	FCC DoC Approved	-
E.	Fixture	NA	NA	NA	NA	Provided by manufacturer

Note: All power cords of the above support units are non-shielded (1.8m).

ID	Descriptions	Qty.	Length (m)	Shielding (Yes/No)	Cores (Qty.)	Remarks
1.	D-sub cable	1	1.8	Y	2	-
2.	USB cable	1	1.8	Y	0	-
3.	USB cable	1	1.8	Y	0	-
4.	Mini USB cable	2	1	Y	0	Provided by manufacturer
5.	Convertible cable	1	0.5	N	0	Provided by manufacturer

Note: The core(s) is(are) originally attached to the cable(s).

3.4.1 Configuration of System under Test

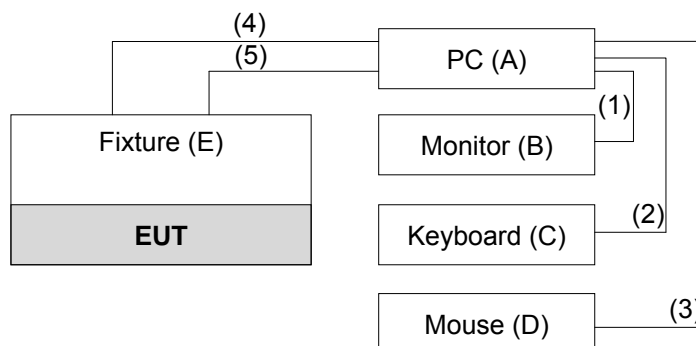

3.5 General Description of Applied Standards

The EUT is a RF Product. According to the specifications of the manufacturer, it must comply with the requirements of the following standards:

FCC Part 15, Subpart E (15.407)

KDB 789033 D02 General UNII Test Procedure New Rules v02r01

KDB 662911 D01 Multiple Transmitter Output v02r01

ANSI C63.10:2013

All test items have been performed and recorded as per the above standards.

4 Test Types and Results

4.1 Radiated Emission and Bandedge Measurement

4.1.1 Limits of Radiated Emission and Bandedge Measurement

Radiated emissions which fall in the restricted bands must comply with the radiated emission limits specified as below table.

Frequencies (MHz)	Field Strength (microvolts/meter)	Measurement Distance (meters)
0.009 ~ 0.490	2400/F(kHz)	300
0.490 ~ 1.705	24000/F(kHz)	30
1.705 ~ 30.0	30	30
30 ~ 88	100	3
88 ~ 216	150	3
216 ~ 960	200	3
Above 960	500	3

Note:

1. The lower limit shall apply at the transition frequencies.
2. Emission level (dBuV/m) = 20 log Emission level (uV/m).
3. For frequencies above 1000MHz, the field strength limits are based on average detector, however, the peak field strength of any emission shall not exceed the maximum permitted average limits, specified above by more than 20dB under any condition of modulation.

Limits of unwanted emission out of the restricted bands

Applicable To		Limit	
789033 D02 General UNII Test Procedure New Rules v02r01		Field Strength at 3m	
		PK: 74 (dBuV/m)	AV: 54 (dBuV/m)
Frequency Band	Applicable To	EIRP Limit	Equivalent Field Strength at 3m
5150~5250 MHz	15.407(b)(1)	PK: -27 (dBm/MHz)	PK: 68.2(dBuV/m)
5250~5350 MHz	15.407(b)(2)		
5470~5725 MHz	15.407(b)(3)		
5725~5850 MHz	<input checked="" type="checkbox"/> 15.407(b)(4)(i)	PK: -27 (dBm/MHz) ^{*1} PK: 10 (dBm/MHz) ^{*2} PK: 15.6 (dBm/MHz) ^{*3} PK: 27 (dBm/MHz) ^{*4}	PK: 68.2(dBuV/m) ^{*1} PK: 105.2 (dBuV/m) ^{*2} PK: 110.8(dBuV/m) ^{*3} PK: 122.2 (dBuV/m) ^{*4}
	<input type="checkbox"/> 15.407(b)(4)(ii)	Emission limits in section 15.247(d)	
*1 beyond 75 MHz or more above of the band edge.		*2 below the band edge increasing linearly to 10 dBm/MHz at 25 MHz above.	
*3 below the band edge increasing linearly to a level of 15.6 dBm/MHz at 5 MHz above.		*4 from 5 MHz above or below the band edge increasing linearly to a level of 27 dBm/MHz at the band edge.	

Note: The following formula is used to convert the equipment isotropic radiated power (eirp) to field strength:

$$E = \frac{1000000 \sqrt{30P}}{3} \mu\text{V/m, where P is the eirp (Watts).}$$

4.1.2 Test Instruments

Test Date: Nov. 30, 2015

Description & Manufacturer	Model No.	Serial No.	Cal. Date	Cal. Due
Test Receiver ROHDE & SCHWARZ	ESCI	100424	Oct. 12, 2015	Oct. 11, 2016
Spectrum Analyzer ROHDE & SCHWARZ	FSP40	100040	Jul. 08, 2015	Jul. 07, 2016
BILOG Antenna SCHWARZBECK	VULB9168	9168-155	Feb. 06, 2015	Feb. 05, 2016
HORN Antenna SCHWARZBECK	BBHA 9120D	9120D-1170	Feb. 05, 2015	Feb. 04, 2016
HORN Antenna SCHWARZBECK	BBHA 9170	BBHA9170241	Feb. 09, 2015	Feb. 08, 2016
Loop Antenna	EM-6879	269	Aug. 11, 2015	Aug. 10, 2016
Preamplifier Agilent	8449B	3008A01960	Aug. 09, 2015	Aug. 08, 2016
Preamplifier Agilent	8447D	2944A10631	Aug. 09, 2015	Aug. 08, 2016
RF signal cable HUBER+SUHNER	SUCOFLEX 104	Cable-CH4-02(295012+309220)	Aug. 09, 2015	Aug. 08, 2016
RF signal cable HUBER+SUHNER	SUCOFLEX 104	Cable-CH4-03(250724)	Aug. 09, 2015	Aug. 08, 2016
Software BV ADT	ADT_Radiated_V7.6.15.9.4	NA	NA	NA
Antenna Tower inn-co GmbH	MA 4000	010303	NA	NA
Antenna Tower Controller BV ADT	AT100	AT93021703	NA	NA
Turn Table BV ADT	TT100	TT93021703	NA	NA
Turn Table Controller BV ADT	SC100.	SC93021703	NA	NA
26GHz ~ 40GHz Amplifier	EM26400	815221	Oct. 18, 2015	Oct. 17, 2016
High Speed Peak Power Meter	ML2495A	0824011	Jul. 09, 2015	Jul. 08, 2016
Power Sensor	MA2411B	0738171	Jul. 09, 2015	Jul. 08, 2016
WIT Standard Temperature And Humidity Chamber	TH-4S-C	W981030	Jun. 08, 2015	Jun. 07, 2016

- Note:
1. The calibration interval of the above test instruments is 12 months and the calibrations are traceable to NML/ROC and NIST/USA.
 2. The test was performed in HwaYa Chamber 4.
 3. The horn antenna and preamplifier (model: 8449B) are used only for the measurement of emission frequency above 1GHz if tested.
 4. The FCC Designation Number is TW0003. The number will be varied with the Lab location and scope as attached.
 5. The IC Site Registration No. is IC7450F-4.

Test Date: Jun. 04 ~ Jun. 06, 2018

Description & Manufacturer	Model No.	Serial No.	Cal. Date	Cal. Due
Test Receiver KEYSIGHT	N9038A	MY55420137	Apr. 11, 2018	Apr. 10, 2019
Spectrum Analyzer ROHDE & SCHWARZ	FSP40	100269	May 29, 2018	May 28, 2019
BILOG Antenna SCHWARZBECK	VULB9168	9168-148	Dec. 11, 2017	Dec. 10, 2018
HORN Antenna SCHWARZBECK	BBHA 9120 D	9120D-1169	Dec. 12, 2017	Dec. 11, 2018
HORN Antenna SCHWARZBECK	BBHA 9170	BBHA9170241	Dec. 01, 2017	Nov. 30, 2018
Loop Antenna EMCI	EM-6879	269	Aug. 11, 2017	Aug. 10, 2018
Preamplifier Agilent (Below 1GHz)	8447D	2944A10638	Aug. 08, 2017	Aug. 07, 2018
Preamplifier Agilent (Above 1GHz)	8449B	3008A01638	Feb. 22, 2018	Feb. 21, 2019
RF signal cable HUBER+SUHNER&EMCI	SUCOFLEX 104 & EMC104-SM-SM8000	CABLE-CH9-02 (248780+171006)	Jan. 15, 2018	Jan. 14, 2019
RF signal cable HUBER+SUHNER	SUCOFLEX 104	CABLE-CH9-(250795/4)	Aug. 08, 2017	Aug. 07, 2018
RF signal cable Woken	8D-FB	Cable-CH9-01	Aug. 01, 2017	Jul. 31, 2018
Software BV ADT	ADT_Radiated_ V7.6.15.9.5	NA	NA	NA
Antenna Tower EMCO	2070/2080	512.835.4684	NA	NA
Turn Table EMCO	2087-2.03	NA	NA	NA
Antenna Tower & Turn BV ADT	AT100	AT93021705	NA	NA
Turn Table BV ADT	TT100	TT93021705	NA	NA
Turn Table Controller BV ADT	SC100	SC93021705	NA	NA
Boresight Antenna Fixture	FBA-01	FBA-SIP01	NA	NA
26GHz ~ 40GHz Amplifier Agilent	8449B	3008A1960	Aug. 08, 2017	Aug. 07, 2018
High Speed Peak Power Meter	ML2495A	0824012	Aug. 18, 2017	Aug. 17, 2018
Power Sensor	MA2411B	0738171	Aug. 18, 2017	Aug. 17, 2018

- Note: 1. The calibration interval of the above test instruments is 12 months and the calibrations are traceable to NML/ROC and NIST/USA.
 2. The test was performed in HwaYa Chamber 9.
 3. The FCC Designation Number is TW0003. The number will be varied with the Lab location and scope as attached.
 4. The IC Site Registration No. is IC 7450F-9.

4.1.3 Test Procedures

For Radiated emission below 30MHz

- a. The EUT was placed on the top of a rotating table 0.8 meters above the ground at a 3 meter chamber room. The table was rotated 360 degrees to determine the position of the highest radiation.
- b. The EUT was set 3 meters away from the interference-receiving antenna, which was mounted on the top of a variable-height antenna tower.
- c. Parallel, perpendicular, and ground-parallel orientations of the antenna are set to make the measurement.
- d. For each suspected emission, the EUT was arranged to its worst case and the rotatable table was turned from 0 degrees to 360 degrees to find the maximum reading.
- e. The test-receiver system was set to Quasi-Peak Detect Function and Specified Bandwidth with Maximum Hold Mode.

Note:

1. The resolution bandwidth and video bandwidth of test receiver/spectrum analyzer is 9kHz at frequency below 30MHz.

For Radiated emission above 30MHz

- a. The EUT was placed on the top of a rotating table 0.8 meters (for 30MHz ~ 1GHz) / 1.5 meters (for above 1GHz) above the ground at 3 meter chamber room for test. The table was rotated 360 degrees to determine the position of the highest radiation.
- b. The EUT was set 3 meters away from the interference-receiving antenna, which was mounted on the top of a variable-height antenna tower.
- c. The height of antenna is varied from one meter to four meters above the ground to determine the maximum value of the field strength. Both horizontal and vertical polarizations of the antenna are set to make the measurement.
- d. For each suspected emission, the EUT was arranged to its worst case and then the antenna was tuned to heights from 1 meter to 4 meters and the rotatable table was turned from 0 degrees to 360 degrees to find the maximum reading.
- e. The test-receiver system was set to quasi-peak detect function and specified bandwidth with maximum hold mode when the test frequency is below 1 GHz.
- f. The test-receiver system was set to peak and average detect function and specified bandwidth with maximum hold mode when the test frequency is above 1 GHz. If the peak reading value also meets average limit, measurement with the average detector is unnecessary.

Note:

1. The resolution bandwidth and video bandwidth of test receiver/spectrum analyzer is 120kHz for Quasi-peak detection (QP) at frequency below 1GHz.
2. The resolution bandwidth of test receiver/spectrum analyzer is 1 MHz and the video bandwidth is 3 MHz for Peak detection (PK) at frequency above 1GHz.
3. The resolution bandwidth of test receiver/spectrum analyzer is 1MHz and the video bandwidth is $\geq 1/T$ (Duty cycle < 98%) or 10Hz (Duty cycle $\geq 98\%$) for Average detection (AV) at frequency above 1GHz.
4. All modes of operation were investigated and the worst-case emissions are reported.

4.1.4 Deviation from Test Standard

No deviation.

4.1.5 Test Setup

For Radiated emission below 30MHz

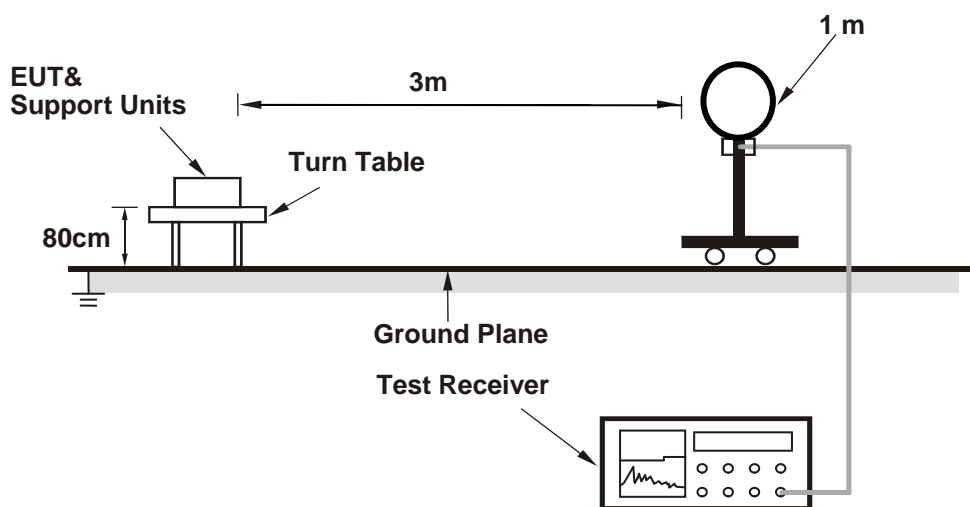

For Radiated emission 30MHz to 1GHz

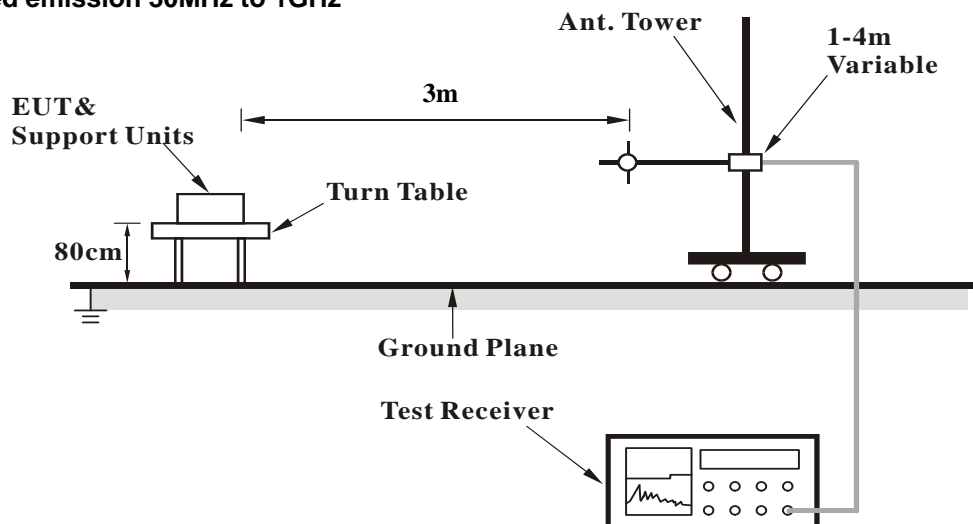

For Radiated emission above 1GHz

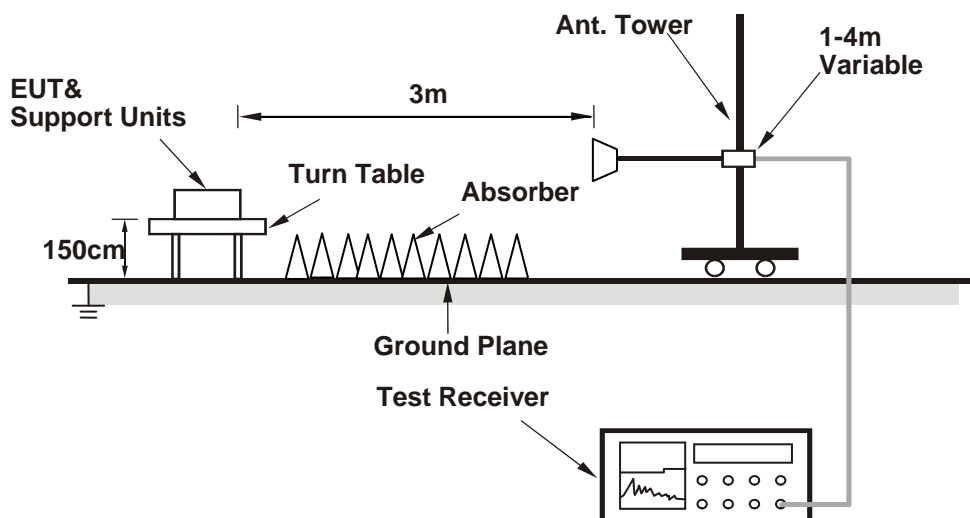

For the actual test configuration, please refer to the attached file (Test Setup Photo).

4.1.6 EUT Operating Conditions

- Connected EUT with PC via Convertible Board through mini USB cable.
- Set the EUT under transmission condition continuously at specific channel frequency.

4.1.7 Test Results

Above 1GHz Worst-case Data:

802.11a

CHANNEL	TX Channel 36	DETECTOR FUNCTION	Peak (PK)
FREQUENCY RANGE	1GHz ~ 40GHz		Average (AV)

ANTENNA POLARITY & TEST DISTANCE: HORIZONTAL AT 3 M								
NO.	FREQ. (MHz)	EMISSION LEVEL (dBuV/m)	LIMIT (dBuV/m)	MARGIN (dB)	ANTENNA HEIGHT (m)	TABLE ANGLE (Degree)	RAW VALUE (dBuV)	CORRECTION FACTOR (dB/m)
1	5150.00	52.3 PK	74.0	-21.7	1.40 H	32	50.4	1.9
2	5150.00	37.7 AV	54.0	-16.3	1.40 H	32	35.8	1.9
3	*5180.00	99.8 PK			1.47 H	317	61.0	38.8
4	*5180.00	89.1 AV			1.47 H	317	50.3	38.8
5	#10360.00	55.8 PK	74.0	-18.2	1.55 H	251	41.3	14.5
6	#10360.00	41.4 AV	54.0	-12.6	1.55 H	251	26.9	14.5
ANTENNA POLARITY & TEST DISTANCE: VERTICAL AT 3 M								
NO.	FREQ. (MHz)	EMISSION LEVEL (dBuV/m)	LIMIT (dBuV/m)	MARGIN (dB)	ANTENNA HEIGHT (m)	TABLE ANGLE (Degree)	RAW VALUE (dBuV)	CORRECTION FACTOR (dB/m)
1	5150.00	54.7 PK	74.0	-19.3	2.17 V	291	52.8	1.9
2	5150.00	39.8 AV	54.0	-14.2	2.17 V	291	37.9	1.9
3	*5180.00	108.4 PK			2.18 V	289	69.6	38.8
4	*5180.00	97.6 AV			2.18 V	289	58.8	38.8
5	#10360.00	58.4 PK	74.0	-15.6	1.54 V	169	43.9	14.5
6	#10360.00	44.1 AV	54.0	-9.9	1.54 V	169	29.6	14.5

Remarks:

1. Emission Level(dBuV/m) = Raw Value(dBuV) + Correction Factor(dB/m)
2. Correction Factor(dB/m) = Antenna Factor(dB/m) + Cable Factor(dB) – Pre-Amplifier Factor(dB)
3. The other emission levels were very low against the limit.
4. Margin value = Emission Level – Limit value
5. " * ": Fundamental frequency.
6. " # ": The radiated frequency is out of the restricted band.

CHANNEL	TX Channel 40	DETECTOR FUNCTION	Peak (PK)
FREQUENCY RANGE	1GHz ~ 40GHz		Average (AV)

ANTENNA POLARITY & TEST DISTANCE: HORIZONTAL AT 3 M

NO.	FREQ. (MHz)	EMISSION LEVEL (dBuV/m)	LIMIT (dBuV/m)	MARGIN (dB)	ANTENNA HEIGHT (m)	TABLE ANGLE (Degree)	RAW VALUE (dBuV)	CORRECTION FACTOR (dB/m)
1	*5200.00	100.1 PK			1.47 H	316	61.4	38.7
2	*5200.00	89.8 AV			1.47 H	316	51.1	38.7
3	#10400.00	57.9 PK	74.0	-16.1	1.42 H	249	43.2	14.7
4	#10400.00	44.4 AV	54.0	-9.6	1.42 H	249	29.7	14.7

ANTENNA POLARITY & TEST DISTANCE: VERTICAL AT 3 M

NO.	FREQ. (MHz)	EMISSION LEVEL (dBuV/m)	LIMIT (dBuV/m)	MARGIN (dB)	ANTENNA HEIGHT (m)	TABLE ANGLE (Degree)	RAW VALUE (dBuV)	CORRECTION FACTOR (dB/m)
1	*5200.00	108.4 PK			2.19 V	288	69.7	38.7
2	*5200.00	97.4 AV			2.19 V	288	58.7	38.7
3	#10400.00	58.6 PK	74.0	-15.4	1.58 V	173	43.9	14.7
4	#10400.00	44.2 AV	54.0	-9.8	1.58 V	173	29.5	14.7

Remarks:

1. Emission Level(dBuV/m) = Raw Value(dBuV) + Correction Factor(dB/m)
2. Correction Factor(dB/m) = Antenna Factor(dB/m) + Cable Factor(dB) – Pre-Amplifier Factor(dB)
3. The other emission levels were very low against the limit.
4. Margin value = Emission Level – Limit value
5. " * ": Fundamental frequency.
6. " # ": The radiated frequency is out of the restricted band.

CHANNEL	TX Channel 48	DETECTOR FUNCTION	Peak (PK)
FREQUENCY RANGE	1GHz ~ 40GHz		Average (AV)

ANTENNA POLARITY & TEST DISTANCE: HORIZONTAL AT 3 M

NO.	FREQ. (MHz)	EMISSION LEVEL (dBuV/m)	LIMIT (dBuV/m)	MARGIN (dB)	ANTENNA HEIGHT (m)	TABLE ANGLE (Degree)	RAW VALUE (dBuV)	CORRECTION FACTOR (dB/m)
1	*5240.00	98.8 PK			1.54 H	318	60.3	38.5
2	*5240.00	88.4 AV			1.54 H	318	49.9	38.5
3	5350.00	52.4 PK	74.0	-21.6	1.58 H	320	50.6	1.8
4	5350.00	38.6 AV	54.0	-15.4	1.58 H	320	36.8	1.8
5	#10480.00	56.7 PK	74.0	-17.3	1.52 H	259	41.6	15.1
6	#10480.00	42.9 AV	54.0	-11.1	1.52 H	259	27.8	15.1

ANTENNA POLARITY & TEST DISTANCE: VERTICAL AT 3 M

NO.	FREQ. (MHz)	EMISSION LEVEL (dBuV/m)	LIMIT (dBuV/m)	MARGIN (dB)	ANTENNA HEIGHT (m)	TABLE ANGLE (Degree)	RAW VALUE (dBuV)	CORRECTION FACTOR (dB/m)
1	*5240.00	108.2 PK			2.25 V	289	69.7	38.5
2	*5240.00	97.3 AV			2.25 V	289	58.8	38.5
3	5350.00	52.3 PK	74.0	-21.7	2.41 V	203	50.5	1.8
4	5350.00	38.1 AV	54.0	-15.9	2.41 V	203	36.3	1.8
5	#10480.00	56.6 PK	74.0	-17.4	1.55 V	235	41.5	15.1
6	#10480.00	42.2 AV	54.0	-11.8	1.55 V	235	27.1	15.1

Remarks:

1. Emission Level(dBuV/m) = Raw Value(dBuV) + Correction Factor(dB/m)
2. Correction Factor(dB/m) = Antenna Factor(dB/m) + Cable Factor(dB) – Pre-Amplifier Factor(dB)
3. The other emission levels were very low against the limit.
4. Margin value = Emission Level – Limit value
5. " * ": Fundamental frequency.
6. " # ": The radiated frequency is out of the restricted band.

CHANNEL	TX Channel 52	DETECTOR FUNCTION	Peak (PK)
FREQUENCY RANGE	1GHz ~ 40GHz		Average (AV)

ANTENNA POLARITY & TEST DISTANCE: HORIZONTAL AT 3 M								
NO.	FREQ. (MHz)	EMISSION LEVEL (dBuV/m)	LIMIT (dBuV/m)	MARGIN (dB)	ANTENNA HEIGHT (m)	TABLE ANGLE (Degree)	RAW VALUE (dBuV)	CORRECTION FACTOR (dB/m)
1	5150.00	51.5 PK	74.0	-22.5	1.67 H	218	49.6	1.9
2	5150.00	39.7 AV	54.0	-14.3	1.67 H	218	37.8	1.9
3	*5260.00	98.8 PK			1.50 H	209	60.4	38.4
4	*5260.00	88.7 AV			1.50 H	209	50.3	38.4
5	#10520.00	56.5 PK	74.0	-17.5	1.73 H	274	41.3	15.2
6	#10520.00	43.8 AV	54.0	-10.2	1.73 H	274	28.6	15.2

ANTENNA POLARITY & TEST DISTANCE: VERTICAL AT 3 M								
NO.	FREQ. (MHz)	EMISSION LEVEL (dBuV/m)	LIMIT (dBuV/m)	MARGIN (dB)	ANTENNA HEIGHT (m)	TABLE ANGLE (Degree)	RAW VALUE (dBuV)	CORRECTION FACTOR (dB/m)
1	5150.00	52.7 PK	74.0	-21.3	2.07 V	351	50.8	1.9
2	5150.00	40.2 AV	54.0	-13.8	2.07 V	351	38.3	1.9
3	*5260.00	107.9 PK			1.93 V	342	69.5	38.4
4	*5260.00	97.9 AV			1.93 V	342	59.5	38.4
5	#10520.00	60.7 PK	74.0	-13.3	2.19 V	214	45.5	15.2
6	#10520.00	47.7 AV	54.0	-6.3	2.19 V	214	32.5	15.2

Remarks:

1. Emission Level(dBuV/m) = Raw Value(dBuV) + Correction Factor(dB/m)
2. Correction Factor(dB/m) = Antenna Factor(dB/m) + Cable Factor(dB) – Pre-Amplifier Factor(dB)
3. The other emission levels were very low against the limit.
4. Margin value = Emission Level – Limit value
5. " * ": Fundamental frequency.
6. " # ": The radiated frequency is out of the restricted band.

CHANNEL	TX Channel 60	DETECTOR FUNCTION	Peak (PK)
FREQUENCY RANGE	1GHz ~ 40GHz		Average (AV)

ANTENNA POLARITY & TEST DISTANCE: HORIZONTAL AT 3 M

NO.	FREQ. (MHz)	EMISSION LEVEL (dBuV/m)	LIMIT (dBuV/m)	MARGIN (dB)	ANTENNA HEIGHT (m)	TABLE ANGLE (Degree)	RAW VALUE (dBuV)	CORRECTION FACTOR (dB/m)
1	*5300.00	99.1 PK			1.55 H	204	60.6	38.5
2	*5300.00	89.0 AV			1.55 H	204	50.5	38.5
3	10600.00	56.7 PK	74.0	-17.3	1.71 H	264	41.6	15.1
4	10600.00	44.8 AV	54.0	-9.2	1.71 H	264	29.7	15.1

ANTENNA POLARITY & TEST DISTANCE: VERTICAL AT 3 M

NO.	FREQ. (MHz)	EMISSION LEVEL (dBuV/m)	LIMIT (dBuV/m)	MARGIN (dB)	ANTENNA HEIGHT (m)	TABLE ANGLE (Degree)	RAW VALUE (dBuV)	CORRECTION FACTOR (dB/m)
1	*5300.00	108.2 PK			2.63 V	290	69.7	38.5
2	*5300.00	98.2 AV			2.63 V	290	59.7	38.5
3	10600.00	61.6 PK	74.0	-12.4	2.64 V	193	46.5	15.1
4	10600.00	48.6 AV	54.0	-5.4	2.64 V	193	33.5	15.1

Remarks:

1. Emission Level(dBuV/m) = Raw Value(dBuV) + Correction Factor(dB/m)
2. Correction Factor(dB/m) = Antenna Factor(dB/m) + Cable Factor(dB) – Pre-Amplifier Factor(dB)
3. The other emission levels were very low against the limit.
4. Margin value = Emission Level – Limit value
5. " * ": Fundamental frequency.

CHANNEL	TX Channel 64	DETECTOR FUNCTION	Peak (PK)
FREQUENCY RANGE	1GHz ~ 40GHz		Average (AV)

ANTENNA POLARITY & TEST DISTANCE: HORIZONTAL AT 3 M

NO.	FREQ. (MHz)	EMISSION LEVEL (dBuV/m)	LIMIT (dBuV/m)	MARGIN (dB)	ANTENNA HEIGHT (m)	TABLE ANGLE (Degree)	RAW VALUE (dBuV)	CORRECTION FACTOR (dB/m)
1	*5320.00	99.0 PK			1.51 H	213	60.4	38.6
2	*5320.00	88.9 AV			1.51 H	213	50.3	38.6
3	5350.00	51.7 PK	74.0	-22.3	1.58 H	227	49.9	1.8
4	5350.00	39.0 AV	54.0	-15.0	1.58 H	227	37.2	1.8
5	10640.00	55.9 PK	74.0	-18.1	1.66 H	279	40.7	15.2
6	10640.00	44.8 AV	54.0	-9.2	1.66 H	279	29.6	15.2

ANTENNA POLARITY & TEST DISTANCE: VERTICAL AT 3 M

NO.	FREQ. (MHz)	EMISSION LEVEL (dBuV/m)	LIMIT (dBuV/m)	MARGIN (dB)	ANTENNA HEIGHT (m)	TABLE ANGLE (Degree)	RAW VALUE (dBuV)	CORRECTION FACTOR (dB/m)
1	*5320.00	107.9 PK			2.63 V	309	69.3	38.6
2	*5320.00	97.9 AV			2.63 V	309	59.3	38.6
3	5350.00	52.2 PK	74.0	-21.8	2.72 V	329	50.4	1.8
4	5350.00	39.6 AV	54.0	-14.4	2.72 V	329	37.8	1.8
5	10640.00	59.8 PK	74.0	-14.2	2.80 V	193	44.6	15.2
6	10640.00	47.6 AV	54.0	-6.4	2.80 V	193	32.4	15.2

Remarks:

1. Emission Level(dBuV/m) = Raw Value(dBuV) + Correction Factor(dB/m)
2. Correction Factor(dB/m) = Antenna Factor(dB/m) + Cable Factor(dB) – Pre-Amplifier Factor(dB)
3. The other emission levels were very low against the limit.
4. Margin value = Emission Level – Limit value
5. " * ": Fundamental frequency.

CHANNEL	TX Channel 100	DETECTOR FUNCTION	Peak (PK)
FREQUENCY RANGE	1GHz ~ 40GHz		Average (AV)

ANTENNA POLARITY & TEST DISTANCE: HORIZONTAL AT 3 M

NO.	FREQ. (MHz)	EMISSION LEVEL (dBuV/m)	LIMIT (dBuV/m)	MARGIN (dB)	ANTENNA HEIGHT (m)	TABLE ANGLE (Degree)	RAW VALUE (dBuV)	CORRECTION FACTOR (dB/m)
1	5460.00	55.0 PK	74.0	-19.0	2.22 H	228	52.8	2.2
2	5460.00	40.5 AV	54.0	-13.5	2.22 H	228	38.3	2.2
3	#5470.00	55.1 PK	74.0	-18.9	2.18 H	225	52.9	2.2
4	#5470.00	40.9 AV	54.0	-13.1	2.18 H	225	38.7	2.2
5	*5500.00	100.0 PK			2.19 H	223	60.8	39.2
6	*5500.00	89.3 AV			2.19 H	223	50.1	39.2
7	11000.00	56.1 PK	74.0	-17.9	1.36 H	115	39.1	17.0
8	11000.00	41.5 AV	54.0	-12.5	1.36 H	115	24.5	17.0

ANTENNA POLARITY & TEST DISTANCE: VERTICAL AT 3 M

NO.	FREQ. (MHz)	EMISSION LEVEL (dBuV/m)	LIMIT (dBuV/m)	MARGIN (dB)	ANTENNA HEIGHT (m)	TABLE ANGLE (Degree)	RAW VALUE (dBuV)	CORRECTION FACTOR (dB/m)
1	5460.00	54.8 PK	74.0	-19.2	1.88 V	224	52.6	2.2
2	5460.00	40.3 AV	54.0	-13.7	1.88 V	224	38.1	2.2
3	#5470.00	55.9 PK	74.0	-18.1	1.85 V	226	53.7	2.2
4	#5470.00	41.4 AV	54.0	-12.6	1.85 V	226	39.2	2.2
5	*5500.00	107.6 PK			1.75 V	225	68.4	39.2
6	*5500.00	97.0 AV			1.75 V	225	57.8	39.2
7	11000.00	60.8 PK	74.0	-13.2	1.38 V	223	43.8	17.0
8	11000.00	46.6 AV	54.0	-7.4	1.38 V	223	29.6	17.0

Remarks:

1. Emission Level(dBuV/m) = Raw Value(dBuV) + Correction Factor(dB/m)
2. Correction Factor(dB/m) = Antenna Factor(dB/m) + Cable Factor(dB) – Pre-Amplifier Factor(dB)
3. The other emission levels were very low against the limit.
4. Margin value = Emission Level – Limit value
5. " * ": Fundamental frequency.
6. " # ": The radiated frequency is out of the restricted band.

CHANNEL	TX Channel 116	DETECTOR FUNCTION	Peak (PK)
FREQUENCY RANGE	1GHz ~ 40GHz		Average (AV)

ANTENNA POLARITY & TEST DISTANCE: HORIZONTAL AT 3 M

NO.	FREQ. (MHz)	EMISSION LEVEL (dBuV/m)	LIMIT (dBuV/m)	MARGIN (dB)	ANTENNA HEIGHT (m)	TABLE ANGLE (Degree)	RAW VALUE (dBuV)	CORRECTION FACTOR (dB/m)
1	*5580.00	99.1 PK			2.27 H	223	59.7	39.4
2	*5580.00	88.4 AV			2.27 H	223	49.0	39.4
3	11160.00	55.8 PK	74.0	-18.2	1.33 H	117	39.8	16.0
4	11160.00	41.3 AV	54.0	-12.7	1.33 H	117	25.3	16.0

ANTENNA POLARITY & TEST DISTANCE: VERTICAL AT 3 M

NO.	FREQ. (MHz)	EMISSION LEVEL (dBuV/m)	LIMIT (dBuV/m)	MARGIN (dB)	ANTENNA HEIGHT (m)	TABLE ANGLE (Degree)	RAW VALUE (dBuV)	CORRECTION FACTOR (dB/m)
1	*5580.00	108.3 PK			1.59 V	217	68.9	39.4
2	*5580.00	97.9 AV			1.59 V	217	58.5	39.4
3	11160.00	58.0 PK	74.0	-16.0	1.41 V	217	42.0	16.0
4	11160.00	44.1 AV	54.0	-9.9	1.41 V	217	28.1	16.0

Remarks:

1. Emission Level(dBuV/m) = Raw Value(dBuV) + Correction Factor(dB/m)
2. Correction Factor(dB/m) = Antenna Factor(dB/m) + Cable Factor(dB) – Pre-Amplifier Factor(dB)
3. The other emission levels were very low against the limit.
4. Margin value = Emission Level – Limit value
5. " * ": Fundamental frequency.

CHANNEL	TX Channel 140	DETECTOR FUNCTION	Peak (PK)
FREQUENCY RANGE	1GHz ~ 40GHz		Average (AV)

ANTENNA POLARITY & TEST DISTANCE: HORIZONTAL AT 3 M								
NO.	FREQ. (MHz)	EMISSION LEVEL (dBuV/m)	LIMIT (dBuV/m)	MARGIN (dB)	ANTENNA HEIGHT (m)	TABLE ANGLE (Degree)	RAW VALUE (dBuV)	CORRECTION FACTOR (dB/m)
1	*5700.00	97.8 PK			1.55 H	280	58.3	39.5
2	*5700.00	87.4 AV			1.55 H	280	47.9	39.5
3	#5725.00	52.5 PK	74.0	-21.5	1.58 H	286	49.7	2.8
4	#5725.00	38.1 AV	54.0	-15.9	1.58 H	286	35.3	2.8
5	11400.00	55.0 PK	74.0	-19.0	1.33 H	119	39.2	15.8
6	11400.00	40.5 AV	54.0	-13.5	1.33 H	119	24.7	15.8
ANTENNA POLARITY & TEST DISTANCE: VERTICAL AT 3 M								
NO.	FREQ. (MHz)	EMISSION LEVEL (dBuV/m)	LIMIT (dBuV/m)	MARGIN (dB)	ANTENNA HEIGHT (m)	TABLE ANGLE (Degree)	RAW VALUE (dBuV)	CORRECTION FACTOR (dB/m)
1	*5700.00	107.5 PK			1.74 V	216	68.0	39.5
2	*5700.00	97.0 AV			1.74 V	216	57.5	39.5
3	#5725.00	54.0 PK	74.0	-20.0	1.65 V	219	51.2	2.8
4	#5725.00	39.1 AV	54.0	-14.9	1.65 V	219	36.3	2.8
5	11400.00	58.9 PK	74.0	-15.1	1.32 V	215	43.1	15.8
6	11400.00	44.1 AV	54.0	-9.9	1.32 V	215	28.3	15.8

Remarks:

1. Emission Level(dBuV/m) = Raw Value(dBuV) + Correction Factor(dB/m)
2. Correction Factor(dB/m) = Antenna Factor(dB/m) + Cable Factor(dB) – Pre-Amplifier Factor(dB)
3. The other emission levels were very low against the limit.
4. Margin value = Emission Level – Limit value
5. " * ": Fundamental frequency.
6. " # ": The radiated frequency is out of the restricted band.

CHANNEL	TX Channel 149	DETECTOR FUNCTION	Peak (PK)
FREQUENCY RANGE	1GHz ~ 40GHz		Average (AV)

ANTENNA POLARITY & TEST DISTANCE: HORIZONTAL AT 3 M

NO.	FREQ. (MHz)	EMISSION LEVEL (dBuV/m)	LIMIT (dBuV/m)	MARGIN (dB)	ANTENNA HEIGHT (m)	TABLE ANGLE (Degree)	RAW VALUE (dBuV)	CORRECTION FACTOR (dB/m)
1	#5607.20	52.9 PK	68.2	-15.3	1.36 H	299	50.4	2.5
2	*5745.00	97.2 PK			1.56 H	299	57.4	39.8
3	*5745.00	86.7 AV			1.56 H	299	46.9	39.8
4	#5947.20	53.7 PK	68.2	-14.5	1.36 H	299	50.0	3.7
5	11490.00	55.2 PK	74.0	-18.8	2.22 H	93	39.9	15.3
6	11490.00	40.6 AV	54.0	-13.4	2.22 H	93	25.3	15.3

ANTENNA POLARITY & TEST DISTANCE: VERTICAL AT 3 M

NO.	FREQ. (MHz)	EMISSION LEVEL (dBuV/m)	LIMIT (dBuV/m)	MARGIN (dB)	ANTENNA HEIGHT (m)	TABLE ANGLE (Degree)	RAW VALUE (dBuV)	CORRECTION FACTOR (dB/m)
1	#5620.80	52.8 PK	68.2	-15.4	2.60 V	334	50.3	2.5
2	*5745.00	105.9 PK			2.60 V	334	66.1	39.8
3	*5745.00	95.2 AV			2.60 V	334	55.4	39.8
4	#5956.80	54.3 PK	68.2	-13.9	2.60 V	334	50.6	3.7
5	11490.00	58.5 PK	74.0	-15.5	3.10 V	203	43.2	15.3
6	11490.00	43.7 AV	54.0	-10.3	3.10 V	203	28.4	15.3

Remarks:

1. Emission Level(dBuV/m) = Raw Value(dBuV) + Correction Factor(dB/m)
2. Correction Factor(dB/m) = Antenna Factor(dB/m) + Cable Factor(dB) – Pre-Amplifier Factor(dB)
3. The other emission levels were very low against the limit.
4. Margin value = Emission Level – Limit value
5. " * ": Fundamental frequency.
6. " # ": The radiated frequency is out of the restricted band.

CHANNEL	TX Channel 157	DETECTOR FUNCTION	Peak (PK)
FREQUENCY RANGE	1GHz ~ 40GHz		Average (AV)

ANTENNA POLARITY & TEST DISTANCE: HORIZONTAL AT 3 M

NO.	FREQ. (MHz)	EMISSION LEVEL (dBuV/m)	LIMIT (dBuV/m)	MARGIN (dB)	ANTENNA HEIGHT (m)	TABLE ANGLE (Degree)	RAW VALUE (dBuV)	CORRECTION FACTOR (dB/m)
1	#5628.00	52.5 PK	68.2	-15.7	1.50 H	300	49.9	2.6
2	*5785.00	99.2 PK			1.50 H	300	59.2	40.0
3	*5785.00	88.3 AV			1.50 H	300	48.3	40.0
4	#5983.20	53.9 PK	68.2	-14.3	1.50 H	300	50.1	3.8
5	11570.00	56.4 PK	74.0	-17.6	2.16 H	88	41.4	15.0
6	11570.00	40.6 AV	54.0	-13.4	2.16 H	88	25.6	15.0

ANTENNA POLARITY & TEST DISTANCE: VERTICAL AT 3 M

NO.	FREQ. (MHz)	EMISSION LEVEL (dBuV/m)	LIMIT (dBuV/m)	MARGIN (dB)	ANTENNA HEIGHT (m)	TABLE ANGLE (Degree)	RAW VALUE (dBuV)	CORRECTION FACTOR (dB/m)
1	#5617.60	53.2 PK	68.2	-15.0	2.58 V	304	50.7	2.5
2	*5785.00	107.7 PK			2.58 V	304	67.7	40.0
3	*5785.00	97.0 AV			2.58 V	304	57.0	40.0
4	#5991.20	54.4 PK	68.2	-13.8	2.58 V	304	50.7	3.7
5	11570.00	56.4 PK	74.0	-17.6	3.05 V	206	41.4	15.0
6	11570.00	42.7 AV	54.0	-11.3	3.05 V	206	27.7	15.0

Remarks:

1. Emission Level(dBuV/m) = Raw Value(dBuV) + Correction Factor(dB/m)
2. Correction Factor(dB/m) = Antenna Factor(dB/m) + Cable Factor(dB) – Pre-Amplifier Factor(dB)
3. The other emission levels were very low against the limit.
4. Margin value = Emission Level – Limit value
5. " * ": Fundamental frequency.
6. " # ": The radiated frequency is out of the restricted band.

CHANNEL	TX Channel 165	DETECTOR FUNCTION	Peak (PK)
FREQUENCY RANGE	1GHz ~ 40GHz		Average (AV)

ANTENNA POLARITY & TEST DISTANCE: HORIZONTAL AT 3 M

NO.	FREQ. (MHz)	EMISSION LEVEL (dBuV/m)	LIMIT (dBuV/m)	MARGIN (dB)	ANTENNA HEIGHT (m)	TABLE ANGLE (Degree)	RAW VALUE (dBuV)	CORRECTION FACTOR (dB/m)
1	#5631.20	52.2 PK	68.2	-16.0	1.53 H	300	49.6	2.6
2	*5825.00	99.2 PK			1.53 H	300	59.1	40.1
3	*5825.00	88.3 AV			1.53 H	300	48.2	40.1
4	#5980.00	53.9 PK	68.2	-14.3	1.53 H	300	50.1	3.8
5	11650.00	55.3 PK	74.0	-18.7	2.22 H	89	40.4	14.9
6	11650.00	40.8 AV	54.0	-13.2	2.22 H	89	25.9	14.9

ANTENNA POLARITY & TEST DISTANCE: VERTICAL AT 3 M

NO.	FREQ. (MHz)	EMISSION LEVEL (dBuV/m)	LIMIT (dBuV/m)	MARGIN (dB)	ANTENNA HEIGHT (m)	TABLE ANGLE (Degree)	RAW VALUE (dBuV)	CORRECTION FACTOR (dB/m)
1	#5601.60	53.5 PK	68.2	-14.7	2.87 V	311	51.0	2.5
2	*5825.00	107.4 PK			2.87 V	311	67.3	40.1
3	*5825.00	96.6 AV			2.87 V	311	56.5	40.1
4	#5993.60	53.9 PK	68.2	-14.3	2.87 V	311	50.2	3.7
5	11650.00	56.8 PK	74.0	-17.2	3.11 V	206	41.9	14.9
6	11650.00	42.8 AV	54.0	-11.2	3.11 V	206	27.9	14.9

Remarks:

1. Emission Level(dBuV/m) = Raw Value(dBuV) + Correction Factor(dB/m)
2. Correction Factor(dB/m) = Antenna Factor(dB/m) + Cable Factor(dB) – Pre-Amplifier Factor(dB)
3. The other emission levels were very low against the limit.
4. Margin value = Emission Level – Limit value
5. " * ": Fundamental frequency.
6. " # ": The radiated frequency is out of the restricted band.

802.11n (HT20)

CHANNEL	TX Channel 36	DETECTOR FUNCTION	Peak (PK)
FREQUENCY RANGE	1GHz ~ 40GHz		Average (AV)

ANTENNA POLARITY & TEST DISTANCE: HORIZONTAL AT 3 M

NO.	FREQ. (MHz)	EMISSION LEVEL (dBuV/m)	LIMIT (dBuV/m)	MARGIN (dB)	ANTENNA HEIGHT (m)	TABLE ANGLE (Degree)	RAW VALUE (dBuV)	CORRECTION FACTOR (dB/m)
1	5150.00	53.7 PK	74.0	-20.3	1.40 H	313	51.8	1.9
2	5150.00	38.7 AV	54.0	-15.3	1.40 H	313	36.8	1.9
3	*5180.00	100.2 PK			1.50 H	317	61.4	38.8
4	*5180.00	88.9 AV			1.50 H	317	50.1	38.8
5	#10360.00	56.0 PK	74.0	-18.0	1.56 H	254	41.5	14.5
6	#10360.00	41.2 AV	54.0	-12.8	1.56 H	254	26.7	14.5

ANTENNA POLARITY & TEST DISTANCE: VERTICAL AT 3 M

NO.	FREQ. (MHz)	EMISSION LEVEL (dBuV/m)	LIMIT (dBuV/m)	MARGIN (dB)	ANTENNA HEIGHT (m)	TABLE ANGLE (Degree)	RAW VALUE (dBuV)	CORRECTION FACTOR (dB/m)
1	5150.00	54.0 PK	74.0	-20.0	2.14 V	290	52.1	1.9
2	5150.00	39.2 AV	54.0	-14.8	2.14 V	290	37.3	1.9
3	*5180.00	107.5 PK			2.17 V	289	68.7	38.8
4	*5180.00	96.4 AV			2.17 V	289	57.6	38.8
5	#10360.00	56.1 PK	74.0	-17.9	1.58 V	244	41.6	14.5
6	#10360.00	41.3 AV	54.0	-12.7	1.58 V	244	26.8	14.5

Remarks:

1. Emission Level(dBuV/m) = Raw Value(dBuV) + Correction Factor(dB/m)
2. Correction Factor(dB/m) = Antenna Factor(dB/m) + Cable Factor(dB) – Pre-Amplifier Factor(dB)
3. The other emission levels were very low against the limit.
4. Margin value = Emission Level – Limit value
5. " * ": Fundamental frequency.
6. " # ": The radiated frequency is out of the restricted band.

CHANNEL	TX Channel 40	DETECTOR FUNCTION	Peak (PK)
FREQUENCY RANGE	1GHz ~ 40GHz		Average (AV)

ANTENNA POLARITY & TEST DISTANCE: HORIZONTAL AT 3 M

NO.	FREQ. (MHz)	EMISSION LEVEL (dBuV/m)	LIMIT (dBuV/m)	MARGIN (dB)	ANTENNA HEIGHT (m)	TABLE ANGLE (Degree)	RAW VALUE (dBuV)	CORRECTION FACTOR (dB/m)
1	*5200.00	99.0 PK			1.45 H	317	60.3	38.7
2	*5200.00	88.9 AV			1.45 H	317	50.2	38.7
3	#10400.00	56.5 PK	74.0	-17.5	1.58 H	251	41.8	14.7
4	#10400.00	41.6 AV	54.0	-12.4	1.58 H	251	26.9	14.7

ANTENNA POLARITY & TEST DISTANCE: VERTICAL AT 3 M

NO.	FREQ. (MHz)	EMISSION LEVEL (dBuV/m)	LIMIT (dBuV/m)	MARGIN (dB)	ANTENNA HEIGHT (m)	TABLE ANGLE (Degree)	RAW VALUE (dBuV)	CORRECTION FACTOR (dB/m)
1	*5200.00	107.8 PK			2.19 V	290	69.1	38.7
2	*5200.00	97.0 AV			2.19 V	290	58.3	38.7
3	#10400.00	58.3 PK	74.0	-15.7	1.57 V	177	43.6	14.7
4	#10400.00	44.4 AV	54.0	-9.6	1.57 V	177	29.7	14.7

Remarks:

1. Emission Level(dBuV/m) = Raw Value(dBuV) + Correction Factor(dB/m)
2. Correction Factor(dB/m) = Antenna Factor(dB/m) + Cable Factor(dB) – Pre-Amplifier Factor(dB)
3. The other emission levels were very low against the limit.
4. Margin value = Emission Level – Limit value
5. " * ": Fundamental frequency.
6. " # ": The radiated frequency is out of the restricted band.

CHANNEL	TX Channel 48	DETECTOR FUNCTION	Peak (PK)
FREQUENCY RANGE	1GHz ~ 40GHz		Average (AV)

ANTENNA POLARITY & TEST DISTANCE: HORIZONTAL AT 3 M

NO.	FREQ. (MHz)	EMISSION LEVEL (dBuV/m)	LIMIT (dBuV/m)	MARGIN (dB)	ANTENNA HEIGHT (m)	TABLE ANGLE (Degree)	RAW VALUE (dBuV)	CORRECTION FACTOR (dB/m)
1	*5240.00	99.1 PK			1.65 H	315	60.6	38.5
2	*5240.00	87.9 AV			1.65 H	315	49.4	38.5
3	5350.00	53.4 PK	74.0	-20.6	1.66 H	312	51.6	1.8
4	5350.00	38.3 AV	54.0	-15.7	1.66 H	312	36.5	1.8
5	#10480.00	56.8 PK	74.0	-17.2	1.51 H	258	41.7	15.1
6	#10480.00	42.0 AV	54.0	-12.0	1.51 H	258	26.9	15.1

ANTENNA POLARITY & TEST DISTANCE: VERTICAL AT 3 M

NO.	FREQ. (MHz)	EMISSION LEVEL (dBuV/m)	LIMIT (dBuV/m)	MARGIN (dB)	ANTENNA HEIGHT (m)	TABLE ANGLE (Degree)	RAW VALUE (dBuV)	CORRECTION FACTOR (dB/m)
1	*5240.00	107.6 PK			2.29 V	288	69.1	38.5
2	*5240.00	96.4 AV			2.29 V	288	57.9	38.5
3	5350.00	52.2 PK	74.0	-21.8	2.24 V	287	50.4	1.8
4	5350.00	38.0 AV	54.0	-16.0	2.24 V	287	36.2	1.8
5	#10480.00	56.9 PK	74.0	-17.1	1.52 V	241	41.8	15.1
6	#10480.00	42.0 AV	54.0	-12.0	1.52 V	241	26.9	15.1

Remarks:

1. Emission Level(dBuV/m) = Raw Value(dBuV) + Correction Factor(dB/m)
2. Correction Factor(dB/m) = Antenna Factor(dB/m) + Cable Factor(dB) – Pre-Amplifier Factor(dB)
3. The other emission levels were very low against the limit.
4. Margin value = Emission Level – Limit value
5. " * ": Fundamental frequency.
6. " # ": The radiated frequency is out of the restricted band.

CHANNEL	TX Channel 52	DETECTOR FUNCTION	Peak (PK)
FREQUENCY RANGE	1GHz ~ 40GHz		Average (AV)

ANTENNA POLARITY & TEST DISTANCE: HORIZONTAL AT 3 M								
NO.	FREQ. (MHz)	EMISSION LEVEL (dBuV/m)	LIMIT (dBuV/m)	MARGIN (dB)	ANTENNA HEIGHT (m)	TABLE ANGLE (Degree)	RAW VALUE (dBuV)	CORRECTION FACTOR (dB/m)
1	5150.00	52.7 PK	74.0	-21.3	1.62 H	217	50.8	1.9
2	5150.00	40.3 AV	54.0	-13.7	1.62 H	217	38.4	1.9
3	*5260.00	98.6 PK			1.57 H	209	60.2	38.4
4	*5260.00	88.4 AV			1.57 H	209	50.0	38.4
5	#10520.00	57.6 PK	74.0	-16.4	1.61 H	269	42.4	15.2
6	#10520.00	43.8 AV	54.0	-10.2	1.61 H	269	28.6	15.2

ANTENNA POLARITY & TEST DISTANCE: VERTICAL AT 3 M								
NO.	FREQ. (MHz)	EMISSION LEVEL (dBuV/m)	LIMIT (dBuV/m)	MARGIN (dB)	ANTENNA HEIGHT (m)	TABLE ANGLE (Degree)	RAW VALUE (dBuV)	CORRECTION FACTOR (dB/m)
1	5150.00	53.1 PK	74.0	-20.9	2.77 V	294	51.2	1.9
2	5150.00	41.3 AV	54.0	-12.7	2.77 V	294	39.4	1.9
3	*5260.00	108.0 PK			2.70 V	287	69.6	38.4
4	*5260.00	98.0 AV			2.70 V	287	59.6	38.4
5	#10520.00	60.5 PK	74.0	-13.5	2.77 V	201	45.3	15.2
6	#10520.00	46.8 AV	54.0	-7.2	2.77 V	201	31.6	15.2

Remarks:

1. Emission Level(dBuV/m) = Raw Value(dBuV) + Correction Factor(dB/m)
2. Correction Factor(dB/m) = Antenna Factor(dB/m) + Cable Factor(dB) – Pre-Amplifier Factor(dB)
3. The other emission levels were very low against the limit.
4. Margin value = Emission Level – Limit value
5. " * ": Fundamental frequency.
6. " # ": The radiated frequency is out of the restricted band.

CHANNEL	TX Channel 60	DETECTOR FUNCTION	Peak (PK)
FREQUENCY RANGE	1GHz ~ 40GHz		Average (AV)

ANTENNA POLARITY & TEST DISTANCE: HORIZONTAL AT 3 M

NO.	FREQ. (MHz)	EMISSION LEVEL (dBuV/m)	LIMIT (dBuV/m)	MARGIN (dB)	ANTENNA HEIGHT (m)	TABLE ANGLE (Degree)	RAW VALUE (dBuV)	CORRECTION FACTOR (dB/m)
1	*5300.00	98.7 PK			1.56 H	218	60.2	38.5
2	*5300.00	88.6 AV			1.56 H	218	50.1	38.5
3	10600.00	55.7 PK	74.0	-18.3	1.64 H	273	40.6	15.1
4	10600.00	43.0 AV	54.0	-11.0	1.64 H	273	27.9	15.1

ANTENNA POLARITY & TEST DISTANCE: VERTICAL AT 3 M

NO.	FREQ. (MHz)	EMISSION LEVEL (dBuV/m)	LIMIT (dBuV/m)	MARGIN (dB)	ANTENNA HEIGHT (m)	TABLE ANGLE (Degree)	RAW VALUE (dBuV)	CORRECTION FACTOR (dB/m)
1	*5300.00	108.3 PK			2.74 V	287	69.8	38.5
2	*5300.00	98.2 AV			2.74 V	287	59.7	38.5
3	10600.00	63.9 PK	74.0	-10.1	2.94 V	196	48.8	15.1
4	10600.00	47.5 AV	54.0	-6.5	2.94 V	196	32.4	15.1

Remarks:

1. Emission Level(dBuV/m) = Raw Value(dBuV) + Correction Factor(dB/m)
2. Correction Factor(dB/m) = Antenna Factor(dB/m) + Cable Factor(dB) – Pre-Amplifier Factor(dB)
3. The other emission levels were very low against the limit.
4. Margin value = Emission Level – Limit value
5. " * ": Fundamental frequency.

CHANNEL	TX Channel 64	DETECTOR FUNCTION	Peak (PK)
FREQUENCY RANGE	1GHz ~ 40GHz		Average (AV)

ANTENNA POLARITY & TEST DISTANCE: HORIZONTAL AT 3 M

NO.	FREQ. (MHz)	EMISSION LEVEL (dBuV/m)	LIMIT (dBuV/m)	MARGIN (dB)	ANTENNA HEIGHT (m)	TABLE ANGLE (Degree)	RAW VALUE (dBuV)	CORRECTION FACTOR (dB/m)
1	*5320.00	97.1 PK			1.42 H	211	58.5	38.6
2	*5320.00	87.0 AV			1.42 H	211	48.4	38.6
3	5350.00	52.5 PK	74.0	-21.5	1.52 H	223	50.7	1.8
4	5350.00	39.9 AV	54.0	-14.1	1.52 H	223	38.1	1.8
5	10640.00	55.4 PK	74.0	-18.6	1.51 H	264	40.2	15.2
6	10640.00	42.4 AV	54.0	-11.6	1.51 H	264	27.2	15.2

ANTENNA POLARITY & TEST DISTANCE: VERTICAL AT 3 M

NO.	FREQ. (MHz)	EMISSION LEVEL (dBuV/m)	LIMIT (dBuV/m)	MARGIN (dB)	ANTENNA HEIGHT (m)	TABLE ANGLE (Degree)	RAW VALUE (dBuV)	CORRECTION FACTOR (dB/m)
1	*5320.00	107.7 PK			2.68 V	311	69.1	38.6
2	*5320.00	97.5 AV			2.68 V	311	58.9	38.6
3	5350.00	53.7 PK	74.0	-20.3	2.85 V	318	51.9	1.8
4	5350.00	42.0 AV	54.0	-12.0	2.85 V	318	40.2	1.8
5	10640.00	61.1 PK	74.0	-12.9	2.72 V	200	45.9	15.2
6	10640.00	48.1 AV	54.0	-5.9	2.72 V	200	32.9	15.2

Remarks:

1. Emission Level(dBuV/m) = Raw Value(dBuV) + Correction Factor(dB/m)
2. Correction Factor(dB/m) = Antenna Factor(dB/m) + Cable Factor(dB) – Pre-Amplifier Factor(dB)
3. The other emission levels were very low against the limit.
4. Margin value = Emission Level – Limit value
5. " * ": Fundamental frequency.

CHANNEL	TX Channel 100	DETECTOR FUNCTION	Peak (PK)
FREQUENCY RANGE	1GHz ~ 40GHz		Average (AV)

ANTENNA POLARITY & TEST DISTANCE: HORIZONTAL AT 3 M

NO.	FREQ. (MHz)	EMISSION LEVEL (dBuV/m)	LIMIT (dBuV/m)	MARGIN (dB)	ANTENNA HEIGHT (m)	TABLE ANGLE (Degree)	RAW VALUE (dBuV)	CORRECTION FACTOR (dB/m)
1	5460.00	54.5 PK	74.0	-19.5	1.68 H	214	52.3	2.2
2	5460.00	40.7 AV	54.0	-13.3	1.68 H	214	38.5	2.2
3	#5470.00	55.3 PK	74.0	-18.7	1.68 H	213	53.1	2.2
4	#5470.00	40.6 AV	54.0	-13.4	1.68 H	213	38.4	2.2
5	*5500.00	96.8 PK			1.66 H	216	57.6	39.2
6	*5500.00	85.6 AV			1.66 H	216	46.4	39.2
7	11000.00	57.0 PK	74.0	-17.0	2.35 H	191	40.0	17.0
8	11000.00	43.0 AV	54.0	-11.0	2.35 H	191	26.0	17.0

ANTENNA POLARITY & TEST DISTANCE: VERTICAL AT 3 M

NO.	FREQ. (MHz)	EMISSION LEVEL (dBuV/m)	LIMIT (dBuV/m)	MARGIN (dB)	ANTENNA HEIGHT (m)	TABLE ANGLE (Degree)	RAW VALUE (dBuV)	CORRECTION FACTOR (dB/m)
1	5460.00	54.4 PK	74.0	-19.6	2.27 V	220	52.2	2.2
2	5460.00	40.8 AV	54.0	-13.2	2.27 V	220	38.6	2.2
3	#5470.00	55.1 PK	74.0	-18.9	2.30 V	216	52.9	2.2
4	#5470.00	41.1 AV	54.0	-12.9	2.30 V	216	38.9	2.2
5	*5500.00	107.8 PK			2.26 V	217	68.6	39.2
6	*5500.00	96.6 AV			2.26 V	217	57.4	39.2
7	11000.00	64.2 PK	74.0	-9.8	2.25 V	195	47.2	17.0
8	11000.00	48.1 AV	54.0	-5.9	2.25 V	195	31.1	17.0

Remarks:

1. Emission Level(dBuV/m) = Raw Value(dBuV) + Correction Factor(dB/m)
2. Correction Factor(dB/m) = Antenna Factor(dB/m) + Cable Factor(dB) – Pre-Amplifier Factor(dB)
3. The other emission levels were very low against the limit.
4. Margin value = Emission Level – Limit value
5. " * ": Fundamental frequency.
6. " # ": The radiated frequency is out of the restricted band.

CHANNEL	TX Channel 116	DETECTOR FUNCTION	Peak (PK)
FREQUENCY RANGE	1GHz ~ 40GHz		Average (AV)

ANTENNA POLARITY & TEST DISTANCE: HORIZONTAL AT 3 M								
NO.	FREQ. (MHz)	EMISSION LEVEL (dBuV/m)	LIMIT (dBuV/m)	MARGIN (dB)	ANTENNA HEIGHT (m)	TABLE ANGLE (Degree)	RAW VALUE (dBuV)	CORRECTION FACTOR (dB/m)
1	*5580.00	99.8 PK			1.64 H	304	60.4	39.4
2	*5580.00	88.5 AV			1.64 H	304	49.1	39.4
3	11160.00	56.1 PK	74.0	-17.9	2.36 H	188	40.1	16.0
4	11160.00	41.8 AV	54.0	-12.2	2.36 H	188	25.8	16.0

ANTENNA POLARITY & TEST DISTANCE: VERTICAL AT 3 M								
NO.	FREQ. (MHz)	EMISSION LEVEL (dBuV/m)	LIMIT (dBuV/m)	MARGIN (dB)	ANTENNA HEIGHT (m)	TABLE ANGLE (Degree)	RAW VALUE (dBuV)	CORRECTION FACTOR (dB/m)
1	*5580.00	105.3 PK			2.34 V	215	65.9	39.4
2	*5580.00	97.3 AV			2.34 V	215	57.9	39.4
3	11160.00	61.2 PK	74.0	-12.8	2.35 V	194	45.2	16.0
4	11160.00	46.1 AV	54.0	-7.9	2.35 V	194	30.1	16.0

Remarks:

1. Emission Level(dBuV/m) = Raw Value(dBuV) + Correction Factor(dB/m)
2. Correction Factor(dB/m) = Antenna Factor(dB/m) + Cable Factor(dB) – Pre-Amplifier Factor(dB)
3. The other emission levels were very low against the limit.
4. Margin value = Emission Level – Limit value
5. " * ": Fundamental frequency.

CHANNEL	TX Channel 140	DETECTOR FUNCTION	Peak (PK)
FREQUENCY RANGE	1GHz ~ 40GHz		Average (AV)

ANTENNA POLARITY & TEST DISTANCE: HORIZONTAL AT 3 M

NO.	FREQ. (MHz)	EMISSION LEVEL (dBuV/m)	LIMIT (dBuV/m)	MARGIN (dB)	ANTENNA HEIGHT (m)	TABLE ANGLE (Degree)	RAW VALUE (dBuV)	CORRECTION FACTOR (dB/m)
1	*5700.00	97.3 PK			1.55 H	280	57.8	39.5
2	*5700.00	86.2 AV			1.55 H	280	46.7	39.5
3	#5725.00	54.5 PK	74.0	-19.5	1.53 H	281	51.7	2.8
4	#5725.00	40.4 AV	54.0	-13.6	1.53 H	281	37.6	2.8
5	11400.00	55.4 PK	74.0	-18.6	1.35 H	121	39.6	15.8
6	11400.00	40.3 AV	54.0	-13.7	1.35 H	121	24.5	15.8

ANTENNA POLARITY & TEST DISTANCE: VERTICAL AT 3 M

NO.	FREQ. (MHz)	EMISSION LEVEL (dBuV/m)	LIMIT (dBuV/m)	MARGIN (dB)	ANTENNA HEIGHT (m)	TABLE ANGLE (Degree)	RAW VALUE (dBuV)	CORRECTION FACTOR (dB/m)
1	*5700.00	106.9 PK			1.72 V	216	67.4	39.5
2	*5700.00	95.9 AV			1.72 V	216	56.4	39.5
3	#5725.00	54.6 PK	74.0	-19.4	1.93 V	217	51.8	2.8
4	#5725.00	40.7 AV	54.0	-13.3	1.93 V	217	37.9	2.8
5	11400.00	60.5 PK	74.0	-13.5	1.98 V	194	44.7	15.8
6	11400.00	44.3 AV	54.0	-9.7	1.98 V	194	28.5	15.8

Remarks:

1. Emission Level(dBuV/m) = Raw Value(dBuV) + Correction Factor(dB/m)
2. Correction Factor(dB/m) = Antenna Factor(dB/m) + Cable Factor(dB) – Pre-Amplifier Factor(dB)
3. The other emission levels were very low against the limit.
4. Margin value = Emission Level – Limit value
5. " * ": Fundamental frequency.
6. " # ": The radiated frequency is out of the restricted band.

CHANNEL	TX Channel 149	DETECTOR FUNCTION	Peak (PK)
FREQUENCY RANGE	1GHz ~ 40GHz		Average (AV)

ANTENNA POLARITY & TEST DISTANCE: HORIZONTAL AT 3 M

NO.	FREQ. (MHz)	EMISSION LEVEL (dBuV/m)	LIMIT (dBuV/m)	MARGIN (dB)	ANTENNA HEIGHT (m)	TABLE ANGLE (Degree)	RAW VALUE (dBuV)	CORRECTION FACTOR (dB/m)
1	#5604.80	54.9 PK	68.2	-13.3	1.92 H	210	52.4	2.5
2	*5745.00	98.7 PK			1.92 H	210	58.9	39.8
3	*5745.00	88.6 AV			1.92 H	210	48.8	39.8
4	#5981.60	55.4 PK	68.2	-12.8	1.92 H	210	51.6	3.8
5	11490.00	56.4 PK	74.0	-17.6	2.12 H	105	41.1	15.3
6	11490.00	42.9 AV	54.0	-11.1	2.12 H	105	27.6	15.3

ANTENNA POLARITY & TEST DISTANCE: VERTICAL AT 3 M

NO.	FREQ. (MHz)	EMISSION LEVEL (dBuV/m)	LIMIT (dBuV/m)	MARGIN (dB)	ANTENNA HEIGHT (m)	TABLE ANGLE (Degree)	RAW VALUE (dBuV)	CORRECTION FACTOR (dB/m)
1	#5642.40	55.7 PK	68.2	-12.5	2.54 V	303	53.1	2.6
2	*5745.00	108.4 PK			2.54 V	303	68.6	39.8
3	*5745.00	98.4 AV			2.54 V	303	58.6	39.8
4	#5997.60	55.3 PK	68.2	-12.9	2.54 V	303	51.6	3.7
5	11490.00	57.5 PK	74.0	-16.5	2.13 V	184	42.2	15.3
6	11490.00	44.5 AV	54.0	-9.5	2.13 V	184	29.2	15.3

Remarks:

1. Emission Level(dBuV/m) = Raw Value(dBuV) + Correction Factor(dB/m)
2. Correction Factor(dB/m) = Antenna Factor(dB/m) + Cable Factor(dB) – Pre-Amplifier Factor(dB)
3. The other emission levels were very low against the limit.
4. Margin value = Emission Level – Limit value
5. " * ": Fundamental frequency.
6. " # ": The radiated frequency is out of the restricted band.

CHANNEL	TX Channel 157	DETECTOR FUNCTION	Peak (PK)
FREQUENCY RANGE	1GHz ~ 40GHz		Average (AV)

ANTENNA POLARITY & TEST DISTANCE: HORIZONTAL AT 3 M

NO.	FREQ. (MHz)	EMISSION LEVEL (dBuV/m)	LIMIT (dBuV/m)	MARGIN (dB)	ANTENNA HEIGHT (m)	TABLE ANGLE (Degree)	RAW VALUE (dBuV)	CORRECTION FACTOR (dB/m)
1	#5640.00	55.4 PK	68.2	-12.8	1.97 H	210	52.8	2.6
2	*5785.00	97.8 PK			1.97 H	210	57.8	40.0
3	*5785.00	87.9 AV			1.97 H	210	47.9	40.0
4	#5972.80	55.1 PK	68.2	-13.1	1.97 H	210	51.4	3.7
5	11570.00	56.2 PK	74.0	-17.8	2.06 H	91	41.2	15.0
6	11570.00	42.2 AV	54.0	-11.8	2.06 H	91	27.2	15.0

ANTENNA POLARITY & TEST DISTANCE: VERTICAL AT 3 M

NO.	FREQ. (MHz)	EMISSION LEVEL (dBuV/m)	LIMIT (dBuV/m)	MARGIN (dB)	ANTENNA HEIGHT (m)	TABLE ANGLE (Degree)	RAW VALUE (dBuV)	CORRECTION FACTOR (dB/m)
1	#5600.80	54.7 PK	68.2	-13.5	2.58 V	305	52.2	2.5
2	*5785.00	108.1 PK			2.58 V	305	68.1	40.0
3	*5785.00	98.1 AV			2.58 V	305	58.1	40.0
4	#5990.40	54.9 PK	68.2	-13.3	2.58 V	305	51.2	3.7
5	11570.00	56.9 PK	74.0	-17.1	2.16 V	181	41.9	15.0
6	11570.00	43.8 AV	54.0	-10.2	2.16 V	181	28.8	15.0

Remarks:

1. Emission Level(dBuV/m) = Raw Value(dBuV) + Correction Factor(dB/m)
2. Correction Factor(dB/m) = Antenna Factor(dB/m) + Cable Factor(dB) – Pre-Amplifier Factor(dB)
3. The other emission levels were very low against the limit.
4. Margin value = Emission Level – Limit value
5. " * ": Fundamental frequency.
6. " # ": The radiated frequency is out of the restricted band.

CHANNEL	TX Channel 165	DETECTOR FUNCTION	Peak (PK)
FREQUENCY RANGE	1GHz ~ 40GHz		Average (AV)

ANTENNA POLARITY & TEST DISTANCE: HORIZONTAL AT 3 M

NO.	FREQ. (MHz)	EMISSION LEVEL (dBuV/m)	LIMIT (dBuV/m)	MARGIN (dB)	ANTENNA HEIGHT (m)	TABLE ANGLE (Degree)	RAW VALUE (dBuV)	CORRECTION FACTOR (dB/m)
1	#5612.00	54.5 PK	68.2	-13.7	2.11 H	208	52.0	2.5
2	*5825.00	97.5 PK			2.11 H	208	57.4	40.1
3	*5825.00	87.5 AV			2.11 H	208	47.4	40.1
4	#5976.80	55.1 PK	68.2	-13.1	2.11 H	208	51.4	3.7
5	11650.00	56.6 PK	74.0	-17.4	2.18 H	84	41.7	14.9
6	11650.00	42.7 AV	54.0	-11.3	2.18 H	84	27.8	14.9

ANTENNA POLARITY & TEST DISTANCE: VERTICAL AT 3 M

NO.	FREQ. (MHz)	EMISSION LEVEL (dBuV/m)	LIMIT (dBuV/m)	MARGIN (dB)	ANTENNA HEIGHT (m)	TABLE ANGLE (Degree)	RAW VALUE (dBuV)	CORRECTION FACTOR (dB/m)
1	#5616.80	55.3 PK	68.2	-12.9	2.64 V	306	52.8	2.5
2	*5825.00	106.7 PK			2.64 V	306	66.6	40.1
3	*5825.00	96.6 AV			2.64 V	306	56.5	40.1
4	#5984.80	55.0 PK	68.2	-13.2	2.64 V	306	51.2	3.8
5	11650.00	57.2 PK	74.0	-16.8	2.23 V	192	42.3	14.9
6	11650.00	44.0 AV	54.0	-10.0	2.23 V	192	29.1	14.9

Remarks:

1. Emission Level(dBuV/m) = Raw Value(dBuV) + Correction Factor(dB/m)
2. Correction Factor(dB/m) = Antenna Factor(dB/m) + Cable Factor(dB) – Pre-Amplifier Factor(dB)
3. The other emission levels were very low against the limit.
4. Margin value = Emission Level – Limit value
5. " * ": Fundamental frequency.
6. " # ": The radiated frequency is out of the restricted band.

802.11n (HT40)

CHANNEL	TX Channel 38	DETECTOR FUNCTION	Peak (PK)
FREQUENCY RANGE	1GHz ~ 40GHz		Average (AV)

ANTENNA POLARITY & TEST DISTANCE: HORIZONTAL AT 3 M

NO.	FREQ. (MHz)	EMISSION LEVEL (dBuV/m)	LIMIT (dBuV/m)	MARGIN (dB)	ANTENNA HEIGHT (m)	TABLE ANGLE (Degree)	RAW VALUE (dBuV)	CORRECTION FACTOR (dB/m)
1	5150.00	55.7 PK	74.0	-18.3	1.52 H	314	53.8	1.9
2	5150.00	40.1 AV	54.0	-13.9	1.52 H	314	38.2	1.9
3	*5190.00	96.8 PK			1.48 H	317	58.1	38.7
4	*5190.00	85.7 AV			1.48 H	317	47.0	38.7
5	#10380.00	56.4 PK	74.0	-17.6	1.58 H	255	41.8	14.6
6	#10380.00	41.5 AV	54.0	-12.5	1.58 H	255	26.9	14.6

ANTENNA POLARITY & TEST DISTANCE: VERTICAL AT 3 M

NO.	FREQ. (MHz)	EMISSION LEVEL (dBuV/m)	LIMIT (dBuV/m)	MARGIN (dB)	ANTENNA HEIGHT (m)	TABLE ANGLE (Degree)	RAW VALUE (dBuV)	CORRECTION FACTOR (dB/m)
1	5150.00	58.9 PK	74.0	-15.1	2.29 V	299	57.0	1.9
2	5150.00	42.7 AV	54.0	-11.3	2.29 V	299	40.8	1.9
3	*5190.00	104.8 PK			2.28 V	288	66.1	38.7
4	*5190.00	93.5 AV			2.28 V	288	54.8	38.7
5	#10380.00	56.2 PK	74.0	-17.8	1.55 V	247	41.6	14.6
6	#10380.00	41.2 AV	54.0	-12.8	1.55 V	247	26.6	14.6

Remarks:

1. Emission Level(dBuV/m) = Raw Value(dBuV) + Correction Factor(dB/m)
2. Correction Factor(dB/m) = Antenna Factor(dB/m) + Cable Factor(dB) – Pre-Amplifier Factor(dB)
3. The other emission levels were very low against the limit.
4. Margin value = Emission Level – Limit value
5. " * ": Fundamental frequency.
6. " # ": The radiated frequency is out of the restricted band.

CHANNEL	TX Channel 46	DETECTOR FUNCTION	Peak (PK)
FREQUENCY RANGE	1GHz ~ 40GHz		Average (AV)

ANTENNA POLARITY & TEST DISTANCE: HORIZONTAL AT 3 M

NO.	FREQ. (MHz)	EMISSION LEVEL (dBuV/m)	LIMIT (dBuV/m)	MARGIN (dB)	ANTENNA HEIGHT (m)	TABLE ANGLE (Degree)	RAW VALUE (dBuV)	CORRECTION FACTOR (dB/m)
1	*5230.00	95.3 PK			1.53 H	316	56.8	38.5
2	*5230.00	84.6 AV			1.53 H	316	46.1	38.5
3	5350.00	55.7 PK	74.0	-18.3	1.55 H	317	53.9	1.8
4	5350.00	40.4 AV	54.0	-13.6	1.55 H	317	38.6	1.8
5	#10460.00	56.5 PK	74.0	-17.5	1.55 H	251	41.6	14.9
6	#10460.00	41.8 AV	54.0	-12.2	1.55 H	251	26.9	14.9

ANTENNA POLARITY & TEST DISTANCE: VERTICAL AT 3 M

NO.	FREQ. (MHz)	EMISSION LEVEL (dBuV/m)	LIMIT (dBuV/m)	MARGIN (dB)	ANTENNA HEIGHT (m)	TABLE ANGLE (Degree)	RAW VALUE (dBuV)	CORRECTION FACTOR (dB/m)
1	*5230.00	104.4 PK			2.26 V	290	65.9	38.5
2	*5230.00	93.1 AV			2.26 V	290	54.6	38.5
3	5350.00	58.1 PK	74.0	-15.9	2.32 V	291	56.3	1.8
4	5350.00	41.4 AV	54.0	-12.6	2.32 V	291	39.6	1.8
5	#10460.00	56.7 PK	74.0	-17.3	1.62 V	244	41.8	14.9
6	#10460.00	41.8 AV	54.0	-12.2	1.62 V	244	26.9	14.9

Remarks:

1. Emission Level(dBuV/m) = Raw Value(dBuV) + Correction Factor(dB/m)
2. Correction Factor(dB/m) = Antenna Factor(dB/m) + Cable Factor(dB) – Pre-Amplifier Factor(dB)
3. The other emission levels were very low against the limit.
4. Margin value = Emission Level – Limit value
5. " * ": Fundamental frequency.
6. " # ": The radiated frequency is out of the restricted band.

CHANNEL	TX Channel 54	DETECTOR FUNCTION	Peak (PK)
FREQUENCY RANGE	1GHz ~ 40GHz		Average (AV)

ANTENNA POLARITY & TEST DISTANCE: HORIZONTAL AT 3 M								
NO.	FREQ. (MHz)	EMISSION LEVEL (dBuV/m)	LIMIT (dBuV/m)	MARGIN (dB)	ANTENNA HEIGHT (m)	TABLE ANGLE (Degree)	RAW VALUE (dBuV)	CORRECTION FACTOR (dB/m)
1	5150.00	52.7 PK	74.0	-21.3	1.62 H	227	50.8	1.9
2	5150.00	39.7 AV	54.0	-14.3	1.62 H	227	37.8	1.9
3	*5270.00	95.4 PK			1.57 H	216	56.9	38.5
4	*5270.00	85.3 AV			1.57 H	216	46.8	38.5
5	#10540.00	56.3 PK	74.0	-17.7	1.62 H	278	41.1	15.2
6	#10540.00	44.0 AV	54.0	-10.0	1.62 H	278	28.8	15.2

ANTENNA POLARITY & TEST DISTANCE: VERTICAL AT 3 M								
NO.	FREQ. (MHz)	EMISSION LEVEL (dBuV/m)	LIMIT (dBuV/m)	MARGIN (dB)	ANTENNA HEIGHT (m)	TABLE ANGLE (Degree)	RAW VALUE (dBuV)	CORRECTION FACTOR (dB/m)
1	5150.00	53.1 PK	74.0	-20.9	2.31 V	318	51.2	1.9
2	5150.00	40.3 AV	54.0	-13.7	2.31 V	318	38.4	1.9
3	*5270.00	104.3 PK			2.48 V	310	65.8	38.5
4	*5270.00	94.2 AV			2.48 V	310	55.7	38.5
5	#10540.00	60.8 PK	74.0	-13.2	2.23 V	218	45.6	15.2
6	#10540.00	47.6 AV	54.0	-6.4	2.23 V	218	32.4	15.2

Remarks:

1. Emission Level(dBuV/m) = Raw Value(dBuV) + Correction Factor(dB/m)
2. Correction Factor(dB/m) = Antenna Factor(dB/m) + Cable Factor(dB) – Pre-Amplifier Factor(dB)
3. The other emission levels were very low against the limit.
4. Margin value = Emission Level – Limit value
5. " * ": Fundamental frequency.
6. " # ": The radiated frequency is out of the restricted band.

CHANNEL	TX Channel 62	DETECTOR FUNCTION	Peak (PK)
FREQUENCY RANGE	1GHz ~ 40GHz		Average (AV)

ANTENNA POLARITY & TEST DISTANCE: HORIZONTAL AT 3 M

NO.	FREQ. (MHz)	EMISSION LEVEL (dBuV/m)	LIMIT (dBuV/m)	MARGIN (dB)	ANTENNA HEIGHT (m)	TABLE ANGLE (Degree)	RAW VALUE (dBuV)	CORRECTION FACTOR (dB/m)
1	*5310.00	96.1 PK			1.47 H	214	57.6	38.5
2	*5310.00	85.9 AV			1.47 H	214	47.4	38.5
3	5350.00	53.1 PK	74.0	-20.9	1.68 H	224	51.3	1.8
4	5350.00	41.2 AV	54.0	-12.8	1.68 H	224	39.4	1.8
5	10620.00	56.0 PK	74.0	-18.0	1.63 H	261	40.8	15.2
6	10620.00	44.4 AV	54.0	-9.6	1.63 H	261	29.2	15.2

ANTENNA POLARITY & TEST DISTANCE: VERTICAL AT 3 M

NO.	FREQ. (MHz)	EMISSION LEVEL (dBuV/m)	LIMIT (dBuV/m)	MARGIN (dB)	ANTENNA HEIGHT (m)	TABLE ANGLE (Degree)	RAW VALUE (dBuV)	CORRECTION FACTOR (dB/m)
1	*5310.00	104.9 PK			2.46 V	271	66.4	38.5
2	*5310.00	94.8 AV			2.46 V	271	56.3	38.5
3	5350.00	58.0 PK	74.0	-16.0	2.54 V	268	56.2	1.8
4	5350.00	43.6 AV	54.0	-10.4	2.54 V	268	41.8	1.8
5	10620.00	60.6 PK	74.0	-13.4	2.03 V	224	45.4	15.2
6	10620.00	47.5 AV	54.0	-6.5	2.03 V	224	32.3	15.2

Remarks:

1. Emission Level(dBuV/m) = Raw Value(dBuV) + Correction Factor(dB/m)
2. Correction Factor(dB/m) = Antenna Factor(dB/m) + Cable Factor(dB) – Pre-Amplifier Factor(dB)
3. The other emission levels were very low against the limit.
4. Margin value = Emission Level – Limit value
5. " * ": Fundamental frequency.

CHANNEL	TX Channel 102	DETECTOR FUNCTION	Peak (PK)
FREQUENCY RANGE	1GHz ~ 40GHz		Average (AV)

ANTENNA POLARITY & TEST DISTANCE: HORIZONTAL AT 3 M								
NO.	FREQ. (MHz)	EMISSION LEVEL (dBuV/m)	LIMIT (dBuV/m)	MARGIN (dB)	ANTENNA HEIGHT (m)	TABLE ANGLE (Degree)	RAW VALUE (dBuV)	CORRECTION FACTOR (dB/m)
1	5460.00	59.6 PK	74.0	-14.4	2.24 H	218	57.4	2.2
2	5460.00	42.3 AV	54.0	-11.7	2.24 H	218	40.1	2.2
3	#5470.00	61.4 PK	74.0	-12.6	2.26 H	222	59.2	2.2
4	#5470.00	43.4 AV	54.0	-10.6	2.26 H	222	41.2	2.2
5	*5510.00	95.8 PK			2.19 H	223	56.5	39.3
6	*5510.00	84.4 AV			2.19 H	223	45.1	39.3
7	11020.00	55.6 PK	74.0	-18.4	1.37 H	119	38.7	16.9
8	11020.00	41.7 AV	54.0	-12.3	1.37 H	119	24.8	16.9
ANTENNA POLARITY & TEST DISTANCE: VERTICAL AT 3 M								
NO.	FREQ. (MHz)	EMISSION LEVEL (dBuV/m)	LIMIT (dBuV/m)	MARGIN (dB)	ANTENNA HEIGHT (m)	TABLE ANGLE (Degree)	RAW VALUE (dBuV)	CORRECTION FACTOR (dB/m)
1	5460.00	59.3 PK	74.0	-14.7	2.73 V	251	57.1	2.2
2	5460.00	42.1 AV	54.0	-11.9	2.73 V	251	39.9	2.2
3	#5470.00	62.5 PK	74.0	-11.5	2.84 V	250	60.3	2.2
4	#5470.00	46.1 AV	54.0	-7.9	2.84 V	250	43.9	2.2
5	*5510.00	104.9 PK			2.84 V	220	65.6	39.3
6	*5510.00	92.9 AV			2.84 V	220	53.6	39.3
7	11020.00	59.4 PK	74.0	-14.6	2.60 V	188	42.5	16.9
8	11020.00	44.9 AV	54.0	-9.1	2.60 V	188	28.0	16.9

Remarks:

1. Emission Level(dBuV/m) = Raw Value(dBuV) + Correction Factor(dB/m)
2. Correction Factor(dB/m) = Antenna Factor(dB/m) + Cable Factor(dB) – Pre-Amplifier Factor(dB)
3. The other emission levels were very low against the limit.
4. Margin value = Emission Level – Limit value
5. " * ": Fundamental frequency.
6. " # ": The radiated frequency is out of the restricted band.

CHANNEL	TX Channel 110	DETECTOR FUNCTION	Peak (PK)
FREQUENCY RANGE	1GHz ~ 40GHz		Average (AV)

ANTENNA POLARITY & TEST DISTANCE: HORIZONTAL AT 3 M

NO.	FREQ. (MHz)	EMISSION LEVEL (dBuV/m)	LIMIT (dBuV/m)	MARGIN (dB)	ANTENNA HEIGHT (m)	TABLE ANGLE (Degree)	RAW VALUE (dBuV)	CORRECTION FACTOR (dB/m)
1	*5550.00	95.0 PK			2.16 H	222	55.7	39.3
2	*5550.00	83.9 AV			2.16 H	222	44.6	39.3
3	11100.00	56.8 PK	74.0	-17.2	1.35 H	120	40.5	16.3
4	11100.00	42.4 AV	54.0	-11.6	1.35 H	120	26.1	16.3

ANTENNA POLARITY & TEST DISTANCE: VERTICAL AT 3 M

NO.	FREQ. (MHz)	EMISSION LEVEL (dBuV/m)	LIMIT (dBuV/m)	MARGIN (dB)	ANTENNA HEIGHT (m)	TABLE ANGLE (Degree)	RAW VALUE (dBuV)	CORRECTION FACTOR (dB/m)
1	*5550.00	104.9 PK			2.61 V	218	65.6	39.3
2	*5550.00	93.0 AV			2.61 V	218	53.7	39.3
3	11100.00	59.5 PK	74.0	-14.5	2.51 V	189	43.2	16.3
4	11100.00	44.7 AV	54.0	-9.3	2.51 V	189	28.4	16.3

Remarks:

1. Emission Level(dBuV/m) = Raw Value(dBuV) + Correction Factor(dB/m)
2. Correction Factor(dB/m) = Antenna Factor(dB/m) + Cable Factor(dB) – Pre-Amplifier Factor(dB)
3. The other emission levels were very low against the limit.
4. Margin value = Emission Level – Limit value
5. " * ": Fundamental frequency.

CHANNEL	TX Channel 134	DETECTOR FUNCTION	Peak (PK)
FREQUENCY RANGE	1GHz ~ 40GHz		Average (AV)

ANTENNA POLARITY & TEST DISTANCE: HORIZONTAL AT 3 M

NO.	FREQ. (MHz)	EMISSION LEVEL (dBuV/m)	LIMIT (dBuV/m)	MARGIN (dB)	ANTENNA HEIGHT (m)	TABLE ANGLE (Degree)	RAW VALUE (dBuV)	CORRECTION FACTOR (dB/m)
1	*5670.00	94.2 PK			2.21 H	296	54.7	39.5
2	*5670.00	83.3 AV			2.21 H	296	43.8	39.5
3	#5725.00	53.7 PK	74.0	-20.3	2.22 H	300	50.9	2.8
4	#5725.00	39.2 AV	54.0	-14.8	2.22 H	300	36.4	2.8
5	11340.00	56.0 PK	74.0	-18.0	1.27 H	124	39.8	16.2
6	11340.00	41.6 AV	54.0	-12.4	1.27 H	124	25.4	16.2

ANTENNA POLARITY & TEST DISTANCE: VERTICAL AT 3 M

NO.	FREQ. (MHz)	EMISSION LEVEL (dBuV/m)	LIMIT (dBuV/m)	MARGIN (dB)	ANTENNA HEIGHT (m)	TABLE ANGLE (Degree)	RAW VALUE (dBuV)	CORRECTION FACTOR (dB/m)
1	*5670.00	103.1 PK			2.37 V	208	63.6	39.5
2	*5670.00	92.3 AV			2.37 V	208	52.8	39.5
3	#5725.00	53.8 PK	74.0	-20.2	2.22 V	206	51.0	2.8
4	#5725.00	39.4 AV	54.0	-14.6	2.22 V	206	36.6	2.8
5	11340.00	57.2 PK	74.0	-16.8	2.29 V	189	41.0	16.2
6	11340.00	42.6 AV	54.0	-11.4	2.29 V	189	26.4	16.2

Remarks:

1. Emission Level(dBuV/m) = Raw Value(dBuV) + Correction Factor(dB/m)
2. Correction Factor(dB/m) = Antenna Factor(dB/m) + Cable Factor(dB) – Pre-Amplifier Factor(dB)
3. The other emission levels were very low against the limit.
4. Margin value = Emission Level – Limit value
5. " * ": Fundamental frequency.
6. " # ": The radiated frequency is out of the restricted band.

CHANNEL	TX Channel 151	DETECTOR FUNCTION	Peak (PK)
FREQUENCY RANGE	1GHz ~ 40GHz		Average (AV)

ANTENNA POLARITY & TEST DISTANCE: HORIZONTAL AT 3 M

NO.	FREQ. (MHz)	EMISSION LEVEL (dBuV/m)	LIMIT (dBuV/m)	MARGIN (dB)	ANTENNA HEIGHT (m)	TABLE ANGLE (Degree)	RAW VALUE (dBuV)	CORRECTION FACTOR (dB/m)
1	#5607.20	55.0 PK	68.2	-13.2	1.92 H	210	52.5	2.5
2	*5755.00	95.5 PK			1.92 H	210	55.6	39.9
3	*5755.00	85.4 AV			1.92 H	210	45.5	39.9
4	#5968.80	55.5 PK	68.2	-12.7	1.92 H	210	51.8	3.7
5	11510.00	56.6 PK	74.0	-17.4	2.08 H	102	41.4	15.2
6	11510.00	42.5 AV	54.0	-11.5	2.08 H	102	27.3	15.2

ANTENNA POLARITY & TEST DISTANCE: VERTICAL AT 3 M

NO.	FREQ. (MHz)	EMISSION LEVEL (dBuV/m)	LIMIT (dBuV/m)	MARGIN (dB)	ANTENNA HEIGHT (m)	TABLE ANGLE (Degree)	RAW VALUE (dBuV)	CORRECTION FACTOR (dB/m)
1	#5640.80	54.3 PK	68.2	-13.9	2.54 V	304	51.7	2.6
2	*5755.00	105.2 PK			2.54 V	304	65.3	39.9
3	*5755.00	95.0 AV			2.54 V	304	55.1	39.9
4	#5936.00	55.3 PK	68.2	-12.9	2.54 V	304	51.6	3.7
5	11510.00	56.9 PK	74.0	-17.1	2.17 V	193	41.7	15.2
6	11510.00	43.8 AV	54.0	-10.2	2.17 V	193	28.6	15.2

Remarks:

1. Emission Level(dBuV/m) = Raw Value(dBuV) + Correction Factor(dB/m)
2. Correction Factor(dB/m) = Antenna Factor(dB/m) + Cable Factor(dB) – Pre-Amplifier Factor(dB)
3. The other emission levels were very low against the limit.
4. Margin value = Emission Level – Limit value
5. " * ": Fundamental frequency.
6. " # ": The radiated frequency is out of the restricted band.

CHANNEL	TX Channel 159	DETECTOR FUNCTION	Peak (PK)
FREQUENCY RANGE	1GHz ~ 40GHz		Average (AV)

ANTENNA POLARITY & TEST DISTANCE: HORIZONTAL AT 3 M

NO.	FREQ. (MHz)	EMISSION LEVEL (dBuV/m)	LIMIT (dBuV/m)	MARGIN (dB)	ANTENNA HEIGHT (m)	TABLE ANGLE (Degree)	RAW VALUE (dBuV)	CORRECTION FACTOR (dB/m)
1	#5616.80	54.8 PK	68.2	-13.4	2.17 H	252	52.3	2.5
2	*5795.00	94.6 PK			2.17 H	252	54.5	40.1
3	*5795.00	84.8 AV			2.17 H	252	44.7	40.1
4	#5964.00	55.4 PK	68.2	-12.8	2.17 H	252	51.7	3.7
5	11590.00	56.2 PK	74.0	-17.8	2.18 H	97	41.2	15.0
6	11590.00	42.5 AV	54.0	-11.5	2.18 H	97	27.5	15.0

ANTENNA POLARITY & TEST DISTANCE: VERTICAL AT 3 M

NO.	FREQ. (MHz)	EMISSION LEVEL (dBuV/m)	LIMIT (dBuV/m)	MARGIN (dB)	ANTENNA HEIGHT (m)	TABLE ANGLE (Degree)	RAW VALUE (dBuV)	CORRECTION FACTOR (dB/m)
1	#5608.80	54.4 PK	68.2	-13.8	2.66 V	305	51.9	2.5
2	*5795.00	104.3 PK			2.66 V	305	64.2	40.1
3	*5795.00	94.2 AV			2.66 V	305	54.1	40.1
4	#5990.40	55.1 PK	68.2	-13.1	2.66 V	305	51.4	3.7
5	11590.00	56.6 PK	74.0	-17.4	2.06 V	191	41.6	15.0
6	11590.00	43.3 AV	54.0	-10.7	2.06 V	191	28.3	15.0

Remarks:

1. Emission Level(dBuV/m) = Raw Value(dBuV) + Correction Factor(dB/m)
2. Correction Factor(dB/m) = Antenna Factor(dB/m) + Cable Factor(dB) – Pre-Amplifier Factor(dB)
3. The other emission levels were very low against the limit.
4. Margin value = Emission Level – Limit value
5. " * ": Fundamental frequency.
6. " # ": The radiated frequency is out of the restricted band.

802.11ac (VHT80)

CHANNEL	TX Channel 42	DETECTOR FUNCTION	Peak (PK)
FREQUENCY RANGE	1GHz ~ 40GHz		Average (AV)

ANTENNA POLARITY & TEST DISTANCE: HORIZONTAL AT 3 M

NO.	FREQ. (MHz)	EMISSION LEVEL (dBuV/m)	LIMIT (dBuV/m)	MARGIN (dB)	ANTENNA HEIGHT (m)	TABLE ANGLE (Degree)	RAW VALUE (dBuV)	CORRECTION FACTOR (dB/m)
1	5150.00	53.8 PK	74.0	-20.2	1.42 H	321	51.9	1.9
2	5150.00	40.7 AV	54.0	-13.3	1.42 H	321	38.8	1.9
3	*5210.00	92.9 PK			1.46 H	317	54.3	38.6
4	*5210.00	84.3 AV			1.46 H	317	45.7	38.6
5	5350.00	53.1 PK	74.0	-20.9	1.46 H	322	51.3	1.8
6	5350.00	40.2 AV	54.0	-13.8	1.46 H	322	38.4	1.8
7	#10420.00	56.0 PK	74.0	-18.0	1.53 H	257	41.3	14.7
8	#10420.00	43.6 AV	54.0	-10.4	1.53 H	257	28.9	14.7

ANTENNA POLARITY & TEST DISTANCE: VERTICAL AT 3 M

NO.	FREQ. (MHz)	EMISSION LEVEL (dBuV/m)	LIMIT (dBuV/m)	MARGIN (dB)	ANTENNA HEIGHT (m)	TABLE ANGLE (Degree)	RAW VALUE (dBuV)	CORRECTION FACTOR (dB/m)
1	5150.00	56.5 PK	74.0	-17.5	2.22 V	294	54.6	1.9
2	5150.00	44.4 AV	54.0	-9.6	2.22 V	294	42.5	1.9
3	*5210.00	101.2 PK			2.25 V	290	62.6	38.6
4	*5210.00	92.1 AV			2.25 V	290	53.5	38.6
5	5350.00	53.4 PK	74.0	-20.6	2.23 V	292	51.6	1.8
6	5350.00	40.4 AV	54.0	-13.6	2.23 V	292	38.6	1.8
7	#10420.00	55.9 PK	74.0	-18.1	1.58 V	241	41.2	14.7
8	#10420.00	43.3 AV	54.0	-10.7	1.58 V	241	28.6	14.7

Remarks:

1. Emission Level(dBuV/m) = Raw Value(dBuV) + Correction Factor(dB/m)
2. Correction Factor(dB/m) = Antenna Factor(dB/m) + Cable Factor(dB) – Pre-Amplifier Factor(dB)
3. The other emission levels were very low against the limit.
4. Margin value = Emission Level – Limit value
5. " * ": Fundamental frequency.
6. " # ": The radiated frequency is out of the restricted band.

CHANNEL	TX Channel 58	DETECTOR FUNCTION	Peak (PK)
FREQUENCY RANGE	1GHz ~ 40GHz		Average (AV)

ANTENNA POLARITY & TEST DISTANCE: HORIZONTAL AT 3 M

NO.	FREQ. (MHz)	EMISSION LEVEL (dBuV/m)	LIMIT (dBuV/m)	MARGIN (dB)	ANTENNA HEIGHT (m)	TABLE ANGLE (Degree)	RAW VALUE (dBuV)	CORRECTION FACTOR (dB/m)
1	*5290.00	91.4 PK			1.53 H	212	52.9	38.5
2	*5290.00	81.3 AV			1.53 H	212	42.8	38.5
3	5350.00	52.9 PK	74.0	-21.1	1.69 H	224	51.1	1.8
4	5350.00	40.0 AV	54.0	-14.0	1.69 H	224	38.2	1.8
5	#10580.00	55.8 PK	74.0	-18.2	1.71 H	268	40.8	15.0
6	#10580.00	43.6 AV	54.0	-10.4	1.71 H	268	28.6	15.0

ANTENNA POLARITY & TEST DISTANCE: VERTICAL AT 3 M

NO.	FREQ. (MHz)	EMISSION LEVEL (dBuV/m)	LIMIT (dBuV/m)	MARGIN (dB)	ANTENNA HEIGHT (m)	TABLE ANGLE (Degree)	RAW VALUE (dBuV)	CORRECTION FACTOR (dB/m)
1	*5290.00	101.0 PK			2.61 V	247	62.5	38.5
2	*5290.00	91.0 AV			2.61 V	247	52.5	38.5
3	5350.00	54.4 PK	74.0	-19.6	2.73 V	252	52.6	1.8
4	5350.00	42.1 AV	54.0	-11.9	2.73 V	252	40.3	1.8
5	#10580.00	58.6 PK	74.0	-15.4	2.14 V	209	43.6	15.0
6	#10580.00	45.8 AV	54.0	-8.2	2.14 V	209	30.8	15.0

Remarks:

1. Emission Level(dBuV/m) = Raw Value(dBuV) + Correction Factor(dB/m)
2. Correction Factor(dB/m) = Antenna Factor(dB/m) + Cable Factor(dB) – Pre-Amplifier Factor(dB)
3. The other emission levels were very low against the limit.
4. Margin value = Emission Level – Limit value
5. " * ": Fundamental frequency.
6. " # ": The radiated frequency is out of the restricted band.

CHANNEL	TX Channel 106	DETECTOR FUNCTION	Peak (PK)
FREQUENCY RANGE	1GHz ~ 40GHz		Average (AV)

ANTENNA POLARITY & TEST DISTANCE: HORIZONTAL AT 3 M

NO.	FREQ. (MHz)	EMISSION LEVEL (dBuV/m)	LIMIT (dBuV/m)	MARGIN (dB)	ANTENNA HEIGHT (m)	TABLE ANGLE (Degree)	RAW VALUE (dBuV)	CORRECTION FACTOR (dB/m)
1	5460.00	55.8 PK	74.0	-18.2	1.53 H	288	53.6	2.2
2	5460.00	43.1 AV	54.0	-10.9	1.53 H	288	40.9	2.2
3	#5470.00	56.5 PK	74.0	-17.5	1.60 H	289	54.3	2.2
4	#5470.00	43.7 AV	54.0	-10.3	1.60 H	289	41.5	2.2
5	*5530.00	92.5 PK			1.60 H	302	53.2	39.3
6	*5530.00	82.7 AV			1.60 H	302	43.4	39.3
7	#5725.00	53.5 PK	74.0	-20.5	1.55 H	279	50.7	2.8
8	#5725.00	39.9 AV	54.0	-14.1	1.55 H	279	37.1	2.8
9	11060.00	56.3 PK	74.0	-17.7	1.61 H	3	39.8	16.5
10	11060.00	43.7 AV	54.0	-10.3	1.61 H	3	27.2	16.5

ANTENNA POLARITY & TEST DISTANCE: VERTICAL AT 3 M

NO.	FREQ. (MHz)	EMISSION LEVEL (dBuV/m)	LIMIT (dBuV/m)	MARGIN (dB)	ANTENNA HEIGHT (m)	TABLE ANGLE (Degree)	RAW VALUE (dBuV)	CORRECTION FACTOR (dB/m)
1	5460.00	61.5 PK	74.0	-12.5	2.34 V	218	59.3	2.2
2	5460.00	49.0 AV	54.0	-5.0	2.34 V	218	46.8	2.2
3	#5470.00	61.6 PK	74.0	-12.4	2.34 V	218	59.4	2.2
4	#5470.00	49.2 AV	54.0	-4.8	2.34 V	218	47.0	2.2
5	*5530.00	101.4 PK			2.34 V	216	62.1	39.3
6	*5530.00	92.3 AV			2.34 V	216	53.0	39.3
7	#5725.00	53.0 PK	74.0	-21.0	2.29 V	211	50.2	2.8
8	#5725.00	39.9 AV	54.0	-14.1	2.29 V	211	37.1	2.8
9	11060.00	58.5 PK	74.0	-15.5	2.66 V	187	42.0	16.5
10	11060.00	46.1 AV	54.0	-7.9	2.66 V	187	29.6	16.5

Remarks:

1. Emission Level(dBuV/m) = Raw Value(dBuV) + Correction Factor(dB/m)
2. Correction Factor(dB/m) = Antenna Factor(dB/m) + Cable Factor(dB) – Pre-Amplifier Factor(dB)
3. The other emission levels were very low against the limit.
4. Margin value = Emission Level – Limit value
5. " * ": Fundamental frequency.
6. " # ": The radiated frequency is out of the restricted band.

CHANNEL	TX Channel 155	DETECTOR FUNCTION	Peak (PK)
FREQUENCY RANGE	1GHz ~ 40GHz		Average (AV)

ANTENNA POLARITY & TEST DISTANCE: HORIZONTAL AT 3 M

NO.	FREQ. (MHz)	EMISSION LEVEL (dBuV/m)	LIMIT (dBuV/m)	MARGIN (dB)	ANTENNA HEIGHT (m)	TABLE ANGLE (Degree)	RAW VALUE (dBuV)	CORRECTION FACTOR (dB/m)
1	#5616.00	55.1 PK	68.2	-13.1	2.18 H	253	52.6	2.5
2	#5650.00	55.8 PK	68.2	-12.4	2.27 H	242	53.3	2.5
3	*5775.00	91.1 PK			2.18 H	253	51.1	40.0
4	*5775.00	81.0 AV			2.18 H	253	41.0	40.0
5	#5925.00	57.2 PK	68.2	-11.0	2.27 H	258	53.4	3.8
6	#5948.80	56.7 PK	68.2	-11.5	2.18 H	253	53.0	3.7
7	11550.00	56.5 PK	74.0	-17.5	2.14 H	86	41.4	15.1
8	11550.00	42.8 AV	54.0	-11.2	2.14 H	86	27.7	15.1

ANTENNA POLARITY & TEST DISTANCE: VERTICAL AT 3 M

NO.	FREQ. (MHz)	EMISSION LEVEL (dBuV/m)	LIMIT (dBuV/m)	MARGIN (dB)	ANTENNA HEIGHT (m)	TABLE ANGLE (Degree)	RAW VALUE (dBuV)	CORRECTION FACTOR (dB/m)
1	#5640.80	55.4 PK	68.2	-12.8	2.60 V	307	52.8	2.6
2	#5650.00	56.7 PK	68.2	-11.5	2.48 V	294	54.2	2.5
3	*5775.00	101.2 PK			2.60 V	307	61.2	40.0
4	*5775.00	91.1 AV			2.60 V	307	51.1	40.0
5	#5925.00	57.6 PK	68.2	-10.6	2.66 V	314	53.8	3.8
6	#5968.00	55.1 PK	68.2	-13.1	2.60 V	307	51.4	3.7
7	11550.00	56.6 PK	74.0	-17.4	2.19 V	173	41.5	15.1
8	11550.00	43.5 AV	54.0	-10.5	2.19 V	173	28.4	15.1

Remarks:

1. Emission Level(dBuV/m) = Raw Value(dBuV) + Correction Factor(dB/m)
2. Correction Factor(dB/m) = Antenna Factor(dB/m) + Cable Factor(dB) – Pre-Amplifier Factor(dB)
3. The other emission levels were very low against the limit.
4. Margin value = Emission Level – Limit value
5. " * ": Fundamental frequency.
6. " # ": The radiated frequency is out of the restricted band.

Below 1GHz worst-case data: 802.11a

CHANNEL	TX Channel 64	DETECTOR FUNCTION	Quasi-Peak (QP)
FREQUENCY RANGE	9kHz ~ 1GHz		

ANTENNA POLARITY & TEST DISTANCE: HORIZONTAL AT 3 M

NO.	FREQ. (MHz)	EMISSION LEVEL (dBuV/m)	LIMIT (dBuV/m)	MARGIN (dB)	ANTENNA HEIGHT (m)	TABLE ANGLE (Degree)	RAW VALUE (dBuV)	CORRECTION FACTOR (dB/m)
1	114.39	38.2 QP	43.5	-5.3	1.25 H	56	49.5	-11.3
2	198.78	38.5 QP	43.5	-5.0	1.50 H	223	49.5	-11.0
3	257.95	40.7 QP	46.0	-5.3	1.25 H	95	49.3	-8.6
4	372.41	39.5 QP	46.0	-6.5	1.00 H	105	45.2	-5.7
5	744.89	41.4 QP	46.0	-4.6	1.50 H	270	39.8	1.6
6	853.53	40.0 QP	46.0	-6.0	1.50 H	9	36.8	3.2

ANTENNA POLARITY & TEST DISTANCE: VERTICAL AT 3 M

NO.	FREQ. (MHz)	EMISSION LEVEL (dBuV/m)	LIMIT (dBuV/m)	MARGIN (dB)	ANTENNA HEIGHT (m)	TABLE ANGLE (Degree)	RAW VALUE (dBuV)	CORRECTION FACTOR (dB/m)
1	71.71	37.4 QP	40.0	-2.6	1.50 V	15	48.0	-10.6
2	178.41	33.4 QP	43.5	-10.1	1.25 V	273	42.7	-9.3
3	315.18	41.8 QP	46.0	-4.2	1.00 V	126	48.5	-6.7
4	486.87	41.2 QP	46.0	-4.8	1.00 V	92	44.9	-3.7
5	742.95	38.5 QP	46.0	-7.5	2.00 V	267	37.0	1.5
6	960.23	40.0 QP	54.0	-14.0	1.25 V	281	34.8	5.2

Remarks:

1. Emission Level(dBuV/m) = Raw Value(dBuV) + Correction Factor(dB/m)
2. Correction Factor(dB/m) = Antenna Factor(dB/m) + Cable Factor(dB) – Pre-Amplifier Factor(dB)
3. The other emission levels were very low against the limit of frequency range 30MHz ~ 1000MHz.
4. Margin value = Emission Level – Limit value
5. The emission levels were very low against the limit of frequency range 9kHz ~ 30MHz.

4.2 Conducted Emission Measurement

4.2.1 Limits of Conducted Emission Measurement

Frequency (MHz)	Conducted Limit (dBuV)	
	Quasi-peak	Average
0.15 - 0.5	66 - 56	56 - 46
0.50 - 5.0	56	46
5.0 - 30.0	60	50

- Note: 1. The lower limit shall apply at the transition frequencies.
 2. The limit decreases in line with the logarithm of the frequency in the range of 0.15 to 0.50MHz.

4.2.2 Test Instruments

Description & Manufacturer	Model No.	Serial No.	Cal. Date	Cal. Due
Test Receiver ROHDE & SCHWARZ	ESCI	100613	Nov. 23, 2017	Nov. 22, 2018
RF signal cable (with 10dB PAD) Woken	5D-FB	Cable-cond1-01	Sep. 05, 2017	Sep. 04, 2018
LISN ROHDE & SCHWARZ (EUT)	ESH3-Z5	835239/001	Mar. 06, 2018	Mar. 05, 2019
LISN ROHDE & SCHWARZ (Peripheral)	ESH3-Z5	100311	Aug. 15, 2017	Aug. 14, 2018
Software ADT	BV ADT_Cond_ V7.3.7.4	NA	NA	NA

- Note: 1. The calibration interval of the above test instruments is 12 months and the calibrations are traceable to NML/ROC and NIST/USA.
 2. The test was performed in HwaYa Shielded Room 1.
 3. The VCCI Site Registration No. is C-2040.

4.2.3 Test Procedures

- The EUT was placed 0.4 meters from the conducting wall of the shielded room with EUT being connected to the power mains through a line impedance stabilization network (LISN). Other support units were connected to the power mains through another LISN. The two LISNs provide 50 ohm/ 50uH of coupling impedance for the measuring instrument.
- Both lines of the power mains connected to the EUT were checked for maximum conducted interference.
- The frequency range from 150kHz to 30MHz was searched. Emission levels under (Limit - 20dB) was not recorded.

Note: The resolution bandwidth and video bandwidth of test receiver is 9kHz for quasi-peak detection (QP) and average detection (AV) at frequency 0.15MHz-30MHz.

4.2.4 Deviation from Test Standard

No deviation.

4.2.5 Test Setup

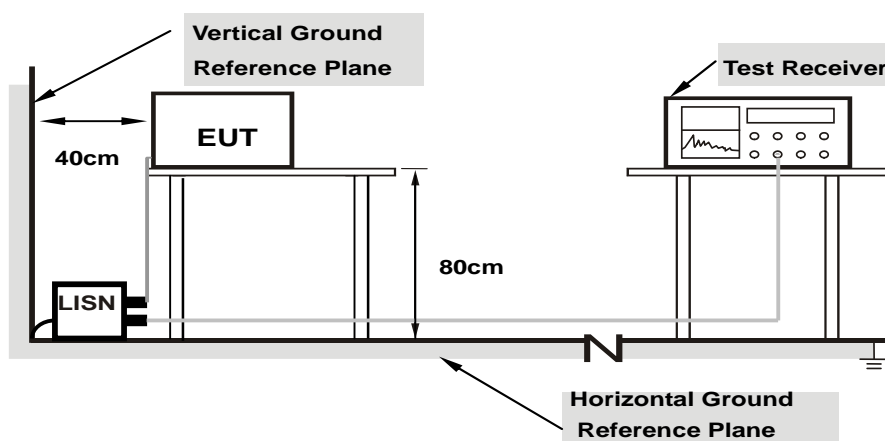

Note: 1.Support units were connected to second LISN.

For the actual test configuration, please refer to the attached file (Test Setup Photo).

4.2.6 EUT Operating Conditions

Same as 4.1.6.

4.2.7 Test Results

Phase	Line (L)	Detector Function	Quasi-Peak (QP) / Average (AV)
-------	----------	-------------------	--------------------------------

No	Freq. [MHz]	Corr. Factor (dB)	Reading Value [dB (uV)]		Emission Level [dB (uV)]		Limit [dB (uV)]		Margin (dB)	
			Q.P.	AV.	Q.P.	AV.	Q.P.	AV.	Q.P.	AV.
			1	0.15000	10.16	33.66	11.25	43.82	21.41	66.00
2	0.20201	10.15	35.73	32.01	45.88	42.16	63.53	53.53	-17.65	-11.37
3	0.34577	10.19	28.18	27.24	38.37	37.43	59.06	49.06	-20.69	-11.63
4	2.95400	10.29	16.87	5.01	27.16	15.30	56.00	46.00	-28.84	-30.70
5	12.66200	10.81	29.76	23.31	40.57	34.12	60.00	50.00	-19.43	-15.88
6	29.65000	11.43	25.94	18.90	37.37	30.33	60.00	50.00	-22.63	-19.67

Remarks:

1. Q.P. and AV. are abbreviations of quasi-peak and average individually.
2. The emission levels of other frequencies were very low against the limit.
3. Margin value = Emission level - Limit value
4. Correction factor = Insertion loss + Cable loss
5. Emission Level = Correction Factor + Reading Value.

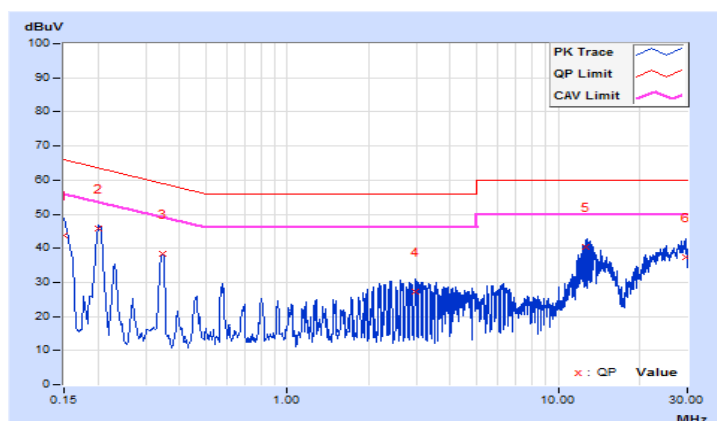

Phase	Neutral (N)	Detector Function	Quasi-Peak (QP) / Average (AV)
-------	-------------	-------------------	--------------------------------

No	Freq. [MHz]	Corr. Factor (dB)	Reading Value [dB (uV)]		Emission Level [dB (uV)]		Limit [dB (uV)]		Margin (dB)	
			Q.P.	AV.	Q.P.	AV.	Q.P.	AV.	Q.P.	AV.
			1	0.15000	10.14	33.55	11.47	43.69	21.61	66.00
2	0.20201	10.16	35.57	31.93	45.73	42.09	63.53	53.53	-17.80	-11.44
3	0.34214	10.19	29.64	27.18	39.83	37.37	59.15	49.15	-19.32	-11.78
4	3.87800	10.34	18.55	5.75	28.89	16.09	56.00	46.00	-27.11	-29.91
5	12.59000	10.69	32.62	26.41	43.31	37.10	60.00	50.00	-16.69	-12.90
6	29.98600	11.13	24.46	18.15	35.59	29.28	60.00	50.00	-24.41	-20.72

Remarks:

1. Q.P. and AV. are abbreviations of quasi-peak and average individually.
2. The emission levels of other frequencies were very low against the limit.
3. Margin value = Emission level - Limit value
4. Correction factor = Insertion loss + Cable loss
5. Emission Level = Correction Factor + Reading Value.

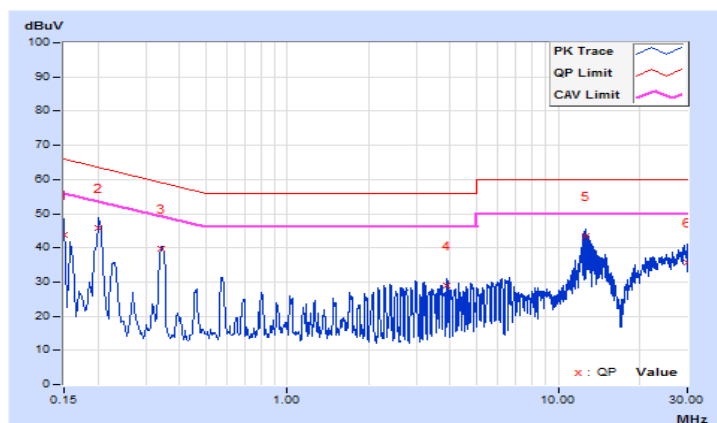

4.3 Transmit Power Measurement

4.3.1 Limits of Transmit Power Measurement

Operation Band	EUT Category		Limit
U-NII-1		Outdoor Access Point	1 Watt (30 dBm) (Max. e.i.r.p \leq 125mW(21 dBm) at any elevation angle above 30 degrees as measured from the horizon)
		Fixed point-to-point Access Point	1 Watt (30 dBm)
		Indoor Access Point	1 Watt (30 dBm)
	√	Mobile and Portable client device	250mW (24 dBm)
U-NII-2A	√		250mW (24 dBm) or 11 dBm+10 log B*
U-NII-2C	√		250mW (24 dBm) or 11 dBm+10 log B*
U-NII-3	√		1 Watt (30 dBm)

*B is the 26 dB emission bandwidth in megahertz

Per KDB 662911 Method of conducted output power measurement on IEEE 802.11 devices,

Array Gain = 0 dB (i.e., no array gain) for $N_{ANT} \leq 4$;

Array Gain = 0 dB (i.e., no array gain) for channel widths ≥ 40 MHz for any N_{ANT} ;

Array Gain = $5 \log(N_{ANT}/N_{SS})$ dB or 3 dB, whichever is less for 20-MHz channel widths with $N_{ANT} \geq 5$.

For power measurements on all other devices: Array Gain = $10 \log(N_{ANT}/N_{SS})$ dB.

4.3.2 Test Setup

For Power Output

802.11a, 802.11n (HT20), 802.11n (HT40)

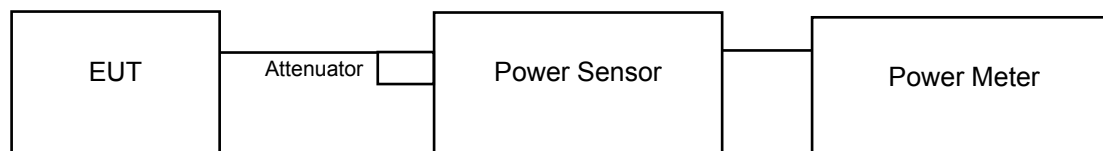

802.11ac (VHT80)

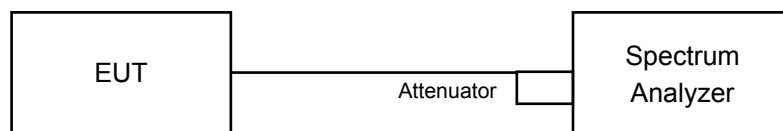

4.3.3 Test Instruments

Refer to section 4.1.2 to get information of above instrument.

4.3.4 Test Procedure

For Average Power Measurement

For 802.11a, 802.11n (HT20), 802.11n (HT40)

Method PM is used to perform output power measurement, trigger and gating function of wide band power meter is enabled to measure max output power of TX on burst and set the detector to average. Duty factor is not added to measured value.

For 802.11ac (VHT80)

- a. Set span to encompass the entire 26 dB EBW (or, alternatively, the entire 99% occupied bandwidth) of the signal.
- b. Set sweep trigger to “free run”.
- c. Set RBW = 1 MHz.
- d. Set VBW \geq 3 MHz.
- e. Number of points in sweep \geq 2 Span / RBW.
- f. Sweep time \leq (number of points in sweep) * T
- g. Using emission bandwidth to determine the frequency span for integration the channel bandwidth.
- h. Detector = RMS.
- i. Trace mode = max hold.
- j. Allow max hold to run for at least 60 seconds, or longer as needed to allow the trace to stabilize.
- k. Compute power by integrating the spectrum across the EBW (or, alternatively, the entire 99% occupied bandwidth) of the signal using the instrument’s band power measurement function with band limits set equal to the EBW (or occupied bandwidth) band edges. If the instrument does not have a band power function, sum the spectrum levels (in power units) at 1 MHz intervals extending across the EBW (or, alternatively, the entire 99% occupied bandwidth) of the spectrum.

For 26dB Bandwidth

- a. Set RBW = approximately 1% of the emission bandwidth.
- b. Set the VBW > RBW.
- c. Detector = Peak.
- d. Trace mode = max hold.
- e. Measure the maximum width of the emission that is 26 dB down from the peak of the emission. Compare this with the RBW setting of the analyzer. Readjust RBW and repeat measurement as needed until the RBW/EBW ratio is approximately 1%.

4.3.5 Deviation from Test Standard

No deviation.

4.3.6 EUT Operating Conditions

The software provided by client to enable the EUT under transmission condition continuously at lowest, middle and highest channel frequencies individually.

4.3.7 Test Result

Power Output:

802.11a

Chan.	Freq. (MHz)	Maximum Conducted Power (dBm)		Total Power (mW)	Total Power (dBm)	Power Limit (dBm)	Pass / Fail
		Chain 0	Chain 1				
36	5180	9.52	9.11	17.101	12.33	24.00	Pass
40	5200	9.34	9.13	16.775	12.25	24.00	Pass
48	5240	9.67	9.15	17.490	12.43	24.00	Pass
52	5260	9.29	9.01	16.454	12.16	24.00	Pass
60	5300	9.21	9.32	16.888	12.28	24.00	Pass
64	5320	9.04	9.46	16.848	12.27	24.00	Pass
100	5500	9.02	9.50	16.893	12.28	24.00	Pass
116	5580	9.06	9.62	17.216	12.36	24.00	Pass
140	5700	9.01	9.22	16.318	12.13	24.00	Pass
149	5745	9.41	9.01	16.692	12.23	30.00	Pass
157	5785	9.59	9.05	17.134	12.34	30.00	Pass
165	5825	9.58	9.09	17.188	12.35	30.00	Pass

Note:

Chain 0

1. $11\text{dBm} + 10\log (21.78) = 24.38 > 24\text{dBm}$
2. $11\text{dBm} + 10\log (21.78) = 24.38 > 24\text{dBm}$
3. $11\text{dBm} + 10\log (21.79) = 24.38 > 24\text{dBm}$
4. $11\text{dBm} + 10\log (21.77) = 24.38 > 24\text{dBm}$
5. $11\text{dBm} + 10\log (21.84) = 24.39 > 24\text{dBm}$
6. $11\text{dBm} + 10\log (21.84) = 24.39 > 24\text{dBm}$

Chain 1

1. $11\text{dBm} + 10\log (21.85) = 24.39 > 24\text{dBm}$
2. $11\text{dBm} + 10\log (22.00) = 24.42 > 24\text{dBm}$
3. $11\text{dBm} + 10\log (21.87) = 24.40 > 24\text{dBm}$
4. $11\text{dBm} + 10\log (21.92) = 24.41 > 24\text{dBm}$
5. $11\text{dBm} + 10\log (21.91) = 24.41 > 24\text{dBm}$
6. $11\text{dBm} + 10\log (21.91) = 24.41 > 24\text{dBm}$

802.11n (HT20)

Chan.	Freq. (MHz)	Maximum Conducted Power (dBm)		Total Power (mW)	Total Power (dBm)	Power Limit (dBm)	Pass / Fail
		Chain 0	Chain 1				
36	5180	9.27	9.05	16.488	12.17	24.00	Pass
40	5200	9.92	7.92	16.011	12.04	24.00	Pass
48	5240	9.89	8.75	17.249	12.37	24.00	Pass
52	5260	9.77	9.68	18.774	12.74	24.00	Pass
60	5300	9.84	9.82	19.232	12.84	24.00	Pass
64	5320	9.76	9.70	18.795	12.74	24.00	Pass
100	5500	9.57	9.66	18.304	12.63	24.00	Pass
116	5580	9.67	9.78	18.774	12.74	24.00	Pass
140	5700	8.80	9.66	16.833	12.26	24.00	Pass
149	5745	9.94	9.31	18.394	12.65	30.00	Pass
157	5785	9.89	9.25	18.164	12.59	30.00	Pass
165	5825	9.59	8.93	16.915	12.28	30.00	Pass

Note:

Chain 0

1. $11\text{dBm} + 10\log (21.93) = 24.41 > 24\text{dBm}$
2. $11\text{dBm} + 10\log (21.90) = 24.40 > 24\text{dBm}$
3. $11\text{dBm} + 10\log (22.01) = 24.43 > 24\text{dBm}$
4. $11\text{dBm} + 10\log (22.07) = 24.44 > 24\text{dBm}$
5. $11\text{dBm} + 10\log (22.05) = 24.43 > 24\text{dBm}$
6. $11\text{dBm} + 10\log (22.11) = 24.45 > 24\text{dBm}$

Chain 1

1. $11\text{dBm} + 10\log (22.13) = 24.45 > 24\text{dBm}$
2. $11\text{dBm} + 10\log (22.05) = 24.43 > 24\text{dBm}$
3. $11\text{dBm} + 10\log (22.21) = 24.47 > 24\text{dBm}$
4. $11\text{dBm} + 10\log (22.08) = 24.44 > 24\text{dBm}$
5. $11\text{dBm} + 10\log (22.10) = 24.44 > 24\text{dBm}$
6. $11\text{dBm} + 10\log (22.09) = 24.44 > 24\text{dBm}$

802.11n (HT40)

Chan.	Freq. (MHz)	Maximum Conducted Power (dBm)		Total Power (mW)	Total Power (dBm)	Power Limit (dBm)	Pass / Fail
		Chain 0	Chain 1				
38	5190	9.04	9.28	16.489	12.17	24.00	Pass
46	5230	10.50	7.70	17.108	12.33	24.00	Pass
54	5270	9.47	9.45	17.661	12.47	24.00	Pass
62	5310	9.52	9.46	17.785	12.50	24.00	Pass
102	5510	7.88	9.23	14.513	11.62	24.00	Pass
110	5550	7.71	9.05	13.937	11.44	24.00	Pass
134	5670	7.73	9.08	14.020	11.47	24.00	Pass
151	5755	9.75	8.85	17.115	12.33	30.00	Pass
159	5795	9.38	8.62	15.948	12.03	30.00	Pass

Note:

Chain 0

1. $11\text{dBm} + 10\log (41.17) = 27.15 > 24\text{dBm}$
2. $11\text{dBm} + 10\log (41.01) = 27.13 > 24\text{dBm}$
3. $11\text{dBm} + 10\log (41.08) = 27.14 > 24\text{dBm}$
4. $11\text{dBm} + 10\log (41.13) = 27.14 > 24\text{dBm}$
5. $11\text{dBm} + 10\log (41.17) = 27.15 > 24\text{dBm}$

Chain 1

1. $11\text{dBm} + 10\log (41.35) = 27.16 > 24\text{dBm}$
2. $11\text{dBm} + 10\log (41.35) = 27.16 > 24\text{dBm}$
3. $11\text{dBm} + 10\log (41.30) = 27.16 > 24\text{dBm}$
4. $11\text{dBm} + 10\log (41.39) = 27.17 > 24\text{dBm}$
5. $11\text{dBm} + 10\log (41.38) = 27.17 > 24\text{dBm}$

802.11ac (VHT80)

Chan.	Freq. (MHz)	Maximum Conducted Power (dBm)		Total Power (mW)	Total Power (dBm)	Power Limit (dBm)	Pass / Fail
		Chain 0	Chain 1				
42	5210	9.66	9.02	17.227	12.36	24.00	Pass
58	5290	9.31	9.49	17.423	12.41	24.00	Pass
106	5530	9.11	9.52	17.101	12.33	24.00	Pass
155	5775	9.58	8.77	16.612	12.20	30.00	Pass

Note:

Chain 0

1. $11\text{dBm} + 10\log (82.52) = 30.17 > 24\text{dBm}$
2. $11\text{dBm} + 10\log (82.32) = 30.16 > 24\text{dBm}$

Chain 1

1. $11\text{dBm} + 10\log (82.84) = 30.18 > 24\text{dBm}$
2. $11\text{dBm} + 10\log (82.65) = 30.17 > 24\text{dBm}$

26dB Bandwidth:

802.11a

Chan.	Freq. (MHz)	26dBc Bandwidth (MHz)	
		Chain 0	Chain 1
52	5260	21.78	21.85
60	5300	21.78	22.00
64	5320	21.79	21.87
100	5500	21.77	21.92
116	5580	21.84	21.91
140	5700	21.84	21.91

802.11n (HT20)

Chan.	Freq. (MHz)	26dBc Bandwidth (MHz)	
		Chain 0	Chain 1
52	5260	21.93	22.13
60	5300	21.90	22.05
64	5320	22.01	22.21
100	5500	22.07	22.08
116	5580	22.05	22.10
140	5700	22.11	22.09

802.11n (HT40)

Chan.	Freq. (MHz)	26dBc Bandwidth (MHz)	
		Chain 0	Chain 1
54	5270	41.17	41.35
62	5310	41.01	41.35
102	5510	41.08	41.30
110	5550	41.13	41.39
134	5670	41.17	41.38

802.11ac (VHT80)

Chan.	Freq. (MHz)	26dBc Bandwidth (MHz)	
		Chain 0	Chain 1
58	5290	82.52	82.84
106	5530	82.32	82.65

Spectrum Plot of Worst Value

802.11a

802.11n (HT20)

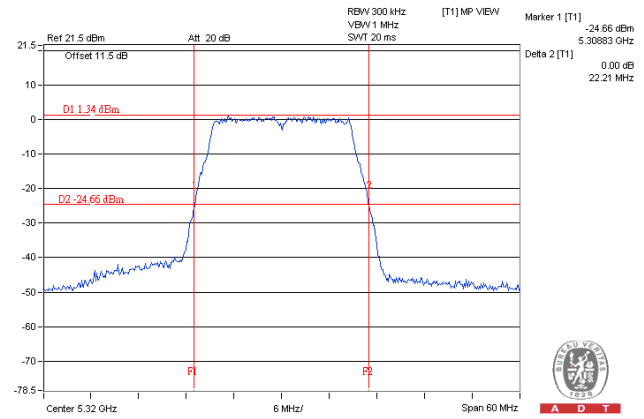
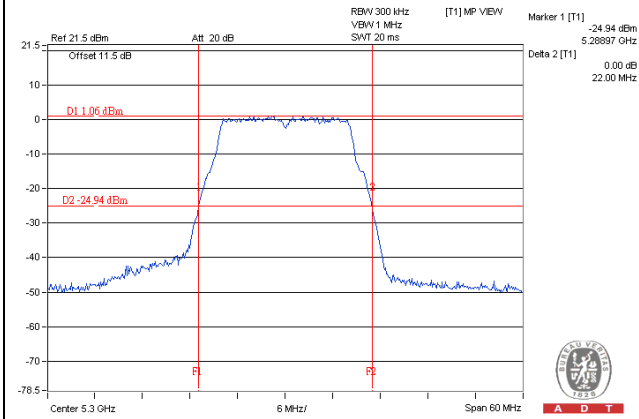

802.11n (HT40)

802.11ac (VHT80)

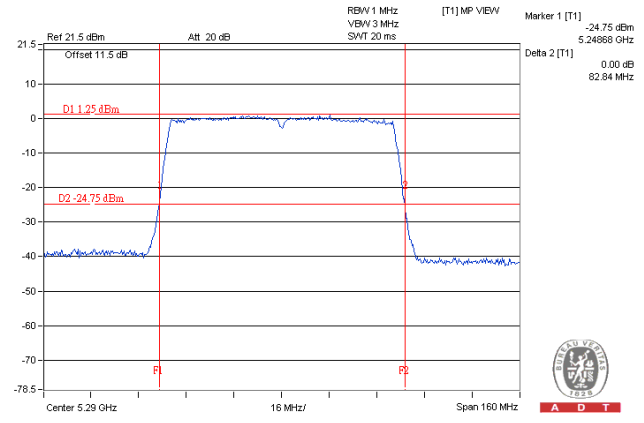
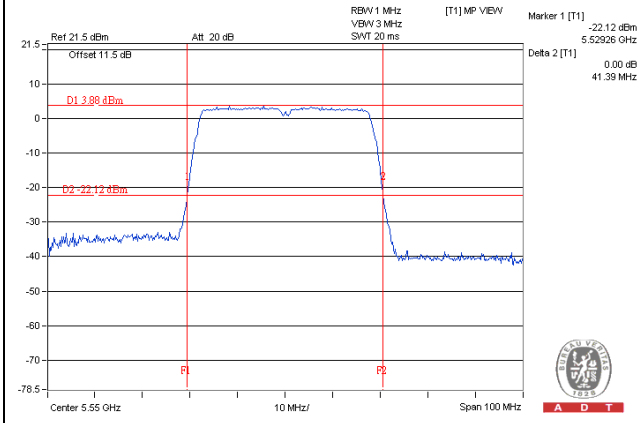

4.4 Occupied Bandwidth Measurement

4.4.1 Test Setup

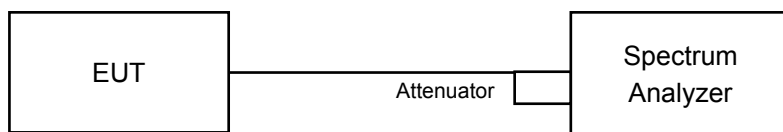

4.4.2 Test Instruments

Refer to section 4.1.2 to get information of above instrument.

4.4.3 Test Procedure

The transmitter output was connected to the spectrum analyzer through an attenuator. The bandwidth of the fundamental frequency was measured by spectrum analyzer with resolution bandwidth in the range of 1% to 5% of the anticipated emission bandwidth, and a video bandwidth at least 3x the resolution bandwidth and set the detector to sampling. The width of a frequency band such that, below the lower and above the upper frequency limits, the mean powers emitted are each equal to a specified percentage 0.5 %of the total mean power of a given emission.

4.4.4 Test Result

802.11a

Chan.	Freq. (MHz)	Occupied Bandwidth (MHz)	
		Chain 0	Chain 1
36	5180	16.92	18.84
40	5200	17.04	17.16
48	5240	17.16	17.16
52	5260	17.16	17.16
60	5300	17.16	17.28
64	5320	17.16	17.04
100	5500	17.04	17.16
116	5580	17.16	17.28
140	5700	17.16	17.16
149	5745	17.04	16.92
157	5785	17.04	17.04
165	5825	17.16	17.04

802.11n (HT20)

Chan.	Freq. (MHz)	Occupied Bandwidth (MHz)	
		Chain 0	Chain 1
36	5180	18.00	18.24
40	5200	18.12	18.12
48	5240	18.00	18.24
52	5260	18.00	18.24
60	5300	18.00	18.24
64	5320	18.00	18.24
100	5500	18.12	18.12
116	5580	18.00	18.24
140	5700	18.00	18.24
149	5745	18.12	18.12
157	5785	18.12	18.12
165	5825	18.12	18.12

802.11n (HT40)

Chan.	Freq. (MHz)	Occupied Bandwidth (MHz)	
		Chain 0	Chain 1
38	5190	36.60	36.60
46	5230	36.72	36.72
54	5270	36.72	36.72
62	5310	36.60	36.72
102	5510	36.72	36.72
110	5550	36.72	36.72
134	5670	36.60	36.84
151	5755	36.72	36.60
159	5795	36.60	36.72

802.11ac (VHT80)

Chan.	Freq. (MHz)	Occupied Bandwidth (MHz)	
		Chain 0	Chain 1
42	5210	75.88	75.88
58	5290	75.88	75.88
106	5530	75.88	75.88
155	5775	76.08	75.84

Spectrum Plot of Worst Value

802.11a

802.11n (HT20)

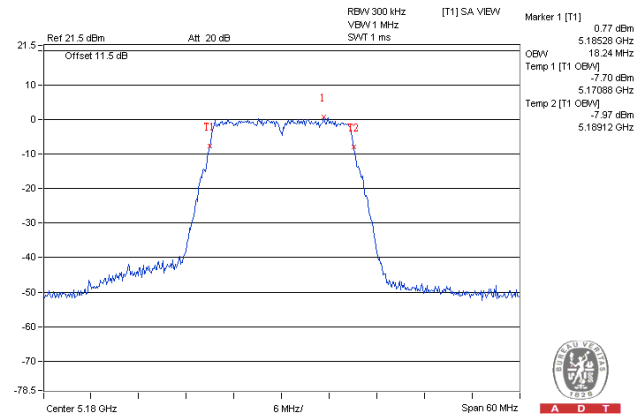
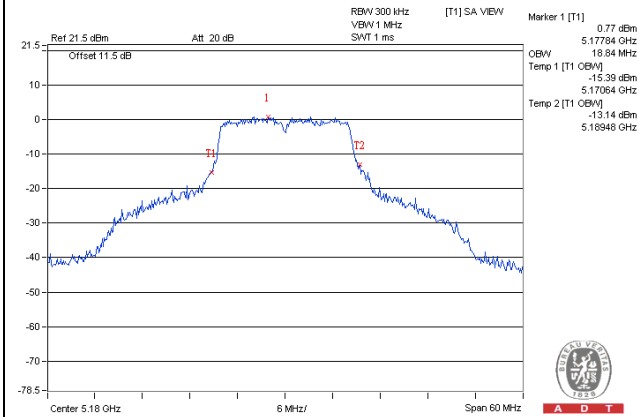

802.11n (HT40)

802.11ac (VHT80)

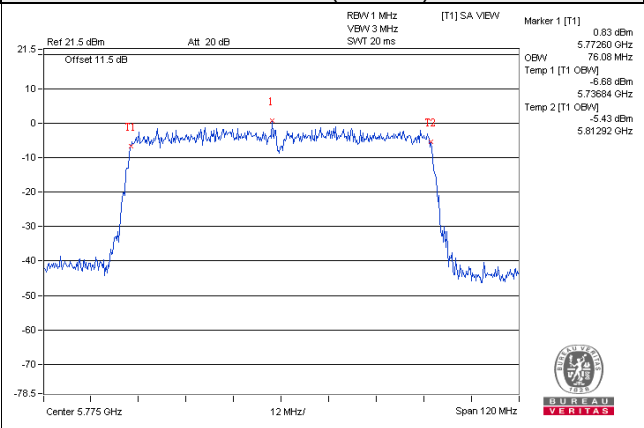
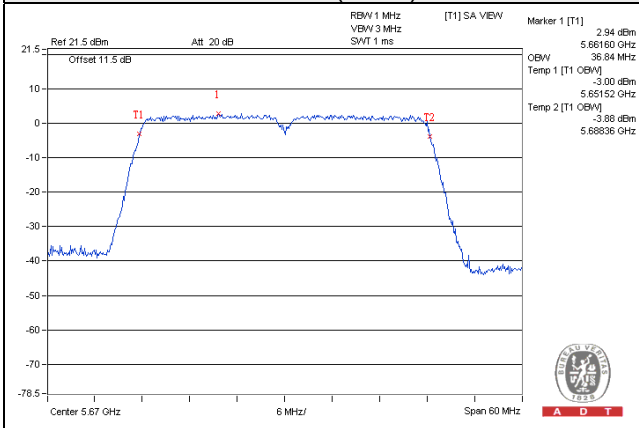

EUT Maximum Conducted Power

802.11a

Frequency Band (MHz)	Max. Power	
	Output Power (mW)	Output Power (dBm)
5250~5350	16.888	12.28
5470~5725	17.216	12.36

802.11n (HT20)

Frequency Band (MHz)	Max. Power	
	Output Power (mW)	Output Power (dBm)
5250~5350	19.232	12.84
5470~5725	18.774	12.74

802.11n (HT40)

Frequency Band (MHz)	Max. Power	
	Output Power (mW)	Output Power (dBm)
5250~5350	17.785	12.50
5470~5725	14.513	11.62

802.11ac (VHT80)

Frequency Band (MHz)	Max. Power	
	Output Power (mW)	Output Power (dBm)
5250~5350	17.423	12.41
5470~5725	17.101	12.33

4.5 Peak Power Spectral Density Measurement

4.5.1 Limits of Peak Power Spectral Density Measurement

Operation Band	EUT Category		Limit
U-NII-1		Outdoor Access Point	17dBm/ MHz
		Fixed point-to-point Access Point	
		Indoor Access Point	
	√	Mobile and Portable client device	11dBm/ MHz
U-NII-2A	√		11dBm/ MHz
U-NII-2C	√		11dBm/ MHz
U-NII-3	√		30dBm/ 500kHz

4.5.2 Test Setup

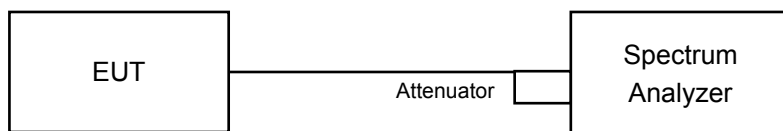

4.5.3 Test Instruments

Refer to section 4.1.2 to get information of above instrument.

4.5.4 Test Procedures

For U-NII-1 band, U-NII-2A, U-NII-2C band:

Duty cycle of test signal is > 98%

Using method SA-1

- Set span to encompass the entire emission bandwidth (EBW) of the signal.
- Set RBW = 1 MHz, Set VBW ≥ 3 MHz, Detector = RMS
- Sweep time = auto, trigger set to “free run”.
- Trace average at least 100 traces in power averaging mode.
- Record the max value

Duty cycle of test signal is < 98%

Using method SA-2

- Set span to encompass the entire emission bandwidth (EBW) of the signal.
- Set RBW = 1MHz, Set VBW ≥ 3 MHz, Detector = RMS
- Set Channel power measure = 1MHz
- Sweep time = auto, trigger set to “free run”.
- Trace average at least 100 traces in power averaging mode.
- Record the max value and add 10 log (1/duty cycle)

For U-NII-3 band:

- a. Set span to encompass the entire emission bandwidth (EBW) of the signal.
- b. Set RBW = 300 kHz, Set VBW \geq 1 MHz, Detector = RMS
- c. Use the peak marker function to determine the maximum power level in any 300 kHz band segment within the fundamental EBW.
- d. Scale the observed power level to an equivalent value in 500 kHz by adjusting (reducing) the measured power by a bandwidth correction factor (BWCF) where $BWCF = 10\log(500 \text{ kHz} / 300 \text{ kHz})$
- e. Sweep time = auto, trigger set to "free run".
- f. Trace average at least 100 traces in power averaging mode.
- g. Record the max value and add $10 \log (1/\text{duty cycle})$

4.5.5 Deviation from Test Standard

No deviation.

4.5.6 EUT Operating Conditions

Same as Item 4.3.6.

4.5.7 Test Results

For U-NII-1 band, U-NII-2A, U-NII-2C band:

802.11a

Chan.	Freq. (MHz)	PSD (dBm/MHz)		Total PSD (dBm/MHz)	Max. Limit (dBm/MHz)	Pass / Fail
		Chain 0	Chain 1			
36	5180	-7.36	-4.12	-2.43	8.49	Pass
40	5200	-5.90	-5.86	-2.87	8.49	Pass
48	5240	-5.72	-4.68	-2.16	8.49	Pass
52	5260	-5.97	-4.39	-2.10	8.49	Pass
60	5300	-4.74	-5.44	-2.06	8.49	Pass
64	5320	-4.89	-4.95	-1.91	8.49	Pass
100	5500	-3.74	-5.51	-1.52	8.49	Pass
116	5580	-3.80	-5.84	-1.69	8.49	Pass
140	5700	-4.00	-6.40	-2.02	8.49	Pass

Note:

- Method 1 of power density measurement of KDB 662911 is using for calculating total power density. Total power density is summing entire spectra across corresponding frequency bins on the various outputs by computer.
- Directional gain = $5.5\text{dBi} + 10\log(2) = 8.51\text{dBi} > 6\text{dBi}$, so the power density limit shall be reduced to $11-(8.51-6) = 8.49\text{dBm}$.

802.11n (HT20)

Chan.	Freq. (MHz)	PSD w/o Duty Factor (dBm/MHz)		Duty Factor (dB)	Total PSD with Duty Factor (dBm/MHz)	Max. Limit (dBm/MHz)	Pass / Fail
		Chain 0	Chain 1				
36	5180	-7.45	-5.04	0.12	-2.95	8.49	Pass
40	5200	-5.63	-5.17	0.12	-2.27	8.49	Pass
48	5240	-5.78	-5.80	0.12	-2.66	8.49	Pass
52	5260	-7.08	-5.24	0.12	-2.93	8.49	Pass
60	5300	-5.62	-5.03	0.12	-2.19	8.49	Pass
64	5320	-4.33	-6.56	0.12	-2.17	8.49	Pass
100	5500	-4.34	-6.18	0.12	-2.03	8.49	Pass
116	5580	-4.78	-6.17	0.12	-2.29	8.49	Pass
140	5700	-5.11	-6.55	0.12	-2.64	8.49	Pass

Note:

- Method 1 of power density measurement of KDB 662911 is using for calculating total power density. Total power density is summing entire spectra across corresponding frequency bins on the various outputs by computer.
- Directional gain = $5.5\text{dBi} + 10\log(2) = 8.51\text{dBi} > 6\text{dBi}$, so the power density limit shall be reduced to $11-(8.51-6) = 8.49\text{dBm}$.
- Refer to section 3.3 for duty cycle spectrum plot.

802.11n (HT40)

Chan.	Freq. (MHz)	PSD w/o Duty Factor (dBm/MHz)		Duty Factor (dB)	Total PSD with Duty Factor (dBm/MHz)	Max. Limit (dBm/MHz)	Pass / Fail
		Chain 0	Chain 1				
38	5190	-6.62	-5.90	0.18	-3.05	8.49	Pass
46	5230	-6.35	-5.76	0.18	-2.85	8.49	Pass
54	5270	-5.84	-6.23	0.18	-2.84	8.49	Pass
62	5310	-5.69	-5.94	0.18	-2.62	8.49	Pass
102	5510	-4.50	-6.54	0.18	-2.21	8.49	Pass
110	5550	-5.94	-6.81	0.18	-3.16	8.49	Pass
134	5670	-6.67	-7.25	0.18	-3.76	8.49	Pass

Note:

- Method 1 of power density measurement of KDB 662911 is using for calculating total power density. Total power density is summing entire spectra across corresponding frequency bins on the various outputs by computer.
- Directional gain = $5.5\text{dBi} + 10\log(2) = 8.51\text{dBi} > 6\text{dBi}$, so the power density limit shall be reduced to $11-(8.51-6) = 8.49\text{dBm}$.
- Refer to section 3.3 for duty cycle spectrum plot.

802.11ac (VHT80)

Chan.	Freq. (MHz)	PSD w/o Duty Factor (dBm/MHz)		Duty Factor (dB)	Total PSD with Duty Factor (dBm/MHz)	Max. Limit (dBm/MHz)	Pass / Fail
		Chain 0	Chain 1				
42	5210	-9.95	-9.34	0.42	-6.21	8.49	Pass
58	5290	-10.65	-9.68	0.42	-6.71	8.49	Pass
106	5530	-9.36	-9.99	0.42	-6.24	8.49	Pass

Note:

- Method 1 of power density measurement of KDB 662911 is using for calculating total power density. Total power density is summing entire spectra across corresponding frequency bins on the various outputs by computer.
- Directional gain = $5.5\text{dBi} + 10\log(2) = 8.51\text{dBi} > 6\text{dBi}$, so the power density limit shall be reduced to $11-(8.51-6) = 8.49\text{dBm}$.
- Refer to section 3.3 for duty cycle spectrum plot.

Spectrum Plot of Worst Value

802.11a / Chain 0 / CH 100

802.11n (HT20) / Chain 0 / CH 64

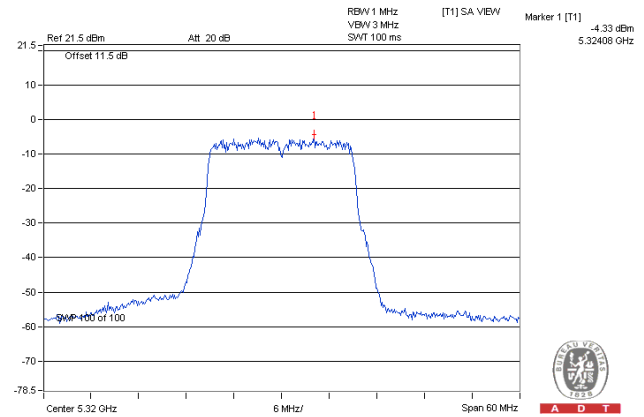
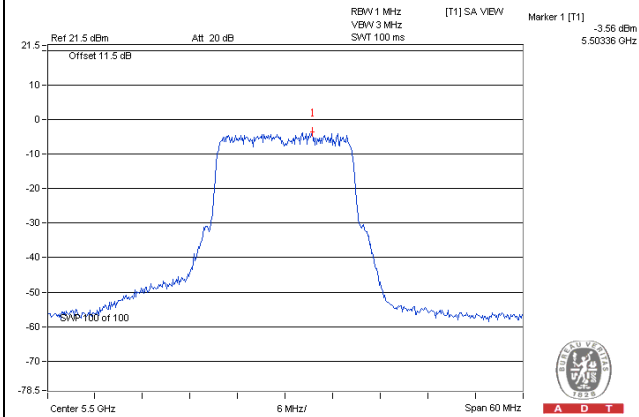

802.11n (HT40) / Chain 0 / CH 102

802.11ac (VHT80) / Chain 1 / CH 42

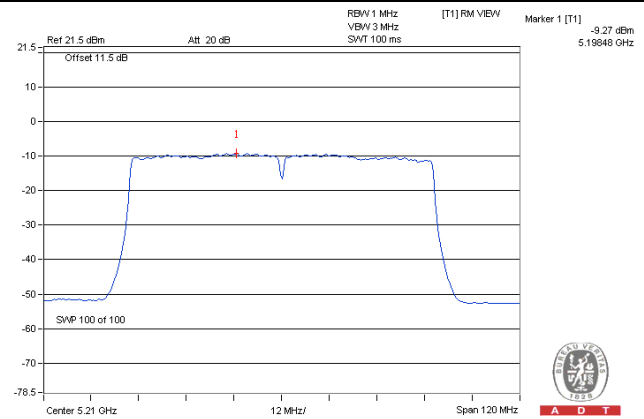
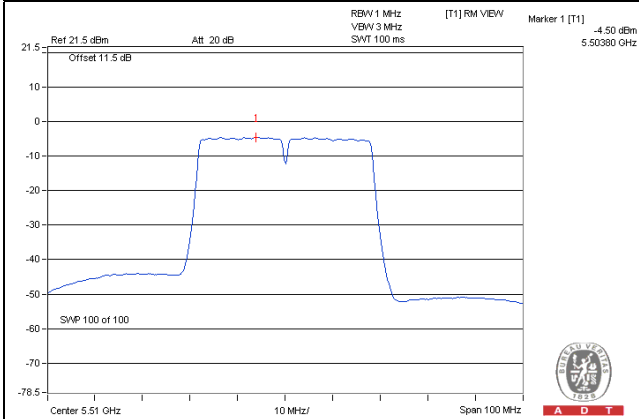

For U-NII-3 band:

802.11a

Ch.	Freq. (MHz)	PSD (dBm/300kHz)		PSD (dBm/500kHz)		Duty factor (dB)	Total PSD (dBm/500kHz)	Limit (dBm/500kHz)	Pass / Fail
		Chain 0	Chain 1	Chain 0	Chain 1				
149	5745	-12.76	-12.46	-10.54	-10.24	0.34	-7.04	27.49	Pass
157	5785	-12.78	-12.76	-10.56	-10.54	0.34	-7.21	27.49	Pass
165	5825	-12.99	-12.97	-10.77	-10.75	0.34	-7.42	27.49	Pass

Note:

- Method 1 of power density measurement of KDB 662911 is using for calculating total power density. Total power density is summing entire spectra across corresponding frequency bins on the various outputs by computer.
- Directional gain = $5.5\text{dBi} + 10\log(2) = 8.51\text{dBi} > 6\text{dBi}$, so the power density limit shall be reduced to $30 - (8.51 - 6) = 27.49\text{dBm}$.

802.11n (HT20)

Ch.	Freq. (MHz)	PSD (dBm/300kHz)		PSD (dBm/500kHz)		Duty factor (dB)	Total PSD (dBm/500kHz)	Limit (dBm/500kHz)	Pass / Fail
		Chain 0	Chain 1	Chain 0	Chain 1				
149	5745	-13.12	-13.17	-10.90	-10.95	0.31	-7.61	27.49	Pass
157	5785	-13.30	-13.43	-11.08	-11.21	0.31	-7.83	27.49	Pass
165	5825	-13.65	-13.79	-11.43	-11.57	0.31	-8.18	27.49	Pass

Note:

- Method 1 of power density measurement of KDB 662911 is using for calculating total power density. Total power density is summing entire spectra across corresponding frequency bins on the various outputs by computer.
- Directional gain = $5.5\text{dBi} + 10\log(2) = 8.51\text{dBi} > 6\text{dBi}$, so the power density limit shall be reduced to $30 - (8.51 - 6) = 27.49\text{dBm}$.
- Refer to section 3.3 for duty cycle spectrum plot.

802.11n (HT40)

Ch.	Freq. (MHz)	PSD (dBm/300kHz)		PSD (dBm/500kHz)		Duty factor (dB)	Total PSD (dBm/500kHz)	Limit (dBm/500kHz)	Pass / Fail
		Chain 0	Chain 1	Chain 0	Chain 1				
151	5755	-16.47	-15.75	-14.25	-13.53	0.23	-10.63	27.49	Pass
159	5795	-16.86	-16.45	-14.64	-14.23	0.23	-11.18	27.49	Pass

Note:

- Method 1 of power density measurement of KDB 662911 is using for calculating total power density. Total power density is summing entire spectra across corresponding frequency bins on the various outputs by computer.
- Directional gain = $5.5\text{dBi} + 10\log(2) = 8.51\text{dBi} > 6\text{dBi}$, so the power density limit shall be reduced to $30 - (8.51 - 6) = 27.49\text{dBm}$.
- Refer to section 3.3 for duty cycle spectrum plot.

802.11ac (VHT80)

Ch.	Freq. (MHz)	PSD (dBm/300kHz)		PSD (dBm/500kHz)		Duty factor (dB)	Total PSD (dBm/500kHz)	Limit (dBm/500kHz)	Pass / Fail
		Chain 0	Chain 1	Chain 0	Chain 1				
155	5775	-19.53	-19.67	-17.31	-17.45	0.27	-14.11	27.49	Pass

Note:

1. Method 1 of power density measurement of KDB 662911 is using for calculating total power density. Total power density is summing entire spectra across corresponding frequency bins on the various outputs by computer.
2. Directional gain = 5.5dBi + 10log(2) = 8.51dBi > 6dBi, so the power density limit shall be reduced to 30-(8.51-6) = 27.49dBm.
3. Refer to section 3.3 for duty cycle spectrum plot.

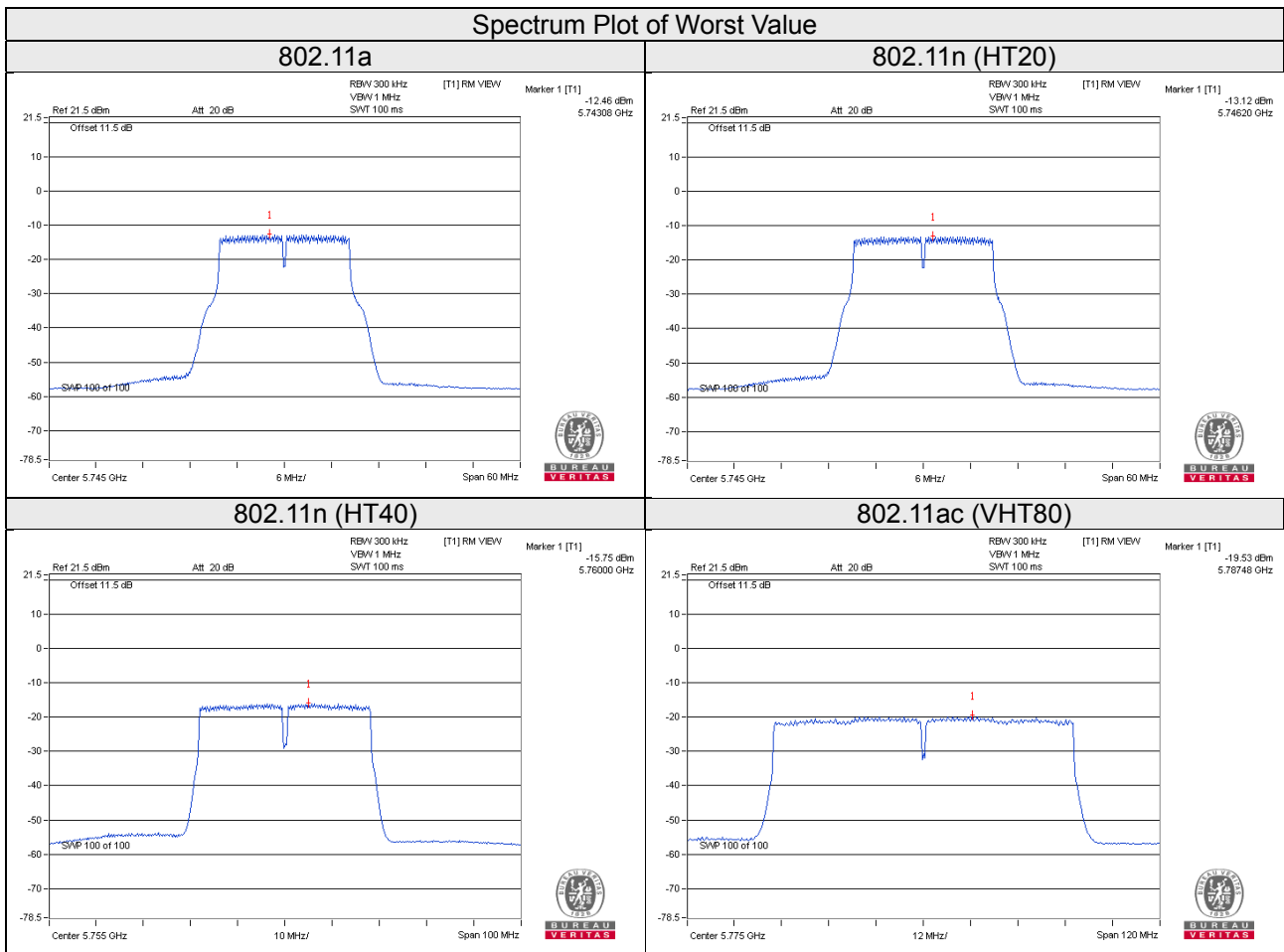

4.6 Frequency Stability

4.6.1 Limits of Frequency Stability Measurement

The frequency of the carrier signal shall be maintained within band of operation

4.6.2 Test Setup

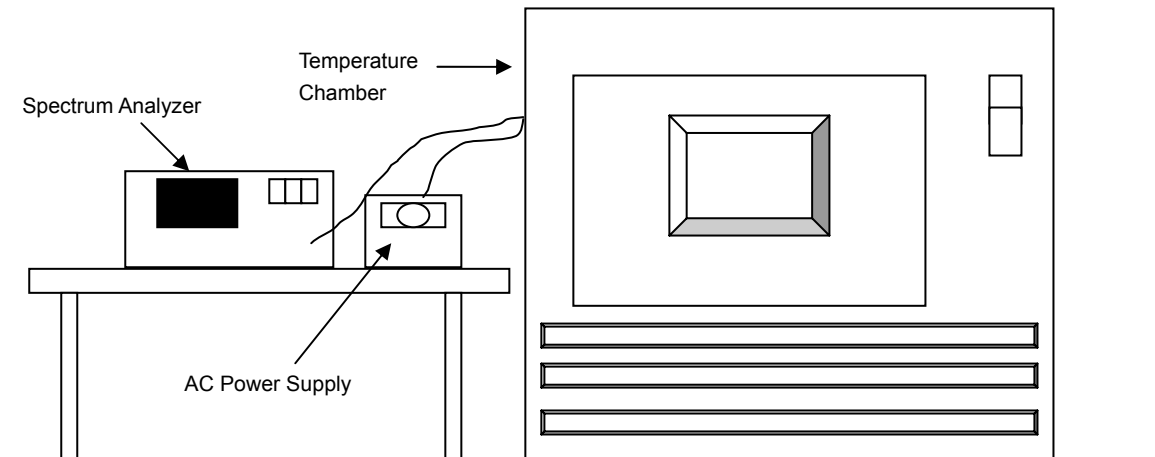

4.6.3 Test Instruments

Refer to section 4.1.2 to get information of above instrument.

4.6.4 Test Procedure

- The EUT was placed inside the environmental test chamber and powered by nominal AC voltage.
- Turn the EUT on and couple its output to a spectrum analyzer.
- Turn the EUT off and set the chamber to the highest temperature specified.
- Allow sufficient time (approximately 30 min) for the temperature of the chamber to stabilize, turn the EUT on and measure the operating frequency after 2, 5, and 10 minutes.
- Repeat step 2 and 3 with the temperature chamber set to the lowest temperature.
- The test chamber was allowed to stabilize at +20 degree C for a minimum of 30 minutes. The supply voltage was then adjusted on the EUT from 85% to 115% and the frequency record.

4.6.5 Deviation from Test Standard

No deviation.

4.6.6 EUT Operating Condition

Set the EUT transmit at un-modulation mode to test frequency stability.

4.6.7 Test Results

Frequency Stability Versus Temp.									
Operating Frequency: 5180MHz									
Temp. (°C)	Power Supply (Vac)	0 Minute		2 Minute		5 Minute		10 Minute	
		Measured Frequency (MHz)	Frequency Drift (%)	Measured Frequency (MHz)	Frequency Drift (%)	Measured Frequency (MHz)	Frequency Drift (%)	Measured Frequency (MHz)	Frequency Drift (%)
50	120	5180.0245	0.00047	5180.0223	0.00043	5180.0248	0.00048	5180.0224	0.00043
40	120	5180.0139	0.00027	5180.0134	0.00026	5180.0156	0.00030	5180.0164	0.00032
30	120	5179.9941	-0.00011	5179.9903	-0.00019	5179.9946	-0.00010	5179.9934	-0.00013
20	120	5179.9748	-0.00049	5179.9772	-0.00044	5179.977	-0.00044	5179.9746	-0.00049
10	120	5180.0207	0.00040	5180.0239	0.00046	5180.0235	0.00045	5180.0215	0.00042
0	120	5179.985	-0.00029	5179.9804	-0.00038	5179.9814	-0.00036	5179.985	-0.00029
-10	120	5179.989	-0.00021	5179.9903	-0.00019	5179.9919	-0.00016	5179.9923	-0.00015
-20	120	5179.9748	-0.00049	5179.973	-0.00052	5179.9732	-0.00052	5179.9751	-0.00048
-30	120	5180.0101	0.00019	5180.0096	0.00019	5180.0097	0.00019	5180.0117	0.00023

Frequency Stability Versus Voltage									
Operating Frequency: 5180MHz									
Temp. (°C)	Power Supply (Vac)	0 Minute		2 Minute		5 Minute		10 Minute	
		Measured Frequency (MHz)	Frequency Drift (%)	Measured Frequency (MHz)	Frequency Drift (%)	Measured Frequency (MHz)	Frequency Drift (%)	Measured Frequency (MHz)	Frequency Drift (%)
20	138	5179.9757	-0.00047	5179.9781	-0.00042	5179.9767	-0.00045	5179.975	-0.00048
	120	5179.9748	-0.00049	5179.9772	-0.00044	5179.977	-0.00044	5179.9746	-0.00049
	102	5179.9758	-0.00047	5179.9773	-0.00044	5179.9766	-0.00045	5179.9748	-0.00049

4.7 6dB Bandwidth Measurement

4.7.1 Limits of 6dB Bandwidth Measurement

The minimum of 6dB Bandwidth Measurement is 0.5MHz.

4.7.2 Test Setup

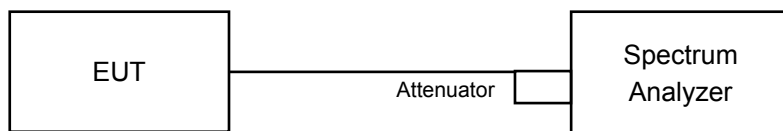

4.7.3 Test Instruments

Refer to section 4.1.2 to get information of above instrument.

4.7.4 Test Procedure

Measurement Procedure REF

- Set resolution bandwidth (RBW) = 100kHz
- Set the video bandwidth (VBW) $\geq 3 \times$ RBW, Detector = Peak.
- Trace mode = max hold.
- Sweep = auto couple.
- Measure the maximum width of the emission that is constrained by the frequencies associated with the two amplitude points (upper and lower) that are attenuated by 6 dB relative to the maximum level measured in the fundamental emission

4.7.5 Deviation from Test Standard

No deviation.

4.7.6 EUT Operating Condition

The software provided by client to enable the EUT under transmission condition continuously at lowest, middle and highest channel frequencies individually.

4.7.7 Test Results

802.11a

Chan.	Freq. (MHz)	6dB Bandwidth (MHz)		Minimum Limit (MHz)	Pass / Fail
		Chain 0	Chain 1		
149	5745	16.41	16.41	0.5	Pass
157	5785	16.44	16.43	0.5	Pass
165	5825	16.44	16.44	0.5	Pass

802.11n (HT20)

Chan.	Freq. (MHz)	6dB Bandwidth (MHz)		Minimum Limit (MHz)	Pass / Fail
		Chain 0	Chain 1		
149	5745	17.65	17.66	0.5	Pass
157	5785	17.65	17.65	0.5	Pass
165	5825	17.65	17.64	0.5	Pass

802.11n (HT40)

Chan.	Freq. (MHz)	6dB Bandwidth (MHz)		Minimum Limit (MHz)	Pass / Fail
		Chain 0	Chain 1		
151	5755	36.42	36.44	0.5	Pass
159	5795	36.45	36.40	0.5	Pass

802.11ac (VHT80)

Chan.	Freq. (MHz)	6dB Bandwidth (MHz)		Minimum Limit (MHz)	Pass / Fail
		Chain 0	Chain 1		
155	5775	76.30	76.05	0.5	Pass

Spectrum Plot of Worst Value

802.11a

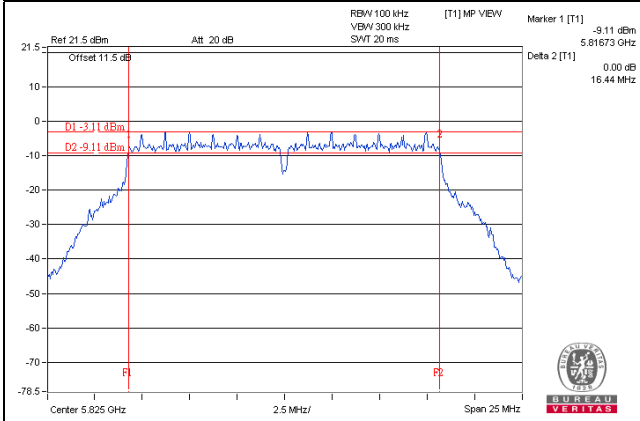

802.11n (HT20)

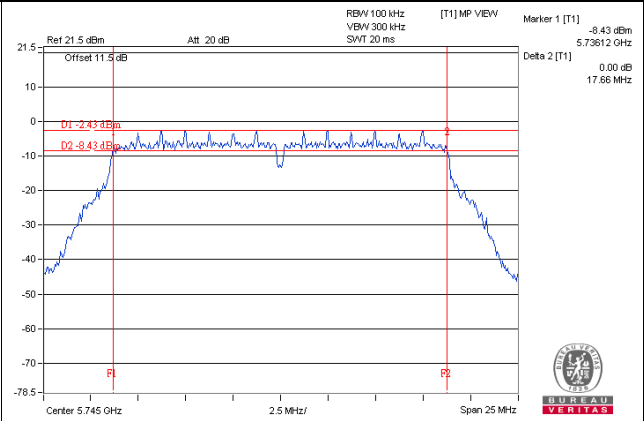

802.11n (HT40)

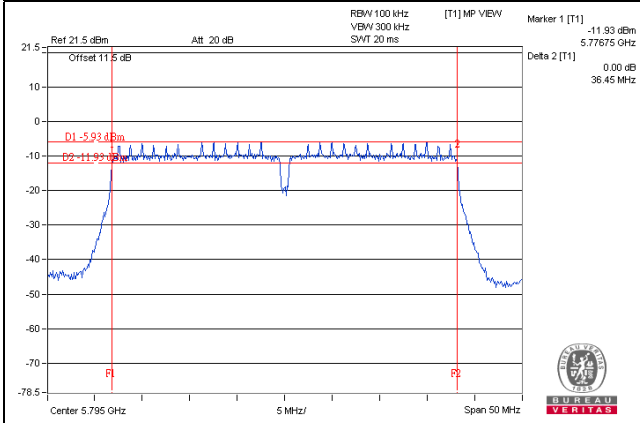

802.11ac (VHT80)

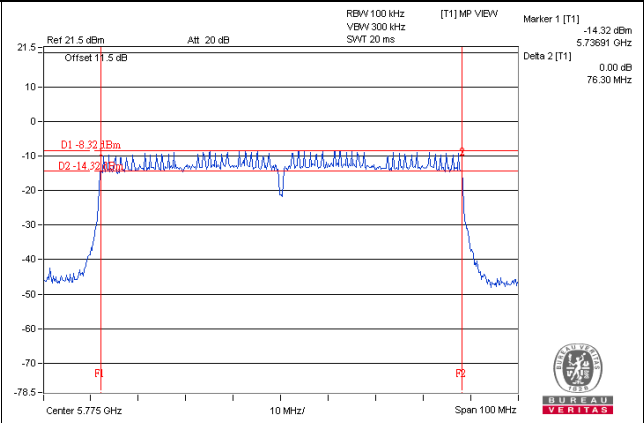

5 Pictures of Test Arrangements

Please refer to the attached file (Test Setup Photo).

Annex A- Radiated Out of Band Emission (OOBE) Measurement (For U-NII-3 band)

802.11a

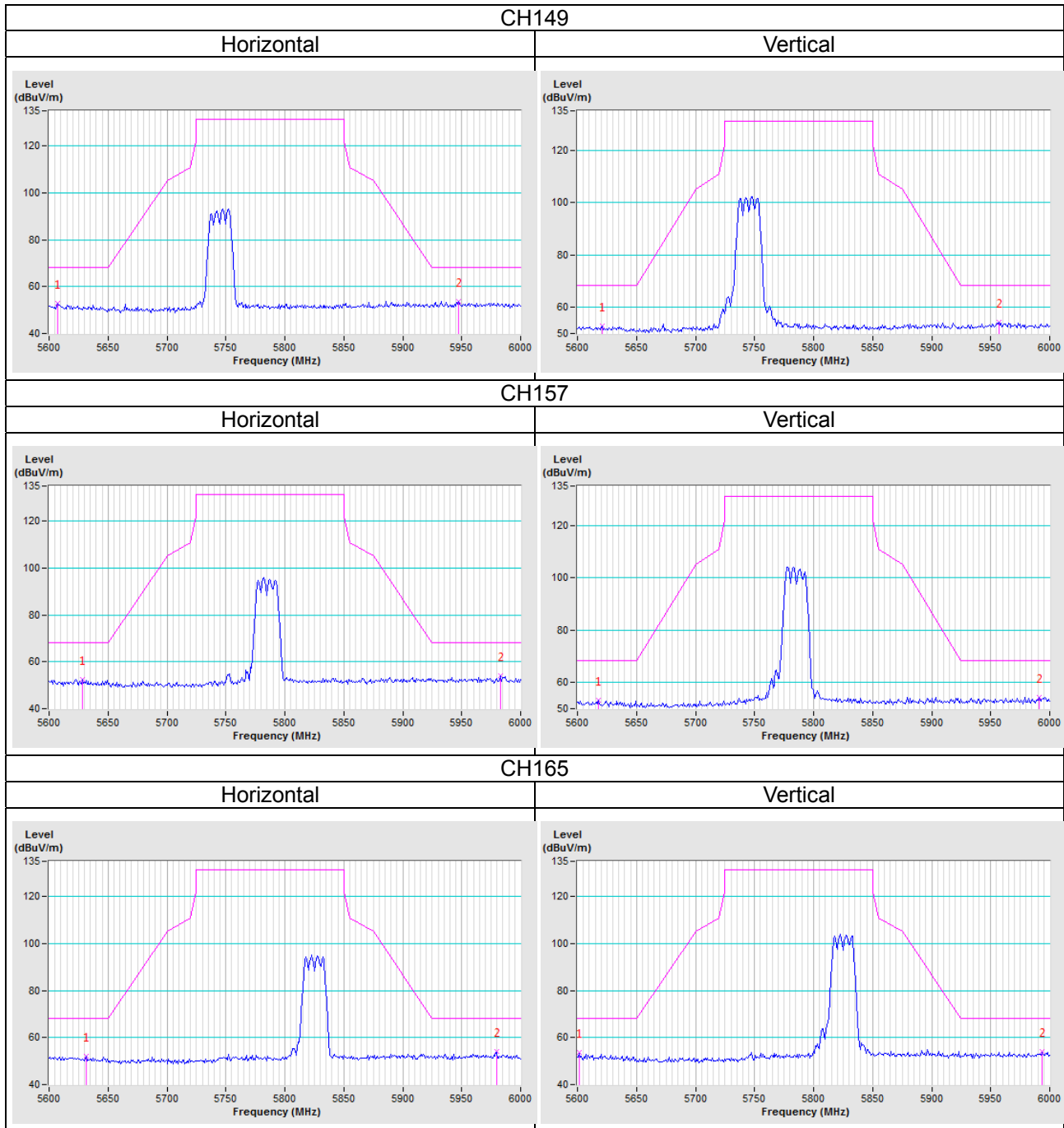

802.11n (HT20)

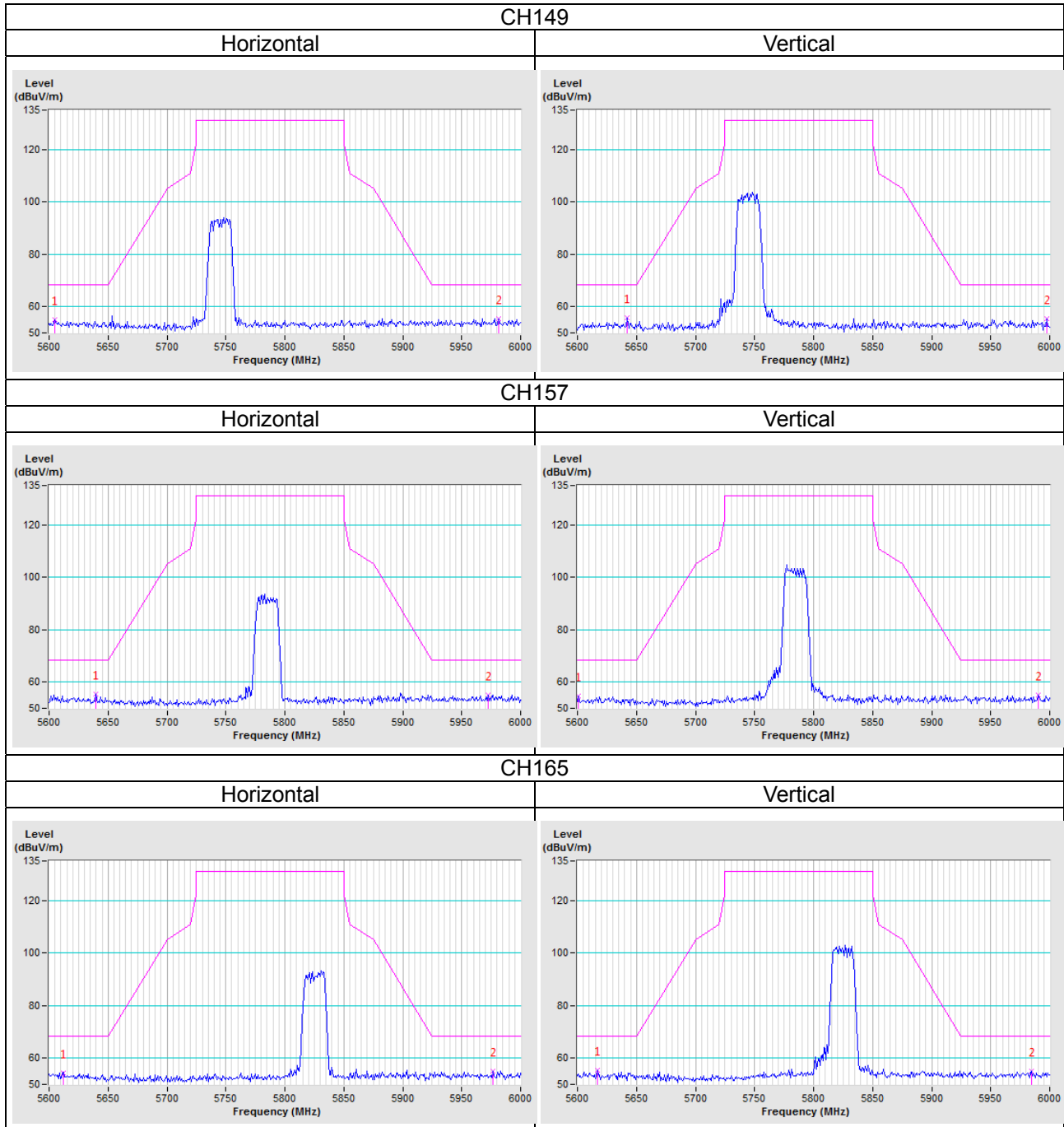

802.11n (HT40)

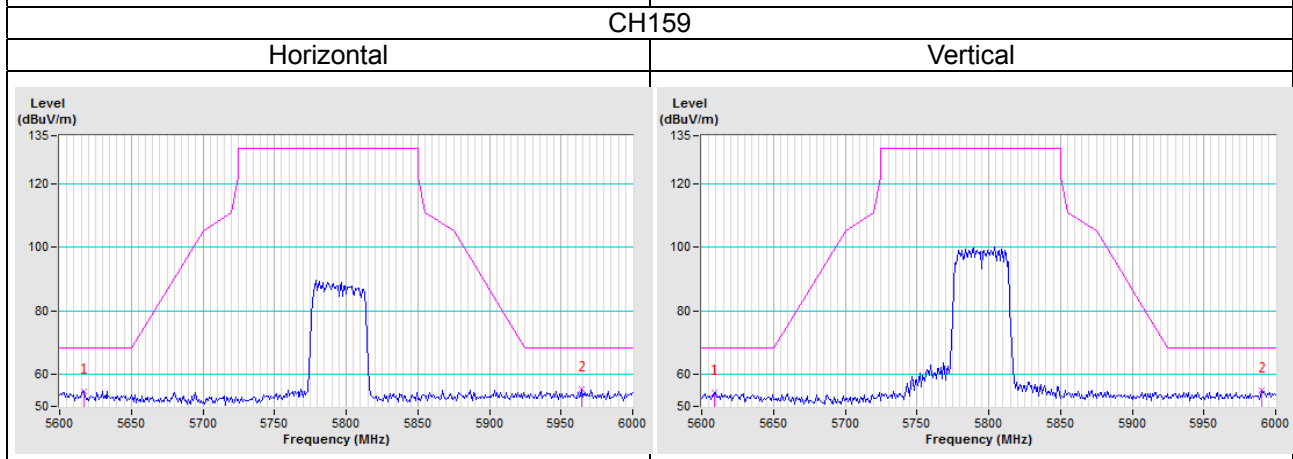
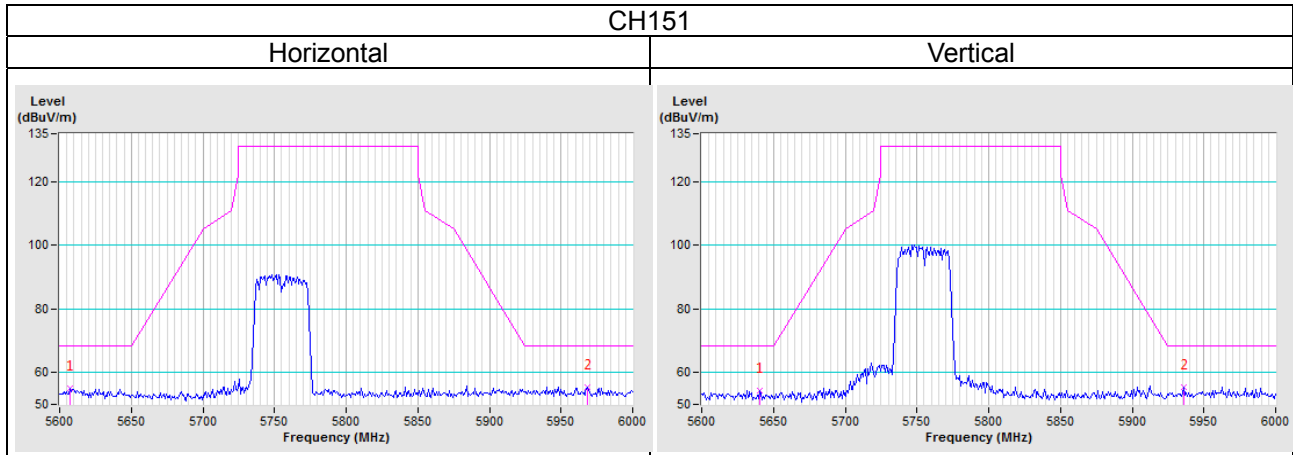

802.11ac (VHT80)

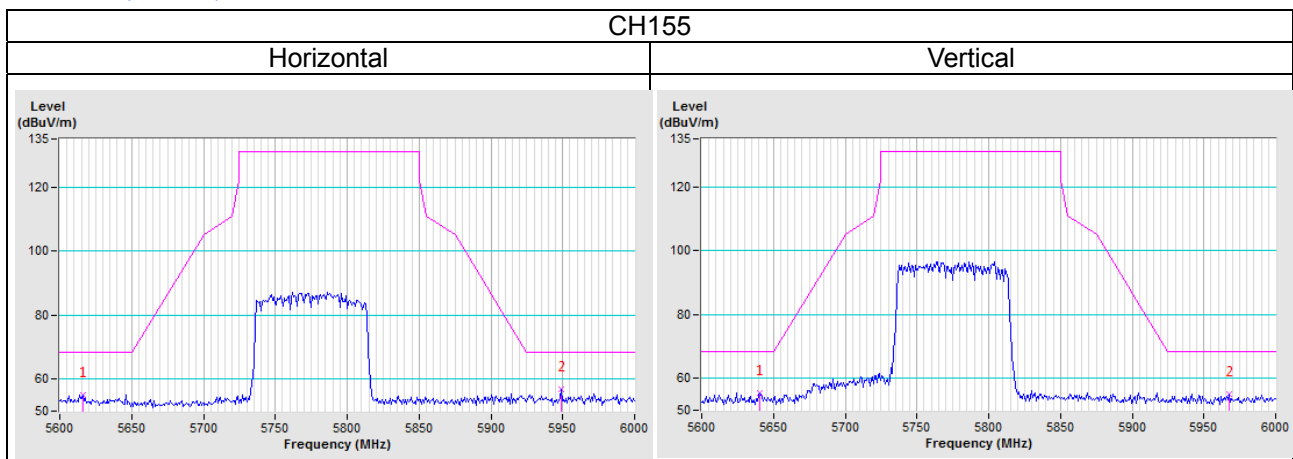

Appendix – Information on the Testing Laboratories

We, Bureau Veritas Consumer Products Services (H.K.) Ltd., Taoyuan Branch, were founded in 1988 to provide our best service in EMC, Radio, Telecom and Safety consultation. Our laboratories are FCC recognized accredited test firms and accredited and approved according to ISO/IEC 17025.

If you have any comments, please feel free to contact us at the following:

Linko EMC/RF Lab

Tel: 886-2-26052180

Fax: 886-2-26051924

Hsin Chu EMC/RF/Telecom Lab

Tel: 886-3-6668565

Fax: 886-3-6668323

Hwa Ya EMC/RF/Safety Lab

Tel: 886-3-3183232

Fax: 886-3-3270892

Email: service.adt@tw.bureauveritas.com

Web Site: www.bureauveritas-adt.com

The address and road map of all our labs can be found in our web site also.

--- END ---