

# FCC C2PC Test Report

**FCC ID** : ZQ6-AP6234A  
**Equipment** : Wifi Dual Band + BT combo module  
**Model No.** : AP6234A, AP6234AL  
**Brand Name** : Ampak  
**Applicant** : Ampak Technology Inc  
**Address** : No.1 Jen Ai Road, Hsinchu Industrial Park,  
Hukou, Hsinchu, Taiwan, 30352  
**Standard** : 47 CFR FCC Part 15.407  
**Received Date** : Jul. 03, 2014  
**Tested Date** : Jul. 03 ~ Jul. 10, 2014

We, International Certification Corp., would like to declare that the tested sample has been evaluated and in compliance with the requirement of the above standards. The test results contained in this report refer exclusively to the product. It may be duplicated completely for legal use with the approval of the applicant. It shall not be reproduced except in full without the written approval of our laboratory.

Approved & Reviewed by:



---

Gary Chang / Manager



---

## Table of Contents

<b>1</b>	<b>GENERAL DESCRIPTION .....</b>	<b>5</b>
1.1	Information.....	5
1.2	Local Support Equipment List .....	8
1.3	Test Setup Chart .....	8
1.4	The Equipment List .....	9
1.5	Testing Applied Standards .....	10
1.6	Measurement Uncertainty .....	10
<b>2</b>	<b>TEST CONFIGURATION .....</b>	<b>11</b>
2.1	Testing Condition .....	11
2.2	The Worst Test Modes and Channel Details .....	11
<b>3</b>	<b>TRANSMITTER TEST RESULTS.....</b>	<b>12</b>
3.1	Conducted Emissions.....	12
3.2	Transmitter Radiated and Band Edge Emissions .....	15
<b>4</b>	<b>TEST LABORATORY INFORMATION .....</b>	<b>70</b>

---

## Release Record

Report No.	Version	Description	Issued Date
FR440102-11AN	Rev. 01	Initial issue	Sep. 18, 2014

---

## Summary of Test Results

FCC Rules	Test Items	Measured	Result
15.207	Conducted Emissions	[dBuV]: 0.154MHz 46.36 (Margin -9.42dB) - AV	Pass
15.407(b) 15.209	Radiated Emissions	[dBuV/m at 3m]: 5725.00MHz 73.42 (Margin -0.58dB) - PK	Pass

# 1 General Description

## 1.1 Information

This report is prepared for FCC class II change

This report is issued as a supplementary report to original ICC report no. FR440102AN. The modification is adding 2nd antenna (PIFA antenna), therefore, radiated emission and conducted emission has been re-tested after re-evaluation, and only its data was recorded in the following sections.

Brand Name	Model Name	Product Name	Description
Ampak	AP6234A	Wifi Dual Band + BT combo module	Without 2.4G SAW filter
	AP6234AL		With 2.4G SAW filter

### 1.1.1 Specification of the Equipment under Test (EUT)

RF General Information					
Frequency Range (MHz)	IEEE Std. 802.11	Ch. Freq. (MHz)	Channel Number	Transmit Chains (N <sub>TX</sub> )	Data Rate / MCS
5150-5250 5250-5350 5470-5725	a	5180-5240 5260-5320 5500-5700	36-48 [4] 52-64 [4] 100-140 [8]	1	6-54 Mbps
5150-5250 5250-5350 5470-5725	n (HT20)	5180-5240 5260-5320 5500-5700	36-48 [4] 52-64 [4] 100-140 [8]	1	MCS 0-7
5150-5250 5250-5350 5470-5725	n (HT40)	5190-5230 5270-5310 5510-5670	38-46 [2] 54-62 [2] 102-134 [3]	1	MCS 0-7

Note 1: RF output power specifies that Maximum Conducted Output Power.  
Note 2: 802.11a/n uses a combination of OFDM-BPSK, QPSK, 16QAM, 64QAM modulation.

### 1.1.2 Antenna Details

Ant. No.	Type	Operating Frequency (MHz) / Gain (dBi)					Connector
		2400~2483.5	5150~5250	5250~5350	5470~5725	5725~5850	
1	Dipole(Original)	2	3	3	3	3	UFL
2	PIFA(New)	3.53	5.30	4.93	5.31	5.55	UFL

### 1.1.3 Power Supply Type of Equipment under Test (EUT)

<b>Power Supply Type</b>	3.3Vdc from host.
--------------------------	-------------------

### 1.1.4 Accessories

N/A

### 1.1.5 Channel List

Frequency band (MHz)		5150~5725	
802.11 a / n HT20		802.11n HT40	
Channel	Frequency(MHz)	Channel	Frequency(MHz)
36	5180	38	5190
40	5200	46	5230
44	5220	54	5270
48	5240	62	5310
52	5260	102	5510
56	5280	110	5550
60	5300	134	5670
64	5320	---	---
100	5500	---	---
104	5520	---	---
108	5540	---	---
112	5560	---	---
116	5580	---	---
132	5660	---	---
136	5680	---	---
140	5700	---	---

### 1.1.6 Test Tool and Duty Cycle

Test Tool	MP tool, V2.0.1.1		
Duty Cycle and Duty Factor	Mode	Duty cycle (%)	Duty factor (dB)
	11a	99.51%	0.02
	HT20	99.26%	0.03
	HT40	98.21%	0.08

### 1.1.7 Power Setting

Channel	Frequency(MHz)	Modulation Mode		
		11a	HT20	HT40
CH 36	5180	60	60	---
CH 40	5200	62	62	---
CH 48	5240	62	62	---
CH 52	5260	92	92	---
CH 60	5300	92	92	---
CH 64	5320	58	58	---
CH 100	5500	60	60	---
CH 116	5580	92	92	---
CH 140	5700	60	60	---
CH 38	5190	---	---	58
CH 46	5230	---	---	92
CH 54	5270	---	---	92
CH 62	5310	---	---	54
CH 102	5510	---	---	58
CH 110	5550	---	---	92
CH 134	5670	---	---	92

## 1.2 Local Support Equipment List

Support Equipment List						
No.	Equipment	Brand	Model	S/N	FCC ID	Signal cable / Length (m)
1	Notebook	DELL	E6430	---	DoC	USB 1.0m shielded cable w/o core.

## 1.3 Test Setup Chart

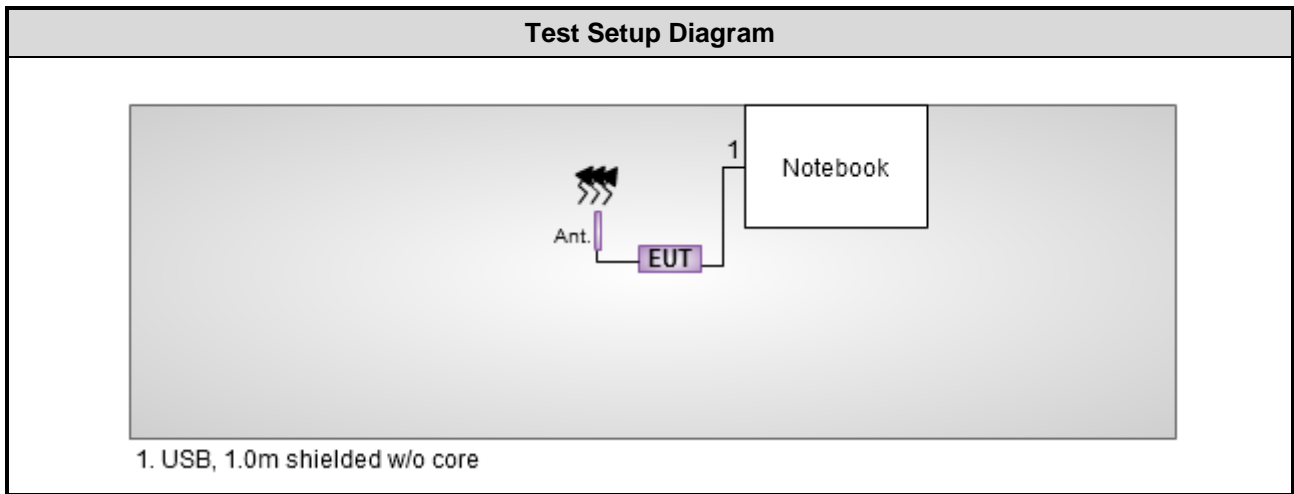



## 1.4 The Equipment List

Test Item	Conducted Emission				
Test Site	Conduction room 1 / (CO01-WS)				
Instrument	Manufacturer	Model No.	Serial No.	Calibration Date	Calibration Until
EMC Receiver	R&S	ESCS 30	100169	Oct. 15, 2013	Oct. 14, 2014
LISN	SCHWARZBECK	Schwarzbeck 8127	8127-667	Nov. 23, 2013	Nov. 22, 2014
LISN (Support Unit)	SCHWARZBECK	Schwarzbeck 8127	8127-666	Dec. 04, 2013	Dec. 03, 2014
RF Cable-CON	Woken	CFD200-NL	CFD200-NL-001	Apr. 23, 2014	Apr. 22, 2015
50 ohm terminal (Support Unit)	NA	50	04	Apr. 18, 2014	Apr. 17, 2015
Note: Calibration Interval of instruments listed above is one year.					

Test Item	Radiated Emission				
Test Site	966 chamber 2 / (03CH02-WS)				
Instrument	Manufacturer	Model No.	Serial No.	Calibration Date	Calibration Until
Spectrum Analyzer	R&S	FSV40	101499	Feb. 08, 2014	Feb. 07, 2015
Receiver	R&S	ESR3	101657	Jan. 18, 2014	Jan. 17, 2015
Bilog Antenna	SCHWARZBECK	VULB9168	VULB9168-524	Jan. 08, 2014	Jan. 07, 2015
Horn Antenna 1G-18G	SCHWARZBECK	BBHA 9120 D	BBHA 9120 D 1095	Jan. 07, 2014	Jan. 06, 2015
Horn Antenna 18G-40G	SCHWARZBECK	BBHA 9170	BBHA 9170517	Dec. 27, 2013	Dec. 26, 2014
Preamplifier	Burgeon	BPA-530	100218	Dec. 09, 2013	Dec. 08, 2014
Preamplifier	Agilent	83017A	MY39501309	Dec. 09, 2013	Dec. 08, 2014
Preamplifier	WM	TF-130N-R1	923365	Oct. 23, 2013	Oct. 22, 2014
RF Cable	HUBER+SUHNER	SUCOFLEX104	MY16140/4	Dec. 17, 2013	Dec. 16, 2014
RF Cable	HUBER+SUHNER	SUCOFLEX104	MY16018/4	Dec. 17, 2013	Dec. 16, 2014
RF Cable	HUBER+SUHNER	SUCOFLEX104	MY16015/4	Dec. 17, 2013	Dec. 16, 2014
LF cable 3M	Woken	CFD400NL-LW	CFD400NL-003	Dec. 17, 2013	Dec. 16, 2014
LF cable 10M	Woken	CFD400NL-LW	CFD400NL-004	Dec. 17, 2013	Dec. 16, 2014
Note: Calibration Interval of instruments listed above is one year.					

Instrument	Manufacturer	Model No.	Serial No.	Calibration Date	Calibration Until
Loop Antenna	R&S	HFH2-Z2	100330	Nov. 15, 2012	Nov. 14, 2014
Note: Calibration Interval of instruments listed above is two year.					

## 1.5 Testing Applied Standards

According to the specification of EUT, the EUT must comply with following standards and KDB documents.

47 CFR FCC Part 15.407

ANSI C63.10-2009

FCC KDB 789033 D01 General UNII Test procedures v01r03

Note: The EUT has been tested and complied with FCC part 15B requirement. FCC Part 15B test results are issued to another report.

## 1.6 Measurement Uncertainty

ISO/IEC 17025 requires that an estimate of the measurement uncertainties associated with the emissions test results be included in the report. The measurement uncertainties given below are based on a 95% confidence level (based on a coverage factor  $k=2$ )

Measurement Uncertainty	
Parameters	Uncertainty
AC conducted emission	$\pm 2.92$ dB
Radiated emission < 1GHz	$\pm 3.26$ dB
Radiated emission > 1GHz	$\pm 4.94$ dB

## 2 Test Configuration

### 2.1 Testing Condition

Test Item	Test Site	Ambient Condition	Tested By
AC Conduction	CO01-WS	22°C / 68%	Skys Huang
Radiated Emissions	03CH02-WS	21-25°C / 65-68%	Anderson Hung York Lin

➤ FCC site registration No.: 657002

➤ IC site registration No.: 10807A-1

### 2.2 The Worst Test Modes and Channel Details

Test item	Modulation Mode	Test Frequency (MHz)	Data rate (Mbps) / MCS	Test Configuration
Conducted Emissions	HT40	5270	MCS 0	1
Radiated Emissions ≤1GHz	HT40	5270	MCS 0	1
Radiated Emissions >1GHz	11a	5180 / 5200 / 5240 / 5260 / 5300 5320 / 5500 / 5580 / 5700	6 Mbps	1
	HT20	5180 / 5200 / 5240 / 5260 / 5300 5320 / 5500 / 5580 / 5700	MCS 0	
	HT40	5190 / 5230 / 5270 / 5310 / 5510 5550 / 5670	MCS 0	

**NOTE:**

- The EUT was pretested with 3 orientations placed on the table for the radiated emission measurement – X, Y, and Z-plane. The **Y-plane** results were found as the worst case and were shown in this report.
- Two samples had been pre-tested on the following test configurations. **Configuration 1** (Model AP6234A) is the worst case and only its data was record in this test report.
  - Configuration 1 : AP6234A
  - Configuration 2 : AP6234AL

## 3 Transmitter Test Results

### 3.1 Conducted Emissions

#### 3.1.1 Limit of Conducted Emissions

Conducted Emissions Limit		
Frequency Emission (MHz)	Quasi-Peak	Average
0.15-0.5	66 - 56 *	56 - 46 *
0.5-5	56	46
5-30	60	50

Note 1: \* Decreases with the logarithm of the frequency.

#### 3.1.2 Test Procedures

1. The device is placed on a test table, raised 80 cm above the reference ground plane. The vertical conducting plane is located 40 cm to the rear of the device.
2. The device is connected to line impedance stabilization network (LISN) and other accessories are connected to other LISN. Measured levels of AC power line conducted emission are across the 50  $\Omega$  LISN port.
3. AC conducted emission measurements is made over frequency range from 150 kHz to 30 MHz.
4. This measurement was performed with AC 120V / 60Hz.

#### 3.1.3 Test Setup



- Note: 1. Support units were connected to second LISN.  
 2. Both of LISNs (AMN) are 80 cm from EUT and at least 80 cm from other units and other metal planes

### 3.1.4 Test Result of Conducted Emissions

Modulation Mode	HT40	Test Freq. (MHz)	5720
Power Phase	Line	Test Configuration	1

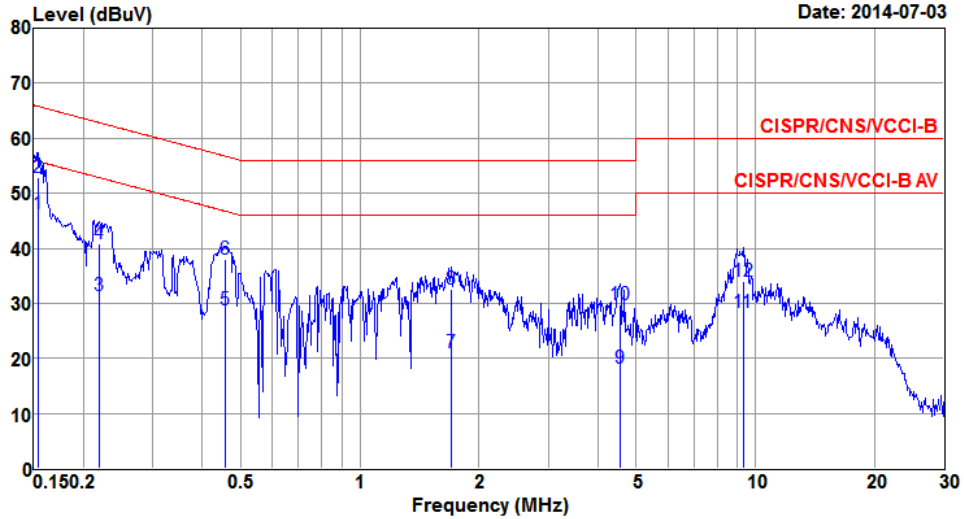

	Freq MHz	Level dBuV	Limit Line dBuV	Over Limit dB	Read Level dBuV	LISN factor dB	cable loss dB	Remark
1*	0.154	46.36	55.78	-9.42	45.94	0.40	0.02	Average
2	0.154	52.97	65.78	-12.81	52.55	0.40	0.02	QP
3	0.220	31.39	52.83	-21.44	30.99	0.39	0.01	Average
4	0.220	40.72	62.83	-22.11	40.32	0.39	0.01	QP
5	0.456	28.73	46.76	-18.03	28.29	0.39	0.05	Average
6	0.456	37.98	56.76	-18.78	37.54	0.39	0.05	QP
7	1.707	21.00	46.00	-25.00	20.51	0.43	0.06	Average
8	1.707	32.67	56.00	-23.33	32.18	0.43	0.06	QP
9	4.549	18.13	46.00	-27.87	17.50	0.47	0.16	Average
10	4.549	29.72	56.00	-26.28	29.09	0.47	0.16	QP
11	9.302	28.44	50.00	-21.56	27.67	0.53	0.24	Average
12	9.302	33.92	60.00	-26.08	33.15	0.53	0.24	QP

Note 1: Level (dBuV) = Read Level (dBuV) + LISN Factor (dB) + Cable Loss (dB).  
 Note 2: Over Limit (dB) = Level (dBuV) – Limit Line (dBuV).

<b>Modulation Mode</b>	HT40	<b>Test Freq. (MHz)</b>	5720
<b>Power Phase</b>	Neutral	<b>Test Configuration</b>	1

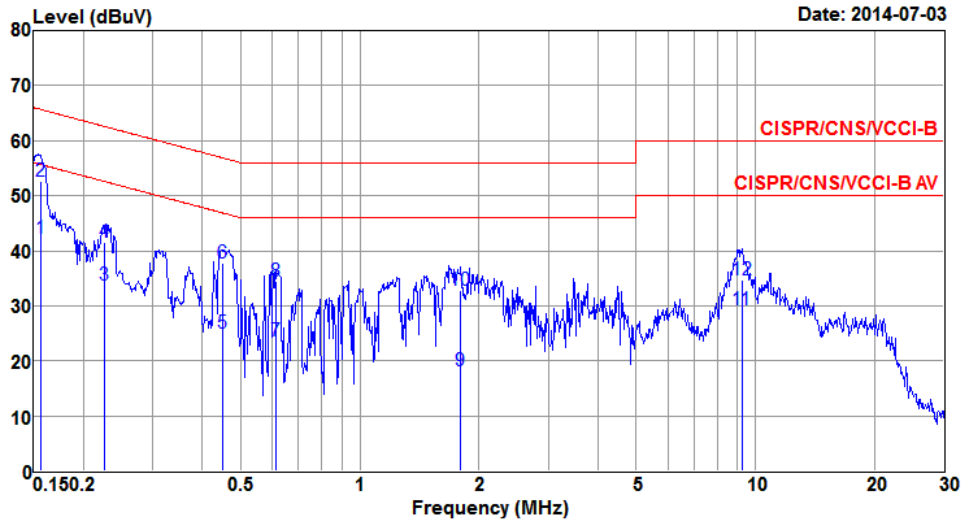

	Freq MHz	Level dBUV	Limit Line dBUV	Over Limit dB	Read Level dBUV	LISN factor dB	cable loss dB	Remark
1	0.156	42.31	55.65	-13.34	41.81	0.48	0.02	Average
2*	0.156	52.62	65.65	-13.03	52.12	0.48	0.02	QP
3	0.227	33.69	52.57	-18.88	33.20	0.48	0.01	Average
4	0.227	41.47	62.57	-21.10	40.98	0.48	0.01	QP
5	0.449	25.01	46.89	-21.88	24.50	0.47	0.04	Average
6	0.449	37.84	56.89	-19.05	37.33	0.47	0.04	QP
7	0.614	23.51	46.00	-22.49	22.94	0.47	0.10	Average
8	0.614	34.50	56.00	-21.50	33.93	0.47	0.10	QP
9	1.800	18.15	46.00	-27.85	17.60	0.50	0.05	Average
10	1.800	32.71	56.00	-23.29	32.16	0.50	0.05	QP
11	9.253	29.18	50.00	-20.82	28.38	0.56	0.24	Average
12	9.253	34.65	60.00	-25.35	33.85	0.56	0.24	QP

Note 1: Level (dBUV) = Read Level (dBUV) + LISN Factor (dB) + Cable Loss (dB).  
 2: Over Limit (dB) = Level (dBUV) – Limit Line (dBUV).

## 3.2 Transmitter Radiated and Band Edge Emissions

### 3.2.1 Limit of Transmitter Radiated and Band Edge Emissions

Restricted Band Emissions Limit			
Frequency Range (MHz)	Field Strength (uV/m)	Field Strength (dBuV/m)	Measure Distance (m)
0.009~0.490	2400/F(kHz)	48.5 - 13.8	300
0.490~1.705	24000/F(kHz)	33.8 - 23	30
1.705~30.0	30	29	30
30~88	100	40	3
88~216	150	43.5	3
216~960	200	46	3
Above 960	500	54	3

**Note 1:**  
Qusai-Peak value is measured for frequency below 1GHz except for 9–90 kHz, 110–490 kHz frequency band. Peak and average value are measured for frequency above 1GHz. The limit on average radio frequency emission is as above table. The limit on peak radio frequency emissions is 20 dB above the maximum permitted average emission limit

**Note 2:**  
Measurements may be performed at a distance other than what is specified provided. When performing measurements at a distance other than that specified, the results shall be extrapolated to the specified distance using an extrapolation factor as below, Frequency at or above 30 MHz: 20 dB/decade Frequency below 30 MHz: 40 dB/decade.

Un-restricted band emissions above 1GHz Limit	
Operating Band	Limit
5.15 - 5.25 GHz	e.i.r.p. -27 dBm [68.2 dBuV/m@3m]
5.25 - 5.35 GHz	e.i.r.p. -27 dBm [68.2 dBuV/m@3m]
5.47 - 5.725 GHz	e.i.r.p. -27 dBm [68.2 dBuV/m@3m]
5.725 - 5.825 GHz	5.715 5.725 GHz: e.i.r.p. -17 dBm [78.2 dBuV/m@3m] 5.825 5.835 GHz: e.i.r.p. -17 dBm [78.2 dBuV/m@3m] Other un-restricted band: e.i.r.p. -27 dBm [68.2 dBuV/m@3m]

**Note 1:** Measurements may be performed at a distance other than the limit distance provided they are not performed in the near field and the emissions to be measured can be detected by the measurement equipment. When performing measurements at a distance other than that specified, the results shall be extrapolated to the specified distance using an extrapolation factor of 20 dB/decade (inverse of linear distance for field-strength measurements, inverse of linear distance-squared for power-density measurements).

### 3.2.2 Test Procedures

1. Measurement is made at a semi-anechoic chamber that incorporates a turntable allowing a EUT rotation of 360°. A continuously-rotating, remotely-controlled turntable is installed at the test site to support the EUT and facilitate determination of the direction of maximum radiation for each EUT emission frequency. The EUT is placed at a height of 0.8 m test table above the ground plane.
2. Measurement is made with the antenna positioned in both the horizontal and vertical planes of polarization. The measurement antenna is varied in height (1m ~ 4m) above the reference ground plane to obtain the maximum signal strength. Distance between EUT and antenna is 3 m.
3. This investigation is performed with the EUT rotated 360°, the antenna height scanned between 1 m and 4 m, and the antenna rotated to repeat the measurements for both the horizontal and vertical antenna polarizations.

Note:

1. 120kHz measurement bandwidth of test receiver and Quasi-peak detector is for radiated emission below 1GHz.
2. RBW=1MHz, VBW=3MHz and Peak detector is for peak measured value of radiated emission above 1GHz.
3. RBW=1MHz, VBW=1/T and Peak detector is for average measured value of radiated emission above 1GHz.



### 3.2.3 Test Setup

#### Radiated Emissions below 1 GHz

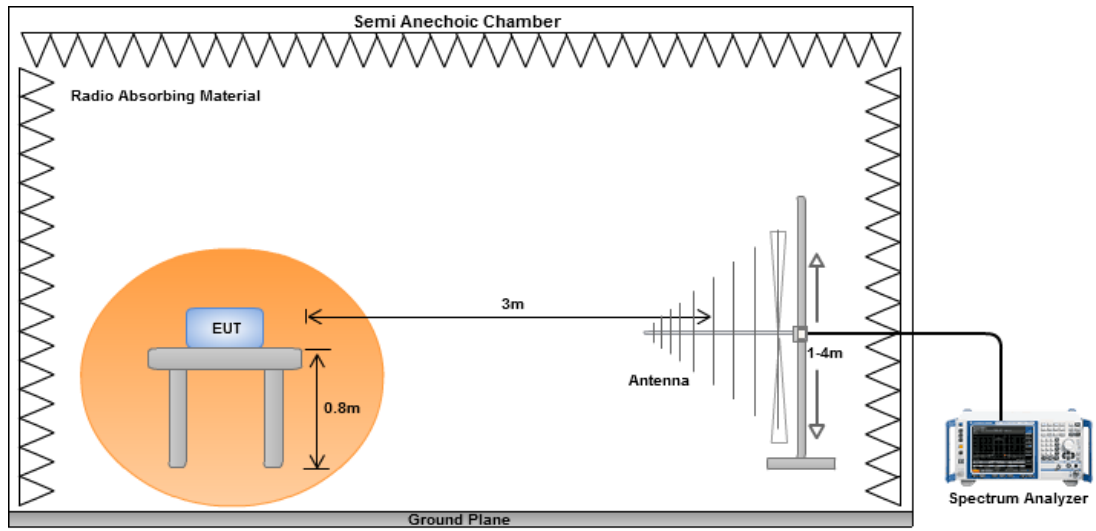

#### Radiated Emissions above 1 GHz

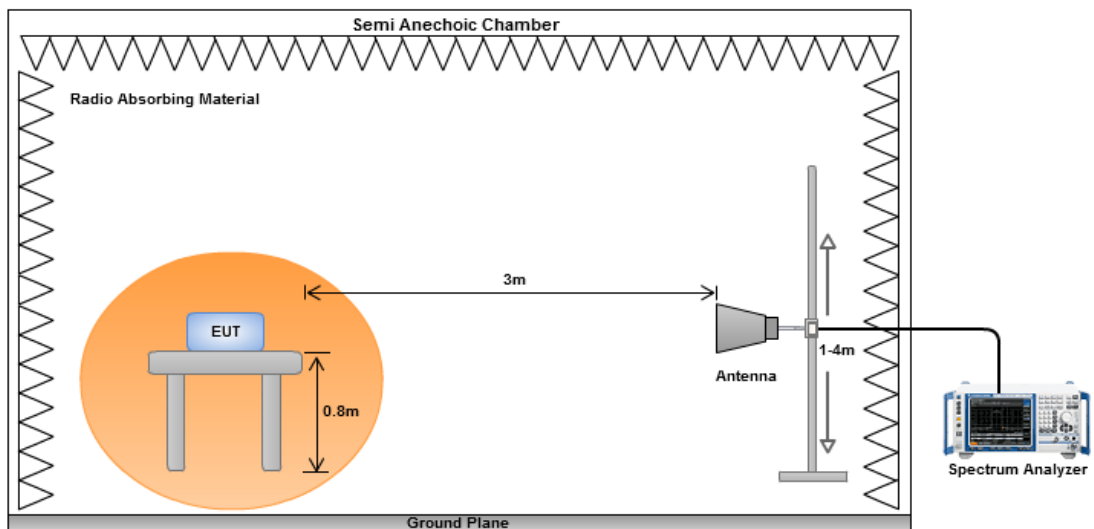

### 3.2.4 Transmitter Radiated Unwanted Emissions (Below 1GHz)

<b>Modulation</b>	HT40	<b>Test Freq. (MHz)</b>	5720
<b>Polarization</b>	Horizontal	<b>Test Configuration</b>	1

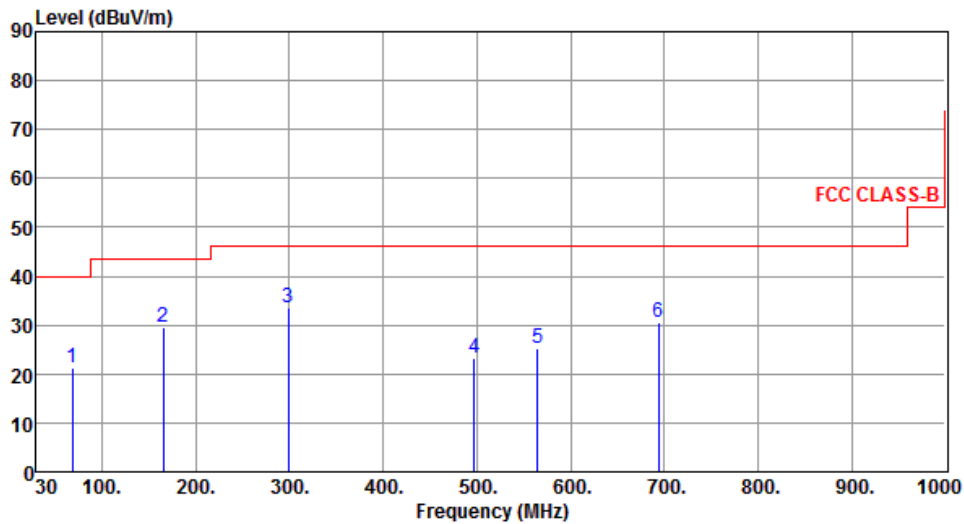

	Freq. MHz	Emission level dBuV/m	Limit dBuV/m	Margin dB	SA reading dBuV	Factor dB	Remark	ANT High cm	Turn Table deg
1	68.80	21.33	40.00	-18.67	40.16	-18.83	Peak	---	---
2	165.80	29.48	43.50	-14.02	46.64	-17.16	Peak	---	---
3	298.69	33.57	46.00	-12.43	49.82	-16.25	Peak	---	---
4	497.54	23.18	46.00	-22.82	34.91	-11.73	Peak	---	---
5	564.47	25.41	46.00	-20.59	35.72	-10.31	Peak	---	---
6	693.48	30.45	46.00	-15.55	38.86	-8.41	Peak	---	---

Note 1: Emission Level (dBuV/m) = SA Reading (dBuV/m) + Factor\* (dB)

\*Factor includes antenna factor, cable loss and amplifier gain

Note 2: Margin (dB) = Emission level (dBuV/m) – Limit (dBuV/m).

Note 3: All spurious emissions below 30MHz are more than 20 dB below the limit.

<b>Modulation</b>	HT40	<b>Test Freq. (MHz)</b>	5720
<b>Polarization</b>	Vertical	<b>Test Configuration</b>	1

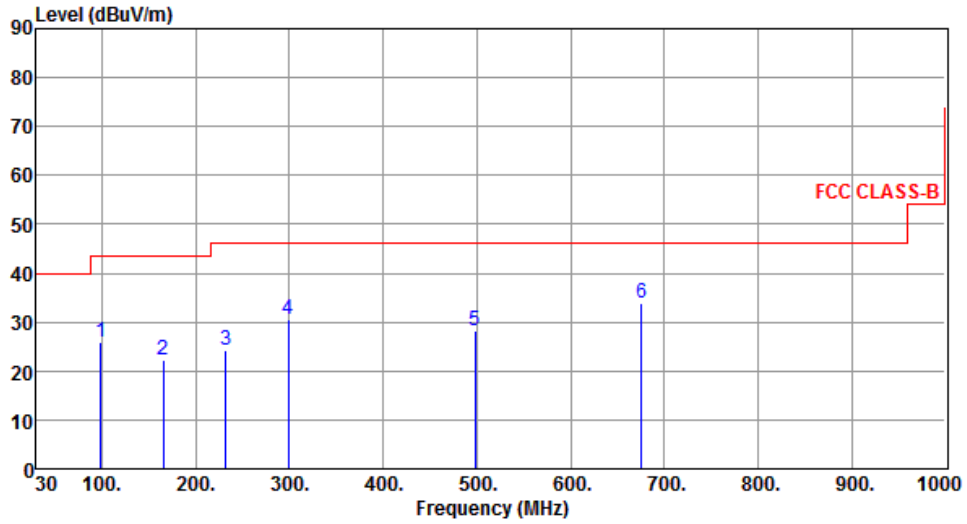

	Freq. MHz	Emission level dBuV/m	Limit dBuV/m	Margin dB	SA reading dBuV	Factor dB	Remark	ANT High cm	Turn Table deg
1	98.87	25.80	43.50	-17.70	47.60	-21.80	Peak	---	---
2	165.80	22.24	43.50	-21.26	39.40	-17.16	Peak	---	---
3	231.76	24.22	46.00	-21.78	42.87	-18.65	Peak	---	---
4	298.69	30.48	46.00	-15.52	46.73	-16.25	Peak	---	---
5	498.51	28.12	46.00	-17.88	39.84	-11.72	Peak	---	---
6	676.02	33.97	46.00	-12.03	42.64	-8.67	Peak	---	---

Note 1: Emission Level (dBuV/m) = SA Reading (dBuV/m) + Factor\* (dB)

\*Factor includes antenna factor , cable loss and amplifier gain

Note 2: Margin (dB) = Emission level (dBuV/m) – Limit (dBuV/m).

Note 3: All spurious emissions below 30MHz are more than 20 dB below the limit.

### 3.2.5 Transmitter Radiated Unwanted Emissions (Above 1GHz) for 11a

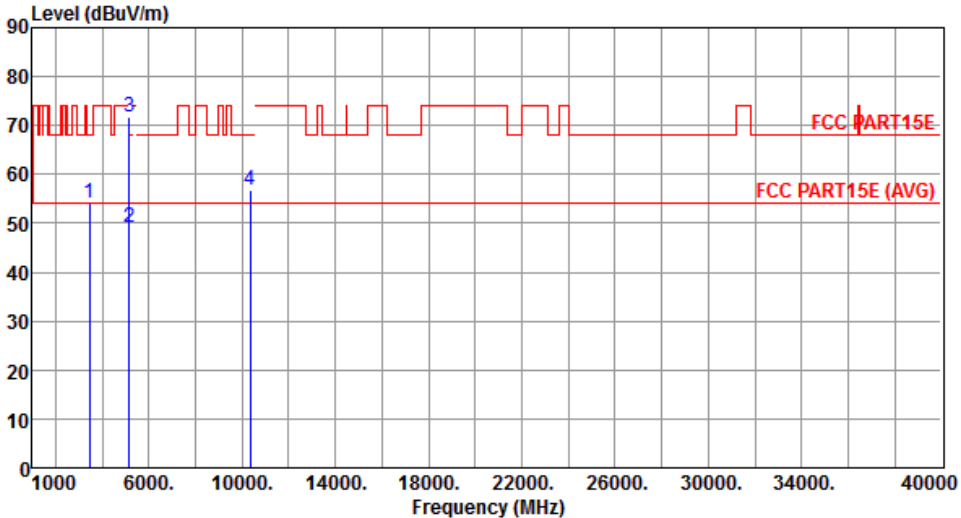
Modulation	11a	Test Freq. (MHz)	5180																																																							
Polarization	Horizontal	Test Configuration	1																																																							
																																																										
	<table border="1"> <thead> <tr> <th>Freq.</th> <th>Emission level</th> <th>Limit</th> <th>Margin</th> <th>SA reading</th> <th>Factor</th> <th>Remark</th> <th>ANT High cm</th> <th>Turn Table deg</th> </tr> <tr> <th>MHz</th> <th>dBuV/m</th> <th>dBuV/m</th> <th>dB</th> <th>dBuV</th> <th>dB</th> <th></th> <th></th> <th></th> </tr> </thead> <tbody> <tr> <td>1</td> <td>3453.00</td> <td>54.06</td> <td>68.20</td> <td>-14.14</td> <td>53.33</td> <td>0.73</td> <td>Peak</td> <td>---</td> </tr> <tr> <td>2</td> <td>5150.00</td> <td>49.03</td> <td>54.00</td> <td>-4.97</td> <td>43.32</td> <td>5.71</td> <td>Average</td> <td>---</td> </tr> <tr> <td>3</td> <td>5150.00</td> <td>71.61</td> <td>74.00</td> <td>-2.39</td> <td>65.90</td> <td>5.71</td> <td>Peak</td> <td>---</td> </tr> <tr> <td>4</td> <td>10360.00</td> <td>56.65</td> <td>68.20</td> <td>-11.55</td> <td>42.21</td> <td>14.44</td> <td>Peak</td> <td>---</td> </tr> </tbody> </table>	Freq.	Emission level	Limit	Margin	SA reading	Factor	Remark	ANT High cm	Turn Table deg	MHz	dBuV/m	dBuV/m	dB	dBuV	dB				1	3453.00	54.06	68.20	-14.14	53.33	0.73	Peak	---	2	5150.00	49.03	54.00	-4.97	43.32	5.71	Average	---	3	5150.00	71.61	74.00	-2.39	65.90	5.71	Peak	---	4	10360.00	56.65	68.20	-11.55	42.21	14.44	Peak	---			
Freq.	Emission level	Limit	Margin	SA reading	Factor	Remark	ANT High cm	Turn Table deg																																																		
MHz	dBuV/m	dBuV/m	dB	dBuV	dB																																																					
1	3453.00	54.06	68.20	-14.14	53.33	0.73	Peak	---																																																		
2	5150.00	49.03	54.00	-4.97	43.32	5.71	Average	---																																																		
3	5150.00	71.61	74.00	-2.39	65.90	5.71	Peak	---																																																		
4	10360.00	56.65	68.20	-11.55	42.21	14.44	Peak	---																																																		
<p>Note 1: Emission Level (dBuV/m) = SA Reading (dBuV/m) + Factor* (dB)            *Factor includes antenna factor , cable loss and amplifier gain            Note 2: Margin (dB) = Emission level (dBuV/m) – Limit (dBuV/m).</p>																																																										

<b>Modulation</b>	11a	<b>Test Freq. (MHz)</b>	5180
<b>Polarization</b>	Vertical	<b>Test Configuration</b>	1

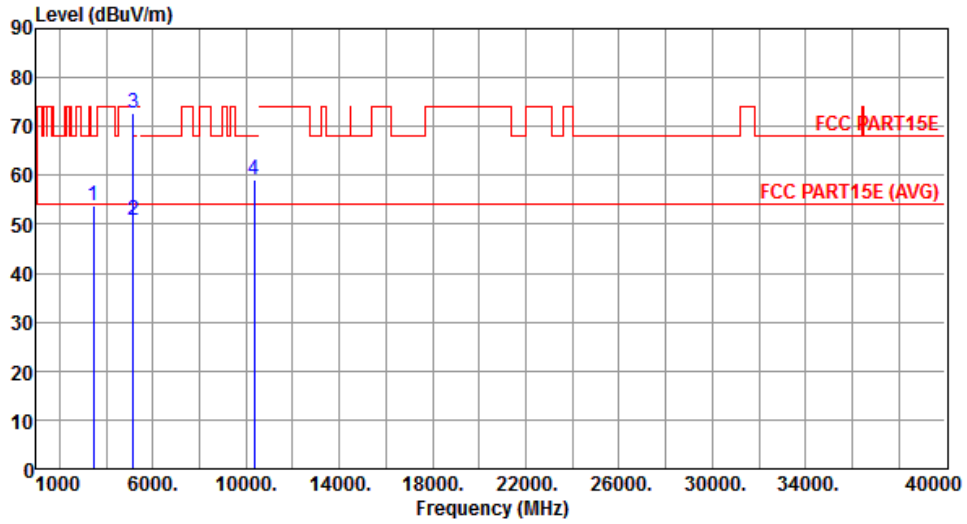

	Freq. MHz	Emission level dBuV/m	Limit dBuV/m	Margin dB	SA reading dBuV	Factor dB	Remark	ANT High cm	Turn Table deg
1	3453.00	53.95	68.20	-14.25	53.22	0.73	Peak	---	---
2	5150.00	50.90	54.00	-3.10	45.19	5.71	Average	---	---
3	5150.00	72.81	74.00	-1.19	67.10	5.71	Peak	---	---
4	10360.00	59.04	68.20	-9.16	44.60	14.44	Peak	---	---

Note 1: Emission Level (dBuV/m) = SA Reading (dBuV/m) + Factor\* (dB)

\*Factor includes antenna factor , cable loss and amplifier gain

Note 2: Margin (dB) = Emission level (dBuV/m) – Limit (dBuV/m).

<b>Modulation</b>	11a	<b>Test Freq. (MHz)</b>	5200
<b>Polarization</b>	Horizontal	<b>Test Configuration</b>	1

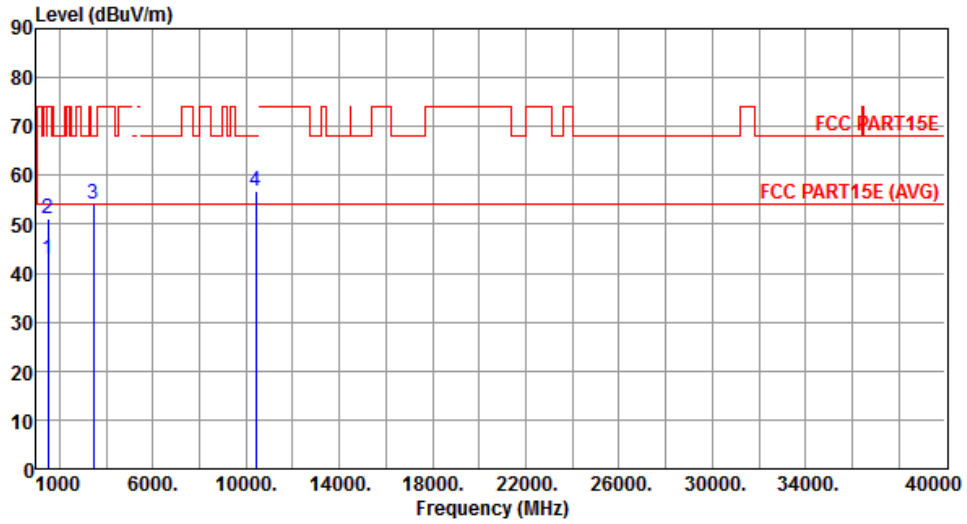

	Freq. MHz	Emission level dBuV/m	Limit dBuV/m	Margin dB	SA reading dBuV	Factor dB	Remark	ANT High cm	Turn Table deg
1	1500.00	42.71	54.00	-11.29	49.18	-6.47	Average	---	---
2	1500.00	50.98	74.00	-23.02	57.45	-6.47	Peak	---	---
3	3466.00	54.22	68.20	-13.98	53.47	0.75	Peak	---	---
4	10400.00	56.65	68.20	-11.55	42.15	14.50	Peak	---	---

Note 1: Emission Level (dBuV/m) = SA Reading (dBuV/m) + Factor\* (dB)

\*Factor includes antenna factor , cable loss and amplifier gain

Note 2: Margin (dB) = Emission level (dBuV/m) – Limit (dBuV/m).

<b>Modulation</b>	11a	<b>Test Freq. (MHz)</b>	5200
<b>Polarization</b>	Vertical	<b>Test Configuration</b>	1

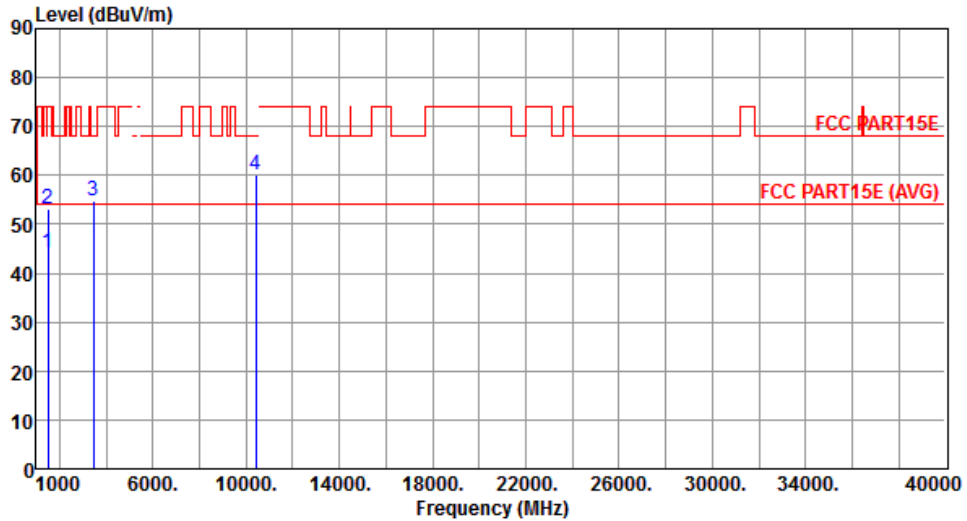

	Freq. MHz	Emission level dBuV/m	Limit dBuV/m	Margin dB	SA reading dBuV	Factor dB	Remark	ANT High cm	Turn Table deg
1	1500.00	44.04	54.00	-9.96	50.51	-6.47	Average	---	---
2	1500.00	53.19	74.00	-20.81	59.66	-6.47	Peak	---	---
3	3466.00	54.77	68.20	-13.43	54.02	0.75	Peak	---	---
4	10400.00	60.06	68.20	-8.14	45.56	14.50	Peak	---	---

Note 1: Emission Level (dBuV/m) = SA Reading (dBuV/m) + Factor\* (dB)

\*Factor includes antenna factor , cable loss and amplifier gain

Note 2: Margin (dB) = Emission level (dBuV/m) – Limit (dBuV/m).

<b>Modulation</b>	11a	<b>Test Freq. (MHz)</b>	5240
<b>Polarization</b>	Horizontal	<b>Test Configuration</b>	1

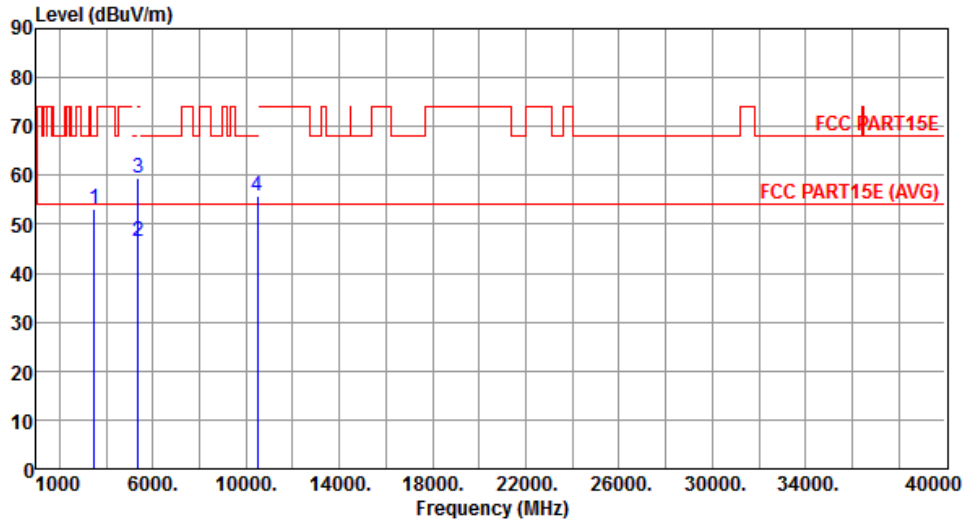

	Freq. MHz	Emission level dBuV/m	Limit dBuV/m	Margin dB	SA reading dBuV	Factor dB	Remark	ANT High cm	Turn Table deg
1	3493.00	53.24	68.20	-14.96	52.46	0.78	Peak	---	---
2	5350.00	46.49	54.00	-7.51	40.50	5.99	Average	---	---
3	5350.00	59.43	74.00	-14.57	53.44	5.99	Peak	---	---
4	10480.00	55.96	68.20	-12.24	41.33	14.63	Peak	---	---

Note 1: Emission Level (dBuV/m) = SA Reading (dBuV/m) + Factor\* (dB)

\*Factor includes antenna factor , cable loss and amplifier gain

Note 2: Margin (dB) = Emission level (dBuV/m) – Limit (dBuV/m).



<b>Modulation</b>	11a	<b>Test Freq. (MHz)</b>	5240
<b>Polarization</b>	Vertical	<b>Test Configuration</b>	1

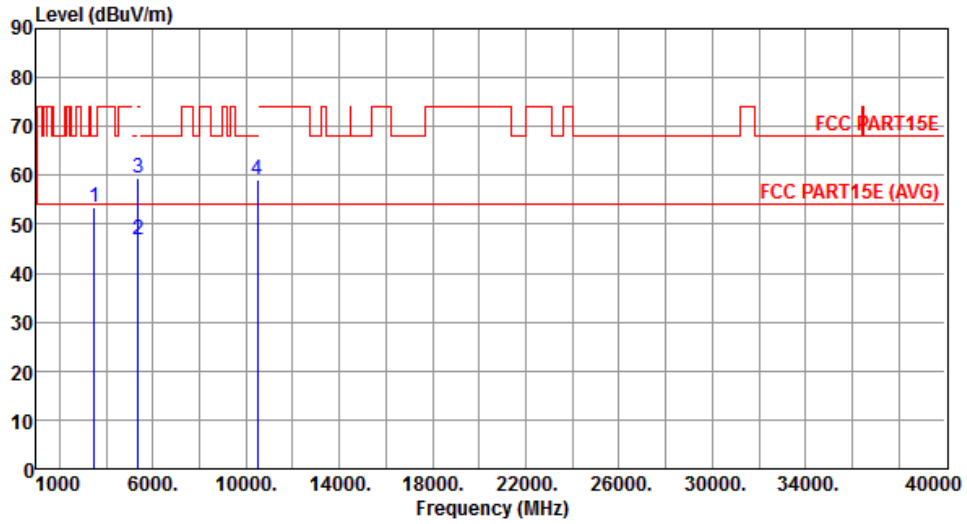

	Freq. MHz	Emission level dBuV/m	Limit dBuV/m	Margin dB	SA reading dBuV	Factor dB	Remark	ANT High cm	Turn Table deg
1	3493.00	53.43	68.20	-14.77	52.65	0.78	Peak	---	---
2	5350.00	46.88	54.00	-7.12	40.89	5.99	Average	---	---
3	5350.00	59.58	74.00	-14.42	53.59	5.99	Peak	---	---
4	10480.00	58.96	68.20	-9.24	44.33	14.63	Peak	---	---

Note 1: Emission Level (dBuV/m) = SA Reading (dBuV/m) + Factor\* (dB)

\*Factor includes antenna factor , cable loss and amplifier gain

Note 2: Margin (dB) = Emission level (dBuV/m) – Limit (dBuV/m).

<b>Modulation</b>	11a	<b>Test Freq. (MHz)</b>	5260
<b>Polarization</b>	Horizontal	<b>Test Configuration</b>	1

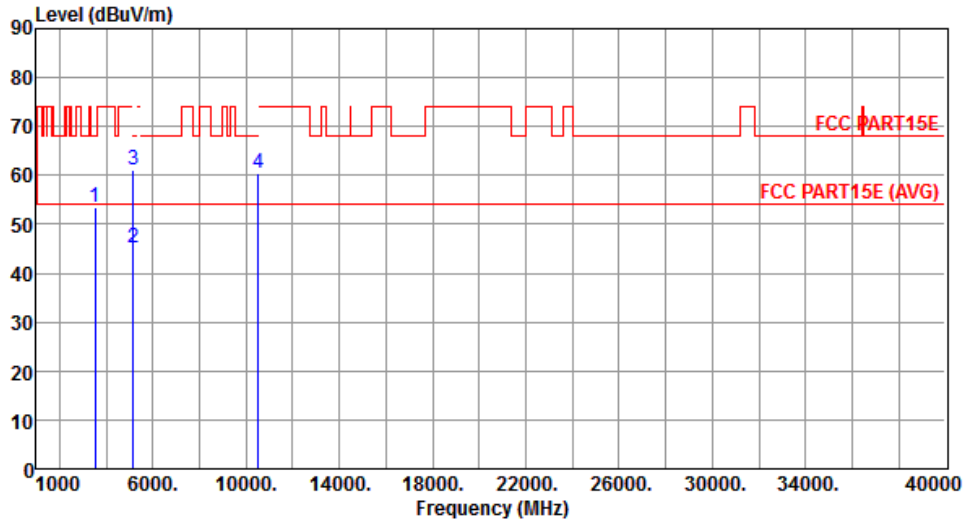

	Freq. MHz	Emission level dBuV/m	Limit dBuV/m	Margin dB	SA reading dBuV	Factor dB	Remark	ANT High cm	Turn Table deg
1	3507.00	53.42	68.20	-14.78	52.63	0.79	Peak	---	---
2	5150.00	45.17	54.00	-8.83	39.46	5.71	Average	---	---
3	5150.00	61.23	74.00	-12.77	55.52	5.71	Peak	---	---
4	10520.00	60.52	68.20	-7.68	45.82	14.70	Peak	---	---

Note 1: Emission Level (dBuV/m) = SA Reading (dBuV/m) + Factor\* (dB)

\*Factor includes antenna factor , cable loss and amplifier gain

Note 2: Margin (dB) = Emission level (dBuV/m) – Limit (dBuV/m).

<b>Modulation</b>	11a	<b>Test Freq. (MHz)</b>	5260
<b>Polarization</b>	Vertical	<b>Test Configuration</b>	1

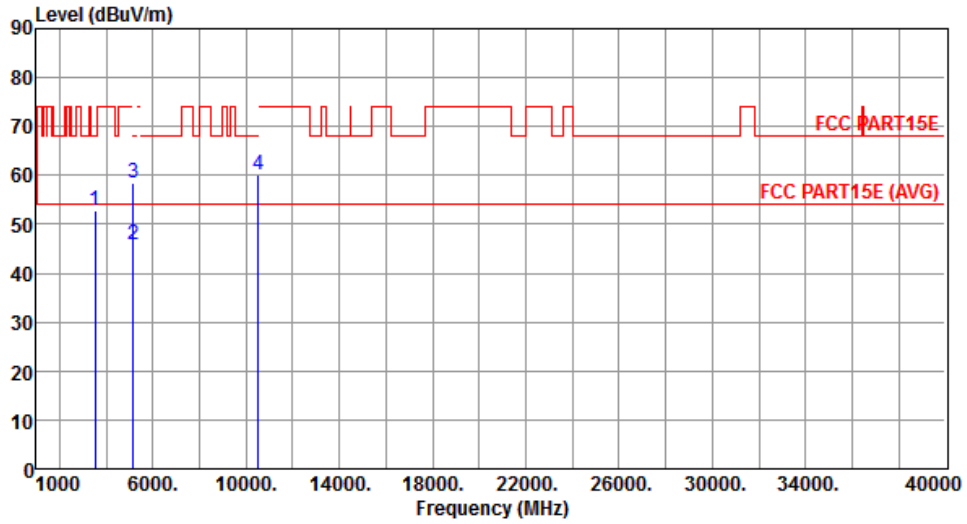

	Freq. MHz	Emission level dBuV/m	Limit dBuV/m	Margin dB	SA reading dBuV	Factor dB	Remark	ANT High cm	Turn Table deg
1	3507.00	52.89	68.20	-15.31	52.10	0.79	Peak	---	---
2	5150.00	45.98	54.00	-8.02	40.27	5.71	Average	---	---
3	5150.00	58.35	74.00	-15.65	52.64	5.71	Peak	---	---
4	10520.00	60.21	68.20	-7.99	45.51	14.70	Peak	---	---

Note 1: Emission Level (dBuV/m) = SA Reading (dBuV/m) + Factor\* (dB)

\*Factor includes antenna factor , cable loss and amplifier gain

Note 2: Margin (dB) = Emission level (dBuV/m) – Limit (dBuV/m).

<b>Modulation</b>	11a	<b>Test Freq. (MHz)</b>	5300
<b>Polarization</b>	Horizontal	<b>Test Configuration</b>	1

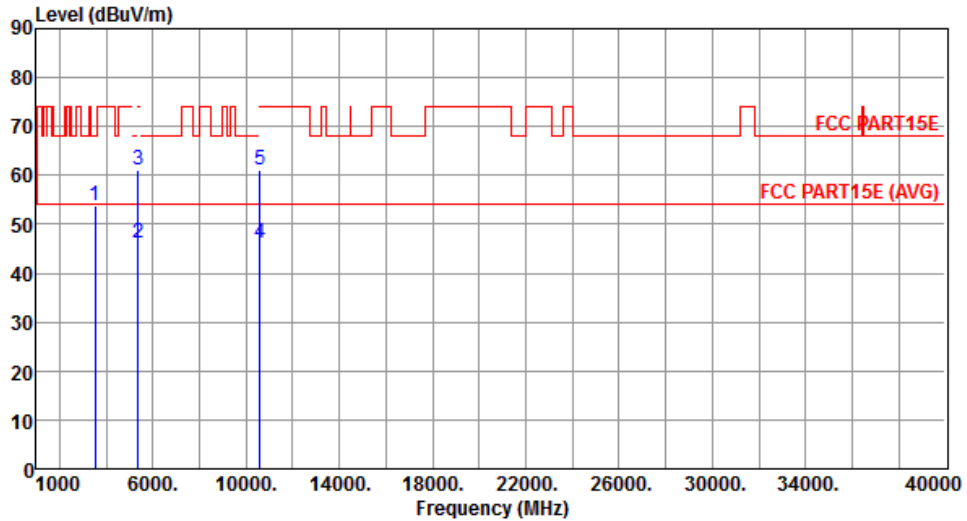

	Freq. MHz	Emission level dBuV/m	Limit dBuV/m	Margin dB	SA reading dBuV	Factor dB	Remark	ANT High cm	Turn Table deg
1	3533.00	53.80	68.20	-14.40	52.93	0.87	Peak	---	---
2	5350.00	46.28	54.00	-7.72	40.29	5.99	Average	---	---
3	5350.00	61.23	74.00	-12.77	55.24	5.99	Peak	---	---
4	10600.00	46.12	54.00	-7.88	31.26	14.86	Average	---	---
5	10600.00	61.06	74.00	-12.94	46.20	14.86	Peak	---	---

Note 1: Emission Level (dBuV/m) = SA Reading (dBuV/m) + Factor\* (dB)

\*Factor includes antenna factor , cable loss and amplifier gain

Note 2: Margin (dB) = Emission level (dBuV/m) – Limit (dBuV/m).

<b>Modulation</b>	11a	<b>Test Freq. (MHz)</b>	5300
<b>Polarization</b>	Vertical	<b>Test Configuration</b>	1

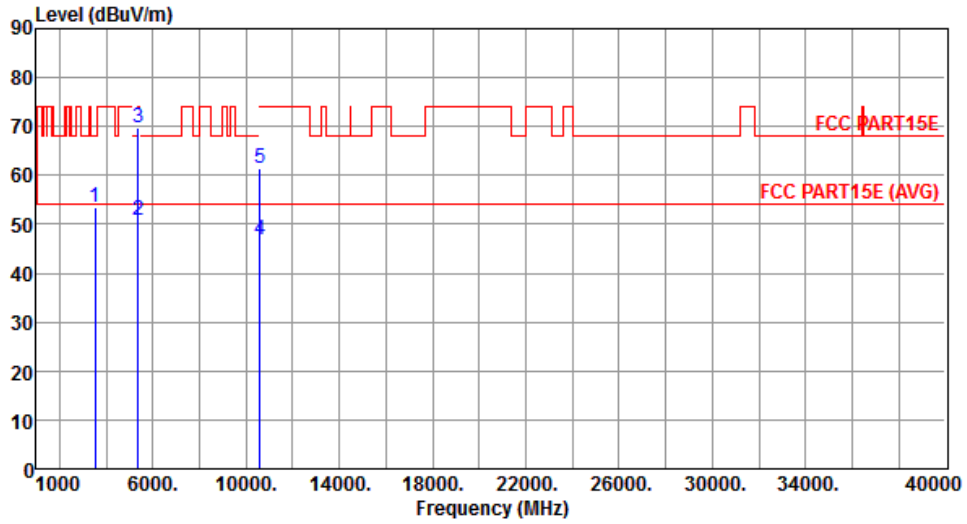

	Freq. MHz	Emission level dBuV/m	Limit dBuV/m	Margin dB	SA reading dBuV	Factor dB	Remark	ANT High cm	Turn Table deg
1	3533.00	53.35	68.20	-14.85	52.48	0.87	Peak	---	---
2	5350.00	50.70	54.00	-3.30	44.71	5.99	Average	---	---
3	5350.00	69.81	74.00	-4.19	63.82	5.99	Peak	---	---
4	10600.00	46.71	54.00	-7.29	31.85	14.86	Average	---	---
5	10600.00	61.33	74.00	-12.67	46.47	14.86	Peak	---	---

Note 1: Emission Level (dBuV/m) = SA Reading (dBuV/m) + Factor\* (dB)

\*Factor includes antenna factor , cable loss and amplifier gain

Note 2: Margin (dB) = Emission level (dBuV/m) – Limit (dBuV/m).

<b>Modulation</b>	11a	<b>Test Freq. (MHz)</b>	5320
<b>Polarization</b>	Horizontal	<b>Test Configuration</b>	1

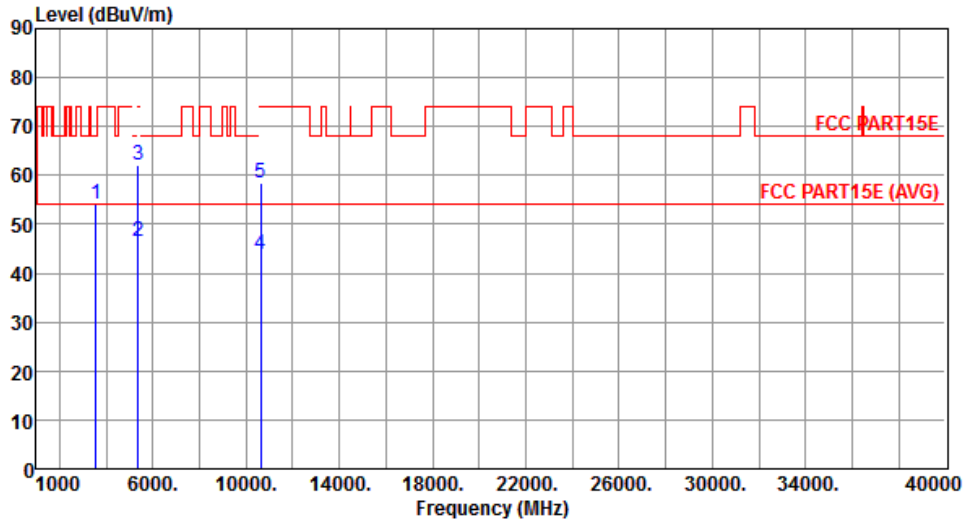

	Freq. MHz	Emission level dBuV/m	Limit dBuV/m	Margin dB	SA reading dBuV	Factor dB	Remark	ANT High cm	Turn Table deg
1	3546.00	54.15	68.20	-14.05	53.25	0.90	Peak	---	---
2	5350.00	46.45	54.00	-7.55	40.46	5.99	Average	---	---
3	5350.00	62.11	74.00	-11.89	56.12	5.99	Peak	---	---
4	10640.00	43.96	54.00	-10.04	29.01	14.95	Average	---	---
5	10640.00	58.37	74.00	-15.63	43.42	14.95	Peak	---	---

Note 1: Emission Level (dBuV/m) = SA Reading (dBuV/m) + Factor\* (dB)

\*Factor includes antenna factor , cable loss and amplifier gain

Note 2: Margin (dB) = Emission level (dBuV/m) – Limit (dBuV/m).

<b>Modulation</b>	11a	<b>Test Freq. (MHz)</b>	5320
<b>Polarization</b>	Vertical	<b>Test Configuration</b>	1

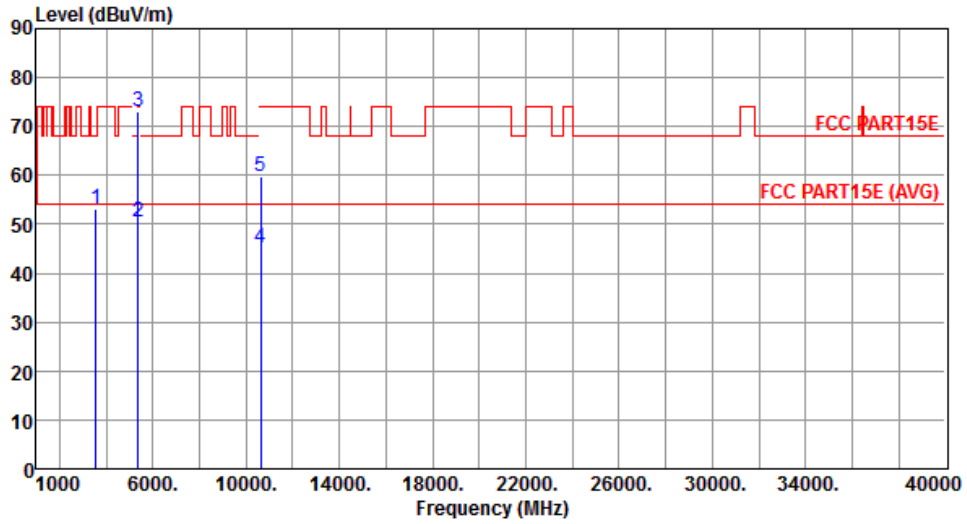

	Freq. MHz	Emission level dBuV/m	Limit dBuV/m	Margin dB	SA reading dBuV	Factor dB	Remark	ANT High cm	Turn Table deg
1	3546.00	53.27	68.20	-14.93	52.37	0.90	Peak	---	---
2	5350.00	50.56	54.00	-3.44	44.57	5.99	Average	---	---
3	5350.00	72.94	74.00	-1.06	66.95	5.99	Peak	---	---
4	10640.00	45.04	54.00	-8.96	30.09	14.95	Average	---	---
5	10640.00	59.92	74.00	-14.08	44.97	14.95	Peak	---	---

Note 1: Emission Level (dBuV/m) = SA Reading (dBuV/m) + Factor\* (dB)

\*Factor includes antenna factor , cable loss and amplifier gain

Note 2: Margin (dB) = Emission level (dBuV/m) – Limit (dBuV/m).

<b>Modulation</b>	11a	<b>Test Freq. (MHz)</b>	5500
<b>Polarization</b>	Horizontal	<b>Test Configuration</b>	1

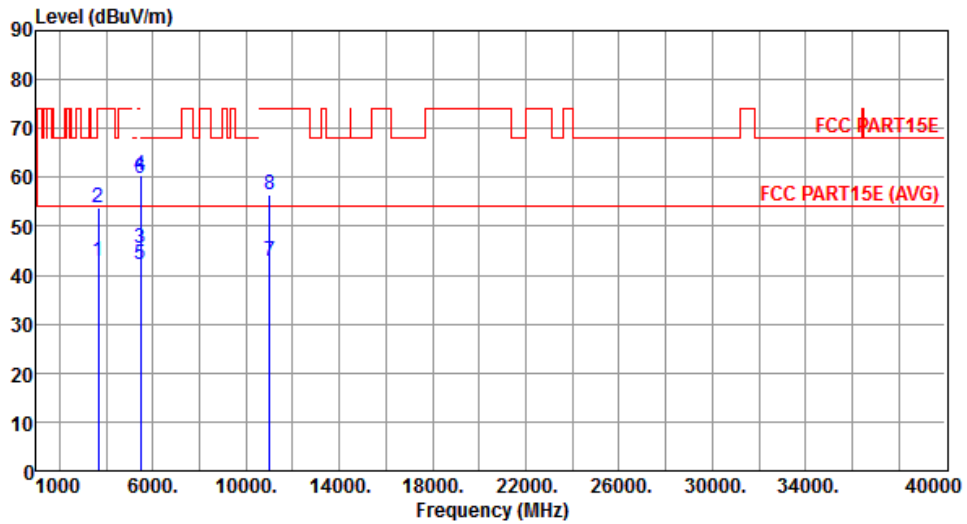

	Freq. MHz	Emission level dBuV/m	Limit dBuV/m	Margin dB	SA reading dBuV	Factor dB	Remark	ANT High cm	Turn Table deg
1	3667.00	42.68	54.00	-11.32	41.42	1.26	Average	---	---
2	3667.00	53.73	74.00	-20.27	52.47	1.26	Peak	---	---
3	5460.00	45.56	54.00	-8.44	39.44	6.12	Average	---	---
4	5460.00	60.38	74.00	-13.62	54.26	6.12	Peak	---	---
5	5470.00	42.13	54.00	-11.87	35.99	6.14	Average	---	---
6	5470.00	59.78	68.20	-8.42	53.64	6.14	Peak	---	---
7	11000.00	42.88	54.00	-11.12	27.19	15.69	Average	---	---
8	11000.00	56.40	74.00	-17.60	40.71	15.69	Peak	---	---

Note 1: Emission Level (dBuV/m) = SA Reading (dBuV/m) + Factor\* (dB)

\*Factor includes antenna factor , cable loss and amplifier gain

Note 2: Margin (dB) = Emission level (dBuV/m) – Limit (dBuV/m).



<b>Modulation</b>	11a	<b>Test Freq. (MHz)</b>	5500
<b>Polarization</b>	Vertical	<b>Test Configuration</b>	1

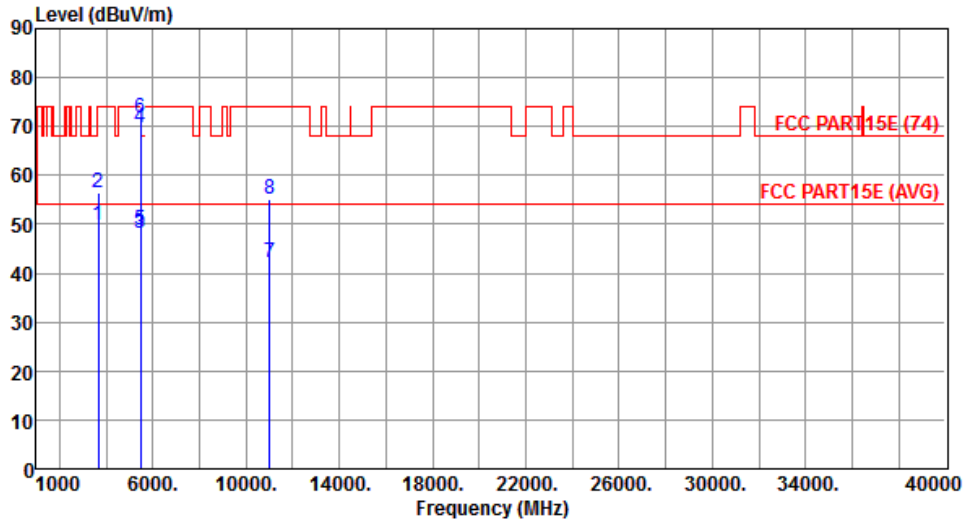

	Freq. MHz	Emission level dBuV/m	Limit dBuV/m	Margin dB	SA reading dBuV	Factor dB	Remark	ANT High cm	Turn Table deg
1	3667.00	49.73	54.00	-4.27	48.47	1.26	Average	---	---
2	3667.00	56.53	74.00	-17.47	55.27	1.26	Peak	---	---
3	5460.00	48.04	54.00	-5.96	41.92	6.12	Average	---	---
4	5460.00	69.78	74.00	-4.22	63.66	6.12	Peak	---	---
5	5470.00	48.95	54.00	-5.05	42.81	6.14	Average	---	---
6	5470.00	71.64	74.00	-2.36	65.50	6.14	Peak	---	---
7	11000.00	42.13	54.00	-11.87	26.44	15.69	Average	---	---
8	11000.00	55.14	74.00	-18.86	39.45	15.69	Peak	---	---

Note 1: Emission Level (dBuV/m) = SA Reading (dBuV/m) + Factor\* (dB)

\*Factor includes antenna factor , cable loss and amplifier gain

Note 2: Margin (dB) = Emission level (dBuV/m) – Limit (dBuV/m).

<b>Modulation</b>	11a	<b>Test Freq. (MHz)</b>	5580
<b>Polarization</b>	Horizontal	<b>Test Configuration</b>	1

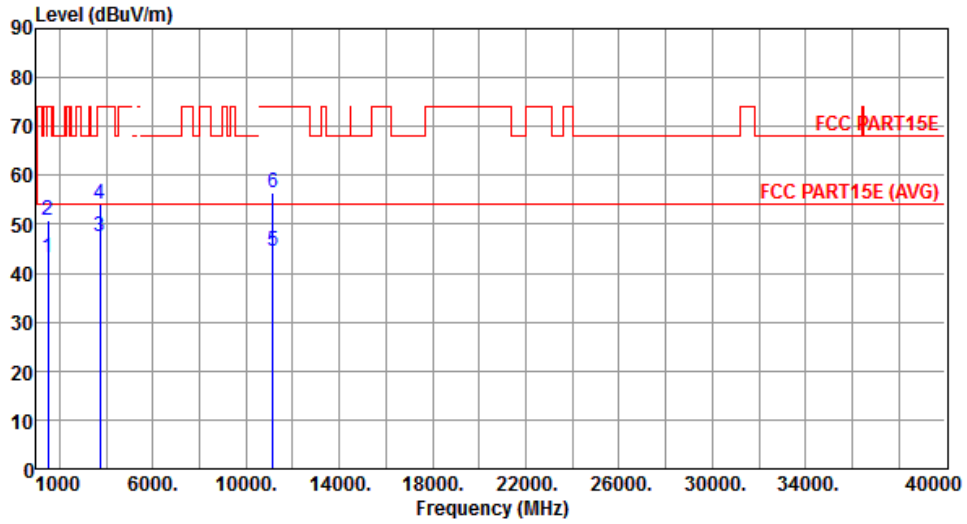

	Freq. MHz	Emission level dBuV/m	Limit dBuV/m	Margin dB	SA reading dBuV	Factor dB	Remark	ANT High cm	Turn Table deg
1	1500.00	43.12	54.00	-10.88	49.59	-6.47	Average	---	---
2	1500.00	50.97	74.00	-23.03	57.44	-6.47	Peak	---	---
3	3720.00	47.37	54.00	-6.63	45.94	1.43	Average	---	---
4	3720.00	54.22	74.00	-19.78	52.79	1.43	Peak	---	---
5	11160.00	44.34	54.00	-9.66	28.81	15.53	Average	---	---
6	11160.00	56.61	74.00	-17.39	41.08	15.53	Peak	---	---

Note 1: Emission Level (dBuV/m) = SA Reading (dBuV/m) + Factor\* (dB)

\*Factor includes antenna factor , cable loss and amplifier gain

Note 2: Margin (dB) = Emission level (dBuV/m) – Limit (dBuV/m).

<b>Modulation</b>	11a	<b>Test Freq. (MHz)</b>	5580
<b>Polarization</b>	Vertical	<b>Test Configuration</b>	1

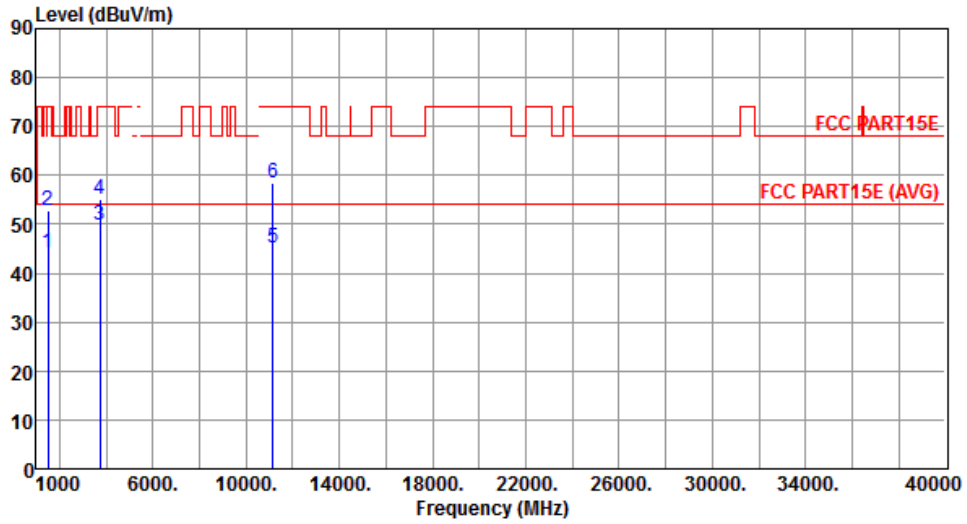

	Freq. MHz	Emission level dBuV/m	Limit dBuV/m	Margin dB	SA reading dBuV	Factor dB	Remark	ANT High cm	Turn Table deg
1	1500.00	44.33	54.00	-9.67	50.80	-6.47	Average	---	---
2	1500.00	52.94	74.00	-21.06	59.41	-6.47	Peak	---	---
3	3720.00	49.87	54.00	-4.13	48.44	1.43	Average	---	---
4	3720.00	55.15	74.00	-18.85	53.72	1.43	Peak	---	---
5	11160.00	45.04	54.00	-8.96	29.51	15.53	Average	---	---
6	11160.00	58.45	74.00	-15.55	42.92	15.53	Peak	---	---

Note 1: Emission Level (dBuV/m) = SA Reading (dBuV/m) + Factor\* (dB)

\*Factor includes antenna factor , cable loss and amplifier gain

Note 2: Margin (dB) = Emission level (dBuV/m) – Limit (dBuV/m).

<b>Modulation</b>	11a	<b>Test Freq. (MHz)</b>	5700
<b>Polarization</b>	Horizontal	<b>Test Configuration</b>	1

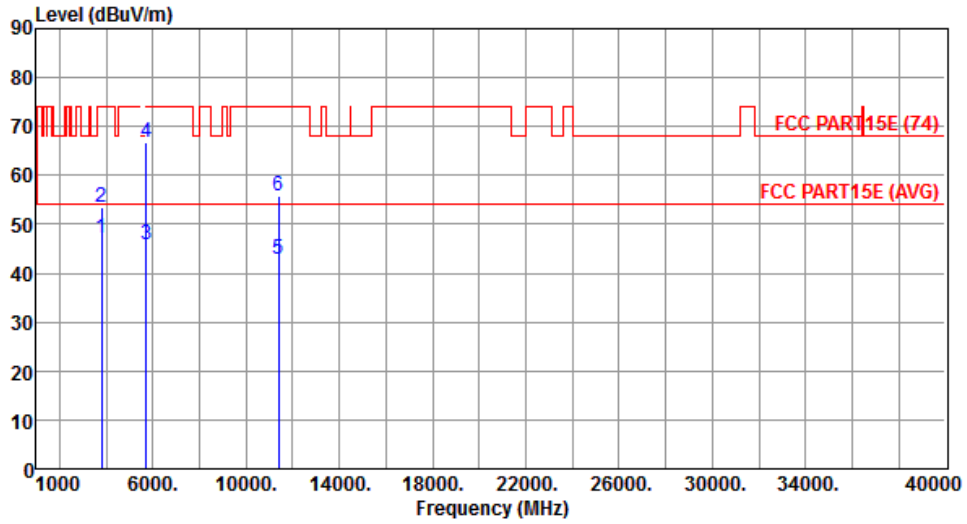

	Freq. MHz	Emission level dBuV/m	Limit dBuV/m	Margin dB	SA reading dBuV	Factor dB	Remark	ANT High cm	Turn Table deg
1	3800.00	47.02	54.00	-6.98	45.34	1.68	Average	---	---
2	3800.00	53.33	74.00	-20.67	51.65	1.68	Peak	---	---
3	5725.00	45.70	54.00	-8.30	39.11	6.59	Average	---	---
4	5725.00	66.63	74.00	-7.37	60.04	6.59	Peak	---	---
5	11400.00	42.92	54.00	-11.08	27.63	15.29	Average	---	---
6	11400.00	55.90	74.00	-18.10	40.61	15.29	Peak	---	---

Note 1: Emission Level (dBuV/m) = SA Reading (dBuV/m) + Factor\* (dB)

\*Factor includes antenna factor , cable loss and amplifier gain

Note 2: Margin (dB) = Emission level (dBuV/m) – Limit (dBuV/m).

<b>Modulation</b>	11a	<b>Test Freq. (MHz)</b>	5700
<b>Polarization</b>	Vertical	<b>Test Configuration</b>	1

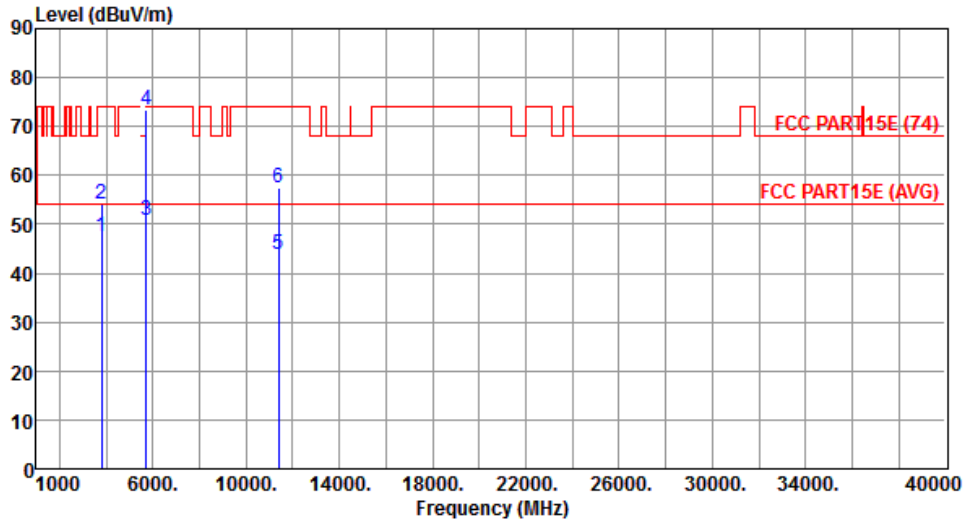

	Freq. MHz	Emission level dBuV/m	Limit dBuV/m	Margin dB	SA reading dBuV	Factor dB	Remark	ANT High cm	Turn Table deg
1	3800.00	47.46	54.00	-6.54	45.78	1.68	Average	---	---
2	3800.00	54.25	74.00	-19.75	52.57	1.68	Peak	---	---
3	5725.00	50.82	54.00	-3.18	44.23	6.59	Average	---	---
4	5725.00	73.42	74.00	-0.58	66.83	6.59	Peak	---	---
5	11400.00	43.84	54.00	-10.16	28.55	15.29	Average	---	---
6	11400.00	57.39	74.00	-16.61	42.10	15.29	Peak	---	---

Note 1: Emission Level (dBuV/m) = SA Reading (dBuV/m) + Factor\* (dB)

\*Factor includes antenna factor , cable loss and amplifier gain

Note 2: Margin (dB) = Emission level (dBuV/m) – Limit (dBuV/m).

### 3.2.6 Transmitter Radiated Unwanted Emissions (Above 1GHz) for HT20

<b>Modulation</b>	HT20	<b>Test Freq. (MHz)</b>	5180
<b>Polarization</b>	Horizontal	<b>Test Configuration</b>	1

  

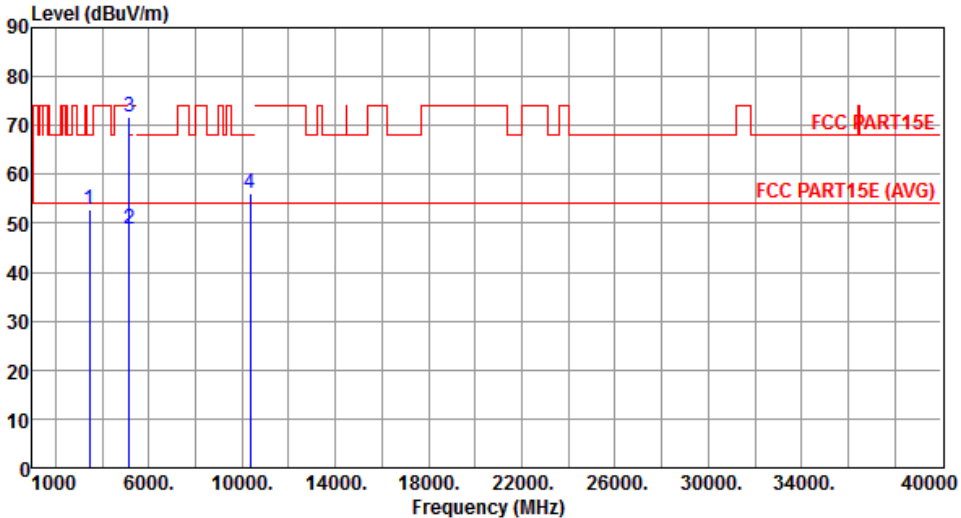

	Freq. MHz	Emission level dBuV/m	Limit dBuV/m	Margin dB	SA reading dBuV	Factor dB	Remark	ANT High cm	Turn Table deg
1	3453.00	52.82	68.20	-15.38	52.09	0.73	Peak	---	---
2	5150.00	48.74	54.00	-5.26	43.03	5.71	Average	---	---
3	5150.00	71.83	74.00	-2.17	66.12	5.71	Peak	---	---
4	10360.00	56.11	68.20	-12.09	41.67	14.44	Peak	---	---

Note 1: Emission Level (dBuV/m) = SA Reading (dBuV/m) + Factor\* (dB)  
 \*Factor includes antenna factor , cable loss and amplifier gain  
 Note 2: Margin (dB) = Emission level (dBuV/m) – Limit (dBuV/m).

<b>Modulation</b>	HT20	<b>Test Freq. (MHz)</b>	5180
<b>Polarization</b>	Vertical	<b>Test Configuration</b>	1

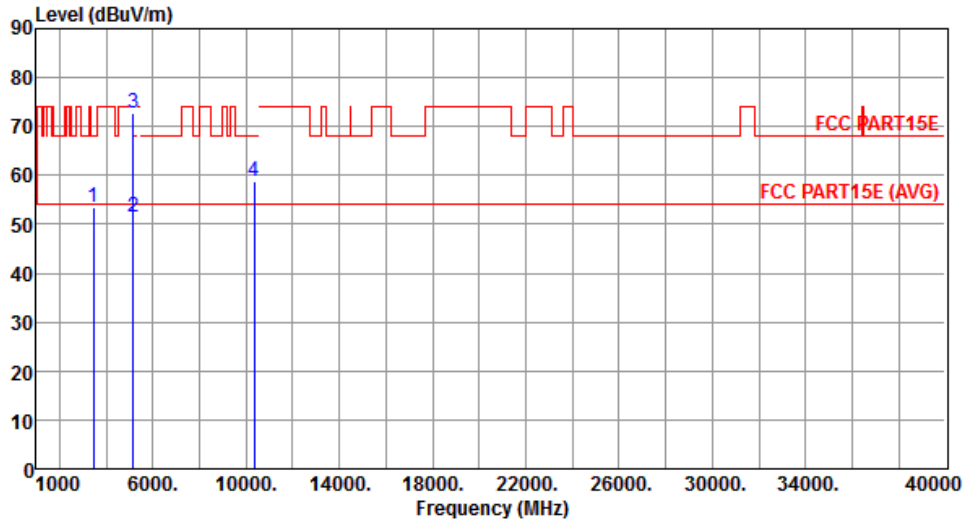

	Freq. MHz	Emission level dBuV/m	Limit dBuV/m	Margin dB	SA reading dBuV	Factor dB	Remark	ANT High cm	Turn Table deg
1	3453.00	53.42	68.20	-14.78	52.69	0.73	Peak	---	---
2	5150.00	51.53	54.00	-2.47	45.82	5.71	Average	---	---
3	5150.00	72.83	74.00	-1.17	67.12	5.71	Peak	---	---
4	10360.00	58.75	68.20	-9.45	44.31	14.44	Peak	---	---

Note 1: Emission Level (dBuV/m) = SA Reading (dBuV/m) + Factor\* (dB)

\*Factor includes antenna factor , cable loss and amplifier gain

Note 2: Margin (dB) = Emission level (dBuV/m) – Limit (dBuV/m).

<b>Modulation</b>	HT20	<b>Test Freq. (MHz)</b>	5200
<b>Polarization</b>	Horizontal	<b>Test Configuration</b>	1

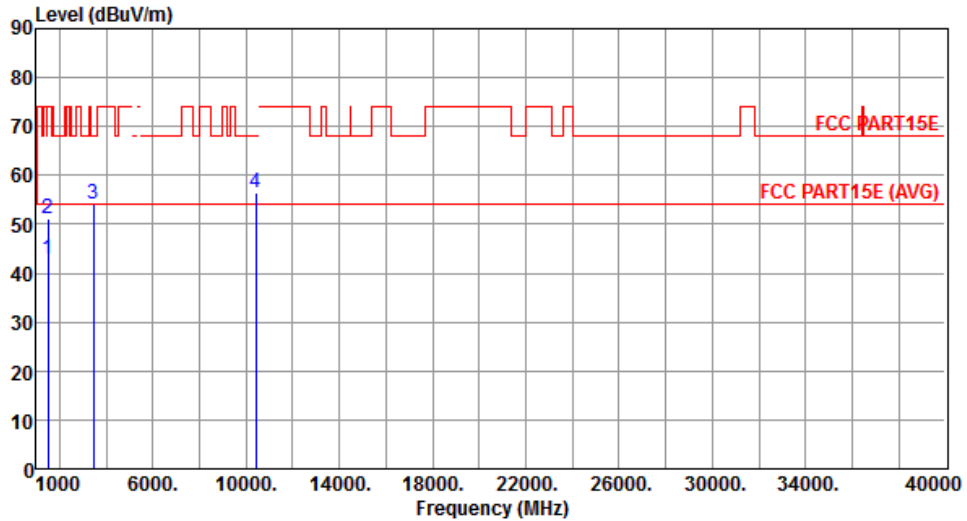

	Freq. MHz	Emission level dBuV/m	Limit dBuV/m	Margin dB	SA reading dBuV	Factor dB	Remark	ANT High cm	Turn Table deg
1	1500.00	42.97	54.00	-11.03	49.44	-6.47	Average	---	---
2	1500.00	51.13	74.00	-22.87	57.60	-6.47	Peak	---	---
3	3466.00	54.00	68.20	-14.20	53.25	0.75	Peak	---	---
4	10400.00	56.37	68.20	-11.83	41.87	14.50	Peak	---	---

Note 1: Emission Level (dBuV/m) = SA Reading (dBuV/m) + Factor\* (dB)

\*Factor includes antenna factor , cable loss and amplifier gain

Note 2: Margin (dB) = Emission level (dBuV/m) – Limit (dBuV/m).



<b>Modulation</b>	HT20	<b>Test Freq. (MHz)</b>	5200
<b>Polarization</b>	Vertical	<b>Test Configuration</b>	1

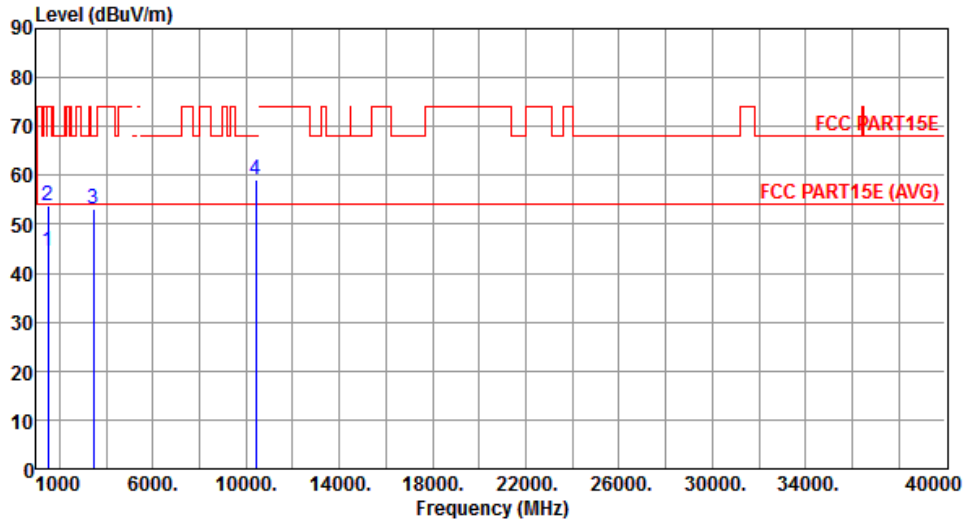

	Freq. MHz	Emission level dBuV/m	Limit dBuV/m	Margin dB	SA reading dBuV	Factor dB	Remark	ANT High cm	Turn Table deg
1	1500.00	44.53	54.00	-9.47	51.00	-6.47	Average	---	---
2	1500.00	53.71	74.00	-20.29	60.18	-6.47	Peak	---	---
3	3466.00	53.27	68.20	-14.93	52.52	0.75	Peak	---	---
4	10400.00	59.17	68.20	-9.03	44.67	14.50	Peak	---	---

Note 1: Emission Level (dBuV/m) = SA Reading (dBuV/m) + Factor\* (dB)

\*Factor includes antenna factor , cable loss and amplifier gain

Note 2: Margin (dB) = Emission level (dBuV/m) – Limit (dBuV/m).

<b>Modulation</b>	HT20	<b>Test Freq. (MHz)</b>	5240
<b>Polarization</b>	Horizontal	<b>Test Configuration</b>	1

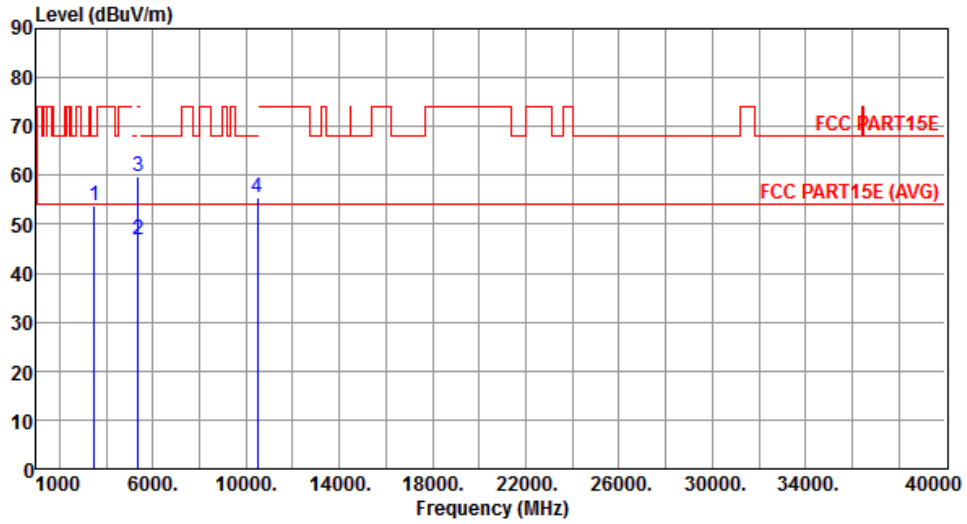

	Freq. MHz	Emission level dBuV/m	Limit dBuV/m	Margin dB	SA reading dBuV	Factor dB	Remark	ANT High cm	Turn Table deg
1	3493.00	53.76	68.20	-14.44	52.98	0.78	Peak	---	---
2	5350.00	46.98	54.00	-7.02	40.99	5.99	Average	---	---
3	5350.00	59.85	74.00	-14.15	53.86	5.99	Peak	---	---
4	10480.00	55.43	68.20	-12.77	40.80	14.63	Peak	---	---

Note 1: Emission Level (dBuV/m) = SA Reading (dBuV/m) + Factor\* (dB)

\*Factor includes antenna factor , cable loss and amplifier gain

Note 2: Margin (dB) = Emission level (dBuV/m) – Limit (dBuV/m).

<b>Modulation</b>	HT20	<b>Test Freq. (MHz)</b>	5240
<b>Polarization</b>	Vertical	<b>Test Configuration</b>	1

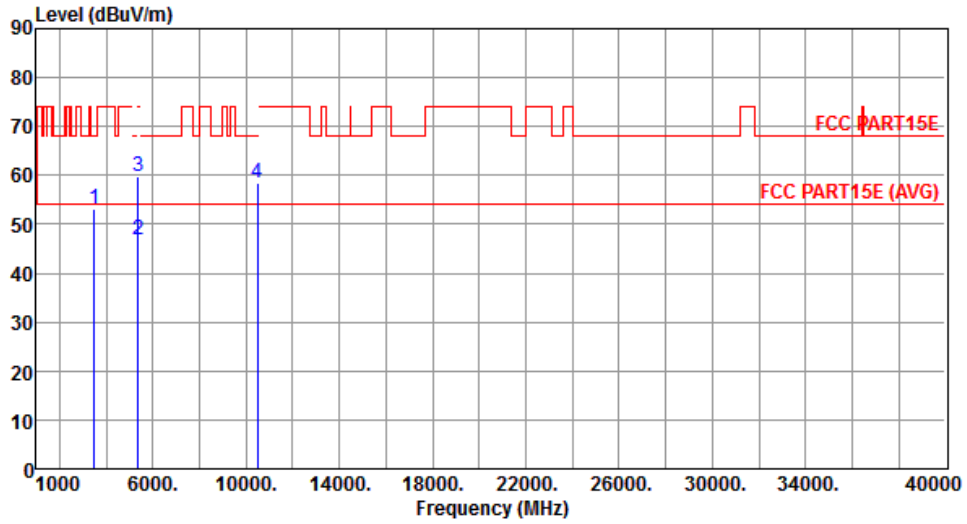

	Freq. MHz	Emission level dBuV/m	Limit dBuV/m	Margin dB	SA reading dBuV	Factor dB	Remark	ANT High cm	Turn Table deg
1	3493.00	53.27	68.20	-14.93	52.49	0.78	Peak	---	---
2	5350.00	46.98	54.00	-7.02	40.99	5.99	Average	---	---
3	5350.00	59.87	74.00	-14.13	53.88	5.99	Peak	---	---
4	10480.00	58.43	68.20	-9.77	43.80	14.63	Peak	---	---

Note 1: Emission Level (dBuV/m) = SA Reading (dBuV/m) + Factor\* (dB)

\*Factor includes antenna factor , cable loss and amplifier gain

Note 2: Margin (dB) = Emission level (dBuV/m) – Limit (dBuV/m).

<b>Modulation</b>	HT20	<b>Test Freq. (MHz)</b>	5260
<b>Polarization</b>	Horizontal	<b>Test Configuration</b>	1

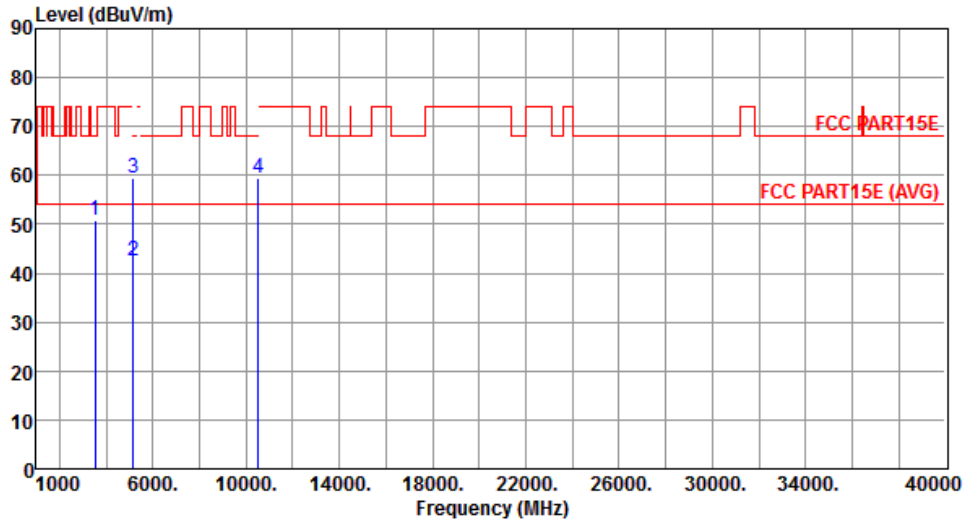

	Freq. MHz	Emission level dBuV/m	Limit dBuV/m	Margin dB	SA reading dBuV	Factor dB	Remark	ANT High cm	Turn Table deg
1	3507.00	50.95	68.20	-17.25	50.16	0.79	Peak	---	---
2	5150.00	42.60	54.00	-11.40	36.89	5.71	Average	---	---
3	5150.00	59.28	74.00	-14.72	53.57	5.71	Peak	---	---
4	10520.00	59.50	68.20	-8.70	44.80	14.70	Peak	---	---

Note 1: Emission Level (dBuV/m) = SA Reading (dBuV/m) + Factor\* (dB)

\*Factor includes antenna factor , cable loss and amplifier gain

Note 2: Margin (dB) = Emission level (dBuV/m) – Limit (dBuV/m).

<b>Modulation</b>	HT20	<b>Test Freq. (MHz)</b>	5260
<b>Polarization</b>	Vertical	<b>Test Configuration</b>	1

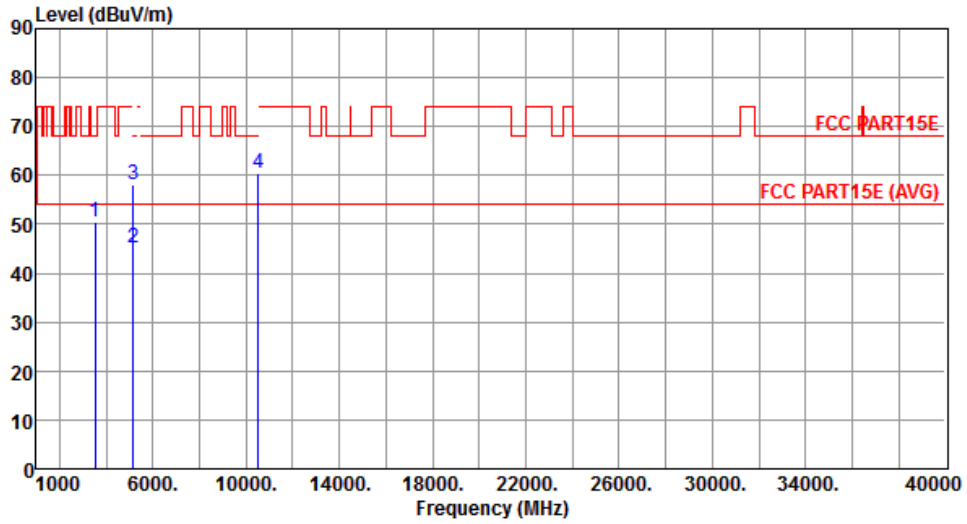

	Freq. MHz	Emission level dBuV/m	Limit dBuV/m	Margin dB	SA reading dBuV	Factor dB	Remark	ANT High cm	Turn Table deg
1	3507.00	50.60	68.20	-17.60	49.81	0.79	Peak	---	---
2	5150.00	45.31	54.00	-8.69	39.60	5.71	Average	---	---
3	5150.00	58.15	74.00	-15.85	52.44	5.71	Peak	---	---
4	10520.00	60.33	68.20	-7.87	45.63	14.70	Peak	---	---

Note 1: Emission Level (dBuV/m) = SA Reading (dBuV/m) + Factor\* (dB)

\*Factor includes antenna factor , cable loss and amplifier gain

Note 2: Margin (dB) = Emission level (dBuV/m) – Limit (dBuV/m).

<b>Modulation</b>	HT20	<b>Test Freq. (MHz)</b>	5300
<b>Polarization</b>	Horizontal	<b>Test Configuration</b>	1

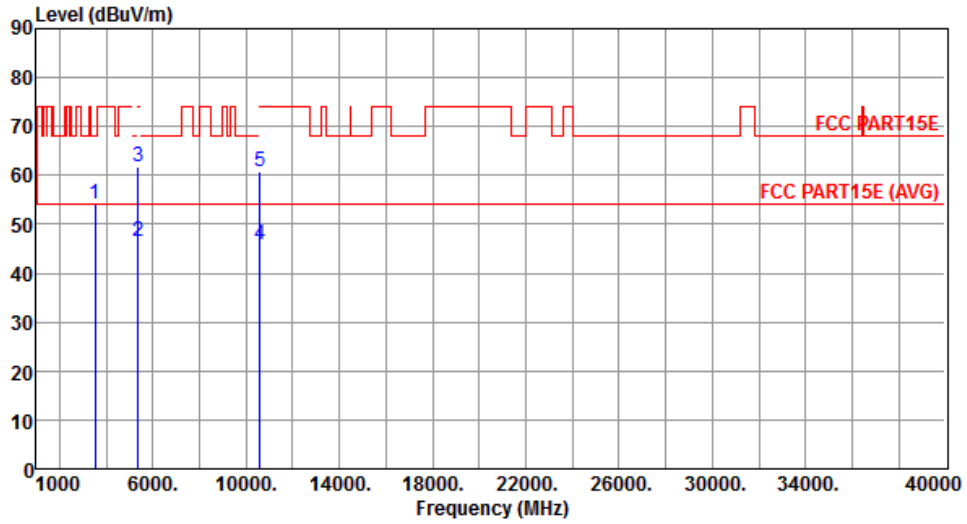

	Freq. MHz	Emission level dBuV/m	Limit dBuV/m	Margin dB	SA reading dBuV	Factor dB	Remark	ANT High cm	Turn Table deg
1	3533.00	54.19	68.20	-14.01	53.32	0.87	Peak	---	---
2	5350.00	46.64	54.00	-7.36	40.65	5.99	Average	---	---
3	5350.00	61.73	74.00	-12.27	55.74	5.99	Peak	---	---
4	10600.00	45.71	54.00	-8.29	30.85	14.86	Average	---	---
5	10600.00	60.64	74.00	-13.36	45.78	14.86	Peak	---	---

Note 1: Emission Level (dBuV/m) = SA Reading (dBuV/m) + Factor\* (dB)

\*Factor includes antenna factor , cable loss and amplifier gain

Note 2: Margin (dB) = Emission level (dBuV/m) – Limit (dBuV/m).

<b>Modulation</b>	HT20	<b>Test Freq. (MHz)</b>	5300
<b>Polarization</b>	Vertical	<b>Test Configuration</b>	1

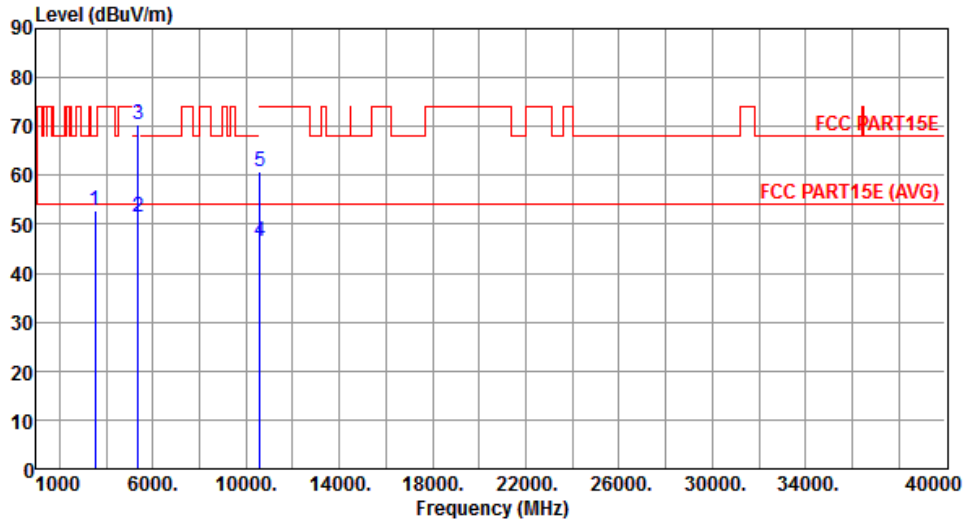

	Freq. MHz	Emission level dBuV/m	Limit dBuV/m	Margin dB	SA reading dBuV	Factor dB	Remark	ANT High cm	Turn Table deg
1	3533.00	52.88	68.20	-15.32	52.01	0.87	Peak	---	---
2	5350.00	51.43	54.00	-2.57	45.44	5.99	Average	---	---
3	5350.00	70.37	74.00	-3.63	64.38	5.99	Peak	---	---
4	10600.00	46.42	54.00	-7.58	31.56	14.86	Average	---	---
5	10600.00	60.78	74.00	-13.22	45.92	14.86	Peak	---	---

Note 1: Emission Level (dBuV/m) = SA Reading (dBuV/m) + Factor\* (dB)

\*Factor includes antenna factor , cable loss and amplifier gain

Note 2: Margin (dB) = Emission level (dBuV/m) – Limit (dBuV/m).

<b>Modulation</b>	HT20	<b>Test Freq. (MHz)</b>	5320
<b>Polarization</b>	Horizontal	<b>Test Configuration</b>	1

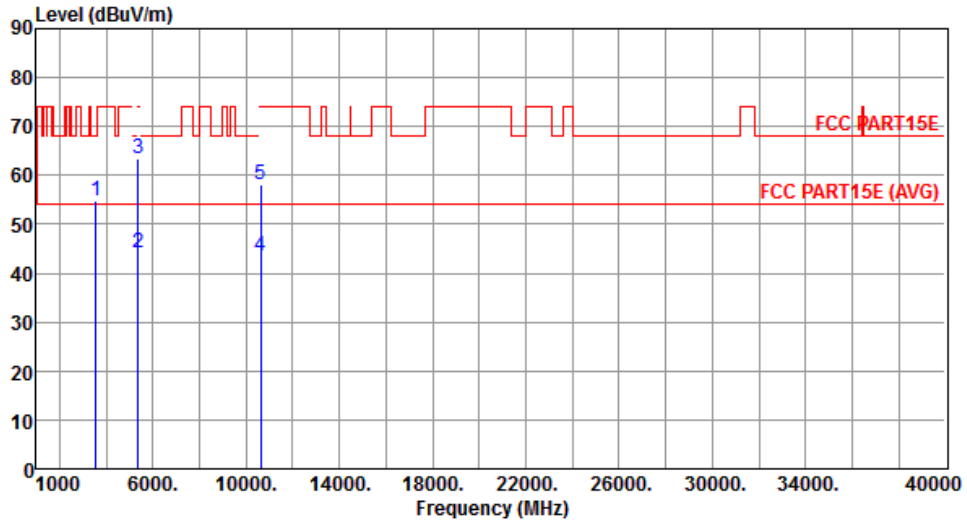

	Freq. MHz	Emission level dBuV/m	Limit dBuV/m	Margin dB	SA reading dBuV	Factor dB	Remark	ANT High cm	Turn Table deg
1	3546.00	54.76	68.20	-13.44	53.86	0.90	Peak	---	---
2	5350.00	44.20	54.00	-9.80	38.21	5.99	Average	---	---
3	5350.00	63.34	74.00	-10.66	57.35	5.99	Peak	---	---
4	10640.00	43.43	54.00	-10.57	28.48	14.95	Average	---	---
5	10640.00	58.03	74.00	-15.97	43.08	14.95	Peak	---	---

Note 1: Emission Level (dBuV/m) = SA Reading (dBuV/m) + Factor\* (dB)

\*Factor includes antenna factor , cable loss and amplifier gain

Note 2: Margin (dB) = Emission level (dBuV/m) – Limit (dBuV/m).



<b>Modulation</b>	HT20	<b>Test Freq. (MHz)</b>	5320
<b>Polarization</b>	Vertical	<b>Test Configuration</b>	1

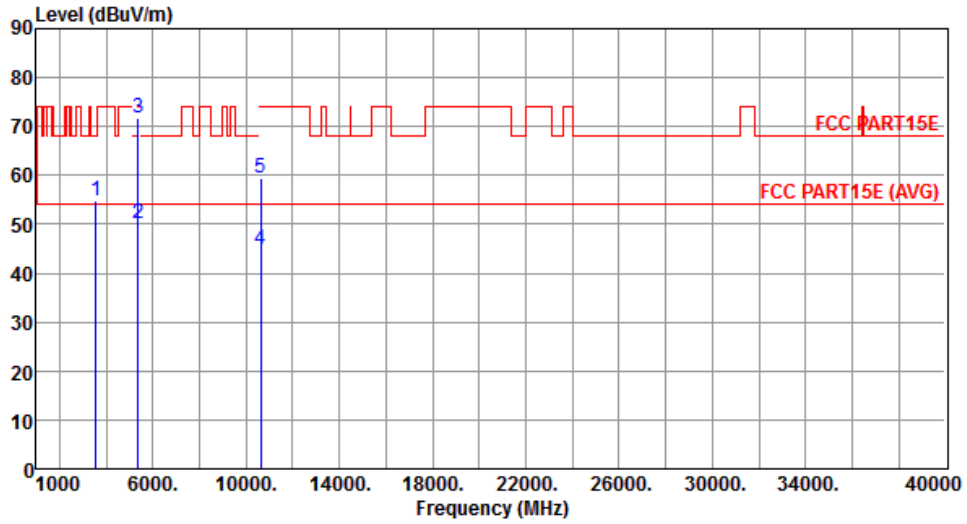

	Freq. MHz	Emission level dBuV/m	Limit dBuV/m	Margin dB	SA reading dBuV	Factor dB	Remark	ANT High cm	Turn Table deg
1	3546.00	54.88	68.20	-13.32	53.98	0.90	Peak	---	---
2	5350.00	50.03	54.00	-3.97	44.04	5.99	Average	---	---
3	5350.00	71.75	74.00	-2.25	65.76	5.99	Peak	---	---
4	10640.00	44.84	54.00	-9.16	29.89	14.95	Average	---	---
5	10640.00	59.46	74.00	-14.54	44.51	14.95	Peak	---	---

Note 1: Emission Level (dBuV/m) = SA Reading (dBuV/m) + Factor\* (dB)

\*Factor includes antenna factor , cable loss and amplifier gain

Note 2: Margin (dB) = Emission level (dBuV/m) – Limit (dBuV/m).

<b>Modulation</b>	HT20	<b>Test Freq. (MHz)</b>	5500
<b>Polarization</b>	Horizontal	<b>Test Configuration</b>	1

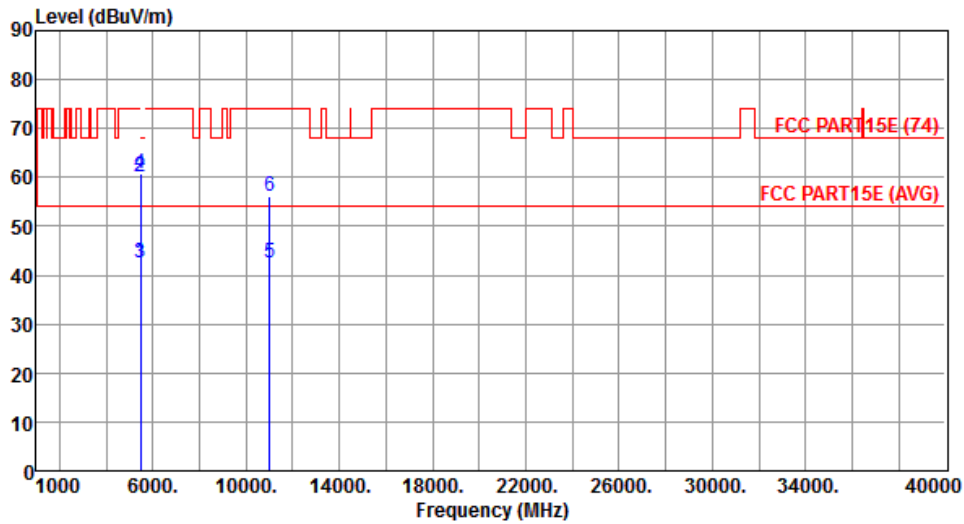

	Freq. MHz	Emission level dBuV/m	Limit dBuV/m	Margin dB	SA reading dBuV	Factor dB	Remark	ANT High cm	Turn Table deg
1	5460.00	42.55	54.00	-11.45	36.43	6.12	Average	---	---
2	5460.00	60.25	74.00	-13.75	54.13	6.12	Peak	---	---
3	5470.00	42.66	54.00	-11.34	36.52	6.14	Average	---	---
4	5470.00	60.93	74.00	-13.07	54.79	6.14	Peak	---	---
5	11000.00	42.43	54.00	-11.57	26.74	15.69	Average	---	---
6	11000.00	56.08	74.00	-17.92	40.39	15.69	Peak	---	---

Note 1: Emission Level (dBuV/m) = SA Reading (dBuV/m) + Factor\* (dB)

\*Factor includes antenna factor , cable loss and amplifier gain

Note 2: Margin (dB) = Emission level (dBuV/m) – Limit (dBuV/m).

<b>Modulation</b>	HT20	<b>Test Freq. (MHz)</b>	5500
<b>Polarization</b>	Vertical	<b>Test Configuration</b>	1

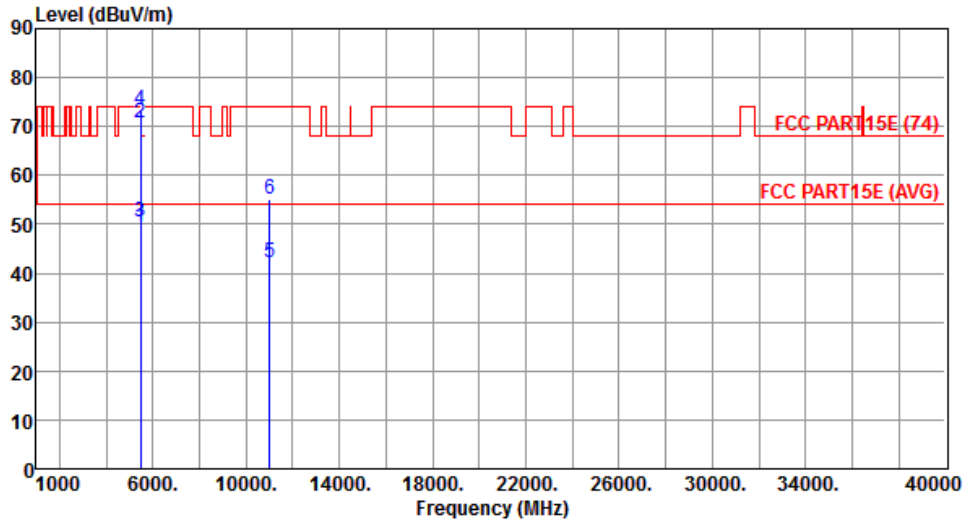

	Freq. MHz	Emission level dBuV/m	Limit dBuV/m	Margin dB	SA reading dBuV	Factor dB	Remark	ANT High cm	Turn Table deg
1	5460.00	49.38	54.00	-4.62	43.26	6.12	Average	---	---
2	5460.00	70.84	74.00	-3.16	64.72	6.12	Peak	---	---
3	5470.00	50.63	54.00	-3.37	44.49	6.14	Average	---	---
4	5470.00	73.35	74.00	-0.65	67.21	6.14	Peak	---	---
5	11000.00	42.03	54.00	-11.97	26.34	15.69	Average	---	---
6	11000.00	55.00	74.00	-19.00	39.31	15.69	Peak	---	---

Note 1: Emission Level (dBuV/m) = SA Reading (dBuV/m) + Factor\* (dB)

\*Factor includes antenna factor , cable loss and amplifier gain

Note 2: Margin (dB) = Emission level (dBuV/m) – Limit (dBuV/m).

<b>Modulation</b>	HT20	<b>Test Freq. (MHz)</b>	5580
<b>Polarization</b>	Horizontal	<b>Test Configuration</b>	1

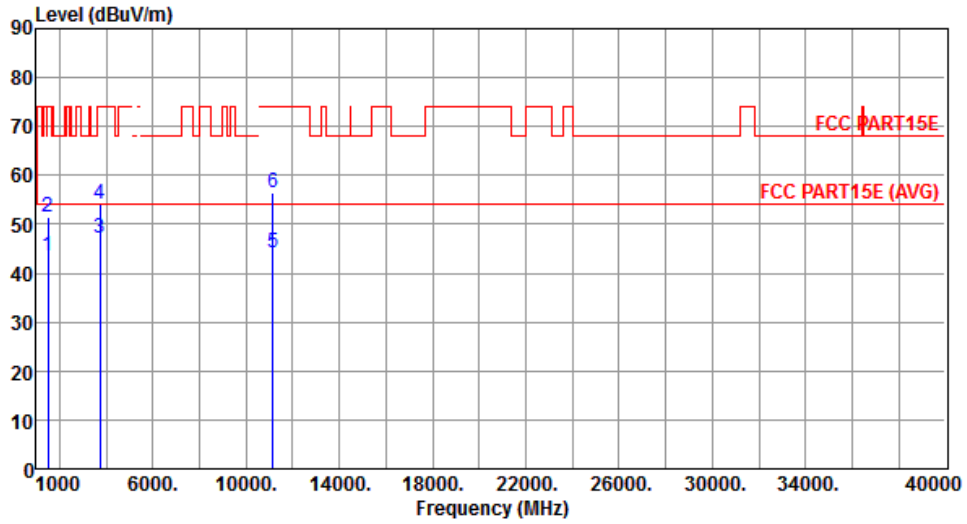

	Freq. MHz	Emission level dBuV/m	Limit dBuV/m	Margin dB	SA reading dBuV	Factor dB	Remark	ANT High cm	Turn Table deg
1	1500.00	43.56	54.00	-10.44	50.03	-6.47	Average	---	---
2	1500.00	51.43	74.00	-22.57	57.90	-6.47	Peak	---	---
3	3720.00	47.11	54.00	-6.89	45.68	1.43	Average	---	---
4	3720.00	54.08	74.00	-19.92	52.65	1.43	Peak	---	---
5	11160.00	44.12	54.00	-9.88	28.59	15.53	Average	---	---
6	11160.00	56.32	74.00	-17.68	40.79	15.53	Peak	---	---

Note 1: Emission Level (dBuV/m) = SA Reading (dBuV/m) + Factor\* (dB)

\*Factor includes antenna factor , cable loss and amplifier gain

Note 2: Margin (dB) = Emission level (dBuV/m) – Limit (dBuV/m).

<b>Modulation</b>	HT20	<b>Test Freq. (MHz)</b>	5580
<b>Polarization</b>	Vertical	<b>Test Configuration</b>	1

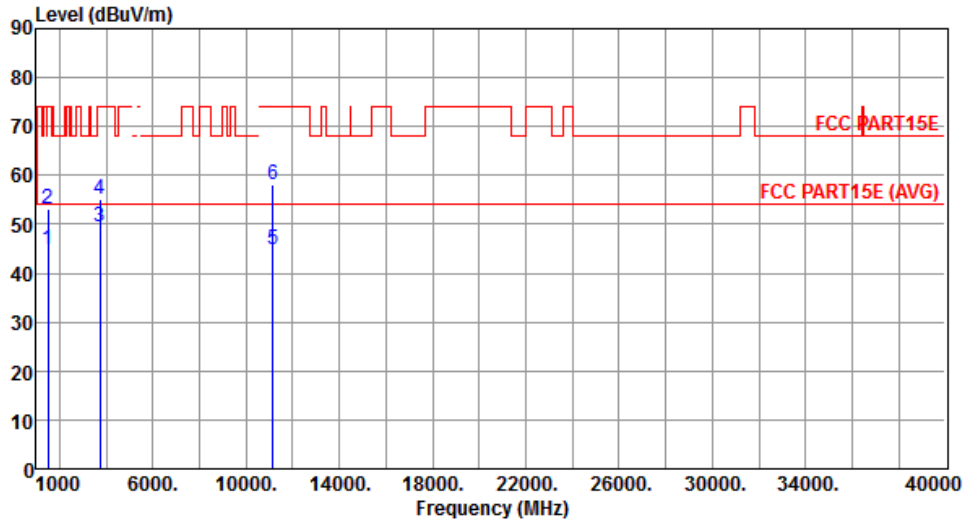

	Freq. MHz	Emission level dBuV/m	Limit dBuV/m	Margin dB	SA reading dBuV	Factor dB	Remark	ANT High cm	Turn Table deg
1	1500.00	44.78	54.00	-9.22	51.25	-6.47	Average	---	---
2	1500.00	53.26	74.00	-20.74	59.73	-6.47	Peak	---	---
3	3720.00	49.60	54.00	-4.40	48.17	1.43	Average	---	---
4	3720.00	55.13	74.00	-18.87	53.70	1.43	Peak	---	---
5	11160.00	44.87	54.00	-9.13	29.34	15.53	Average	---	---
6	11160.00	58.13	74.00	-15.87	42.60	15.53	Peak	---	---

Note 1: Emission Level (dBuV/m) = SA Reading (dBuV/m) + Factor\* (dB)

\*Factor includes antenna factor , cable loss and amplifier gain

Note 2: Margin (dB) = Emission level (dBuV/m) – Limit (dBuV/m).

<b>Modulation</b>	HT20	<b>Test Freq. (MHz)</b>	5700
<b>Polarization</b>	Horizontal	<b>Test Configuration</b>	1

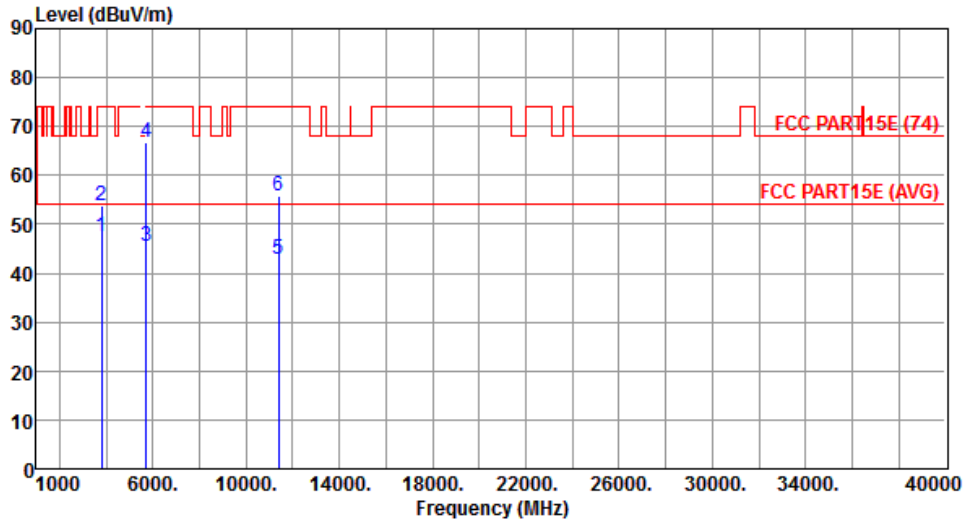

	Freq. MHz	Emission level dBuV/m	Limit dBuV/m	Margin dB	SA reading dBuV	Factor dB	Remark	ANT High cm	Turn Table deg
1	3800.00	47.37	54.00	-6.63	45.69	1.68	Average	---	---
2	3800.00	53.88	74.00	-20.12	52.20	1.68	Peak	---	---
3	5725.00	45.56	54.00	-8.44	38.97	6.59	Average	---	---
4	5725.00	66.86	74.00	-7.14	60.27	6.59	Peak	---	---
5	11400.00	42.68	54.00	-11.32	27.39	15.29	Average	---	---
6	11400.00	55.87	74.00	-18.13	40.58	15.29	Peak	---	---

Note 1: Emission Level (dBuV/m) = SA Reading (dBuV/m) + Factor\* (dB)

\*Factor includes antenna factor , cable loss and amplifier gain

Note 2: Margin (dB) = Emission level (dBuV/m) – Limit (dBuV/m).

<b>Modulation</b>	HT20	<b>Test Freq. (MHz)</b>	5700
<b>Polarization</b>	Vertical	<b>Test Configuration</b>	1

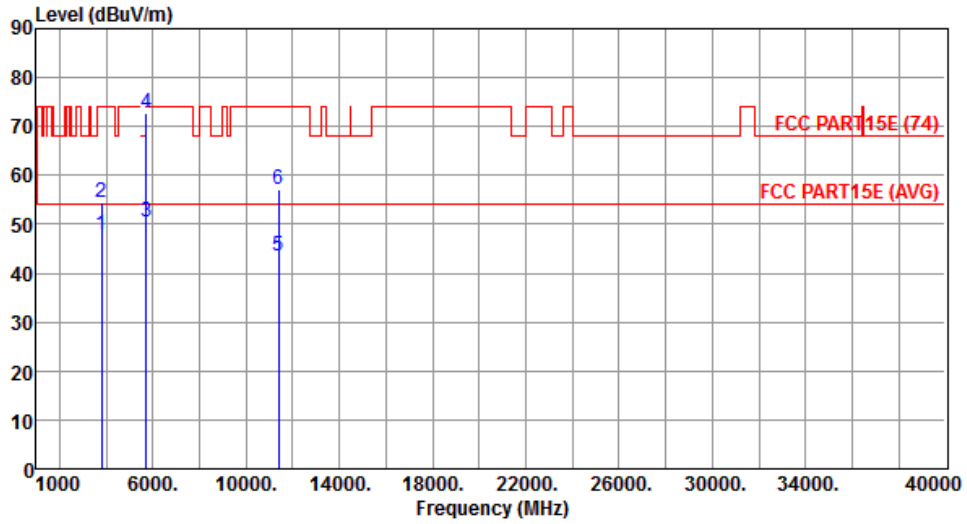

	Freq. MHz	Emission level dBuV/m	Limit dBuV/m	Margin dB	SA reading dBuV	Factor dB	Remark	ANT High cm	Turn Table deg
1	3800.00	47.84	54.00	-6.16	46.16	1.68	Average	---	---
2	3800.00	54.58	74.00	-19.42	52.90	1.68	Peak	---	---
3	5725.00	50.42	54.00	-3.58	43.83	6.59	Average	---	---
4	5725.00	72.85	74.00	-1.15	66.26	6.59	Peak	---	---
5	11400.00	43.43	54.00	-10.57	28.14	15.29	Average	---	---
6	11400.00	57.17	74.00	-16.83	41.88	15.29	Peak	---	---

Note 1: Emission Level (dBuV/m) = SA Reading (dBuV/m) + Factor\* (dB)

\*Factor includes antenna factor , cable loss and amplifier gain

Note 2: Margin (dB) = Emission level (dBuV/m) – Limit (dBuV/m).

### 3.2.7 Transmitter Radiated Unwanted Emissions (Above 1GHz) for HT40

<b>Modulation</b>	HT40	<b>Test Freq. (MHz)</b>	5190
<b>Polarization</b>	Horizontal	<b>Test Configuration</b>	1

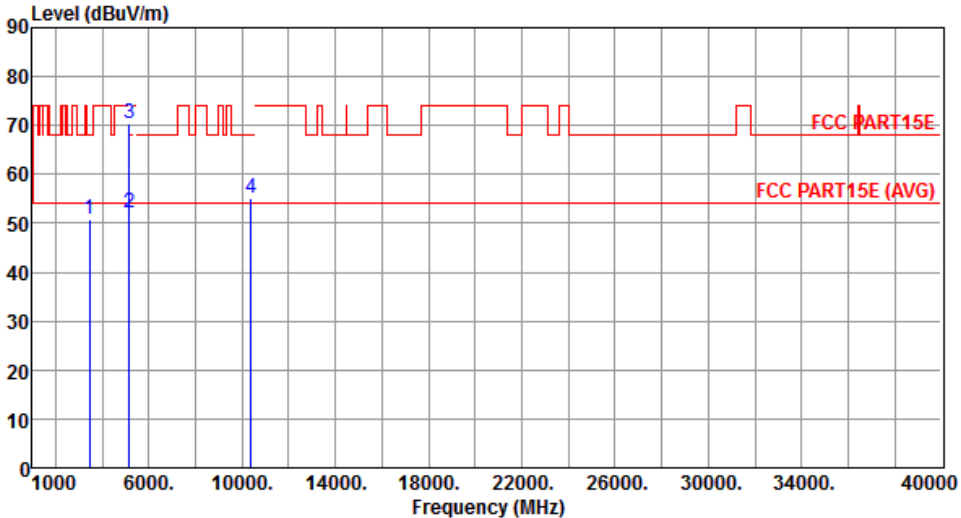

	Freq. MHz	Emission level dBuV/m	Limit dBuV/m	Margin dB	SA reading dBuV	Factor dB	Remark	ANT High cm	Turn Table deg
1	3460.00	50.95	68.20	-17.25	50.22	0.73	Peak	---	---
2	5150.00	52.19	54.00	-1.81	46.48	5.71	Average	---	---
3	5150.00	70.51	74.00	-3.49	64.80	5.71	Peak	---	---
4	10380.00	55.02	68.20	-13.18	40.56	14.46	Peak	---	---

Note 1: Emission Level (dBuV/m) = SA Reading (dBuV/m) + Factor\* (dB)  
\*Factor includes antenna factor , cable loss and amplifier gain  
Note 2: Margin (dB) = Emission level (dBuV/m) – Limit (dBuV/m).



<b>Modulation</b>	HT40	<b>Test Freq. (MHz)</b>	5190
<b>Polarization</b>	Vertical	<b>Test Configuration</b>	1

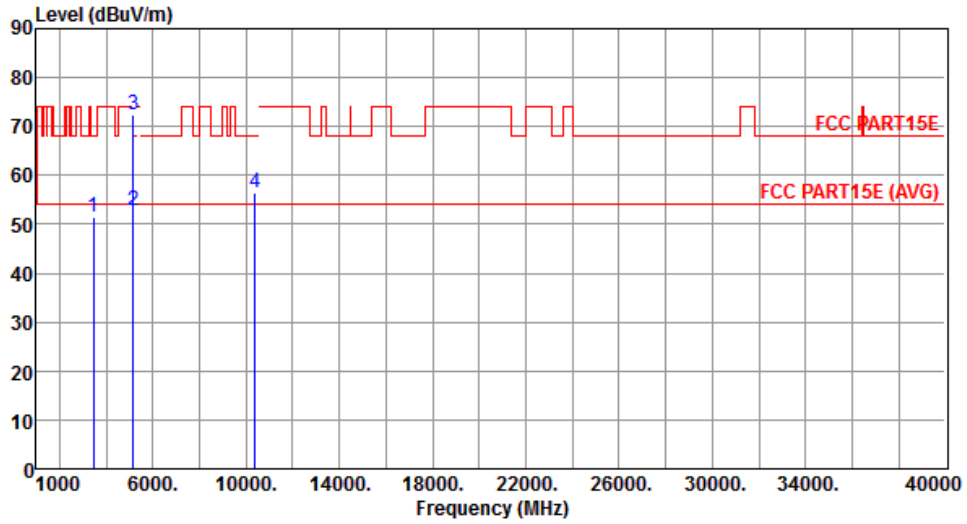

	Freq. MHz	Emission level dBuV/m	Limit dBuV/m	Margin dB	SA reading dBuV	Factor dB	Remark	ANT High cm	Turn Table deg
1	3460.00	51.49	68.20	-16.71	50.76	0.73	Peak	---	---
2	5150.00	52.67	54.00	-1.33	46.96	5.71	Average	---	---
3	5150.00	72.32	74.00	-1.68	66.61	5.71	Peak	---	---
4	10380.00	56.43	68.20	-11.77	41.97	14.46	Peak	---	---

Note 1: Emission Level (dBuV/m) = SA Reading (dBuV/m) + Factor\* (dB)

\*Factor includes antenna factor , cable loss and amplifier gain

Note 2: Margin (dB) = Emission level (dBuV/m) – Limit (dBuV/m).

<b>Modulation</b>	HT40	<b>Test Freq. (MHz)</b>	5230
<b>Polarization</b>	Horizontal	<b>Test Configuration</b>	1

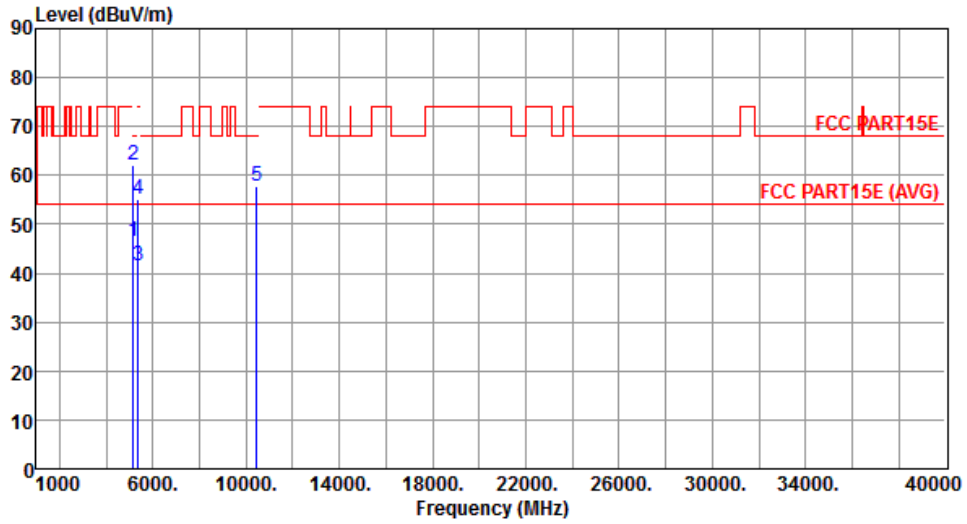

	Freq. MHz	Emission level dBuV/m	Limit dBuV/m	Margin dB	SA reading dBuV	Factor dB	Remark	ANT High cm	Turn Table deg
1	5150.00	46.56	54.00	-7.44	40.85	5.71	Average	---	---
2	5150.00	62.08	74.00	-11.92	56.37	5.71	Peak	---	---
3	5350.00	41.54	54.00	-12.46	35.55	5.99	Average	---	---
4	5350.00	55.04	74.00	-18.96	49.05	5.99	Peak	---	---
5	10460.00	57.92	68.20	-10.28	43.32	14.60	Peak	---	---

Note 1: Emission Level (dBuV/m) = SA Reading (dBuV/m) + Factor\* (dB)

\*Factor includes antenna factor , cable loss and amplifier gain

Note 2: Margin (dB) = Emission level (dBuV/m) – Limit (dBuV/m).

<b>Modulation</b>	HT40	<b>Test Freq. (MHz)</b>	5230
<b>Polarization</b>	Vertical	<b>Test Configuration</b>	1

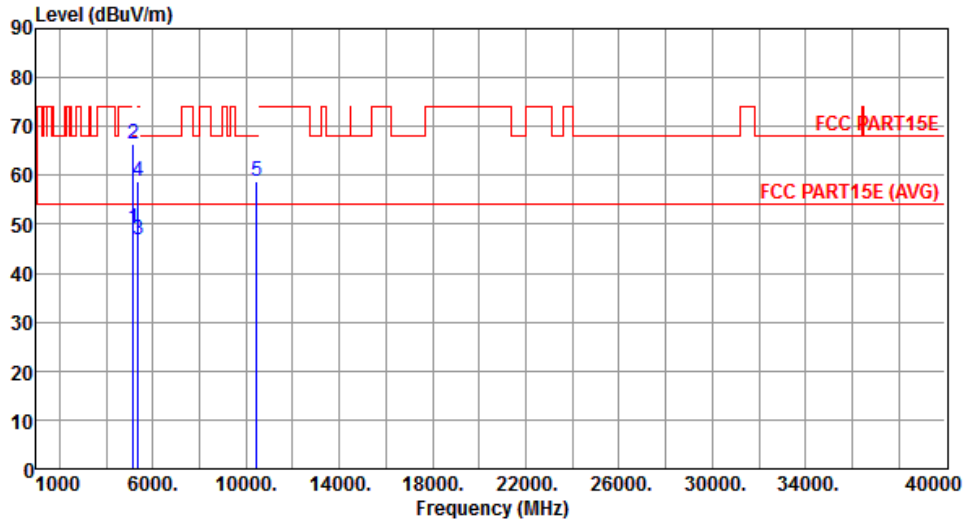

	Freq. MHz	Emission level dBuV/m	Limit dBuV/m	Margin dB	SA reading dBuV	Factor dB	Remark	ANT High cm	Turn Table deg
1	5150.00	49.12	54.00	-4.88	43.41	5.71	Average	---	---
2	5150.00	66.35	74.00	-7.65	60.64	5.71	Peak	---	---
3	5350.00	46.98	54.00	-7.02	40.99	5.99	Average	---	---
4	5350.00	58.87	74.00	-15.13	52.88	5.99	Peak	---	---
5	10460.00	58.87	68.20	-9.33	44.27	14.60	Peak	---	---

Note 1: Emission Level (dBuV/m) = SA Reading (dBuV/m) + Factor\* (dB)

\*Factor includes antenna factor , cable loss and amplifier gain

Note 2: Margin (dB) = Emission level (dBuV/m) – Limit (dBuV/m).

<b>Modulation</b>	HT40	<b>Test Freq. (MHz)</b>	5270
<b>Polarization</b>	Horizontal	<b>Test Configuration</b>	1

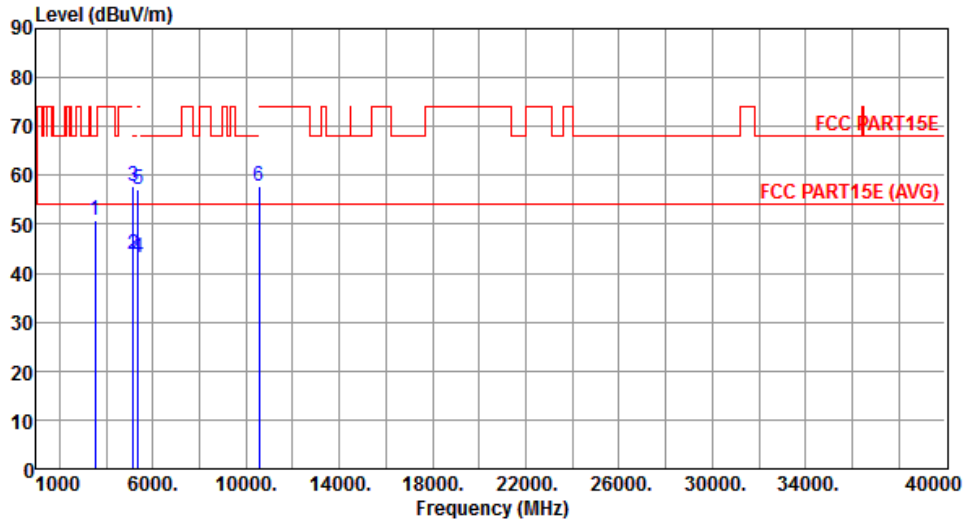

	Freq. MHz	Emission level dBuV/m	Limit dBuV/m	Margin dB	SA reading dBuV	Factor dB	Remark	ANT High cm	Turn Table deg
1	3513.30	50.71	68.20	-17.49	49.89	0.82	Peak	---	---
2	5150.00	43.91	54.00	-10.09	38.20	5.71	Average	---	---
3	5150.00	57.92	74.00	-16.08	52.21	5.71	Peak	---	---
4	5350.00	43.04	54.00	-10.96	37.05	5.99	Average	---	---
5	5350.00	56.97	74.00	-17.03	50.98	5.99	Peak	---	---
6	10540.00	57.65	68.20	-10.55	42.90	14.75	Peak	---	---

Note 1: Emission Level (dBuV/m) = SA Reading (dBuV/m) + Factor\* (dB)

\*Factor includes antenna factor , cable loss and amplifier gain

Note 2: Margin (dB) = Emission level (dBuV/m) – Limit (dBuV/m).

<b>Modulation</b>	HT40	<b>Test Freq. (MHz)</b>	5270
<b>Polarization</b>	Vertical	<b>Test Configuration</b>	1

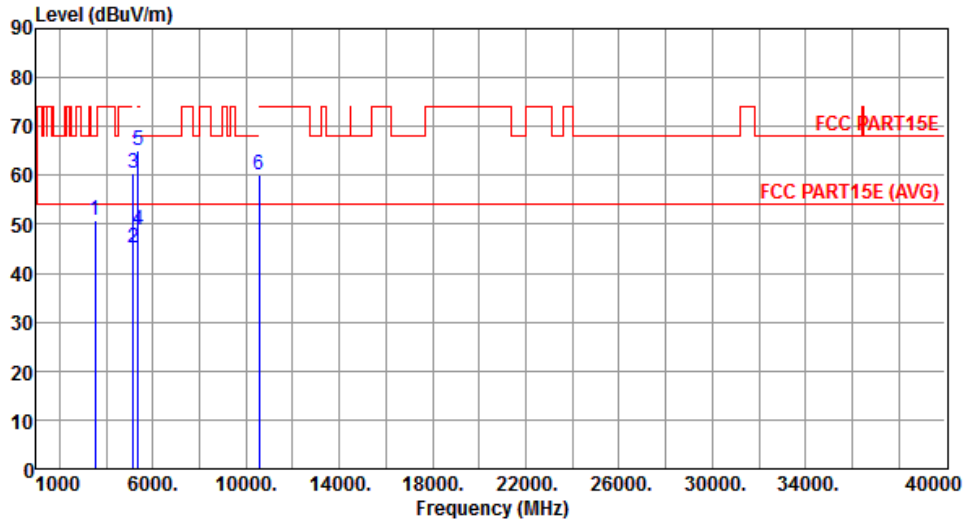

	Freq. MHz	Emission level dBuV/m	Limit dBuV/m	Margin dB	SA reading dBuV	Factor dB	Remark	ANT High cm	Turn Table deg
1	3513.30	50.78	68.20	-17.42	49.96	0.82	Peak	---	---
2	5150.00	45.19	54.00	-8.81	39.48	5.71	Average	---	---
3	5150.00	60.42	74.00	-13.58	54.71	5.71	Peak	---	---
4	5350.00	48.66	54.00	-5.34	42.67	5.99	Average	---	---
5	5350.00	65.09	74.00	-8.91	59.10	5.99	Peak	---	---
6	10540.00	60.10	68.20	-8.10	45.35	14.75	Peak	---	---

Note 1: Emission Level (dBuV/m) = SA Reading (dBuV/m) + Factor\* (dB)

\*Factor includes antenna factor , cable loss and amplifier gain

Note 2: Margin (dB) = Emission level (dBuV/m) – Limit (dBuV/m).

<b>Modulation</b>	HT40	<b>Test Freq. (MHz)</b>	5310
<b>Polarization</b>	Horizontal	<b>Test Configuration</b>	1

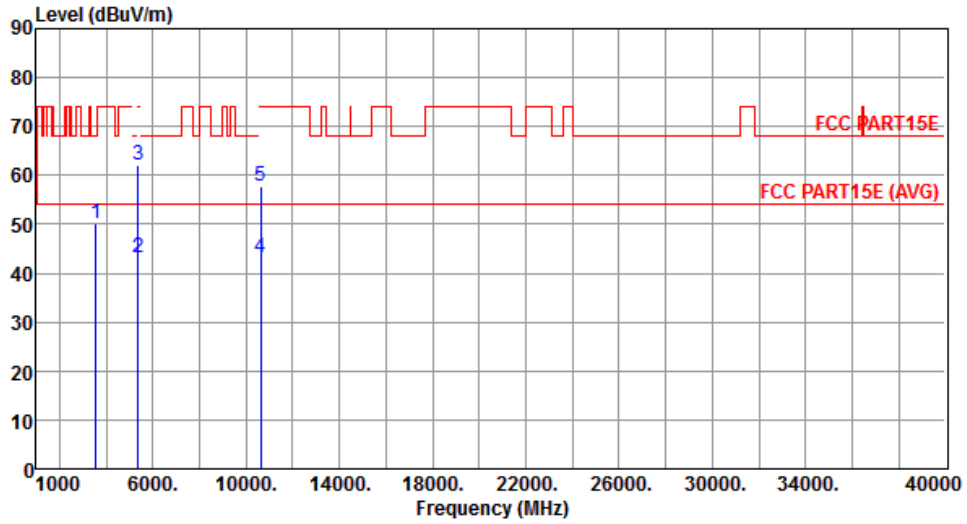

	Freq. MHz	Emission level dBuV/m	Limit dBuV/m	Margin dB	SA reading dBuV	Factor dB	Remark	ANT High cm	Turn Table deg
1	3540.00	50.27	68.20	-17.93	49.38	0.89	Peak	---	---
2	5350.00	43.03	54.00	-10.97	37.04	5.99	Average	---	---
3	5350.00	61.98	74.00	-12.02	55.99	5.99	Peak	---	---
4	10620.00	43.11	54.00	-10.89	28.21	14.90	Average	---	---
5	10620.00	57.70	74.00	-16.30	42.80	14.90	Peak	---	---

Note 1: Emission Level (dBuV/m) = SA Reading (dBuV/m) + Factor\* (dB)

\*Factor includes antenna factor , cable loss and amplifier gain

Note 2: Margin (dB) = Emission level (dBuV/m) – Limit (dBuV/m).

<b>Modulation</b>	HT40	<b>Test Freq. (MHz)</b>	5310
<b>Polarization</b>	Vertical	<b>Test Configuration</b>	1

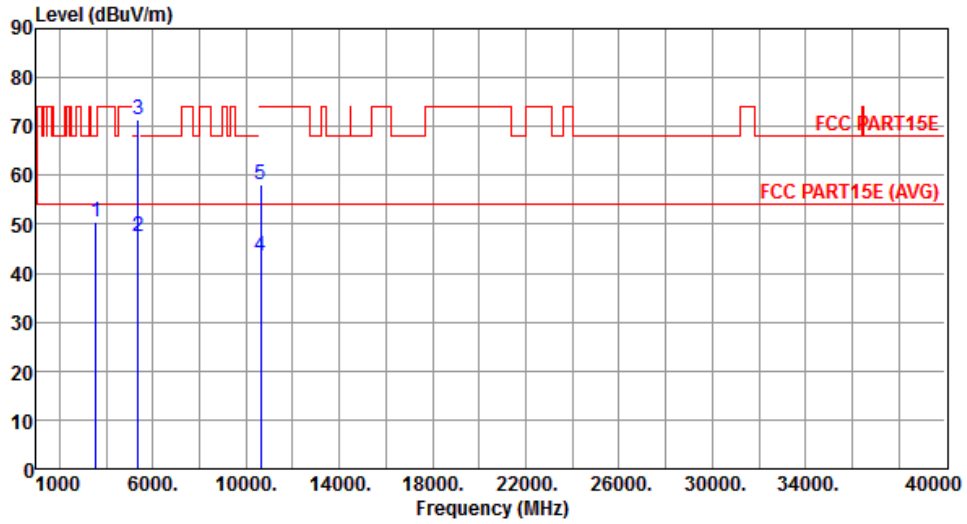

	Freq. MHz	Emission level dBuV/m	Limit dBuV/m	Margin dB	SA reading dBuV	Factor dB	Remark	ANT High cm	Turn Table deg
1	3540.00	50.46	68.20	-17.74	49.57	0.89	Peak	---	---
2	5350.00	47.34	54.00	-6.66	41.35	5.99	Average	---	---
3	5350.00	71.34	74.00	-2.66	65.35	5.99	Peak	---	---
4	10620.00	43.58	54.00	-10.42	28.68	14.90	Average	---	---
5	10620.00	58.27	74.00	-15.73	43.37	14.90	Peak	---	---

Note 1: Emission Level (dBuV/m) = SA Reading (dBuV/m) + Factor\* (dB)

\*Factor includes antenna factor , cable loss and amplifier gain

Note 2: Margin (dB) = Emission level (dBuV/m) – Limit (dBuV/m).

<b>Modulation</b>	HT40	<b>Test Freq. (MHz)</b>	5510
<b>Polarization</b>	Horizontal	<b>Test Configuration</b>	1

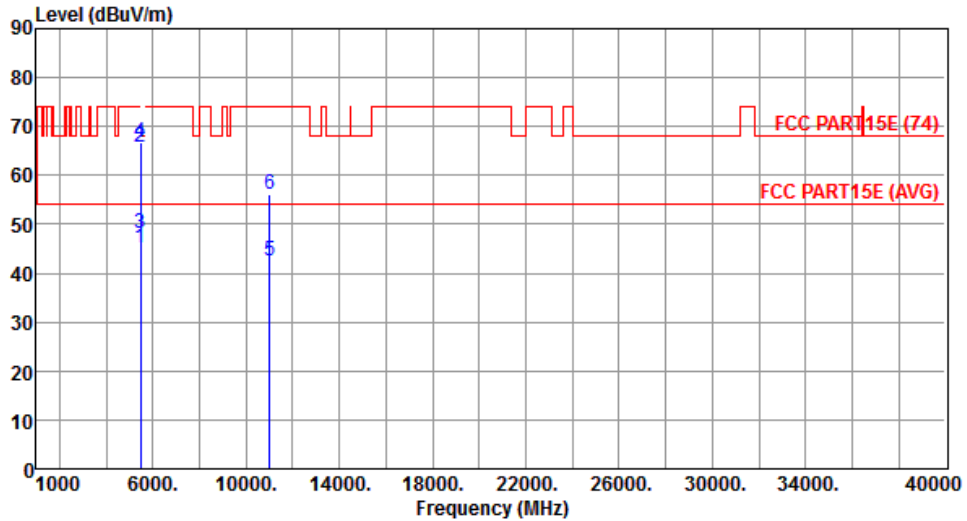

	Freq. MHz	Emission level dBuV/m	Limit dBuV/m	Margin dB	SA reading dBuV	Factor dB	Remark	ANT High cm	Turn Table deg
1	5460.00	45.12	54.00	-8.88	39.00	6.12	Average	---	---
2	5460.00	65.92	74.00	-8.08	59.80	6.12	Peak	---	---
3	5470.00	48.14	54.00	-5.86	42.00	6.14	Average	---	---
4	5470.00	66.76	74.00	-7.24	60.62	6.14	Peak	---	---
5	11020.00	42.55	54.00	-11.45	26.89	15.66	Average	---	---
6	11020.00	56.13	74.00	-17.87	40.47	15.66	Peak	---	---

Note 1: Emission Level (dBuV/m) = SA Reading (dBuV/m) + Factor\* (dB)

\*Factor includes antenna factor , cable loss and amplifier gain

Note 2: Margin (dB) = Emission level (dBuV/m) – Limit (dBuV/m).



<b>Modulation</b>	HT40	<b>Test Freq. (MHz)</b>	5510
<b>Polarization</b>	Vertical	<b>Test Configuration</b>	1

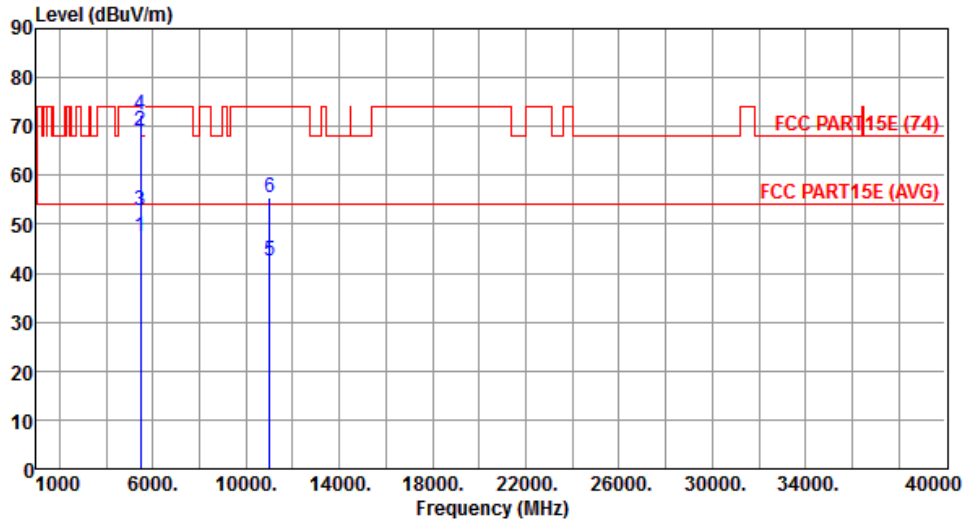

	Freq. MHz	Emission level dBuV/m	Limit dBuV/m	Margin dB	SA reading dBuV	Factor dB	Remark	ANT High cm	Turn Table deg
1	5460.00	47.46	54.00	-6.54	41.34	6.12	Average	---	---
2	5460.00	69.22	74.00	-4.78	63.10	6.12	Peak	---	---
3	5470.00	52.94	54.00	-1.06	46.80	6.14	Average	---	---
4	5470.00	72.47	74.00	-1.53	66.33	6.14	Peak	---	---
5	11020.00	42.43	54.00	-11.57	26.77	15.66	Average	---	---
6	11020.00	55.43	74.00	-18.57	39.77	15.66	Peak	---	---

Note 1: Emission Level (dBuV/m) = SA Reading (dBuV/m) + Factor\* (dB)

\*Factor includes antenna factor , cable loss and amplifier gain

Note 2: Margin (dB) = Emission level (dBuV/m) – Limit (dBuV/m).

<b>Modulation</b>	HT40	<b>Test Freq. (MHz)</b>	5550
<b>Polarization</b>	Horizontal	<b>Test Configuration</b>	1

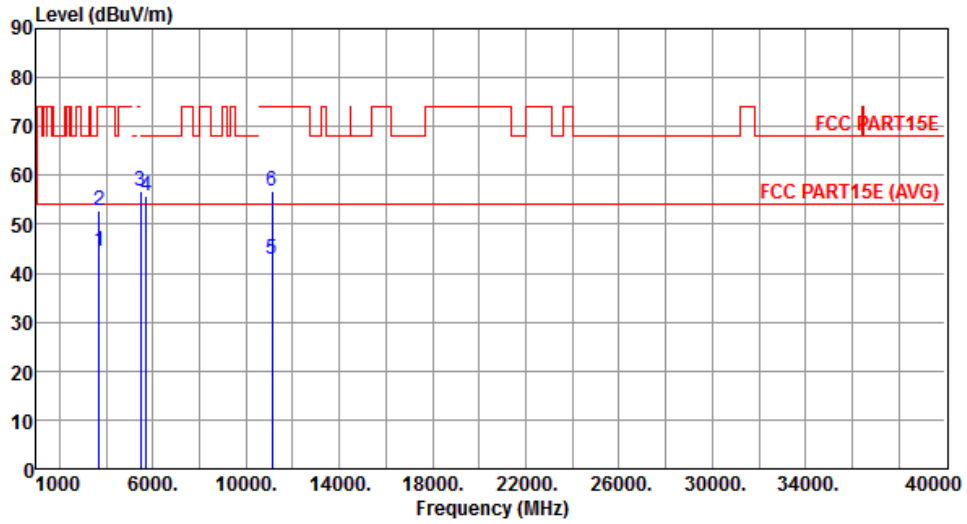

	Freq. MHz	Emission level dBuV/m	Limit dBuV/m	Margin dB	SA reading dBuV	Factor dB	Remark	ANT High cm	Turn Table deg
1	3700.00	44.61	54.00	-9.39	43.23	1.38	Average	---	---
2	3700.00	52.93	74.00	-21.07	51.55	1.38	Peak	---	---
3	5470.00	56.87	68.20	-11.33	50.73	6.14	Peak	---	---
4	5725.00	55.92	68.20	-12.28	49.33	6.59	Peak	---	---
5	11100.00	42.98	54.00	-11.02	27.39	15.59	Average	---	---
6	11100.00	56.79	74.00	-17.21	41.20	15.59	Peak	---	---

Note 1: Emission Level (dBuV/m) = SA Reading (dBuV/m) + Factor\* (dB)

\*Factor includes antenna factor , cable loss and amplifier gain

Note 2: Margin (dB) = Emission level (dBuV/m) – Limit (dBuV/m).

<b>Modulation</b>	HT40	<b>Test Freq. (MHz)</b>	5550
<b>Polarization</b>	Vertical	<b>Test Configuration</b>	1

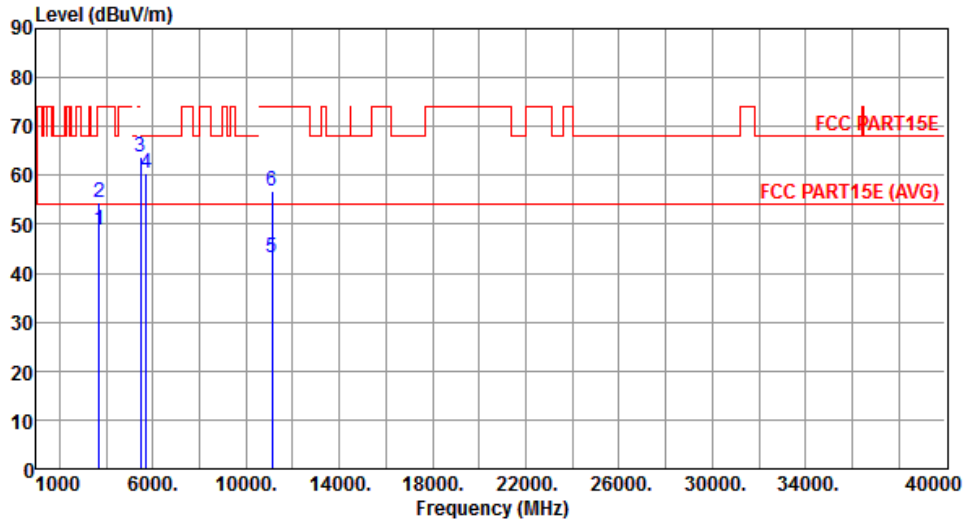

	Freq. MHz	Emission level dBuV/m	Limit dBuV/m	Margin dB	SA reading dBuV	Factor dB	Remark	ANT High cm	Turn Table deg
1	3700.00	48.67	54.00	-5.33	47.29	1.38	Average	---	---
2	3700.00	54.62	74.00	-19.38	53.24	1.38	Peak	---	---
3	5470.00	63.67	68.20	-4.53	57.53	6.14	Peak	---	---
4	5725.00	60.47	68.20	-7.73	53.88	6.59	Peak	---	---
5	11100.00	43.26	54.00	-10.74	27.67	15.59	Average	---	---
6	11100.00	56.69	74.00	-17.31	41.10	15.59	Peak	---	---

Note 1: Emission Level (dBuV/m) = SA Reading (dBuV/m) + Factor\* (dB)

\*Factor includes antenna factor , cable loss and amplifier gain

Note 2: Margin (dB) = Emission level (dBuV/m) – Limit (dBuV/m).

<b>Modulation</b>	HT40	<b>Test Freq. (MHz)</b>	5670
<b>Polarization</b>	Horizontal	<b>Test Configuration</b>	1

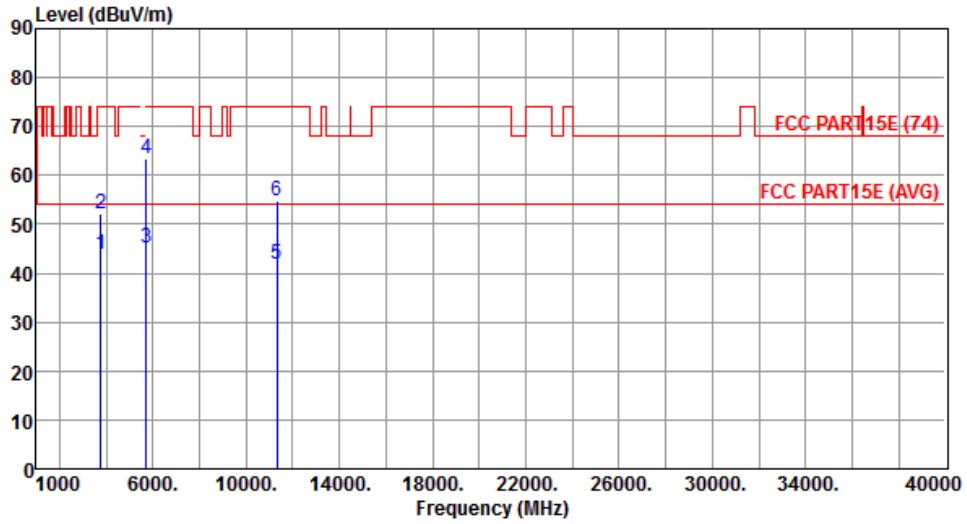

	Freq. MHz	Emission level dBuV/m	Limit dBuV/m	Margin dB	SA reading dBuV	Factor dB	Remark	ANT High cm	Turn Table deg
1	3780.00	43.87	54.00	-10.13	42.25	1.62	Average	---	---
2	3780.00	52.06	74.00	-21.94	50.44	1.62	Peak	---	---
3	5725.00	45.25	54.00	-8.75	38.66	6.59	Average	---	---
4	5725.00	63.42	74.00	-10.58	56.83	6.59	Peak	---	---
5	11340.00	41.78	54.00	-12.22	26.43	15.35	Average	---	---
6	11340.00	54.94	74.00	-19.06	39.59	15.35	Peak	---	---

Note 1: Emission Level (dBuV/m) = SA Reading (dBuV/m) + Factor\* (dB)

\*Factor includes antenna factor , cable loss and amplifier gain

Note 2: Margin (dB) = Emission level (dBuV/m) – Limit (dBuV/m).

<b>Modulation</b>	HT40	<b>Test Freq. (MHz)</b>	5670
<b>Polarization</b>	Vertical	<b>Test Configuration</b>	1

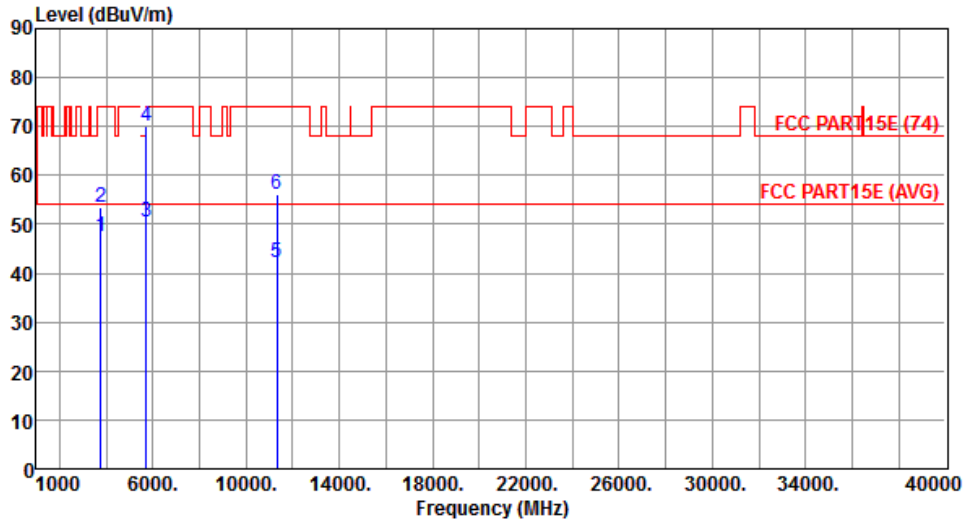

	Freq. MHz	Emission level dBuV/m	Limit dBuV/m	Margin dB	SA reading dBuV	Factor dB	Remark	ANT High cm	Turn Table deg
1	3780.00	47.55	54.00	-6.45	45.93	1.62	Average	---	---
2	3780.00	53.55	74.00	-20.45	51.93	1.62	Peak	---	---
3	5725.00	50.38	54.00	-3.62	43.79	6.59	Average	---	---
4	5725.00	70.00	74.00	-4.00	63.41	6.59	Peak	---	---
5	11340.00	42.18	54.00	-11.82	26.83	15.35	Average	---	---
6	11340.00	56.05	74.00	-17.95	40.70	15.35	Peak	---	---

Note 1: Emission Level (dBuV/m) = SA Reading (dBuV/m) + Factor\* (dB)

\*Factor includes antenna factor , cable loss and amplifier gain

Note 2: Margin (dB) = Emission level (dBuV/m) – Limit (dBuV/m).

## 4 Test laboratory information

Established in 2012, ICC provides foremost EMC & RF Testing and advisory consultation services by our skilled engineers and technicians. Our services employ a wide variety of advanced edge test equipment and one of the widest certification extents in the business.

International Certification Corp, it is our definitive objective is to institute long term, trust-based associations with our clients. The expectation we set up with our clients is based on outstanding service, practical expertise and devotion to a certified value structure. Our passion is to grant our clients with best EMC / RF services by oriented knowledgeable and accommodating staff.

Our Test sites are located at Linkou District and Kwei Shan Hsiang. Location map can be found on our website <http://www.icertifi.com.tw>.

### **Linkou**

Tel: 886-2-2601-1640

No. 30-2, Ding Fwu Tsuen, Lin Kou  
District, New Taipei City, Taiwan,  
R.O.C.

### **Kwei Shan**

Tel: 886-3-271-8666

No. 3-1, Lane 6, Wen San 3rd  
St., Kwei Shan Hsiang, Tao Yuan  
Hsien 333, Taiwan, R.O.C.

### **Kwei Shan Site II**

Tel: 886-3-271-8640

No. 14-1, Lane 19, Wen San 3rd  
St., Kwei Shan Hsiang, Tao Yuan  
Hsien 333, Taiwan, R.O.C.

If you have any suggestion, please feel free to contact us as below information

Tel: 886-3-271-8666

Fax: 886-3-318-0155

Email: ICC\_Service@icertifi.com.tw

==END==