

FCC C2PC Test Report

FCC ID : ZQ6-AP6234A
Equipment : Wifi Dual Band + BT combo module
Model No. : AP6234A, AP6234AL
Brand Name : Ampak
Applicant : Ampak Technology Inc
Address : No.1 Jen Ai Road, Hsinchu Industrial Park,
Hukou, Hsinchu, Taiwan, 30352
Standard : 47 CFR FCC Part 15.247
Received Date : Jul. 03, 2014
Tested Date : Jul. 03 ~ Jul. 10, 2014

We, International Certification Corp., would like to declare that the tested sample has been evaluated and in compliance with the requirement of the above standards. The test results contained in this report refer exclusively to the product. It may be duplicated completely for legal use with the approval of the applicant. It shall not be reproduced except in full without the written approval of our laboratory.

Approved & Reviewed by:



Gary Chang / Manager

Table of Contents

1	GENERAL DESCRIPTION	5
1.1	Information.....	5
1.2	Local Support Equipment List	7
1.3	Test Setup Chart	7
1.4	The Equipment List	8
1.5	Test Standards	9
1.6	Measurement Uncertainty	9
2	TEST CONFIGURATION	10
2.1	Testing Condition	10
2.2	The Worst Test Modes and Channel Details	10
3	TRANSMITTER TEST RESULTS.....	11
3.1	Conducted Emissions.....	11
3.2	Unwanted Emissions into Restricted Frequency Bands	16
4	TEST LABORATORY INFORMATION	46

Release Record

Report No.	Version	Description	Issued Date
FR440102-11AD	Rev. 01	Initial issue	Sep. 18, 2014

Summary of Test Results

FCC Rules	Test Items	Measured	Result
15.207	Conducted Emissions	[dBuV]: 0.154MHz 43.35 (Margin -12.43dB) - AV	Pass
15.247(d) 15.209	Radiated Emissions	[dBuV/m at 3m]: 1534.00MHz 48.97 (Margin -5.03dB) - AV	Pass

1 General Description

1.1 Information

This report is prepared for FCC class II change.

This report is issued as a supplementary report to original ICC report no. FR440102-07AD. The modification is adding 2nd antenna (PIFA antenna), therefore, radiated emission and conducted emission has been re-tested after re-evaluation, and only its data was recorded in the following sections.

Brand Name	Model Name	Product Name	Description
Ampak	AP6234A	Wifi Dual Band + BT combo module	Without 2.4G SAW filter
	AP6234AL		With 2.4G SAW filter

1.1.1 Specification of the Equipment under Test (EUT)

RF General Information				
Frequency Range (MHz)	Bluetooth Mode	Ch. Frequency (MHz)	Channel Number	Data Rate
2400-2483.5	BR V2.1	2402-2480	0-78 [79]	1 Mbps
2400-2483.5	EDR V2.1	2402-2480	0-78 [79]	2 Mbps
2400-2483.5	EDR V2.1	2402-2480	0-78 [79]	3 Mbps

Note 1: RF output power specifies that Maximum Peak Conducted Output Power.
 Note 2: Bluetooth BR uses a GFSK.
 Note 3: Bluetooth EDR uses a combination of $\pi/4$ -DQPSK and 8DPSK.

1.1.2 Antenna Details

Ant. No.	Type	Gain (dBi)	Connector	Remark
1	Dipole(Original)	2	UFL	---
2	PIFA(New)	3.53	UFL	---

1.1.3 Power Supply Type of Equipment under Test (EUT)

Power Supply Type
3.3Vdc from host.

1.1.4 Accessories

N/A

1.1.5 Channel List

Frequency band (MHz)				2400~2483.5			
Channel	Frequency (MHz)	Channel	Frequency (MHz)	Channel	Frequency (MHz)	Channel	Frequency (MHz)
0	2402	20	2422	40	2442	60	2462
1	2403	21	2423	41	2443	61	2463
2	2404	22	2424	42	2444	62	2464
3	2405	23	2425	43	2445	63	2465
4	2406	24	2426	44	2446	64	2466
5	2407	25	2427	45	2447	65	2467
6	2408	26	2428	46	2448	66	2468
7	2409	27	2429	47	2449	67	2469
8	2410	28	2430	48	2450	68	2470
9	2411	29	2431	49	2451	69	2471
10	2412	30	2432	50	2452	70	2472
11	2413	31	2433	51	2453	71	2473
12	2414	32	2434	52	2454	72	2474
13	2415	33	2435	53	2455	73	2475
14	2416	34	2436	54	2456	74	2476
15	2417	35	2437	55	2457	75	2477
16	2418	36	2438	56	2458	76	2478
17	2419	37	2439	57	2459	77	2479
18	2420	38	2440	58	2460	78	2480
19	2421	39	2441	59	2461	---	---

1.1.6 Test Tool and Duty Cycle

Test Tool	Brocom Blue Tool, V.1.7.3.3
------------------	-----------------------------

1.1.7 Power Setting

Model	AP6234A		
Modulation Mode	Test Frequency (MHz)		
	2402	2441	2480
GFSK/1Mbps	specify power index 0	specify power index 0	specify power index 0
$\pi/4$ DQPSK	specify power index 0	specify power index 0	specify power index 0
8DPSK/3Mbps	specify power index 0	specify power index 0	specify power index 0

Model	AP6234AL		
Modulation Mode	Test Frequency (MHz)		
	2402	2441	2480
GFSK/1Mbps	255,63	255,63	255,63
$\pi/4$ DQPSK	255,63	255,63	255,63
8DPSK/3Mbps	255,63	255,63	255,63

1.2 Local Support Equipment List

Support Equipment List						
No.	Equipment	Brand	Model	S/N	FCC ID	Signal cable / Length (m)
1	Notebook	DELL	E6430	---	DoC	USB 1.0m shielded cable w/o core.

1.3 Test Setup Chart

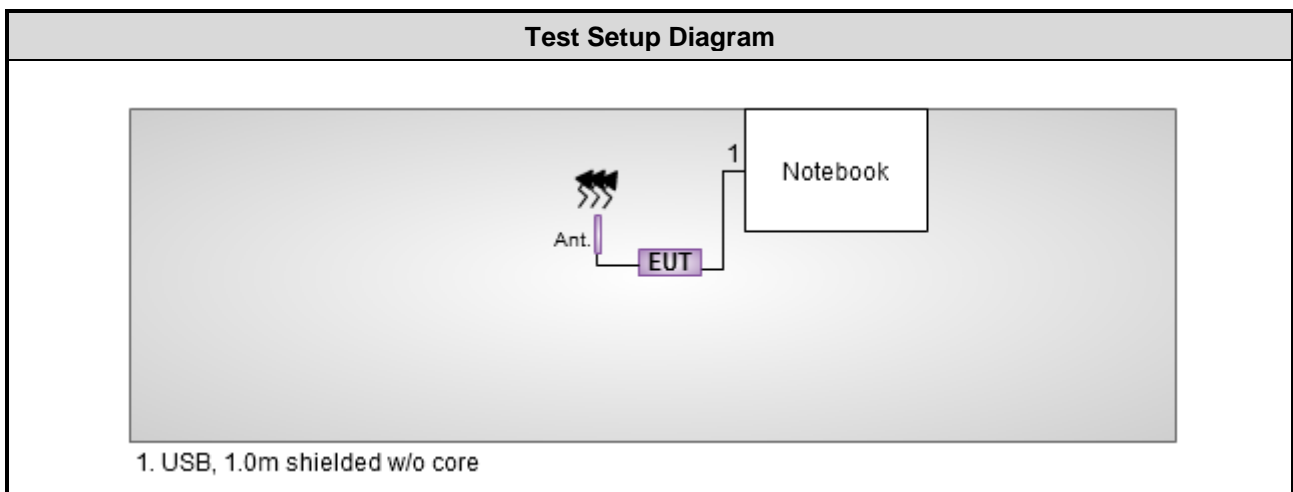

1.4 The Equipment List

Test Item	Conducted Emission				
Test Site	Conduction room 1 / (CO01-WS)				
Instrument	Manufacturer	Model No.	Serial No.	Calibration Date	Calibration Until
EMC Receiver	R&S	ESCS 30	100169	Oct. 15, 2013	Oct. 14, 2014
LISN	SCHWARZBECK	Schwarzbeck 8127	8127-667	Nov. 23, 2013	Nov. 22, 2014
LISN (Support Unit)	SCHWARZBECK	Schwarzbeck 8127	8127-666	Dec. 04, 2013	Dec. 03, 2014
RF Cable-CON	Woken	CFD200-NL	CFD200-NL-001	Apr. 23, 2014	Apr. 22, 2015
50 ohm terminal (Support Unit)	NA	50	04	Apr. 18, 2014	Apr. 17, 2015

Note: Calibration Interval of instruments listed above is one year.

Test Item	Radiated Emission				
Test Site	966 chamber 2 / (03CH02-WS)				
Instrument	Manufacturer	Model No.	Serial No.	Calibration Date	Calibration Until
Spectrum Analyzer	R&S	FSV40	101499	Feb. 08, 2014	Feb. 07, 2015
Receiver	R&S	ESR3	101657	Jan. 18, 2014	Jan. 17, 2015
Bilog Antenna	SCHWARZBECK	VULB9168	VULB9168-524	Jan. 08, 2014	Jan. 07, 2015
Horn Antenna 1G-18G	SCHWARZBECK	BBHA 9120 D	BBHA 9120 D 1095	Jan. 07, 2014	Jan. 06, 2015
Horn Antenna 18G-40G	SCHWARZBECK	BBHA 9170	BBHA 9170517	Dec. 27, 2013	Dec. 26, 2014
Preamplifier	Burgeon	BPA-530	100218	Dec. 09, 2013	Dec. 08, 2014
Preamplifier	Agilent	83017A	MY39501309	Dec. 09, 2013	Dec. 08, 2014
Preamplifier	WM	TF-130N-R1	923365	Oct. 23, 2013	Oct. 22, 2014
RF Cable	HUBER+SUHNER	SUCOFLEX104	MY16140/4	Dec. 17, 2013	Dec. 16, 2014
RF Cable	HUBER+SUHNER	SUCOFLEX104	MY16018/4	Dec. 17, 2013	Dec. 16, 2014
RF Cable	HUBER+SUHNER	SUCOFLEX104	MY16015/4	Dec. 17, 2013	Dec. 16, 2014
LF cable 3M	Woken	CFD400NL-LW	CFD400NL-003	Dec. 17, 2013	Dec. 16, 2014
LF cable 10M	Woken	CFD400NL-LW	CFD400NL-004	Dec. 17, 2013	Dec. 16, 2014

Note: Calibration Interval of instruments listed above is one year.

Instrument	Manufacturer	Model No.	Serial No.	Calibration Date	Calibration Until
Loop Antenna	R&S	HFH2-Z2	100330	Nov. 15, 2012	Nov. 14, 2014

Note: Calibration Interval of instruments listed above is two year.

1.5 Test Standards

According to the specification of EUT, the EUT must comply with following standards and KDB documents.

47 CFR FCC Part 15.247

FCC Public notice DA 00-705

ANSI C63.10-2009

Note: The EUT has been tested and complied with FCC part 15B requirement. FCC Part 15B test results are issued to another report.

1.6 Measurement Uncertainty

ISO/IEC 17025 requires that an estimate of the measurement uncertainties associated with the emissions test results be included in the report. The measurement uncertainties given below are based on a 95% confidence level (based on a coverage factor $k=2$)

Measurement Uncertainty	
Parameters	Uncertainty
AC conducted emission	± 2.92 dB
Radiated emission < 1GHz	± 3.26 dB
Radiated emission > 1GHz	± 4.94 dB

2 Test Configuration

2.1 Testing Condition

Test Item	Test Site	Ambient Condition	Tested By
AC Conduction	CO01-WS	21°C / 55%	Skys Huang
Radiated Emissions	03CH02-WS	20-21°C / 64-68%	Anderson Hung

- FCC site registration No.: 657002
- IC site registration No.: 10807A-1

2.2 The Worst Test Modes and Channel Details

Test item	Mode	Test Frequency (MHz)	Data Rate (Mbps)	Test Configuration
Conducted Emissions	GFSK	2441	1Mbps	1, 2
Radiated Emissions ≤1GHz	GFSK	2441	1Mbps	1, 2
Radiated Emissions > 1GHz	GFSK 8DPSK	2402, 2441, 2480 2402, 2441, 2480	1Mbps 3Mbps	1, 2

NOTE:

1. The EUT was pretested with 3 orientations placed on the table for the radiated emission measurement – X, Y, and Z-plane. The **Z-plane** results were found as the worst case and were shown in this report.
2. Two samples had been tested on the following test configurations.
 - 1) Configuration 1 : AP6234A
 - 2) Configuration 2 : AP6234AL

3 Transmitter Test Results

3.1 Conducted Emissions

3.1.1 Limit of Conducted Emissions

Conducted Emissions Limit		
Frequency Emission (MHz)	Quasi-Peak	Average
0.15-0.5	66 - 56 *	56 - 46 *
0.5-5	56	46
5-30	60	50

Note 1: * Decreases with the logarithm of the frequency.

3.1.2 Test Procedures

1. The device is placed on a test table, raised 80 cm above the reference ground plane. The vertical conducting plane is located 40 cm to the rear of the device.
2. The device is connected to line impedance stabilization network (LISN) and other accessories are connected to other LISN. Measured levels of AC power line conducted emission are across the 50 Ω LISN port.
3. AC conducted emission measurements is made over frequency range from 150 kHz to 30 MHz.
4. This measurement was performed with AC 120V/60Hz

3.1.3 Test Setup



- Note: 1. Support units were connected to second LISN.
 2. Both of LISNs (AMN) are 80 cm from EUT and at least 80 cm from other units and other metal planes

3.1.4 Test Result of Conducted Emissions

Modulation	GFSK	Test Freq. (MHz)	2441
Power Phase	Line	Test Configuration	1

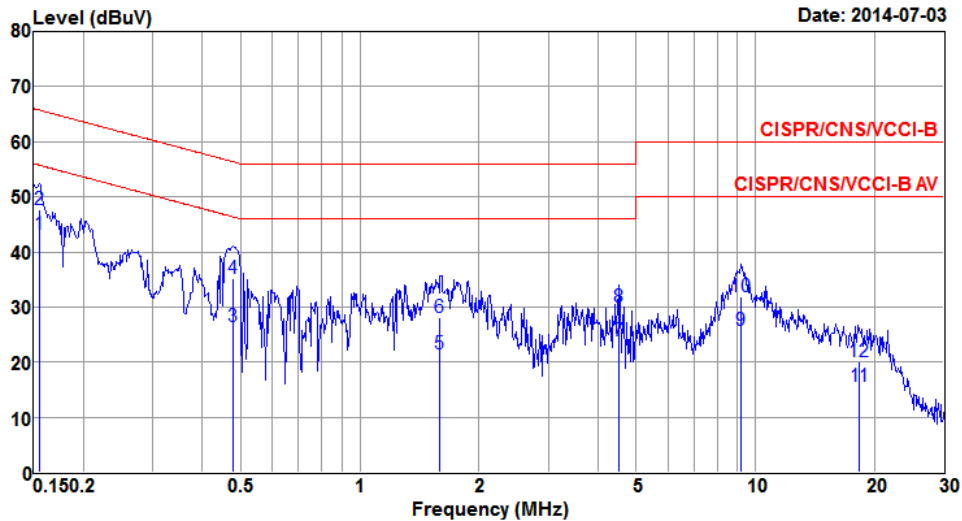

	Freq MHz	Level dBuV	Limit Line dBuV	Over Limit dB	Read Level dBuV	LISN factor dB	cable loss dB	Remark
1*	0.155	43.17	55.74	-12.57	42.75	0.40	0.02	Average
2	0.155	47.71	65.74	-18.03	47.29	0.40	0.02	QP
3	0.479	26.55	46.36	-19.81	26.10	0.39	0.06	Average
4	0.479	35.20	56.36	-21.16	34.75	0.39	0.06	QP
5	1.593	21.41	46.00	-24.59	20.91	0.42	0.08	Average
6	1.593	28.07	56.00	-27.93	27.57	0.42	0.08	QP
7	4.525	23.74	46.00	-22.26	23.11	0.47	0.16	Average
8	4.525	30.06	56.00	-25.94	29.43	0.47	0.16	QP
9	9.204	25.83	50.00	-24.17	25.06	0.53	0.24	Average
10	9.204	31.83	60.00	-28.17	31.06	0.53	0.24	QP
11	18.328	15.62	50.00	-34.38	14.70	0.55	0.37	Average
12	18.328	19.99	60.00	-40.01	19.07	0.55	0.37	QP

Note 1: Level (dBuV) = Read Level (dBuV) + LISN Factor (dB) + Cable Loss (dB).
 2: Over Limit (dB) = Level (dBuV) – Limit Line (dBuV).

Modulation	GFSK	Test Freq. (MHz)	2441
Power Phase	Neutral	Test Configuration	1

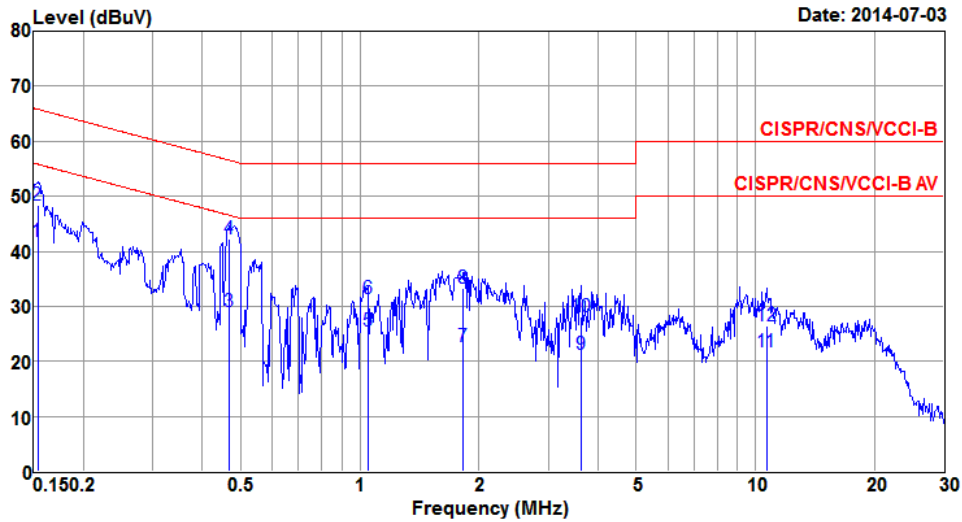

	Freq MHz	Level dBuV	Limit Line dBuV	Over Limit dB	Read Level dBuV	LISN factor dB	cable loss dB	Remark
1*	0.153	41.72	55.82	-14.10	41.22	0.48	0.02	Average
2	0.153	48.27	65.82	-17.55	47.77	0.48	0.02	QP
3	0.469	28.99	46.54	-17.55	28.47	0.47	0.05	Average
4	0.469	42.23	56.54	-14.31	41.71	0.47	0.05	QP
5	1.049	25.43	46.00	-20.57	24.76	0.48	0.19	Average
6	1.049	31.38	56.00	-24.62	30.71	0.48	0.19	QP
7	1.829	22.66	46.00	-23.34	22.12	0.50	0.04	Average
8	1.829	33.30	56.00	-22.70	32.76	0.50	0.04	QP
9	3.623	21.27	46.00	-24.73	20.62	0.52	0.13	Average
10	3.623	28.02	56.00	-27.98	27.37	0.52	0.13	QP
11	10.676	21.68	50.00	-28.32	20.86	0.56	0.26	Average
12	10.676	26.45	60.00	-33.55	25.63	0.56	0.26	QP

Note 1: Level (dBuV) = Read Level (dBuV) + LISN Factor (dB) + Cable Loss (dB).
 Note 2: Over Limit (dB) = Level (dBuV) – Limit Line (dBuV).

Modulation	GFSK	Test Freq. (MHz)	2441
Power Phase	Line	Test Configuration	2

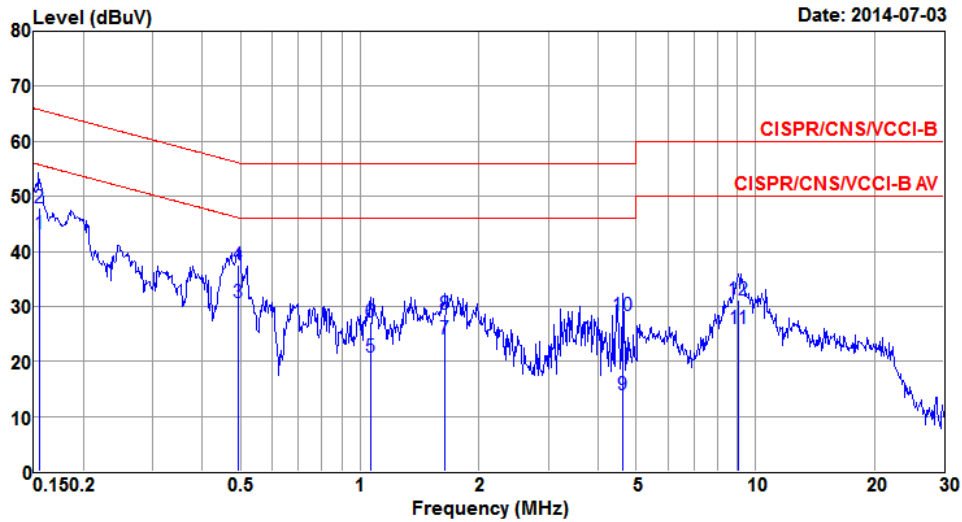

	Freq MHz	Level dBuV	Limit Line dBuV	Over Limit dB	Read Level dBuV	LISN factor dB	cable loss dB	Remark
1*	0.155	43.09	55.74	-12.65	42.67	0.40	0.02	Average
2	0.155	47.94	65.74	-17.80	47.52	0.40	0.02	QP
3	0.494	30.76	46.10	-15.34	30.31	0.39	0.06	Average
4	0.494	37.43	56.10	-18.67	36.98	0.39	0.06	QP
5	1.065	20.72	46.00	-25.28	20.13	0.41	0.18	Average
6	1.065	27.06	56.00	-28.94	26.47	0.41	0.18	QP
7	1.645	24.16	46.00	-21.84	23.67	0.42	0.07	Average
8	1.645	28.56	56.00	-27.44	28.07	0.42	0.07	QP
9	4.622	13.99	46.00	-32.01	13.35	0.47	0.17	Average
10	4.622	28.44	56.00	-27.56	27.80	0.47	0.17	QP
11	9.059	25.99	50.00	-24.01	25.22	0.53	0.24	Average
12	9.059	31.18	60.00	-28.82	30.41	0.53	0.24	QP

Note 1: Level (dBuV) = Read Level (dBuV) + LISN Factor (dB) + Cable Loss (dB).
 Note 2: Over Limit (dB) = Level (dBuV) – Limit Line (dBuV).

Modulation	GFSK	Test Freq. (MHz)	2441
Power Phase	Neutral	Test Configuration	2

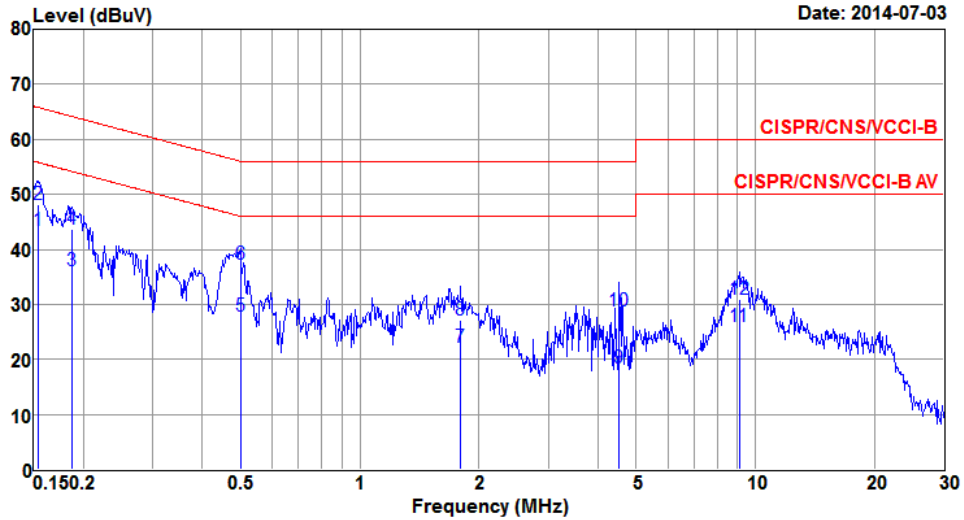

	Freq MHz	Level dBuV	Limit Line dBuV	Over Limit dB	Read Level dBuV	LISN factor dB	cable loss dB	Remark
1*	0.154	43.35	55.78	-12.43	42.85	0.48	0.02	Average
2	0.154	48.21	65.78	-17.57	47.71	0.48	0.02	QP
3	0.187	36.16	54.15	-17.99	35.67	0.48	0.01	Average
4	0.187	43.72	64.15	-20.43	43.23	0.48	0.01	QP
5	0.499	27.90	46.01	-18.11	27.37	0.47	0.06	Average
6	0.499	37.26	56.01	-18.75	36.73	0.47	0.06	QP
7	1.800	22.08	46.00	-23.92	21.53	0.50	0.05	Average
8	1.800	27.23	56.00	-28.77	26.68	0.50	0.05	QP
9	4.525	18.32	46.00	-27.68	17.63	0.53	0.16	Average
10	4.525	28.73	56.00	-27.27	28.04	0.53	0.16	QP
11	9.107	25.94	50.00	-24.06	25.14	0.56	0.24	Average
12	9.107	31.03	60.00	-28.97	30.23	0.56	0.24	QP

Note 1: Level (dBuV) = Read Level (dBuV) + LISN Factor (dB) + Cable Loss (dB).
 Note 2: Over Limit (dB) = Level (dBuV) – Limit Line (dBuV).

3.2 Unwanted Emissions into Restricted Frequency Bands

3.2.1 Limit of Unwanted Emissions into Restricted Frequency Bands

Restricted Band Emissions Limit			
Frequency Range (MHz)	Field Strength (uV/m)	Field Strength (dBuV/m)	Measure Distance (m)
0.009~0.490	2400/F(kHz)	48.5 - 13.8	300
0.490~1.705	24000/F(kHz)	33.8 - 23	30
1.705~30.0	30	29	30
30~88	100	40	3
88~216	150	43.5	3
216~960	200	46	3
Above 960	500	54	3

Note 1:
Qusai-Peak value is measured for frequency below 1GHz except for 9–90 kHz, 110–490 kHz frequency band. Peak and average value are measured for frequency above 1GHz. The limit on average radio frequency emission is as above table. The limit on peak radio frequency emissions is 20 dB above the maximum permitted average emission limit

Note 2:
Measurements may be performed at a distance other than what is specified provided. When performing measurements at a distance other than that specified, the results shall be extrapolated to the specified distance using an extrapolation factor as below, Frequency at or above 30 MHz: 20 dB/decade Frequency below 30 MHz: 40 dB/decade.

3.2.2 Test Procedures

1. Measurement is made at a semi-anechoic chamber that incorporates a turntable allowing a EUT rotation of 360°. A continuously-rotating, remotely-controlled turntable is installed at the test site to support the EUT and facilitate determination of the direction of maximum radiation for each EUT emission frequency. The EUT is placed at a height of 0.8 m test table above the ground plane.
2. Measurement is made with the antenna positioned in both the horizontal and vertical planes of polarization. The measurement antenna is varied in height (1m ~ 4m) above the reference ground plane to obtain the maximum signal strength. Distance between EUT and antenna is 3 m.
3. This investigation is performed with the EUT rotated 360°, the antenna height scanned between 1 m and 4 m, and the antenna rotated to repeat the measurements for both the horizontal and vertical antenna polarizations.

Note:

1. 120kHz measurement bandwidth of test receiver and Quasi-peak detector is for radiated emission below 1GHz.
2. Radiated emission above 1GHz / Peak value
RBW=1MHz, VBW=3MHz and Peak detector
Radiated emission above 1GHz / Average value for harmonics
The average value is: Average = Peak value + 20log(Duty cycle) Where the duty factor is calculated from following formula for DH5 packet type which has worst duty factor:
3.
$$20\log(\text{Duty cycle}) = 20\log \frac{1\text{s} / 1600 * 5}{100\text{ ms}} = -30.1\text{dB}$$
4. Radiated emission above 1GHz / Average value for other emissions
RBW=1MHz, VBW=1/T and Peak detector

3.2.3 Test Setup

Radiated Emissions below 1 GHz

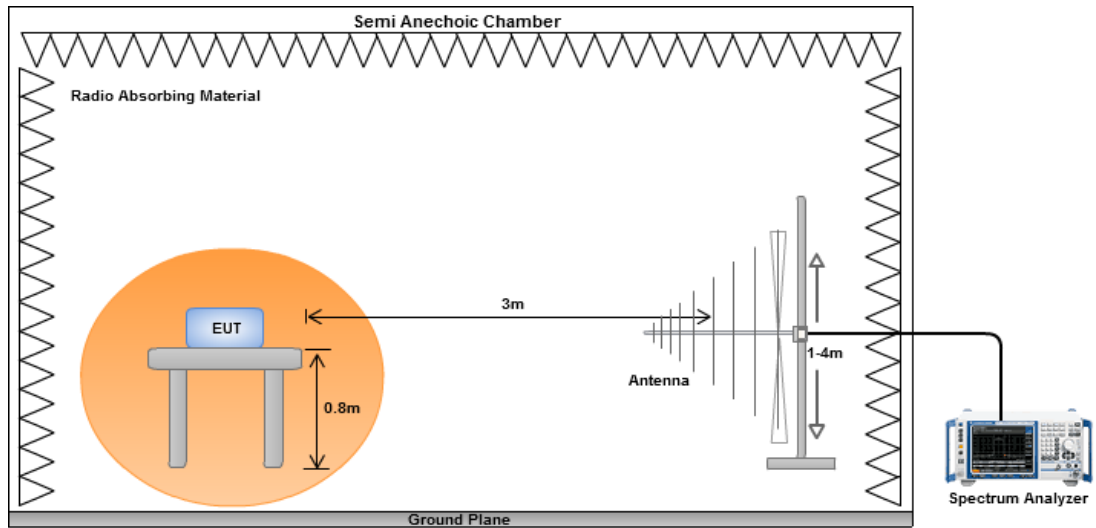

Radiated Emissions above 1 GHz

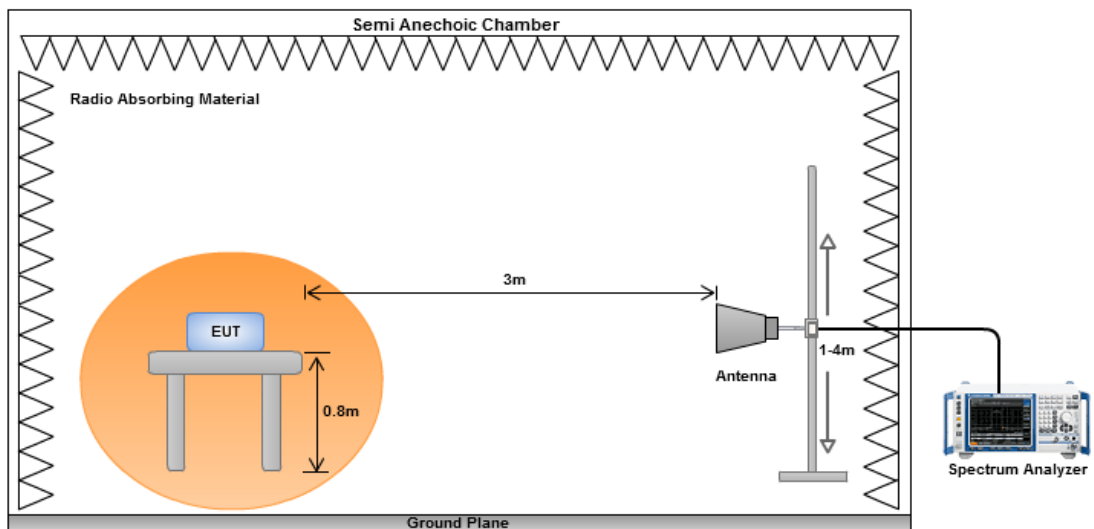

3.2.4 Transmitter Radiated Unwanted Emissions (Below 1GHz)

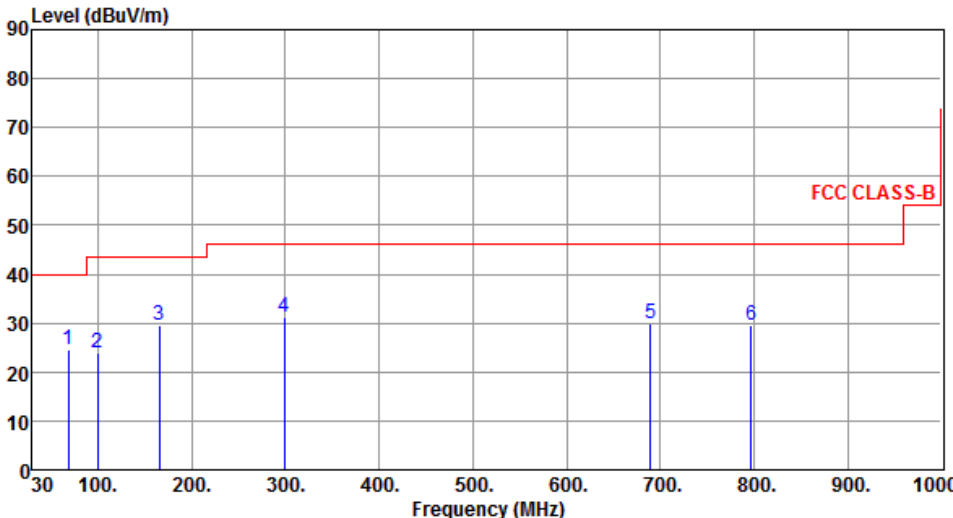
Modulation	GFSK	Test Freq. (MHz)	2441																																																																								
Polarization	Horizontal	Test Configuration	1																																																																								
 <p>The graph displays the radiated unwanted emissions for a transmitter. The y-axis represents the emission level in dBuV/m, ranging from 0 to 90. The x-axis represents the frequency in MHz, ranging from 30 to 1000. A red stepped line indicates the FCC CLASS-B limit, which is approximately 40 dBuV/m from 30 MHz to 100 MHz, 45 dBuV/m from 100 MHz to 300 MHz, and 55 dBuV/m from 300 MHz to 1000 MHz. Six blue vertical lines represent measured emission peaks, labeled 1 through 6, with their respective frequencies and levels.</p>																																																																											
	<table border="1"> <thead> <tr> <th>Freq.</th> <th>Emission level</th> <th>Limit</th> <th>Margin</th> <th>SA reading</th> <th>Factor</th> <th>Remark</th> <th>ANT High</th> <th>Turn Table</th> </tr> <tr> <th>MHz</th> <th>dBuV/m</th> <th>dBuV/m</th> <th>dB</th> <th>dBuV</th> <th>dB</th> <th></th> <th>cm</th> <th>deg</th> </tr> </thead> <tbody> <tr> <td>1</td> <td>68.80</td> <td>24.53</td> <td>40.00</td> <td>-15.47</td> <td>43.36</td> <td>-18.83</td> <td>Peak</td> <td>---</td> </tr> <tr> <td>2</td> <td>99.84</td> <td>23.87</td> <td>43.50</td> <td>-19.63</td> <td>45.53</td> <td>-21.66</td> <td>Peak</td> <td>---</td> </tr> <tr> <td>3</td> <td>165.80</td> <td>29.39</td> <td>43.50</td> <td>-14.11</td> <td>46.55</td> <td>-17.16</td> <td>Peak</td> <td>---</td> </tr> <tr> <td>4</td> <td>298.69</td> <td>31.06</td> <td>46.00</td> <td>-14.94</td> <td>47.31</td> <td>-16.25</td> <td>Peak</td> <td>---</td> </tr> <tr> <td>5</td> <td>689.60</td> <td>29.85</td> <td>46.00</td> <td>-16.15</td> <td>38.32</td> <td>-8.47</td> <td>Peak</td> <td>---</td> </tr> <tr> <td>6</td> <td>797.27</td> <td>29.41</td> <td>46.00</td> <td>-16.59</td> <td>36.13</td> <td>-6.72</td> <td>Peak</td> <td>---</td> </tr> </tbody> </table>	Freq.	Emission level	Limit	Margin	SA reading	Factor	Remark	ANT High	Turn Table	MHz	dBuV/m	dBuV/m	dB	dBuV	dB		cm	deg	1	68.80	24.53	40.00	-15.47	43.36	-18.83	Peak	---	2	99.84	23.87	43.50	-19.63	45.53	-21.66	Peak	---	3	165.80	29.39	43.50	-14.11	46.55	-17.16	Peak	---	4	298.69	31.06	46.00	-14.94	47.31	-16.25	Peak	---	5	689.60	29.85	46.00	-16.15	38.32	-8.47	Peak	---	6	797.27	29.41	46.00	-16.59	36.13	-6.72	Peak	---		
Freq.	Emission level	Limit	Margin	SA reading	Factor	Remark	ANT High	Turn Table																																																																			
MHz	dBuV/m	dBuV/m	dB	dBuV	dB		cm	deg																																																																			
1	68.80	24.53	40.00	-15.47	43.36	-18.83	Peak	---																																																																			
2	99.84	23.87	43.50	-19.63	45.53	-21.66	Peak	---																																																																			
3	165.80	29.39	43.50	-14.11	46.55	-17.16	Peak	---																																																																			
4	298.69	31.06	46.00	-14.94	47.31	-16.25	Peak	---																																																																			
5	689.60	29.85	46.00	-16.15	38.32	-8.47	Peak	---																																																																			
6	797.27	29.41	46.00	-16.59	36.13	-6.72	Peak	---																																																																			
<p>Note 1: Emission Level (dBuV/m) = SA Reading (dBuV/m) + Factor* (dB) *Factor includes antenna factor , cable loss and amplifier gain Note 2: Margin (dB) = Emission level (dBuV/m) – Limit (dBuV/m). Note 3: All spurious emissions below 30MHz are more than 20 dB below the limit.</p>																																																																											

Modulation	GFSK	Test Freq. (MHz)	2441
Polarization	Vertical	Test Configuration	1

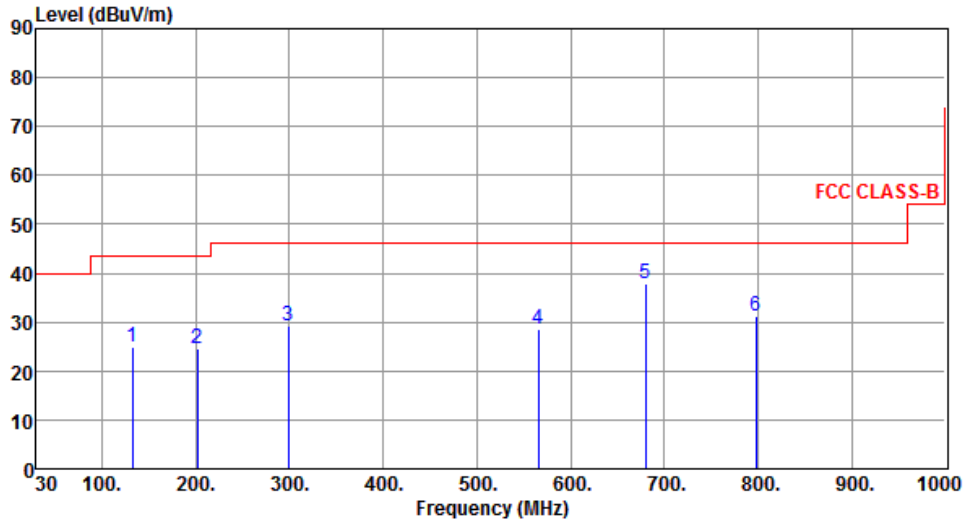

	Freq. MHz	Emission level dBuV/m	Limit dBuV/m	Margin dB	SA reading dBuV	Factor dB	Remark	ANT High cm	Turn Table deg
1	132.82	25.04	43.50	-18.46	42.91	-17.87	Peak	---	---
2	201.69	24.61	43.50	-18.89	44.42	-19.81	Peak	---	---
3	298.69	29.27	46.00	-16.73	45.52	-16.25	Peak	---	---
4	565.44	28.52	46.00	-17.48	38.81	-10.29	Peak	---	---
5	679.90	37.76	46.00	-8.24	46.37	-8.61	Peak	---	---
6	798.24	31.26	46.00	-14.74	37.96	-6.70	Peak	---	---

Note 1: Emission Level (dBuV/m) = SA Reading (dBuV/m) + Factor* (dB)

*Factor includes antenna factor , cable loss and amplifier gain

Note 2: Margin (dB) = Emission level (dBuV/m) – Limit (dBuV/m).

Note 3: All spurious emissions below 30MHz are more than 20 dB below the limit.

Modulation	GFSK	Test Freq. (MHz)	2441
Polarization	Horizontal	Test Configuration	2

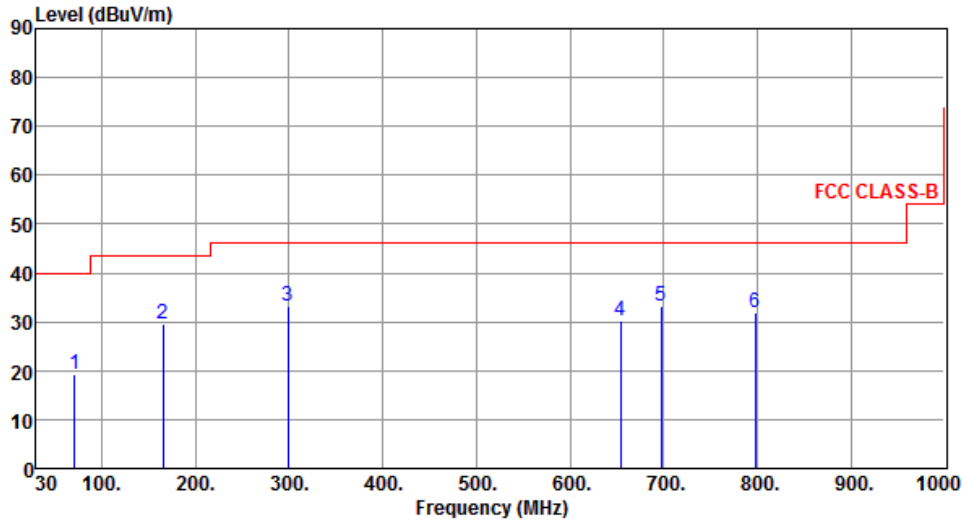

	Freq. MHz	Emission level dBuV/m	Limit dBuV/m	Margin dB	SA reading dBuV	Factor dB	Remark	ANT High cm	Turn Table deg
1	70.74	19.38	40.00	-20.62	38.59	-19.21	Peak	---	---
2	165.80	29.62	43.50	-13.88	46.78	-17.16	Peak	---	---
3	298.69	33.17	46.00	-12.83	49.42	-16.25	Peak	---	---
4	653.71	30.20	46.00	-15.80	39.19	-8.99	Peak	---	---
5	697.36	33.33	46.00	-12.67	41.69	-8.36	Peak	---	---
6	798.24	31.99	46.00	-14.01	38.69	-6.70	Peak	---	---

Note 1: Emission Level (dBuV/m) = SA Reading (dBuV/m) + Factor* (dB)

*Factor includes antenna factor, cable loss and amplifier gain

Note 2: Margin (dB) = Emission level (dBuV/m) – Limit (dBuV/m).

Note 3: All spurious emissions below 30MHz are more than 20 dB below the limit.

Modulation	GFSK	Test Freq. (MHz)	2441
Polarization	Vertical	Test Configuration	2

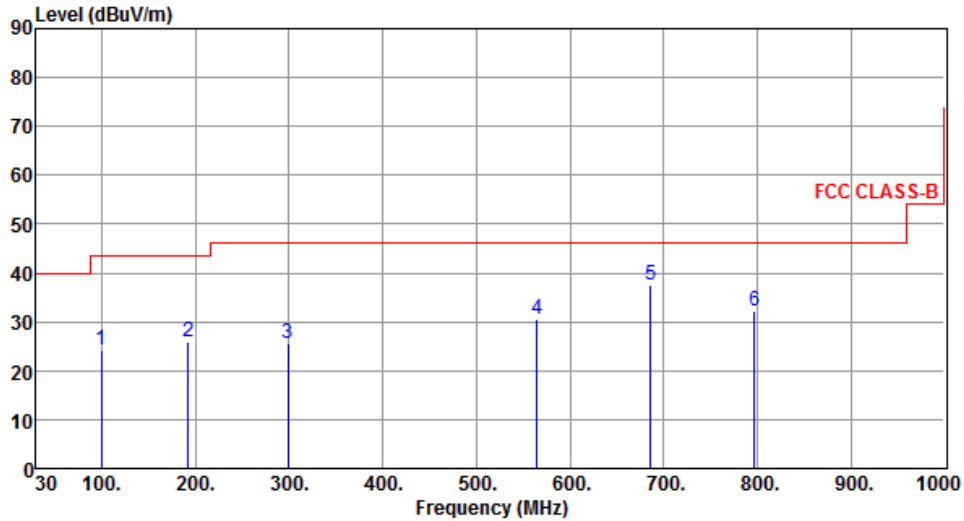

	Freq. MHz	Emission level dBuV/m	Limit dBuV/m	Margin dB	SA reading dBuV	Factor dB	Remark	ANT High cm	Turn Table deg
1	99.84	24.27	43.50	-19.23	45.93	-21.66	Peak	---	---
2	191.99	25.95	43.50	-17.55	45.54	-19.59	Peak	---	---
3	298.69	25.62	46.00	-20.38	41.87	-16.25	Peak	---	---
4	564.47	30.59	46.00	-15.41	40.90	-10.31	Peak	---	---
5	685.72	37.52	46.00	-8.48	46.05	-8.53	Peak	---	---
6	797.27	32.12	46.00	-13.88	38.84	-6.72	Peak	---	---

Note 1: Emission Level (dBuV/m) = SA Reading (dBuV/m) + Factor* (dB)

*Factor includes antenna factor, cable loss and amplifier gain

Note 2: Margin (dB) = Emission level (dBuV/m) – Limit (dBuV/m).

Note 3: All spurious emissions below 30MHz are more than 20 dB below the limit.

3.2.5 Transmitter Radiated Unwanted Emissions (Above 1GHz) for GFSK

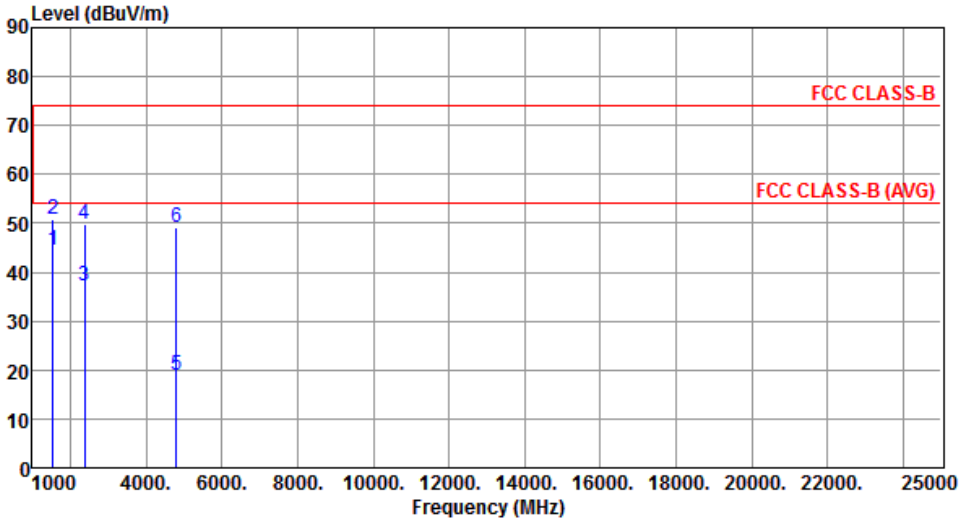
Modulation	GFSK	Test Freq. (MHz)	2402																																																																																											
Polarization	Horizontal	Test Configuration	1																																																																																											
																																																																																														
	<table border="1"> <thead> <tr> <th></th> <th>Freq.</th> <th>Emission</th> <th>Limit</th> <th>Margin</th> <th>SA</th> <th>Factor</th> <th>Remark</th> <th>ANT</th> <th>Turn</th> </tr> <tr> <th></th> <th>MHz</th> <th>level</th> <th>dBuV/m</th> <th>dB</th> <th>reading</th> <th>dB</th> <th></th> <th>High</th> <th>Table</th> </tr> <tr> <th></th> <th></th> <th>dBuV/m</th> <th></th> <th></th> <th>dBuV</th> <th></th> <th></th> <th>cm</th> <th>deg</th> </tr> </thead> <tbody> <tr> <td>1</td> <td>1535.00</td> <td>44.45</td> <td>54.00</td> <td>-9.55</td> <td>50.78</td> <td>-6.33</td> <td>Average</td> <td>---</td> <td>---</td> </tr> <tr> <td>2</td> <td>1535.00</td> <td>50.87</td> <td>74.00</td> <td>-23.13</td> <td>57.20</td> <td>-6.33</td> <td>Peak</td> <td>---</td> <td>---</td> </tr> <tr> <td>3</td> <td>2390.00</td> <td>37.14</td> <td>54.00</td> <td>-16.86</td> <td>39.96</td> <td>-2.82</td> <td>Average</td> <td>---</td> <td>---</td> </tr> <tr> <td>4</td> <td>2390.00</td> <td>49.98</td> <td>74.00</td> <td>-24.02</td> <td>52.80</td> <td>-2.82</td> <td>Peak</td> <td>---</td> <td>---</td> </tr> <tr> <td>5</td> <td>4804.00</td> <td>19.05</td> <td>54.00</td> <td>-34.95</td> <td>14.00</td> <td>5.05</td> <td>Average</td> <td>---</td> <td>---</td> </tr> <tr> <td>6</td> <td>4804.00</td> <td>49.15</td> <td>74.00</td> <td>-24.85</td> <td>44.10</td> <td>5.05</td> <td>Peak</td> <td>---</td> <td>---</td> </tr> </tbody> </table>		Freq.	Emission	Limit	Margin	SA	Factor	Remark	ANT	Turn		MHz	level	dBuV/m	dB	reading	dB		High	Table			dBuV/m			dBuV			cm	deg	1	1535.00	44.45	54.00	-9.55	50.78	-6.33	Average	---	---	2	1535.00	50.87	74.00	-23.13	57.20	-6.33	Peak	---	---	3	2390.00	37.14	54.00	-16.86	39.96	-2.82	Average	---	---	4	2390.00	49.98	74.00	-24.02	52.80	-2.82	Peak	---	---	5	4804.00	19.05	54.00	-34.95	14.00	5.05	Average	---	---	6	4804.00	49.15	74.00	-24.85	44.10	5.05	Peak	---	---			
	Freq.	Emission	Limit	Margin	SA	Factor	Remark	ANT	Turn																																																																																					
	MHz	level	dBuV/m	dB	reading	dB		High	Table																																																																																					
		dBuV/m			dBuV			cm	deg																																																																																					
1	1535.00	44.45	54.00	-9.55	50.78	-6.33	Average	---	---																																																																																					
2	1535.00	50.87	74.00	-23.13	57.20	-6.33	Peak	---	---																																																																																					
3	2390.00	37.14	54.00	-16.86	39.96	-2.82	Average	---	---																																																																																					
4	2390.00	49.98	74.00	-24.02	52.80	-2.82	Peak	---	---																																																																																					
5	4804.00	19.05	54.00	-34.95	14.00	5.05	Average	---	---																																																																																					
6	4804.00	49.15	74.00	-24.85	44.10	5.05	Peak	---	---																																																																																					
<p>Note 1: Emission Level (dBuV/m) = SA Reading (dBuV/m) + Factor* (dB) *Factor includes antenna factor , cable loss and amplifier gain Note 2: Margin (dB) = Emission level (dBuV/m) – Limit (dBuV/m).</p>																																																																																														

Modulation	GFSK	Test Freq. (MHz)	2402
Polarization	Vertical	Test Configuration	1

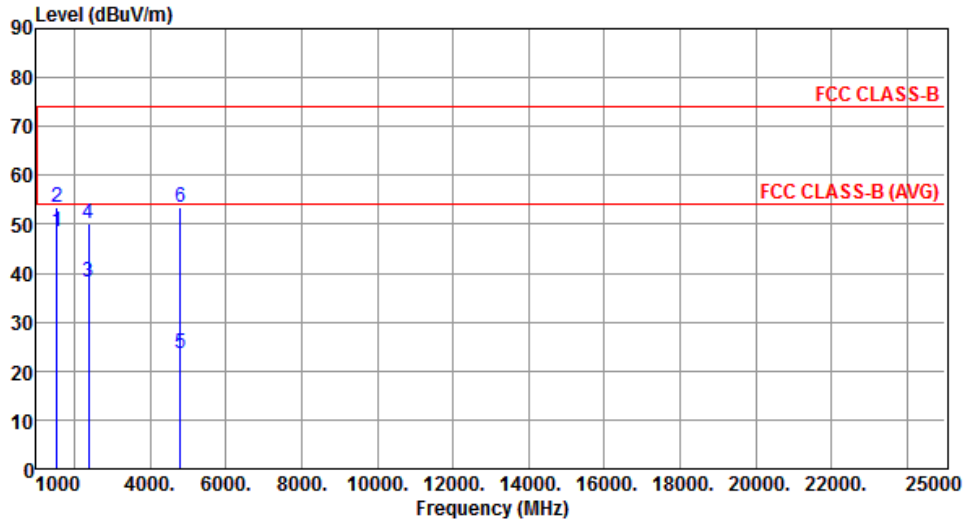

	Freq. MHz	Emission level dBuV/m	Limit dBuV/m	Margin dB	SA reading dBuV	Factor dB	Remark	ANT High cm	Turn Table deg
1	1535.00	48.57	54.00	-5.43	54.90	-6.33	Average	---	---
2	1535.00	53.34	74.00	-20.66	59.67	-6.33	Peak	---	---
3	2390.00	38.29	54.00	-15.71	41.11	-2.82	Average	---	---
4	2390.00	50.19	74.00	-23.81	53.01	-2.82	Peak	---	---
5	4804.00	23.51	54.00	-30.49	18.46	5.05	Average	---	---
6	4804.00	53.61	74.00	-20.39	48.56	5.05	Peak	---	---

Note 1: Emission Level (dBuV/m) = SA Reading (dBuV/m) + Factor* (dB)

*Factor includes antenna factor , cable loss and amplifier gain

Note 2: Margin (dB) = Emission level (dBuV/m) – Limit (dBuV/m).

Modulation	GFSK	Test Freq. (MHz)	2441
Polarization	Horizontal	Test Configuration	1

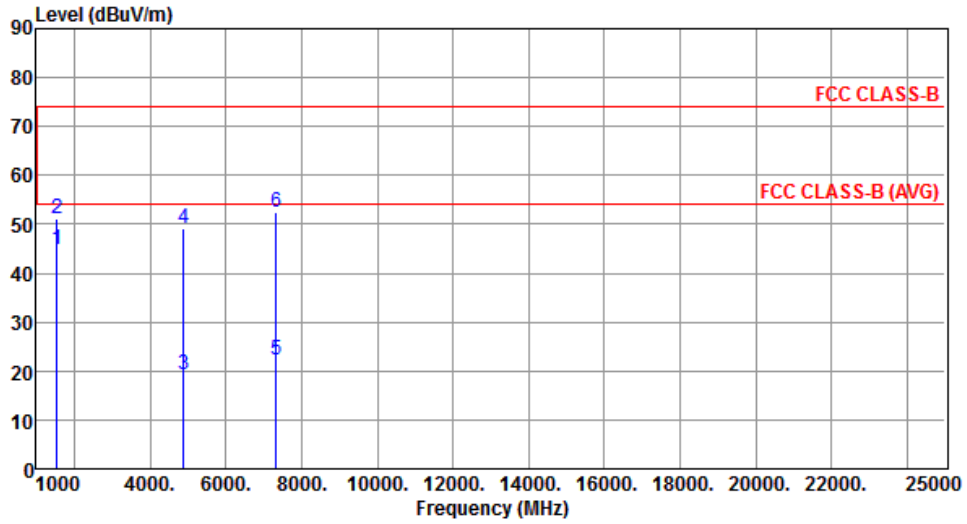

	Freq. MHz	Emission level dBuV/m	Limit dBuV/m	Margin dB	SA reading dBuV	Factor dB	Remark	ANT High cm	Turn Table deg
1	1535.00	44.84	54.00	-9.16	51.17	-6.33	Average	---	---
2	1535.00	51.10	74.00	-22.90	57.43	-6.33	Peak	---	---
3	4882.00	19.20	54.00	-34.80	14.01	5.19	Average	---	---
4	4882.00	49.30	74.00	-24.70	44.11	5.19	Peak	---	---
5	7323.00	22.35	54.00	-31.65	11.60	10.75	Average	---	---
6	7323.00	52.45	74.00	-21.55	41.70	10.75	Peak	---	---

Note 1: Emission Level (dBuV/m) = SA Reading (dBuV/m) + Factor* (dB)

*Factor includes antenna factor , cable loss and amplifier gain

Note 2: Margin (dB) = Emission level (dBuV/m) – Limit (dBuV/m).

Modulation	GFSK	Test Freq. (MHz)	2441
Polarization	Vertical	Test Configuration	1

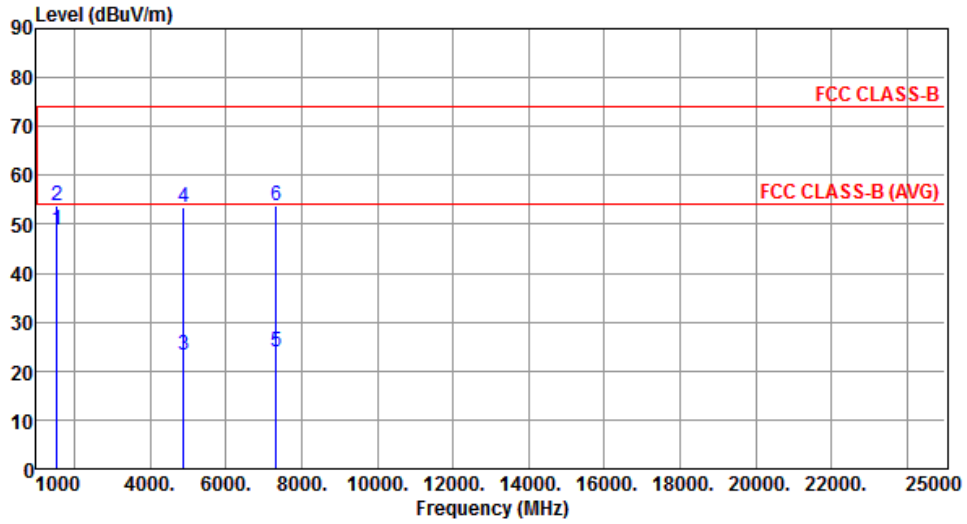

	Freq. MHz	Emission level dBuV/m	Limit dBuV/m	Margin dB	SA reading dBuV	Factor dB	Remark	ANT High cm	Turn Table deg
1	1535.00	48.94	54.00	-5.06	55.27	-6.33	Average	---	---
2	1535.00	53.78	74.00	-20.22	60.11	-6.33	Peak	---	---
3	4882.00	23.25	54.00	-30.75	18.06	5.19	Average	---	---
4	4882.00	53.35	74.00	-20.65	48.16	5.19	Peak	---	---
5	7323.00	23.75	54.00	-30.25	13.00	10.75	Average	---	---
6	7323.00	53.85	74.00	-20.15	43.10	10.75	Peak	---	---

Note 1: Emission Level (dBuV/m) = SA Reading (dBuV/m) + Factor* (dB)

*Factor includes antenna factor , cable loss and amplifier gain

Note 2: Margin (dB) = Emission level (dBuV/m) – Limit (dBuV/m).

Modulation	GFSK	Test Freq. (MHz)	2480
Polarization	Horizontal	Test Configuration	1

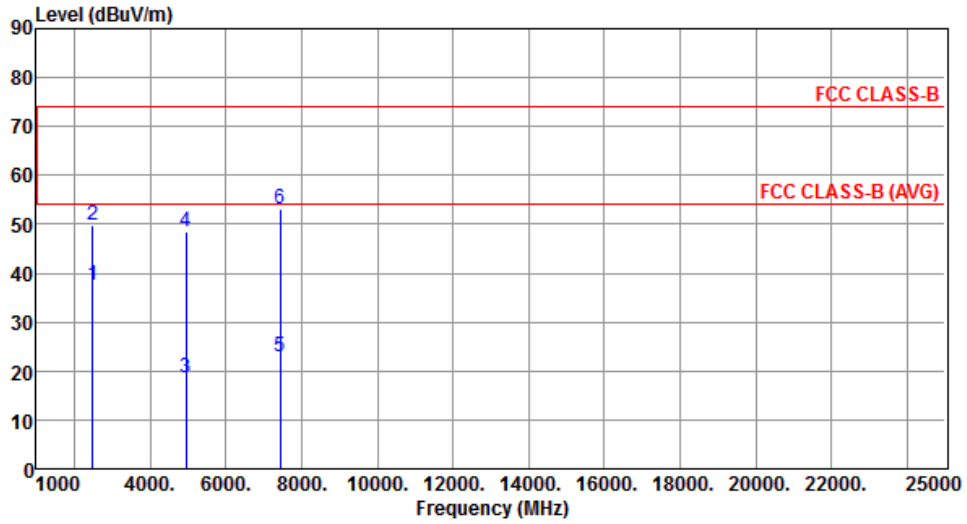

	Freq. MHz	Emission level dBuV/m	Limit dBuV/m	Margin dB	SA reading dBuV	Factor dB	Remark	ANT High cm	Turn Table deg
1	2483.50	37.53	54.00	-16.47	39.92	-2.39	Average	---	---
2	2483.50	49.90	74.00	-24.10	52.29	-2.39	Peak	---	---
3	4960.00	18.54	54.00	-35.46	13.20	5.34	Average	---	---
4	4960.00	48.64	74.00	-25.36	43.30	5.34	Peak	---	---
5	7440.00	22.97	54.00	-31.03	12.04	10.93	Average	---	---
6	7440.00	53.07	74.00	-20.93	42.14	10.93	Peak	---	---

Note 1: Emission Level (dBuV/m) = SA Reading (dBuV/m) + Factor* (dB)

*Factor includes antenna factor , cable loss and amplifier gain

Note 2: Margin (dB) = Emission level (dBuV/m) – Limit (dBuV/m).

Modulation	GFSK	Test Freq. (MHz)	2480
Polarization	Vertical	Test Configuration	1

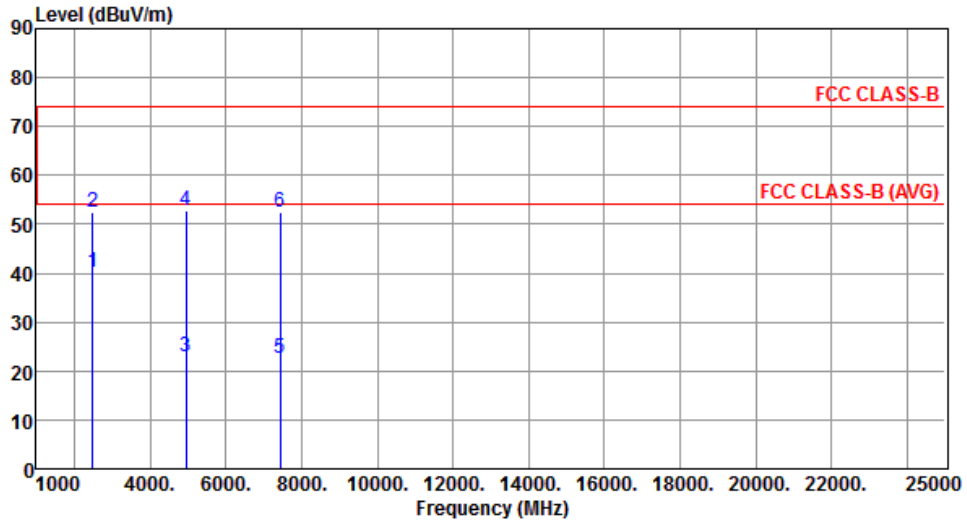

	Freq. MHz	Emission level dBuV/m	Limit dBuV/m	Margin dB	SA reading dBuV	Factor dB	Remark	ANT High cm	Turn Table deg
1	2483.50	40.21	54.00	-13.79	42.60	-2.39	Average	---	---
2	2483.50	52.60	74.00	-21.40	54.99	-2.39	Peak	---	---
3	4960.00	22.83	54.00	-31.17	17.49	5.34	Average	---	---
4	4960.00	52.93	74.00	-21.07	47.59	5.34	Peak	---	---
5	7440.00	22.50	54.00	-31.50	11.57	10.93	Average	---	---
6	7440.00	52.60	74.00	-21.40	41.67	10.93	Peak	---	---

Note 1: Emission Level (dBuV/m) = SA Reading (dBuV/m) + Factor* (dB)

*Factor includes antenna factor , cable loss and amplifier gain

Note 2: Margin (dB) = Emission level (dBuV/m) – Limit (dBuV/m).

Modulation	GFSK	Test Freq. (MHz)	2402
Polarization	Horizontal	Test Configuration	2

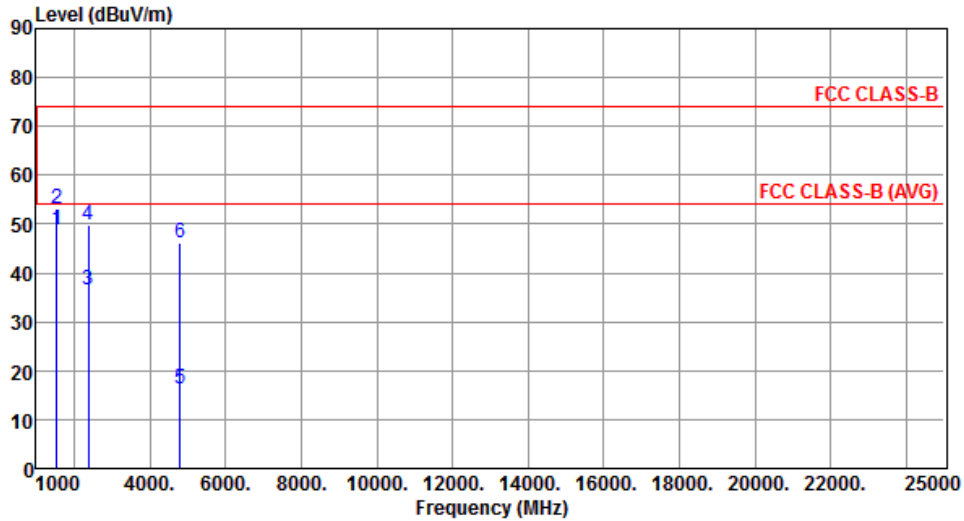

	Freq. MHz	Emission level dBuV/m	Limit dBuV/m	Margin dB	SA reading dBuV	Factor dB	Remark	ANT High cm	Turn Table deg
1	1534.00	48.97	54.00	-5.03	55.30	-6.33	Average	---	---
2	1534.00	53.23	74.00	-20.77	59.56	-6.33	Peak	---	---
3	2390.00	36.54	54.00	-17.46	39.36	-2.82	Average	---	---
4	2390.00	49.84	74.00	-24.16	52.66	-2.82	Peak	---	---
5	4804.00	16.13	54.00	-37.87	11.08	5.05	Average	---	---
6	4804.00	46.23	74.00	-27.77	41.18	5.05	Peak	---	---

Note 1: Emission Level (dBuV/m) = SA Reading (dBuV/m) + Factor* (dB)

*Factor includes antenna factor , cable loss and amplifier gain

Note 2: Margin (dB) = Emission level (dBuV/m) – Limit (dBuV/m).

Modulation	GFSK	Test Freq. (MHz)	2402
Polarization	Vertical	Test Configuration	2

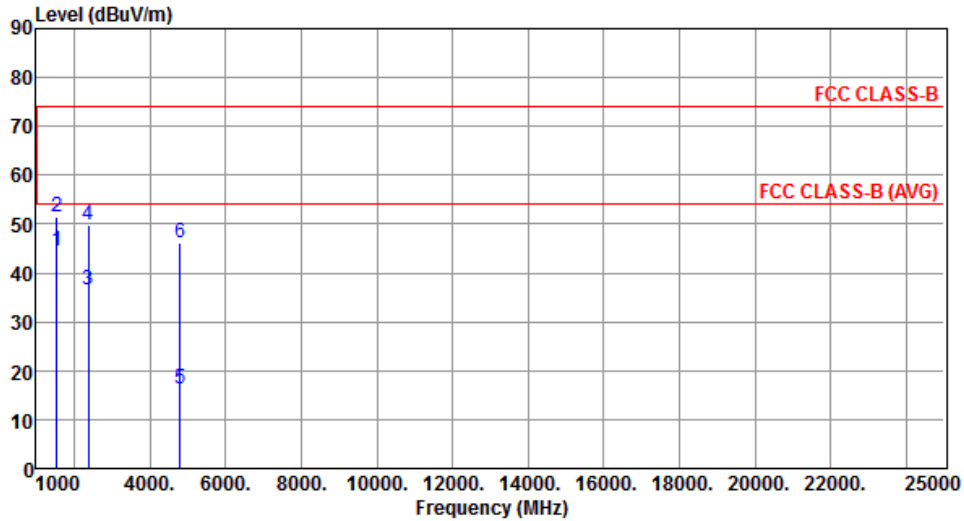

	Freq. MHz	Emission level dBuV/m	Limit dBuV/m	Margin dB	SA reading dBuV	Factor dB	Remark	ANT High cm	Turn Table deg
1	1534.00	44.58	54.00	-9.42	50.91	-6.33	Average	---	---
2	1534.00	51.36	74.00	-22.64	57.69	-6.33	Peak	---	---
3	2390.00	36.43	54.00	-17.57	39.25	-2.82	Average	---	---
4	2390.00	49.87	74.00	-24.13	52.69	-2.82	Peak	---	---
5	4804.00	16.17	54.00	-37.83	11.12	5.05	Average	---	---
6	4804.00	46.27	74.00	-27.73	41.22	5.05	Peak	---	---

Note 1: Emission Level (dBuV/m) = SA Reading (dBuV/m) + Factor* (dB)

*Factor includes antenna factor , cable loss and amplifier gain

Note 2: Margin (dB) = Emission level (dBuV/m) – Limit (dBuV/m).

Modulation	GFSK	Test Freq. (MHz)	2441
Polarization	Horizontal	Test Configuration	2

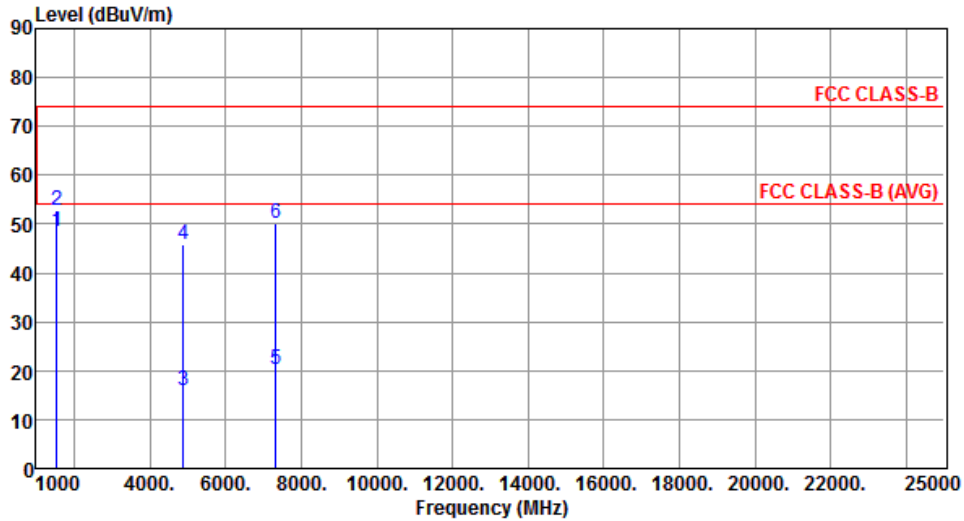

	Freq. MHz	Emission level dBuV/m	Limit dBuV/m	Margin dB	SA reading dBuV	Factor dB	Remark	ANT High cm	Turn Table deg
1	1534.00	48.59	54.00	-5.41	54.92	-6.33	Average	---	---
2	1534.00	52.93	74.00	-21.07	59.26	-6.33	Peak	---	---
3	4882.00	15.88	54.00	-38.12	10.69	5.19	Average	---	---
4	4882.00	45.98	74.00	-28.02	40.79	5.19	Peak	---	---
5	7323.00	20.17	54.00	-33.83	9.42	10.75	Average	---	---
6	7323.00	50.27	74.00	-23.73	39.52	10.75	Peak	---	---

Note 1: Emission Level (dBuV/m) = SA Reading (dBuV/m) + Factor* (dB)

*Factor includes antenna factor , cable loss and amplifier gain

Note 2: Margin (dB) = Emission level (dBuV/m) – Limit (dBuV/m).

Modulation	GFSK	Test Freq. (MHz)	2441
Polarization	Vertical	Test Configuration	2

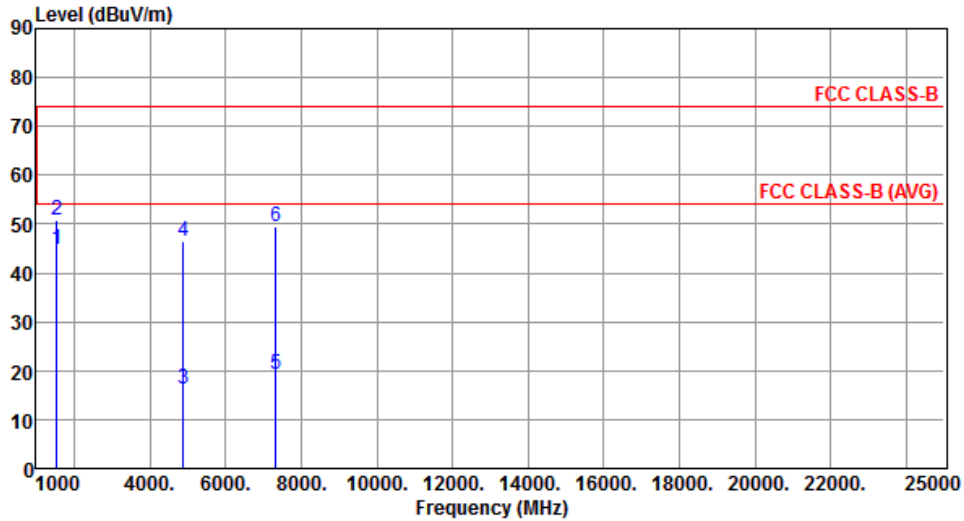

	Freq. MHz	Emission level dBuV/m	Limit dBuV/m	Margin dB	SA reading dBuV	Factor dB	Remark	ANT High cm	Turn Table deg
1	1534.00	44.76	54.00	-9.24	51.09	-6.33	Average	---	---
2	1534.00	50.83	74.00	-23.17	57.16	-6.33	Peak	---	---
3	4882.00	16.26	54.00	-37.74	11.07	5.19	Average	---	---
4	4882.00	46.36	74.00	-27.64	41.17	5.19	Peak	---	---
5	7323.00	19.34	54.00	-34.66	8.59	10.75	Average	---	---
6	7323.00	49.44	74.00	-24.56	38.69	10.75	Peak	---	---

Note 1: Emission Level (dBuV/m) = SA Reading (dBuV/m) + Factor* (dB)

*Factor includes antenna factor , cable loss and amplifier gain

Note 2: Margin (dB) = Emission level (dBuV/m) – Limit (dBuV/m).

Modulation	GFSK	Test Freq. (MHz)	2480
Polarization	Horizontal	Test Configuration	2

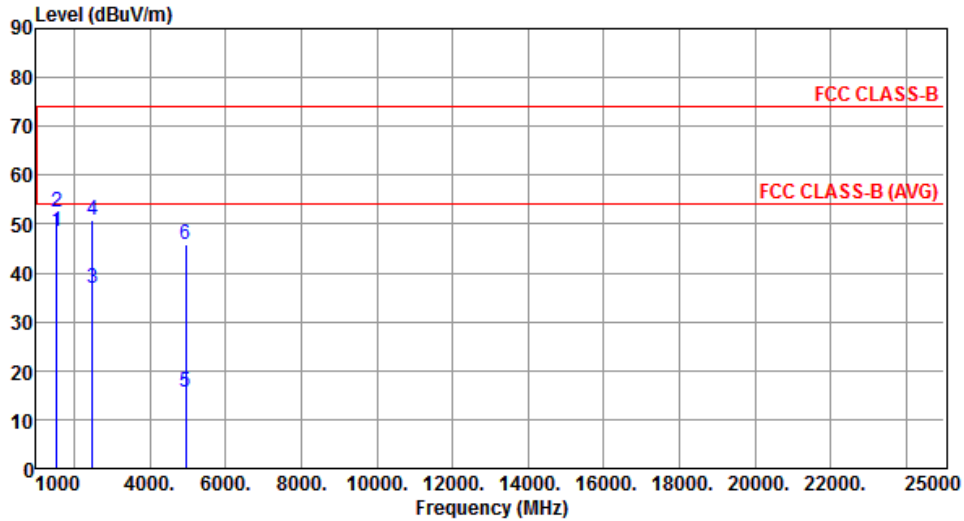

	Freq. MHz	Emission level dBuV/m	Limit dBuV/m	Margin dB	SA reading dBuV	Factor dB	Remark	ANT High cm	Turn Table deg
1	1534.00	48.56	54.00	-5.44	54.89	-6.33	Average	---	---
2	1534.00	52.49	74.00	-21.51	58.82	-6.33	Peak	---	---
3	2483.50	36.73	54.00	-17.27	39.12	-2.39	Average	---	---
4	2483.50	50.68	74.00	-23.32	53.07	-2.39	Peak	---	---
5	4960.00	15.75	54.00	-38.25	10.41	5.34	Average	---	---
6	4960.00	45.85	74.00	-28.15	40.51	5.34	Peak	---	---

Note 1: Emission Level (dBuV/m) = SA Reading (dBuV/m) + Factor* (dB)

*Factor includes antenna factor , cable loss and amplifier gain

Note 2: Margin (dB) = Emission level (dBuV/m) – Limit (dBuV/m).

Modulation	GFSK	Test Freq. (MHz)	2480
Polarization	Vertical	Test Configuration	2

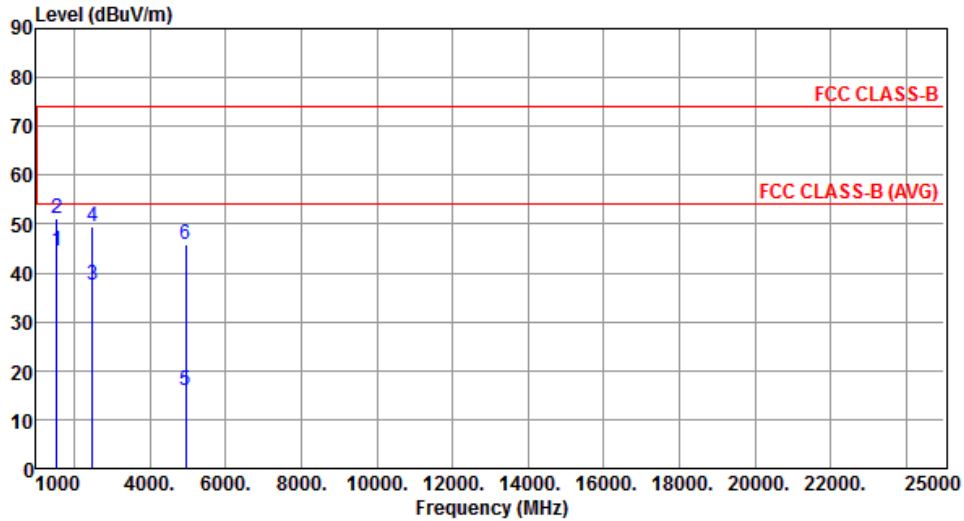

	Freq. MHz	Emission level dBuV/m	Limit dBuV/m	Margin dB	SA reading dBuV	Factor dB	Remark	ANT High cm	Turn Table deg
1	1534.00	44.63	54.00	-9.37	50.96	-6.33	Average	---	---
2	1534.00	50.98	74.00	-23.02	57.31	-6.33	Peak	---	---
3	2483.50	37.52	54.00	-16.48	39.91	-2.39	Average	---	---
4	2483.50	49.35	74.00	-24.65	51.74	-2.39	Peak	---	---
5	4960.00	15.89	54.00	-38.11	10.55	5.34	Average	---	---
6	4960.00	45.99	74.00	-28.01	40.65	5.34	Peak	---	---

Note 1: Emission Level (dBuV/m) = SA Reading (dBuV/m) + Factor* (dB)

*Factor includes antenna factor , cable loss and amplifier gain

Note 2: Margin (dB) = Emission level (dBuV/m) – Limit (dBuV/m).

3.2.6 Transmitter Radiated Unwanted Emissions (Above 1GHz) for 8DPSK

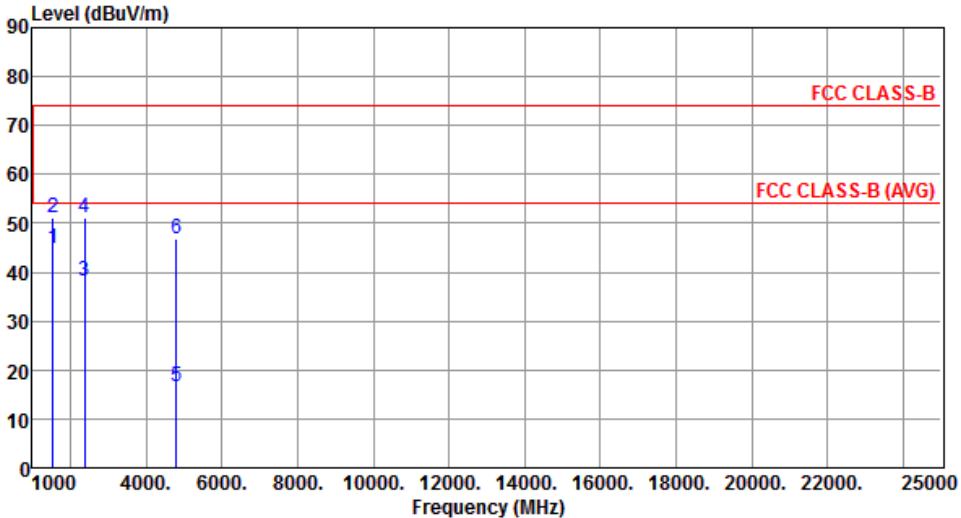
Modulation	8DPSK	Test Freq. (MHz)	2402																																																																						
Polarization	Horizontal	Test Configuration	1																																																																						
																																																																									
	<table border="1"> <thead> <tr> <th>Freq.</th> <th>Emission level</th> <th>Limit</th> <th>Margin</th> <th>SA reading</th> <th>Factor</th> <th>Remark</th> <th>ANT High cm</th> <th>Turn Table deg</th> </tr> <tr> <th>MHz</th> <th>dBuV/m</th> <th>dBuV/m</th> <th>dB</th> <th>dBuV</th> <th>dB</th> <th></th> <th></th> <th></th> </tr> </thead> <tbody> <tr> <td>1</td> <td>1535.00</td> <td>44.84</td> <td>54.00</td> <td>-9.16</td> <td>51.17</td> <td>-6.33</td> <td>Average</td> <td>---</td> </tr> <tr> <td>2</td> <td>1535.00</td> <td>51.23</td> <td>74.00</td> <td>-22.77</td> <td>57.56</td> <td>-6.33</td> <td>Peak</td> <td>---</td> </tr> <tr> <td>3</td> <td>2390.00</td> <td>38.03</td> <td>54.00</td> <td>-15.97</td> <td>40.85</td> <td>-2.82</td> <td>Average</td> <td>---</td> </tr> <tr> <td>4</td> <td>2390.00</td> <td>51.22</td> <td>74.00</td> <td>-22.78</td> <td>54.04</td> <td>-2.82</td> <td>Peak</td> <td>---</td> </tr> <tr> <td>5</td> <td>4804.00</td> <td>16.68</td> <td>54.00</td> <td>-37.32</td> <td>11.63</td> <td>5.05</td> <td>Average</td> <td>---</td> </tr> <tr> <td>6</td> <td>4804.00</td> <td>46.78</td> <td>74.00</td> <td>-27.22</td> <td>41.73</td> <td>5.05</td> <td>Peak</td> <td>---</td> </tr> </tbody> </table>	Freq.	Emission level	Limit	Margin	SA reading	Factor	Remark	ANT High cm	Turn Table deg	MHz	dBuV/m	dBuV/m	dB	dBuV	dB				1	1535.00	44.84	54.00	-9.16	51.17	-6.33	Average	---	2	1535.00	51.23	74.00	-22.77	57.56	-6.33	Peak	---	3	2390.00	38.03	54.00	-15.97	40.85	-2.82	Average	---	4	2390.00	51.22	74.00	-22.78	54.04	-2.82	Peak	---	5	4804.00	16.68	54.00	-37.32	11.63	5.05	Average	---	6	4804.00	46.78	74.00	-27.22	41.73	5.05	Peak	---
Freq.	Emission level	Limit	Margin	SA reading	Factor	Remark	ANT High cm	Turn Table deg																																																																	
MHz	dBuV/m	dBuV/m	dB	dBuV	dB																																																																				
1	1535.00	44.84	54.00	-9.16	51.17	-6.33	Average	---																																																																	
2	1535.00	51.23	74.00	-22.77	57.56	-6.33	Peak	---																																																																	
3	2390.00	38.03	54.00	-15.97	40.85	-2.82	Average	---																																																																	
4	2390.00	51.22	74.00	-22.78	54.04	-2.82	Peak	---																																																																	
5	4804.00	16.68	54.00	-37.32	11.63	5.05	Average	---																																																																	
6	4804.00	46.78	74.00	-27.22	41.73	5.05	Peak	---																																																																	
<p>Note 1: Emission Level (dBuV/m) = SA Reading (dBuV/m) + Factor* (dB) *Factor includes antenna factor , cable loss and amplifier gain Note 2: Margin (dB) = Emission level (dBuV/m) – Limit (dBuV/m).</p>																																																																									

Modulation	8DPSK	Test Freq. (MHz)	2402
Polarization	Vertical	Test Configuration	1

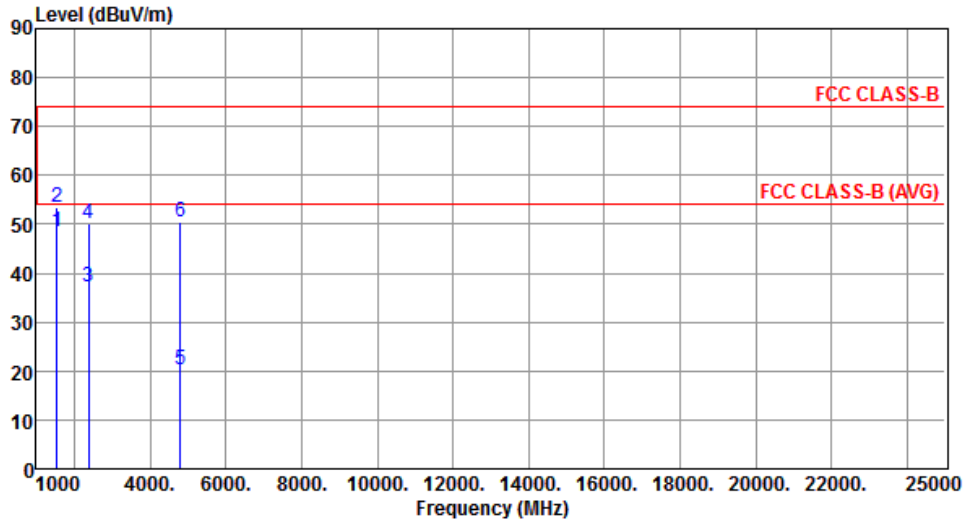

	Freq. MHz	Emission level dBuV/m	Limit dBuV/m	Margin dB	SA reading dBuV	Factor dB	Remark	ANT High cm	Turn Table deg
1	1535.00	48.57	54.00	-5.43	54.90	-6.33	Average	---	---
2	1535.00	53.34	74.00	-20.66	59.67	-6.33	Peak	---	---
3	2390.00	37.25	54.00	-16.75	40.07	-2.82	Average	---	---
4	2390.00	50.29	74.00	-23.71	53.11	-2.82	Peak	---	---
5	4804.00	20.35	54.00	-33.65	15.30	5.05	Average	---	---
6	4804.00	50.45	74.00	-23.55	45.40	5.05	Peak	---	---

Note 1: Emission Level (dBuV/m) = SA Reading (dBuV/m) + Factor* (dB)

*Factor includes antenna factor , cable loss and amplifier gain

Note 2: Margin (dB) = Emission level (dBuV/m) – Limit (dBuV/m).

Modulation	8DPSK	Test Freq. (MHz)	2441
Polarization	Horizontal	Test Configuration	1

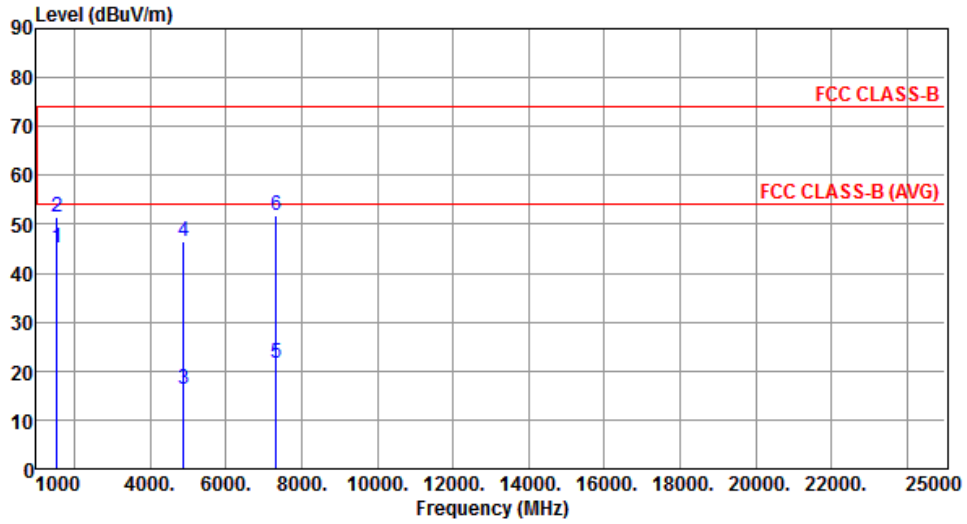

	Freq. MHz	Emission level dBuV/m	Limit dBuV/m	Margin dB	SA reading dBuV	Factor dB	Remark	ANT High cm	Turn Table deg
1	1535.00	45.17	54.00	-8.83	51.50	-6.33	Average	---	---
2	1535.00	51.46	74.00	-22.54	57.79	-6.33	Peak	---	---
3	4882.00	16.33	54.00	-37.67	11.14	5.19	Average	---	---
4	4882.00	46.43	74.00	-27.57	41.24	5.19	Peak	---	---
5	7323.00	21.58	54.00	-32.42	10.83	10.75	Average	---	---
6	7323.00	51.68	74.00	-22.32	40.93	10.75	Peak	---	---

Note 1: Emission Level (dBuV/m) = SA Reading (dBuV/m) + Factor* (dB)

*Factor includes antenna factor , cable loss and amplifier gain

Note 2: Margin (dB) = Emission level (dBuV/m) – Limit (dBuV/m).

Modulation	8DPSK	Test Freq. (MHz)	2441
Polarization	Vertical	Test Configuration	1

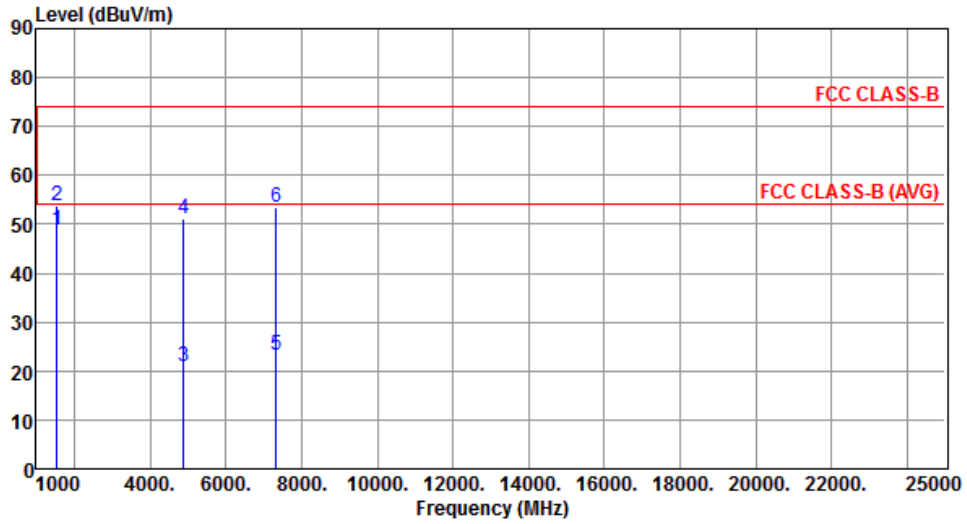

	Freq. MHz	Emission level dBuV/m	Limit dBuV/m	Margin dB	SA reading dBuV	Factor dB	Remark	ANT High cm	Turn Table deg
1	1535.00	48.94	54.00	-5.06	55.27	-6.33	Average	---	---
2	1535.00	53.78	74.00	-20.22	60.11	-6.33	Peak	---	---
3	4882.00	20.89	54.00	-33.11	15.70	5.19	Average	---	---
4	4882.00	50.99	74.00	-23.01	45.80	5.19	Peak	---	---
5	7323.00	23.31	54.00	-30.69	12.56	10.75	Average	---	---
6	7323.00	53.41	74.00	-20.59	42.66	10.75	Peak	---	---

Note 1: Emission Level (dBuV/m) = SA Reading (dBuV/m) + Factor* (dB)

*Factor includes antenna factor , cable loss and amplifier gain

Note 2: Margin (dB) = Emission level (dBuV/m) – Limit (dBuV/m).

Modulation	8DPSK	Test Freq. (MHz)	2480
Polarization	Horizontal	Test Configuration	1

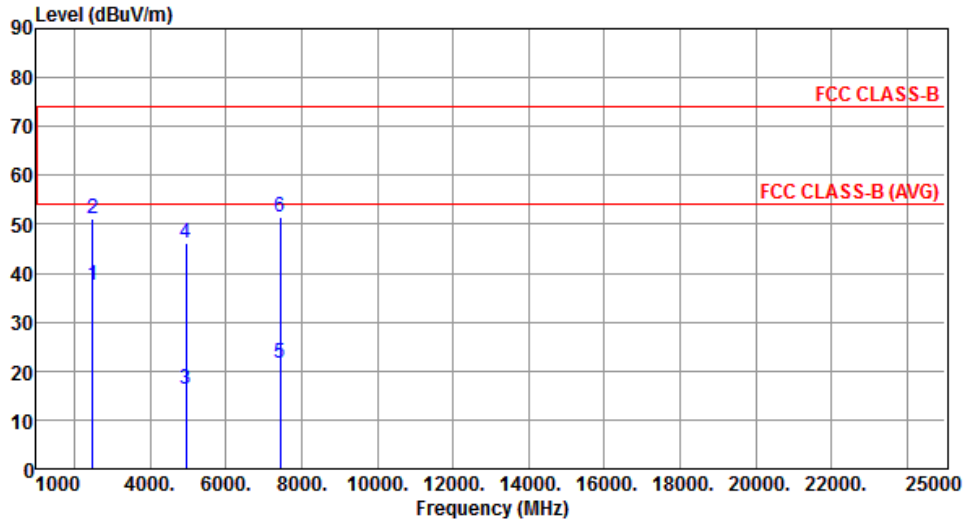

	Freq. MHz	Emission level dBuV/m	Limit dBuV/m	Margin dB	SA reading dBuV	Factor dB	Remark	ANT High cm	Turn Table deg
1	2483.50	37.58	54.00	-16.42	39.97	-2.39	Average	---	---
2	2483.50	51.09	74.00	-22.91	53.48	-2.39	Peak	---	---
3	4960.00	16.14	54.00	-37.86	10.80	5.34	Average	---	---
4	4960.00	46.24	74.00	-27.76	40.90	5.34	Peak	---	---
5	7440.00	21.44	54.00	-32.56	10.51	10.93	Average	---	---
6	7440.00	51.54	74.00	-22.46	40.61	10.93	Peak	---	---

Note 1: Emission Level (dBuV/m) = SA Reading (dBuV/m) + Factor* (dB)

*Factor includes antenna factor , cable loss and amplifier gain

Note 2: Margin (dB) = Emission level (dBuV/m) – Limit (dBuV/m).

Modulation	8DPSK	Test Freq. (MHz)	2480
Polarization	Vertical	Test Configuration	1

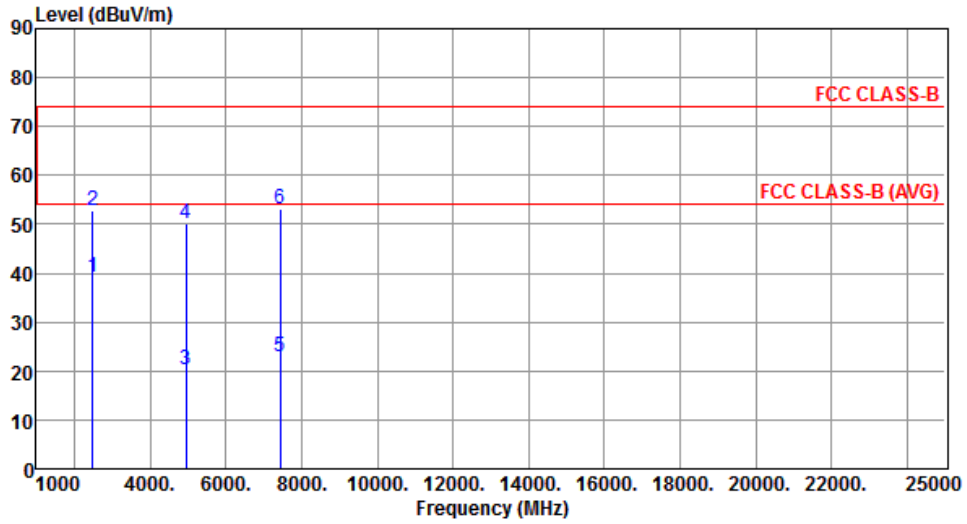

	Freq. MHz	Emission level dBuV/m	Limit dBuV/m	Margin dB	SA reading dBuV	Factor dB	Remark	ANT High cm	Turn Table deg
1	2483.50	39.07	54.00	-14.93	41.46	-2.39	Average	---	---
2	2483.50	52.90	74.00	-21.10	55.29	-2.39	Peak	---	---
3	4960.00	20.13	54.00	-33.87	14.79	5.34	Average	---	---
4	4960.00	50.23	74.00	-23.77	44.89	5.34	Peak	---	---
5	7440.00	22.88	54.00	-31.12	11.95	10.93	Average	---	---
6	7440.00	52.98	74.00	-21.02	42.05	10.93	Peak	---	---

Note 1: Emission Level (dBuV/m) = SA Reading (dBuV/m) + Factor* (dB)

*Factor includes antenna factor , cable loss and amplifier gain

Note 2: Margin (dB) = Emission level (dBuV/m) – Limit (dBuV/m).

Modulation	8DPSK	Test Freq. (MHz)	2402
Polarization	Horizontal	Test Configuration	2

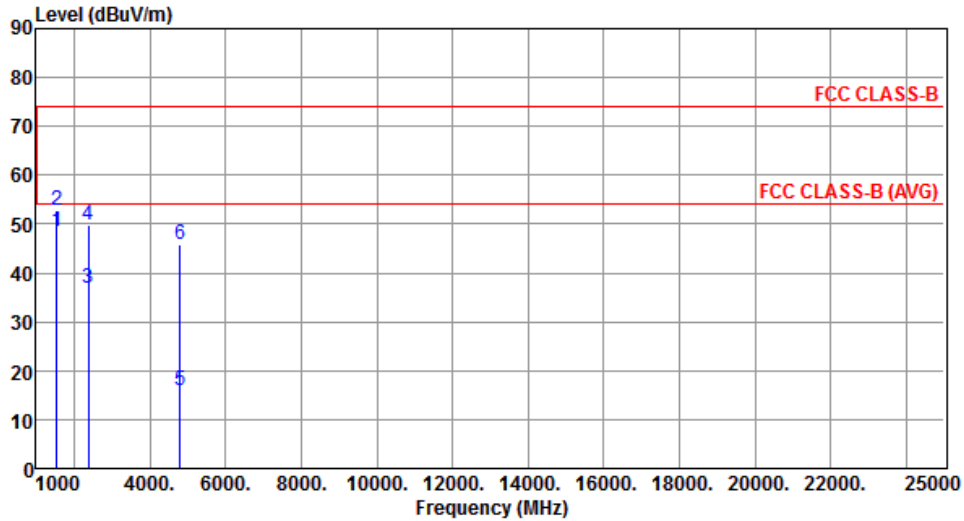

	Freq. MHz	Emission level dBuV/m	Limit dBuV/m	Margin dB	SA reading dBuV	Factor dB	Remark	ANT High cm	Turn Table deg
1	1534.00	48.64	54.00	-5.36	54.97	-6.33	Average	---	---
2	1534.00	52.73	74.00	-21.27	59.06	-6.33	Peak	---	---
3	2390.00	36.94	54.00	-17.06	39.76	-2.82	Average	---	---
4	2390.00	49.81	74.00	-24.19	52.63	-2.82	Peak	---	---
5	4804.00	15.84	54.00	-38.16	10.79	5.05	Average	---	---
6	4804.00	45.94	74.00	-28.06	40.89	5.05	Peak	---	---

Note 1: Emission Level (dBuV/m) = SA Reading (dBuV/m) + Factor* (dB)

*Factor includes antenna factor , cable loss and amplifier gain

Note 2: Margin (dB) = Emission level (dBuV/m) – Limit (dBuV/m).

Modulation	8DPSK	Test Freq. (MHz)	2402
Polarization	Vertical	Test Configuration	2

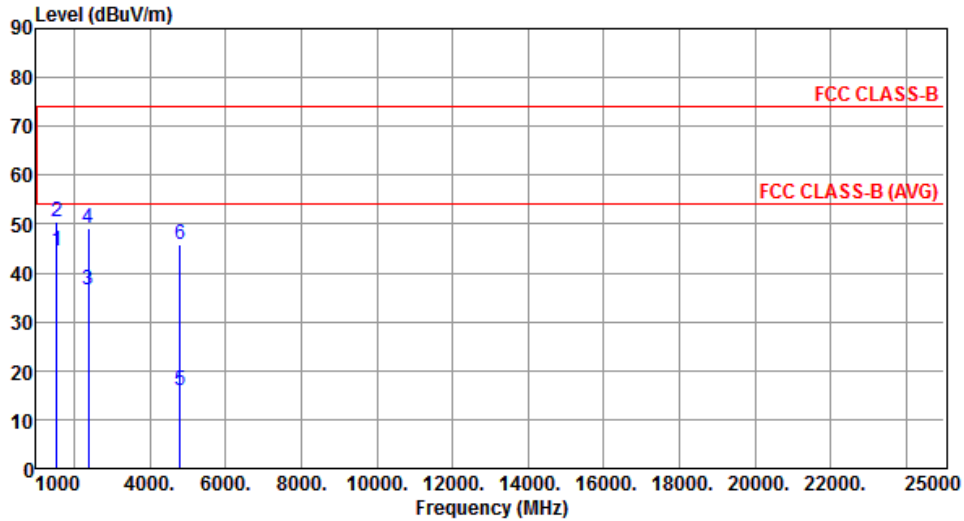

	Freq. MHz	Emission level dBuV/m	Limit dBuV/m	Margin dB	SA reading dBuV	Factor dB	Remark	ANT High cm	Turn Table deg
1	1534.00	44.66	54.00	-9.34	50.99	-6.33	Average	---	---
2	1534.00	50.58	74.00	-23.42	56.91	-6.33	Peak	---	---
3	2390.00	36.43	54.00	-17.57	39.25	-2.82	Average	---	---
4	2390.00	49.18	74.00	-24.82	52.00	-2.82	Peak	---	---
5	4804.00	15.87	54.00	-38.13	10.82	5.05	Average	---	---
6	4804.00	45.97	74.00	-28.03	40.92	5.05	Peak	---	---

Note 1: Emission Level (dBuV/m) = SA Reading (dBuV/m) + Factor* (dB)

*Factor includes antenna factor , cable loss and amplifier gain

Note 2: Margin (dB) = Emission level (dBuV/m) – Limit (dBuV/m).

Modulation	8DPSK	Test Freq. (MHz)	2441
Polarization	Horizontal	Test Configuration	2

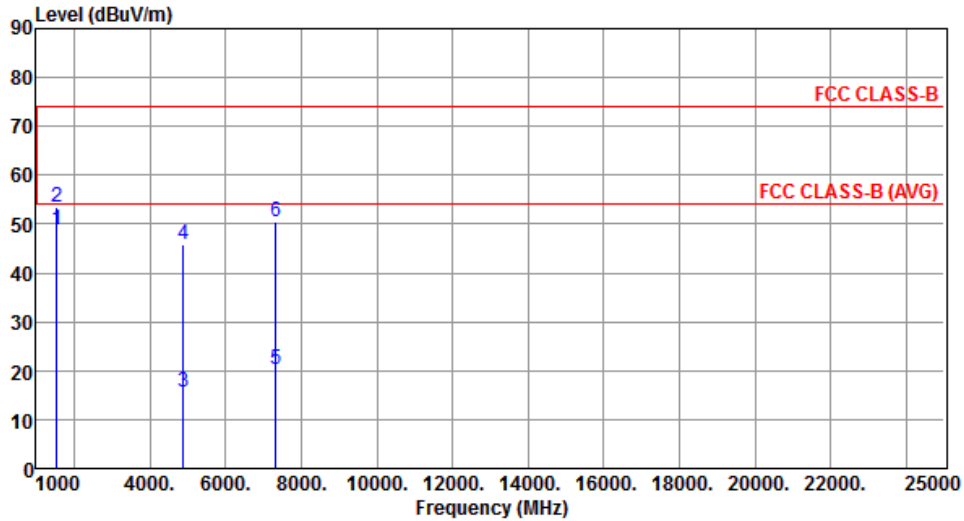

	Freq. MHz	Emission level dBuV/m	Limit dBuV/m	Margin dB	SA reading dBuV	Factor dB	Remark	ANT High cm	Turn Table deg
1	1534.00	48.96	54.00	-5.04	55.29	-6.33	Average	---	---
2	1534.00	53.42	74.00	-20.58	59.75	-6.33	Peak	---	---
3	4882.00	15.68	54.00	-38.32	10.49	5.19	Average	---	---
4	4882.00	45.78	74.00	-28.22	40.59	5.19	Peak	---	---
5	7323.00	20.33	54.00	-33.67	9.58	10.75	Average	---	---
6	7323.00	50.43	74.00	-23.57	39.68	10.75	Peak	---	---

Note 1: Emission Level (dBuV/m) = SA Reading (dBuV/m) + Factor* (dB)

*Factor includes antenna factor , cable loss and amplifier gain

Note 2: Margin (dB) = Emission level (dBuV/m) – Limit (dBuV/m).

Modulation	8DPSK	Test Freq. (MHz)	2441
Polarization	Vertical	Test Configuration	2

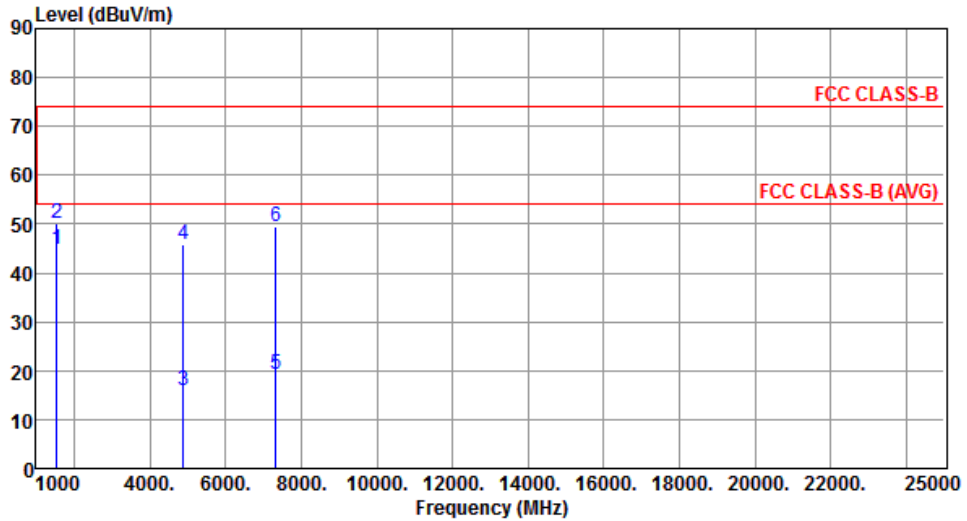

	Freq. MHz	Emission level dBuV/m	Limit dBuV/m	Margin dB	SA reading dBuV	Factor dB	Remark	ANT High cm	Turn Table deg
1	1534.00	44.92	54.00	-9.08	51.25	-6.33	Average	---	---
2	1534.00	50.17	74.00	-23.83	56.50	-6.33	Peak	---	---
3	4882.00	15.87	54.00	-38.13	10.68	5.19	Average	---	---
4	4882.00	45.97	74.00	-28.03	40.78	5.19	Peak	---	---
5	7323.00	19.36	54.00	-34.64	8.61	10.75	Average	---	---
6	7323.00	49.46	74.00	-24.54	38.71	10.75	Peak	---	---

Note 1: Emission Level (dBuV/m) = SA Reading (dBuV/m) + Factor* (dB)

*Factor includes antenna factor , cable loss and amplifier gain

Note 2: Margin (dB) = Emission level (dBuV/m) – Limit (dBuV/m).

Modulation	8DPSK	Test Freq. (MHz)	2480
Polarization	Horizontal	Test Configuration	2

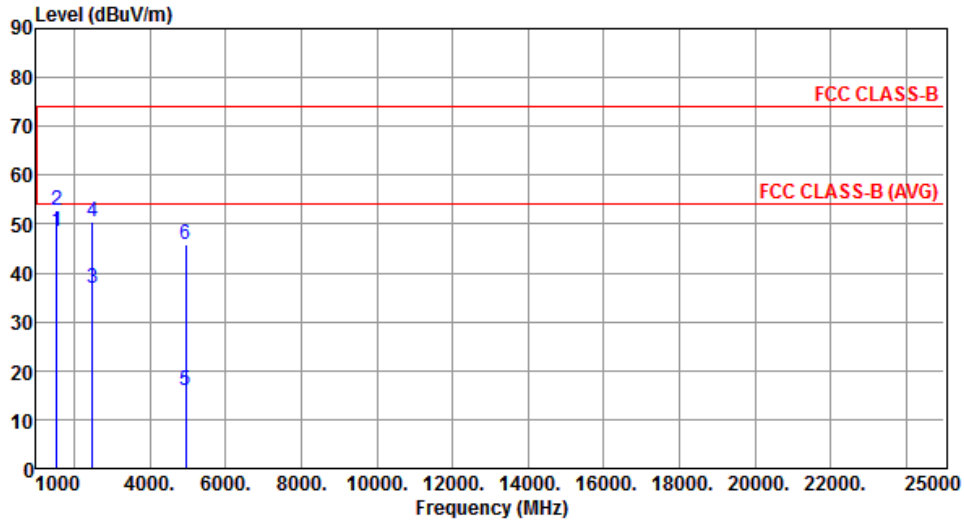

	Freq. MHz	Emission level dBuV/m	Limit dBuV/m	Margin dB	SA reading dBuV	Factor dB	Remark	ANT High cm	Turn Table deg
1	1534.00	48.62	54.00	-5.38	54.95	-6.33	Average	---	---
2	1534.00	52.97	74.00	-21.03	59.30	-6.33	Peak	---	---
3	2483.50	36.78	54.00	-17.22	39.17	-2.39	Average	---	---
4	2483.50	50.47	74.00	-23.53	52.86	-2.39	Peak	---	---
5	4960.00	15.88	54.00	-38.12	10.54	5.34	Average	---	---
6	4960.00	45.98	74.00	-28.02	40.64	5.34	Peak	---	---

Note 1: Emission Level (dBuV/m) = SA Reading (dBuV/m) + Factor* (dB)

*Factor includes antenna factor , cable loss and amplifier gain

Note 2: Margin (dB) = Emission level (dBuV/m) – Limit (dBuV/m).

Modulation	8DPSK	Test Freq. (MHz)	2480
Polarization	Vertical	Test Configuration	2

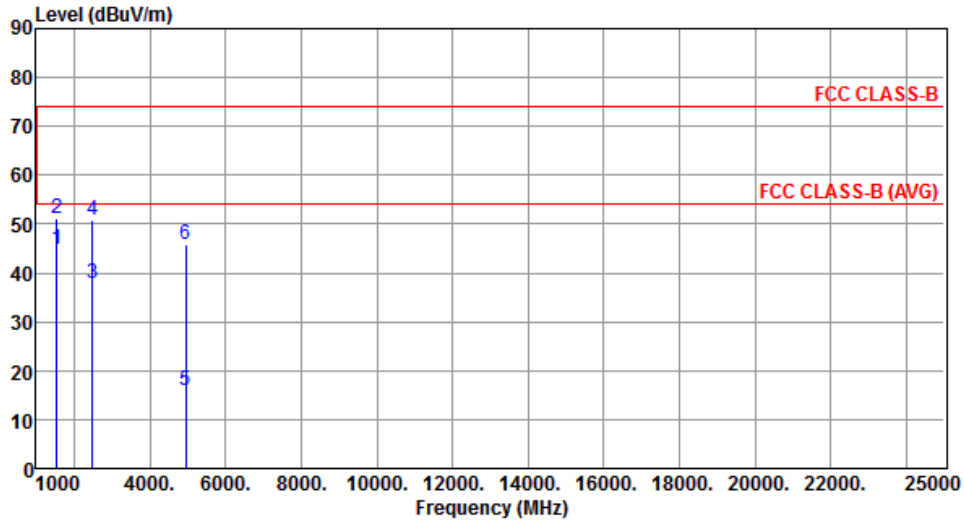

	Freq. MHz	Emission level dBuV/m	Limit dBuV/m	Margin dB	SA reading dBuV	Factor dB	Remark	ANT High cm	Turn Table deg
1	1534.00	44.99	54.00	-9.01	51.32	-6.33	Average	---	---
2	1534.00	51.13	74.00	-22.87	57.46	-6.33	Peak	---	---
3	2483.50	37.83	54.00	-16.17	40.22	-2.39	Average	---	---
4	2483.50	50.76	74.00	-23.24	53.15	-2.39	Peak	---	---
5	4960.00	15.84	54.00	-38.16	10.50	5.34	Average	---	---
6	4960.00	45.94	74.00	-28.06	40.60	5.34	Peak	---	---

Note 1: Emission Level (dBuV/m) = SA Reading (dBuV/m) + Factor* (dB)

*Factor includes antenna factor , cable loss and amplifier gain

Note 2: Margin (dB) = Emission level (dBuV/m) – Limit (dBuV/m).

4 Test laboratory information

Established in 2012, ICC provides foremost EMC & RF Testing and advisory consultation services by our skilled engineers and technicians. Our services employ a wide variety of advanced edge test equipment and one of the widest certification extents in the business.

International Certification Corp, it is our definitive objective is to institute long term, trust-based associations with our clients. The expectation we set up with our clients is based on outstanding service, practical expertise and devotion to a certified value structure. Our passion is to grant our clients with best EMC / RF services by oriented knowledgeable and accommodating staff.

Our Test sites are located at Linkou District and Kwei Shan Hsiang. Location map can be found on our website <http://www.icertifi.com.tw>.

Linkou

Tel: 886-2-2601-1640

No. 30-2, Ding Fwu Tsuen, Lin Kou
District, New Taipei City, Taiwan,
R.O.C.

Kwei Shan

Tel: 886-3-271-8666

No. 3-1, Lane 6, Wen San 3rd
St., Kwei Shan Hsiang, Tao Yuan
Hsien 333, Taiwan, R.O.C.

Kwei Shan Site II

Tel: 886-3-271-8640

No. 14-1, Lane 19, Wen San 3rd
St., Kwei Shan Hsiang, Tao Yuan
Hsien 333, Taiwan, R.O.C.

If you have any suggestion, please feel free to contact us as below information

Tel: 886-3-271-8666

Fax: 886-3-318-0155

Email: ICC_Service@icertifi.com.tw

==END==