



BLIND SPOT DETECTION SYSTEM

User Manual & Installation Guide



VS-95A043

For Passenger Cars

Blind Spot Detection / Lane Change Alert

CONTENTS

1.	Precautions	2
2.	Introduction	5
2.1	System block	5
2.2	Product specifications	5
3.	Installation Guide	6
3.1	Installation diagram	6
3.2	Package contents	6
3.3	Installation steps	7
3.4	Reinstallation	9
4.	User Manual	10
4.1	System startup and shut off	10
4.1.1	System startup	10
4.1.2	System shut off	10
4.2	Function	10
4.2.1	Detection zone	11
4.2.2	Blind Spot Detection (BSD)	11
4.2.3	Lane Change Alert (LCA)	11
4.3	System abnormalities	12
4.3.1	Malfunction prompts	12
4.3.2	Troubleshooting	12

Before using this device, please read this instruction manual carefully before installing or removing it to ensure that the device is safe to use. The Company shall not be liable for any damage arising from failure to comply with the following matters.

BEFORE INSTALLING

- (1) If you wish to laminate your car's rear windshield with or it has already laminated with a heat insulation film, please contact the dealer to ensure that the heat insulation film does not technically contain metal components. If it contains the metal components, it is recommended not to install this device.
- (2) If your car has the following conditions, please consult a professional technician to evaluate whether or not to install this device :
 - If the angle between the rear windshield and the horizon is not within 20 - 60 degrees, it is recommended not to install this device.
 - If the third brake light is on top of the interior rear windshield, it may affect the radar installation position.
 - If there is a rear spoiler, rear spare tire, or a bicycle, it may block the radar and affect the system performance.
- (3) Due to the highly sensitive detection performance of this device, please ensure to follow the installation procedures and precautions during installation to avoid affecting the device performance, and please ensure to hide the wires properly according to the layout of the car to avoid the wiring harness from affecting driving safety, and obstructing you from getting in and off the car. It is recommended that you consult a professional technician for installation.
- (4) Please follow the preparatory works before installation :



Please wear protective goggles.



Please work with an assistant.



Please tighten with a specified torque wrench



If the connector is dislocated, please replace the connector to its original position.

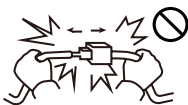

Please do not pull the connector apart by pulling the harness.



Please do not pull the harness by force.

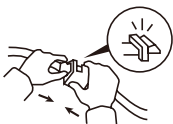

Connect the connector and terminal tightly.



Cut off the excessive length of the cable tie.

RF STANDARD

(1) NCC low-power radio waves radiated device management methods :

Article 12: Companies, stores, or users are prohibited from changing the frequency, increasing the power, or modifying the characteristics and functions of the original design of the certified low-power radio waves radiated device without permission.

Article 14: The use of low-power RF devices must not affect the safety of aviation and interfere with legal communications. If any interference occurs, they should be stopped immediately and improved to the extent of no interference before users can use the legal communications mentioned in the previous paragraph, i.e., radio communications under the provisions of the Telecommunications Act. Low-power RF devices must endure interference from legal communications or industrial, scientific, and medical radio wave-radiated electrical equipment.

(2) FCC regulations :

This device complies with part 15 of the FCC Rules. Operation is subject to the following two conditions:

- This device may not cause harmful interference, and
- This device must accept any interference received, including interference that may cause undesired operation.

NOTE : This equipment has been tested and found to comply with the limits for a Class B digital device, pursuant to part 15 of the FCC Rules. These limits are designed to provide reasonable protection against harmful interference in a residential installation.

This equipment generates, uses and can radiate radio frequency energy and, if not installed and used in accordance with the instructions, may cause harmful interference to radio communications. However, there is no guarantee that interference will not occur in a particular installation.

If this equipment does cause harmful interference to radio or television reception, which can be determined by turning the equipment off and on, the user is encouraged to try to correct the interference by one or more of the following measures :

- Reorient or relocate the receiving antenna.
- Increase the separation between the equipment and receiver.
- Connect the equipment into an outlet on a circuit different from that to which the receiver is connected.
- Consult the dealer or an experienced radio/TV technician for help.

Changes or modifications not expressly approved by the party responsible for compliance could void the user's authority to operate the equipment.

This equipment complies with FCC radiation exposure limits set forth for an uncontrolled environment. This equipment should be installed and operated with a minimum distance of 20 cm between the radiator and a human body.

Although the device provides blind spot detection assistance warning function, it might still be affected by multiple factors such as road conditions, driver behaviors, driving environment or weather which may result in occasional false alarm/no alarm. Therefore, the device does not guarantee 100 % detection accuracy rate. Do not over-rely on the device for avoidance of accidents, and you shall at all times follow the traffic rules, pay attention to the actual road conditions, stay alert, drive carefully.

Thank you for purchasing this device. The device uses a 77 GHz millimeter-wave radar to detect vehicles coming behind your car. When there is a car getting in the detection zone, the device will provide visual and audible warnings to remind you to pay attention to the car in order to protect the safety of the driver and passengers. If you have any problems while using it, please contact your dealer.

2-1 SYSTEM BLOCK

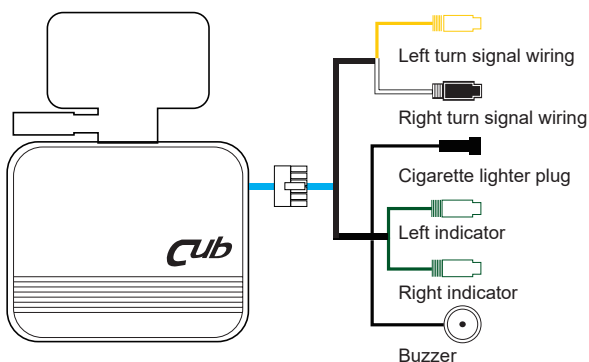

2-2 PRODUCT SPECIFICATIONS

Radar frequency	76-77 GHz
Operating temperature	-40°C ~ +85°C
Storage temperature	-40°C ~ +95°C
Input voltage	9~16 V
Current consumption	6 W (Max.)

3-1 INSTALLATION DIAGRAM

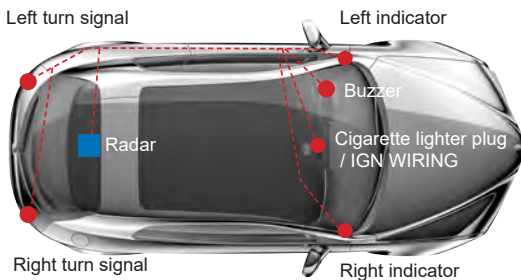

3-2 PACKAGE CONTENTS

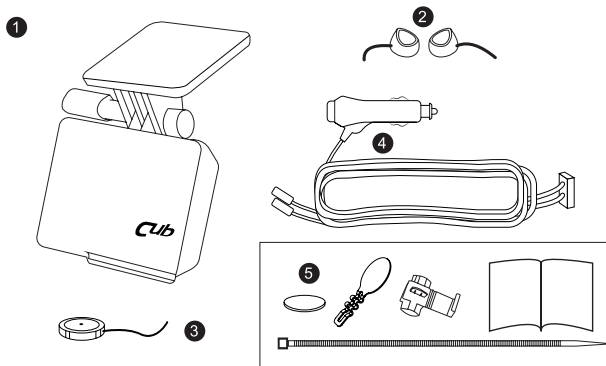

No.	Item	Q'ty
①	Radar with its bracket	1 set
②	Indicator	2 pcs
③	Buzzer	1 pcs
④	Main power harness	1 set
⑤	Accessories (including 2 iron plates, 2 indicator adhesive tapes, 15 cable ties, 4 crab clips, 1 manual)	1 bag

3-3 INSTALLATION STEPS

Note: Please ensure that the heat insulation film on the rear windshield does not contain metal components.

Please prepare a tape measure, a multimeter and an alcohol pad before installing.

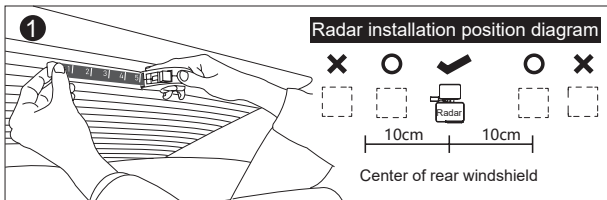

Find a position ± 10 cm at the center of the rear windshield's upper edge with a tape measure, and wipe it with an alcohol pad.

Note 1: There must not be any no-original object such as driving recorder, brake light and other devices within 5 cm left and right of the radar.

Note 2: If the third brake light is located at the center of the rear windshield's upper edge, it is recommended to install the radar beneath it with the distance at least 2 cm.

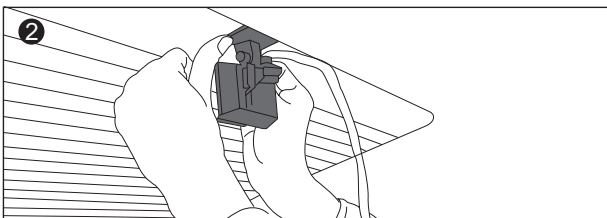

Tear off the tape on the radar's bracket, face the surface printed with the logo Cub outdoors, and attach the bracket parallel and close to the ceiling or align along the defog line. Be careful not to attach it to the defog line.

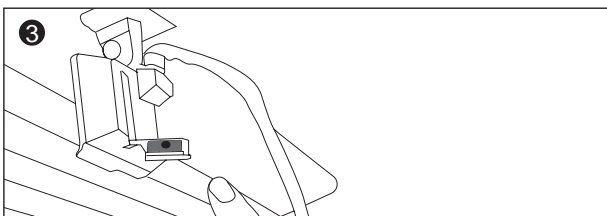

Flip down radar's level, adjust the bracket until the bubble in the level is at the center of the two vertical black lines, and then tighten the knob.

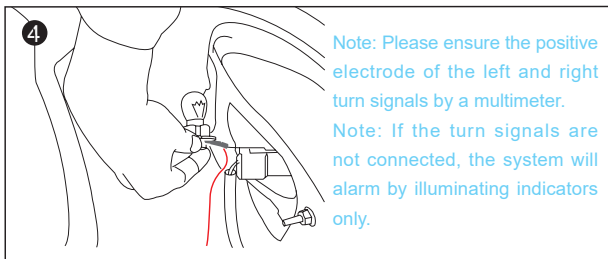

After connecting the radar and main power harness, hide the wires along with the ceiling to the C-pillar on the driver side, and connect the left and right turn signal wirings to the car's left and right turn signal trigger wires(+) with crab clips.

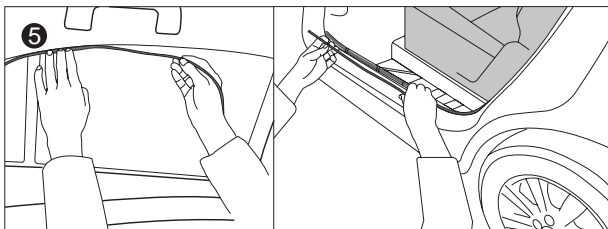

Continue to hide the main power harness along with the ceiling or down the door frame's waterproof strip to the driver side's A-pillar, connect the indicators and buzzer, and hide the two wire harnesses into the door rubber strip.

If there is a risk of airbags'interference when hiding harness, please hide harness down the door frame's waterproof strip to the driver side' s A-pillar.

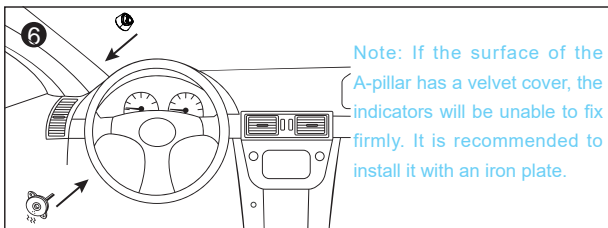

Attach the left indicators directly to the A-pillar at an appropriate visible height, or attach it to an iron plate, insert it between the A-pillar and the instrument panel, and then adjust the best viewing angle. Attach the alarm buzzer at a position near the instrument panel.

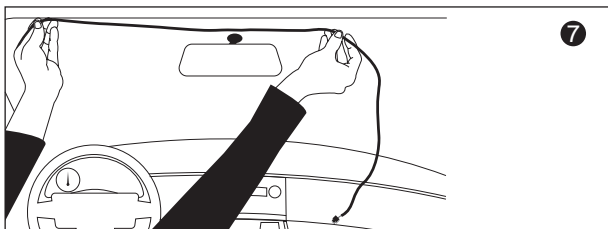

Right indicator goes to right side A-pillar through the left side A-pillar and then the ceiling. The installation height and method is the same with the left one.

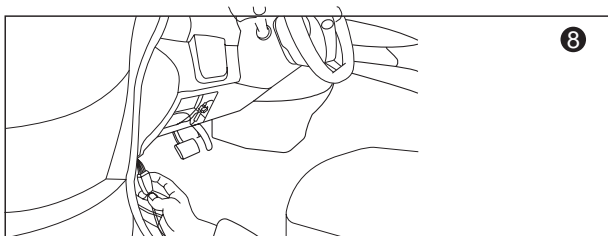

Please ensure to hide all the wires properly into the trims and frame's waterproof strips to avoid the wiring harness from affecting driving safety, and obstructing you from getting in and off the car. Besides please hide the splitter into the trim under the instrument panel properly and use cable ties to fix with the car cables.

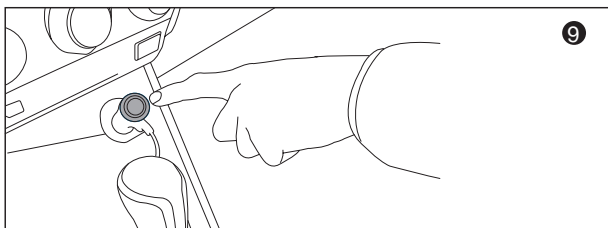

Plug into Cigarette lighter and hide the remaining wires properly. When ACC ON, the indicators will light up for 3 seconds, and the buzzer will chime once, indicating that the system has started normally.

3-4 REINSTALLATION

If the bracket is incidentally attached wrongly, such as not at the center of the rear windshield, not close to the upper edge of the rear windshield, or not maintained at a horizontal level, etc., and you wish to remove and reattach, spray alcohol around the bracket base in contact with rear windshield. Then use a thin line such as a fishing line to scrape the edges of the bottom back and forth.

4-1 SYSTEM STARTUP AND SHUT OFF

4.1.1 System startup

When ACC is ON, the indicator will illuminate for 3 seconds, and the buzzer will chime once, indicating that the system starts normally.

Note: The system self-tests within 10 seconds after power-on, and using the turn signals or hazard warning lights in this period time would lead to the indicators flashing, which means the system reads the turn signals correctly. However, if the turn signals are not connected, no response resulted.

4.1.2 System shut off

When you park the car and stop the ignition, the system will shut off.

4-2 FUNCTION

When your speed achieves 5 km/h(3 mph), Blind Spot Detection(BSD) and Lane Change Alert(LCA) functions will be activated. The radar will detect the vehicle entering the detection zone with a relative speed less than 40 km/h(25 mph), and the system will provide visual and audible warnings to remind you to pay attention to driving safety until the vehicle is not in the detection zone, if it meets other warning requirements.

Note :

- (1) If the vehicle is overtaking at a close distance from behind, or the vehicle, with body length less than 4 m, coming from behind and entering the second lane from the third lane, the device may fail to provide a correct warning.
- (2) If the vehicle traveling from behind is driving at the similar speed with your vehicle(relative speed below 5 km/h(3 mph)) and continuously driving in the detection zone for a period of time, or your car starts from a standstill and accelerates, and the vehicle initially staying in the detection zone is also starting from a standstill and keep staying in the detection zone, the device may fail to provide a correct warning.
- (3) If a motorcycle rides too close(1 m or 3.2 feet) to your vehicle, the device may fail to provide a correct warning.
- (4) If the motorcycle is riding too close to the vehicle which is travelling behind your vehicle at a close distance and therefore obstructed by such vehicle, or if there is any vehicle behind your vehicle while your vehicle is turning, the device may fail to provide a correct warning.

4.2.1 Detection zone

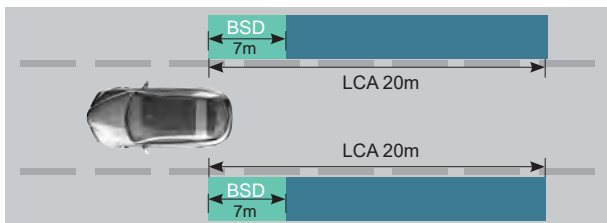

4.2.2 Blind Spot Detection (BSD)

When a vehicle approaches your car from behind and enters the detection zone, extending rearward from the radar to approximately 7 m, the corresponding indicator will illuminate.

If the corresponding turn signal is ON, the system not only light up the indicator, but also sound an audible alert.

Note: If the turn signals are not connected, the system will alarm by illuminating indicators only.

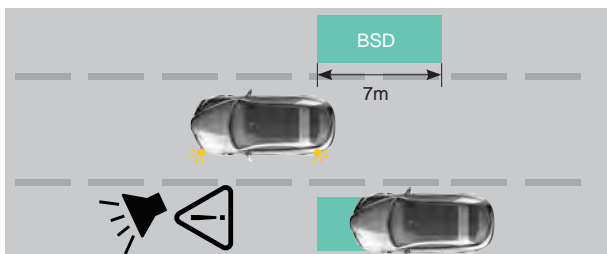

4.2.3 Lane Change Alert(LCA)

When a vehicle approaches your car from behind, if it enters the detection zone, extending rearward from the radar to approximately 20 m, and the collision time with your car is within 2 seconds, the corresponding indicator will illuminate.

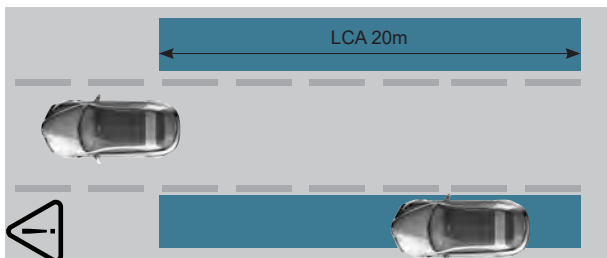

If the corresponding turn signal is ON, the system not only light up the indicator, but also sound an audible alert.

Note: If the turn signals are not connected, the system will alarm by illuminating indicators only.

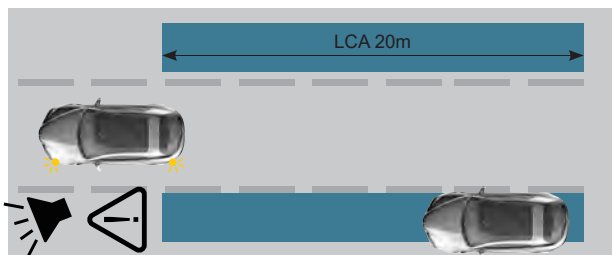

4-3 SYSTEM ABNORMALITIES

4.3.1 Malfunction prompts

If the system malfunctions, the buzzer will sound an audible alert for 3 seconds for every 10 minutes. and the two indicators will light up until the system returns to normal.

4.3.2 Troubleshooting

When a malfunction occurs, please contact the dealer as soon as possible or go to the service for repair. Shown below are some simple troubleshooting methods for reference

Item	Abnormal Status	Possible Causes	Possible solution
Power-on self-test	Not response after ACC ON	Power abnormality	Please check if pressing the button on the cigarette lighter plug or there is poor connect. If there is a breakage, please contact the dealer. If there is no abnormality, please recheck the wire harness
		Wire harness abnormality	Please check if the wire harness is damaged or there is a poor connect or not. If there is a breakage, please contact the dealer. If there is no abnormality, please recheck the power supply

Item	Abnormal Status	Possible Causes	Possible solution
power on self - inspection	The indicator does not light up.	Damaged connector or poor contact	Re-plug the connector and check if the indicator can light up or not. If it still does not light up, please contact the dealer
	No sound.	Damaged connector or poor contact	Re-plug the connector and check if the buzzer can sound or not. If it still does not sound, contact your dealer
System	The indicator lights up continuously, and there is an audible alert	Radar abnormality	Contact your dealer
Functions	The indicator does not light up	It does not meet the warning requirement	Please ensure that the alarm has met the alarm condition. If there is no warning when the alarm condition is met, please contact the dealer
	No second-level warning	No turn signals	Please connect the turn signals correctly
		It does not meet the warning requirement	If there is no alarm when the warning requirement is met, please contact the dealer
		The buzzer connector is damaged or there is a poor connect	Re-plug the connector to check if the buzzer can sound, or ensure If the warning requirement is met. If the buzzer still does not sound, contact your dealer
Other	When the engine stalls, the light on the Cigarette lighter plug is still on	Cigarette lighter supplies uninterrupted power	Press the button on the cigarette lighter plug to turn off the system or unplug the cigarette lighter plug, or please consult a professional technician to install this product changing to IGN power supply

Cub



www.cubelec.com.tw

E-mail: adasinfo@cubelec.com.tw

Address : NO.6, LANE 546, SEC.6, changlu RD., fuhsin
township, changhua county 50648, taiwan(R.O.C.)