

Impedance Measurement Plot for Head TSL

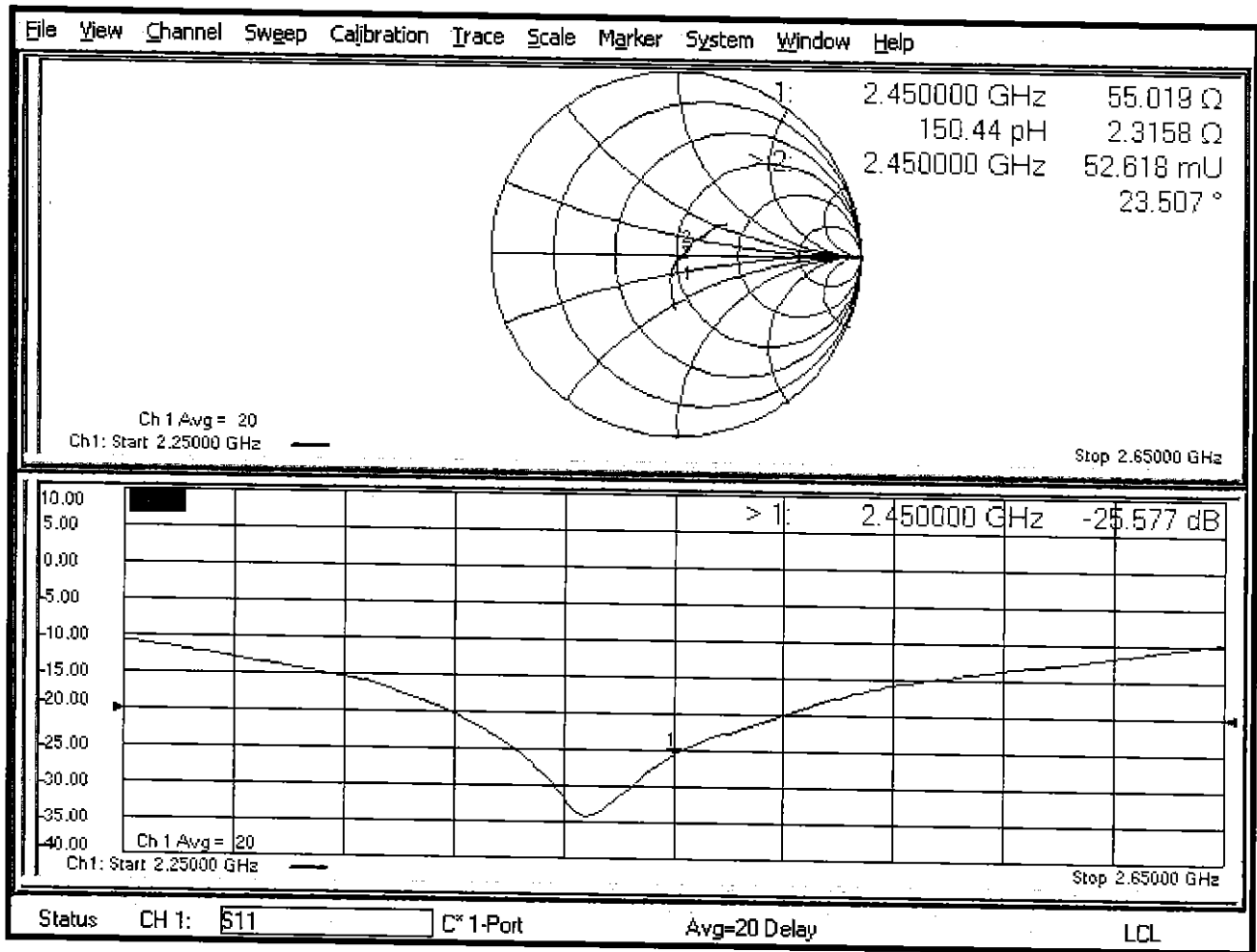

DASY5 Validation Report for Body TSL

Date: 13.08.2018

Test Laboratory: SPEAG, Zurich, Switzerland

DUT: Dipole 2450 MHz; Type: D2450V2; Serial: D2450V2 - SN:981

Communication System: UID 0 - CW; Frequency: 2450 MHz

Medium parameters used: $f = 2450$ MHz; $\sigma = 2.02$ S/m; $\epsilon_r = 51.8$; $\rho = 1000$ kg/m³

Phantom section: Flat Section

Measurement Standard: DASY5 (IEEE/IEC/ANSI C63.19-2011)

DASY52 Configuration:

- Probe: EX3DV4 - SN7349; ConvF(8.01, 8.01, 8.01) @ 2450 MHz; Calibrated: 30.12.2017
- Sensor-Surface: 1.4mm (Mechanical Surface Detection)
- Electronics: DAE4 Sn601; Calibrated: 26.10.2017
- Phantom: Flat Phantom 5.0 (back); Type: QD 000 P50 AA; Serial: 1002
- DASY52 52.10.1(1476); SEMCAD X 14.6.11(7439)

Dipole Calibration for Body Tissue/Pin=250 mW, d=10mm/Zoom Scan (7x7x7)/Cube 0:

Measurement grid: dx=5mm, dy=5mm, dz=5mm

Reference Value = 107.0 V/m; Power Drift = -0.08 dB

Peak SAR (extrapolated) = 25.3 W/kg

SAR(1 g) = 13 W/kg; SAR(10 g) = 6.11 W/kg

Maximum value of SAR (measured) = 20.7 W/kg

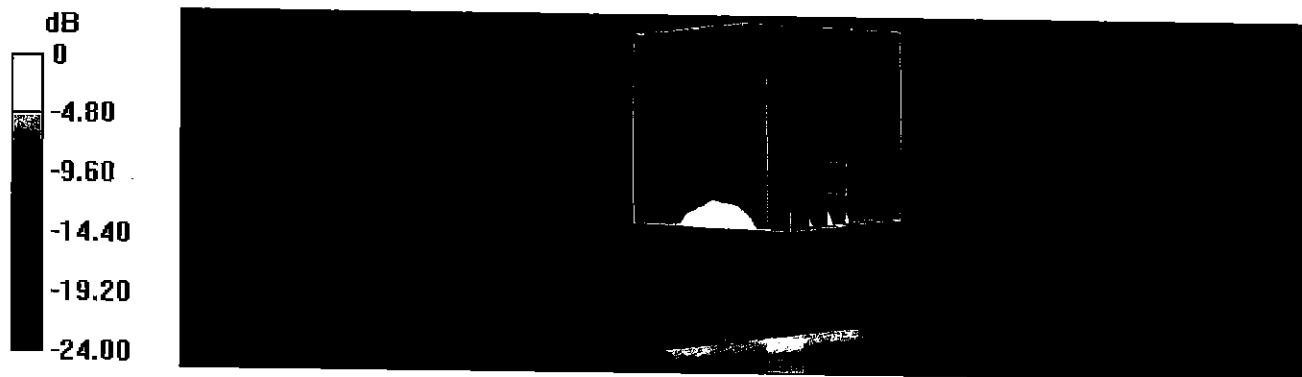

Impedance Measurement Plot for Body TSL

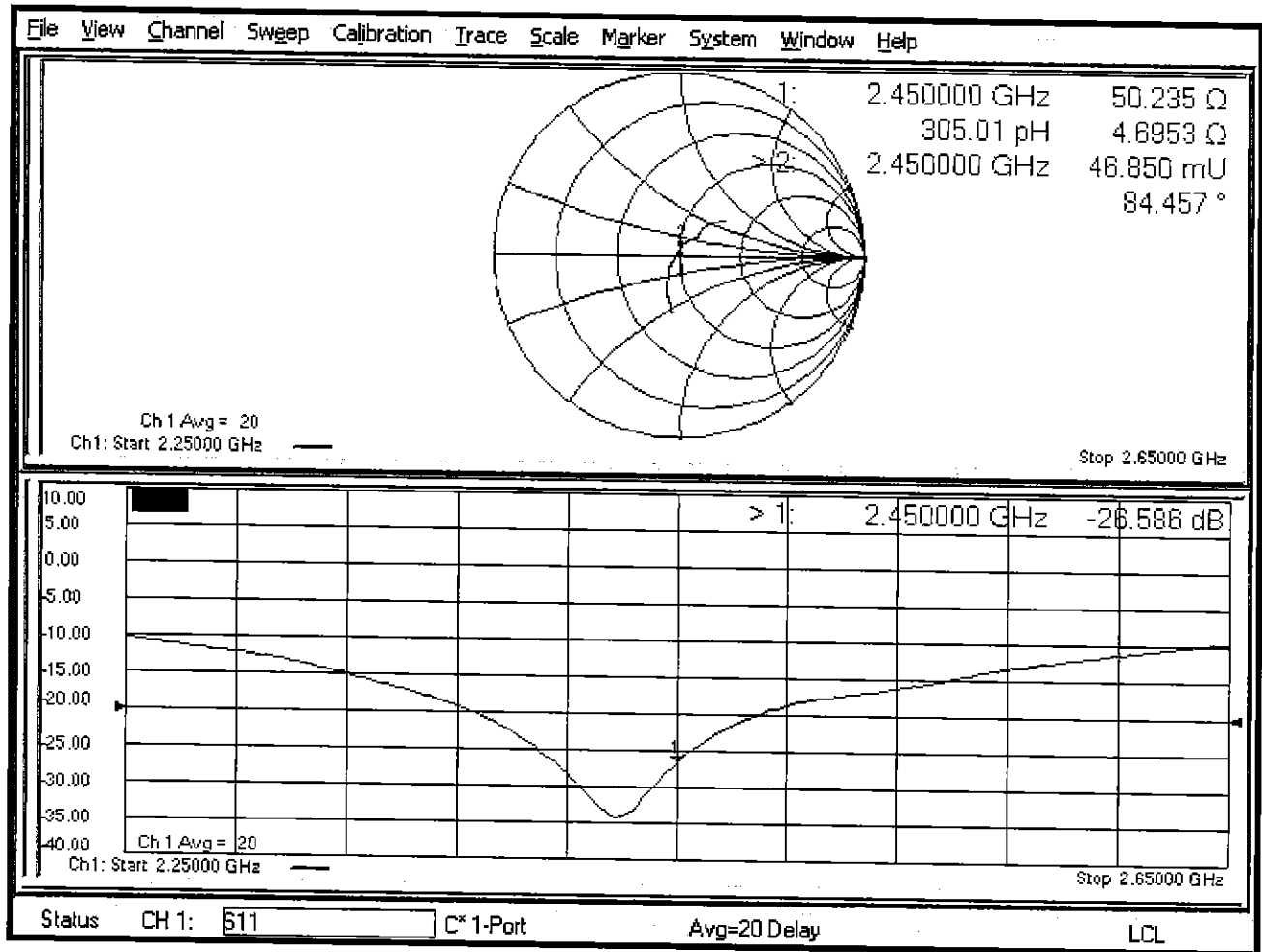

DASY5 Validation Report for SAM Head

Date: 16.08.2018

Test Laboratory: SPEAG, Zurich, Switzerland

DUT: Dipole 2450 MHz; Type: D2450V2; Serial: D2450V2 - SN:981

Communication System: UID 0 - CW ; Frequency: 2450 MHz

Medium parameters used: $f = 2450$ MHz; $\sigma = 1.85$ S/m; $\epsilon_r = 40.2$; $\rho = 1000$ kg/m³

Measurement Standard: DASY5 (IEEE/IEC/ANSI C63.19-2011)

DASY52 Configuration:

- Probe: EX3DV4 - SN7349; ConvF(7.88, 7.88, 7.88) @ 2450 MHz; Calibrated: 30.12.2017
- Sensor-Surface: 1.4mm (Mechanical Surface Detection)
- Electronics: DAE4 Sn601; Calibrated: 26.10.2017
- Phantom: SAM Head
- DASY52 52.10.1(1476); SEMCAD X 14.6.11(7439)

SAM Head Top/Zoom Scan (7x7x7)/Cube 0: Measurement grid: dx=5mm, dy=5mm, dz=5mm

Reference Value = 116.2 V/m; Power Drift = 0.00 dB

Peak SAR (extrapolated) = 26.4 W/kg

SAR(1 g) = 13.6 W/kg; SAR(10 g) = 6.33 W/kg

Maximum value of SAR (measured) = 22.0 W/kg

SAM Head Mouth/Zoom Scan (7x7x7)/Cube 0: Measurement grid: dx=5mm, dy=5mm, dz=5mm

Reference Value = 116.9 V/m; Power Drift = 0.01 dB

Peak SAR (extrapolated) = 26.3 W/kg

SAR(1 g) = 13.6 W/kg; SAR(10 g) = 6.35 W/kg

Maximum value of SAR (measured) = 21.7 W/kg

SAM Head Neck/Zoom Scan (7x7x7)/Cube 0: Measurement grid: dx=5mm, dy=5mm, dz=5mm

Reference Value = 112.0 V/m; Power Drift = 0.03 dB

Peak SAR (extrapolated) = 24.1 W/kg

SAR(1 g) = 12.9 W/kg; SAR(10 g) = 6.11 W/kg

Maximum value of SAR (measured) = 20.5 W/kg

SAM Head Ear/Zoom Scan (7x7x7)/Cube 0: Measurement grid: dx=5mm, dy=5mm, dz=5mm

Reference Value = 91.03 V/m; Power Drift = -0.01 dB

Peak SAR (extrapolated) = 15.8 W/kg

SAR(1 g) = 8.74 W/kg; SAR(10 g) = 4.4 W/kg

Maximum value of SAR (measured) = 13.5 W/kg

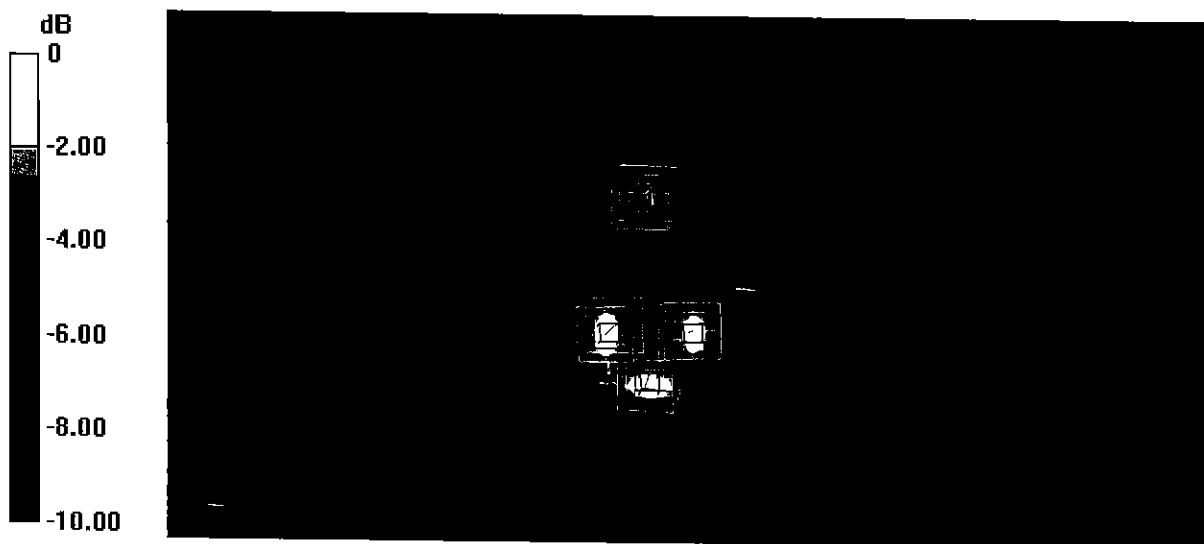

0 dB = 22.0 W/kg = 13.42 dBW/kg



Accredited by the Swiss Accreditation Service (SAS)
The Swiss Accreditation Service is one of the signatories to the EA
Multilateral Agreement for the recognition of calibration certificates

Accreditation No.: **SCS 0108**

Client **PC Test**

Certificate No: **D2600V2-1064_Jun17**

CALIBRATION CERTIFICATE

Object **D2600V2 - SN:1064**

Calibration procedure(s) **QA CAL-05.v9
Calibration procedure for dipole validation kits above 700 MHz**

Calibration date: **June 07, 2017**

*BNW
8/5/2017
Extended
BNW
07/18/2018*

This calibration certificate documents the traceability to national standards, which realize the physical units of measurements (SI).
The measurements and the uncertainties with confidence probability are given on the following pages and are part of the certificate.

All calibrations have been conducted in the closed laboratory facility: environment temperature (22 ± 3)°C and humidity < 70%.

Calibration Equipment used (M&TE critical for calibration)

Primary Standards	ID #	Cal Date (Certificate No.)	Scheduled Calibration
Power meter NRP	SN: 104778	04-Apr-17 (No. 217-02521/02522)	Apr-18
Power sensor NRP-Z91	SN: 103244	04-Apr-17 (No. 217-02521)	Apr-18
Power sensor NRP-Z91	SN: 103245	04-Apr-17 (No. 217-02522)	Apr-18
Reference 20 dB Attenuator	SN: 5058 (20k)	07-Apr-17 (No. 217-02528)	Apr-18
Type-N mismatch combination	SN: 5047.2 / 06327	07-Apr-17 (No. 217-02529)	Apr-18
Reference Probe EX3DV4	SN: 7349	31-Dec-16 (No. EX3-7349_Dec16)	Dec-17
DAE4	SN: 601	28-Mar-17 (No. DAE4-601_Mar17)	Mar-18

Secondary Standards	ID #	Check Date (in house)	Scheduled Check
Power meter EPM-442A	SN: GB37480704	07-Oct-15 (in house check Oct-16)	In house check: Oct-18
Power sensor HP 8481A	SN: US37292783	07-Oct-15 (in house check Oct-16)	In house check: Oct-18
Power sensor HP 8481A	SN: MY41092317	07-Oct-15 (in house check Oct-16)	In house check: Oct-18
RF generator R&S SMT-06	SN: 100972	15-Jun-15 (in house check Oct-16)	In house check: Oct-18
Network Analyzer HP 8753E	SN: US37390585	18-Oct-01 (in house check Oct-16)	In house check: Oct-17

Calibrated by:	Name Johannes Kurikka	Function Laboratory Technician	Signature <i>Johannes Kurikka</i>
Approved by:	Name Katja Pokovic	Function Technical Manager	Signature <i>Katja Pokovic</i>

Issued: June 8, 2017

This calibration certificate shall not be reproduced except in full without written approval of the laboratory.



Accredited by the Swiss Accreditation Service (SAS)
The Swiss Accreditation Service is one of the signatories to the EA
Multilateral Agreement for the recognition of calibration certificates

Accreditation No.: **SCS 0108**

Glossary:

TSL	tissue simulating liquid
ConvF	sensitivity in TSL / NORM x,y,z
N/A	not applicable or not measured

Calibration is Performed According to the Following Standards:

- IEEE Std 1528-2013, "IEEE Recommended Practice for Determining the Peak Spatial-Averaged Specific Absorption Rate (SAR) in the Human Head from Wireless Communications Devices: Measurement Techniques", June 2013
- IEC 62209-1, "Measurement procedure for the assessment of Specific Absorption Rate (SAR) from hand-held and body-mounted devices used next to the ear (frequency range of 300 MHz to 6 GHz)", July 2016
- IEC 62209-2, "Procedure to determine the Specific Absorption Rate (SAR) for wireless communication devices used in close proximity to the human body (frequency range of 30 MHz to 6 GHz)", March 2010
- KDB 865664, "SAR Measurement Requirements for 100 MHz to 6 GHz"

Additional Documentation:

- DASY4/5 System Handbook

Methods Applied and Interpretation of Parameters:

- Measurement Conditions:** Further details are available from the Validation Report at the end of the certificate. All figures stated in the certificate are valid at the frequency indicated.
- Antenna Parameters with TSL:** The dipole is mounted with the spacer to position its feed point exactly below the center marking of the flat phantom section, with the arms oriented parallel to the body axis.
- Feed Point Impedance and Return Loss:** These parameters are measured with the dipole positioned under the liquid filled phantom. The impedance stated is transformed from the measurement at the SMA connector to the feed point. The Return Loss ensures low reflected power. No uncertainty required.
- Electrical Delay:** One-way delay between the SMA connector and the antenna feed point. No uncertainty required.
- SAR measured:** SAR measured at the stated antenna input power.
- SAR normalized:** SAR as measured, normalized to an input power of 1 W at the antenna connector.
- SAR for nominal TSL parameters:** The measured TSL parameters are used to calculate the nominal SAR result.

The reported uncertainty of measurement is stated as the standard uncertainty of measurement multiplied by the coverage factor $k=2$, which for a normal distribution corresponds to a coverage probability of approximately 95%.

Measurement Conditions

DASY system configuration, as far as not given on page 1.

DASY Version	DASY5	V52.10.0
Extrapolation	Advanced Extrapolation	
Phantom	Modular Flat Phantom	
Distance Dipole Center - TSL	10 mm	with Spacer
Zoom Scan Resolution	dx, dy, dz = 5 mm	
Frequency	2600 MHz ± 1 MHz	

Head TSL parameters

The following parameters and calculations were applied.

	Temperature	Permittivity	Conductivity
Nominal Head TSL parameters	22.0 °C	39.0	1.96 mho/m
Measured Head TSL parameters	(22.0 ± 0.2) °C	37.3 ± 6 %	2.02 mho/m ± 6 %
Head TSL temperature change during test	< 0.5 °C	----	----

SAR result with Head TSL

SAR averaged over 1 cm³ (1 g) of Head TSL	Condition	
SAR measured	250 mW input power	14.6 W/kg
SAR for nominal Head TSL parameters	normalized to 1W	57.0 W/kg ± 17.0 % (k=2)

SAR averaged over 10 cm³ (10 g) of Head TSL	condition	
SAR measured	250 mW input power	6.46 W/kg
SAR for nominal Head TSL parameters	normalized to 1W	25.5 W/kg ± 16.5 % (k=2)

Body TSL parameters

The following parameters and calculations were applied.

	Temperature	Permittivity	Conductivity
Nominal Body TSL parameters	22.0 °C	52.5	2.16 mho/m
Measured Body TSL parameters	(22.0 ± 0.2) °C	51.7 ± 6 %	2.22 mho/m ± 6 %
Body TSL temperature change during test	< 0.5 °C	----	----

SAR result with Body TSL

SAR averaged over 1 cm³ (1 g) of Body TSL	Condition	
SAR measured	250 mW input power	13.9 W/kg
SAR for nominal Body TSL parameters	normalized to 1W	54.7 W/kg ± 17.0 % (k=2)

SAR averaged over 10 cm³ (10 g) of Body TSL	condition	
SAR measured	250 mW input power	6.15 W/kg
SAR for nominal Body TSL parameters	normalized to 1W	24.4 W/kg ± 16.5 % (k=2)

Appendix (Additional assessments outside the scope of SCS 0108)

Antenna Parameters with Head TSL

Impedance, transformed to feed point	49.4 Ω - 6.3 j Ω
Return Loss	- 23.9 dB

Antenna Parameters with Body TSL

Impedance, transformed to feed point	46.4 Ω - 4.1 j Ω
Return Loss	- 25.0 dB

General Antenna Parameters and Design

Electrical Delay (one direction)	1.151 ns
----------------------------------	----------

After long term use with 100W radiated power, only a slight warming of the dipole near the feedpoint can be measured.

The dipole is made of standard semirigid coaxial cable. The center conductor of the feeding line is directly connected to the second arm of the dipole. The antenna is therefore short-circuited for DC-signals. On some of the dipoles, small end caps are added to the dipole arms in order to improve matching when loaded according to the position as explained in the "Measurement Conditions" paragraph. The SAR data are not affected by this change. The overall dipole length is still according to the Standard.

No excessive force must be applied to the dipole arms, because they might bend or the soldered connections near the feedpoint may be damaged.

Additional EUT Data

Manufactured by	SPEAG
Manufactured on	August 14, 2012

DASY5 Validation Report for Head TSL

Date: 07.06.2017

Test Laboratory: SPEAG, Zurich, Switzerland

DUT: Dipole 2600 MHz; Type: D2600V2; Serial: D2600V2 - SN:1064

Communication System: UID 0 - CW; Frequency: 2600 MHz

Medium parameters used: $f = 2600$ MHz; $\sigma = 2.02$ S/m; $\epsilon_r = 37.3$; $\rho = 1000$ kg/m³

Phantom section: Flat Section

Measurement Standard: DASY5 (IEEE/IEC/ANSI C63.19-2011)

DASY52 Configuration:

- Probe: EX3DV4 - SN7349; ConvF(7.96, 7.96, 7.96); Calibrated: 31.05.2017;
- Sensor-Surface: 1.4mm (Mechanical Surface Detection)
- Electronics: DAE4 Sn601; Calibrated: 28.03.2017
- Phantom: Flat Phantom 5.0 (front); Type: QD 000 P50 AA; Serial: 1001
- DASY52 52.10.0(1446); SEMCAD X 14.6.10(7417)

Dipole Calibration for Head Tissue/Pin=250 mW, d=10mm/Zoom Scan (7x7x7)/Cube 0:

Measurement grid: dx=5mm, dy=5mm, dz=5mm

Reference Value = 115.9 V/m; Power Drift = -0.07 dB

Peak SAR (extrapolated) = 32.1 W/kg

SAR(1 g) = 14.6 W/kg; SAR(10 g) = 6.46 W/kg

Maximum value of SAR (measured) = 24.5 W/kg

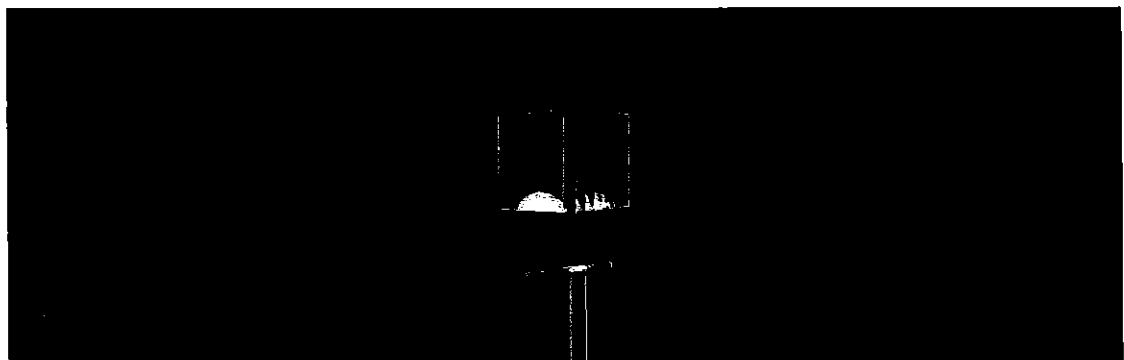
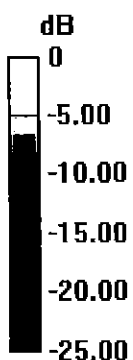

0 dB = 24.5 W/kg = 13.89 dBW/kg

Impedance Measurement Plot for Head TSL

7 Jun 2017 13:11:46

CH1 S11 1 U FS 1: 49.422 Ω -6.3379 Ω 9.6583 pF 2 600.000 000 MHz

*
De1

CA

Avg
16

H1 d

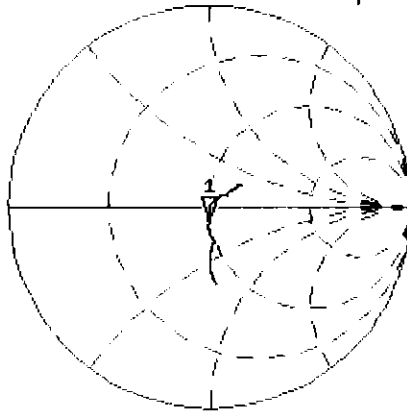

CH2 S11 LOG 5 dB/REF -20 dB 1: -23.893 dB 2 500.000 000 MHz

CA

Avg
16

H1 d

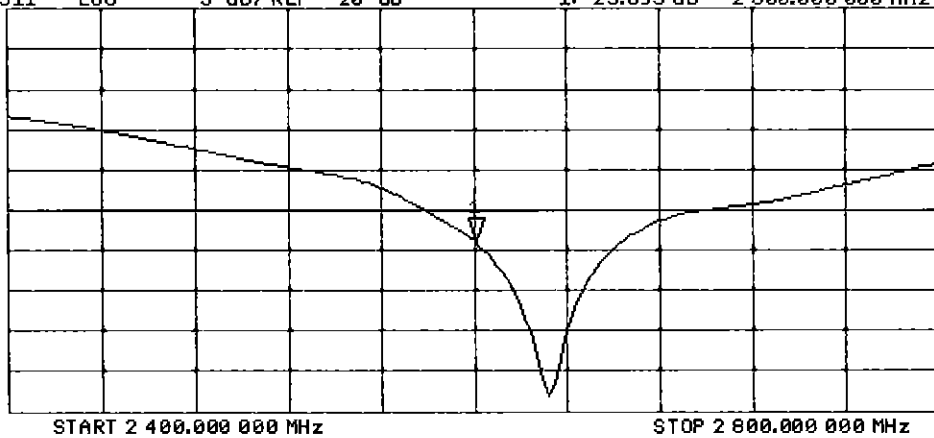

DASY5 Validation Report for Body TSL

Date: 07.06.2017

Test Laboratory: SPEAG, Zurich, Switzerland

DUT: Dipole 2600 MHz; Type: D2600V2; Serial: D2600V2 - SN:1064

Communication System: UID 0 - CW; Frequency: 2600 MHz

Medium parameters used: $f = 2600$ MHz; $\sigma = 2.22$ S/m; $\epsilon_r = 51.7$; $\rho = 1000$ kg/m³

Phantom section: Flat Section

Measurement Standard: DASY5 (IEEE/IEC/ANSI C63.19-2011)

DASY52 Configuration:

- Probe: EX3DV4 - SN7349; ConvF(7.94, 7.94, 7.94); Calibrated: 31.05.2017;
- Sensor-Surface: 1.4mm (Mechanical Surface Detection)
- Electronics: DAE4 Sn601; Calibrated: 28.03.2017
- Phantom: Flat Phantom 5.0 (back); Type: QD 000 P50 AA; Serial: 1002
- DASY52 52.10.0(1446); SEMCAD X 14.6.10(7417)

Dipole Calibration for Body Tissue/Pin=250 mW, d=10mm/Zoom Scan (7x7x7)/Cube 0:

Measurement grid: dx=5mm, dy=5mm, dz=5mm

Reference Value = 101.9 V/m; Power Drift = -0.04 dB

Peak SAR (extrapolated) = 29.8 W/kg

SAR(1 g) = 13.9 W/kg; SAR(10 g) = 6.15 W/kg

Maximum value of SAR (measured) = 22.4 W/kg



0 dB = 22.4 W/kg = 13.50 dBW/kg

Impedance Measurement Plot for Body TSL

7 Jun 2017 13:11:10

CH1 S11 1 U FS 1: 46.383 Ω -4.0801 Ω 15.003 pF 2 600.000 000 MHz

*
De1

CA

Avg
16

H1d

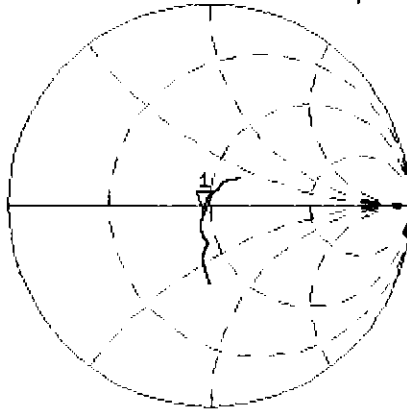

CH2 S11 LOG 5 dB/REF -20 dB 1:-24.957 dB 2 600.000 000 MHz

CA

Avg
16

H1d

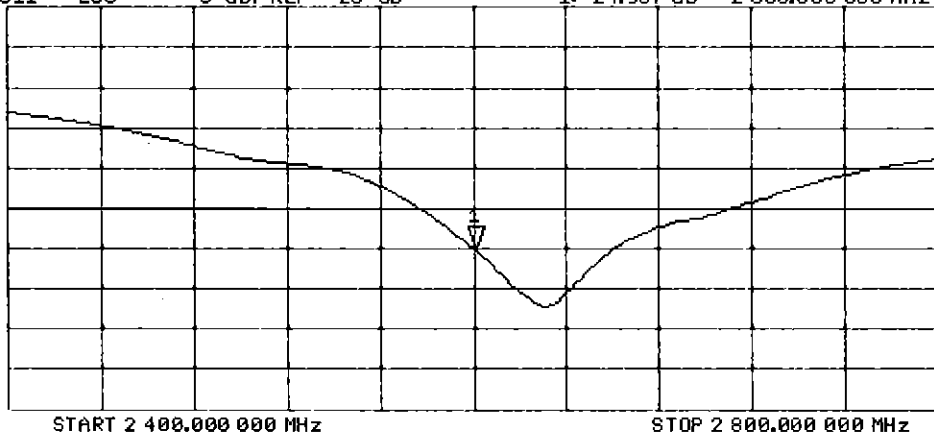

Certification of Calibration

Object: D2600V2 – SN: 1064

Calibration procedure(s): Procedure for Calibration Extension for SAR Dipoles.

Extended Calibration date: 06/04/2018

Description: SAR Validation Dipole at 2600 MHz.

Calibration Equipment used:

Manufacturer	Model	Description	Cal Date	Cal Interval	Cal Due	Serial Number
Agilent	E4438C	ESG Vector Signal Generator	3/24/2017	Biennial	3/24/2019	MY42082385
Agilent	8753ES	S-Parameter Network Analyzer	9/14/2017	Annual	9/14/2018	US39170118
Amplifier Research	15S1G6	Amplifier	CBT	N/A	CBT	433971
Anritsu	ML2495A	Power Meter	11/28/2017	Annual	11/28/2018	1039008
Anritsu	MA2411B	Pulse Power Sensor	3/2/2018	Annual	3/2/2019	1207364
Anritsu	MA2411B	Pulse Power Sensor	11/15/2017	Annual	11/15/2018	1339007
Control Company	4040	Therm./Clock/Humidity Monitor	3/31/2017	Biennial	3/31/2019	170232394
Control Company	4352	Ultra Long Stem Thermometer	5/2/2017	Biennial	5/2/2019	170330156
Keysight	772D	Dual Directional Coupler	CBT	N/A	CBT	MY52180215
Keysight Technologies	85033E	Standard Mechanical Calibration Kit (DC to 9GHz, 3.5mm)	6/4/2018	Annual	6/4/2019	MY53401181
Mini-Circuits	BW-N20W5+	DC to 18 GHz Precision Fixed 20 dB Attenuator	CBT	N/A	CBT	N/A
Mini-Circuits	NLP-2950+	Low Pass Filter DC to 2700 MHz	CBT	N/A	CBT	N/A
Narda	4772-3	Attenuator (3dB)	CBT	N/A	CBT	9406
Pasternack	PE2209-10	Bidirectional Coupler	CBT	N/A	CBT	N/A
Pasternack	PE5011-1	Torque Wrench	7/19/2017	Biennial	7/19/2019	N/A
SPEAG	DAE4	Dasy Data Acquisition Electronics	6/21/2017	Annual	6/21/2018	1333
SPEAG	DAE4	Dasy Data Acquisition Electronics	3/7/2018	Annual	3/7/2019	1368
SPEAG	DAKS-3.5	Portable Dielectric Assessment Kit	7/11/2017	Annual	7/11/2018	1039
SPEAG	ES3DV3	SAR Probe	8/14/2017	Annual	8/14/2018	3332
SPEAG	ES3DV3	SAR Probe	3/13/2018	Annual	3/13/2019	3319

Measurement Uncertainty = $\pm 23\%$ (k=2)

	Name	Function	Signature
Calibrated By:	Brodie Halfoster	Test Engineer	<i>BRODIE HALFOSTER</i>
Approved By:	Kaitlin O'Keefe	Senior Technical Manager	<i>KOK</i>

DIPOLE CALIBRATION EXTENSION

Per KDB 865664 D01, calibration intervals of up to three years may be considered for reference dipoles when it is demonstrated that the SAR target, impedance and return loss of a dipole have remained stable according to the following requirements:

1. The measured SAR does not deviate more than 10% from the target on the calibration certificate.
2. The return-loss does not deviate more than 20% from the previous measurement and meets the required 20dB minimum return-loss requirement.
3. The measurement of real or imaginary parts of impedance does not deviate more than 5Ω from the previous measurement.

The following dipole was checked to pass the above 3 requirements to have 2-year calibration period from the calibration date:

Calibration Date	Extension Date	Certificate Electrical Delay (ns)	Certificate SAR Target Head (1g) W/kg @ 20.0 dBm	Measured Head SAR (1g) W/kg @ 20.0 dBm	Deviation 1g (%)	Certificate SAR Target Head (10g) W/kg @ 20.0 dBm	Measured Head SAR (10g) W/kg @ 20.0 dBm	Deviation 10g (%)	Certificate Impedance Head (Ohm) Real	Measured Impedance Head (Ohm) Real	Difference (Ohm) Real	Certificate Impedance Head (Ohm) Imaginary	Measured Impedance Head (Ohm) Imaginary	Difference (Ohm) Imaginary	Certificate Return Loss Head (dB)	Measured Return Loss Head (dB)	Deviation (%)	PASS/FAIL
6/7/2017	6/4/2018	1.151	5.70	5.71	0.18%	2.55	2.51	-1.57%	49.4	53.4	4.0	-6.3	-6.7	0.4	-23.9	-22.5	5.90%	PASS
Calibration Date	Extension Date	Certificate Electrical Delay (ns)	Certificate SAR Target Body (1g) W/kg @ 20.0 dBm	Measured Body SAR (1g) W/kg @ 20.0 dBm	Deviation 1g (%)	Certificate SAR Target Body (10g) W/kg @ 20.0 dBm	Measured Body SAR (10g) W/kg @ 20.0 dBm	Deviation 10g (%)	Certificate Impedance Body (Ohm) Real	Measured Impedance Body (Ohm) Real	Difference (Ohm) Real	Certificate Impedance Body (Ohm) Imaginary	Measured Impedance Body (Ohm) Imaginary	Difference (Ohm) Imaginary	Certificate Return Loss Body (dB)	Measured Return Loss Body (dB)	Deviation (%)	PASS/FAIL
6/7/2017	6/4/2018	1.151	5.47	5.65	3.29%	2.44	2.48	1.64%	46.4	49.5	3.1	-4.1	-8.2	4.1	-25.0	-21.8	12.80%	PASS

Impedance & Return-Loss Measurement Plot for Head TSL

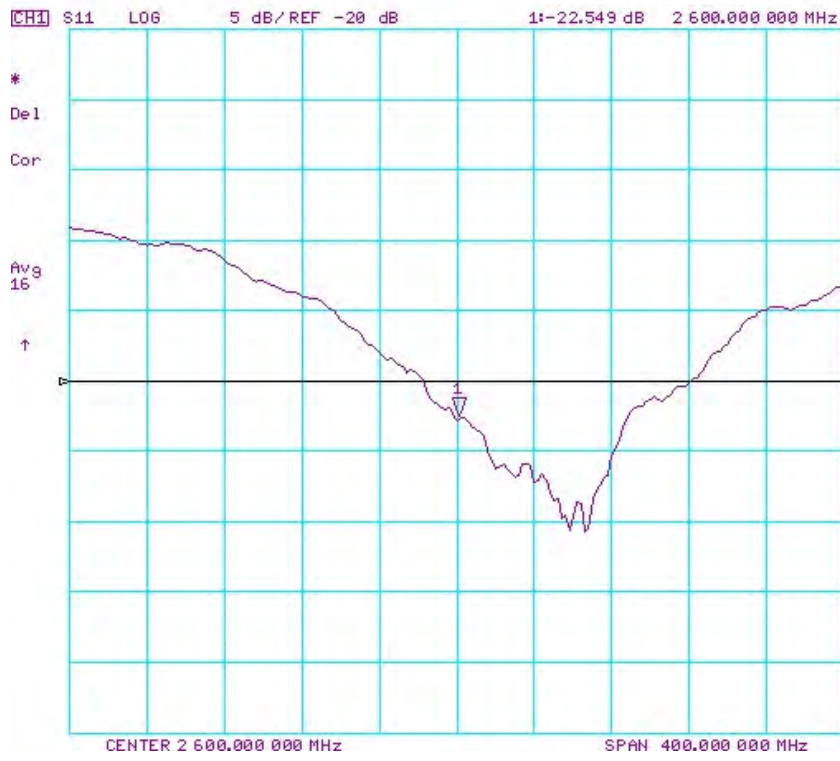
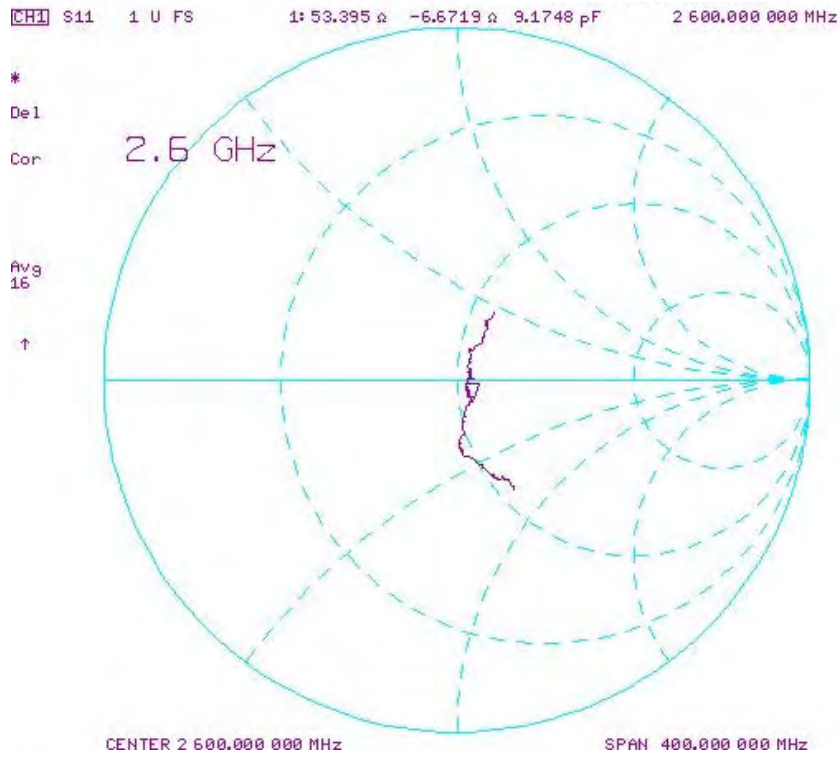

Impedance & Return-Loss Measurement Plot for Body TSL

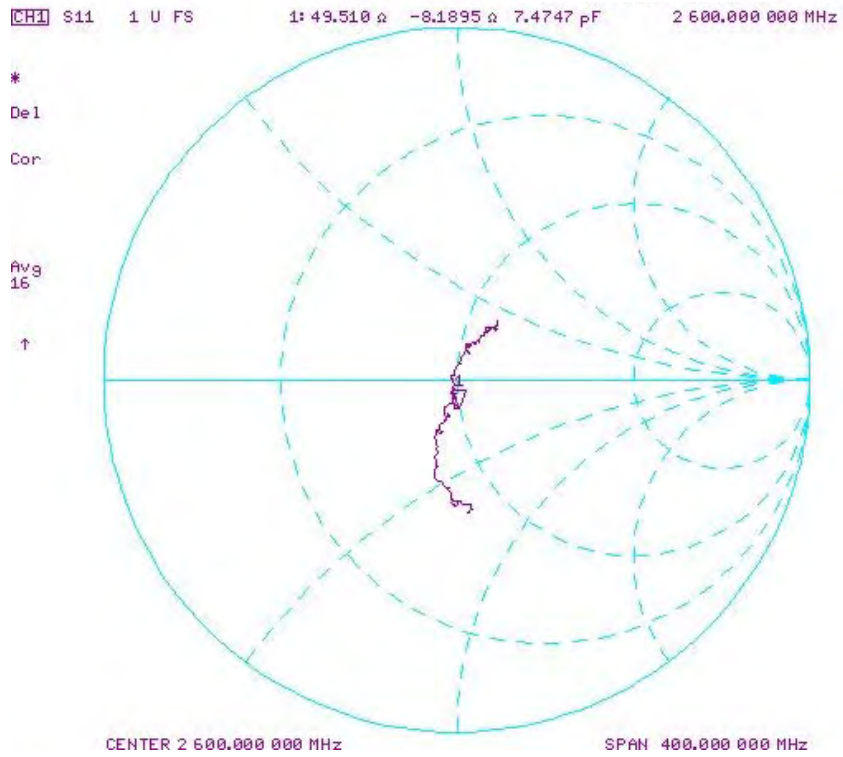



Accredited by the Swiss Accreditation Service (SAS)
The Swiss Accreditation Service is one of the signatories to the EA
Multilateral Agreement for the recognition of calibration certificates

Accreditation No.: **SCS 0108**

Client **PC Test**

Certificate No: **D5GHzV2-1191_Sep16**

CALIBRATION CERTIFICATE

Object **D5GHzV2 - SN:1191**

Calibration procedure(s) **QA CAL-22.v2**
Calibration procedure for dipole validation kits between 3-6 GHz

BNV
09-28-2016

Calibration date: **September 21, 2016**

Extended PMV
9/20/2018

This calibration certificate documents the traceability to national standards, which realize the physical units of measurements (SI).
The measurements and the uncertainties with confidence probability are given on the following pages and are part of the certificate.

All calibrations have been conducted in the closed laboratory facility: environment temperature (22 ± 3)°C and humidity < 70%.

Calibration Equipment used (M&TE critical for calibration)

Primary Standards	ID #	Cal Date (Certificate No.)	Scheduled Calibration
Power meter NRP	SN: 104778	06-Apr-16 (No. 217-02288/02289)	Apr-17
Power sensor NRP-Z91	SN: 103244	08-Apr-16 (No. 217-02288)	Apr-17
Power sensor NRP-Z91	SN: 103245	06-Apr-16 (No. 217-02289)	Apr-17
Reference 20 dB Attenuator	SN: 5058 (20k)	05-Apr-16 (No. 217-02292)	Apr-17
Type-N mismatch combination	SN: 5047.2 / 06327	05-Apr-16 (No. 217-02295)	Apr-17
Reference Probe EX3DV4	SN: 3503	30-Jun-16 (No. EX3-3503_Jun16)	Jun-17
DAE4	SN: 601	30-Dec-15 (No. DAE4-601_Dec15)	Dec-16
Secondary Standards	ID #	Check Date (in house)	Scheduled Check
Power meter EPM-442A	SN: GB37480704	07-Oct-15 (No. 217-02222)	In house check: Oct-16
Power sensor HP 8481A	SN: US37292783	07-Oct-15 (No. 217-02222)	In house check: Oct-16
Power sensor HP 8481A	SN: MY41092317	07-Oct-15 (No. 217-02223)	In house check: Oct-16
RF generator R&S SMT-06	SN: 100972	15-Jun-15 (in house check Jun-15)	In house check: Oct-16
Network Analyzer HP 8753E	SN: US37390585	18-Oct-01 (in house check Oct-15)	In house check: Oct-16

Calibrated by: **Leif Klysner** Name: **Leif Klysner** Function: **Laboratory Technician**

Signature: *Leif Klysner*

Approved by: **Katja Pokovic** Name: **Katja Pokovic** Function: **Technical Manager**

Signature: *Katja Pokovic*

Issued: September 22, 2016

This calibration certificate shall not be reproduced except in full without written approval of the laboratory.



Accredited by the Swiss Accreditation Service (SAS)
The Swiss Accreditation Service is one of the signatories to the EA
Multilateral Agreement for the recognition of calibration certificates

Accreditation No.: **SCS 0108**

Glossary:

TSL	tissue simulating liquid
ConvF	sensitivity in TSL / NORM x,y,z
N/A	not applicable or not measured

Calibration is Performed According to the Following Standards:

- IEEE Std 1528-2013, "IEEE Recommended Practice for Determining the Peak Spatial-Averaged Specific Absorption Rate (SAR) in the Human Head from Wireless Communications Devices: Measurement Techniques", June 2013
- IEC 62209-2, "Procedure to determine the Specific Absorption Rate (SAR) for wireless communication devices used in close proximity to the human body (frequency range of 30 MHz to 6 GHz)", March 2010
- KDB 865664, "SAR Measurement Requirements for 100 MHz to 6 GHz"

Additional Documentation:

- DASY4/5 System Handbook

Methods Applied and Interpretation of Parameters:

- Measurement Conditions:** Further details are available from the Validation Report at the end of the certificate. All figures stated in the certificate are valid at the frequency indicated.
- Antenna Parameters with TSL:** The dipole is mounted with the spacer to position its feed point exactly below the center marking of the flat phantom section, with the arms oriented parallel to the body axis.
- Feed Point Impedance and Return Loss:** These parameters are measured with the dipole positioned under the liquid filled phantom. The impedance stated is transformed from the measurement at the SMA connector to the feed point. The Return Loss ensures low reflected power. No uncertainty required.
- Electrical Delay:** One-way delay between the SMA connector and the antenna feed point. No uncertainty required.
- SAR measured:** SAR measured at the stated antenna input power.
- SAR normalized:** SAR as measured, normalized to an input power of 1 W at the antenna connector.
- SAR for nominal TSL parameters:** The measured TSL parameters are used to calculate the nominal SAR result.

The reported uncertainty of measurement is stated as the standard uncertainty of measurement multiplied by the coverage factor $k=2$, which for a normal distribution corresponds to a coverage probability of approximately 95%.

Measurement Conditions

DASY system configuration, as far as not given on page 1.

DASY Version	DASY5	V52.8.8
Extrapolation	Advanced Extrapolation	
Phantom	Modular Flat Phantom V5.0	
Distance Dipole Center - TSL	10 mm	with Spacer
Zoom Scan Resolution	dx, dy = 4.0 mm, dz = 1.4 mm	Graded Ratio = 1.4 (Z direction)
Frequency	5250 MHz ± 1 MHz 5600 MHz ± 1 MHz 5750 MHz ± 1 MHz	

Head TSL parameters at 5250 MHz

The following parameters and calculations were applied.

	Temperature	Permittivity	Conductivity
Nominal Head TSL parameters	22.0 °C	35.9	4.71 mho/m
Measured Head TSL parameters	(22.0 ± 0.2) °C	34.5 ± 6 %	4.59 mho/m ± 6 %
Head TSL temperature change during test	< 0.5 °C	----	----

SAR result with Head TSL at 5250 MHz

SAR averaged over 1 cm ³ (1 g) of Head TSL	Condition	
SAR measured	100 mW input power	7.96 W/kg
SAR for nominal Head TSL parameters	normalized to 1W	78.9 W/kg ± 19.9 % (k=2)

SAR averaged over 10 cm ³ (10 g) of Head TSL	condition	
SAR measured	100 mW input power	2.29 W/kg
SAR for nominal Head TSL parameters	normalized to 1W	22.6 W/kg ± 19.5 % (k=2)

Head TSL parameters at 5600 MHz

The following parameters and calculations were applied.

	Temperature	Permittivity	Conductivity
Nominal Head TSL parameters	22.0 °C	35.5	5.07 mho/m
Measured Head TSL parameters	(22.0 ± 0.2) °C	34.0 ± 6 %	4.93 mho/m ± 6 %
Head TSL temperature change during test	< 0.5 °C	----	----

SAR result with Head TSL at 5600 MHz

SAR averaged over 1 cm ³ (1 g) of Head TSL	Condition	
SAR measured	100 mW input power	8.45 W/kg
SAR for nominal Head TSL parameters	normalized to 1W	83.6 W / kg ± 19.9 % (k=2)

SAR averaged over 10 cm ³ (10 g) of Head TSL	condition	
SAR measured	100 mW input power	2.41 W/kg
SAR for nominal Head TSL parameters	normalized to 1W	23.8 W/kg ± 19.5 % (k=2)

Head TSL parameters at 5750 MHz

The following parameters and calculations were applied.

	Temperature	Permittivity	Conductivity
Nominal Head TSL parameters	22.0 °C	35.4	5.22 mho/m
Measured Head TSL parameters	(22.0 ± 0.2) °C	33.8 ± 6 %	5.08 mho/m ± 6 %
Head TSL temperature change during test	< 0.5 °C	----	----

SAR result with Head TSL at 5750 MHz

SAR averaged over 1 cm ³ (1 g) of Head TSL	Condition	
SAR measured	100 mW input power	7.99 W/kg
SAR for nominal Head TSL parameters	normalized to 1W	79.1 W/kg ± 19.9 % (k=2)

SAR averaged over 10 cm ³ (10 g) of Head TSL	condition	
SAR measured	100 mW input power	2.27 W/kg
SAR for nominal Head TSL parameters	normalized to 1W	22.4 W/kg ± 19.5 % (k=2)

Body TSL parameters at 5250 MHz

The following parameters and calculations were applied.

	Temperature	Permittivity	Conductivity
Nominal Body TSL parameters	22.0 °C	48.9	5.36 mho/m
Measured Body TSL parameters	(22.0 ± 0.2) °C	47.4 ± 6 %	5.52 mho/m ± 6 %
Body TSL temperature change during test	< 0.5 °C	----	----

SAR result with Body TSL at 5250 MHz

SAR averaged over 1 cm ³ (1 g) of Body TSL	Condition	
SAR measured	100 mW input power	7.74 W/kg
SAR for nominal Body TSL parameters	normalized to 1W	77.0 W/kg ± 19.9 % (k=2)

SAR averaged over 10 cm ³ (10 g) of Body TSL	condition	
SAR measured	100 mW input power	2.17 W/kg
SAR for nominal Body TSL parameters	normalized to 1W	21.6 W/kg ± 19.5 % (k=2)

Body TSL parameters at 5600 MHz

The following parameters and calculations were applied.

	Temperature	Permittivity	Conductivity
Nominal Body TSL parameters	22.0 °C	48.5	5.77 mho/m
Measured Body TSL parameters	(22.0 ± 0.2) °C	46.8 ± 6 %	6.00 mho/m ± 6 %
Body TSL temperature change during test	< 0.5 °C	----	----

SAR result with Body TSL at 5600 MHz

SAR averaged over 1 cm ³ (1 g) of Body TSL	Condition	
SAR measured	100 mW input power	7.96 W/kg
SAR for nominal Body TSL parameters	normalized to 1W	79.2 W/kg ± 19.9 % (k=2)

SAR averaged over 10 cm ³ (10 g) of Body TSL	condition	
SAR measured	100 mW input power	2.24 W/kg
SAR for nominal Body TSL parameters	normalized to 1W	22.2 W/kg ± 19.5 % (k=2)

Body TSL parameters at 5750 MHz

The following parameters and calculations were applied.

	Temperature	Permittivity	Conductivity
Nominal Body TSL parameters	22.0 °C	48.3	5.94 mho/m
Measured Body TSL parameters	(22.0 ± 0.2) °C	46.5 ± 6 %	6.21 mho/m ± 6 %
Body TSL temperature change during test	< 0.5 °C	----	----

SAR result with Body TSL at 5750 MHz

SAR averaged over 1 cm ³ (1 g) of Body TSL	Condition	
SAR measured	100 mW input power	7.65 W/kg
SAR for nominal Body TSL parameters	normalized to 1W	76.1 W/kg ± 19.9 % (k=2)

SAR averaged over 10 cm ³ (10 g) of Body TSL	condition	
SAR measured	100 mW input power	2.14 W/kg
SAR for nominal Body TSL parameters	normalized to 1W	21.2 W/kg ± 19.5 % (k=2)

Appendix (Additional assessments outside the scope of SCS 0108)

Antenna Parameters with Head TSL at 5250 MHz

Impedance, transformed to feed point	55.7 Ω - 4.3 j Ω
Return Loss	- 23.4 dB

Antenna Parameters with Head TSL at 5600 MHz

Impedance, transformed to feed point	58.3 Ω - 3.2 j Ω
Return Loss	- 21.8 dB

Antenna Parameters with Head TSL at 5750 MHz

Impedance, transformed to feed point	58.1 Ω + 4.8 j Ω
Return Loss	- 21.2 dB

Antenna Parameters with Body TSL at 5250 MHz

Impedance, transformed to feed point	56.1 Ω - 3.7 j Ω
Return Loss	- 23.4 dB

Antenna Parameters with Body TSL at 5600 MHz

Impedance, transformed to feed point	58.9 Ω - 1.7 j Ω
Return Loss	- 21.7 dB

Antenna Parameters with Body TSL at 5750 MHz

Impedance, transformed to feed point	59.5 Ω + 6.9 j Ω
Return Loss	- 19.4 dB

General Antenna Parameters and Design

Electrical Delay (one direction)	1.204 ns
----------------------------------	----------

After long term use with 100W radiated power, only a slight warming of the dipole near the feedpoint can be measured.

The dipole is made of standard semirigid coaxial cable. The center conductor of the feeding line is directly connected to the second arm of the dipole. The antenna is therefore short-circuited for DC-signals. On some of the dipoles, small end caps are added to the dipole arms in order to improve matching when loaded according to the position as explained in the "Measurement Conditions" paragraph. The SAR data are not affected by this change. The overall dipole length is still according to the Standard.

No excessive force must be applied to the dipole arms, because they might bend or the soldered connections near the feedpoint may be damaged.

Additional EUT Data

Manufactured by	SPEAG
Manufactured on	August 28, 2003

DASY5 Validation Report for Head TSL

Date: 21.09.2016

Test Laboratory: SPEAG, Zurich, Switzerland

DUT: Dipole D5GHzV2; Type: D5GHzV2; Serial: D5GHzV2 - SN:1191

Communication System: UID 0 - CW; Frequency: 5250 MHz, Frequency: 5600 MHz, Frequency: 5750 MHz
Medium parameters used: $f = 5250$ MHz; $\sigma = 4.59$ S/m; $\epsilon_r = 34.5$; $\rho = 1000$ kg/m³, Medium parameters used: $f = 5600$ MHz; $\sigma = 4.93$ S/m; $\epsilon_r = 34$; $\rho = 1000$ kg/m³, Medium parameters used: $f = 5750$ MHz; $\sigma = 5.08$ S/m; $\epsilon_r = 33.8$; $\rho = 1000$ kg/m³

Phantom section: Flat Section

Measurement Standard: DASY5 (IEEE/IEC/ANSI C63.19-2011)

DASY52 Configuration:

- Probe: EX3DV4 - SN3503; ConvF(5.42, 5.42, 5.42); Calibrated: 30.06.2016, ConvF(4.89, 4.89, 4.89); Calibrated: 30.06.2016, ConvF(4.85, 4.85, 4.85); Calibrated: 30.06.2016;
- Sensor-Surface: 1.4mm (Mechanical Surface Detection)
- Electronics: DAE4 Sn601; Calibrated: 30.12.2015
- Phantom: Flat Phantom 5.0 (front); Type: QD000P50AA; Serial: 1001
- DASY52 52.8.8(1258); SEMCAD X 14.6.10(7372)

Dipole Calibration for Head Tissue/Pin=100mW, dist=10mm, f=5250 MHz/Zoom Scan,

dist=1.4mm (8x8x7)/Cube 0: Measurement grid: dx=4mm, dy=4mm, dz=1.4mm

Reference Value = 68.49 V/m; Power Drift = 0.01 dB

Peak SAR (extrapolated) = 28.6 W/kg

SAR(1 g) = 7.96 W/kg; SAR(10 g) = 2.29 W/kg

Maximum value of SAR (measured) = 18.2 W/kg

Dipole Calibration for Head Tissue/Pin=100mW, dist=10mm, f=5600 MHz/Zoom Scan,

dist=1.4mm (8x8x7)/Cube 0: Measurement grid: dx=4mm, dy=4mm, dz=1.4mm

Reference Value = 69.34 V/m; Power Drift = -0.00 dB

Peak SAR (extrapolated) = 32.9 W/kg

SAR(1 g) = 8.45 W/kg; SAR(10 g) = 2.41 W/kg

Maximum value of SAR (measured) = 20.0 W/kg

Dipole Calibration for Head Tissue/Pin=100mW, dist=10mm, f=5750 MHz/Zoom Scan,

dist=1.4mm (8x8x7)/Cube 0: Measurement grid: dx=4mm, dy=4mm, dz=1.4mm

Reference Value = 67.15 V/m; Power Drift = 0.02 dB

Peak SAR (extrapolated) = 32.3 W/kg

SAR(1 g) = 7.99 W/kg; SAR(10 g) = 2.27 W/kg

Maximum value of SAR (measured) = 19.3 W/kg

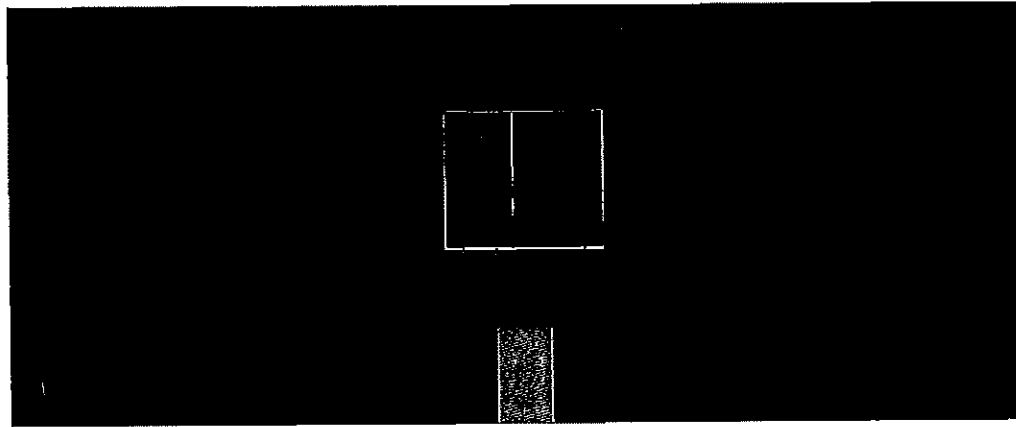

0 dB = 18.2 W/kg = 12.60 dBW/kg

Impedance Measurement Plot for Head TSL

20 Sep 2016 13:20:17
CH1 S11 1 U FS 1: 55.695 Ω -4.2793 Ω 7.0042 pF 5 250.000 000 MHz

*
 De1
 Cor
 Avg
 16
 H1d

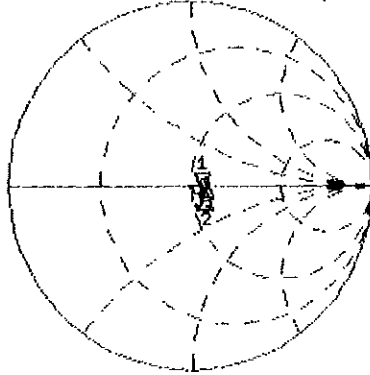

CH1 Markers
 2: 58.262 Ω
 -3.1738 Ω
 5.60000 GHz
 3: 58.078 Ω
 4.7969 Ω
 5.75000 GHz

CH2 S11 LOG 5 dB/REF -20 dB 1: -23.432 dB 5 250.000 000 MHz

Cor
 Avg
 16
 H1d

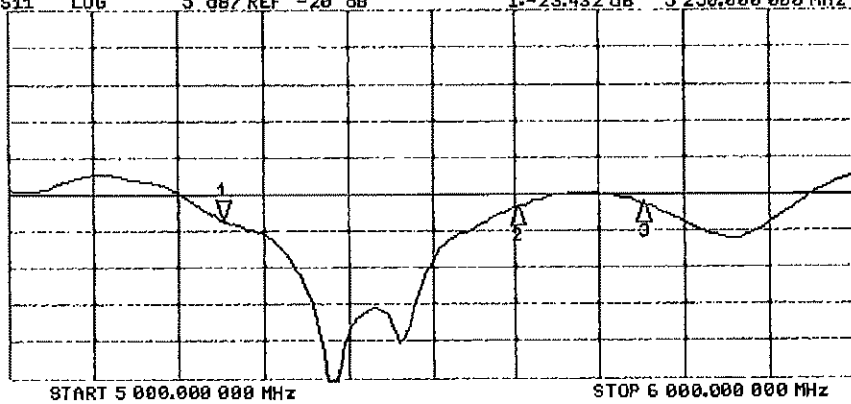

CH2 Markers
 2: -21.752 dB
 5.60000 GHz
 3: -21.226 dB
 5.75000 GHz

START 5 000.000 000 MHz

STOP 6 000.000 000 MHz

DASY5 Validation Report for Body TSL

Date: 20.09.2016

Test Laboratory: SPEAG, Zurich, Switzerland

DUT: Dipole D5GHzV2; Type: D5GHzV2; Serial: D5GHzV2 - SN:1191

Communication System: UID 0 - CW; Frequency: 5250 MHz, Frequency: 5600 MHz, Frequency: 5750 MHz
Medium parameters used: $f = 5250$ MHz; $\sigma = 5.52$ S/m; $\epsilon_r = 47.4$; $\rho = 1000$ kg/m³, Medium parameters used: $f = 5600$ MHz; $\sigma = 6$ S/m; $\epsilon_r = 46.8$; $\rho = 1000$ kg/m³, Medium parameters used: $f = 5750$ MHz; $\sigma = 6.21$ S/m; $\epsilon_r = 46.5$; $\rho = 1000$ kg/m³

Phantom section: Flat Section

Measurement Standard: DASY5 (IEEE/IEC/ANSI C63.19-2011)

DASY52 Configuration:

- Probe: EX3DV4 - SN3503; ConvF(4.85, 4.85, 4.85); Calibrated: 30.06.2016, ConvF(4.35, 4.35, 4.35); Calibrated: 30.06.2016, ConvF(4.3, 4.3, 4.3); Calibrated: 30.06.2016;
- Sensor-Surface: 1.4mm (Mechanical Surface Detection)
- Electronics: DAE4 Sn601; Calibrated: 30.12.2015
- Phantom: Flat Phantom 5.0 (back); Type: QD000P50AA; Serial: 1002
- DASY52 52.8.8(1258); SEMCAD X 14.6.10(7372)

Dipole Calibration for Body Tissue/Pin=100mW, dist=10mm, f=5250MHz/Zoom Scan, dist=1.4mm (8x8x7)/Cube 0: Measurement grid: dx=4mm, dy=4mm, dz=1.4mm

Reference Value = 66.49 V/m; Power Drift = -0.07 dB

Peak SAR (extrapolated) = 29.1 W/kg

SAR(1 g) = 7.74 W/kg; SAR(10 g) = 2.17 W/kg

Maximum value of SAR (measured) = 17.7 W/kg

Dipole Calibration for Body Tissue/Pin=100mW, dist=10mm, f=5600 MHz/Zoom Scan, dist=1.4mm (8x8x7)/Cube 0: Measurement grid: dx=4mm, dy=4mm, dz=1.4mm

Reference Value = 65.85 V/m; Power Drift = -0.09 dB

Peak SAR (extrapolated) = 32.5 W/kg

SAR(1 g) = 7.96 W/kg; SAR(10 g) = 2.24 W/kg

Maximum value of SAR (measured) = 18.8 W/kg

Dipole Calibration for Body Tissue/Pin=100mW, dist=10mm, f=5750 MHz/Zoom Scan, dist=1.4mm (8x8x7)/Cube 0: Measurement grid: dx=4mm, dy=4mm, dz=1.4mm

Reference Value = 64.21 V/m; Power Drift = -0.09 dB

Peak SAR (extrapolated) = 32.7 W/kg

SAR(1 g) = 7.65 W/kg; SAR(10 g) = 2.14 W/kg

Maximum value of SAR (measured) = 18.5 W/kg

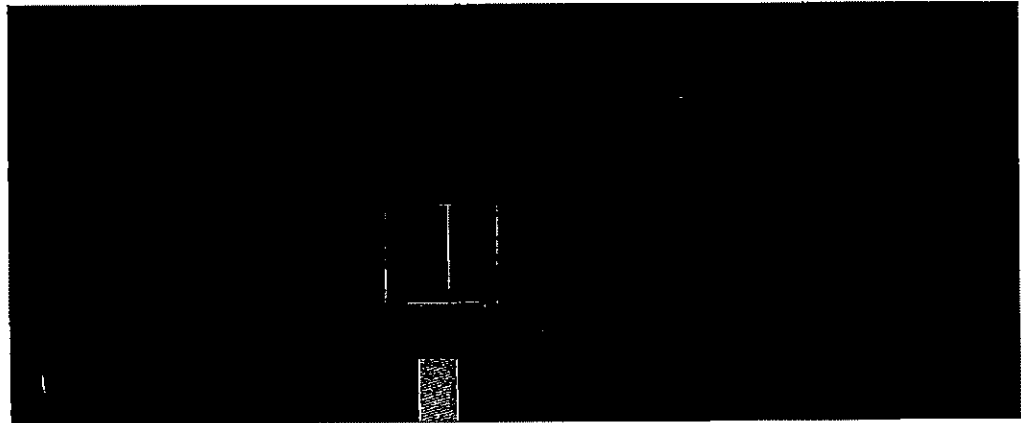
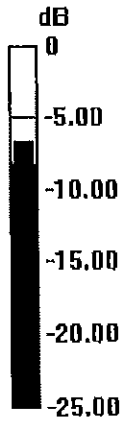

0 dB = 17.7 W/kg = 12.48 dBW/kg

Impedance Measurement Plot for Body TSL

20 Sep 2016 13:19:13

CH1 S11 1 U FS 1: 56.143 Ω -3.6992 Ω 8.1950 pF 5 250.000 000 MHz

De l
Cor
Avg 16
H1 d

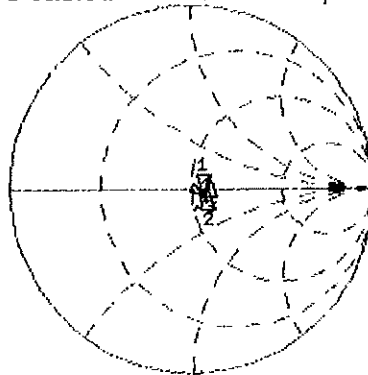

CH1 Markers
2: 58.887 Ω
-1.6504 Ω
5.60000 GHz
3: 59.510 Ω
6.9121 Ω
5.75000 GHz

CH2 S11 LOG 5 dB/ REF -20 dB 1: -23.406 dB 5 250.000 000 MHz

Cor
Avg 16
H1 d

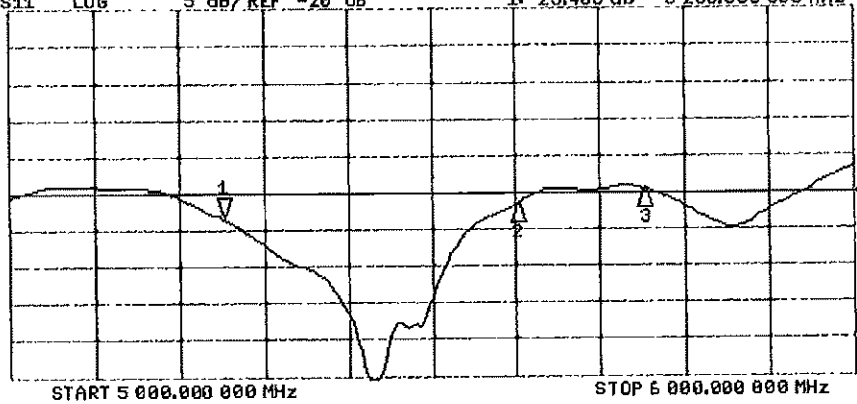

CH2 Markers
2: -21.616 dB
5.60000 GHz
3: -19.400 dB
5.75000 GHz

Certification of Calibration

Object: D5GHzV2 – SN: 1191

Calibration procedure(s): Procedure for Calibration Extension for SAR Dipoles.

Extension Calibration date: 9/19/2017

Description: SAR Validation Dipole at 5250, 5600, and 5750 MHz.

Calibration Equipment used:

Manufacturer	Model	Description	Cal Date	Cal Interval	Cal Due	Serial Number
Control Company	4040	Therm./Clock/Humidity Monitor	3/31/2017	Biennial	3/31/2019	170232394
Control Company	4352	Ultra Long Stem Thermometer	5/2/2017	Biennial	5/2/2019	170330156
Amplifier Research	15S1G6	Amplifier	CBT	N/A	CBT	433971
Narda	4772-3	Attenuator (3dB)	CBT	N/A	CBT	9406
Keysight	7720	Dual Directional Coupler	CBT	N/A	CBT	MYS2180215
Keysight Technologies	85033E	Standard Mechanical Calibration Kit (DC to 9GHz, 3.5mm)	6/1/2017	Annual	6/1/2018	MYS3401181
Agilent	8753ES	S-Parameter Network Analyzer	10/26/2016	Annual	10/26/2017	US39170118
Mini-Circuits	BW-N20W5+	DC to 18 GHz Precision Fixed 20 dB Attenuator	CBT	N/A	CBT	N/A
SPEAG	DAK-3.S	Dielectric Assessment Kit	5/10/2017	Annual	5/10/2018	1070
SPEAG	EX3DV4	SAR Probe	1/13/2017	Annual	1/13/2018	3589
SPEAG	EX3DV4	SAR Probe	2/13/2017	Annual	2/13/2018	3914
SPEAG	DAE4	Dasy Data Acquisition Electronics	1/16/2017	Annual	1/16/2018	1466
SPEAG	DAE4	Dasy Data Acquisition Electronics	2/9/2017	Annual	2/9/2018	665
Anritsu	MA2411B	Pulse Power Sensor	2/10/2017	Annual	2/10/2018	1207364
Anritsu	MA2411B	Pulse Power Sensor	2/10/2017	Annual	2/10/2018	1339018
Anritsu	ML2495A	Power Meter	10/16/2015	Biennial	10/16/2017	941001
Agilent	N5182A	MXG Vector Signal Generator	2/28/2017	Annual	2/28/2018	MY47420800
Seekonk	NC-100	Torque Wrench	11/6/2015	Biennial	11/6/2017	N/A
MiniCircuits	VLF-6000+	Low Pass Filter	CBT	N/A	CBT	N/A
Narda	4014C-6	4 - 8 GHz SMA 6 dB Directional Coupler	CBT	N/A	CBT	N/A

Measurement Uncertainty = $\pm 23\%$ (k=2)

	Name	Function	Signature
Calibrated By:	Brodie Halfoster	Test Engineer	<i>BRODIE HALFOSTER</i>
Approved By:	Kaitlin O'Keefe	Senior Technical Manager	<i>KOK</i>

DIPOLE CALIBRATION EXTENSION

Per KDB 865664 D01, calibration intervals of up to three years may be considered for reference dipoles when it is demonstrated that the SAR target, impedance and return loss of a dipole have remained stable according to the following requirements:

1. The measured SAR does not deviate more than 10% from the target on the calibration certificate.
2. The return-loss does not deviate more than 20% from the previous measurement and meets the required 20dB minimum return-loss requirement.
3. The measurement of real or imaginary parts of impedance does not deviate more than 5Ω from the previous measurement.

The following dipole was checked to pass the above 3 requirements to have 2-year calibration period from the calibration date:

Frequency (MHz)	Calibration Date	Extension Date	Certificate Electrical Delay (ns)	Certificate SAR Target Head (1g W/kg @ 17.0 dBm)	Measured Head SAR (1g) W/kg @ 17.0 dBm	Deviation 1g (%)	Certificate SAR Target Head (10g W/kg @ 17.0 dBm)	Measured Head SAR (10g) W/kg @ 17.0 dBm	Deviation 10g (%)	Certificate Impedance Head (Ohm) Real	Measured Impedance Head (Ohm) Real	Difference (Ohm) Real	Certificate Impedance Head (Ohm) Imaginary	Measured Impedance Head (Ohm) Imaginary	Difference (Ohm) Imaginary	Certificate Return Loss Head (dB)	Measured Return Loss Head (dB)	Deviation (%)	PASS/FAIL
5250	9/21/2016	9/19/2017	1.204	3.95	3.70	-6.21%	1.13	1.05	-7.08%	55.7	53.4	2.3	-4.3	-6.4	2.1	-23.4	-26.9	-15.00%	PASS
5600	9/21/2016	9/19/2017	1.204	4.18	4.03	-3.59%	1.19	1.13	-5.04%	58.3	55.8	2.7	-3.2	-1.2	2.0	-21.8	-26.1	-19.80%	PASS
5750	9/21/2016	9/19/2017	1.204	3.96	3.84	-3.08%	1.12	1.10	-1.79%	58.1	57.4	0.7	4.8	3.2	1.6	-21.2	-21.0	0.90%	PASS

Frequency (MHz)	Calibration Date	Extension Date	Certificate Electrical Delay (ns)	Certificate SAR Target Body (1g W/kg @ 17.0 dBm)	Measured Body SAR (1g) W/kg @ 17.0 dBm	Deviation 1g (%)	Certificate SAR Target Body (10g W/kg @ 17.0 dBm)	Measured Body SAR (10g) W/kg @ 17.0 dBm	Deviation 10g (%)	Certificate Impedance Body (Ohm) Real	Measured Impedance Body (Ohm) Real	Difference (Ohm) Real	Certificate Impedance Body (Ohm) Imaginary	Measured Impedance Body (Ohm) Imaginary	Difference (Ohm) Imaginary	Certificate Return Loss Body (dB)	Measured Return Loss Body (dB)	Deviation (%)	PASS/FAIL
5250	9/21/2016	9/19/2017	1.204	3.85	3.80	-1.30%	1.08	1.06	-1.85%	56.1	54.0	2.1	-3.7	-3.3	0.4	-23.4	-26.0	-11.10%	PASS
5600	9/21/2016	9/19/2017	1.204	3.96	4.06	2.53%	1.11	1.13	1.80%	58.9	56.5	2.4	-1.7	0.5	2.2	-21.7	-24.5	-12.80%	PASS
5750	9/21/2016	9/19/2017	1.204	3.81	3.66	-3.81%	1.06	1.02	-3.77%	59.5	58.0	1.5	6.9	5.2	1.7	-19.4	-21.1	-8.70%	PASS

Impedance & Return-Loss Measurement Plot for Head TSL

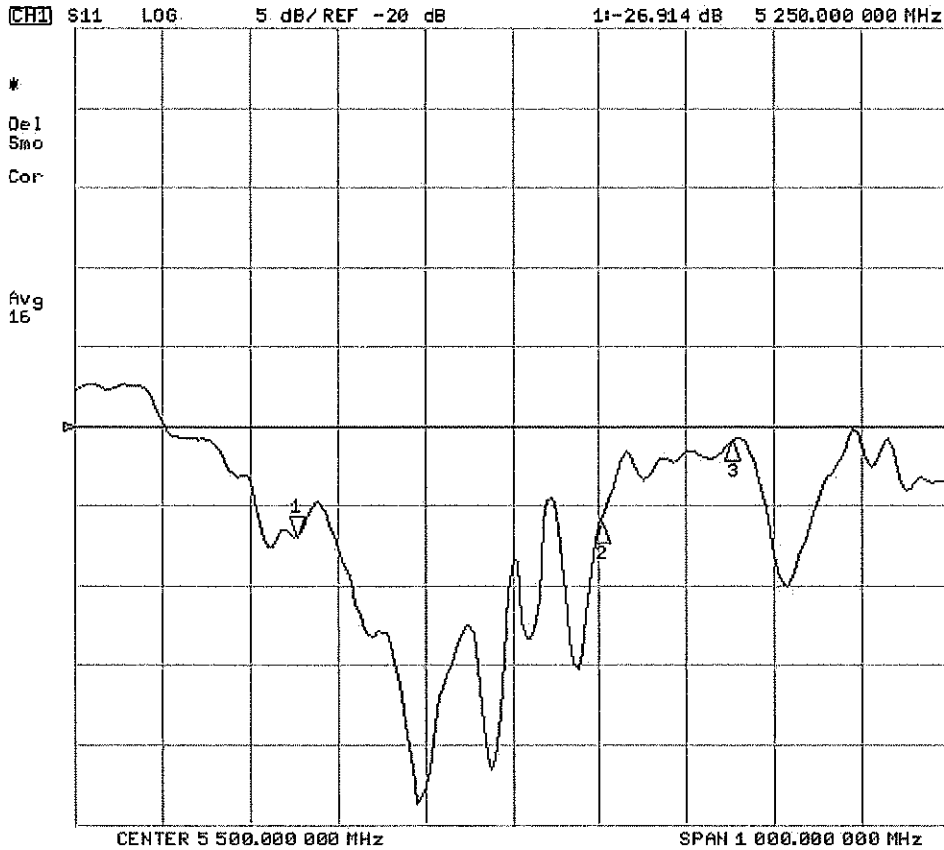
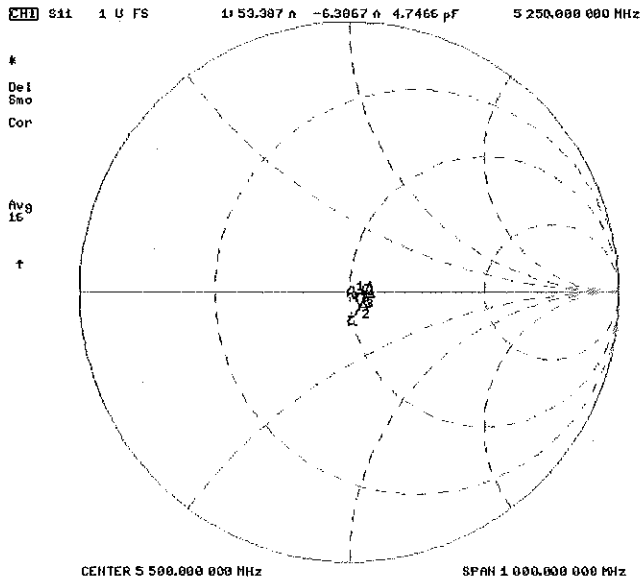

Impedance & Return-Loss Measurement Plot for Body TSL

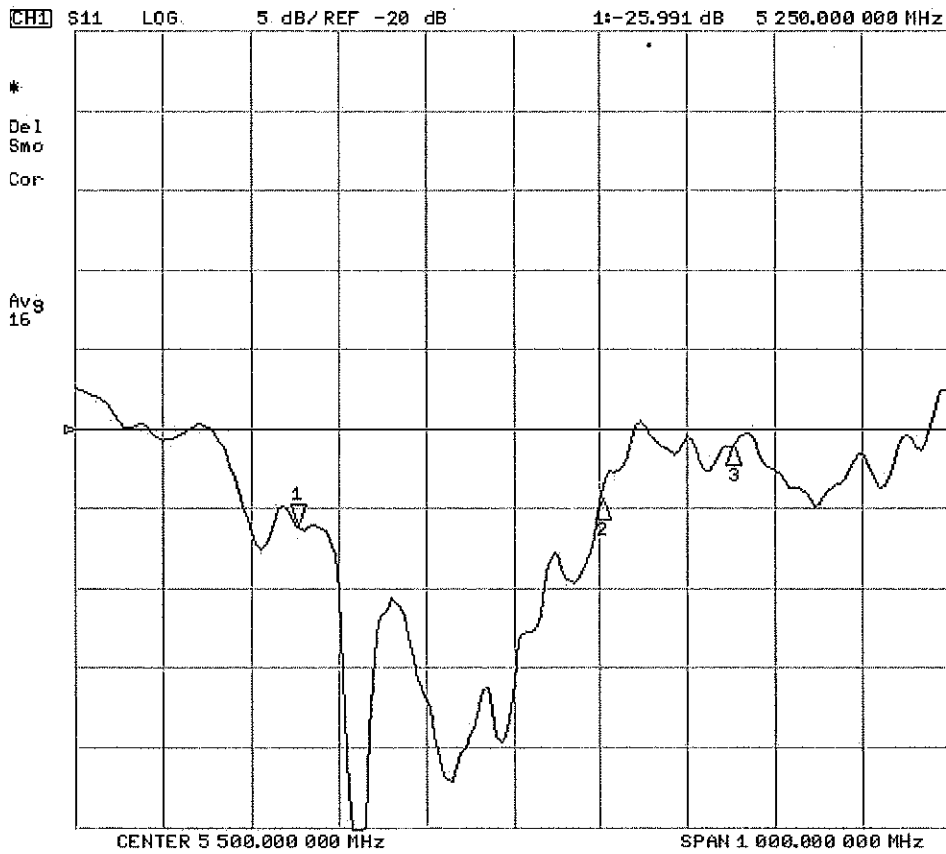
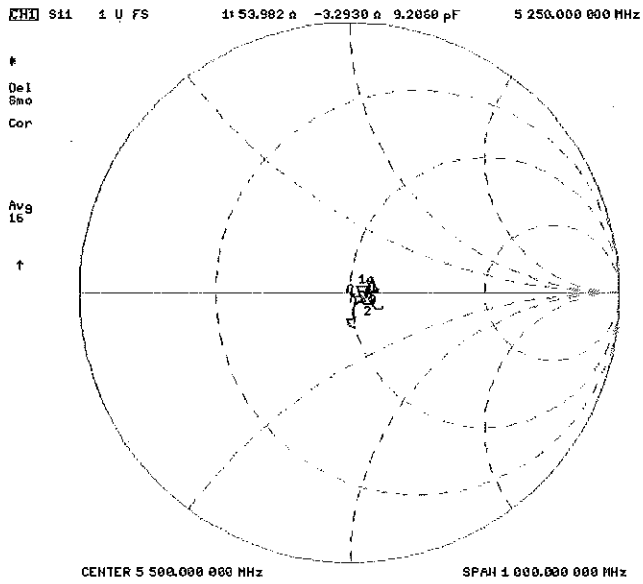

Certification of Calibration

Object: D5GHzV2 – SN: 1191

Calibration procedure(s): Procedure for Calibration Extension for SAR Dipoles.

Extension Calibration date: 9/11/2018

Description: SAR Validation Dipole at 5250, 5600, and 5750 MHz.

Calibration Equipment used:

Manufacturer	Model	Description	Cal Date	Cal Interval	Cal Due	Serial Number
Control Company	4040	Therm./Clock/Humidity Monitor	3/31/2017	Biennial	3/31/2019	170232394
Control Company	4352	Ultra Long Stem Thermometer	5/2/2017	Biennial	5/2/2019	170330156
Amplifier Research	1551G6	Amplifier	CBT	N/A	CBT	433971
Narda	4772-3	Attenuator (3dB)	CBT	N/A	CBT	9406
Keysight	772D	Dual Directional Coupler	CBT	N/A	CBT	MY52180215
Keysight Technologies	85033E	Standard Mechanical Calibration Kit (DC to 9GHz, 3.5mm)	6/4/2018	Annual	6/4/2019	MY53401181
Agilent	8753ES	S-Parameter Vector Network Analyzer	8/30/2018	Annual	8/30/2019	MY40003841
Mini-Circuits	BW-N20W5+	DC to 18 GHz Precision Fixed 20 dB Attenuator	CBT	N/A	CBT	N/A
SPEAG	DAK-3.5	Dielectric Assessment Kit	5/15/2018	Annual	5/15/2019	1070
SPEAG	EX3DV4	SAR Probe	6/25/2018	Annual	6/25/2019	7409
SPEAG	DAE4	Dasy Data Acquisition Electronics	6/18/2018	Annual	6/18/2019	1334
SPEAG	EX3DV4	SAR Probe	4/18/2018	Annual	4/18/2019	7357
SPEAG	DAE4	Dasy Data Acquisition Electronics	4/11/2018	Annual	4/11/2019	1407
Anritsu	MA2411B	Pulse Power Sensor	3/2/2018	Annual	3/2/2019	1207364
Anritsu	MA2411B	Pulse Power Sensor	3/2/2018	Annual	3/2/2019	1339018
Anritsu	ML2495A	Power Meter	10/22/2017	Annual	10/22/2018	1328004
Agilent	N5182A	MXG Vector Signal Generator	4/18/2018	Annual	4/18/2019	MY47420800
Seekonk	NC-100	Torque Wrench	7/11/2018	Annual	7/11/2019	N/A
MiniCircuits	VLF-6000+	Low Pass Filter	CBT	N/A	CBT	N/A
Narda	4014C-6	4 - 8 GHz SMA 6 dB Directional Coupler	CBT	N/A	CBT	N/A

Note: CBT (Calibrated Before Testing). Prior to testing, the measurement paths containing a cable, amplifier, attenuator, coupler or filter were connected to a calibrated source (i.e. a signal generator) to determine the losses of the measurement path.

Measurement Uncertainty = $\pm 23\%$ (k=2)

	Name	Function	Signature
Calibrated By:	Brodie Halfoster	Test Engineer	<i>BRODIE HALFOSTER</i>
Approved By:	Kaitlin O'Keefe	Senior Technical Manager	<i>KOK</i>

DIPOLE CALIBRATION EXTENSION

Per KDB 865664 D01, calibration intervals of up to three years may be considered for reference dipoles when it is demonstrated that the SAR target, impedance and return loss of a dipole have remained stable according to the following requirements:

1. The measured SAR does not deviate more than 10% from the target on the calibration certificate.
2. The return-loss does not deviate more than 20% from the previous measurement and meets the required 20dB minimum return-loss requirement.
3. The measurement of real or imaginary parts of impedance does not deviate more than 5Ω from the previous measurement.

The following dipole was checked to pass the above 3 requirements to have 3-year calibration period from the calibration date:

Frequency (MHz)	Calibration Date	Extension Date	Certificate Electrical Delay (ns)	Certificate SAR Target Head (1g) W/kg @ 17.0 dBm	Measured Head SAR (1g) W/kg @ 17.0 dBm	Deviation 1g (%)	Certificate SAR Target Head (10g) W/kg @ 17.0 dBm	Measured Head SAR (10g) W/kg @ 17.0 dBm	Deviation 10g (%)	Certificate Impedance Head (Ohm) Real	Measured Impedance Head (Ohm) Real	Difference (Ohm) Real	Certificate Impedance Head (Ohm) Imaginary	Measured Impedance Head (Ohm) Imaginary	Difference (Ohm) Imaginary	Certificate Return Loss Head (dB)	Measured Return Loss Head (dB)	Deviation (%)	PASS/FAIL
5250	9/21/2016	9/11/2018	1.204	3.945	3.9	-1.14%	1.13	1.11	-1.77%	55.7	54.9	0.8	-4.3	-7.7	3.4	-23.4	-21.3	9.10%	PASS
5600	9/21/2016	9/11/2018	1.204	4.18	4.19	0.24%	1.19	1.18	-0.84%	58.3	54.6	3.7	-3.2	-6.2	3	-21.8	-22.7	-4.30%	PASS
5750	9/21/2016	9/11/2018	1.204	3.955	3.82	-3.41%	1.12	1.08	-3.57%	58.1	58.7	0.6	4.8	7.4	2.6	-21.2	-19.5	7.80%	PASS
Frequency (MHz)	Calibration Date	Extension Date	Certificate Electrical Delay (ns)	Certificate SAR Target Body (1g) W/kg @ 17.0 dBm	Measured Body SAR (1g) W/kg @ 17.0 dBm	Deviation 1g (%)	Certificate SAR Target Body (10g) W/kg @ 17.0 dBm	Measured Body SAR (10g) W/kg @ 17.0 dBm	Deviation 10g (%)	Certificate Impedance Body (Ohm) Real	Measured Impedance Body (Ohm) Real	Difference (Ohm) Real	Certificate Impedance Body (Ohm) Imaginary	Measured Impedance Body (Ohm) Imaginary	Difference (Ohm) Imaginary	Certificate Return Loss Body (dB)	Measured Return Loss Body (dB)	Deviation (%)	PASS/FAIL
5250	9/21/2016	9/11/2018	1.204	3.85	3.6	-6.49%	1.08	1.01	-6.48%	56.1	53.6	2.5	-3.7	-5.5	1.8	-23.4	-24	-2.40%	PASS
5600	9/21/2016	9/11/2018	1.204	3.96	4.01	1.26%	1.11	1.1	-0.90%	58.9	57	1.9	-1.7	0.1	1.8	-21.7	-23.8	-9.70%	PASS
5750	9/21/2016	9/11/2018	1.204	3.805	3.88	1.97%	1.06	1.06	0.00%	59.5	60.3	0.8	6.9	6.1	0.8	-19.4	-19.2	1.00%	PASS

Impedance & Return-Loss Measurement Plot for Head TSL

11 Sep 2018 05:03:18
 [CH1] S11 1 U FS 1: 54.093 Ω -7.7207 Ω 3.9265 pF 5 250.000 000 MHz

*
 Del
 Smo
 Cor
 Avg
 16

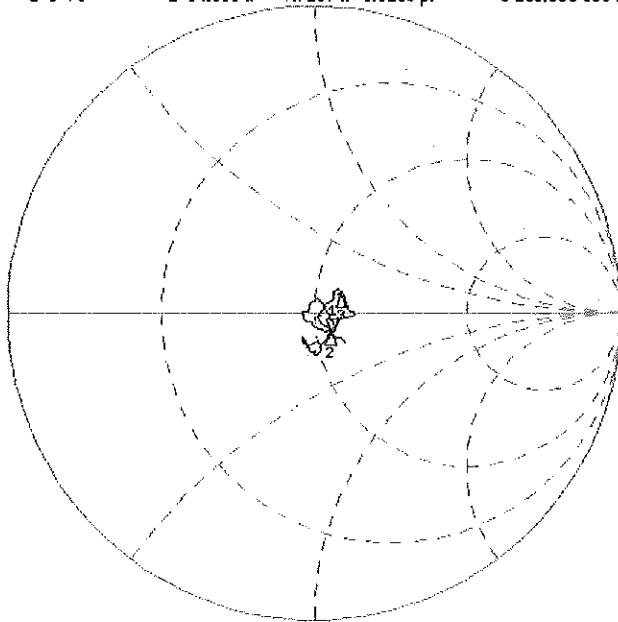

CH1 Markers
 2: 54.590 Ω
 -6.1797 Ω
 5.60000 GHz
 3: 50.559 Ω
 7.3097 Ω
 5.75000 GHz

CENTER 5 500.000 000 MHz SPAN 1 000.000 000 MHz
 11 Sep 2018 05:01:49

[CH1] S11 LOG 5 dB/REF -20 dB 1: -21.279 dB 5 250.000 000 MHz

*
 Del
 Smo
 Cor
 Avg
 16

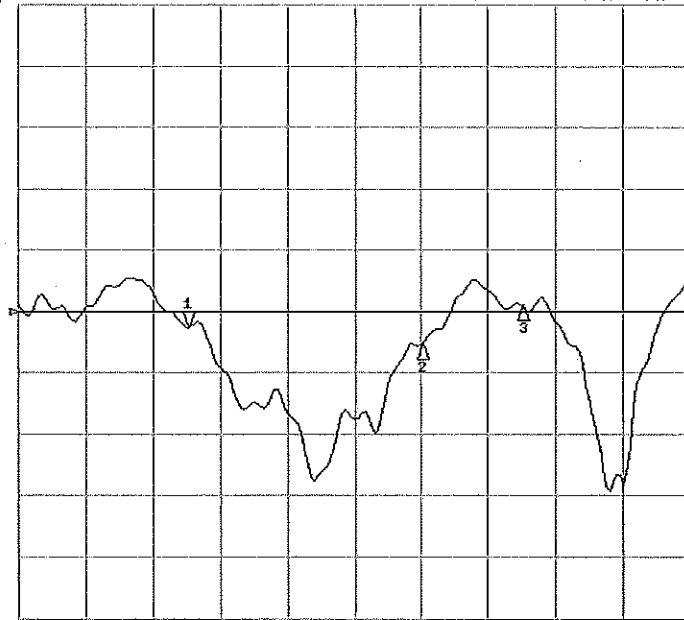

CH1 Markers
 2: -22.747 dB
 5.60000 GHz
 3: -19.546 dB
 5.75000 GHz

CENTER 5 500.000 000 MHz SPAN 1 000.000 000 MHz

Impedance & Return-Loss Measurement Plot for Body TSL

11 Sep 2018 05:00:12
 [CH1] S11 1 U F6 1: 53.613 n -5.4005 n 5.5315 pF 5 250.000 000 MHz

*
 Del
 Smo
 Cor
 Avg
 16

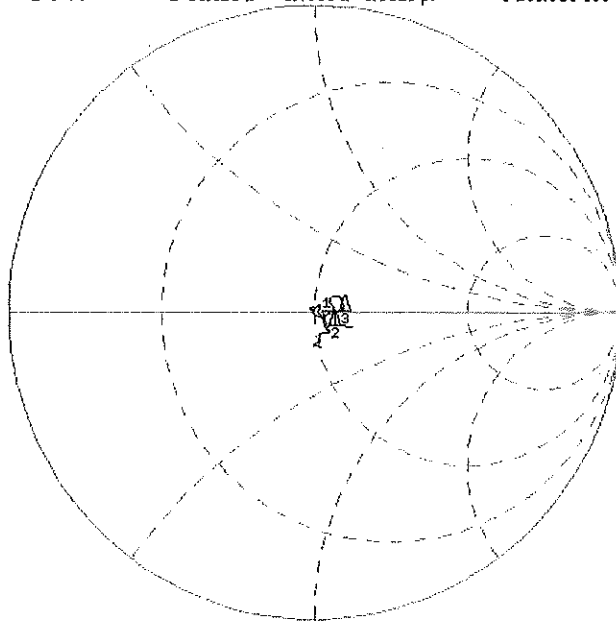

CH1 Markers
 2: 56.973 n
 0.0742 n
 5.60000 GHz
 3: 60.309 n
 6.0377 n
 5.75000 GHz

CENTER 5 500.000 000 MHz SPAN 1 000.000 000 MHz
 11 Sep 2018 05:00:43

[CH1] S11 LOG 5 dB/REF -20 dB 11-23.952 dB 5 250.000 000 MHz

*
 Del
 Smo
 Cor
 Avg
 16
 f

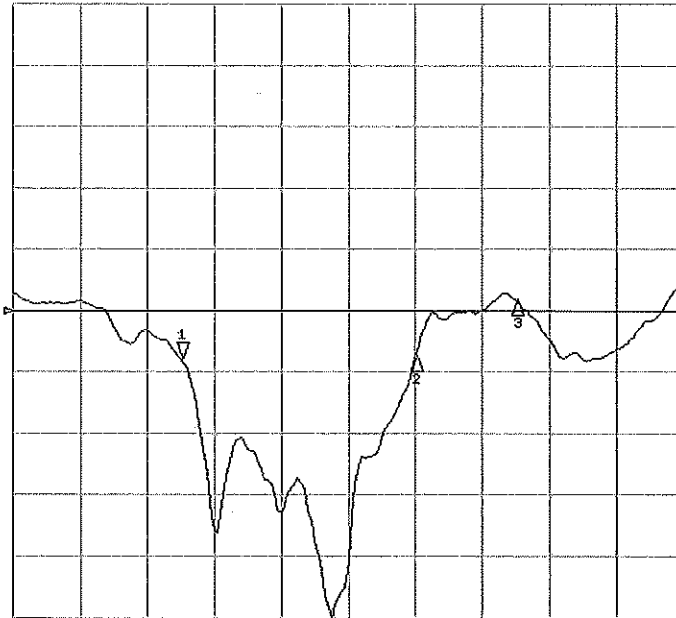

CH1 Markers
 2: -23.002 dB
 5.60000 GHz
 3: -19.200 dB
 5.75000 GHz

CENTER 5 500.000 000 MHz SPAN 1 000.000 000 MHz



Accredited by the Swiss Accreditation Service (SAS)
The Swiss Accreditation Service is one of the signatories to the EA
Multilateral Agreement for the recognition of calibration certificates

Accreditation No.: **SCS 0108**

Client **PC Test**

Certificate No: **D750V3-1161_Oct18**

CALIBRATION CERTIFICATE

Object **D750V3 - SN:1161**

Calibration procedure(s) **QA CAL-05.v10
Calibration procedure for dipole validation kits above 700 MHz**

Calibration date: **October 19, 2018**

*BN ✓
10-30-2018*

This calibration certificate documents the traceability to national standards, which realize the physical units of measurements (SI).
The measurements and the uncertainties with confidence probability are given on the following pages and are part of the certificate.

All calibrations have been conducted in the closed laboratory facility: environment temperature (22 ± 3)°C and humidity < 70%.

Calibration Equipment used (M&TE critical for calibration)

Primary Standards	ID #	Cal Date (Certificate No.)	Scheduled Calibration
Power meter NRP	SN: 104778	04-Apr-18 (No. 217-02672/02673)	Apr-19
Power sensor NRP-Z91	SN: 103244	04-Apr-18 (No. 217-02672)	Apr-19
Power sensor NRP-Z91	SN: 103245	04-Apr-18 (No. 217-02673)	Apr-19
Reference 20 dB Attenuator	SN: 5058 (20k)	04-Apr-18 (No. 217-02682)	Apr-19
Type-N mismatch combination	SN: 5047.2 / 06327	04-Apr-18 (No. 217-02683)	Apr-19
Reference Probe EX3DV4	SN: 7349	30-Dec-17 (No. EX3-7349_Dec17)	Dec-18
DAE4	SN: 601	04-Oct-18 (No. DAE4-601_Oct18)	Oct-19

Secondary Standards	ID #	Check Date (in house)	Scheduled Check
Power meter EPM-442A	SN: GB37480704	07-Oct-15 (in house check Oct-18)	In house check: Oct-20
Power sensor HP 8481A	SN: US37292783	07-Oct-15 (in house check Oct-18)	In house check: Oct-20
Power sensor HP 8481A	SN: MY41092317	07-Oct-15 (in house check Oct-18)	In house check: Oct-20
RF generator R&S SMT-06	SN: 100972	15-Jun-15 (in house check Oct-18)	In house check: Oct-20
Network Analyzer Agilent E8358A	SN: US41080477	31-Mar-14 (in house check Oct-18)	In house check: Oct-19

Calibrated by: **Manu Seitz** Name: **Manu Seitz** Function: **Laboratory Technician**

Approved by: **Katja Pokovic** Name: **Katja Pokovic** Function: **Technical Manager**

Issued: October 22, 2018

This calibration certificate shall not be reproduced except in full without written approval of the laboratory.



Accredited by the Swiss Accreditation Service (SAS)

The Swiss Accreditation Service is one of the signatories to the EA
Multilateral Agreement for the recognition of calibration certificates

Accreditation No.: **SCS 0108**

Glossary:

TSL	tissue simulating liquid
ConvF	sensitivity in TSL / NORM x,y,z
N/A	not applicable or not measured

Calibration is Performed According to the Following Standards:

- IEEE Std 1528-2013, "IEEE Recommended Practice for Determining the Peak Spatial-Averaged Specific Absorption Rate (SAR) in the Human Head from Wireless Communications Devices: Measurement Techniques", June 2013
- IEC 62209-1, "Measurement procedure for the assessment of Specific Absorption Rate (SAR) from hand-held and body-mounted devices used next to the ear (frequency range of 300 MHz to 6 GHz)", July 2016
- IEC 62209-2, "Procedure to determine the Specific Absorption Rate (SAR) for wireless communication devices used in close proximity to the human body (frequency range of 30 MHz to 6 GHz)", March 2010
- KDB 865664, "SAR Measurement Requirements for 100 MHz to 6 GHz"

Additional Documentation:

- DASY4/5 System Handbook

Methods Applied and Interpretation of Parameters:

- Measurement Conditions:** Further details are available from the Validation Report at the end of the certificate. All figures stated in the certificate are valid at the frequency indicated.
- Antenna Parameters with TSL:** The dipole is mounted with the spacer to position its feed point exactly below the center marking of the flat phantom section, with the arms oriented parallel to the body axis.
- Feed Point Impedance and Return Loss:** These parameters are measured with the dipole positioned under the liquid filled phantom. The impedance stated is transformed from the measurement at the SMA connector to the feed point. The Return Loss ensures low reflected power. No uncertainty required.
- Electrical Delay:** One-way delay between the SMA connector and the antenna feed point. No uncertainty required.
- SAR measured:** SAR measured at the stated antenna input power.
- SAR normalized:** SAR as measured, normalized to an input power of 1 W at the antenna connector.
- SAR for nominal TSL parameters:** The measured TSL parameters are used to calculate the nominal SAR result.

The reported uncertainty of measurement is stated as the standard uncertainty of measurement multiplied by the coverage factor $k=2$, which for a normal distribution corresponds to a coverage probability of approximately 95%.

Measurement Conditions

DASY system configuration, as far as not given on page 1.

DASY Version	DASY5	V52.10.2
Extrapolation	Advanced Extrapolation	
Phantom	Modular Flat Phantom	
Distance Dipole Center - TSL	15 mm	with Spacer
Zoom Scan Resolution	dx, dy, dz = 5 mm	
Frequency	750 MHz ± 1 MHz	

Head TSL parameters

The following parameters and calculations were applied.

	Temperature	Permittivity	Conductivity
Nominal Head TSL parameters	22.0 °C	41.9	0.89 mho/m
Measured Head TSL parameters	(22.0 ± 0.2) °C	40.8 ± 6 %	0.89 mho/m ± 6 %
Head TSL temperature change during test	< 0.5 °C	----	----

SAR result with Head TSL

SAR averaged over 1 cm³ (1 g) of Head TSL	Condition	
SAR measured	250 mW input power	2.02 W/kg
SAR for nominal Head TSL parameters	normalized to 1W	8.03 W/kg ± 17.0 % (k=2)

SAR averaged over 10 cm³ (10 g) of Head TSL	condition	
SAR measured	250 mW input power	1.32 W/kg
SAR for nominal Head TSL parameters	normalized to 1W	5.26 W/kg ± 16.5 % (k=2)

Body TSL parameters

The following parameters and calculations were applied.

	Temperature	Permittivity	Conductivity
Nominal Body TSL parameters	22.0 °C	55.5	0.96 mho/m
Measured Body TSL parameters	(22.0 ± 0.2) °C	55.1 ± 6 %	0.96 mho/m ± 6 %
Body TSL temperature change during test	< 0.5 °C	----	----

SAR result with Body TSL

SAR averaged over 1 cm³ (1 g) of Body TSL	Condition	
SAR measured	250 mW input power	2.11 W/kg
SAR for nominal Body TSL parameters	normalized to 1W	8.43 W/kg ± 17.0 % (k=2)

SAR averaged over 10 cm³ (10 g) of Body TSL	condition	
SAR measured	250 mW input power	1.39 W/kg
SAR for nominal Body TSL parameters	normalized to 1W	5.55 W/kg ± 16.5 % (k=2)

Appendix (Additional assessments outside the scope of SCS 0108)

Antenna Parameters with Head TSL

Impedance, transformed to feed point	55.6 Ω - 1.9 j Ω
Return Loss	- 25.0 dB

Antenna Parameters with Body TSL

Impedance, transformed to feed point	50.6 Ω - 4.2 j Ω
Return Loss	- 27.6 dB

General Antenna Parameters and Design

Electrical Delay (one direction)	1.032 ns
----------------------------------	----------

After long term use with 100W radiated power, only a slight warming of the dipole near the feedpoint can be measured.

The dipole is made of standard semirigid coaxial cable. The center conductor of the feeding line is directly connected to the second arm of the dipole. The antenna is therefore short-circuited for DC-signals. On some of the dipoles, small end caps are added to the dipole arms in order to improve matching when loaded according to the position as explained in the "Measurement Conditions" paragraph. The SAR data are not affected by this change. The overall dipole length is still according to the Standard.

No excessive force must be applied to the dipole arms, because they might bend or the soldered connections near the feedpoint may be damaged.

Additional EUT Data

Manufactured by	SPEAG
Manufactured on	November 19, 2015

DASY5 Validation Report for Head TSL

Date: 19.10.2018

Test Laboratory: SPEAG, Zurich, Switzerland

DUT: Dipole 750 MHz; Type: D750V3; Serial: D750V3 - SN:1161

Communication System: UID 0 - CW; Frequency: 750 MHz

Medium parameters used: $f = 750$ MHz; $\sigma = 0.89$ S/m; $\epsilon_r = 40.8$; $\rho = 1000$ kg/m³

Phantom section: Flat Section

Measurement Standard: DASY5 (IEEE/IEC/ANSI C63.19-2011)

DASY52 Configuration:

- Probe: EX3DV4 - SN7349; ConvF(10.22, 10.22, 10.22) @ 750 MHz; Calibrated: 30.12.2017
- Sensor-Surface: 1.4mm (Mechanical Surface Detection)
- Electronics: DAE4 Sn601; Calibrated: 04.10.2018
- Phantom: Flat Phantom 4.9 (front); Type: QD 00L P49 AA; Serial: 1001
- DASY52 52.10.2(1495); SEMCAD X 14.6.12(7450)

Dipole Calibration for Head Tissue/Pin=250 mW, d=15mm/Zoom Scan (7x7x7)/Cube 0:

Measurement grid: dx=5mm, dy=5mm, dz=5mm

Reference Value = 58.51 V/m; Power Drift = -0.04 dB

Peak SAR (extrapolated) = 3.04 W/kg

SAR(1 g) = 2.02 W/kg; SAR(10 g) = 1.32 W/kg

Maximum value of SAR (measured) = 2.70 W/kg

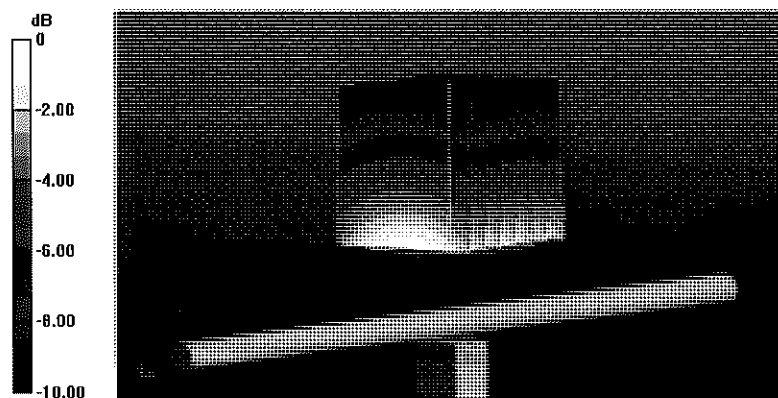

0 dB = 2.70 W/kg = 4.31 dBW/kg

Impedance Measurement Plot for Head TSL

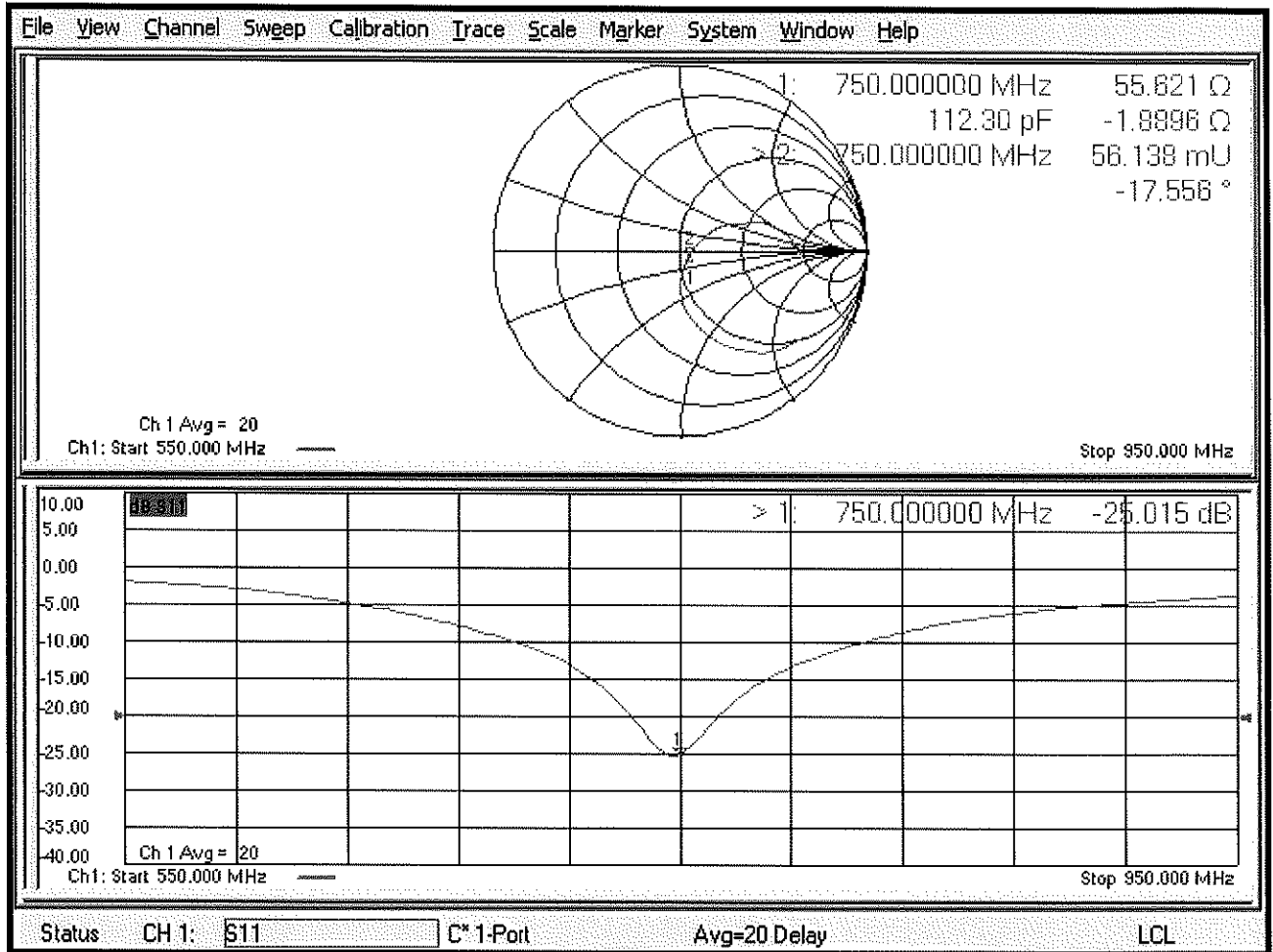

DASY5 Validation Report for Body TSL

Date: 19.10.2018

Test Laboratory: SPEAG, Zurich, Switzerland

DUT: Dipole 750 MHz; Type: D750V3; Serial: D750V3 - SN:1161

Communication System: UID 0 - CW; Frequency: 750 MHz

Medium parameters used: $f = 750$ MHz; $\sigma = 0.96$ S/m; $\epsilon_r = 55.1$; $\rho = 1000$ kg/m³

Phantom section: Flat Section

Measurement Standard: DASY5 (IEEE/IEC/ANSI C63.19-2011)

DASY52 Configuration:

- Probe: EX3DV4 - SN7349; ConvF(10.19, 10.19, 10.19) @ 750 MHz; Calibrated: 30.12.2017
- Sensor-Surface: 1.4mm (Mechanical Surface Detection)
- Electronics: DAE4 Sn601; Calibrated: 04.10.2018
- Phantom: Flat Phantom 4.9 (Back); Type: QD 00R P49 AA; Serial: 1005
- DASY52 52.10.2(1495); SEMCAD X 14.6.12(7450)

Dipole Calibration for Body Tissue/Pin=250 mW, d=15mm/Zoom Scan (7x7x7)/Cube 0:

Measurement grid: dx=5mm, dy=5mm, dz=5mm

Reference Value = 57.57 V/m; Power Drift = -0.02 dB

Peak SAR (extrapolated) = 3.18 W/kg

SAR(1 g) = 2.11 W/kg; SAR(10 g) = 1.39 W/kg

Maximum value of SAR (measured) = 2.83 W/kg

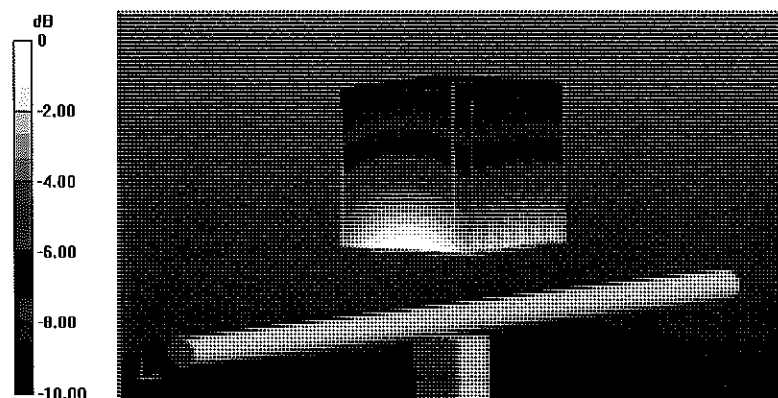

0 dB = 2.83 W/kg = 4.52 dBW/kg

Impedance Measurement Plot for Body TSL

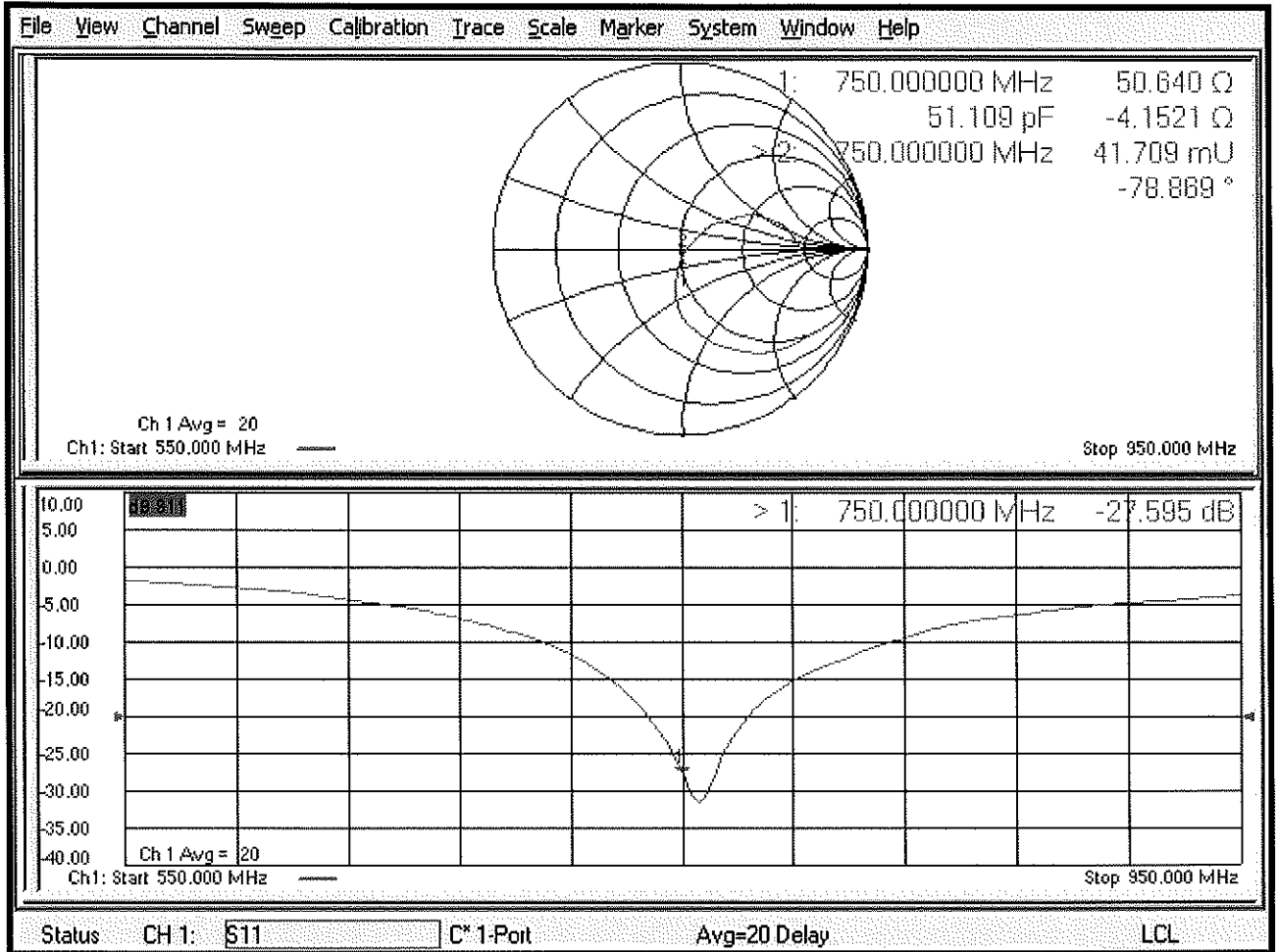



Accredited by the Swiss Accreditation Service (SAS)
The Swiss Accreditation Service is one of the signatories to the EA
Multilateral Agreement for the recognition of calibration certificates

Accreditation No.: **SCS 0108**

Client **PC-Test**

Certificate No: **D1750V2-1148_May17**

CALIBRATION CERTIFICATE

Object **D1750V2 - SN:1148**

Calibration procedure(s) **QA CAL-05.v9
Calibration procedure for dipole validation kits above 700 MHz**

Calibration date: **May 09, 2017**

*BN ✓
05-23-2017
BN ✓
05-09-2018*

This calibration certificate documents the traceability to national standards, which realize the physical units of measurements (SI).
The measurements and the uncertainties with confidence probability are given on the following pages and are part of the certificate.

All calibrations have been conducted in the closed laboratory facility: environment temperature (22 ± 3)°C and humidity < 70%.

Calibration Equipment used (M&TE critical for calibration)

Primary Standards	ID #	Cal Date (Certificate No.)	Scheduled Calibration
Power meter NRP	SN: 104778	04-Apr-17 (No. 217-02521/02522)	Apr-18
Power sensor NRP-Z91	SN: 103244	04-Apr-17 (No. 217-02521)	Apr-18
Power sensor NRP-Z91	SN: 103245	04-Apr-17 (No. 217-02522)	Apr-18
Reference 20 dB Attenuator	SN: 5058 (20k)	07-Apr-17 (No. 217-02528)	Apr-18
Type-N mismatch combination	SN: 5047.2 / 06327	07-Apr-17 (No. 217-02529)	Apr-18
Reference Probe EX3DV4	SN: 7349	31-Dec-16 (No. EX3-7349_Dec16)	Dec-17
DAE4	SN: 601	28-Mar-17 (No. DAE4-601_Mar17)	Mar-18

Secondary Standards	ID #	Check Date (in house)	Scheduled Check
Power meter EPM-442A	SN: GB37480704	07-Oct-15 (in house check Oct-16)	In house check: Oct-18
Power sensor HP 8481A	SN: US37292783	07-Oct-15 (in house check Oct-16)	in house check: Oct-18
Power sensor HP 8481A	SN: MY41092317	07-Oct-15 (in house check Oct-16)	in house check: Oct-18
RF generator R&S SMT-06	SN: 100972	15-Jun-15 (in house check Oct-16)	In house check: Oct-18
Network Analyzer HP 8753E	SN: US37390585	18-Oct-01 (in house check Oct-16)	In house check: Oct-17

Calibrated by: **Claudio Leubler** Name: Claudio Leubler Function: **Laboratory Technician** Signature: *[Signature]*

Approved by: **Katja Pokovic** Name: Katja Pokovic Function: **Technical Manager** Signature: *[Signature]*

Issued: May 11, 2017

This calibration certificate shall not be reproduced except in full without written approval of the laboratory.



Accredited by the Swiss Accreditation Service (SAS)

Accreditation No.: **SCS 0108**

The Swiss Accreditation Service is one of the signatories to the EA Multilateral Agreement for the recognition of calibration certificates

Glossary:

TSL	tissue simulating liquid
ConvF	sensitivity in TSL / NORM x,y,z
N/A	not applicable or not measured

Calibration is Performed According to the Following Standards:

- IEEE Std 1528-2013, "IEEE Recommended Practice for Determining the Peak Spatial-Averaged Specific Absorption Rate (SAR) in the Human Head from Wireless Communications Devices: Measurement Techniques", June 2013
- IEC 62209-1, "Procedure to measure the Specific Absorption Rate (SAR) for hand-held devices used in close proximity to the ear (frequency range of 300 MHz to 3 GHz)", February 2005
- IEC 62209-2, "Procedure to determine the Specific Absorption Rate (SAR) for wireless communication devices used in close proximity to the human body (frequency range of 30 MHz to 6 GHz)", March 2010
- KDB 865664, "SAR Measurement Requirements for 100 MHz to 6 GHz"

Additional Documentation:

- DASY4/5 System Handbook

Methods Applied and Interpretation of Parameters:

- Measurement Conditions:** Further details are available from the Validation Report at the end of the certificate. All figures stated in the certificate are valid at the frequency indicated.
- Antenna Parameters with TSL:** The dipole is mounted with the spacer to position its feed point exactly below the center marking of the flat phantom section, with the arms oriented parallel to the body axis.
- Feed Point Impedance and Return Loss:** These parameters are measured with the dipole positioned under the liquid filled phantom. The impedance stated is transformed from the measurement at the SMA connector to the feed point. The Return Loss ensures low reflected power. No uncertainty required.
- Electrical Delay:** One-way delay between the SMA connector and the antenna feed point. No uncertainty required.
- SAR measured:** SAR measured at the stated antenna input power.
- SAR normalized:** SAR as measured, normalized to an input power of 1 W at the antenna connector.
- SAR for nominal TSL parameters:** The measured TSL parameters are used to calculate the nominal SAR result.

The reported uncertainty of measurement is stated as the standard uncertainty of measurement multiplied by the coverage factor $k=2$, which for a normal distribution corresponds to a coverage probability of approximately 95%.

Measurement Conditions

DASY system configuration, as far as not given on page 1.

DASY Version	DASY5	V52.10.0
Extrapolation	Advanced Extrapolation	
Phantom	Modular Flat Phantom	
Distance Dipole Center - TSL	10 mm	with Spacer
Zoom Scan Resolution	dx, dy, dz = 5 mm	
Frequency	1750 MHz ± 1 MHz	

Head TSL parameters

The following parameters and calculations were applied.

	Temperature	Permittivity	Conductivity
Nominal Head TSL parameters	22.0 °C	40.1	1.37 mho/m
Measured Head TSL parameters	(22.0 ± 0.2) °C	39.0 ± 6 %	1.36 mho/m ± 6 %
Head TSL temperature change during test	< 0.5 °C	----	----

SAR result with Head TSL

SAR averaged over 1 cm ³ (1 g) of Head TSL	Condition	
SAR measured	250 mW input power	9.11 W/kg
SAR for nominal Head TSL parameters	normalized to 1W	36.4 W/kg ± 17.0 % (k=2)

SAR averaged over 10 cm ³ (10 g) of Head TSL	condition	
SAR measured	250 mW input power	4.83 W/kg
SAR for nominal Head TSL parameters	normalized to 1W	19.3 W/kg ± 16.5 % (k=2)

Body TSL parameters

The following parameters and calculations were applied.

	Temperature	Permittivity	Conductivity
Nominal Body TSL parameters	22.0 °C	53.4	1.49 mho/m
Measured Body TSL parameters	(22.0 ± 0.2) °C	53.7 ± 6 %	1.47 mho/m ± 6 %
Body TSL temperature change during test	< 0.5 °C	----	----

SAR result with Body TSL

SAR averaged over 1 cm ³ (1 g) of Body TSL	Condition	
SAR measured	250 mW input power	9.17 W/kg
SAR for nominal Body TSL parameters	normalized to 1W	37.0 W/kg ± 17.0 % (k=2)

SAR averaged over 10 cm ³ (10 g) of Body TSL	condition	
SAR measured	250 mW input power	4.93 W/kg
SAR for nominal Body TSL parameters	normalized to 1W	19.8 W/kg ± 16.5 % (k=2)

Appendix (Additional assessments outside the scope of SCS 0108)

Antenna Parameters with Head TSL

Impedance, transformed to feed point	49.8 Ω - 0.7 j Ω
Return Loss	- 42.9 dB

Antenna Parameters with Body TSL

Impedance, transformed to feed point	45.7 Ω - 0.5 j Ω
Return Loss	- 26.9 dB

General Antenna Parameters and Design

Electrical Delay (one direction)	1.223 ns
----------------------------------	----------

After long term use with 100W radiated power, only a slight warming of the dipole near the feedpoint can be measured.

The dipole is made of standard semirigid coaxial cable. The center conductor of the feeding line is directly connected to the second arm of the dipole. The antenna is therefore short-circuited for DC-signals. On some of the dipoles, small end caps are added to the dipole arms in order to improve matching when loaded according to the position as explained in the "Measurement Conditions" paragraph. The SAR data are not affected by this change. The overall dipole length is still according to the Standard.

No excessive force must be applied to the dipole arms, because they might bend or the soldered connections near the feedpoint may be damaged.

Additional EUT Data

Manufactured by	SPEAG
Manufactured on	September 30, 2014

DASY5 Validation Report for Head TSL

Date: 09.05.2017

Test Laboratory: SPEAG, Zurich, Switzerland

DUT: Dipole 1750 MHz; Type: D1750V2; Serial: D1750V2 - SN:1148

Communication System: UID 0 - CW; Frequency: 1750 MHz

Medium parameters used: $f = 1750$ MHz; $\sigma = 1.36$ S/m; $\epsilon_r = 39$; $\rho = 1000$ kg/m³

Phantom section: Flat Section

Measurement Standard: DASY5 (IEEE/IEC/ANSI C63.19-2011)

DASY52 Configuration:

- Probe: EX3DV4 - SN7349; ConvF(8.46, 8.46, 8.46); Calibrated: 31.12.2016;
- Sensor-Surface: 1.4mm (Mechanical Surface Detection)
- Electronics: DAE4 Sn601; Calibrated: 28.03.2017
- Phantom: Flat Phantom 5.0 (front); Type: QD000P50AA; Serial: 1001
- DASY52 52.10.0(1442); SEMCAD X 14.6.10(7413)

Dipole Calibration for Head Tissue/Pin=250 mW, d=10mm/Zoom Scan (7x7x7)/Cube 0:

Measurement grid: dx=5mm, dy=5mm, dz=5mm

Reference Value = 105.4 V/m; Power Drift = -0.01 dB

Peak SAR (extrapolated) = 16.5 W/kg

SAR(1 g) = 9.11 W/kg; SAR(10 g) = 4.83 W/kg

Maximum value of SAR (measured) = 13.9 W/kg

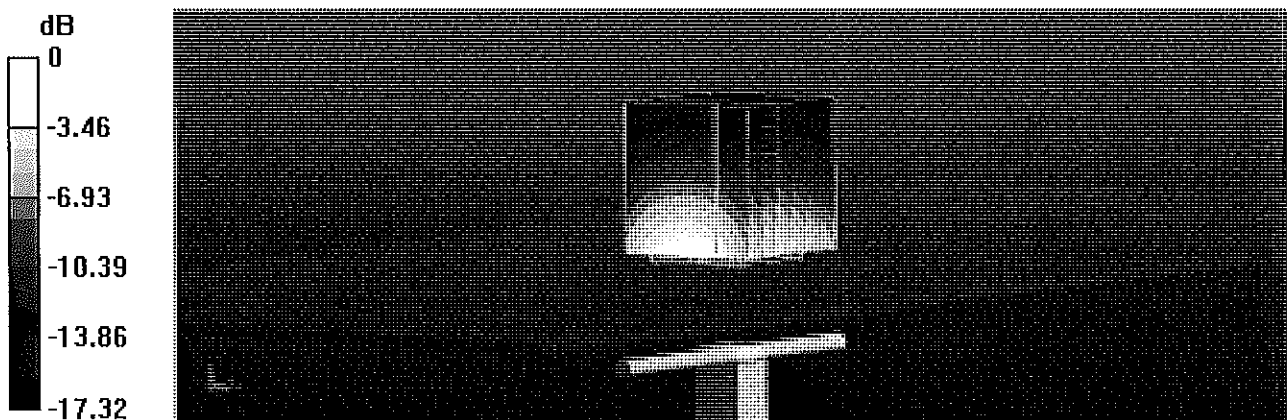

0 dB = 13.9 W/kg = 11.43 dBW/kg

Impedance Measurement Plot for Head TSL

9 May 2017 14:43:11

CH1 S11 1 U FS 1: 49.777 Ω -683.59 m Ω 133.04 pF 1 750.000 000 MHz

*
De1
CA
AVG
16
H1d

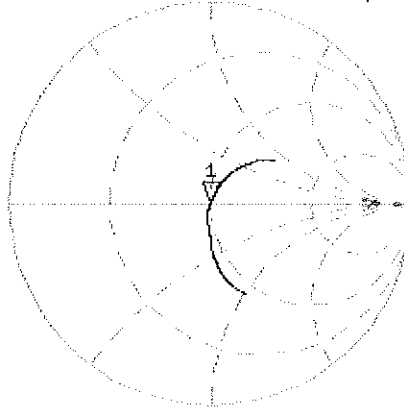

CH2 S11 LOG 5 dB/REF -20 dB 1: -42.893 dB 1 750.000 000 MHz

CA
AVG
16
H1d

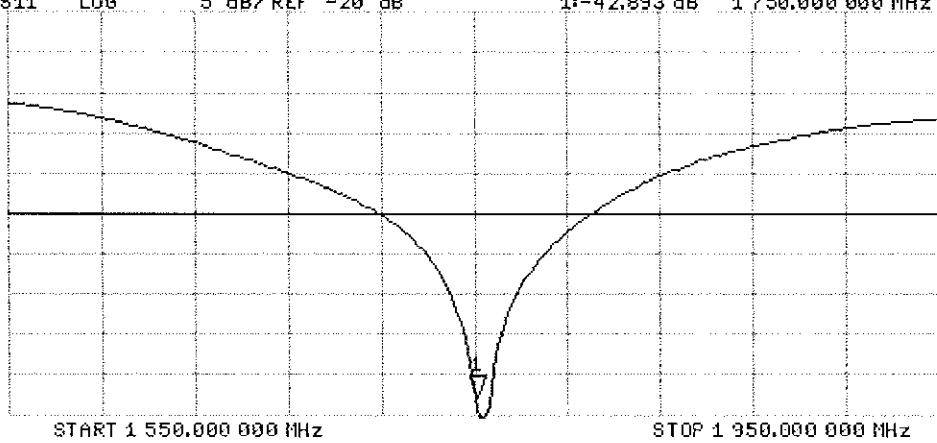

DASY5 Validation Report for Body TSL

Date: 09.05.2017

Test Laboratory: SPEAG, Zurich, Switzerland

DUT: Dipole 1750 MHz; Type: D1750V2; Serial: D1750V2 - SN:1148

Communication System: UID 0 - CW; Frequency: 1750 MHz

Medium parameters used: $f = 1750$ MHz; $\sigma = 1.47$ S/m; $\epsilon_r = 53.7$; $\rho = 1000$ kg/m³

Phantom section: Flat Section

Measurement Standard: DASY5 (IEEE/IEC/ANSI C63.19-2011)

DASY52 Configuration:

- Probe: EX3DV4 - SN7349; ConvF(8.25, 8.25, 8.25); Calibrated: 31.12.2016;
- Sensor-Surface: 1.4mm (Mechanical Surface Detection)
- Electronics: DAE4 Sn601; Calibrated: 28.03.2017
- Phantom: Flat Phantom 5.0 (back); Type: QD 000 P50 AA; Serial: 1002
- DASY52 52.10.0(1442); SEMCAD X 14.6.10(7413)

Dipole Calibration for Body Tissue/Pin=250 mW, d=10mm/Zoom Scan (7x7x7)/Cube 0:

Measurement grid: dx=5mm, dy=5mm, dz=5mm

Reference Value = 99.49 V/m; Power Drift = -0.04 dB

Peak SAR (extrapolated) = 15.9 W/kg

SAR(1 g) = 9.17 W/kg; SAR(10 g) = 4.93 W/kg

Maximum value of SAR (measured) = 13.1 W/kg

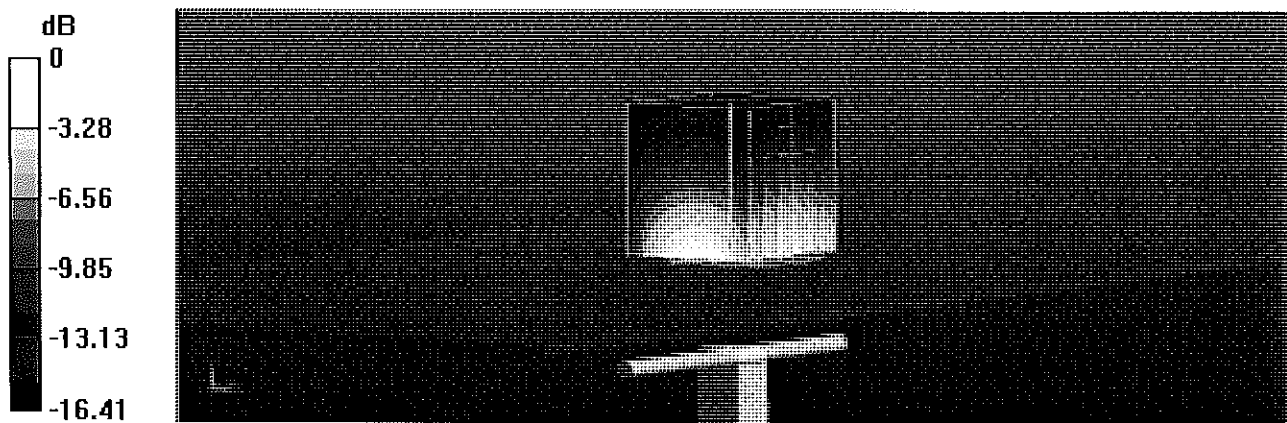

0 dB = 13.1 W/kg = 11.17 dBW/kg

Impedance Measurement Plot for Body TSL

9 May 2017 14:42:25

[CH1] S11 1 U FS 1: 45.707 Ω -513.67 $m\Omega$ 177.05 pF 1 750.000 000 MHz

*
De1
CA
Avg
16
H1d

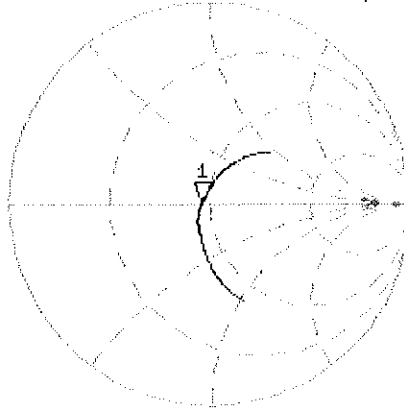

CH2 S11 LOG 5 dB/REF -20 dB 1:-26.901 dB 1 750.000 000 MHz

CA
Avg
16
H1d

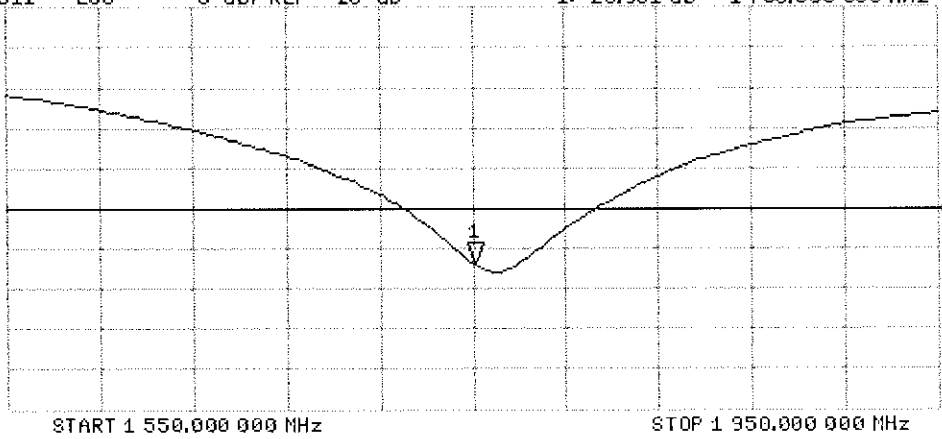

Certification of Calibration

Object: D1750V2 – SN: 1148

Calibration procedure(s): Procedure for Calibration Extension for SAR Dipoles.

Extended Calibration date: May 09, 2018

Description: SAR Validation Dipole at 1750 MHz.

Calibration Equipment used:

Manufacturer	Model	Description	Cal Date	Cal Interval	Cal Due	Serial Number
Control Company	4040	Therm./Clock/Humidity Monitor	3/31/2017	Biennial	3/31/2019	170232394
Control Company	4352	Ultra Long Stem Thermometer	5/2/2017	Biennial	5/2/2019	170330156
Amplifier Research	15S1G6	Amplifier	CBT	N/A	CBT	433971
Narda	4772-3	Attenuator (3dB)	CBT	N/A	CBT	9406
Keysight	772D	Dual Directional Coupler	CBT	N/A	CBT	MY52180215
Keysight Technologies	85033E	Standard Mechanical Calibration Kit (DC to 9GHz, 3.5mm)	6/1/2017	Annual	6/1/2018	MY53401181
Mini-Circuits	BW-N20W5+	DC to 18 GHz Precision Fixed 20 dB Attenuator	CBT	N/A	CBT	N/A
SPEAG	DAE4	Dasy Data Acquisition Electronics	2/9/2018	Annual	2/9/2019	1272
SPEAG	DAE4	Dasy Data Acquisition Electronics	6/21/2017	Annual	6/21/2018	1333
SPEAG	DAK-3.5	Dielectric Assessment Kit	9/12/2017	Annual	9/12/2018	1091
SPEAG	ES3DV3	SAR Probe	9/18/2017	Annual	9/18/2018	3287
SPEAG	ES3DV3	SAR Probe	2/13/2018	Annual	2/13/2019	3213
Anritsu	MA2411B	Pulse Power Sensor	3/2/2018	Annual	3/2/2019	1207364
Anritsu	MA2411B	Pulse Power Sensor	3/2/2018	Annual	3/2/2019	1339018
Agilent	N5182A	MXG Vector Signal Generator	4/18/2018	Annual	4/18/2019	MY47420800
Mini-Circuits	NLP-2950+	Low Pass Filter DC to 2700 MHz	CBT	N/A	CBT	N/A
Pasternack	PE2209-10	Bidirectional Coupler	CBT	N/A	CBT	N/A
Agilent	8753ES	S-Parameter Network Analyzer	9/14/2017	Annual	9/14/2018	US39170118
Pasternack	NC-100	Torque Wrench	4/18/2018	Annual	4/18/2019	1445
Anritsu	ML2495A	Power Meter	10/22/2017	Annual	10/22/2018	941001

Measurement Uncertainty = $\pm 23\%$ (k=2)

	Name	Function	Signature
Calibrated By:	Brodie Halfoster	Test Engineer	<i>BRODIE HALFOSTER</i>
Approved By:	Kaitlin O'Keefe	Senior Technical Manager	<i>KOK</i>

DIPOLE CALIBRATION EXTENSION

Per KDB 865664 D01, calibration intervals of up to three years may be considered for reference dipoles when it is demonstrated that the SAR target, impedance and return loss of a dipole have remained stable according to the following requirements:

1. The measured SAR does not deviate more than 10% from the target on the calibration certificate.
2. The return-loss does not deviate more than 20% from the previous measurement and meets the required 20dB minimum return-loss requirement.
3. The measurement of real or imaginary parts of impedance does not deviate more than 5Ω from the previous measurement.

The following dipole was checked to pass the above 3 requirements to have 2-year calibration period from the calibration date:

Calibration Date	Extension Date	Certificate Electrical Delay (ns)	Certificate SAR Target Head (1g) W/kg @ 20.0 dBm	Measured Head SAR (1g) W/kg @ 20.0 dBm	Deviation 1g (%)	Certificate SAR Target Head (10g) W/kg @ 20.0 dBm	Measured Head SAR (10g) W/kg @ 20.0 dBm	Deviation 10g (%)	Certificate Impedance Head (Ohm) Real	Measured Impedance Head (Ohm) Real	Difference (Ohm) Real	Certificate Impedance Head (Ohm) Imaginary	Measured Impedance Head (Ohm) Imaginary	Difference (Ohm) Imaginary	Certificate Return Loss Head (dB)	Measured Return Loss Head (dB)	Deviation (%)	PASS/FAIL
5/9/2017	5/9/2018	1.223	3.64	3.55	-1.37%	1.53	1.51	-1.04%	49.8	49.0	0.8	-0.7	0.1	0.8	-42.9	-38.7	9.90%	PASS
Calibration Date	Extension Date	Certificate Electrical Delay (ns)	Certificate SAR Target Body (1g) W/kg @ 20.0 dBm	Measured Body SAR (1g) W/kg @ 20.0 dBm	Deviation 1g (%)	Certificate SAR Target Body (10g) W/kg @ 20.0 dBm	Measured Body SAR (10g) W/kg @ 20.0 dBm	Deviation 10g (%)	Certificate Impedance Body (Ohm) Real	Measured Impedance Body (Ohm) Real	Difference (Ohm) Real	Certificate Impedance Body (Ohm) Imaginary	Measured Impedance Body (Ohm) Imaginary	Difference (Ohm) Imaginary	Certificate Return Loss Body (dB)	Measured Return Loss Body (dB)	Deviation (%)	PASS/FAIL
5/9/2017	5/9/2018	1.223	3.7	3.88	4.86%	1.98	2.06	4.04%	45.7	45.4	0.3	-0.5	-2.6	2.1	-26.9	-25.0	7.20%	PASS

Impedance & Return-Loss Measurement Plot for Head TSL

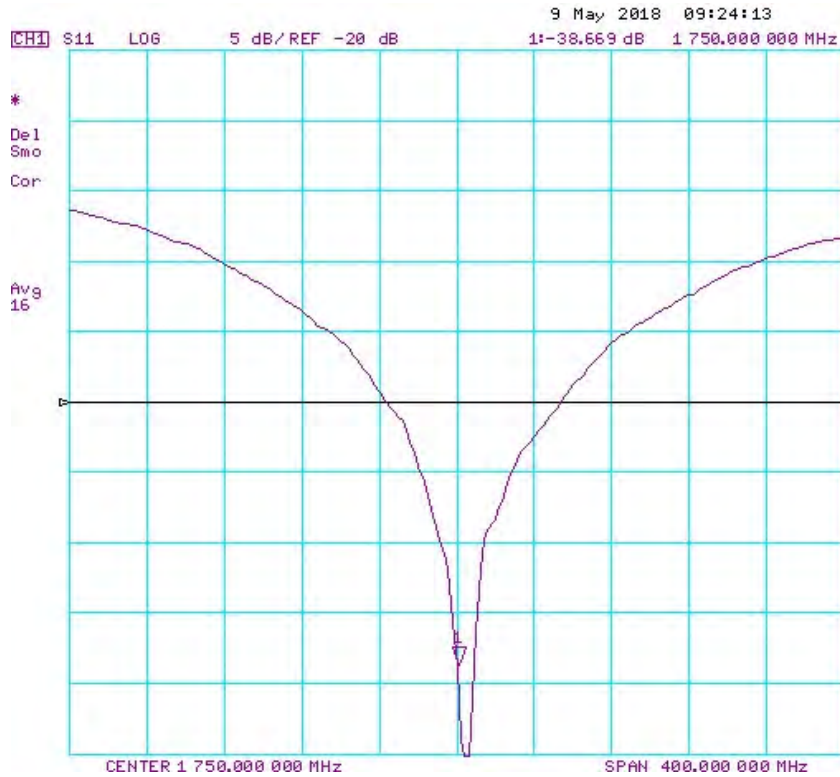
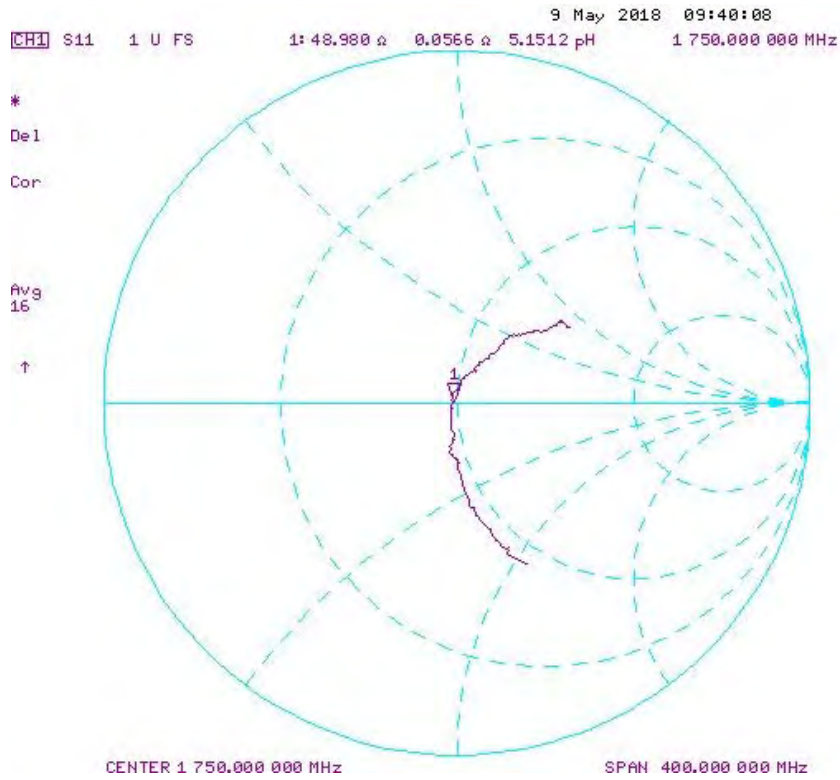

Impedance & Return-Loss Measurement Plot for Body TSL

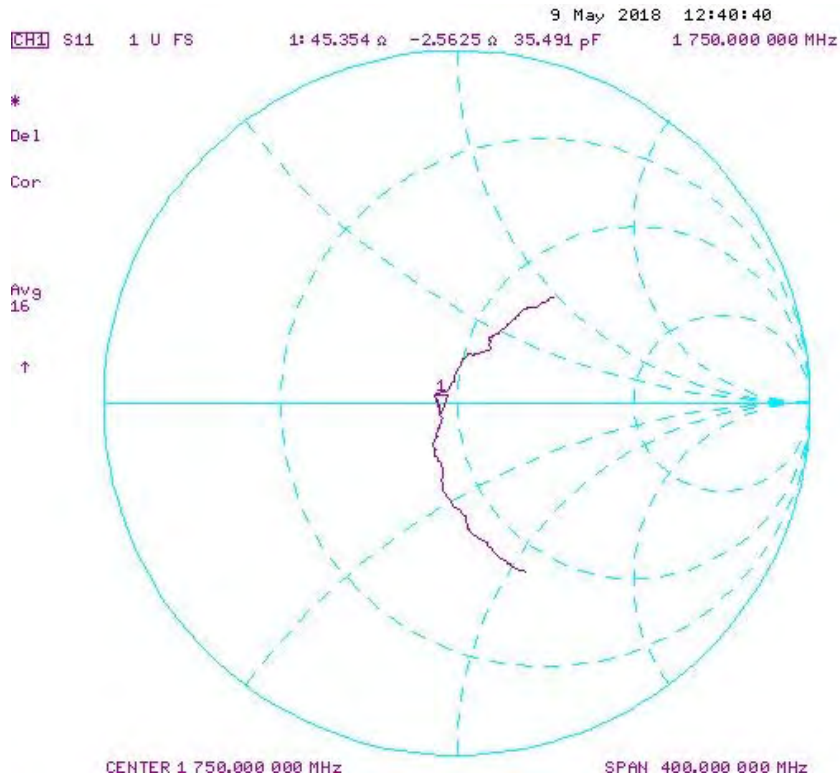



Accredited by the Swiss Accreditation Service (SAS)
The Swiss Accreditation Service is one of the signatories to the EA
Multilateral Agreement for the recognition of calibration certificates

Accreditation No.: **SCS 0108**

Client **PC Test**

Certificate No: **D1900V2-5d149_Oct18**

CALIBRATION CERTIFICATE

Object **D1900V2 - SN:5d149**

Calibration procedure(s) **QA CAL-05.v10
Calibration procedure for dipole validation kits above 700 MHz**

Calibration date: **October 23, 2018**

*BNV
10-30-2018*

This calibration certificate documents the traceability to national standards, which realize the physical units of measurements (SI).
The measurements and the uncertainties with confidence probability are given on the following pages and are part of the certificate.

All calibrations have been conducted in the closed laboratory facility: environment temperature $(22 \pm 3)^\circ\text{C}$ and humidity $< 70\%$.

Calibration Equipment used (M&TE critical for calibration)

Primary Standards	ID #	Cal Date (Certificate No.)	Scheduled Calibration
Power meter NRP	SN: 104778	04-Apr-18 (No. 217-02672/02673)	Apr-19
Power sensor NRP-Z91	SN: 103244	04-Apr-18 (No. 217-02672)	Apr-19
Power sensor NRP-Z91	SN: 103245	04-Apr-18 (No. 217-02673)	Apr-19
Reference 20 dB Attenuator	SN: 5058 (20k)	04-Apr-18 (No. 217-02682)	Apr-19
Type-N mismatch combination	SN: 5047.2 / 06327	04-Apr-18 (No. 217-02683)	Apr-19
Reference Probe EX3DV4	SN: 7349	30-Dec-17 (No. EX3-7349_Dec17)	Dec-18
DAE4	SN: 601	04-Oct-18 (No. DAE4-601_Oct18)	Oct-19

Secondary Standards	ID #	Check Date (in house)	Scheduled Check
Power meter EPM-442A	SN: GB37480704	07-Oct-15 (in house check Oct-18)	In house check: Oct-20
Power sensor HP 8481A	SN: US37292783	07-Oct-15 (in house check Oct-18)	In house check: Oct-20
Power sensor HP 8481A	SN: MY41092317	07-Oct-15 (in house check Oct-18)	In house check: Oct-20
RF generator R&S SMT-06	SN: 100972	15-Jun-15 (in house check Oct-18)	In house check: Oct-20
Network Analyzer Agilent E8358A	SN: US41080477	31-Mar-14 (in house check Oct-18)	In house check: Oct-19

Calibrated by: **Jeton Kastrati** **Function: Laboratory Technician**

Approved by: **Katja Pokovic** **Technical Manager**

Signature
[Handwritten signatures]

Issued: October 23, 2018

This calibration certificate shall not be reproduced except in full without written approval of the laboratory.



Accredited by the Swiss Accreditation Service (SAS)
The Swiss Accreditation Service is one of the signatories to the EA
Multilateral Agreement for the recognition of calibration certificates

Accreditation No.: **SCS 0108**

Glossary:

TSL	tissue simulating liquid
ConvF	sensitivity in TSL / NORM x,y,z
N/A	not applicable or not measured

Calibration is Performed According to the Following Standards:

- IEEE Std 1528-2013, "IEEE Recommended Practice for Determining the Peak Spatial-Averaged Specific Absorption Rate (SAR) in the Human Head from Wireless Communications Devices: Measurement Techniques", June 2013
- IEC 62209-1, "Measurement procedure for the assessment of Specific Absorption Rate (SAR) from hand-held and body-mounted devices used next to the ear (frequency range of 300 MHz to 6 GHz)", July 2016
- IEC 62209-2, "Procedure to determine the Specific Absorption Rate (SAR) for wireless communication devices used in close proximity to the human body (frequency range of 30 MHz to 6 GHz)", March 2010
- KDB 865664, "SAR Measurement Requirements for 100 MHz to 6 GHz"

Additional Documentation:

- DASY4/5 System Handbook

Methods Applied and Interpretation of Parameters:

- Measurement Conditions:** Further details are available from the Validation Report at the end of the certificate. All figures stated in the certificate are valid at the frequency indicated.
- Antenna Parameters with TSL:** The dipole is mounted with the spacer to position its feed point exactly below the center marking of the flat phantom section, with the arms oriented parallel to the body axis.
- Feed Point Impedance and Return Loss:** These parameters are measured with the dipole positioned under the liquid filled phantom. The impedance stated is transformed from the measurement at the SMA connector to the feed point. The Return Loss ensures low reflected power. No uncertainty required.
- Electrical Delay:** One-way delay between the SMA connector and the antenna feed point. No uncertainty required.
- SAR measured:** SAR measured at the stated antenna input power.
- SAR normalized:** SAR as measured, normalized to an input power of 1 W at the antenna connector.
- SAR for nominal TSL parameters:** The measured TSL parameters are used to calculate the nominal SAR result.

The reported uncertainty of measurement is stated as the standard uncertainty of measurement multiplied by the coverage factor $k=2$, which for a normal distribution corresponds to a coverage probability of approximately 95%.

Measurement Conditions

DASY system configuration, as far as not given on page 1.

DASY Version	DASY5	V52.10.2
Extrapolation	Advanced Extrapolation	
Phantom	Modular Flat Phantom	
Distance Dipole Center - TSL	10 mm	with Spacer
Zoom Scan Resolution	dx, dy, dz = 5 mm	
Frequency	1900 MHz \pm 1 MHz	

Head TSL parameters

The following parameters and calculations were applied.

	Temperature	Permittivity	Conductivity
Nominal Head TSL parameters	22.0 °C	40.0	1.40 mho/m
Measured Head TSL parameters	(22.0 \pm 0.2) °C	40.3 \pm 6 %	1.40 mho/m \pm 6 %
Head TSL temperature change during test	< 0.5 °C	----	----

SAR result with Head TSL

SAR averaged over 1 cm³ (1 g) of Head TSL	Condition	
SAR measured	250 mW input power	9.80 W/kg
SAR for nominal Head TSL parameters	normalized to 1W	39.3 W/kg \pm 17.0 % (k=2)

SAR averaged over 10 cm³ (10 g) of Head TSL	condition	
SAR measured	250 mW input power	5.11 W/kg
SAR for nominal Head TSL parameters	normalized to 1W	20.5 W/kg \pm 16.5 % (k=2)

Body TSL parameters

The following parameters and calculations were applied.

	Temperature	Permittivity	Conductivity
Nominal Body TSL parameters	22.0 °C	53.3	1.52 mho/m
Measured Body TSL parameters	(22.0 \pm 0.2) °C	52.9 \pm 6 %	1.47 mho/m \pm 6 %
Body TSL temperature change during test	< 0.5 °C	----	----

SAR result with Body TSL

SAR averaged over 1 cm³ (1 g) of Body TSL	Condition	
SAR measured	250 mW input power	9.68 W/kg
SAR for nominal Body TSL parameters	normalized to 1W	39.4 W/kg \pm 17.0 % (k=2)

SAR averaged over 10 cm³ (10 g) of Body TSL	condition	
SAR measured	250 mW input power	5.11 W/kg
SAR for nominal Body TSL parameters	normalized to 1W	20.7 W/kg \pm 16.5 % (k=2)

Appendix (Additional assessments outside the scope of SCS 0108)

Antenna Parameters with Head TSL

Impedance, transformed to feed point	52.9 Ω + 6.3 j Ω
Return Loss	- 23.4 dB

Antenna Parameters with Body TSL

Impedance, transformed to feed point	48.5 Ω + 8.2 j Ω
Return Loss	- 21.5 dB

General Antenna Parameters and Design

Electrical Delay (one direction)	1.193 ns
----------------------------------	----------

After long term use with 100W radiated power, only a slight warming of the dipole near the feedpoint can be measured.

The dipole is made of standard semirigid coaxial cable. The center conductor of the feeding line is directly connected to the second arm of the dipole. The antenna is therefore short-circuited for DC-signals. On some of the dipoles, small end caps are added to the dipole arms in order to improve matching when loaded according to the position as explained in the "Measurement Conditions" paragraph. The SAR data are not affected by this change. The overall dipole length is still according to the Standard.

No excessive force must be applied to the dipole arms, because they might bend or the soldered connections near the feedpoint may be damaged.

Additional EUT Data

Manufactured by	SPEAG
Manufactured on	March 11, 2011

DASY5 Validation Report for Head TSL

Date: 23.10.2018

Test Laboratory: SPEAG, Zurich, Switzerland

DUT: Dipole 1900 MHz; Type: D1900V2; Serial: D1900V2 - SN:5d149

Communication System: UID 0 - CW; Frequency: 1900 MHz

Medium parameters used: $f = 1900$ MHz; $\sigma = 1.4$ S/m; $\epsilon_r = 40.3$; $\rho = 1000$ kg/m³

Phantom section: Flat Section

Measurement Standard: DASY5 (IEEE/IEC/ANSI C63.19-2011)

DASY52 Configuration:

- Probe: EX3DV4 - SN7349; ConvF(8.18, 8.18, 8.18) @ 1900 MHz; Calibrated: 30.12.2017
- Sensor-Surface: 1.4mm (Mechanical Surface Detection)
- Electronics: DAE4 Sn601; Calibrated: 04.10.2018
- Phantom: Flat Phantom 5.0 (front); Type: QD 000 P50 AA; Serial: 1001
- DASY52 52.10.2(1495); SEMCAD X 14.6.12(7450)

Dipole Calibration for Head Tissue/Pin=250 mW, d=10mm/Zoom Scan (7x7x7)/Cube 0:

Measurement grid: dx=5mm, dy=5mm, dz=5mm

Reference Value = 110.0 V/m; Power Drift = -0.03 dB

Peak SAR (extrapolated) = 18.5 W/kg

SAR(1 g) = 9.8 W/kg; SAR(10 g) = 5.11 W/kg

Maximum value of SAR (measured) = 15.4 W/kg

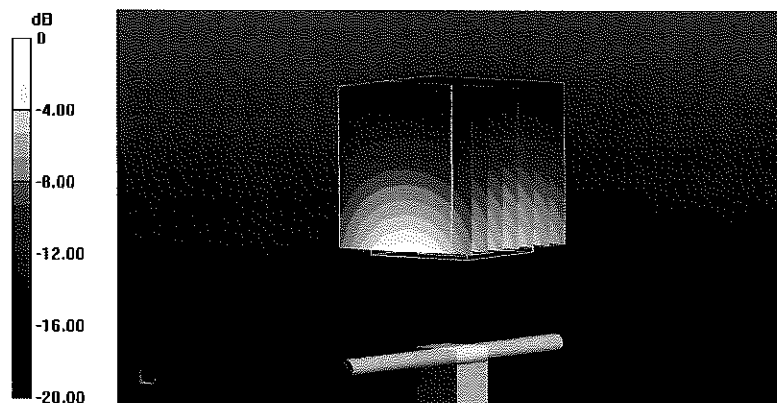

0 dB = 15.4 W/kg = 11.88 dBW/kg

Impedance Measurement Plot for Head TSL

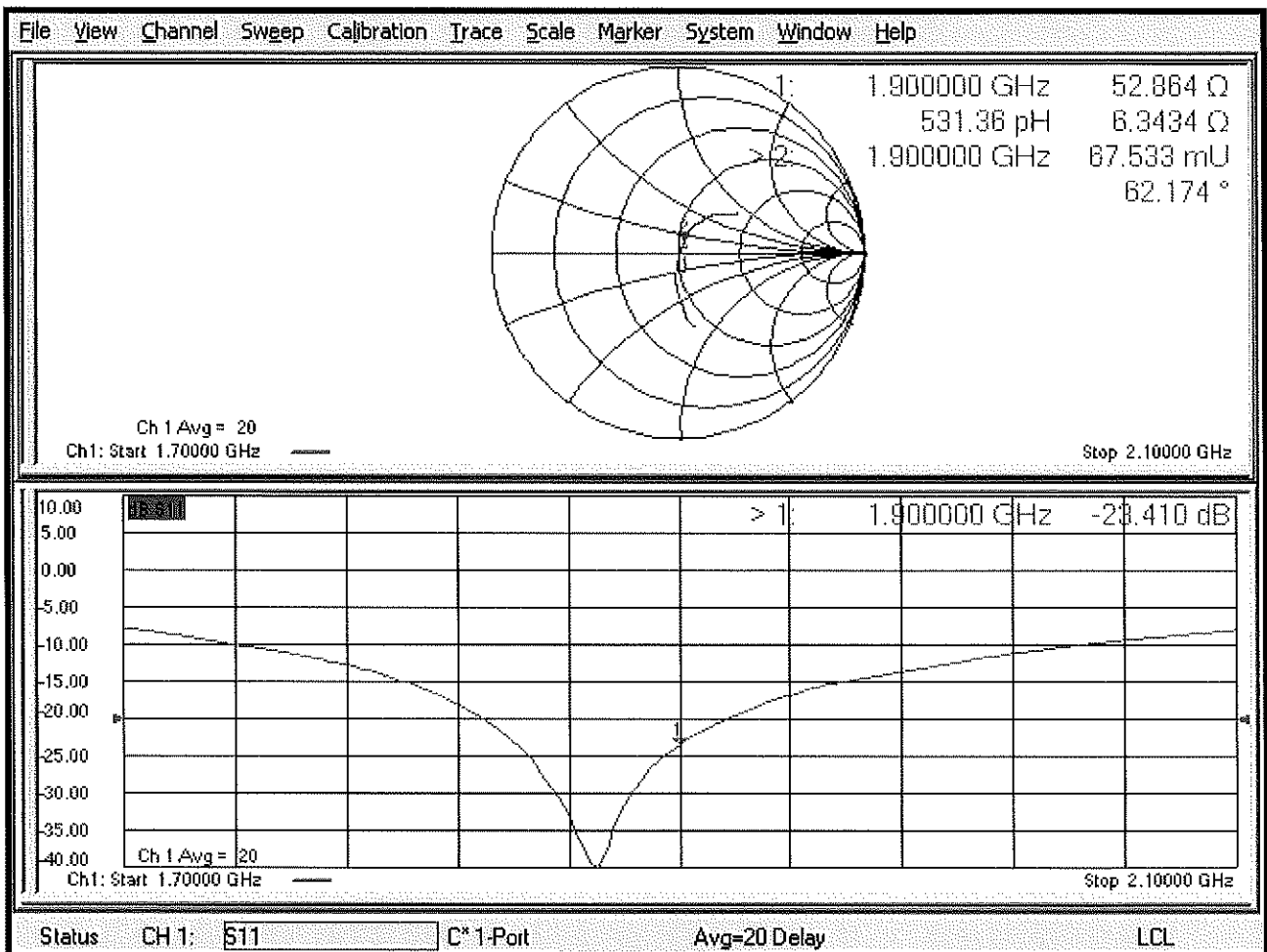

DASY5 Validation Report for Body TSL

Date: 23.10.2018

Test Laboratory: SPEAG, Zurich, Switzerland

DUT: Dipole 1900 MHz; Type: D1900V2; Serial: D1900V2 - SN:5d149

Communication System: UID 0 - CW; Frequency: 1900 MHz

Medium parameters used: $f = 1900$ MHz; $\sigma = 1.47$ S/m; $\epsilon_r = 52.9$; $\rho = 1000$ kg/m³

Phantom section: Flat Section

Measurement Standard: DASY5 (IEEE/IEC/ANSI C63.19-2011)

DASY52 Configuration:

- Probe: EX3DV4 - SN7349; ConvF(8.15, 8.15, 8.15) @ 1900 MHz; Calibrated: 30.12.2017
- Sensor-Surface: 1.4mm (Mechanical Surface Detection)
- Electronics: DAE4 Sn601; Calibrated: 04.10.2018
- Phantom: Flat Phantom 5.0 (back); Type: QD 000 P50 AA; Serial: 1002
- DASY52 52.10.2(1495); SEMCAD X 14.6.12(7450)

Dipole Calibration for Body Tissue/Pin=250 mW, d=10mm/Zoom Scan (7x7x7)/Cube 0:

Measurement grid: dx=5mm, dy=5mm, dz=5mm

Reference Value = 103.1 V/m; Power Drift = -0.03 dB

Peak SAR (extrapolated) = 17.5 W/kg

SAR(1 g) = 9.68 W/kg; SAR(10 g) = 5.11 W/kg

Maximum value of SAR (measured) = 14.2 W/kg

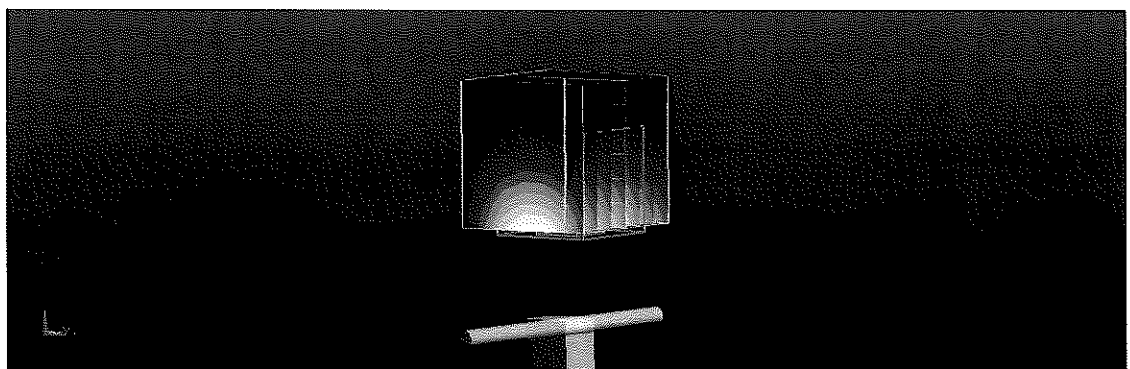
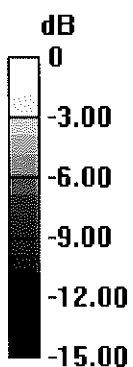

0 dB = 14.2 W/kg = 11.52 dBW/kg

Impedance Measurement Plot for Body TSL

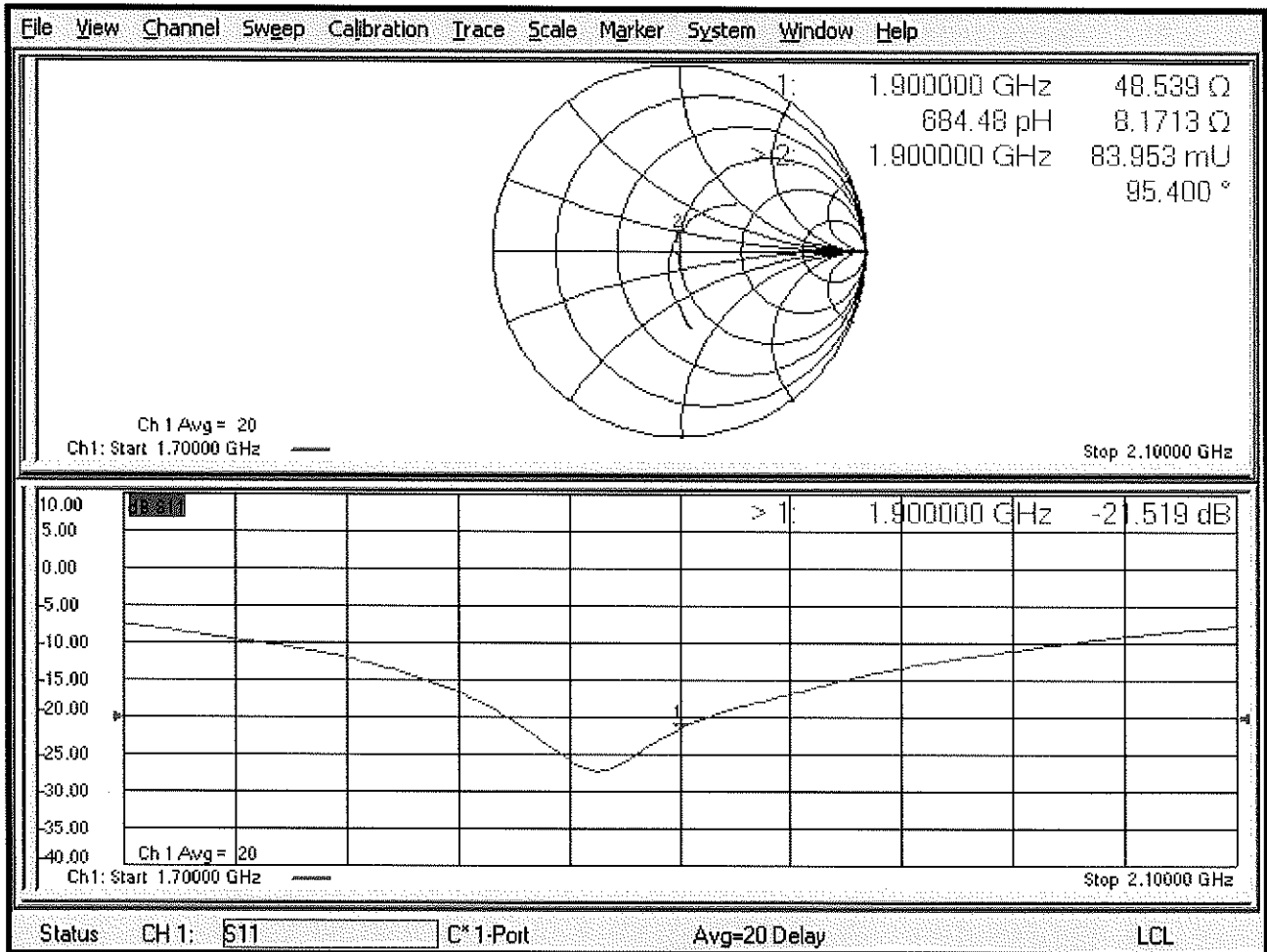

**Calibration Laboratory of
Schmid & Partner
Engineering AG**
Zeughausstrasse 43, 8004 Zurich, Switzerland



S Schweizerischer Kallbrlerdienst
C Service suisse d'etalonnage
S Servizio svizzero di taratura
S Swiss Callbration Service

Accredited by the Swiss Accreditation Service (SAS)
The Swiss Accreditation Service is one of the signatories to the EA
Multilateral Agreement for the recognition of calibration certificates

Accreditation No.: **SCS 0108**

Client **PC Test**

Certificate No: **D2450V2-797_Sep17**

CALIBRATION CERTIFICATE

Object **D2450V2 - SN:797**

Calibration procedure(s) **QA CAL-05.v9**
Calibration procedure for dipole validation kits above 700 MHz

Calibration date: **September 11, 2017**

SCV
10/03/2017
Extended PMV
9/20/2018

This calibration certificate documents the traceability to national standards, which realize the physical units of measurements (SI).
The measurements and the uncertainties with confidence probability are given on the following pages and are part of the certificate.

All calibrations have been conducted in the closed laboratory facility: environment temperature (22 ± 3)°C and humidity < 70%.

Calibration Equipment used (M&TE critical for calibration)

Primary Standards	ID #	Cal Date (Certificate No.)	Scheduled Calibration
Power meter NRP	SN: 104778	04-Apr-17 (No. 217-02521/02522)	Apr-18
Power sensor NRP-Z91	SN: 103244	04-Apr-17 (No. 217-02521)	Apr-18
Power sensor NRP-Z91	SN: 103245	04-Apr-17 (No. 217-02522)	Apr-18
Reference 20 dB Attenuator	SN: 5058 (20k)	07-Apr-17 (No. 217-02528)	Apr-18
Type-N mismatch combination	SN: 5047.2 / 08327	07-Apr-17 (No. 217-02529)	Apr-18
Reference Probe EX3DV4	SN: 7349	31-May-17 (No. EX3-7349_May17)	May-18
DAE4	SN: 601	28-Mar-17 (No. DAE4-601_Mar17)	Mar-18
Secondary Standards	ID #	Check Date (in house)	Scheduled Check
Power meter EPM-442A	SN: GB37480704	07-Oct-15 (in house check Oct-16)	In house check: Oct-18
Power sensor HP 8481A	SN: US37292783	07-Oct-15 (in house check Oct-16)	In house check: Oct-18
Power sensor HP 8481A	SN: MY41092317	07-Oct-15 (in house check Oct-16)	In house check: Oct-18
RF generator R&S SMT-08	SN: 100972	15-Jun-15 (in house check Oct-16)	In house check: Oct-18
Network Analyzer HP 8753E	SN: US37390585	18-Oct-01 (in house check Oct-16)	In house check: Oct-17

Calibrated by: **Michael Weber** Name: Michael Weber Function: Laboratory Technician

Approved by: **Katja Pokovic** Name: Katja Pokovic Function: Technical Manager

Signature
M. Weber
K. Pokovic

Issued: September 11, 2017

This calibration certificate shall not be reproduced except in full without written approval of the laboratory.

**Calibration Laboratory of
Schmid & Partner
Engineering AG**
Zeughausstrasse 43, 8004 Zurich, Switzerland



S Schweizerischer Kalibrierdienst
C Service suisse d'étalonnage
S Servizio svizzero di taratura
S Swiss Calibration Service

Accredited by the Swiss Accreditation Service (SAS)
The Swiss Accreditation Service is one of the signatories to the EA
Multilateral Agreement for the recognition of calibration certificates

Accreditation No.: **SCS 0108**

Glossary:

TSL tissue simulating liquid
ConvF sensitivity in TSL / NORM x,y,z
N/A not applicable or not measured

Calibration is Performed According to the Following Standards:

- a) IEEE Std 1528-2013, "IEEE Recommended Practice for Determining the Peak Spatial-Averaged Specific Absorption Rate (SAR) in the Human Head from Wireless Communications Devices: Measurement Techniques", June 2013
- b) IEC 62209-1, "Measurement procedure for the assessment of Specific Absorption Rate (SAR) from hand-held and body-mounted devices used next to the ear (frequency range of 300 MHz to 6 GHz)", July 2016
- c) IEC 62209-2, "Procedure to determine the Specific Absorption Rate (SAR) for wireless communication devices used in close proximity to the human body (frequency range of 30 MHz to 6 GHz)", March 2010
- d) KDB 865664, "SAR Measurement Requirements for 100 MHz to 6 GHz"

Additional Documentation:

- e) DASY4/5 System Handbook

Methods Applied and Interpretation of Parameters:

- *Measurement Conditions:* Further details are available from the Validation Report at the end of the certificate. All figures stated in the certificate are valid at the frequency indicated.
- *Antenna Parameters with TSL:* The dipole is mounted with the spacer to position its feed point exactly below the center marking of the flat phantom section, with the arms oriented parallel to the body axis.
- *Feed Point Impedance and Return Loss:* These parameters are measured with the dipole positioned under the liquid filled phantom. The impedance stated is transformed from the measurement at the SMA connector to the feed point. The Return Loss ensures low reflected power. No uncertainty required.
- *Electrical Delay:* One-way delay between the SMA connector and the antenna feed point. No uncertainty required.
- *SAR measured:* SAR measured at the stated antenna input power.
- *SAR normalized:* SAR as measured, normalized to an input power of 1 W at the antenna connector.
- *SAR for nominal TSL parameters:* The measured TSL parameters are used to calculate the nominal SAR result.

The reported uncertainty of measurement is stated as the standard uncertainty of measurement multiplied by the coverage factor $k=2$, which for a normal distribution corresponds to a coverage probability of approximately 95%.

Measurement Conditions

DASY system configuration, as far as not given on page 1.

DASY Version	DASY5	V52.10.0
Extrapolation	Advanced Extrapolation	
Phantom	Modular Flat Phantom	
Distance Dipole Center - TSL	10 mm	with Spacer
Zoom Scan Resolution	dx, dy, dz = 5 mm	
Frequency	2450 MHz ± 1 MHz	

Head TSL parameters

The following parameters and calculations were applied.

	Temperature	Permittivity	Conductivity
Nominal Head TSL parameters	22.0 °C	39.2	1.80 mho/m
Measured Head TSL parameters	(22.0 ± 0.2) °C	37.8 ± 6 %	1.86 mho/m ± 6 %
Head TSL temperature change during test	< 0.5 °C	----	----

SAR result with Head TSL

SAR averaged over 1 cm ³ (1 g) of Head TSL	Condition	
SAR measured	250 mW input power	13.5 W/kg
SAR for nominal Head TSL parameters	normalized to 1W	52.7 W/kg ± 17.0 % (k=2)

SAR averaged over 10 cm ³ (10 g) of Head TSL	condition	
SAR measured	250 mW input power	6.28 W/kg
SAR for nominal Head TSL parameters	normalized to 1W	24.8 W/kg ± 16.5 % (k=2)

Body TSL parameters

The following parameters and calculations were applied.

	Temperature	Permittivity	Conductivity
Nominal Body TSL parameters	22.0 °C	52.7	1.95 mho/m
Measured Body TSL parameters	(22.0 ± 0.2) °C	51.9 ± 6 %	2.04 mho/m ± 6 %
Body TSL temperature change during test	< 0.5 °C	----	----

SAR result with Body TSL

SAR averaged over 1 cm ³ (1 g) of Body TSL	Condition	
SAR measured	250 mW input power	13.1 W/kg
SAR for nominal Body TSL parameters	normalized to 1W	51.1 W/kg ± 17.0 % (k=2)

SAR averaged over 10 cm ³ (10 g) of Body TSL	condition	
SAR measured	250 mW input power	6.14 W/kg
SAR for nominal Body TSL parameters	normalized to 1W	24.2 W/kg ± 16.5 % (k=2)

Appendix (Additional assessments outside the scope of SCS 0108)

Antenna Parameters with Head TSL

Impedance, transformed to feed point	53.8 Ω + 7.4 j Ω
Return Loss	- 21.9 dB

Antenna Parameters with Body TSL

Impedance, transformed to feed point	49.7 Ω + 9.1 j Ω
Return Loss	- 20.9 dB

General Antenna Parameters and Design

Electrical Delay (one direction)	1.152 ns
----------------------------------	----------

After long term use with 100W radiated power, only a slight warming of the dipole near the feedpoint can be measured.

The dipole is made of standard semirigid coaxial cable. The center conductor of the feeding line is directly connected to the second arm of the dipole. The antenna is therefore short-circuited for DC-signals. On some of the dipoles, small end caps are added to the dipole arms in order to improve matching when loaded according to the position as explained in the "Measurement Conditions" paragraph. The SAR data are not affected by this change. The overall dipole length is still according to the Standard.

No excessive force must be applied to the dipole arms, because they might bend or the soldered connections near the feedpoint may be damaged.

Additional EUT Data

Manufactured by	SPEAG
Manufactured on	January 24, 2006

DASY5 Validation Report for Head TSL

Date: 11.09.2017

Test Laboratory: SPEAG, Zurich, Switzerland

DUT: Dipole 2450 MHz; Type: D2450V2; Serial: D2450V2 - SN: 797

Communication System: UID 0 - CW; Frequency: 2450 MHz

Medium parameters used: $f = 2450$ MHz; $\sigma = 1.86$ S/m; $\epsilon_r = 37.8$; $\rho = 1000$ kg/m³

Phantom section: Flat Section

Measurement Standard: DASY5 (IEEE/IEC/ANSI C63.19-2011)

DASY52 Configuration:

- Probe: EX3DV4 - SN7349; ConvF(8.12, 8.12, 8.12); Calibrated: 31.05.2017;
- Sensor-Surface: 1.4mm (Mechanical Surface Detection)
- Electronics: DAE4 Sn601; Calibrated: 28.03.2017
- Phantom: Flat Phantom 5.0 (front); Type: QD 000 P50 AA; Serial: 1001
- DASY52 52.10.0(1446); SEMCAD X 14.6.10(7417)

Dipole Calibration for Head Tissue/ $P_{in}=250$ mW, $d=10$ mm/Zoom Scan (7x7x7)/Cube 0:

Measurement grid: $dx=5$ mm, $dy=5$ mm, $dz=5$ mm

Reference Value = 113.5 V/m; Power Drift = -0.08 dB

Peak SAR (extrapolated) = 26.9 W/kg

SAR(1 g) = 13.5 W/kg; SAR(10 g) = 6.28 W/kg

Maximum value of SAR (measured) = 21.6 W/kg

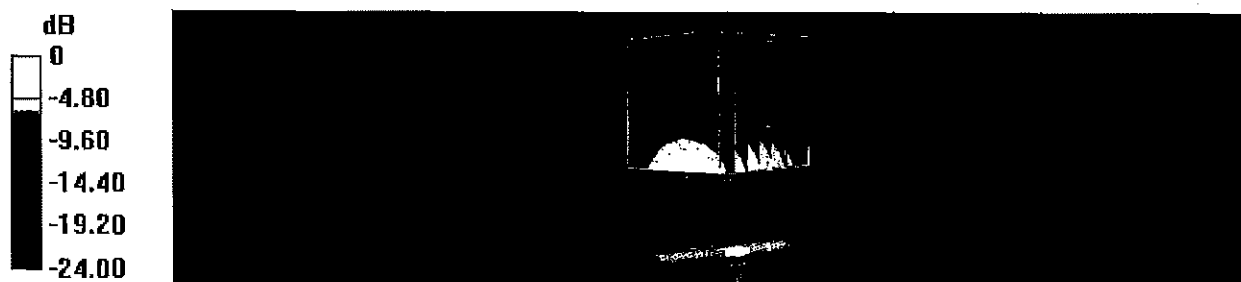

0 dB = 21.6 W/kg = 13.34 dBW/kg

Impedance Measurement Plot for Head TSL

11 Sep 2017 11:52:57

CH1 S11 1 U FS 1: 53.777 Ω 7.4395 Ω 483.28 μ H 2 450.000 000 MHz

*
DeI
CA

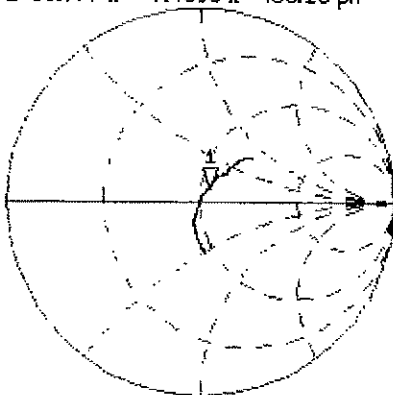

Avg
16

H1d

CH2 S11 LOG 5 dB/REF -20 dB 1: -21.911 dB 2 450.000 000 MHz

CA

Avg
16

H1d

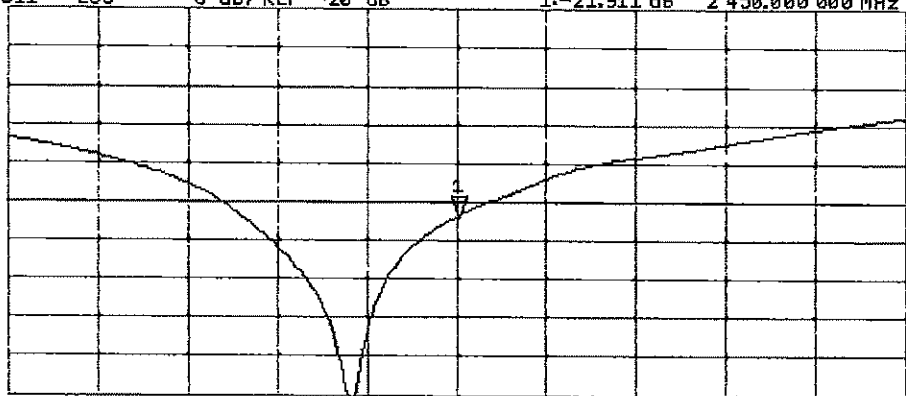

START 2 250.000 000 MHz

STOP 2 650.000 000 MHz

DASY5 Validation Report for Body TSL

Date: 11.09.2017

Test Laboratory: SPEAG, Zurich, Switzerland

DUT: Dipole 2450 MHz; Type: D2450V2; Serial: D2450V2 - SN: 797

Communication System: UID 0 - CW; Frequency: 2450 MHz

Medium parameters used: $f = 2450$ MHz; $\sigma = 2.04$ S/m; $\epsilon_r = 51.9$; $\rho = 1000$ kg/m³

Phantom section: Flat Section

Measurement Standard: DASY5 (IEEE/IEC/ANSI C63.19-2011)

DASY52 Configuration:

- Probe: EX3DV4 - SN7349; ConvF(8.1, 8.1, 8.1); Calibrated: 31.05.2017;
- Sensor-Surface: 1.4mm (Mechanical Surface Detection)
- Electronics: DAB4 Sn601; Calibrated: 28.03.2017
- Phantom: Flat Phantom 5.0 (back); Type: QD 000 P50 AA; Serial: 1002
- DASY52 52.10.0(1446); SEMCAD X 14.6.10(7417)

Dipole Calibration for Body Tissue/Pin=250 mW, d=10mm/Zoom Scan (7x7x7)/Cube 0:

Measurement grid: dx=5mm, dy=5mm, dz=5mm

Reference Value = 105.4 V/m; Power Drift = -0.08 dB

Peak SAR (extrapolated) = 25.6 W/kg

SAR(1 g) = 13.1 W/kg; SAR(10 g) = 6.14 W/kg

Maximum value of SAR (measured) = 20.3 W/kg

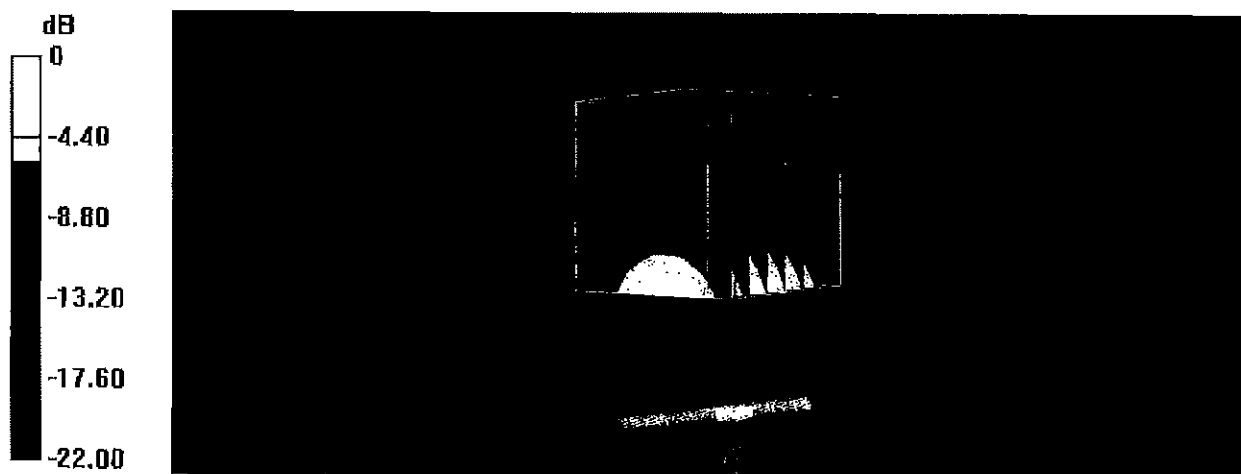

0 dB = 20.3 W/kg = 13.07 dBW/kg

Impedance Measurement Plot for Body TSL

11 Sep 2017 11:52:10

CH1 S11 1 U FS 1: 49.725 Ω 9.0703 Ω 589.22 pF 2 450.000 000 MHz

De1
CA

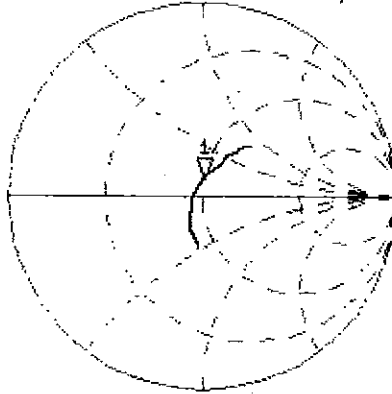

Avg
16

H1d

CH2 S11 LOG 5 dB/REF -20 dB 1: -20.854 dB 2 450.000 000 MHz

CA

Avg
16

H1d

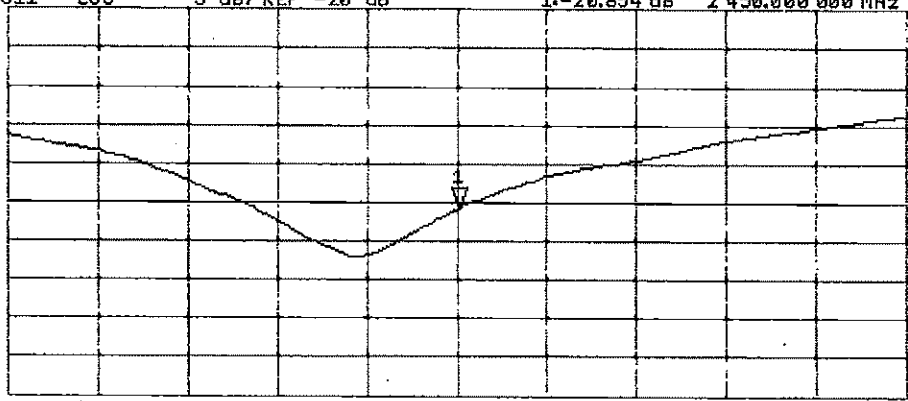

START 2 250.000 000 MHz

STOP 2 650.000 000 MHz

Certification of Calibration

Object: D2450V2 – SN: 797

Calibration procedure(s): Procedure for Calibration Extension for SAR Dipoles.

Extended Calibration date: September 11, 2018

Description: SAR Validation Dipole at 2450 MHz.

Calibration Equipment used:

Manufacturer	Model	Description	Cal Date	Cal Interval	Cal Due	Serial Number
Control Company	4040	Therm./Clock/Humidity Monitor	3/31/2017	Biennial	3/31/2019	170232394
Control Company	4352	Ultra Long Stem Thermometer	5/2/2017	Biennial	5/2/2019	170330156
Amplifier Research	1551G6	Amplifier	CBT	N/A	CBT	433971
Narda	4772-3	Attenuator {3dB}	CBT	N/A	CBT	9406
Keysight	772D	Dual Directional Coupler	CBT	N/A	CBT	MY52180215
Keysight Technologies	85033E	Standard Mechanical Calibration Kit (DC to 9GHz, 3.5mm)	6/4/2018	Annual	6/4/2019	MY53401181
Agilent	8753ES	S-Parameter Vector Network Analyzer	8/30/2018	Annual	8/30/2019	MY40003841
Mini-Circuits	BW-N20W5+	DC to 18 GHz Precision Fixed 20 dB Attenuator	CBT	N/A	CBT	N/A
SPEAG	DAK-3.5	Dielectric Assessment Kit	5/15/2018	Annual	5/15/2019	1070
SPEAG	EX3DV4	SAR Probe	7/20/2018	Annual	7/20/2019	7410
SPEAG	DAE4	Dasy Data Acquisition Electronics	7/11/2018	Annual	7/11/2019	1322
SPEAG	ES3DV3	SAR Probe	3/13/2018	Annual	3/13/2019	3319
SPEAG	DAE4	Dasy Data Acquisition Electronics	3/7/2018	Annual	3/7/2019	1368
Anritsu	MA2411B	Pulse Power Sensor	3/2/2018	Annual	3/2/2019	1207364
Anritsu	MA2411B	Pulse Power Sensor	3/2/2018	Annual	3/2/2019	1339018
Anritsu	ML2495A	Power Meter	10/22/2017	Annual	10/22/2018	1328004
Agilent	NS182A	MXG Vector Signal Generator	4/18/2018	Annual	4/18/2019	MY47420800
Seekonk	NC-100	Torque Wrench	7/11/2018	Annual	7/11/2019	N/A
MiniCircuits	VLF-6000+	Low Pass Filter	CBT	N/A	CBT	N/A
Narda	4014C-6	4 - 8 GHz SMA 6 dB Directional Coupler	CBT	N/A	CBT	N/A

Note: CBT (Calibrated Before Testing). Prior to testing, the measurement paths containing a cable, amplifier, attenuator, coupler or filter were connected to a calibrated source (i.e. a signal generator) to determine the losses of the measurement path.

Measurement Uncertainty = $\pm 23\%$ (k=2)

	Name	Function	Signature
Calibrated By:	Brodie Halfoster	Team Lead Engineer	<i>BRODIE HALFOSTER</i>
Approved By:	Kaitlin O'Keefe	Senior Technical Manager	<i>KOK</i>

DIPOLE CALIBRATION EXTENSION

Per KDB 865664 D01, calibration intervals of up to three years may be considered for reference dipoles when it is demonstrated that the SAR target, impedance and return loss of a dipole have remained stable according to the following requirements:

1. The measured SAR does not deviate more than 10% from the target on the calibration certificate.
2. The return-loss does not deviate more than 20% from the previous measurement and meets the required 20dB minimum return-loss requirement.
3. The measurement of real or imaginary parts of impedance does not deviate more than 5Ω from the previous measurement.

The following dipole was checked to pass the above 3 requirements to have 2-year calibration period from the calibration date:

Calibration Date	Extension Date	Certificate Electrical Delay (ns)	Certificate SAR Target Head (1g) W/kg @ 20.0 dBm	Measured Head SAR (1g) W/kg @ 20.0 dBm	Deviation 1g (%)	Certificate SAR Target Head (10g) W/kg @ 20.0 dBm	Measured Head SAR (10g) W/kg @ 20.0 dBm	Deviation 10g (%)	Certificate Impedance Head (Ohm) Real	Measured Impedance Head (Ohm) Real	Difference (Ohm) Real	Certificate Impedance Head (Ohm) Imaginary	Measured Impedance Head (Ohm) Imaginary	Difference (Ohm) Imaginary	Certificate Return Loss Head (dB)	Measured Return Loss Head (dB)	Deviation (%)	PASS/FAIL
9/11/2017	9/11/2018	1.152	5.27	5.52	4.74%	2.48	2.54	2.42%	53.8	49.8	4	7.4	7.1	0.3	-21.9	-23	-4.80%	PASS

Calibration Date	Extension Date	Certificate Electrical Delay (ns)	Certificate SAR Target Body (1g) W/kg @ 20.0 dBm	Measured Body SAR (1g) W/kg @ 20.0 dBm	Deviation 1g (%)	Certificate SAR Target Body (10g) W/kg @ 20.0 dBm	Measured Body SAR (10g) W/kg @ 20.0 dBm	Deviation 10g (%)	Certificate Impedance Body (Ohm) Real	Measured Impedance Body (Ohm) Real	Difference (Ohm) Real	Certificate Impedance Body (Ohm) Imaginary	Measured Impedance Body (Ohm) Imaginary	Difference (Ohm) Imaginary	Certificate Return Loss Body (dB)	Measured Return Loss Body (dB)	Deviation (%)	PASS/FAIL
9/11/2017	9/11/2018	1.152	5.11	5.17	1.17%	2.42	2.37	-2.07%	49.7	49.8	0.1	9.1	7.2	1.9	-20.9	-22.6	-8.20%	PASS

Impedance & Return-Loss Measurement Plot for Head TSL

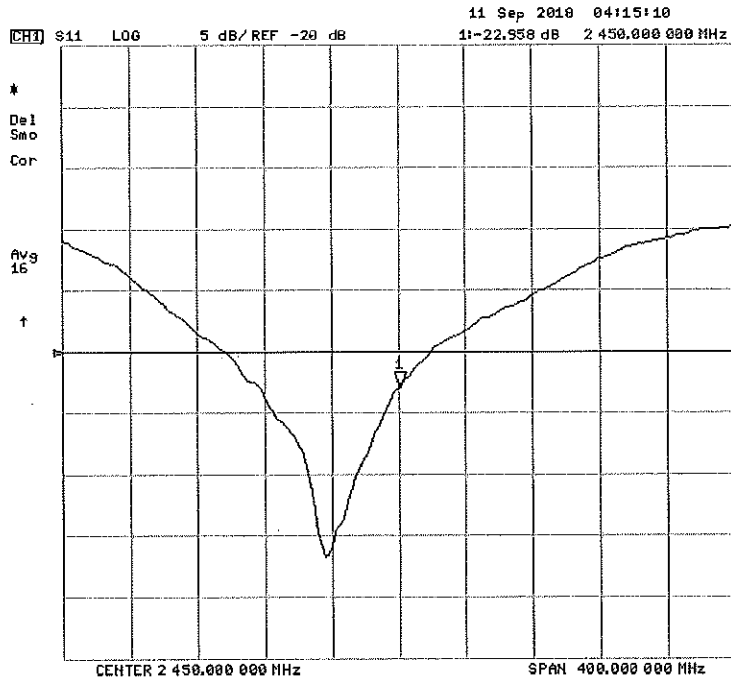
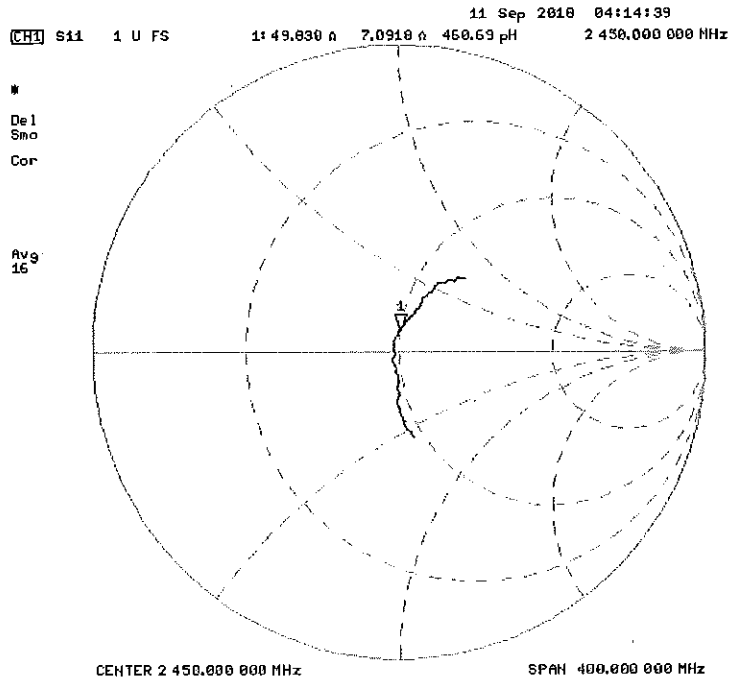

Impedance & Return-Loss Measurement Plot for Body TSL

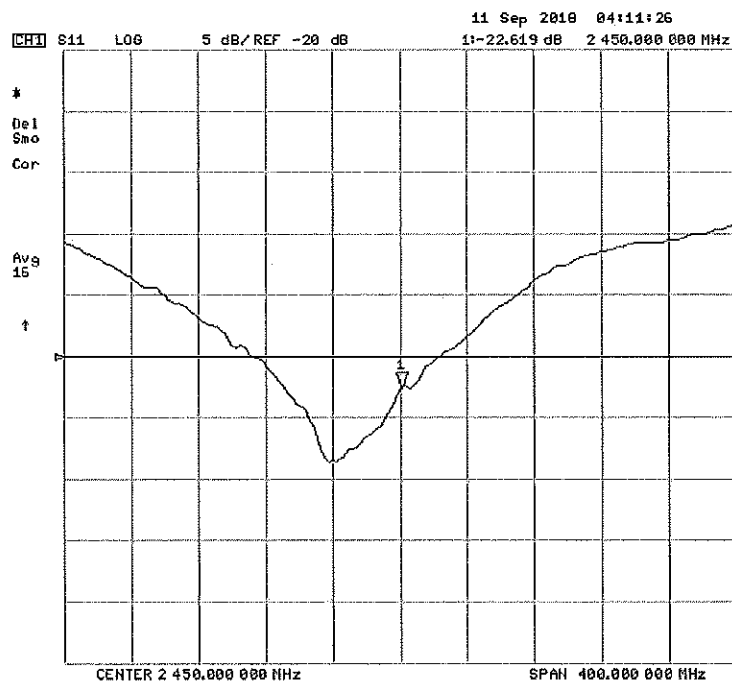
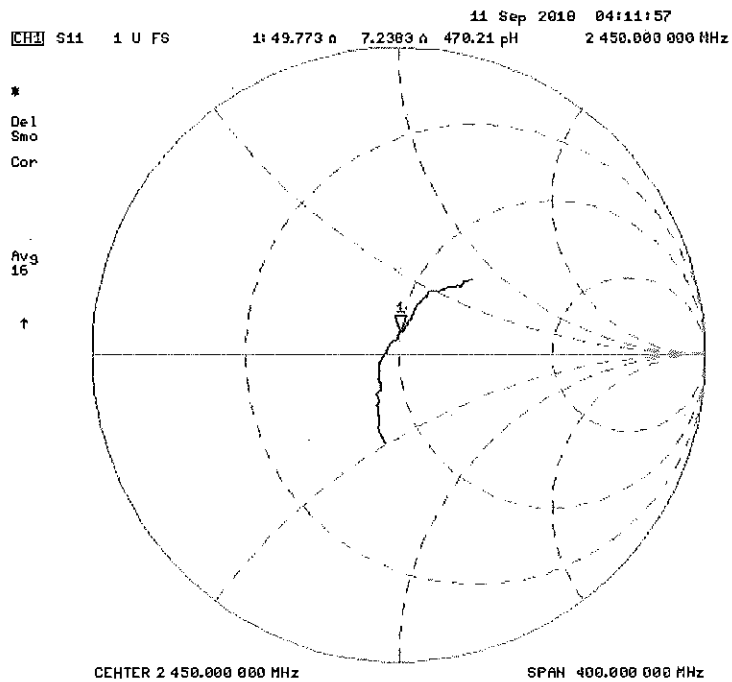



Accredited by the Swiss Accreditation Service (SAS)
The Swiss Accreditation Service is one of the signatories to the EA
Multilateral Agreement for the recognition of calibration certificates

Accreditation No.: **SCS 0108**

Client **PC Test**

Certificate No: **D2600V2-1071_Sep16**

CALIBRATION CERTIFICATE

Object : **D2600V2 - SN:1071**

Calibration procedure(s) : **QA CAL-05.v9**
Calibration procedure for dipole validation kits above 700 MHz.

BNV
09-28-2016

Calibration date: **September 13, 2016**

Extended PM ✓
9/20/2018

This calibration certificate documents the traceability to national standards, which realize the physical units of measurements (SI).
The measurements and the uncertainties with confidence probability are given on the following pages and are part of the certificate.

All calibrations have been conducted in the closed laboratory facility: environment temperature (22 ± 3)°C and humidity < 70%.

Calibration Equipment used (M&TE critical for calibration)

Primary Standards	ID #	Cal Date (Certificate No.)	Scheduled Calibration
Power meter NRP	SN: 104778	06-Apr-16 (No. 217-02288/02289)	Apr-17
Power sensor NRP-Z91	SN: 103244	06-Apr-16 (No. 217-02288)	Apr-17
Power sensor NRP-Z91	SN: 103245	06-Apr-16 (No. 217-02289)	Apr-17
Reference 20 dB Attenuator	SN: 5058 (20k)	05-Apr-16 (No. 217-02292)	Apr-17
Type-N mismatch combination	SN: 5047.2 / 06327	05-Apr-16 (No. 217-02295)	Apr-17
Reference Probe EX3DV4	SN: 7349	15-Jun-16 (No. EX3-7349_Jun16)	Jun-17
DAE4	SN: 601	30-Dec-15 (No. DAE4-601_Dec15)	Dec-16

Secondary Standards	ID #	Check Date (in house)	Scheduled Check
Power meter EPM-442A	SN: GB37480704	07-Oct-15 (No. 217-02222)	In house check: Oct-16
Power sensor HP 8481A	SN: US37292783	07-Oct-15 (No. 217-02222)	In house check: Oct-16
Power sensor HP 8481A	SN: MY41092317	07-Oct-15 (No. 217-02223)	In house check: Oct-16
RF generator R&S SMT-06	SN: 100972	15-Jun-15 (in house check Jun-15)	In house check: Oct-16
Network Analyzer HP 8753E	SN: US37390585	18-Oct-01 (in house check Oct-15)	In house check: Oct-16

Calibrated by: **Jeton Kastalt** Name: **Jeton Kastalt** Function: **Laboratory Technician**

Approved by: **Katja Pokovic** Name: **Katja Pokovic** Function: **Technical Manager**

Signature
[Handwritten Signature]
[Handwritten Signature]

Issued: September 13, 2016

This calibration certificate shall not be reproduced except in full without written approval of the laboratory.

**Calibration Laboratory of
Schmid & Partner
Engineering AG**
Zeughausstrasse 43, 8004 Zurich, Switzerland



S Schweizerischer Kalibrierdienst
C Service suisse d'étalonnage
S Servizio svizzero di taratura
S Swiss Calibration Service

Accredited by the Swiss Accreditation Service (SAS)
The Swiss Accreditation Service is one of the signatories to the EA
Multilateral Agreement for the recognition of calibration certificates

Accreditation No.: **SCS 0108**

Glossary:

TSL tissue simulating liquid
ConvF sensitivity in TSL / NORM x,y,z
N/A not applicable or not measured

Calibration is Performed According to the Following Standards:

- a) IEEE Std 1528-2013, "IEEE Recommended Practice for Determining the Peak Spatial-Averaged Specific Absorption Rate (SAR) in the Human Head from Wireless Communications Devices: Measurement Techniques", June 2013
- b) IEC 62209-1, "Procedure to measure the Specific Absorption Rate (SAR) for hand-held devices used in close proximity to the ear (frequency range of 300 MHz to 3 GHz)", February 2005
- c) IEC 62209-2, "Procedure to determine the Specific Absorption Rate (SAR) for wireless communication devices used in close proximity to the human body (frequency range of 30 MHz to 6 GHz)", March 2010
- d) KDB 865664, "SAR Measurement Requirements for 100 MHz to 6 GHz"

Additional Documentation:

- e) DASY4/5 System Handbook

Methods Applied and Interpretation of Parameters:

- *Measurement Conditions:* Further details are available from the Validation Report at the end of the certificate. All figures stated in the certificate are valid at the frequency indicated.
- *Antenna Parameters with TSL:* The dipole is mounted with the spacer to position its feed point exactly below the center marking of the flat phantom section, with the arms oriented parallel to the body axis.
- *Feed Point Impedance and Return Loss:* These parameters are measured with the dipole positioned under the liquid filled phantom. The impedance stated is transformed from the measurement at the SMA connector to the feed point. The Return Loss ensures low reflected power. No uncertainty required.
- *Electrical Delay:* One-way delay between the SMA connector and the antenna feed point. No uncertainty required.
- *SAR measured:* SAR measured at the stated antenna input power.
- *SAR normalized:* SAR as measured, normalized to an input power of 1 W at the antenna connector.
- *SAR for nominal TSL parameters:* The measured TSL parameters are used to calculate the nominal SAR result.

The reported uncertainty of measurement is stated as the standard uncertainty of measurement multiplied by the coverage factor $k=2$, which for a normal distribution corresponds to a coverage probability of approximately 95%.

Measurement Conditions

DASY system configuration, as far as not given on page 1.

DASY Version	DASY5	V52.8.8
Extrapolation	Advanced Extrapolation	
Phantom	Modular Flat Phantom	
Distance Dipole Center - TSL	10 mm	with Spacer
Zoom Scan Resolution	dx, dy, dz = 5 mm	
Frequency	2600 MHz ± 1 MHz	

Head TSL parameters

The following parameters and calculations were applied.

	Temperature	Permittivity	Conductivity
Nominal Head TSL parameters	22.0 °C	39.0	1.96 mho/m
Measured Head TSL parameters	(22.0 ± 0.2) °C	37.3 ± 6 %	2.05 mho/m ± 6 %
Head TSL temperature change during test	< 0.5 °C	----	----

SAR result with Head TSL

SAR averaged over 1 cm ³ (1 g) of Head TSL	Condition	
SAR measured	250 mW input power	14.5 W/kg
SAR for nominal Head TSL parameters	normalized to 1W	56.3 W/kg ± 17.0 % (k=2)

SAR averaged over 10 cm ³ (10 g) of Head TSL	condition	
SAR measured	250 mW input power	6.45 W/kg
SAR for nominal Head TSL parameters	normalized to 1W	25.3 W/kg ± 16.5 % (k=2)

Body TSL parameters

The following parameters and calculations were applied.

	Temperature	Permittivity	Conductivity
Nominal Body TSL parameters	22.0 °C	52.5	2.16 mho/m
Measured Body TSL parameters	(22.0 ± 0.2) °C	51.1 ± 6 %	2.22 mho/m ± 6 %
Body TSL temperature change during test	< 0.5 °C	----	----

SAR result with Body TSL

SAR averaged over 1 cm ³ (1 g) of Body TSL	Condition	
SAR measured	250 mW input power	13.8 W/kg
SAR for nominal Body TSL parameters	normalized to 1W	54.2 W/kg ± 17.0 % (k=2)

SAR averaged over 10 cm ³ (10 g) of Body TSL	condition	
SAR measured	250 mW input power	6.20 W/kg
SAR for nominal Body TSL parameters	normalized to 1W	24.5 W/kg ± 16.5 % (k=2)

Appendix (Additional assessments outside the scope of SCS 0108)

Antenna Parameters with Head TSL

Impedance, transformed to feed point	49.9 Ω - 6.7 j Ω
Return Loss	-23.5 dB

Antenna Parameters with Body TSL

Impedance, transformed to feed point	46.1 Ω - 2.1 j Ω
Return Loss	-26.7 dB

General Antenna Parameters and Design

Electrical Delay (one direction)	1.153 ns
----------------------------------	----------

After long term use with 100W radiated power, only a slight warming of the dipole near the feedpoint can be measured.

The dipole is made of standard semirigid coaxial cable. The center conductor of the feeding line is directly connected to the second arm of the dipole. The antenna is therefore short-circuited for DC-signals. On some of the dipoles, small end caps are added to the dipole arms in order to improve matching when loaded according to the position as explained in the "Measurement Conditions" paragraph. The SAR data are not affected by this change. The overall dipole length is still according to the Standard.

No excessive force must be applied to the dipole arms, because they might bend or the soldered connections near the feedpoint may be damaged.

Additional EUT Data

Manufactured by	SPEAG
Manufactured on	July 17, 2013

DASY5 Validation Report for Head TSL

Date: 13.09.2016

Test Laboratory: SPEAG, Zurich, Switzerland

DUT: Dipole 2600 MHz; Type: D2600V2; Serial: D2600V2 - SN:1071

Communication System: UID 0 - CW; Frequency: 2600 MHz

Medium parameters used: $f = 2600$ MHz; $\sigma = 2.05$ S/m; $\epsilon_r = 37.3$; $\rho = 1000$ kg/m³

Phantom section: Flat Section

Measurement Standard: DASY5 (IEBE/IEC/ANSI C63.19-2011)

DASY52 Configuration:

- Probe: EX3DV4 - SN7349; ConvF(7.56, 7.56, 7.56); Calibrated: 15.06.2016;
- Sensor-Surface: 1.4mm (Mechanical Surface Detection)
- Electronics: DAB4 Sn601; Calibrated: 30.12.2015
- Phantom: Flat Phantom 5.0 (front); Type: QD000P50AA; Serial: 1001
- DASY52 52.8.8(1258); SEMCAD X 14.6.10(7372)

Dipole Calibration for Head Tissue/Pin=250 mW, d=10mm/Zoom Scan (7x7x7)/Cube 0:

Measurement grid: dx=5mm, dy=5mm, dz=5mm

Reference Value = 115.1 V/m; Power Drift = -0.02 dB

Peak SAR (extrapolated) = 30.4 W/kg

SAR(1 g) = 14.5 W/kg; SAR(10 g) = 6.45 W/kg

Maximum value of SAR (measured) = 24.6 W/kg



Impedance Measurement Plot for Head TSL

CH1 S11 1 U F8 12 Sep 2016 13:13:44
 4: 49.902 Ω -6.6523 Ω 9.2010 pF 2 600.000 000 MHz

*
 De l
 CA
 Avg
 16
 H1 d

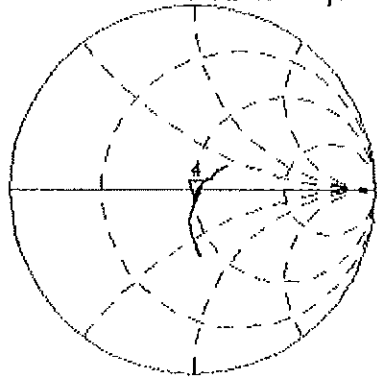

CH2 S11 LOG 5 dB/REF -20 dB 4: -23.548 dB 2 600.000 000 MHz

CA
 Avg
 16
 H1 d

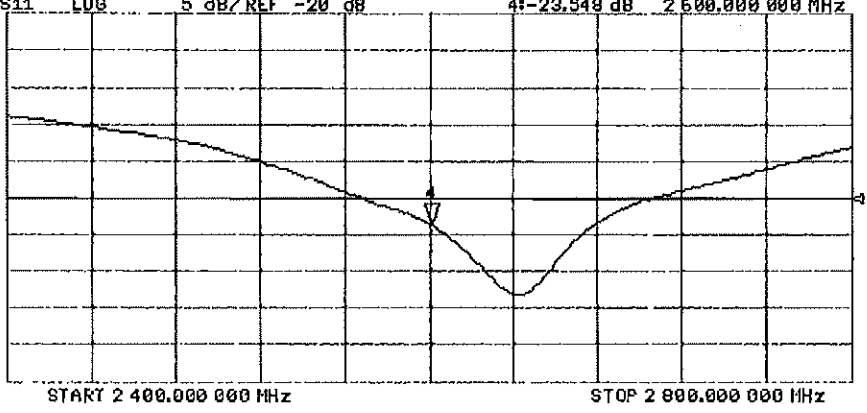

DASY5 Validation Report for Body TSL

Date: 13.09.2016

Test Laboratory: SPEAG, Zurich, Switzerland

DUT: Dipole 2600 MHz; Type: D2600V2; Serial: D2600V2 - SN:1071

Communication System: UID 0 - CW; Frequency: 2600 MHz

Medium parameters used: $f = 2600$ MHz; $\sigma = 2.22$ S/m; $\epsilon_r = 51.1$; $\rho = 1000$ kg/m³

Phantom section: Flat Section

Measurement Standard: DASY5 (IEEE/IEC/ANSI C63.19-2011)

DASY52 Configuration:

- Probe: EX3DV4 - SN7349; ConvF(7.48, 7.48, 7.48); Calibrated: 15.06.2016;
- Sensor-Surface: 1.4mm (Mechanical Surface Detection)
- Electronics: DAE4 Sn601; Calibrated: 30.12.2015
- Phantom: Flat Phantom 5.0 (back); Type: QD000P50AA; Serial: 1002
- DASY52 52.8.8(1258); SEMCAD X 14.6.10(7372)

Dipole Calibration for Body Tissue/Pin=250 mW, d=10mm/Zoom Scan (7x7x7)/Cube 0:

Measurement grid: $dx=5$ mm, $dy=5$ mm, $dz=5$ mm

Reference Value = 107.7 V/m; Power Drift = -0.03 dB

Peak SAR (extrapolated) = 28.3 W/kg

SAR(1 g) = 13.8 W/kg; SAR(10 g) = 6.2 W/kg

Maximum value of SAR (measured) = 23.3 W/kg

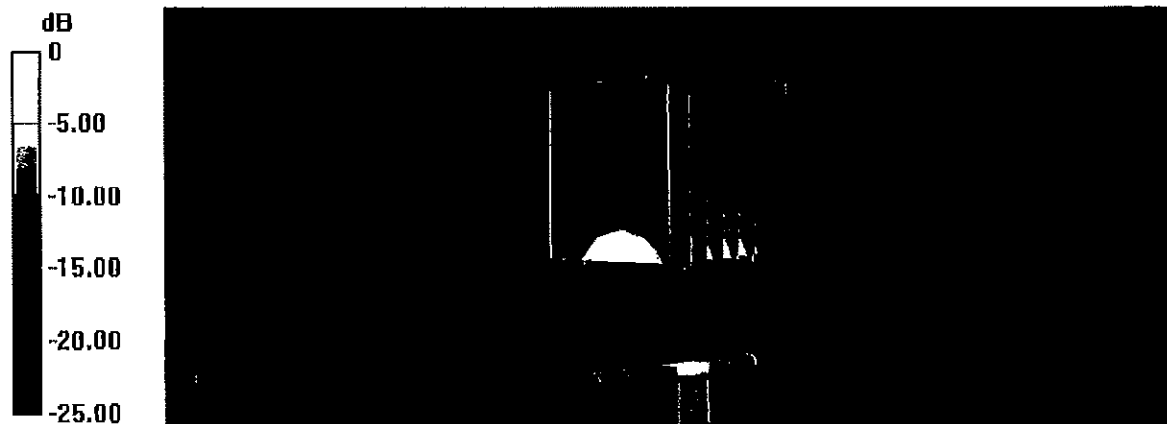

0 dB = 23.3 W/kg = 13.67 dBW/kg

Impedance Measurement Plot for Body TSL

CH1 S11 1 U FS 41 46.078 n -2.0762 n 29.404 pF 12 Sep 2016 13:13:09 2 600.000 000 MHz

*
 De l
 CA

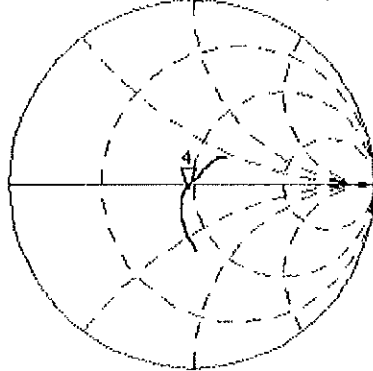

Avg
 16

H1d

CH2 S11 LOG 5 dB/REF -20 dB 41-26.721 dB 2 600.000 000 MHz

CA

Avg
 16

H1d

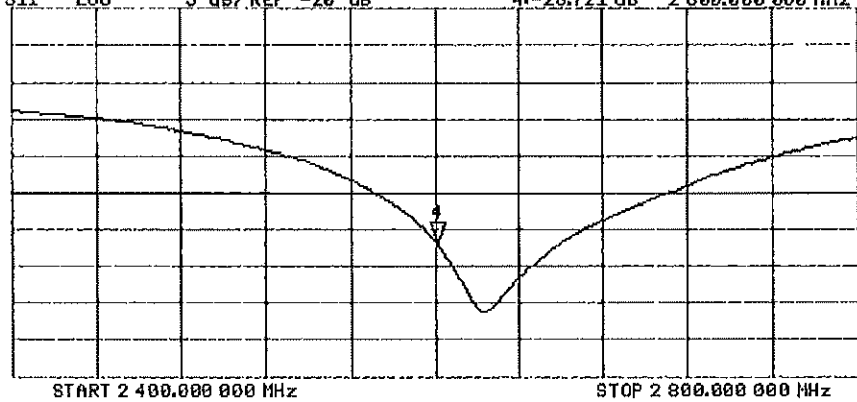

START 2 400.000 000 MHz

STOP 2 800.000 000 MHz

Certification of Calibration

Object: D2600V2 – SN: 1071

Calibration procedure(s): Procedure for Calibration Extension for SAR Dipoles.

Calibration date: 09/07/2017

Description: SAR Validation Dipole at 2600 MHz.

Calibration Equipment used:

Manufacturer	Model	Description	Cal Date	Cal Interval	Cal Due	Serial Number
Control Company	4040	Therm./Clock/Humidity Monitor	3/31/2017	Biennial	3/31/2019	170232394
Control Company	4352	Ultra Long Stem Thermometer	5/2/2017	Biennial	5/2/2019	170330156
Amplifier Research	15S1G6	Amplifier	CBT	N/A	CBT	433971
Narda	4772-3	Attenuator (3dB)	CBT	N/A	CBT	9406
Keysight	772D	Dual Directional Coupler	CBT	N/A	CBT	MY52180215
Keysight Technologies	85033E	Standard Mechanical Calibration Kit (DC to 9GHz, 3.5mm)	6/1/2017	Annual	6/1/2018	MY53401181
Agilent	8759ES	S-Parameter Network Analyzer	10/26/2016	Annual	10/26/2017	US39170118
Mini-Circuits	BW-N20W5+	DC to 18 GHz Precision Fixed 20 dB Attenuator	CBT	N/A	CBT	N/A
SPEAG	DAE4	Dasy Data Acquisition Electronics	7/13/2017	Annual	7/13/2018	1322
SPEAG	DAK-3.5	Dielectric Assessment Kit	5/10/2017	Annual	5/10/2018	1070
SPEAG	EX3DV4	SAR Probe	7/17/2017	Annual	7/17/2018	7410
Anritsu	MA2411B	Pulse Power Sensor	2/10/2017	Annual	2/10/2018	1207364
Anritsu	MA2411B	Pulse Power Sensor	2/10/2017	Annual	2/10/2018	1339018
Anritsu	ML2495A	Power Meter	10/16/2015	Biennial	10/16/2017	941001
Agilent	N5182A	MXG Vector Signal Generator	2/28/2017	Annual	2/28/2018	MY47420800
Seekonk	NC-100	Torque Wrench	11/6/2015	Biennial	11/6/2017	N/A
Mini-Circuits	NLP-2950+	Low Pass Filter DC to 2700 MHz	CBT	N/A	CBT	N/A

Note: CBT (Calibrated Before Testing). Prior to testing, the measurement paths containing a cable, amplifier, attenuator, coupler or filter were connected to a calibrated source (i.e. a signal generator) to determine the losses of the measurement path.

Measurement Uncertainty = $\pm 23\%$ (k=2)

	Name	Function	Signature
Calibrated By:	Brodie Halfoster	Test Engineer	<i>BRODIE HALFOSTER</i>
Approved By:	Kaitlin O'Keefe	Senior Technical Manager	<i>KOK</i>

DIPOLE CALIBRATION EXTENSION

Per KDB 865664 D01, calibration intervals of up to three years may be considered for reference dipoles when it is demonstrated that the SAR target, impedance and return loss of a dipole have remained stable according to the following requirements:

1. The measured SAR does not deviate more than 10% from the target on the calibration certificate.
2. The return-loss does not deviate more than 20% from the previous measurement and meets the required 20dB minimum return-loss requirement.
3. The measurement of real or imaginary parts of impedance does not deviate more than 5Ω from the previous measurement.

The following dipole was checked to pass the above 3 requirements to have 2-year calibration period from the calibration date:

Calibration Date	Extension Date	Certificate Electrical Delay (ns)	Certificate SAR Target Head (1g) W/kg @ 20.0 dBm	Measured Head SAR (1g) W/kg @ 20.0 dBm	Deviation 1g (%)	Certificate SAR Target Head (10g) W/kg @ 20.0 dBm	Measured Head SAR (10g) W/kg @ 20.0 dBm	Deviation 10g (%)	Certificate Impedance Head (Ohm) Real	Measured Impedance Head (Ohm) Real	Difference (Ohm) Real	Certificate Impedance Head (Ohm) Imaginary	Measured Impedance Head (Ohm) Imaginary	Difference (Ohm) Imaginary	Certificate Return Loss Head (dB)	Measured Return Loss Head (dB)	Deviation (%)	PASS/FAIL
9/13/2016	9/7/2017	1.153	5.63	5.73	1.78%	2.53	2.52	-0.40%	49.9	50.3	0.4	-6.7	-5.7	1.0	-23.5	-24.0	-2.10%	PASS
Calibration Date	Extension Date	Certificate Electrical Delay (ns)	Certificate SAR Target Body (1g) W/kg @ 20.0 dBm	Measured Body SAR (1g) W/kg @ 20.0 dBm	Deviation 1g (%)	Certificate SAR Target Body (10g) W/kg @ 20.0 dBm	Measured Body SAR (10g) W/kg @ 20.0 dBm	Deviation 10g (%)	Certificate Impedance Body (Ohm) Real	Measured Impedance Body (Ohm) Real	Difference (Ohm) Real	Certificate Impedance Body (Ohm) Imaginary	Measured Impedance Body (Ohm) Imaginary	Difference (Ohm) Imaginary	Certificate Return Loss Body (dB)	Measured Return Loss Body (dB)	Deviation (%)	PASS/FAIL
9/13/2016	9/7/2017	1.153	5.42	5.34	-1.48%	2.45	2.33	-4.90%	46.1	47.9	1.8	-2.1	-5.3	3.2	-26.7	-25.0	6.40%	PASS

Impedance & Return-Loss Measurement Plot for Head TSL

7 Sep 2017 06:46:37
 [CH1] S11 1 U FS 1: 50.281 Ω -5.7227 Ω 10.595 pF 2 500.000 000 MHz

 De1
 Smo
 Cor

Avg
 15

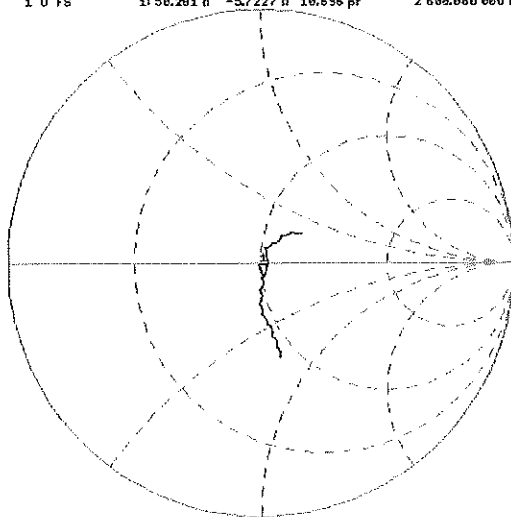

7 Sep 2017 06:47:02
 [CH1] S11 L00 5 dB/REF -20 dB 1:-24.018 dB 2 500.000 000 MHz

 De1
 Smo
 Cor

Avg
 15

†

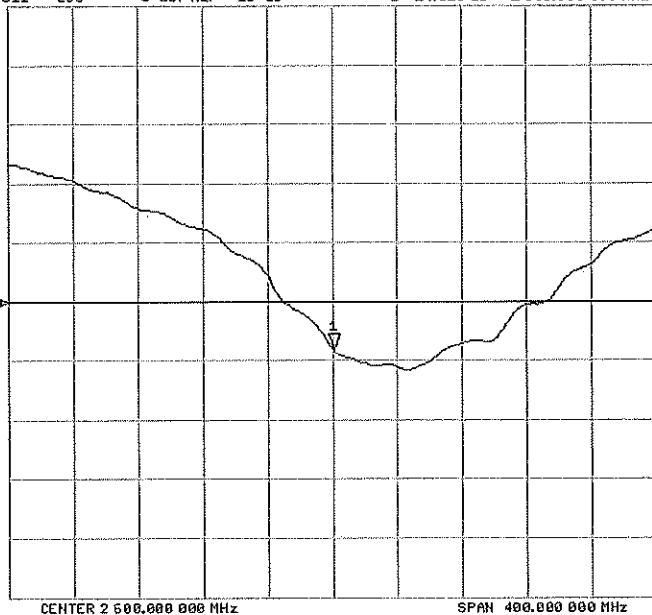

Impedance & Return-Loss Measurement Plot for Body TSL

7 Sep 2017 07:30:38
 [CH1] S11 1 U FS 1: 47.926 Ω -5.3252 Ω 11.493 pF 2 600.000 000 MHz

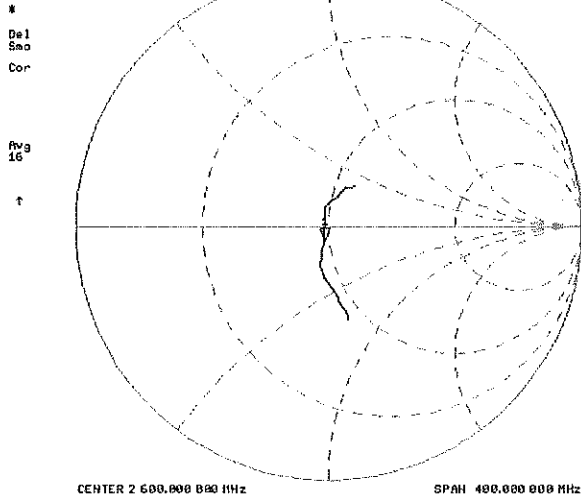

7 Sep 2017 07:31:13
 [CH1] S11 LOG 5 dB/REF -20 dB 1:-24.991 dB 2 600.000 000 MHz

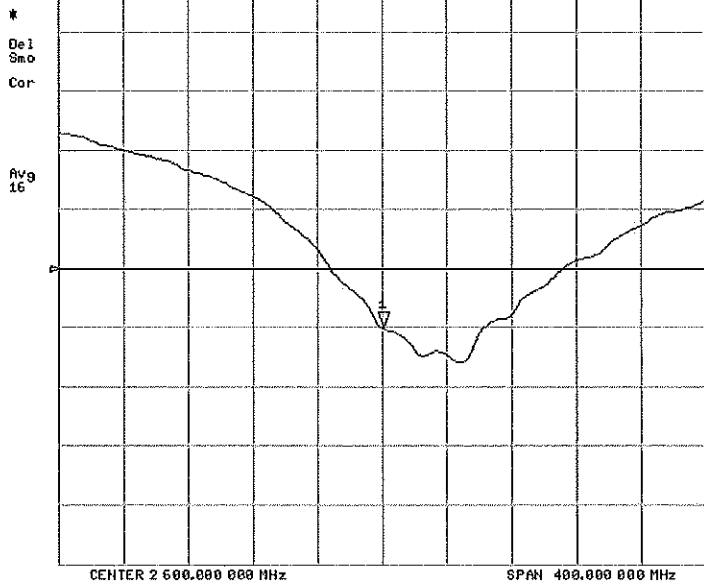

Certification of Calibration

Object: D2600V2 – SN: 1071

Calibration procedure(s): Procedure for Calibration Extension for SAR Dipoles.

Calibration date: 09/11/2018

Description: SAR Validation Dipole at 2600 MHz.

Calibration Equipment used:

Manufacturer	Model	Description	Cal Date	Cal Interval	Cal Due	Serial Number
Control Company	4040	Therm./Clock/Humidity Monitor	3/31/2017	Biennial	3/31/2019	170232394
Control Company	4352	Ultra Long Stem Thermometer	5/2/2017	Biennial	5/2/2019	170330156
Amplifier Research	15S1G6	Amplifier	CBT	N/A	CBT	433971
Narda	4772-3	Attenuator (3dB)	CBT	N/A	CBT	9406
Keysight	772D	Dual Directional Coupler	CBT	N/A	CBT	MY52180215
Keysight Technologies	B5033E	Standard Mechanical Calibration Kit (DC to 9GHz, 3.5mm)	6/4/2018	Annual	6/4/2019	MY53401181
Agilent	8753ES	S-Parameter Vector Network Analyzer	8/30/2018	Annual	8/30/2019	MY40003841
Mini-Circuits	8W-N20W5+	DC to 18 GHz Precision Fixed 20 dB Attenuator	CBT	N/A	CBT	N/A
SPEAG	DAK-3.5	Dielectric Assessment Kit	5/15/2018	Annual	5/15/2019	1070
SPEAG	EK3DV4	SAR Probe	7/20/2018	Annual	7/20/2019	7410
SPEAG	DAE4	Dasy Data Acquisition Electronics	7/11/2018	Annual	7/11/2019	1322
SPEAG	ES3DV3	SAR Probe	3/13/2018	Annual	3/13/2019	3319
SPEAG	DAE4	Dasy Data Acquisition Electronics	3/7/2018	Annual	3/7/2019	1368
Anritsu	MA2411B	Pulse Power Sensor	3/2/2018	Annual	3/2/2019	1207364
Anritsu	MA2411B	Pulse Power Sensor	3/2/2018	Annual	3/2/2019	1339018
Anritsu	ML2495A	Power Meter	10/22/2017	Annual	10/22/2018	1328004
Agilent	NS182A	MXG Vector Signal Generator	4/18/2018	Annual	4/18/2019	MY47420800
Seekonk	NC-100	Torque Wrench	7/11/2018	Annual	7/11/2019	N/A
MiniCircuits	VLF-6000+	Low Pass Filter	CBT	N/A	CBT	N/A
Narda	4014C-6	4 - 8 GHz SMA 6 dB Directional Coupler	CBT	N/A	CBT	N/A

Note: CBT (Calibrated Before Testing). Prior to testing, the measurement paths containing a cable, amplifier, attenuator, coupler or filter were connected to a calibrated source (i.e. a signal generator) to determine the losses of the measurement path.

Measurement Uncertainty = $\pm 23\%$ (k=2)

	Name	Function	Signature
Calibrated By:	Brodie Halfoster	Test Engineer	<i>BRODIE HALFOSTER</i>
Approved By:	Kaitlin O'Keefe	Senior Technical Manager	<i>KOK</i>

DIPOLE CALIBRATION EXTENSION

Per KDB 865664 D01, calibration intervals of up to three years may be considered for reference dipoles when it is demonstrated that the SAR target, impedance and return loss of a dipole have remained stable according to the following requirements:

1. The measured SAR does not deviate more than 10% from the target on the calibration certificate.
2. The return-loss does not deviate more than 20% from the previous measurement and meets the required 20dB minimum return-loss requirement.
3. The measurement of real or imaginary parts of impedance does not deviate more than 5Ω from the previous measurement.

The following dipole was checked to pass the above 3 requirements to have 3-year calibration period from the calibration date:

Calibration Date	Extension Date	Certificate Electrical Delay (ns)	Certificate SAR Target Head (1g) W/kg @ 20.0 dBm	Measured Head SAR (1g) W/kg @ 20.0 dBm	Deviation 1g (%)	Certificate SAR Target Head (10g) W/kg @ 20.0 dBm	Measured Head SAR (10g) W/kg @ 20.0 dBm	Deviation 10g (%)	Certificate Impedance Head (Ohm) Real	Measured Impedance Head (Ohm) Real	Difference (Ohm) Real	Certificate Impedance Head (Ohm) Imaginary	Measured Impedance Head (Ohm) Imaginary	Difference (Ohm) Imaginary	Certificate Return Loss Head (dB)	Measured Return Loss Head (dB)	Deviation (%)	PASS/FAIL
9/13/2016	9/11/2018	1.153	5.63	5.52	-1.95%	2.53	2.47	-2.37%	49.9	49	0.9	-6.7	-5.4	1.3	-23.5	-25.2	-7.40%	PASS
Calibration Date	Extension Date	Certificate Electrical Delay (ns)	Certificate SAR Target Body (1g) W/kg @ 20.0 dBm	Measured Body SAR (1g) W/kg @ 20.0 dBm	Deviation 1g (%)	Certificate SAR Target Body (10g) W/kg @ 20.0 dBm	Measured Body SAR (10g) W/kg @ 20.0 dBm	Deviation 10g (%)	Certificate Impedance Body (Ohm) Real	Measured Impedance Body (Ohm) Real	Difference (Ohm) Real	Certificate Impedance Body (Ohm) Imaginary	Measured Impedance Body (Ohm) Imaginary	Difference (Ohm) Imaginary	Certificate Return Loss Body (dB)	Measured Return Loss Body (dB)	Deviation (%)	PASS/FAIL
9/13/2016	9/11/2018	1.153	5.42	5.57	2.77%	2.45	2.46	0.41%	46.1	47.7	1.6	-2.1	-4.6	2.5	-26.7	-25.6	4.30%	PASS

Impedance & Return-Loss Measurement Plot for Head TSL

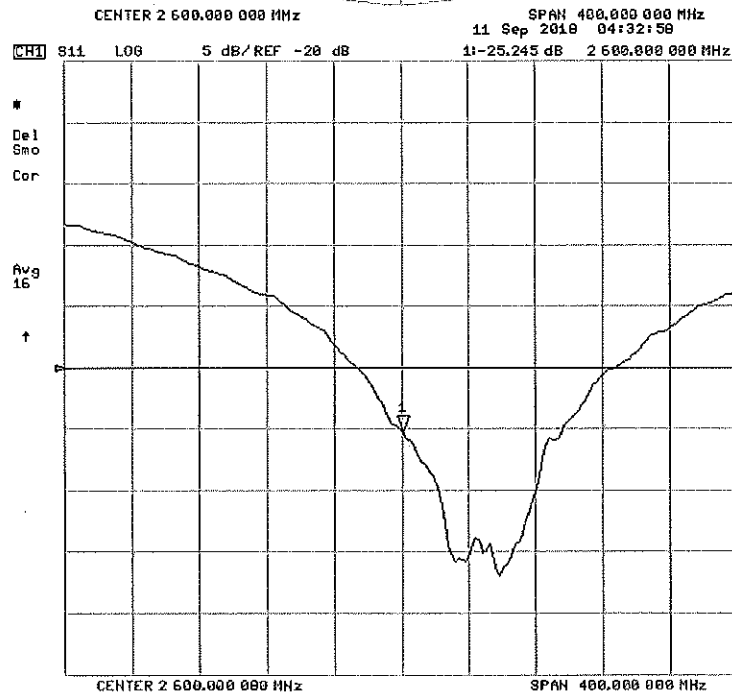
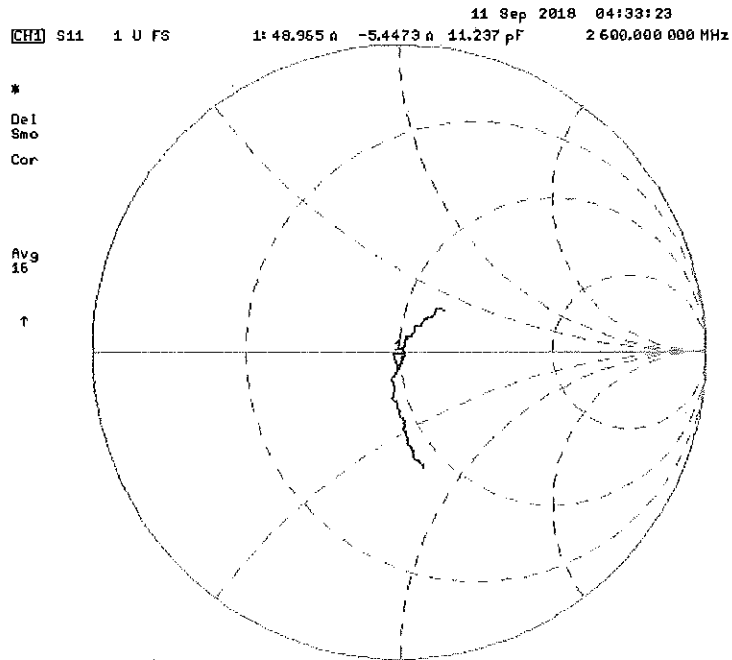

Impedance & Return-Loss Measurement Plot for Body TSL

11 Sep 2018 04:34:32
[CH1] S11 1 U FS 1:47.696 Ω -4.5665 Ω 13.422 pF 2 600.000 000 MHz

*
 Del
 Smo
 Cor

Avg
 16

↑

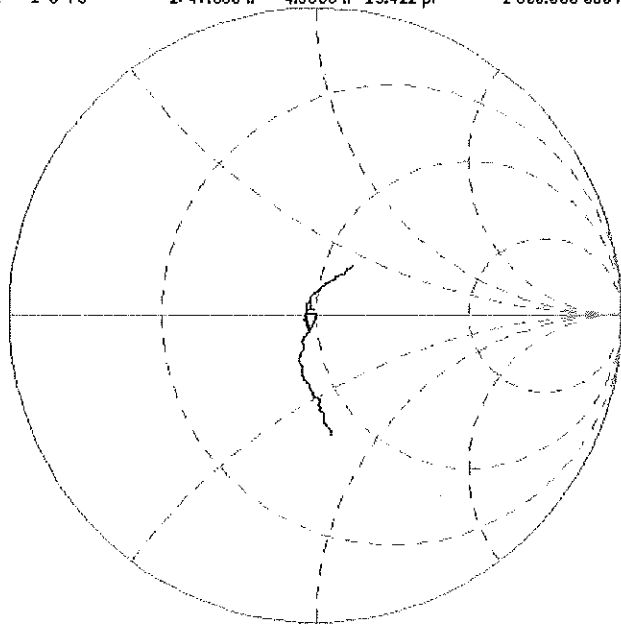

CENTER 2 600.000 000 MHz SPAN 400.000 000 MHz

11 Sep 2018 04:34:52
[CH1] S11 LOG 5 dB/REF -20 dB 1:-25.552 dB 2 600.000 000 MHz

*
 Del
 Smo
 Cor

Avg
 16

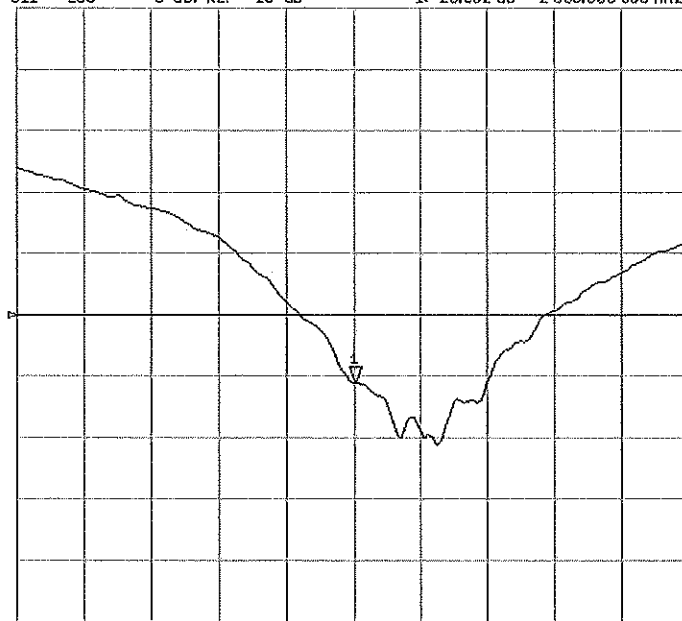

CENTER 2 600.000 000 MHz SPAN 400.000 000 MHz



Accredited by the Swiss Accreditation Service (SAS)
The Swiss Accreditation Service is one of the signatories to the EA
Multilateral Agreement for the recognition of calibration certificates

Accreditation No.: **SCS 0108**

Client **PC Test**

Certificate No: **D5GHzV2-1057_Jan18**

CALIBRATION CERTIFICATE

Object **D5GHzV2 - SN:1057**

Calibration procedure(s) **QA CAL-22.v2
Calibration procedure for dipole validation kits between 3-6 GHz**

Calibration date: **January 16, 2018**

*BN ✓
01-25-2018*

This calibration certificate documents the traceability to national standards, which realize the physical units of measurements (SI).
The measurements and the uncertainties with confidence probability are given on the following pages and are part of the certificate.

*BN ✓
02/06/2019*

All calibrations have been conducted in the closed laboratory facility: environment temperature (22 ± 3)°C and humidity < 70%.

Calibration Equipment used (M&TE critical for calibration)

Primary Standards	ID #	Cal Date (Certificate No.)	Scheduled Calibration
Power meter NRP	SN: 104778	04-Apr-17 (No. 217-02521/02522)	Apr-18
Power sensor NRP-Z91	SN: 103244	04-Apr-17 (No. 217-02521)	Apr-18
Power sensor NRP-Z91	SN: 103245	04-Apr-17 (No. 217-02522)	Apr-18
Reference 20 dB Attenuator	SN: 5058 (20k)	07-Apr-17 (No. 217-02528)	Apr-18
Type-N mismatch combination	SN: 5047.2 / 06327	07-Apr-17 (No. 217-02529)	Apr-18
Reference Probe EX3DV4	SN: 3503	30-Dec-17 (No. EX3-3503_Dec17)	Dec-18
DAE4	SN: 601	26-Oct-17 (No. DAE4-601_Oct17)	Oct-18

Secondary Standards	ID #	Check Date (in house)	Scheduled Check
Power meter EPM-442A	SN: GB37490704	07-Oct-15 (in house check Oct-16)	In house check: Oct-18
Power sensor HP 8481A	SN: US37292783	07-Oct-15 (in house check Oct-16)	In house check: Oct-18
Power sensor HP 8481A	SN: MY41092317	07-Oct-15 (in house check Oct-16)	In house check: Oct-18
RF generator R&S SMT-06	SN: 100972	15-Jun-15 (in house check Oct-16)	In house check: Oct-18
Network Analyzer HP 8753E	SN: US37390585	18-Oct-01 (in house check Oct-17)	In house check: Oct-18

Calibrated by: **Leif Klysner** Name: **Leif Klysner** Function: **Laboratory Technician**

Signature
[Handwritten Signature]

Approved by: **Katja Pokovic** Name: **Katja Pokovic** Function: **Technical Manager**

[Handwritten Signature]

Issued: January 18, 2018

This calibration certificate shall not be reproduced except in full without written approval of the laboratory.



Accredited by the Swiss Accreditation Service (SAS)
The Swiss Accreditation Service is one of the signatories to the EA
Multilateral Agreement for the recognition of calibration certificates

Accreditation No.: **SCS 0108**

Glossary:

TSL	tissue simulating liquid
ConvF	sensitivity in TSL / NORM x,y,z
N/A	not applicable or not measured

Calibration is Performed According to the Following Standards:

- IEEE Std 1528-2013, "IEEE Recommended Practice for Determining the Peak Spatial-Averaged Specific Absorption Rate (SAR) in the Human Head from Wireless Communications Devices: Measurement Techniques", June 2013
- IEC 62209-1, "Measurement procedure for the assessment of Specific Absorption Rate (SAR) from hand-held and body-mounted devices used next to the ear (frequency range of 300 MHz to 6 GHz)", July 2016
- IEC 62209-2, "Procedure to determine the Specific Absorption Rate (SAR) for wireless communication devices used in close proximity to the human body (frequency range of 30 MHz to 6 GHz)", March 2010
- KDB 865664, "SAR Measurement Requirements for 100 MHz to 6 GHz"

Additional Documentation:

- DASY4/5 System Handbook

Methods Applied and Interpretation of Parameters:

- Measurement Conditions:* Further details are available from the Validation Report at the end of the certificate. All figures stated in the certificate are valid at the frequency indicated.
- Antenna Parameters with TSL:* The dipole is mounted with the spacer to position its feed point exactly below the center marking of the flat phantom section, with the arms oriented parallel to the body axis.
- Feed Point Impedance and Return Loss:* These parameters are measured with the dipole positioned under the liquid filled phantom. The impedance stated is transformed from the measurement at the SMA connector to the feed point. The Return Loss ensures low reflected power. No uncertainty required.
- Electrical Delay:* One-way delay between the SMA connector and the antenna feed point. No uncertainty required.
- SAR measured:* SAR measured at the stated antenna input power.
- SAR normalized:* SAR as measured, normalized to an input power of 1 W at the antenna connector.
- SAR for nominal TSL parameters:* The measured TSL parameters are used to calculate the nominal SAR result.

The reported uncertainty of measurement is stated as the standard uncertainty of measurement multiplied by the coverage factor $k=2$, which for a normal distribution corresponds to a coverage probability of approximately 95%.

Measurement Conditions

DASY system configuration, as far as not given on page 1.

DASY Version	DASY5	V52.10.0
Extrapolation	Advanced Extrapolation	
Phantom	Modular Flat Phantom V5.0	
Distance Dipole Center - TSL	10 mm	with Spacer
Zoom Scan Resolution	dx, dy = 4.0 mm, dz = 1.4 mm	Graded Ratio = 1.4 (Z direction)
Frequency	5200 MHz ± 1 MHz 5250 MHz ± 1 MHz 5600 MHz ± 1 MHz 5750 MHz ± 1 MHz 5800 MHz ± 1 MHz	

Head TSL parameters at 5250 MHz

The following parameters and calculations were applied.

	Temperature	Permittivity	Conductivity
Nominal Head TSL parameters	22.0 °C	35.9	4.71 mho/m
Measured Head TSL parameters	(22.0 ± 0.2) °C	36.2 ± 6 %	4.55 mho/m ± 6 %
Head TSL temperature change during test	< 0.5 °C	----	----

SAR result with Head TSL at 5250 MHz

SAR averaged over 1 cm ³ (1 g) of Head TSL	Condition	
SAR measured	100 mW input power	7.91 W/kg
SAR for nominal Head TSL parameters	normalized to 1W	79.2 W/kg ± 19.9 % (k=2)

SAR averaged over 10 cm ³ (10 g) of Head TSL	condition	
SAR measured	100 mW input power	2.28 W/kg
SAR for nominal Head TSL parameters	normalized to 1W	22.8 W/kg ± 19.5 % (k=2)

Head TSL parameters at 5600 MHz

The following parameters and calculations were applied.

	Temperature	Permittivity	Conductivity
Nominal Head TSL parameters	22.0 °C	35.5	5.07 mho/m
Measured Head TSL parameters	(22.0 ± 0.2) °C	35.8 ± 6 %	4.90 mho/m ± 6 %
Head TSL temperature change during test	< 0.5 °C	----	----

SAR result with Head TSL at 5600 MHz

SAR averaged over 1 cm ³ (1 g) of Head TSL	Condition	
SAR measured	100 mW input power	8.41 W/kg
SAR for nominal Head TSL parameters	normalized to 1W	84.1 W/kg ± 19.9 % (k=2)

SAR averaged over 10 cm ³ (10 g) of Head TSL	condition	
SAR measured	100 mW input power	2.40 W/kg
SAR for nominal Head TSL parameters	normalized to 1W	24.0 W/kg ± 19.5 % (k=2)

Head TSL parameters at 5750 MHz

The following parameters and calculations were applied.

	Temperature	Permittivity	Conductivity
Nominal Head TSL parameters	22.0 °C	35.4	5.22 mho/m
Measured Head TSL parameters	(22.0 ± 0.2) °C	35.5 ± 6 %	5.06 mho/m ± 6 %
Head TSL temperature change during test	< 0.5 °C	----	----

SAR result with Head TSL at 5750 MHz

SAR averaged over 1 cm ³ (1 g) of Head TSL	Condition	
SAR measured	100 mW input power	8.06 W/kg
SAR for nominal Head TSL parameters	normalized to 1W	80.5 W/kg ± 19.9 % (k=2)

SAR averaged over 10 cm ³ (10 g) of Head TSL	condition	
SAR measured	100 mW input power	2.30 W/kg
SAR for nominal Head TSL parameters	normalized to 1W	23.0 W/kg ± 19.5 % (k=2)

Body TSL parameters at 5200 MHz

The following parameters and calculations were applied.

	Temperature	Permittivity	Conductivity
Nominal Body TSL parameters	22.0 °C	49.0	5.30 mho/m
Measured Body TSL parameters	(22.0 ± 0.2) °C	47.3 ± 6 %	5.41 mho/m ± 6 %
Body TSL temperature change during test	< 0.5 °C	----	----

SAR result with Body TSL at 5200 MHz

SAR averaged over 1 cm ³ (1 g) of Body TSL	Condition	
SAR measured	100 mW input power	7.36 W/kg
SAR for nominal Body TSL parameters	normalized to 1W	73.1 W/kg ± 19.9 % (k=2)

SAR averaged over 10 cm ³ (10 g) of Body TSL	condition	
SAR measured	100 mW input power	2.06 W/kg
SAR for nominal Body TSL parameters	normalized to 1W	20.4 W/kg ± 19.5 % (k=2)

Body TSL parameters at 5250 MHz

The following parameters and calculations were applied.

	Temperature	Permittivity	Conductivity
Nominal Body TSL parameters	22.0 °C	48.9	5.36 mho/m
Measured Body TSL parameters	(22.0 ± 0.2) °C	47.2 ± 6 %	5.48 mho/m ± 6 %
Body TSL temperature change during test	< 0.5 °C	----	----

SAR result with Body TSL at 5250 MHz

SAR averaged over 1 cm ³ (1 g) of Body TSL	Condition	
SAR measured	100 mW input power	7.64 W/kg
SAR for nominal Body TSL parameters	normalized to 1W	75.9 W/kg ± 19.9 % (k=2)

SAR averaged over 10 cm ³ (10 g) of Body TSL	condition	
SAR measured	100 mW input power	2.13 W/kg
SAR for nominal Body TSL parameters	normalized to 1W	21.1 W/kg ± 19.5 % (k=2)

Body TSL parameters at 5600 MHz

The following parameters and calculations were applied.

	Temperature	Permittivity	Conductivity
Nominal Body TSL parameters	22.0 °C	48.5	5.77 mho/m
Measured Body TSL parameters	(22.0 ± 0.2) °C	46.6 ± 6 %	5.94 mho/m ± 6 %
Body TSL temperature change during test	< 0.5 °C	----	----

SAR result with Body TSL at 5600 MHz

SAR averaged over 1 cm ³ (1 g) of Body TSL	Condition	
SAR measured	100 mW input power	8.05 W/kg
SAR for nominal Body TSL parameters	normalized to 1W	79.9 W/kg ± 19.9 % (k=2)

SAR averaged over 10 cm ³ (10 g) of Body TSL	condition	
SAR measured	100 mW input power	2.25 W/kg
SAR for nominal Body TSL parameters	normalized to 1W	22.3 W/kg ± 19.5 % (k=2)

Body TSL parameters at 5750 MHz

The following parameters and calculations were applied.

	Temperature	Permittivity	Conductivity
Nominal Body TSL parameters	22.0 °C	48.3	5.94 mho/m
Measured Body TSL parameters	(22.0 ± 0.2) °C	46.3 ± 6 %	6.15 mho/m ± 6 %
Body TSL temperature change during test	< 0.5 °C	----	----

SAR result with Body TSL at 5750 MHz

SAR averaged over 1 cm ³ (1 g) of Body TSL	Condition	
SAR measured	100 mW input power	7.72 W/kg
SAR for nominal Body TSL parameters	normalized to 1W	76.7 W/kg ± 19.9 % (k=2)

SAR averaged over 10 cm ³ (10 g) of Body TSL	condition	
SAR measured	100 mW input power	2.14 W/kg
SAR for nominal Body TSL parameters	normalized to 1W	21.2 W/kg ± 19.5 % (k=2)

Body TSL parameters at 5800 MHz

The following parameters and calculations were applied.

	Temperature	Permittivity	Conductivity
Nominal Body TSL parameters	22.0 °C	48.2	6.00 mho/m
Measured Body TSL parameters	(22.0 ± 0.2) °C	46.2 ± 6 %	6.22 mho/m ± 6 %
Body TSL temperature change during test	< 0.5 °C	----	----

SAR result with Body TSL at 5800 MHz

SAR averaged over 1 cm ³ (1 g) of Body TSL	Condition	
SAR measured	100 mW input power	7.68 W/kg
SAR for nominal Body TSL parameters	normalized to 1W	76.3 W/kg ± 19.9 % (k=2)

SAR averaged over 10 cm ³ (10 g) of Body TSL	condition	
SAR measured	100 mW input power	2.13 W/kg
SAR for nominal Body TSL parameters	normalized to 1W	21.1 W/kg ± 19.5 % (k=2)

Appendix (Additional assessments outside the scope of SCS 0108)

Antenna Parameters with Head TSL at 5250 MHz

Impedance, transformed to feed point	50.0 Ω - 5.5 j Ω
Return Loss	- 25.2 dB

Antenna Parameters with Head TSL at 5600 MHz

Impedance, transformed to feed point	54.7 Ω - 2.1 j Ω
Return Loss	- 26.2 dB

Antenna Parameters with Head TSL at 5750 MHz

Impedance, transformed to feed point	52.7 Ω + 0.0 j Ω
Return Loss	- 31.5 dB

Antenna Parameters with Body TSL at 5200 MHz

Impedance, transformed to feed point	49.3 Ω - 6.7 j Ω
Return Loss	- 23.4 dB

Antenna Parameters with Body TSL at 5250 MHz

Impedance, transformed to feed point	48.4 Ω - 3.9 j Ω
Return Loss	- 27.4 dB

Antenna Parameters with Body TSL at 5600 MHz

Impedance, transformed to feed point	55.3 Ω - 1.6 j Ω
Return Loss	- 25.6 dB

Antenna Parameters with Body TSL at 5750 MHz

Impedance, transformed to feed point	52.6 Ω + 1.1 j Ω
Return Loss	- 31.2 dB

Antenna Parameters with Body TSL at 5800 MHz

Impedance, transformed to feed point	51.8 Ω - 0.4 j Ω
Return Loss	- 34.9 dB

General Antenna Parameters and Design

Electrical Delay (one direction)	1.203 ns
----------------------------------	----------

After long term use with 100W radiated power, only a slight warming of the dipole near the feedpoint can be measured.

The dipole is made of standard semirigid coaxial cable. The center conductor of the feeding line is directly connected to the second arm of the dipole. The antenna is therefore short-circuited for DC-signals. On some of the dipoles, small end caps are added to the dipole arms in order to improve matching when loaded according to the position as explained in the "Measurement Conditions" paragraph. The SAR data are not affected by this change. The overall dipole length is still according to the Standard.

No excessive force must be applied to the dipole arms, because they might bend or the soldered connections near the feedpoint may be damaged.

Additional EUT Data

Manufactured by	SPEAG
Manufactured on	November 27, 2006

Appendix (Additional assessments outside the scope of SCS 0108)

Measurement Conditions (f=5200 MHz)

DASY system configuration, as far as not given on page 1 and 3.

Phantom	SAM Head Phantom	For usage with cSAR3DV2-R/L
---------	------------------	-----------------------------

SAR result with SAM Head (Top)

SAR averaged over 1 cm ³ (1 g) of Head TSL	Condition	
SAR measured	100 mW input power	8.24 W/kg
SAR for nominal Head TSL parameters	normalized to 1W	82.6 W/kg ± 20.3 % (k=2)

SAR averaged over 10 cm ³ (10 g) of Head TSL	condition	
SAR measured	100 mW input power	2.35 W/kg
SAR for nominal Head TSL parameters	normalized to 1W	23.6 W/kg ± 19.9 % (k=2)

SAR result with SAM Head (Mouth)

SAR averaged over 1 cm ³ (1 g) of Head TSL	Condition	
SAR measured	100 mW input power	8.54 W/kg
SAR for nominal Head TSL parameters	normalized to 1W	85.6 W/kg ± 20.3 % (k=2)

SAR averaged over 10 cm ³ (10 g) of Head TSL	condition	
SAR measured	100 mW input power	2.37 W/kg
SAR for nominal Head TSL parameters	normalized to 1W	23.7 W/kg ± 19.9 % (k=2)

SAR result with SAM Head (Neck)

SAR averaged over 1 cm ³ (1 g) of Head TSL	Condition	
SAR measured	100 mW input power	8.14 W/kg
SAR for nominal Head TSL parameters	normalized to 1W	81.6 W/kg ± 20.3 % (k=2)

SAR averaged over 10 cm ³ (10 g) of Head TSL	condition	
SAR measured	100 mW input power	2.37 W/kg
SAR for nominal Head TSL parameters	normalized to 1W	23.7 W/kg ± 19.9 % (k=2)

SAR result with SAM Head (Ear)

SAR averaged over 1 cm ³ (1 g) of Head TSL	Condition	
SAR measured	100 mW input power	5.16 W/kg
SAR for nominal Head TSL parameters	normalized to 1W	51.7 W/kg ± 20.3 % (k=2)

SAR averaged over 10 cm ³ (10 g) of Head TSL	condition	
SAR measured	100 mW input power	1.76 W/kg
SAR for nominal Head TSL parameters	normalized to 1W	17.7 W/kg ± 19.9 % (k=2)

Measurement Conditions (f=5800 MHz)

DASY system configuration, as far as not given on page 1 and 3.

Phantom	SAM Head Phantom	For usage with cSAR3DV2-R/L
---------	------------------	-----------------------------

SAR result with SAM Head (Top)

SAR averaged over 1 cm ³ (1 g) of Head TSL	Condition	
SAR measured	100 mW input power	8.62 W/kg
SAR for nominal Head TSL parameters	normalized to 1W	86.3 W/kg ± 20.3 % (k=2)

SAR averaged over 10 cm ³ (10 g) of Head TSL	condition	
SAR measured	100 mW input power	2.41 W/kg
SAR for nominal Head TSL parameters	normalized to 1W	24.1 W/kg ± 19.9 % (k=2)

SAR result with SAM Head (Mouth)

SAR averaged over 1 cm ³ (1 g) of Head TSL	Condition	
SAR measured	100 mW input power	8.88 W/kg
SAR for nominal Head TSL parameters	normalized to 1W	88.9 W/kg ± 20.3 % (k=2)

SAR averaged over 10 cm ³ (10 g) of Head TSL	condition	
SAR measured	100 mW input power	2.44 W/kg
SAR for nominal Head TSL parameters	normalized to 1W	24.4 W/kg ± 19.9 % (k=2)

SAR result with SAM Head (Neck)

SAR averaged over 1 cm ³ (1 g) of Head TSL	Condition	
SAR measured	100 mW input power	8.33 W/kg
SAR for nominal Head TSL parameters	normalized to 1W	83.4 W/kg ± 20.3 % (k=2)

SAR averaged over 10 cm ³ (10 g) of Head TSL	condition	
SAR measured	100 mW input power	2.35 W/kg
SAR for nominal Head TSL parameters	normalized to 1W	23.5 W/kg ± 19.9 % (k=2)

SAR result with SAM Head (Ear)

SAR averaged over 1 cm ³ (1 g) of Head TSL	Condition	
SAR measured	100 mW input power	5.68 W/kg
SAR for nominal Head TSL parameters	normalized to 1W	56.8 W/kg ± 20.3 % (k=2)

SAR averaged over 10 cm ³ (10 g) of Head TSL	condition	
SAR measured	100 mW input power	1.89 W/kg
SAR for nominal Head TSL parameters	normalized to 1W	18.9 W/kg ± 19.9 % (k=2)

Test Laboratory: SPEAG, Zurich, Switzerland

DUT: Dipole D5GHzV2; Type: D5GHzV2; Serial: D5GHzV2 - SN:1057

Communication System: UID 0 - CW; Frequency: 5250 MHz, Frequency: 5600 MHz, Frequency: 5750 MHz
Medium parameters used: $f = 5250$ MHz; $\sigma = 4.55$ S/m; $\epsilon_r = 36.2$; $\rho = 1000$ kg/m³,
Medium parameters used: $f = 5600$ MHz; $\sigma = 4.9$ S/m; $\epsilon_r = 35.8$; $\rho = 1000$ kg/m³,
Medium parameters used: $f = 5750$ MHz; $\sigma = 5.06$ S/m; $\epsilon_r = 35.5$; $\rho = 1000$ kg/m³
Phantom section: Flat Section
Measurement Standard: DASY5 (IEEE/IEC/ANSI C63.19-2011)

DASY52 Configuration:

- Probe: EX3DV4 - SN3503; ConvF(5.51, 5.51, 5.51); Calibrated: 30.12.2017, ConvF(5.05, 5.05, 5.05); Calibrated: 30.12.2017, ConvF(4.98, 4.98, 4.98); Calibrated: 30.12.2017;
- Sensor-Surface: 1.4mm (Mechanical Surface Detection)
- Electronics: DAE4 Sn601 - modified; Calibrated: 26.10.2017
- Phantom: Flat Phantom 5.0 (front); Type: QD 000 P50 AA; Serial: 1001
- DASY52 52.10.0(1446); SEMCAD X 14.6.10(7417)

Dipole Calibration for Head Tissue/Pin=100mW, dist=10mm, f=5250 MHz/Zoom Scan, dist=1.4mm (8x8x7)/Cube 0: Measurement grid: dx=4mm, dy=4mm, dz=1.4mm
Reference Value = 72.54 V/m; Power Drift = -0.02 dB
Peak SAR (extrapolated) = 27.5 W/kg
SAR(1 g) = 7.91 W/kg; SAR(10 g) = 2.28 W/kg
Maximum value of SAR (measured) = 17.7 W/kg

Dipole Calibration for Head Tissue/Pin=100mW, dist=10mm, f=5600 MHz/Zoom Scan, dist=1.4mm (8x8x7)/Cube 0: Measurement grid: dx=4mm, dy=4mm, dz=1.4mm
Reference Value = 72.77 V/m; Power Drift = -0.07 dB
Peak SAR (extrapolated) = 32.2 W/kg
SAR(1 g) = 8.41 W/kg; SAR(10 g) = 2.4 W/kg
Maximum value of SAR (measured) = 19.7 W/kg

Dipole Calibration for Head Tissue/Pin=100mW, dist=10mm, f=5750 MHz/Zoom Scan, dist=1.4mm (8x8x7)/Cube 0: Measurement grid: dx=4mm, dy=4mm, dz=1.4mm
Reference Value = 70.93 V/m; Power Drift = -0.09 dB
Peak SAR (extrapolated) = 31.4 W/kg
SAR(1 g) = 8.06 W/kg; SAR(10 g) = 2.3 W/kg
Maximum value of SAR (measured) = 18.9 W/kg

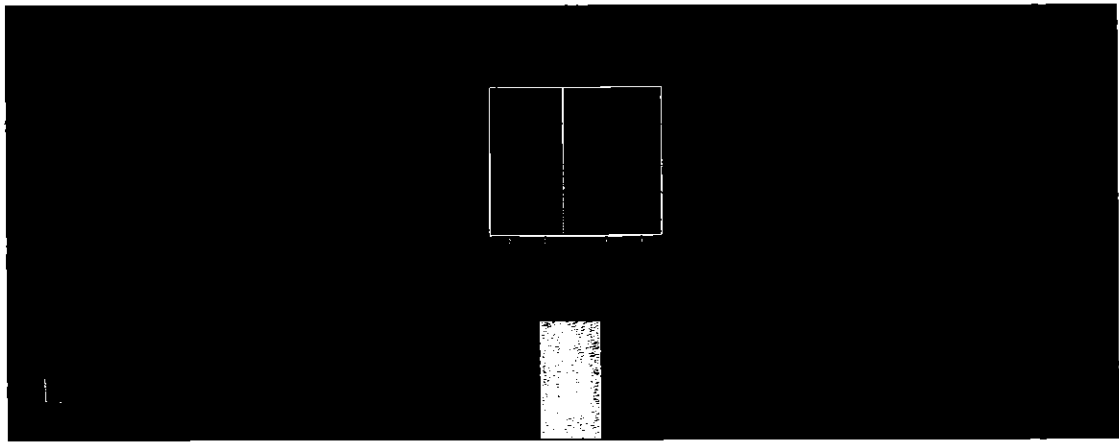
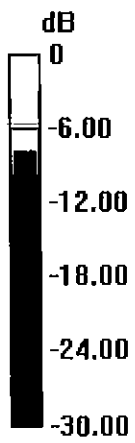

0 dB = 18.9 W/kg = 12.76 dBW/kg

Impedance Measurement Plot for Head TSL

11 Jan 2018 15:50:25

CH1 S11 1 U FS 1: 50.010 Ω -5.5215 Ω 5.4904 pF 5 250.000 000 MHz

De1
Cor
Avg
16
H1d

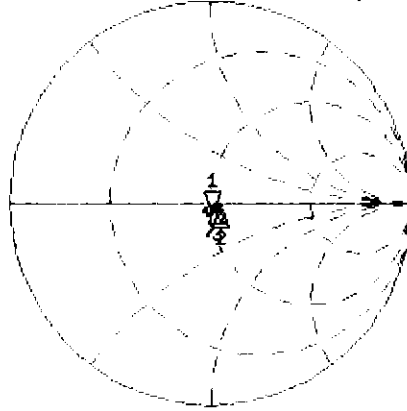

CH1 Markers
2: 54.660 Ω
-2.1445 Ω
5.60000 GHz
3: 52.729 Ω
-44.922 m Ω
5.75000 GHz

CH2 S11 LOG 5 dB/ REF -20 dB 1: -25.170 dB 5 250.000 000 MHz

Cor
Avg
16
H1d

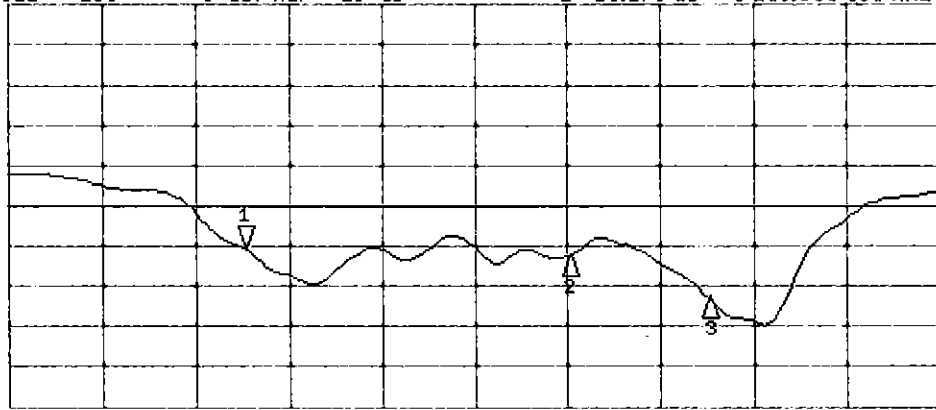

CH2 Markers
2: -26.187 dB
5.60000 GHz
3: -31.504 dB
5.75000 GHz

START 5 000.000 000 MHz

STOP 6 000.000 000 MHz

DASY5 Validation Report for Body TSL

Date: 10.01.2018

Test Laboratory: SPEAG, Zurich, Switzerland

DUT: Dipole D5GHzV2; Type: D5GHzV2; Serial: D5GHzV2 - SN:1057

Communication System: UID 0 - CW; Frequency: 5200 MHz, Frequency: 5250 MHz, Frequency: 5600 MHz, Frequency: 5750 MHz, Frequency: 5800 MHz

Medium parameters used: $f = 5200$ MHz; $\sigma = 5.41$ S/m; $\epsilon_r = 47.3$; $\rho = 1000$ kg/m³,

Medium parameters used: $f = 5250$ MHz; $\sigma = 5.48$ S/m; $\epsilon_r = 47.2$; $\rho = 1000$ kg/m³,

Medium parameters used: $f = 5600$ MHz; $\sigma = 5.94$ S/m; $\epsilon_r = 46.6$; $\rho = 1000$ kg/m³,

Medium parameters used: $f = 5750$ MHz; $\sigma = 6.15$ S/m; $\epsilon_r = 46.3$; $\rho = 1000$ kg/m³,

Medium parameters used: $f = 5800$ MHz; $\sigma = 6.22$ S/m; $\epsilon_r = 46.2$; $\rho = 1000$ kg/m³

Phantom section: Flat Section

Measurement Standard: DASY5 (IEEE/IEC/ANSI C63.19-2011)

DASY52 Configuration:

- Probe: EX3DV4 - SN3503; ConvF(5.35, 5.35, 5.35); Calibrated: 30.12.2017, ConvF(5.26, 5.26, 5.26); Calibrated: 30.12.2017, ConvF(4.65, 4.65, 4.65); Calibrated: 30.12.2017, ConvF(4.57, 4.57, 4.57); Calibrated: 30.12.2017, ConvF(4.53, 4.53, 4.53); Calibrated: 30.12.2017;
- Sensor-Surface: 1.4mm (Mechanical Surface Detection)
- Electronics: DAE4 Sn601; Calibrated: 26.10.2017
- Phantom: Flat Phantom 5.0 (back); Type: QD 000 P50 AA; Serial: 1002
- DASY52 52.10.0(1446); SEMCAD X 14.6.10(7417)

Dipole Calibration for Body Tissue/Pin=100mW, dist=10mm, f=5200 MHz/Zoom Scan, dist=1.4mm (8x8x7)/Cube 0: Measurement grid: dx=4mm, dy=4mm, dz=1.4mm

Reference Value = 64.05 V/m; Power Drift = -0.03 dB

Peak SAR (extrapolated) = 27.6 W/kg

SAR(1 g) = 7.36 W/kg; SAR(10 g) = 2.06 W/kg

Maximum value of SAR (measured) = 17.1 W/kg

Dipole Calibration for Body Tissue/Pin=100mW, dist=10mm, f=5250 MHz/Zoom Scan, dist=1.4mm (8x8x7)/Cube 0: Measurement grid: dx=4mm, dy=4mm, dz=1.4mm

Reference Value = 64.53 V/m; Power Drift = -0.02 dB

Peak SAR (extrapolated) = 29.4 W/kg

SAR(1 g) = 7.64 W/kg; SAR(10 g) = 2.13 W/kg

Maximum value of SAR (measured) = 17.9 W/kg

Dipole Calibration for Body Tissue/Pin=100mW, dist=10mm, f=5600 MHz/Zoom Scan, dist=1.4mm (8x8x7)/Cube 0: Measurement grid: dx=4mm, dy=4mm, dz=1.4mm
Reference Value = 65.09 V/m; Power Drift = -0.08 dB
Peak SAR (extrapolated) = 34.0 W/kg
SAR(1 g) = 8.05 W/kg; SAR(10 g) = 2.25 W/kg
Maximum value of SAR (measured) = 19.5 W/kg

Dipole Calibration for Body Tissue/Pin=100mW, dist=10mm, f=5750 MHz/Zoom Scan, dist=1.4mm (8x8x7)/Cube 0: Measurement grid: dx=4mm, dy=4mm, dz=1.4mm
Reference Value = 63.45 V/m; Power Drift = -0.06 dB
Peak SAR (extrapolated) = 32.9 W/kg
SAR(1 g) = 7.72 W/kg; SAR(10 g) = 2.14 W/kg
Maximum value of SAR (measured) = 18.9 W/kg

Dipole Calibration for Body Tissue/Pin=100mW, dist=10mm, f=5800 MHz/Zoom Scan, dist=1.4mm (8x8x7)/Cube 0: Measurement grid: dx=4mm, dy=4mm, dz=1.4mm
Reference Value = 63.14 V/m; Power Drift = -0.08 dB
Peak SAR (extrapolated) = 33.3 W/kg
SAR(1 g) = 7.68 W/kg; SAR(10 g) = 2.13 W/kg

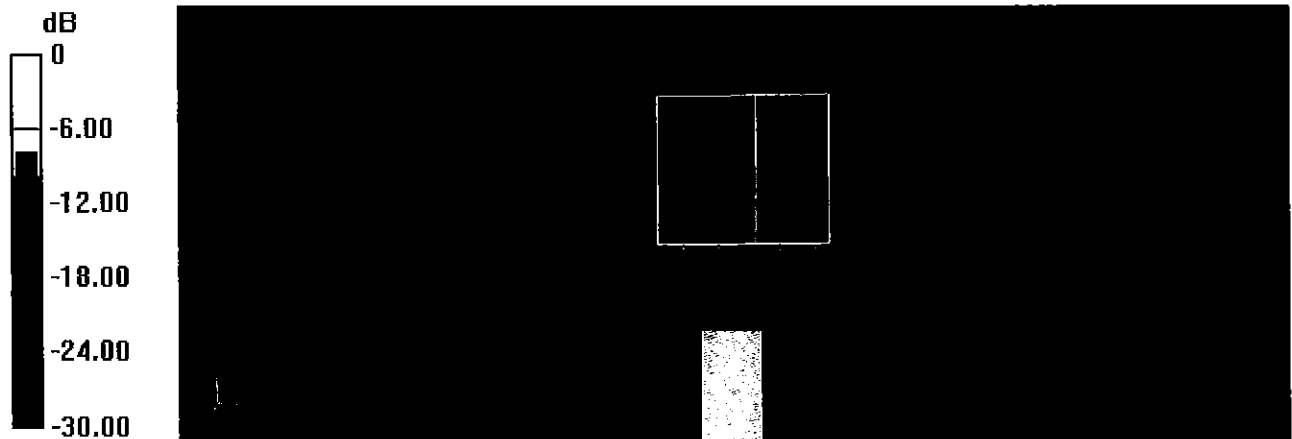

0 dB = 18.9 W/kg = 12.76 dBW/kg

Impedance Measurement Plot for Body TSL

10 Jan 2018 17:45:41

CH1 S11 1 U FS 1: 49.266 Ω -6.6719 Ω 4.5874 pF 5 200.000 000 MHz

*
Del
Cor
Avg 16
H1d

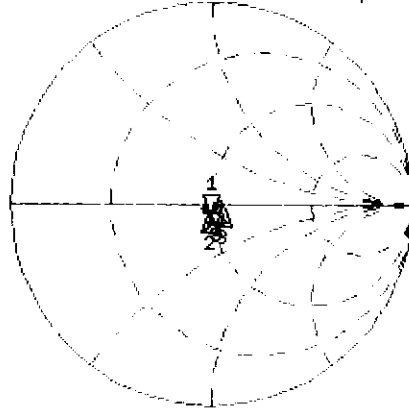

CH1 Markers

- 2: 48.449 Ω
-3.9297 Ω
5.25000 GHz
- 3: 55.279 Ω
-1.5723 Ω
5.60000 GHz
- 4: 52.627 Ω
1.0625 Ω
5.75000 GHz
- 5: 51.801 Ω
-375.00 m Ω
5.80000 GHz

CH2 S11 LOG 5 dB/REF -20 dB 1: -23.417 dB 5 200.000 000 MHz

Cor
Avg 16
H1d

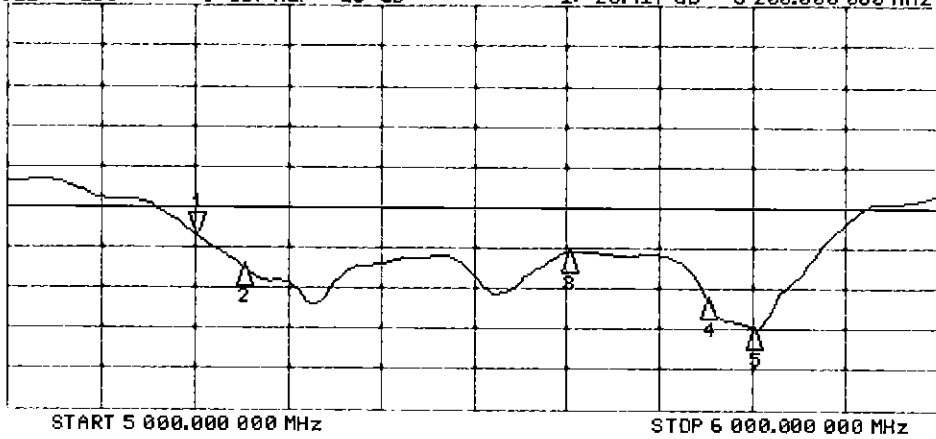

CH2 Markers

- 2: -27.356 dB
5.25000 GHz
- 3: -25.621 dB
5.60000 GHz
- 4: -31.162 dB
5.75000 GHz
- 5: -34.851 dB
5.80000 GHz

DASY5 Validation Report for SAM Head

Date: 16.01.2018

Test Laboratory: SPEAG, Zurich, Switzerland

DUT: Dipole 5GHz; Type: D5GHzV2; Serial: D5GHzV2 - SN:1057

Communication System: UID 0 - CW; Frequency: 5200 MHz, Frequency: 5800 MHz
Medium parameters used: $f = 5200$ MHz; $\sigma = 4.59$ S/m; $\epsilon_r = 36.5$; $\rho = 1000$ kg/m³ ,
Medium parameters used: $f = 5800$ MHz; $\sigma = 5.28$ S/m; $\epsilon_r = 35.4$; $\rho = 1000$ kg/m³
Measurement Standard: DASY5 (IEEE/IEC/ANSI C63.19-2007)

DASY52 Configuration:

- Probe: EX3DV4 - SN3503; ConvF(5.75, 5.75, 5.75); Calibrated: 30.12.2017, ConvF(4.96, 4.96, 4.96); Calibrated: 30.12.2017;
- Sensor-Surface: 1.4mm (Mechanical Surface Detection)
- Electronics: DAE4 Sn601; Calibrated: 26.10.2017
- Phantom: SAM Head
- DASY52 52.10.0(1446); SEMCAD X 14.6.10(7417)

SAM Head/Top - 5200/Zoom Scan (8x8x7)/Cube 0: Measurement grid: dx=4mm, dy=4mm, dz=1.4mm

Reference Value = 72.99 V/m; Power Drift = 0.04 dB
Peak SAR (extrapolated) = 30.6 W/kg
SAR(1 g) = 8.24 W/kg; SAR(10 g) = 2.35 W/kg
Maximum value of SAR (measured) = 19.7 W/kg

SAM Head/Top - 5800/Zoom Scan (8x8x7)/Cube 0: Measurement grid: dx=4mm, dy=4mm, dz=1.4mm

Reference Value = 73.00 V/m; Power Drift = 0.07 dB
Peak SAR (extrapolated) = 36.5 W/kg
SAR(1 g) = 8.62 W/kg; SAR(10 g) = 2.41 W/kg
Maximum value of SAR (measured) = 21.9 W/kg

SAM Head/Mouth - 5200/Zoom Scan (8x8x7)/Cube 0: Measurement grid: dx=4mm, dy=4mm, dz=1.4mm

Reference Value = 72.79 V/m; Power Drift = -0.04 dB
Peak SAR (extrapolated) = 29.5 W/kg
SAR(1 g) = 8.54 W/kg; SAR(10 g) = 2.37 W/kg
Maximum value of SAR (measured) = 20.7 W/kg

SAM Head/Mouth - 5800/Zoom Scan (8x8x7)/Cube 0: Measurement grid: dx=4mm, dy=4mm, dz=1.4mm

Reference Value = 71.69 V/m; Power Drift = -0.07 dB

Peak SAR (extrapolated) = 34.9 W/kg

SAR(1 g) = 8.88 W/kg; SAR(10 g) = 2.44 W/kg

Maximum value of SAR (measured) = 23.0 W/kg

SAM Head/Neck - 5200/Zoom Scan (8x8x7)/Cube 0: Measurement grid: dx=4mm, dy=4mm, dz=1.4mm

Reference Value = 72.48 V/m; Power Drift = 0.05 dB

Peak SAR (extrapolated) = 27.9 W/kg

SAR(1 g) = 8.14 W/kg; SAR(10 g) = 2.37 W/kg

Maximum value of SAR (measured) = 19.3 W/kg

SAM Head/Neck - 5800/Zoom Scan (8x8x7)/Cube 0: Measurement grid: dx=4mm, dy=4mm, dz=1.4mm

Reference Value = 72.90 V/m; Power Drift = 0.01 dB

Peak SAR (extrapolated) = 33.4 W/kg

SAR(1 g) = 8.33 W/kg; SAR(10 g) = 2.35 W/kg

Maximum value of SAR (measured) = 21.8 W/kg

SAM Head/Ear - 5200/Zoom Scan (8x8x7)/Cube 0: Measurement grid: dx=4mm, dy=4mm, dz=1.4mm

Reference Value = 54.68 V/m; Power Drift = 0.03 dB

Peak SAR (extrapolated) = 16.3 W/kg

SAR(1 g) = 5.16 W/kg; SAR(10 g) = 1.76 W/kg

Maximum value of SAR (measured) = 11.1 W/kg

SAM Head/Ear - 5800/Zoom Scan (8x8x7)/Cube 0: Measurement grid: dx=4mm, dy=4mm, dz=1.4mm

Reference Value = 56.96 V/m; Power Drift = -0.05 dB

Peak SAR (extrapolated) = 21.2 W/kg

SAR(1 g) = 5.68 W/kg; SAR(10 g) = 1.89 W/kg

Maximum value of SAR (measured) = 13.8 W/kg

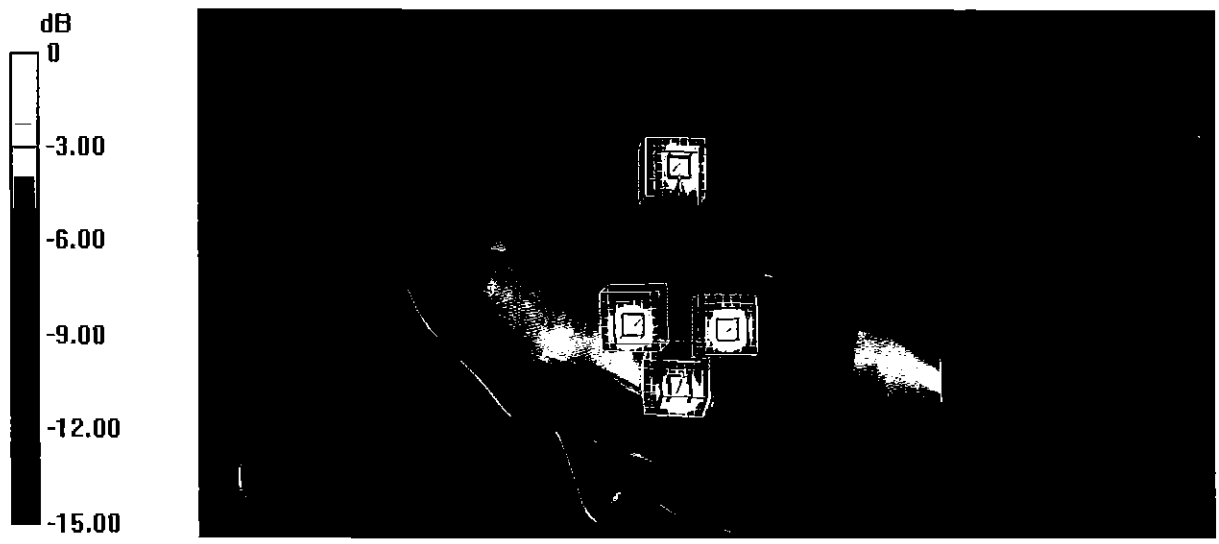

0 dB = 13.8 W/kg = 11.40 dBW/kg

Certification of Calibration

Object: D5GHzV2 – SN: 1057

Calibration procedure(s): Procedure for Calibration Extension for SAR Dipoles.

Extension Calibration date: 1/16/2019

Description: SAR Validation Dipole at 5250, 5600, and 5750 MHz.

Calibration Equipment used:

Manufacturer	Model	Description	Cal Date	Cal Interval	Cal Due	Serial Number
Agilent	8753ES	S-Parameter Network Analyzer	2/8/2018	Annual	2/8/2019	US39170122
Agilent	N5182A	MXG Vector Signal Generator	4/18/2018	Annual	4/18/2019	MY47420800
Amplifier Research	15S1G6	Amplifier	CBT	N/A	CBT	433971
Anritsu	MA2411B	Pulse Power Sensor	3/2/2018	Annual	3/2/2019	1207364
Anritsu	MA2411B	Pulse Power Sensor	3/2/2018	Annual	3/2/2019	1339018
Anritsu	ML2495A	Power Meter	10/21/2018	Annual	10/21/2019	941001
Control Company	4040	Therm./Clock/Humidity Monitor	3/31/2017	Biennial	3/31/2019	170232394
Control Company	4352	Ultra Long Stem Thermometer	5/2/2017	Biennial	5/2/2019	170330156
Keysight	772D	Dual Directional Coupler	CBT	N/A	CBT	MY52180215
Keysight Technologies	85033E	Standard Mechanical Calibration Kit (DC to 9GHz, 3.5mm)	6/4/2018	Annual	6/4/2019	MY53401181
MiniCircuits	VLF-6000+	Low Pass Filter	CBT	N/A	CBT	N/A
Mini-Circuits	BW-N20W5+	DC to 18 GHz Precision Fixed 20 dB Attenuator	CBT	N/A	CBT	N/A
Narda	4772-3	Attenuator (3dB)	CBT	N/A	CBT	9406
Pasternack	PE2209-10	Bidirectional Coupler	CBT	N/A	CBT	N/A
Seekonk	NC-100	Torque Wrench	7/11/2018	Annual	7/11/2019	N/A
SPEAG	DAE4	Dasy Data Acquisition Electronics	10/3/2018	Annual	10/3/2019	1558
SPEAG	DAE4	Dasy Data Acquisition Electronics	6/18/2018	Annual	6/18/2019	1334
SPEAG	DAK-3.5	Dielectric Assessment Kit	9/11/2018	Annual	9/11/2019	1091
SPEAG	EX3DV4	SAR Probe	8/23/2018	Annual	8/23/2019	7308
SPEAG	EX3DV4	SAR Probe	6/25/2018	Annual	6/25/2019	7409

Measurement Uncertainty = $\pm 23\%$ (k=2)

	Name	Function	Signature
Calibrated By:	Brodie Halfoster	Test Engineer	<i>BRODIE HALFOSTER</i>
Approved By:	Kaitlin O'Keefe	Senior Technical Manager	<i>KOK</i>

DIPOLE CALIBRATION EXTENSION

Per KDB 865664 D01, calibration intervals of up to three years may be considered for reference dipoles when it is demonstrated that the SAR target, impedance and return loss of a dipole have remained stable according to the following requirements:

1. The measured SAR does not deviate more than 10% from the target on the calibration certificate.
2. The return-loss does not deviate more than 20% from the previous measurement and meets the required 20dB minimum return-loss requirement.
3. The measurement of real or imaginary parts of impedance does not deviate more than 5Ω from the previous measurement.

The following dipole was checked to pass the above 3 requirements to have 2-year calibration period from the calibration date:

Frequency (MHz)	Calibration Date	Extension Date	Certificate Electrical Delay (ns)	Certificate SAR Target Head (1g) W/kg @ 17.0 dBm	Measured Head SAR (1g) W/kg @ 17.0 dBm	Deviation 1g (%)	Certificate SAR Target Head (10g) W/kg @ 17.0 dBm	Measured Head SAR (10g) W/kg @ 17.0 dBm	Deviation 10g (%)	Certificate Impedance Head (Ohm) Real	Measured Impedance Head (Ohm) Real	Difference (Ohm) Real	Certificate Impedance Head (Ohm) Imaginary	Measured Impedance Head (Ohm) Imaginary	Difference (Ohm) Imaginary	Certificate Return Loss Head (dB)	Measured Return Loss Head (dB)	Deviation (%)	PASS/FAIL
5250	1/16/2018	1/16/2019	1.203	3.95	3.63	-8.33%	1.14	1.04	-8.77%	50	47.6	2.4	-5.5	-8.7	1.2	-25.2	-22.8	9.60%	PASS
5600	1/16/2018	1/16/2019	1.203	4.205	3.84	-8.88%	1.2	1.09	-9.17%	54.7	52.5	2.2	-2.1	1.6	3.7	-26.2	-30.6	-16.80%	PASS
5750	1/16/2018	1/16/2019	1.203	4.025	3.76	-6.98%	1.15	1.07	-6.96%	52.7	54.4	1.7	0	0.1	0.1	-31.5	-27.5	12.70%	PASS
Frequency (MHz)	Calibration Date	Extension Date	Certificate Electrical Delay (ns)	Certificate SAR Target Body (1g) W/kg @ 17.0 dBm	Measured Body SAR (1g) W/kg @ 17.0 dBm	Deviation 1g (%)	Certificate SAR Target Body (10g) W/kg @ 17.0 dBm	Measured Body SAR (10g) W/kg @ 17.0 dBm	Deviation 10g (%)	Certificate Impedance Body (Ohm) Real	Measured Impedance Body (Ohm) Real	Difference (Ohm) Real	Certificate Impedance Body (Ohm) Imaginary	Measured Impedance Body (Ohm) Imaginary	Difference (Ohm) Imaginary	Certificate Return Loss Body (dB)	Measured Return Loss Body (dB)	Deviation (%)	PASS/FAIL
5250	1/16/2018	1/16/2019	1.203	3.795	3.73	-1.71%	1.06	1.03	-2.37%	48.4	45.9	2.5	-3.9	-4	0.1	-27.4	-24.5	10.50%	PASS
5600	1/16/2018	1/16/2019	1.203	3.995	4.06	1.63%	1.12	1.12	0.46%	55.3	51	4.3	-1.6	2.8	4.4	-25.6	-30.7	-20.00%	PASS
5750	1/16/2018	1/16/2019	1.203	3.835	3.65	-4.82%	1.06	1.02	-3.77%	52.6	52.9	0.3	1.1	0.6	0.5	-31.2	-30.7	1.60%	PASS

Impedance & Return-Loss Measurement Plot for Head TSL

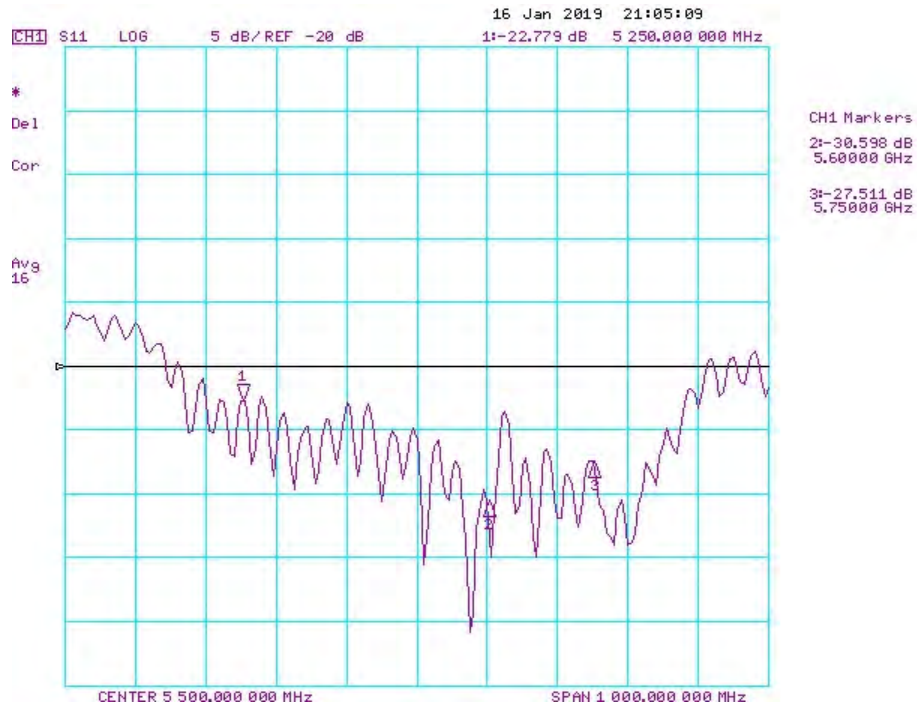
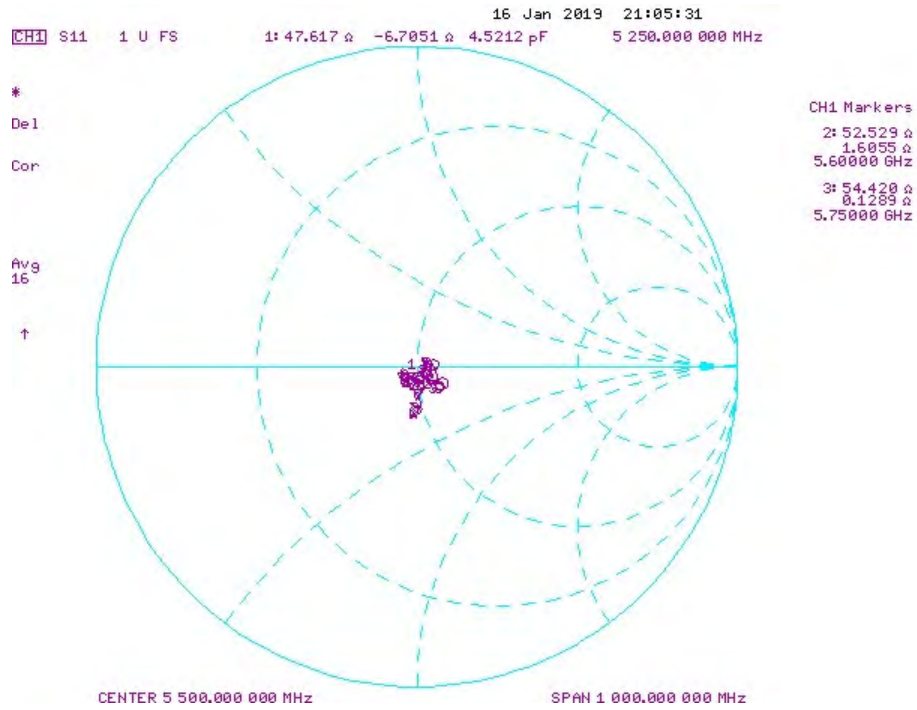

Impedance & Return-Loss Measurement Plot for Body TSL

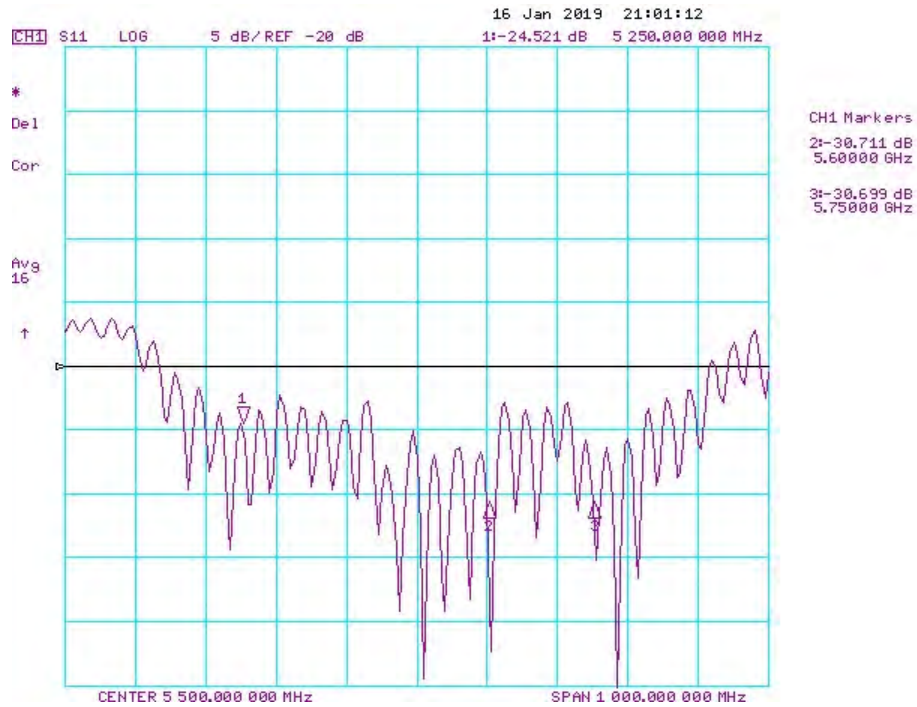
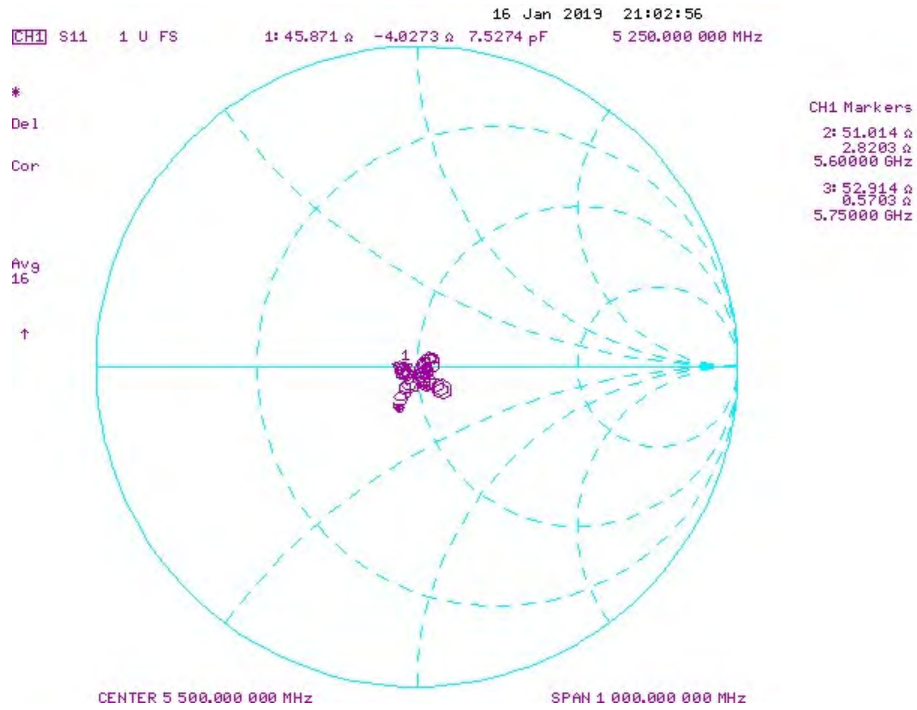

**Calibration Laboratory of
Schmid & Partner
Engineering AG**
Zeughausstrasse 43, 8004 Zurich, Switzerland



S Schweizerischer Kalibrierdienst
C Service suisse d'étalonnage
S Servizio svizzero di taratura
S Swiss Calibration Service

Accredited by the Swiss Accreditation Service (SAS)
The Swiss Accreditation Service is one of the signatories to the EA
Multilateral Agreement for the recognition of calibration certificates

Accreditation No.: **SCS 0108**

Client **PC Test**

Certificate No: **D2450V2-719_Aug17**

CALIBRATION CERTIFICATE

Object **D2450V2 - SN:719**

Calibration procedure(s) **QA CAL-05.v9**
Calibration procedure for dipole validation kits above 700 MHz

Calibration date: **August 17, 2017**

PNV
8/27/17
Extended
BN
7/19/2018

This calibration certificate documents the traceability to national standards, which realize the physical units of measurements (SI).
The measurements and the uncertainties with confidence probability are given on the following pages and are part of the certificate.

All calibrations have been conducted in the closed laboratory facility: environment temperature (22 ± 3)°C and humidity < 70%.

Calibration Equipment used (M&TE critical for calibration)

Primary Standards	ID #	Cal Date (Certificate No.)	Scheduled Calibration
Power meter NRP	SN: 104778	04-Apr-17 (No. 217-02521/02522)	Apr-18
Power sensor NRP-Z91	SN: 103244	04-Apr-17 (No. 217-02521)	Apr-18
Power sensor NRP-Z91	SN: 103245	04-Apr-17 (No. 217-02522)	Apr-18
Reference 20 dB Attenuator	SN: 5058 (20K)	07-Apr-17 (No. 217-02528)	Apr-18
Type-N mismatch combination	SN: 5047.2 / 06327	07-Apr-17 (No. 217-02529)	Apr-18
Reference Probe EX3DV4	SN: 7349	31-May-17 (No. EX3-7349_May17)	May-18
DAE4	SN: 601	28-Mar-17 (No. DAE4-601_Mar17)	Mar-18

Secondary Standards	ID #	Check Date (in house)	Scheduled Check
Power meter EPM-442A	SN: GB37480704	07-Oct-15 (in house check Oct-16)	In house check: Oct-18
Power sensor HP 8481A	SN: US37292783	07-Oct-15 (in house check Oct-16)	In house check: Oct-18
Power sensor HP 8481A	SN: MY41092317	07-Oct-15 (in house check Oct-16)	In house check: Oct-18
RF generator R&S SMT-06	SN: 100972	15-Jun-15 (in house check Oct-16)	In house check: Oct-18
Network Analyzer HP 8753E	SN: US37390585	18-Oct-01 (in house check Oct-16)	In house check: Oct-17

Calibrated by: **Michael Weber** Name: Michael Weber Function: Laboratory Technician

Approved by: **Katja Pokovic** Name: Katja Pokovic Function: Technical Manager

Signature
M. Weber
K. Pokovic

Issued: August 17, 2017

This calibration certificate shall not be reproduced except in full without written approval of the laboratory.



Accredited by the Swiss Accreditation Service (SAS)
The Swiss Accreditation Service is one of the signatories to the EA
Multilateral Agreement for the recognition of calibration certificates

Accreditation No.: **SCS 0108**

Glossary:

TSL	tissue simulating liquid
ConvF	sensitivity in TSL / NORM x,y,z
N/A	not applicable or not measured

Calibration is Performed According to the Following Standards:

- IEEE Std 1528-2013, "IEEE Recommended Practice for Determining the Peak Spatial-Averaged Specific Absorption Rate (SAR) in the Human Head from Wireless Communications Devices: Measurement Techniques", June 2013
- IEC 62209-1, "Measurement procedure for the assessment of Specific Absorption Rate (SAR) from hand-held and body-mounted devices used next to the ear (frequency range of 300 MHz to 6 GHz)", July 2016
- IEC 62209-2, "Procedure to determine the Specific Absorption Rate (SAR) for wireless communication devices used in close proximity to the human body (frequency range of 30 MHz to 6 GHz)", March 2010
- KDB 865664, "SAR Measurement Requirements for 100 MHz to 6 GHz"

Additional Documentation:

- DASY4/5 System Handbook

Methods Applied and Interpretation of Parameters:

- Measurement Conditions:** Further details are available from the Validation Report at the end of the certificate. All figures stated in the certificate are valid at the frequency indicated.
- Antenna Parameters with TSL:** The dipole is mounted with the spacer to position its feed point exactly below the center marking of the flat phantom section, with the arms oriented parallel to the body axis.
- Feed Point Impedance and Return Loss:** These parameters are measured with the dipole positioned under the liquid filled phantom. The impedance stated is transformed from the measurement at the SMA connector to the feed point. The Return Loss ensures low reflected power. No uncertainty required.
- Electrical Delay:** One-way delay between the SMA connector and the antenna feed point. No uncertainty required.
- SAR measured:** SAR measured at the stated antenna input power.
- SAR normalized:** SAR as measured, normalized to an input power of 1 W at the antenna connector.
- SAR for nominal TSL parameters:** The measured TSL parameters are used to calculate the nominal SAR result.

The reported uncertainty of measurement is stated as the standard uncertainty of measurement multiplied by the coverage factor $k=2$, which for a normal distribution corresponds to a coverage probability of approximately 95%.

Measurement Conditions

DASY system configuration, as far as not given on page 1.

DASY Version	DASY5	V52.10.0
Extrapolation	Advanced Extrapolation	
Phantom	Modular Flat Phantom	
Distance Dipole Center - TSL	10 mm	with Spacer
Zoom Scan Resolution	dx, dy, dz = 5 mm	
Frequency	2450 MHz ± 1 MHz	

Head TSL parameters

The following parameters and calculations were applied.

	Temperature	Permittivity	Conductivity
Nominal Head TSL parameters	22.0 °C	39.2	1.80 mho/m
Measured Head TSL parameters	(22.0 ± 0.2) °C	37.8 ± 6 %	1.86 mho/m ± 6 %
Head TSL temperature change during test	< 0.5 °C	----	----

SAR result with Head TSL

SAR averaged over 1 cm³ (1 g) of Head TSL	Condition	
SAR measured	250 mW input power	13.3 W/kg
SAR for nominal Head TSL parameters	normalized to 1W	51.9 W/kg ± 17.0 % (k=2)

SAR averaged over 10 cm³ (10 g) of Head TSL	condition	
SAR measured	250 mW input power	6.15 W/kg
SAR for nominal Head TSL parameters	normalized to 1W	24.3 W/kg ± 16.5 % (k=2)

Body TSL parameters

The following parameters and calculations were applied.

	Temperature	Permittivity	Conductivity
Nominal Body TSL parameters	22.0 °C	52.7	1.95 mho/m
Measured Body TSL parameters	(22.0 ± 0.2) °C	51.9 ± 6 %	2.03 mho/m ± 6 %
Body TSL temperature change during test	< 0.5 °C	----	----

SAR result with Body TSL

SAR averaged over 1 cm³ (1 g) of Body TSL	Condition	
SAR measured	250 mW input power	12.8 W/kg
SAR for nominal Body TSL parameters	normalized to 1W	50.1 W/kg ± 17.0 % (k=2)

SAR averaged over 10 cm³ (10 g) of Body TSL	condition	
SAR measured	250 mW input power	6.00 W/kg
SAR for nominal Body TSL parameters	normalized to 1W	23.7 W/kg ± 16.5 % (k=2)

Appendix (Additional assessments outside the scope of SCS 0108)

Antenna Parameters with Head TSL

Impedance, transformed to feed point	55.7 Ω + 7.0 j Ω
Return Loss	- 21.4 dB

Antenna Parameters with Body TSL

Impedance, transformed to feed point	51.4 Ω + 8.1 j Ω
Return Loss	- 21.8 dB

General Antenna Parameters and Design

Electrical Delay (one direction)	1.150 ns
----------------------------------	----------

After long term use with 100W radiated power, only a slight warming of the dipole near the feedpoint can be measured.

The dipole is made of standard semirigid coaxial cable. The center conductor of the feeding line is directly connected to the second arm of the dipole. The antenna is therefore short-circuited for DC-signals. On some of the dipoles, small end caps are added to the dipole arms in order to improve matching when loaded according to the position as explained in the "Measurement Conditions" paragraph. The SAR data are not affected by this change. The overall dipole length is still according to the Standard.

No excessive force must be applied to the dipole arms, because they might bend or the soldered connections near the feedpoint may be damaged.

Additional EUT Data

Manufactured by	SPEAG
Manufactured on	September 10, 2002

DASY5 Validation Report for Head TSL

Date: 17.08.2017

Test Laboratory: SPEAG, Zurich, Switzerland

DUT: Dipole 2450 MHz; Type: D2450V2; Serial: D2450V2 - SN: 719

Communication System: UID 0 - CW; Frequency: 2450 MHz

Medium parameters used: $f = 2450$ MHz; $\sigma = 1.86$ S/m; $\epsilon_r = 37.8$; $\rho = 1000$ kg/m³

Phantom section: Flat Section

Measurement Standard: DASY5 (IEEE/IEC/ANSI C63.19-2011)

DASY52 Configuration:

- Probe: EX3DV4 - SN7349; ConvF(8.12, 8.12, 8.12); Calibrated: 31.05.2017;
- Sensor-Surface: 1.4mm (Mechanical Surface Detection)
- Electronics: DAE4 Sn601; Calibrated: 28.03.2017
- Phantom: Flat Phantom 5.0 (front); Type: QD 000 P50 AA; Serial: 1001
- DASY52 52.10.0(1446); SEMCAD X 14.6.10(7417)

Dipole Calibration for Head Tissue/Pin=250 mW, d=10mm/Zoom Scan (7x7x7)/Cube 0:

Measurement grid: dx=5mm, dy=5mm, dz=5mm

Reference Value = 112.8 V/m; Power Drift = -0.01 dB

Peak SAR (extrapolated) = 26.9 W/kg

SAR(1 g) = 13.3 W/kg; SAR(10 g) = 6.15 W/kg

Maximum value of SAR (measured) = 21.6 W/kg

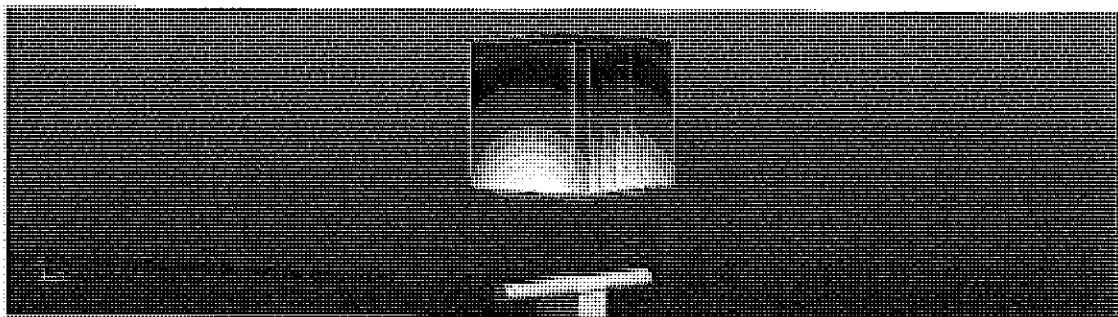
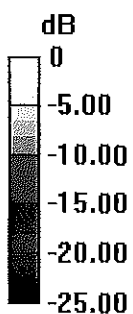

0 dB = 21.6 W/kg = 13.34 dBW/kg

Impedance Measurement Plot for Head TSL

17 Aug 2017 12:38:03
 CH1 S11 1 U FS 1: 55.682 Ω 6.9766 Ω 453.21 μH 2 450.000 000 MHz

*
 De1
 CA

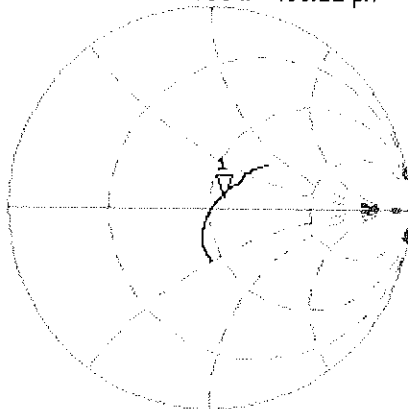

Avg
 16

H1d

CH2 S11 LOG 5 dB/REF -20 dB 1: -21.413 dB 2 450.000 000 MHz

CA

Avg
 16

H1d

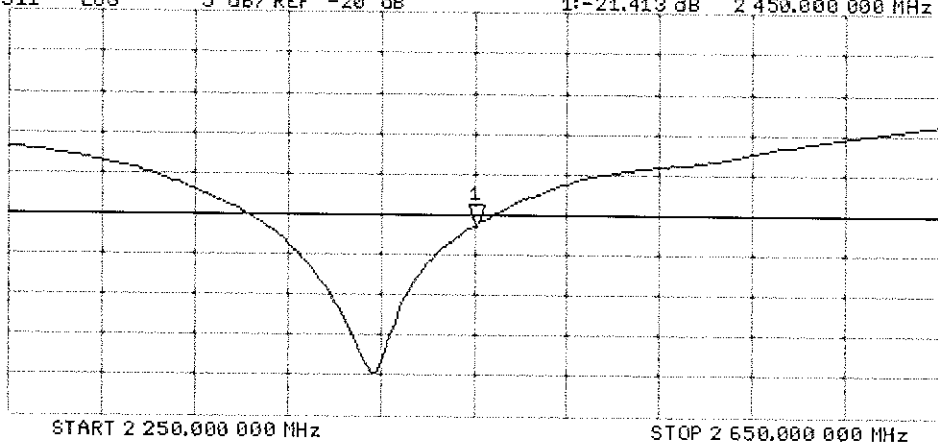

DASY5 Validation Report for Body TSL

Date: 17.08.2017

Test Laboratory: SPEAG, Zurich, Switzerland

DUT: Dipole 2450 MHz; Type: D2450V2; Serial: D2450V2 - SN: 719

Communication System: UID 0 - CW; Frequency: 2450 MHz

Medium parameters used: $f = 2450$ MHz; $\sigma = 2.03$ S/m; $\epsilon_r = 51.9$; $\rho = 1000$ kg/m³

Phantom section: Flat Section

Measurement Standard: DASY5 (IEEE/IEC/ANSI C63.19-2011)

DASY52 Configuration:

- Probe: EX3DV4 - SN7349; ConvF(8.1, 8.1, 8.1); Calibrated: 31.05.2017;
- Sensor-Surface: 1.4mm (Mechanical Surface Detection)
- Electronics: DAE4 Sn601; Calibrated: 28.03.2017
- Phantom: Flat Phantom 5.0 (back); Type: QD 000 P50 AA; Serial: 1002
- DASY52 52.10.0(1446); SEMCAD X 14.6.10(7417)

Dipole Calibration for Body Tissue/Pin=250 mW, d=10mm/Zoom Scan (7x7x7)/Cube 0:

Measurement grid: dx=5mm, dy=5mm, dz=5mm

Reference Value = 103.0 V/m; Power Drift = -0.07 dB

Peak SAR (extrapolated) = 25.2 W/kg

SAR(1 g) = 12.8 W/kg; SAR(10 g) = 6 W/kg

Maximum value of SAR (measured) = 19.8 W/kg

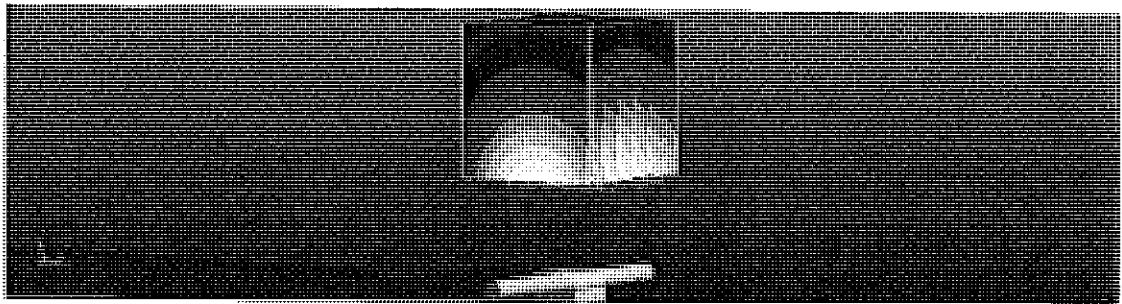
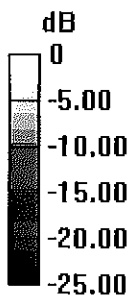

0 dB = 19.8 W/kg = 12.97 dBW/kg

Impedance Measurement Plot for Body TSL

17 Aug 2017 12:37:27
[CH1] S11 1 U FS 1: 51.379 Ω 8.1367 Ω 528.57 pF 2 450.000 000 MHz

*
De1
C4

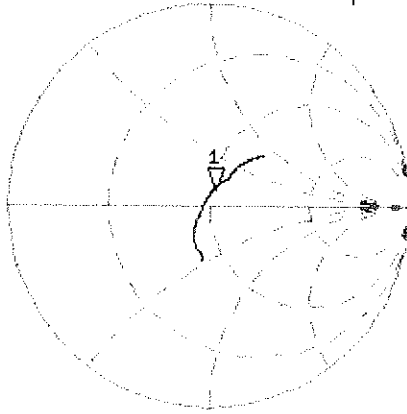

Avg
16

H1d

CH2 S11 LOG 5 dB/REF -20 dB 1: -21.809 dB 2 450.000 000 MHz

C4

Avg
16

H1d

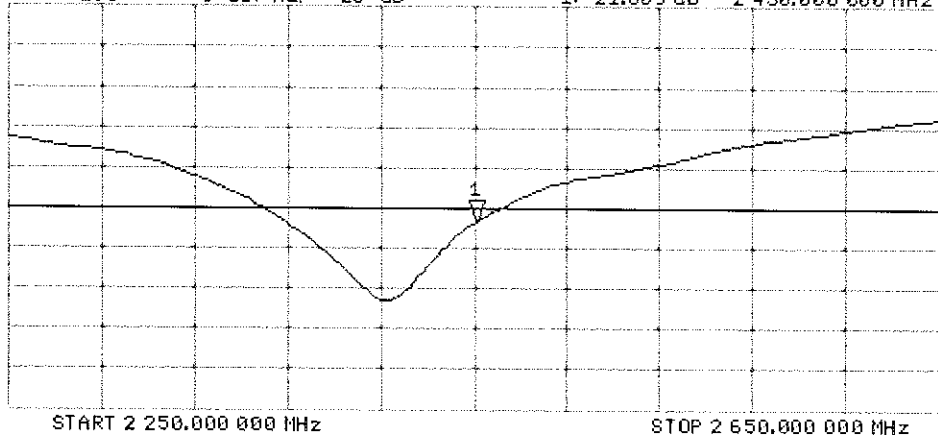

Certification of Calibration

Object: D2450V2 – SN: 719

Calibration procedure(s): Procedure for Calibration Extension for SAR Dipoles.

Extended Calibration date: 07/18/2018

Description: SAR Validation Dipole at 2450 MHz.

Calibration Equipment used:

Manufacturer	Model	Description	Cal Date	Cal Interval	Cal Due	Serial Number
Agilent	E4438C	ESG Vector Signal Generator	3/24/2017	Biennial	3/24/2019	MY42082385
Agilent	8753ES	S-Parameter Network Analyzer	9/14/2017	Annual	9/14/2018	US39170118
Amplifier Research	15S1G6	Amplifier	CBT	N/A	CBT	433971
Anritsu	ML2495A	Power Meter	11/28/2017	Annual	11/28/2018	1039008
Anritsu	MA2411B	Pulse Power Sensor	3/2/2018	Annual	3/2/2019	1207364
Anritsu	MA2411B	Pulse Power Sensor	11/15/2017	Annual	11/15/2018	1339007
Control Company	4040	Therm./Clock/Humidity Monitor	3/31/2017	Biennial	3/31/2019	170232394
Control Company	4352	Ultra Long Stem Thermometer	5/2/2017	Biennial	5/2/2019	170330156
Keysight	772D	Dual Directional Coupler	CBT	N/A	CBT	MY52180215
Keysight Technologies	85033E	Standard Mechanical Calibration Kit (DC to 9GHz, 3.5mm)	6/4/2018	Annual	6/4/2019	MY53401181
Mini-Circuits	BW-N20W5+	DC to 18 GHz Precision Fixed 20 dB Attenuator	CBT	N/A	CBT	N/A
Mini-Circuits	NLP-2950+	Low Pass Filter DC to 2700 MHz	CBT	N/A	CBT	N/A
Narda	4772-3	Attenuator (3dB)	CBT	N/A	CBT	9406
Pasternack	PE2209-10	Bidirectional Coupler	CBT	N/A	CBT	N/A
Pasternack	PE5011-1	Torque Wrench	7/19/2017	Biennial	7/19/2019	N/A
SPEAG	DAE4	Dasy Data Acquisition Electronics	3/7/2018	Annual	3/7/2019	1368
SPEAG	DAE4	Dasy Data Acquisition Electronics	8/9/2017	Annual	8/9/2018	1323
SPEAG	DAK-3.5	Dielectric Assessment Kit	9/12/2017	Annual	9/12/2018	1091
SPEAG	ES3DV3	SAR Probe	3/13/2018	Annual	3/13/2019	3319
SPEAG	ES3DV3	SAR Probe	8/14/2017	Annual	8/14/2018	3332

Measurement Uncertainty = $\pm 23\%$ (k=2)

	Name	Function	Signature
Calibrated By:	Brodie Halfoster	Test Engineer	<i>BRODIE HALFOSTER</i>
Approved By:	Kaitlin O'Keefe	Senior Technical Manager	<i>KOK</i>

DIPOLE CALIBRATION EXTENSION

Per KDB 865664 D01, calibration intervals of up to three years may be considered for reference dipoles when it is demonstrated that the SAR target, impedance and return loss of a dipole have remained stable according to the following requirements:

1. The measured SAR does not deviate more than 10% from the target on the calibration certificate.
2. The return-loss does not deviate more than 20% from the previous measurement and meets the required 20dB minimum return-loss requirement.
3. The measurement of real or imaginary parts of impedance does not deviate more than 5Ω from the previous measurement.

The following dipole was checked to pass the above 3 requirements to have 2-year calibration period from the calibration date:

Calibration Date	Extension Date	Certificate Electrical Delay (ns)	Certificate SAR Target Head (1g) W/kg @ 20.0 dBm	Measured Head SAR (1g) W/kg @ 20.0 dBm	Deviation 1g (%)	Certificate SAR Target Head (10g) W/kg @ 20.0 dBm	Measured Head SAR (10g) W/kg @ 20.0 dBm	Deviation 10g (%)	Certificate Impedance Head (Ohm) Real	Measured Impedance Head (Ohm) Real	Difference (Ohm) Real	Certificate Impedance Head (Ohm) Imaginary	Measured Impedance Head (Ohm) Imaginary	Difference (Ohm) Imaginary	Certificate Return Loss Head (dB)	Measured Return Loss Head (dB)	Deviation (%)	PASS/FAIL
8/17/2017	7/18/2018	1.150	5.19	5.46	5.20%	2.43	2.51	3.29%	55.7	53.9	1.8	7.0	2.9	4.1	-21.4	-25.4	-18.70%	PASS
Calibration Date	Extension Date	Certificate Electrical Delay (ns)	Certificate SAR Target Body (1g) W/kg @ 20.0 dBm	Measured Body SAR (1g) W/kg @ 20.0 dBm	Deviation 1g (%)	Certificate SAR Target Body (10g) W/kg @ 20.0 dBm	Measured Body SAR (10g) W/kg @ 20.0 dBm	Deviation 10g (%)	Certificate Impedance Body (Ohm) Real	Measured Impedance Body (Ohm) Real	Difference (Ohm) Real	Certificate Impedance Body (Ohm) Imaginary	Measured Impedance Body (Ohm) Imaginary	Difference (Ohm) Imaginary	Certificate Return Loss Body (dB)	Measured Return Loss Body (dB)	Deviation (%)	PASS/FAIL
8/17/2017	7/18/2018	1.150	5.01	5.19	3.59%	2.37	2.38	0.42%	51.4	50.2	1.2	8.1	5.9	2.2	-21.8	-24.6	-12.80%	PASS

Impedance & Return-Loss Measurement Plot for Head TSL

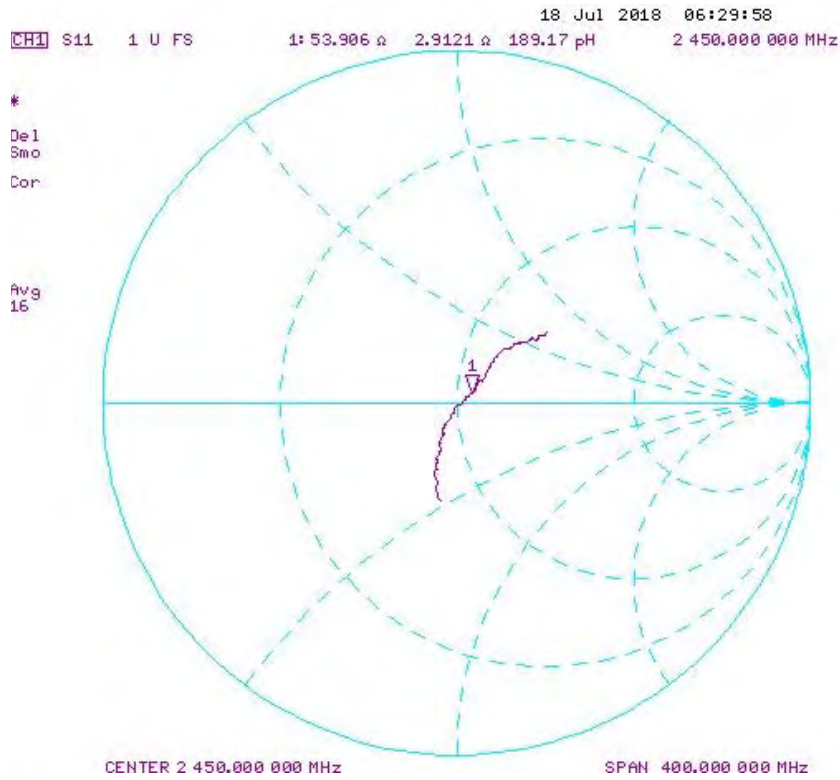

Impedance & Return-Loss Measurement Plot for Body TSL

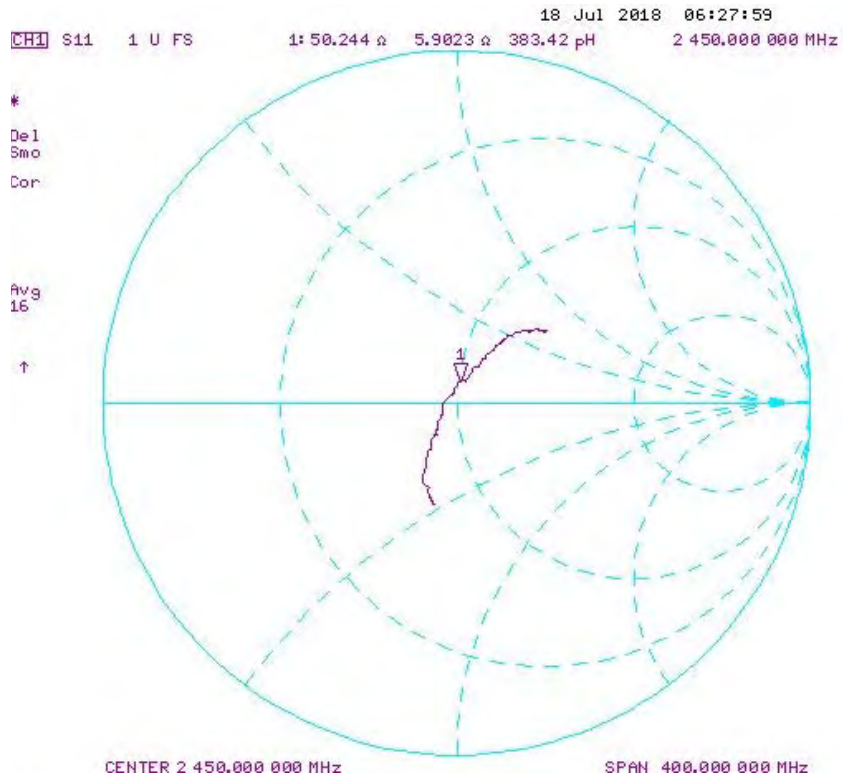



Accredited by the Swiss Accreditation Service (SAS)
The Swiss Accreditation Service is one of the signatories to the EA
Multilateral Agreement for the recognition of calibration certificates

Accreditation No.: **SCS 0108**

Client **PC Test**

Certificate No: **EX3-7409_Jun18**

CALIBRATION CERTIFICATE

Object: **EX3DV4 - SN:7409**

Calibration procedure(s): **QA CAL-01.v9, QA CAL-14.v4, QA CAL-23.v5, QA CAL-25.v6
Calibration procedure for dosimetric E-field probes**

Calibration date: **June 25, 2018**

This calibration certificate documents the traceability to national standards, which realize the physical units of measurements (SI).
The measurements and the uncertainties with confidence probability are given on the following pages and are part of the certificate.

All calibrations have been conducted in the closed laboratory facility: environment temperature (22 ± 3)°C and humidity < 70%.

Calibration Equipment used (M&TE critical for calibration)

*BN ✓
07/16/2018*

Primary Standards	ID	Cal Date (Certificate No.)	Scheduled Calibration
Power meter NRP	SN: 104778	04-Apr-18 (No. 217-02672/02673)	Apr-19
Power sensor NRP-Z91	SN: 103244	04-Apr-18 (No. 217-02672)	Apr-19
Power sensor NRP-Z91	SN: 103245	04-Apr-18 (No. 217-02673)	Apr-19
Reference 20 dB Attenuator	SN: S5277 (20x)	04-Apr-18 (No. 217-02682)	Apr-19
Reference Probe ES3DV2	SN: 3013	30-Dec-17 (No. ES3-3013_Dec17)	Dec-18
DAE4	SN: 660	21-Dec-17 (No. DAE4-660_Dec17)	Dec-18
Secondary Standards	ID	Check Date (in house)	Scheduled Check
Power meter E4419B	SN: GB41293874	06-Apr-16 (in house check Jun-18)	In house check: Jun-20
Power sensor E4412A	SN: MY41498087	06-Apr-16 (in house check Jun-18)	In house check: Jun-20
Power sensor E4412A	SN: 000110210	06-Apr-16 (in house check Jun-18)	In house check: Jun-20
RF generator HP 8648C	SN: US3642U01700	04-Aug-99 (in house check Jun-18)	In house check: Jun-20
Network Analyzer HP 8753E	SN: US37390585	18-Oct-01 (in house check Oct-17)	In house check: Oct-18

Calibrated by: **Claudio Leubler** (Name), **Laboratory Technician** (Function), *[Signature]* (Signature)

Approved by: **Katja Pokovic** (Name), **Technical Manager** (Function), *[Signature]* (Signature)

Issued: June 26, 2018

This calibration certificate shall not be reproduced except in full without written approval of the laboratory.



Accredited by the Swiss Accreditation Service (SAS)

Accreditation No.: **SCS 0108**

The Swiss Accreditation Service is one of the signatories to the EA Multilateral Agreement for the recognition of calibration certificates

Glossary:

TSL	tissue simulating liquid
NORM _{x,y,z}	sensitivity in free space
ConvF	sensitivity in TSL / NORM _{x,y,z}
DCP	diode compression point
CF	crest factor (1/duty_cycle) of the RF signal
A, B, C, D	modulation dependent linearization parameters
Polarization φ	φ rotation around probe axis
Polarization ϑ	ϑ rotation around an axis that is in the plane normal to probe axis (at measurement center), i.e., $\vartheta = 0$ is normal to probe axis
Connector Angle	information used in DASY system to align probe sensor X to the robot coordinate system

Calibration is Performed According to the Following Standards:

- IEEE Std 1528-2013, "IEEE Recommended Practice for Determining the Peak Spatial-Averaged Specific Absorption Rate (SAR) in the Human Head from Wireless Communications Devices: Measurement Techniques", June 2013
- IEC 62209-1, "Measurement procedure for the assessment of Specific Absorption Rate (SAR) from hand-held and body-mounted devices used next to the ear (frequency range of 300 MHz to 6 GHz)", July 2016
- IEC 62209-2, "Procedure to determine the Specific Absorption Rate (SAR) for wireless communication devices used in close proximity to the human body (frequency range of 30 MHz to 6 GHz)", March 2010
- KDB 865664, "SAR Measurement Requirements for 100 MHz to 6 GHz"

Methods Applied and Interpretation of Parameters:

- NORM_{x,y,z}**: Assessed for E-field polarization $\vartheta = 0$ ($f \leq 900$ MHz in TEM-cell; $f > 1800$ MHz: R22 waveguide). NORM_{x,y,z} are only intermediate values, i.e., the uncertainties of NORM_{x,y,z} does not affect the E²-field uncertainty inside TSL (see below *ConvF*).
- NORM(f)_{x,y,z}** = NORM_{x,y,z} * frequency_response (see Frequency Response Chart). This linearization is implemented in DASY4 software versions later than 4.2. The uncertainty of the frequency response is included in the stated uncertainty of *ConvF*.
- DCP_{x,y,z}**: DCP are numerical linearization parameters assessed based on the data of power sweep with CW signal (no uncertainty required). DCP does not depend on frequency nor media.
- PAR**: PAR is the Peak to Average Ratio that is not calibrated but determined based on the signal characteristics
- A_{x,y,z}; B_{x,y,z}; C_{x,y,z}; D_{x,y,z}; VR_{x,y,z}**: A, B, C, D are numerical linearization parameters assessed based on the data of power sweep for specific modulation signal. The parameters do not depend on frequency nor media. VR is the maximum calibration range expressed in RMS voltage across the diode.
- ConvF and Boundary Effect Parameters**: Assessed in flat phantom using E-field (or Temperature Transfer Standard for $f \leq 800$ MHz) and inside waveguide using analytical field distributions based on power measurements for $f > 800$ MHz. The same setups are used for assessment of the parameters applied for boundary compensation (alpha, depth) of which typical uncertainty values are given. These parameters are used in DASY4 software to improve probe accuracy close to the boundary. The sensitivity in TSL corresponds to NORM_{x,y,z} * ConvF whereby the uncertainty corresponds to that given for ConvF. A frequency dependent ConvF is used in DASY version 4.4 and higher which allows extending the validity from ± 50 MHz to ± 100 MHz.
- Spherical isotropy (3D deviation from isotropy)**: in a field of low gradients realized using a flat phantom exposed by a patch antenna.
- Sensor Offset**: The sensor offset corresponds to the offset of virtual measurement center from the probe tip (on probe axis). No tolerance required.
- Connector Angle**: The angle is assessed using the information gained by determining the NORM_x (no uncertainty required).

Probe EX3DV4

SN:7409

Manufactured: November 24, 2015
Calibrated: June 25, 2018

Calibrated for DASY/EASY Systems
(Note: non-compatible with DASY2 system!)

DASY/EASY - Parameters of Probe: EX3DV4 - SN:7409

Basic Calibration Parameters

	Sensor X	Sensor Y	Sensor Z	Unc (k=2)
Norm ($\mu\text{V}/(\text{V}/\text{m})^2$) ^A	0.38	0.33	0.38	$\pm 10.1\%$
DCP (mV) ^B	100.8	102.3	97.7	

Modulation Calibration Parameters

UID	Communication System Name		A dB	B dB $\sqrt{\mu\text{V}}$	C	D dB	VR mV	Unc ^E (k=2)
0	CW	X	0.0	0.0	1.0	0.00	157.1	$\pm 2.2\%$
		Y	0.0	0.0	1.0		172.6	
		Z	0.0	0.0	1.0		175.7	

Note: For details on UID parameters see Appendix.

Sensor Model Parameters

	C1 fF	C2 fF	α V^{-1}	T1 $\text{ms}\cdot\text{V}^{-2}$	T2 $\text{ms}\cdot\text{V}^{-1}$	T3 ms	T4 V^{-2}	T5 V^{-1}	T6
X	15.40	116.5	36.38	2.655	0.140	4.978	0.000	0.017	1.008
Y	27.94	206.6	35.20	4.338	0.095	4.989	1.642	0.000	1.004
Z	31.47	244.0	37.99	3.819	0.313	5.030	0.103	0.363	1.006

The reported uncertainty of measurement is stated as the standard uncertainty of measurement multiplied by the coverage factor $k=2$, which for a normal distribution corresponds to a coverage probability of approximately 95%.

^A The uncertainties of Norm X,Y,Z do not affect the E^2 -field uncertainty inside TSL (see Pages 5 and 6).

^B Numerical linearization parameter: uncertainty not required.

^E Uncertainty is determined using the max. deviation from linear response applying rectangular distribution and is expressed for the square of the field value.

DASY/EASY - Parameters of Probe: EX3DV4 - SN:7409

Calibration Parameter Determined in Head Tissue Simulating Media

f (MHz) ^C	Relative Permittivity ^F	Conductivity (S/m) ^F	ConvF X	ConvF Y	ConvF Z	Alpha ^G	Depth ^G (mm)	Unc (k=2)
750	41.9	0.89	9.91	9.91	9.91	0.44	0.90	± 12.0 %
835	41.5	0.90	9.67	9.67	9.67	0.46	0.85	± 12.0 %
1750	40.1	1.37	8.43	8.43	8.43	0.38	0.80	± 12.0 %
1900	40.0	1.40	8.05	8.05	8.05	0.38	0.84	± 12.0 %
2300	39.5	1.67	7.57	7.57	7.57	0.32	0.80	± 12.0 %
2450	39.2	1.80	7.23	7.23	7.23	0.34	0.86	± 12.0 %
2600	39.0	1.96	6.98	6.98	6.98	0.39	0.86	± 12.0 %
5250	35.9	4.71	5.20	5.20	5.20	0.40	1.80	± 13.1 %
5600	35.5	5.07	4.77	4.77	4.77	0.40	1.80	± 13.1 %
5750	35.4	5.22	4.82	4.82	4.82	0.40	1.80	± 13.1 %

^C Frequency validity above 300 MHz of ± 100 MHz only applies for DASY v4.4 and higher (see Page 2), else it is restricted to ± 50 MHz. The uncertainty is the RSS of the ConvF uncertainty at calibration frequency and the uncertainty for the indicated frequency band. Frequency validity below 300 MHz is ± 10, 25, 40, 50 and 70 MHz for ConvF assessments at 30, 64, 128, 150 and 220 MHz respectively. Above 5 GHz frequency validity can be extended to ± 110 MHz.

^F At frequencies below 3 GHz, the validity of tissue parameters (ϵ and σ) can be relaxed to ± 10% if liquid compensation formula is applied to measured SAR values. At frequencies above 3 GHz, the validity of tissue parameters (ϵ and σ) is restricted to ± 5%. The uncertainty is the RSS of the ConvF uncertainty for indicated target tissue parameters.

^G Alpha/Depth are determined during calibration. SPEAG warrants that the remaining deviation due to the boundary effect after compensation is always less than ± 1% for frequencies below 3 GHz and below ± 2% for frequencies between 3-6 GHz at any distance larger than half the probe tip diameter from the boundary.

DASY/EASY - Parameters of Probe: EX3DV4 - SN:7409

Calibration Parameter Determined in Body Tissue Simulating Media

f (MHz) ^C	Relative Permittivity ^F	Conductivity (S/m) ^F	ConvF X	ConvF Y	ConvF Z	Alpha ^G	Depth ^G (mm)	Unc (k=2)
750	55.5	0.96	9.82	9.82	9.82	0.52	0.84	± 12.0 %
835	55.2	0.97	9.63	9.63	9.63	0.48	0.80	± 12.0 %
1750	53.4	1.49	7.91	7.91	7.91	0.36	0.93	± 12.0 %
1900	53.3	1.52	7.60	7.60	7.60	0.44	0.80	± 12.0 %
2300	52.9	1.81	7.36	7.36	7.36	0.38	0.88	± 12.0 %
2450	52.7	1.95	7.24	7.24	7.24	0.33	0.89	± 12.0 %
2600	52.5	2.16	7.07	7.07	7.07	0.32	0.96	± 12.0 %
5250	48.9	5.36	4.67	4.67	4.67	0.50	1.90	± 13.1 %
5600	48.5	5.77	4.25	4.25	4.25	0.50	1.90	± 13.1 %
5750	48.3	5.94	4.32	4.32	4.32	0.50	1.90	± 13.1 %

^C Frequency validity above 300 MHz of ± 100 MHz only applies for DASY v4.4 and higher (see Page 2), else it is restricted to ± 50 MHz. The uncertainty is the RSS of the ConvF uncertainty at calibration frequency and the uncertainty for the indicated frequency band. Frequency validity below 300 MHz is ± 10, 25, 40, 50 and 70 MHz for ConvF assessments at 30, 64, 128, 150 and 220 MHz respectively. Above 5 GHz frequency validity can be extended to ± 110 MHz.

^F At frequencies below 3 GHz, the validity of tissue parameters (ϵ and σ) can be relaxed to ± 10% if liquid compensation formula is applied to measured SAR values. At frequencies above 3 GHz, the validity of tissue parameters (ϵ and σ) is restricted to ± 5%. The uncertainty is the RSS of the ConvF uncertainty for indicated target tissue parameters.

^G Alpha/Depth are determined during calibration. SPEAG warrants that the remaining deviation due to the boundary effect after compensation is always less than ± 1% for frequencies below 3 GHz and below ± 2% for frequencies between 3-6 GHz at any distance larger than half the probe tip diameter from the boundary.

Frequency Response of E-Field (TEM-Cell:ifi110 EXX, Waveguide: R22)

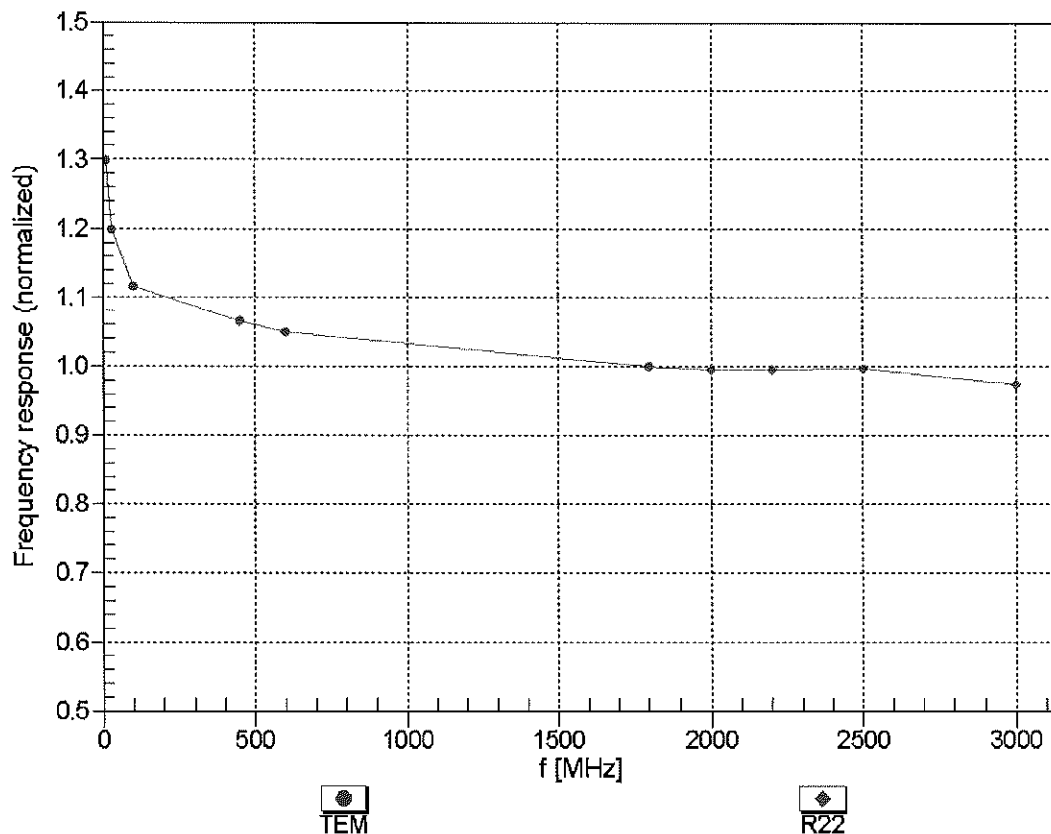

Uncertainty of Frequency Response of E-field: $\pm 6.3\%$ (k=2)

Receiving Pattern (ϕ), $\theta = 0^\circ$

f=600 MHz,TEM

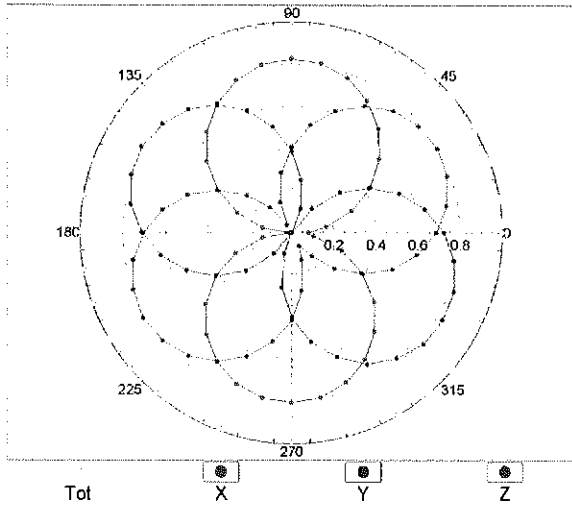

f=1800 MHz,R22

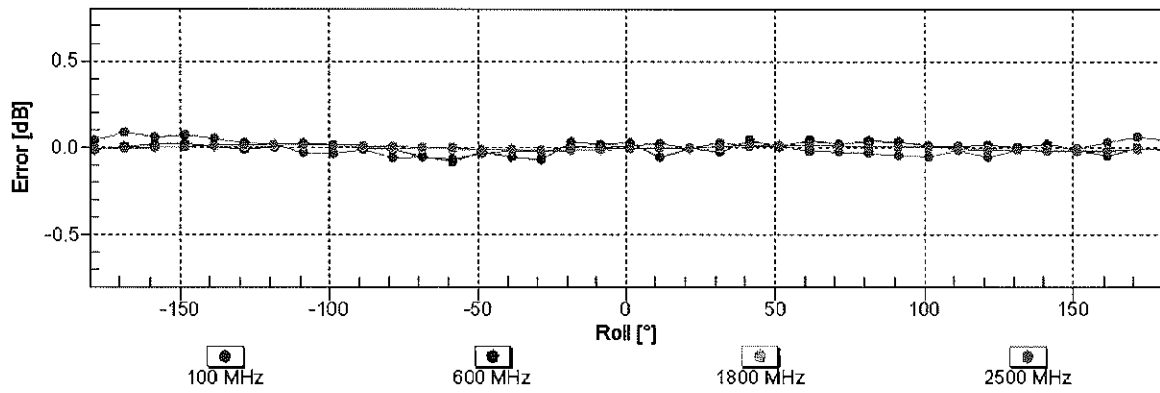
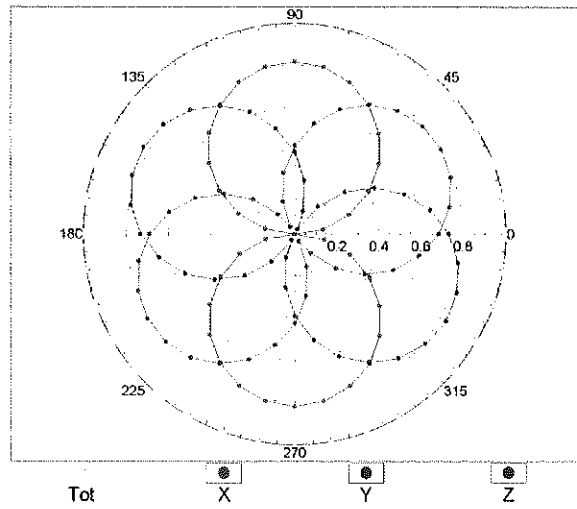

Uncertainty of Axial Isotropy Assessment: $\pm 0.5\%$ ($k=2$)

Dynamic Range $f(SAR_{head})$ (TEM cell, $f_{eval} = 1900$ MHz)

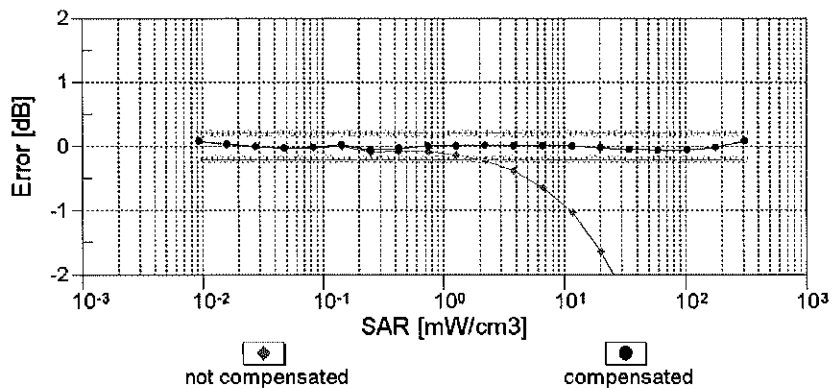
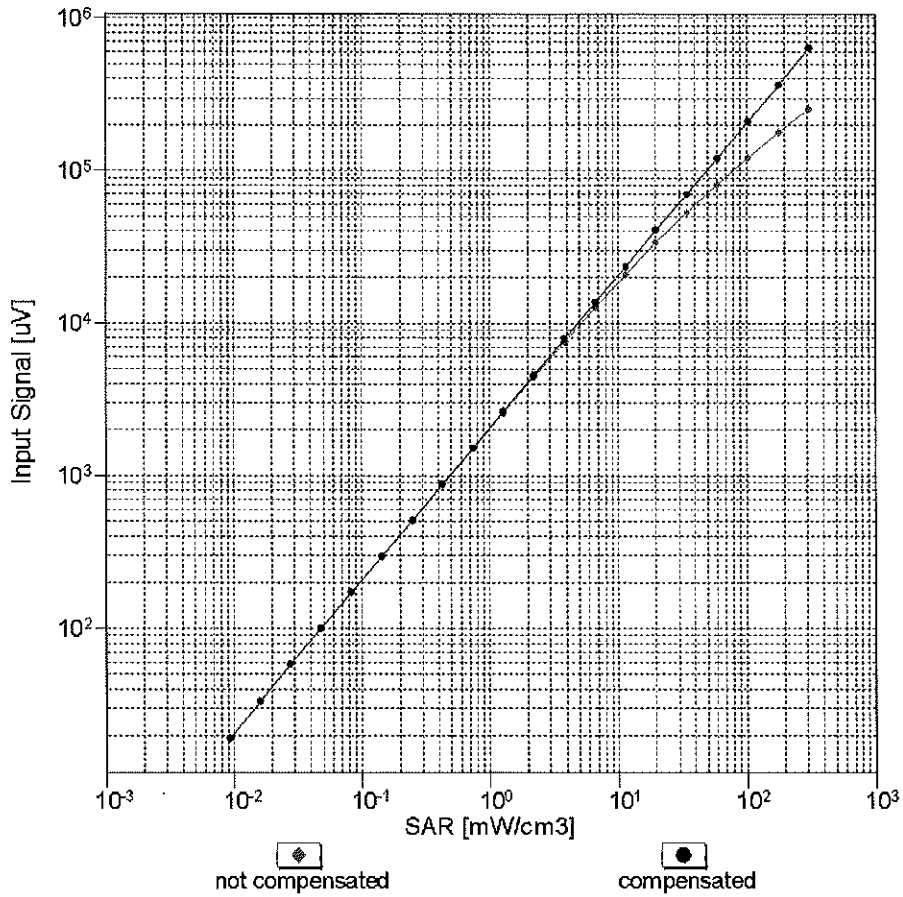

Uncertainty of Linearity Assessment: $\pm 0.6\%$ (k=2)

Conversion Factor Assessment

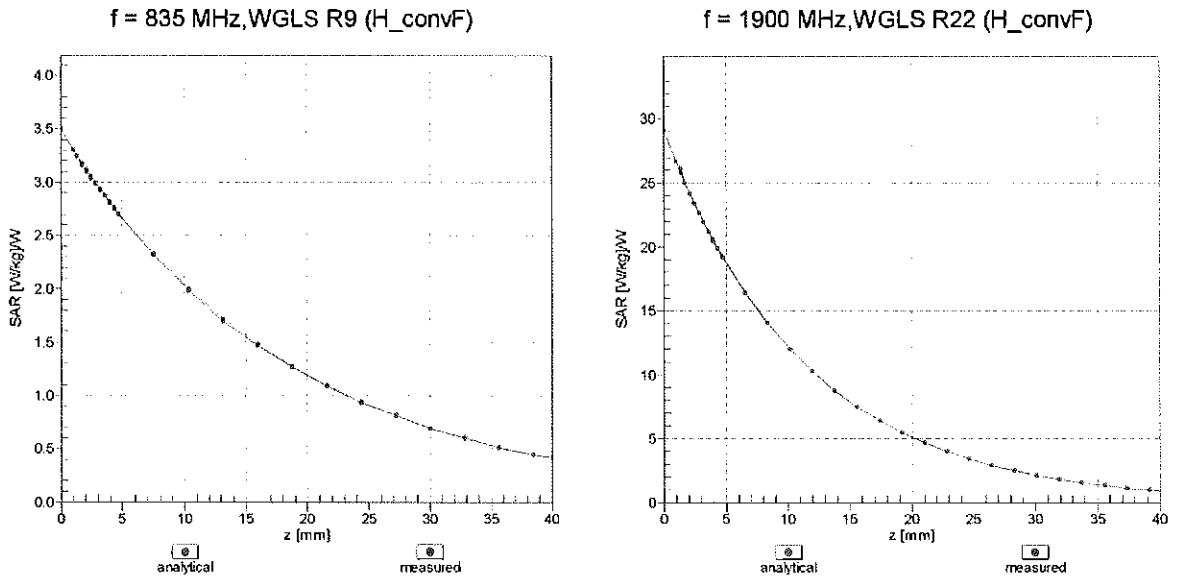

Deviation from Isotropy in Liquid Error (ϕ, θ), f = 900 MHz

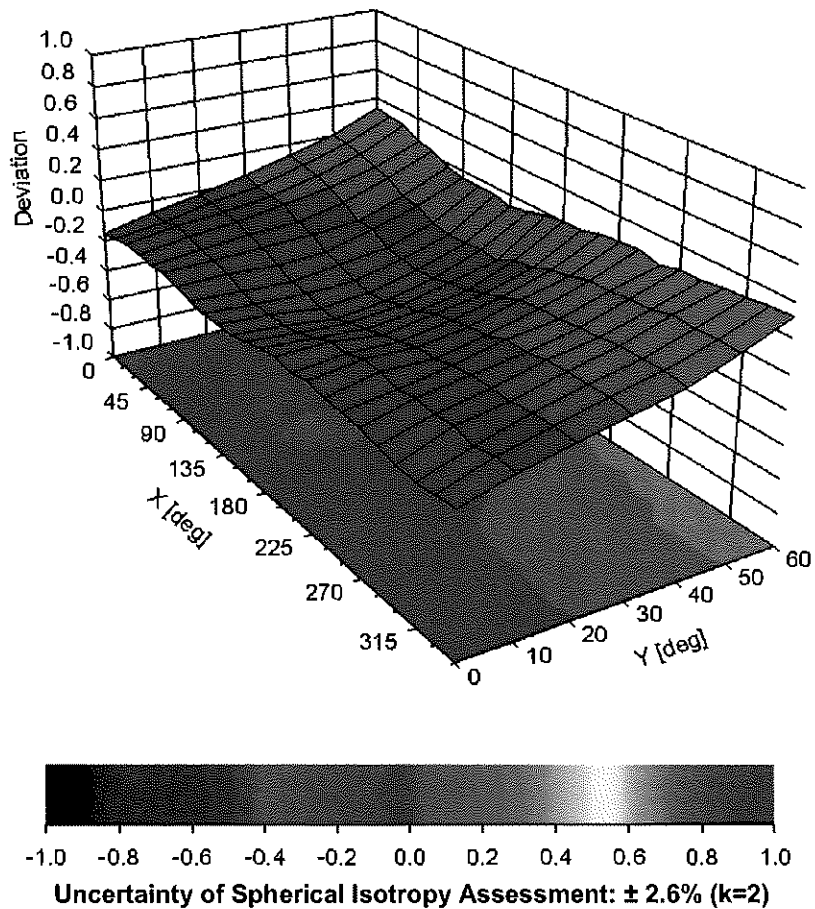

DASY/EASY - Parameters of Probe: EX3DV4 - SN:7409

Other Probe Parameters

Sensor Arrangement	Triangular
Connector Angle (°)	41.5
Mechanical Surface Detection Mode	enabled
Optical Surface Detection Mode	disabled
Probe Overall Length	337 mm
Probe Body Diameter	10 mm
Tip Length	9 mm
Tip Diameter	2.5 mm
Probe Tip to Sensor X Calibration Point	1 mm
Probe Tip to Sensor Y Calibration Point	1 mm
Probe Tip to Sensor Z Calibration Point	1 mm
Recommended Measurement Distance from Surface	1.4 mm

Appendix: Modulation Calibration Parameters

UID	Communication System Name		A dB	B dB $\sqrt{\mu}$ V	C	D dB	VR mV	Max Unc ^E (k=2)
0	CW	X	0.00	0.00	1.00	0.00	157.1	$\pm 2.2\%$
		Y	0.00	0.00	1.00		172.6	
		Z	0.00	0.00	1.00		175.7	
10010- CAA	SAR Validation (Square, 100ms, 10ms)	X	1.25	60.42	5.97	10.00	20.0	$\pm 9.6\%$
		Y	1.37	61.35	6.72		20.0	
		Z	1.46	61.54	7.06		20.0	
10011- CAB	UMTS-FDD (WCDMA)	X	0.71	66.47	12.38	0.00	150.0	$\pm 9.6\%$
		Y	1.49	76.31	19.52		150.0	
		Z	0.80	65.38	13.27		150.0	
10012- CAB	IEEE 802.11b WiFi 2.4 GHz (DSSS, 1 Mbps)	X	0.97	63.61	14.22	0.41	150.0	$\pm 9.6\%$
		Y	1.14	65.32	16.39		150.0	
		Z	1.01	62.66	14.20		150.0	
10013- CAB	IEEE 802.11g WiFi 2.4 GHz (DSSS-OFDM, 6 Mbps)	X	3.98	66.92	16.39	1.46	150.0	$\pm 9.6\%$
		Y	4.51	67.09	17.14		150.0	
		Z	4.51	66.48	16.81		150.0	
10021- DAC	GSM-FDD (TDMA, GMSK)	X	2.93	68.02	10.47	9.39	50.0	$\pm 9.6\%$
		Y	5.30	74.12	13.20		50.0	
		Z	8.30	79.26	15.55		50.0	
10023- DAC	GPRS-FDD (TDMA, GMSK, TN 0)	X	2.04	64.26	8.75	9.57	50.0	$\pm 9.6\%$
		Y	3.75	70.52	11.87		50.0	
		Z	5.18	74.16	13.81		50.0	
10024- DAC	GPRS-FDD (TDMA, GMSK, TN 0-1)	X	0.77	60.84	5.97	6.56	60.0	$\pm 9.6\%$
		Y	100.00	98.81	18.33		60.0	
		Z	7.39	79.44	14.17		60.0	
10025- DAC	EDGE-FDD (TDMA, 8PSK, TN 0)	X	2.92	62.32	21.25	12.57	50.0	$\pm 9.6\%$
		Y	3.79	70.21	26.28		50.0	
		Z	3.08	62.64	21.59		50.0	
10026- DAC	EDGE-FDD (TDMA, 8PSK, TN 0-1)	X	4.19	76.79	26.73	9.56	60.0	$\pm 9.6\%$
		Y	5.08	81.51	29.10		60.0	
		Z	4.89	79.35	27.91		60.0	
10027- DAC	GPRS-FDD (TDMA, GMSK, TN 0-1-2)	X	0.43	60.00	4.84	4.80	80.0	$\pm 9.6\%$
		Y	100.00	98.82	17.61		80.0	
		Z	99.96	97.90	17.31		80.0	
10028- DAC	GPRS-FDD (TDMA, GMSK, TN 0-1-2-3)	X	0.29	60.00	4.20	3.55	100.0	$\pm 9.6\%$
		Y	100.00	100.72	17.79		100.0	
		Z	0.57	63.31	6.83		100.0	
10029- DAC	EDGE-FDD (TDMA, 8PSK, TN 0-1-2)	X	3.08	70.55	22.84	7.80	80.0	$\pm 9.6\%$
		Y	3.50	73.17	24.28		80.0	
		Z	3.45	72.07	23.57		80.0	
10030- CAA	IEEE 802.15.1 Bluetooth (GFSK, DH1)	X	0.52	60.00	4.79	5.30	70.0	$\pm 9.6\%$
		Y	1.54	67.33	9.06		70.0	
		Z	1.17	65.26	8.49		70.0	
10031- CAA	IEEE 802.15.1 Bluetooth (GFSK, DH3)	X	0.04	196.26	30.81	1.88	100.0	$\pm 9.6\%$
		Y	0.17	60.00	4.10		100.0	
		Z	15.90	60.96	1.69		100.0	

10032-CAA	IEEE 802.15.1 Bluetooth (GFSK, DH5)	X	0.00	86.08	35.43	1.17	100.0	± 9.6 %
		Y	99.99	344.89	100.44		100.0	
		Z	1.14	132.41	13.71		100.0	
10033-CAA	IEEE 802.15.1 Bluetooth (PI/4-DQPSK, DH1)	X	0.95	60.75	6.54	5.30	70.0	± 9.6 %
		Y	4.98	80.79	18.23		70.0	
		Z	3.25	75.39	16.74		70.0	
10034-CAA	IEEE 802.15.1 Bluetooth (PI/4-DQPSK, DH3)	X	3.04	65.72	5.34	1.88	100.0	± 9.6 %
		Y	1.68	70.56	12.82		100.0	
		Z	0.99	64.34	10.07		100.0	
10035-CAA	IEEE 802.15.1 Bluetooth (PI/4-DQPSK, DH5)	X	24.75	218.80	26.78	1.17	100.0	± 9.6 %
		Y	1.37	69.43	12.15		100.0	
		Z	0.77	62.85	8.95		100.0	
10036-CAA	IEEE 802.15.1 Bluetooth (8-DPSK, DH1)	X	0.94	60.83	6.63	5.30	70.0	± 9.6 %
		Y	7.23	85.73	19.90		70.0	
		Z	3.94	78.17	17.83		70.0	
10037-CAA	IEEE 802.15.1 Bluetooth (8-DPSK, DH3)	X	1.41	63.61	4.82	1.88	100.0	± 9.6 %
		Y	1.40	68.85	12.14		100.0	
		Z	0.93	63.88	9.84		100.0	
10038-CAA	IEEE 802.15.1 Bluetooth (8-DPSK, DH5)	X	26.17	217.46	26.16	1.17	100.0	± 9.6 %
		Y	1.45	70.29	12.67		100.0	
		Z	0.78	63.02	9.17		100.0	
10039-CAB	CDMA2000 (1xRTT, RC1)	X	21.96	306.20	30.49	0.00	150.0	± 9.6 %
		Y	1.63	72.13	12.95		150.0	
		Z	0.63	61.62	7.75		150.0	
10042-CAB	IS-54 / IS-136 FDD (TDMA/FDM, PI/4-DQPSK, Halfrate)	X	1.01	60.95	6.26	7.78	50.0	± 9.6 %
		Y	1.74	65.58	9.03		50.0	
		Z	1.77	65.58	9.34		50.0	
10044-CAA	IS-91/EIA/TIA-553 FDD (FDMA, FM)	X	0.10	124.30	3.45	0.00	150.0	± 9.6 %
		Y	0.01	119.74	2.99		150.0	
		Z	0.14	123.41	9.03		150.0	
10048-CAA	DECT (TDD, TDMA/FDM, GFSK, Full Slot, 24)	X	2.82	62.25	9.34	13.80	25.0	± 9.6 %
		Y	3.46	64.98	10.90		25.0	
		Z	4.35	67.54	12.61		25.0	
10049-CAA	DECT (TDD, TDMA/FDM, GFSK, Double Slot, 12)	X	2.47	64.28	8.96	10.79	40.0	± 9.6 %
		Y	3.27	67.55	10.82		40.0	
		Z	4.02	69.88	12.36		40.0	
10056-CAA	UMTS-TDD (TD-SCDMA, 1.28 Mcps)	X	2.81	66.64	10.78	9.03	50.0	± 9.6 %
		Y	11.82	86.24	20.09		50.0	
		Z	9.59	84.12	20.02		50.0	
10058-DAC	EDGE-FDD (TDMA, 8PSK, TN 0-1-2-3)	X	2.65	68.11	20.96	6.55	100.0	± 9.6 %
		Y	2.94	70.05	22.07		100.0	
		Z	2.91	69.15	21.44		100.0	
10059-CAB	IEEE 802.11b WiFi 2.4 GHz (DSSS, 2 Mbps)	X	0.95	64.02	14.39	0.61	110.0	± 9.6 %
		Y	1.14	66.10	16.82		110.0	
		Z	1.00	63.23	14.55		110.0	
10060-CAB	IEEE 802.11b WiFi 2.4 GHz (DSSS, 5.5 Mbps)	X	1.76	81.26	19.48	1.30	110.0	± 9.6 %
		Y	100.00	150.16	40.00		110.0	
		Z	1.90	81.85	20.27		110.0	

10061-CAB	IEEE 802.11b WiFi 2.4 GHz (DSSS, 11 Mbps)	X	1.18	69.71	16.58	2.04	110.0	± 9.6 %
		Y	1.94	78.32	21.99		110.0	
		Z	1.40	71.35	18.33		110.0	
10062-CAC	IEEE 802.11a/h WiFi 5 GHz (OFDM, 6 Mbps)	X	3.80	66.99	15.87	0.49	100.0	± 9.6 %
		Y	4.35	67.21	16.69		100.0	
		Z	4.31	66.43	16.23		100.0	
10063-CAC	IEEE 802.11a/h WiFi 5 GHz (OFDM, 9 Mbps)	X	3.81	67.06	15.96	0.72	100.0	± 9.6 %
		Y	4.36	67.29	16.77		100.0	
		Z	4.32	66.52	16.32		100.0	
10064-CAC	IEEE 802.11a/h WiFi 5 GHz (OFDM, 12 Mbps)	X	3.97	67.23	16.12	0.86	100.0	± 9.6 %
		Y	4.56	67.40	16.91		100.0	
		Z	4.55	66.72	16.52		100.0	
10065-CAC	IEEE 802.11a/h WiFi 5 GHz (OFDM, 18 Mbps)	X	3.85	66.82	16.06	1.21	100.0	± 9.6 %
		Y	4.42	67.15	16.92		100.0	
		Z	4.42	66.52	16.58		100.0	
10066-CAC	IEEE 802.11a/h WiFi 5 GHz (OFDM, 24 Mbps)	X	3.83	66.65	16.06	1.46	100.0	± 9.6 %
		Y	4.41	67.05	17.01		100.0	
		Z	4.42	66.49	16.71		100.0	
10067-CAC	IEEE 802.11a/h WiFi 5 GHz (OFDM, 36 Mbps)	X	4.01	66.66	16.35	2.04	100.0	± 9.6 %
		Y	4.65	67.23	17.40		100.0	
		Z	4.70	66.78	17.19		100.0	
10068-CAC	IEEE 802.11a/h WiFi 5 GHz (OFDM, 48 Mbps)	X	4.12	66.97	16.78	2.55	100.0	± 9.6 %
		Y	4.69	67.14	17.56		100.0	
		Z	4.73	66.69	17.36		100.0	
10069-CAC	IEEE 802.11a/h WiFi 5 GHz (OFDM, 54 Mbps)	X	4.11	66.73	16.77	2.67	100.0	± 9.6 %
		Y	4.72	67.08	17.69		100.0	
		Z	4.78	66.70	17.53		100.0	
10071-CAB	IEEE 802.11g WiFi 2.4 GHz (DSSS/OFDM, 9 Mbps)	X	4.07	66.96	16.68	1.99	100.0	± 9.6 %
		Y	4.59	67.07	17.37		100.0	
		Z	4.60	66.53	17.10		100.0	
10072-CAB	IEEE 802.11g WiFi 2.4 GHz (DSSS/OFDM, 12 Mbps)	X	3.98	66.89	16.71	2.30	100.0	± 9.6 %
		Y	4.51	67.19	17.50		100.0	
		Z	4.54	66.70	17.26		100.0	
10073-CAB	IEEE 802.11g WiFi 2.4 GHz (DSSS/OFDM, 18 Mbps)	X	4.03	67.09	17.06	2.83	100.0	± 9.6 %
		Y	4.56	67.35	17.81		100.0	
		Z	4.59	66.87	17.58		100.0	
10074-CAB	IEEE 802.11g WiFi 2.4 GHz (DSSS/OFDM, 24 Mbps)	X	4.11	67.36	17.40	3.30	100.0	± 9.6 %
		Y	4.57	67.31	17.95		100.0	
		Z	4.60	66.82	17.73		100.0	
10075-CAB	IEEE 802.11g WiFi 2.4 GHz (DSSS/OFDM, 36 Mbps)	X	4.18	67.58	17.73	3.82	90.0	± 9.6 %
		Y	4.58	67.25	18.15		90.0	
		Z	4.61	66.79	17.96		90.0	
10076-CAB	IEEE 802.11g WiFi 2.4 GHz (DSSS/OFDM, 48 Mbps)	X	4.24	67.48	17.91	4.15	90.0	± 9.6 %
		Y	4.61	67.08	18.28		90.0	
		Z	4.65	66.67	18.13		90.0	
10077-CAB	IEEE 802.11g WiFi 2.4 GHz (DSSS/OFDM, 54 Mbps)	X	4.28	67.60	18.06	4.30	90.0	± 9.6 %
		Y	4.64	67.18	18.41		90.0	
		Z	4.68	66.76	18.25		90.0	

10081-CAB	CDMA2000 (1xRTT, RC3)	X	7.85	258.95	40.09	0.00	150.0	± 9.6 %
		Y	0.57	64.50	9.19		150.0	
		Z	0.37	60.00	6.09		150.0	
10082-CAB	IS-54 / IS-136 FDD (TDMA/FDM, PI/4-DQPSK, Fullrate)	X	72.13	59.07	0.77	4.77	80.0	± 9.6 %
		Y	7.02	60.09	1.53		80.0	
		Z	7.63	60.12	1.53		80.0	
10090-DAC	GPRS-FDD (TDMA, GMSK, TN 0-4)	X	0.78	60.88	6.00	6.56	60.0	± 9.6 %
		Y	100.00	98.83	18.35		60.0	
		Z	8.66	80.77	14.58		60.0	
10097-CAB	UMTS-FDD (HSDPA)	X	1.12	65.69	11.46	0.00	150.0	± 9.6 %
		Y	2.39	74.48	18.29		150.0	
		Z	1.58	66.95	14.31		150.0	
10098-CAB	UMTS-FDD (HSUPA, Subtest 2)	X	1.11	65.81	11.55	0.00	150.0	± 9.6 %
		Y	2.34	74.47	18.31		150.0	
		Z	1.54	66.88	14.28		150.0	
10099-DAC	EDGE-FDD (TDMA, 8PSK, TN 0-4)	X	4.22	76.90	26.77	9.56	60.0	± 9.6 %
		Y	5.12	81.66	29.15		60.0	
		Z	4.92	79.46	27.95		60.0	
10100-CAD	LTE-FDD (SC-FDMA, 100% RB, 20 MHz, QPSK)	X	2.39	69.31	16.37	0.00	150.0	± 9.6 %
		Y	3.20	72.58	18.18		150.0	
		Z	2.69	68.81	15.94		150.0	
10101-CAD	LTE-FDD (SC-FDMA, 100% RB, 20 MHz, 16-QAM)	X	2.61	67.07	15.44	0.00	150.0	± 9.6 %
		Y	3.12	68.53	16.66		150.0	
		Z	2.91	66.65	15.40		150.0	
10102-CAD	LTE-FDD (SC-FDMA, 100% RB, 20 MHz, 64-QAM)	X	2.71	67.23	15.58	0.00	150.0	± 9.6 %
		Y	3.22	68.53	16.74		150.0	
		Z	3.02	66.72	15.54		150.0	
10103-CAD	LTE-TDD (SC-FDMA, 100% RB, 20 MHz, QPSK)	X	3.72	71.26	18.49	3.98	65.0	± 9.6 %
		Y	4.70	73.63	19.84		65.0	
		Z	4.41	71.81	18.98		65.0	
10104-CAD	LTE-TDD (SC-FDMA, 100% RB, 20 MHz, 16-QAM)	X	3.95	69.27	17.90	3.98	65.0	± 9.6 %
		Y	4.71	71.04	19.29		65.0	
		Z	4.63	70.10	18.86		65.0	
10105-CAD	LTE-TDD (SC-FDMA, 100% RB, 20 MHz, 64-QAM)	X	3.78	68.25	17.72	3.98	65.0	± 9.6 %
		Y	4.47	69.73	18.97		65.0	
		Z	4.37	68.68	18.48		65.0	
10108-CAE	LTE-FDD (SC-FDMA, 100% RB, 10 MHz, QPSK)	X	1.98	69.15	15.95	0.00	150.0	± 9.6 %
		Y	2.77	72.39	18.20		150.0	
		Z	2.29	68.22	15.72		150.0	
10109-CAE	LTE-FDD (SC-FDMA, 100% RB, 10 MHz, 16-QAM)	X	2.19	67.24	14.70	0.00	150.0	± 9.6 %
		Y	2.80	69.06	16.71		150.0	
		Z	2.54	66.58	15.14		150.0	
10110-CAE	LTE-FDD (SC-FDMA, 100% RB, 5 MHz, QPSK)	X	1.35	66.94	13.41	0.00	150.0	± 9.6 %
		Y	2.32	72.63	18.00		150.0	
		Z	1.78	67.28	14.92		150.0	
10111-CAE	LTE-FDD (SC-FDMA, 100% RB, 5 MHz, 16-QAM)	X	1.58	65.90	12.12	0.00	150.0	± 9.6 %
		Y	2.81	72.30	17.60		150.0	
		Z	2.22	67.49	14.99		150.0	

10112-CAE	LTE-FDD (SC-FDMA, 100% RB, 10 MHz, 64-QAM)	X	2.30	67.45	14.81	0.00	150.0	± 9.6 %
		Y	2.93	69.12	16.76		150.0	
		Z	2.66	66.72	15.26		150.0	
10113-CAE	LTE-FDD (SC-FDMA, 100% RB, 5 MHz, 64-QAM)	X	1.64	65.77	12.05	0.00	150.0	± 9.6 %
		Y	2.95	72.32	17.65		150.0	
		Z	2.37	67.73	15.17		150.0	
10114-CAC	IEEE 802.11n (HT Greenfield, 13.5 Mbps, BPSK)	X	4.34	66.99	16.28	0.00	150.0	± 9.6 %
		Y	4.86	67.57	16.78		150.0	
		Z	4.82	66.90	16.32		150.0	
10115-CAC	IEEE 802.11n (HT Greenfield, 81 Mbps, 16-QAM)	X	4.58	67.29	16.33	0.00	150.0	± 9.6 %
		Y	5.08	67.61	16.77		150.0	
		Z	5.06	66.98	16.35		150.0	
10116-CAC	IEEE 802.11n (HT Greenfield, 135 Mbps, 64-QAM)	X	4.40	67.26	16.31	0.00	150.0	± 9.6 %
		Y	4.93	67.75	16.79		150.0	
		Z	4.89	67.04	16.31		150.0	
10117-CAC	IEEE 802.11n (HT Mixed, 13.5 Mbps, BPSK)	X	4.33	66.90	16.26	0.00	150.0	± 9.6 %
		Y	4.84	67.46	16.74		150.0	
		Z	4.79	66.75	16.26		150.0	
10118-CAC	IEEE 802.11n (HT Mixed, 81 Mbps, 16-QAM)	X	4.58	67.24	16.31	0.00	150.0	± 9.6 %
		Y	5.15	67.78	16.86		150.0	
		Z	5.14	67.21	16.48		150.0	
10119-CAC	IEEE 802.11n (HT Mixed, 135 Mbps, 64-QAM)	X	4.39	67.16	16.27	0.00	150.0	± 9.6 %
		Y	4.94	67.78	16.81		150.0	
		Z	4.90	67.08	16.34		150.0	
10140-CAD	LTE-FDD (SC-FDMA, 100% RB, 15 MHz, 16-QAM)	X	2.65	67.18	15.35	0.00	150.0	± 9.6 %
		Y	3.23	68.57	16.65		150.0	
		Z	3.03	66.74	15.44		150.0	
10141-CAD	LTE-FDD (SC-FDMA, 100% RB, 15 MHz, 64-QAM)	X	2.80	67.68	15.68	0.00	150.0	± 9.6 %
		Y	3.37	68.79	16.86		150.0	
		Z	3.16	66.97	15.67		150.0	
10142-CAD	LTE-FDD (SC-FDMA, 100% RB, 3 MHz, QPSK)	X	0.71	61.44	8.06	0.00	150.0	± 9.6 %
		Y	2.27	74.06	17.56		150.0	
		Z	1.48	66.51	13.59		150.0	
10143-CAD	LTE-FDD (SC-FDMA, 100% RB, 3 MHz, 16-QAM)	X	0.73	60.00	6.15	0.00	150.0	± 9.6 %
		Y	2.80	73.44	16.54		150.0	
		Z	1.85	66.55	13.15		150.0	
10144-CAD	LTE-FDD (SC-FDMA, 100% RB, 3 MHz, 64-QAM)	X	0.73	60.00	5.65	0.00	150.0	± 9.6 %
		Y	1.85	66.75	12.85		150.0	
		Z	1.61	64.01	11.28		150.0	
10145-CAE	LTE-FDD (SC-FDMA, 100% RB, 1.4 MHz, QPSK)	X	5.16	385.51	36.59	0.00	150.0	± 9.6 %
		Y	0.54	60.00	5.91		150.0	
		Z	0.58	60.00	5.88		150.0	
10146-CAE	LTE-FDD (SC-FDMA, 100% RB, 1.4 MHz, 16-QAM)	X	0.00	60.00	0.00	0.00	150.0	± 9.6 %
		Y	0.74	60.00	4.95		150.0	
		Z	0.80	60.00	5.53		150.0	
10147-CAE	LTE-FDD (SC-FDMA, 100% RB, 1.4 MHz, 64-QAM)	X	0.00	60.00	0.00	0.00	150.0	± 9.6 %
		Y	0.60	58.26	3.86		150.0	
		Z	0.82	60.00	5.58		150.0	

10149-CAD	LTE-FDD (SC-FDMA, 50% RB, 20 MHz, 16-QAM)	X	2.21	67.36	14.78	0.00	150.0	± 9.6 %
		Y	2.81	69.16	16.77		150.0	
		Z	2.55	66.65	15.19		150.0	
10150-CAD	LTE-FDD (SC-FDMA, 50% RB, 20 MHz, 64-QAM)	X	2.32	67.56	14.88	0.00	150.0	± 9.6 %
		Y	2.94	69.22	16.82		150.0	
		Z	2.67	66.78	15.30		150.0	
10151-CAD	LTE-TDD (SC-FDMA, 50% RB, 20 MHz, QPSK)	X	3.66	73.29	18.78	3.98	65.0	± 9.6 %
		Y	4.98	76.80	21.12		65.0	
		Z	4.55	74.40	20.06		65.0	
10152-CAD	LTE-TDD (SC-FDMA, 50% RB, 20 MHz, 16-QAM)	X	3.31	68.29	16.15	3.98	65.0	± 9.6 %
		Y	4.23	70.96	18.67		65.0	
		Z	4.14	69.89	18.22		65.0	
10153-CAD	LTE-TDD (SC-FDMA, 50% RB, 20 MHz, 64-QAM)	X	3.64	69.78	17.29	3.98	65.0	± 9.6 %
		Y	4.61	72.30	19.68		65.0	
		Z	4.49	71.11	19.19		65.0	
10154-CAE	LTE-FDD (SC-FDMA, 50% RB, 10 MHz, QPSK)	X	1.38	67.29	13.63	0.00	150.0	± 9.6 %
		Y	2.40	73.30	18.35		150.0	
		Z	1.82	67.63	15.14		150.0	
10155-CAE	LTE-FDD (SC-FDMA, 50% RB, 10 MHz, 16-QAM)	X	1.60	66.02	12.20	0.00	150.0	± 9.6 %
		Y	2.83	72.40	17.66		150.0	
		Z	2.23	67.54	15.03		150.0	
10156-CAE	LTE-FDD (SC-FDMA, 50% RB, 5 MHz, QPSK)	X	0.51	60.00	5.91	0.00	150.0	± 9.6 %
		Y	2.15	74.23	16.90		150.0	
		Z	1.25	65.50	12.43		150.0	
10157-CAE	LTE-FDD (SC-FDMA, 50% RB, 5 MHz, 16-QAM)	X	0.57	60.00	4.69	0.00	150.0	± 9.6 %
		Y	1.61	66.51	12.13		150.0	
		Z	1.35	63.41	10.38		150.0	
10158-CAE	LTE-FDD (SC-FDMA, 50% RB, 10 MHz, 64-QAM)	X	1.65	65.90	12.13	0.00	150.0	± 9.6 %
		Y	2.98	72.51	17.74		150.0	
		Z	2.38	67.83	15.24		150.0	
10159-CAE	LTE-FDD (SC-FDMA, 50% RB, 5 MHz, 64-QAM)	X	0.59	60.00	4.69	0.00	150.0	± 9.6 %
		Y	1.68	66.77	12.27		150.0	
		Z	1.39	63.54	10.48		150.0	
10160-CAD	LTE-FDD (SC-FDMA, 50% RB, 15 MHz, QPSK)	X	1.93	68.16	15.00	0.00	150.0	± 9.6 %
		Y	2.76	71.39	17.74		150.0	
		Z	2.38	67.93	15.64		150.0	
10161-CAD	LTE-FDD (SC-FDMA, 50% RB, 15 MHz, 16-QAM)	X	2.12	67.05	14.02	0.00	150.0	± 9.6 %
		Y	2.84	69.35	16.71		150.0	
		Z	2.55	66.69	15.09		150.0	
10162-CAD	LTE-FDD (SC-FDMA, 50% RB, 15 MHz, 64-QAM)	X	2.21	67.37	14.17	0.00	150.0	± 9.6 %
		Y	2.96	69.65	16.87		150.0	
		Z	2.66	66.96	15.26		150.0	
10166-CAE	LTE-FDD (SC-FDMA, 50% RB, 1.4 MHz, QPSK)	X	2.13	65.17	17.70	3.01	150.0	± 9.6 %
		Y	3.00	69.75	19.60		150.0	
		Z	2.90	67.96	18.43		150.0	
10167-CAE	LTE-FDD (SC-FDMA, 50% RB, 1.4 MHz, 16-QAM)	X	1.98	65.92	17.43	3.01	150.0	± 9.6 %
		Y	3.74	74.17	20.63		150.0	
		Z	3.28	70.17	18.57		150.0	

10168-CAE	LTE-FDD (SC-FDMA, 50% RB, 1.4 MHz, 64-QAM)	X	2.18	68.43	19.32	3.01	150.0	± 9.6 %
		Y	4.55	78.58	22.96		150.0	
		Z	3.73	73.08	20.34		150.0	
10169-CAD	LTE-FDD (SC-FDMA, 1 RB, 20 MHz, QPSK)	X	1.87	64.00	17.04	3.01	150.0	± 9.6 %
		Y	2.53	68.75	19.16		150.0	
		Z	2.36	66.10	17.52		150.0	
10170-CAD	LTE-FDD (SC-FDMA, 1 RB, 20 MHz, 16-QAM)	X	1.85	66.74	18.73	3.01	150.0	± 9.6 %
		Y	3.84	78.32	23.19		150.0	
		Z	2.87	70.66	19.54		150.0	
10171-AAD	LTE-FDD (SC-FDMA, 1 RB, 20 MHz, 64-QAM)	X	1.59	63.66	15.82	3.01	150.0	± 9.6 %
		Y	2.83	71.75	19.17		150.0	
		Z	2.39	66.90	16.66		150.0	
10172-CAD	LTE-TDD (SC-FDMA, 1 RB, 20 MHz, QPSK)	X	1.63	66.94	19.47	6.02	65.0	± 9.6 %
		Y	2.64	75.18	23.09		65.0	
		Z	2.68	72.94	21.86		65.0	
10173-CAD	LTE-TDD (SC-FDMA, 1 RB, 20 MHz, 16-QAM)	X	1.75	70.70	19.61	6.02	65.0	± 9.6 %
		Y	6.55	90.87	26.66		65.0	
		Z	4.15	79.90	22.82		65.0	
10174-CAD	LTE-TDD (SC-FDMA, 1 RB, 20 MHz, 64-QAM)	X	1.33	66.12	16.85	6.02	65.0	± 9.6 %
		Y	3.87	81.08	22.62		65.0	
		Z	2.77	72.65	19.43		65.0	
10175-CAE	LTE-FDD (SC-FDMA, 1 RB, 10 MHz, QPSK)	X	1.85	63.78	16.81	3.01	150.0	± 9.6 %
		Y	2.49	68.40	18.88		150.0	
		Z	2.33	65.83	17.28		150.0	
10176-CAE	LTE-FDD (SC-FDMA, 1 RB, 10 MHz, 16-QAM)	X	1.86	66.75	18.74	3.01	150.0	± 9.6 %
		Y	3.85	78.36	23.20		150.0	
		Z	2.87	70.68	19.55		150.0	
10177-CAG	LTE-FDD (SC-FDMA, 1 RB, 5 MHz, QPSK)	X	1.86	63.82	16.84	3.01	150.0	± 9.6 %
		Y	2.51	68.53	18.95		150.0	
		Z	2.34	65.93	17.35		150.0	
10178-CAE	LTE-FDD (SC-FDMA, 1 RB, 5 MHz, 16-QAM)	X	1.85	66.70	18.70	3.01	150.0	± 9.6 %
		Y	3.81	78.15	23.10		150.0	
		Z	2.85	70.55	19.47		150.0	
10179-CAE	LTE-FDD (SC-FDMA, 1 RB, 10 MHz, 64-QAM)	X	1.70	65.12	17.16	3.01	150.0	± 9.6 %
		Y	3.27	74.82	21.01		150.0	
		Z	2.59	68.61	17.93		150.0	
10180-CAE	LTE-FDD (SC-FDMA, 1 RB, 5 MHz, 64-QAM)	X	1.59	63.66	15.82	3.01	150.0	± 9.6 %
		Y	2.82	71.71	19.14		150.0	
		Z	2.39	66.88	16.63		150.0	
10181-CAD	LTE-FDD (SC-FDMA, 1 RB, 15 MHz, QPSK)	X	1.86	63.82	16.84	3.01	150.0	± 9.6 %
		Y	2.50	68.51	18.95		150.0	
		Z	2.34	65.92	17.34		150.0	
10182-CAD	LTE-FDD (SC-FDMA, 1 RB, 15 MHz, 16-QAM)	X	1.85	66.68	18.69	3.01	150.0	± 9.6 %
		Y	3.80	78.11	23.08		150.0	
		Z	2.85	70.52	19.45		150.0	
10183-AAC	LTE-FDD (SC-FDMA, 1 RB, 15 MHz, 64-QAM)	X	1.59	63.65	15.80	3.01	150.0	± 9.6 %
		Y	2.82	71.68	19.12		150.0	
		Z	2.38	66.86	16.62		150.0	

10184-CAD	LTE-FDD (SC-FDMA, 1 RB, 3 MHz, QPSK)	X	1.86	63.84	16.85	3.01	150.0	± 9.6 %
		Y	2.51	68.55	18.97		150.0	
		Z	2.35	65.96	17.36		150.0	
10185-CAD	LTE-FDD (SC-FDMA, 1 RB, 3 MHz, 16-QAM)	X	1.86	66.74	18.73	3.01	150.0	± 9.6 %
		Y	3.83	78.22	23.13		150.0	
		Z	2.86	70.59	19.49		150.0	
10186-AAD	LTE-FDD (SC-FDMA, 1 RB, 3 MHz, 64-QAM)	X	1.59	63.69	15.83	3.01	150.0	± 9.6 %
		Y	2.83	71.76	19.16		150.0	
		Z	2.39	66.91	16.65		150.0	
10187-CAE	LTE-FDD (SC-FDMA, 1 RB, 1.4 MHz, QPSK)	X	1.87	63.97	16.99	3.01	150.0	± 9.6 %
		Y	2.53	68.67	19.08		150.0	
		Z	2.36	66.04	17.45		150.0	
10188-CAE	LTE-FDD (SC-FDMA, 1 RB, 1.4 MHz, 16-QAM)	X	1.89	67.14	19.05	3.01	150.0	± 9.6 %
		Y	4.00	79.20	23.64		150.0	
		Z	2.94	71.15	19.86		150.0	
10189-AAE	LTE-FDD (SC-FDMA, 1 RB, 1.4 MHz, 64-QAM)	X	1.61	63.93	16.07	3.01	150.0	± 9.6 %
		Y	2.91	72.32	19.52		150.0	
		Z	2.43	67.24	16.90		150.0	
10193-CAC	IEEE 802.11n (HT Greenfield, 6.5 Mbps, BPSK)	X	3.74	67.40	15.79	0.00	150.0	± 9.6 %
		Y	4.29	67.57	16.55		150.0	
		Z	4.20	66.51	15.90		150.0	
10194-CAC	IEEE 802.11n (HT Greenfield, 39 Mbps, 16-QAM)	X	3.82	67.41	15.90	0.00	150.0	± 9.6 %
		Y	4.40	67.71	16.67		150.0	
		Z	4.32	66.72	16.05		150.0	
10195-CAC	IEEE 802.11n (HT Greenfield, 65 Mbps, 64-QAM)	X	3.83	67.37	15.89	0.00	150.0	± 9.6 %
		Y	4.42	67.68	16.66		150.0	
		Z	4.35	66.72	16.06		150.0	
10196-CAC	IEEE 802.11n (HT Mixed, 6.5 Mbps, BPSK)	X	3.72	67.37	15.75	0.00	150.0	± 9.6 %
		Y	4.26	67.52	16.51		150.0	
		Z	4.17	66.48	15.88		150.0	
10197-CAC	IEEE 802.11n (HT Mixed, 39 Mbps, 16-QAM)	X	3.82	67.41	15.91	0.00	150.0	± 9.6 %
		Y	4.41	67.70	16.67		150.0	
		Z	4.33	66.72	16.05		150.0	
10198-CAC	IEEE 802.11n (HT Mixed, 65 Mbps, 64-QAM)	X	3.82	67.36	15.88	0.00	150.0	± 9.6 %
		Y	4.41	67.66	16.65		150.0	
		Z	4.34	66.71	16.05		150.0	
10219-CAC	IEEE 802.11n (HT Mixed, 7.2 Mbps, BPSK)	X	3.68	67.48	15.78	0.00	150.0	± 9.6 %
		Y	4.22	67.61	16.52		150.0	
		Z	4.13	66.53	15.85		150.0	
10220-CAC	IEEE 802.11n (HT Mixed, 43.3 Mbps, 16-QAM)	X	3.82	67.41	15.91	0.00	150.0	± 9.6 %
		Y	4.40	67.66	16.65		150.0	
		Z	4.32	66.68	16.04		150.0	
10221-CAC	IEEE 802.11n (HT Mixed, 72.2 Mbps, 64-QAM)	X	3.85	67.40	15.91	0.00	150.0	± 9.6 %
		Y	4.43	67.62	16.64		150.0	
		Z	4.36	66.67	16.05		150.0	
10222-CAC	IEEE 802.11n (HT Mixed, 15 Mbps, BPSK)	X	4.34	66.97	16.27	0.00	150.0	± 9.6 %
		Y	4.82	67.47	16.73		150.0	
		Z	4.77	66.77	16.26		150.0	

10223-CAC	IEEE 802.11n (HT Mixed, 90 Mbps, 16-QAM)	X	4.49	67.10	16.25	0.00	150.0	± 9.6 %
		Y	5.02	67.50	16.74		150.0	
		Z	5.01	66.90	16.33		150.0	
10224-CAC	IEEE 802.11n (HT Mixed, 150 Mbps, 64-QAM)	X	4.35	67.14	16.26	0.00	150.0	± 9.6 %
		Y	4.86	67.63	16.73		150.0	
		Z	4.81	66.90	16.25		150.0	
10225-CAB	UMTS-FDD (HSPA+)	X	1.60	62.87	10.00	0.00	150.0	± 9.6 %
		Y	2.64	67.73	15.37		150.0	
		Z	2.42	65.46	14.06		150.0	
10226-CAA	LTE-TDD (SC-FDMA, 1 RB, 1.4 MHz, 16-QAM)	X	1.83	71.58	20.13	6.02	65.0	± 9.6 %
		Y	7.36	93.10	27.50		65.0	
		Z	4.39	80.98	23.33		65.0	
10227-CAA	LTE-TDD (SC-FDMA, 1 RB, 1.4 MHz, 64-QAM)	X	1.73	70.59	18.93	6.02	65.0	± 9.6 %
		Y	7.00	90.72	25.86		65.0	
		Z	4.34	79.99	22.28		65.0	
10228-CAA	LTE-TDD (SC-FDMA, 1 RB, 1.4 MHz, QPSK)	X	1.83	69.36	20.71	6.02	65.0	± 9.6 %
		Y	3.28	79.62	24.97		65.0	
		Z	3.15	76.53	23.48		65.0	
10229-CAB	LTE-TDD (SC-FDMA, 1 RB, 3 MHz, 16-QAM)	X	1.76	70.79	19.64	6.02	65.0	± 9.6 %
		Y	6.63	91.03	26.72		65.0	
		Z	4.18	80.00	22.86		65.0	
10230-CAB	LTE-TDD (SC-FDMA, 1 RB, 3 MHz, 64-QAM)	X	1.65	69.73	18.45	6.02	65.0	± 9.6 %
		Y	6.22	88.63	25.09		65.0	
		Z	4.10	78.96	21.82		65.0	
10231-CAB	LTE-TDD (SC-FDMA, 1 RB, 3 MHz, QPSK)	X	1.79	68.81	20.33	6.02	65.0	± 9.6 %
		Y	3.15	78.74	24.52		65.0	
		Z	3.06	75.85	23.10		65.0	
10232-CAD	LTE-TDD (SC-FDMA, 1 RB, 5 MHz, 16-QAM)	X	1.76	70.77	19.64	6.02	65.0	± 9.6 %
		Y	6.61	91.00	26.71		65.0	
		Z	4.18	79.98	22.86		65.0	
10233-CAD	LTE-TDD (SC-FDMA, 1 RB, 5 MHz, 64-QAM)	X	1.65	69.70	18.44	6.02	65.0	± 9.6 %
		Y	6.19	88.57	25.08		65.0	
		Z	4.09	78.93	21.81		65.0	
10234-CAD	LTE-TDD (SC-FDMA, 1 RB, 5 MHz, QPSK)	X	1.76	68.43	20.02	6.02	65.0	± 9.6 %
		Y	3.07	78.12	24.14		65.0	
		Z	2.98	75.33	22.76		65.0	
10235-CAD	LTE-TDD (SC-FDMA, 1 RB, 10 MHz, 16-QAM)	X	1.76	70.76	19.64	6.02	65.0	± 9.6 %
		Y	6.61	91.04	26.73		65.0	
		Z	4.18	80.00	22.87		65.0	
10236-CAD	LTE-TDD (SC-FDMA, 1 RB, 10 MHz, 64-QAM)	X	1.66	69.79	18.48	6.02	65.0	± 9.6 %
		Y	6.30	88.80	25.14		65.0	
		Z	4.13	79.05	21.85		65.0	
10237-CAD	LTE-TDD (SC-FDMA, 1 RB, 10 MHz, QPSK)	X	1.78	68.76	20.32	6.02	65.0	± 9.6 %
		Y	3.15	78.74	24.53		65.0	
		Z	3.05	75.85	23.11		65.0	
10238-CAD	LTE-TDD (SC-FDMA, 1 RB, 15 MHz, 16-QAM)	X	1.76	70.75	19.64	6.02	65.0	± 9.6 %
		Y	6.59	90.97	26.70		65.0	
		Z	4.17	79.95	22.85		65.0	

10239-CAD	LTE-TDD (SC-FDMA, 1 RB, 15 MHz, 64-QAM)	X	1.65	69.67	18.43	6.02	65.0	± 9.6 %
		Y	6.16	88.50	25.06		65.0	
		Z	4.07	78.89	21.79		65.0	
10240-CAD	LTE-TDD (SC-FDMA, 1 RB, 15 MHz, QPSK)	X	1.78	68.77	20.32	6.02	65.0	± 9.6 %
		Y	3.14	78.73	24.52		65.0	
		Z	3.05	75.83	23.10		65.0	
10241-CAA	LTE-TDD (SC-FDMA, 50% RB, 1.4 MHz, 16-QAM)	X	3.09	71.04	21.81	6.98	65.0	± 9.6 %
		Y	5.84	80.29	25.20		65.0	
		Z	5.54	77.13	23.79		65.0	
10242-CAA	LTE-TDD (SC-FDMA, 50% RB, 1.4 MHz, 64-QAM)	X	2.70	68.41	20.47	6.98	65.0	± 9.6 %
		Y	4.94	76.94	23.76		65.0	
		Z	4.89	74.64	22.64		65.0	
10243-CAA	LTE-TDD (SC-FDMA, 50% RB, 1.4 MHz, QPSK)	X	2.78	67.24	20.54	6.98	65.0	± 9.6 %
		Y	4.14	72.94	22.88		65.0	
		Z	4.22	71.72	22.18		65.0	
10244-CAB	LTE-TDD (SC-FDMA, 50% RB, 3 MHz, 16-QAM)	X	0.80	57.73	3.36	3.98	65.0	± 9.6 %
		Y	2.15	64.01	10.18		65.0	
		Z	2.44	64.99	11.42		65.0	
10245-CAB	LTE-TDD (SC-FDMA, 50% RB, 3 MHz, 64-QAM)	X	0.82	57.61	3.20	3.98	65.0	± 9.6 %
		Y	2.13	63.69	9.96		65.0	
		Z	2.42	64.65	11.19		65.0	
10246-CAB	LTE-TDD (SC-FDMA, 50% RB, 3 MHz, QPSK)	X	0.87	60.00	5.50	3.98	65.0	± 9.6 %
		Y	2.12	67.09	12.65		65.0	
		Z	2.17	66.84	12.89		65.0	
10247-CAD	LTE-TDD (SC-FDMA, 50% RB, 5 MHz, 16-QAM)	X	1.26	60.00	6.38	3.98	65.0	± 9.6 %
		Y	2.78	67.32	13.60		65.0	
		Z	2.82	66.99	13.82		65.0	
10248-CAD	LTE-TDD (SC-FDMA, 50% RB, 5 MHz, 64-QAM)	X	1.30	60.00	6.40	3.98	65.0	± 9.6 %
		Y	2.73	66.64	13.26		65.0	
		Z	2.81	66.52	13.58		65.0	
10249-CAD	LTE-TDD (SC-FDMA, 50% RB, 5 MHz, QPSK)	X	1.24	61.72	8.36	3.98	65.0	± 9.6 %
		Y	3.85	75.74	18.20		65.0	
		Z	3.35	73.06	17.32		65.0	
10250-CAD	LTE-TDD (SC-FDMA, 50% RB, 10 MHz, 16-QAM)	X	2.74	67.58	14.25	3.98	65.0	± 9.6 %
		Y	4.25	73.58	19.37		65.0	
		Z	4.02	71.93	18.78		65.0	
10251-CAD	LTE-TDD (SC-FDMA, 50% RB, 10 MHz, 64-QAM)	X	2.46	65.14	12.48	3.98	65.0	± 9.6 %
		Y	3.86	70.68	17.56		65.0	
		Z	3.78	69.64	17.25		65.0	
10252-CAD	LTE-TDD (SC-FDMA, 50% RB, 10 MHz, QPSK)	X	2.82	71.28	16.40	3.98	65.0	± 9.6 %
		Y	4.98	79.52	21.77		65.0	
		Z	4.29	76.11	20.42		65.0	
10253-CAD	LTE-TDD (SC-FDMA, 50% RB, 15 MHz, 16-QAM)	X	3.12	67.32	15.07	3.98	65.0	± 9.6 %
		Y	4.18	70.66	18.33		65.0	
		Z	4.10	69.61	17.93		65.0	
10254-CAD	LTE-TDD (SC-FDMA, 50% RB, 15 MHz, 64-QAM)	X	3.39	68.52	15.96	3.98	65.0	± 9.6 %
		Y	4.50	71.75	19.15		65.0	
		Z	4.39	70.63	18.74		65.0	

10255-CAD	LTE-TDD (SC-FDMA, 50% RB, 15 MHz, QPSK)	X	3.40	72.07	17.90	3.98	65.0	± 9.6 %
		Y	4.72	76.03	20.86		65.0	
		Z	4.36	73.79	19.90		65.0	
10256-CAA	LTE-TDD (SC-FDMA, 100% RB, 1.4 MHz, 16-QAM)	X	0.74	56.57	1.48	3.98	65.0	± 9.6 %
		Y	1.50	60.83	7.03		65.0	
		Z	1.77	61.73	8.31		65.0	
10257-CAA	LTE-TDD (SC-FDMA, 100% RB, 1.4 MHz, 64-QAM)	X	0.63	56.72	1.58	3.98	65.0	± 9.6 %
		Y	1.50	60.62	6.80		65.0	
		Z	1.77	61.47	8.06		65.0	
10258-CAA	LTE-TDD (SC-FDMA, 100% RB, 1.4 MHz, QPSK)	X	0.75	60.00	4.13	3.98	65.0	± 9.6 %
		Y	1.38	61.96	8.52		65.0	
		Z	1.52	62.42	9.24		65.0	
10259-CAB	LTE-TDD (SC-FDMA, 100% RB, 3 MHz, 16-QAM)	X	1.62	61.68	8.48	3.98	65.0	± 9.6 %
		Y	3.35	69.89	15.82		65.0	
		Z	3.28	68.97	15.69		65.0	
10260-CAB	LTE-TDD (SC-FDMA, 100% RB, 3 MHz, 64-QAM)	X	1.65	61.61	8.42	3.98	65.0	± 9.6 %
		Y	3.36	69.55	15.64		65.0	
		Z	3.31	68.75	15.57		65.0	
10261-CAB	LTE-TDD (SC-FDMA, 100% RB, 3 MHz, QPSK)	X	1.63	64.06	10.69	3.98	65.0	± 9.6 %
		Y	4.19	76.83	19.42		65.0	
		Z	3.63	73.87	18.36		65.0	
10262-CAD	LTE-TDD (SC-FDMA, 100% RB, 5 MHz, 16-QAM)	X	2.73	67.47	14.17	3.98	65.0	± 9.6 %
		Y	4.22	73.47	19.30		65.0	
		Z	4.00	71.83	18.72		65.0	
10263-CAD	LTE-TDD (SC-FDMA, 100% RB, 5 MHz, 64-QAM)	X	2.46	65.13	12.47	3.98	65.0	± 9.6 %
		Y	3.85	70.66	17.56		65.0	
		Z	3.77	69.62	17.25		65.0	
10264-CAD	LTE-TDD (SC-FDMA, 100% RB, 5 MHz, QPSK)	X	2.78	71.03	16.25	3.98	65.0	± 9.6 %
		Y	4.91	79.23	21.63		65.0	
		Z	4.25	75.88	20.29		65.0	
10265-CAD	LTE-TDD (SC-FDMA, 100% RB, 10 MHz, 16-QAM)	X	3.31	68.31	16.16	3.98	65.0	± 9.6 %
		Y	4.23	70.96	18.67		65.0	
		Z	4.14	69.89	18.23		65.0	
10266-CAD	LTE-TDD (SC-FDMA, 100% RB, 10 MHz, 64-QAM)	X	3.64	69.75	17.27	3.98	65.0	± 9.6 %
		Y	4.61	72.28	19.66		65.0	
		Z	4.48	71.09	19.18		65.0	
10267-CAD	LTE-TDD (SC-FDMA, 100% RB, 10 MHz, QPSK)	X	3.65	73.23	18.74	3.98	65.0	± 9.6 %
		Y	4.96	76.74	21.09		65.0	
		Z	4.55	74.35	20.04		65.0	
10268-CAD	LTE-TDD (SC-FDMA, 100% RB, 15 MHz, 16-QAM)	X	4.08	69.60	17.97	3.98	65.0	± 9.6 %
		Y	4.89	71.20	19.41		65.0	
		Z	4.81	70.25	18.99		65.0	
10269-CAD	LTE-TDD (SC-FDMA, 100% RB, 15 MHz, 64-QAM)	X	4.15	69.51	17.90	3.98	65.0	± 9.6 %
		Y	4.93	70.92	19.29		65.0	
		Z	4.85	69.98	18.89		65.0	
10270-CAD	LTE-TDD (SC-FDMA, 100% RB, 15 MHz, QPSK)	X	4.11	72.44	19.03	3.98	65.0	± 9.6 %
		Y	5.01	74.05	20.18		65.0	
		Z	4.76	72.38	19.41		65.0	

10274-CAB	UMTS-FDD (HSUPA, Subtest 5, 3GPP Rel8.10)	X	1.45	63.39	10.22	0.00	150.0	± 9.6 %
		Y	2.58	68.99	15.79		150.0	
		Z	2.26	65.99	14.08		150.0	
10275-CAB	UMTS-FDD (HSUPA, Subtest 5, 3GPP Rel8.4)	X	1.00	66.09	12.05	0.00	150.0	± 9.6 %
		Y	1.98	74.04	18.23		150.0	
		Z	1.30	66.38	13.95		150.0	
10277-CAA	PHS (QPSK)	X	4.43	65.00	5.66	9.03	50.0	± 9.6 %
		Y	1.25	57.54	2.57		50.0	
		Z	1.34	58.35	3.69		50.0	
10278-CAA	PHS (QPSK, BW 884MHz, Rolloff 0.5)	X	1.39	58.79	4.19	9.03	50.0	± 9.6 %
		Y	2.00	62.01	7.70		50.0	
		Z	2.27	62.99	8.81		50.0	
10279-CAA	PHS (QPSK, BW 884MHz, Rolloff 0.38)	X	1.42	58.87	4.28	9.03	50.0	± 9.6 %
		Y	2.04	62.14	7.84		50.0	
		Z	2.32	63.16	8.96		50.0	
10290-AAB	CDMA2000, RC1, SO55, Full Rate	X	24.89	264.54	21.43	0.00	150.0	± 9.6 %
		Y	0.75	64.32	9.28		150.0	
		Z	0.55	60.53	6.84		150.0	
10291-AAB	CDMA2000, RC3, SO55, Full Rate	X	8.17	257.05	37.61	0.00	150.0	± 9.6 %
		Y	0.54	64.12	8.98		150.0	
		Z	0.37	60.00	6.07		150.0	
10292-AAB	CDMA2000, RC3, SO32, Full Rate	X	2.31	326.58	8.83	0.00	150.0	± 9.6 %
		Y	100.00	114.29	23.68		150.0	
		Z	0.37	60.29	6.50		150.0	
10293-AAB	CDMA2000, RC3, SO3, Full Rate	X	2.41	304.08	37.98	0.00	150.0	± 9.6 %
		Y	100.00	121.87	26.96		150.0	
		Z	0.47	62.33	8.10		150.0	
10295-AAB	CDMA2000, RC1, SO3, 1/8th Rate 25 fr.	X	11.16	76.14	13.68	9.03	50.0	± 9.6 %
		Y	24.30	94.04	23.00		50.0	
		Z	21.29	93.19	23.41		50.0	
10297-AAC	LTE-FDD (SC-FDMA, 50% RB, 20 MHz, QPSK)	X	2.00	69.33	16.06	0.00	150.0	± 9.6 %
		Y	2.80	72.57	18.31		150.0	
		Z	2.31	68.33	15.80		150.0	
10298-AAC	LTE-FDD (SC-FDMA, 50% RB, 3 MHz, QPSK)	X	8.49	243.95	30.00	0.00	150.0	± 9.6 %
		Y	0.98	64.80	10.42		150.0	
		Z	0.78	61.52	8.38		150.0	
10299-AAC	LTE-FDD (SC-FDMA, 50% RB, 3 MHz, 16-QAM)	X	12.17	331.10	45.12	0.00	150.0	± 9.6 %
		Y	0.99	61.11	7.01		150.0	
		Z	1.06	61.03	7.46		150.0	
10300-AAC	LTE-FDD (SC-FDMA, 50% RB, 3 MHz, 64-QAM)	X	10.15	348.38	28.30	0.00	150.0	± 9.6 %
		Y	0.82	59.43	5.36		150.0	
		Z	0.95	60.00	6.23		150.0	
10301-AAA	IEEE 802.16e WIMAX (29:18, 5ms, 10MHz, QPSK, PUSC)	X	3.30	64.31	15.03	4.17	50.0	± 9.6 %
		Y	4.07	65.29	17.00		50.0	
		Z	4.16	64.88	16.72		50.0	
10302-AAA	IEEE 802.16e WIMAX (29:18, 5ms, 10MHz, QPSK, PUSC, 3 CTRL symbols)	X	3.81	65.12	15.99	4.96	50.0	± 9.6 %
		Y	4.52	65.76	17.66		50.0	
		Z	4.66	65.71	17.60		50.0	

10303-AAA	IEEE 802.16e WiMAX (31:15, 5ms, 10MHz, 64QAM, PUSC)	X	3.64	65.07	15.71	4.96	50.0	± 9.6 %
		Y	4.29	65.44	17.44		50.0	
		Z	4.42	65.39	17.39		50.0	
10304-AAA	IEEE 802.16e WiMAX (29:18, 5ms, 10MHz, 64QAM, PUSC)	X	3.46	64.98	15.29	4.17	50.0	± 9.6 %
		Y	4.15	65.58	17.11		50.0	
		Z	4.21	64.95	16.68		50.0	
10305-AAA	IEEE 802.16e WiMAX (31:15, 10ms, 10MHz, 64QAM, PUSC, 15 symbols)	X	2.52	62.00	12.12	6.02	35.0	± 9.6 %
		Y	3.52	65.78	17.45		35.0	
		Z	3.76	66.23	17.67		35.0	
10306-AAA	IEEE 802.16e WiMAX (29:18, 10ms, 10MHz, 64QAM, PUSC, 18 symbols)	X	3.12	63.64	14.29	6.02	35.0	± 9.6 %
		Y	3.94	65.53	17.75		35.0	
		Z	4.14	65.73	17.85		35.0	
10307-AAA	IEEE 802.16e WiMAX (29:18, 10ms, 10MHz, QPSK, PUSC, 18 symbols)	X	3.01	63.42	14.02	6.02	35.0	± 9.6 %
		Y	3.81	65.44	17.59		35.0	
		Z	4.01	65.68	17.70		35.0	
10308-AAA	IEEE 802.16e WiMAX (29:18, 10ms, 10MHz, 16QAM, PUSC)	X	3.02	63.75	14.28	6.02	35.0	± 9.6 %
		Y	3.78	65.60	17.74		35.0	
		Z	3.98	65.86	17.83		35.0	
10309-AAA	IEEE 802.16e WiMAX (29:18, 10ms, 10MHz, 16QAM, AMC 2x3, 18 symbols)	X	3.17	63.94	14.58	6.02	35.0	± 9.6 %
		Y	3.94	65.55	17.83		35.0	
		Z	4.14	65.77	17.93		35.0	
10310-AAA	IEEE 802.16e WiMAX (29:18, 10ms, 10MHz, QPSK, AMC 2x3, 18 symbols)	X	3.11	63.82	14.42	6.02	35.0	± 9.6 %
		Y	3.89	65.58	17.76		35.0	
		Z	4.09	65.78	17.84		35.0	
10311-AAC	LTE-FDD (SC-FDMA, 100% RB, 15 MHz, QPSK)	X	2.31	68.15	15.92	0.00	150.0	± 9.6 %
		Y	3.15	71.23	17.71		150.0	
		Z	2.66	67.57	15.55		150.0	
10313-AAA	iDEN 1:3	X	1.67	67.67	13.40	6.99	70.0	± 9.6 %
		Y	2.25	71.10	15.22		70.0	
		Z	1.73	67.06	13.24		70.0	
10314-AAA	iDEN 1:6	X	6.12	86.17	23.14	10.00	30.0	± 9.6 %
		Y	7.14	89.19	24.60		30.0	
		Z	3.49	76.84	20.05		30.0	
10315-AAB	IEEE 802.11b WiFi 2.4 GHz (DSSS, 1 Mbps, 96pc duty cycle)	X	0.91	63.92	14.34	0.17	150.0	± 9.6 %
		Y	1.09	65.84	16.70		150.0	
		Z	0.93	62.70	14.16		150.0	
10316-AAB	IEEE 802.11g WiFi 2.4 GHz (ERP-OFDM, 6 Mbps, 96pc duty cycle)	X	3.71	66.95	15.64	0.17	150.0	± 9.6 %
		Y	4.26	67.26	16.51		150.0	
		Z	4.21	66.40	15.98		150.0	
10317-AAC	IEEE 802.11a WiFi 5 GHz (OFDM, 6 Mbps, 96pc duty cycle)	X	3.71	66.95	15.64	0.17	150.0	± 9.6 %
		Y	4.26	67.26	16.51		150.0	
		Z	4.21	66.40	15.98		150.0	
10400-AAD	IEEE 802.11ac WiFi (20MHz, 64-QAM, 99pc duty cycle)	X	3.67	66.95	15.61	0.00	150.0	± 9.6 %
		Y	4.32	67.59	16.58		150.0	
		Z	4.27	66.67	15.99		150.0	
10401-AAD	IEEE 802.11ac WiFi (40MHz, 64-QAM, 99pc duty cycle)	X	4.49	66.84	16.09	0.00	150.0	± 9.6 %
		Y	5.01	67.23	16.55		150.0	
		Z	4.95	66.47	16.07		150.0	

10402-AAD	IEEE 802.11ac WiFi (80MHz, 64-QAM, 99pc duty cycle)	X	4.90	67.23	16.33	0.00	150.0	± 9.6 %
		Y	5.37	67.75	16.72		150.0	
		Z	5.33	67.10	16.30		150.0	
10403-AAB	CDMA2000 (1xEV-DO, Rev. 0)	X	24.89	264.54	21.43	0.00	115.0	± 9.6 %
		Y	0.75	64.32	9.28		115.0	
		Z	0.55	60.53	6.84		115.0	
10404-AAB	CDMA2000 (1xEV-DO, Rev. A)	X	24.89	264.54	21.43	0.00	115.0	± 9.6 %
		Y	0.75	64.32	9.28		115.0	
		Z	0.55	60.53	6.84		115.0	
10406-AAB	CDMA2000, RC3, SO32, SCH0, Full Rate	X	0.25	60.00	3.04	0.00	100.0	± 9.6 %
		Y	100.00	107.14	22.27		100.0	
		Z	35.03	104.04	23.84		100.0	
10410-AAD	LTE-TDD (SC-FDMA, 1 RB, 10 MHz, QPSK, UL Subframe=2,3,4,7,8,9, Subframe Conf=4)	X	1.11	74.02	16.29	3.23	80.0	± 9.6 %
		Y	100.00	123.32	29.06		80.0	
		Z	3.02	80.23	18.57		80.0	
10415-AAA	IEEE 802.11b WiFi 2.4 GHz (DSSS, 1 Mbps, 99pc duty cycle)	X	0.88	63.60	14.08	0.00	150.0	± 9.6 %
		Y	1.05	65.44	16.40		150.0	
		Z	0.90	62.27	13.77		150.0	
10416-AAA	IEEE 802.11g WiFi 2.4 GHz (ERP-OFDM, 6 Mbps, 99pc duty cycle)	X	3.72	67.22	15.78	0.00	150.0	± 9.6 %
		Y	4.26	67.46	16.59		150.0	
		Z	4.18	66.47	15.97		150.0	
10417-AAB	IEEE 802.11a/h WiFi 5 GHz (OFDM, 6 Mbps, 99pc duty cycle)	X	3.72	67.22	15.78	0.00	150.0	± 9.6 %
		Y	4.26	67.46	16.59		150.0	
		Z	4.18	66.47	15.97		150.0	
10418-AAA	IEEE 802.11g WiFi 2.4 GHz (DSSS-OFDM, 6 Mbps, 99pc duty cycle, Long preamble)	X	3.67	67.37	15.86	0.00	150.0	± 9.6 %
		Y	4.26	67.73	16.69		150.0	
		Z	4.18	66.68	16.03		150.0	
10419-AAA	IEEE 802.11g WiFi 2.4 GHz (DSSS-OFDM, 6 Mbps, 99pc duty cycle, Short preamble)	X	3.70	67.32	15.83	0.00	150.0	± 9.6 %
		Y	4.28	67.63	16.66		150.0	
		Z	4.19	66.61	16.02		150.0	
10422-AAB	IEEE 802.11n (HT Greenfield, 7.2 Mbps, BPSK)	X	3.79	67.23	15.85	0.00	150.0	± 9.6 %
		Y	4.37	67.55	16.64		150.0	
		Z	4.30	66.59	16.04		150.0	
10423-AAB	IEEE 802.11n (HT Greenfield, 43.3 Mbps, 16-QAM)	X	3.85	67.43	15.91	0.00	150.0	± 9.6 %
		Y	4.48	67.79	16.72		150.0	
		Z	4.41	66.83	16.12		150.0	
10424-AAB	IEEE 802.11n (HT Greenfield, 72.2 Mbps, 64-QAM)	X	3.80	67.32	15.87	0.00	150.0	± 9.6 %
		Y	4.41	67.73	16.70		150.0	
		Z	4.34	66.77	16.09		150.0	
10425-AAB	IEEE 802.11n (HT Greenfield, 15 Mbps, BPSK)	X	4.52	67.29	16.36	0.00	150.0	± 9.6 %
		Y	5.01	67.60	16.77		150.0	
		Z	5.00	66.98	16.36		150.0	
10426-AAB	IEEE 802.11n (HT Greenfield, 90 Mbps, 16-QAM)	X	4.54	67.39	16.40	0.00	150.0	± 9.6 %
		Y	5.06	67.79	16.86		150.0	
		Z	5.04	67.17	16.45		150.0	

10427-AAB	IEEE 802.11n (HT Greenfield, 150 Mbps, 64-QAM)	X	4.54	67.34	16.38	0.00	150.0	± 9.6 %
		Y	5.02	67.56	16.74		150.0	
		Z	4.99	66.89	16.30		150.0	
10430-AAB	LTE-FDD (OFDMA, 5 MHz, E-TM 3.1)	X	2.54	67.86	12.99	0.00	150.0	± 9.6 %
		Y	5.20	77.46	20.26		150.0	
		Z	4.04	72.15	17.87		150.0	
10431-AAB	LTE-FDD (OFDMA, 10 MHz, E-TM 3.1)	X	3.04	66.93	14.37	0.00	150.0	± 9.6 %
		Y	3.88	68.36	16.49		150.0	
		Z	3.75	66.95	15.66		150.0	
10432-AAB	LTE-FDD (OFDMA, 15 MHz, E-TM 3.1)	X	3.52	67.40	15.50	0.00	150.0	± 9.6 %
		Y	4.19	67.98	16.66		150.0	
		Z	4.09	66.85	15.96		150.0	
10433-AAB	LTE-FDD (OFDMA, 20 MHz, E-TM 3.1)	X	3.82	67.39	15.92	0.00	150.0	± 9.6 %
		Y	4.43	67.78	16.72		150.0	
		Z	4.36	66.81	16.12		150.0	
10434-AAA	W-CDMA (BS Test Model 1, 64 DPCH)	X	1.61	62.74	9.15	0.00	150.0	± 9.6 %
		Y	5.68	78.98	20.05		150.0	
		Z	3.98	72.24	17.17		150.0	
10435-AAC	LTE-TDD (SC-FDMA, 1 RB, 20 MHz, QPSK, UL Subframe=2,3,4,7,8,9)	X	1.04	73.03	15.81	3.23	80.0	± 9.6 %
		Y	100.00	122.83	28.83		80.0	
		Z	2.85	79.40	18.23		80.0	
10447-AAB	LTE-FDD (OFDMA, 5 MHz, E-TM 3.1, Clipping 44%)	X	1.63	62.08	8.98	0.00	150.0	± 9.6 %
		Y	3.10	68.15	14.99		150.0	
		Z	2.89	66.18	13.94		150.0	
10448-AAB	LTE-FDD (OFDMA, 10 MHz, E-TM 3.1, Clipping 44%)	X	2.97	66.84	14.33	0.00	150.0	± 9.6 %
		Y	3.76	68.19	16.40		150.0	
		Z	3.63	66.75	15.54		150.0	
10449-AAB	LTE-FDD (OFDMA, 15 MHz, E-TM 3.1, Clipping 44%)	X	3.43	67.31	15.47	0.00	150.0	± 9.6 %
		Y	4.05	67.84	16.58		150.0	
		Z	3.95	66.68	15.86		150.0	
10450-AAB	LTE-FDD (OFDMA, 20 MHz, E-TM 3.1, Clipping 44%)	X	3.70	67.17	15.79	0.00	150.0	± 9.6 %
		Y	4.26	67.58	16.60		150.0	
		Z	4.17	66.58	15.96		150.0	
10451-AAA	W-CDMA (BS Test Model 1, 64 DPCH, Clipping 44%)	X	1.22	60.20	6.79	0.00	150.0	± 9.6 %
		Y	2.78	67.25	13.76		150.0	
		Z	2.61	65.48	12.83		150.0	
10456-AAB	IEEE 802.11ac WiFi (160MHz, 64-QAM, 99pc duty cycle)	X	5.60	67.64	16.61	0.00	150.0	± 9.6 %
		Y	6.26	68.94	17.34		150.0	
		Z	6.00	67.69	16.64		150.0	
10457-AAA	UMTS-FDD (DC-HSDPA)	X	3.27	66.46	15.58	0.00	150.0	± 9.6 %
		Y	3.68	66.34	16.37		150.0	
		Z	3.59	65.30	15.71		150.0	
10458-AAA	CDMA2000 (1xEV-DO, Rev. B, 2 carriers)	X	1.12	60.00	5.83	0.00	150.0	± 9.6 %
		Y	3.56	71.73	16.05		150.0	
		Z	3.03	68.42	14.58		150.0	
10459-AAA	CDMA2000 (1xEV-DO, Rev. B, 3 carriers)	X	2.37	61.19	9.10	0.00	150.0	± 9.6 %
		Y	4.86	70.51	17.92		150.0	
		Z	4.63	68.94	17.35		150.0	

10460-AAA	UMTS-FDD (WCDMA, AMR)	X	0.77	69.97	14.37	0.00	150.0	± 9.6 %
		Y	1.81	83.33	22.94		150.0	
		Z	0.70	66.15	13.99		150.0	
10461-AAA	LTE-TDD (SC-FDMA, 1 RB, 1.4 MHz, QPSK, UL Subframe=2,3,4,7,8,9)	X	1.10	74.88	17.91	3.29	80.0	± 9.6 %
		Y	100.00	130.63	32.41		80.0	
		Z	2.28	78.08	18.84		80.0	
10462-AAA	LTE-TDD (SC-FDMA, 1 RB, 1.4 MHz, 16-QAM, UL Subframe=2,3,4,7,8,9)	X	5.93	230.19	29.26	3.23	80.0	± 9.6 %
		Y	0.59	60.00	5.55		80.0	
		Z	0.64	60.00	7.06		80.0	
10463-AAA	LTE-TDD (SC-FDMA, 1 RB, 1.4 MHz, 64-QAM, UL Subframe=2,3,4,7,8,9)	X	3.96	233.23	22.29	3.23	80.0	± 9.6 %
		Y	23.26	230.85	21.52		80.0	
		Z	0.66	60.00	6.36		80.0	
10464-AAA	LTE-TDD (SC-FDMA, 1 RB, 3 MHz, QPSK, UL Subframe=2,3,4,7,8,9)	X	0.60	67.04	13.62	3.23	80.0	± 9.6 %
		Y	100.00	124.51	29.50		80.0	
		Z	1.46	72.00	15.83		80.0	
10465-AAA	LTE-TDD (SC-FDMA, 1 RB, 3 MHz, 16-QAM, UL Subframe=2,3,4,7,8,9)	X	6.88	228.32	21.10	3.23	80.0	± 9.6 %
		Y	0.24	55.14	2.95		80.0	
		Z	0.64	60.00	7.00		80.0	
10466-AAA	LTE-TDD (SC-FDMA, 1 RB, 3 MHz, 64-QAM, UL Subframe=2,3,4,7,8,9)	X	4.90	230.59	11.80	3.23	80.0	± 9.6 %
		Y	24.92	227.37	29.84		80.0	
		Z	0.66	60.00	6.32		80.0	
10467-AAC	LTE-TDD (SC-FDMA, 1 RB, 5 MHz, QPSK, UL Subframe=2,3,4,7,8,9)	X	0.65	68.17	14.23	3.23	80.0	± 9.6 %
		Y	100.00	125.25	29.82		80.0	
		Z	1.58	73.06	16.29		80.0	
10468-AAC	LTE-TDD (SC-FDMA, 1 RB, 5 MHz, 16-QAM, UL Subframe=2,3,4,7,8,9)	X	6.75	228.62	22.92	3.23	80.0	± 9.6 %
		Y	0.24	55.19	3.02		80.0	
		Z	0.64	60.00	7.02		80.0	
10469-AAC	LTE-TDD (SC-FDMA, 1 RB, 5 MHz, 64-QAM, UL Subframe=2,3,4,7,8,9)	X	4.89	230.67	12.36	3.23	80.0	± 9.6 %
		Y	24.62	227.52	30.16		80.0	
		Z	0.66	60.00	6.32		80.0	
10470-AAC	LTE-TDD (SC-FDMA, 1 RB, 10 MHz, QPSK, UL Subframe=2,3,4,7,8,9)	X	0.65	68.21	14.25	3.23	80.0	± 9.6 %
		Y	100.00	125.26	29.81		80.0	
		Z	1.58	73.08	16.29		80.0	
10471-AAC	LTE-TDD (SC-FDMA, 1 RB, 10 MHz, 16-QAM, UL Subframe=2,3,4,7,8,9)	X	6.71	228.68	22.79	3.23	80.0	± 9.6 %
		Y	0.24	55.16	2.98		80.0	
		Z	0.64	60.00	7.01		80.0	
10472-AAC	LTE-TDD (SC-FDMA, 1 RB, 10 MHz, 64-QAM, UL Subframe=2,3,4,7,8,9)	X	4.83	230.72	12.16	3.23	80.0	± 9.6 %
		Y	24.39	227.78	30.29		80.0	
		Z	0.66	60.00	6.30		80.0	
10473-AAC	LTE-TDD (SC-FDMA, 1 RB, 15 MHz, QPSK, UL Subframe=2,3,4,7,8,9)	X	0.65	68.12	14.21	3.23	80.0	± 9.6 %
		Y	100.00	125.20	29.78		80.0	
		Z	1.57	73.01	16.25		80.0	
10474-AAC	LTE-TDD (SC-FDMA, 1 RB, 15 MHz, 16-QAM, UL Subframe=2,3,4,7,8,9)	X	6.67	228.73	22.56	3.23	80.0	± 9.6 %
		Y	0.59	60.00	5.48		80.0	
		Z	0.64	60.00	7.01		80.0	
10475-AAC	LTE-TDD (SC-FDMA, 1 RB, 15 MHz, 64-QAM, UL Subframe=2,3,4,7,8,9)	X	4.82	230.67	11.80	3.23	80.0	± 9.6 %
		Y	24.34	227.67	30.21		80.0	
		Z	0.66	60.00	6.30		80.0	

10477-AAC	LTE-TDD (SC-FDMA, 1 RB, 20 MHz, 16-QAM, UL Subframe=2,3,4,7,8,9)	X	6.74	228.54	21.21	3.23	80.0	± 9.6 %
		Y	0.23	55.08	2.89		80.0	
		Z	0.64	60.00	6.98		80.0	
10478-AAC	LTE-TDD (SC-FDMA, 1 RB, 20 MHz, 64-QAM, UL Subframe=2,3,4,7,8,9)	X	4.84	230.57	11.22	3.23	80.0	± 9.6 %
		Y	24.37	227.68	30.04		80.0	
		Z	0.66	60.00	6.29		80.0	
10479-AAA	LTE-TDD (SC-FDMA, 50% RB, 1.4 MHz, QPSK, UL Subframe=2,3,4,7,8,9)	X	3.02	84.98	21.47	3.23	80.0	± 9.6 %
		Y	100.00	125.48	31.72		80.0	
		Z	5.02	83.00	20.76		80.0	
10480-AAA	LTE-TDD (SC-FDMA, 50% RB, 1.4 MHz, 16-QAM, UL Subframe=2,3,4,7,8,9)	X	0.47	60.00	6.63	3.23	80.0	± 9.6 %
		Y	1.92	67.54	11.86		80.0	
		Z	1.73	65.44	11.67		80.0	
10481-AAA	LTE-TDD (SC-FDMA, 50% RB, 1.4 MHz, 64-QAM, UL Subframe=2,3,4,7,8,9)	X	0.22	55.04	3.12	3.23	80.0	± 9.6 %
		Y	1.09	61.90	8.89		80.0	
		Z	1.31	62.31	9.77		80.0	
10482-AAA	LTE-TDD (SC-FDMA, 50% RB, 3 MHz, QPSK, UL Subframe=2,3,4,7,8,9)	X	53.67	208.87	10.65	2.23	80.0	± 9.6 %
		Y	1.05	62.14	9.95		80.0	
		Z	0.98	60.56	9.26		80.0	
10483-AAA	LTE-TDD (SC-FDMA, 50% RB, 3 MHz, 16-QAM, UL Subframe=2,3,4,7,8,9)	X	64.01	327.64	15.81	2.23	80.0	± 9.6 %
		Y	1.10	60.00	7.60		80.0	
		Z	1.21	60.00	8.23		80.0	
10484-AAA	LTE-TDD (SC-FDMA, 50% RB, 3 MHz, 64-QAM, UL Subframe=2,3,4,7,8,9)	X	72.15	316.72	7.23	2.23	80.0	± 9.6 %
		Y	1.13	60.00	7.59		80.0	
		Z	1.24	60.00	8.22		80.0	
10485-AAC	LTE-TDD (SC-FDMA, 50% RB, 5 MHz, QPSK, UL Subframe=2,3,4,7,8,9)	X	0.75	60.00	6.88	2.23	80.0	± 9.6 %
		Y	2.48	72.41	16.54		80.0	
		Z	1.64	65.93	13.71		80.0	
10486-AAC	LTE-TDD (SC-FDMA, 50% RB, 5 MHz, 16-QAM, UL Subframe=2,3,4,7,8,9)	X	1.01	60.00	5.53	2.23	80.0	± 9.6 %
		Y	1.68	63.79	11.57		80.0	
		Z	1.58	62.22	10.94		80.0	
10487-AAC	LTE-TDD (SC-FDMA, 50% RB, 5 MHz, 64-QAM, UL Subframe=2,3,4,7,8,9)	X	1.04	60.00	5.50	2.23	80.0	± 9.6 %
		Y	1.66	63.28	11.27		80.0	
		Z	1.59	61.98	10.79		80.0	
10488-AAC	LTE-TDD (SC-FDMA, 50% RB, 10 MHz, QPSK, UL Subframe=2,3,4,7,8,9)	X	1.44	64.72	13.06	2.23	80.0	± 9.6 %
		Y	2.82	72.60	18.56		80.0	
		Z	2.27	68.12	16.38		80.0	
10489-AAC	LTE-TDD (SC-FDMA, 50% RB, 10 MHz, 16-QAM, UL Subframe=2,3,4,7,8,9)	X	1.47	61.87	10.73	2.23	80.0	± 9.6 %
		Y	2.82	68.91	16.54		80.0	
		Z	2.48	66.05	15.16		80.0	
10490-AAC	LTE-TDD (SC-FDMA, 50% RB, 10 MHz, 64-QAM, UL Subframe=2,3,4,7,8,9)	X	1.47	61.55	10.50	2.23	80.0	± 9.6 %
		Y	2.86	68.61	16.37		80.0	
		Z	2.55	65.97	15.11		80.0	
10491-AAC	LTE-TDD (SC-FDMA, 50% RB, 15 MHz, QPSK, UL Subframe=2,3,4,7,8,9)	X	1.98	66.25	14.91	2.23	80.0	± 9.6 %
		Y	2.98	70.44	18.02		80.0	
		Z	2.64	67.54	16.51		80.0	
10492-AAC	LTE-TDD (SC-FDMA, 50% RB, 15 MHz, 16-QAM, UL Subframe=2,3,4,7,8,9)	X	2.19	64.63	13.64	2.23	80.0	± 9.6 %
		Y	3.11	67.88	16.76		80.0	
		Z	2.90	65.95	15.77		80.0	

10493-AAC	LTE-TDD (SC-FDMA, 50% RB, 15 MHz, 64-QAM, UL Subframe=2,3,4,7,8,9)	X	2.21	64.43	13.47	2.23	80.0	± 9.6 %
		Y	3.16	67.71	16.66		80.0	
		Z	2.96	65.87	15.72		80.0	
10494-AAC	LTE-TDD (SC-FDMA, 50% RB, 20 MHz, QPSK, UL Subframe=2,3,4,7,8,9)	X	2.11	67.23	15.74	2.23	80.0	± 9.6 %
		Y	3.21	71.79	18.57		80.0	
		Z	2.78	68.52	16.88		80.0	
10495-AAC	LTE-TDD (SC-FDMA, 50% RB, 20 MHz, 16-QAM, UL Subframe=2,3,4,7,8,9)	X	2.35	65.50	14.66	2.23	80.0	± 9.6 %
		Y	3.14	68.07	17.04		80.0	
		Z	2.93	66.16	16.02		80.0	
10496-AAC	LTE-TDD (SC-FDMA, 50% RB, 20 MHz, 64-QAM, UL Subframe=2,3,4,7,8,9)	X	2.42	65.39	14.61	2.23	80.0	± 9.6 %
		Y	3.21	67.85	16.95		80.0	
		Z	3.02	66.06	16.01		80.0	
10497-AAA	LTE-TDD (SC-FDMA, 100% RB, 1.4 MHz, QPSK, UL Subframe=2,3,4,7,8,9)	X	4.50	220.48	26.76	2.23	80.0	± 9.6 %
		Y	0.82	60.00	6.90		80.0	
		Z	0.88	60.00	7.23		80.0	
10498-AAA	LTE-TDD (SC-FDMA, 100% RB, 1.4 MHz, 16-QAM, UL Subframe=2,3,4,7,8,9)	X	0.00	60.00	0.00	2.23	80.0	± 9.6 %
		Y	1.06	60.00	5.49		80.0	
		Z	1.08	60.00	6.01		80.0	
10499-AAA	LTE-TDD (SC-FDMA, 100% RB, 1.4 MHz, 64-QAM, UL Subframe=2,3,4,7,8,9)	X	0.00	60.00	0.00	2.23	80.0	± 9.6 %
		Y	1.10	60.00	5.30		80.0	
		Z	1.11	60.00	5.84		80.0	
10500-AAA	LTE-TDD (SC-FDMA, 100% RB, 3 MHz, QPSK, UL Subframe=2,3,4,7,8,9)	X	0.83	60.00	8.23	2.23	80.0	± 9.6 %
		Y	2.68	72.91	17.52		80.0	
		Z	1.91	67.05	14.90		80.0	
10501-AAA	LTE-TDD (SC-FDMA, 100% RB, 3 MHz, 16-QAM, UL Subframe=2,3,4,7,8,9)	X	1.03	60.00	6.96	2.23	80.0	± 9.6 %
		Y	2.26	66.74	13.90		80.0	
		Z	1.97	64.14	12.76		80.0	
10502-AAA	LTE-TDD (SC-FDMA, 100% RB, 3 MHz, 64-QAM, UL Subframe=2,3,4,7,8,9)	X	1.05	60.00	6.86	2.23	80.0	± 9.6 %
		Y	2.24	66.31	13.60		80.0	
		Z	1.99	63.95	12.58		80.0	
10503-AAC	LTE-TDD (SC-FDMA, 100% RB, 5 MHz, QPSK, UL Subframe=2,3,4,7,8,9)	X	1.42	64.51	12.94	2.23	80.0	± 9.6 %
		Y	2.78	72.32	18.42		80.0	
		Z	2.24	67.93	16.27		80.0	
10504-AAC	LTE-TDD (SC-FDMA, 100% RB, 5 MHz, 16-QAM, UL Subframe=2,3,4,7,8,9)	X	1.45	61.75	10.65	2.23	80.0	± 9.6 %
		Y	2.79	68.76	16.45		80.0	
		Z	2.46	65.95	15.09		80.0	
10505-AAC	LTE-TDD (SC-FDMA, 100% RB, 5 MHz, 64-QAM, UL Subframe=2,3,4,7,8,9)	X	1.46	61.45	10.42	2.23	80.0	± 9.6 %
		Y	2.84	68.47	16.29		80.0	
		Z	2.53	65.87	15.05		80.0	
10506-AAC	LTE-TDD (SC-FDMA, 100% RB, 10 MHz, QPSK, UL Subframe=2,3,4,7,8,9)	X	2.09	67.08	15.65	2.23	80.0	± 9.6 %
		Y	3.18	71.61	18.48		80.0	
		Z	2.76	68.39	16.81		80.0	
10507-AAC	LTE-TDD (SC-FDMA, 100% RB, 10 MHz, 16-QAM, UL Subframe=2,3,4,7,8,9)	X	2.34	65.41	14.60	2.23	80.0	± 9.6 %
		Y	3.12	67.99	16.99		80.0	
		Z	2.92	66.10	15.98		80.0	

10508-AAC	LTE-TDD (SC-FDMA, 100% RB, 10 MHz, 64-QAM, UL Subframe=2,3,4,7,8,9)	X	2.40	65.29	14.54	2.23	80.0	± 9.6 %
		Y	3.20	67.76	16.90		80.0	
		Z	3.01	65.99	15.96		80.0	
10509-AAC	LTE-TDD (SC-FDMA, 100% RB, 15 MHz, QPSK, UL Subframe=2,3,4,7,8,9)	X	2.58	67.03	16.09	2.23	80.0	± 9.6 %
		Y	3.55	70.28	17.97		80.0	
		Z	3.24	67.94	16.71		80.0	
10510-AAC	LTE-TDD (SC-FDMA, 100% RB, 15 MHz, 16-QAM, UL Subframe=2,3,4,7,8,9)	X	2.84	65.59	15.48	2.23	80.0	± 9.6 %
		Y	3.55	67.42	17.00		80.0	
		Z	3.41	66.05	16.23		80.0	
10511-AAC	LTE-TDD (SC-FDMA, 100% RB, 15 MHz, 64-QAM, UL Subframe=2,3,4,7,8,9)	X	2.92	65.56	15.46	2.23	80.0	± 9.6 %
		Y	3.62	67.28	16.95		80.0	
		Z	3.49	65.96	16.22		80.0	
10512-AAC	LTE-TDD (SC-FDMA, 100% RB, 20 MHz, QPSK, UL Subframe=2,3,4,7,8,9)	X	2.57	67.43	16.22	2.23	80.0	± 9.6 %
		Y	3.65	71.51	18.37		80.0	
		Z	3.23	68.73	16.92		80.0	
10513-AAC	LTE-TDD (SC-FDMA, 100% RB, 20 MHz, 16-QAM, UL Subframe=2,3,4,7,8,9)	X	2.79	65.51	15.59	2.23	80.0	± 9.6 %
		Y	3.45	67.50	17.07		80.0	
		Z	3.30	66.08	16.26		80.0	
10514-AAC	LTE-TDD (SC-FDMA, 100% RB, 20 MHz, 64-QAM, UL Subframe=2,3,4,7,8,9)	X	2.87	65.41	15.56	2.23	80.0	± 9.6 %
		Y	3.50	67.18	16.96		80.0	
		Z	3.36	65.86	16.21		80.0	
10515-AAA	IEEE 802.11b WiFi 2.4 GHz (DSSS, 2 Mbps, 99pc duty cycle)	X	0.84	63.77	14.11	0.00	150.0	± 9.6 %
		Y	1.02	65.86	16.61		150.0	
		Z	0.85	62.40	13.77		150.0	
10516-AAA	IEEE 802.11b WiFi 2.4 GHz (DSSS, 5.5 Mbps, 99pc duty cycle)	X	0.62	73.89	17.55	0.00	150.0	± 9.6 %
		Y	4.44	111.45	33.24		150.0	
		Z	0.45	67.70	14.48		150.0	
10517-AAA	IEEE 802.11b WiFi 2.4 GHz (DSSS, 11 Mbps, 99pc duty cycle)	X	0.68	65.50	14.61	0.00	150.0	± 9.6 %
		Y	0.96	70.28	18.66		150.0	
		Z	0.68	63.72	13.93		150.0	
10518-AAB	IEEE 802.11a/h WiFi 5 GHz (OFDM, 9 Mbps, 99pc duty cycle)	X	3.70	67.39	15.82	0.00	150.0	± 9.6 %
		Y	4.26	67.62	16.61		150.0	
		Z	4.17	66.58	15.96		150.0	
10519-AAB	IEEE 802.11a/h WiFi 5 GHz (OFDM, 12 Mbps, 99pc duty cycle)	X	3.79	67.51	15.88	0.00	150.0	± 9.6 %
		Y	4.38	67.73	16.67		150.0	
		Z	4.31	66.74	16.05		150.0	
10520-AAB	IEEE 802.11a/h WiFi 5 GHz (OFDM, 18 Mbps, 99pc duty cycle)	X	3.65	67.31	15.75	0.00	150.0	± 9.6 %
		Y	4.25	67.68	16.61		150.0	
		Z	4.16	66.65	15.95		150.0	
10521-AAB	IEEE 802.11a/h WiFi 5 GHz (OFDM, 24 Mbps, 99pc duty cycle)	X	3.59	67.16	15.66	0.00	150.0	± 9.6 %
		Y	4.18	67.62	16.58		150.0	
		Z	4.10	66.58	15.92		150.0	
10522-AAB	IEEE 802.11a/h WiFi 5 GHz (OFDM, 36 Mbps, 99pc duty cycle)	X	3.61	67.21	15.68	0.00	150.0	± 9.6 %
		Y	4.20	67.65	16.61		150.0	
		Z	4.13	66.67	15.99		150.0	

10523-AAB	IEEE 802.11a/h WiFi 5 GHz (OFDM, 48 Mbps, 99pc duty cycle)	X	3.58	67.41	15.78	0.00	150.0	± 9.6 %
		Y	4.19	67.90	16.68		150.0	
		Z	4.09	66.77	15.97		150.0	
10524-AAB	IEEE 802.11a/h WiFi 5 GHz (OFDM, 54 Mbps, 99pc duty cycle)	X	3.55	67.17	15.73	0.00	150.0	± 9.6 %
		Y	4.18	67.74	16.69		150.0	
		Z	4.09	66.69	16.02		150.0	
10525-AAB	IEEE 802.11ac WiFi (20MHz, MCS0, 99pc duty cycle)	X	3.68	66.62	15.57	0.00	150.0	± 9.6 %
		Y	4.25	66.93	16.35		150.0	
		Z	4.15	65.82	15.66		150.0	
10526-AAB	IEEE 802.11ac WiFi (20MHz, MCS1, 99pc duty cycle)	X	3.72	66.70	15.62	0.00	150.0	± 9.6 %
		Y	4.34	67.14	16.44		150.0	
		Z	4.25	66.06	15.76		150.0	
10527-AAB	IEEE 802.11ac WiFi (20MHz, MCS2, 99pc duty cycle)	X	3.68	66.74	15.58	0.00	150.0	± 9.6 %
		Y	4.29	67.16	16.40		150.0	
		Z	4.18	66.03	15.70		150.0	
10528-AAB	IEEE 802.11ac WiFi (20MHz, MCS3, 99pc duty cycle)	X	3.67	66.65	15.55	0.00	150.0	± 9.6 %
		Y	4.30	67.15	16.42		150.0	
		Z	4.20	66.04	15.73		150.0	
10529-AAB	IEEE 802.11ac WiFi (20MHz, MCS4, 99pc duty cycle)	X	3.67	66.65	15.55	0.00	150.0	± 9.6 %
		Y	4.30	67.15	16.42		150.0	
		Z	4.20	66.04	15.73		150.0	
10531-AAB	IEEE 802.11ac WiFi (20MHz, MCS6, 99pc duty cycle)	X	3.64	66.66	15.53	0.00	150.0	± 9.6 %
		Y	4.25	67.14	16.38		150.0	
		Z	4.15	66.02	15.69		150.0	
10532-AAB	IEEE 802.11ac WiFi (20MHz, MCS7, 99pc duty cycle)	X	3.57	66.55	15.48	0.00	150.0	± 9.6 %
		Y	4.15	67.03	16.34		150.0	
		Z	4.04	65.89	15.62		150.0	
10533-AAB	IEEE 802.11ac WiFi (20MHz, MCS8, 99pc duty cycle)	X	3.68	66.88	15.62	0.00	150.0	± 9.6 %
		Y	4.30	67.28	16.44		150.0	
		Z	4.20	66.13	15.73		150.0	
10534-AAB	IEEE 802.11ac WiFi (40MHz, MCS0, 99pc duty cycle)	X	4.34	66.44	15.93	0.00	150.0	± 9.6 %
		Y	4.85	66.86	16.39		150.0	
		Z	4.79	66.06	15.87		150.0	
10535-AAB	IEEE 802.11ac WiFi (40MHz, MCS1, 99pc duty cycle)	X	4.34	66.46	15.95	0.00	150.0	± 9.6 %
		Y	4.87	66.95	16.44		150.0	
		Z	4.82	66.17	15.93		150.0	
10536-AAB	IEEE 802.11ac WiFi (40MHz, MCS2, 99pc duty cycle)	X	4.25	66.45	15.91	0.00	150.0	± 9.6 %
		Y	4.78	66.98	16.43		150.0	
		Z	4.71	66.14	15.89		150.0	
10537-AAB	IEEE 802.11ac WiFi (40MHz, MCS3, 99pc duty cycle)	X	4.35	66.61	16.01	0.00	150.0	± 9.6 %
		Y	4.86	67.05	16.47		150.0	
		Z	4.80	66.24	15.94		150.0	
10538-AAB	IEEE 802.11ac WiFi (40MHz, MCS4, 99pc duty cycle)	X	4.37	66.44	15.94	0.00	150.0	± 9.6 %
		Y	4.89	66.89	16.42		150.0	
		Z	4.84	66.13	15.93		150.0	
10540-AAB	IEEE 802.11ac WiFi (40MHz, MCS6, 99pc duty cycle)	X	4.31	66.35	15.93	0.00	150.0	± 9.6 %
		Y	4.83	66.86	16.43		150.0	
		Z	4.77	66.08	15.92		150.0	

10541-AAB	IEEE 802.11ac WiFi (40MHz, MCS7, 99pc duty cycle)	X	4.33	66.41	15.92	0.00	150.0	± 9.6 %
		Y	4.83	66.83	16.39		150.0	
		Z	4.77	66.02	15.87		150.0	
10542-AAB	IEEE 802.11ac WiFi (40MHz, MCS8, 99pc duty cycle)	X	4.45	66.54	16.01	0.00	150.0	± 9.6 %
		Y	4.97	66.88	16.43		150.0	
		Z	4.91	66.12	15.94		150.0	
10543-AAB	IEEE 802.11ac WiFi (40MHz, MCS9, 99pc duty cycle)	X	4.48	66.49	16.02	0.00	150.0	± 9.6 %
		Y	5.04	66.97	16.50		150.0	
		Z	5.01	66.28	16.06		150.0	
10544-AAB	IEEE 802.11ac WiFi (80MHz, MCS0, 99pc duty cycle)	X	4.77	66.20	15.88	0.00	150.0	± 9.6 %
		Y	5.21	66.81	16.32		150.0	
		Z	5.15	66.11	15.87		150.0	
10545-AAB	IEEE 802.11ac WiFi (80MHz, MCS1, 99pc duty cycle)	X	4.82	66.41	15.96	0.00	150.0	± 9.6 %
		Y	5.37	67.24	16.50		150.0	
		Z	5.34	66.63	16.10		150.0	
10546-AAB	IEEE 802.11ac WiFi (80MHz, MCS2, 99pc duty cycle)	X	4.77	66.27	15.89	0.00	150.0	± 9.6 %
		Y	5.24	66.91	16.35		150.0	
		Z	5.18	66.22	15.90		150.0	
10547-AAB	IEEE 802.11ac WiFi (80MHz, MCS3, 99pc duty cycle)	X	4.83	66.38	15.95	0.00	150.0	± 9.6 %
		Y	5.36	67.18	16.48		150.0	
		Z	5.31	66.51	16.04		150.0	
10548-AAB	IEEE 802.11ac WiFi (80MHz, MCS4, 99pc duty cycle)	X	4.82	66.54	16.01	0.00	150.0	± 9.6 %
		Y	5.39	67.48	16.61		150.0	
		Z	5.39	66.96	16.24		150.0	
10550-AAB	IEEE 802.11ac WiFi (80MHz, MCS6, 99pc duty cycle)	X	4.79	66.46	16.00	0.00	150.0	± 9.6 %
		Y	5.34	67.29	16.55		150.0	
		Z	5.30	66.62	16.12		150.0	
10551-AAB	IEEE 802.11ac WiFi (80MHz, MCS7, 99pc duty cycle)	X	4.75	66.25	15.87	0.00	150.0	± 9.6 %
		Y	5.21	66.84	16.29		150.0	
		Z	5.16	66.14	15.84		150.0	
10552-AAB	IEEE 802.11ac WiFi (80MHz, MCS8, 99pc duty cycle)	X	4.78	66.50	15.97	0.00	150.0	± 9.6 %
		Y	5.22	66.98	16.36		150.0	
		Z	5.16	66.23	15.88		150.0	
10553-AAB	IEEE 802.11ac WiFi (80MHz, MCS9, 99pc duty cycle)	X	4.79	66.33	15.90	0.00	150.0	± 9.6 %
		Y	5.26	66.86	16.32		150.0	
		Z	5.20	66.16	15.87		150.0	
10554-AAC	IEEE 802.11ac WiFi (160MHz, MCS0, 99pc duty cycle)	X	5.25	66.42	15.95	0.00	150.0	± 9.6 %
		Y	5.65	67.07	16.36		150.0	
		Z	5.60	66.46	15.97		150.0	
10555-AAC	IEEE 802.11ac WiFi (160MHz, MCS1, 99pc duty cycle)	X	5.31	66.63	16.05	0.00	150.0	± 9.6 %
		Y	5.71	67.24	16.43		150.0	
		Z	5.68	66.67	16.06		150.0	
10556-AAC	IEEE 802.11ac WiFi (160MHz, MCS2, 99pc duty cycle)	X	5.32	66.65	16.05	0.00	150.0	± 9.6 %
		Y	5.77	67.42	16.51		150.0	
		Z	5.74	66.86	16.15		150.0	
10557-AAC	IEEE 802.11ac WiFi (160MHz, MCS3, 99pc duty cycle)	X	5.28	66.55	16.01	0.00	150.0	± 9.6 %
		Y	5.72	67.25	16.45		150.0	
		Z	5.67	66.64	16.06		150.0	

10558-AAC	IEEE 802.11ac WiFi (160MHz, MCS4, 99pc duty cycle)	X	5.24	66.46	15.98	0.00	150.0	± 9.6 %
		Y	5.69	67.20	16.44		150.0	
		Z	5.65	66.61	16.06		150.0	
10560-AAC	IEEE 802.11ac WiFi (160MHz, MCS6, 99pc duty cycle)	X	5.28	66.44	16.00	0.00	150.0	± 9.6 %
		Y	5.72	67.18	16.47		150.0	
		Z	5.68	66.60	16.09		150.0	
10561-AAC	IEEE 802.11ac WiFi (160MHz, MCS7, 99pc duty cycle)	X	5.21	66.38	15.99	0.00	150.0	± 9.6 %
		Y	5.66	67.17	16.49		150.0	
		Z	5.63	66.59	16.12		150.0	
10562-AAC	IEEE 802.11ac WiFi (160MHz, MCS8, 99pc duty cycle)	X	5.30	66.67	16.13	0.00	150.0	± 9.6 %
		Y	5.70	67.29	16.55		150.0	
		Z	5.66	66.70	16.17		150.0	
10563-AAC	IEEE 802.11ac WiFi (160MHz, MCS9, 99pc duty cycle)	X	5.57	67.31	16.43	0.00	150.0	± 9.6 %
		Y	5.83	67.40	16.57		150.0	
		Z	5.78	66.77	16.18		150.0	
10564-AAA	IEEE 802.11g WiFi 2.4 GHz (DSSS-OFDM, 9 Mbps, 99pc duty cycle)	X	3.98	67.19	15.91	0.46	150.0	± 9.6 %
		Y	4.54	67.45	16.63		150.0	
		Z	4.49	66.59	16.10		150.0	
10565-AAA	IEEE 802.11g WiFi 2.4 GHz (DSSS-OFDM, 12 Mbps, 99pc duty cycle)	X	4.14	67.73	16.32	0.46	150.0	± 9.6 %
		Y	4.73	67.88	16.97		150.0	
		Z	4.67	67.02	16.44		150.0	
10566-AAA	IEEE 802.11g WiFi 2.4 GHz (DSSS-OFDM, 18 Mbps, 99pc duty cycle)	X	3.97	67.32	16.02	0.46	150.0	± 9.6 %
		Y	4.56	67.66	16.76		150.0	
		Z	4.51	66.79	16.21		150.0	
10567-AAA	IEEE 802.11g WiFi 2.4 GHz (DSSS-OFDM, 24 Mbps, 99pc duty cycle)	X	4.06	67.96	16.56	0.46	150.0	± 9.6 %
		Y	4.62	68.16	17.21		150.0	
		Z	4.55	67.23	16.63		150.0	
10568-AAA	IEEE 802.11g WiFi 2.4 GHz (DSSS-OFDM, 36 Mbps, 99pc duty cycle)	X	3.80	66.64	15.45	0.46	150.0	± 9.6 %
		Y	4.41	67.18	16.36		150.0	
		Z	4.38	66.42	15.88		150.0	
10569-AAA	IEEE 802.11g WiFi 2.4 GHz (DSSS-OFDM, 48 Mbps, 99pc duty cycle)	X	4.07	68.35	16.82	0.46	150.0	± 9.6 %
		Y	4.63	68.53	17.43		150.0	
		Z	4.55	67.52	16.81		150.0	
10570-AAA	IEEE 802.11g WiFi 2.4 GHz (DSSS-OFDM, 54 Mbps, 99pc duty cycle)	X	3.99	67.81	16.52	0.46	150.0	± 9.6 %
		Y	4.60	68.17	17.24		150.0	
		Z	4.53	67.25	16.66		150.0	
10571-AAA	IEEE 802.11b WiFi 2.4 GHz (DSSS, 1 Mbps, 90pc duty cycle)	X	0.93	63.68	14.15	0.46	130.0	± 9.6 %
		Y	1.11	65.62	16.53		130.0	
		Z	0.97	62.81	14.25		130.0	
10572-AAA	IEEE 802.11b WiFi 2.4 GHz (DSSS, 2 Mbps, 90pc duty cycle)	X	0.94	64.27	14.56	0.46	130.0	± 9.6 %
		Y	1.13	66.40	17.03		130.0	
		Z	0.97	63.27	14.57		130.0	
10573-AAA	IEEE 802.11b WiFi 2.4 GHz (DSSS, 5.5 Mbps, 90pc duty cycle)	X	1.10	79.41	19.97	0.46	130.0	± 9.6 %
		Y	29.09	140.84	40.18		130.0	
		Z	0.81	73.52	17.65		130.0	
10574-AAA	IEEE 802.11b WiFi 2.4 GHz (DSSS, 11 Mbps, 90pc duty cycle)	X	1.00	70.10	17.80	0.46	130.0	± 9.6 %
		Y	1.40	75.63	21.83		130.0	
		Z	0.96	67.63	16.92		130.0	

10575-AAA	IEEE 802.11g WiFi 2.4 GHz (DSSS-OFDM, 6 Mbps, 90pc duty cycle)	X	3.74	66.83	15.70	0.46	130.0	± 9.6 %
		Y	4.30	67.12	16.57		130.0	
		Z	4.26	66.31	16.08		130.0	
10576-AAA	IEEE 802.11g WiFi 2.4 GHz (DSSS-OFDM, 9 Mbps, 90pc duty cycle)	X	3.78	67.20	15.91	0.46	130.0	± 9.6 %
		Y	4.34	67.41	16.71		130.0	
		Z	4.29	66.55	16.18		130.0	
10577-AAA	IEEE 802.11g WiFi 2.4 GHz (DSSS-OFDM, 12 Mbps, 90pc duty cycle)	X	3.89	67.42	16.06	0.46	130.0	± 9.6 %
		Y	4.48	67.61	16.83		130.0	
		Z	4.44	66.77	16.33		130.0	
10578-AAA	IEEE 802.11g WiFi 2.4 GHz (DSSS-OFDM, 18 Mbps, 90pc duty cycle)	X	3.83	67.60	16.23	0.46	130.0	± 9.6 %
		Y	4.40	67.82	17.00		130.0	
		Z	4.35	66.92	16.45		130.0	
10579-AAA	IEEE 802.11g WiFi 2.4 GHz (DSSS-OFDM, 24 Mbps, 90pc duty cycle)	X	3.51	66.09	15.01	0.46	130.0	± 9.6 %
		Y	4.12	66.74	16.08		130.0	
		Z	4.09	65.97	15.60		130.0	
10580-AAA	IEEE 802.11g WiFi 2.4 GHz (DSSS-OFDM, 36 Mbps, 90pc duty cycle)	X	3.49	65.97	14.89	0.46	130.0	± 9.6 %
		Y	4.12	66.69	16.03		130.0	
		Z	4.11	65.99	15.59		130.0	
10581-AAA	IEEE 802.11g WiFi 2.4 GHz (DSSS-OFDM, 48 Mbps, 90pc duty cycle)	X	3.74	67.63	16.20	0.46	130.0	± 9.6 %
		Y	4.33	67.99	17.02		130.0	
		Z	4.26	67.01	16.43		130.0	
10582-AAA	IEEE 802.11g WiFi 2.4 GHz (DSSS-OFDM, 54 Mbps, 90pc duty cycle)	X	3.37	65.61	14.64	0.46	130.0	± 9.6 %
		Y	4.03	66.45	15.82		130.0	
		Z	4.01	65.72	15.36		130.0	
10583-AAB	IEEE 802.11a/h WiFi 5 GHz (OFDM, 6 Mbps, 90pc duty cycle)	X	3.74	66.83	15.70	0.46	130.0	± 9.6 %
		Y	4.30	67.12	16.57		130.0	
		Z	4.26	66.31	16.08		130.0	
10584-AAB	IEEE 802.11a/h WiFi 5 GHz (OFDM, 9 Mbps, 90pc duty cycle)	X	3.78	67.20	15.91	0.46	130.0	± 9.6 %
		Y	4.34	67.41	16.71		130.0	
		Z	4.29	66.55	16.18		130.0	
10585-AAB	IEEE 802.11a/h WiFi 5 GHz (OFDM, 12 Mbps, 90pc duty cycle)	X	3.89	67.42	16.06	0.46	130.0	± 9.6 %
		Y	4.48	67.61	16.83		130.0	
		Z	4.44	66.77	16.33		130.0	
10586-AAB	IEEE 802.11a/h WiFi 5 GHz (OFDM, 18 Mbps, 90pc duty cycle)	X	3.83	67.60	16.23	0.46	130.0	± 9.6 %
		Y	4.40	67.82	17.00		130.0	
		Z	4.35	66.92	16.45		130.0	
10587-AAB	IEEE 802.11a/h WiFi 5 GHz (OFDM, 24 Mbps, 90pc duty cycle)	X	3.51	66.09	15.01	0.46	130.0	± 9.6 %
		Y	4.12	66.74	16.08		130.0	
		Z	4.09	65.97	15.60		130.0	
10588-AAB	IEEE 802.11a/h WiFi 5 GHz (OFDM, 36 Mbps, 90pc duty cycle)	X	3.49	65.97	14.89	0.46	130.0	± 9.6 %
		Y	4.12	66.69	16.03		130.0	
		Z	4.11	65.99	15.59		130.0	
10589-AAB	IEEE 802.11a/h WiFi 5 GHz (OFDM, 48 Mbps, 90pc duty cycle)	X	3.74	67.63	16.20	0.46	130.0	± 9.6 %
		Y	4.33	67.99	17.02		130.0	
		Z	4.26	67.01	16.43		130.0	
10590-AAB	IEEE 802.11a/h WiFi 5 GHz (OFDM, 54 Mbps, 90pc duty cycle)	X	3.37	65.61	14.64	0.46	130.0	± 9.6 %
		Y	4.03	66.45	15.82		130.0	
		Z	4.01	65.72	15.36		130.0	

10591-AAB	IEEE 802.11n (HT Mixed, 20MHz, MCS0, 90pc duty cycle)	X	3.91	67.05	15.98	0.46	130.0	± 9.6 %
		Y	4.46	67.24	16.72		130.0	
		Z	4.42	66.45	16.24		130.0	
10592-AAB	IEEE 802.11n (HT Mixed, 20MHz, MCS1, 90pc duty cycle)	X	3.96	67.20	16.07	0.46	130.0	± 9.6 %
		Y	4.56	67.49	16.83		130.0	
		Z	4.52	66.71	16.36		130.0	
10593-AAB	IEEE 802.11n (HT Mixed, 20MHz, MCS2, 90pc duty cycle)	X	3.89	67.09	15.91	0.46	130.0	± 9.6 %
		Y	4.48	67.36	16.68		130.0	
		Z	4.44	66.57	16.20		130.0	
10594-AAB	IEEE 802.11n (HT Mixed, 20MHz, MCS3, 90pc duty cycle)	X	3.93	67.20	16.06	0.46	130.0	± 9.6 %
		Y	4.53	67.56	16.87		130.0	
		Z	4.50	66.76	16.38		130.0	
10595-AAB	IEEE 802.11n (HT Mixed, 20MHz, MCS4, 90pc duty cycle)	X	3.88	67.15	15.95	0.46	130.0	± 9.6 %
		Y	4.50	67.54	16.78		130.0	
		Z	4.46	66.73	16.29		130.0	
10596-AAB	IEEE 802.11n (HT Mixed, 20MHz, MCS5, 90pc duty cycle)	X	3.78	66.88	15.82	0.46	130.0	± 9.6 %
		Y	4.41	67.44	16.74		130.0	
		Z	4.38	66.66	16.26		130.0	
10597-AAB	IEEE 802.11n (HT Mixed, 20MHz, MCS6, 90pc duty cycle)	X	3.79	66.92	15.72	0.46	130.0	± 9.6 %
		Y	4.37	67.31	16.57		130.0	
		Z	4.34	66.51	16.09		130.0	
10598-AAB	IEEE 802.11n (HT Mixed, 20MHz, MCS7, 90pc duty cycle)	X	3.85	67.45	16.19	0.46	130.0	± 9.6 %
		Y	4.40	67.66	16.93		130.0	
		Z	4.34	66.79	16.40		130.0	
10599-AAB	IEEE 802.11n (HT Mixed, 40MHz, MCS0, 90pc duty cycle)	X	4.79	67.73	16.77	0.46	130.0	± 9.6 %
		Y	5.21	67.73	17.04		130.0	
		Z	5.16	67.02	16.62		130.0	
10600-AAB	IEEE 802.11n (HT Mixed, 40MHz, MCS1, 90pc duty cycle)	X	4.68	67.39	16.57	0.46	130.0	± 9.6 %
		Y	5.21	67.78	17.04		130.0	
		Z	5.26	67.42	16.79		130.0	
10601-AAB	IEEE 802.11n (HT Mixed, 40MHz, MCS2, 90pc duty cycle)	X	4.64	67.32	16.56	0.46	130.0	± 9.6 %
		Y	5.18	67.81	17.08		130.0	
		Z	5.18	67.25	16.73		130.0	
10602-AAB	IEEE 802.11n (HT Mixed, 40MHz, MCS3, 90pc duty cycle)	X	4.63	67.06	16.35	0.46	130.0	± 9.6 %
		Y	5.19	67.55	16.86		130.0	
		Z	5.23	67.15	16.59		130.0	
10603-AAB	IEEE 802.11n (HT Mixed, 40MHz, MCS4, 90pc duty cycle)	X	4.68	67.32	16.65	0.46	130.0	± 9.6 %
		Y	5.23	67.74	17.10		130.0	
		Z	5.27	67.35	16.84		130.0	
10604-AAB	IEEE 802.11n (HT Mixed, 40MHz, MCS5, 90pc duty cycle)	X	4.64	67.04	16.46	0.46	130.0	± 9.6 %
		Y	5.12	67.34	16.87		130.0	
		Z	5.13	66.84	16.55		130.0	
10605-AAB	IEEE 802.11n (HT Mixed, 40MHz, MCS6, 90pc duty cycle)	X	4.61	67.01	16.45	0.46	130.0	± 9.6 %
		Y	5.17	67.54	16.97		130.0	
		Z	5.21	67.15	16.70		130.0	
10606-AAB	IEEE 802.11n (HT Mixed, 40MHz, MCS7, 90pc duty cycle)	X	4.52	66.73	16.13	0.46	130.0	± 9.6 %
		Y	5.04	67.22	16.65		130.0	
		Z	5.04	66.71	16.33		130.0	

10607-AAB	IEEE 802.11ac WiFi (20MHz, MCS0, 90pc duty cycle)	X	3.77	66.40	15.66	0.46	130.0	± 9.6 %
		Y	4.33	66.69	16.43		130.0	
		Z	4.27	65.78	15.88		130.0	
10608-AAB	IEEE 802.11ac WiFi (20MHz, MCS1, 90pc duty cycle)	X	3.82	66.54	15.73	0.46	130.0	± 9.6 %
		Y	4.44	66.96	16.55		130.0	
		Z	4.38	66.06	16.01		130.0	
10609-AAB	IEEE 802.11ac WiFi (20MHz, MCS2, 90pc duty cycle)	X	3.73	66.35	15.52	0.46	130.0	± 9.6 %
		Y	4.34	66.78	16.36		130.0	
		Z	4.28	65.87	15.81		130.0	
10610-AAB	IEEE 802.11ac WiFi (20MHz, MCS3, 90pc duty cycle)	X	3.78	66.52	15.70	0.46	130.0	± 9.6 %
		Y	4.40	66.99	16.56		130.0	
		Z	4.34	66.07	16.00		130.0	
10611-AAB	IEEE 802.11ac WiFi (20MHz, MCS4, 90pc duty cycle)	X	3.70	66.30	15.52	0.46	130.0	± 9.6 %
		Y	4.30	66.73	16.37		130.0	
		Z	4.25	65.83	15.82		130.0	
10612-AAB	IEEE 802.11ac WiFi (20MHz, MCS5, 90pc duty cycle)	X	3.61	66.09	15.37	0.46	130.0	± 9.6 %
		Y	4.27	66.79	16.38		130.0	
		Z	4.22	65.92	15.84		130.0	
10613-AAB	IEEE 802.11ac WiFi (20MHz, MCS6, 90pc duty cycle)	X	3.64	66.03	15.27	0.46	130.0	± 9.6 %
		Y	4.27	66.59	16.20		130.0	
		Z	4.22	65.72	15.67		130.0	
10614-AAB	IEEE 802.11ac WiFi (20MHz, MCS7, 90pc duty cycle)	X	3.70	66.56	15.73	0.46	130.0	± 9.6 %
		Y	4.27	66.95	16.54		130.0	
		Z	4.20	66.00	15.96		130.0	
10615-AAB	IEEE 802.11ac WiFi (20MHz, MCS8, 90pc duty cycle)	X	3.64	65.99	15.16	0.46	130.0	± 9.6 %
		Y	4.28	66.52	16.09		130.0	
		Z	4.23	65.64	15.56		130.0	
10616-AAB	IEEE 802.11ac WiFi (40MHz, MCS0, 90pc duty cycle)	X	4.45	66.34	16.08	0.46	130.0	± 9.6 %
		Y	4.95	66.71	16.53		130.0	
		Z	4.93	66.07	16.13		130.0	
10617-AAB	IEEE 802.11ac WiFi (40MHz, MCS1, 90pc duty cycle)	X	4.43	66.27	16.03	0.46	130.0	± 9.6 %
		Y	4.97	66.78	16.54		130.0	
		Z	4.96	66.18	16.16		130.0	
10618-AAB	IEEE 802.11ac WiFi (40MHz, MCS2, 90pc duty cycle)	X	4.37	66.39	16.11	0.46	130.0	± 9.6 %
		Y	4.90	66.88	16.61		130.0	
		Z	4.86	66.19	16.18		130.0	
10619-AAB	IEEE 802.11ac WiFi (40MHz, MCS3, 90pc duty cycle)	X	4.42	66.32	16.00	0.46	130.0	± 9.6 %
		Y	4.94	66.79	16.49		130.0	
		Z	4.93	66.18	16.10		130.0	
10620-AAB	IEEE 802.11ac WiFi (40MHz, MCS4, 90pc duty cycle)	X	4.43	66.13	15.93	0.46	130.0	± 9.6 %
		Y	4.96	66.62	16.45		130.0	
		Z	4.96	66.05	16.09		130.0	
10621-AAB	IEEE 802.11ac WiFi (40MHz, MCS5, 90pc duty cycle)	X	4.50	66.48	16.27	0.46	130.0	± 9.6 %
		Y	5.00	66.84	16.69		130.0	
		Z	4.97	66.18	16.29		130.0	
10622-AAB	IEEE 802.11ac WiFi (40MHz, MCS6, 90pc duty cycle)	X	4.46	66.43	16.25	0.46	130.0	± 9.6 %
		Y	4.98	66.91	16.73		130.0	
		Z	4.96	66.27	16.33		130.0	

10623-AAB	IEEE 802.11ac WiFi (40MHz, MCS7, 90pc duty cycle)	X	4.39	66.10	15.89	0.46	130.0	± 9.6 %
		Y	4.89	66.49	16.36		130.0	
		Z	4.86	65.84	15.96		130.0	
10624-AAB	IEEE 802.11ac WiFi (40MHz, MCS8, 90pc duty cycle)	X	4.54	66.35	16.10	0.46	130.0	± 9.6 %
		Y	5.06	66.70	16.53		130.0	
		Z	5.05	66.11	16.17		130.0	
10625-AAB	IEEE 802.11ac WiFi (40MHz, MCS9, 90pc duty cycle)	X	4.65	66.63	16.32	0.46	130.0	± 9.6 %
		Y	5.15	66.88	16.69		130.0	
		Z	5.16	66.34	16.36		130.0	
10626-AAB	IEEE 802.11ac WiFi (80MHz, MCS0, 90pc duty cycle)	X	4.87	66.09	16.03	0.46	130.0	± 9.6 %
		Y	5.31	66.64	16.44		130.0	
		Z	5.28	66.07	16.09		130.0	
10627-AAB	IEEE 802.11ac WiFi (80MHz, MCS1, 90pc duty cycle)	X	4.96	66.39	16.17	0.46	130.0	± 9.6 %
		Y	5.52	67.25	16.73		130.0	
		Z	5.53	66.80	16.43		130.0	
10628-AAB	IEEE 802.11ac WiFi (80MHz, MCS2, 90pc duty cycle)	X	4.83	65.96	15.85	0.46	130.0	± 9.6 %
		Y	5.28	66.56	16.30		130.0	
		Z	5.27	66.03	15.96		130.0	
10629-AAB	IEEE 802.11ac WiFi (80MHz, MCS3, 90pc duty cycle)	X	4.89	66.11	15.93	0.46	130.0	± 9.6 %
		Y	5.45	66.99	16.52		130.0	
		Z	5.45	66.49	16.20		130.0	
10630-AAB	IEEE 802.11ac WiFi (80MHz, MCS4, 90pc duty cycle)	X	4.94	66.47	16.13	0.46	130.0	± 9.6 %
		Y	5.52	67.40	16.73		130.0	
		Z	5.58	67.09	16.50		130.0	
10631-AAB	IEEE 802.11ac WiFi (80MHz, MCS5, 90pc duty cycle)	X	5.04	67.01	16.63	0.46	130.0	± 9.6 %
		Y	5.56	67.66	17.07		130.0	
		Z	5.56	67.16	16.74		130.0	
10632-AAB	IEEE 802.11ac WiFi (80MHz, MCS6, 90pc duty cycle)	X	5.02	66.85	16.55	0.46	130.0	± 9.6 %
		Y	5.59	67.70	17.10		130.0	
		Z	5.59	67.18	16.77		130.0	
10633-AAB	IEEE 802.11ac WiFi (80MHz, MCS7, 90pc duty cycle)	X	4.86	66.17	16.01	0.46	130.0	± 9.6 %
		Y	5.30	66.64	16.39		130.0	
		Z	5.27	66.07	16.03		130.0	
10634-AAB	IEEE 802.11ac WiFi (80MHz, MCS8, 90pc duty cycle)	X	4.95	66.64	16.30	0.46	130.0	± 9.6 %
		Y	5.35	66.92	16.58		130.0	
		Z	5.32	66.32	16.21		130.0	
10635-AAB	IEEE 802.11ac WiFi (80MHz, MCS9, 90pc duty cycle)	X	4.70	65.44	15.34	0.46	130.0	± 9.6 %
		Y	5.17	66.01	15.82		130.0	
		Z	5.16	65.50	15.50		130.0	
10636-AAC	IEEE 802.11ac WiFi (160MHz, MCS0, 90pc duty cycle)	X	5.37	66.35	16.11	0.46	130.0	± 9.6 %
		Y	5.75	66.94	16.50		130.0	
		Z	5.74	66.45	16.20		130.0	
10637-AAC	IEEE 802.11ac WiFi (160MHz, MCS1, 90pc duty cycle)	X	5.47	66.68	16.28	0.46	130.0	± 9.6 %
		Y	5.84	67.17	16.61		130.0	
		Z	5.85	66.75	16.34		130.0	
10638-AAC	IEEE 802.11ac WiFi (160MHz, MCS2, 90pc duty cycle)	X	5.45	66.60	16.21	0.46	130.0	± 9.6 %
		Y	5.91	67.37	16.68		130.0	
		Z	5.90	66.89	16.39		130.0	

10639-AAC	IEEE 802.11ac WiFi (160MHz, MCS3, 90pc duty cycle)	X	5.40	66.48	16.20	0.46	130.0	± 9.6 %
		Y	5.83	67.15	16.61		130.0	
		Z	5.82	66.67	16.32		130.0	
10640-AAC	IEEE 802.11ac WiFi (160MHz, MCS4, 90pc duty cycle)	X	5.32	66.22	15.99	0.46	130.0	± 9.6 %
		Y	5.75	66.89	16.42		130.0	
		Z	5.75	66.45	16.15		130.0	
10641-AAC	IEEE 802.11ac WiFi (160MHz, MCS5, 90pc duty cycle)	X	5.45	66.45	16.13	0.46	130.0	± 9.6 %
		Y	5.88	67.07	16.54		130.0	
		Z	5.90	66.70	16.30		130.0	
10642-AAC	IEEE 802.11ac WiFi (160MHz, MCS6, 90pc duty cycle)	X	5.46	66.60	16.39	0.46	130.0	± 9.6 %
		Y	5.90	67.28	16.81		130.0	
		Z	5.89	66.80	16.53		130.0	
10643-AAC	IEEE 802.11ac WiFi (160MHz, MCS7, 90pc duty cycle)	X	5.28	66.13	16.00	0.46	130.0	± 9.6 %
		Y	5.73	66.91	16.51		130.0	
		Z	5.74	66.48	16.24		130.0	
10644-AAC	IEEE 802.11ac WiFi (160MHz, MCS8, 90pc duty cycle)	X	5.42	66.58	16.26	0.46	130.0	± 9.6 %
		Y	5.78	67.08	16.62		130.0	
		Z	5.78	66.62	16.33		130.0	
10645-AAC	IEEE 802.11ac WiFi (160MHz, MCS9, 90pc duty cycle)	X	5.81	67.58	16.73	0.46	130.0	± 9.6 %
		Y	5.91	67.16	16.62		130.0	
		Z	5.93	66.77	16.38		130.0	
10646-AAD	LTE-TDD (SC-FDMA, 1 RB, 5 MHz, QPSK, UL Subframe=2,7)	X	2.64	72.38	24.11	9.30	60.0	± 9.6 %
		Y	4.60	84.41	29.31		60.0	
		Z	4.84	83.41	28.63		60.0	
10647-AAC	LTE-TDD (SC-FDMA, 1 RB, 20 MHz, QPSK, UL Subframe=2,7)	X	2.46	71.01	23.55	9.30	60.0	± 9.6 %
		Y	4.04	81.81	28.38		60.0	
		Z	4.35	81.42	27.96		60.0	
10648-AAA	CDMA2000 (1x Advanced)	X	2.44	155.88	0.83	0.00	150.0	± 9.6 %
		Y	0.35	60.28	6.28		150.0	
		Z	0.35	60.00	5.54		150.0	
10652-AAB	LTE-TDD (OFDMA, 5 MHz, E-TM 3.1, Clipping 44%)	X	2.08	63.49	12.30	2.23	80.0	± 9.6 %
		Y	3.15	67.39	16.19		80.0	
		Z	2.91	65.29	15.14		80.0	
10653-AAB	LTE-TDD (OFDMA, 10 MHz, E-TM 3.1, Clipping 44%)	X	3.02	65.17	14.89	2.23	80.0	± 9.6 %
		Y	3.64	66.22	16.46		80.0	
		Z	3.52	64.96	15.78		80.0	
10654-AAB	LTE-TDD (OFDMA, 15 MHz, E-TM 3.1, Clipping 44%)	X	3.20	64.95	15.39	2.23	80.0	± 9.6 %
		Y	3.67	65.70	16.49		80.0	
		Z	3.57	64.61	15.88		80.0	
10655-AAB	LTE-TDD (OFDMA, 20 MHz, E-TM 3.1, Clipping 44%)	X	3.35	64.77	15.59	2.23	80.0	± 9.6 %
		Y	3.76	65.50	16.51		80.0	
		Z	3.66	64.52	15.94		80.0	
10658-AAA	Pulse Waveform (200Hz, 10%)	X	2.01	62.76	7.94	10.00	50.0	± 9.6 %
		Y	2.58	65.57	9.73		50.0	
		Z	3.05	67.26	11.01		50.0	
10659-AAA	Pulse Waveform (200Hz, 20%)	X	0.84	60.00	5.36	6.99	60.0	± 9.6 %
		Y	1.33	63.54	7.82		60.0	
		Z	1.53	64.53	8.66		60.0	

10660-AAA	Pulse Waveform (200Hz, 40%)	X	0.39	60.00	3.98	3.98	80.0	± 9.6 %
		Y	0.54	61.57	5.88		80.0	
		Z	0.45	60.00	5.04		80.0	
10661-AAA	Pulse Waveform (200Hz, 60%)	X	17.64	60.43	1.44	2.22	100.0	± 9.6 %
		Y	0.23	60.00	4.28		100.0	
		Z	0.25	60.00	3.48		100.0	
10662-AAA	Pulse Waveform (200Hz, 80%)	X	0.00	84.91	40.93	0.97	120.0	± 9.6 %
		Y	49.30	1078.61	357.44		120.0	
		Z	0.03	139.18	4.12		120.0	

^E Uncertainty is determined using the max. deviation from linear response applying rectangular distribution and is expressed for the square of the field value.



Accredited by the Swiss Accreditation Service (SAS)
The Swiss Accreditation Service is one of the signatories to the EA
Multilateral Agreement for the recognition of calibration certificates

Accreditation No.: **SCS 0108**

Client **PG Test**

Certificate No: **EX3-3914_Feb19**

CALIBRATION CERTIFICATE

Object **EX3DV4 - SN:3914**

Calibration procedure(s) **DA CAL-01 v5, DA CAL-12 v5, DA CAL-14 v5, DA CAL-20 v5,
DA CAL-25 v7
Calibration procedure for dosimetric E-field probes**

Calibration date: **February 19, 2019**

02-26-2019

This calibration certificate documents the traceability to national standards, which realize the physical units of measurements (SI).
The measurements and the uncertainties with confidence probability are given on the following pages and are part of the certificate.

All calibrations have been conducted in the closed laboratory facility: environment temperature (22 ± 3)°C and humidity < 70%.

Calibration Equipment used (M&TE critical for calibration)

Primary Standards	ID	Cal Date (Certificate No.)	Scheduled Calibration
Power meter NRP	SN: 104778	04-Apr-18 (No. 217-02672/02673)	Apr-19
Power sensor NRP-Z91	SN: 103244	04-Apr-18 (No. 217-02672)	Apr-19
Power sensor NRP-Z91	SN: 103245	04-Apr-18 (No. 217-02673)	Apr-19
Reference 20 dB Attenuator	SN: S5277 (20x)	04-Apr-18 (No. 217-02682)	Apr-19
DAE4	SN: 660	19-Dec-18 (No. DAE4-660_Dec18)	Dec-19
Reference Probe ES3DV2	SN: 3013	31-Dec-18 (No. ES3-3013_Dec18)	Dec-19
Secondary Standards	ID	Check Date (in house)	Scheduled Check
Power meter E4419B	SN: GB41293874	06-Apr-16 (in house check Jun-18)	In house check: Jun-20
Power sensor E4412A	SN: MY41498087	06-Apr-16 (in house check Jun-18)	In house check: Jun-20
Power sensor E4412A	SN: 000110210	06-Apr-16 (in house check Jun-18)	In house check: Jun-20
RF generator HP 8648C	SN: US3642U01700	04-Aug-99 (in house check Jun-18)	In house check: Jun-20
Network Analyzer E8358A	SN: US41080477	31-Mar-14 (in house check Oct-18)	In house check: Oct-19

	Name	Function	Signature
Calibrated by:	Jeton Kastrati	Laboratory Technician	
Approved by:	Katja Pokovic	Technical Manager	

Issued: February 20, 2019

This calibration certificate shall not be reproduced except in full without written approval of the laboratory.



Accredited by the Swiss Accreditation Service (SAS)

Accreditation No.: **SCS 0108**

The Swiss Accreditation Service is one of the signatories to the EA Multilateral Agreement for the recognition of calibration certificates

Glossary:

TSL	tissue simulating liquid
NORM _{x,y,z}	sensitivity in free space
ConvF	sensitivity in TSL / NORM _{x,y,z}
DCP	diode compression point
CF	crest factor (1/duty_cycle) of the RF signal
A, B, C, D	modulation dependent linearization parameters
Polarization φ	φ rotation around probe axis
Polarization ϑ	ϑ rotation around an axis that is in the plane normal to probe axis (at measurement center), i.e., $\vartheta = 0$ is normal to probe axis
Connector Angle	information used in DASY system to align probe sensor X to the robot coordinate system

Calibration is Performed According to the Following Standards:

- IEEE Std 1528-2013, "IEEE Recommended Practice for Determining the Peak Spatial-Averaged Specific Absorption Rate (SAR) in the Human Head from Wireless Communications Devices: Measurement Techniques", June 2013
- IEC 62209-1, "Measurement procedure for the assessment of Specific Absorption Rate (SAR) from hand-held and body-mounted devices used next to the ear (frequency range of 300 MHz to 6 GHz)", July 2016
- IEC 62209-2, "Procedure to determine the Specific Absorption Rate (SAR) for wireless communication devices used in close proximity to the human body (frequency range of 30 MHz to 6 GHz)", March 2010
- KDB 865664, "SAR Measurement Requirements for 100 MHz to 6 GHz"

Methods Applied and Interpretation of Parameters:

- NORM_{x,y,z}**: Assessed for E-field polarization $\vartheta = 0$ ($f \leq 900$ MHz in TEM-cell; $f > 1800$ MHz: R22 waveguide). NORM_{x,y,z} are only intermediate values, i.e., the uncertainties of NORM_{x,y,z} does not affect the E²-field uncertainty inside TSL (see below ConvF).
- NORM(f)_{x,y,z} = NORM_{x,y,z} * frequency_response** (see Frequency Response Chart). This linearization is implemented in DASY4 software versions later than 4.2. The uncertainty of the frequency response is included in the stated uncertainty of ConvF.
- DCP_{x,y,z}**: DCP are numerical linearization parameters assessed based on the data of power sweep with CW signal (no uncertainty required). DCP does not depend on frequency nor media.
- PAR**: PAR is the Peak to Average Ratio that is not calibrated but determined based on the signal characteristics
- A_{x,y,z}; B_{x,y,z}; C_{x,y,z}; D_{x,y,z}; VR_{x,y,z}; A, B, C, D** are numerical linearization parameters assessed based on the data of power sweep for specific modulation signal. The parameters do not depend on frequency nor media. VR is the maximum calibration range expressed in RMS voltage across the diode.
- ConvF and Boundary Effect Parameters**: Assessed in flat phantom using E-field (or Temperature Transfer Standard for $f \leq 800$ MHz) and inside waveguide using analytical field distributions based on power measurements for $f > 800$ MHz. The same setups are used for assessment of the parameters applied for boundary compensation (alpha, depth) of which typical uncertainty values are given. These parameters are used in DASY4 software to improve probe accuracy close to the boundary. The sensitivity in TSL corresponds to NORM_{x,y,z} * ConvF whereby the uncertainty corresponds to that given for ConvF. A frequency dependent ConvF is used in DASY version 4.4 and higher which allows extending the validity from ± 50 MHz to ± 100 MHz.
- Spherical isotropy (3D deviation from isotropy)**: in a field of low gradients realized using a flat phantom exposed by a patch antenna.
- Sensor Offset**: The sensor offset corresponds to the offset of virtual measurement center from the probe tip (on probe axis). No tolerance required.
- Connector Angle**: The angle is assessed using the information gained by determining the NORM_x (no uncertainty required).

DASY/EASY - Parameters of Probe: EX3DV4 - SN:3914

Basic Calibration Parameters

	Sensor X	Sensor Y	Sensor Z	Unc (k=2)
Norm ($\mu\text{V}/(\text{V}/\text{m})^2$) ^A	0.46	0.41	0.44	$\pm 10.1 \%$
DCP (mV) ^B	98.0	104.4	100.8	

Calibration Results for Modulation Response

UID	Communication System Name		A dB	B dB $\sqrt{\mu\text{V}}$	C	D dB	VR mV	Max dev.	Max Unc ^E (k=2)
0	CW	X	0.00	0.00	1.00	0.00	135.8	$\pm 3.3 \%$	$\pm 4.7 \%$
		Y	0.00	0.00	1.00		149.1		
		Z	0.00	0.00	1.00		130.4		
10352- AAA	Pulse Waveform (200Hz, 10%)	X	11.50	82.25	17.46	10.00	60.0	$\pm 2.9 \%$	$\pm 9.6 \%$
		Y	13.06	84.85	18.88		60.0		
		Z	15.00	85.74	19.04		60.0		
10353- AAA	Pulse Waveform (200Hz, 20%)	X	15.00	85.61	17.12	6.99	80.0	$\pm 1.7 \%$	$\pm 9.6 \%$
		Y	15.00	87.20	18.40		80.0		
		Z	15.00	86.88	18.11		80.0		
10354- AAA	Pulse Waveform (200Hz, 40%)	X	15.00	85.07	15.18	3.98	95.0	$\pm 1.1 \%$	$\pm 9.6 \%$
		Y	15.00	89.57	18.09		95.0		
		Z	15.00	87.22	16.52		95.0		
10355- AAA	Pulse Waveform (200Hz, 60%)	X	0.82	65.05	7.38	2.22	120.0	$\pm 1.2 \%$	$\pm 9.6 \%$
		Y	15.00	94.17	19.03		120.0		
		Z	15.00	84.14	13.59		120.0		
10387- AAA	QPSK Waveform, 1 MHz	X	0.56	60.35	7.26	0.00	150.0	$\pm 2.8 \%$	$\pm 9.6 \%$
		Y	0.80	64.04	10.54		150.0		
		Z	0.51	60.00	6.79		150.0		
10388- AAA	QPSK Waveform, 10 MHz	X	2.18	68.24	15.67	0.00	150.0	$\pm 1.2 \%$	$\pm 9.6 \%$
		Y	2.41	70.06	16.91		150.0		
		Z	2.04	67.38	15.28		150.0		
10396- AAA	64-QAM Waveform, 100 kHz	X	2.71	69.05	18.06	3.01	150.0	$\pm 0.7 \%$	$\pm 9.6 \%$
		Y	3.50	74.05	20.22		150.0		
		Z	2.76	69.32	18.16		150.0		
10399- AAA	64-QAM Waveform, 40 MHz	X	3.50	67.38	15.86	0.00	150.0	$\pm 2.2 \%$	$\pm 9.6 \%$
		Y	3.57	67.89	16.25		150.0		
		Z	3.38	66.82	15.58		150.0		
10414- AAA	WLAN CCDF, 64-QAM, 40MHz	X	4.87	65.94	15.72	0.00	150.0	$\pm 4.2 \%$	$\pm 9.6 \%$
		Y	4.84	65.99	15.74		150.0		
		Z	4.71	65.47	15.46		150.0		

Note: For details on UID parameters see Appendix

The reported uncertainty of measurement is stated as the standard uncertainty of measurement multiplied by the coverage factor $k=2$, which for a normal distribution corresponds to a coverage probability of approximately 95%.

^A The uncertainties of Norm X,Y,Z do not affect the E^2 -field uncertainty inside TSL (see Pages 5 and 6).

^B Numerical linearization parameter: uncertainty not required.

^E Uncertainty is determined using the max. deviation from linear response applying rectangular distribution and is expressed for the square of the field value.

DASY/EASY - Parameters of Probe: EX3DV4 - SN:3914

Sensor Model Parameters

	C1 fF	C2 fF	α V ⁻¹	T1 ms.V ⁻²	T2 ms.V ⁻¹	T3 ms	T4 V ⁻²	T5 V ⁻¹	T6
X	42.5	324.17	36.82	9.95	0.55	5.06	0.00	0.49	1.01
Y	42.9	310.45	33.81	12.34	0.63	5.02	2.00	0.15	1.01
Z	39.7	301.66	36.55	9.75	0.75	5.05	0.45	0.44	1.01

Other Probe Parameters

Sensor Arrangement	Triangular
Connector Angle (°)	0.5
Mechanical Surface Detection Mode	enabled
Optical Surface Detection Mode	disabled
Probe Overall Length	337 mm
Probe Body Diameter	10 mm
Tip Length	9 mm
Tip Diameter	2.5 mm
Probe Tip to Sensor X Calibration Point	1 mm
Probe Tip to Sensor Y Calibration Point	1 mm
Probe Tip to Sensor Z Calibration Point	1 mm
Recommended Measurement Distance from Surface	1.4 mm

DASY/EASY - Parameters of Probe: EX3DV4 - SN:3914

Calibration Parameter Determined in Head Tissue Simulating Media

f (MHz) ^C	Relative Permittivity ^F	Conductivity (S/m) ^F	ConvF X	ConvF Y	ConvF Z	Alpha ^G	Depth ^G (mm)	Unc (k=2)
6	55.5	0.75	21.24	21.24	21.24	0.00	1.00	± 13.3 %
13	55.5	0.75	18.06	18.06	18.06	0.00	1.00	± 13.3 %
750	41.9	0.89	10.00	10.00	10.00	0.54	0.82	± 12.0 %
835	41.5	0.90	9.50	9.50	9.50	0.50	0.86	± 12.0 %
1750	40.1	1.37	8.16	8.16	8.16	0.41	0.80	± 12.0 %
1900	40.0	1.40	7.80	7.80	7.80	0.40	0.84	± 12.0 %
2300	39.5	1.67	7.44	7.44	7.44	0.37	0.84	± 12.0 %
2450	39.2	1.80	7.13	7.13	7.13	0.39	0.86	± 12.0 %
2600	39.0	1.96	7.11	7.11	7.11	0.39	0.89	± 12.0 %
3500	37.9	2.91	6.99	6.99	6.99	0.25	1.20	± 13.1 %
3700	37.7	3.12	6.75	6.75	6.75	0.25	1.20	± 13.1 %
5250	35.9	4.71	5.19	5.19	5.19	0.40	1.80	± 13.1 %
5600	35.5	5.07	4.73	4.73	4.73	0.40	1.80	± 13.1 %
5750	35.4	5.22	4.90	4.90	4.90	0.40	1.80	± 13.1 %

^C Frequency validity above 300 MHz of ± 100 MHz only applies for DASY v4.4 and higher (see Page 2), else it is restricted to ± 50 MHz. The uncertainty is the RSS of the ConvF uncertainty at calibration frequency and the uncertainty for the indicated frequency band. Frequency validity below 300 MHz is ± 10, 25, 40, 50 and 70 MHz for ConvF assessments at 30, 64, 128, 150 and 220 MHz respectively. Validity of ConvF assessed at 6 MHz is 4-9 MHz, and ConvF assessed at 13 MHz is 9-19 MHz. Above 5 GHz frequency validity can be extended to ± 110 MHz.

^F At frequencies below 3 GHz, the validity of tissue parameters (ϵ and σ) can be relaxed to ± 10% if liquid compensation formula is applied to measured SAR values. At frequencies above 3 GHz, the validity of tissue parameters (ϵ and σ) is restricted to ± 5%. The uncertainty is the RSS of the ConvF uncertainty for indicated target tissue parameters.

^G Alpha/Depth are determined during calibration. SPEAG warrants that the remaining deviation due to the boundary effect after compensation is always less than ± 1% for frequencies below 3 GHz and below ± 2% for frequencies between 3-6 GHz at any distance larger than half the probe tip diameter from the boundary.

DASY/EASY - Parameters of Probe: EX3DV4 - SN:3914

Calibration Parameter Determined in Body Tissue Simulating Media

f (MHz) ^C	Relative Permittivity ^F	Conductivity (S/m) ^F	ConvF X	ConvF Y	ConvF Z	Alpha ^G	Depth ^G (mm)	Unc (k=2)
750	55.5	0.96	9.73	9.73	9.73	0.54	0.84	± 12.0 %
835	55.2	0.97	9.46	9.46	9.46	0.50	0.80	± 12.0 %
1750	53.4	1.49	7.89	7.89	7.89	0.38	0.84	± 12.0 %
1900	53.3	1.52	7.60	7.60	7.60	0.29	1.03	± 12.0 %
2300	52.9	1.81	7.43	7.43	7.43	0.38	0.84	± 12.0 %
2450	52.7	1.95	7.34	7.34	7.34	0.33	0.87	± 12.0 %
2600	52.5	2.16	7.15	7.15	7.15	0.26	0.97	± 12.0 %
3500	51.3	3.31	6.88	6.88	6.88	0.25	1.15	± 13.1 %
3700	51.0	3.55	6.58	6.58	6.58	0.30	1.15	± 13.1 %
5250	48.9	5.36	4.61	4.61	4.61	0.50	1.90	± 13.1 %
5600	48.5	5.77	3.92	3.92	3.92	0.50	1.90	± 13.1 %
5750	48.3	5.94	4.05	4.05	4.05	0.50	1.90	± 13.1 %

^C Frequency validity above 300 MHz of ± 100 MHz only applies for DASY v4.4 and higher (see Page 2), else it is restricted to ± 50 MHz. The uncertainty is the RSS of the ConvF uncertainty at calibration frequency and the uncertainty for the indicated frequency band. Frequency validity below 300 MHz is ± 10, 25, 40, 50 and 70 MHz for ConvF assessments at 30, 64, 128, 150 and 220 MHz respectively. Validity of ConvF assessed at 6 MHz is 4-9 MHz, and ConvF assessed at 13 MHz is 9-19 MHz. Above 5 GHz frequency validity can be extended to ± 110 MHz.

^F At frequencies below 3 GHz, the validity of tissue parameters (ϵ and σ) can be relaxed to ± 10% if liquid compensation formula is applied to measured SAR values. At frequencies above 3 GHz, the validity of tissue parameters (ϵ and σ) is restricted to ± 5%. The uncertainty is the RSS of the ConvF uncertainty for indicated target tissue parameters.

^G Alpha/Depth are determined during calibration. SPEAG warrants that the remaining deviation due to the boundary effect after compensation is always less than ± 1% for frequencies below 3 GHz and below ± 2% for frequencies between 3-6 GHz at any distance larger than half the probe tip diameter from the boundary.

Frequency Response of E-Field (TEM-Cell:ifi110 EXX, Waveguide: R22)

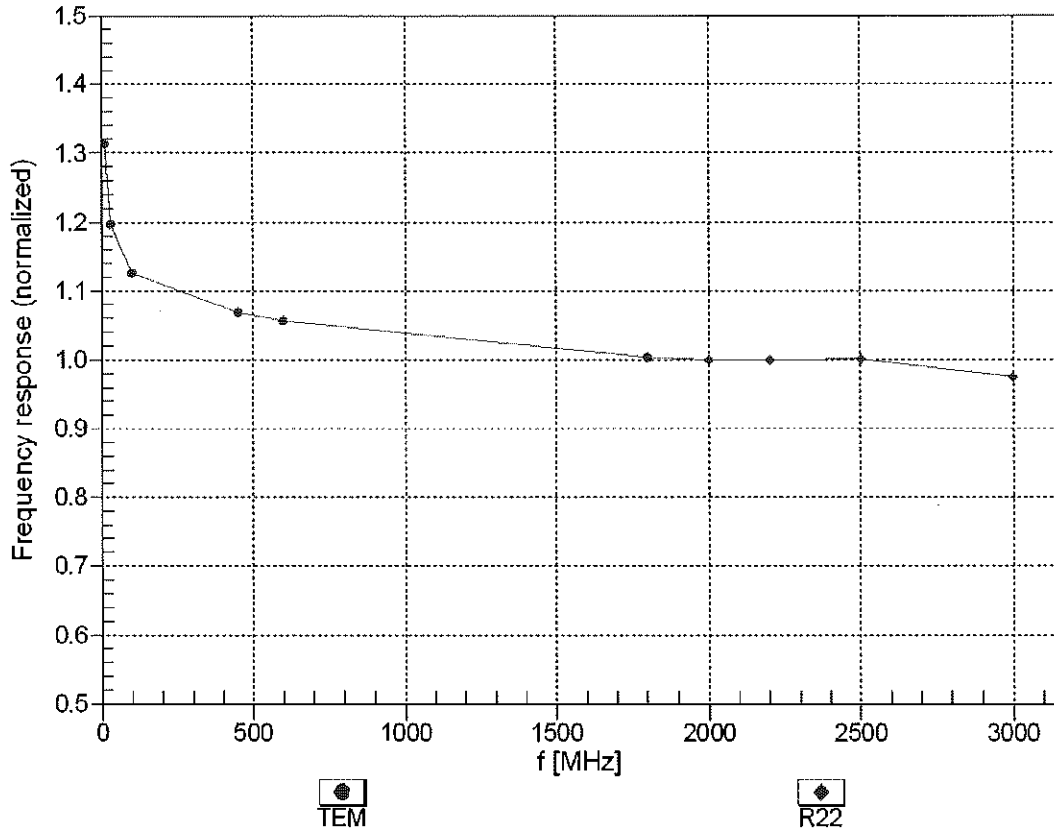

Uncertainty of Frequency Response of E-field: $\pm 6.3\%$ (k=2)

Receiving Pattern (ϕ), $\theta = 0^\circ$

f=600 MHz,TEM

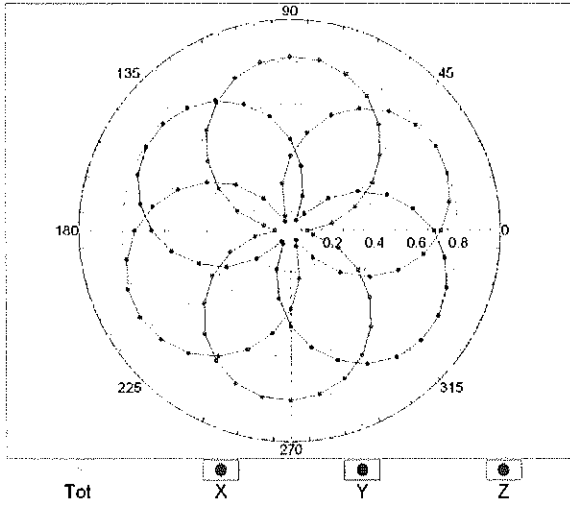

f=1800 MHz,R22

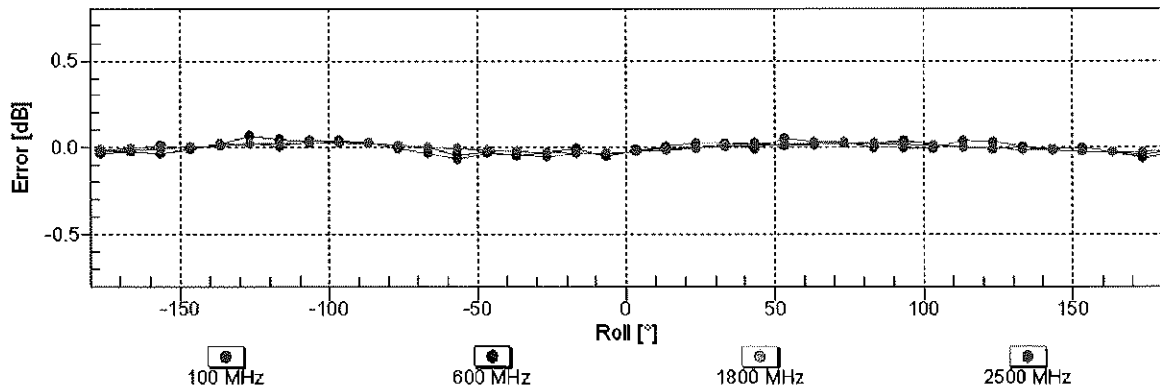
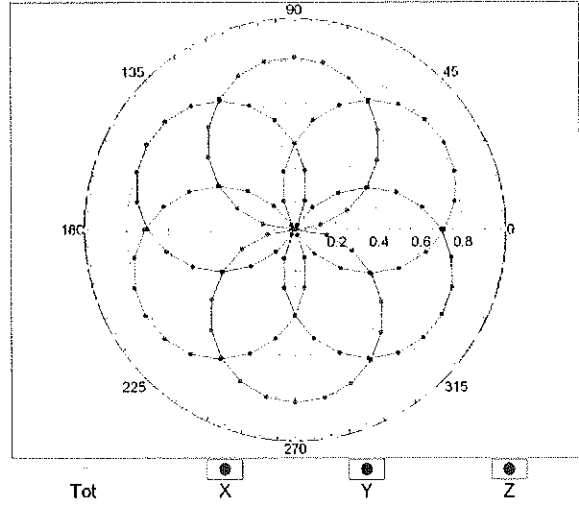

Uncertainty of Axial Isotropy Assessment: $\pm 0.5\%$ ($k=2$)

Dynamic Range $f(SAR_{head})$ (TEM cell , $f_{eval}= 1900$ MHz)

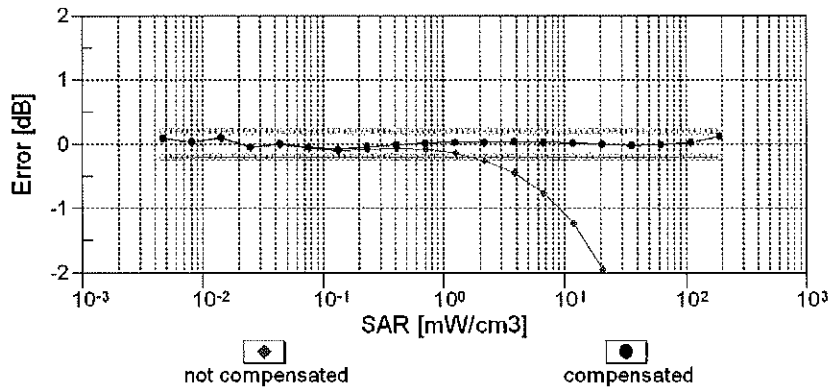
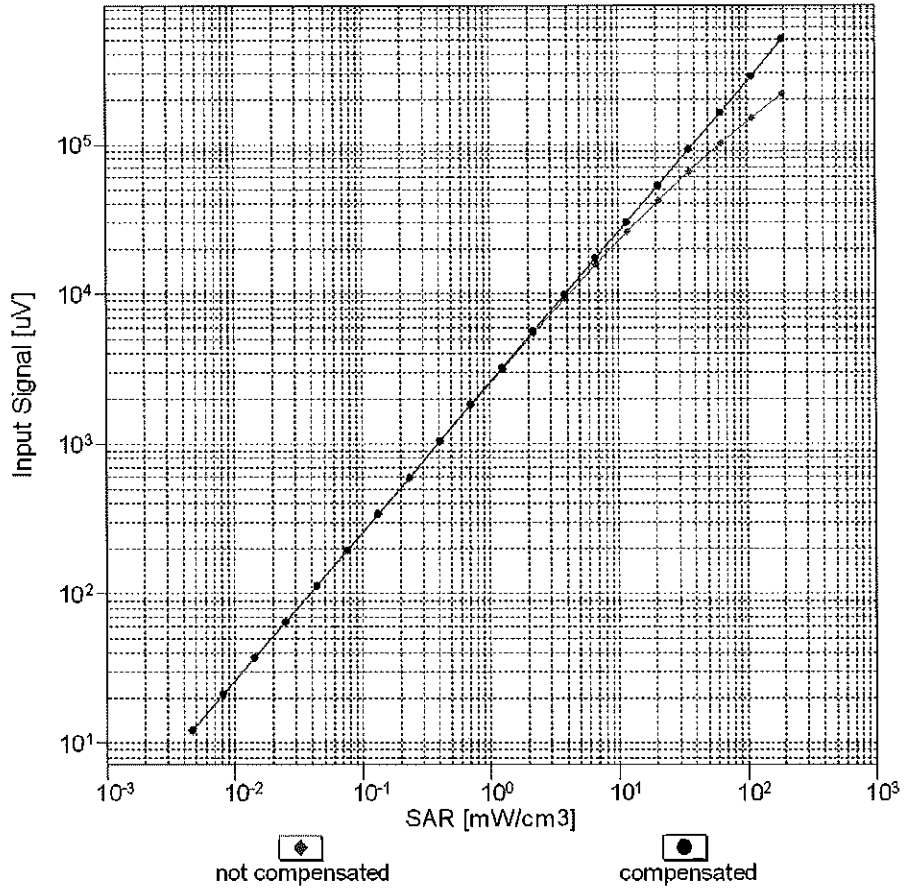

Uncertainty of Linearity Assessment: $\pm 0.6\%$ ($k=2$)

Conversion Factor Assessment

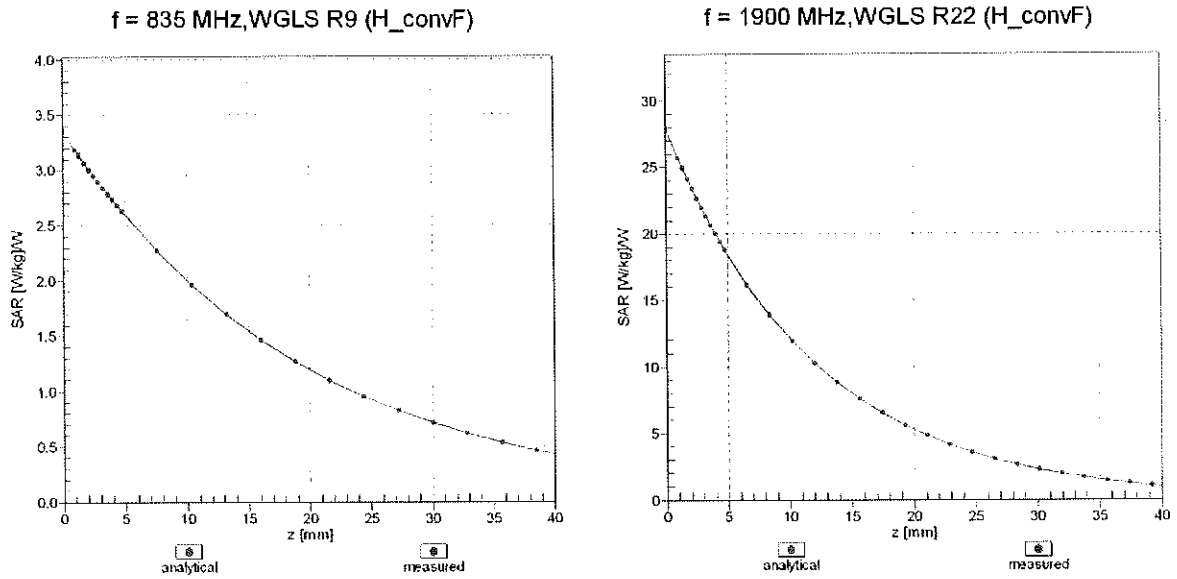

Deviation from Isotropy in Liquid

Error (ϕ, θ), f = 900 MHz

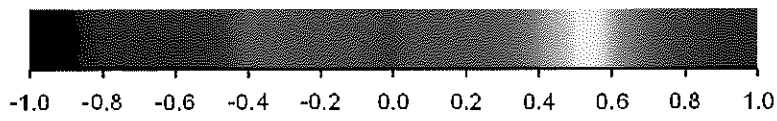
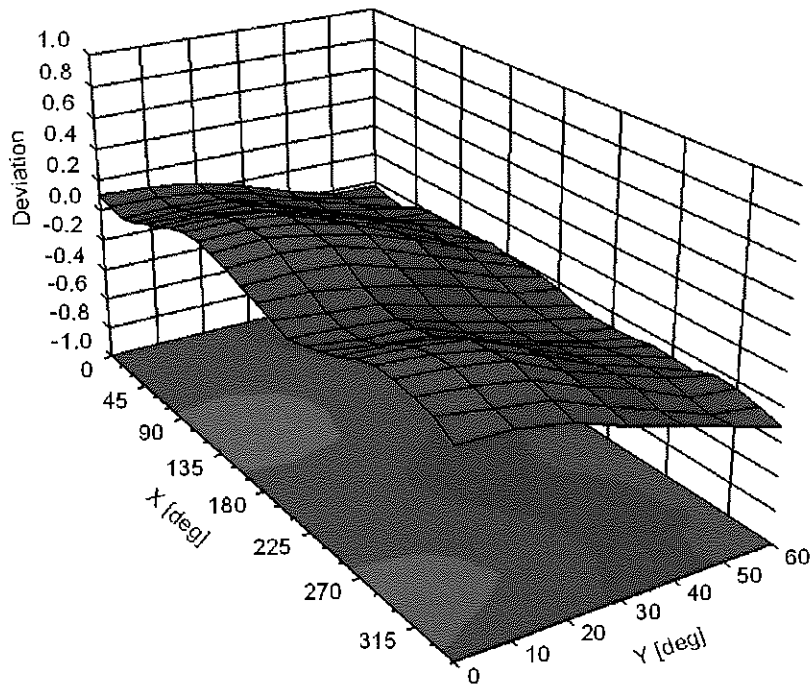

Uncertainty of Spherical Isotropy Assessment: $\pm 2.6\%$ (k=2)

Appendix: Modulation Calibration Parameters

UID	Rev	Communication System Name	Group	PAR (dB)	Unc ^E (k=2)
0		CW	CW	0.00	± 4.7 %
10010	CAA	SAR Validation (Square, 100ms, 10ms)	Test	10.00	± 9.6 %
10011	CAB	UMTS-FDD (WCDMA)	WCDMA	2.91	± 9.6 %
10012	CAB	IEEE 802.11b WiFi 2.4 GHz (DSSS, 1 Mbps)	WLAN	1.87	± 9.6 %
10013	CAB	IEEE 802.11g WiFi 2.4 GHz (DSSS-OFDM, 6 Mbps)	WLAN	9.46	± 9.6 %
10021	DAC	GSM-FDD (TDMA, GMSK)	GSM	9.39	± 9.6 %
10023	DAC	GPRS-FDD (TDMA, GMSK, TN 0)	GSM	9.57	± 9.6 %
10024	DAC	GPRS-FDD (TDMA, GMSK, TN 0-1)	GSM	6.56	± 9.6 %
10025	DAC	EDGE-FDD (TDMA, 8PSK, TN 0)	GSM	12.62	± 9.6 %
10026	DAC	EDGE-FDD (TDMA, 8PSK, TN 0-1)	GSM	9.55	± 9.6 %
10027	DAC	GPRS-FDD (TDMA, GMSK, TN 0-1-2)	GSM	4.80	± 9.6 %
10028	DAC	GPRS-FDD (TDMA, GMSK, TN 0-1-2-3)	GSM	3.55	± 9.6 %
10029	DAC	EDGE-FDD (TDMA, 8PSK, TN 0-1-2)	GSM	7.78	± 9.6 %
10030	CAA	IEEE 802.15.1 Bluetooth (GFSK, DH1)	Bluetooth	5.30	± 9.6 %
10031	CAA	IEEE 802.15.1 Bluetooth (GFSK, DH3)	Bluetooth	1.87	± 9.6 %
10032	CAA	IEEE 802.15.1 Bluetooth (GFSK, DH5)	Bluetooth	1.16	± 9.6 %
10033	CAA	IEEE 802.15.1 Bluetooth (PI/4-DQPSK, DH1)	Bluetooth	7.74	± 9.6 %
10034	CAA	IEEE 802.15.1 Bluetooth (PI/4-DQPSK, DH3)	Bluetooth	4.53	± 9.6 %
10035	CAA	IEEE 802.15.1 Bluetooth (PI/4-DQPSK, DH5)	Bluetooth	3.83	± 9.6 %
10036	CAA	IEEE 802.15.1 Bluetooth (8-DPSK, DH1)	Bluetooth	8.01	± 9.6 %
10037	CAA	IEEE 802.15.1 Bluetooth (8-DPSK, DH3)	Bluetooth	4.77	± 9.6 %
10038	CAA	IEEE 802.15.1 Bluetooth (8-DPSK, DH5)	Bluetooth	4.10	± 9.6 %
10039	CAB	CDMA2000 (1xRTT, RC1)	CDMA2000	4.57	± 9.6 %
10042	CAB	IS-54 / IS-136 FDD (TDMA/FDM, PI/4-DQPSK, Halfrate)	AMPS	7.78	± 9.6 %
10044	CAA	IS-91/EIA/TIA-553 FDD (FDMA, FM)	AMPS	0.00	± 9.6 %
10048	CAA	DECT (TDD, TDMA/FDM, GFSK, Full Slot, 24)	DECT	13.80	± 9.6 %
10049	CAA	DECT (TDD, TDMA/FDM, GFSK, Double Slot, 12)	DECT	10.79	± 9.6 %
10056	CAA	UMTS-TDD (TD-SCDMA, 1.28 Mcps)	TD-SCDMA	11.01	± 9.6 %
10058	DAC	EDGE-FDD (TDMA, 8PSK, TN 0-1-2-3)	GSM	6.52	± 9.6 %
10059	CAB	IEEE 802.11b WiFi 2.4 GHz (DSSS, 2 Mbps)	WLAN	2.12	± 9.6 %
10060	CAB	IEEE 802.11b WiFi 2.4 GHz (DSSS, 5.5 Mbps)	WLAN	2.83	± 9.6 %
10061	CAB	IEEE 802.11b WiFi 2.4 GHz (DSSS, 11 Mbps)	WLAN	3.60	± 9.6 %
10062	CAC	IEEE 802.11a/h WiFi 5 GHz (OFDM, 6 Mbps)	WLAN	8.68	± 9.6 %
10063	CAC	IEEE 802.11a/h WiFi 5 GHz (OFDM, 9 Mbps)	WLAN	8.63	± 9.6 %
10064	CAC	IEEE 802.11a/h WiFi 5 GHz (OFDM, 12 Mbps)	WLAN	9.09	± 9.6 %
10065	CAC	IEEE 802.11a/h WiFi 5 GHz (OFDM, 18 Mbps)	WLAN	9.00	± 9.6 %
10066	CAC	IEEE 802.11a/h WiFi 5 GHz (OFDM, 24 Mbps)	WLAN	9.38	± 9.6 %
10067	CAC	IEEE 802.11a/h WiFi 5 GHz (OFDM, 36 Mbps)	WLAN	10.12	± 9.6 %
10068	CAC	IEEE 802.11a/h WiFi 5 GHz (OFDM, 48 Mbps)	WLAN	10.24	± 9.6 %
10069	CAC	IEEE 802.11a/h WiFi 5 GHz (OFDM, 54 Mbps)	WLAN	10.56	± 9.6 %
10071	CAB	IEEE 802.11g WiFi 2.4 GHz (DSSS/OFDM, 9 Mbps)	WLAN	9.83	± 9.6 %
10072	CAB	IEEE 802.11g WiFi 2.4 GHz (DSSS/OFDM, 12 Mbps)	WLAN	9.62	± 9.6 %
10073	CAB	IEEE 802.11g WiFi 2.4 GHz (DSSS/OFDM, 18 Mbps)	WLAN	9.94	± 9.6 %
10074	CAB	IEEE 802.11g WiFi 2.4 GHz (DSSS/OFDM, 24 Mbps)	WLAN	10.30	± 9.6 %
10075	CAB	IEEE 802.11g WiFi 2.4 GHz (DSSS/OFDM, 36 Mbps)	WLAN	10.77	± 9.6 %
10076	CAB	IEEE 802.11g WiFi 2.4 GHz (DSSS/OFDM, 48 Mbps)	WLAN	10.94	± 9.6 %
10077	CAB	IEEE 802.11g WiFi 2.4 GHz (DSSS/OFDM, 54 Mbps)	WLAN	11.00	± 9.6 %
10081	CAB	CDMA2000 (1xRTT, RC3)	CDMA2000	3.97	± 9.6 %
10082	CAB	IS-54 / IS-136 FDD (TDMA/FDM, PI/4-DQPSK, Fullrate)	AMPS	4.77	± 9.6 %
10090	DAC	GPRS-FDD (TDMA, GMSK, TN 0-4)	GSM	6.56	± 9.6 %
10097	CAB	UMTS-FDD (HSDPA)	WCDMA	3.98	± 9.6 %
10098	CAB	UMTS-FDD (HSUPA, Subtest 2)	WCDMA	3.98	± 9.6 %
10099	DAC	EDGE-FDD (TDMA, 8PSK, TN 0-4)	GSM	9.55	± 9.6 %
10100	CAE	LTE-FDD (SC-FDMA, 100% RB, 20 MHz, QPSK)	LTE-FDD	5.67	± 9.6 %
10101	CAE	LTE-FDD (SC-FDMA, 100% RB, 20 MHz, 16-QAM)	LTE-FDD	6.42	± 9.6 %
10102	CAE	LTE-FDD (SC-FDMA, 100% RB, 20 MHz, 64-QAM)	LTE-FDD	6.60	± 9.6 %
10103	CAG	LTE-TDD (SC-FDMA, 100% RB, 20 MHz, QPSK)	LTE-TDD	9.29	± 9.6 %
10104	CAG	LTE-TDD (SC-FDMA, 100% RB, 20 MHz, 16-QAM)	LTE-TDD	9.97	± 9.6 %
10105	CAG	LTE-TDD (SC-FDMA, 100% RB, 20 MHz, 64-QAM)	LTE-TDD	10.01	± 9.6 %
10108	CAG	LTE-FDD (SC-FDMA, 100% RB, 10 MHz, QPSK)	LTE-FDD	5.80	± 9.6 %

10109	CAG	LTE-FDD (SC-FDMA, 100% RB, 10 MHz, 16-QAM)	LTE-FDD	6.43	±9.6 %
10110	CAG	LTE-FDD (SC-FDMA, 100% RB, 5 MHz, QPSK)	LTE-FDD	5.75	±9.6 %
10111	CAG	LTE-FDD (SC-FDMA, 100% RB, 5 MHz, 16-QAM)	LTE-FDD	6.44	±9.6 %
10112	CAG	LTE-FDD (SC-FDMA, 100% RB, 10 MHz, 64-QAM)	LTE-FDD	6.59	±9.6 %
10113	CAG	LTE-FDD (SC-FDMA, 100% RB, 5 MHz, 64-QAM)	LTE-FDD	6.62	±9.6 %
10114	CAC	IEEE 802.11n (HT Greenfield, 13.5 Mbps, BPSK)	WLAN	8.10	±9.6 %
10115	CAC	IEEE 802.11n (HT Greenfield, 81 Mbps, 16-QAM)	WLAN	8.46	±9.6 %
10116	CAC	IEEE 802.11n (HT Greenfield, 135 Mbps, 64-QAM)	WLAN	8.15	±9.6 %
10117	CAC	IEEE 802.11n (HT Mixed, 13.5 Mbps, BPSK)	WLAN	8.07	±9.6 %
10118	CAC	IEEE 802.11n (HT Mixed, 81 Mbps, 16-QAM)	WLAN	8.59	±9.6 %
10119	CAC	IEEE 802.11n (HT Mixed, 135 Mbps, 64-QAM)	WLAN	8.13	±9.6 %
10140	CAE	LTE-FDD (SC-FDMA, 100% RB, 15 MHz, 16-QAM)	LTE-FDD	6.49	±9.6 %
10141	CAE	LTE-FDD (SC-FDMA, 100% RB, 15 MHz, 64-QAM)	LTE-FDD	6.53	±9.6 %
10142	CAE	LTE-FDD (SC-FDMA, 100% RB, 3 MHz, QPSK)	LTE-FDD	5.73	±9.6 %
10143	CAE	LTE-FDD (SC-FDMA, 100% RB, 3 MHz, 16-QAM)	LTE-FDD	6.35	±9.6 %
10144	CAE	LTE-FDD (SC-FDMA, 100% RB, 3 MHz, 64-QAM)	LTE-FDD	6.65	±9.6 %
10145	CAF	LTE-FDD (SC-FDMA, 100% RB, 1.4 MHz, QPSK)	LTE-FDD	5.76	±9.6 %
10146	CAF	LTE-FDD (SC-FDMA, 100% RB, 1.4 MHz, 16-QAM)	LTE-FDD	6.41	±9.6 %
10147	CAF	LTE-FDD (SC-FDMA, 100% RB, 1.4 MHz, 64-QAM)	LTE-FDD	6.72	±9.6 %
10149	CAE	LTE-FDD (SC-FDMA, 50% RB, 20 MHz, 16-QAM)	LTE-FDD	6.42	±9.6 %
10150	CAE	LTE-FDD (SC-FDMA, 50% RB, 20 MHz, 64-QAM)	LTE-FDD	6.60	±9.6 %
10151	CAG	LTE-TDD (SC-FDMA, 50% RB, 20 MHz, QPSK)	LTE-TDD	9.28	±9.6 %
10152	CAG	LTE-TDD (SC-FDMA, 50% RB, 20 MHz, 16-QAM)	LTE-TDD	9.92	±9.6 %
10153	CAG	LTE-TDD (SC-FDMA, 50% RB, 20 MHz, 64-QAM)	LTE-TDD	10.05	±9.6 %
10154	CAG	LTE-FDD (SC-FDMA, 50% RB, 10 MHz, QPSK)	LTE-FDD	5.75	±9.6 %
10155	CAG	LTE-FDD (SC-FDMA, 50% RB, 10 MHz, 16-QAM)	LTE-FDD	6.43	±9.6 %
10156	CAG	LTE-FDD (SC-FDMA, 50% RB, 5 MHz, QPSK)	LTE-FDD	5.79	±9.6 %
10157	CAG	LTE-FDD (SC-FDMA, 50% RB, 5 MHz, 16-QAM)	LTE-FDD	6.49	±9.6 %
10158	CAG	LTE-FDD (SC-FDMA, 50% RB, 10 MHz, 64-QAM)	LTE-FDD	6.62	±9.6 %
10159	CAG	LTE-FDD (SC-FDMA, 50% RB, 5 MHz, 64-QAM)	LTE-FDD	6.56	±9.6 %
10160	CAE	LTE-FDD (SC-FDMA, 50% RB, 15 MHz, QPSK)	LTE-FDD	5.82	±9.6 %
10161	CAE	LTE-FDD (SC-FDMA, 50% RB, 15 MHz, 16-QAM)	LTE-FDD	6.43	±9.6 %
10162	CAE	LTE-FDD (SC-FDMA, 50% RB, 15 MHz, 64-QAM)	LTE-FDD	6.58	±9.6 %
10166	CAF	LTE-FDD (SC-FDMA, 50% RB, 1.4 MHz, QPSK)	LTE-FDD	5.46	±9.6 %
10167	CAF	LTE-FDD (SC-FDMA, 50% RB, 1.4 MHz, 16-QAM)	LTE-FDD	6.21	±9.6 %
10168	CAF	LTE-FDD (SC-FDMA, 50% RB, 1.4 MHz, 64-QAM)	LTE-FDD	6.79	±9.6 %
10169	CAE	LTE-FDD (SC-FDMA, 1 RB, 20 MHz, QPSK)	LTE-FDD	5.73	±9.6 %
10170	CAE	LTE-FDD (SC-FDMA, 1 RB, 20 MHz, 16-QAM)	LTE-FDD	6.52	±9.6 %
10171	AAE	LTE-FDD (SC-FDMA, 1 RB, 20 MHz, 64-QAM)	LTE-FDD	6.49	±9.6 %
10172	CAG	LTE-TDD (SC-FDMA, 1 RB, 20 MHz, QPSK)	LTE-TDD	9.21	±9.6 %
10173	CAG	LTE-TDD (SC-FDMA, 1 RB, 20 MHz, 16-QAM)	LTE-TDD	9.48	±9.6 %
10174	CAG	LTE-TDD (SC-FDMA, 1 RB, 20 MHz, 64-QAM)	LTE-TDD	10.25	±9.6 %
10175	CAG	LTE-FDD (SC-FDMA, 1 RB, 10 MHz, QPSK)	LTE-FDD	5.72	±9.6 %
10176	CAG	LTE-FDD (SC-FDMA, 1 RB, 10 MHz, 16-QAM)	LTE-FDD	6.52	±9.6 %
10177	CAI	LTE-FDD (SC-FDMA, 1 RB, 5 MHz, QPSK)	LTE-FDD	5.73	±9.6 %
10178	CAG	LTE-FDD (SC-FDMA, 1 RB, 5 MHz, 16-QAM)	LTE-FDD	6.52	±9.6 %
10179	CAG	LTE-FDD (SC-FDMA, 1 RB, 10 MHz, 64-QAM)	LTE-FDD	6.50	±9.6 %
10180	CAG	LTE-FDD (SC-FDMA, 1 RB, 5 MHz, 64-QAM)	LTE-FDD	6.50	±9.6 %
10181	CAE	LTE-FDD (SC-FDMA, 1 RB, 15 MHz, QPSK)	LTE-FDD	5.72	±9.6 %
10182	CAE	LTE-FDD (SC-FDMA, 1 RB, 15 MHz, 16-QAM)	LTE-FDD	6.52	±9.6 %
10183	AAD	LTE-FDD (SC-FDMA, 1 RB, 15 MHz, 64-QAM)	LTE-FDD	6.50	±9.6 %
10184	CAE	LTE-FDD (SC-FDMA, 1 RB, 3 MHz, QPSK)	LTE-FDD	5.73	±9.6 %
10185	CAE	LTE-FDD (SC-FDMA, 1 RB, 3 MHz, 16-QAM)	LTE-FDD	6.51	±9.6 %
10186	AAE	LTE-FDD (SC-FDMA, 1 RB, 3 MHz, 64-QAM)	LTE-FDD	6.50	±9.6 %
10187	CAF	LTE-FDD (SC-FDMA, 1 RB, 1.4 MHz, QPSK)	LTE-FDD	5.73	±9.6 %
10188	CAF	LTE-FDD (SC-FDMA, 1 RB, 1.4 MHz, 16-QAM)	LTE-FDD	6.52	±9.6 %
10189	AAF	LTE-FDD (SC-FDMA, 1 RB, 1.4 MHz, 64-QAM)	LTE-FDD	6.50	±9.6 %
10193	CAC	IEEE 802.11n (HT Greenfield, 6.5 Mbps, BPSK)	WLAN	8.09	±9.6 %
10194	CAC	IEEE 802.11n (HT Greenfield, 39 Mbps, 16-QAM)	WLAN	8.12	±9.6 %
10195	CAC	IEEE 802.11n (HT Greenfield, 65 Mbps, 64-QAM)	WLAN	8.21	±9.6 %
10196	CAC	IEEE 802.11n (HT Mixed, 6.5 Mbps, BPSK)	WLAN	8.10	±9.6 %
10197	CAC	IEEE 802.11n (HT Mixed, 39 Mbps, 16-QAM)	WLAN	8.13	±9.6 %
10198	CAC	IEEE 802.11n (HT Mixed, 65 Mbps, 64-QAM)	WLAN	8.27	±9.6 %
10219	CAC	IEEE 802.11n (HT Mixed, 7.2 Mbps, BPSK)	WLAN	8.03	±9.6 %

10220	CAC	IEEE 802.11n (HT Mixed, 43.3 Mbps, 16-QAM)	WLAN	8.13	± 9.6 %
10221	CAC	IEEE 802.11n (HT Mixed, 72.2 Mbps, 64-QAM)	WLAN	8.27	± 9.6 %
10222	CAC	IEEE 802.11n (HT Mixed, 15 Mbps, BPSK)	WLAN	8.06	± 9.6 %
10223	CAC	IEEE 802.11n (HT Mixed, 90 Mbps, 16-QAM)	WLAN	8.48	± 9.6 %
10224	CAC	IEEE 802.11n (HT Mixed, 150 Mbps, 64-QAM)	WLAN	8.08	± 9.6 %
10225	CAB	UMTS-FDD (HSPA+)	WCDMA	5.97	± 9.6 %
10226	CAA	LTE-TDD (SC-FDMA, 1 RB, 1.4 MHz, 16-QAM)	LTE-TDD	9.49	± 9.6 %
10227	CAA	LTE-TDD (SC-FDMA, 1 RB, 1.4 MHz, 64-QAM)	LTE-TDD	10.26	± 9.6 %
10228	CAA	LTE-TDD (SC-FDMA, 1 RB, 1.4 MHz, QPSK)	LTE-TDD	9.22	± 9.6 %
10229	CAC	LTE-TDD (SC-FDMA, 1 RB, 3 MHz, 16-QAM)	LTE-TDD	9.48	± 9.6 %
10230	CAC	LTE-TDD (SC-FDMA, 1 RB, 3 MHz, 64-QAM)	LTE-TDD	10.25	± 9.6 %
10231	CAC	LTE-TDD (SC-FDMA, 1 RB, 3 MHz, QPSK)	LTE-TDD	9.19	± 9.6 %
10232	CAF	LTE-TDD (SC-FDMA, 1 RB, 5 MHz, 16-QAM)	LTE-TDD	9.48	± 9.6 %
10233	CAF	LTE-TDD (SC-FDMA, 1 RB, 5 MHz, 64-QAM)	LTE-TDD	10.25	± 9.6 %
10234	CAF	LTE-TDD (SC-FDMA, 1 RB, 5 MHz, QPSK)	LTE-TDD	9.21	± 9.6 %
10235	CAF	LTE-TDD (SC-FDMA, 1 RB, 10 MHz, 16-QAM)	LTE-TDD	9.48	± 9.6 %
10236	CAF	LTE-TDD (SC-FDMA, 1 RB, 10 MHz, 64-QAM)	LTE-TDD	10.25	± 9.6 %
10237	CAF	LTE-TDD (SC-FDMA, 1 RB, 10 MHz, QPSK)	LTE-TDD	9.21	± 9.6 %
10238	CAF	LTE-TDD (SC-FDMA, 1 RB, 15 MHz, 16-QAM)	LTE-TDD	9.48	± 9.6 %
10239	CAF	LTE-TDD (SC-FDMA, 1 RB, 15 MHz, 64-QAM)	LTE-TDD	10.25	± 9.6 %
10240	CAF	LTE-TDD (SC-FDMA, 1 RB, 15 MHz, QPSK)	LTE-TDD	9.21	± 9.6 %
10241	CAA	LTE-TDD (SC-FDMA, 50% RB, 1.4 MHz, 16-QAM)	LTE-TDD	9.82	± 9.6 %
10242	CAA	LTE-TDD (SC-FDMA, 50% RB, 1.4 MHz, 64-QAM)	LTE-TDD	9.86	± 9.6 %
10243	CAA	LTE-TDD (SC-FDMA, 50% RB, 1.4 MHz, QPSK)	LTE-TDD	9.46	± 9.6 %
10244	CAC	LTE-TDD (SC-FDMA, 50% RB, 3 MHz, 16-QAM)	LTE-TDD	10.06	± 9.6 %
10245	CAC	LTE-TDD (SC-FDMA, 50% RB, 3 MHz, 64-QAM)	LTE-TDD	10.06	± 9.6 %
10246	CAC	LTE-TDD (SC-FDMA, 50% RB, 3 MHz, QPSK)	LTE-TDD	9.30	± 9.6 %
10247	CAF	LTE-TDD (SC-FDMA, 50% RB, 5 MHz, 16-QAM)	LTE-TDD	9.91	± 9.6 %
10248	CAF	LTE-TDD (SC-FDMA, 50% RB, 5 MHz, 64-QAM)	LTE-TDD	10.09	± 9.6 %
10249	CAF	LTE-TDD (SC-FDMA, 50% RB, 5 MHz, QPSK)	LTE-TDD	9.29	± 9.6 %
10250	CAF	LTE-TDD (SC-FDMA, 50% RB, 10 MHz, 16-QAM)	LTE-TDD	9.81	± 9.6 %
10251	CAF	LTE-TDD (SC-FDMA, 50% RB, 10 MHz, 64-QAM)	LTE-TDD	10.17	± 9.6 %
10252	CAF	LTE-TDD (SC-FDMA, 50% RB, 10 MHz, QPSK)	LTE-TDD	9.24	± 9.6 %
10253	CAF	LTE-TDD (SC-FDMA, 50% RB, 15 MHz, 16-QAM)	LTE-TDD	9.90	± 9.6 %
10254	CAF	LTE-TDD (SC-FDMA, 50% RB, 15 MHz, 64-QAM)	LTE-TDD	10.14	± 9.6 %
10255	CAF	LTE-TDD (SC-FDMA, 50% RB, 15 MHz, QPSK)	LTE-TDD	9.20	± 9.6 %
10256	CAA	LTE-TDD (SC-FDMA, 100% RB, 1.4 MHz, 16-QAM)	LTE-TDD	9.96	± 9.6 %
10257	CAA	LTE-TDD (SC-FDMA, 100% RB, 1.4 MHz, 64-QAM)	LTE-TDD	10.08	± 9.6 %
10258	CAA	LTE-TDD (SC-FDMA, 100% RB, 1.4 MHz, QPSK)	LTE-TDD	9.34	± 9.6 %
10259	CAC	LTE-TDD (SC-FDMA, 100% RB, 3 MHz, 16-QAM)	LTE-TDD	9.98	± 9.6 %
10260	CAC	LTE-TDD (SC-FDMA, 100% RB, 3 MHz, 64-QAM)	LTE-TDD	9.97	± 9.6 %
10261	CAC	LTE-TDD (SC-FDMA, 100% RB, 3 MHz, QPSK)	LTE-TDD	9.24	± 9.6 %
10262	CAF	LTE-TDD (SC-FDMA, 100% RB, 5 MHz, 16-QAM)	LTE-TDD	9.83	± 9.6 %
10263	CAF	LTE-TDD (SC-FDMA, 100% RB, 5 MHz, 64-QAM)	LTE-TDD	10.16	± 9.6 %
10264	CAF	LTE-TDD (SC-FDMA, 100% RB, 5 MHz, QPSK)	LTE-TDD	9.23	± 9.6 %
10265	CAF	LTE-TDD (SC-FDMA, 100% RB, 10 MHz, 16-QAM)	LTE-TDD	9.92	± 9.6 %
10266	CAF	LTE-TDD (SC-FDMA, 100% RB, 10 MHz, 64-QAM)	LTE-TDD	10.07	± 9.6 %
10267	CAF	LTE-TDD (SC-FDMA, 100% RB, 10 MHz, QPSK)	LTE-TDD	9.30	± 9.6 %
10268	CAF	LTE-TDD (SC-FDMA, 100% RB, 15 MHz, 16-QAM)	LTE-TDD	10.06	± 9.6 %
10269	CAF	LTE-TDD (SC-FDMA, 100% RB, 15 MHz, 64-QAM)	LTE-TDD	10.13	± 9.6 %
10270	CAF	LTE-TDD (SC-FDMA, 100% RB, 15 MHz, QPSK)	LTE-TDD	9.58	± 9.6 %
10274	CAB	UMTS-FDD (HSUPA, Subtest 5, 3GPP Rel8.10)	WCDMA	4.87	± 9.6 %
10275	CAB	UMTS-FDD (HSUPA, Subtest 5, 3GPP Rel8.4)	WCDMA	3.96	± 9.6 %
10277	CAA	PHS (QPSK)	PHS	11.81	± 9.6 %
10278	CAA	PHS (QPSK, BW 884MHz, Rolloff 0.5)	PHS	11.81	± 9.6 %
10279	CAA	PHS (QPSK, BW 884MHz, Rolloff 0.38)	PHS	12.18	± 9.6 %
10290	AAB	CDMA2000, RC1, SO55, Full Rate	CDMA2000	3.91	± 9.6 %
10291	AAB	CDMA2000, RC3, SO55, Full Rate	CDMA2000	3.46	± 9.6 %
10292	AAB	CDMA2000, RC3, SO32, Full Rate	CDMA2000	3.39	± 9.6 %
10293	AAB	CDMA2000, RC3, SO3, Full Rate	CDMA2000	3.50	± 9.6 %
10295	AAB	CDMA2000, RC1, SO3, 1/8th Rate 25 fr.	CDMA2000	12.49	± 9.6 %
10297	AAD	LTE-FDD (SC-FDMA, 50% RB, 20 MHz, QPSK)	LTE-FDD	5.81	± 9.6 %
10298	AAD	LTE-FDD (SC-FDMA, 50% RB, 3 MHz, QPSK)	LTE-FDD	5.72	± 9.6 %
10299	AAD	LTE-FDD (SC-FDMA, 50% RB, 3 MHz, 16-QAM)	LTE-FDD	6.39	± 9.6 %

10300	AAD	LTE-FDD (SC-FDMA, 50% RB, 3 MHz, 64-QAM)	LTE-FDD	6.60	± 9.6 %
10301	AAA	IEEE 802.16e WiMAX (29:18, 5ms, 10MHz, QPSK, PUSC)	WiMAX	12.03	± 9.6 %
10302	AAA	IEEE 802.16e WiMAX (29:18, 5ms, 10MHz, QPSK, PUSC, 3 CTRL symbols)	WiMAX	12.57	± 9.6 %
10303	AAA	IEEE 802.16e WiMAX (31:15, 5ms, 10MHz, 64QAM, PUSC)	WiMAX	12.52	± 9.6 %
10304	AAA	IEEE 802.16e WiMAX (29:18, 5ms, 10MHz, 64QAM, PUSC)	WiMAX	11.86	± 9.6 %
10305	AAA	IEEE 802.16e WiMAX (31:15, 10ms, 10MHz, 64QAM, PUSC, 15 symbols)	WiMAX	15.24	± 9.6 %
10306	AAA	IEEE 802.16e WiMAX (29:18, 10ms, 10MHz, 64QAM, PUSC, 18 symbols)	WiMAX	14.67	± 9.6 %
10307	AAA	IEEE 802.16e WiMAX (29:18, 10ms, 10MHz, QPSK, PUSC, 18 symbols)	WiMAX	14.49	± 9.6 %
10308	AAA	IEEE 802.16e WiMAX (29:18, 10ms, 10MHz, 16QAM, PUSC)	WiMAX	14.46	± 9.6 %
10309	AAA	IEEE 802.16e WiMAX (29:18, 10ms, 10MHz, 16QAM, AMC 2x3, 18 symbols)	WiMAX	14.58	± 9.6 %
10310	AAA	IEEE 802.16e WiMAX (29:18, 10ms, 10MHz, QPSK, AMC 2x3, 18 symbols)	WiMAX	14.57	± 9.6 %
10311	AAD	LTE-FDD (SC-FDMA, 100% RB, 15 MHz, QPSK)	LTE-FDD	6.06	± 9.6 %
10313	AAA	iDEN 1:3	iDEN	10.51	± 9.6 %
10314	AAA	iDEN 1:6	iDEN	13.48	± 9.6 %
10315	AAB	IEEE 802.11b WiFi 2.4 GHz (DSSS, 1 Mbps, 96pc duty cycle)	WLAN	1.71	± 9.6 %
10316	AAB	IEEE 802.11g WiFi 2.4 GHz (ERP-OFDM, 6 Mbps, 96pc duty cycle)	WLAN	8.36	± 9.6 %
10317	AAC	IEEE 802.11a WiFi 5 GHz (OFDM, 6 Mbps, 96pc duty cycle)	WLAN	8.36	± 9.6 %
10352	AAA	Pulse Waveform (200Hz, 10%)	Generic	10.00	± 9.6 %
10353	AAA	Pulse Waveform (200Hz, 20%)	Generic	6.99	± 9.6 %
10354	AAA	Pulse Waveform (200Hz, 40%)	Generic	3.98	± 9.6 %
10355	AAA	Pulse Waveform (200Hz, 60%)	Generic	2.22	± 9.6 %
10356	AAA	Pulse Waveform (200Hz, 80%)	Generic	0.97	± 9.6 %
10387	AAA	QPSK Waveform, 1 MHz	Generic	5.10	± 9.6 %
10388	AAA	QPSK Waveform, 10 MHz	Generic	5.22	± 9.6 %
10396	AAA	64-QAM Waveform, 100 kHz	Generic	6.27	± 9.6 %
10399	AAA	64-QAM Waveform, 40 MHz	Generic	6.27	± 9.6 %
10400	AAD	IEEE 802.11ac WiFi (20MHz, 64-QAM, 99pc duty cycle)	WLAN	8.37	± 9.6 %
10401	AAD	IEEE 802.11ac WiFi (40MHz, 64-QAM, 99pc duty cycle)	WLAN	8.60	± 9.6 %
10402	AAD	IEEE 802.11ac WiFi (80MHz, 64-QAM, 99pc duty cycle)	WLAN	8.53	± 9.6 %
10403	AAB	CDMA2000 (1xEV-DO, Rev. 0)	CDMA2000	3.76	± 9.6 %
10404	AAB	CDMA2000 (1xEV-DO, Rev. A)	CDMA2000	3.77	± 9.6 %
10406	AAB	CDMA2000, RC3, SO32, SCH0, Full Rate	CDMA2000	5.22	± 9.6 %
10410	AAF	LTE-TDD (SC-FDMA, 1 RB, 10 MHz, QPSK, UL Subframe=2,3,4,7,8,9, Subframe Conf=4)	LTE-TDD	7.82	± 9.6 %
10414	AAA	WLAN CCDF, 64-QAM, 40MHz	Generic	8.54	± 9.6 %
10415	AAA	IEEE 802.11b WiFi 2.4 GHz (DSSS, 1 Mbps, 99pc duty cycle)	WLAN	1.54	± 9.6 %
10416	AAA	IEEE 802.11g WiFi 2.4 GHz (ERP-OFDM, 6 Mbps, 99pc duty cycle)	WLAN	8.23	± 9.6 %
10417	AAB	IEEE 802.11a/h WiFi 5 GHz (OFDM, 6 Mbps, 99pc duty cycle)	WLAN	8.23	± 9.6 %
10418	AAA	IEEE 802.11g WiFi 2.4 GHz (DSSS-OFDM, 6 Mbps, 99pc duty cycle, Long preamble)	WLAN	8.14	± 9.6 %
10419	AAA	IEEE 802.11g WiFi 2.4 GHz (DSSS-OFDM, 6 Mbps, 99pc duty cycle, Short preamble)	WLAN	8.19	± 9.6 %
10422	AAB	IEEE 802.11n (HT Greenfield, 7.2 Mbps, BPSK)	WLAN	8.32	± 9.6 %
10423	AAB	IEEE 802.11n (HT Greenfield, 43.3 Mbps, 16-QAM)	WLAN	8.47	± 9.6 %
10424	AAB	IEEE 802.11n (HT Greenfield, 72.2 Mbps, 64-QAM)	WLAN	8.40	± 9.6 %
10425	AAB	IEEE 802.11n (HT Greenfield, 15 Mbps, BPSK)	WLAN	8.41	± 9.6 %
10426	AAB	IEEE 802.11n (HT Greenfield, 90 Mbps, 16-QAM)	WLAN	8.45	± 9.6 %
10427	AAB	IEEE 802.11n (HT Greenfield, 150 Mbps, 64-QAM)	WLAN	8.41	± 9.6 %
10430	AAD	LTE-FDD (OFDMA, 5 MHz, E-TM 3.1)	LTE-FDD	8.28	± 9.6 %
10431	AAD	LTE-FDD (OFDMA, 10 MHz, E-TM 3.1)	LTE-FDD	8.38	± 9.6 %
10432	AAC	LTE-FDD (OFDMA, 15 MHz, E-TM 3.1)	LTE-FDD	8.34	± 9.6 %
10433	AAC	LTE-FDD (OFDMA, 20 MHz, E-TM 3.1)	LTE-FDD	8.34	± 9.6 %
10434	AAA	W-CDMA (BS Test Model 1, 64 DPCH)	WCDMA	8.60	± 9.6 %
10435	AAF	LTE-TDD (SC-FDMA, 1 RB, 20 MHz, QPSK, UL Subframe=2,3,4,7,8,9)	LTE-TDD	7.82	± 9.6 %
10447	AAD	LTE-FDD (OFDMA, 5 MHz, E-TM 3.1, Clipping 44%)	LTE-FDD	7.56	± 9.6 %
10448	AAD	LTE-FDD (OFDMA, 10 MHz, E-TM 3.1, Clipping 44%)	LTE-FDD	7.53	± 9.6 %
10449	AAC	LTE-FDD (OFDMA, 15 MHz, E-TM 3.1, Clipping 44%)	LTE-FDD	7.51	± 9.6 %
10450	AAC	LTE-FDD (OFDMA, 20 MHz, E-TM 3.1, Clipping 44%)	LTE-FDD	7.48	± 9.6 %

10451	AAA	W-CDMA (BS Test Model 1, 64 DPCH, Clipping 44%)	WCDMA	7.59	± 9.6 %
10456	AAB	IEEE 802.11ac WIFI (160MHz, 64-QAM, 99pc duty cycle)	WLAN	8.63	± 9.6 %
10457	AAA	UMTS-FDD (DC-HSDPA)	WCDMA	6.62	± 9.6 %
10458	AAA	CDMA2000 (1xEV-DO, Rev. B, 2 carriers)	CDMA2000	6.55	± 9.6 %
10459	AAA	CDMA2000 (1xEV-DO, Rev. B, 3 carriers)	CDMA2000	8.25	± 9.6 %
10460	AAA	UMTS-FDD (WCDMA, AMR)	WCDMA	2.39	± 9.6 %
10461	AAA	LTE-TDD (SC-FDMA, 1 RB, 1.4 MHz, QPSK, UL Subframe=2,3,4,7,8,9)	LTE-TDD	7.82	± 9.6 %
10462	AAA	LTE-TDD (SC-FDMA, 1 RB, 1.4 MHz, 16-QAM, UL Subframe=2,3,4,7,8,9)	LTE-TDD	8.30	± 9.6 %
10463	AAA	LTE-TDD (SC-FDMA, 1 RB, 1.4 MHz, 64-QAM, UL Subframe=2,3,4,7,8,9)	LTE-TDD	8.56	± 9.6 %
10464	AAB	LTE-TDD (SC-FDMA, 1 RB, 3 MHz, QPSK, UL Subframe=2,3,4,7,8,9)	LTE-TDD	7.82	± 9.6 %
10465	AAB	LTE-TDD (SC-FDMA, 1 RB, 3 MHz, 16-QAM, UL Subframe=2,3,4,7,8,9)	LTE-TDD	8.32	± 9.6 %
10466	AAB	LTE-TDD (SC-FDMA, 1 RB, 3 MHz, 64-QAM, UL Subframe=2,3,4,7,8,9)	LTE-TDD	8.57	± 9.6 %
10467	AAE	LTE-TDD (SC-FDMA, 1 RB, 5 MHz, QPSK, UL Subframe=2,3,4,7,8,9)	LTE-TDD	7.82	± 9.6 %
10468	AAE	LTE-TDD (SC-FDMA, 1 RB, 5 MHz, 16-QAM, UL Subframe=2,3,4,7,8,9)	LTE-TDD	8.32	± 9.6 %
10469	AAE	LTE-TDD (SC-FDMA, 1 RB, 5 MHz, 64-QAM, UL Subframe=2,3,4,7,8,9)	LTE-TDD	8.56	± 9.6 %
10470	AAE	LTE-TDD (SC-FDMA, 1 RB, 10 MHz, QPSK, UL Subframe=2,3,4,7,8,9)	LTE-TDD	7.82	± 9.6 %
10471	AAE	LTE-TDD (SC-FDMA, 1 RB, 10 MHz, 16-QAM, UL Subframe=2,3,4,7,8,9)	LTE-TDD	8.32	± 9.6 %
10472	AAE	LTE-TDD (SC-FDMA, 1 RB, 10 MHz, 64-QAM, UL Subframe=2,3,4,7,8,9)	LTE-TDD	8.57	± 9.6 %
10473	AAE	LTE-TDD (SC-FDMA, 1 RB, 15 MHz, QPSK, UL Subframe=2,3,4,7,8,9)	LTE-TDD	7.82	± 9.6 %
10474	AAE	LTE-TDD (SC-FDMA, 1 RB, 15 MHz, 16-QAM, UL Subframe=2,3,4,7,8,9)	LTE-TDD	8.32	± 9.6 %
10475	AAE	LTE-TDD (SC-FDMA, 1 RB, 15 MHz, 64-QAM, UL Subframe=2,3,4,7,8,9)	LTE-TDD	8.57	± 9.6 %
10477	AAF	LTE-TDD (SC-FDMA, 1 RB, 20 MHz, 16-QAM, UL Subframe=2,3,4,7,8,9)	LTE-TDD	8.32	± 9.6 %
10478	AAF	LTE-TDD (SC-FDMA, 1 RB, 20 MHz, 64-QAM, UL Subframe=2,3,4,7,8,9)	LTE-TDD	8.57	± 9.6 %
10479	AAA	LTE-TDD (SC-FDMA, 50% RB, 1.4 MHz, QPSK, UL Subframe=2,3,4,7,8,9)	LTE-TDD	7.74	± 9.6 %
10480	AAA	LTE-TDD (SC-FDMA, 50% RB, 1.4 MHz, 16-QAM, UL Subframe=2,3,4,7,8,9)	LTE-TDD	8.18	± 9.6 %
10481	AAA	LTE-TDD (SC-FDMA, 50% RB, 1.4 MHz, 64-QAM, UL Subframe=2,3,4,7,8,9)	LTE-TDD	8.45	± 9.6 %
10482	AAB	LTE-TDD (SC-FDMA, 50% RB, 3 MHz, QPSK, UL Subframe=2,3,4,7,8,9)	LTE-TDD	7.71	± 9.6 %
10483	AAB	LTE-TDD (SC-FDMA, 50% RB, 3 MHz, 16-QAM, UL Subframe=2,3,4,7,8,9)	LTE-TDD	8.39	± 9.6 %
10484	AAB	LTE-TDD (SC-FDMA, 50% RB, 3 MHz, 64-QAM, UL Subframe=2,3,4,7,8,9)	LTE-TDD	8.47	± 9.6 %
10485	AAE	LTE-TDD (SC-FDMA, 50% RB, 5 MHz, QPSK, UL Subframe=2,3,4,7,8,9)	LTE-TDD	7.59	± 9.6 %
10486	AAE	LTE-TDD (SC-FDMA, 50% RB, 5 MHz, 16-QAM, UL Subframe=2,3,4,7,8,9)	LTE-TDD	8.38	± 9.6 %
10487	AAE	LTE-TDD (SC-FDMA, 50% RB, 5 MHz, 64-QAM, UL Subframe=2,3,4,7,8,9)	LTE-TDD	8.60	± 9.6 %
10488	AAE	LTE-TDD (SC-FDMA, 50% RB, 10 MHz, QPSK, UL Subframe=2,3,4,7,8,9)	LTE-TDD	7.70	± 9.6 %
10489	AAE	LTE-TDD (SC-FDMA, 50% RB, 10 MHz, 16-QAM, UL Subframe=2,3,4,7,8,9)	LTE-TDD	8.31	± 9.6 %
10490	AAE	LTE-TDD (SC-FDMA, 50% RB, 10 MHz, 64-QAM, UL Subframe=2,3,4,7,8,9)	LTE-TDD	8.54	± 9.6 %
10491	AAE	LTE-TDD (SC-FDMA, 50% RB, 15 MHz, QPSK, UL Subframe=2,3,4,7,8,9)	LTE-TDD	7.74	± 9.6 %

10492	AAE	LTE-TDD (SC-FDMA, 50% RB, 15 MHz, 16-QAM, UL Subframe=2,3,4,7,8,9)	LTE-TDD	8.41	± 9.6 %
10493	AAE	LTE-TDD (SC-FDMA, 50% RB, 15 MHz, 64-QAM, UL Subframe=2,3,4,7,8,9)	LTE-TDD	8.55	± 9.6 %
10494	AAF	LTE-TDD (SC-FDMA, 50% RB, 20 MHz, QPSK, UL Subframe=2,3,4,7,8,9)	LTE-TDD	7.74	± 9.6 %
10495	AAF	LTE-TDD (SC-FDMA, 50% RB, 20 MHz, 16-QAM, UL Subframe=2,3,4,7,8,9)	LTE-TDD	8.37	± 9.6 %
10496	AAF	LTE-TDD (SC-FDMA, 50% RB, 20 MHz, 64-QAM, UL Subframe=2,3,4,7,8,9)	LTE-TDD	8.54	± 9.6 %
10497	AAA	LTE-TDD (SC-FDMA, 100% RB, 1.4 MHz, QPSK, UL Subframe=2,3,4,7,8,9)	LTE-TDD	7.67	± 9.6 %
10498	AAA	LTE-TDD (SC-FDMA, 100% RB, 1.4 MHz, 16-QAM, UL Subframe=2,3,4,7,8,9)	LTE-TDD	8.40	± 9.6 %
10499	AAA	LTE-TDD (SC-FDMA, 100% RB, 1.4 MHz, 64-QAM, UL Subframe=2,3,4,7,8,9)	LTE-TDD	8.68	± 9.6 %
10500	AAB	LTE-TDD (SC-FDMA, 100% RB, 3 MHz, QPSK, UL Subframe=2,3,4,7,8,9)	LTE-TDD	7.67	± 9.6 %
10501	AAB	LTE-TDD (SC-FDMA, 100% RB, 3 MHz, 16-QAM, UL Subframe=2,3,4,7,8,9)	LTE-TDD	8.44	± 9.6 %
10502	AAB	LTE-TDD (SC-FDMA, 100% RB, 3 MHz, 64-QAM, UL Subframe=2,3,4,7,8,9)	LTE-TDD	8.52	± 9.6 %
10503	AAE	LTE-TDD (SC-FDMA, 100% RB, 5 MHz, QPSK, UL Subframe=2,3,4,7,8,9)	LTE-TDD	7.72	± 9.6 %
10504	AAE	LTE-TDD (SC-FDMA, 100% RB, 5 MHz, 16-QAM, UL Subframe=2,3,4,7,8,9)	LTE-TDD	8.31	± 9.6 %
10505	AAE	LTE-TDD (SC-FDMA, 100% RB, 5 MHz, 64-QAM, UL Subframe=2,3,4,7,8,9)	LTE-TDD	8.54	± 9.6 %
10506	AAE	LTE-TDD (SC-FDMA, 100% RB, 10 MHz, QPSK, UL Subframe=2,3,4,7,8,9)	LTE-TDD	7.74	± 9.6 %
10507	AAE	LTE-TDD (SC-FDMA, 100% RB, 10 MHz, 16-QAM, UL Subframe=2,3,4,7,8,9)	LTE-TDD	8.36	± 9.6 %
10508	AAE	LTE-TDD (SC-FDMA, 100% RB, 10 MHz, 64-QAM, UL Subframe=2,3,4,7,8,9)	LTE-TDD	8.55	± 9.6 %
10509	AAE	LTE-TDD (SC-FDMA, 100% RB, 15 MHz, QPSK, UL Subframe=2,3,4,7,8,9)	LTE-TDD	7.99	± 9.6 %
10510	AAE	LTE-TDD (SC-FDMA, 100% RB, 15 MHz, 16-QAM, UL Subframe=2,3,4,7,8,9)	LTE-TDD	8.49	± 9.6 %
10511	AAE	LTE-TDD (SC-FDMA, 100% RB, 15 MHz, 64-QAM, UL Subframe=2,3,4,7,8,9)	LTE-TDD	8.51	± 9.6 %
10512	AAF	LTE-TDD (SC-FDMA, 100% RB, 20 MHz, QPSK, UL Subframe=2,3,4,7,8,9)	LTE-TDD	7.74	± 9.6 %
10513	AAF	LTE-TDD (SC-FDMA, 100% RB, 20 MHz, 16-QAM, UL Subframe=2,3,4,7,8,9)	LTE-TDD	8.42	± 9.6 %
10514	AAF	LTE-TDD (SC-FDMA, 100% RB, 20 MHz, 64-QAM, UL Subframe=2,3,4,7,8,9)	LTE-TDD	8.45	± 9.6 %
10515	AAA	IEEE 802.11b WiFi 2.4 GHz (DSSS, 2 Mbps, 99pc duty cycle)	WLAN	1.58	± 9.6 %
10516	AAA	IEEE 802.11b WiFi 2.4 GHz (DSSS, 5.5 Mbps, 99pc duty cycle)	WLAN	1.57	± 9.6 %
10517	AAA	IEEE 802.11b WiFi 2.4 GHz (DSSS, 11 Mbps, 99pc duty cycle)	WLAN	1.58	± 9.6 %
10518	AAB	IEEE 802.11a/h WiFi 5 GHz (OFDM, 9 Mbps, 99pc duty cycle)	WLAN	8.23	± 9.6 %
10519	AAB	IEEE 802.11a/h WiFi 5 GHz (OFDM, 12 Mbps, 99pc duty cycle)	WLAN	8.39	± 9.6 %
10520	AAB	IEEE 802.11a/h WiFi 5 GHz (OFDM, 18 Mbps, 99pc duty cycle)	WLAN	8.12	± 9.6 %
10521	AAB	IEEE 802.11a/h WiFi 5 GHz (OFDM, 24 Mbps, 99pc duty cycle)	WLAN	7.97	± 9.6 %
10522	AAB	IEEE 802.11a/h WiFi 5 GHz (OFDM, 36 Mbps, 99pc duty cycle)	WLAN	8.45	± 9.6 %
10523	AAB	IEEE 802.11a/h WiFi 5 GHz (OFDM, 48 Mbps, 99pc duty cycle)	WLAN	8.08	± 9.6 %
10524	AAB	IEEE 802.11a/h WiFi 5 GHz (OFDM, 54 Mbps, 99pc duty cycle)	WLAN	8.27	± 9.6 %
10525	AAB	IEEE 802.11ac WiFi (20MHz, MCS0, 99pc duty cycle)	WLAN	8.36	± 9.6 %
10526	AAB	IEEE 802.11ac WiFi (20MHz, MCS1, 99pc duty cycle)	WLAN	8.42	± 9.6 %
10527	AAB	IEEE 802.11ac WiFi (20MHz, MCS2, 99pc duty cycle)	WLAN	8.21	± 9.6 %
10528	AAB	IEEE 802.11ac WiFi (20MHz, MCS3, 99pc duty cycle)	WLAN	8.36	± 9.6 %
10529	AAB	IEEE 802.11ac WiFi (20MHz, MCS4, 99pc duty cycle)	WLAN	8.36	± 9.6 %
10531	AAB	IEEE 802.11ac WiFi (20MHz, MCS6, 99pc duty cycle)	WLAN	8.43	± 9.6 %
10532	AAB	IEEE 802.11ac WiFi (20MHz, MCS7, 99pc duty cycle)	WLAN	8.29	± 9.6 %
10533	AAB	IEEE 802.11ac WiFi (20MHz, MCS8, 99pc duty cycle)	WLAN	8.38	± 9.6 %
10534	AAB	IEEE 802.11ac WiFi (40MHz, MCS0, 99pc duty cycle)	WLAN	8.45	± 9.6 %

10535	AAB	IEEE 802.11ac WiFi (40MHz, MCS1, 99pc duty cycle)	WLAN	8.45	± 9.6 %
10536	AAB	IEEE 802.11ac WiFi (40MHz, MCS2, 99pc duty cycle)	WLAN	8.32	± 9.6 %
10537	AAB	IEEE 802.11ac WiFi (40MHz, MCS3, 99pc duty cycle)	WLAN	8.44	± 9.6 %
10538	AAB	IEEE 802.11ac WiFi (40MHz, MCS4, 99pc duty cycle)	WLAN	8.54	± 9.6 %
10540	AAB	IEEE 802.11ac WiFi (40MHz, MCS6, 99pc duty cycle)	WLAN	8.39	± 9.6 %
10541	AAB	IEEE 802.11ac WiFi (40MHz, MCS7, 99pc duty cycle)	WLAN	8.46	± 9.6 %
10542	AAB	IEEE 802.11ac WiFi (40MHz, MCS8, 99pc duty cycle)	WLAN	8.65	± 9.6 %
10543	AAB	IEEE 802.11ac WiFi (40MHz, MCS9, 99pc duty cycle)	WLAN	8.65	± 9.6 %
10544	AAB	IEEE 802.11ac WiFi (80MHz, MCS0, 99pc duty cycle)	WLAN	8.47	± 9.6 %
10545	AAB	IEEE 802.11ac WiFi (80MHz, MCS1, 99pc duty cycle)	WLAN	8.55	± 9.6 %
10546	AAB	IEEE 802.11ac WiFi (80MHz, MCS2, 99pc duty cycle)	WLAN	8.35	± 9.6 %
10547	AAB	IEEE 802.11ac WiFi (80MHz, MCS3, 99pc duty cycle)	WLAN	8.49	± 9.6 %
10548	AAB	IEEE 802.11ac WiFi (80MHz, MCS4, 99pc duty cycle)	WLAN	8.37	± 9.6 %
10550	AAB	IEEE 802.11ac WiFi (80MHz, MCS6, 99pc duty cycle)	WLAN	8.38	± 9.6 %
10551	AAB	IEEE 802.11ac WiFi (80MHz, MCS7, 99pc duty cycle)	WLAN	8.50	± 9.6 %
10552	AAB	IEEE 802.11ac WiFi (80MHz, MCS8, 99pc duty cycle)	WLAN	8.42	± 9.6 %
10553	AAB	IEEE 802.11ac WiFi (80MHz, MCS9, 99pc duty cycle)	WLAN	8.45	± 9.6 %
10554	AAC	IEEE 802.11ac WiFi (160MHz, MCS0, 99pc duty cycle)	WLAN	8.48	± 9.6 %
10555	AAC	IEEE 802.11ac WiFi (160MHz, MCS1, 99pc duty cycle)	WLAN	8.47	± 9.6 %
10556	AAC	IEEE 802.11ac WiFi (160MHz, MCS2, 99pc duty cycle)	WLAN	8.50	± 9.6 %
10557	AAC	IEEE 802.11ac WiFi (160MHz, MCS3, 99pc duty cycle)	WLAN	8.52	± 9.6 %
10558	AAC	IEEE 802.11ac WiFi (160MHz, MCS4, 99pc duty cycle)	WLAN	8.61	± 9.6 %
10560	AAC	IEEE 802.11ac WiFi (160MHz, MCS6, 99pc duty cycle)	WLAN	8.73	± 9.6 %
10561	AAC	IEEE 802.11ac WiFi (160MHz, MCS7, 99pc duty cycle)	WLAN	8.56	± 9.6 %
10562	AAC	IEEE 802.11ac WiFi (160MHz, MCS8, 99pc duty cycle)	WLAN	8.69	± 9.6 %
10563	AAC	IEEE 802.11ac WiFi (160MHz, MCS9, 99pc duty cycle)	WLAN	8.77	± 9.6 %
10564	AAA	IEEE 802.11g WiFi 2.4 GHz (DSSS-OFDM, 9 Mbps, 99pc duty cycle)	WLAN	8.25	± 9.6 %
10565	AAA	IEEE 802.11g WiFi 2.4 GHz (DSSS-OFDM, 12 Mbps, 99pc duty cycle)	WLAN	8.45	± 9.6 %
10566	AAA	IEEE 802.11g WiFi 2.4 GHz (DSSS-OFDM, 18 Mbps, 99pc duty cycle)	WLAN	8.13	± 9.6 %
10567	AAA	IEEE 802.11g WiFi 2.4 GHz (DSSS-OFDM, 24 Mbps, 99pc duty cycle)	WLAN	8.00	± 9.6 %
10568	AAA	IEEE 802.11g WiFi 2.4 GHz (DSSS-OFDM, 36 Mbps, 99pc duty cycle)	WLAN	8.37	± 9.6 %
10569	AAA	IEEE 802.11g WiFi 2.4 GHz (DSSS-OFDM, 48 Mbps, 99pc duty cycle)	WLAN	8.10	± 9.6 %
10570	AAA	IEEE 802.11g WiFi 2.4 GHz (DSSS-OFDM, 54 Mbps, 99pc duty cycle)	WLAN	8.30	± 9.6 %
10571	AAA	IEEE 802.11b WiFi 2.4 GHz (DSSS, 1 Mbps, 90pc duty cycle)	WLAN	1.99	± 9.6 %
10572	AAA	IEEE 802.11b WiFi 2.4 GHz (DSSS, 2 Mbps, 90pc duty cycle)	WLAN	1.99	± 9.6 %
10573	AAA	IEEE 802.11b WiFi 2.4 GHz (DSSS, 5.5 Mbps, 90pc duty cycle)	WLAN	1.98	± 9.6 %
10574	AAA	IEEE 802.11b WiFi 2.4 GHz (DSSS, 11 Mbps, 90pc duty cycle)	WLAN	1.98	± 9.6 %
10575	AAA	IEEE 802.11g WiFi 2.4 GHz (DSSS-OFDM, 6 Mbps, 90pc duty cycle)	WLAN	8.59	± 9.6 %
10576	AAA	IEEE 802.11g WiFi 2.4 GHz (DSSS-OFDM, 9 Mbps, 90pc duty cycle)	WLAN	8.60	± 9.6 %
10577	AAA	IEEE 802.11g WiFi 2.4 GHz (DSSS-OFDM, 12 Mbps, 90pc duty cycle)	WLAN	8.70	± 9.6 %
10578	AAA	IEEE 802.11g WiFi 2.4 GHz (DSSS-OFDM, 18 Mbps, 90pc duty cycle)	WLAN	8.49	± 9.6 %
10579	AAA	IEEE 802.11g WiFi 2.4 GHz (DSSS-OFDM, 24 Mbps, 90pc duty cycle)	WLAN	8.36	± 9.6 %
10580	AAA	IEEE 802.11g WiFi 2.4 GHz (DSSS-OFDM, 36 Mbps, 90pc duty cycle)	WLAN	8.76	± 9.6 %
10581	AAA	IEEE 802.11g WiFi 2.4 GHz (DSSS-OFDM, 48 Mbps, 90pc duty cycle)	WLAN	8.35	± 9.6 %
10582	AAA	IEEE 802.11g WiFi 2.4 GHz (DSSS-OFDM, 54 Mbps, 90pc duty cycle)	WLAN	8.67	± 9.6 %
10583	AAB	IEEE 802.11a/h WiFi 5 GHz (OFDM, 6 Mbps, 90pc duty cycle)	WLAN	8.59	± 9.6 %
10584	AAB	IEEE 802.11a/h WiFi 5 GHz (OFDM, 9 Mbps, 90pc duty cycle)	WLAN	8.60	± 9.6 %
10585	AAB	IEEE 802.11a/h WiFi 5 GHz (OFDM, 12 Mbps, 90pc duty cycle)	WLAN	8.70	± 9.6 %
10586	AAB	IEEE 802.11a/h WiFi 5 GHz (OFDM, 18 Mbps, 90pc duty cycle)	WLAN	8.49	± 9.6 %
10587	AAB	IEEE 802.11a/h WiFi 5 GHz (OFDM, 24 Mbps, 90pc duty cycle)	WLAN	8.36	± 9.6 %

10588	AAB	IEEE 802.11a/h WiFi 5 GHz (OFDM, 36 Mbps, 90pc duty cycle)	WLAN	8.76	± 9.6 %
10589	AAB	IEEE 802.11a/h WiFi 5 GHz (OFDM, 48 Mbps, 90pc duty cycle)	WLAN	8.35	± 9.6 %
10590	AAB	IEEE 802.11a/h WiFi 5 GHz (OFDM, 54 Mbps, 90pc duty cycle)	WLAN	8.67	± 9.6 %
10591	AAB	IEEE 802.11n (HT Mixed, 20MHz, MCS0, 90pc duty cycle)	WLAN	8.63	± 9.6 %
10592	AAB	IEEE 802.11n (HT Mixed, 20MHz, MCS1, 90pc duty cycle)	WLAN	8.79	± 9.6 %
10593	AAB	IEEE 802.11n (HT Mixed, 20MHz, MCS2, 90pc duty cycle)	WLAN	8.64	± 9.6 %
10594	AAB	IEEE 802.11n (HT Mixed, 20MHz, MCS3, 90pc duty cycle)	WLAN	8.74	± 9.6 %
10595	AAB	IEEE 802.11n (HT Mixed, 20MHz, MCS4, 90pc duty cycle)	WLAN	8.74	± 9.6 %
10596	AAB	IEEE 802.11n (HT Mixed, 20MHz, MCS5, 90pc duty cycle)	WLAN	8.71	± 9.6 %
10597	AAB	IEEE 802.11n (HT Mixed, 20MHz, MCS6, 90pc duty cycle)	WLAN	8.72	± 9.6 %
10598	AAB	IEEE 802.11n (HT Mixed, 20MHz, MCS7, 90pc duty cycle)	WLAN	8.50	± 9.6 %
10599	AAB	IEEE 802.11n (HT Mixed, 40MHz, MCS0, 90pc duty cycle)	WLAN	8.79	± 9.6 %
10600	AAB	IEEE 802.11n (HT Mixed, 40MHz, MCS1, 90pc duty cycle)	WLAN	8.88	± 9.6 %
10601	AAB	IEEE 802.11n (HT Mixed, 40MHz, MCS2, 90pc duty cycle)	WLAN	8.82	± 9.6 %
10602	AAB	IEEE 802.11n (HT Mixed, 40MHz, MCS3, 90pc duty cycle)	WLAN	8.94	± 9.6 %
10603	AAB	IEEE 802.11n (HT Mixed, 40MHz, MCS4, 90pc duty cycle)	WLAN	9.03	± 9.6 %
10604	AAB	IEEE 802.11n (HT Mixed, 40MHz, MCS5, 90pc duty cycle)	WLAN	8.76	± 9.6 %
10605	AAB	IEEE 802.11n (HT Mixed, 40MHz, MCS6, 90pc duty cycle)	WLAN	8.97	± 9.6 %
10606	AAB	IEEE 802.11n (HT Mixed, 40MHz, MCS7, 90pc duty cycle)	WLAN	8.82	± 9.6 %
10607	AAB	IEEE 802.11ac WiFi (20MHz, MCS0, 90pc duty cycle)	WLAN	8.64	± 9.6 %
10608	AAB	IEEE 802.11ac WiFi (20MHz, MCS1, 90pc duty cycle)	WLAN	8.77	± 9.6 %
10609	AAB	IEEE 802.11ac WiFi (20MHz, MCS2, 90pc duty cycle)	WLAN	8.57	± 9.6 %
10610	AAB	IEEE 802.11ac WiFi (20MHz, MCS3, 90pc duty cycle)	WLAN	8.78	± 9.6 %
10611	AAB	IEEE 802.11ac WiFi (20MHz, MCS4, 90pc duty cycle)	WLAN	8.70	± 9.6 %
10612	AAB	IEEE 802.11ac WiFi (20MHz, MCS5, 90pc duty cycle)	WLAN	8.77	± 9.6 %
10613	AAB	IEEE 802.11ac WiFi (20MHz, MCS6, 90pc duty cycle)	WLAN	8.94	± 9.6 %
10614	AAB	IEEE 802.11ac WiFi (20MHz, MCS7, 90pc duty cycle)	WLAN	8.59	± 9.6 %
10615	AAB	IEEE 802.11ac WiFi (20MHz, MCS8, 90pc duty cycle)	WLAN	8.82	± 9.6 %
10616	AAB	IEEE 802.11ac WiFi (40MHz, MCS0, 90pc duty cycle)	WLAN	8.82	± 9.6 %
10617	AAB	IEEE 802.11ac WiFi (40MHz, MCS1, 90pc duty cycle)	WLAN	8.81	± 9.6 %
10618	AAB	IEEE 802.11ac WiFi (40MHz, MCS2, 90pc duty cycle)	WLAN	8.58	± 9.6 %
10619	AAB	IEEE 802.11ac WiFi (40MHz, MCS3, 90pc duty cycle)	WLAN	8.86	± 9.6 %
10620	AAB	IEEE 802.11ac WiFi (40MHz, MCS4, 90pc duty cycle)	WLAN	8.87	± 9.6 %
10621	AAB	IEEE 802.11ac WiFi (40MHz, MCS5, 90pc duty cycle)	WLAN	8.77	± 9.6 %
10622	AAB	IEEE 802.11ac WiFi (40MHz, MCS6, 90pc duty cycle)	WLAN	8.68	± 9.6 %
10623	AAB	IEEE 802.11ac WiFi (40MHz, MCS7, 90pc duty cycle)	WLAN	8.82	± 9.6 %
10624	AAB	IEEE 802.11ac WiFi (40MHz, MCS8, 90pc duty cycle)	WLAN	8.96	± 9.6 %
10625	AAB	IEEE 802.11ac WiFi (40MHz, MCS9, 90pc duty cycle)	WLAN	8.96	± 9.6 %
10626	AAB	IEEE 802.11ac WiFi (80MHz, MCS0, 90pc duty cycle)	WLAN	8.83	± 9.6 %
10627	AAB	IEEE 802.11ac WiFi (80MHz, MCS1, 90pc duty cycle)	WLAN	8.88	± 9.6 %
10628	AAB	IEEE 802.11ac WiFi (80MHz, MCS2, 90pc duty cycle)	WLAN	8.71	± 9.6 %
10629	AAB	IEEE 802.11ac WiFi (80MHz, MCS3, 90pc duty cycle)	WLAN	8.85	± 9.6 %
10630	AAB	IEEE 802.11ac WiFi (80MHz, MCS4, 90pc duty cycle)	WLAN	8.72	± 9.6 %
10631	AAB	IEEE 802.11ac WiFi (80MHz, MCS5, 90pc duty cycle)	WLAN	8.81	± 9.6 %
10632	AAB	IEEE 802.11ac WiFi (80MHz, MCS6, 90pc duty cycle)	WLAN	8.74	± 9.6 %
10633	AAB	IEEE 802.11ac WiFi (80MHz, MCS7, 90pc duty cycle)	WLAN	8.83	± 9.6 %
10634	AAB	IEEE 802.11ac WiFi (80MHz, MCS8, 90pc duty cycle)	WLAN	8.80	± 9.6 %
10635	AAB	IEEE 802.11ac WiFi (80MHz, MCS9, 90pc duty cycle)	WLAN	8.81	± 9.6 %
10636	AAC	IEEE 802.11ac WiFi (160MHz, MCS0, 90pc duty cycle)	WLAN	8.83	± 9.6 %
10637	AAC	IEEE 802.11ac WiFi (160MHz, MCS1, 90pc duty cycle)	WLAN	8.79	± 9.6 %
10638	AAC	IEEE 802.11ac WiFi (160MHz, MCS2, 90pc duty cycle)	WLAN	8.86	± 9.6 %
10639	AAC	IEEE 802.11ac WiFi (160MHz, MCS3, 90pc duty cycle)	WLAN	8.85	± 9.6 %
10640	AAC	IEEE 802.11ac WiFi (160MHz, MCS4, 90pc duty cycle)	WLAN	8.98	± 9.6 %
10641	AAC	IEEE 802.11ac WiFi (160MHz, MCS5, 90pc duty cycle)	WLAN	9.06	± 9.6 %
10642	AAC	IEEE 802.11ac WiFi (160MHz, MCS6, 90pc duty cycle)	WLAN	9.06	± 9.6 %
10643	AAC	IEEE 802.11ac WiFi (160MHz, MCS7, 90pc duty cycle)	WLAN	8.89	± 9.6 %
10644	AAC	IEEE 802.11ac WiFi (160MHz, MCS8, 90pc duty cycle)	WLAN	9.05	± 9.6 %
10645	AAC	IEEE 802.11ac WiFi (160MHz, MCS9, 90pc duty cycle)	WLAN	9.11	± 9.6 %
10646	AAF	LTE-TDD (SC-FDMA, 1 RB, 5 MHz, QPSK, UL Subframe=2,7)	LTE-TDD	11.96	± 9.6 %
10647	AAF	LTE-TDD (SC-FDMA, 1 RB, 20 MHz, QPSK, UL Subframe=2,7)	LTE-TDD	11.96	± 9.6 %
10648	AAA	CDMA2000 (1x Advanced)	CDMA2000	3.45	± 9.6 %
10652	AAD	LTE-TDD (OFDMA, 5 MHz, E-TM 3.1, Clipping 44%)	LTE-TDD	6.91	± 9.6 %
10653	AAD	LTE-TDD (OFDMA, 10 MHz, E-TM 3.1, Clipping 44%)	LTE-TDD	7.42	± 9.6 %
10654	AAD	LTE-TDD (OFDMA, 15 MHz, E-TM 3.1, Clipping 44%)	LTE-TDD	6.96	± 9.6 %

10655	AAE	LTE-TDD (OFDMA, 20 MHz, E-TM 3.1, Clipping 44%)	LTE-TDD	7.21	± 9.6 %
10658	AAA	Pulse Waveform (200Hz, 10%)	Test	10.00	± 9.6 %
10659	AAA	Pulse Waveform (200Hz, 20%)	Test	6.99	± 9.6 %
10660	AAA	Pulse Waveform (200Hz, 40%)	Test	3.98	± 9.6 %
10661	AAA	Pulse Waveform (200Hz, 60%)	Test	2.22	± 9.6 %
10662	AAA	Pulse Waveform (200Hz, 80%)	Test	0.97	± 9.6 %
10670	AAA	Bluetooth Low Energy	Bluetooth	2.19	± 9.6 %

^E Uncertainty is determined using the max. deviation from linear response applying rectangular distribution and is expressed for the square of the field value.



Accredited by the Swiss Accreditation Service (SAS)
The Swiss Accreditation Service is one of the signatories to the EA
Multilateral Agreement for the recognition of calibration certificates

Accreditation No.: **SCS 0108**

Client **PC Test**

Certificate No: **EX3-3589_Jan19**

CALIBRATION CERTIFICATE

Object **EX3DV4 - SN:3589**

Calibration procedure(s) **QA CAL-01.v9, QA CAL-14.v5, QA CAL-23.v5, QA CAL-25.v7
Calibration procedure for dosimetric E-field probes**

*BN ✓
02-06-2019*

Calibration date: **January 25, 2019**

This calibration certificate documents the traceability to national standards, which realize the physical units of measurements (SI).
The measurements and the uncertainties with confidence probability are given on the following pages and are part of the certificate.

All calibrations have been conducted in the closed laboratory facility: environment temperature (22 ± 3)°C and humidity < 70%.

Calibration Equipment used (M&TE critical for calibration)

Primary Standards	ID	Cal Date (Certificate No.)	Scheduled Calibration
Power meter NRP	SN: 104778	04-Apr-18 (No. 217-02672/02673)	Apr-19
Power sensor NRP-Z91	SN: 103244	04-Apr-18 (No. 217-02672)	Apr-19
Power sensor NRP-Z91	SN: 103245	04-Apr-18 (No. 217-02673)	Apr-19
Reference 20 dB Attenuator	SN: S5277 (20x)	04-Apr-18 (No. 217-02682)	Apr-19
DAE4	SN: 660	19-Dec-18 (No. DAE4-660_Dec18)	Dec-19
Reference Probe ES3DV2	SN: 3013	31-Dec-18 (No. ES3-3013_Dec18)	Dec-19
Secondary Standards	ID	Check Date (in house)	Scheduled Check
Power meter E4419B	SN: GB41293874	06-Apr-16 (in house check Jun-18)	In house check: Jun-20
Power sensor E4412A	SN: MY41498087	06-Apr-16 (in house check Jun-18)	In house check: Jun-20
Power sensor E4412A	SN: 000110210	06-Apr-16 (in house check Jun-18)	In house check: Jun-20
RF generator HP 8648C	SN: US3642U01700	04-Aug-99 (in house check Jun-18)	In house check: Jun-20
Network Analyzer E8358A	SN: US41080477	31-Mar-14 (in house check Oct-18)	In house check: Oct-19

Calibrated by:	Name Jeton Kastrati	Function Laboratory Technician	Signature
Approved by:	Name Katja Pokovic	Function Technical Manager	Signature

Issued: January 29, 2019

This calibration certificate shall not be reproduced except in full without written approval of the laboratory.



Accredited by the Swiss Accreditation Service (SAS)

Accreditation No.: **SCS 0108**

The Swiss Accreditation Service is one of the signatories to the EA
Multilateral Agreement for the recognition of calibration certificates

Glossary:

TSL	tissue simulating liquid
NORM _{x,y,z}	sensitivity in free space
ConvF	sensitivity in TSL / NORM _{x,y,z}
DCP	diode compression point
CF	crest factor (1/duty_cycle) of the RF signal
A, B, C, D	modulation dependent linearization parameters
Polarization φ	φ rotation around probe axis
Polarization ϑ	ϑ rotation around an axis that is in the plane normal to probe axis (at measurement center), i.e., $\vartheta = 0$ is normal to probe axis
Connector Angle	information used in DASY system to align probe sensor X to the robot coordinate system

Calibration is Performed According to the Following Standards:

- IEEE Std 1528-2013, "IEEE Recommended Practice for Determining the Peak Spatial-Averaged Specific Absorption Rate (SAR) in the Human Head from Wireless Communications Devices: Measurement Techniques", June 2013
- IEC 62209-1, "Measurement procedure for the assessment of Specific Absorption Rate (SAR) from hand-held and body-mounted devices used next to the ear (frequency range of 300 MHz to 6 GHz)", July 2016
- IEC 62209-2, "Procedure to determine the Specific Absorption Rate (SAR) for wireless communication devices used in close proximity to the human body (frequency range of 30 MHz to 6 GHz)", March 2010
- KDB 865664, "SAR Measurement Requirements for 100 MHz to 6 GHz"

Methods Applied and Interpretation of Parameters:

- NORM_{x,y,z}**: Assessed for E-field polarization $\vartheta = 0$ ($f \leq 900$ MHz in TEM-cell; $f > 1800$ MHz: R22 waveguide). NORM_{x,y,z} are only intermediate values, i.e., the uncertainties of NORM_{x,y,z} does not affect the E^2 -field uncertainty inside TSL (see below ConvF).
- NORM(f)_{x,y,z}** = NORM_{x,y,z} * frequency_response (see Frequency Response Chart). This linearization is implemented in DASY4 software versions later than 4.2. The uncertainty of the frequency response is included in the stated uncertainty of ConvF.
- DCP_{x,y,z}**: DCP are numerical linearization parameters assessed based on the data of power sweep with CW signal (no uncertainty required). DCP does not depend on frequency nor media.
- PAR**: PAR is the Peak to Average Ratio that is not calibrated but determined based on the signal characteristics
- A_{x,y,z}; B_{x,y,z}; C_{x,y,z}; D_{x,y,z}; VR_{x,y,z}**: A, B, C, D are numerical linearization parameters assessed based on the data of power sweep for specific modulation signal. The parameters do not depend on frequency nor media. VR is the maximum calibration range expressed in RMS voltage across the diode.
- ConvF and Boundary Effect Parameters**: Assessed in flat phantom using E-field (or Temperature Transfer Standard for $f \leq 800$ MHz) and inside waveguide using analytical field distributions based on power measurements for $f > 800$ MHz. The same setups are used for assessment of the parameters applied for boundary compensation (alpha, depth) of which typical uncertainty values are given. These parameters are used in DASY4 software to improve probe accuracy close to the boundary. The sensitivity in TSL corresponds to NORM_{x,y,z} * ConvF whereby the uncertainty corresponds to that given for ConvF. A frequency dependent ConvF is used in DASY version 4.4 and higher which allows extending the validity from ± 50 MHz to ± 100 MHz.
- Spherical isotropy (3D deviation from isotropy)**: in a field of low gradients realized using a flat phantom exposed by a patch antenna.
- Sensor Offset**: The sensor offset corresponds to the offset of virtual measurement center from the probe tip (on probe axis). No tolerance required.
- Connector Angle**: The angle is assessed using the information gained by determining the NORM_x (no uncertainty required).

DASY/EASY - Parameters of Probe: EX3DV4 - SN:3589

Basic Calibration Parameters

	Sensor X	Sensor Y	Sensor Z	Unc (k=2)
Norm ($\mu\text{V}/(\text{V}/\text{m})^2$) ^A	0.44	0.40	0.39	± 10.1 %
DCP (mV) ^B	104.1	102.3	101.6	

Calibration Results for Modulation Response

UID	Communication System Name		A dB	B dB $\sqrt{\mu\text{V}}$	C	D dB	VR mV	Max dev.	Max Unc ^E (k=2)
0	CW	X	0.00	0.00	1.00	0.00	161.0	± 2.2 %	± 4.7 %
		Y	0.00	0.00	1.00		172.8		
		Z	0.00	0.00	1.00		161.9		
10352- AAA	Pulse Waveform (200Hz, 10%)	X	15.00	89.05	22.73	10.00	60.0	± 1.8 %	± 9.6 %
		Y	15.00	87.03	21.09		60.0		
		Z	15.00	88.89	22.24		60.0		
10353- AAA	Pulse Waveform (200Hz, 20%)	X	15.00	89.55	21.62	6.99	80.0	± 0.9 %	± 9.6 %
		Y	15.00	87.28	19.70		80.0		
		Z	15.00	89.25	21.07		80.0		
10354- AAA	Pulse Waveform (200Hz, 40%)	X	15.00	91.62	21.02	3.98	95.0	± 0.9 %	± 9.6 %
		Y	15.00	87.00	17.73		95.0		
		Z	15.00	91.02	20.33		95.0		
10355- AAA	Pulse Waveform (200Hz, 60%)	X	15.00	97.72	22.56	2.22	120.0	± 1.3 %	± 9.6 %
		Y	15.00	85.70	15.52		120.0		
		Z	15.00	94.39	20.55		120.0		
10387- AAA	QPSK Waveform, 1 MHz	X	0.93	64.13	11.59	0.00	150.0	± 3.0 %	± 9.6 %
		Y	0.57	60.00	7.45		150.0		
		Z	0.83	63.49	10.36		150.0		
10388- AAA	QPSK Waveform, 10 MHz	X	2.36	68.76	16.09	0.00	150.0	± 1.5 %	± 9.6 %
		Y	1.95	66.09	14.43		150.0		
		Z	2.37	69.14	16.27		150.0		
10396- AAA	64-QAM Waveform, 100 kHz	X	3.76	72.95	19.72	3.01	150.0	± 0.7 %	± 9.6 %
		Y	3.11	69.51	18.06		150.0		
		Z	4.24	75.35	20.59		150.0		
10399- AAA	64-QAM Waveform, 40 MHz	X	3.57	67.40	15.92	0.00	150.0	± 2.7 %	± 9.6 %
		Y	3.33	66.26	15.18		150.0		
		Z	3.47	67.09	15.77		150.0		
10414- AAA	WLAN CCDF, 64-QAM, 40MHz	X	4.95	65.72	15.56	0.00	150.0	± 4.8 %	± 9.6 %
		Y	4.74	65.16	15.23		150.0		
		Z	4.81	65.57	15.48		150.0		

Note: For details on UID parameters see Appendix

The reported uncertainty of measurement is stated as the standard uncertainty of measurement multiplied by the coverage factor k=2, which for a normal distribution corresponds to a coverage probability of approximately 95%.

^A The uncertainties of Norm X,Y,Z do not affect the E²-field uncertainty inside TSL (see Pages 5 and 6).

^B Numerical linearization parameter: uncertainty not required.

^E Uncertainty is determined using the max. deviation from linear response applying rectangular distribution and is expressed for the square of the field value.

DASY/EASY - Parameters of Probe: EX3DV4 - SN:3589

Sensor Model Parameters

	C1 fF	C2 fF	α V ⁻¹	T1 ms.V ⁻²	T2 ms.V ⁻¹	T3 ms	T4 V ⁻²	T5 V ⁻¹	T6
X	55.3	407.97	34.85	27.50	1.34	5.10	1.23	0.50	1.01
Y	46.7	357.99	37.12	21.71	1.59	5.07	0.00	0.73	1.01
Z	46.1	339.04	34.64	23.94	1.27	5.07	1.73	0.40	1.01

Other Probe Parameters

Sensor Arrangement	Triangular
Connector Angle (°)	-30.3
Mechanical Surface Detection Mode	enabled
Optical Surface Detection Mode	disabled
Probe Overall Length	337 mm
Probe Body Diameter	10 mm
Tip Length	9 mm
Tip Diameter	2.5 mm
Probe Tip to Sensor X Calibration Point	1 mm
Probe Tip to Sensor Y Calibration Point	1 mm
Probe Tip to Sensor Z Calibration Point	1 mm
Recommended Measurement Distance from Surface	1.4 mm

DASY/EASY - Parameters of Probe: EX3DV4 - SN:3589

Calibration Parameter Determined in Head Tissue Simulating Media

f (MHz) ^C	Relative Permittivity ^F	Conductivity (S/m) ^F	ConvF X	ConvF Y	ConvF Z	Alpha ^G	Depth (mm) ^G	Unc (k=2)
750	41.9	0.89	8.67	8.67	8.67	0.70	0.80	± 12.0 %
835	41.5	0.90	8.39	8.39	8.39	0.63	0.81	± 12.0 %
1750	40.1	1.37	7.31	7.31	7.31	0.40	0.80	± 12.0 %
1900	40.0	1.40	7.08	7.08	7.08	0.39	0.80	± 12.0 %
2300	39.5	1.67	6.77	6.77	6.77	0.31	0.85	± 12.0 %
2450	39.2	1.80	6.46	6.46	6.46	0.30	0.85	± 12.0 %
2600	39.0	1.96	6.25	6.25	6.25	0.40	0.83	± 12.0 %
3500	37.9	2.91	6.16	6.16	6.16	0.26	1.20	± 13.1 %
3700	37.7	3.12	6.02	6.02	6.02	0.26	1.20	± 13.1 %

^C Frequency validity above 300 MHz of ± 100 MHz only applies for DASY v4.4 and higher (see Page 2), else it is restricted to ± 50 MHz. The uncertainty is the RSS of the ConvF uncertainty at calibration frequency and the uncertainty for the indicated frequency band. Frequency validity below 300 MHz is ± 10, 25, 40, 50 and 70 MHz for ConvF assessments at 30, 64, 128, 150 and 220 MHz respectively. Validity of ConvF assessed at 6 MHz is 4-9 MHz, and ConvF assessed at 13 MHz is 9-19 MHz. Above 5 GHz frequency validity can be extended to ± 110 MHz.

^F At frequencies below 3 GHz, the validity of tissue parameters (ϵ and σ) can be relaxed to ± 10% if liquid compensation formula is applied to measured SAR values. At frequencies above 3 GHz, the validity of tissue parameters (ϵ and σ) is restricted to ± 5%. The uncertainty is the RSS of the ConvF uncertainty for indicated target tissue parameters.

^G Alpha/Depth are determined during calibration. SPEAG warrants that the remaining deviation due to the boundary effect after compensation is always less than ± 1% for frequencies below 3 GHz and below ± 2% for frequencies between 3-6 GHz at any distance larger than half the probe tip diameter from the boundary.

DASY/EASY - Parameters of Probe: EX3DV4 - SN:3589

Calibration Parameter Determined in Body Tissue Simulating Media

f (MHz) ^C	Relative Permittivity ^F	Conductivity (S/m) ^F	ConvF X	ConvF Y	ConvF Z	Alpha ^G	Depth ^G (mm)	Unc (k=2)
750	55.5	0.96	8.34	8.34	8.34	0.42	0.84	± 12.0 %
835	55.2	0.97	8.29	8.29	8.29	0.41	0.84	± 12.0 %
1750	53.4	1.49	6.82	6.82	6.82	0.43	0.80	± 12.0 %
1900	53.3	1.52	6.75	6.75	6.75	0.35	0.85	± 12.0 %
2300	52.9	1.81	6.71	6.71	6.71	0.36	0.87	± 12.0 %
2450	52.7	1.95	6.66	6.66	6.66	0.34	0.88	± 12.0 %
2600	52.5	2.16	6.47	6.47	6.47	0.28	0.95	± 12.0 %
3500	51.3	3.31	6.21	6.21	6.21	0.25	1.25	± 13.1 %
3700	51.0	3.55	6.13	6.13	6.13	0.20	1.25	± 13.1 %

^C Frequency validity above 300 MHz of ± 100 MHz only applies for DASY v4.4 and higher (see Page 2), else it is restricted to ± 50 MHz. The uncertainty is the RSS of the ConvF uncertainty at calibration frequency and the uncertainty for the indicated frequency band. Frequency validity below 300 MHz is ± 10, 25, 40, 50 and 70 MHz for ConvF assessments at 30, 64, 128, 150 and 220 MHz respectively. Validity of ConvF assessed at 6 MHz is 4-9 MHz, and ConvF assessed at 13 MHz is 9-19 MHz. Above 5 GHz frequency validity can be extended to ± 110 MHz.

^F At frequencies below 3 GHz, the validity of tissue parameters (ϵ and σ) can be relaxed to ± 10% if liquid compensation formula is applied to measured SAR values. At frequencies above 3 GHz, the validity of tissue parameters (ϵ and σ) is restricted to ± 5%. The uncertainty is the RSS of the ConvF uncertainty for indicated target tissue parameters.

^G Alpha/Depth are determined during calibration. SPEAG warrants that the remaining deviation due to the boundary effect after compensation is always less than ± 1% for frequencies below 3 GHz and below ± 2% for frequencies between 3-6 GHz at any distance larger than half the probe tip diameter from the boundary.

Frequency Response of E-Field (TEM-Cell:ifi110 EXX, Waveguide: R22)

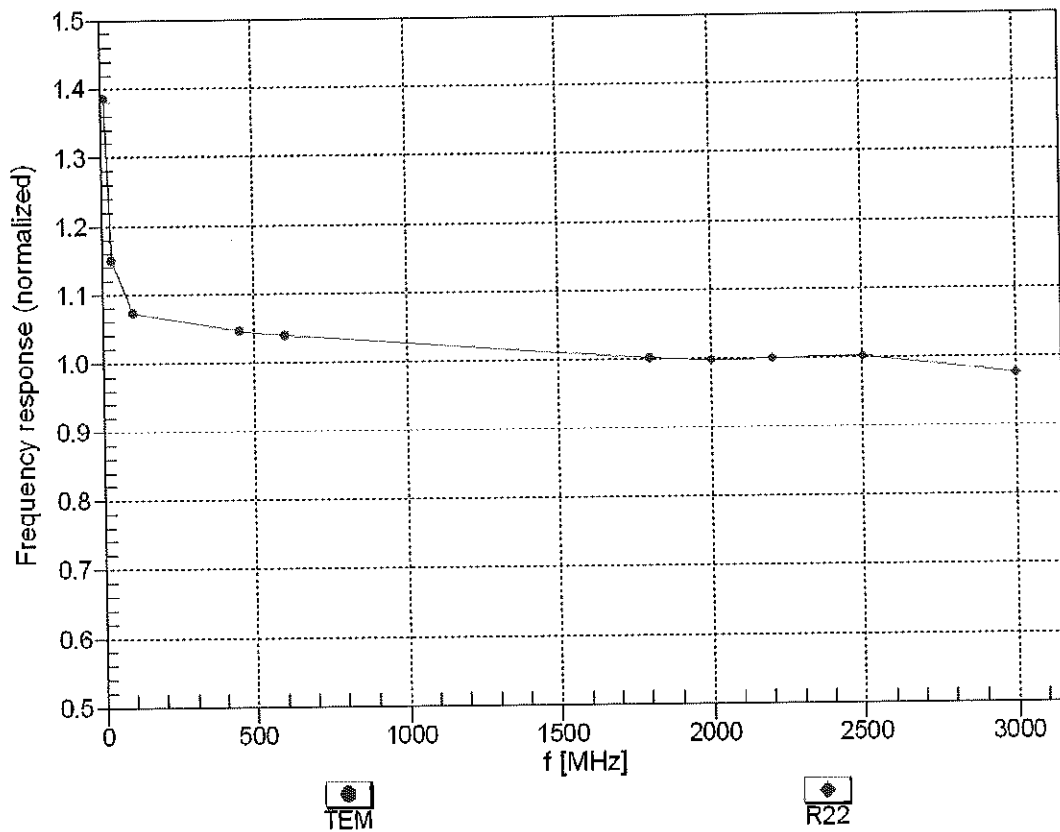

Uncertainty of Frequency Response of E-field: $\pm 6.3\%$ (k=2)

Receiving Pattern (ϕ), $\vartheta = 0^\circ$

f=600 MHz, TEM

f=1800 MHz, R22

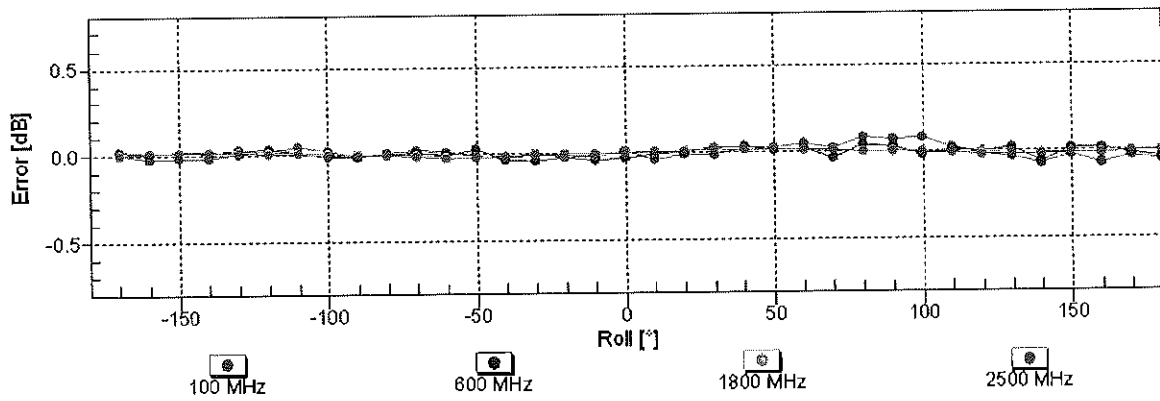
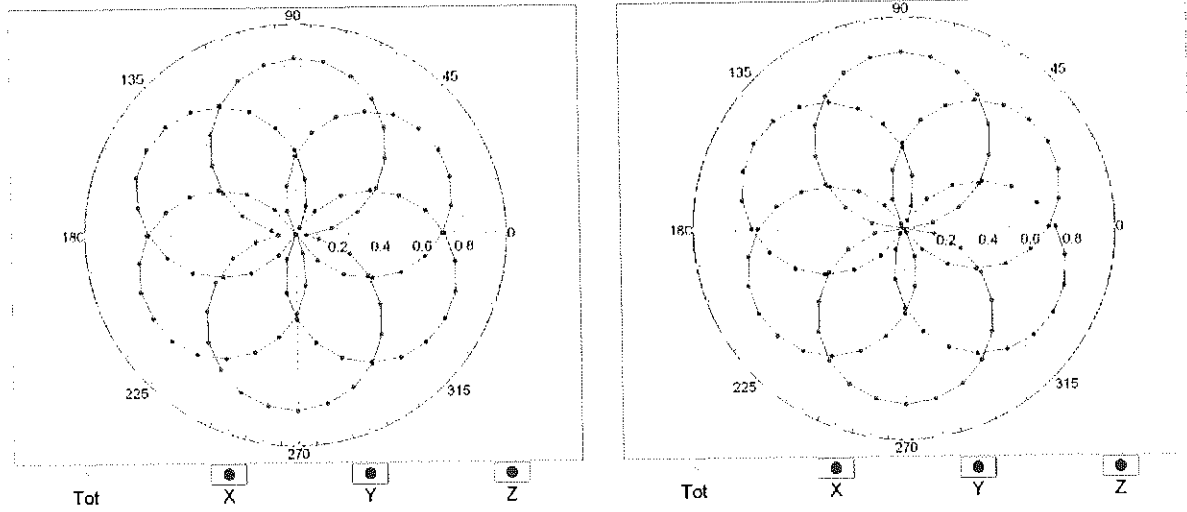

Uncertainty of Axial Isotropy Assessment: $\pm 0.5\%$ ($k=2$)

Dynamic Range f(SAR_{head}) (TEM cell , f_{eval}= 1900 MHz)

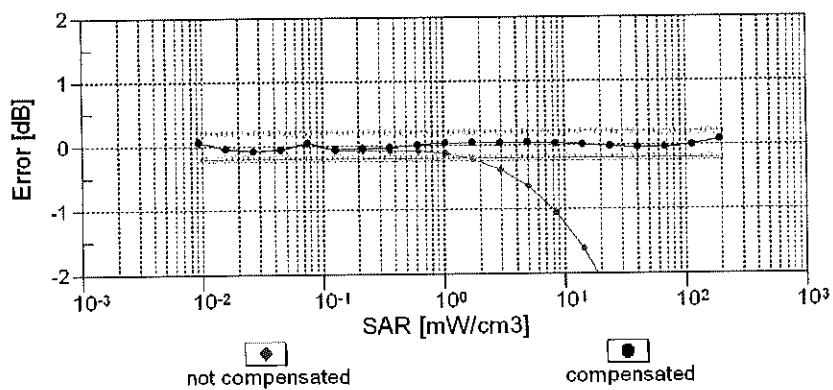
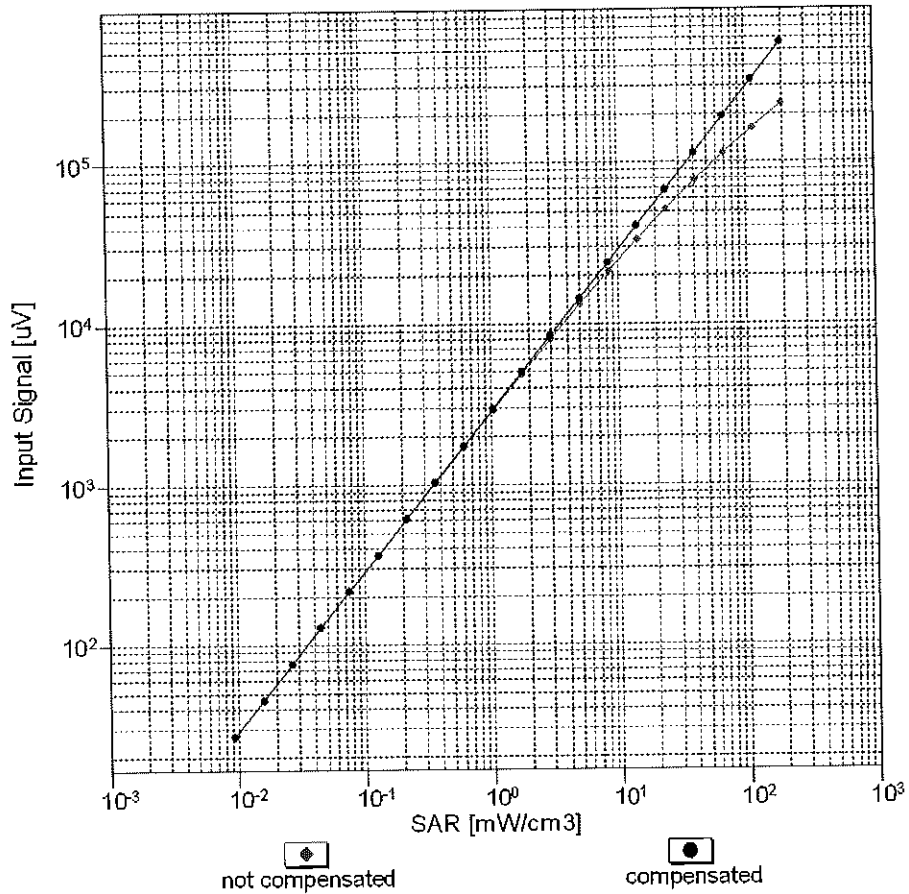

Uncertainty of Linearity Assessment: ± 0.6% (k=2)

Conversion Factor Assessment

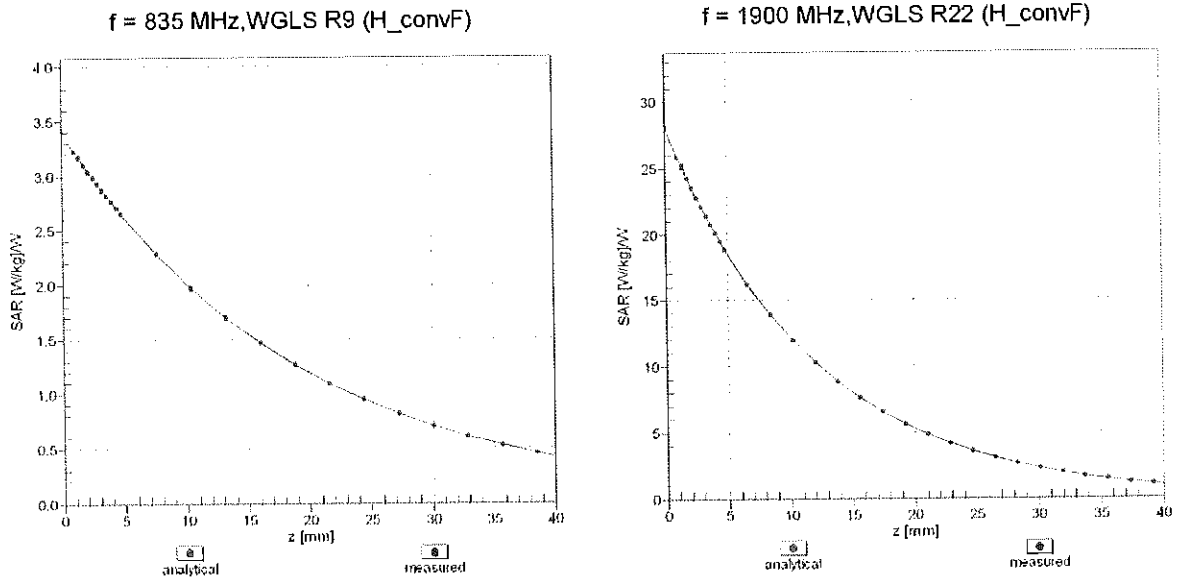

Deviation from Isotropy in Liquid Error (ϕ, θ), f = 900 MHz

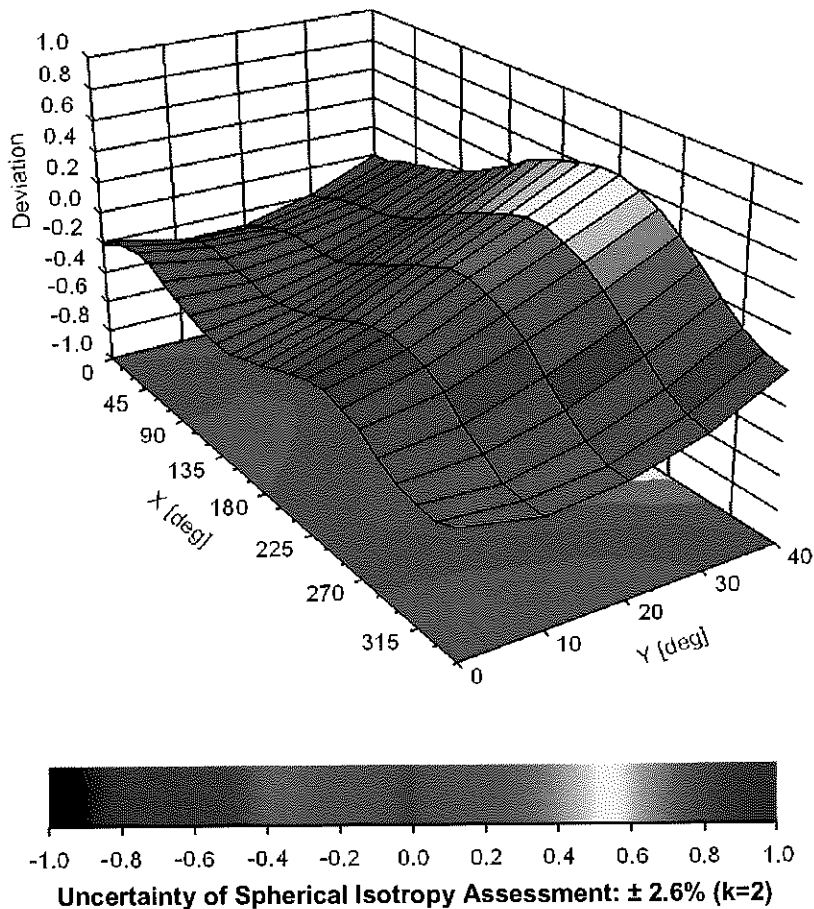

Appendix: Modulation Calibration Parameters

UID	Rev	Communication System Name	Group	PAR (dB)	Unc ^E (k=2)
0		CW	CW	0.00	± 4.7 %
10010	CAA	SAR Validation (Square, 100ms, 10ms)	Test	10.00	± 9.6 %
10011	CAB	UMTS-FDD (WCDMA)	WCDMA	2.91	± 9.6 %
10012	CAB	IEEE 802.11b WiFi 2.4 GHz (DSSS, 1 Mbps)	WLAN	1.87	± 9.6 %
10013	CAB	IEEE 802.11g WiFi 2.4 GHz (DSSS-OFDM, 6 Mbps)	WLAN	9.46	± 9.6 %
10021	DAC	GSM-FDD (TDMA, GMSK)	GSM	9.39	± 9.6 %
10023	DAC	GPRS-FDD (TDMA, GMSK, TN 0)	GSM	9.57	± 9.6 %
10024	DAC	GPRS-FDD (TDMA, GMSK, TN 0-1)	GSM	6.56	± 9.6 %
10025	DAC	EDGE-FDD (TDMA, 8PSK, TN 0)	GSM	12.62	± 9.6 %
10026	DAC	EDGE-FDD (TDMA, 8PSK, TN 0-1)	GSM	9.55	± 9.6 %
10027	DAC	GPRS-FDD (TDMA, GMSK, TN 0-1-2)	GSM	4.80	± 9.6 %
10028	DAC	GPRS-FDD (TDMA, GMSK, TN 0-1-2-3)	GSM	3.55	± 9.6 %
10029	DAC	EDGE-FDD (TDMA, 8PSK, TN 0-1-2)	GSM	7.78	± 9.6 %
10030	CAA	IEEE 802.15.1 Bluetooth (GFSK, DH1)	Bluetooth	5.30	± 9.6 %
10031	CAA	IEEE 802.15.1 Bluetooth (GFSK, DH3)	Bluetooth	1.87	± 9.6 %
10032	CAA	IEEE 802.15.1 Bluetooth (GFSK, DH5)	Bluetooth	1.16	± 9.6 %
10033	CAA	IEEE 802.15.1 Bluetooth (PI/4-DQPSK, DH1)	Bluetooth	7.74	± 9.6 %
10034	CAA	IEEE 802.15.1 Bluetooth (PI/4-DQPSK, DH3)	Bluetooth	4.53	± 9.6 %
10035	CAA	IEEE 802.15.1 Bluetooth (PI/4-DQPSK, DH5)	Bluetooth	3.83	± 9.6 %
10036	CAA	IEEE 802.15.1 Bluetooth (8-DPSK, DH1)	Bluetooth	8.01	± 9.6 %
10037	CAA	IEEE 802.15.1 Bluetooth (8-DPSK, DH3)	Bluetooth	4.77	± 9.6 %
10038	CAA	IEEE 802.15.1 Bluetooth (8-DPSK, DH5)	Bluetooth	4.10	± 9.6 %
10039	CAB	CDMA2000 (1xRTT, RC1)	CDMA2000	4.57	± 9.6 %
10042	CAB	IS-54 / IS-136 FDD (TDMA/FDM, PI/4-DQPSK, Halfrate)	AMPS	7.78	± 9.6 %
10044	CAA	IS-91/EIA/TIA-553 FDD (FDMA, FM)	AMPS	0.00	± 9.6 %
10048	CAA	DECT (TDD, TDMA/FDM, GFSK, Full Slot, 24)	DECT	13.80	± 9.6 %
10049	CAA	DECT (TDD, TDMA/FDM, GFSK, Double Slot, 12)	DECT	10.79	± 9.6 %
10056	CAA	UMTS-TDD (TD-SCDMA, 1.28 Mcps)	TD-SCDMA	11.01	± 9.6 %
10058	DAC	EDGE-FDD (TDMA, 8PSK, TN 0-1-2-3)	GSM	6.52	± 9.6 %
10059	CAB	IEEE 802.11b WiFi 2.4 GHz (DSSS, 2 Mbps)	WLAN	2.12	± 9.6 %
10060	CAB	IEEE 802.11b WiFi 2.4 GHz (DSSS, 5.5 Mbps)	WLAN	2.83	± 9.6 %
10061	CAB	IEEE 802.11b WiFi 2.4 GHz (DSSS, 11 Mbps)	WLAN	3.60	± 9.6 %
10062	CAC	IEEE 802.11a/h WiFi 5 GHz (OFDM, 6 Mbps)	WLAN	8.68	± 9.6 %
10063	CAC	IEEE 802.11a/h WiFi 5 GHz (OFDM, 9 Mbps)	WLAN	8.63	± 9.6 %
10064	CAC	IEEE 802.11a/h WiFi 5 GHz (OFDM, 12 Mbps)	WLAN	9.09	± 9.6 %
10065	CAC	IEEE 802.11a/h WiFi 5 GHz (OFDM, 18 Mbps)	WLAN	9.00	± 9.6 %
10066	CAC	IEEE 802.11a/h WiFi 5 GHz (OFDM, 24 Mbps)	WLAN	9.38	± 9.6 %
10067	CAC	IEEE 802.11a/h WiFi 5 GHz (OFDM, 36 Mbps)	WLAN	10.12	± 9.6 %
10068	CAC	IEEE 802.11a/h WiFi 5 GHz (OFDM, 48 Mbps)	WLAN	10.24	± 9.6 %
10069	CAC	IEEE 802.11a/h WiFi 5 GHz (OFDM, 54 Mbps)	WLAN	10.56	± 9.6 %
10071	CAB	IEEE 802.11g WiFi 2.4 GHz (DSSS/OFDM, 9 Mbps)	WLAN	9.83	± 9.6 %
10072	CAB	IEEE 802.11g WiFi 2.4 GHz (DSSS/OFDM, 12 Mbps)	WLAN	9.62	± 9.6 %
10073	CAB	IEEE 802.11g WiFi 2.4 GHz (DSSS/OFDM, 18 Mbps)	WLAN	9.94	± 9.6 %
10074	CAB	IEEE 802.11g WiFi 2.4 GHz (DSSS/OFDM, 24 Mbps)	WLAN	10.30	± 9.6 %
10075	CAB	IEEE 802.11g WiFi 2.4 GHz (DSSS/OFDM, 36 Mbps)	WLAN	10.77	± 9.6 %
10076	CAB	IEEE 802.11g WiFi 2.4 GHz (DSSS/OFDM, 48 Mbps)	WLAN	10.94	± 9.6 %
10077	CAB	IEEE 802.11g WiFi 2.4 GHz (DSSS/OFDM, 54 Mbps)	WLAN	11.00	± 9.6 %
10081	CAB	CDMA2000 (1xRTT, RC3)	CDMA2000	3.97	± 9.6 %
10082	CAB	IS-54 / IS-136 FDD (TDMA/FDM, PI/4-DQPSK, Fullrate)	AMPS	4.77	± 9.6 %
10090	DAC	GPRS-FDD (TDMA, GMSK, TN 0-4)	GSM	6.56	± 9.6 %
10097	CAB	UMTS-FDD (HSDPA)	WCDMA	3.98	± 9.6 %
10098	CAB	UMTS-FDD (HSUPA, Subtest 2)	WCDMA	3.98	± 9.6 %
10099	DAC	EDGE-FDD (TDMA, 8PSK, TN 0-4)	GSM	9.55	± 9.6 %
10100	CAE	LTE-FDD (SC-FDMA, 100% RB, 20 MHz, QPSK)	LTE-FDD	5.67	± 9.6 %
10101	CAE	LTE-FDD (SC-FDMA, 100% RB, 20 MHz, 16-QAM)	LTE-FDD	6.42	± 9.6 %
10102	CAE	LTE-FDD (SC-FDMA, 100% RB, 20 MHz, 64-QAM)	LTE-FDD	6.60	± 9.6 %
10103	CAG	LTE-TDD (SC-FDMA, 100% RB, 20 MHz, QPSK)	LTE-TDD	9.29	± 9.6 %
10104	CAG	LTE-TDD (SC-FDMA, 100% RB, 20 MHz, 16-QAM)	LTE-TDD	9.97	± 9.6 %
10105	CAG	LTE-TDD (SC-FDMA, 100% RB, 20 MHz, 64-QAM)	LTE-TDD	10.01	± 9.6 %
10108	CAG	LTE-FDD (SC-FDMA, 100% RB, 10 MHz, QPSK)	LTE-FDD	5.80	± 9.6 %

10109	CAG	LTE-FDD (SC-FDMA, 100% RB, 10 MHz, 16-QAM)	LTE-FDD	6.43	± 9.6 %
10110	CAG	LTE-FDD (SC-FDMA, 100% RB, 5 MHz, QPSK)	LTE-FDD	5.75	± 9.6 %
10111	CAG	LTE-FDD (SC-FDMA, 100% RB, 5 MHz, 16-QAM)	LTE-FDD	6.44	± 9.6 %
10112	CAG	LTE-FDD (SC-FDMA, 100% RB, 10 MHz, 64-QAM)	LTE-FDD	6.59	± 9.6 %
10113	CAG	LTE-FDD (SC-FDMA, 100% RB, 5 MHz, 64-QAM)	LTE-FDD	6.62	± 9.6 %
10114	CAC	IEEE 802.11n (HT Greenfield, 13.5 Mbps, BPSK)	WLAN	8.10	± 9.6 %
10115	CAC	IEEE 802.11n (HT Greenfield, 81 Mbps, 16-QAM)	WLAN	8.46	± 9.6 %
10116	CAC	IEEE 802.11n (HT Greenfield, 135 Mbps, 64-QAM)	WLAN	8.15	± 9.6 %
10117	CAC	IEEE 802.11n (HT Mixed, 13.5 Mbps, BPSK)	WLAN	8.07	± 9.6 %
10118	CAC	IEEE 802.11n (HT Mixed, 81 Mbps, 16-QAM)	WLAN	8.59	± 9.6 %
10119	CAC	IEEE 802.11n (HT Mixed, 135 Mbps, 64-QAM)	WLAN	8.13	± 9.6 %
10140	CAE	LTE-FDD (SC-FDMA, 100% RB, 15 MHz, 16-QAM)	LTE-FDD	6.49	± 9.6 %
10141	CAE	LTE-FDD (SC-FDMA, 100% RB, 15 MHz, 64-QAM)	LTE-FDD	6.53	± 9.6 %
10142	CAE	LTE-FDD (SC-FDMA, 100% RB, 3 MHz, QPSK)	LTE-FDD	5.73	± 9.6 %
10143	CAE	LTE-FDD (SC-FDMA, 100% RB, 3 MHz, 16-QAM)	LTE-FDD	6.35	± 9.6 %
10144	CAE	LTE-FDD (SC-FDMA, 100% RB, 3 MHz, 64-QAM)	LTE-FDD	6.65	± 9.6 %
10145	CAF	LTE-FDD (SC-FDMA, 100% RB, 1.4 MHz, QPSK)	LTE-FDD	5.76	± 9.6 %
10146	CAF	LTE-FDD (SC-FDMA, 100% RB, 1.4 MHz, 16-QAM)	LTE-FDD	6.41	± 9.6 %
10147	CAF	LTE-FDD (SC-FDMA, 100% RB, 1.4 MHz, 64-QAM)	LTE-FDD	6.72	± 9.6 %
10149	CAE	LTE-FDD (SC-FDMA, 50% RB, 20 MHz, 16-QAM)	LTE-FDD	6.42	± 9.6 %
10150	CAE	LTE-FDD (SC-FDMA, 50% RB, 20 MHz, 64-QAM)	LTE-FDD	6.60	± 9.6 %
10151	CAG	LTE-TDD (SC-FDMA, 50% RB, 20 MHz, QPSK)	LTE-TDD	9.28	± 9.6 %
10152	CAG	LTE-TDD (SC-FDMA, 50% RB, 20 MHz, 16-QAM)	LTE-TDD	9.92	± 9.6 %
10153	CAG	LTE-TDD (SC-FDMA, 50% RB, 20 MHz, 64-QAM)	LTE-TDD	10.05	± 9.6 %
10154	CAG	LTE-FDD (SC-FDMA, 50% RB, 10 MHz, QPSK)	LTE-FDD	5.75	± 9.6 %
10155	CAG	LTE-FDD (SC-FDMA, 50% RB, 10 MHz, 16-QAM)	LTE-FDD	6.43	± 9.6 %
10156	CAG	LTE-FDD (SC-FDMA, 50% RB, 5 MHz, QPSK)	LTE-FDD	5.79	± 9.6 %
10157	CAG	LTE-FDD (SC-FDMA, 50% RB, 5 MHz, 16-QAM)	LTE-FDD	6.49	± 9.6 %
10158	CAG	LTE-FDD (SC-FDMA, 50% RB, 10 MHz, 64-QAM)	LTE-FDD	6.62	± 9.6 %
10159	CAG	LTE-FDD (SC-FDMA, 50% RB, 5 MHz, 64-QAM)	LTE-FDD	6.56	± 9.6 %
10160	CAE	LTE-FDD (SC-FDMA, 50% RB, 15 MHz, QPSK)	LTE-FDD	5.82	± 9.6 %
10161	CAE	LTE-FDD (SC-FDMA, 50% RB, 15 MHz, 16-QAM)	LTE-FDD	6.43	± 9.6 %
10162	CAE	LTE-FDD (SC-FDMA, 50% RB, 15 MHz, 64-QAM)	LTE-FDD	6.58	± 9.6 %
10166	CAF	LTE-FDD (SC-FDMA, 50% RB, 1.4 MHz, QPSK)	LTE-FDD	5.46	± 9.6 %
10167	CAF	LTE-FDD (SC-FDMA, 50% RB, 1.4 MHz, 16-QAM)	LTE-FDD	6.21	± 9.6 %
10168	CAF	LTE-FDD (SC-FDMA, 50% RB, 1.4 MHz, 64-QAM)	LTE-FDD	6.79	± 9.6 %
10169	CAE	LTE-FDD (SC-FDMA, 1 RB, 20 MHz, QPSK)	LTE-FDD	5.73	± 9.6 %
10170	CAE	LTE-FDD (SC-FDMA, 1 RB, 20 MHz, 16-QAM)	LTE-FDD	6.52	± 9.6 %
10171	AAE	LTE-FDD (SC-FDMA, 1 RB, 20 MHz, 64-QAM)	LTE-FDD	6.49	± 9.6 %
10172	CAG	LTE-TDD (SC-FDMA, 1 RB, 20 MHz, QPSK)	LTE-TDD	9.21	± 9.6 %
10173	CAG	LTE-TDD (SC-FDMA, 1 RB, 20 MHz, 16-QAM)	LTE-TDD	9.48	± 9.6 %
10174	CAG	LTE-TDD (SC-FDMA, 1 RB, 20 MHz, 64-QAM)	LTE-TDD	10.25	± 9.6 %
10175	CAG	LTE-FDD (SC-FDMA, 1 RB, 10 MHz, QPSK)	LTE-FDD	5.72	± 9.6 %
10176	CAG	LTE-FDD (SC-FDMA, 1 RB, 10 MHz, 16-QAM)	LTE-FDD	6.52	± 9.6 %
10177	CAI	LTE-FDD (SC-FDMA, 1 RB, 5 MHz, QPSK)	LTE-FDD	5.73	± 9.6 %
10178	CAG	LTE-FDD (SC-FDMA, 1 RB, 5 MHz, 16-QAM)	LTE-FDD	6.52	± 9.6 %
10179	CAG	LTE-FDD (SC-FDMA, 1 RB, 10 MHz, 64-QAM)	LTE-FDD	6.50	± 9.6 %
10180	CAG	LTE-FDD (SC-FDMA, 1 RB, 5 MHz, 64-QAM)	LTE-FDD	6.50	± 9.6 %
10181	CAE	LTE-FDD (SC-FDMA, 1 RB, 15 MHz, QPSK)	LTE-FDD	5.72	± 9.6 %
10182	CAE	LTE-FDD (SC-FDMA, 1 RB, 15 MHz, 16-QAM)	LTE-FDD	6.52	± 9.6 %
10183	AAD	LTE-FDD (SC-FDMA, 1 RB, 15 MHz, 64-QAM)	LTE-FDD	6.50	± 9.6 %
10184	CAE	LTE-FDD (SC-FDMA, 1 RB, 3 MHz, QPSK)	LTE-FDD	5.73	± 9.6 %
10185	CAE	LTE-FDD (SC-FDMA, 1 RB, 3 MHz, 16-QAM)	LTE-FDD	6.51	± 9.6 %
10186	AAE	LTE-FDD (SC-FDMA, 1 RB, 3 MHz, 64-QAM)	LTE-FDD	6.50	± 9.6 %
10187	CAF	LTE-FDD (SC-FDMA, 1 RB, 1.4 MHz, QPSK)	LTE-FDD	5.73	± 9.6 %
10188	CAF	LTE-FDD (SC-FDMA, 1 RB, 1.4 MHz, 16-QAM)	LTE-FDD	6.52	± 9.6 %
10189	AAF	LTE-FDD (SC-FDMA, 1 RB, 1.4 MHz, 64-QAM)	LTE-FDD	6.50	± 9.6 %
10193	CAC	IEEE 802.11n (HT Greenfield, 6.5 Mbps, BPSK)	WLAN	8.09	± 9.6 %
10194	CAC	IEEE 802.11n (HT Greenfield, 39 Mbps, 16-QAM)	WLAN	8.12	± 9.6 %
10195	CAC	IEEE 802.11n (HT Greenfield, 65 Mbps, 64-QAM)	WLAN	8.21	± 9.6 %
10196	CAC	IEEE 802.11n (HT Mixed, 6.5 Mbps, BPSK)	WLAN	8.10	± 9.6 %
10197	CAC	IEEE 802.11n (HT Mixed, 39 Mbps, 16-QAM)	WLAN	8.13	± 9.6 %
10198	CAC	IEEE 802.11n (HT Mixed, 65 Mbps, 64-QAM)	WLAN	8.27	± 9.6 %
10219	CAC	IEEE 802.11n (HT Mixed, 7.2 Mbps, BPSK)	WLAN	8.03	± 9.6 %

10220	CAC	IEEE 802.11n (HT Mixed, 43.3 Mbps, 16-QAM)	WLAN	8.13	± 9.6 %
10221	CAC	IEEE 802.11n (HT Mixed, 72.2 Mbps, 64-QAM)	WLAN	8.27	± 9.6 %
10222	CAC	IEEE 802.11n (HT Mixed, 15 Mbps, BPSK)	WLAN	8.06	± 9.6 %
10223	CAC	IEEE 802.11n (HT Mixed, 90 Mbps, 16-QAM)	WLAN	8.48	± 9.6 %
10224	CAC	IEEE 802.11n (HT Mixed, 150 Mbps, 64-QAM)	WLAN	8.08	± 9.6 %
10225	CAB	UMTS-FDD (HSPA+)	WCDMA	5.97	± 9.6 %
10226	CAA	LTE-TDD (SC-FDMA, 1 RB, 1.4 MHz, 16-QAM)	LTE-TDD	9.49	± 9.6 %
10227	CAA	LTE-TDD (SC-FDMA, 1 RB, 1.4 MHz, 64-QAM)	LTE-TDD	10.26	± 9.6 %
10228	CAA	LTE-TDD (SC-FDMA, 1 RB, 1.4 MHz, QPSK)	LTE-TDD	9.22	± 9.6 %
10229	CAC	LTE-TDD (SC-FDMA, 1 RB, 3 MHz, 16-QAM)	LTE-TDD	9.48	± 9.6 %
10230	CAC	LTE-TDD (SC-FDMA, 1 RB, 3 MHz, 64-QAM)	LTE-TDD	10.25	± 9.6 %
10231	CAC	LTE-TDD (SC-FDMA, 1 RB, 3 MHz, QPSK)	LTE-TDD	9.19	± 9.6 %
10232	CAF	LTE-TDD (SC-FDMA, 1 RB, 5 MHz, 16-QAM)	LTE-TDD	9.48	± 9.6 %
10233	CAF	LTE-TDD (SC-FDMA, 1 RB, 5 MHz, 64-QAM)	LTE-TDD	10.25	± 9.6 %
10234	CAF	LTE-TDD (SC-FDMA, 1 RB, 5 MHz, QPSK)	LTE-TDD	9.21	± 9.6 %
10235	CAF	LTE-TDD (SC-FDMA, 1 RB, 10 MHz, 16-QAM)	LTE-TDD	9.48	± 9.6 %
10236	CAF	LTE-TDD (SC-FDMA, 1 RB, 10 MHz, 64-QAM)	LTE-TDD	10.25	± 9.6 %
10237	CAF	LTE-TDD (SC-FDMA, 1 RB, 10 MHz, QPSK)	LTE-TDD	9.21	± 9.6 %
10238	CAF	LTE-TDD (SC-FDMA, 1 RB, 15 MHz, 16-QAM)	LTE-TDD	9.48	± 9.6 %
10239	CAF	LTE-TDD (SC-FDMA, 1 RB, 15 MHz, 64-QAM)	LTE-TDD	10.25	± 9.6 %
10240	CAF	LTE-TDD (SC-FDMA, 1 RB, 15 MHz, QPSK)	LTE-TDD	9.21	± 9.6 %
10241	CAA	LTE-TDD (SC-FDMA, 50% RB, 1.4 MHz, 16-QAM)	LTE-TDD	9.82	± 9.6 %
10242	CAA	LTE-TDD (SC-FDMA, 50% RB, 1.4 MHz, 64-QAM)	LTE-TDD	9.86	± 9.6 %
10243	CAA	LTE-TDD (SC-FDMA, 50% RB, 1.4 MHz, QPSK)	LTE-TDD	9.46	± 9.6 %
10244	CAC	LTE-TDD (SC-FDMA, 50% RB, 3 MHz, 16-QAM)	LTE-TDD	10.06	± 9.6 %
10245	CAC	LTE-TDD (SC-FDMA, 50% RB, 3 MHz, 64-QAM)	LTE-TDD	10.06	± 9.6 %
10246	CAC	LTE-TDD (SC-FDMA, 50% RB, 3 MHz, QPSK)	LTE-TDD	9.30	± 9.6 %
10247	CAF	LTE-TDD (SC-FDMA, 50% RB, 5 MHz, 16-QAM)	LTE-TDD	9.91	± 9.6 %
10248	CAF	LTE-TDD (SC-FDMA, 50% RB, 5 MHz, 64-QAM)	LTE-TDD	10.09	± 9.6 %
10249	CAF	LTE-TDD (SC-FDMA, 50% RB, 5 MHz, QPSK)	LTE-TDD	9.29	± 9.6 %
10250	CAF	LTE-TDD (SC-FDMA, 50% RB, 10 MHz, 16-QAM)	LTE-TDD	9.81	± 9.6 %
10251	CAF	LTE-TDD (SC-FDMA, 50% RB, 10 MHz, 64-QAM)	LTE-TDD	10.17	± 9.6 %
10252	CAF	LTE-TDD (SC-FDMA, 50% RB, 10 MHz, QPSK)	LTE-TDD	9.24	± 9.6 %
10253	CAF	LTE-TDD (SC-FDMA, 50% RB, 15 MHz, 16-QAM)	LTE-TDD	9.90	± 9.6 %
10254	CAF	LTE-TDD (SC-FDMA, 50% RB, 15 MHz, 64-QAM)	LTE-TDD	10.14	± 9.6 %
10255	CAF	LTE-TDD (SC-FDMA, 50% RB, 15 MHz, QPSK)	LTE-TDD	9.20	± 9.6 %
10256	CAA	LTE-TDD (SC-FDMA, 100% RB, 1.4 MHz, 16-QAM)	LTE-TDD	9.96	± 9.6 %
10257	CAA	LTE-TDD (SC-FDMA, 100% RB, 1.4 MHz, 64-QAM)	LTE-TDD	10.08	± 9.6 %
10258	CAA	LTE-TDD (SC-FDMA, 100% RB, 1.4 MHz, QPSK)	LTE-TDD	9.34	± 9.6 %
10259	CAC	LTE-TDD (SC-FDMA, 100% RB, 3 MHz, 16-QAM)	LTE-TDD	9.98	± 9.6 %
10260	CAC	LTE-TDD (SC-FDMA, 100% RB, 3 MHz, 64-QAM)	LTE-TDD	9.97	± 9.6 %
10261	CAC	LTE-TDD (SC-FDMA, 100% RB, 3 MHz, QPSK)	LTE-TDD	9.24	± 9.6 %
10262	CAF	LTE-TDD (SC-FDMA, 100% RB, 5 MHz, 16-QAM)	LTE-TDD	9.83	± 9.6 %
10263	CAF	LTE-TDD (SC-FDMA, 100% RB, 5 MHz, 64-QAM)	LTE-TDD	10.16	± 9.6 %
10264	CAF	LTE-TDD (SC-FDMA, 100% RB, 5 MHz, QPSK)	LTE-TDD	9.23	± 9.6 %
10265	CAF	LTE-TDD (SC-FDMA, 100% RB, 10 MHz, 16-QAM)	LTE-TDD	9.92	± 9.6 %
10266	CAF	LTE-TDD (SC-FDMA, 100% RB, 10 MHz, 64-QAM)	LTE-TDD	10.07	± 9.6 %
10267	CAF	LTE-TDD (SC-FDMA, 100% RB, 10 MHz, QPSK)	LTE-TDD	9.30	± 9.6 %
10268	CAF	LTE-TDD (SC-FDMA, 100% RB, 15 MHz, 16-QAM)	LTE-TDD	10.06	± 9.6 %
10269	CAF	LTE-TDD (SC-FDMA, 100% RB, 15 MHz, 64-QAM)	LTE-TDD	10.13	± 9.6 %
10270	CAF	LTE-TDD (SC-FDMA, 100% RB, 15 MHz, QPSK)	LTE-TDD	9.58	± 9.6 %
10274	CAB	UMTS-FDD (HSUPA, Subtest 5, 3GPP Rel8.10)	WCDMA	4.87	± 9.6 %
10275	CAB	UMTS-FDD (HSUPA, Subtest 5, 3GPP Rel8.4)	WCDMA	3.96	± 9.6 %
10277	CAA	PHS (QPSK)	PHS	11.81	± 9.6 %
10278	CAA	PHS (QPSK, BW 884MHz, Rolloff 0.5)	PHS	11.81	± 9.6 %
10279	CAA	PHS (QPSK, BW 884MHz, Rolloff 0.38)	PHS	12.18	± 9.6 %
10290	AAB	CDMA2000, RC1, SO55, Full Rate	CDMA2000	3.91	± 9.6 %
10291	AAB	CDMA2000, RC3, SO55, Full Rate	CDMA2000	3.46	± 9.6 %
10292	AAB	CDMA2000, RC3, SO32, Full Rate	CDMA2000	3.39	± 9.6 %
10293	AAB	CDMA2000, RC3, SO3, Full Rate	CDMA2000	3.50	± 9.6 %
10295	AAB	CDMA2000, RC1, SO3, 1/8th Rate 25 fr.	CDMA2000	12.49	± 9.6 %
10297	AAD	LTE-FDD (SC-FDMA, 50% RB, 20 MHz, QPSK)	LTE-FDD	5.81	± 9.6 %
10298	AAD	LTE-FDD (SC-FDMA, 50% RB, 3 MHz, QPSK)	LTE-FDD	5.72	± 9.6 %
10299	AAD	LTE-FDD (SC-FDMA, 50% RB, 3 MHz, 16-QAM)	LTE-FDD	6.39	± 9.6 %

10300	AAD	LTE-FDD (SC-FDMA, 50% RB, 3 MHz, 64-QAM)	LTE-FDD	6.60	± 9.6 %
10301	AAA	IEEE 802.16e WiMAX (29:18, 5ms, 10MHz, QPSK, PUSC)	WiMAX	12.03	± 9.6 %
10302	AAA	IEEE 802.16e WiMAX (29:18, 5ms, 10MHz, QPSK, PUSC, 3 CTRL symbols)	WiMAX	12.57	± 9.6 %
10303	AAA	IEEE 802.16e WiMAX (31:15, 5ms, 10MHz, 64QAM, PUSC)	WiMAX	12.52	± 9.6 %
10304	AAA	IEEE 802.16e WiMAX (29:18, 5ms, 10MHz, 64QAM, PUSC)	WiMAX	11.86	± 9.6 %
10305	AAA	IEEE 802.16e WiMAX (31:15, 10ms, 10MHz, 64QAM, PUSC, 15 symbols)	WiMAX	15.24	± 9.6 %
10306	AAA	IEEE 802.16e WiMAX (29:18, 10ms, 10MHz, 64QAM, PUSC, 18 symbols)	WiMAX	14.67	± 9.6 %
10307	AAA	IEEE 802.16e WiMAX (29:18, 10ms, 10MHz, QPSK, PUSC, 18 symbols)	WiMAX	14.49	± 9.6 %
10308	AAA	IEEE 802.16e WiMAX (29:18, 10ms, 10MHz, 16QAM, PUSC)	WiMAX	14.46	± 9.6 %
10309	AAA	IEEE 802.16e WiMAX (29:18, 10ms, 10MHz, 16QAM, AMC 2x3, 18 symbols)	WiMAX	14.58	± 9.6 %
10310	AAA	IEEE 802.16e WiMAX (29:18, 10ms, 10MHz, QPSK, AMC 2x3, 18 symbols)	WiMAX	14.57	± 9.6 %
10311	AAD	LTE-FDD (SC-FDMA, 100% RB, 15 MHz, QPSK)	LTE-FDD	6.06	± 9.6 %
10313	AAA	iDEN 1:3	iDEN	10.51	± 9.6 %
10314	AAA	iDEN 1:6	iDEN	13.48	± 9.6 %
10315	AAB	IEEE 802.11b WiFi 2.4 GHz (DSSS, 1 Mbps, 96pc duty cycle)	WLAN	1.71	± 9.6 %
10316	AAB	IEEE 802.11g WiFi 2.4 GHz (ERP-OFDM, 6 Mbps, 96pc duty cycle)	WLAN	8.36	± 9.6 %
10317	AAC	IEEE 802.11a WiFi 5 GHz (OFDM, 6 Mbps, 96pc duty cycle)	WLAN	8.36	± 9.6 %
10352	AAA	Pulse Waveform (200Hz, 10%)	Generic	10.00	± 9.6 %
10353	AAA	Pulse Waveform (200Hz, 20%)	Generic	6.99	± 9.6 %
10354	AAA	Pulse Waveform (200Hz, 40%)	Generic	3.98	± 9.6 %
10355	AAA	Pulse Waveform (200Hz, 60%)	Generic	2.22	± 9.6 %
10356	AAA	Pulse Waveform (200Hz, 80%)	Generic	0.97	± 9.6 %
10387	AAA	QPSK Waveform, 1 MHz	Generic	5.10	± 9.6 %
10388	AAA	QPSK Waveform, 10 MHz	Generic	5.22	± 9.6 %
10396	AAA	64-QAM Waveform, 100 kHz	Generic	6.27	± 9.6 %
10399	AAA	64-QAM Waveform, 40 MHz	Generic	6.27	± 9.6 %
10400	AAD	IEEE 802.11ac WiFi (20MHz, 64-QAM, 99pc duty cycle)	WLAN	8.37	± 9.6 %
10401	AAD	IEEE 802.11ac WiFi (40MHz, 64-QAM, 99pc duty cycle)	WLAN	8.60	± 9.6 %
10402	AAD	IEEE 802.11ac WiFi (80MHz, 64-QAM, 99pc duty cycle)	WLAN	8.53	± 9.6 %
10403	AAB	CDMA2000 (1xEV-DO, Rev. 0)	CDMA2000	3.76	± 9.6 %
10404	AAB	CDMA2000 (1xEV-DO, Rev. A)	CDMA2000	3.77	± 9.6 %
10406	AAB	CDMA2000, RC3, SO32, SCH0, Full Rate	CDMA2000	5.22	± 9.6 %
10410	AAF	LTE-TDD (SC-FDMA, 1 RB, 10 MHz, QPSK, UL Subframe=2,3,4,7,8,9, Subframe Conf=4)	LTE-TDD	7.82	± 9.6 %
10414	AAA	WLAN CCDF, 64-QAM, 40MHz	Generic	8.54	± 9.6 %
10415	AAA	IEEE 802.11b WiFi 2.4 GHz (DSSS, 1 Mbps, 99pc duty cycle)	WLAN	1.54	± 9.6 %
10416	AAA	IEEE 802.11g WiFi 2.4 GHz (ERP-OFDM, 6 Mbps, 99pc duty cycle)	WLAN	8.23	± 9.6 %
10417	AAB	IEEE 802.11a/h WiFi 5 GHz (OFDM, 6 Mbps, 99pc duty cycle)	WLAN	8.23	± 9.6 %
10418	AAA	IEEE 802.11g WiFi 2.4 GHz (DSSS-OFDM, 6 Mbps, 99pc duty cycle, Long preamble)	WLAN	8.14	± 9.6 %
10419	AAA	IEEE 802.11g WiFi 2.4 GHz (DSSS-OFDM, 6 Mbps, 99pc duty cycle, Short preamble)	WLAN	8.19	± 9.6 %
10422	AAB	IEEE 802.11n (HT Greenfield, 7.2 Mbps, BPSK)	WLAN	8.32	± 9.6 %
10423	AAB	IEEE 802.11n (HT Greenfield, 43.3 Mbps, 16-QAM)	WLAN	8.47	± 9.6 %
10424	AAB	IEEE 802.11n (HT Greenfield, 72.2 Mbps, 64-QAM)	WLAN	8.40	± 9.6 %
10425	AAB	IEEE 802.11n (HT Greenfield, 15 Mbps, BPSK)	WLAN	8.41	± 9.6 %
10426	AAB	IEEE 802.11n (HT Greenfield, 90 Mbps, 16-QAM)	WLAN	8.45	± 9.6 %
10427	AAB	IEEE 802.11n (HT Greenfield, 150 Mbps, 64-QAM)	WLAN	8.41	± 9.6 %
10430	AAD	LTE-FDD (OFDMA, 5 MHz, E-TM 3.1)	LTE-FDD	8.28	± 9.6 %
10431	AAD	LTE-FDD (OFDMA, 10 MHz, E-TM 3.1)	LTE-FDD	8.38	± 9.6 %
10432	AAC	LTE-FDD (OFDMA, 15 MHz, E-TM 3.1)	LTE-FDD	8.34	± 9.6 %
10433	AAC	LTE-FDD (OFDMA, 20 MHz, E-TM 3.1)	LTE-FDD	8.34	± 9.6 %
10434	AAA	W-CDMA (BS Test Model 1, 64 DPCH)	WCDMA	8.60	± 9.6 %
10435	AAF	LTE-TDD (SC-FDMA, 1 RB, 20 MHz, QPSK, UL Subframe=2,3,4,7,8,9)	LTE-TDD	7.82	± 9.6 %
10447	AAD	LTE-FDD (OFDMA, 5 MHz, E-TM 3.1, Clipping 44%)	LTE-FDD	7.56	± 9.6 %
10448	AAD	LTE-FDD (OFDMA, 10 MHz, E-TM 3.1, Clipping 44%)	LTE-FDD	7.53	± 9.6 %
10449	AAC	LTE-FDD (OFDMA, 15 MHz, E-TM 3.1, Clipping 44%)	LTE-FDD	7.51	± 9.6 %
10450	AAC	LTE-FDD (OFDMA, 20 MHz, E-TM 3.1, Clipping 44%)	LTE-FDD	7.48	± 9.6 %

10451	AAA	W-CDMA (BS Test Model 1, 64 DPCH, Clipping 44%)	WCDMA	7.59	± 9.6 %
10456	AAB	IEEE 802.11ac WiFi (160MHz, 64-QAM, 99pc duty cycle)	WLAN	8.63	± 9.6 %
10457	AAA	UMTS-FDD (DC-HSDPA)	WCDMA	6.62	± 9.6 %
10458	AAA	CDMA2000 (1xEV-DO, Rev. B, 2 carriers)	CDMA2000	6.55	± 9.6 %
10459	AAA	CDMA2000 (1xEV-DO, Rev. B, 3 carriers)	CDMA2000	8.25	± 9.6 %
10460	AAA	UMTS-FDD (WCDMA, AMR)	WCDMA	2.39	± 9.6 %
10461	AAA	LTE-TDD (SC-FDMA, 1 RB, 1.4 MHz, QPSK, UL Subframe=2,3,4,7,8,9)	LTE-TDD	7.82	± 9.6 %
10462	AAA	LTE-TDD (SC-FDMA, 1 RB, 1.4 MHz, 16-QAM, UL Subframe=2,3,4,7,8,9)	LTE-TDD	8.30	± 9.6 %
10463	AAA	LTE-TDD (SC-FDMA, 1 RB, 1.4 MHz, 64-QAM, UL Subframe=2,3,4,7,8,9)	LTE-TDD	8.56	± 9.6 %
10464	AAB	LTE-TDD (SC-FDMA, 1 RB, 3 MHz, QPSK, UL Subframe=2,3,4,7,8,9)	LTE-TDD	7.82	± 9.6 %
10465	AAB	LTE-TDD (SC-FDMA, 1 RB, 3 MHz, 16-QAM, UL Subframe=2,3,4,7,8,9)	LTE-TDD	8.32	± 9.6 %
10466	AAB	LTE-TDD (SC-FDMA, 1 RB, 3 MHz, 64-QAM, UL Subframe=2,3,4,7,8,9)	LTE-TDD	8.57	± 9.6 %
10467	AAE	LTE-TDD (SC-FDMA, 1 RB, 5 MHz, QPSK, UL Subframe=2,3,4,7,8,9)	LTE-TDD	7.82	± 9.6 %
10468	AAE	LTE-TDD (SC-FDMA, 1 RB, 5 MHz, 16-QAM, UL Subframe=2,3,4,7,8,9)	LTE-TDD	8.32	± 9.6 %
10469	AAE	LTE-TDD (SC-FDMA, 1 RB, 5 MHz, 64-QAM, UL Subframe=2,3,4,7,8,9)	LTE-TDD	8.56	± 9.6 %
10470	AAE	LTE-TDD (SC-FDMA, 1 RB, 10 MHz, QPSK, UL Subframe=2,3,4,7,8,9)	LTE-TDD	7.82	± 9.6 %
10471	AAE	LTE-TDD (SC-FDMA, 1 RB, 10 MHz, 16-QAM, UL Subframe=2,3,4,7,8,9)	LTE-TDD	8.32	± 9.6 %
10472	AAE	LTE-TDD (SC-FDMA, 1 RB, 10 MHz, 64-QAM, UL Subframe=2,3,4,7,8,9)	LTE-TDD	8.57	± 9.6 %
10473	AAE	LTE-TDD (SC-FDMA, 1 RB, 15 MHz, QPSK, UL Subframe=2,3,4,7,8,9)	LTE-TDD	7.82	± 9.6 %
10474	AAE	LTE-TDD (SC-FDMA, 1 RB, 15 MHz, 16-QAM, UL Subframe=2,3,4,7,8,9)	LTE-TDD	8.32	± 9.6 %
10475	AAE	LTE-TDD (SC-FDMA, 1 RB, 15 MHz, 64-QAM, UL Subframe=2,3,4,7,8,9)	LTE-TDD	8.57	± 9.6 %
10477	AAF	LTE-TDD (SC-FDMA, 1 RB, 20 MHz, 16-QAM, UL Subframe=2,3,4,7,8,9)	LTE-TDD	8.32	± 9.6 %
10478	AAF	LTE-TDD (SC-FDMA, 1 RB, 20 MHz, 64-QAM, UL Subframe=2,3,4,7,8,9)	LTE-TDD	8.57	± 9.6 %
10479	AAA	LTE-TDD (SC-FDMA, 50% RB, 1.4 MHz, QPSK, UL Subframe=2,3,4,7,8,9)	LTE-TDD	7.74	± 9.6 %
10480	AAA	LTE-TDD (SC-FDMA, 50% RB, 1.4 MHz, 16-QAM, UL Subframe=2,3,4,7,8,9)	LTE-TDD	8.18	± 9.6 %
10481	AAA	LTE-TDD (SC-FDMA, 50% RB, 1.4 MHz, 64-QAM, UL Subframe=2,3,4,7,8,9)	LTE-TDD	8.45	± 9.6 %
10482	AAB	LTE-TDD (SC-FDMA, 50% RB, 3 MHz, QPSK, UL Subframe=2,3,4,7,8,9)	LTE-TDD	7.71	± 9.6 %
10483	AAB	LTE-TDD (SC-FDMA, 50% RB, 3 MHz, 16-QAM, UL Subframe=2,3,4,7,8,9)	LTE-TDD	8.39	± 9.6 %
10484	AAB	LTE-TDD (SC-FDMA, 50% RB, 3 MHz, 64-QAM, UL Subframe=2,3,4,7,8,9)	LTE-TDD	8.47	± 9.6 %
10485	AAE	LTE-TDD (SC-FDMA, 50% RB, 5 MHz, QPSK, UL Subframe=2,3,4,7,8,9)	LTE-TDD	7.59	± 9.6 %
10486	AAE	LTE-TDD (SC-FDMA, 50% RB, 5 MHz, 16-QAM, UL Subframe=2,3,4,7,8,9)	LTE-TDD	8.38	± 9.6 %
10487	AAE	LTE-TDD (SC-FDMA, 50% RB, 5 MHz, 64-QAM, UL Subframe=2,3,4,7,8,9)	LTE-TDD	8.60	± 9.6 %
10488	AAE	LTE-TDD (SC-FDMA, 50% RB, 10 MHz, QPSK, UL Subframe=2,3,4,7,8,9)	LTE-TDD	7.70	± 9.6 %
10489	AAE	LTE-TDD (SC-FDMA, 50% RB, 10 MHz, 16-QAM, UL Subframe=2,3,4,7,8,9)	LTE-TDD	8.31	± 9.6 %
10490	AAE	LTE-TDD (SC-FDMA, 50% RB, 10 MHz, 64-QAM, UL Subframe=2,3,4,7,8,9)	LTE-TDD	8.54	± 9.6 %
10491	AAE	LTE-TDD (SC-FDMA, 50% RB, 15 MHz, QPSK, UL Subframe=2,3,4,7,8,9)	LTE-TDD	7.74	± 9.6 %

10492	AAE	LTE-TDD (SC-FDMA, 50% RB, 15 MHz, 16-QAM, UL Subframe=2,3,4,7,8,9)	LTE-TDD	8.41	± 9.6 %
10493	AAE	LTE-TDD (SC-FDMA, 50% RB, 15 MHz, 64-QAM, UL Subframe=2,3,4,7,8,9)	LTE-TDD	8.55	± 9.6 %
10494	AAF	LTE-TDD (SC-FDMA, 50% RB, 20 MHz, QPSK, UL Subframe=2,3,4,7,8,9)	LTE-TDD	7.74	± 9.6 %
10495	AAF	LTE-TDD (SC-FDMA, 50% RB, 20 MHz, 16-QAM, UL Subframe=2,3,4,7,8,9)	LTE-TDD	8.37	± 9.6 %
10496	AAF	LTE-TDD (SC-FDMA, 50% RB, 20 MHz, 64-QAM, UL Subframe=2,3,4,7,8,9)	LTE-TDD	8.54	± 9.6 %
10497	AAA	LTE-TDD (SC-FDMA, 100% RB, 1.4 MHz, QPSK, UL Subframe=2,3,4,7,8,9)	LTE-TDD	7.67	± 9.6 %
10498	AAA	LTE-TDD (SC-FDMA, 100% RB, 1.4 MHz, 16-QAM, UL Subframe=2,3,4,7,8,9)	LTE-TDD	8.40	± 9.6 %
10499	AAA	LTE-TDD (SC-FDMA, 100% RB, 1.4 MHz, 64-QAM, UL Subframe=2,3,4,7,8,9)	LTE-TDD	8.68	± 9.6 %
10500	AAB	LTE-TDD (SC-FDMA, 100% RB, 3 MHz, QPSK, UL Subframe=2,3,4,7,8,9)	LTE-TDD	7.67	± 9.6 %
10501	AAB	LTE-TDD (SC-FDMA, 100% RB, 3 MHz, 16-QAM, UL Subframe=2,3,4,7,8,9)	LTE-TDD	8.44	± 9.6 %
10502	AAB	LTE-TDD (SC-FDMA, 100% RB, 3 MHz, 64-QAM, UL Subframe=2,3,4,7,8,9)	LTE-TDD	8.52	± 9.6 %
10503	AAE	LTE-TDD (SC-FDMA, 100% RB, 5 MHz, QPSK, UL Subframe=2,3,4,7,8,9)	LTE-TDD	7.72	± 9.6 %
10504	AAE	LTE-TDD (SC-FDMA, 100% RB, 5 MHz, 16-QAM, UL Subframe=2,3,4,7,8,9)	LTE-TDD	8.31	± 9.6 %
10505	AAE	LTE-TDD (SC-FDMA, 100% RB, 5 MHz, 64-QAM, UL Subframe=2,3,4,7,8,9)	LTE-TDD	8.54	± 9.6 %
10506	AAE	LTE-TDD (SC-FDMA, 100% RB, 10 MHz, QPSK, UL Subframe=2,3,4,7,8,9)	LTE-TDD	7.74	± 9.6 %
10507	AAE	LTE-TDD (SC-FDMA, 100% RB, 10 MHz, 16-QAM, UL Subframe=2,3,4,7,8,9)	LTE-TDD	8.36	± 9.6 %
10508	AAE	LTE-TDD (SC-FDMA, 100% RB, 10 MHz, 64-QAM, UL Subframe=2,3,4,7,8,9)	LTE-TDD	8.55	± 9.6 %
10509	AAE	LTE-TDD (SC-FDMA, 100% RB, 15 MHz, QPSK, UL Subframe=2,3,4,7,8,9)	LTE-TDD	7.99	± 9.6 %
10510	AAE	LTE-TDD (SC-FDMA, 100% RB, 15 MHz, 16-QAM, UL Subframe=2,3,4,7,8,9)	LTE-TDD	8.49	± 9.6 %
10511	AAE	LTE-TDD (SC-FDMA, 100% RB, 15 MHz, 64-QAM, UL Subframe=2,3,4,7,8,9)	LTE-TDD	8.51	± 9.6 %
10512	AAF	LTE-TDD (SC-FDMA, 100% RB, 20 MHz, QPSK, UL Subframe=2,3,4,7,8,9)	LTE-TDD	7.74	± 9.6 %
10513	AAF	LTE-TDD (SC-FDMA, 100% RB, 20 MHz, 16-QAM, UL Subframe=2,3,4,7,8,9)	LTE-TDD	8.42	± 9.6 %
10514	AAF	LTE-TDD (SC-FDMA, 100% RB, 20 MHz, 64-QAM, UL Subframe=2,3,4,7,8,9)	LTE-TDD	8.45	± 9.6 %
10515	AAA	IEEE 802.11b WiFi 2.4 GHz (DSSS, 2 Mbps, 99pc duty cycle)	WLAN	1.58	± 9.6 %
10516	AAA	IEEE 802.11b WiFi 2.4 GHz (DSSS, 5.5 Mbps, 99pc duty cycle)	WLAN	1.57	± 9.6 %
10517	AAA	IEEE 802.11b WiFi 2.4 GHz (DSSS, 11 Mbps, 99pc duty cycle)	WLAN	1.58	± 9.6 %
10518	AAB	IEEE 802.11a/h WiFi 5 GHz (OFDM, 9 Mbps, 99pc duty cycle)	WLAN	8.23	± 9.6 %
10519	AAB	IEEE 802.11a/h WiFi 5 GHz (OFDM, 12 Mbps, 99pc duty cycle)	WLAN	8.39	± 9.6 %
10520	AAB	IEEE 802.11a/h WiFi 5 GHz (OFDM, 18 Mbps, 99pc duty cycle)	WLAN	8.12	± 9.6 %
10521	AAB	IEEE 802.11a/h WiFi 5 GHz (OFDM, 24 Mbps, 99pc duty cycle)	WLAN	7.97	± 9.6 %
10522	AAB	IEEE 802.11a/h WiFi 5 GHz (OFDM, 36 Mbps, 99pc duty cycle)	WLAN	8.45	± 9.6 %
10523	AAB	IEEE 802.11a/h WiFi 5 GHz (OFDM, 48 Mbps, 99pc duty cycle)	WLAN	8.08	± 9.6 %
10524	AAB	IEEE 802.11a/h WiFi 5 GHz (OFDM, 54 Mbps, 99pc duty cycle)	WLAN	8.27	± 9.6 %
10525	AAB	IEEE 802.11ac WiFi (20MHz, MCS0, 99pc duty cycle)	WLAN	8.36	± 9.6 %
10526	AAB	IEEE 802.11ac WiFi (20MHz, MCS1, 99pc duty cycle)	WLAN	8.42	± 9.6 %
10527	AAB	IEEE 802.11ac WiFi (20MHz, MCS2, 99pc duty cycle)	WLAN	8.21	± 9.6 %
10528	AAB	IEEE 802.11ac WiFi (20MHz, MCS3, 99pc duty cycle)	WLAN	8.36	± 9.6 %
10529	AAB	IEEE 802.11ac WiFi (20MHz, MCS4, 99pc duty cycle)	WLAN	8.36	± 9.6 %
10531	AAB	IEEE 802.11ac WiFi (20MHz, MCS6, 99pc duty cycle)	WLAN	8.43	± 9.6 %
10532	AAB	IEEE 802.11ac WiFi (20MHz, MCS7, 99pc duty cycle)	WLAN	8.29	± 9.6 %
10533	AAB	IEEE 802.11ac WiFi (20MHz, MCS8, 99pc duty cycle)	WLAN	8.38	± 9.6 %
10534	AAB	IEEE 802.11ac WiFi (40MHz, MCS0, 99pc duty cycle)	WLAN	8.45	± 9.6 %

10535	AAB	IEEE 802.11ac WiFi (40MHz, MCS1, 99pc duty cycle)	WLAN	8.45	± 9.6 %
10536	AAB	IEEE 802.11ac WiFi (40MHz, MCS2, 99pc duty cycle)	WLAN	8.32	± 9.6 %
10537	AAB	IEEE 802.11ac WiFi (40MHz, MCS3, 99pc duty cycle)	WLAN	8.44	± 9.6 %
10538	AAB	IEEE 802.11ac WiFi (40MHz, MCS4, 99pc duty cycle)	WLAN	8.54	± 9.6 %
10540	AAB	IEEE 802.11ac WiFi (40MHz, MCS6, 99pc duty cycle)	WLAN	8.39	± 9.6 %
10541	AAB	IEEE 802.11ac WiFi (40MHz, MCS7, 99pc duty cycle)	WLAN	8.46	± 9.6 %
10542	AAB	IEEE 802.11ac WiFi (40MHz, MCS8, 99pc duty cycle)	WLAN	8.65	± 9.6 %
10543	AAB	IEEE 802.11ac WiFi (40MHz, MCS9, 99pc duty cycle)	WLAN	8.65	± 9.6 %
10544	AAB	IEEE 802.11ac WiFi (80MHz, MCS0, 99pc duty cycle)	WLAN	8.47	± 9.6 %
10545	AAB	IEEE 802.11ac WiFi (80MHz, MCS1, 99pc duty cycle)	WLAN	8.55	± 9.6 %
10546	AAB	IEEE 802.11ac WiFi (80MHz, MCS2, 99pc duty cycle)	WLAN	8.35	± 9.6 %
10547	AAB	IEEE 802.11ac WiFi (80MHz, MCS3, 99pc duty cycle)	WLAN	8.49	± 9.6 %
10548	AAB	IEEE 802.11ac WiFi (80MHz, MCS4, 99pc duty cycle)	WLAN	8.37	± 9.6 %
10550	AAB	IEEE 802.11ac WiFi (80MHz, MCS6, 99pc duty cycle)	WLAN	8.38	± 9.6 %
10551	AAB	IEEE 802.11ac WiFi (80MHz, MCS7, 99pc duty cycle)	WLAN	8.50	± 9.6 %
10552	AAB	IEEE 802.11ac WiFi (80MHz, MCS8, 99pc duty cycle)	WLAN	8.42	± 9.6 %
10553	AAB	IEEE 802.11ac WiFi (80MHz, MCS9, 99pc duty cycle)	WLAN	8.45	± 9.6 %
10554	AAC	IEEE 802.11ac WiFi (160MHz, MCS0, 99pc duty cycle)	WLAN	8.48	± 9.6 %
10555	AAC	IEEE 802.11ac WiFi (160MHz, MCS1, 99pc duty cycle)	WLAN	8.47	± 9.6 %
10556	AAC	IEEE 802.11ac WiFi (160MHz, MCS2, 99pc duty cycle)	WLAN	8.50	± 9.6 %
10557	AAC	IEEE 802.11ac WiFi (160MHz, MCS3, 99pc duty cycle)	WLAN	8.52	± 9.6 %
10558	AAC	IEEE 802.11ac WiFi (160MHz, MCS4, 99pc duty cycle)	WLAN	8.61	± 9.6 %
10560	AAC	IEEE 802.11ac WiFi (160MHz, MCS6, 99pc duty cycle)	WLAN	8.73	± 9.6 %
10561	AAC	IEEE 802.11ac WiFi (160MHz, MCS7, 99pc duty cycle)	WLAN	8.56	± 9.6 %
10562	AAC	IEEE 802.11ac WiFi (160MHz, MCS8, 99pc duty cycle)	WLAN	8.69	± 9.6 %
10563	AAC	IEEE 802.11ac WiFi (160MHz, MCS9, 99pc duty cycle)	WLAN	8.77	± 9.6 %
10564	AAA	IEEE 802.11g WiFi 2.4 GHz (DSSS-OFDM, 9 Mbps, 99pc duty cycle)	WLAN	8.25	± 9.6 %
10565	AAA	IEEE 802.11g WiFi 2.4 GHz (DSSS-OFDM, 12 Mbps, 99pc duty cycle)	WLAN	8.45	± 9.6 %
10566	AAA	IEEE 802.11g WiFi 2.4 GHz (DSSS-OFDM, 18 Mbps, 99pc duty cycle)	WLAN	8.13	± 9.6 %
10567	AAA	IEEE 802.11g WiFi 2.4 GHz (DSSS-OFDM, 24 Mbps, 99pc duty cycle)	WLAN	8.00	± 9.6 %
10568	AAA	IEEE 802.11g WiFi 2.4 GHz (DSSS-OFDM, 36 Mbps, 99pc duty cycle)	WLAN	8.37	± 9.6 %
10569	AAA	IEEE 802.11g WiFi 2.4 GHz (DSSS-OFDM, 48 Mbps, 99pc duty cycle)	WLAN	8.10	± 9.6 %
10570	AAA	IEEE 802.11g WiFi 2.4 GHz (DSSS-OFDM, 54 Mbps, 99pc duty cycle)	WLAN	8.30	± 9.6 %
10571	AAA	IEEE 802.11b WiFi 2.4 GHz (DSSS, 1 Mbps, 90pc duty cycle)	WLAN	1.99	± 9.6 %
10572	AAA	IEEE 802.11b WiFi 2.4 GHz (DSSS, 2 Mbps, 90pc duty cycle)	WLAN	1.99	± 9.6 %
10573	AAA	IEEE 802.11b WiFi 2.4 GHz (DSSS, 5.5 Mbps, 90pc duty cycle)	WLAN	1.98	± 9.6 %
10574	AAA	IEEE 802.11b WiFi 2.4 GHz (DSSS, 11 Mbps, 90pc duty cycle)	WLAN	1.98	± 9.6 %
10575	AAA	IEEE 802.11g WiFi 2.4 GHz (DSSS-OFDM, 6 Mbps, 90pc duty cycle)	WLAN	8.59	± 9.6 %
10576	AAA	IEEE 802.11g WiFi 2.4 GHz (DSSS-OFDM, 9 Mbps, 90pc duty cycle)	WLAN	8.60	± 9.6 %
10577	AAA	IEEE 802.11g WiFi 2.4 GHz (DSSS-OFDM, 12 Mbps, 90pc duty cycle)	WLAN	8.70	± 9.6 %
10578	AAA	IEEE 802.11g WiFi 2.4 GHz (DSSS-OFDM, 18 Mbps, 90pc duty cycle)	WLAN	8.49	± 9.6 %
10579	AAA	IEEE 802.11g WiFi 2.4 GHz (DSSS-OFDM, 24 Mbps, 90pc duty cycle)	WLAN	8.36	± 9.6 %
10580	AAA	IEEE 802.11g WiFi 2.4 GHz (DSSS-OFDM, 36 Mbps, 90pc duty cycle)	WLAN	8.76	± 9.6 %
10581	AAA	IEEE 802.11g WiFi 2.4 GHz (DSSS-OFDM, 48 Mbps, 90pc duty cycle)	WLAN	8.35	± 9.6 %
10582	AAA	IEEE 802.11g WiFi 2.4 GHz (DSSS-OFDM, 54 Mbps, 90pc duty cycle)	WLAN	8.67	± 9.6 %
10583	AAB	IEEE 802.11a/h WiFi 5 GHz (OFDM, 6 Mbps, 90pc duty cycle)	WLAN	8.59	± 9.6 %
10584	AAB	IEEE 802.11a/h WiFi 5 GHz (OFDM, 9 Mbps, 90pc duty cycle)	WLAN	8.60	± 9.6 %
10585	AAB	IEEE 802.11a/h WiFi 5 GHz (OFDM, 12 Mbps, 90pc duty cycle)	WLAN	8.70	± 9.6 %
10586	AAB	IEEE 802.11a/h WiFi 5 GHz (OFDM, 18 Mbps, 90pc duty cycle)	WLAN	8.49	± 9.6 %
10587	AAB	IEEE 802.11a/h WiFi 5 GHz (OFDM, 24 Mbps, 90pc duty cycle)	WLAN	8.36	± 9.6 %

10588	AAB	IEEE 802.11a/h WiFi 5 GHz (OFDM, 36 Mbps, 90pc duty cycle)	WLAN	8.76	± 9.6 %
10589	AAB	IEEE 802.11a/h WiFi 5 GHz (OFDM, 48 Mbps, 90pc duty cycle)	WLAN	8.35	± 9.6 %
10590	AAB	IEEE 802.11a/h WiFi 5 GHz (OFDM, 54 Mbps, 90pc duty cycle)	WLAN	8.67	± 9.6 %
10591	AAB	IEEE 802.11n (HT Mixed, 20MHz, MCS0, 90pc duty cycle)	WLAN	8.63	± 9.6 %
10592	AAB	IEEE 802.11n (HT Mixed, 20MHz, MCS1, 90pc duty cycle)	WLAN	8.79	± 9.6 %
10593	AAB	IEEE 802.11n (HT Mixed, 20MHz, MCS2, 90pc duty cycle)	WLAN	8.64	± 9.6 %
10594	AAB	IEEE 802.11n (HT Mixed, 20MHz, MCS3, 90pc duty cycle)	WLAN	8.74	± 9.6 %
10595	AAB	IEEE 802.11n (HT Mixed, 20MHz, MCS4, 90pc duty cycle)	WLAN	8.74	± 9.6 %
10596	AAB	IEEE 802.11n (HT Mixed, 20MHz, MCS5, 90pc duty cycle)	WLAN	8.71	± 9.6 %
10597	AAB	IEEE 802.11n (HT Mixed, 20MHz, MCS6, 90pc duty cycle)	WLAN	8.72	± 9.6 %
10598	AAB	IEEE 802.11n (HT Mixed, 20MHz, MCS7, 90pc duty cycle)	WLAN	8.50	± 9.6 %
10599	AAB	IEEE 802.11n (HT Mixed, 40MHz, MCS0, 90pc duty cycle)	WLAN	8.79	± 9.6 %
10600	AAB	IEEE 802.11n (HT Mixed, 40MHz, MCS1, 90pc duty cycle)	WLAN	8.88	± 9.6 %
10601	AAB	IEEE 802.11n (HT Mixed, 40MHz, MCS2, 90pc duty cycle)	WLAN	8.82	± 9.6 %
10602	AAB	IEEE 802.11n (HT Mixed, 40MHz, MCS3, 90pc duty cycle)	WLAN	8.94	± 9.6 %
10603	AAB	IEEE 802.11n (HT Mixed, 40MHz, MCS4, 90pc duty cycle)	WLAN	9.03	± 9.6 %
10604	AAB	IEEE 802.11n (HT Mixed, 40MHz, MCS5, 90pc duty cycle)	WLAN	8.76	± 9.6 %
10605	AAB	IEEE 802.11n (HT Mixed, 40MHz, MCS6, 90pc duty cycle)	WLAN	8.97	± 9.6 %
10606	AAB	IEEE 802.11n (HT Mixed, 40MHz, MCS7, 90pc duty cycle)	WLAN	8.82	± 9.6 %
10607	AAB	IEEE 802.11ac WiFi (20MHz, MCS0, 90pc duty cycle)	WLAN	8.64	± 9.6 %
10608	AAB	IEEE 802.11ac WiFi (20MHz, MCS1, 90pc duty cycle)	WLAN	8.77	± 9.6 %
10609	AAB	IEEE 802.11ac WiFi (20MHz, MCS2, 90pc duty cycle)	WLAN	8.57	± 9.6 %
10610	AAB	IEEE 802.11ac WiFi (20MHz, MCS3, 90pc duty cycle)	WLAN	8.78	± 9.6 %
10611	AAB	IEEE 802.11ac WiFi (20MHz, MCS4, 90pc duty cycle)	WLAN	8.70	± 9.6 %
10612	AAB	IEEE 802.11ac WiFi (20MHz, MCS5, 90pc duty cycle)	WLAN	8.77	± 9.6 %
10613	AAB	IEEE 802.11ac WiFi (20MHz, MCS6, 90pc duty cycle)	WLAN	8.94	± 9.6 %
10614	AAB	IEEE 802.11ac WiFi (20MHz, MCS7, 90pc duty cycle)	WLAN	8.59	± 9.6 %
10615	AAB	IEEE 802.11ac WiFi (20MHz, MCS8, 90pc duty cycle)	WLAN	8.82	± 9.6 %
10616	AAB	IEEE 802.11ac WiFi (40MHz, MCS0, 90pc duty cycle)	WLAN	8.82	± 9.6 %
10617	AAB	IEEE 802.11ac WiFi (40MHz, MCS1, 90pc duty cycle)	WLAN	8.81	± 9.6 %
10618	AAB	IEEE 802.11ac WiFi (40MHz, MCS2, 90pc duty cycle)	WLAN	8.58	± 9.6 %
10619	AAB	IEEE 802.11ac WiFi (40MHz, MCS3, 90pc duty cycle)	WLAN	8.86	± 9.6 %
10620	AAB	IEEE 802.11ac WiFi (40MHz, MCS4, 90pc duty cycle)	WLAN	8.87	± 9.6 %
10621	AAB	IEEE 802.11ac WiFi (40MHz, MCS5, 90pc duty cycle)	WLAN	8.77	± 9.6 %
10622	AAB	IEEE 802.11ac WiFi (40MHz, MCS6, 90pc duty cycle)	WLAN	8.68	± 9.6 %
10623	AAB	IEEE 802.11ac WiFi (40MHz, MCS7, 90pc duty cycle)	WLAN	8.82	± 9.6 %
10624	AAB	IEEE 802.11ac WiFi (40MHz, MCS8, 90pc duty cycle)	WLAN	8.96	± 9.6 %
10625	AAB	IEEE 802.11ac WiFi (40MHz, MCS9, 90pc duty cycle)	WLAN	8.96	± 9.6 %
10626	AAB	IEEE 802.11ac WiFi (80MHz, MCS0, 90pc duty cycle)	WLAN	8.83	± 9.6 %
10627	AAB	IEEE 802.11ac WiFi (80MHz, MCS1, 90pc duty cycle)	WLAN	8.88	± 9.6 %
10628	AAB	IEEE 802.11ac WiFi (80MHz, MCS2, 90pc duty cycle)	WLAN	8.71	± 9.6 %
10629	AAB	IEEE 802.11ac WiFi (80MHz, MCS3, 90pc duty cycle)	WLAN	8.85	± 9.6 %
10630	AAB	IEEE 802.11ac WiFi (80MHz, MCS4, 90pc duty cycle)	WLAN	8.72	± 9.6 %
10631	AAB	IEEE 802.11ac WiFi (80MHz, MCS5, 90pc duty cycle)	WLAN	8.81	± 9.6 %
10632	AAB	IEEE 802.11ac WiFi (80MHz, MCS6, 90pc duty cycle)	WLAN	8.74	± 9.6 %
10633	AAB	IEEE 802.11ac WiFi (80MHz, MCS7, 90pc duty cycle)	WLAN	8.83	± 9.6 %
10634	AAB	IEEE 802.11ac WiFi (80MHz, MCS8, 90pc duty cycle)	WLAN	8.80	± 9.6 %
10635	AAB	IEEE 802.11ac WiFi (80MHz, MCS9, 90pc duty cycle)	WLAN	8.81	± 9.6 %
10636	AAC	IEEE 802.11ac WiFi (160MHz, MCS0, 90pc duty cycle)	WLAN	8.83	± 9.6 %
10637	AAC	IEEE 802.11ac WiFi (160MHz, MCS1, 90pc duty cycle)	WLAN	8.79	± 9.6 %
10638	AAC	IEEE 802.11ac WiFi (160MHz, MCS2, 90pc duty cycle)	WLAN	8.86	± 9.6 %
10639	AAC	IEEE 802.11ac WiFi (160MHz, MCS3, 90pc duty cycle)	WLAN	8.85	± 9.6 %
10640	AAC	IEEE 802.11ac WiFi (160MHz, MCS4, 90pc duty cycle)	WLAN	8.98	± 9.6 %
10641	AAC	IEEE 802.11ac WiFi (160MHz, MCS5, 90pc duty cycle)	WLAN	9.06	± 9.6 %
10642	AAC	IEEE 802.11ac WiFi (160MHz, MCS6, 90pc duty cycle)	WLAN	9.06	± 9.6 %
10643	AAC	IEEE 802.11ac WiFi (160MHz, MCS7, 90pc duty cycle)	WLAN	8.89	± 9.6 %
10644	AAC	IEEE 802.11ac WiFi (160MHz, MCS8, 90pc duty cycle)	WLAN	9.05	± 9.6 %
10645	AAC	IEEE 802.11ac WiFi (160MHz, MCS9, 90pc duty cycle)	WLAN	9.11	± 9.6 %
10646	AAF	LTE-TDD (SC-FDMA, 1 RB, 5 MHz, QPSK, UL Subframe=2,7)	LTE-TDD	11.96	± 9.6 %
10647	AAF	LTE-TDD (SC-FDMA, 1 RB, 20 MHz, QPSK, UL Subframe=2,7)	LTE-TDD	11.96	± 9.6 %
10648	AAA	CDMA2000 (1x Advanced)	CDMA2000	3.45	± 9.6 %
10652	AAD	LTE-TDD (OFDMA, 5 MHz, E-TM 3.1, Clipping 44%)	LTE-TDD	6.91	± 9.6 %
10653	AAD	LTE-TDD (OFDMA, 10 MHz, E-TM 3.1, Clipping 44%)	LTE-TDD	7.42	± 9.6 %
10654	AAD	LTE-TDD (OFDMA, 15 MHz, E-TM 3.1, Clipping 44%)	LTE-TDD	6.96	± 9.6 %

10655	AAE	LTE-TDD (OFDMA, 20 MHz, E-TM 3.1, Clipping 44%)	LTE-TDD	7.21	± 9.6 %
10658	AAA	Pulse Waveform (200Hz, 10%)	Test	10.00	± 9.6 %
10659	AAA	Pulse Waveform (200Hz, 20%)	Test	6.99	± 9.6 %
10660	AAA	Pulse Waveform (200Hz, 40%)	Test	3.98	± 9.6 %
10661	AAA	Pulse Waveform (200Hz, 60%)	Test	2.22	± 9.6 %
10662	AAA	Pulse Waveform (200Hz, 80%)	Test	0.97	± 9.6 %
10670	AAA	Bluetooth Low Energy	Bluetooth	2.19	± 9.6 %

^E Uncertainty is determined using the max. deviation from linear response applying rectangular distribution and is expressed for the square of the field value.



Accredited by the Swiss Accreditation Service (SAS)
The Swiss Accreditation Service is one of the signatories to the EA
Multilateral Agreement for the recognition of calibration certificates

Accreditation No.: **SCS 0108**

Client **PC-Test**

Certificate No: **EX3-7308_Aug18**

CALIBRATION CERTIFICATE

Object: **EX3DV4 - SN:7308**

Calibration procedure(s): **QA CAL-01.v9, QA CAL-14.v4, QA CAL-23.v5, QA CAL-25.v6
Calibration procedure for dosimetric E-field probes**

Calibration date: **August 23, 2018**

*BN ✓
09-06-2018*

This calibration certificate documents the traceability to national standards, which realize the physical units of measurements (SI).
The measurements and the uncertainties with confidence probability are given on the following pages and are part of the certificate.

All calibrations have been conducted in the closed laboratory facility: environment temperature (22 ± 3)°C and humidity < 70%.

Calibration Equipment used (M&TE critical for calibration)

Primary Standards	ID	Cal Date (Certificate No.)	Scheduled Calibration
Power meter NRP	SN: 104778	04-Apr-18 (No. 217-02672/02673)	Apr-19
Power sensor NRP-Z91	SN: 103244	04-Apr-18 (No. 217-02672)	Apr-19
Power sensor NRP-Z91	SN: 103245	04-Apr-18 (No. 217-02673)	Apr-19
Reference 20 dB Attenuator	SN: S5277 (20x)	04-Apr-18 (No. 217-02682)	Apr-19
Reference Probe ES3DV2	SN: 3013	30-Dec-17 (No. ES3-3013_Dec17)	Dec-18
DAE4	SN: 660	21-Dec-17 (No. DAE4-660_Dec17)	Dec-18
Secondary Standards	ID	Check Date (in house)	Scheduled Check
Power meter E4419B	SN: GB41293874	06-Apr-16 (in house check Jun-18)	In house check: Jun-20
Power sensor E4412A	SN: MY41498087	06-Apr-16 (in house check Jun-18)	In house check: Jun-20
Power sensor E4412A	SN: 000110210	06-Apr-16 (in house check Jun-18)	In house check: Jun-20
RF generator HP 8648C	SN: US3642U01700	04-Aug-99 (in house check Jun-18)	In house check: Jun-20
Network Analyzer E8358A	SN: US41080477	31-Mar-14 (in house check Oct-17)	In house check: Oct-18

Calibrated by: **Jeton Kastrati** (Name), **Laboratory Technician** (Function), [Signature]

Approved by: **Katja Pokovic** (Name), **Technical Manager** (Function), [Signature]

This calibration certificate shall not be reproduced except in full without written approval of the laboratory. Issued: August 24, 2018



Accredited by the Swiss Accreditation Service (SAS)

Accreditation No.: **SCS 0108**

The Swiss Accreditation Service is one of the signatories to the EA Multilateral Agreement for the recognition of calibration certificates

Glossary:

TSL	tissue simulating liquid
NORM _{x,y,z}	sensitivity in free space
ConvF	sensitivity in TSL / NORM _{x,y,z}
DCP	diode compression point
CF	crest factor (1/duty_cycle) of the RF signal
A, B, C, D	modulation dependent linearization parameters
Polarization φ	φ rotation around probe axis
Polarization ϑ	ϑ rotation around an axis that is in the plane normal to probe axis (at measurement center), i.e., $\vartheta = 0$ is normal to probe axis
Connector Angle	information used in DASY system to align probe sensor X to the robot coordinate system

Calibration is Performed According to the Following Standards:

- a) IEEE Std 1528-2013, "IEEE Recommended Practice for Determining the Peak Spatial-Averaged Specific Absorption Rate (SAR) in the Human Head from Wireless Communications Devices: Measurement Techniques", June 2013
- b) IEC 62209-1, "Measurement procedure for the assessment of Specific Absorption Rate (SAR) from hand-held and body-mounted devices used next to the ear (frequency range of 300 MHz to 6 GHz)", July 2016
- c) IEC 62209-2, "Procedure to determine the Specific Absorption Rate (SAR) for wireless communication devices used in close proximity to the human body (frequency range of 30 MHz to 6 GHz)", March 2010
- d) KDB 865664, "SAR Measurement Requirements for 100 MHz to 6 GHz"

Methods Applied and Interpretation of Parameters:

- *NORM_{x,y,z}*: Assessed for E-field polarization $\vartheta = 0$ ($f \leq 900$ MHz in TEM-cell; $f > 1800$ MHz: R22 waveguide). *NORM_{x,y,z}* are only intermediate values, i.e., the uncertainties of *NORM_{x,y,z}* does not affect the E^2 -field uncertainty inside TSL (see below *ConvF*).
- *NORM(f)_{x,y,z}* = *NORM_{x,y,z}* * *frequency_response* (see Frequency Response Chart). This linearization is implemented in DASY4 software versions later than 4.2. The uncertainty of the frequency response is included in the stated uncertainty of *ConvF*.
- *DCP_{x,y,z}*: DCP are numerical linearization parameters assessed based on the data of power sweep with CW signal (no uncertainty required). DCP does not depend on frequency nor media.
- *PAR*: PAR is the Peak to Average Ratio that is not calibrated but determined based on the signal characteristics
- *A_{x,y,z}; B_{x,y,z}; C_{x,y,z}; D_{x,y,z}; VR_{x,y,z}*: A, B, C, D are numerical linearization parameters assessed based on the data of power sweep for specific modulation signal. The parameters do not depend on frequency nor media. VR is the maximum calibration range expressed in RMS voltage across the diode.
- *ConvF and Boundary Effect Parameters*: Assessed in flat phantom using E-field (or Temperature Transfer Standard for $f \leq 800$ MHz) and inside waveguide using analytical field distributions based on power measurements for $f > 800$ MHz. The same setups are used for assessment of the parameters applied for boundary compensation (alpha, depth) of which typical uncertainty values are given. These parameters are used in DASY4 software to improve probe accuracy close to the boundary. The sensitivity in TSL corresponds to *NORM_{x,y,z}* * *ConvF* whereby the uncertainty corresponds to that given for *ConvF*. A frequency dependent *ConvF* is used in DASY version 4.4 and higher which allows extending the validity from ± 50 MHz to ± 100 MHz.
- *Spherical isotropy (3D deviation from isotropy)*: in a field of low gradients realized using a flat phantom exposed by a patch antenna.
- *Sensor Offset*: The sensor offset corresponds to the offset of virtual measurement center from the probe tip (on probe axis). No tolerance required.
- *Connector Angle*: The angle is assessed using the information gained by determining the *NORM_x* (no uncertainty required).

Probe EX3DV4

SN:7308

Manufactured: March 11, 2014
Calibrated: August 23, 2018

Calibrated for DASYS/EASY Systems
(Note: non-compatible with DASYS2 system!)

DASY/EASY - Parameters of Probe: EX3DV4 - SN:7308

Basic Calibration Parameters

	Sensor X	Sensor Y	Sensor Z	Unc (k=2)
Norm ($\mu V/(V/m)^2$) ^A	0.49	0.60	0.44	$\pm 10.1 \%$
DCP (mV) ^B	99.6	97.1	102.5	

Modulation Calibration Parameters

UID	Communication System Name		A dB	B dB $\sqrt{\mu V}$	C	D dB	VR mV	Unc ^E (k=2)
0	CW	X	0.0	0.0	1.0	0.00	177.2	$\pm 3.5 \%$
		Y	0.0	0.0	1.0		165.4	
		Z	0.0	0.0	1.0		159.6	

Note: For details on UID parameters see Appendix.

Sensor Model Parameters

	C1 fF	C2 fF	α V ⁻¹	T1 ms.V ⁻²	T2 ms.V ⁻¹	T3 ms	T4 V ⁻²	T5 V ⁻¹	T6
X	53.71	401.2	35.76	12.80	0.351	5.077	0.717	0.413	1.005
Y	56.67	439.8	38.08	13.44	0.524	5.100	0.000	0.597	1.012
Z	40.98	304.1	35.29	8.573	0.334	5.045	1.531	0.174	1.005

The reported uncertainty of measurement is stated as the standard uncertainty of measurement multiplied by the coverage factor k=2, which for a normal distribution corresponds to a coverage probability of approximately 95%.

^A The uncertainties of Norm X,Y,Z do not affect the E²-field uncertainty inside TSL (see Pages 5 and 6).

^B Numerical linearization parameter: uncertainty not required.

^E Uncertainty is determined using the max. deviation from linear response applying rectangular distribution and is expressed for the square of the field value.

DASY/EASY - Parameters of Probe: EX3DV4 - SN:7308

Calibration Parameter Determined in Head Tissue Simulating Media

f (MHz) ^C	Relative Permittivity ^F	Conductivity (S/m) ^F	ConvF X	ConvF Y	ConvF Z	Alpha ^G	Depth (mm) ^G	Unc (k=2)
750	41.9	0.89	10.23	10.23	10.23	0.57	0.81	± 12.0 %
835	41.5	0.90	9.96	9.96	9.96	0.58	0.81	± 12.0 %
1750	40.1	1.37	8.66	8.66	8.66	0.36	0.80	± 12.0 %
1900	40.0	1.40	8.26	8.26	8.26	0.29	0.85	± 12.0 %
2300	39.5	1.67	7.81	7.81	7.81	0.29	0.85	± 12.0 %
2450	39.2	1.80	7.45	7.45	7.45	0.35	0.91	± 12.0 %
2600	39.0	1.96	7.30	7.30	7.30	0.35	0.87	± 12.0 %
5250	35.9	4.71	5.10	5.10	5.10	0.40	1.80	± 13.1 %
5600	35.5	5.07	4.85	4.85	4.85	0.40	1.80	± 13.1 %
5750	35.4	5.22	5.04	5.04	5.04	0.40	1.80	± 13.1 %

^C Frequency validity above 300 MHz of ± 100 MHz only applies for DASY v4.4 and higher (see Page 2), else it is restricted to ± 50 MHz. The uncertainty is the RSS of the ConvF uncertainty at calibration frequency and the uncertainty for the indicated frequency band. Frequency validity below 300 MHz is ± 10, 25, 40, 50 and 70 MHz for ConvF assessments at 30, 64, 128, 150 and 220 MHz respectively. Above 5 GHz frequency validity can be extended to ± 110 MHz.

^F At frequencies below 3 GHz, the validity of tissue parameters (ϵ and σ) can be relaxed to ± 10% if liquid compensation formula is applied to measured SAR values. At frequencies above 3 GHz, the validity of tissue parameters (ϵ and σ) is restricted to ± 5%. The uncertainty is the RSS of the ConvF uncertainty for indicated target tissue parameters.

^G Alpha/Depth are determined during calibration. SPEAG warrants that the remaining deviation due to the boundary effect after compensation is always less than ± 1% for frequencies below 3 GHz and below ± 2% for frequencies between 3-6 GHz at any distance larger than half the probe tip diameter from the boundary.

DASY/EASY - Parameters of Probe: EX3DV4 - SN:7308

Calibration Parameter Determined in Body Tissue Simulating Media

f (MHz) ^C	Relative Permittivity ^F	Conductivity (S/m) ^F	ConvF X	ConvF Y	ConvF Z	Alpha ^G	Depth ^G (mm)	Unc (k=2)
750	55.5	0.96	10.38	10.38	10.38	0.36	0.99	± 12.0 %
835	55.2	0.97	10.19	10.19	10.19	0.50	0.82	± 12.0 %
1750	53.4	1.49	8.13	8.13	8.13	0.27	1.04	± 12.0 %
1900	53.3	1.52	7.79	7.79	7.79	0.38	0.85	± 12.0 %
2300	52.9	1.81	7.73	7.73	7.73	0.37	0.80	± 12.0 %
2450	52.7	1.95	7.57	7.57	7.57	0.34	0.88	± 12.0 %
2600	52.5	2.16	7.40	7.40	7.40	0.29	0.95	± 12.0 %
5250	48.9	5.36	4.48	4.48	4.48	0.50	1.90	± 13.1 %
5600	48.5	5.77	4.00	4.00	4.00	0.50	1.90	± 13.1 %
5750	48.3	5.94	4.18	4.18	4.18	0.50	1.90	± 13.1 %

^C Frequency validity above 300 MHz of ± 100 MHz only applies for DASY v4.4 and higher (see Page 2), else it is restricted to ± 50 MHz. The uncertainty is the RSS of the ConvF uncertainty at calibration frequency and the uncertainty for the indicated frequency band. Frequency validity below 300 MHz is ± 10, 25, 40, 50 and 70 MHz for ConvF assessments at 30, 64, 128, 150 and 220 MHz respectively. Above 5 GHz frequency validity can be extended to ± 110 MHz.

^F At frequencies below 3 GHz, the validity of tissue parameters (ϵ and σ) can be relaxed to ± 10% if liquid compensation formula is applied to measured SAR values. At frequencies above 3 GHz, the validity of tissue parameters (ϵ and σ) is restricted to ± 5%. The uncertainty is the RSS of the ConvF uncertainty for indicated target tissue parameters.

^G Alpha/Depth are determined during calibration. SPEAG warrants that the remaining deviation due to the boundary effect after compensation is always less than ± 1% for frequencies below 3 GHz and below ± 2% for frequencies between 3-6 GHz at any distance larger than half the probe tip diameter from the boundary.

Frequency Response of E-Field

(TEM-Cell:ifi110 EXX, Waveguide: R22)

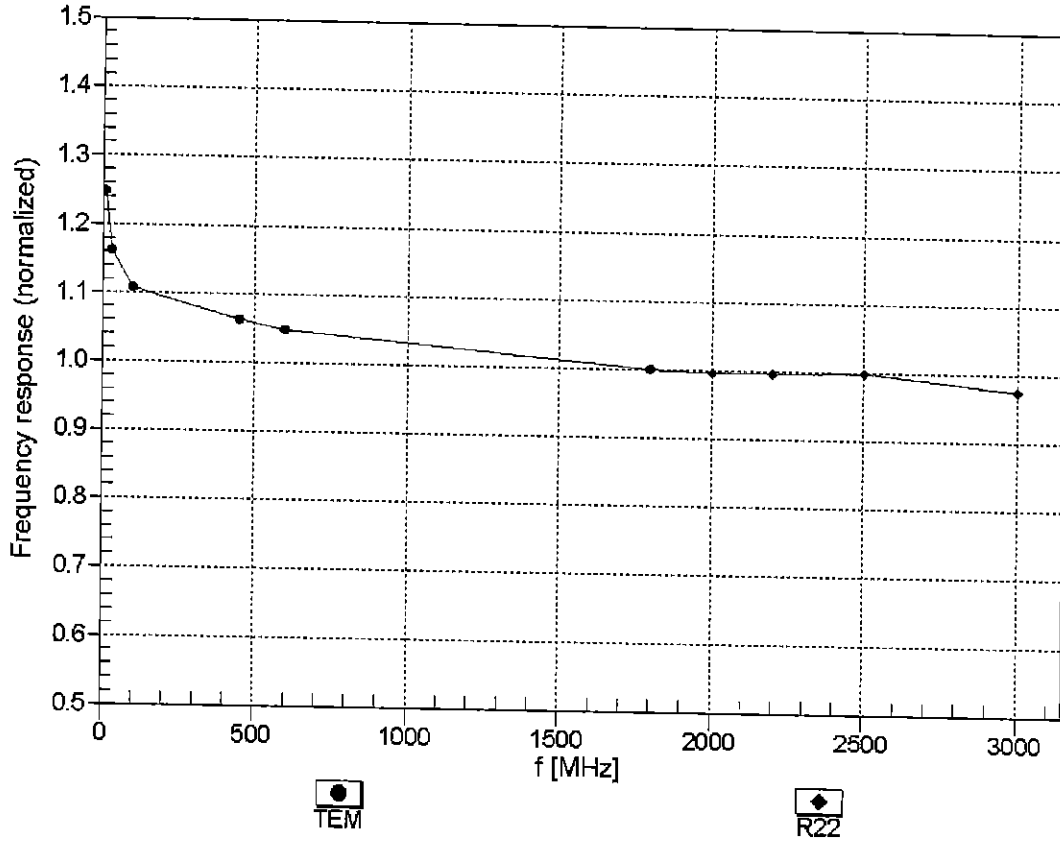

Uncertainty of Frequency Response of E-field: $\pm 6.3\%$ (k=2)

Receiving Pattern (ϕ), $\theta = 0^\circ$

f=600 MHz, TEM

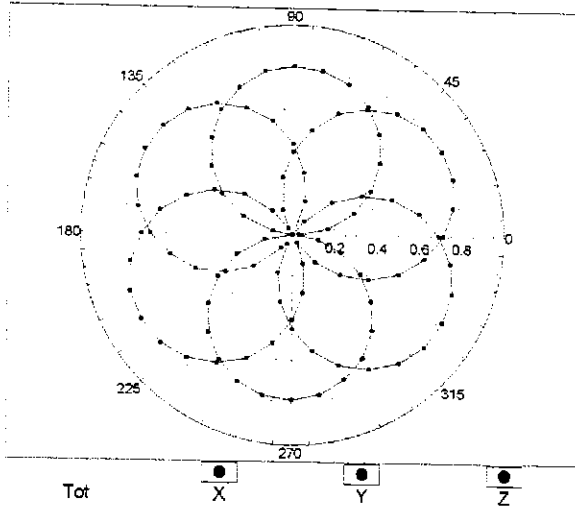

f=1800 MHz, R22

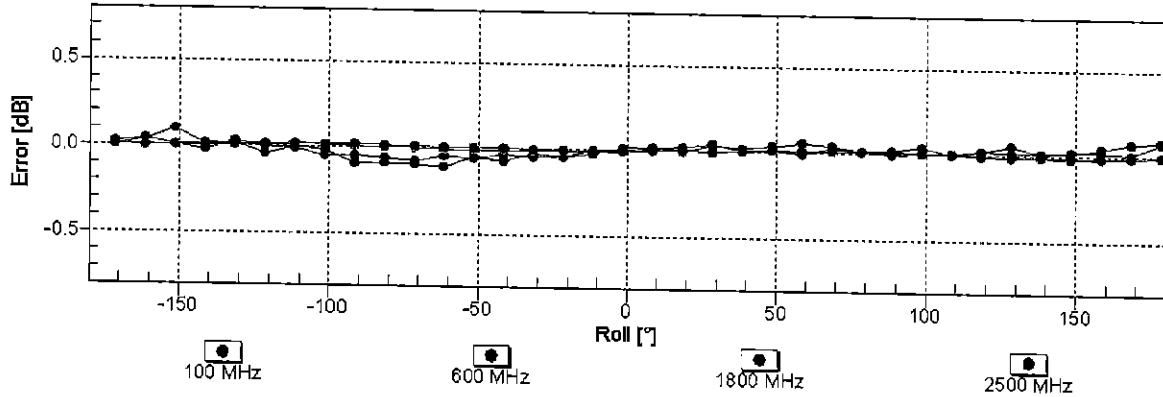
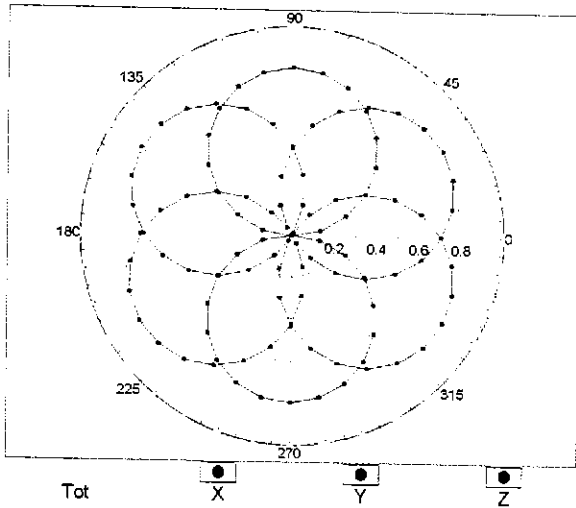

Uncertainty of Axial Isotropy Assessment: $\pm 0.5\%$ (k=2)

Dynamic Range f(SAR_{head}) (TEM cell , f_{eval}= 1900 MHz)

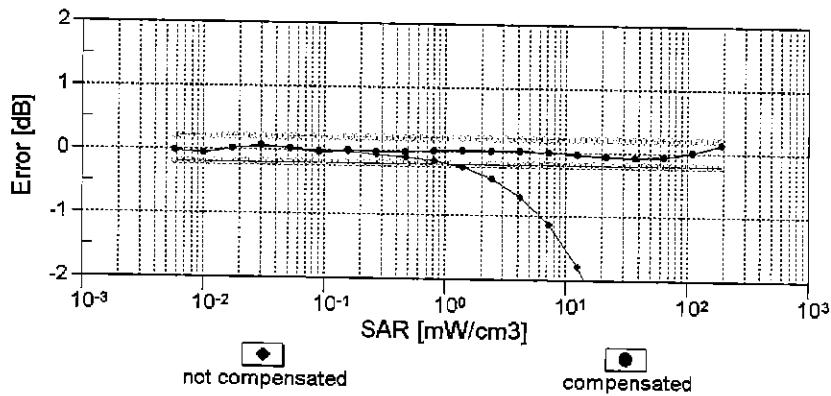
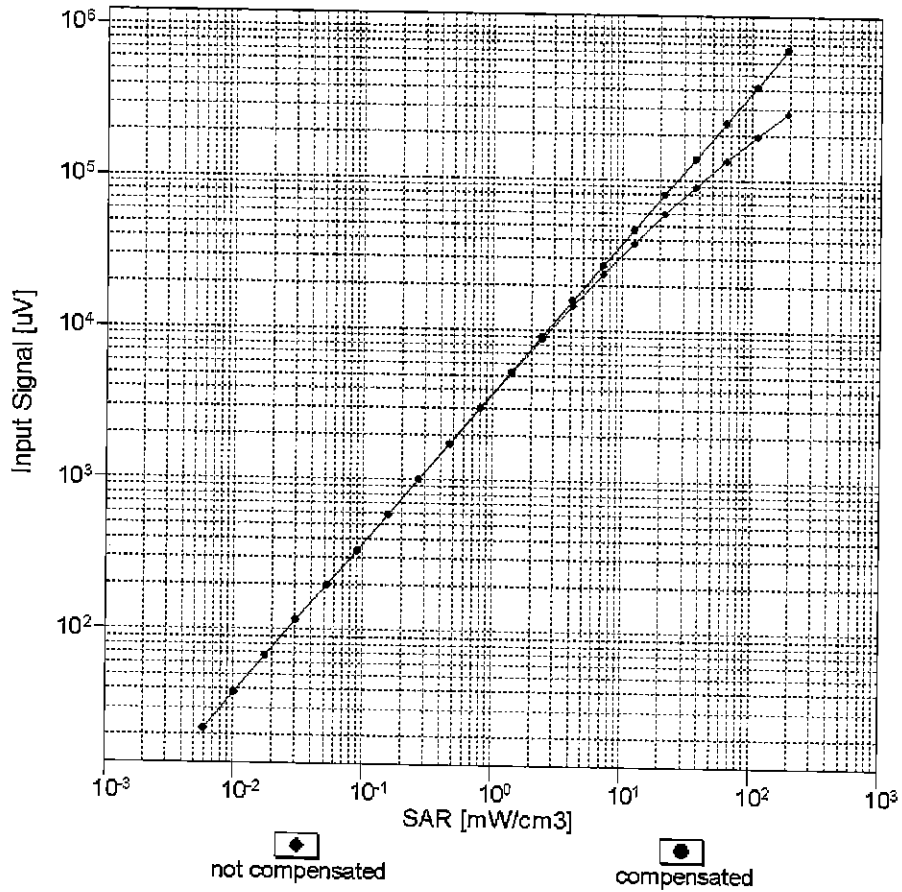

Uncertainty of Linearity Assessment: ± 0.6% (k=2)

Conversion Factor Assessment

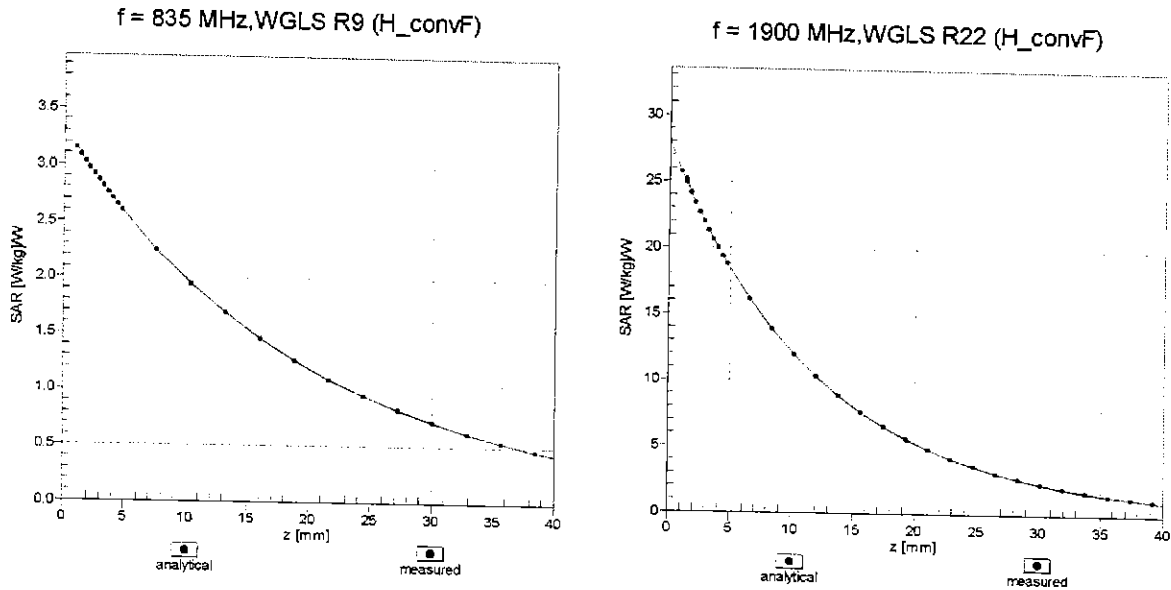

Deviation from Isotropy in Liquid Error (ϕ, θ), f = 900 MHz

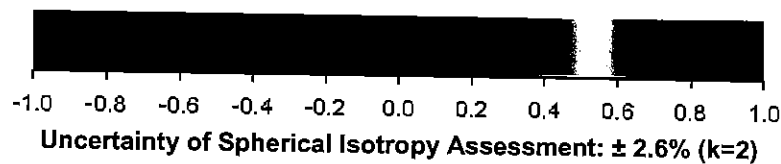
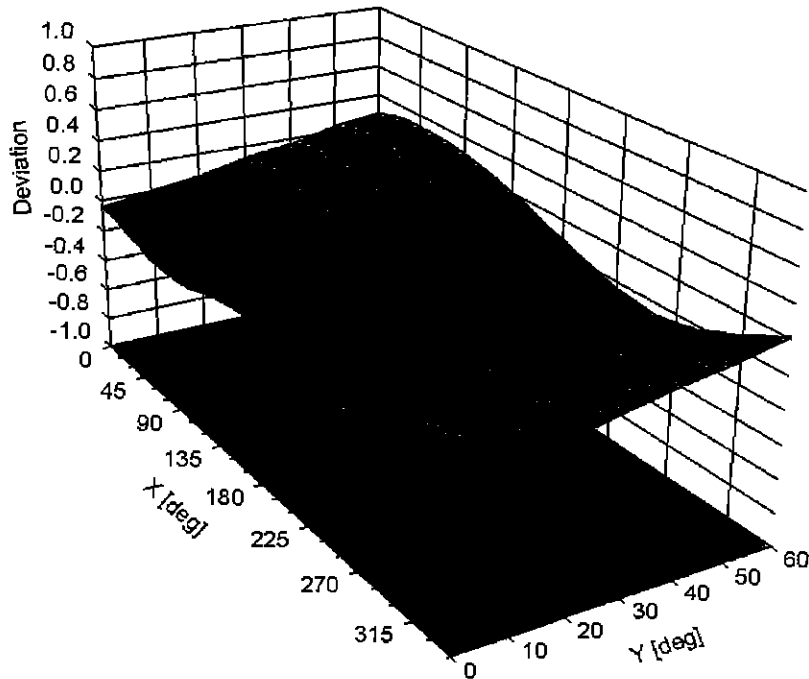

DASY/EASY - Parameters of Probe: EX3DV4 - SN:7308

Other Probe Parameters

Sensor Arrangement	Triangular
Connector Angle (°)	108.5
Mechanical Surface Detection Mode	enabled
Optical Surface Detection Mode	disabled
Probe Overall Length	337 mm
Probe Body Diameter	10 mm
Tip Length	9 mm
Tip Diameter	2.5 mm
Probe Tip to Sensor X Calibration Point	1 mm
Probe Tip to Sensor Y Calibration Point	1 mm
Probe Tip to Sensor Z Calibration Point	1 mm
Recommended Measurement Distance from Surface	1.4 mm

Appendix: Modulation Calibration Parameters

UID	Communication System Name		A dB	B dB $\sqrt{\mu}$ V	C	D dB	VR mV	Max Unc ^E (k=2)
0	CW	X	0.00	0.00	1.00	0.00	177.2	± 3.5 %
		Y	0.00	0.00	1.00		165.4	
		Z	0.00	0.00	1.00		159.6	
10010- CAA	SAR Validation (Square, 100ms, 10ms)	X	2.71	68.17	11.26	10.00	20.0	± 9.6 %
		Y	2.39	66.64	10.67		20.0	
		Z	1.90	64.26	9.03		20.0	
10011- CAB	UMTS-FDD (WCDMA)	X	1.19	70.37	17.06	0.00	150.0	± 9.6 %
		Y	0.96	66.50	14.51		150.0	
		Z	1.05	68.92	16.00		150.0	
10012- CAB	IEEE 802.11b WiFi 2.4 GHz (DSSS, 1 Mbps)	X	1.18	64.67	16.08	0.41	150.0	± 9.6 %
		Y	1.11	63.43	15.04		150.0	
		Z	1.13	64.11	15.48		150.0	
10013- CAB	IEEE 802.11g WiFi 2.4 GHz (DSSS-OFDM, 6 Mbps)	X	4.93	66.75	17.26	1.46	150.0	± 9.6 %
		Y	4.92	66.47	17.15		150.0	
		Z	4.74	66.75	17.08		150.0	
10021- DAC	GSM-FDD (TDMA, GMSK)	X	100.00	114.38	27.28	9.39	50.0	± 9.6 %
		Y	100.00	114.83	27.64		50.0	
		Z	100.00	109.69	24.90		50.0	
10023- DAC	GPRS-FDD (TDMA, GMSK, TN 0)	X	100.00	113.94	27.13	9.57	50.0	± 9.6 %
		Y	100.00	114.49	27.54		50.0	
		Z	100.00	109.21	24.74		50.0	
10024- DAC	GPRS-FDD (TDMA, GMSK, TN 0-1)	X	100.00	115.48	26.77	6.56	60.0	± 9.6 %
		Y	100.00	114.18	26.29		60.0	
		Z	100.00	109.85	23.86		60.0	
10025- DAC	EDGE-FDD (TDMA, 8PSK, TN 0)	X	6.22	84.66	34.29	12.57	50.0	± 9.6 %
		Y	4.94	76.24	29.94		50.0	
		Z	5.36	79.88	31.57		50.0	
10026- DAC	EDGE-FDD (TDMA, 8PSK, TN 0-1)	X	11.81	100.22	36.35	9.56	60.0	± 9.6 %
		Y	11.10	97.75	35.30		60.0	
		Z	7.89	90.81	32.78		60.0	
10027- DAC	GPRS-FDD (TDMA, GMSK, TN 0-1-2)	X	100.00	118.27	27.22	4.80	80.0	± 9.6 %
		Y	100.00	114.44	25.61		80.0	
		Z	100.00	111.67	23.86		80.0	
10028- DAC	GPRS-FDD (TDMA, GMSK, TN 0-1-2-3)	X	100.00	122.72	28.40	3.55	100.0	± 9.6 %
		Y	100.00	114.80	25.04		100.0	
		Z	100.00	114.83	24.49		100.0	
10029- DAC	EDGE-FDD (TDMA, 8PSK, TN 0-1-2)	X	6.56	85.50	29.56	7.80	80.0	± 9.6 %
		Y	6.53	84.80	29.16		80.0	
		Z	4.80	79.03	26.78		80.0	
10030- CAA	IEEE 802.15.1 Bluetooth (GFSK, DH1)	X	100.00	114.96	26.10	5.30	70.0	± 9.6 %
		Y	100.00	112.69	25.18		70.0	
		Z	100.00	108.37	22.73		70.0	
10031- CAA	IEEE 802.15.1 Bluetooth (GFSK, DH3)	X	100.00	126.84	28.53	1.88	100.0	± 9.6 %
		Y	100.00	105.21	19.68		100.0	
		Z	100.00	108.61	20.59		100.0	

10032-CAA	IEEE 802.15.1 Bluetooth (GFSK, DH5)	X	100.00	146.53	35.02	1.17	100.0	± 9.6 %
		Y	100.00	95.65	15.05		100.0	
		Z	100.00	112.23	21.08		100.0	
10033-CAA	IEEE 802.15.1 Bluetooth (PI/4-DQPSK, DH1)	X	100.00	133.98	36.90	5.30	70.0	± 9.6 %
		Y	94.91	132.14	36.35		70.0	
		Z	24.70	106.96	28.52		70.0	
10034-CAA	IEEE 802.15.1 Bluetooth (PI/4-DQPSK, DH3)	X	8.70	95.28	25.33	1.88	100.0	± 9.6 %
		Y	4.18	83.23	21.11		100.0	
		Z	3.97	82.01	19.44		100.0	
10035-CAA	IEEE 802.15.1 Bluetooth (PI/4-DQPSK, DH5)	X	3.83	83.82	21.38	1.17	100.0	± 9.6 %
		Y	2.23	74.99	17.69		100.0	
		Z	2.33	75.94	16.98		100.0	
10036-CAA	IEEE 802.15.1 Bluetooth (8-DPSK, DH1)	X	100.00	134.50	37.14	5.30	70.0	± 9.6 %
		Y	100.00	133.48	36.76		70.0	
		Z	56.60	119.91	31.85		70.0	
10037-CAA	IEEE 802.15.1 Bluetooth (8-DPSK, DH3)	X	7.69	93.53	24.78	1.88	100.0	± 9.6 %
		Y	3.89	82.31	20.76		100.0	
		Z	3.40	80.12	18.77		100.0	
10038-CAA	IEEE 802.15.1 Bluetooth (8-DPSK, DH5)	X	3.93	84.59	21.78	1.17	100.0	± 9.6 %
		Y	2.28	75.57	18.03		100.0	
		Z	2.38	76.51	17.34		100.0	
10039-CAB	CDMA2000 (1xRTT, RC1)	X	2.78	78.14	18.71	0.00	150.0	± 9.6 %
		Y	1.67	70.12	14.94		150.0	
		Z	2.00	74.01	15.76		150.0	
10042-CAB	IS-54 / IS-136 FDD (TDMA/FDM, PI/4-DQPSK, Halfrate)	X	100.00	110.92	24.96	7.78	50.0	± 9.6 %
		Y	100.00	110.22	24.75		50.0	
		Z	100.00	106.01	22.46		50.0	
10044-CAA	IS-91/EIA/TIA-553 FDD (FDMA, FM)	X	0.00	112.58	4.43	0.00	150.0	± 9.6 %
		Y	0.07	121.95	9.84		150.0	
		Z	0.01	118.94	9.83		150.0	
10048-CAA	DECT (TDD, TDMA/FDM, GFSK, Full Slot, 24)	X	100.00	111.48	27.44	13.80	25.0	± 9.6 %
		Y	100.00	112.85	28.28		25.0	
		Z	18.65	86.54	19.90		25.0	
10049-CAA	DECT (TDD, TDMA/FDM, GFSK, Double Slot, 12)	X	100.00	112.40	26.75	10.79	40.0	± 9.6 %
		Y	100.00	113.42	27.38		40.0	
		Z	46.23	99.19	22.45		40.0	
10056-CAA	UMTS-TDD (TD-SCDMA, 1.28 Mcps)	X	100.00	126.85	34.82	9.03	50.0	± 9.6 %
		Y	100.00	126.84	34.96		50.0	
		Z	73.14	116.99	30.84		50.0	
10058-DAC	EDGE-FDD (TDMA, 8PSK, TN 0-1-2-3)	X	4.87	79.06	26.07	6.55	100.0	± 9.6 %
		Y	4.89	78.72	25.82		100.0	
		Z	3.78	74.24	23.87		100.0	
10059-CAB	IEEE 802.11b WiFi 2.4 GHz (DSSS, 2 Mbps)	X	1.24	66.08	16.89	0.61	110.0	± 9.6 %
		Y	1.15	64.70	15.80		110.0	
		Z	1.15	65.12	16.08		110.0	
10060-CAB	IEEE 802.11b WiFi 2.4 GHz (DSSS, 5.5 Mbps)	X	100.00	145.11	38.67	1.30	110.0	± 9.6 %
		Y	100.00	138.14	35.54		110.0	
		Z	100.00	143.13	37.45		110.0	

10061-CAB	IEEE 802.11b WiFi 2.4 GHz (DSSS, 11 Mbps)	X	5.01	92.44	27.34	2.04	110.0	± 9.6 %
		Y	3.88	86.79	24.94		110.0	
		Z	2.64	81.37	23.02		110.0	
10062-CAC	IEEE 802.11a/h WiFi 5 GHz (OFDM, 6 Mbps)	X	4.74	66.80	16.70	0.49	100.0	± 9.6 %
		Y	4.72	66.44	16.52		100.0	
		Z	4.55	66.78	16.53		100.0	
10063-CAC	IEEE 802.11a/h WiFi 5 GHz (OFDM, 9 Mbps)	X	4.76	66.90	16.81	0.72	100.0	± 9.6 %
		Y	4.74	66.55	16.64		100.0	
		Z	4.57	66.86	16.62		100.0	
10064-CAC	IEEE 802.11a/h WiFi 5 GHz (OFDM, 12 Mbps)	X	5.07	67.18	17.05	0.86	100.0	± 9.6 %
		Y	5.06	66.88	16.91		100.0	
		Z	4.83	67.08	16.83		100.0	
10065-CAC	IEEE 802.11a/h WiFi 5 GHz (OFDM, 18 Mbps)	X	4.93	67.08	17.15	1.21	100.0	± 9.6 %
		Y	4.92	66.80	17.03		100.0	
		Z	4.69	66.95	16.91		100.0	
10066-CAC	IEEE 802.11a/h WiFi 5 GHz (OFDM, 24 Mbps)	X	4.95	67.11	17.33	1.46	100.0	± 9.6 %
		Y	4.94	66.84	17.22		100.0	
		Z	4.70	66.94	17.07		100.0	
10067-CAC	IEEE 802.11a/h WiFi 5 GHz (OFDM, 36 Mbps)	X	5.22	67.17	17.72	2.04	100.0	± 9.6 %
		Y	5.23	66.94	17.65		100.0	
		Z	4.99	67.15	17.52		100.0	
10068-CAC	IEEE 802.11a/h WiFi 5 GHz (OFDM, 48 Mbps)	X	5.28	67.31	17.99	2.55	100.0	± 9.6 %
		Y	5.30	67.12	17.95		100.0	
		Z	5.01	67.08	17.69		100.0	
10069-CAC	IEEE 802.11a/h WiFi 5 GHz (OFDM, 54 Mbps)	X	5.36	67.24	18.15	2.67	100.0	± 9.6 %
		Y	5.38	67.05	18.11		100.0	
		Z	5.09	67.11	17.88		100.0	
10071-CAB	IEEE 802.11g WiFi 2.4 GHz (DSSS/OFDM, 9 Mbps)	X	5.01	66.83	17.56	1.99	100.0	± 9.6 %
		Y	5.01	66.58	17.48		100.0	
		Z	4.83	66.80	17.36		100.0	
10072-CAB	IEEE 802.11g WiFi 2.4 GHz (DSSS/OFDM, 12 Mbps)	X	5.00	67.20	17.81	2.30	100.0	± 9.6 %
		Y	5.01	66.96	17.73		100.0	
		Z	4.79	67.07	17.56		100.0	
10073-CAB	IEEE 802.11g WiFi 2.4 GHz (DSSS/OFDM, 18 Mbps)	X	5.05	67.32	18.13	2.83	100.0	± 9.6 %
		Y	5.06	67.11	18.07		100.0	
		Z	4.84	67.21	17.87		100.0	
10074-CAB	IEEE 802.11g WiFi 2.4 GHz (DSSS/OFDM, 24 Mbps)	X	5.01	67.17	18.27	3.30	100.0	± 9.6 %
		Y	5.03	66.98	18.23		100.0	
		Z	4.82	67.10	18.01		100.0	
10075-CAB	IEEE 802.11g WiFi 2.4 GHz (DSSS/OFDM, 36 Mbps)	X	5.05	67.33	18.61	3.82	90.0	± 9.6 %
		Y	5.08	67.18	18.60		90.0	
		Z	4.84	67.13	18.28		90.0	
10076-CAB	IEEE 802.11g WiFi 2.4 GHz (DSSS/OFDM, 48 Mbps)	X	5.04	67.01	18.67	4.15	90.0	± 9.6 %
		Y	5.06	66.85	18.66		90.0	
		Z	4.86	66.95	18.41		90.0	
10077-CAB	IEEE 802.11g WiFi 2.4 GHz (DSSS/OFDM, 54 Mbps)	X	5.05	67.06	18.76	4.30	90.0	± 9.6 %
		Y	5.07	66.89	18.74		90.0	
		Z	4.89	67.03	18.52		90.0	

10081-CAB	CDMA2000 (1xRTT, RC3)	X	1.10	69.87	14.99	0.00	150.0	± 9.6 %
		Y	0.78	64.74	11.83		150.0	
		Z	0.78	66.34	11.97		150.0	
10082-CAB	IS-54 / IS-136 FDD (TDMA/FDM, PI/4-DQPSK, Fullrate)	X	0.69	60.00	4.39	4.77	80.0	± 9.6 %
		Y	0.71	60.00	4.39		80.0	
		Z	7.97	68.50	6.36		80.0	
10090-DAC	GPRS-FDD (TDMA, GMSK, TN 0-4)	X	100.00	115.53	26.81	6.56	60.0	± 9.6 %
		Y	100.00	114.29	26.36		60.0	
		Z	100.00	109.90	23.90		60.0	
10097-CAB	UMTS-FDD (HSDPA)	X	1.95	68.97	16.62	0.00	150.0	± 9.6 %
		Y	1.75	66.81	15.24		150.0	
		Z	1.87	68.90	16.13		150.0	
10098-CAB	UMTS-FDD (HSUPA, Subtest 2)	X	1.91	68.95	16.60	0.00	150.0	± 9.6 %
		Y	1.71	66.77	15.20		150.0	
		Z	1.83	68.86	16.11		150.0	
10099-DAC	EDGE-FDD (TDMA, 8PSK, TN 0-4)	X	11.93	100.45	36.42	9.56	60.0	± 9.6 %
		Y	11.20	97.95	35.37		60.0	
		Z	7.96	90.99	32.84		60.0	
10100-CAE	LTE-FDD (SC-FDMA, 100% RB, 20 MHz, QPSK)	X	3.40	71.76	17.45	0.00	150.0	± 9.6 %
		Y	3.10	69.82	16.33		150.0	
		Z	3.12	70.91	17.03		150.0	
10101-CAE	LTE-FDD (SC-FDMA, 100% RB, 20 MHz, 16-QAM)	X	3.36	68.15	16.35	0.00	150.0	± 9.6 %
		Y	3.24	67.23	15.77		150.0	
		Z	3.17	67.74	16.07		150.0	
10102-CAE	LTE-FDD (SC-FDMA, 100% RB, 20 MHz, 64-QAM)	X	3.45	68.05	16.42	0.00	150.0	± 9.6 %
		Y	3.34	67.19	15.87		150.0	
		Z	3.28	67.71	16.16		150.0	
10103-CAF	LTE-TDD (SC-FDMA, 100% RB, 20 MHz, QPSK)	X	6.86	77.75	21.56	3.98	65.0	± 9.6 %
		Y	6.56	76.62	21.10		65.0	
		Z	5.69	75.27	20.45		65.0	
10104-CAF	LTE-TDD (SC-FDMA, 100% RB, 20 MHz, 16-QAM)	X	6.41	74.58	21.07	3.98	65.0	± 9.6 %
		Y	6.33	74.04	20.86		65.0	
		Z	5.58	72.74	20.11		65.0	
10105-CAF	LTE-TDD (SC-FDMA, 100% RB, 20 MHz, 64-QAM)	X	6.09	73.43	20.88	3.98	65.0	± 9.6 %
		Y	6.03	72.95	20.69		65.0	
		Z	5.24	71.29	19.75		65.0	
10108-CAF	LTE-FDD (SC-FDMA, 100% RB, 10 MHz, QPSK)	X	2.97	70.94	17.29	0.00	150.0	± 9.6 %
		Y	2.72	69.08	16.17		150.0	
		Z	2.70	70.20	16.88		150.0	
10109-CAF	LTE-FDD (SC-FDMA, 100% RB, 10 MHz, 16-QAM)	X	3.02	68.05	16.32	0.00	150.0	± 9.6 %
		Y	2.90	67.02	15.66		150.0	
		Z	2.83	67.71	15.99		150.0	
10110-CAF	LTE-FDD (SC-FDMA, 100% RB, 5 MHz, QPSK)	X	2.42	70.09	17.00	0.00	150.0	± 9.6 %
		Y	2.21	68.14	15.78		150.0	
		Z	2.18	69.46	16.49		150.0	
10111-CAF	LTE-FDD (SC-FDMA, 100% RB, 5 MHz, 16-QAM)	X	2.76	69.06	16.78	0.00	150.0	± 9.6 %
		Y	2.59	67.59	15.88		150.0	
		Z	2.59	68.99	16.39		150.0	

10112-CAF	LTE-FDD (SC-FDMA, 100% RB, 10 MHz, 64-QAM)	X	3.14	67.97	16.35	0.00	150.0	± 9.6 %
		Y	3.03	67.00	15.72		150.0	
		Z	2.95	67.72	16.05		150.0	
10113-CAF	LTE-FDD (SC-FDMA, 100% RB, 5 MHz, 64-QAM)	X	2.92	69.11	16.87	0.00	150.0	± 9.6 %
		Y	2.75	67.72	16.02		150.0	
		Z	2.74	69.14	16.51		150.0	
10114-CAC	IEEE 802.11n (HT Greenfield, 13.5 Mbps, BPSK)	X	5.18	67.31	16.57	0.00	150.0	± 9.6 %
		Y	5.14	66.93	16.36		150.0	
		Z	5.02	67.26	16.48		150.0	
10115-CAC	IEEE 802.11n (HT Greenfield, 81 Mbps, 16-QAM)	X	5.52	67.57	16.70	0.00	150.0	± 9.6 %
		Y	5.51	67.29	16.56		150.0	
		Z	5.27	67.30	16.50		150.0	
10116-CAC	IEEE 802.11n (HT Greenfield, 135 Mbps, 64-QAM)	X	5.29	67.56	16.61	0.00	150.0	± 9.6 %
		Y	5.27	67.21	16.43		150.0	
		Z	5.10	67.44	16.50		150.0	
10117-CAC	IEEE 802.11n (HT Mixed, 13.5 Mbps, BPSK)	X	5.16	67.25	16.55	0.00	150.0	± 9.6 %
		Y	5.13	66.89	16.36		150.0	
		Z	4.99	67.15	16.44		150.0	
10118-CAC	IEEE 802.11n (HT Mixed, 81 Mbps, 16-QAM)	X	5.59	67.74	16.79	0.00	150.0	± 9.6 %
		Y	5.60	67.49	16.67		150.0	
		Z	5.34	67.49	16.60		150.0	
10119-CAC	IEEE 802.11n (HT Mixed, 135 Mbps, 64-QAM)	X	5.26	67.49	16.59	0.00	150.0	± 9.6 %
		Y	5.24	67.15	16.41		150.0	
		Z	5.09	67.40	16.49		150.0	
10140-CAE	LTE-FDD (SC-FDMA, 100% RB, 15 MHz, 16-QAM)	X	3.50	68.05	16.33	0.00	150.0	± 9.6 %
		Y	3.39	67.19	15.79		150.0	
		Z	3.30	67.72	16.07		150.0	
10141-CAE	LTE-FDD (SC-FDMA, 100% RB, 15 MHz, 64-QAM)	X	3.62	68.10	16.48	0.00	150.0	± 9.6 %
		Y	3.51	67.27	15.96		150.0	
		Z	3.43	67.85	16.25		150.0	
10142-CAE	LTE-FDD (SC-FDMA, 100% RB, 3 MHz, QPSK)	X	2.22	70.35	16.88	0.00	150.0	± 9.6 %
		Y	1.98	67.98	15.45		150.0	
		Z	1.97	69.67	16.10		150.0	
10143-CAE	LTE-FDD (SC-FDMA, 100% RB, 3 MHz, 16-QAM)	X	2.70	70.21	16.79	0.00	150.0	± 9.6 %
		Y	2.44	68.12	15.58		150.0	
		Z	2.48	69.97	16.00		150.0	
10144-CAE	LTE-FDD (SC-FDMA, 100% RB, 3 MHz, 64-QAM)	X	2.42	67.64	15.07	0.00	150.0	± 9.6 %
		Y	2.26	66.15	14.15		150.0	
		Z	2.13	66.86	13.96		150.0	
10145-CAF	LTE-FDD (SC-FDMA, 100% RB, 1.4 MHz, QPSK)	X	1.54	68.23	14.00	0.00	150.0	± 9.6 %
		Y	1.25	64.93	12.03		150.0	
		Z	1.00	63.72	10.21		150.0	
10146-CAF	LTE-FDD (SC-FDMA, 100% RB, 1.4 MHz, 16-QAM)	X	2.38	68.67	13.30	0.00	150.0	± 9.6 %
		Y	2.63	70.03	14.41		150.0	
		Z	1.37	62.94	8.80		150.0	
10147-CAF	LTE-FDD (SC-FDMA, 100% RB, 1.4 MHz, 64-QAM)	X	3.01	71.74	14.81	0.00	150.0	± 9.6 %
		Y	3.44	73.73	16.16		150.0	
		Z	1.50	63.86	9.38		150.0	

10149-CAE	LTE-FDD (SC-FDMA, 50% RB, 20 MHz, 16-QAM)	X	3.03	68.12	16.37	0.00	150.0	± 9.6 %
		Y	2.91	67.08	15.71		150.0	
		Z	2.84	67.78	16.04		150.0	
10150-CAE	LTE-FDD (SC-FDMA, 50% RB, 20 MHz, 64-QAM)	X	3.15	68.03	16.39	0.00	150.0	± 9.6 %
		Y	3.03	67.05	15.76		150.0	
		Z	2.96	67.78	16.09		150.0	
10151-CAF	LTE-TDD (SC-FDMA, 50% RB, 20 MHz, QPSK)	X	7.33	80.62	22.85	3.98	65.0	± 9.6 %
		Y	6.93	79.21	22.28		65.0	
		Z	6.07	78.22	21.74		65.0	
10152-CAF	LTE-TDD (SC-FDMA, 50% RB, 20 MHz, 16-QAM)	X	5.98	74.73	20.92	3.98	65.0	± 9.6 %
		Y	5.89	74.12	20.68		65.0	
		Z	5.12	72.74	19.78		65.0	
10153-CAF	LTE-TDD (SC-FDMA, 50% RB, 20 MHz, 64-QAM)	X	6.33	75.57	21.65	3.98	65.0	± 9.6 %
		Y	6.23	74.94	21.41		65.0	
		Z	5.49	73.78	20.61		65.0	
10154-CAF	LTE-FDD (SC-FDMA, 50% RB, 10 MHz, QPSK)	X	2.49	70.63	17.32	0.00	150.0	± 9.6 %
		Y	2.26	68.57	16.06		150.0	
		Z	2.24	69.92	16.77		150.0	
10155-CAF	LTE-FDD (SC-FDMA, 50% RB, 10 MHz, 16-QAM)	X	2.77	69.07	16.79	0.00	150.0	± 9.6 %
		Y	2.59	67.59	15.89		150.0	
		Z	2.59	69.02	16.41		150.0	
10156-CAF	LTE-FDD (SC-FDMA, 50% RB, 5 MHz, QPSK)	X	2.11	70.85	16.93	0.00	150.0	± 9.6 %
		Y	1.83	68.04	15.26		150.0	
		Z	1.82	69.80	15.80		150.0	
10157-CAF	LTE-FDD (SC-FDMA, 50% RB, 5 MHz, 16-QAM)	X	2.31	68.61	15.35	0.00	150.0	± 9.6 %
		Y	2.08	66.62	14.16		150.0	
		Z	1.98	67.47	13.92		150.0	
10158-CAF	LTE-FDD (SC-FDMA, 50% RB, 10 MHz, 64-QAM)	X	2.92	69.17	16.92	0.00	150.0	± 9.6 %
		Y	2.75	67.77	16.06		150.0	
		Z	2.75	69.22	16.57		150.0	
10159-CAF	LTE-FDD (SC-FDMA, 50% RB, 5 MHz, 64-QAM)	X	2.44	69.17	15.69	0.00	150.0	± 9.6 %
		Y	2.19	67.06	14.45		150.0	
		Z	2.09	67.96	14.21		150.0	
10160-CAE	LTE-FDD (SC-FDMA, 50% RB, 15 MHz, QPSK)	X	2.90	69.57	16.90	0.00	150.0	± 9.6 %
		Y	2.74	68.24	16.05		150.0	
		Z	2.70	69.25	16.60		150.0	
10161-CAE	LTE-FDD (SC-FDMA, 50% RB, 15 MHz, 16-QAM)	X	3.05	67.98	16.35	0.00	150.0	± 9.6 %
		Y	2.93	66.95	15.69		150.0	
		Z	2.86	67.77	16.01		150.0	
10162-CAE	LTE-FDD (SC-FDMA, 50% RB, 15 MHz, 64-QAM)	X	3.15	68.06	16.42	0.00	150.0	± 9.6 %
		Y	3.03	67.06	15.79		150.0	
		Z	2.97	67.96	16.14		150.0	
10166-CAF	LTE-FDD (SC-FDMA, 50% RB, 1.4 MHz, QPSK)	X	3.67	69.77	19.22	3.01	150.0	± 9.6 %
		Y	3.71	69.61	19.37		150.0	
		Z	3.45	70.11	19.35		150.0	
10167-CAF	LTE-FDD (SC-FDMA, 50% RB, 1.4 MHz, 16-QAM)	X	4.61	72.92	19.78	3.01	150.0	± 9.6 %
		Y	4.57	72.37	19.78		150.0	
		Z	4.42	74.02	20.14		150.0	

10168-CAF	LTE-FDD (SC-FDMA, 50% RB, 1.4 MHz, 64-QAM)	X	5.13	75.25	21.12	3.01	150.0	± 9.6 %
		Y	5.05	74.54	21.07		150.0	
		Z	5.13	77.22	21.87		150.0	
10169-CAE	LTE-FDD (SC-FDMA, 1 RB, 20 MHz, QPSK)	X	3.12	70.03	19.37	3.01	150.0	± 9.6 %
		Y	3.15	69.73	19.46		150.0	
		Z	2.86	69.57	19.15		150.0	
10170-CAE	LTE-FDD (SC-FDMA, 1 RB, 20 MHz, 16-QAM)	X	4.58	77.10	22.08	3.01	150.0	± 9.6 %
		Y	4.39	75.79	21.81		150.0	
		Z	4.44	78.23	22.53		150.0	
10171-AAE	LTE-FDD (SC-FDMA, 1 RB, 20 MHz, 64-QAM)	X	3.64	72.24	19.05	3.01	150.0	± 9.6 %
		Y	3.59	71.47	18.98		150.0	
		Z	3.36	72.39	19.02		150.0	
10172-CAF	LTE-TDD (SC-FDMA, 1 RB, 20 MHz, QPSK)	X	12.64	100.34	31.84	6.02	65.0	± 9.6 %
		Y	12.97	100.68	32.37		65.0	
		Z	5.77	87.24	27.51		65.0	
10173-CAF	LTE-TDD (SC-FDMA, 1 RB, 20 MHz, 16-QAM)	X	36.96	114.71	33.67	6.02	65.0	± 9.6 %
		Y	30.92	112.16	33.64		65.0	
		Z	22.36	108.00	31.61		65.0	
10174-CAF	LTE-TDD (SC-FDMA, 1 RB, 20 MHz, 64-QAM)	X	22.92	104.35	30.17	6.02	65.0	± 9.6 %
		Y	21.96	104.04	30.70		65.0	
		Z	11.65	95.24	27.25		65.0	
10175-CAF	LTE-FDD (SC-FDMA, 1 RB, 10 MHz, QPSK)	X	3.08	69.68	19.10	3.01	150.0	± 9.6 %
		Y	3.11	69.39	19.20		150.0	
		Z	2.82	69.22	18.88		150.0	
10176-CAF	LTE-FDD (SC-FDMA, 1 RB, 10 MHz, 16-QAM)	X	4.59	77.13	22.09	3.01	150.0	± 9.6 %
		Y	4.40	75.82	21.82		150.0	
		Z	4.45	78.26	22.55		150.0	
10177-CAH	LTE-FDD (SC-FDMA, 1 RB, 5 MHz, QPSK)	X	3.11	69.85	19.21	3.01	150.0	± 9.6 %
		Y	3.14	69.56	19.30		150.0	
		Z	2.84	69.38	18.97		150.0	
10178-CAF	LTE-FDD (SC-FDMA, 1 RB, 5 MHz, 16-QAM)	X	4.53	76.83	21.94	3.01	150.0	± 9.6 %
		Y	4.34	75.53	21.68		150.0	
		Z	4.39	77.99	22.42		150.0	
10179-CAF	LTE-FDD (SC-FDMA, 1 RB, 10 MHz, 64-QAM)	X	4.06	74.50	20.40	3.01	150.0	± 9.6 %
		Y	3.95	73.49	20.26		150.0	
		Z	3.83	75.09	20.61		150.0	
10180-CAF	LTE-FDD (SC-FDMA, 1 RB, 5 MHz, 64-QAM)	X	3.62	72.15	18.99	3.01	150.0	± 9.6 %
		Y	3.58	71.38	18.93		150.0	
		Z	3.35	72.32	18.97		150.0	
10181-CAE	LTE-FDD (SC-FDMA, 1 RB, 15 MHz, QPSK)	X	3.10	69.83	19.20	3.01	150.0	± 9.6 %
		Y	3.13	69.54	19.29		150.0	
		Z	2.84	69.36	18.97		150.0	
10182-CAE	LTE-FDD (SC-FDMA, 1 RB, 15 MHz, 16-QAM)	X	4.52	76.80	21.93	3.01	150.0	± 9.6 %
		Y	4.33	75.51	21.66		150.0	
		Z	4.38	77.96	22.40		150.0	
10183-AAE	LTE-FDD (SC-FDMA, 1 RB, 15 MHz, 64-QAM)	X	3.62	72.12	18.97	3.01	150.0	± 9.6 %
		Y	3.57	71.35	18.91		150.0	
		Z	3.34	72.29	18.96		150.0	

10184-CAE	LTE-FDD (SC-FDMA, 1 RB, 3 MHz, QPSK)	X	3.11	69.88	19.22	3.01	150.0	± 9.6 %
		Y	3.14	69.58	19.32		150.0	
		Z	2.85	69.41	18.99		150.0	
10185-CAE	LTE-FDD (SC-FDMA, 1 RB, 3 MHz, 16-QAM)	X	4.54	76.88	21.97	3.01	150.0	± 9.6 %
		Y	4.35	75.59	21.70		150.0	
		Z	4.41	78.06	22.45		150.0	
10186-AAE	LTE-FDD (SC-FDMA, 1 RB, 3 MHz, 64-QAM)	X	3.64	72.20	19.01	3.01	150.0	± 9.6 %
		Y	3.59	71.42	18.95		150.0	
		Z	3.36	72.37	19.00		150.0	
10187-CAF	LTE-FDD (SC-FDMA, 1 RB, 1.4 MHz, QPSK)	X	3.12	69.93	19.28	3.01	150.0	± 9.6 %
		Y	3.15	69.63	19.37		150.0	
		Z	2.86	69.48	19.07		150.0	
10188-CAF	LTE-FDD (SC-FDMA, 1 RB, 1.4 MHz, 16-QAM)	X	4.72	77.70	22.40	3.01	150.0	± 9.6 %
		Y	4.51	76.33	22.11		150.0	
		Z	4.61	78.98	22.92		150.0	
10189-AAF	LTE-FDD (SC-FDMA, 1 RB, 1.4 MHz, 64-QAM)	X	3.73	72.70	19.32	3.01	150.0	± 9.6 %
		Y	3.67	71.88	19.24		150.0	
		Z	3.46	72.92	19.33		150.0	
10193-CAC	IEEE 802.11n (HT Greenfield, 6.5 Mbps, BPSK)	X	4.59	66.76	16.33	0.00	150.0	± 9.6 %
		Y	4.55	66.31	16.09		150.0	
		Z	4.42	66.80	16.19		150.0	
10194-CAC	IEEE 802.11n (HT Greenfield, 39 Mbps, 16-QAM)	X	4.77	67.10	16.45	0.00	150.0	± 9.6 %
		Y	4.74	66.66	16.21		150.0	
		Z	4.58	67.08	16.32		150.0	
10195-CAC	IEEE 802.11n (HT Greenfield, 65 Mbps, 64-QAM)	X	4.82	67.12	16.46	0.00	150.0	± 9.6 %
		Y	4.78	66.69	16.22		150.0	
		Z	4.62	67.10	16.34		150.0	
10196-CAC	IEEE 802.11n (HT Mixed, 6.5 Mbps, BPSK)	X	4.60	66.84	16.36	0.00	150.0	± 9.6 %
		Y	4.56	66.40	16.12		150.0	
		Z	4.41	66.83	16.20		150.0	
10197-CAC	IEEE 802.11n (HT Mixed, 39 Mbps, 16-QAM)	X	4.79	67.12	16.46	0.00	150.0	± 9.6 %
		Y	4.75	66.69	16.22		150.0	
		Z	4.59	67.09	16.33		150.0	
10198-CAC	IEEE 802.11n (HT Mixed, 65 Mbps, 64-QAM)	X	4.82	67.14	16.47	0.00	150.0	± 9.6 %
		Y	4.78	66.71	16.24		150.0	
		Z	4.61	67.11	16.35		150.0	
10219-CAC	IEEE 802.11n (HT Mixed, 7.2 Mbps, BPSK)	X	4.55	66.86	16.33	0.00	150.0	± 9.6 %
		Y	4.51	66.41	16.08		150.0	
		Z	4.37	66.86	16.17		150.0	
10220-CAC	IEEE 802.11n (HT Mixed, 43.3 Mbps, 16-QAM)	X	4.79	67.10	16.45	0.00	150.0	± 9.6 %
		Y	4.75	66.67	16.22		150.0	
		Z	4.58	67.05	16.32		150.0	
10221-CAC	IEEE 802.11n (HT Mixed, 72.2 Mbps, 64-QAM)	X	4.83	67.06	16.45	0.00	150.0	± 9.6 %
		Y	4.79	66.64	16.23		150.0	
		Z	4.62	67.04	16.33		150.0	
10222-CAC	IEEE 802.11n (HT Mixed, 15 Mbps, BPSK)	X	5.14	67.26	16.55	0.00	150.0	± 9.6 %
		Y	5.11	66.90	16.36		150.0	
		Z	4.97	67.15	16.43		150.0	

10223-CAC	IEEE 802.11n (HT Mixed, 90 Mbps, 16-QAM)	X	5.45	67.43	16.65	0.00	150.0	± 9.6 %
		Y	5.45	67.18	16.52		150.0	
		Z	5.25	67.35	16.55		150.0	
10224-CAC	IEEE 802.11n (HT Mixed, 150 Mbps, 64-QAM)	X	5.19	67.37	16.53	0.00	150.0	± 9.6 %
		Y	5.15	66.99	16.33		150.0	
		Z	5.01	67.26	16.42		150.0	
10225-CAB	UMTS-FDD (HSPA+)	X	2.89	66.55	15.78	0.00	150.0	± 9.6 %
		Y	2.80	65.71	15.24		150.0	
		Z	2.72	66.49	15.32		150.0	
10226-CAA	LTE-TDD (SC-FDMA, 1 RB, 1.4 MHz, 16-QAM)	X	42.12	117.30	34.47	6.02	65.0	± 9.6 %
		Y	34.39	114.35	34.35		65.0	
		Z	25.78	110.75	32.49		65.0	
10227-CAA	LTE-TDD (SC-FDMA, 1 RB, 1.4 MHz, 64-QAM)	X	33.34	110.83	32.01	6.02	65.0	± 9.6 %
		Y	29.14	109.23	32.25		65.0	
		Z	23.91	107.08	30.63		65.0	
10228-CAA	LTE-TDD (SC-FDMA, 1 RB, 1.4 MHz, QPSK)	X	15.66	105.06	33.38	6.02	65.0	± 9.6 %
		Y	15.84	105.37	33.95		65.0	
		Z	7.75	93.33	29.68		65.0	
10229-CAC	LTE-TDD (SC-FDMA, 1 RB, 3 MHz, 16-QAM)	X	37.28	114.84	33.72	6.02	65.0	± 9.6 %
		Y	31.13	112.26	33.67		65.0	
		Z	22.62	108.17	31.67		65.0	
10230-CAC	LTE-TDD (SC-FDMA, 1 RB, 3 MHz, 64-QAM)	X	29.88	108.76	31.36	6.02	65.0	± 9.6 %
		Y	26.58	107.43	31.66		65.0	
		Z	20.85	104.61	29.86		65.0	
10231-CAC	LTE-TDD (SC-FDMA, 1 RB, 3 MHz, QPSK)	X	14.65	103.59	32.85	6.02	65.0	± 9.6 %
		Y	14.88	103.95	33.43		65.0	
		Z	7.34	92.15	29.19		65.0	
10232-CAE	LTE-TDD (SC-FDMA, 1 RB, 5 MHz, 16-QAM)	X	37.25	114.84	33.71	6.02	65.0	± 9.6 %
		Y	31.10	112.26	33.67		65.0	
		Z	22.58	108.16	31.67		65.0	
10233-CAE	LTE-TDD (SC-FDMA, 1 RB, 5 MHz, 64-QAM)	X	29.82	108.74	31.35	6.02	65.0	± 9.6 %
		Y	26.53	107.41	31.66		65.0	
		Z	20.76	104.56	29.85		65.0	
10234-CAE	LTE-TDD (SC-FDMA, 1 RB, 5 MHz, QPSK)	X	13.83	102.21	32.30	6.02	65.0	± 9.6 %
		Y	14.10	102.64	32.91		65.0	
		Z	7.03	91.14	28.71		65.0	
10235-CAE	LTE-TDD (SC-FDMA, 1 RB, 10 MHz, 16-QAM)	X	37.39	114.93	33.74	6.02	65.0	± 9.6 %
		Y	31.21	112.34	33.70		65.0	
		Z	22.65	108.24	31.69		65.0	
10236-CAE	LTE-TDD (SC-FDMA, 1 RB, 10 MHz, 64-QAM)	X	30.43	109.05	31.43	6.02	65.0	± 9.6 %
		Y	27.03	107.71	31.73		65.0	
		Z	21.22	104.87	29.93		65.0	
10237-CAE	LTE-TDD (SC-FDMA, 1 RB, 10 MHz, QPSK)	X	14.73	103.74	32.90	6.02	65.0	± 9.6 %
		Y	14.96	104.11	33.48		65.0	
		Z	7.35	92.21	29.22		65.0	
10238-CAE	LTE-TDD (SC-FDMA, 1 RB, 15 MHz, 16-QAM)	X	37.20	114.83	33.71	6.02	65.0	± 9.6 %
		Y	31.07	112.26	33.67		65.0	
		Z	22.51	108.13	31.66		65.0	

10239-CAE	LTE-TDD (SC-FDMA, 1 RB, 15 MHz, 64-QAM)	X	29.73	108.72	31.35	6.02	65.0	± 9.6 %
		Y	26.48	107.40	31.66		65.0	
		Z	20.66	104.50	29.83		65.0	
10240-CAE	LTE-TDD (SC-FDMA, 1 RB, 15 MHz, QPSK)	X	14.67	103.66	32.88	6.02	65.0	± 9.6 %
		Y	14.89	104.03	33.46		65.0	
		Z	7.33	92.17	29.20		65.0	
10241-CAA	LTE-TDD (SC-FDMA, 50% RB, 1.4 MHz, 16-QAM)	X	8.22	81.62	25.84	6.98	65.0	± 9.6 %
		Y	8.21	81.11	25.93		65.0	
		Z	7.55	81.89	25.74		65.0	
10242-CAA	LTE-TDD (SC-FDMA, 50% RB, 1.4 MHz, 64-QAM)	X	7.60	79.92	25.06	6.98	65.0	± 9.6 %
		Y	7.70	79.68	25.24		65.0	
		Z	6.63	79.21	24.57		65.0	
10243-CAA	LTE-TDD (SC-FDMA, 50% RB, 1.4 MHz, QPSK)	X	6.06	76.28	24.43	6.98	65.0	± 9.6 %
		Y	6.20	76.29	24.69		65.0	
		Z	5.27	75.02	23.70		65.0	
10244-CAC	LTE-TDD (SC-FDMA, 50% RB, 3 MHz, 16-QAM)	X	6.94	79.13	20.40	3.98	65.0	± 9.6 %
		Y	7.61	80.93	21.65		65.0	
		Z	4.63	73.01	16.54		65.0	
10245-CAC	LTE-TDD (SC-FDMA, 50% RB, 3 MHz, 64-QAM)	X	6.74	78.35	20.03	3.98	65.0	± 9.6 %
		Y	7.38	80.11	21.28		65.0	
		Z	4.46	72.20	16.14		65.0	
10246-CAC	LTE-TDD (SC-FDMA, 50% RB, 3 MHz, QPSK)	X	8.26	86.16	23.38	3.98	65.0	± 9.6 %
		Y	7.07	83.23	22.34		65.0	
		Z	4.76	77.46	19.00		65.0	
10247-CAE	LTE-TDD (SC-FDMA, 50% RB, 5 MHz, 16-QAM)	X	5.60	76.50	20.35	3.98	65.0	± 9.6 %
		Y	5.37	75.45	19.96		65.0	
		Z	4.29	72.64	17.71		65.0	
10248-CAE	LTE-TDD (SC-FDMA, 50% RB, 5 MHz, 64-QAM)	X	5.54	75.70	19.98	3.98	65.0	± 9.6 %
		Y	5.35	74.79	19.65		65.0	
		Z	4.24	71.91	17.36		65.0	
10249-CAE	LTE-TDD (SC-FDMA, 50% RB, 5 MHz, QPSK)	X	9.19	88.24	24.95	3.98	65.0	± 9.6 %
		Y	7.96	85.32	23.90		65.0	
		Z	6.28	82.28	22.02		65.0	
10250-CAE	LTE-TDD (SC-FDMA, 50% RB, 10 MHz, 16-QAM)	X	6.20	77.76	22.32	3.98	65.0	± 9.6 %
		Y	6.01	76.85	21.97		65.0	
		Z	5.20	75.42	20.86		65.0	
10251-CAE	LTE-TDD (SC-FDMA, 50% RB, 10 MHz, 64-QAM)	X	5.85	75.32	20.92	3.98	65.0	± 9.6 %
		Y	5.73	74.58	20.63		65.0	
		Z	4.92	73.12	19.45		65.0	
10252-CAE	LTE-TDD (SC-FDMA, 50% RB, 10 MHz, QPSK)	X	8.09	84.95	24.58	3.98	65.0	± 9.6 %
		Y	7.42	82.94	23.81		65.0	
		Z	6.31	81.52	22.96		65.0	
10253-CAE	LTE-TDD (SC-FDMA, 50% RB, 15 MHz, 16-QAM)	X	5.80	74.00	20.63	3.98	65.0	± 9.6 %
		Y	5.72	73.40	20.39		65.0	
		Z	5.04	72.28	19.52		65.0	
10254-CAE	LTE-TDD (SC-FDMA, 50% RB, 15 MHz, 64-QAM)	X	6.14	74.84	21.30	3.98	65.0	± 9.6 %
		Y	6.05	74.22	21.07		65.0	
		Z	5.36	73.21	20.25		65.0	

10255-CAE	LTE-TDD (SC-FDMA, 50% RB, 15 MHz, QPSK)	X	6.81	79.50	22.67	3.98	65.0	± 9.6 %
		Y	6.50	78.25	22.16		65.0	
		Z	5.72	77.37	21.59		65.0	
10256-CAA	LTE-TDD (SC-FDMA, 100% RB, 1.4 MHz, 16-QAM)	X	5.54	75.38	17.88	3.98	65.0	± 9.6 %
		Y	6.45	78.02	19.55		65.0	
		Z	3.15	67.52	12.83		65.0	
10257-CAA	LTE-TDD (SC-FDMA, 100% RB, 1.4 MHz, 64-QAM)	X	5.31	74.31	17.34	3.98	65.0	± 9.6 %
		Y	6.14	76.80	18.96		65.0	
		Z	3.05	66.79	12.37		65.0	
10258-CAA	LTE-TDD (SC-FDMA, 100% RB, 1.4 MHz, QPSK)	X	6.24	81.13	20.76	3.98	65.0	± 9.6 %
		Y	5.52	78.91	19.97		65.0	
		Z	3.09	70.62	15.05		65.0	
10259-CAC	LTE-TDD (SC-FDMA, 100% RB, 3 MHz, 16-QAM)	X	5.84	76.93	21.04	3.98	65.0	± 9.6 %
		Y	5.63	75.94	20.66		65.0	
		Z	4.68	73.82	18.92		65.0	
10260-CAC	LTE-TDD (SC-FDMA, 100% RB, 3 MHz, 64-QAM)	X	5.84	76.54	20.88	3.98	65.0	± 9.6 %
		Y	5.65	75.62	20.54		65.0	
		Z	4.68	73.47	18.76		65.0	
10261-CAC	LTE-TDD (SC-FDMA, 100% RB, 3 MHz, QPSK)	X	7.94	85.32	24.30	3.98	65.0	± 9.6 %
		Y	7.17	83.07	23.45		65.0	
		Z	5.90	80.89	22.01		65.0	
10262-CAE	LTE-TDD (SC-FDMA, 100% RB, 5 MHz, 16-QAM)	X	6.19	77.72	22.28	3.98	65.0	± 9.6 %
		Y	6.00	76.81	21.93		65.0	
		Z	5.19	75.36	20.81		65.0	
10263-CAE	LTE-TDD (SC-FDMA, 100% RB, 5 MHz, 64-QAM)	X	5.84	75.30	20.91	3.98	65.0	± 9.6 %
		Y	5.72	74.57	20.63		65.0	
		Z	4.91	73.09	19.44		65.0	
10264-CAE	LTE-TDD (SC-FDMA, 100% RB, 5 MHz, QPSK)	X	8.00	84.72	24.48	3.98	65.0	± 9.6 %
		Y	7.34	82.73	23.71		65.0	
		Z	6.24	81.28	22.84		65.0	
10265-CAE	LTE-TDD (SC-FDMA, 100% RB, 10 MHz, 16-QAM)	X	5.98	74.73	20.93	3.98	65.0	± 9.6 %
		Y	5.89	74.12	20.69		65.0	
		Z	5.12	72.74	19.78		65.0	
10266-CAE	LTE-TDD (SC-FDMA, 100% RB, 10 MHz, 64-QAM)	X	6.33	75.56	21.64	3.98	65.0	± 9.6 %
		Y	6.22	74.93	21.40		65.0	
		Z	5.49	73.76	20.60		65.0	
10267-CAE	LTE-TDD (SC-FDMA, 100% RB, 10 MHz, QPSK)	X	7.32	80.56	22.82	3.98	65.0	± 9.6 %
		Y	6.92	79.16	22.26		65.0	
		Z	6.05	78.17	21.72		65.0	
10268-CAE	LTE-TDD (SC-FDMA, 100% RB, 15 MHz, 16-QAM)	X	6.52	74.24	21.04	3.98	65.0	± 9.6 %
		Y	6.45	73.73	20.85		65.0	
		Z	5.74	72.63	20.16		65.0	
10269-CAE	LTE-TDD (SC-FDMA, 100% RB, 15 MHz, 64-QAM)	X	6.46	73.71	20.87	3.98	65.0	± 9.6 %
		Y	6.39	73.22	20.69		65.0	
		Z	5.73	72.22	20.02		65.0	
10270-CAE	LTE-TDD (SC-FDMA, 100% RB, 15 MHz, QPSK)	X	6.79	76.82	21.42	3.98	65.0	± 9.6 %
		Y	6.57	75.90	21.04		65.0	
		Z	5.88	75.11	20.59		65.0	

10274-CAB	UMTS-FDD (HSUPA, Subtest 5, 3GPP Rel8.10)	X	2.66	66.98	15.73	0.00	150.0	± 9.6 %
		Y	2.54	65.90	15.04		150.0	
		Z	2.55	67.07	15.35		150.0	
10275-CAB	UMTS-FDD (HSUPA, Subtest 5, 3GPP Rel8.4)	X	1.78	69.77	16.72	0.00	150.0	± 9.6 %
		Y	1.55	67.13	15.03		150.0	
		Z	1.62	69.04	16.02		150.0	
10277-CAA	PHS (QPSK)	X	2.12	61.97	7.55	9.03	50.0	± 9.6 %
		Y	2.25	62.30	7.96		50.0	
		Z	1.72	60.31	5.78		50.0	
10278-CAA	PHS (QPSK, BW 884MHz, Rolloff 0.5)	X	10.93	86.19	21.29	9.03	50.0	± 9.6 %
		Y	9.64	84.41	20.95		50.0	
		Z	3.57	69.00	13.15		50.0	
10279-CAA	PHS (QPSK, BW 884MHz, Rolloff 0.38)	X	11.22	86.49	21.46	9.03	50.0	± 9.6 %
		Y	9.91	84.71	21.11		50.0	
		Z	3.69	69.35	13.38		50.0	
10290-AAB	CDMA2000, RC1, SO55, Full Rate	X	1.95	72.86	16.32	0.00	150.0	± 9.6 %
		Y	1.38	67.46	13.46		150.0	
		Z	1.34	68.81	13.27		150.0	
10291-AAB	CDMA2000, RC3, SO55, Full Rate	X	1.06	69.47	14.79	0.00	150.0	± 9.6 %
		Y	0.76	64.53	11.71		150.0	
		Z	0.76	66.05	11.81		150.0	
10292-AAB	CDMA2000, RC3, SO32, Full Rate	X	1.83	78.35	18.94	0.00	150.0	± 9.6 %
		Y	0.91	67.73	13.68		150.0	
		Z	1.34	73.93	15.68		150.0	
10293-AAB	CDMA2000, RC3, SO3, Full Rate	X	4.73	93.04	24.47	0.00	150.0	± 9.6 %
		Y	1.31	72.72	16.40		150.0	
		Z	6.43	94.81	23.11		150.0	
10295-AAB	CDMA2000, RC1, SO3, 1/8th Rate 25 fr.	X	10.60	89.87	26.40	9.03	50.0	± 9.6 %
		Y	10.25	88.78	26.08		50.0	
		Z	12.25	89.80	24.68		50.0	
10297-AAD	LTE-FDD (SC-FDMA, 50% RB, 20 MHz, QPSK)	X	2.99	71.06	17.36	0.00	150.0	± 9.6 %
		Y	2.73	69.18	16.24		150.0	
		Z	2.72	70.32	16.96		150.0	
10298-AAD	LTE-FDD (SC-FDMA, 50% RB, 3 MHz, QPSK)	X	1.90	70.47	15.90	0.00	150.0	± 9.6 %
		Y	1.56	67.01	13.91		150.0	
		Z	1.44	67.67	13.50		150.0	
10299-AAD	LTE-FDD (SC-FDMA, 50% RB, 3 MHz, 16-QAM)	X	3.07	71.64	15.53	0.00	150.0	± 9.6 %
		Y	3.23	72.42	16.33		150.0	
		Z	2.17	67.61	12.32		150.0	
10300-AAD	LTE-FDD (SC-FDMA, 50% RB, 3 MHz, 64-QAM)	X	2.19	66.26	12.34	0.00	150.0	± 9.6 %
		Y	2.31	66.80	13.02		150.0	
		Z	1.57	63.33	9.50		150.0	
10301-AAA	IEEE 802.16e WiMAX (29:18, 5ms, 10MHz, QPSK, PUSC)	X	4.82	65.43	17.57	4.17	50.0	± 9.6 %
		Y	4.87	65.32	17.50		50.0	
		Z	4.60	65.72	17.49		50.0	
10302-AAA	IEEE 802.16e WiMAX (29:18, 5ms, 10MHz, QPSK, PUSC, 3 CTRL symbols)	X	5.31	66.17	18.35	4.96	50.0	± 9.6 %
		Y	5.36	66.00	18.25		50.0	
		Z	5.00	66.00	18.02		50.0	

10303-AAA	IEEE 802.16e WiMAX (31:15, 5ms, 10MHz, 64QAM, PUSC)	X	5.06	65.83	18.21	4.96	50.0	± 9.6 %
		Y	5.11	65.70	18.12		50.0	
		Z	4.75	65.61	17.82		50.0	
10304-AAA	IEEE 802.16e WiMAX (29:18, 5ms, 10MHz, 64QAM, PUSC)	X	4.87	65.69	17.69	4.17	50.0	± 9.6 %
		Y	4.90	65.47	17.55		50.0	
		Z	4.58	65.56	17.35		50.0	
10305-AAA	IEEE 802.16e WiMAX (31:15, 10ms, 10MHz, 64QAM, PUSC, 15 symbols)	X	4.43	67.35	19.83	6.02	35.0	± 9.6 %
		Y	4.56	67.70	19.98		35.0	
		Z	4.15	67.17	19.10		35.0	
10306-AAA	IEEE 802.16e WiMAX (29:18, 10ms, 10MHz, 64QAM, PUSC, 18 symbols)	X	4.77	66.43	19.36	6.02	35.0	± 9.6 %
		Y	4.86	66.61	19.45		35.0	
		Z	4.49	66.31	18.82		35.0	
10307-AAA	IEEE 802.16e WiMAX (29:18, 10ms, 10MHz, QPSK, PUSC, 18 symbols)	X	4.67	66.65	19.36	6.02	35.0	± 9.6 %
		Y	4.78	66.88	19.46		35.0	
		Z	4.37	66.39	18.75		35.0	
10308-AAA	IEEE 802.16e WiMAX (29:18, 10ms, 10MHz, 16QAM, PUSC)	X	4.64	66.81	19.48	6.02	35.0	± 9.6 %
		Y	4.74	67.03	19.58		35.0	
		Z	4.35	66.60	18.90		35.0	
10309-AAA	IEEE 802.16e WiMAX (29:18, 10ms, 10MHz, 16QAM, AMC 2x3, 18 symbols)	X	4.84	66.72	19.54	6.02	35.0	± 9.6 %
		Y	4.94	66.92	19.63		35.0	
		Z	4.52	66.47	18.95		35.0	
10310-AAA	IEEE 802.16e WiMAX (29:18, 10ms, 10MHz, QPSK, AMC 2x3, 18 symbols)	X	4.71	66.49	19.33	6.02	35.0	± 9.6 %
		Y	4.81	66.68	19.42		35.0	
		Z	4.43	66.37	18.80		35.0	
10311-AAD	LTE-FDD (SC-FDMA, 100% RB, 15 MHz, QPSK)	X	3.36	70.26	16.95	0.00	150.0	± 9.6 %
		Y	3.08	68.46	15.91		150.0	
		Z	3.08	69.51	16.57		150.0	
10313-AAA	IDEN 1:3	X	5.95	81.40	19.48	6.99	70.0	± 9.6 %
		Y	4.30	76.35	17.48		70.0	
		Z	3.21	73.80	16.43		70.0	
10314-AAA	IDEN 1:6	X	12.17	97.07	27.72	10.00	30.0	± 9.6 %
		Y	7.44	87.94	24.60		30.0	
		Z	6.18	85.76	23.72		30.0	
10315-AAB	IEEE 802.11b WiFi 2.4 GHz (DSSS, 1 Mbps, 96pc duty cycle)	X	1.10	64.61	16.02	0.17	150.0	± 9.6 %
		Y	1.01	63.21	14.85		150.0	
		Z	1.05	64.14	15.48		150.0	
10316-AAB	IEEE 802.11g WiFi 2.4 GHz (ERP-OFDM, 6 Mbps, 96pc duty cycle)	X	4.65	66.81	16.47	0.17	150.0	± 9.6 %
		Y	4.62	66.42	16.27		150.0	
		Z	4.46	66.78	16.31		150.0	
10317-AAC	IEEE 802.11a WiFi 5 GHz (OFDM, 6 Mbps, 96pc duty cycle)	X	4.65	66.81	16.47	0.17	150.0	± 9.6 %
		Y	4.62	66.42	16.27		150.0	
		Z	4.46	66.78	16.31		150.0	
10400-AAD	IEEE 802.11ac WiFi (20MHz, 64-QAM, 99pc duty cycle)	X	4.78	67.16	16.44	0.00	150.0	± 9.6 %
		Y	4.74	66.73	16.21		150.0	
		Z	4.55	67.11	16.31		150.0	
10401-AAD	IEEE 802.11ac WiFi (40MHz, 64-QAM, 99pc duty cycle)	X	5.43	67.23	16.53	0.00	150.0	± 9.6 %
		Y	5.42	66.92	16.38		150.0	
		Z	5.24	67.11	16.40		150.0	

10402-AAD	IEEE 802.11ac WiFi (80MHz, 64-QAM, 99pc duty cycle)	X	5.71	67.66	16.59	0.00	150.0	± 9.6 %
		Y	5.70	67.34	16.43		150.0	
		Z	5.52	67.48	16.45		150.0	
10403-AAB	CDMA2000 (1xEV-DO, Rev. 0)	X	1.95	72.86	16.32	0.00	115.0	± 9.6 %
		Y	1.38	67.46	13.46		115.0	
		Z	1.34	68.81	13.27		115.0	
10404-AAB	CDMA2000 (1xEV-DO, Rev. A)	X	1.95	72.86	16.32	0.00	115.0	± 9.6 %
		Y	1.38	67.46	13.46		115.0	
		Z	1.34	68.81	13.27		115.0	
10406-AAB	CDMA2000, RC3, SO32, SCH0, Full Rate	X	100.00	122.38	30.73	0.00	100.0	± 9.6 %
		Y	81.48	123.67	32.28		100.0	
		Z	100.00	114.83	26.66		100.0	
10410-AAE	LTE-TDD (SC-FDMA, 1 RB, 10 MHz, QPSK, UL Subframe=2,3,4,7,8,9, Subframe Conf=4)	X	100.00	123.65	31.04	3.23	80.0	± 9.6 %
		Y	100.00	127.30	33.02		80.0	
		Z	100.00	122.18	29.60		80.0	
10415-AAA	IEEE 802.11b WiFi 2.4 GHz (DSSS, 1 Mbps, 99pc duty cycle)	X	1.02	63.74	15.40	0.00	150.0	± 9.6 %
		Y	0.94	62.36	14.20		150.0	
		Z	0.99	63.49	14.99		150.0	
10416-AAA	IEEE 802.11g WiFi 2.4 GHz (ERP-OFDM, 6 Mbps, 99pc duty cycle)	X	4.59	66.79	16.39	0.00	150.0	± 9.6 %
		Y	4.55	66.36	16.15		150.0	
		Z	4.42	66.82	16.27		150.0	
10417-AAB	IEEE 802.11a/h WiFi 5 GHz (OFDM, 6 Mbps, 99pc duty cycle)	X	4.59	66.79	16.39	0.00	150.0	± 9.6 %
		Y	4.55	66.36	16.15		150.0	
		Z	4.42	66.82	16.27		150.0	
10418-AAA	IEEE 802.11g WiFi 2.4 GHz (DSSS-OFDM, 6 Mbps, 99pc duty cycle, Long preamble)	X	4.58	66.96	16.41	0.00	150.0	± 9.6 %
		Y	4.54	66.49	16.15		150.0	
		Z	4.42	67.01	16.31		150.0	
10419-AAA	IEEE 802.11g WiFi 2.4 GHz (DSSS-OFDM, 6 Mbps, 99pc duty cycle, Short preamble)	X	4.61	66.90	16.41	0.00	150.0	± 9.6 %
		Y	4.56	66.45	16.16		150.0	
		Z	4.43	66.95	16.30		150.0	
10422-AAB	IEEE 802.11n (HT Greenfield, 7.2 Mbps, BPSK)	X	4.73	66.90	16.41	0.00	150.0	± 9.6 %
		Y	4.69	66.47	16.18		150.0	
		Z	4.54	66.92	16.31		150.0	
10423-AAB	IEEE 802.11n (HT Greenfield, 43.3 Mbps, 16-QAM)	X	4.91	67.24	16.54	0.00	150.0	± 9.6 %
		Y	4.87	66.82	16.31		150.0	
		Z	4.68	67.21	16.40		150.0	
10424-AAB	IEEE 802.11n (HT Greenfield, 72.2 Mbps, 64-QAM)	X	4.82	67.19	16.51	0.00	150.0	± 9.6 %
		Y	4.79	66.76	16.28		150.0	
		Z	4.61	67.16	16.38		150.0	
10425-AAB	IEEE 802.11n (HT Greenfield, 15 Mbps, BPSK)	X	5.41	67.47	16.65	0.00	150.0	± 9.6 %
		Y	5.40	67.17	16.50		150.0	
		Z	5.21	67.35	16.53		150.0	
10426-AAB	IEEE 802.11n (HT Greenfield, 90 Mbps, 16-QAM)	X	5.41	67.47	16.65	0.00	150.0	± 9.6 %
		Y	5.40	67.19	16.50		150.0	
		Z	5.23	67.42	16.56		150.0	

10427-AAB	IEEE 802.11n (HT Greenfield, 150 Mbps, 64-QAM)	X	5.42	67.47	16.64	0.00	150.0	± 9.6 %
		Y	5.41	67.16	16.48		150.0	
		Z	5.22	67.32	16.51		150.0	
10430-AAC	LTE-FDD (OFDMA, 5 MHz, E-TM 3.1)	X	4.40	71.17	18.58	0.00	150.0	± 9.6 %
		Y	4.23	70.08	17.99		150.0	
		Z	4.30	72.10	18.56		150.0	
10431-AAC	LTE-FDD (OFDMA, 10 MHz, E-TM 3.1)	X	4.31	67.42	16.46	0.00	150.0	± 9.6 %
		Y	4.26	66.88	16.15		150.0	
		Z	4.07	67.45	16.24		150.0	
10432-AAC	LTE-FDD (OFDMA, 15 MHz, E-TM 3.1)	X	4.60	67.26	16.49	0.00	150.0	± 9.6 %
		Y	4.56	66.79	16.22		150.0	
		Z	4.38	67.26	16.33		150.0	
10433-AAC	LTE-FDD (OFDMA, 20 MHz, E-TM 3.1)	X	4.84	67.23	16.53	0.00	150.0	± 9.6 %
		Y	4.80	66.80	16.30		150.0	
		Z	4.63	67.20	16.40		150.0	
10434-AAA	W-CDMA (BS Test Model 1, 64 DPCH)	X	4.54	72.17	18.64	0.00	150.0	± 9.6 %
		Y	4.31	70.81	17.94		150.0	
		Z	4.47	73.20	18.53		150.0	
10435-AAE	LTE-TDD (SC-FDMA, 1 RB, 20 MHz, QPSK, UL Subframe=2,3,4,7,8,9)	X	100.00	123.43	30.93	3.23	80.0	± 9.6 %
		Y	100.00	127.09	32.93		80.0	
		Z	100.00	121.88	29.46		80.0	
10447-AAC	LTE-FDD (OFDMA, 5 MHz, E-TM 3.1, Clipping 44%)	X	3.63	67.60	15.97	0.00	150.0	± 9.6 %
		Y	3.55	66.82	15.51		150.0	
		Z	3.36	67.49	15.39		150.0	
10448-AAC	LTE-FDD (OFDMA, 10 MHz, E-TM 3.1, Clipping 44%)	X	4.14	67.21	16.33	0.00	150.0	± 9.6 %
		Y	4.08	66.64	16.00		150.0	
		Z	3.93	67.24	16.11		150.0	
10449-AAC	LTE-FDD (OFDMA, 15 MHz, E-TM 3.1, Clipping 44%)	X	4.40	67.10	16.39	0.00	150.0	± 9.6 %
		Y	4.35	66.60	16.11		150.0	
		Z	4.21	67.10	16.24		150.0	
10450-AAC	LTE-FDD (OFDMA, 20 MHz, E-TM 3.1, Clipping 44%)	X	4.59	67.00	16.40	0.00	150.0	± 9.6 %
		Y	4.54	66.54	16.14		150.0	
		Z	4.41	66.98	16.27		150.0	
10451-AAA	W-CDMA (BS Test Model 1, 64 DPCH, Clipping 44%)	X	3.56	67.91	15.68	0.00	150.0	± 9.6 %
		Y	3.45	67.01	15.16		150.0	
		Z	3.21	67.51	14.85		150.0	
10456-AAB	IEEE 802.11ac WiFi (160MHz, 64-QAM, 99pc duty cycle)	X	6.26	68.01	16.78	0.00	150.0	± 9.6 %
		Y	6.26	67.75	16.66		150.0	
		Z	6.13	67.97	16.72		150.0	
10457-AAA	UMTS-FDD (DC-HSDPA)	X	3.81	65.42	16.11	0.00	150.0	± 9.6 %
		Y	3.77	64.98	15.86		150.0	
		Z	3.73	65.50	15.98		150.0	
10458-AAA	CDMA2000 (1xEV-DO, Rev. B, 2 carriers)	X	4.16	71.37	18.08	0.00	150.0	± 9.6 %
		Y	3.92	69.91	17.32		150.0	
		Z	4.02	72.11	17.63		150.0	
10459-AAA	CDMA2000 (1xEV-DO, Rev. B, 3 carriers)	X	5.19	68.40	18.36	0.00	150.0	± 9.6 %
		Y	5.10	67.75	18.06		150.0	
		Z	5.01	69.18	18.25		150.0	

10460-AAA	UMTS-FDD (WCDMA, AMR)	X	1.07	72.05	18.39	0.00	150.0	± 9.6 %
		Y	0.81	67.05	15.17		150.0	
		Z	0.95	70.49	17.24		150.0	
10461-AAA	LTE-TDD (SC-FDMA, 1 RB, 1.4 MHz, QPSK, UL Subframe=2,3,4,7,8,9)	X	100.00	129.11	33.59	3.29	80.0	± 9.6 %
		Y	100.00	132.68	35.56		80.0	
		Z	100.00	128.17	32.38		80.0	
10462-AAA	LTE-TDD (SC-FDMA, 1 RB, 1.4 MHz, 16-QAM, UL Subframe=2,3,4,7,8,9)	X	29.76	94.39	20.32	3.23	80.0	± 9.6 %
		Y	100.00	112.07	25.94		80.0	
		Z	0.79	60.49	7.76		80.0	
10463-AAA	LTE-TDD (SC-FDMA, 1 RB, 1.4 MHz, 64-QAM, UL Subframe=2,3,4,7,8,9)	X	2.50	68.97	12.20	3.23	80.0	± 9.6 %
		Y	100.00	107.58	23.85		80.0	
		Z	0.77	60.00	6.89		80.0	
10464-AAB	LTE-TDD (SC-FDMA, 1 RB, 3 MHz, QPSK, UL Subframe=2,3,4,7,8,9)	X	100.00	126.29	32.12	3.23	80.0	± 9.6 %
		Y	100.00	130.29	34.26		80.0	
		Z	100.00	124.25	30.42		80.0	
10465-AAB	LTE-TDD (SC-FDMA, 1 RB, 3 MHz, 16-QAM, UL Subframe=2,3,4,7,8,9)	X	9.13	82.53	17.12	3.23	80.0	± 9.6 %
		Y	100.00	111.30	25.58		80.0	
		Z	0.75	60.00	7.44		80.0	
10466-AAB	LTE-TDD (SC-FDMA, 1 RB, 3 MHz, 64-QAM, UL Subframe=2,3,4,7,8,9)	X	1.98	66.71	11.27	3.23	80.0	± 9.6 %
		Y	99.88	106.88	23.53		80.0	
		Z	0.78	60.00	6.83		80.0	
10467-AAD	LTE-TDD (SC-FDMA, 1 RB, 5 MHz, QPSK, UL Subframe=2,3,4,7,8,9)	X	100.00	126.60	32.25	3.23	80.0	± 9.6 %
		Y	100.00	130.59	34.40		80.0	
		Z	100.00	124.67	30.60		80.0	
10468-AAD	LTE-TDD (SC-FDMA, 1 RB, 5 MHz, 16-QAM, UL Subframe=2,3,4,7,8,9)	X	11.66	85.00	17.83	3.23	80.0	± 9.6 %
		Y	100.00	111.53	25.68		80.0	
		Z	0.75	60.09	7.51		80.0	
10469-AAD	LTE-TDD (SC-FDMA, 1 RB, 5 MHz, 64-QAM, UL Subframe=2,3,4,7,8,9)	X	1.98	66.75	11.28	3.23	80.0	± 9.6 %
		Y	100.00	106.90	23.54		80.0	
		Z	0.77	60.00	6.83		80.0	
10470-AAD	LTE-TDD (SC-FDMA, 1 RB, 10 MHz, QPSK, UL Subframe=2,3,4,7,8,9)	X	100.00	126.64	32.26	3.23	80.0	± 9.6 %
		Y	100.00	130.65	34.41		80.0	
		Z	100.00	124.69	30.60		80.0	
10471-AAD	LTE-TDD (SC-FDMA, 1 RB, 10 MHz, 16-QAM, UL Subframe=2,3,4,7,8,9)	X	11.32	84.67	17.72	3.23	80.0	± 9.6 %
		Y	100.00	111.46	25.64		80.0	
		Z	0.75	60.04	7.47		80.0	
10472-AAD	LTE-TDD (SC-FDMA, 1 RB, 10 MHz, 64-QAM, UL Subframe=2,3,4,7,8,9)	X	1.96	66.63	11.22	3.23	80.0	± 9.6 %
		Y	100.00	106.82	23.49		80.0	
		Z	0.77	60.00	6.81		80.0	
10473-AAD	LTE-TDD (SC-FDMA, 1 RB, 15 MHz, QPSK, UL Subframe=2,3,4,7,8,9)	X	100.00	126.60	32.24	3.23	80.0	± 9.6 %
		Y	100.00	130.61	34.39		80.0	
		Z	100.00	124.64	30.58		80.0	
10474-AAD	LTE-TDD (SC-FDMA, 1 RB, 15 MHz, 16-QAM, UL Subframe=2,3,4,7,8,9)	X	11.06	84.45	17.66	3.23	80.0	± 9.6 %
		Y	100.00	111.47	25.64		80.0	
		Z	0.74	60.02	7.45		80.0	
10475-AAD	LTE-TDD (SC-FDMA, 1 RB, 15 MHz, 64-QAM, UL Subframe=2,3,4,7,8,9)	X	1.95	66.59	11.20	3.23	80.0	± 9.6 %
		Y	99.99	106.84	23.50		80.0	
		Z	0.77	60.00	6.81		80.0	

10477-AAE	LTE-TDD (SC-FDMA, 1 RB, 20 MHz, 16-QAM, UL Subframe=2,3,4,7,8,9)	X	9.10	82.47	17.07	3.23	80.0	± 9.6 %
		Y	100.00	111.24	25.54		80.0	
		Z	0.74	60.00	7.42		80.0	
10478-AAE	LTE-TDD (SC-FDMA, 1 RB, 20 MHz, 64-QAM, UL Subframe=2,3,4,7,8,9)	X	1.93	66.47	11.14	3.23	80.0	± 9.6 %
		Y	96.81	106.44	23.40		80.0	
		Z	0.77	60.00	6.80		80.0	
10479-AAA	LTE-TDD (SC-FDMA, 50% RB, 1.4 MHz, QPSK, UL Subframe=2,3,4,7,8,9)	X	9.68	90.97	25.10	3.23	80.0	± 9.6 %
		Y	13.83	97.37	27.65		80.0	
		Z	12.23	94.71	25.17		80.0	
10480-AAA	LTE-TDD (SC-FDMA, 50% RB, 1.4 MHz, 16-QAM, UL Subframe=2,3,4,7,8,9)	X	11.91	88.02	22.17	3.23	80.0	± 9.6 %
		Y	19.25	95.65	25.10		80.0	
		Z	7.50	81.30	18.54		80.0	
10481-AAA	LTE-TDD (SC-FDMA, 50% RB, 1.4 MHz, 64-QAM, UL Subframe=2,3,4,7,8,9)	X	9.15	83.59	20.38	3.23	80.0	± 9.6 %
		Y	15.12	91.18	23.39		80.0	
		Z	4.40	74.24	15.71		80.0	
10482-AAB	LTE-TDD (SC-FDMA, 50% RB, 3 MHz, QPSK, UL Subframe=2,3,4,7,8,9)	X	4.76	79.70	20.44	2.23	80.0	± 9.6 %
		Y	3.53	74.74	18.45		80.0	
		Z	2.62	71.60	16.13		80.0	
10483-AAB	LTE-TDD (SC-FDMA, 50% RB, 3 MHz, 16-QAM, UL Subframe=2,3,4,7,8,9)	X	5.87	78.17	19.16	2.23	80.0	± 9.6 %
		Y	8.24	83.44	21.55		80.0	
		Z	2.93	69.04	14.15		80.0	
10484-AAB	LTE-TDD (SC-FDMA, 50% RB, 3 MHz, 64-QAM, UL Subframe=2,3,4,7,8,9)	X	5.35	76.61	18.60	2.23	80.0	± 9.6 %
		Y	7.24	81.28	20.83		80.0	
		Z	2.73	67.94	13.69		80.0	
10485-AAD	LTE-TDD (SC-FDMA, 50% RB, 5 MHz, QPSK, UL Subframe=2,3,4,7,8,9)	X	4.47	78.87	21.04	2.23	80.0	± 9.6 %
		Y	3.68	75.23	19.49		80.0	
		Z	3.15	74.27	18.50		80.0	
10486-AAD	LTE-TDD (SC-FDMA, 50% RB, 5 MHz, 16-QAM, UL Subframe=2,3,4,7,8,9)	X	3.79	72.50	18.04	2.23	80.0	± 9.6 %
		Y	3.38	70.29	17.05		80.0	
		Z	2.84	69.02	15.57		80.0	
10487-AAD	LTE-TDD (SC-FDMA, 50% RB, 5 MHz, 64-QAM, UL Subframe=2,3,4,7,8,9)	X	3.74	71.89	17.77	2.23	80.0	± 9.6 %
		Y	3.37	69.86	16.85		80.0	
		Z	2.81	68.50	15.32		80.0	
10488-AAD	LTE-TDD (SC-FDMA, 50% RB, 10 MHz, QPSK, UL Subframe=2,3,4,7,8,9)	X	4.24	75.86	20.43	2.23	80.0	± 9.6 %
		Y	3.83	73.65	19.40		80.0	
		Z	3.28	72.72	18.85		80.0	
10489-AAD	LTE-TDD (SC-FDMA, 50% RB, 10 MHz, 16-QAM, UL Subframe=2,3,4,7,8,9)	X	3.72	70.49	18.27	2.23	80.0	± 9.6 %
		Y	3.53	69.26	17.66		80.0	
		Z	3.19	68.97	17.14		80.0	
10490-AAD	LTE-TDD (SC-FDMA, 50% RB, 10 MHz, 64-QAM, UL Subframe=2,3,4,7,8,9)	X	3.79	70.18	18.14	2.23	80.0	± 9.6 %
		Y	3.62	69.04	17.58		80.0	
		Z	3.27	68.77	17.05		80.0	
10491-AAD	LTE-TDD (SC-FDMA, 50% RB, 15 MHz, QPSK, UL Subframe=2,3,4,7,8,9)	X	4.23	73.19	19.42	2.23	80.0	± 9.6 %
		Y	3.95	71.65	18.67		80.0	
		Z	3.47	70.90	18.25		80.0	
10492-AAD	LTE-TDD (SC-FDMA, 50% RB, 15 MHz, 16-QAM, UL Subframe=2,3,4,7,8,9)	X	3.97	69.24	17.95	2.23	80.0	± 9.6 %
		Y	3.85	68.36	17.51		80.0	
		Z	3.50	68.04	17.11		80.0	

10493-AAD	LTE-TDD (SC-FDMA, 50% RB, 15 MHz, 64-QAM, UL Subframe=2,3,4,7,8,9)	X	4.03	69.04	17.87	2.23	80.0	± 9.6 %
		Y	3.92	68.21	17.46		80.0	
		Z	3.56	67.90	17.04		80.0	
10494-AAE	LTE-TDD (SC-FDMA, 50% RB, 20 MHz, QPSK, UL Subframe=2,3,4,7,8,9)	X	4.79	75.46	20.14	2.23	80.0	± 9.6 %
		Y	4.38	73.53	19.24		80.0	
		Z	3.78	72.48	18.78		80.0	
10495-AAE	LTE-TDD (SC-FDMA, 50% RB, 20 MHz, 16-QAM, UL Subframe=2,3,4,7,8,9)	X	4.03	69.76	18.19	2.23	80.0	± 9.6 %
		Y	3.90	68.85	17.73		80.0	
		Z	3.53	68.35	17.31		80.0	
10496-AAE	LTE-TDD (SC-FDMA, 50% RB, 20 MHz, 64-QAM, UL Subframe=2,3,4,7,8,9)	X	4.08	69.35	18.04	2.23	80.0	± 9.6 %
		Y	3.97	68.51	17.62		80.0	
		Z	3.60	68.09	17.22		80.0	
10497-AAA	LTE-TDD (SC-FDMA, 100% RB, 1.4 MHz, QPSK, UL Subframe=2,3,4,7,8,9)	X	3.72	75.87	18.08	2.23	80.0	± 9.6 %
		Y	2.64	70.76	15.98		80.0	
		Z	1.51	64.60	11.77		80.0	
10498-AAA	LTE-TDD (SC-FDMA, 100% RB, 1.4 MHz, 16-QAM, UL Subframe=2,3,4,7,8,9)	X	2.30	66.27	12.99	2.23	80.0	± 9.6 %
		Y	2.02	64.31	12.06		80.0	
		Z	1.20	60.00	8.21		80.0	
10499-AAA	LTE-TDD (SC-FDMA, 100% RB, 1.4 MHz, 64-QAM, UL Subframe=2,3,4,7,8,9)	X	2.18	65.35	12.41	2.23	80.0	± 9.6 %
		Y	1.97	63.70	11.62		80.0	
		Z	1.22	60.00	8.05		80.0	
10500-AAB	LTE-TDD (SC-FDMA, 100% RB, 3 MHz, QPSK, UL Subframe=2,3,4,7,8,9)	X	4.19	76.87	20.53	2.23	80.0	± 9.6 %
		Y	3.63	74.04	19.27		80.0	
		Z	3.15	73.35	18.54		80.0	
10501-AAB	LTE-TDD (SC-FDMA, 100% RB, 3 MHz, 16-QAM, UL Subframe=2,3,4,7,8,9)	X	3.74	71.57	18.07	2.23	80.0	± 9.6 %
		Y	3.44	69.83	17.26		80.0	
		Z	3.03	69.25	16.29		80.0	
10502-AAB	LTE-TDD (SC-FDMA, 100% RB, 3 MHz, 64-QAM, UL Subframe=2,3,4,7,8,9)	X	3.79	71.34	17.92	2.23	80.0	± 9.6 %
		Y	3.50	69.66	17.14		80.0	
		Z	3.07	69.05	16.12		80.0	
10503-AAD	LTE-TDD (SC-FDMA, 100% RB, 5 MHz, QPSK, UL Subframe=2,3,4,7,8,9)	X	4.18	75.62	20.32	2.23	80.0	± 9.6 %
		Y	3.77	73.43	19.30		80.0	
		Z	3.23	72.50	18.74		80.0	
10504-AAD	LTE-TDD (SC-FDMA, 100% RB, 5 MHz, 16-QAM, UL Subframe=2,3,4,7,8,9)	X	3.70	70.40	18.21	2.23	80.0	± 9.6 %
		Y	3.52	69.18	17.61		80.0	
		Z	3.17	68.86	17.07		80.0	
10505-AAD	LTE-TDD (SC-FDMA, 100% RB, 5 MHz, 64-QAM, UL Subframe=2,3,4,7,8,9)	X	3.77	70.08	18.09	2.23	80.0	± 9.6 %
		Y	3.60	68.95	17.53		80.0	
		Z	3.25	68.67	16.99		80.0	
10506-AAD	LTE-TDD (SC-FDMA, 100% RB, 10 MHz, QPSK, UL Subframe=2,3,4,7,8,9)	X	4.74	75.29	20.06	2.23	80.0	± 9.6 %
		Y	4.34	73.37	19.17		80.0	
		Z	3.74	72.32	18.70		80.0	
10507-AAD	LTE-TDD (SC-FDMA, 100% RB, 10 MHz, 16-QAM, UL Subframe=2,3,4,7,8,9)	X	4.01	69.69	18.15	2.23	80.0	± 9.6 %
		Y	3.88	68.79	17.69		80.0	
		Z	3.51	68.29	17.27		80.0	

10508-AAD	LTE-TDD (SC-FDMA, 100% RB, 10 MHz, 64-QAM, UL Subframe=2,3,4,7,8,9)	X	4.07	69.28	18.00	2.23	80.0	± 9.6 %
		Y	3.96	68.45	17.58		80.0	
		Z	3.59	68.02	17.17		80.0	
10509-AAD	LTE-TDD (SC-FDMA, 100% RB, 15 MHz, QPSK, UL Subframe=2,3,4,7,8,9)	X	4.87	73.12	19.15	2.23	80.0	± 9.6 %
		Y	4.57	71.69	18.46		80.0	
		Z	4.08	70.95	18.12		80.0	
10510-AAD	LTE-TDD (SC-FDMA, 100% RB, 15 MHz, 16-QAM, UL Subframe=2,3,4,7,8,9)	X	4.46	69.19	17.97	2.23	80.0	± 9.6 %
		Y	4.36	68.46	17.61		80.0	
		Z	3.98	67.93	17.23		80.0	
10511-AAD	LTE-TDD (SC-FDMA, 100% RB, 15 MHz, 64-QAM, UL Subframe=2,3,4,7,8,9)	X	4.49	68.83	17.85	2.23	80.0	± 9.6 %
		Y	4.40	68.15	17.52		80.0	
		Z	4.03	67.70	17.16		80.0	
10512-AAE	LTE-TDD (SC-FDMA, 100% RB, 20 MHz, QPSK, UL Subframe=2,3,4,7,8,9)	X	5.35	75.53	19.95	2.23	80.0	± 9.6 %
		Y	4.89	73.64	19.09		80.0	
		Z	4.27	72.56	18.64		80.0	
10513-AAE	LTE-TDD (SC-FDMA, 100% RB, 20 MHz, 16-QAM, UL Subframe=2,3,4,7,8,9)	X	4.37	69.62	18.15	2.23	80.0	± 9.6 %
		Y	4.26	68.83	17.75		80.0	
		Z	3.86	68.15	17.33		80.0	
10514-AAE	LTE-TDD (SC-FDMA, 100% RB, 20 MHz, 64-QAM, UL Subframe=2,3,4,7,8,9)	X	4.36	69.04	17.95	2.23	80.0	± 9.6 %
		Y	4.26	68.32	17.60		80.0	
		Z	3.89	67.75	17.20		80.0	
10515-AAA	IEEE 802.11b WiFi 2.4 GHz (DSSS, 2 Mbps, 99pc duty cycle)	X	0.98	64.01	15.52	0.00	150.0	± 9.6 %
		Y	0.90	62.52	14.23		150.0	
		Z	0.95	63.71	15.08		150.0	
10516-AAA	IEEE 802.11b WiFi 2.4 GHz (DSSS, 5.5 Mbps, 99pc duty cycle)	X	0.96	80.43	22.24	0.00	150.0	± 9.6 %
		Y	0.52	69.16	15.73		150.0	
		Z	0.74	75.71	19.80		150.0	
10517-AAA	IEEE 802.11b WiFi 2.4 GHz (DSSS, 11 Mbps, 99pc duty cycle)	X	0.87	66.95	16.73	0.00	150.0	± 9.6 %
		Y	0.75	64.30	14.64		150.0	
		Z	0.81	66.10	15.98		150.0	
10518-AAB	IEEE 802.11a/h WiFi 5 GHz (OFDM, 9 Mbps, 99pc duty cycle)	X	4.59	66.88	16.37	0.00	150.0	± 9.6 %
		Y	4.55	66.43	16.12		150.0	
		Z	4.41	66.91	16.25		150.0	
10519-AAB	IEEE 802.11a/h WiFi 5 GHz (OFDM, 12 Mbps, 99pc duty cycle)	X	4.79	67.13	16.49	0.00	150.0	± 9.6 %
		Y	4.75	66.71	16.26		150.0	
		Z	4.57	67.10	16.35		150.0	
10520-AAB	IEEE 802.11a/h WiFi 5 GHz (OFDM, 18 Mbps, 99pc duty cycle)	X	4.64	67.11	16.43	0.00	150.0	± 9.6 %
		Y	4.60	66.67	16.18		150.0	
		Z	4.43	67.05	16.27		150.0	
10521-AAB	IEEE 802.11a/h WiFi 5 GHz (OFDM, 24 Mbps, 99pc duty cycle)	X	4.57	67.12	16.42	0.00	150.0	± 9.6 %
		Y	4.53	66.66	16.16		150.0	
		Z	4.36	67.04	16.26		150.0	
10522-AAB	IEEE 802.11a/h WiFi 5 GHz (OFDM, 36 Mbps, 99pc duty cycle)	X	4.63	67.16	16.48	0.00	150.0	± 9.6 %
		Y	4.59	66.70	16.22		150.0	
		Z	4.42	67.17	16.36		150.0	

10523-AAB	IEEE 802.11a/h WiFi 5 GHz (OFDM, 48 Mbps, 99pc duty cycle)	X	4.51	67.05	16.34	0.00	150.0	± 9.6 %
		Y	4.46	66.56	16.06		150.0	
		Z	4.33	67.10	16.24		150.0	
10524-AAB	IEEE 802.11a/h WiFi 5 GHz (OFDM, 54 Mbps, 99pc duty cycle)	X	4.58	67.09	16.46	0.00	150.0	± 9.6 %
		Y	4.53	66.64	16.20		150.0	
		Z	4.37	67.10	16.33		150.0	
10525-AAB	IEEE 802.11ac WiFi (20MHz, MCS0, 99pc duty cycle)	X	4.55	66.14	16.05	0.00	150.0	± 9.6 %
		Y	4.50	65.66	15.78		150.0	
		Z	4.38	66.18	15.95		150.0	
10526-AAB	IEEE 802.11ac WiFi (20MHz, MCS1, 99pc duty cycle)	X	4.74	66.53	16.19	0.00	150.0	± 9.6 %
		Y	4.69	66.05	15.93		150.0	
		Z	4.52	66.50	16.07		150.0	
10527-AAB	IEEE 802.11ac WiFi (20MHz, MCS2, 99pc duty cycle)	X	4.66	66.50	16.15	0.00	150.0	± 9.6 %
		Y	4.61	66.01	15.87		150.0	
		Z	4.45	66.47	16.02		150.0	
10528-AAB	IEEE 802.11ac WiFi (20MHz, MCS3, 99pc duty cycle)	X	4.67	66.52	16.18	0.00	150.0	± 9.6 %
		Y	4.62	66.03	15.91		150.0	
		Z	4.47	66.48	16.05		150.0	
10529-AAB	IEEE 802.11ac WiFi (20MHz, MCS4, 99pc duty cycle)	X	4.67	66.52	16.18	0.00	150.0	± 9.6 %
		Y	4.62	66.03	15.91		150.0	
		Z	4.47	66.48	16.05		150.0	
10531-AAB	IEEE 802.11ac WiFi (20MHz, MCS6, 99pc duty cycle)	X	4.67	66.65	16.20	0.00	150.0	± 9.6 %
		Y	4.63	66.16	15.93		150.0	
		Z	4.44	66.54	16.04		150.0	
10532-AAB	IEEE 802.11ac WiFi (20MHz, MCS7, 99pc duty cycle)	X	4.53	66.51	16.14	0.00	150.0	± 9.6 %
		Y	4.48	66.01	15.86		150.0	
		Z	4.32	66.41	15.98		150.0	
10533-AAB	IEEE 802.11ac WiFi (20MHz, MCS8, 99pc duty cycle)	X	4.68	66.56	16.16	0.00	150.0	± 9.6 %
		Y	4.63	66.06	15.89		150.0	
		Z	4.48	66.56	16.05		150.0	
10534-AAB	IEEE 802.11ac WiFi (40MHz, MCS0, 99pc duty cycle)	X	5.19	66.60	16.20	0.00	150.0	± 9.6 %
		Y	5.16	66.20	15.99		150.0	
		Z	5.01	66.50	16.09		150.0	
10535-AAB	IEEE 802.11ac WiFi (40MHz, MCS1, 99pc duty cycle)	X	5.26	66.75	16.27	0.00	150.0	± 9.6 %
		Y	5.22	66.35	16.06		150.0	
		Z	5.06	66.65	16.16		150.0	
10536-AAB	IEEE 802.11ac WiFi (40MHz, MCS2, 99pc duty cycle)	X	5.13	66.73	16.24	0.00	150.0	± 9.6 %
		Y	5.09	66.32	16.02		150.0	
		Z	4.95	66.64	16.13		150.0	
10537-AAB	IEEE 802.11ac WiFi (40MHz, MCS3, 99pc duty cycle)	X	5.19	66.69	16.22	0.00	150.0	± 9.6 %
		Y	5.15	66.30	16.01		150.0	
		Z	5.00	66.59	16.11		150.0	
10538-AAB	IEEE 802.11ac WiFi (40MHz, MCS4, 99pc duty cycle)	X	5.28	66.73	16.28	0.00	150.0	± 9.6 %
		Y	5.26	66.36	16.08		150.0	
		Z	5.08	66.58	16.14		150.0	
10540-AAB	IEEE 802.11ac WiFi (40MHz, MCS6, 99pc duty cycle)	X	5.21	66.72	16.29	0.00	150.0	± 9.6 %
		Y	5.17	66.33	16.08		150.0	
		Z	5.01	66.56	16.15		150.0	

10541-AAB	IEEE 802.11ac WiFi (40MHz, MCS7, 99pc duty cycle)	X	5.18	66.60	16.22	0.00	150.0	± 9.6 %
		Y	5.14	66.20	16.01		150.0	
		Z	4.99	66.47	16.09		150.0	
10542-AAB	IEEE 802.11ac WiFi (40MHz, MCS8, 99pc duty cycle)	X	5.33	66.65	16.26	0.00	150.0	± 9.6 %
		Y	5.31	66.28	16.07		150.0	
		Z	5.14	66.55	16.15		150.0	
10543-AAB	IEEE 802.11ac WiFi (40MHz, MCS9, 99pc duty cycle)	X	5.41	66.68	16.29	0.00	150.0	± 9.6 %
		Y	5.39	66.31	16.11		150.0	
		Z	5.20	66.56	16.18		150.0	
10544-AAB	IEEE 802.11ac WiFi (80MHz, MCS0, 99pc duty cycle)	X	5.49	66.70	16.18	0.00	150.0	± 9.6 %
		Y	5.45	66.31	15.98		150.0	
		Z	5.34	66.58	16.07		150.0	
10545-AAB	IEEE 802.11ac WiFi (80MHz, MCS1, 99pc duty cycle)	X	5.68	67.09	16.32	0.00	150.0	± 9.6 %
		Y	5.66	66.76	16.15		150.0	
		Z	5.51	66.98	16.23		150.0	
10546-AAB	IEEE 802.11ac WiFi (80MHz, MCS2, 99pc duty cycle)	X	5.57	66.94	16.26	0.00	150.0	± 9.6 %
		Y	5.54	66.57	16.08		150.0	
		Z	5.38	66.73	16.11		150.0	
10547-AAB	IEEE 802.11ac WiFi (80MHz, MCS3, 99pc duty cycle)	X	5.64	66.98	16.27	0.00	150.0	± 9.6 %
		Y	5.63	66.66	16.11		150.0	
		Z	5.45	66.79	16.14		150.0	
10548-AAB	IEEE 802.11ac WiFi (80MHz, MCS4, 99pc duty cycle)	X	5.90	67.92	16.71	0.00	150.0	± 9.6 %
		Y	5.97	67.87	16.68		150.0	
		Z	5.63	67.50	16.47		150.0	
10550-AAB	IEEE 802.11ac WiFi (80MHz, MCS6, 99pc duty cycle)	X	5.59	66.92	16.26	0.00	150.0	± 9.6 %
		Y	5.55	66.54	16.07		150.0	
		Z	5.42	66.82	16.17		150.0	
10551-AAB	IEEE 802.11ac WiFi (80MHz, MCS7, 99pc duty cycle)	X	5.60	66.98	16.25	0.00	150.0	± 9.6 %
		Y	5.56	66.60	16.06		150.0	
		Z	5.40	66.75	16.10		150.0	
10552-AAB	IEEE 802.11ac WiFi (80MHz, MCS8, 99pc duty cycle)	X	5.51	66.77	16.16	0.00	150.0	± 9.6 %
		Y	5.47	66.37	15.96		150.0	
		Z	5.35	66.67	16.06		150.0	
10553-AAB	IEEE 802.11ac WiFi (80MHz, MCS9, 99pc duty cycle)	X	5.60	66.81	16.21	0.00	150.0	± 9.6 %
		Y	5.56	66.43	16.01		150.0	
		Z	5.41	66.65	16.08		150.0	
10554-AAC	IEEE 802.11ac WiFi (160MHz, MCS0, 99pc duty cycle)	X	5.89	67.05	16.26	0.00	150.0	± 9.6 %
		Y	5.86	66.69	16.08		150.0	
		Z	5.75	66.91	16.14		150.0	
10555-AAC	IEEE 802.11ac WiFi (160MHz, MCS1, 99pc duty cycle)	X	6.02	67.35	16.38	0.00	150.0	± 9.6 %
		Y	6.00	67.02	16.22		150.0	
		Z	5.86	67.17	16.25		150.0	
10556-AAC	IEEE 802.11ac WiFi (160MHz, MCS2, 99pc duty cycle)	X	6.04	67.39	16.40	0.00	150.0	± 9.6 %
		Y	6.02	67.06	16.23		150.0	
		Z	5.88	67.24	16.28		150.0	
10557-AAC	IEEE 802.11ac WiFi (160MHz, MCS3, 99pc duty cycle)	X	6.01	67.32	16.38	0.00	150.0	± 9.6 %
		Y	5.99	66.98	16.22		150.0	
		Z	5.85	67.13	16.24		150.0	

10558-AAC	IEEE 802.11ac WiFi (160MHz, MCS4, 99pc duty cycle)	X	6.07	67.49	16.48	0.00	150.0	± 9.6 %
		Y	6.05	67.17	16.33		150.0	
		Z	5.88	67.26	16.33		150.0	
10560-AAC	IEEE 802.11ac WiFi (160MHz, MCS6, 99pc duty cycle)	X	6.06	67.34	16.44	0.00	150.0	± 9.6 %
		Y	6.04	66.99	16.28		150.0	
		Z	5.88	67.13	16.30		150.0	
10561-AAC	IEEE 802.11ac WiFi (160MHz, MCS7, 99pc duty cycle)	X	5.98	67.30	16.46	0.00	150.0	± 9.6 %
		Y	5.96	66.96	16.30		150.0	
		Z	5.81	67.11	16.32		150.0	
10562-AAC	IEEE 802.11ac WiFi (160MHz, MCS8, 99pc duty cycle)	X	6.11	67.72	16.67	0.00	150.0	± 9.6 %
		Y	6.12	67.46	16.55		150.0	
		Z	5.89	67.37	16.45		150.0	
10563-AAC	IEEE 802.11ac WiFi (160MHz, MCS9, 99pc duty cycle)	X	6.43	68.23	16.87	0.00	150.0	± 9.6 %
		Y	6.50	68.16	16.85		150.0	
		Z	5.96	67.23	16.35		150.0	
10564-AAA	IEEE 802.11g WiFi 2.4 GHz (DSSS-OFDM, 9 Mbps, 99pc duty cycle)	X	4.91	66.93	16.51	0.46	150.0	± 9.6 %
		Y	4.88	66.54	16.31		150.0	
		Z	4.73	66.93	16.37		150.0	
10565-AAA	IEEE 802.11g WiFi 2.4 GHz (DSSS-OFDM, 12 Mbps, 99pc duty cycle)	X	5.16	67.40	16.83	0.46	150.0	± 9.6 %
		Y	5.13	67.02	16.64		150.0	
		Z	4.93	67.35	16.69		150.0	
10566-AAA	IEEE 802.11g WiFi 2.4 GHz (DSSS-OFDM, 18 Mbps, 99pc duty cycle)	X	4.99	67.26	16.66	0.46	150.0	± 9.6 %
		Y	4.96	66.87	16.45		150.0	
		Z	4.77	67.18	16.50		150.0	
10567-AAA	IEEE 802.11g WiFi 2.4 GHz (DSSS-OFDM, 24 Mbps, 99pc duty cycle)	X	5.02	67.67	17.02	0.46	150.0	± 9.6 %
		Y	4.98	67.25	16.79		150.0	
		Z	4.81	67.60	16.88		150.0	
10568-AAA	IEEE 802.11g WiFi 2.4 GHz (DSSS-OFDM, 36 Mbps, 99pc duty cycle)	X	4.90	67.00	16.42	0.46	150.0	± 9.6 %
		Y	4.87	66.62	16.22		150.0	
		Z	4.67	66.94	16.26		150.0	
10569-AAA	IEEE 802.11g WiFi 2.4 GHz (DSSS-OFDM, 48 Mbps, 99pc duty cycle)	X	4.97	67.73	17.07	0.46	150.0	± 9.6 %
		Y	4.93	67.29	16.83		150.0	
		Z	4.78	67.78	16.99		150.0	
10570-AAA	IEEE 802.11g WiFi 2.4 GHz (DSSS-OFDM, 54 Mbps, 99pc duty cycle)	X	5.01	67.57	17.00	0.46	150.0	± 9.6 %
		Y	4.97	67.15	16.77		150.0	
		Z	4.80	67.57	16.89		150.0	
10571-AAA	IEEE 802.11b WiFi 2.4 GHz (DSSS, 1 Mbps, 90pc duty cycle)	X	1.17	65.22	16.39	0.46	130.0	± 9.6 %
		Y	1.09	63.89	15.30		130.0	
		Z	1.10	64.48	15.68		130.0	
10572-AAA	IEEE 802.11b WiFi 2.4 GHz (DSSS, 2 Mbps, 90pc duty cycle)	X	1.19	65.91	16.81	0.46	130.0	± 9.6 %
		Y	1.10	64.45	15.65		130.0	
		Z	1.12	65.08	16.07		130.0	
10573-AAA	IEEE 802.11b WiFi 2.4 GHz (DSSS, 5.5 Mbps, 90pc duty cycle)	X	11.95	118.97	33.95	0.46	130.0	± 9.6 %
		Y	2.10	86.50	22.92		130.0	
		Z	2.78	93.83	26.37		130.0	
10574-AAA	IEEE 802.11b WiFi 2.4 GHz (DSSS, 11 Mbps, 90pc duty cycle)	X	1.42	73.69	20.72	0.46	130.0	± 9.6 %
		Y	1.20	70.19	18.52		130.0	
		Z	1.24	71.54	19.44		130.0	

10575-AAA	IEEE 802.11g WiFi 2.4 GHz (DSSS-OFDM, 6 Mbps, 90pc duty cycle)	X	4.69	66.71	16.57	0.46	130.0	± 9.6 %
		Y	4.67	66.34	16.38		130.0	
		Z	4.50	66.68	16.40		130.0	
10576-AAA	IEEE 802.11g WiFi 2.4 GHz (DSSS-OFDM, 9 Mbps, 90pc duty cycle)	X	4.72	66.88	16.64	0.46	130.0	± 9.6 %
		Y	4.69	66.50	16.44		130.0	
		Z	4.53	66.88	16.48		130.0	
10577-AAA	IEEE 802.11g WiFi 2.4 GHz (DSSS-OFDM, 12 Mbps, 90pc duty cycle)	X	4.94	67.20	16.81	0.46	130.0	± 9.6 %
		Y	4.91	66.83	16.62		130.0	
		Z	4.71	67.13	16.63		130.0	
10578-AAA	IEEE 802.11g WiFi 2.4 GHz (DSSS-OFDM, 18 Mbps, 90pc duty cycle)	X	4.83	67.37	16.92	0.46	130.0	± 9.6 %
		Y	4.81	66.98	16.72		130.0	
		Z	4.61	67.29	16.74		130.0	
10579-AAA	IEEE 802.11g WiFi 2.4 GHz (DSSS-OFDM, 24 Mbps, 90pc duty cycle)	X	4.60	66.66	16.24	0.46	130.0	± 9.6 %
		Y	4.57	66.30	16.05		130.0	
		Z	4.37	66.49	16.00		130.0	
10580-AAA	IEEE 802.11g WiFi 2.4 GHz (DSSS-OFDM, 36 Mbps, 90pc duty cycle)	X	4.64	66.67	16.25	0.46	130.0	± 9.6 %
		Y	4.62	66.31	16.06		130.0	
		Z	4.41	66.55	16.03		130.0	
10581-AAA	IEEE 802.11g WiFi 2.4 GHz (DSSS-OFDM, 48 Mbps, 90pc duty cycle)	X	4.73	67.42	16.87	0.46	130.0	± 9.6 %
		Y	4.70	67.02	16.65		130.0	
		Z	4.52	67.36	16.71		130.0	
10582-AAA	IEEE 802.11g WiFi 2.4 GHz (DSSS-OFDM, 54 Mbps, 90pc duty cycle)	X	4.54	66.41	16.03	0.46	130.0	± 9.6 %
		Y	4.53	66.07	15.85		130.0	
		Z	4.30	66.25	15.78		130.0	
10583-AAB	IEEE 802.11a/h WiFi 5 GHz (OFDM, 6 Mbps, 90pc duty cycle)	X	4.69	66.71	16.57	0.46	130.0	± 9.6 %
		Y	4.67	66.34	16.38		130.0	
		Z	4.50	66.68	16.40		130.0	
10584-AAB	IEEE 802.11a/h WiFi 5 GHz (OFDM, 9 Mbps, 90pc duty cycle)	X	4.72	66.88	16.64	0.46	130.0	± 9.6 %
		Y	4.69	66.50	16.44		130.0	
		Z	4.53	66.88	16.48		130.0	
10585-AAB	IEEE 802.11a/h WiFi 5 GHz (OFDM, 12 Mbps, 90pc duty cycle)	X	4.94	67.20	16.81	0.46	130.0	± 9.6 %
		Y	4.91	66.83	16.62		130.0	
		Z	4.71	67.13	16.63		130.0	
10586-AAB	IEEE 802.11a/h WiFi 5 GHz (OFDM, 18 Mbps, 90pc duty cycle)	X	4.83	67.37	16.92	0.46	130.0	± 9.6 %
		Y	4.81	66.98	16.72		130.0	
		Z	4.61	67.29	16.74		130.0	
10587-AAB	IEEE 802.11a/h WiFi 5 GHz (OFDM, 24 Mbps, 90pc duty cycle)	X	4.60	66.66	16.24	0.46	130.0	± 9.6 %
		Y	4.57	66.30	16.05		130.0	
		Z	4.37	66.49	16.00		130.0	
10588-AAB	IEEE 802.11a/h WiFi 5 GHz (OFDM, 36 Mbps, 90pc duty cycle)	X	4.64	66.67	16.25	0.46	130.0	± 9.6 %
		Y	4.62	66.31	16.06		130.0	
		Z	4.41	66.55	16.03		130.0	
10589-AAB	IEEE 802.11a/h WiFi 5 GHz (OFDM, 48 Mbps, 90pc duty cycle)	X	4.73	67.42	16.87	0.46	130.0	± 9.6 %
		Y	4.70	67.02	16.65		130.0	
		Z	4.52	67.36	16.71		130.0	
10590-AAB	IEEE 802.11a/h WiFi 5 GHz (OFDM, 54 Mbps, 90pc duty cycle)	X	4.54	66.41	16.03	0.46	130.0	± 9.6 %
		Y	4.53	66.07	15.85		130.0	
		Z	4.30	66.25	15.78		130.0	

10591-AAB	IEEE 802.11n (HT Mixed, 20MHz, MCS0, 90pc duty cycle)	X	4.84	66.77	16.66	0.46	130.0	± 9.6 %
		Y	4.82	66.41	16.48		130.0	
		Z	4.66	66.76	16.51		130.0	
10592-AAB	IEEE 802.11n (HT Mixed, 20MHz, MCS1, 90pc duty cycle)	X	5.01	67.12	16.79	0.46	130.0	± 9.6 %
		Y	4.99	66.76	16.61		130.0	
		Z	4.79	67.07	16.64		130.0	
10593-AAB	IEEE 802.11n (HT Mixed, 20MHz, MCS2, 90pc duty cycle)	X	4.93	67.04	16.68	0.46	130.0	± 9.6 %
		Y	4.91	66.69	16.51		130.0	
		Z	4.71	66.95	16.50		130.0	
10594-AAB	IEEE 802.11n (HT Mixed, 20MHz, MCS3, 90pc duty cycle)	X	4.98	67.20	16.83	0.46	130.0	± 9.6 %
		Y	4.96	66.84	16.65		130.0	
		Z	4.76	67.13	16.67		130.0	
10595-AAB	IEEE 802.11n (HT Mixed, 20MHz, MCS4, 90pc duty cycle)	X	4.95	67.16	16.73	0.46	130.0	± 9.6 %
		Y	4.93	66.80	16.55		130.0	
		Z	4.73	67.10	16.57		130.0	
10596-AAB	IEEE 802.11n (HT Mixed, 20MHz, MCS5, 90pc duty cycle)	X	4.89	67.16	16.74	0.46	130.0	± 9.6 %
		Y	4.87	66.79	16.55		130.0	
		Z	4.66	67.08	16.56		130.0	
10597-AAB	IEEE 802.11n (HT Mixed, 20MHz, MCS6, 90pc duty cycle)	X	4.84	67.08	16.63	0.46	130.0	± 9.6 %
		Y	4.82	66.71	16.44		130.0	
		Z	4.61	66.96	16.43		130.0	
10598-AAB	IEEE 802.11n (HT Mixed, 20MHz, MCS7, 90pc duty cycle)	X	4.82	67.33	16.90	0.46	130.0	± 9.6 %
		Y	4.80	66.95	16.70		130.0	
		Z	4.60	67.20	16.70		130.0	
10599-AAB	IEEE 802.11n (HT Mixed, 40MHz, MCS0, 90pc duty cycle)	X	5.51	67.30	16.83	0.46	130.0	± 9.6 %
		Y	5.50	67.04	16.72		130.0	
		Z	5.31	67.18	16.69		130.0	
10600-AAB	IEEE 802.11n (HT Mixed, 40MHz, MCS1, 90pc duty cycle)	X	5.66	67.75	17.03	0.46	130.0	± 9.6 %
		Y	5.70	67.66	17.00		130.0	
		Z	5.42	67.55	16.85		130.0	
10601-AAB	IEEE 802.11n (HT Mixed, 40MHz, MCS2, 90pc duty cycle)	X	5.54	67.49	16.91	0.46	130.0	± 9.6 %
		Y	5.55	67.29	16.83		130.0	
		Z	5.33	67.34	16.76		130.0	
10602-AAB	IEEE 802.11n (HT Mixed, 40MHz, MCS3, 90pc duty cycle)	X	5.62	67.47	16.82	0.46	130.0	± 9.6 %
		Y	5.64	67.27	16.74		130.0	
		Z	5.46	67.51	16.77		130.0	
10603-AAB	IEEE 802.11n (HT Mixed, 40MHz, MCS4, 90pc duty cycle)	X	5.72	67.83	17.13	0.46	130.0	± 9.6 %
		Y	5.72	67.56	17.01		130.0	
		Z	5.53	67.80	17.05		130.0	
10604-AAB	IEEE 802.11n (HT Mixed, 40MHz, MCS5, 90pc duty cycle)	X	5.51	67.26	16.84	0.46	130.0	± 9.6 %
		Y	5.51	67.00	16.72		130.0	
		Z	5.40	67.44	16.85		130.0	
10605-AAB	IEEE 802.11n (HT Mixed, 40MHz, MCS6, 90pc duty cycle)	X	5.62	67.58	16.99	0.46	130.0	± 9.6 %
		Y	5.63	67.37	16.91		130.0	
		Z	5.43	67.48	16.86		130.0	
10606-AAB	IEEE 802.11n (HT Mixed, 40MHz, MCS7, 90pc duty cycle)	X	5.39	67.04	16.59	0.46	130.0	± 9.6 %
		Y	5.38	66.75	16.46		130.0	
		Z	5.18	66.82	16.39		130.0	

10607-AAB	IEEE 802.11ac WiFi (20MHz, MCS0, 90pc duty cycle)	X	4.69	66.11	16.30	0.46	130.0	± 9.6 %
		Y	4.65	65.70	16.09		130.0	
		Z	4.51	66.12	16.16		130.0	
10608-AAB	IEEE 802.11ac WiFi (20MHz, MCS1, 90pc duty cycle)	X	4.89	66.54	16.47	0.46	130.0	± 9.6 %
		Y	4.86	66.13	16.26		130.0	
		Z	4.67	66.48	16.32		130.0	
10609-AAB	IEEE 802.11ac WiFi (20MHz, MCS2, 90pc duty cycle)	X	4.78	66.40	16.32	0.46	130.0	± 9.6 %
		Y	4.74	65.99	16.10		130.0	
		Z	4.56	66.32	16.14		130.0	
10610-AAB	IEEE 802.11ac WiFi (20MHz, MCS3, 90pc duty cycle)	X	4.83	66.56	16.48	0.46	130.0	± 9.6 %
		Y	4.80	66.15	16.27		130.0	
		Z	4.61	66.49	16.31		130.0	
10611-AAB	IEEE 802.11ac WiFi (20MHz, MCS4, 90pc duty cycle)	X	4.74	66.37	16.33	0.46	130.0	± 9.6 %
		Y	4.71	65.96	16.12		130.0	
		Z	4.52	66.28	16.15		130.0	
10612-AAB	IEEE 802.11ac WiFi (20MHz, MCS5, 90pc duty cycle)	X	4.76	66.53	16.38	0.46	130.0	± 9.6 %
		Y	4.73	66.12	16.16		130.0	
		Z	4.52	66.43	16.20		130.0	
10613-AAB	IEEE 802.11ac WiFi (20MHz, MCS6, 90pc duty cycle)	X	4.76	66.43	16.27	0.46	130.0	± 9.6 %
		Y	4.74	66.03	16.06		130.0	
		Z	4.52	66.26	16.05		130.0	
10614-AAB	IEEE 802.11ac WiFi (20MHz, MCS7, 90pc duty cycle)	X	4.70	66.62	16.50	0.46	130.0	± 9.6 %
		Y	4.67	66.19	16.28		130.0	
		Z	4.48	66.49	16.31		130.0	
10615-AAB	IEEE 802.11ac WiFi (20MHz, MCS8, 90pc duty cycle)	X	4.74	66.19	16.10	0.46	130.0	± 9.6 %
		Y	4.72	65.79	15.90		130.0	
		Z	4.52	66.11	15.92		130.0	
10616-AAB	IEEE 802.11ac WiFi (40MHz, MCS0, 90pc duty cycle)	X	5.34	66.61	16.47	0.46	130.0	± 9.6 %
		Y	5.32	66.28	16.32		130.0	
		Z	5.14	66.47	16.32		130.0	
10617-AAB	IEEE 802.11ac WiFi (40MHz, MCS1, 90pc duty cycle)	X	5.40	66.74	16.51	0.46	130.0	± 9.6 %
		Y	5.38	66.41	16.35		130.0	
		Z	5.21	66.65	16.39		130.0	
10618-AAB	IEEE 802.11ac WiFi (40MHz, MCS2, 90pc duty cycle)	X	5.29	66.79	16.56	0.46	130.0	± 9.6 %
		Y	5.27	66.46	16.39		130.0	
		Z	5.11	66.70	16.43		130.0	
10619-AAB	IEEE 802.11ac WiFi (40MHz, MCS3, 90pc duty cycle)	X	5.31	66.61	16.40	0.46	130.0	± 9.6 %
		Y	5.30	66.30	16.25		130.0	
		Z	5.11	66.46	16.24		130.0	
10620-AAB	IEEE 802.11ac WiFi (40MHz, MCS4, 90pc duty cycle)	X	5.41	66.67	16.47	0.46	130.0	± 9.6 %
		Y	5.41	66.38	16.34		130.0	
		Z	5.19	66.48	16.30		130.0	
10621-AAB	IEEE 802.11ac WiFi (40MHz, MCS5, 90pc duty cycle)	X	5.40	66.76	16.64	0.46	130.0	± 9.6 %
		Y	5.38	66.43	16.48		130.0	
		Z	5.21	66.64	16.50		130.0	
10622-AAB	IEEE 802.11ac WiFi (40MHz, MCS6, 90pc duty cycle)	X	5.41	66.91	16.70	0.46	130.0	± 9.6 %
		Y	5.39	66.60	16.55		130.0	
		Z	5.20	66.74	16.55		130.0	

10623-AAB	IEEE 802.11ac WiFi (40MHz, MCS7, 90pc duty cycle)	X	5.29	66.45	16.36	0.46	130.0	± 9.6 %
		Y	5.27	66.12	16.20		130.0	
		Z	5.08	66.28	16.19		130.0	
10624-AAB	IEEE 802.11ac WiFi (40MHz, MCS8, 90pc duty cycle)	X	5.48	66.64	16.51	0.46	130.0	± 9.6 %
		Y	5.47	66.35	16.38		130.0	
		Z	5.28	66.51	16.36		130.0	
10625-AAB	IEEE 802.11ac WiFi (40MHz, MCS9, 90pc duty cycle)	X	5.87	67.67	17.07	0.46	130.0	± 9.6 %
		Y	5.92	67.56	17.03		130.0	
		Z	5.48	66.99	16.66		130.0	
10626-AAB	IEEE 802.11ac WiFi (80MHz, MCS0, 90pc duty cycle)	X	5.62	66.65	16.41	0.46	130.0	± 9.6 %
		Y	5.59	66.32	16.26		130.0	
		Z	5.46	66.52	16.28		130.0	
10627-AAB	IEEE 802.11ac WiFi (80MHz, MCS1, 90pc duty cycle)	X	5.86	67.19	16.64	0.46	130.0	± 9.6 %
		Y	5.87	66.96	16.54		130.0	
		Z	5.68	67.07	16.52		130.0	
10628-AAB	IEEE 802.11ac WiFi (80MHz, MCS2, 90pc duty cycle)	X	5.67	66.78	16.37	0.46	130.0	± 9.6 %
		Y	5.65	66.49	16.24		130.0	
		Z	5.47	66.52	16.18		130.0	
10629-AAB	IEEE 802.11ac WiFi (80MHz, MCS3, 90pc duty cycle)	X	5.76	66.87	16.41	0.46	130.0	± 9.6 %
		Y	5.74	66.55	16.26		130.0	
		Z	5.55	66.62	16.22		130.0	
10630-AAB	IEEE 802.11ac WiFi (80MHz, MCS4, 90pc duty cycle)	X	6.21	68.41	17.17	0.46	130.0	± 9.6 %
		Y	6.36	68.57	17.26		130.0	
		Z	5.84	67.72	16.78		130.0	
10631-AAB	IEEE 802.11ac WiFi (80MHz, MCS5, 90pc duty cycle)	X	6.11	68.22	17.27	0.46	130.0	± 9.6 %
		Y	6.15	68.07	17.21		130.0	
		Z	5.81	67.73	16.97		130.0	
10632-AAB	IEEE 802.11ac WiFi (80MHz, MCS6, 90pc duty cycle)	X	5.83	67.26	16.81	0.46	130.0	± 9.6 %
		Y	5.82	66.98	16.68		130.0	
		Z	5.67	67.19	16.73		130.0	
10633-AAB	IEEE 802.11ac WiFi (80MHz, MCS7, 90pc duty cycle)	X	5.73	66.95	16.48	0.46	130.0	± 9.6 %
		Y	5.72	66.66	16.35		130.0	
		Z	5.54	66.74	16.32		130.0	
10634-AAB	IEEE 802.11ac WiFi (80MHz, MCS8, 90pc duty cycle)	X	5.72	66.98	16.56	0.46	130.0	± 9.6 %
		Y	5.70	66.65	16.41		130.0	
		Z	5.52	66.78	16.40		130.0	
10635-AAB	IEEE 802.11ac WiFi (80MHz, MCS9, 90pc duty cycle)	X	5.60	66.32	15.97	0.46	130.0	± 9.6 %
		Y	5.59	66.03	15.84		130.0	
		Z	5.39	66.04	15.76		130.0	
10636-AAC	IEEE 802.11ac WiFi (160MHz, MCS0, 90pc duty cycle)	X	6.03	67.02	16.50	0.46	130.0	± 9.6 %
		Y	6.02	66.74	16.37		130.0	
		Z	5.89	66.87	16.36		130.0	
10637-AAC	IEEE 802.11ac WiFi (160MHz, MCS1, 90pc duty cycle)	X	6.19	67.40	16.66	0.46	130.0	± 9.6 %
		Y	6.19	67.15	16.56		130.0	
		Z	6.02	67.21	16.51		130.0	
10638-AAC	IEEE 802.11ac WiFi (160MHz, MCS2, 90pc duty cycle)	X	6.19	67.38	16.63	0.46	130.0	± 9.6 %
		Y	6.19	67.12	16.52		130.0	
		Z	6.03	67.21	16.49		130.0	

10639-AAC	IEEE 802.11ac WiFi (160MHz, MCS3, 90pc duty cycle)	X	6.18	67.36	16.66	0.46	130.0	± 9.6 %
		Y	6.17	67.09	16.55		130.0	
		Z	6.00	67.13	16.50		130.0	
10640-AAC	IEEE 802.11ac WiFi (160MHz, MCS4, 90pc duty cycle)	X	6.19	67.39	16.62	0.46	130.0	± 9.6 %
		Y	6.20	67.16	16.53		130.0	
		Z	5.99	67.11	16.43		130.0	
10641-AAC	IEEE 802.11ac WiFi (160MHz, MCS5, 90pc duty cycle)	X	6.21	67.22	16.56	0.46	130.0	± 9.6 %
		Y	6.20	66.94	16.44		130.0	
		Z	6.05	67.08	16.43		130.0	
10642-AAC	IEEE 802.11ac WiFi (160MHz, MCS6, 90pc duty cycle)	X	6.27	67.52	16.87	0.46	130.0	± 9.6 %
		Y	6.26	67.23	16.75		130.0	
		Z	6.09	67.31	16.72		130.0	
10643-AAC	IEEE 802.11ac WiFi (160MHz, MCS7, 90pc duty cycle)	X	6.10	67.19	16.61	0.46	130.0	± 9.6 %
		Y	6.09	66.93	16.50		130.0	
		Z	5.93	67.00	16.46		130.0	
10644-AAC	IEEE 802.11ac WiFi (160MHz, MCS8, 90pc duty cycle)	X	6.29	67.77	16.92	0.46	130.0	± 9.6 %
		Y	6.32	67.61	16.86		130.0	
		Z	6.02	67.30	16.63		130.0	
10645-AAC	IEEE 802.11ac WiFi (160MHz, MCS9, 90pc duty cycle)	X	6.72	68.61	17.29	0.46	130.0	± 9.6 %
		Y	6.81	68.60	17.31		130.0	
		Z	6.13	67.29	16.58		130.0	
10646-AAE	LTE-TDD (SC-FDMA, 1 RB, 5 MHz, QPSK, UL Subframe=2,7)	X	26.22	119.06	40.53	9.30	60.0	± 9.6 %
		Y	23.98	116.77	40.23		60.0	
		Z	13.39	105.96	36.68		60.0	
10647-AAE	LTE-TDD (SC-FDMA, 1 RB, 20 MHz, QPSK, UL Subframe=2,7)	X	21.91	115.56	39.67	9.30	60.0	± 9.6 %
		Y	20.79	114.08	39.59		60.0	
		Z	11.12	102.25	35.63		60.0	
10648-AAA	CDMA2000 (1x Advanced)	X	0.80	65.60	12.34	0.00	150.0	± 9.6 %
		Y	0.65	62.69	10.17		150.0	
		Z	0.58	62.96	9.61		150.0	
10652-AAC	LTE-TDD (OFDMA, 5 MHz, E-TM 3.1, Clipping 44%)	X	3.70	67.38	17.08	2.23	80.0	± 9.6 %
		Y	3.59	66.56	16.66		80.0	
		Z	3.39	66.83	16.41		80.0	
10653-AAC	LTE-TDD (OFDMA, 10 MHz, E-TM 3.1, Clipping 44%)	X	4.17	66.50	17.03	2.23	80.0	± 9.6 %
		Y	4.11	65.95	16.76		80.0	
		Z	3.90	66.02	16.55		80.0	
10654-AAC	LTE-TDD (OFDMA, 15 MHz, E-TM 3.1, Clipping 44%)	X	4.13	66.12	17.00	2.23	80.0	± 9.6 %
		Y	4.07	65.60	16.75		80.0	
		Z	3.90	65.62	16.55		80.0	
10655-AAD	LTE-TDD (OFDMA, 20 MHz, E-TM 3.1, Clipping 44%)	X	4.19	66.12	17.04	2.23	80.0	± 9.6 %
		Y	4.13	65.62	16.79		80.0	
		Z	3.96	65.57	16.58		80.0	
10658-AAA	Pulse Waveform (200Hz, 10%)	X	100.00	111.27	26.15	10.00	50.0	± 9.6 %
		Y	100.00	112.15	26.71		50.0	
		Z	14.35	85.50	18.40		50.0	
10659-AAA	Pulse Waveform (200Hz, 20%)	X	100.00	110.66	24.83	6.99	60.0	± 9.6 %
		Y	100.00	110.25	24.76		60.0	
		Z	100.00	105.29	22.07		60.0	

10660-AAA	Pulse Waveform (200Hz, 40%)	X	100.00	112.93	24.53	3.98	80.0	± 9.6 %
		Y	100.00	108.47	22.64		80.0	
		Z	100.00	104.83	20.58		80.0	
10661-AAA	Pulse Waveform (200Hz, 60%)	X	100.00	118.71	25.68	2.22	100.0	± 9.6 %
		Y	100.00	104.33	19.70		100.0	
		Z	100.00	104.48	19.32		100.0	
10662-AAA	Pulse Waveform (200Hz, 80%)	X	100.00	138.66	31.49	0.97	120.0	± 9.6 %
		Y	0.19	60.00	4.09		120.0	
		Z	100.00	91.23	12.90		120.0	

^E Uncertainty is determined using the max. deviation from linear response applying rectangular distribution and is expressed for the square of the field value.



Accredited by the Swiss Accreditation Service (SAS)
The Swiss Accreditation Service is one of the signatories to the EA
Multilateral Agreement for the recognition of calibration certificates

Accreditation No.: **SCS 0108**

Client **PC Test**

Certificate No: **EX3-7488_Jan19**

CALIBRATION CERTIFICATE

Object **EX3DV4 - SN:7488**

Calibration procedure(s) **DA CAL-01 v8, DA CAL-14 v5, DA CAL-23 v5, DA CAL-25 v7**
Calibration procedure for dielectric E-field probes

Handwritten: 11/06/2019

Calibration date: **January 24, 2019**

This calibration certificate documents the traceability to national standards, which realize the physical units of measurements (SI).
The measurements and the uncertainties with confidence probability are given on the following pages and are part of the certificate.

All calibrations have been conducted in the closed laboratory facility: environment temperature (22 ± 3)°C and humidity < 70%.

Calibration Equipment used (M&TE critical for calibration)

Primary Standards	ID	Cal Date (Certificate No.)	Scheduled Calibration
Power meter NRP	SN: 104778	04-Apr-18 (No. 217-02672/02673)	Apr-19
Power sensor NRP-Z91	SN: 103244	04-Apr-18 (No. 217-02672)	Apr-19
Power sensor NRP-Z91	SN: 103245	04-Apr-18 (No. 217-02673)	Apr-19
Reference 20 dB Attenuator	SN: S5277 (20x)	04-Apr-18 (No. 217-02682)	Apr-19
DAE4	SN: 660	19-Dec-18 (No. DAE4-660_Dec18)	Dec-19
Reference Probe ES3DV2	SN: 3013	31-Dec-18 (No. ES3-3013_Dec18)	Dec-19
Secondary Standards	ID	Check Date (in house)	Scheduled Check
Power meter E4419B	SN: GB41293874	06-Apr-16 (in house check Jun-18)	In house check: Jun-20
Power sensor E4412A	SN: MY41498087	06-Apr-16 (in house check Jun-18)	In house check: Jun-20
Power sensor E4412A	SN: 000110210	06-Apr-16 (in house check Jun-18)	In house check: Jun-20
RF generator HP 8648C	SN: US3642U01700	04-Aug-99 (in house check Jun-18)	In house check: Jun-20
Network Analyzer E8358A	SN: US41080477	31-Mar-14 (in house check Oct-18)	In house check: Oct-19

Calibrated by:	Name Jeton Kastrati	Function Laboratory Technician	Signature
Approved by:	Name Katja Pokovic	Function Technical Manager	Signature

Issued: January 29, 2019

This calibration certificate shall not be reproduced except in full without written approval of the laboratory.



Accredited by the Swiss Accreditation Service (SAS)

Accreditation No.: **SCS 0108**

The Swiss Accreditation Service is one of the signatories to the EA
Multilateral Agreement for the recognition of calibration certificates

Glossary:

TSL	tissue simulating liquid
NORM _{x,y,z}	sensitivity in free space
ConvF	sensitivity in TSL / NORM _{x,y,z}
DCP	diode compression point
CF	crest factor (1/duty_cycle) of the RF signal
A, B, C, D	modulation dependent linearization parameters
Polarization φ	φ rotation around probe axis
Polarization ϑ	ϑ rotation around an axis that is in the plane normal to probe axis (at measurement center), i.e., $\vartheta = 0$ is normal to probe axis
Connector Angle	information used in DASY system to align probe sensor X to the robot coordinate system

Calibration is Performed According to the Following Standards:

- IEEE Std 1528-2013, "IEEE Recommended Practice for Determining the Peak Spatial-Averaged Specific Absorption Rate (SAR) in the Human Head from Wireless Communications Devices: Measurement Techniques", June 2013
- IEC 62209-1, "Measurement procedure for the assessment of Specific Absorption Rate (SAR) from hand-held and body-mounted devices used next to the ear (frequency range of 300 MHz to 6 GHz)", July 2016
- IEC 62209-2, "Procedure to determine the Specific Absorption Rate (SAR) for wireless communication devices used in close proximity to the human body (frequency range of 30 MHz to 6 GHz)", March 2010
- KDB 865664, "SAR Measurement Requirements for 100 MHz to 6 GHz"

Methods Applied and Interpretation of Parameters:

- NORM_{x,y,z}**: Assessed for E-field polarization $\vartheta = 0$ ($f \leq 900$ MHz in TEM-cell; $f > 1800$ MHz: R22 waveguide). NORM_{x,y,z} are only intermediate values, i.e., the uncertainties of NORM_{x,y,z} does not affect the E²-field uncertainty inside TSL (see below ConvF).
- NORM(f)_{x,y,z}** = NORM_{x,y,z} * frequency_response (see Frequency Response Chart). This linearization is implemented in DASY4 software versions later than 4.2. The uncertainty of the frequency response is included in the stated uncertainty of ConvF.
- DCP_{x,y,z}**: DCP are numerical linearization parameters assessed based on the data of power sweep with CW signal (no uncertainty required). DCP does not depend on frequency nor media.
- PAR**: PAR is the Peak to Average Ratio that is not calibrated but determined based on the signal characteristics
- A_{x,y,z}; B_{x,y,z}; C_{x,y,z}; D_{x,y,z}; VR_{x,y,z}**: A, B, C, D are numerical linearization parameters assessed based on the data of power sweep for specific modulation signal. The parameters do not depend on frequency nor media. VR is the maximum calibration range expressed in RMS voltage across the diode.
- ConvF and Boundary Effect Parameters**: Assessed in flat phantom using E-field (or Temperature Transfer Standard for $f \leq 800$ MHz) and inside waveguide using analytical field distributions based on power measurements for $f > 800$ MHz. The same setups are used for assessment of the parameters applied for boundary compensation (alpha, depth) of which typical uncertainty values are given. These parameters are used in DASY4 software to improve probe accuracy close to the boundary. The sensitivity in TSL corresponds to NORM_{x,y,z} * ConvF whereby the uncertainty corresponds to that given for ConvF. A frequency dependent ConvF is used in DASY version 4.4 and higher which allows extending the validity from ± 50 MHz to ± 100 MHz.
- Spherical isotropy (3D deviation from isotropy)**: in a field of low gradients realized using a flat phantom exposed by a patch antenna.
- Sensor Offset**: The sensor offset corresponds to the offset of virtual measurement center from the probe tip (on probe axis). No tolerance required.
- Connector Angle**: The angle is assessed using the information gained by determining the NORM_x (no uncertainty required).

DASY/EASY - Parameters of Probe: EX3DV4 - SN:7488

Basic Calibration Parameters

	Sensor X	Sensor Y	Sensor Z	Unc (k=2)
Norm ($\mu\text{V}/(\text{V}/\text{m})^2$) ^A	0.45	0.49	0.50	± 10.1 %
DCP (mV) ^B	98.9	102.3	99.6	

Calibration Results for Modulation Response

UID	Communication System Name		A dB	B dB $\cdot\mu\text{V}$	C	D dB	VR mV	Max dev.	Max Unc ^E (k=2)
0	CW	X	0.00	0.00	1.00	0.00	149.5	± 2.7 %	± 4.7 %
		Y	0.00	0.00	1.00		140.8		
		Z	0.00	0.00	1.00		138.2		
10352- AAA	Pulse Waveform (200Hz, 10%)	X	10.21	80.63	15.98	10.00	60.0	± 3.1 %	± 9.6 %
		Y	5.90	74.67	14.18		60.0		
		Z	15.00	89.30	20.53		60.0		
10353- AAA	Pulse Waveform (200Hz, 20%)	X	15.00	85.88	16.55	6.99	80.0	± 2.1 %	± 9.6 %
		Y	15.00	84.35	15.79		80.0		
		Z	15.00	92.51	21.01		80.0		
10354- AAA	Pulse Waveform (200Hz, 40%)	X	15.00	90.08	17.19	3.98	95.0	± 1.3 %	± 9.6 %
		Y	15.00	83.37	13.66		95.0		
		Z	15.00	104.27	25.33		95.0		
10355- AAA	Pulse Waveform (200Hz, 60%)	X	15.00	97.36	19.30	2.22	120.0	± 1.2 %	± 9.6 %
		Y	0.26	60.00	4.43		120.0		
		Z	15.00	117.38	29.81		120.0		
10387- AAA	QPSK Waveform, 1 MHz	X	0.51	60.28	7.04	0.00	150.0	± 3.3 %	± 9.6 %
		Y	0.47	60.00	5.79		150.0		
		Z	0.61	61.09	8.42		150.0		
10388- AAA	QPSK Waveform, 10 MHz	X	2.29	69.54	16.64	0.00	150.0	± 1.1 %	± 9.6 %
		Y	1.90	66.64	14.97		150.0		
		Z	2.23	68.54	16.09		150.0		
10396- AAA	64-QAM Waveform, 100 kHz	X	2.94	72.04	19.55	3.01	150.0	± 0.7 %	± 9.6 %
		Y	2.49	68.13	17.71		150.0		
		Z	3.35	73.33	20.07		150.0		
10399- AAA	64-QAM Waveform, 40 MHz	X	3.54	67.80	16.20	0.00	150.0	± 2.2 %	± 9.6 %
		Y	3.42	67.12	15.74		150.0		
		Z	3.49	67.32	15.92		150.0		
10414- AAA	WLAN CCDF, 64-QAM, 40MHz	X	4.65	65.56	15.55	0.00	150.0	± 4.0 %	± 9.6 %
		Y	4.74	65.87	15.68		150.0		
		Z	4.80	65.75	15.62		150.0		

Note: For details on UID parameters see Appendix

The reported uncertainty of measurement is stated as the standard uncertainty of measurement multiplied by the coverage factor k=2, which for a normal distribution corresponds to a coverage probability of approximately 95%.

^A The uncertainties of Norm X,Y,Z do not affect the E²-field uncertainty inside TSL (see Pages 5 and 6).

^B Numerical linearization parameter: uncertainty not required.

^E Uncertainty is determined using the max. deviation from linear response applying rectangular distribution and is expressed for the square of the field value.

DASY/EASY - Parameters of Probe: EX3DV4 - SN:7488

Sensor Model Parameters

	C1 fF	C2 fF	α V ⁻¹	T1 ms.V ⁻²	T2 ms.V ⁻¹	T3 ms	T4 V ⁻²	T5 V ⁻¹	T6
X	35.2	259.64	34.83	7.55	0.00	5.04	1.52	0.11	1.01
Y	34.3	261.80	36.90	6.01	0.21	5.06	0.00	0.41	1.01
Z	40.7	301.53	35.10	11.37	0.14	5.09	1.94	0.15	1.01

Other Probe Parameters

Sensor Arrangement	Triangular
Connector Angle (°)	-129.2
Mechanical Surface Detection Mode	enabled
Optical Surface Detection Mode	disabled
Probe Overall Length	337 mm
Probe Body Diameter	10 mm
Tip Length	9 mm
Tip Diameter	2.5 mm
Probe Tip to Sensor X Calibration Point	1 mm
Probe Tip to Sensor Y Calibration Point	1 mm
Probe Tip to Sensor Z Calibration Point	1 mm
Recommended Measurement Distance from Surface	1.4 mm

DASY/EASY - Parameters of Probe: EX3DV4 - SN:7488

Calibration Parameter Determined in Head Tissue Simulating Media

f (MHz) ^C	Relative Permittivity ^F	Conductivity (S/m) ^F	ConvF X	ConvF Y	ConvF Z	Alpha ^G	Depth ^G (mm)	Unc (k=2)
750	41.9	0.89	10.77	10.77	10.77	0.56	0.80	± 12.0 %
835	41.5	0.90	10.37	10.37	10.37	0.40	0.93	± 12.0 %
1750	40.1	1.37	8.87	8.87	8.87	0.33	0.84	± 12.0 %
1900	40.0	1.40	8.53	8.53	8.53	0.27	0.84	± 12.0 %
2300	39.5	1.67	8.25	8.25	8.25	0.33	0.85	± 12.0 %
2450	39.2	1.80	7.86	7.86	7.86	0.34	0.90	± 12.0 %
2600	39.0	1.96	7.69	7.69	7.69	0.35	0.86	± 12.0 %
5250	35.9	4.71	5.35	5.35	5.35	0.40	1.80	± 13.1 %
5600	35.5	5.07	4.70	4.70	4.70	0.40	1.80	± 13.1 %
5750	35.4	5.22	5.03	5.03	5.03	0.40	1.80	± 13.1 %

^C Frequency validity above 300 MHz of ± 100 MHz only applies for DASY v4.4 and higher (see Page 2), else it is restricted to ± 50 MHz. The uncertainty is the RSS of the ConvF uncertainty at calibration frequency and the uncertainty for the indicated frequency band. Frequency validity below 300 MHz is ± 10, 25, 40, 50 and 70 MHz for ConvF assessments at 30, 64, 128, 150 and 220 MHz respectively. Validity of ConvF assessed at 6 MHz is 4-9 MHz, and ConvF assessed at 13 MHz is 9-19 MHz. Above 5 GHz frequency validity can be extended to ± 110 MHz.

^F At frequencies below 3 GHz, the validity of tissue parameters (ϵ and σ) can be relaxed to ± 10% if liquid compensation formula is applied to measured SAR values. At frequencies above 3 GHz, the validity of tissue parameters (ϵ and σ) is restricted to ± 5%. The uncertainty is the RSS of the ConvF uncertainty for indicated target tissue parameters.

^G Alpha/Depth are determined during calibration. SPEAG warrants that the remaining deviation due to the boundary effect after compensation is always less than ± 1% for frequencies below 3 GHz and below ± 2% for frequencies between 3-6 GHz at any distance larger than half the probe tip diameter from the boundary.

DASY/EASY - Parameters of Probe: EX3DV4 - SN:7488

Calibration Parameter Determined in Body Tissue Simulating Media

f (MHz) ^C	Relative Permittivity ^F	Conductivity (S/m) ^F	ConvF X	ConvF Y	ConvF Z	Alpha ^G	Depth ^G (mm)	Unc (k=2)
750	55.5	0.96	11.28	11.28	11.28	0.46	0.80	± 12.0 %
835	55.2	0.97	11.03	11.03	11.03	0.46	0.81	± 12.0 %
1750	53.4	1.49	8.68	8.68	8.68	0.38	0.88	± 12.0 %
1900	53.3	1.52	8.37	8.37	8.37	0.38	0.88	± 12.0 %
2300	52.9	1.81	8.21	8.21	8.21	0.42	0.84	± 12.0 %
2450	52.7	1.95	8.07	8.07	8.07	0.35	0.98	± 12.0 %
2600	52.5	2.16	7.94	7.94	7.94	0.25	0.95	± 12.0 %
5250	48.9	5.36	4.82	4.82	4.82	0.50	1.90	± 13.1 %
5600	48.5	5.77	4.09	4.09	4.09	0.50	1.90	± 13.1 %
5750	48.3	5.94	4.32	4.32	4.32	0.50	1.90	± 13.1 %

^C Frequency validity above 300 MHz of ± 100 MHz only applies for DASY v4.4 and higher (see Page 2), else it is restricted to ± 50 MHz. The uncertainty is the RSS of the ConvF uncertainty at calibration frequency and the uncertainty for the indicated frequency band. Frequency validity below 300 MHz is ± 10, 25, 40, 50 and 70 MHz for ConvF assessments at 30, 64, 128, 150 and 220 MHz respectively. Validity of ConvF assessed at 6 MHz is 4-9 MHz, and ConvF assessed at 13 MHz is 9-19 MHz. Above 5 GHz frequency validity can be extended to ± 110 MHz.

^F At frequencies below 3 GHz, the validity of tissue parameters (ϵ and σ) can be relaxed to ± 10% if liquid compensation formula is applied to measured SAR values. At frequencies above 3 GHz, the validity of tissue parameters (ϵ and σ) is restricted to ± 5%. The uncertainty is the RSS of the ConvF uncertainty for indicated target tissue parameters.

^G Alpha/Depth are determined during calibration. SPEAG warrants that the remaining deviation due to the boundary effect after compensation is always less than ± 1% for frequencies below 3 GHz and below ± 2% for frequencies between 3-6 GHz at any distance larger than half the probe tip diameter from the boundary.

Frequency Response of E-Field (TEM-Cell:ifi110 EXX, Waveguide: R22)

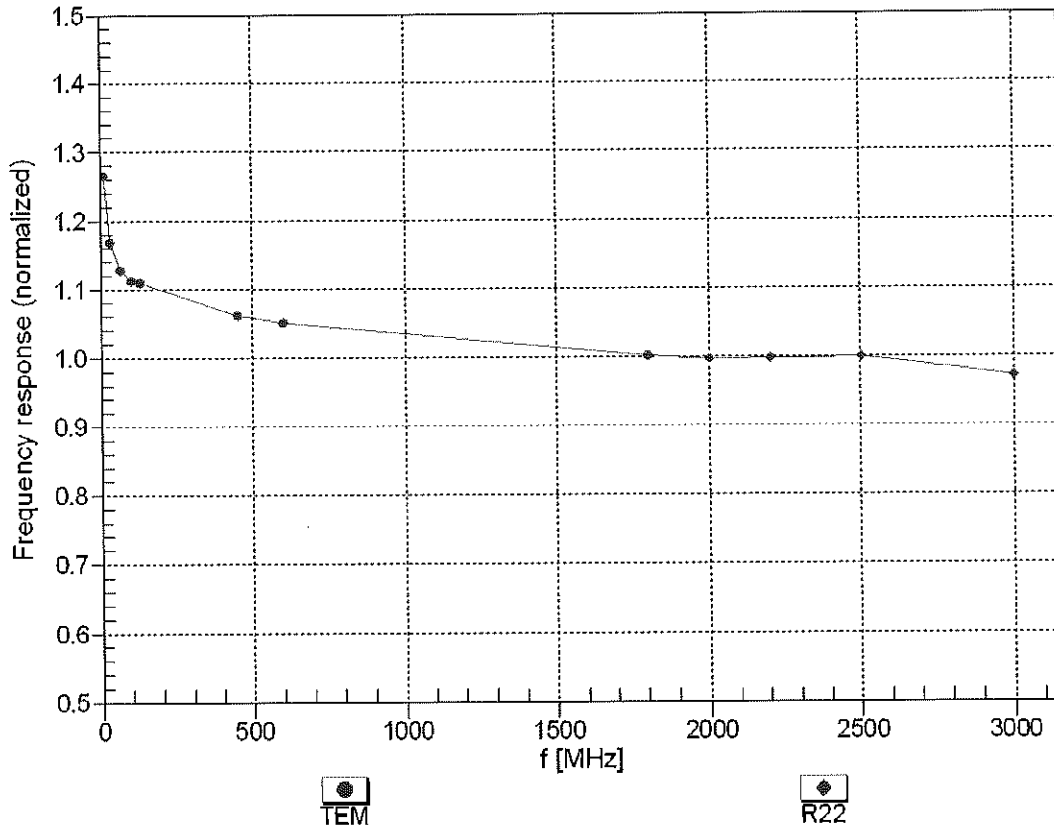

Uncertainty of Frequency Response of E-field: $\pm 6.3\%$ (k=2)

Receiving Pattern (ϕ), $\theta = 0^\circ$

f=600 MHz, TEM

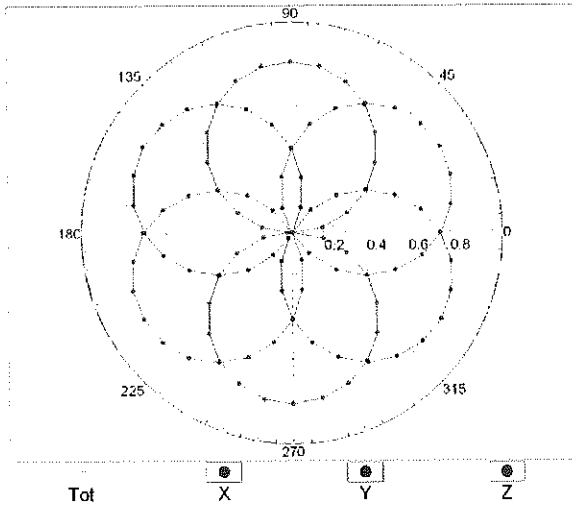

f=1800 MHz, R22

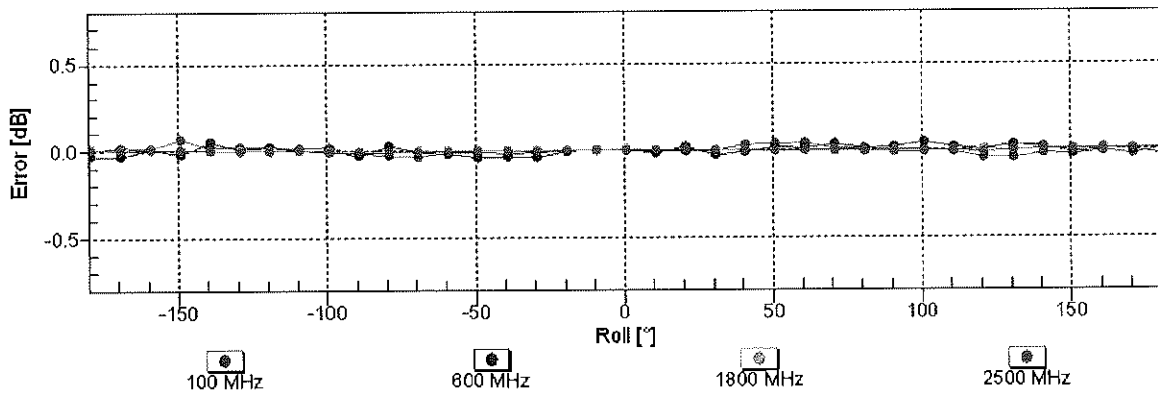
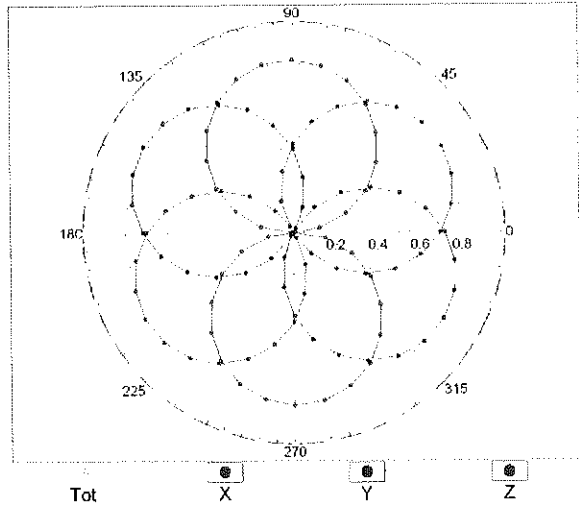

Uncertainty of Axial Isotropy Assessment: $\pm 0.5\%$ (k=2)

Dynamic Range f(SAR_{head}) (TEM cell , f_{eval}= 1900 MHz)

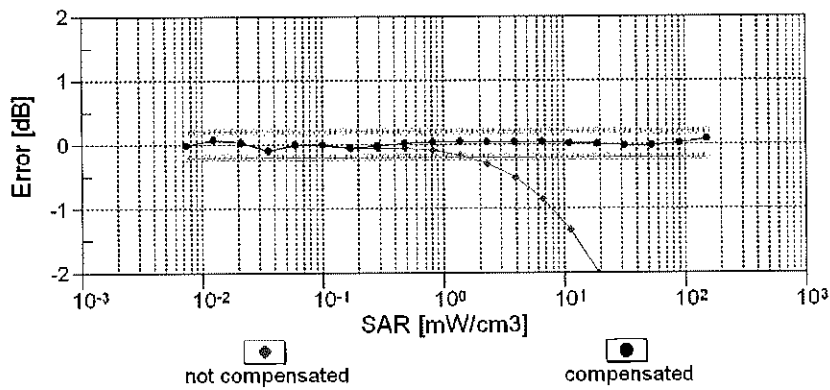
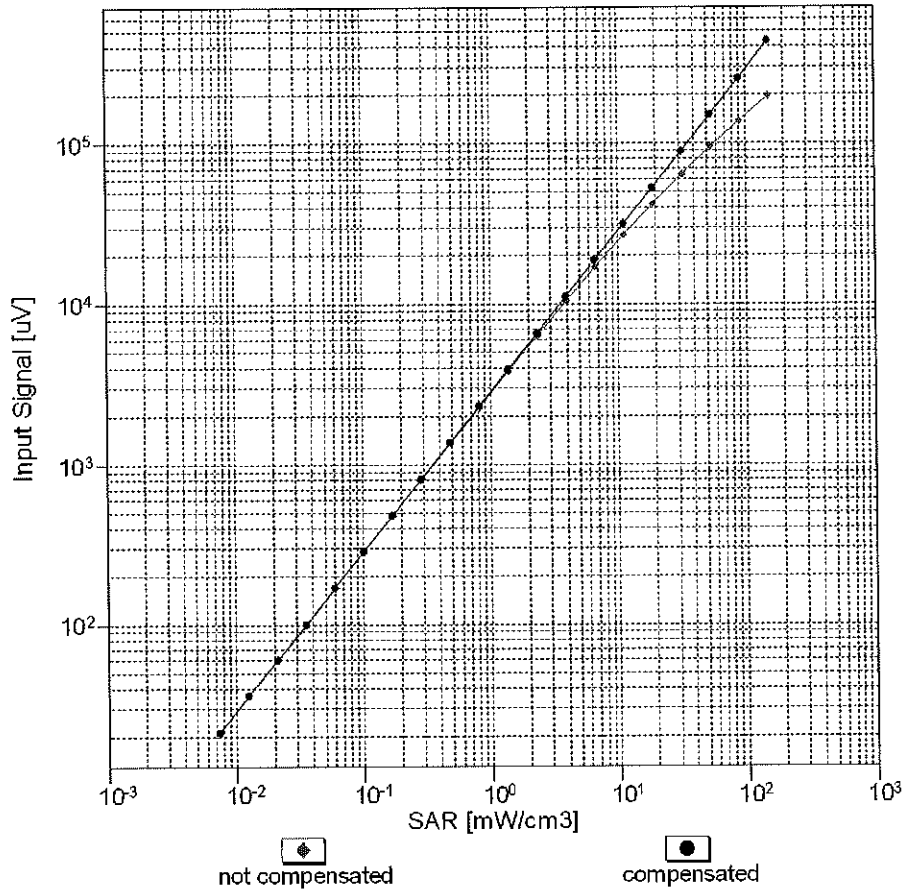

Uncertainty of Linearity Assessment: ± 0.6% (k=2)

Conversion Factor Assessment

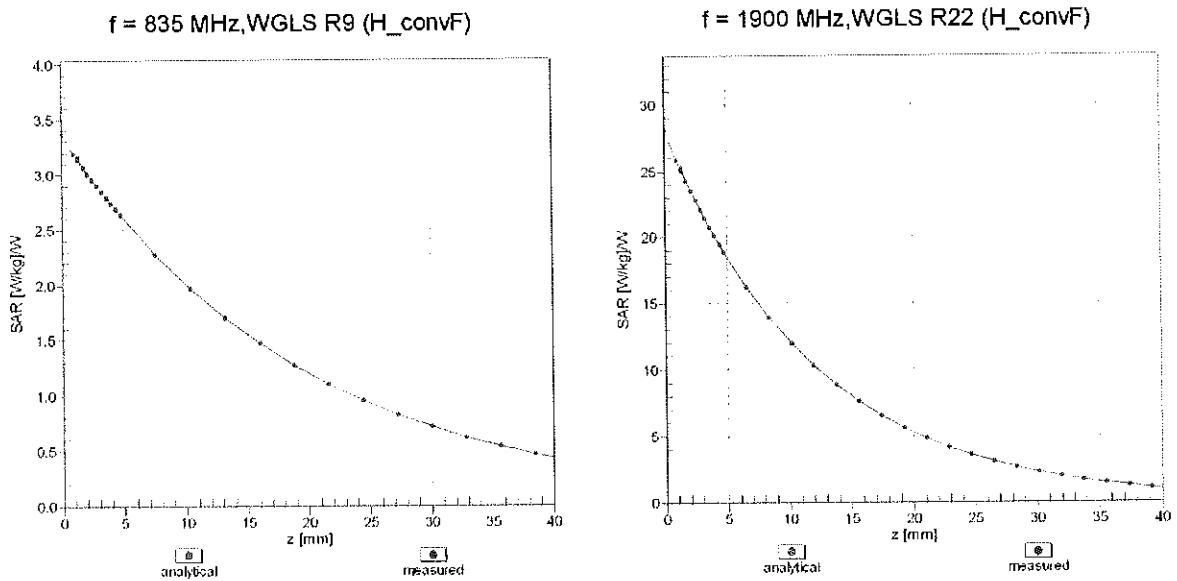

Deviation from Isotropy in Liquid

Error (ϕ, θ), f = 900 MHz

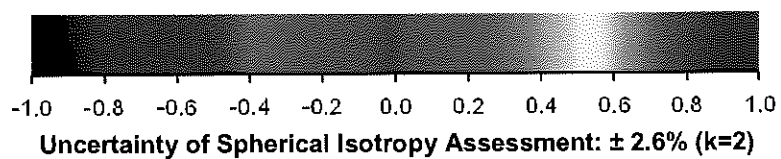
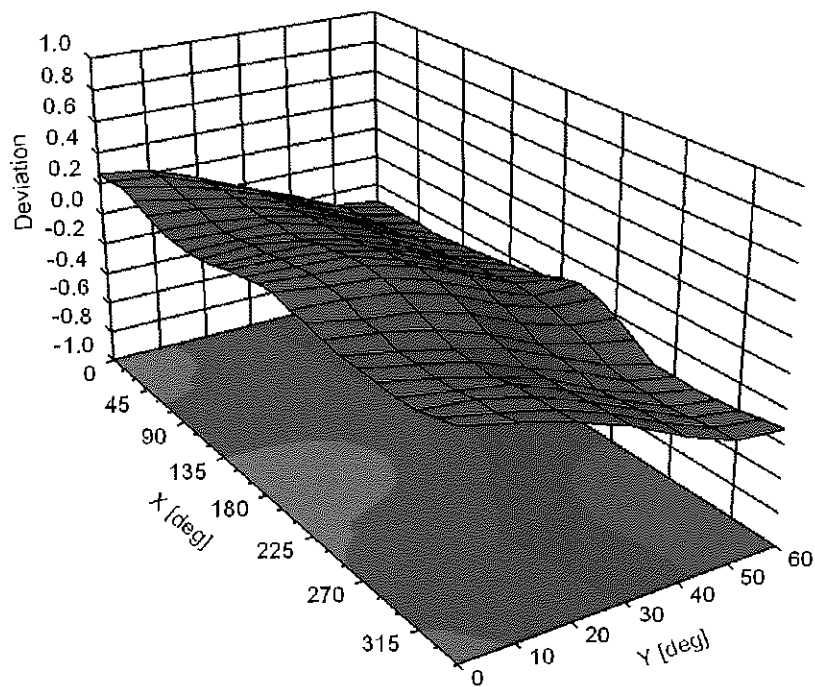

Appendix: Modulation Calibration Parameters

UID	Rev	Communication System Name	Group	PAR (dB)	Unc ^F (k=2)
0		CW	CW	0.00	± 4.7 %
10010	CAA	SAR Validation (Square, 100ms, 10ms)	Test	10.00	± 9.6 %
10011	CAB	UMTS-FDD (WCDMA)	WCDMA	2.91	± 9.6 %
10012	CAB	IEEE 802.11b WiFi 2.4 GHz (DSSS, 1 Mbps)	WLAN	1.87	± 9.6 %
10013	CAB	IEEE 802.11g WiFi 2.4 GHz (DSSS-OFDM, 6 Mbps)	WLAN	9.46	± 9.6 %
10021	DAC	GSM-FDD (TDMA, GMSK)	GSM	9.39	± 9.6 %
10023	DAC	GPRS-FDD (TDMA, GMSK, TN 0)	GSM	9.57	± 9.6 %
10024	DAC	GPRS-FDD (TDMA, GMSK, TN 0-1)	GSM	6.56	± 9.6 %
10025	DAC	EDGE-FDD (TDMA, 8PSK, TN 0)	GSM	12.62	± 9.6 %
10026	DAC	EDGE-FDD (TDMA, 8PSK, TN 0-1)	GSM	9.55	± 9.6 %
10027	DAC	GPRS-FDD (TDMA, GMSK, TN 0-1-2)	GSM	4.80	± 9.6 %
10028	DAC	GPRS-FDD (TDMA, GMSK, TN 0-1-2-3)	GSM	3.55	± 9.6 %
10029	DAC	EDGE-FDD (TDMA, 8PSK, TN 0-1-2)	GSM	7.78	± 9.6 %
10030	CAA	IEEE 802.15.1 Bluetooth (GFSK, DH1)	Bluetooth	5.30	± 9.6 %
10031	CAA	IEEE 802.15.1 Bluetooth (GFSK, DH3)	Bluetooth	1.87	± 9.6 %
10032	CAA	IEEE 802.15.1 Bluetooth (GFSK, DH5)	Bluetooth	1.16	± 9.6 %
10033	CAA	IEEE 802.15.1 Bluetooth (PI/4-DQPSK, DH1)	Bluetooth	7.74	± 9.6 %
10034	CAA	IEEE 802.15.1 Bluetooth (PI/4-DQPSK, DH3)	Bluetooth	4.53	± 9.6 %
10035	CAA	IEEE 802.15.1 Bluetooth (PI/4-DQPSK, DH5)	Bluetooth	3.83	± 9.6 %
10036	CAA	IEEE 802.15.1 Bluetooth (8-DPSK, DH1)	Bluetooth	8.01	± 9.6 %
10037	CAA	IEEE 802.15.1 Bluetooth (8-DPSK, DH3)	Bluetooth	4.77	± 9.6 %
10038	CAA	IEEE 802.15.1 Bluetooth (8-DPSK, DH5)	Bluetooth	4.10	± 9.6 %
10039	CAB	CDMA2000 (1xRTT, RC1)	CDMA2000	4.57	± 9.6 %
10042	CAB	IS-54 / IS-136 FDD (TDMA/FDM, PI/4-DQPSK, Halfrate)	AMPS	7.78	± 9.6 %
10044	CAA	IS-91/EIA/TIA-553 FDD (FDMA, FM)	AMPS	0.00	± 9.6 %
10048	CAA	DECT (TDD, TDMA/FDM, GFSK, Full Slot, 24)	DECT	13.80	± 9.6 %
10049	CAA	DECT (TDD, TDMA/FDM, GFSK, Double Slot, 12)	DECT	10.79	± 9.6 %
10056	CAA	UMTS-TDD (TD-SCDMA, 1.28 Mcps)	TD-SCDMA	11.01	± 9.6 %
10058	DAC	EDGE-FDD (TDMA, 8PSK, TN 0-1-2-3)	GSM	6.52	± 9.6 %
10059	CAB	IEEE 802.11b WiFi 2.4 GHz (DSSS, 2 Mbps)	WLAN	2.12	± 9.6 %
10060	CAB	IEEE 802.11b WiFi 2.4 GHz (DSSS, 5.5 Mbps)	WLAN	2.83	± 9.6 %
10061	CAB	IEEE 802.11b WiFi 2.4 GHz (DSSS, 11 Mbps)	WLAN	3.60	± 9.6 %
10062	CAC	IEEE 802.11a/h WiFi 5 GHz (OFDM, 6 Mbps)	WLAN	8.68	± 9.6 %
10063	CAC	IEEE 802.11a/h WiFi 5 GHz (OFDM, 9 Mbps)	WLAN	8.63	± 9.6 %
10064	CAC	IEEE 802.11a/h WiFi 5 GHz (OFDM, 12 Mbps)	WLAN	9.09	± 9.6 %
10065	CAC	IEEE 802.11a/h WiFi 5 GHz (OFDM, 18 Mbps)	WLAN	9.00	± 9.6 %
10066	CAC	IEEE 802.11a/h WiFi 5 GHz (OFDM, 24 Mbps)	WLAN	9.38	± 9.6 %
10067	CAC	IEEE 802.11a/h WiFi 5 GHz (OFDM, 36 Mbps)	WLAN	10.12	± 9.6 %
10068	CAC	IEEE 802.11a/h WiFi 5 GHz (OFDM, 48 Mbps)	WLAN	10.24	± 9.6 %
10069	CAC	IEEE 802.11a/h WiFi 5 GHz (OFDM, 54 Mbps)	WLAN	10.56	± 9.6 %
10071	CAB	IEEE 802.11g WiFi 2.4 GHz (DSSS/OFDM, 9 Mbps)	WLAN	9.83	± 9.6 %
10072	CAB	IEEE 802.11g WiFi 2.4 GHz (DSSS/OFDM, 12 Mbps)	WLAN	9.62	± 9.6 %
10073	CAB	IEEE 802.11g WiFi 2.4 GHz (DSSS/OFDM, 18 Mbps)	WLAN	9.94	± 9.6 %
10074	CAB	IEEE 802.11g WiFi 2.4 GHz (DSSS/OFDM, 24 Mbps)	WLAN	10.30	± 9.6 %
10075	CAB	IEEE 802.11g WiFi 2.4 GHz (DSSS/OFDM, 36 Mbps)	WLAN	10.77	± 9.6 %
10076	CAB	IEEE 802.11g WiFi 2.4 GHz (DSSS/OFDM, 48 Mbps)	WLAN	10.94	± 9.6 %
10077	CAB	IEEE 802.11g WiFi 2.4 GHz (DSSS/OFDM, 54 Mbps)	WLAN	11.00	± 9.6 %
10081	CAB	CDMA2000 (1xRTT, RC3)	CDMA2000	3.97	± 9.6 %
10082	CAB	IS-54 / IS-136 FDD (TDMA/FDM, PI/4-DQPSK, Fullrate)	AMPS	4.77	± 9.6 %
10090	DAC	GPRS-FDD (TDMA, GMSK, TN 0-4)	GSM	6.56	± 9.6 %
10097	CAB	UMTS-FDD (HSDPA)	WCDMA	3.98	± 9.6 %
10098	CAB	UMTS-FDD (HSUPA, Subtest 2)	WCDMA	3.98	± 9.6 %
10099	DAC	EDGE-FDD (TDMA, 8PSK, TN 0-4)	GSM	9.55	± 9.6 %
10100	CAE	LTE-FDD (SC-FDMA, 100% RB, 20 MHz, QPSK)	LTE-FDD	5.67	± 9.6 %
10101	CAE	LTE-FDD (SC-FDMA, 100% RB, 20 MHz, 16-QAM)	LTE-FDD	6.42	± 9.6 %
10102	CAE	LTE-FDD (SC-FDMA, 100% RB, 20 MHz, 64-QAM)	LTE-FDD	6.60	± 9.6 %
10103	CAG	LTE-TDD (SC-FDMA, 100% RB, 20 MHz, QPSK)	LTE-TDD	9.29	± 9.6 %
10104	CAG	LTE-TDD (SC-FDMA, 100% RB, 20 MHz, 16-QAM)	LTE-TDD	9.97	± 9.6 %
10105	CAG	LTE-TDD (SC-FDMA, 100% RB, 20 MHz, 64-QAM)	LTE-TDD	10.01	± 9.6 %
10108	CAG	LTE-FDD (SC-FDMA, 100% RB, 10 MHz, QPSK)	LTE-FDD	5.80	± 9.6 %

10109	CAG	LTE-FDD (SC-FDMA, 100% RB, 10 MHz, 16-QAM)	LTE-FDD	6.43	±9.6 %
10110	CAG	LTE-FDD (SC-FDMA, 100% RB, 5 MHz, QPSK)	LTE-FDD	5.75	±9.6 %
10111	CAG	LTE-FDD (SC-FDMA, 100% RB, 5 MHz, 16-QAM)	LTE-FDD	6.44	±9.6 %
10112	CAG	LTE-FDD (SC-FDMA, 100% RB, 10 MHz, 64-QAM)	LTE-FDD	6.59	±9.6 %
10113	CAG	LTE-FDD (SC-FDMA, 100% RB, 5 MHz, 64-QAM)	LTE-FDD	6.62	±9.6 %
10114	CAC	IEEE 802.11n (HT Greenfield, 13.5 Mbps, BPSK)	WLAN	8.10	±9.6 %
10115	CAC	IEEE 802.11n (HT Greenfield, 81 Mbps, 16-QAM)	WLAN	8.46	±9.6 %
10116	CAC	IEEE 802.11n (HT Greenfield, 135 Mbps, 64-QAM)	WLAN	8.15	±9.6 %
10117	CAC	IEEE 802.11n (HT Mixed, 13.5 Mbps, BPSK)	WLAN	8.07	±9.6 %
10118	CAC	IEEE 802.11n (HT Mixed, 81 Mbps, 16-QAM)	WLAN	8.59	±9.6 %
10119	CAC	IEEE 802.11n (HT Mixed, 135 Mbps, 64-QAM)	WLAN	8.13	±9.6 %
10140	CAE	LTE-FDD (SC-FDMA, 100% RB, 15 MHz, 16-QAM)	LTE-FDD	6.49	±9.6 %
10141	CAE	LTE-FDD (SC-FDMA, 100% RB, 15 MHz, 64-QAM)	LTE-FDD	6.53	±9.6 %
10142	CAE	LTE-FDD (SC-FDMA, 100% RB, 3 MHz, QPSK)	LTE-FDD	5.73	±9.6 %
10143	CAE	LTE-FDD (SC-FDMA, 100% RB, 3 MHz, 16-QAM)	LTE-FDD	6.35	±9.6 %
10144	CAE	LTE-FDD (SC-FDMA, 100% RB, 3 MHz, 64-QAM)	LTE-FDD	6.65	±9.6 %
10145	CAF	LTE-FDD (SC-FDMA, 100% RB, 1.4 MHz, QPSK)	LTE-FDD	5.76	±9.6 %
10146	CAF	LTE-FDD (SC-FDMA, 100% RB, 1.4 MHz, 16-QAM)	LTE-FDD	6.41	±9.6 %
10147	CAF	LTE-FDD (SC-FDMA, 100% RB, 1.4 MHz, 64-QAM)	LTE-FDD	6.72	±9.6 %
10149	CAE	LTE-FDD (SC-FDMA, 50% RB, 20 MHz, 16-QAM)	LTE-FDD	6.42	±9.6 %
10150	CAE	LTE-FDD (SC-FDMA, 50% RB, 20 MHz, 64-QAM)	LTE-FDD	6.60	±9.6 %
10151	CAG	LTE-TDD (SC-FDMA, 50% RB, 20 MHz, QPSK)	LTE-TDD	9.28	±9.6 %
10152	CAG	LTE-TDD (SC-FDMA, 50% RB, 20 MHz, 16-QAM)	LTE-TDD	9.92	±9.6 %
10153	CAG	LTE-TDD (SC-FDMA, 50% RB, 20 MHz, 64-QAM)	LTE-TDD	10.05	±9.6 %
10154	CAG	LTE-FDD (SC-FDMA, 50% RB, 10 MHz, QPSK)	LTE-FDD	5.75	±9.6 %
10155	CAG	LTE-FDD (SC-FDMA, 50% RB, 10 MHz, 16-QAM)	LTE-FDD	6.43	±9.6 %
10156	CAG	LTE-FDD (SC-FDMA, 50% RB, 5 MHz, QPSK)	LTE-FDD	5.79	±9.6 %
10157	CAG	LTE-FDD (SC-FDMA, 50% RB, 5 MHz, 16-QAM)	LTE-FDD	6.49	±9.6 %
10158	CAG	LTE-FDD (SC-FDMA, 50% RB, 10 MHz, 64-QAM)	LTE-FDD	6.62	±9.6 %
10159	CAG	LTE-FDD (SC-FDMA, 50% RB, 5 MHz, 64-QAM)	LTE-FDD	6.56	±9.6 %
10160	CAE	LTE-FDD (SC-FDMA, 50% RB, 15 MHz, QPSK)	LTE-FDD	5.82	±9.6 %
10161	CAE	LTE-FDD (SC-FDMA, 50% RB, 15 MHz, 16-QAM)	LTE-FDD	6.43	±9.6 %
10162	CAE	LTE-FDD (SC-FDMA, 50% RB, 15 MHz, 64-QAM)	LTE-FDD	6.58	±9.6 %
10166	CAF	LTE-FDD (SC-FDMA, 50% RB, 1.4 MHz, QPSK)	LTE-FDD	5.46	±9.6 %
10167	CAF	LTE-FDD (SC-FDMA, 50% RB, 1.4 MHz, 16-QAM)	LTE-FDD	6.21	±9.6 %
10168	CAF	LTE-FDD (SC-FDMA, 50% RB, 1.4 MHz, 64-QAM)	LTE-FDD	6.79	±9.6 %
10169	CAE	LTE-FDD (SC-FDMA, 1 RB, 20 MHz, QPSK)	LTE-FDD	5.73	±9.6 %
10170	CAE	LTE-FDD (SC-FDMA, 1 RB, 20 MHz, 16-QAM)	LTE-FDD	6.52	±9.6 %
10171	AAE	LTE-FDD (SC-FDMA, 1 RB, 20 MHz, 64-QAM)	LTE-FDD	6.49	±9.6 %
10172	CAG	LTE-TDD (SC-FDMA, 1 RB, 20 MHz, QPSK)	LTE-TDD	9.21	±9.6 %
10173	CAG	LTE-TDD (SC-FDMA, 1 RB, 20 MHz, 16-QAM)	LTE-TDD	9.48	±9.6 %
10174	CAG	LTE-TDD (SC-FDMA, 1 RB, 20 MHz, 64-QAM)	LTE-TDD	10.25	±9.6 %
10175	CAG	LTE-FDD (SC-FDMA, 1 RB, 10 MHz, QPSK)	LTE-FDD	5.72	±9.6 %
10176	CAG	LTE-FDD (SC-FDMA, 1 RB, 10 MHz, 16-QAM)	LTE-FDD	6.52	±9.6 %
10177	CAI	LTE-FDD (SC-FDMA, 1 RB, 5 MHz, QPSK)	LTE-FDD	5.73	±9.6 %
10178	CAG	LTE-FDD (SC-FDMA, 1 RB, 5 MHz, 16-QAM)	LTE-FDD	6.52	±9.6 %
10179	CAG	LTE-FDD (SC-FDMA, 1 RB, 10 MHz, 64-QAM)	LTE-FDD	6.50	±9.6 %
10180	CAG	LTE-FDD (SC-FDMA, 1 RB, 5 MHz, 64-QAM)	LTE-FDD	6.50	±9.6 %
10181	CAE	LTE-FDD (SC-FDMA, 1 RB, 15 MHz, QPSK)	LTE-FDD	5.72	±9.6 %
10182	CAE	LTE-FDD (SC-FDMA, 1 RB, 15 MHz, 16-QAM)	LTE-FDD	6.52	±9.6 %
10183	AAD	LTE-FDD (SC-FDMA, 1 RB, 15 MHz, 64-QAM)	LTE-FDD	6.50	±9.6 %
10184	CAE	LTE-FDD (SC-FDMA, 1 RB, 3 MHz, QPSK)	LTE-FDD	5.73	±9.6 %
10185	CAE	LTE-FDD (SC-FDMA, 1 RB, 3 MHz, 16-QAM)	LTE-FDD	6.51	±9.6 %
10186	AAE	LTE-FDD (SC-FDMA, 1 RB, 3 MHz, 64-QAM)	LTE-FDD	6.50	±9.6 %
10187	CAF	LTE-FDD (SC-FDMA, 1 RB, 1.4 MHz, QPSK)	LTE-FDD	5.73	±9.6 %
10188	CAF	LTE-FDD (SC-FDMA, 1 RB, 1.4 MHz, 16-QAM)	LTE-FDD	6.52	±9.6 %
10189	AAF	LTE-FDD (SC-FDMA, 1 RB, 1.4 MHz, 64-QAM)	LTE-FDD	6.50	±9.6 %
10193	CAC	IEEE 802.11n (HT Greenfield, 6.5 Mbps, BPSK)	WLAN	8.09	±9.6 %
10194	CAC	IEEE 802.11n (HT Greenfield, 39 Mbps, 16-QAM)	WLAN	8.12	±9.6 %
10195	CAC	IEEE 802.11n (HT Greenfield, 65 Mbps, 64-QAM)	WLAN	8.21	±9.6 %
10196	CAC	IEEE 802.11n (HT Mixed, 6.5 Mbps, BPSK)	WLAN	8.10	±9.6 %
10197	CAC	IEEE 802.11n (HT Mixed, 39 Mbps, 16-QAM)	WLAN	8.13	±9.6 %
10198	CAC	IEEE 802.11n (HT Mixed, 65 Mbps, 64-QAM)	WLAN	8.27	±9.6 %
10219	CAC	IEEE 802.11n (HT Mixed, 7.2 Mbps, BPSK)	WLAN	8.03	±9.6 %