



SAR EVALUATION REPORT

Applicant Name:
 LG Electronics U.S.A., Inc.
 1000 Sylvan Avenue
 Englewood Cliffs, NJ 07632
 United States

Date of Testing:
 05/08/19 - 05/16/19
Test Site/Location:
 PCTEST Lab, Columbia, MD, USA
Document Serial No.:
 1M1905090070-01-R2.ZNF

FCC ID: ZNFX420AS
APPLICANT: LG ELECTRONICS U.S.A., INC.

DUT Type: Portable Handset
Application Type: Certification
FCC Rule Part(s): CFR §2.1093
Model: LM-X420AS
Additional Model(s): LMX420AS, X420AS

Equipment Class	Band & Mode	Tx Frequency	SAR			
			1g Head (W/kg)	1g Body-Worn (W/kg)	1g Hotspot (W/kg)	10g Phablet (W/kg)
PCE	GSMGPRS/EDGE 850	824.20 - 848.80 MHz	0.45	0.48	0.50	N/A
PCE	GSMGPRS/EDGE 1900	1850.20 - 1909.80 MHz	0.25	0.36	0.36	N/A
PCE	UMTS 850	826.40 - 846.60 MHz	0.49	0.58	0.73	N/A
PCE	UMTS 1750	1712.4 - 1752.6 MHz	0.37	1.04	1.04	3.13
PCE	UMTS 1900	1852.4 - 1907.6 MHz	0.56	0.93	0.93	3.07
PCE	LTE Band 12	699.7 - 715.3 MHz	0.31	0.58	0.59	N/A
PCE	LTE Band 14	790.5 - 795.5 MHz	0.26	0.34	0.38	N/A
PCE	LTE Band 5 (Cell)	824.7 - 848.3 MHz	0.52	0.55	0.63	N/A
PCE	LTE Band 66 (AWS)	1710.7 - 1779.3 MHz	0.41	1.09	1.09	3.17
PCE	LTE Band 4 (AWS)	1710.7 - 1754.3 MHz	N/A	N/A	N/A	N/A
PCE	LTE Band 2 (PCS)	1850.7 - 1909.3 MHz	0.57	0.82	0.82	3.08
PCE	LTE Band 30	2307.5 - 2312.5 MHz	0.21	0.82	1.11	1.80
DTS	2.4 GHz WLAN	2412 - 2462 MHz	0.72	0.13	0.13	N/A
DSS/DTS	Bluetooth	2402 - 2480 MHz	0.21	N/A	N/A	N/A
Simultaneous SAR per KDB 690783 D01v01r03:			1.29	1.30	1.32	3.33

Note: This revised Test Report (S/N: 1M1905090070-01-R2.ZNF) supersedes and replaces the previously issued test report on the same subject device for the same type of testing as indicated. Please discard or destroy the previously issued test report(s) and dispose of it accordingly.

This wireless portable device has been shown to be capable of compliance for localized specific absorption rate (SAR) for uncontrolled environment/general population exposure limits specified in ANSI/IEEE C95.1-1992 and has been tested in accordance with the measurement procedures specified in Section 1.8 of this report; for North American frequency bands only.

I attest to the accuracy of data. All measurements reported herein were performed by me or were made under my supervision and are correct to the best of my knowledge and belief. I assume full responsibility for the completeness of these measurements and vouch for the qualifications of all persons taking them. Test results reported herein relate only to the item(s) tested.

Randy Ortanez
 President





The SAR Tick is an initiative of the Mobile & Wireless Forum (MWF). While a product may be considered eligible, use of the SAR Tick logo requires an agreement with the MWF. Further details can be obtained by emailing: sartick@mwfai.info.

FCC ID: ZNFX420AS		SAR EVALUATION REPORT		Approved by: Quality Manager
Document S/N: 1M1905090070-01-R2.ZNF	Test Dates: 05/08/19 - 05/16/19	DUT Type: Portable Handset	Page 1 of 84	

TABLE OF CONTENTS

1	DEVICE UNDER TEST	3
2	LTE INFORMATION	13
3	INTRODUCTION	14
4	DOSIMETRIC ASSESSMENT	15
5	DEFINITION OF REFERENCE POINTS.....	16
6	TEST CONFIGURATION POSITIONS.....	17
7	RF EXPOSURE LIMITS	21
8	FCC MEASUREMENT PROCEDURES.....	22
9	RF CONDUCTED POWERS	27
10	SYSTEM VERIFICATION.....	52
11	SAR DATA SUMMARY	56
12	FCC MULTI-TX AND ANTENNA SAR CONSIDERATIONS.....	73
13	SAR MEASUREMENT VARIABILITY	78
14	EQUIPMENT LIST.....	80
15	MEASUREMENT UNCERTAINTIES.....	81
16	CONCLUSION.....	82
17	REFERENCES	83
APPENDIX A:	SAR TEST PLOTS	
APPENDIX B:	SAR DIPOLE VERIFICATION PLOTS	
APPENDIX C:	PROBE AND DIPOLE CALIBRATION CERTIFICATES	
APPENDIX D:	SAR TISSUE SPECIFICATIONS	
APPENDIX E:	SAR SYSTEM VALIDATION	
APPENDIX F:	DUT ANTENNA DIAGRAM & SAR TEST SETUP PHOTOGRAPHS	
APPENDIX G:	POWER REDUCTION VERIFICATION	
APPENDIX H:	DOWNLINK LTE CA RF CONDUCTED POWERS	

FCC ID: ZNFX420AS	 SAR EVALUATION REPORT		Approved by: Quality Manager
Document S/N: 1M1905090070-01-R2-ZNF	Test Dates: 05/08/19 - 05/16/19	DUT Type: Portable Handset	Page 2 of 84



1 DEVICE UNDER TEST

1.1 Device Overview

Band & Mode	Operating Modes	Tx Frequency
GSM/GPRS/EDGE 850	Voice/Data	824.20 - 848.80 MHz
GSM/GPRS/EDGE 1900	Voice/Data	1850.20 - 1909.80 MHz
UMTS 850	Voice/Data	826.40 - 846.60 MHz
UMTS 1750	Voice/Data	1712.4 - 1752.6 MHz
UMTS 1900	Voice/Data	1852.4 - 1907.6 MHz
LTE Band 12	Voice/Data	699.7 - 715.3 MHz
LTE Band 14	Voice/Data	790.5 - 795.5 MHz
LTE Band 5 (Cell)	Voice/Data	824.7 - 848.3 MHz
LTE Band 66 (AWS)	Voice/Data	1710.7 - 1779.3 MHz
LTE Band 4 (AWS)	Voice/Data	1710.7 - 1754.3 MHz
LTE Band 2 (PCS)	Voice/Data	1850.7 - 1909.3 MHz
LTE Band 30	Voice/Data	2307.5 - 2312.5 MHz
2.4 GHz WLAN	Voice/Data	2412 - 2462 MHz
Bluetooth	Data	2402 - 2480 MHz
NFC	Data	13.56 MHz

1.2 Power Reduction for SAR

This device uses a power reduction mechanism for SAR compliance. The power reduction mechanism is activated when the device is used in close proximity to the user's body. FCC KDB Publication 616217 D04v01r02 Section 6 was used as a guideline for selecting SAR test distances for this device. Detailed descriptions of the power reduction mechanism are included in the operational description.

FCC ID: ZNFX420AS	 PCTEST ENGINEERING LABORATORY, INC.	SAR EVALUATION REPORT	 LG	Approved by: Quality Manager
Document S/N: 1M1905090070-01-R2.ZNF	Test Dates: 05/08/19 - 05/16/19	DUT Type: Portable Handset	Page 3 of 84	

1.3 Nominal and Maximum Output Power Specifications



This device operates using the following maximum and nominal output power specifications. SAR values were scaled to the maximum allowed power to determine compliance per KDB Publication 447498 D01v06.

1.3.1 Maximum Output Power

Mode / Band		Voice (dBm)	Burst Average GMSK (dBm)		Burst Average 8-PSK (dBm)	
		1 TX Slot	1 TX Slots	2 TX Slots	1 TX Slots	2 TX Slots
GSM/GPRS/EDGE 850	Maximum	32.7	32.7	30.7	27.2	25.7
	Nominal	32.2	32.2	30.2	26.7	25.2
GSM/GPRS/EDGE 1900	Maximum	29.7	29.7	28.2	26.7	24.7
	Nominal	29.2	29.2	27.7	26.2	24.2



Mode / Band		Modulated Average (dBm)	
		3GPP WCDMA	
UMTS Band 5 (850 MHz)	Maximum	25.2	
	Nominal	24.7	
UMTS Band 4 (1750 MHz)	Maximum	24.2	
	Nominal	23.7	
UMTS Band 2 (1900 MHz)	Maximum	24.4	
	Nominal	23.9	

Mode / Band		Modulated Average (dBm)	
		Nominal	Maximum
B5			
HSDPA	Subtest1	23.7	24.2
	Subtest2	23.7	24.2
	Subtest3	23.2	23.7
	Subtest4	23.2	23.7
HSUPA	Subtest1	21.7	22.2
	Subtest2	21.7	22.2
	Subtest3	22.7	23.2
	Subtest4	21.2	21.7
	Subtest5	22.7	23.2

FCC ID: ZNFX420AS	 PCTEST ENGINEERING LABORATORY, INC.	SAR EVALUATION REPORT		Approved by: Quality Manager
Document S/N: 1M1905090070-01-R2.ZNF	Test Dates: 05/08/19 - 05/16/19	DUT Type: Portable Handset	Page 4 of 84	



Mode / Band		Modulated Average (dBm)	
B4		Nominal	Maximum
HSDPA	Subtest1	22.7	23.2
	Subtest2	22.7	23.2
	Subtest3	22.2	22.7
	Subtest4	22.2	22.7
HSUPA	Subtest1	20.7	21.2
	Subtest2	20.7	21.2
	Subtest3	21.7	22.2
	Subtest4	20.2	20.7
	Subtest5	21.7	22.2

Mode / Band		Modulated Average (dBm)	
B2		Nominal	Maximum
HSDPA	Subtest1	22.9	23.4
	Subtest2	22.9	23.4
	Subtest3	22.4	22.9
	Subtest4	22.4	22.9
HSUPA	Subtest1	20.9	21.4
	Subtest2	20.9	21.4
	Subtest3	21.9	22.4
	Subtest4	20.4	20.9
	Subtest5	21.9	22.4

FCC ID: ZNFX420AS	 PCTEST ENGINEERING LABORATORY, INC.	SAR EVALUATION REPORT	 LG	Approved by: Quality Manager
Document S/N: 1M1905090070-01-R2.ZNF	Test Dates: 05/08/19 - 05/16/19	DUT Type: Portable Handset	Page 5 of 84	

Mode / Band		Modulated Average (dBm)
LTE Band 12	Maximum	25.2
	Nominal	24.7
LTE Band 14	Maximum	23.2
	Nominal	22.7
LTE Band 5 (Cell)	Maximum	25.2
	Nominal	24.7
LTE Band 66 (AWS)	Maximum	24.4
	Nominal	23.9
LTE Band 4 (AWS)	Maximum	24.4
	Nominal	23.9
LTE Band 2 (PCS)	Maximum	24.4
	Nominal	23.9
LTE Band 30	Maximum	23.0
	Nominal	22.5

Mode / Band		Modulated Average (dBm)				
		Ch 1	Ch 2	Ch 3-9	Ch 10	Ch 11
IEEE 802.11b (2.4 GHz)	Maximum	15.0				
	Nominal	14.0				
IEEE 802.11g (2.4 GHz)	Maximum	12.5	14.5	14.5	14.5	12.5
	Nominal	11.5	13.5	13.5	13.5	11.5
IEEE 802.11n (2.4 GHz)	Maximum	12.5	13.5	13.5	13.5	12.5
	Nominal	11.5	12.5	12.5	12.5	11.5



FCC ID: ZNFX420AS	 PCTEST ENGINEERING LABORATORY, INC.	SAR EVALUATION REPORT	 LG	Approved by: Quality Manager
Document S/N: 1M1905090070-01-R2.ZNF	Test Dates: 05/08/19 - 05/16/19	DUT Type: Portable Handset	Page 6 of 84	

Mode / Band		Modulated Average (dBm)
Bluetooth	Maximum	10.0
	Nominal	9.0
Bluetooth (2-DH5)	Maximum	7.0
	Nominal	6.0
Bluetooth (3-DH5)	Maximum	7.0
	Nominal	6.0
Bluetooth LE	Maximum	-0.5
	Nominal	-1.5

1.3.2 Reduced Output Power



Mode / Band		Modulated Average (dBm)
		3GPP WCDMA
UMTS Band 4 (1750 MHz)	Maximum	22.7
	Nominal	22.2
UMTS Band 2 (1900 MHz)	Maximum	22.9
	Nominal	22.4

Mode / Band		Modulated Average (dBm)	
		Nominal	Maximum
B4			
HSDPA	Subtest1	22.2	22.7
	Subtest2	22.2	22.7
	Subtest3	22.2	22.7
	Subtest4	22.2	22.7
HSUPA	Subtest1	20.7	21.2
	Subtest2	20.7	21.2
	Subtest3	21.7	22.2
	Subtest4	20.2	20.7
	Subtest5	21.7	22.2

FCC ID: ZNFX420AS	 PCTEST ENGINEERING LABORATORY, INC.	SAR EVALUATION REPORT	 LG	Approved by: Quality Manager
Document S/N: 1M1905090070-01-R2.ZNF	Test Dates: 05/08/19 - 05/16/19	DUT Type: Portable Handset		Page 7 of 84

Mode / Band		Modulated Average (dBm)	
B2		Nominal	Maximum
HSDPA	Subtest1	22.4	22.9
	Subtest2	22.4	22.9
	Subtest3	22.4	22.9
	Subtest4	22.4	22.9
HSUPA	Subtest1	20.9	21.4
	Subtest2	20.9	21.4
	Subtest3	21.9	22.4
	Subtest4	20.4	20.9
	Subtest5	21.9	22.4

Mode / Band		Modulated Average (dBm)	
LTE Band 66 (AWS)	Maximum	22.9	
	Nominal	22.4	
LTE Band 4 (AWS)	Maximum	22.9	
	Nominal	22.4	
LTE Band 2 (PCS)	Maximum	22.9	
	Nominal	22.4	
LTE Band 30	Maximum	21.5	
	Nominal	21.0	

FCC ID: ZNFX420AS	 PCTEST ENGINEERING LABORATORY, INC.	SAR EVALUATION REPORT	 LG	Approved by: Quality Manager
Document S/N: 1M1905090070-01-R2.ZNF	Test Dates: 05/08/19 - 05/16/19	DUT Type: Portable Handset	Page 8 of 84	

1.4 DUT Antenna Locations

The overall dimensions of this device are > 9 x 5 cm. A diagram showing the location of the device antennas can be found in Appendix F. Since the diagonal dimension of this device is > 160 mm and <200 mm, it is considered a “phablet.”



**Table 1-1
Device Edges/Sides for SAR Testing**

Mode	Back	Front	Top	Bottom	Right	Left
GPRS 850	Yes	Yes	No	Yes	Yes	Yes
GPRS 1900	Yes	Yes	No	Yes	No	Yes
UMTS 850	Yes	Yes	No	Yes	Yes	Yes
UMTS 1750	Yes	Yes	No	Yes	No	Yes
UMTS 1900	Yes	Yes	No	Yes	No	Yes
LTE Band 12	Yes	Yes	No	Yes	Yes	Yes
LTE Band 14	Yes	Yes	No	Yes	Yes	Yes
LTE Band 5 (Cell)	Yes	Yes	No	Yes	Yes	Yes
LTE Band 66 (AWS)	Yes	Yes	No	Yes	No	Yes
LTE Band 2 (PCS)	Yes	Yes	No	Yes	No	Yes
LTE Band 30	Yes	Yes	No	Yes	Yes	Yes
2.4 GHz WLAN	Yes	Yes	Yes	No	No	Yes

Note: Particular DUT edges were not required to be evaluated for wireless router SAR or phablet SAR if the edges were greater than 2.5 cm from the transmitting antenna according to FCC KDB Publication 941225 D06v02r01 Section III and FCC KDB Publication 648474 D04v01r03. The distances between the transmit antennas and the edges of the device are included in the filing.

1.5 Near Field Communications (NFC) Antenna

This DUT has NFC operations. The NFC antenna is integrated into the device for this model. Therefore, all SAR tests were performed with the device which already incorporates the NFC antenna. A diagram showing the location of the NFC antenna can be found in Appendix F.

FCC ID: ZNFX420AS	 PCTEST ENGINEERING LABORATORY, INC.	SAR EVALUATION REPORT	 LG	Approved by: Quality Manager
Document S/N: 1M1905090070-01-R2.ZNF	Test Dates: 05/08/19 - 05/16/19	DUT Type: Portable Handset	Page 9 of 84	

1.6 Simultaneous Transmission Capabilities

According to FCC KDB Publication 447498 D01v06, transmitters are considered to be operating simultaneously when there is overlapping transmission, with the exception of transmissions during network hand-offs with maximum hand-off duration less than 30 seconds.

This device contains multiple transmitters that may operate simultaneously, and therefore requires a simultaneous transmission analysis according to FCC KDB Publication 447498 D01v06 4.3.2 procedures.

**Table 1-2
Simultaneous Transmission Scenarios**

No.	Capable Transmit Configuration	Head	Body-Worn Accessory	Wireless Router	Phablet	Notes
1	GSM voice + 2.4 GHz W-Fi	Yes	Yes	N/A	Yes	
2	GSM voice + 2.4 GHz Bluetooth	Yes^	Yes	N/A	Yes	^Bluetooth Tethering is considered
3	UMTS + 2.4 GHz W-Fi	Yes	Yes	Yes	Yes	
4	UMTS + 2.4 GHz Bluetooth	Yes^	Yes	Yes^	Yes	^Bluetooth Tethering is considered
5	LTE + 2.4 GHz W-Fi	Yes	Yes	Yes	Yes	
6	LTE + 2.4 GHz Bluetooth	Yes^	Yes	Yes^	Yes	^Bluetooth Tethering is considered
7	GPRS/EDGE + 2.4 GHz W-Fi	Yes*	Yes*	Yes	Yes	* Pre-installed VOIP applications are considered
8	GPRS/EDGE + 2.4 GHz Bluetooth	Yes*^	Yes*	Yes^	Yes	* Pre-installed VOIP applications are considered ^Bluetooth Tethering is considered

- 2.4 GHz WLAN, and 2.4 GHz Bluetooth share the same antenna path and cannot transmit simultaneously.
- All licensed modes share the same antenna path and cannot transmit simultaneously.
- When the user utilizes multiple services in UMTS 3G mode it uses multi-Radio Access Bearer or multi-RAB. The power control is based on a physical control channel (Dedicated Physical Control Channel [DPCCH]) and power control will be adjusted to meet the needs of both services. Therefore, the UMTS+WLAN scenario also represents the UMTS Voice/DATA + WLAN Hotspot scenario.
- Per the manufacturer, WIFI Direct is expected to be used in conjunction with a held-to-ear or body-worn accessory voice call. Therefore, there are no simultaneous transmission scenarios involving WIFI direct beyond that listed in the above table.
- This device supports VOLTE.
- This device supports VoWIFI.
- This device supports Bluetooth Tethering.



1.7 Miscellaneous SAR Test Considerations

(A) WIFI/BT

Per FCC KDB 447498 D01v06, the 1g SAR exclusion threshold for distances <50mm is defined by the following equation:

$$\frac{\text{Max Power of Channel (mW)}}{\text{Test Separation Dist (mm)}} * \sqrt{\text{Frequency(GHz)}} \leq 3.0$$

Based on the maximum conducted power of Bluetooth (rounded to the nearest mW) and the antenna to user separation distance, body-worn and Hotspot Bluetooth SAR was not required; $[(10/10) * \sqrt{2.480}] = 1.6 < 3.0$. Per KDB Publication 447498 D01v06, the maximum power of the channel was rounded to the nearest mW before calculation.

FCC ID: ZNFX420AS	 PCTEST ENGINEERING LABORATORY, INC.	SAR EVALUATION REPORT		Approved by: Quality Manager
Document S/N: 1M1905090070-01-R2-ZNF	Test Dates: 05/08/19 - 05/16/19	DUT Type: Portable Handset		Page 10 of 84

Per FCC KDB 447498 D01v06, the 10g SAR exclusion threshold for distances <50mm is defined by the following equation:

$$\frac{\text{Max Power of Channel (mW)}}{\text{Test Separation Dist (mm)}} * \sqrt{\text{Frequency(GHz)}} \leq 7.5$$

Based on the maximum conducted power of Bluetooth (rounded to the nearest mW) and the antenna to user separation distance, phablet Bluetooth SAR was not required; $[(10/ 5) * \sqrt{2.480}] = 3.1 < 7.5$. Per KDB Publication 447498 D01v06, the maximum power of the channel was rounded to the nearest mW before calculation.

Per FCC KDB Publication 648474 D04v01r03, this device is considered a "phablet" since the diagonal dimension is greater than 160mm and less than 200mm. Phablet SAR tests are required when wireless router mode does not apply or if wireless router 1g SAR > 1.2 W/kg. Phablet SAR was not evaluated for 2.4 GHz WLAN operations since wireless router 1g SAR was < 1.2 W/kg.

(B) Licensed Transmitter(s)

GSM/GPRS/EDGE DTM is not supported for US bands. Therefore, the GSM Voice modes in this report do not transmit simultaneously with GPRS/EDGE Data.



This device is only capable of QPSK HSUPA in the uplink. Therefore, no additional SAR tests are required beyond that described for devices with HSUPA in KDB 941225 D01v03r01.

LTE SAR for the higher modulations and lower bandwidths were not tested since the maximum average output power of all required channels and configurations was not more than 0.5 dB higher than the highest bandwidth; and the reported LTE SAR for the highest bandwidth was less than 1.45 W/kg for all configurations according to FCC KDB 941225 D05v02r04.

This device supports LTE Carrier Aggregation (CA) in the downlink only. All uplink communications are identical to Release 8 specifications. Per FCC KDB Publication 941225 D05A v01r02, SAR for LTE CA operations was not needed since the maximum average output power in LTE CA mode was not >0.25 dB higher than the maximum output power when downlink carrier aggregation was inactive. The downlink carrier aggregation exclusion analysis can be found in Appendix H.

Per FCC KDB Publication 648474 D04v01r03, this device is considered a "phablet" since the diagonal dimension is greater than 160mm and less than 200mm. Therefore, phablet SAR tests are required when wireless router mode does not apply or if wireless router 1g SAR > 1.2 W/kg. Additional SAR tests for phablet SAR were evaluated per KDB 616217 Section 6 (See Section 6.9 for more information.)

This device supports LTE capabilities with overlapping transmission frequency ranges. When the supported frequency range of an LTE Band falls completely within an LTE band with a larger transmission frequency range, both LTE bands have the same target power (or the band with the larger transmission frequency range has a higher target power), and both LTE bands share the same transmission path and signal characteristics, SAR was only assessed for the band with the larger transmission frequency range.



FCC ID: ZNFX420AS	 SAR EVALUATION REPORT 		Approved by: Quality Manager
Document S/N: 1M1905090070-01-R2.ZNF	Test Dates: 05/08/19 - 05/16/19	DUT Type: Portable Handset	Page 11 of 84

1.8 Guidance Applied

- IEEE 1528-2013
- FCC KDB Publication 941225 D01v03r01, D05v02r04, D05Av01r02, D06v02r01 (2G/3G/4G and Hotspot)
- FCC KDB Publication 248227 D01v02r02 (SAR Considerations for 802.11 Devices)
- FCC KDB Publication 447498 D01v06 (General SAR Guidance)
- FCC KDB Publication 865664 D01v01r04, D02v01r02 (SAR Measurements up to 6 GHz)
- FCC KDB Publication 648474 D04v01r03 (Phablet Procedures)
- FCC KDB Publication 616217 D04v01r02 (Proximity Sensor)
- October 2013 TCB Workshop Notes (GPRS Testing Considerations)
- April 2018 TCB Workshop Notes (LTE Carrier Aggregation)

1.9 Device Serial Numbers



Several samples with identical hardware were used to support SAR testing. The manufacturer has confirmed that the device(s) tested have the same physical, mechanical and thermal characteristics and are within operational tolerances expected for production units. The serial numbers used for each test are indicated alongside the results in Section 11.

FCC ID: ZNFX420AS	 SAR EVALUATION REPORT 		Approved by: Quality Manager
Document S/N: 1M1905090070-01-R2.ZNF	Test Dates: 05/08/19 - 05/16/19	DUT Type: Portable Handset	Page 12 of 84

2

LTE INFORMATION

LTE Information			
Form Factor	Portable Handset		
Frequency Range of each LTE transmission band	LTE Band 12 (699.7 - 715.3 MHz)		
	LTE Band 14 (790.5 - 795.5 MHz)		
	LTE Band 5 (Cell) (824.7 - 848.3 MHz)		
	LTE Band 66 (AWS) (1710.7 - 1779.3 MHz)		
	LTE Band 4 (AWS) (1710.7 - 1754.3 MHz)		
	LTE Band 2 (PCS) (1850.7 - 1909.3 MHz)		
	LTE Band 30 (2307.5 - 2312.5 MHz)		
Channel Bandwidths	LTE Band 12: 1.4 MHz, 3 MHz, 5 MHz, 10 MHz		
	LTE Band 14: 5 MHz, 10 MHz		
	LTE Band 5 (Cell): 1.4 MHz, 3 MHz, 5 MHz, 10 MHz		
	LTE Band 66 (AWS): 1.4 MHz, 3 MHz, 5 MHz, 10 MHz, 15 MHz, 20 MHz		
	LTE Band 4 (AWS): 1.4 MHz, 3 MHz, 5 MHz, 10 MHz, 15 MHz, 20 MHz		
	LTE Band 2 (PCS): 1.4 MHz, 3 MHz, 5 MHz, 10 MHz, 15 MHz, 20 MHz		
	LTE Band 30: 5 MHz, 10 MHz		
Channel Numbers and Frequencies (MHz)	Low	Mid	High
LTE Band 12: 1.4 MHz	699.7 (23017)	707.5 (23095)	715.3 (23173)
LTE Band 12: 3 MHz	700.5 (23025)	707.5 (23095)	714.5 (23165)
LTE Band 12: 5 MHz	701.5 (23035)	707.5 (23095)	713.5 (23155)
LTE Band 12: 10 MHz	704 (23060)	707.5 (23095)	711 (23130)
LTE Band 14: 5 MHz	790.5 (23305)	793 (23330)	795.5 (23355)
LTE Band 14: 10 MHz	N/A	793 (23330)	N/A
LTE Band 5 (Cell): 1.4 MHz	824.7 (20407)	836.5 (20525)	848.3 (20643)
LTE Band 5 (Cell): 3 MHz	825.5 (20415)	836.5 (20525)	847.5 (20635)
LTE Band 5 (Cell): 5 MHz	826.5 (20425)	836.5 (20525)	846.5 (20625)
LTE Band 5 (Cell): 10 MHz	829 (20450)	836.5 (20525)	844 (20600)
LTE Band 66 (AWS): 1.4 MHz	1710.7 (131979)	1745 (132322)	1779.3 (132665)
LTE Band 66 (AWS): 3 MHz	1711.5 (131987)	1745 (132322)	1778.5 (132657)
LTE Band 66 (AWS): 5 MHz	1712.5 (131997)	1745 (132322)	1777.5 (132647)
LTE Band 66 (AWS): 10 MHz	1715 (132022)	1745 (132322)	1775 (132622)
LTE Band 66 (AWS): 15 MHz	1717.5 (132047)	1745 (132322)	1772.5 (132597)
LTE Band 66 (AWS): 20 MHz	1720 (132072)	1745 (132322)	1770 (132572)
LTE Band 4 (AWS): 1.4 MHz	1710.7 (19957)	1732.5 (20175)	1754.3 (20393)
LTE Band 4 (AWS): 3 MHz	1711.5 (19965)	1732.5 (20175)	1753.5 (20385)
LTE Band 4 (AWS): 5 MHz	1712.5 (19975)	1732.5 (20175)	1752.5 (20375)
LTE Band 4 (AWS): 10 MHz	1715 (20000)	1732.5 (20175)	1750 (20350)
LTE Band 4 (AWS): 15 MHz	1717.5 (20025)	1732.5 (20175)	1747.5 (20325)
LTE Band 4 (AWS): 20 MHz	1720 (20050)	1732.5 (20175)	1745 (20300)
LTE Band 2 (PCS): 1.4 MHz	1850.7 (18607)	1880 (18900)	1909.3 (19193)
LTE Band 2 (PCS): 3 MHz	1851.5 (18615)	1880 (18900)	1908.5 (19185)
LTE Band 2 (PCS): 5 MHz	1852.5 (18625)	1880 (18900)	1907.5 (19175)
LTE Band 2 (PCS): 10 MHz	1855 (18650)	1880 (18900)	1905 (19150)
LTE Band 2 (PCS): 15 MHz	1857.5 (18675)	1880 (18900)	1902.5 (19125)
LTE Band 2 (PCS): 20 MHz	1860 (18700)	1880 (18900)	1900 (19100)
LTE Band 30: 5 MHz	2307.5 (27685)	2310 (27710)	2312.5 (27735)
LTE Band 30: 10 MHz	N/A	2310 (27710)	N/A
UE Category	DL UE Cat 6, UL UE Cat 4		
Modulations Supported in UL	QPSK, 16QAM		
LTE MPR Permanently implemented per 3GPP TS 36.101 section 6.2.3-6.2.5? (manufacturer attestation to be provided)	YES		
A-MPR (Additional MPR) disabled for SAR Testing?	YES		
LTE Carrier Aggregation Possible Combinations	The technical description includes all the possible carrier aggregation combinations		
LTE Additional Information	This device does not support full CA features on 3GPP Release 11. It supports carrier aggregation features as shown in Appendix H. All other uplink communications are identical to the Release 8 Specifications. Uplink communications are done on the PCC. The following LTE Release 11 Features are not supported: Relay, HetNet, Enhanced MIMO, eCIC, WiFi Offloading, eMBMS, Cross-Carrier scheduling, Enhanced SC-FDMA.		

FCC ID: ZNFX420AS		SAR EVALUATION REPORT		Approved by: Quality Manager
Document S/N: 1M1905090070-01-R2.ZNF	Test Dates: 05/08/19 - 05/16/19	DUT Type: Portable Handset		Page 13 of 84

3 INTRODUCTION

The FCC and Innovation, Science, and Economic Development Canada have adopted the guidelines for evaluating the environmental effects of radio frequency (RF) radiation in ET Docket 93-62 on Aug. 6, 1996 and Health Canada Safety Code 6 to protect the public and workers from the potential hazards of RF emissions due to FCC-regulated portable devices. [1]

The safety limits used for the environmental evaluation measurements are based on the criteria published by the American National Standards Institute (ANSI) for localized specific absorption rate (SAR) in IEEE/ANSI C95.1-1992 Standard for Safety Levels with Respect to Human Exposure to Radio Frequency Electromagnetic Fields, 3 kHz to 300 GHz [3] and Health Canada RF Exposure Guidelines Safety Code 6 [22]. The measurement procedure described in IEEE/ANSI C95.3-2002 Recommended Practice for the Measurement of Potentially Hazardous Electromagnetic Fields - RF and Microwave [4] is used for guidance in measuring the Specific Absorption Rate (SAR) due to the RF radiation exposure from the Equipment Under Test (EUT). These criteria for SAR evaluation are similar to those recommended by the International Committee for Non-Ionizing Radiation Protection (ICNIRP) in Biological Effects and Exposure Criteria for Radiofrequency Electromagnetic Fields,” Report No. Vol 74. SAR is a measure of the rate of energy absorption due to exposure to an RF transmitting source. SAR values have been related to threshold levels for potential biological hazards.

3.1 SAR Definition

Specific Absorption Rate is defined as the time derivative (rate) of the incremental energy (dU) absorbed by (dissipated in) an incremental mass (dm) contained in a volume element (dV) of a given density (ρ). It is also defined as the rate of RF energy absorption per unit mass at a point in an absorbing body (see Equation 3-1).

**Equation 3-1
SAR Mathematical Equation**

$$SAR = \frac{d}{dt} \left(\frac{dU}{dm} \right) = \frac{d}{dt} \left(\frac{dU}{\rho dv} \right)$$



SAR is expressed in units of Watts per Kilogram (W/kg).

$$SAR = \frac{\sigma \cdot E^2}{\rho}$$

where:

- σ = conductivity of the tissue-simulating material (S/m)
- ρ = mass density of the tissue-simulating material (kg/m³)
- E = Total RMS electric field strength (V/m)

NOTE: The primary factors that control rate of energy absorption were found to be the wavelength of the incident field in relation to the dimensions and geometry of the irradiated organism, the orientation of the organism in relation to the polarity of field vectors, the presence of reflecting surfaces, and whether conductive contact is made by the organism with a ground plane.[6]

FCC ID: ZNFX420AS	 SAR EVALUATION REPORT 		Approved by: Quality Manager
Document S/N: 1M1905090070-01-R2.ZNF	Test Dates: 05/08/19 - 05/16/19	DUT Type: Portable Handset	Page 14 of 84

4 DOSIMETRIC ASSESSMENT

4.1 Measurement Procedure

The evaluation was performed using the following procedure compliant to FCC KDB Publication 865664 D01v01r04 and IEEE 1528-2013:

1. The SAR distribution at the exposed side of the head or body was measured at a distance no greater than 5.0 mm from the inner surface of the shell. The area covered the entire dimension of the device-head and body interface and the horizontal grid resolution was determined per FCC KDB Publication 865664 D01v01r04 (See Table 4-1) and IEEE 1528-2013.
2. The point SAR measurement was taken at the maximum SAR region determined from Step 1 to enable the monitoring of SAR fluctuations/drifts during the 1g/10g cube evaluation. SAR at this fixed point was measured and used as a reference value.
3. Based on the area scan data, the peak of the region with maximum SAR was determined by spline interpolation. Around this point, a volume was assessed according to the measurement resolution and volume size requirements of FCC KDB Publication 865664 D01v01r04 (See Table 4-1) and IEEE 1528-2013. On the basis of this data set, the spatial peak SAR value was evaluated with the following procedure (see references or the DASY manual online for more details):
 - a. SAR values at the inner surface of the phantom are extrapolated from the measured values along the line away from the surface with spacing no greater than that in Table 4-1. The extrapolation was based on a least-squares algorithm. A polynomial of the fourth order was calculated through the points in the z-axis (normal to the phantom shell).
 - b. After the maximum interpolated values were calculated between the points in the cube, the SAR was averaged over the spatial volume (1g or 10g) using a 3D-Spline interpolation algorithm. The 3D-spline is composed of three one-dimensional splines with the “Not a knot” condition (in x, y, and z directions). The volume was then integrated with the trapezoidal algorithm. One thousand points (10 x 10 x 10) were obtained through interpolation, in order to calculate the averaged SAR.
 - c. All neighboring volumes were evaluated until no neighboring volume with a higher average value was found.
4. The SAR reference value, at the same location as step 2, was re-measured after the zoom scan was complete to calculate the SAR drift. If the drift deviated by more than 5%, the SAR test and drift measurements were repeated.

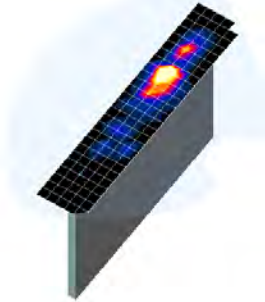



Figure 4-1
Sample SAR Area Scan

Table 4-1
Area and Zoom Scan Resolutions per FCC KDB Publication 865664 D01v01r04*

Frequency	Maximum Area Scan Resolution (mm) ($\Delta x_{\text{area}}, \Delta y_{\text{area}}$)	Maximum Zoom Scan Resolution (mm) ($\Delta x_{\text{zoom}}, \Delta y_{\text{zoom}}$)	Maximum Zoom Scan Spatial Resolution (mm)			Minimum Zoom Scan Volume (mm) (x,y,z)
			Uniform Grid	Graded Grid		
			$\Delta z_{\text{zoom}}(n)$	$\Delta z_{\text{zoom}}(1)^*$	$\Delta z_{\text{zoom}}(n-1)^*$	
≤ 2 GHz	≤ 15	≤ 8	≤ 5	≤ 4	≤ 1.5* $\Delta z_{\text{zoom}}(n-1)$	≥ 30
2-3 GHz	≤ 12	≤ 5	≤ 5	≤ 4	≤ 1.5* $\Delta z_{\text{zoom}}(n-1)$	≥ 30
3-4 GHz	≤ 12	≤ 5	≤ 4	≤ 3	≤ 1.5* $\Delta z_{\text{zoom}}(n-1)$	≥ 28
4-5 GHz	≤ 10	≤ 4	≤ 3	≤ 2.5	≤ 1.5* $\Delta z_{\text{zoom}}(n-1)$	≥ 25
5-6 GHz	≤ 10	≤ 4	≤ 2	≤ 2	≤ 1.5* $\Delta z_{\text{zoom}}(n-1)$	≥ 22

*Also compliant to IEEE 1528-2013 Table 6

FCC ID: ZNFX420AS	 SAR EVALUATION REPORT 		Approved by: Quality Manager
Document S/N: 1M1905090070-01-R2.ZNF	Test Dates: 05/08/19 - 05/16/19	DUT Type: Portable Handset	Page 15 of 84

5 DEFINITION OF REFERENCE POINTS

5.1 EAR REFERENCE POINT

Figure 5-2 shows the front, back and side views of the SAM Twin Phantom. The point “M” is the reference point for the center of the mouth, “LE” is the left ear reference point (ERP), and “RE” is the right ERP. The ERP is 15mm posterior to the entrance to the ear canal (EEC) along the B-M line (Back-Mouth), as shown in Figure 5-1. The plane passing through the two ear canals and M is defined as the Reference Plane. The line N-F (Neck-Front), also called the Reference Pivoting Line, is not perpendicular to the reference plane (see Figure 5-1). Line B-M is perpendicular to the N-F line. Both N-F and B-M lines are marked on the external phantom shell to facilitate handset positioning [5].

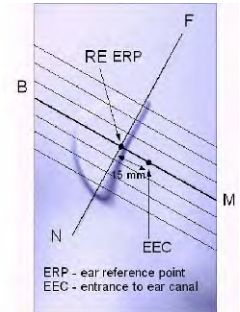

Figure 5-1
Close-Up Side view of ERP

5.2 HANDSET REFERENCE POINTS

Two imaginary lines on the handset were established: the vertical centerline and the horizontal line. The test device was placed in a normal operating position with the acoustic output located along the “vertical centerline” on the front of the device aligned to the “ear reference point” (See Figure 5-3). The acoustic output was then located at the same level as the center of the ear reference point. The test device was positioned so that the “vertical centerline” was bisecting the front surface of the handset at its top and bottom edges, positioning the “ear reference point” on the outer surface of the both the left and right head phantoms on the ear reference point.



Figure 5-2
Front, back and side view of SAM Twin Phantom

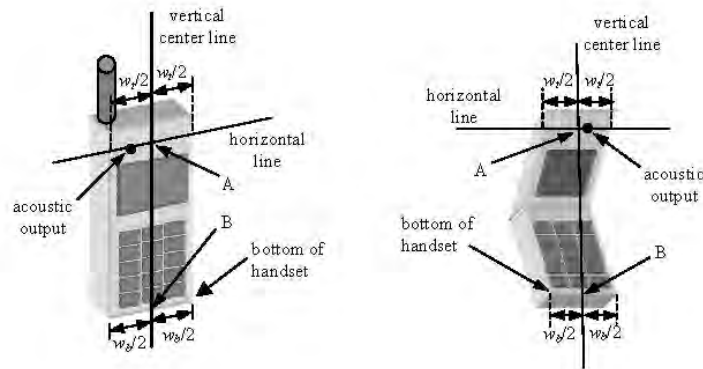



Figure 5-3
Handset Vertical Center & Horizontal Line Reference Points

FCC ID: ZNFX420AS	 PCTEST ENGINEERING LABORATORY, INC.	SAR EVALUATION REPORT	 LG	Approved by: Quality Manager
Document S/N: 1M1905090070-01-R2.ZNF	Test Dates: 05/08/19 - 05/16/19	DUT Type: Portable Handset		Page 16 of 84

6 TEST CONFIGURATION POSITIONS

6.1 Device Holder

The device holder is made out of low-loss POM material having the following dielectric parameters: relative permittivity $\epsilon = 3$ and loss tangent $\delta = 0.02$.

6.2 Positioning for Cheek

1. The test device was positioned with the device close to the surface of the phantom such that point A is on the (virtual) extension of the line passing through points RE and LE on the phantom (see Figure 6-1), such that the plane defined by the vertical center line and the horizontal line of the phone is approximately parallel to the sagittal plane of the phantom.





Figure 6-1 Front, Side and Top View of Cheek Position

2. The handset was translated towards the phantom along the line passing through RE & LE until the handset touches the pinna.
3. While maintaining the handset in this plane, the handset was rotated around the LE-RE line until the vertical centerline was in the reference plane.
4. The phone was then rotated around the vertical centerline until the phone (horizontal line) was symmetrical with respect to the line NF.
5. While maintaining the vertical centerline in the reference plane, keeping point A on the line passing through RE and LE, and maintaining the device contact with the ear, the device was rotated about the NF line until any point on the handset made contact with a phantom point below the ear (cheek) (See Figure 6-2).

6.3 Positioning for Ear / 15° Tilt

With the test device aligned in the “Cheek Position”:

1. While maintaining the orientation of the phone, the phone was retracted parallel to the reference plane far enough to enable a rotation of the phone by 15 degrees.
2. The phone was then rotated around the horizontal line by 15 degrees.
3. While maintaining the orientation of the phone, the phone was moved parallel to the reference plane until any part of the handset touched the head. (In this position, point A was located on the line RE-LE). The tilted position is obtained when the contact is on the pinna. If the contact was at any location other than the pinna, the angle of the phone would then be reduced. In this situation, the tilted position was obtained when any part of the phone was in contact of the ear as well as a second part of the phone was in contact with the head (see Figure 6-2).

FCC ID: ZNFX420AS			SAR EVALUATION REPORT		Approved by: Quality Manager
Document S/N: 1M1905090070-01-R2.ZNF	Test Dates: 05/08/19 - 05/16/19	DUT Type: Portable Handset	Page 17 of 84		

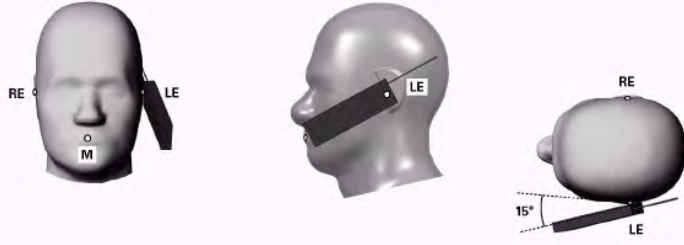

Figure 6-2 Front, Side and Top View of Ear/15° Tilt Position

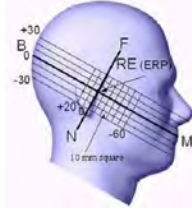

Figure 6-3 Side view w/ relevant markings

6.4 SAR Evaluations near the Mouth/Jaw Regions of the SAM Phantom

Antennas located near the bottom of a phone may require SAR measurements around the mouth and jaw regions of the SAM head phantom. This typically applies to clam-shell style phones that are generally longer in the unfolded normal use positions or to certain older style long rectangular phones. Per IEEE 1528-2013, a rotated SAM phantom is necessary to allow probe access to such regions. Both SAM heads of the TwinSAM-Chin20 are rotated 20 degrees around the NF line. Each head can be removed from the table for emptying and cleaning.

Under these circumstances, the following procedures apply, adopted from the FCC guidance on SAR handsets document FCC KDB Publication 648474 D04v01r03. The SAR required in these regions of SAM should be measured using a flat phantom. The phone should be positioned with a separation distance of 4 mm between the ear reference point (ERP) and the outer surface of the flat phantom shell. While maintaining this distance at the ERP location, the low (bottom) edge of the phone should be lowered from the phantom to establish the same separation distance between the peak SAR location identified by the truncated partial SAR distribution measured with the SAM phantom. The distance from the peak SAR location to the phone is determined by the straight line passing perpendicularly through the phantom surface. When it is not feasible to maintain 4 mm separation at the ERP while also establishing the required separation at the peak SAR location, the top edge of the phone will be allowed to touch the phantom with a separation < 4 mm at the ERP. The phone should not be tilted to the left or right while placed in this inclined position to the flat phantom.

6.5 Body-Worn Accessory Configurations

Body-worn operating configurations are tested with the belt-clips and holsters attached to the device and positioned against a flat phantom in a normal use configuration (see Figure 6-4). Per FCC KDB Publication 648474 D04v01r03, Body-worn accessory exposure is typically related to voice mode operations when handsets are carried in body-worn accessories. The body-worn accessory procedures in FCC KDB Publication 447498 D01v06 should be used to test for body-worn accessory SAR compliance, without a headset connected to it. This enables the test results for such configuration to be compatible with that required for hotspot mode when the body-worn accessory test separation distance is greater than or equal to that required for hotspot mode, when applicable. When the reported SAR for a body-worn accessory, measured without a headset connected to the handset, is > 1.2 W/kg, the highest reported SAR configuration for that wireless mode and frequency band should be repeated for that body-worn accessory with a headset attached to the handset.

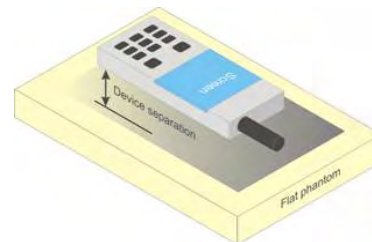



Figure 6-4 Sample Body-Worn Diagram

Accessories for Body-worn operation configurations are divided into two categories: those that do not contain metallic components and those that do contain metallic components. When multiple accessories that do not

FCC ID: ZNFX420AS	 PCTEST ENGINEERING LABORATORY, INC.	SAR EVALUATION REPORT	 LG	Approved by: Quality Manager
Document S/N: 1M1905090070-01-R2.ZNF	Test Dates: 05/08/19 - 05/16/19	DUT Type: Portable Handset		Page 18 of 84

contain metallic components are supplied with the device, the device is tested with only the accessory that dictates the closest spacing to the body. Then multiple accessories that contain metallic components are tested with the device with each accessory. If multiple accessories share an identical metallic component (i.e. the same metallic belt-clip used with different holsters with no other metallic components) only the accessory that dictates the closest spacing to the body is tested.

Body-worn accessories may not always be supplied or available as options for some devices intended to be authorized for body-worn use. In this case, a test configuration with a separation distance between the back of the device and the flat phantom is used. Test position spacing was documented. Transmitters that are designed to operate in front of a person's face, as in push-to-talk configurations, are tested for SAR compliance with the front of the device positioned to face the flat phantom in head fluid. For devices that are carried next to the body such as a shoulder, waist or chest-worn transmitters, SAR compliance is tested with the accessories, including headsets and microphones, attached to the device and positioned against a flat phantom in a normal use configuration.

6.6 Extremity Exposure Configurations



Devices that are designed or intended for use on extremities or mainly operated in extremity only exposure conditions; i.e., hands, wrists, feet and ankles, may require extremity SAR evaluation. When the device also operates in close proximity to the user's body, SAR compliance for the body is also required. The 1g body and 10g extremity SAR Exclusion Thresholds found in KDB Publication 447498 D01v06 should be applied to determine SAR test requirements.

Per KDB Publication 447498 D01v06, Cell phones (handsets) are not normally designed to be used on extremities or operated in extremity only exposure conditions. The maximum output power levels of handsets generally do not require extremity SAR testing to show compliance. Therefore, extremity SAR was not evaluated for this device.

6.7 Wireless Router Configurations

Some battery-operated handsets have the capability to transmit and receive user data through simultaneous transmission of WIFI simultaneously with a separate licensed transmitter. The FCC has provided guidance in FCC KDB Publication 941225 D06v02r01 where SAR test considerations for handsets ($L \times W \geq 9 \text{ cm} \times 5 \text{ cm}$) are based on a composite test separation distance of 10 mm from the front, back and edges of the device containing transmitting antennas within 2.5 cm of their edges, determined from general mixed use conditions for this type of devices. Since the hotspot SAR results may overlap with the body-worn accessory SAR requirements, the more conservative configurations can be considered, thus excluding some body-worn accessory SAR tests.

When the user enables the personal wireless router functions for the handset, actual operations include simultaneous transmission of both the WIFI transmitter and another licensed transmitter. Both transmitters often do not transmit at the same transmitting frequency and thus cannot be evaluated for SAR under actual use conditions due to the limitations of the SAR assessment probes. Therefore, SAR must be evaluated for each frequency transmission and mode separately and spatially summed with the WIFI transmitter according to FCC KDB Publication 447498 D01v06 procedures. The "Portable Hotspot" feature on the handset was NOT activated during SAR assessments, to ensure the SAR measurements were evaluated for a single transmission frequency RF signal at a time.

FCC ID: ZNFX420AS	 PCTEST ENGINEERING LABORATORY, INC.	SAR EVALUATION REPORT	 LG	Approved by: Quality Manager
Document S/N: 1M1905090070-01-R2.ZNF	Test Dates: 05/08/19 - 05/16/19	DUT Type: Portable Handset		Page 19 of 84

6.8 Phablet Configurations



For smart phones with a display diagonal dimension > 150 mm or an overall diagonal dimension > 160 mm that provide similar mobile web access and multimedia support found in mini-tablets or UMPC mini-tablets that support voice calls next to the ear, the phablets procedures outlined in KDB Publication 648474 D04v01r03 should be applied to evaluate SAR compliance. A device marketed as phablets, regardless of form factors and operating characteristics must be tested as a phablet to determine SAR compliance. In addition to the normally required head and body-worn accessory SAR test procedures required for handsets, the UMPC mini-tablet procedures must also be applied to test the SAR of all surfaces and edges with an antenna ≤ 25 mm from that surface or edge, in direct contact with the phantom, for 10g SAR. The UMPC mini-tablet 1g SAR at 5 mm is not required. When hotspot mode applies, 10g SAR is required only for the surfaces and edges with hotspot mode 1g SAR > 1.2 W/kg.

6.9 Proximity Sensor Configurations

This device uses a power reduction mechanism to reduce output powers in certain use conditions when the device is used close the user's body.

When the device's antenna is within a certain distance of the user, the sensor activates and reduces the maximum allowed output power. However, the sensor is not active when the device is moved beyond the sensor triggering distance and the maximum output power is no longer limited. Therefore, additional evaluation is needed in the vicinity of the triggering distance to ensure SAR is compliant when the device is allowed to operate at a non-reduced output power level. FCC KDB Publication 616217 D04v01r02 Section 6 was used as a guideline for selecting SAR test distances for this device at these additional test positions. Sensor triggering distance summary data is included in Appendix G.

The sensor is designed to support sufficient detection range and sensitivity to cover regions of the sensors in all applicable directions since the sensor entirely covers the antennas.

FCC ID: ZNFX420AS	 SAR EVALUATION REPORT 		Approved by: Quality Manager
Document S/N: 1M1905090070-01-R2.ZNF	Test Dates: 05/08/19 - 05/16/19	DUT Type: Portable Handset	Page 20 of 84

7 RF EXPOSURE LIMITS

7.1 Uncontrolled Environment

UNCONTROLLED ENVIRONMENTS are defined as locations where there is the exposure of individuals who have no knowledge or control of their exposure. The general population/uncontrolled exposure limits are applicable to situations in which the general public may be exposed or in which persons who are exposed as a consequence of their employment may not be made fully aware of the potential for exposure or cannot exercise control over their exposure. Members of the general public would come under this category when exposure is not employment-related; for example, in the case of a wireless transmitter that exposes persons in its vicinity.



7.2 Controlled Environment

CONTROLLED ENVIRONMENTS are defined as locations where there is exposure that may be incurred by persons who are aware of the potential for exposure, (i.e. as a result of employment or occupation). In general, occupational/controlled exposure limits are applicable to situations in which persons are exposed as a consequence of their employment, who have been made fully aware of the potential for exposure and can exercise control over their exposure. This exposure category is also applicable when the exposure is of a transient nature due to incidental passage through a location where the exposure levels may be higher than the general population/uncontrolled limits, but the exposed person is fully aware of the potential for exposure and can exercise control over his or her exposure by leaving the area or by some other appropriate means.

**Table 7-1
SAR Human Exposure Specified in ANSI/IEEE C95.1-1992 and Health Canada Safety Code 6**

HUMAN EXPOSURE LIMITS		
	UNCONTROLLED ENVIRONMENT <i>General Population</i> (W/kg) or (mW/g)	CONTROLLED ENVIRONMENT <i>Occupational</i> (W/kg) or (mW/g)
Peak Spatial Average SAR Head	1.6	8.0
Whole Body SAR	0.08	0.4
Peak Spatial Average SAR Hands, Feet, Ankle, Wrists, etc.	4.0	20

1. The Spatial Peak value of the SAR averaged over any 1 gram of tissue (defined as a tissue volume in the shape of a cube) and over the appropriate averaging time.
2. The Spatial Average value of the SAR averaged over the whole body.
3. The Spatial Peak value of the SAR averaged over any 10 grams of tissue (defined as a tissue volume in the shape of a cube) and over the appropriate averaging time.

FCC ID: ZNFX420AS	 PCTEST ENGINEERING LABORATORY, INC.	SAR EVALUATION REPORT	 LG	Approved by: Quality Manager
Document S/N: 1M1905090070-01-R2.ZNF	Test Dates: 05/08/19 - 05/16/19	DUT Type: Portable Handset		Page 21 of 84

8 FCC MEASUREMENT PROCEDURES

Power measurements for licensed transmitters are performed using a base station simulator under digital average power.

8.1 Measured and Reported SAR

Per FCC KDB Publication 447498 D01v06, when SAR is not measured at the maximum power level allowed for production units, the results must be scaled to the maximum tune-up tolerance limit according to the power applied to the individual channels tested to determine compliance. For simultaneous transmission, the measured aggregate SAR must be scaled according to the sum of the differences between the maximum tune-up tolerance and actual power used to test each transmitter. When SAR is measured at or scaled to the maximum tune-up tolerance limit, the results are referred to as *reported* SAR. The highest *reported* SAR results are identified on the grant of equipment authorization according to procedures in KDB 690783 D01v01r03.

8.2 3G SAR Test Reduction Procedure

In FCC KDB Publication 941225 D01v03r01, certain transmission modes within a frequency band and wireless mode evaluated for SAR are defined as primary modes. The equivalent modes considered for SAR test reduction are denoted as secondary modes. When the maximum output power including tune-up tolerance specified for production units in a secondary mode is ≤ 0.25 dB higher than the primary mode or when the highest reported SAR of the primary mode, scaled by the ratio of specified maximum output power and tune-up tolerance of secondary to primary mode, is ≤ 1.2 W/kg, SAR measurements are not required for the secondary mode. These criteria are referred to as the 3G SAR test reduction procedure. When the 3G SAR test reduction procedure is not satisfied, SAR measurements are additionally required for the secondary mode.

8.3 Procedures Used to Establish RF Signal for SAR



The following procedures are according to FCC KDB Publication 941225 D01v03r01 “3G SAR Measurement Procedures.”

The device is placed into a simulated call using a base station simulator in a RF shielded chamber. Establishing connections in this manner ensure a consistent means for testing SAR and are recommended for evaluating SAR [4]. Devices under test are evaluated prior to testing, with a fully charged battery and were configured to operate at maximum output power. In order to verify that the device is tested throughout the SAR test at maximum output power, the SAR measurement system measures a “point SAR” at an arbitrary reference point at the start and end of the 1 gram SAR evaluation, to assess for any power drifts during the evaluation. If the power drift deviates by more than 5%, the SAR test and drift measurements are repeated.

8.4 SAR Measurement Conditions for UMTS

8.4.1 Output Power Verification

Maximum output power is verified on the High, Middle and Low channels according to the general descriptions in section 5.2 of 3GPP TS 34.121, using the appropriate RMC with TPC (transmit power control) set to all “1s” or applying the required inner loop power control procedures to maintain maximum output power while HSUPA is active. Results for all applicable physical channel configurations (DPCCCH, DPDCHn and spreading codes, HS-DPCCH etc) are tabulated in this test report. All configurations that are not supported by the DUT or cannot be measured due to technical or equipment limitations are identified.

FCC ID: ZNFX420AS		SAR EVALUATION REPORT		Approved by: Quality Manager
Document S/N: 1M1905090070-01-R2.ZNF	Test Dates: 05/08/19 - 05/16/19	DUT Type: Portable Handset		Page 22 of 84

8.4.2 Head SAR Measurements

SAR for next to the ear head exposure is measured using a 12.2 kbps RMC with TPC bits configured to all “1’s”. The 3G SAR test reduction procedure is applied to AMR configurations with 12.2 kbps RMC as the primary mode. Otherwise, SAR is measured for 12.2 kbps AMR in 3.4 kbps SRB (signaling radio bearer) using the highest reported SAR configuration in 12.2 kbps RMC for head exposure.

8.4.3 Body SAR Measurements

SAR for body exposure configurations is measured using the 12.2 kbps RMC with the TPC bits all “1s”. The 3G SAR test reduction procedure is applied to other spreading codes and multiple DPDCH_n configurations supported by the handset with 12.2 kbps RMC as the primary mode. Otherwise, SAR is measured using an applicable RMC configuration with the corresponding spreading code or DPDCH_n, for the highest reported SAR configuration in 12.2 kbps RMC.

8.4.4 SAR Measurements with Rel 5 HSDPA

The 3G SAR test reduction procedure is applied to HSDPA body configurations with 12.2 kbps RMC as the primary mode. Otherwise, Body SAR for HSDPA is measured using an FRC with H-Set 1 in Sub-test 1 and a 12.2 kbps RMC configured in Test Loop Mode 1, for the highest reported SAR configuration in 12.2 kbps RMC without HSDPA. Handsets with both HSDPA and HSUPA are tested according to Release 6 HSPA test procedures.

8.4.5 SAR Measurements with Rel 6 HSUPA

The 3G SAR test reduction procedure is applied to HSPA (HSUPA/HSDPA with RMC) body configurations with 12.2 kbps RMC as the primary mode. Otherwise, Body SAR for HSPA is measured with E-DCH Sub-test 5, using H-Set 1 and QPSK for FRC and a 12.2 kbps RMC configured in Test Loop Mode 1 and power control algorithm 2, according to the highest reported body SAR configuration in 12.2 kbps RMC without HSPA.

When VOIP applies to head exposure, the 3G SAR test reduction procedure is applied with 12.2 kbps RMC as the primary mode; otherwise, the same HSPA configuration used for body SAR measurements are applied to head exposure testing.

8.5 SAR Measurement Conditions for LTE



LTE modes are tested according to FCC KDB 941225 D05v02r04 publication. Establishing connections with base station simulators ensure a consistent means for testing SAR and are recommended for evaluating SAR [4]. The R&S CMW500 or Anritsu MT8820C simulators are used for LTE output power measurements and SAR testing. Closed loop power control was used so the UE transmits with maximum output power during SAR testing. SAR tests were performed with the same number of RB and RB offsets transmitting on all TTI frames (maximum TTI).

8.5.1 Spectrum Plots for RB Configurations

A properly configured base station simulator was used for SAR tests and power measurements. Therefore, spectrum plots for RB configurations were not required to be included in this report.

8.5.2 MPR

MPR is permanently implemented for this device by the manufacturer. The specific manufacturer target MPR is indicated alongside the SAR results. MPR is enabled for this device, according to 3GPP TS36.101 Section 6.2.3 – 6.2.5 under Table 6.2.3-1.

FCC ID: ZNFX420AS	 PCTEST ENGINEERING LABORATORY, INC.	SAR EVALUATION REPORT	 LG	Approved by: Quality Manager
Document S/N: 1M1905090070-01-R2-ZNF	Test Dates: 05/08/19 - 05/16/19	DUT Type: Portable Handset		Page 23 of 84

8.5.3 A-MPR

A-MPR (Additional MPR) has been disabled for all SAR tests by setting NS=01 on the base station simulator.

8.5.4 Required RB Size and RB Offsets for SAR Testing

According to FCC KDB 941225 D05v02r04:



- a. Per Section 5.2.1, SAR is required for QPSK 1 RB Allocation for the largest bandwidth
 - i. The required channel and offset combination with the highest maximum output power is required for SAR.
 - ii. When the reported SAR is ≤ 0.8 W/kg, testing of the remaining RB offset configurations and required test channels is not required. Otherwise, SAR is required for the remaining required test channels using the RB offset configuration with highest output power for that channel.
 - iii. When the reported SAR for a required test channel is > 1.45 W/kg, SAR is required for all RB offset configurations for that channel.
- b. Per Section 5.2.2, SAR is required for 50% RB allocation using the largest bandwidth following the same procedures outlined in Section 5.2.1.
- c. Per Section 5.2.3, QPSK SAR is not required for the 100% allocation when the highest maximum output power for the 100% allocation is less than the highest maximum output power of the 1 RB and 50% RB allocations and the reported SAR for the 1 RB and 50% RB allocations is < 0.8 W/kg.
- d. Per Section 5.2.4 and 5.3, SAR tests for higher order modulations and lower bandwidths configurations are not required when the conducted power of the required test configurations determined by Sections 5.2.1 through 5.2.3 is less than or equal to $\frac{1}{2}$ dB higher than the equivalent configuration using QPSK modulation and when the QPSK SAR for those configurations is < 1.45 W/kg.

8.5.5 Downlink Only Carrier Aggregation

Conducted power measurements with LTE Carrier Aggregation (CA) (downlink only) active are made in accordance to KDB Publication 941225 D05Av01r02. The RRC connection is only handled by one cell, the primary component carrier (PCC) for downlink and uplink communications. After making a data connection to the PCC, the UE device adds secondary component carrier(s) (SCC) on the downlink only. All uplink communications and acknowledgements remain identical to specifications when downlink carrier aggregation is inactive on the PCC. Additional conducted output powers are measured with the downlink carrier aggregation active for the configuration with highest measured maximum conducted power with downlink carrier aggregation inactive measured among the channel bandwidth, modulation, and RB combinations in each frequency band. Per FCC KDB Publication 941225 D05Av01r02, no SAR measurements are required for downlink only carrier aggregation configurations when the average output power with downlink only carrier aggregation active is not more than 0.25 dB higher than the average output power with downlink only carrier aggregation inactive.

8.6 SAR Testing with 802.11 Transmitters

The normal network operating configurations of 802.11 transmitters are not suitable for SAR measurements. Unpredictable fluctuations in network traffic and antenna diversity conditions can introduce undesirable variations in SAR results. The SAR for these devices should be measured using chipset based test mode software to ensure the results are consistent and reliable. See KDB Publication 248227 D01v02r02 for more details.

FCC ID: ZNFX420AS	 PCTEST ENGINEERING LABORATORY, INC.	SAR EVALUATION REPORT	 LG	Approved by: Quality Manager
Document S/N: 1M1905090070-01-R2.ZNF	Test Dates: 05/08/19 - 05/16/19	DUT Type: Portable Handset		Page 24 of 84

8.6.1 General Device Setup

Chipset based test mode software is hardware dependent and generally varies among manufacturers. The device operating parameters established in test mode for SAR measurements must be identical to those programmed in production units, including output power levels, amplifier gain settings and other RF performance tuning parameters.

A periodic duty factor is required for current generation SAR systems to measure SAR. When 802.11 frame gaps are accounted for in the transmission, a maximum transmission duty factor of 92 - 96% is typically achievable in most test mode configurations. A minimum transmission duty factor of 85% is required to avoid certain hardware and device implementation issues related to wide range SAR scaling. The reported SAR is scaled to 100% transmission duty factor to determine compliance at the maximum tune-up tolerance limit.

8.6.2 Initial Test Position Procedure

For exposure conditions with multiple test positions, such as handset operating next to the ear, devices with hotspot mode or UMPC mini-tablet, procedures for initial test position can be applied. Using the transmission mode determined by the DSSS procedure or initial test configuration, area scans are measured for all positions in an exposure condition. The test position with the highest extrapolated (peak) SAR is used as the initial test position. When reported SAR for the initial test position is ≤ 0.4 W/kg, no additional testing for the remaining test positions is required. Otherwise, SAR is evaluated at the subsequent highest peak SAR positions until the reported SAR result is ≤ 0.8 W/kg or all test positions are measured. When 10g SAR measurement is considered, a factor of 2.5 is applied to the thresholds above.

8.6.3 2.4 GHz SAR Test Requirements



SAR is measured for 2.4 GHz 802.11b DSSS using either the fixed test position or, when applicable, the initial test position procedure. SAR test reduction is determined according to the following:

- 1) When the reported SAR of the highest measured maximum output power channel for the exposure configuration is ≤ 0.8 W/kg, no further SAR testing is required for 802.11b DSSS in that exposure configuration.
- 2) When the reported SAR is > 0.8 W/kg, SAR is required for that position using the next highest measured output power channel. When any reported SAR is > 1.2 W/kg, SAR is required for the third channel; i.e., all channels require testing.

2.4 GHz 802.11 g/n OFDM are additionally evaluated for SAR if the highest reported SAR for 802.11b, adjusted by the ratio of the OFDM to DSSS specified maximum output power, is > 1.2 W/kg. When SAR is required for OFDM modes in 2.4 GHz band, the Initial Test Configuration Procedures should be followed. When 10g SAR measurement is considered, a factor of 2.5 is applied to the thresholds above.

8.6.4 OFDM Transmission Mode and SAR Test Channel Selection

When the same maximum output power was specified for multiple OFDM transmission mode configurations in a frequency band or aggregated band, SAR is measured using the configuration with the largest channel bandwidth, lowest order modulation and lowest data rate. When the maximum output power of a channel is the same for equivalent OFDM configurations; for example, 802.11g and 802.11n with the same channel bandwidth, modulation and data rate etc., the lower order 802.11 mode i.e., 802.11g then 802.11n, is used for SAR measurement. When the maximum output power are the same for multiple test channels, either according to the default or additional power measurement requirements, SAR is measured using the channel closest to the middle of the frequency band or aggregated band. When there are multiple channels with the same maximum output power, SAR is measured using the higher number channel.

FCC ID: ZNFX420AS	 PCTEST ENGINEERING LABORATORY, INC.	SAR EVALUATION REPORT		Approved by: Quality Manager
Document S/N: 1M1905090070-01-R2-ZNF	Test Dates: 05/08/19 - 05/16/19	DUT Type: Portable Handset		Page 25 of 84



8.6.5 Initial Test Configuration Procedure

For OFDM, an initial test configuration is determined for each frequency band and aggregated band, according to the transmission mode with the highest maximum output power specified for SAR measurements. When the same maximum output power is specified for multiple OFDM transmission mode configurations in a frequency band or aggregated band, SAR is measured using the configuration(s) with the largest channel bandwidth, lowest order modulation, lowest data rate and lowest order IEEE 802.11 mode. The channel of the transmission mode with the highest average RF output conducted power will be the initial test configuration.

When the reported SAR is ≤ 0.8 W/kg, no additional measurements on other test channels are required. Otherwise, SAR is evaluated using the subsequent highest average RF output channel until the reported SAR result is ≤ 1.2 W/kg or all channels are measured. When there are multiple untested channels having the same subsequent highest average RF output power, the channel with higher frequency from the lowest 802.11 mode is considered for SAR measurements (See Section 8.6.4). When 10g SAR measurement is considered, a factor of 2.5 is applied to the thresholds above.

8.6.6 Subsequent Test Configuration Procedures

For OFDM configurations in each frequency band and aggregated band, SAR is evaluated for initial test configuration using the fixed test position or the initial test position procedure. When the highest reported SAR (for the initial test configuration), adjusted by the ratio of the specified maximum output power of the subsequent test configuration to initial test configuration, is ≤ 1.2 W/kg, no additional SAR tests for the subsequent test configurations are required. When 10g SAR measurement is considered, a factor of 2.5 is applied to the thresholds above.

FCC ID: ZNFX420AS	 SAR EVALUATION REPORT 		Approved by: Quality Manager
Document S/N: 1M1905090070-01-R2.ZNF	Test Dates: 05/08/19 - 05/16/19	DUT Type: Portable Handset	Page 26 of 84

9 RF CONDUCTED POWERS



9.1 GSM Conducted Powers

Table 9-1
Maximum Conducted Power

Maximum Burst-Averaged Output Power						
Band	Channel	Voice	GPRS/EDGE Data (GMSK)		EDGE Data (8-PSK)	
		GSM [dBm] CS (1 Slot)	GPRS [dBm] 1 Tx Slot	GPRS [dBm] 2 Tx Slot	EDGE [dBm] 1 Tx Slot	EDGE [dBm] 2 Tx Slot
GSM 850	128	32.53	32.53	30.39	27.01	25.50
	190	32.68	32.69	30.57	27.07	25.54
	251	32.70	32.70	30.66	27.08	25.62
GSM 1900	512	29.60	29.60	27.91	26.68	24.62
	661	29.68	29.67	28.10	26.45	24.30
	810	29.69	29.70	28.20	26.70	24.65

Calculated Maximum Frame-Averaged Output Power						
Band	Channel	Voice	GPRS/EDGE Data (GMSK)		EDGE Data (8-PSK)	
		GSM [dBm] CS (1 Slot)	GPRS [dBm] 1 Tx Slot	GPRS [dBm] 2 Tx Slot	EDGE [dBm] 1 Tx Slot	EDGE [dBm] 2 Tx Slot
GSM 850	128	23.50	23.50	24.37	17.98	19.48
	190	23.65	23.66	24.55	18.04	19.52
	251	23.67	23.67	24.64	18.05	19.60
GSM 1900	512	20.57	20.57	21.89	17.65	18.60
	661	20.65	20.64	22.08	17.42	18.28
	810	20.66	20.67	22.18	17.67	18.63

GSM 850	Frame	23.17	23.17	24.18	17.67	19.18
GSM 1900	Avg. Targets:	20.17	20.17	21.68	17.17	18.18

FCC ID: ZNFX420AS		SAR EVALUATION REPORT			Approved by: Quality Manager
Document S/N: 1M1905090070-01-R2.ZNF	Test Dates: 05/08/19 - 05/16/19	DUT Type: Portable Handset		Page 27 of 84	



Note:

1. Both burst-averaged and calculated frame-averaged powers are included. Frame-averaged power was calculated from the measured burst-averaged power by converting the slot powers into linear units and calculating the energy over 8 timeslots.
2. GPRS/EDGE (GMSK) output powers were measured with coding scheme setting of 1 (CS1) on the base station simulator. CS1 was configured to measure GPRS output power measurements and SAR to ensure GMSK modulation in the signal. Our Investigation has shown that CS1 - CS4 settings do not have any impact on the output levels or modulation in the GPRS modes.
3. EDGE (8-PSK) output powers were measured with MCS7 on the base station simulator. MCS7 coding scheme was used to measure the output powers for EDGE since investigation has shown that choosing MCS7 coding scheme will ensure 8-PSK modulation. It has been shown that MCS levels that produce 8PSK modulation do not have an impact on output power.

GSM Class: B
GPRS Multislot class: 10 (Max 2 Tx uplink slots)
EDGE Multislot class: 10 (Max 2 Tx uplink slots)
DTM Multislot Class: N/A



Figure 9-1
Power Measurement Setup

FCC ID: ZNFX420AS	 SAR EVALUATION REPORT 		Approved by: Quality Manager
Document S/N: 1M1905090070-01-R2.ZNF	Test Dates: 05/08/19 - 05/16/19	DUT Type: Portable Handset	Page 28 of 84

9.2 UMTS Conducted Powers

Table 9-2
Maximum Conducted Power

3GPP Release Version	Mode	3GPP 34.121 Subtest	Cellular Band [dBm]			AWS Band [dBm]			PCS Band [dBm]			3GPP MPR [dB]
			4132	4183	4233	1312	1412	1513	9262	9400	9538	
99	WCDMA	12.2 kbps RMC	25.08	25.16	25.06	23.98	24.10	24.01	23.97	23.99	24.04	-
99		12.2 kbps AMR	25.15	25.13	25.06	24.06	24.12	24.05	24.01	24.05	23.96	-
6	HSDPA	Subtest 1	24.19	23.98	24.10	22.85	22.93	22.65	22.89	22.80	22.80	0
6		Subtest 2	23.88	24.04	23.90	22.82	22.80	22.83	22.91	22.89	22.83	0
6		Subtest 3	23.52	23.56	23.60	22.63	22.24	22.34	22.33	22.39	22.55	0.5
6		Subtest 4	23.45	23.37	23.57	22.28	22.35	22.26	22.24	22.28	22.35	0.5
6	HSUPA	Subtest 1	22.16	22.18	22.12	21.07	21.17	21.08	21.18	21.21	21.15	0
6		Subtest 2	21.18	21.19	21.10	21.10	21.15	21.04	21.20	21.22	21.19	2
6		Subtest 3	22.18	22.17	22.10	21.80	21.85	21.82	21.80	21.90	21.93	1
6		Subtest 4	20.37	20.39	20.31	20.37	20.46	20.44	20.51	20.52	20.46	2
6		Subtest 5	23.14	23.15	23.08	21.86	21.98	21.87	21.95	21.98	21.94	0

Table 9-3
Reduced Conducted Power

3GPP Release Version	Mode	3GPP 34.121 Subtest	AWS Band [dBm]			PCS Band [dBm]			3GPP MPR [dB]
			1312	1412	1513	9262	9400	9538	
99	WCDMA	12.2 kbps RMC	22.67	22.70	22.68	22.68	22.74	22.73	-
99		12.2 kbps AMR	22.70	22.69	22.70	22.68	22.74	22.73	-
6	HSDPA	Subtest 1	22.70	22.69	22.66	22.86	22.90	22.89	0
6		Subtest 2	22.63	22.67	22.58	22.85	22.87	22.83	0
6		Subtest 3	22.19	22.20	22.12	22.38	22.34	22.37	0.5
6		Subtest 4	22.18	22.20	22.09	22.29	22.32	22.32	0.5
6	HSUPA	Subtest 1	21.07	21.17	21.08	21.18	21.21	21.15	0
6		Subtest 2	21.10	21.15	21.04	21.20	21.22	21.19	2
6		Subtest 3	21.80	21.85	21.82	21.80	21.90	21.93	1
6		Subtest 4	20.37	20.46	20.44	20.51	20.52	20.46	2
6		Subtest 5	21.86	21.98	21.87	21.95	21.98	21.94	0

This device does not support DC-HSDPA.

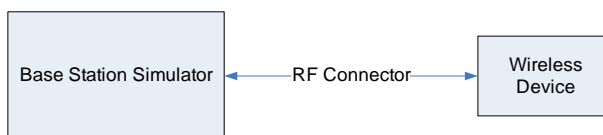



Figure 9-2
Power Measurement Setup

FCC ID: ZNFX420AS		SAR EVALUATION REPORT		Approved by: Quality Manager
Document S/N: 1M1905090070-01-R2.ZNF	Test Dates: 05/08/19 - 05/16/19	DUT Type: Portable Handset	Page 29 of 84	

9.3 LTE Conducted Powers

9.3.1 LTE Band 12

Table 9-4
LTE Band 12 Conducted Powers - 10 MHz Bandwidth

LTE Band 12 10 MHz Bandwidth					
Modulation	RB Size	RB Offset	Mid Channel	MPR Allowed per 3GPP [dB]	MPR [dB]
			23095 (707.5 MHz)		
			Conducted Power [dBm]		
QPSK	1	0	24.94	0	0
	1	25	24.93		0
	1	49	24.74		0
	25	0	23.94	0-1	1
	25	12	23.97		1
	25	25	23.84		1
	50	0	23.91		1
16QAM	1	0	24.17	0-1	1
	1	25	24.09		1
	1	49	23.95		1
	25	0	22.92	0-2	2
	25	12	22.93		2
	25	25	22.81		2
	50	0	22.87		2

Note: LTE Band 12 at 10 MHz bandwidth does not support three non-overlapping channels. Per KDB Publication 941225 D05v02, when a device supports overlapping channel assignment in a channel bandwidth configuration, the middle channel of the group of overlapping channels should be selected for testing.

Table 9-5
LTE Band 12 Conducted Powers - 5 MHz Bandwidth

LTE Band 12 5 MHz Bandwidth							
Modulation	RB Size	RB Offset	Low Channel	Mid Channel	High Channel	MPR Allowed per 3GPP [dB]	MPR [dB]
			23035 (701.5 MHz)	23095 (707.5 MHz)	23155 (713.5 MHz)		
			Conducted Power [dBm]				
QPSK	1	0	24.79	24.64	24.54	0	0
	1	12	24.72	24.91	24.83		0
	1	24	25.01	24.62	24.54		0
	12	0	23.69	23.79	23.77	0-1	1
	12	6	23.87	23.87	23.81		1
	12	13	23.97	23.77	23.65		1
	25	0	23.98	23.80	23.74		1
16QAM	1	0	23.94	23.87	23.75	0-1	1
	1	12	23.92	24.13	24.09		1
	1	24	23.96	23.79	23.84		1
	12	0	22.89	22.78	22.78	0-2	2
	12	6	23.00	22.85	22.84		2
	12	13	23.00	22.73	22.73		2
	25	0	22.95	22.76	22.77		2





FCC ID: ZNFX420AS		SAR EVALUATION REPORT		Approved by: Quality Manager
Document S/N: 1M1905090070-01-R2.ZNF	Test Dates: 05/08/19 - 05/16/19	DUT Type: Portable Handset		Page 30 of 84

Table 9-6
LTE Band 12 Conducted Powers - 3 MHz Bandwidth

LTE Band 12 3 MHz Bandwidth							
Modulation	RB Size	RB Offset	Low Channel	Mid Channel	High Channel	MPR Allowed per 3GPP [dB]	MPR [dB]
			23025 (700.5 MHz)	23095 (707.5 MHz)	23165 (714.5 MHz)		
			Conducted Power [dBm]				
QPSK	1	0	24.84	24.72	24.63	0	0
	1	7	24.83	24.89	24.83		0
	1	14	24.83	24.73	24.64		0
	8	0	23.92	23.80	23.71	0-1	1
	8	4	23.94	23.83	23.74		1
	8	7	23.91	23.79	23.69		1
	15	0	23.95	23.82	23.73		1
16QAM	1	0	24.01	23.91	23.87	0-1	1
	1	7	24.19	24.08	23.92		1
	1	14	24.08	23.88	23.95		1
	8	0	22.99	22.83	22.82	0-2	2
	8	4	22.99	22.84	22.80		2
	8	7	22.99	22.81	22.80		2
	15	0	22.91	22.75	22.74		2

Table 9-7
LTE Band 12 Conducted Powers -1.4 MHz Bandwidth

LTE Band 12 1.4 MHz Bandwidth							
Modulation	RB Size	RB Offset	Low Channel	Mid Channel	High Channel	MPR Allowed per 3GPP [dB]	MPR [dB]
			23017 (699.7 MHz)	23095 (707.5 MHz)	23173 (715.3 MHz)		
			Conducted Power [dBm]				
QPSK	1	0	24.82	24.68	24.59	0	0
	1	2	24.96	24.82	24.72		0
	1	5	24.80	24.68	24.58		0
	3	0	24.94	24.80	24.70		0
	3	2	24.97	24.83	24.72		0
	3	3	24.91	24.80	24.72		0
	6	0	24.00	23.85	23.77	0-1	1
16QAM	1	0	24.01	23.88	23.87	0-1	1
	1	2	24.13	24.01	24.00		1
	1	5	24.00	23.87	23.89		1
	3	0	23.97	23.84	23.81		1
	3	2	24.02	23.88	23.85		1
	3	3	23.97	23.84	23.83		1
	6	0	23.04	22.86	22.86	0-2	2

FCC ID: ZNFX420AS		SAR EVALUATION REPORT		Approved by: Quality Manager
Document S/N: 1M1905090070-01-R2.ZNF	Test Dates: 05/08/19 - 05/16/19	DUT Type: Portable Handset		Page 31 of 84

9.3.2

LTE Band 14



Table 9-8
LTE Band 14 Conducted Powers - 10 MHz Bandwidth

LTE Band 14 10 MHz Bandwidth					
Modulation	RB Size	RB Offset	Mid Channel	MPR Allowed per 3GPP [dB]	MPR [dB]
			23330 (793.0 MHz)		
			Conducted Power [dBm]		
QPSK	1	0	22.82	0	0
	1	25	22.95		0
	1	49	22.84		0
	25	0	21.98	0-1	1
	25	12	21.94		1
	25	25	22.00		1
	50	0	21.99		1
16QAM	1	0	22.12	0-1	1
	1	25	22.20		1
	1	49	22.14		1
	25	0	21.00	0-2	2
	25	12	20.97		2
	25	25	21.03		2
	50	0	21.01		2

Table 9-9
LTE Band 14 Conducted Powers - 5 MHz Bandwidth

LTE Band 14 5 MHz Bandwidth					
Modulation	RB Size	RB Offset	Mid Channel	MPR Allowed per 3GPP [dB]	MPR [dB]
			23330 (793.0 MHz)		
			Conducted Power [dBm]		
QPSK	1	0	22.68	0	0
	1	12	22.96		0
	1	24	22.73		0
	12	0	21.88	0-1	1
	12	6	21.92		1
	12	13	21.88		1
	25	0	21.87		1
16QAM	1	0	21.95	0-1	1
	1	12	22.20		1
	1	24	22.05		1
	12	0	20.91	0-2	2
	12	6	20.96		2
	12	13	20.92		2
	25	0	20.90		2

Note: LTE Band 14 at 5 MHz bandwidth does not support three non-overlapping channels. Per KDB Publication 941225 D05v02, when a device supports overlapping channel assignment in a channel bandwidth configuration, the middle channel of the group of overlapping channels should be selected for testing.

FCC ID: ZNFX420AS		SAR EVALUATION REPORT		Approved by: Quality Manager
Document S/N: 1M1905090070-01-R2.ZNF	Test Dates: 05/08/19 - 05/16/19	DUT Type: Portable Handset		Page 32 of 84

9.3.3

LTE Band 5 (Cell)

Table 9-10
LTE Band 5 (Cell) Conducted Powers - 10 MHz Bandwidth

LTE Band 5 (Cell) 10 MHz Bandwidth					
Modulation	RB Size	RB Offset	Mid Channel	MPR Allowed per 3GPP [dB]	MPR [dB]
			20525 (836.5 MHz)		
			Conducted Power [dBm]		
QPSK	1	0	24.92	0	0
	1	25	25.10		0
	1	49	24.90		0
	25	0	23.99	0-1	1
	25	12	24.07		1
	25	25	24.08		1
16QAM	50	0	24.03	0-1	1
	1	0	24.19		1
	1	25	24.20		1
	1	49	24.13	0-2	1
	25	0	23.13		2
	25	12	23.20		2
	25	25	23.19	2	
	50	0	23.15	2	

Note: LTE Band 5 (Cell) at 10 MHz bandwidth does not support three non-overlapping channels. Per KDB Publication 941225 D05v02, when a device supports overlapping channel assignment in a channel bandwidth configuration, the middle channel of the group of overlapping channels should be selected for testing.

Table 9-11
LTE Band 5 (Cell) Conducted Powers - 5 MHz Bandwidth

LTE Band 5 (Cell) 5 MHz Bandwidth								
Modulation	RB Size	RB Offset	Low Channel	Mid Channel	High Channel	MPR Allowed per 3GPP [dB]	MPR [dB]	
			20425 (826.5 MHz)	20525 (836.5 MHz)	20625 (846.5 MHz)			
			Conducted Power [dBm]					
QPSK	1	0	24.67	24.83	24.81	0	0	
	1	12	24.98	25.14	25.09		0	
	1	24	24.76	24.84	24.84		0	
	12	0	23.93	23.96	24.05	0-1	1	
	12	6	23.96	24.06	24.06		1	
	12	13	23.90	24.06	23.99		1	
16QAM	25	0	23.94	24.03	24.05	0-1	1	
	1	0	23.92	24.18	23.99		0-1	1
	1	12	24.20	24.20	24.20			1
	1	24	24.03	24.13	23.97	0-2		1
	12	0	23.04	23.13	23.13		2	
	12	6	23.07	23.20	23.14		2	
	12	13	23.02	23.20	23.07	2		
	25	0	23.03	23.17	23.11	2		





FCC ID: ZNFX420AS		SAR EVALUATION REPORT		Approved by: Quality Manager
Document S/N: 1M1905090070-01-R2.ZNF	Test Dates: 05/08/19 - 05/16/19	DUT Type: Portable Handset		Page 33 of 84

Table 9-12
LTE Band 5 (Cell) Conducted Powers - 3 MHz Bandwidth

LTE Band 5 (Cell) 3 MHz Bandwidth							
Modulation	RB Size	RB Offset	Low Channel	Mid Channel	High Channel	MPR Allowed per 3GPP [dB]	MPR [dB]
			20415 (825.5 MHz)	20525 (836.5 MHz)	20635 (847.5 MHz)		
			Conducted Power [dBm]				
QPSK	1	0	24.77	24.93	24.93	0	0
	1	7	24.99	25.12	25.10		0
	1	14	24.86	24.96	24.95		0
	8	0	23.88	23.99	23.98	0-1	1
	8	4	23.89	24.08	24.04		1
	8	7	23.88	24.03	24.00		1
	15	0	23.90	24.05	24.07		1
16QAM	1	0	24.01	24.20	24.08	0-1	1
	1	7	24.20	24.20	24.20		1
	1	14	24.10	24.20	24.09		1
	8	0	23.02	23.20	23.11	0-2	2
	8	4	23.03	23.20	23.14		2
	8	7	23.03	23.20	23.10		2
	15	0	22.95	23.14	23.09		2

Table 9-13
LTE Band 5 (Cell) Conducted Powers -1.4 MHz Bandwidth

LTE Band 5 (Cell) 1.4 MHz Bandwidth							
Modulation	RB Size	RB Offset	Low Channel	Mid Channel	High Channel	MPR Allowed per 3GPP [dB]	MPR [dB]
			20407 (824.7 MHz)	20525 (836.5 MHz)	20643 (848.3 MHz)		
			Conducted Power [dBm]				
QPSK	1	0	24.74	24.93	24.87	0	0
	1	2	24.90	25.05	25.05		0
	1	5	24.76	24.91	24.89		0
	3	0	24.85	25.03	25.03		0
	3	2	24.91	25.04	25.05		0
	3	3	24.89	25.04	25.03		0
	6	0	23.89	24.07	24.07	0-1	1
16QAM	1	0	23.99	24.20	24.02	0-1	1
	1	2	24.14	24.20	24.17		1
	1	5	24.02	24.20	24.02		1
	3	0	23.95	24.20	24.03		1
	3	2	24.01	24.20	24.04		1
	3	3	23.98	24.19	24.01		1
	6	0	23.03	23.20	23.18	0-2	2

FCC ID: ZNFX420AS	 PCTEST <small>PROTECTING OPERATORS, THE WORLD</small>	SAR EVALUATION REPORT	 LG	Approved by: Quality Manager
Document S/N: 1M1905090070-01-R2.ZNF	Test Dates: 05/08/19 - 05/16/19	DUT Type: Portable Handset	Page 34 of 84	

9.3.4

LTE Band 66 (AWS)

Table 9-14
LTE Band 66 (AWS) Conducted Powers - 20 MHz Bandwidth

LTE Band 66 (AWS) 20 MHz Bandwidth							
Modulation	RB Size	RB Offset	Low Channel	Mid Channel	High Channel	MPR Allowed per 3GPP [dB]	MPR [dB]
			132072 (1720.0 MHz)	132322 (1745.0 MHz)	132572 (1770.0 MHz)		
			Conducted Power [dBm]				
QPSK	1	0	23.90	23.90	23.90	0	0
	1	50	24.17	24.15	24.16		0
	1	99	23.96	23.91	23.92		0
	50	0	23.09	23.10	23.18	0-1	1
	50	25	23.19	23.17	23.19		1
	50	50	23.17	23.22	23.12		1
16QAM	100	0	23.12	23.15	23.15	0-1	1
	1	0	22.83	22.85	22.84		1
	1	50	23.16	23.20	23.15		1
	1	99	22.91	22.93	22.86	0-2	1
	50	0	22.11	22.15	22.19		2
	50	25	22.20	22.21	22.20		2
	50	50	22.17	22.24	22.13	2	
	100	0	22.12	22.19	22.16	2	

Table 9-15
LTE Band 66 (AWS) Conducted Powers - 15 MHz Bandwidth

LTE Band 66 (AWS) 15 MHz Bandwidth							
Modulation	RB Size	RB Offset	Low Channel	Mid Channel	High Channel	MPR Allowed per 3GPP [dB]	MPR [dB]
			132047 (1717.5 MHz)	132322 (1745.0 MHz)	132597 (1772.5 MHz)		
			Conducted Power [dBm]				
QPSK	1	0	23.94	23.95	23.89	0	0
	1	36	23.98	24.07	23.90		0
	1	74	23.95	23.93	23.92		0
	36	0	23.08	23.11	23.11	0-1	1
	36	18	23.18	23.14	23.15		1
	36	37	23.16	23.17	23.06		1
16QAM	75	0	23.10	23.12	23.10	0-1	1
	1	0	22.88	22.87	22.86		1
	1	36	23.04	23.12	23.12		1
	1	74	22.90	22.91	22.84	0-2	1
	36	0	22.08	22.12	22.08		2
	36	18	22.19	22.16	22.13		2
	36	37	22.16	22.19	22.13	2	
	75	0	22.07	22.22	22.40	2	



FCC ID: ZNFX420AS		SAR EVALUATION REPORT		Approved by: Quality Manager
Document S/N: 1M1905090070-01-R2.ZNF	Test Dates: 05/08/19 - 05/16/19	DUT Type: Portable Handset		Page 35 of 84

Table 9-16
LTE Band 66 (AWS) Conducted Powers - 10 MHz Bandwidth

LTE Band 66 (AWS) 10 MHz Bandwidth							
Modulation	RB Size	RB Offset	Low Channel	Mid Channel	High Channel	MPR Allowed per 3GPP [dB]	MPR [dB]
			132022 (1715.0 MHz)	132322 (1745.0 MHz)	132622 (1775.0 MHz)		
			Conducted Power [dBm]				
QPSK	1	0	23.98	23.97	23.99	0	0
	1	25	23.99	24.11	24.05		0
	1	49	23.94	23.95	23.91		0
	25	0	23.11	23.03	23.10	0-1	1
	25	12	23.16	23.08	23.10		1
	25	25	23.14	23.17	23.10		1
	50	0	23.17	23.13	23.03	1	
16QAM	1	0	22.90	23.05	23.07	0-1	1
	1	25	23.12	23.10	22.97		1
	1	49	22.93	22.98	23.07		1
	25	0	22.09	22.11	22.05	0-2	2
	25	12	22.16	22.20	22.13		2
	25	25	22.19	22.25	22.06		2
	50	0	22.18	22.23	22.07	2	

Table 9-17
LTE Band 66 (AWS) Conducted Powers - 5 MHz Bandwidth

LTE Band 66 (AWS) 5 MHz Bandwidth							
Modulation	RB Size	RB Offset	Low Channel	Mid Channel	High Channel	MPR Allowed per 3GPP [dB]	MPR [dB]
			131997 (1712.5 MHz)	132322 (1745.0 MHz)	132647 (1777.5 MHz)		
			Conducted Power [dBm]				
QPSK	1	0	23.89	23.91	23.90	0	0
	1	12	24.21	24.18	24.00		0
	1	24	23.90	23.95	23.87		0
	12	0	23.04	23.06	23.12	0-1	1
	12	6	23.11	23.10	23.13		1
	12	13	23.12	23.07	23.18		1
	25	0	23.05	23.09	23.06	1	
16QAM	1	0	22.74	22.94	22.74	0-1	1
	1	12	22.94	23.10	23.07		1
	1	24	22.95	22.98	22.82		1
	12	0	22.10	22.16	22.16	0-2	2
	12	6	22.19	22.20	22.16		2
	12	13	22.19	22.25	22.03		2
	25	0	22.12	22.13	22.06	2	



FCC ID: ZNFX420AS	 PCTEST <small>ENGINEERING LABORATORY, INC.</small>	SAR EVALUATION REPORT	 LG	Approved by: Quality Manager
Document S/N: 1M1905090070-01-R2.ZNF	Test Dates: 05/08/19 - 05/16/19	DUT Type: Portable Handset	Page 36 of 84	

Table 9-18
LTE Band 66 (AWS) Conducted Powers - 3 MHz Bandwidth

LTE Band 66 (AWS) 3 MHz Bandwidth							
Modulation	RB Size	RB Offset	Low Channel	Mid Channel	High Channel	MPR Allowed per 3GPP [dB]	MPR [dB]
			131987 (1711.5 MHz)	132322 (1745.0 MHz)	132657 (1778.5 MHz)		
			Conducted Power [dBm]				
QPSK	1	0	23.99	23.90	24.06	0	0
	1	7	23.99	24.07	24.18		0
	1	14	24.07	24.03	24.03		0
	8	0	23.06	23.05	23.16	0-1	1
	8	4	23.10	23.09	23.19		1
	8	7	23.08	23.07	23.15		1
	15	0	23.11	23.04	23.16		1
16QAM	1	0	23.03	23.12	23.04	0-1	1
	1	7	23.20	23.20	23.29		1
	1	14	23.35	22.95	23.00		1
	8	0	22.20	22.26	22.25	0-2	2
	8	4	22.21	22.25	22.23		2
	8	7	22.18	22.21	22.15		2
	15	0	22.10	22.19	22.18		2

Table 9-19
LTE Band 66 (AWS) Conducted Powers -1.4 MHz Bandwidth

LTE Band 66 (AWS) 1.4 MHz Bandwidth							
Modulation	RB Size	RB Offset	Low Channel	Mid Channel	High Channel	MPR Allowed per 3GPP [dB]	MPR [dB]
			131979 (1710.7 MHz)	132322 (1745.0 MHz)	132665 (1779.3 MHz)		
			Conducted Power [dBm]				
QPSK	1	0	24.06	24.07	24.02	0	0
	1	2	24.18	24.12	24.12		0
	1	5	24.05	24.06	23.98		0
	3	0	24.19	24.13	24.13		0
	3	2	24.15	24.14	24.19		0
	3	3	24.18	24.11	24.13		0
	6	0	23.23	23.15	23.21	0-1	1
16QAM	1	0	23.12	23.21	23.15	0-1	1
	1	2	23.17	23.23	23.15		1
	1	5	23.05	23.19	23.01		1
	3	0	22.94	22.95	22.92		1
	3	2	23.15	22.83	22.93		1
	3	3	22.91	23.08	22.88		1
	6	0	22.24	22.25	22.23	0-2	2



FCC ID: ZNFX420AS	 PCTEST <small>ENGINEERING LABORATORY, INC.</small>	SAR EVALUATION REPORT		Approved by: Quality Manager
Document S/N: 1M1905090070-01-R2.ZNF	Test Dates: 05/08/19 - 05/16/19	DUT Type: Portable Handset		Page 37 of 84

Table 9-20
LTE Band 66 (AWS) Reduced Conducted Powers - 20 MHz Bandwidth

LTE Band 66 (AWS) 20 MHz Bandwidth							
Modulation	RB Size	RB Offset	Low Channel	Mid Channel	High Channel	MPR Allowed per 3GPP [dB]	MPR [dB]
			132072 (1720.0 MHz)	132322 (1745.0 MHz)	132572 (1770.0 MHz)		
			Conducted Power [dBm]				
QPSK	1	0	22.42	22.47	22.42	0	0
	1	50	22.70	22.73	22.70		0
	1	99	22.47	22.44	22.43		0
	50	0	22.58	22.62	22.64	0-1	0
	50	25	22.65	22.66	22.66		0
	50	50	22.64	22.73	22.60		0
	100	0	22.61	22.65	22.63	0	
16QAM	1	0	22.70	22.72	22.66	0-1	0
	1	50	22.90	22.90	22.89		0
	1	99	22.74	22.75	22.65		0
	50	0	22.10	22.15	22.18	0-2	0.5
	50	25	22.19	22.22	22.20		0.5
	50	50	22.17	22.26	22.13		0.5
	100	0	22.12	22.19	22.15	0.5	

Table 9-21
LTE Band 66 (AWS) Reduced Conducted Powers - 15 MHz Bandwidth

LTE Band 66 (AWS) 15 MHz Bandwidth							
Modulation	RB Size	RB Offset	Low Channel	Mid Channel	High Channel	MPR Allowed per 3GPP [dB]	MPR [dB]
			132047 (1717.5 MHz)	132322 (1745.0 MHz)	132597 (1772.5 MHz)		
			Conducted Power [dBm]				
QPSK	1	0	22.44	22.51	22.49	0	0
	1	36	22.52	22.53	22.56		0
	1	74	22.48	22.46	22.46		0
	36	0	22.59	22.65	22.62	0-1	0
	36	18	22.57	22.61	22.67		0
	36	37	22.63	22.64	22.64		0
	75	0	22.64	22.65	22.64	0	
16QAM	1	0	22.45	22.71	22.22	0-1	0
	1	36	22.55	22.78	22.35		0
	1	74	22.49	22.75	22.25		0
	36	0	22.13	22.12	22.04	0-2	0.5
	36	18	22.17	22.07	22.09		0.5
	36	37	22.19	22.06	22.14		0.5
	75	0	22.17	22.13	22.15	0.5	



FCC ID: ZNFX420AS	 PCTEST <small>ENGINEERING LABORATORY, INC.</small>	SAR EVALUATION REPORT		Approved by: Quality Manager
Document S/N: 1M1905090070-01-R2.ZNF	Test Dates: 05/08/19 - 05/16/19	DUT Type: Portable Handset	Page 38 of 84	

Table 9-22
LTE Band 66 (AWS) Reduced Conducted Powers - 10 MHz Bandwidth

LTE Band 66 (AWS) 10 MHz Bandwidth							
Modulation	RB Size	RB Offset	Low Channel	Mid Channel	High Channel	MPR Allowed per 3GPP [dB]	MPR [dB]
			132022 (1715.0 MHz)	132322 (1745.0 MHz)	132622 (1775.0 MHz)		
			Conducted Power [dBm]				
QPSK	1	0	22.42	22.59	22.53	0	0
	1	25	22.53	22.71	22.66		0
	1	49	22.49	22.53	22.53		0
	25	0	22.56	22.63	22.66	0-1	0
	25	12	22.56	22.61	22.62		0
	25	25	22.60	22.67	22.64		0
	50	0	22.63	22.65	22.66		0
16QAM	1	0	22.17	22.85	22.78	0-1	0
	1	25	22.27	22.88	22.85		0
	1	49	22.23	22.84	22.73		0
	25	0	22.17	22.20	22.19	0-2	0.5
	25	12	22.10	22.18	22.14		0.5
	25	25	22.14	22.24	22.15		0.5
	50	0	22.11	22.19	22.19		0.5

Table 9-23
LTE Band 66 (AWS) Reduced Conducted Powers - 5 MHz Bandwidth

LTE Band 66 (AWS) 5 MHz Bandwidth							
Modulation	RB Size	RB Offset	Low Channel	Mid Channel	High Channel	MPR Allowed per 3GPP [dB]	MPR [dB]
			131997 (1712.5 MHz)	132322 (1745.0 MHz)	132647 (1777.5 MHz)		
			Conducted Power [dBm]				
QPSK	1	0	22.42	22.47	22.36	0	0
	1	12	22.76	22.82	22.63		0
	1	24	22.39	22.48	22.37		0
	12	0	22.49	22.53	22.61	0-1	0
	12	6	22.52	22.61	22.61		0
	12	13	22.49	22.56	22.53		0
	25	0	22.52	22.59	22.57		0
16QAM	1	0	22.73	22.78	22.47	0-1	0
	1	12	22.82	22.89	22.79		0
	1	24	22.77	22.85	22.48		0
	12	0	22.14	22.13	22.11	0-2	0.5
	12	6	22.17	22.20	22.16		0.5
	12	13	22.11	22.18	22.03		0.5
	25	0	22.05	22.13	22.14		0.5





FCC ID: ZNFX420AS	 PCTEST <small>ENGINEERING LABORATORY, INC.</small>	SAR EVALUATION REPORT	 LG	Approved by: Quality Manager
Document S/N: 1M1905090070-01-R2.ZNF	Test Dates: 05/08/19 - 05/16/19	DUT Type: Portable Handset	Page 39 of 84	

Table 9-24
LTE Band 66 (AWS) Reduced Conducted Powers - 3 MHz Bandwidth

LTE Band 66 (AWS) 3 MHz Bandwidth							
Modulation	RB Size	RB Offset	Low Channel	Mid Channel	High Channel	MPR Allowed per 3GPP [dB]	MPR [dB]
			131987 (1711.5 MHz)	132322 (1745.0 MHz)	132657 (1778.5 MHz)		
			Conducted Power [dBm]				
QPSK	1	0	22.46	22.51	22.58	0	0
	1	7	22.51	22.70	22.79		0
	1	14	22.43	22.48	22.57		0
	8	0	22.50	22.51	22.60	0-1	0
	8	4	22.54	22.55	22.56		0
	8	7	22.50	22.51	22.55		0
	15	0	22.51	22.52	22.55		0
16QAM	1	0	22.65	22.74	22.27	0-1	0
	1	7	22.74	22.89	22.45		0
	1	14	22.60	22.74	22.28		0
	8	0	22.09	22.12	22.16	0-2	0.5
	8	4	22.12	22.17	22.18		0.5
	8	7	22.06	22.13	22.11		0.5
	15	0	22.05	22.10	22.00		0.5

Table 9-25
LTE Band 66 (AWS) Reduced Conducted Powers -1.4 MHz Bandwidth

LTE Band 66 (AWS) 1.4 MHz Bandwidth							
Modulation	RB Size	RB Offset	Low Channel	Mid Channel	High Channel	MPR Allowed per 3GPP [dB]	MPR [dB]
			131979 (1710.7 MHz)	132322 (1745.0 MHz)	132665 (1779.3 MHz)		
			Conducted Power [dBm]				
QPSK	1	0	22.48	22.47	22.47	0	0
	1	2	22.66	22.62	22.69		0
	1	5	22.43	22.49	22.48		0
	3	0	22.66	22.60	22.63		0
	3	2	22.65	22.63	22.66		0
	3	3	22.67	22.64	22.65		0
	6	0	22.49	22.53	22.56	0-1	0
16QAM	1	0	22.79	22.66	22.19	0-1	0
	1	2	22.88	22.83	22.38		0
	1	5	22.83	22.68	22.17		0
	3	0	22.79	22.76	22.66		0
	3	2	22.83	22.74	22.68		0
	3	3	22.82	22.73	22.68		0
	6	0	22.04	22.18	22.18	0-2	0.5

FCC ID: ZNFX420AS	 PCTEST <small>ENGINEERING LABORATORY, INC.</small>	SAR EVALUATION REPORT	 LG	Approved by: Quality Manager
Document S/N: 1M1905090070-01-R2.ZNF	Test Dates: 05/08/19 - 05/16/19	DUT Type: Portable Handset	Page 40 of 84	

9.3.5



LTE Band 2 (PCS)

Table 9-26
LTE Band 2 (PCS) Conducted Powers - 20 MHz Bandwidth

LTE Band 2 (PCS) 20 MHz Bandwidth							
Modulation	RB Size	RB Offset	Low Channel	Mid Channel	High Channel	MPR Allowed per 3GPP [dB]	MPR [dB]
			18700 (1860.0 MHz)	18900 (1880.0 MHz)	19100 (1900.0 MHz)		
			Conducted Power [dBm]				
QPSK	1	0	23.86	23.91	24.03	0	0
	1	50	24.14	24.18	24.26		0
	1	99	23.87	23.99	23.95		0
	50	0	23.10	23.26	23.34	0-1	1
	50	25	23.24	23.25	23.37		1
	50	50	23.15	23.31	23.25		1
	100	0	23.14	23.30	23.29		1
16QAM	1	0	22.95	22.96	23.16	0-1	1
	1	50	23.23	23.24	23.32		1
	1	99	22.97	23.10	22.92		1
	50	0	22.14	22.28	22.38	0-2	2
	50	25	22.28	22.30	22.39		2
	50	50	22.18	22.34	22.27		2
	100	0	22.16	22.32	22.30		2

Table 9-27
LTE Band 2 (PCS) Conducted Powers - 15 MHz Bandwidth

LTE Band 2 (PCS) 15 MHz Bandwidth							
Modulation	RB Size	RB Offset	Low Channel	Mid Channel	High Channel	MPR Allowed per 3GPP [dB]	MPR [dB]
			18675 (1857.5 MHz)	18900 (1880.0 MHz)	19125 (1902.5 MHz)		
			Conducted Power [dBm]				
QPSK	1	0	23.99	23.99	24.13	0	0
	1	36	24.11	24.14	24.20		0
	1	74	23.99	24.08	24.03		0
	36	0	23.24	23.33	23.40	0-1	1
	36	18	23.30	23.34	23.39		1
	36	37	23.31	23.35	23.34		1
	75	0	23.25	23.34	23.36		1
16QAM	1	0	23.02	23.05	23.16	0-1	1
	1	36	23.19	23.23	23.24		1
	1	74	23.01	23.16	23.22		1
	36	0	22.23	22.32	22.39	0-2	2
	36	18	22.29	22.34	22.40		2
	36	37	22.32	22.35	22.32		2
	75	0	22.26	22.35	22.38		2

FCC ID: ZNFX420AS		SAR EVALUATION REPORT		Approved by: Quality Manager
Document S/N: 1M1905090070-01-R2.ZNF	Test Dates: 05/08/19 - 05/16/19	DUT Type: Portable Handset		Page 41 of 84

**Table 9-28
LTE Band 2 (PCS) Conducted Powers - 10 MHz Bandwidth**

LTE Band 2 (PCS) 10 MHz Bandwidth							
Modulation	RB Size	RB Offset	Low Channel	Mid Channel	High Channel	MPR Allowed per 3GPP [dB]	MPR [dB]
			18650 (1855.0 MHz)	18900 (1880.0 MHz)	19150 (1905.0 MHz)		
			Conducted Power [dBm]				
QPSK	1	0	24.01	24.04	24.12	0	0
	1	25	24.13	24.20	24.23		0
	1	49	24.04	24.05	24.05		0
	25	0	23.24	23.31	23.20	0-1	1
	25	12	23.28	23.30	23.40		1
	25	25	23.31	23.35	23.28		1
	50	0	23.31	23.34	23.38		1
16QAM	1	0	23.11	23.10	23.17	0-1	1
	1	25	23.16	23.20	23.25		1
	1	49	23.15	23.12	22.94		1
	25	0	22.25	22.35	22.19	0-2	2
	25	12	22.31	22.34	22.40		2
	25	25	22.34	22.38	22.26		2
	50	0	22.31	22.36	22.31		2

**Table 9-29
LTE Band 2 (PCS) Conducted Powers - 5 MHz Bandwidth**

LTE Band 2 (PCS) 5 MHz Bandwidth							
Modulation	RB Size	RB Offset	Low Channel	Mid Channel	High Channel	MPR Allowed per 3GPP [dB]	MPR [dB]
			18625 (1852.5 MHz)	18900 (1880.0 MHz)	19175 (1907.5 MHz)		
			Conducted Power [dBm]				
QPSK	1	0	23.93	23.99	24.02	0	0
	1	12	24.13	24.23	24.22		0
	1	24	23.91	23.98	23.97		0
	12	0	23.17	23.27	23.32	0-1	1
	12	6	23.24	23.31	23.33		1
	12	13	23.21	23.26	23.20		1
	25	0	23.18	23.35	23.34		1
16QAM	1	0	23.05	23.07	23.09	0-1	1
	1	12	23.12	23.11	23.04		1
	1	24	23.11	23.12	22.80		1
	12	0	22.27	22.30	22.27	0-2	2
	12	6	22.31	22.14	22.22		2
	12	13	22.25	22.33	22.16		2
	25	0	22.33	22.35	22.25		2



FCC ID: ZNFX420AS	 PCTEST <small>ENGINEERING LABORATORY, INC.</small>	SAR EVALUATION REPORT	 LG	Approved by: Quality Manager
Document S/N: 1M1905090070-01-R2.ZNF	Test Dates: 05/08/19 - 05/16/19	DUT Type: Portable Handset	Page 42 of 84	

Table 9-30
LTE Band 2 (PCS) Conducted Powers - 3 MHz Bandwidth

LTE Band 2 (PCS) 3 MHz Bandwidth							
Modulation	RB Size	RB Offset	Low Channel	Mid Channel	High Channel	MPR Allowed per 3GPP [dB]	MPR [dB]
			18615 (1851.5 MHz)	18900 (1880.0 MHz)	19185 (1908.5 MHz)		
			Conducted Power [dBm]				
QPSK	1	0	24.07	24.15	24.14	0	0
	1	7	24.22	24.20	24.22		0
	1	14	24.06	24.12	23.96		0
	8	0	23.22	23.27	23.29	0-1	1
	8	4	23.21	23.29	23.28		1
	8	7	23.19	23.28	23.30		1
16QAM	15	0	23.27	23.29	23.34	0-1	1
	1	0	23.12	23.25	23.11		1
	1	7	23.21	23.32	23.27		1
	1	14	23.12	23.24	23.12	0-2	1
	8	0	22.30	22.28	22.36		2
	8	4	22.31	22.31	22.31		2
	8	7	22.23	22.32	22.28	2	
	15	0	22.25	22.29	22.30	2	

Table 9-31
LTE Band 2 (PCS) Conducted Powers - 1.4 MHz Bandwidth

LTE Band 2 (PCS) 1.4 MHz Bandwidth							
Modulation	RB Size	RB Offset	Low Channel	Mid Channel	High Channel	MPR Allowed per 3GPP [dB]	MPR [dB]
			18607 (1850.7 MHz)	18900 (1880.0 MHz)	19193 (1909.3 MHz)		
			Conducted Power [dBm]				
QPSK	1	0	24.03	24.07	24.06	0	0
	1	2	24.10	24.19	24.18		0
	1	5	24.03	24.11	24.04		0
	3	0	24.14	24.15	24.19		0
	3	2	24.15	24.19	24.17		0
	3	3	24.12	24.25	24.15		0
16QAM	6	0	23.29	23.31	23.20	0-1	1
	1	0	23.09	23.21	23.11	0-1	1
	1	2	23.22	23.30	23.22		1
	1	5	23.14	23.17	23.11		1
	3	0	22.97	23.02	23.01		1
	3	2	23.04	22.88	23.01		1
3	3	22.71	22.80	22.99	1		
	6	0	22.35	22.35	22.37	0-2	2



FCC ID: ZNFX420AS	 PCTEST <small>ENGINEERING LABORATORY, INC.</small>	SAR EVALUATION REPORT		Approved by: Quality Manager
Document S/N: 1M1905090070-01-R2.ZNF	Test Dates: 05/08/19 - 05/16/19	DUT Type: Portable Handset		Page 43 of 84

Table 9-32
LTE Band 2 (PCS) Reduced Conducted Powers - 20 MHz Bandwidth

LTE Band 2 (PCS) 20 MHz Bandwidth							
Modulation	RB Size	RB Offset	Low Channel	Mid Channel	High Channel	MPR Allowed per 3GPP [dB]	MPR [dB]
			18700 (1860.0 MHz)	18900 (1880.0 MHz)	19100 (1900.0 MHz)		
			Conducted Power [dBm]				
QPSK	1	0	22.50	22.52	22.65	0	0
	1	50	22.79	22.81	22.88		0
	1	99	22.48	22.63	22.59		0
	50	0	22.58	22.74	22.83	0-1	0
	50	25	22.74	22.75	22.85		0
	50	50	22.65	22.80	22.74		0
	100	0	22.64	22.79	22.79		0
16QAM	1	0	22.76	22.90	22.89	0-1	0
	1	50	22.90	22.89	22.90		0
	1	99	22.84	22.87	22.77		0
	50	0	22.14	22.28	22.37	0-2	0.5
	50	25	22.28	22.30	22.39		0.5
	50	50	22.19	22.33	22.26		0.5
	100	0	22.18	22.31	22.29		0.5

Table 9-33
LTE Band 2 (PCS) Reduced Conducted Powers - 15 MHz Bandwidth

LTE Band 2 (PCS) 15 MHz Bandwidth							
Modulation	RB Size	RB Offset	Low Channel	Mid Channel	High Channel	MPR Allowed per 3GPP [dB]	MPR [dB]
			18675 (1857.5 MHz)	18900 (1880.0 MHz)	19125 (1902.5 MHz)		
			Conducted Power [dBm]				
QPSK	1	0	22.55	22.83	22.66	0	0
	1	36	22.57	22.89	22.74		0
	1	74	22.47	22.79	22.70		0
	36	0	22.65	22.83	22.80	0-1	0
	36	18	22.66	22.88	22.90		0
	36	37	22.66	22.84	22.84		0
	75	0	22.65	22.86	22.82		0
16QAM	1	0	22.89	22.84	22.78	0-1	0
	1	36	22.90	22.90	22.83		0
	1	74	22.90	22.85	22.69		0
	36	0	22.09	22.37	22.30	0-2	0.5
	36	18	22.15	22.35	22.38		0.5
	36	37	22.14	22.28	22.31		0.5
	75	0	22.17	22.37	22.34		0.5



FCC ID: ZNFX420AS	 PCTEST ENGINEERING LABORATORY, INC.	SAR EVALUATION REPORT	 LG	Approved by: Quality Manager
Document S/N: 1M1905090070-01-R2.ZNF	Test Dates: 05/08/19 - 05/16/19	DUT Type: Portable Handset		Page 44 of 84

Table 9-34
LTE Band 2 (PCS) Reduced Conducted Powers - 10 MHz Bandwidth

LTE Band 2 (PCS) 10 MHz Bandwidth							
Modulation	RB Size	RB Offset	Low Channel	Mid Channel	High Channel	MPR Allowed per 3GPP [dB]	MPR [dB]
			18650 (1855.0 MHz)	18900 (1880.0 MHz)	19150 (1905.0 MHz)		
			Conducted Power [dBm]				
QPSK	1	0	22.61	22.59	22.64	0	0
	1	25	22.76	22.73	22.88		0
	1	49	22.59	22.53	22.63		0
	25	0	22.68	22.72	22.88	0-1	0
	25	12	22.72	22.74	22.82		0
	25	25	22.69	22.67	22.69		0
	50	0	22.69	22.71	22.81		0
16QAM	1	0	22.89	22.87	22.65	0-1	0
	1	25	22.90	22.79	22.70		0
	1	49	22.87	22.78	22.85		0
	25	0	22.23	22.24	22.40	0-2	0.5
	25	12	22.28	22.28	22.39		0.5
	25	25	22.29	22.26	22.26		0.5
	50	0	22.24	22.21	22.29		0.5

Table 9-35
LTE Band 2 (PCS) Reduced Conducted Powers - 5 MHz Bandwidth

LTE Band 2 (PCS) 5 MHz Bandwidth							
Modulation	RB Size	RB Offset	Low Channel	Mid Channel	High Channel	MPR Allowed per 3GPP [dB]	MPR [dB]
			18625 (1852.5 MHz)	18900 (1880.0 MHz)	19175 (1907.5 MHz)		
			Conducted Power [dBm]				
QPSK	1	0	22.54	22.62	22.68	0	0
	1	12	22.76	22.88	22.86		0
	1	24	22.47	22.60	22.67		0
	12	0	22.64	22.71	22.79	0-1	0
	12	6	22.73	22.75	22.84		0
	12	13	22.71	22.70	22.68		0
	25	0	22.70	22.72	22.77		0
16QAM	1	0	22.81	22.71	22.74	0-1	0
	1	12	22.79	22.90	22.90		0
	1	24	22.81	22.70	22.69		0
	12	0	22.14	22.36	22.24	0-2	0.5
	12	6	22.24	22.30	22.30		0.5
	12	13	22.20	22.35	22.18		0.5
	25	0	22.28	22.23	22.30		0.5





FCC ID: ZNFX420AS	 PCTEST <small>ENGINEERING LABORATORY, INC.</small>	SAR EVALUATION REPORT	 LG	Approved by: Quality Manager
Document S/N: 1M1905090070-01-R2.ZNF	Test Dates: 05/08/19 - 05/16/19	DUT Type: Portable Handset	Page 45 of 84	

Table 9-36
LTE Band 2 (PCS) Reduced Conducted Powers - 3 MHz Bandwidth

LTE Band 2 (PCS) 3 MHz Bandwidth							
Modulation	RB Size	RB Offset	Low Channel	Mid Channel	High Channel	MPR Allowed per 3GPP [dB]	MPR [dB]
			18615 (1851.5 MHz)	18900 (1880.0 MHz)	19185 (1908.5 MHz)		
			Conducted Power [dBm]				
QPSK	1	0	22.64	22.66	22.74	0	0
	1	7	22.78	22.80	22.90		0
	1	14	22.63	22.65	22.71		0
	8	0	22.70	22.73	22.80	0-1	0
	8	4	22.76	22.71	22.81		0
	8	7	22.70	22.70	22.76		0
16QAM	15	0	22.70	22.69	22.79	0-1	0
	1	0	22.55	22.80	22.87		0
	1	7	22.68	22.85	22.86		0
	1	14	22.55	22.67	22.80	0-2	0
	8	0	22.33	22.35	22.30		0.5
	8	4	22.38	22.36	22.33		0.5
	8	7	22.30	22.31	22.33	0.5	
	15	0	22.32	22.28	22.20	0.5	

Table 9-37
LTE Band 2 (PCS) Reduced Conducted Powers -1.4 MHz Bandwidth

LTE Band 2 (PCS) 1.4 MHz Bandwidth							
Modulation	RB Size	RB Offset	Low Channel	Mid Channel	High Channel	MPR Allowed per 3GPP [dB]	MPR [dB]
			18607 (1850.7 MHz)	18900 (1880.0 MHz)	19193 (1909.3 MHz)		
			Conducted Power [dBm]				
QPSK	1	0	22.58	22.60	22.84	0	0
	1	2	22.71	22.72	22.80		0
	1	5	22.56	22.59	22.84		0
	3	0	22.73	22.76	22.87	0-1	0
	3	2	22.79	22.82	22.87		0
	3	3	22.76	22.77	22.87		0
16QAM	6	0	22.71	22.72	22.83	0-1	0
	1	0	22.87	22.68	22.70		0
	1	2	22.80	22.75	22.81		0
	1	5	22.69	22.67	22.72	0-1	0
	3	0	22.74	22.75	22.80		0
	3	2	22.73	22.76	22.82		0
	3	3	22.70	22.74	22.79	0	
	6	0	22.23	22.26	22.38	0-2	0.5

FCC ID: ZNFX420AS	 PCTEST <small>ENGINEERING LABORATORY, INC.</small>	SAR EVALUATION REPORT		Approved by: Quality Manager
Document S/N: 1M1905090070-01-R2.ZNF	Test Dates: 05/08/19 - 05/16/19	DUT Type: Portable Handset		Page 46 of 84

9.3.6

LTE Band 30

Table 9-38
LTE Band 30 Conducted Powers - 10 MHz Bandwidth

LTE Band 30 10 MHz Bandwidth					
Modulation	RB Size	RB Offset	Mid Channel	MPR Allowed per 3GPP [dB]	MPR [dB]
			27710 (2310.0 MHz)		
			Conducted Power [dBm]		
QPSK	1	0	22.60	0	0
	1	25	22.71		0
	1	49	22.45		0
	25	0	21.74	0-1	1
	25	12	21.59		1
	25	25	21.50		1
	50	0	21.56		1
16QAM	1	0	21.68	0-1	1
	1	25	21.83		1
	1	49	21.49		1
	25	0	20.57	0-2	2
	25	12	20.50		2
	25	25	20.39		2
	50	0	20.49		2

Table 9-39
LTE Band 30 Conducted Powers - 5 MHz Bandwidth

LTE Band 30 5 MHz Bandwidth					
Modulation	RB Size	RB Offset	Mid Channel	MPR Allowed per 3GPP [dB]	MPR [dB]
			27710 (2310.0 MHz)		
			Conducted Power [dBm]		
QPSK	1	0	22.49	0	0
	1	12	22.60		0
	1	24	22.31		0
	12	0	21.54	0-1	1
	12	6	21.57		1
	12	13	21.53		1
	25	0	21.53		1
16QAM	1	0	21.58	0-1	1
	1	12	21.73		1
	1	24	21.44		1
	12	0	20.42	0-2	2
	12	6	20.45		2
	12	13	20.31		2
	25	0	20.42		2

Note: LTE Band 30 at 5 MHz bandwidth does not support three non-overlapping channels. Per KDB Publication 941225 D05v02, when a device supports overlapping channel assignment in a channel bandwidth configuration, the middle channel of the group of overlapping channels should be selected for testing.



FCC ID: ZNFX420AS	 PCTEST ENGINEERING LABORATORY, INC.	SAR EVALUATION REPORT	 LG	Approved by: Quality Manager
Document S/N: 1M1905090070-01-R2.ZNF	Test Dates: 05/08/19 - 05/16/19	DUT Type: Portable Handset		Page 47 of 84



Table 9-40
LTE Band 30 Reduced Conducted Powers - 10 MHz Bandwidth

LTE Band 30 10 MHz Bandwidth					
Modulation	RB Size	RB Offset	Mid Channel	MPR Allowed per 3GPP [dB]	MPR [dB]
			27710 (2310.0 MHz)		
			Conducted Power [dBm]		
QPSK	1	0	21.23	0	0
	1	25	21.31		0
	1	49	21.02		0
	25	0	21.27	0-1	0
	25	12	21.24		0
	25	25	21.12		0
	50	0	21.19		0
16QAM	1	0	21.48	0-1	0
	1	25	21.50		0
	1	49	21.25		0
	25	0	20.79	0-2	0.5
	25	12	20.76		0.5
	25	25	20.65		0.5
	50	0	20.70		0.5

Table 9-41
LTE Band 30 Reduced Conducted Powers - 5 MHz Bandwidth

LTE Band 30 5 MHz Bandwidth					
Modulation	RB Size	RB Offset	Mid Channel	MPR Allowed per 3GPP [dB]	MPR [dB]
			27710 (2310.0 MHz)		
			Conducted Power [dBm]		
QPSK	1	0	21.12	0	0
	1	12	21.38		0
	1	24	21.02		0
	12	0	21.23	0-1	0
	12	6	21.25		0
	12	13	21.14		0
	25	0	21.22		0
16QAM	1	0	21.42	0-1	0
	1	12	21.50		0
	1	24	21.31		0
	12	0	20.78	0-2	0.5
	12	6	20.79		0.5
	12	13	20.70		0.5
	25	0	20.76		0.5

Note: LTE Band 30 at 5 MHz bandwidth does not support three non-overlapping channels. Per KDB Publication 941225 D05v02, when a device supports overlapping channel assignment in a channel bandwidth configuration, the middle channel of the group of overlapping channels should be selected for testing.

FCC ID: ZNFX420AS	 PCTEST <small>ENGINEERING LABORATORY, INC.</small>	SAR EVALUATION REPORT	 LG	Approved by: Quality Manager
Document S/N: 1M1905090070-01-R2.ZNF	Test Dates: 05/08/19 - 05/16/19	DUT Type: Portable Handset		Page 48 of 84

9.4 WLAN Conducted Powers

Table 9-42
2.4 GHz WLAN Maximum Average RF Power

2.4GHz Conducted Power [dBm]				
Freq [MHz]	Channel	IEEE Transmission Mode		
		802.11b	802.11g	802.11n
		Average	Average	Average
2412	1	14.98	12.01	11.86
2417	2	N/A	14.28	13.19
2437	6	14.68	14.49	13.46
2457	10	N/A	14.34	13.36
2462	11	14.46	12.34	12.18

Justification for test configurations for WLAN per KDB Publication 248227 D01v02r02:

- Power measurements were performed for the transmission mode configuration with the highest maximum output power specified for production units.
- For transmission modes with the same maximum output power specification, powers were measured for the largest channel bandwidth, lowest order modulation and lowest data rate.
- For transmission modes with identical maximum specified output power, channel bandwidth, modulation and data rates, power measurements were required for all identical configurations.

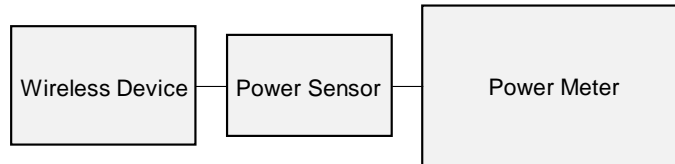



Figure 9-3
Power Measurement Setup

FCC ID: ZNFX420AS		SAR EVALUATION REPORT		Approved by: Quality Manager
Document S/N: 1M1905090070-01-R2.ZNF	Test Dates: 05/08/19 - 05/16/19	DUT Type: Portable Handset		Page 49 of 84

9.5 Bluetooth Conducted Powers

Table 9-43
Bluetooth Average RF Power

Frequency [MHz]	Data Rate [Mbps]	Channel No.	Avg Conducted Power	
			[dBm]	[mW]
2402	1.0	0	8.88	7.731
2441	1.0	39	9.48	8.881
2480	1.0	78	8.39	6.896
2402	2.0	0	5.19	3.303
2441	2.0	39	5.95	3.935
2480	2.0	78	4.82	3.037
2402	3.0	0	5.28	3.374
2441	3.0	39	6.04	4.019
2480	3.0	78	4.91	3.098



FCC ID: ZNFX420AS	 PCTEST ENGINEERING LABORATORY, INC.	SAR EVALUATION REPORT	 LG	Approved by: Quality Manager
Document S/N: 1M1905090070-01-R2.ZNF	Test Dates: 05/08/19 - 05/16/19	DUT Type: Portable Handset	Page 50 of 84	



Figure 9-4
Bluetooth Transmission Plot

Equation 9-1
Bluetooth Duty Cycle Calculation

$$Duty\ Cycle = \frac{Pulse\ Width}{Period} * 100\% = \frac{2.88ms}{3.75ms} * 100\% = 76.8\%$$

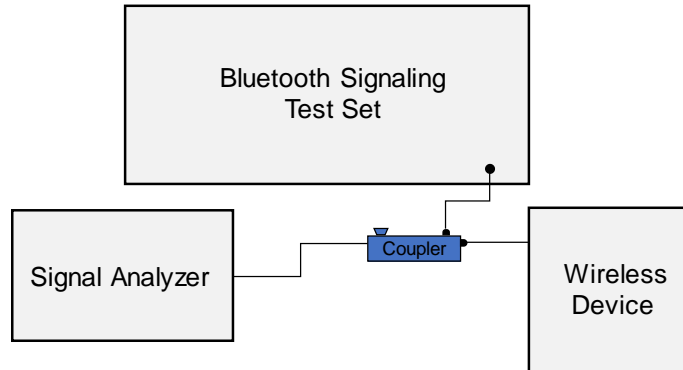

Figure 9-5
Power Measurement Setup



FCC ID: ZNFX420AS	PCTEST ENGINEERING LABORATORY, INC.	SAR EVALUATION REPORT	LG	Approved by: Quality Manager
Document S/N: 1M1905090070-01-R2-ZNF	Test Dates: 05/08/19 - 05/16/19	DUT Type: Portable Handset		Page 51 of 84

10 SYSTEM VERIFICATION

10.1 Tissue Verification

**Table 10-1
Head Measured Tissue Properties**



Calibrated for Tests Performed on:	Tissue Type	Tissue Temp During Calibration (°C)	Measured Frequency (MHz)	Measured Conductivity, σ (S/m)	Measured Dielectric Constant, ϵ	TARGET Conductivity, σ (S/m)	TARGET Dielectric Constant, ϵ	% dev σ	% dev ϵ
5/9/2019	750H	22.3	700	0.901	43.029	0.889	42.201	1.35%	1.96%
			710	0.904	42.997	0.890	42.149	1.57%	2.01%
			740	0.915	42.922	0.893	41.994	2.46%	2.21%
			755	0.920	42.881	0.894	41.916	2.91%	2.30%
			785	0.930	42.781	0.896	41.760	3.79%	2.44%
			800	0.935	42.730	0.897	41.682	4.24%	2.51%
5/14/2019	835H	20.9	820	0.884	40.960	0.899	41.578	-1.67%	-1.49%
			835	0.900	40.761	0.900	41.500	0.00%	-1.78%
			850	0.915	40.562	0.916	41.500	-0.11%	-2.26%
5/14/2019	1750H	20.4	1710	1.346	42.124	1.348	40.142	-0.15%	4.94%
			1750	1.371	42.068	1.371	40.079	0.00%	4.96%
			1790	1.395	41.991	1.394	40.016	0.07%	4.94%
5/12/2019	1900H	21.1	1850	1.405	38.795	1.400	40.000	0.36%	-3.01%
			1880	1.437	38.657	1.400	40.000	2.64%	-3.36%
			1910	1.468	38.521	1.400	40.000	4.86%	-3.70%
5/10/2019	2450H	21.7	2300	1.710	38.550	1.670	39.500	2.40%	-2.41%
			2310	1.717	38.545	1.679	39.480	2.26%	-2.37%
			2320	1.723	38.538	1.687	39.460	2.13%	-2.34%
5/13/2019	2450H	19.5	2400	1.834	39.017	1.756	39.289	4.44%	-0.69%
			2450	1.876	38.916	1.800	39.200	4.22%	-0.72%
			2500	1.920	38.842	1.855	39.136	3.50%	-0.75%

FCC ID: ZNFX420AS	 PCTEST ENGINEERING LABORATORY, INC.	SAR EVALUATION REPORT	 LG	Approved by: Quality Manager
Document S/N: 1M1905090070-01-R2.ZNF	Test Dates: 05/08/19 - 05/16/19	DUT Type: Portable Handset		Page 52 of 84

**Table 10-2
Body Measured Tissue Properties**

Calibrated for Tests Performed on:	Tissue Type	Tissue Temp During Calibration (°C)	Measured Frequency (MHz)	Measured Conductivity, σ (S/m)	Measured Dielectric Constant, ϵ	TARGET Conductivity, σ (S/m)	TARGET Dielectric Constant, ϵ	% dev σ	% dev ϵ
5/16/2019	750B	23.5	700	0.919	56.674	0.959	55.726	-4.17%	1.70%
			710	0.923	56.651	0.960	55.687	-3.85%	1.73%
			740	0.934	56.574	0.963	55.570	-3.01%	1.81%
			755	0.939	56.534	0.964	55.512	-2.59%	1.84%
			785	0.949	56.469	0.966	55.395	-1.76%	1.94%
5/13/2019	835B	19.2	800	0.954	56.444	0.967	55.336	-1.34%	2.00%
			820	0.972	53.717	0.969	55.258	0.31%	-2.79%
			835	0.978	53.681	0.970	55.200	0.82%	-2.75%
5/13/2019	1750B	20.5	850	0.984	53.656	0.988	55.154	-0.40%	-2.72%
			1710	1.465	52.137	1.463	53.537	0.14%	-2.62%
			1750	1.493	52.076	1.488	53.432	0.34%	-2.54%
5/15/2019	1750B	22.0	1790	1.520	52.011	1.514	53.326	0.40%	-2.47%
			1710	1.440	51.727	1.463	53.537	-1.57%	-3.38%
			1750	1.484	51.570	1.488	53.432	-0.27%	-3.48%
05/08/2019	1900B	23.4	1790	1.527	51.415	1.514	53.326	0.86%	-3.58%
			1850	1.485	52.047	1.520	53.300	-2.30%	-2.35%
			1880	1.518	51.958	1.520	53.300	-0.13%	-2.52%
5/15/2019	1900B	22.7	1910	1.552	51.869	1.520	53.300	2.11%	-2.68%
			1850	1.521	52.154	1.520	53.300	0.07%	-2.15%
			1880	1.552	52.031	1.520	53.300	2.11%	-2.38%
5/16/2019	2450B	22.8	1910	1.586	51.946	1.520	53.300	4.34%	-2.54%
			2300	1.866	52.492	1.809	52.900	3.15%	-0.77%
			2310	1.877	52.465	1.816	52.887	3.36%	-0.80%
5/15/2019	2450B	19.9	2320	1.888	52.436	1.826	52.873	3.40%	-0.83%
			2400	1.984	52.742	1.902	52.767	4.31%	-0.05%
			2450	2.031	52.652	1.950	52.700	4.15%	-0.09%
			2500	2.079	52.583	2.021	52.636	2.87%	-0.10%

The above measured tissue parameters were used in the DASY software. The DASY software was used to perform interpolation to determine the dielectric parameters at the SAR test device frequencies (per KDB Publication 865664 D01v01r04 and IEEE 1528-2013 6.6.1.2). The tissue parameters listed in the SAR test plots may slightly differ from the table above due to significant digit rounding in the software.



FCC ID: ZNFX420AS		SAR EVALUATION REPORT		Approved by: Quality Manager
Document S/N: 1M1905090070-01-R2.ZNF	Test Dates: 05/08/19 - 05/16/19	DUT Type: Portable Handset		Page 53 of 84

10.2 Test System Verification

Prior to SAR assessment, the system is verified to $\pm 10\%$ of the SAR measurement on the reference dipole at the time of calibration by the calibration facility. Full system validation status and result summary can be found in Appendix E.

Table 10-3
System Verification Results – 1g

System Verification TARGET & MEASURED												
SAR System #	Tissue Frequency (MHz)	Tissue Type	Date	Amb. Temp (°C)	Liquid Temp (°C)	Input Power (W)	Source SN	Probe SN	Measured SAR _{1g} (W/kg)	1 W Target SAR _{1g} (W/kg)	1 W Normalized SAR _{1g} (W/kg)	Deviation _{1g} (%)
D	750	HEAD	05/09/2019	23.1	22.3	0.200	1161	3914	1.730	8.030	8.650	7.72%
E	835	HEAD	05/14/2019	22.0	20.8	0.200	4d132	3589	2.020	9.590	10.100	5.32%
H	1750	HEAD	05/14/2019	20.2	20.4	0.100	1008	7409	3.530	36.200	35.300	-2.49%
G	1900	HEAD	05/12/2019	21.3	21.1	0.100	5d149	7410	4.240	39.300	42.400	7.89%
H	2300	HEAD	05/10/2019	22.6	21.7	0.100	1064	7409	5.050	47.600	50.500	6.09%
E	2450	HEAD	05/13/2019	21.2	19.5	0.100	981	3589	5.340	52.300	53.400	2.10%
I	750	BODY	05/16/2019	22.8	22.1	0.200	1003	7357	1.700	8.580	8.500	-0.93%
J	835	BODY	05/13/2019	19.7	19.2	0.200	4d133	7488	1.860	9.750	9.300	-4.62%
D	1750	BODY	05/13/2019	21.3	20.5	0.100	1008	3914	3.920	37.400	39.200	4.81%
D	1750	BODY	05/15/2019	23.1	22.0	0.100	1008	3914	3.920	37.400	39.200	4.81%
I	1900	BODY	05/08/2019	23.5	21.6	0.100	5d149	7357	4.200	39.400	42.000	6.60%
G	1900	BODY	05/15/2019	22.8	21.7	0.100	5d080	7410	4.180	39.200	41.800	6.63%
K	2300	BODY	05/16/2019	23.4	22.8	0.100	1073	7417	5.080	47.700	50.800	6.50%
L	2450	BODY	05/15/2019	21.6	20.2	0.100	719	7308	4.960	50.100	49.600	-1.00%

FCC ID: ZNFX420AS	 PCTEST ENGINEERING LABORATORY, INC.	SAR EVALUATION REPORT	 LG	Approved by: Quality Manager
Document S/N: 1M1905090070-01-R2.ZNF	Test Dates: 05/08/19 - 05/16/19	DUT Type: Portable Handset		Page 54 of 84

**Table 10-4
System Verification Results – 10g**

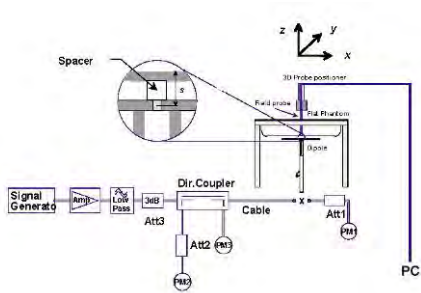

System Verification TARGET & MEASURED												
SAR System #	Tissue Frequency (MHz)	Tissue Type	Date	Amb. Temp (°C)	Liquid Temp (°C)	Input Power (W)	Source SN	Probe SN	Measured SAR _{10g} (W/kg)	1 W Target SAR _{10g} (W/kg)	1 W Normalized SAR _{10g} (W/kg)	Deviation _{10g} (%)
D	1750	BODY	05/13/2019	21.3	20.5	0.100	1008	3914	2.050	19.900	20.500	3.02%
D	1750	BODY	05/15/2019	23.1	22.0	0.100	1008	3914	2.060	19.900	20.600	3.52%
G	1900	BODY	05/15/2019	22.8	21.7	0.100	5d080	7410	2.150	20.600	21.500	4.37%
K	2300	BODY	05/16/2019	23.4	22.8	0.100	1073	7417	2.410	23.200	24.100	3.88%



**Figure 10-1
System Verification Setup Diagram**



**Figure 10-2
System Verification Setup Photo**

FCC ID: ZNFX420AS		SAR EVALUATION REPORT		Approved by: Quality Manager
Document S/N: 1M1905090070-01-R2.ZNF	Test Dates: 05/08/19 - 05/16/19	DUT Type: Portable Handset		Page 55 of 84

11 SAR DATA SUMMARY



11.1 Standalone Head SAR Data

**Table 11-1
GSM 850 Head SAR**

MEASUREMENT RESULTS															
FREQUENCY		Mode/Band	Service	Maximum Allowed Power [dBm]	Conducted Power [dBm]	Power Drift [dB]	Side	Test Position	Device Serial Number	# of Time Slots	Duty Cycle	SAR (1g)	Scaling Factor	Reported SAR (1g)	Plot #
MHz	Ch.											(W/kg)		(W/kg)	
836.60	190	GSM 850	GSM	32.7	32.68	0.04	Right	Cheek	51576	1	1:8.3	0.374	1.005	0.376	
836.60	190	GSM 850	GSM	32.7	32.68	-0.05	Right	Tilt	51576	1	1:8.3	0.212	1.005	0.213	
836.60	190	GSM 850	GSM	32.7	32.68	0.00	Left	Cheek	51576	1	1:8.3	0.304	1.005	0.306	
836.60	190	GSM 850	GSM	32.7	32.68	0.08	Left	Tilt	51576	1	1:8.3	0.203	1.005	0.204	
836.60	190	GSM 850	GPRS	30.7	30.57	-0.04	Right	Cheek	51576	2	1:4.15	0.433	1.030	0.446	A1
836.60	190	GSM 850	GPRS	30.7	30.57	0.04	Right	Tilt	51576	2	1:4.15	0.241	1.030	0.248	
836.60	190	GSM 850	GPRS	30.7	30.57	0.10	Left	Cheek	51576	2	1:4.15	0.331	1.030	0.341	
836.60	190	GSM 850	GPRS	30.7	30.57	0.08	Left	Tilt	51576	2	1:4.15	0.226	1.030	0.233	
ANSI / IEEE C95.1 1992 - SAFETY LIMIT Spatial Peak Uncontrolled Exposure/General Population							Head 1.6 W/kg (mW/g) averaged over 1 gram								

**Table 11-2
GSM 1900 Head SAR**

MEASUREMENT RESULTS															
FREQUENCY		Mode/Band	Service	Maximum Allowed Power [dBm]	Conducted Power [dBm]	Power Drift [dB]	Side	Test Position	Device Serial Number	# of Time Slots	Duty Cycle	SAR (1g)	Scaling Factor	Reported SAR (1g)	Plot #
MHz	Ch.											(W/kg)		(W/kg)	
1880.00	661	GSM 1900	GSM	29.7	29.68	-0.06	Right	Cheek	51576	1	1:8.3	0.109	1.005	0.110	
1880.00	661	GSM 1900	GSM	29.7	29.68	0.20	Right	Tilt	51576	1	1:8.3	0.076	1.005	0.076	
1880.00	661	GSM 1900	GSM	29.7	29.68	0.08	Left	Cheek	51576	1	1:8.3	0.174	1.005	0.175	
1880.00	661	GSM 1900	GSM	29.7	29.68	0.14	Left	Tilt	51576	1	1:8.3	0.064	1.005	0.064	
1880.00	661	GSM 1900	GPRS	28.2	28.10	-0.14	Right	Cheek	51576	2	1:4.15	0.147	1.023	0.150	
1880.00	661	GSM 1900	GPRS	28.2	28.10	0.10	Right	Tilt	51576	2	1:4.15	0.101	1.023	0.103	
1880.00	661	GSM 1900	GPRS	28.2	28.10	0.06	Left	Cheek	51576	2	1:4.15	0.242	1.023	0.248	A2
1880.00	661	GSM 1900	GPRS	28.2	28.10	0.06	Left	Tilt	51576	2	1:4.15	0.085	1.023	0.087	
ANSI / IEEE C95.1 1992 - SAFETY LIMIT Spatial Peak Uncontrolled Exposure/General Population							Head 1.6 W/kg (mW/g) averaged over 1 gram								

FCC ID: ZNFX420AS		SAR EVALUATION REPORT		Approved by: Quality Manager
Document S/N: 1M1905090070-01-R2-ZNF	Test Dates: 05/08/19 - 05/16/19	DUT Type: Portable Handset		Page 56 of 84

**Table 11-3
UMTS 850 Head SAR**



MEASUREMENT RESULTS														
FREQUENCY		Mode/Band	Service	Maximum Allowed Power [dBm]	Conducted Power [dBm]	Power Drift [dB]	Side	Test Position	Device Serial Number	Duty Cycle	SAR (1g)	Scaling Factor	Reported SAR (1g)	Plot #
MHz	Ch.										(W/kg)		(W/kg)	
836.60	4183	UMTS 850	RMC	25.2	25.16	0.00	Right	Cheek	51576	1:1	0.481	1.009	0.485	A3
836.60	4183	UMTS 850	RMC	25.2	25.16	0.05	Right	Tilt	51576	1:1	0.281	1.009	0.284	
836.60	4183	UMTS 850	RMC	25.2	25.16	-0.01	Left	Cheek	51576	1:1	0.373	1.009	0.376	
836.60	4183	UMTS 850	RMC	25.2	25.16	-0.10	Left	Tilt	51576	1:1	0.272	1.009	0.274	
ANSI / IEEE C95.1 1992 - SAFETY LIMIT Spatial Peak Uncontrolled Exposure/General Population							Head 1.6 W/kg (mW/g) averaged over 1 gram							

**Table 11-4
UMTS 1750 Head SAR**

MEASUREMENT RESULTS														
FREQUENCY		Mode/Band	Service	Maximum Allowed Power [dBm]	Conducted Power [dBm]	Power Drift [dB]	Side	Test Position	Device Serial Number	Duty Cycle	SAR (1g)	Scaling Factor	Reported SAR (1g)	Plot #
MHz	Ch.										(W/kg)		(W/kg)	
1732.40	1412	UMTS 1750	RMC	24.2	24.10	-0.16	Right	Cheek	51592	1:1	0.245	1.023	0.251	
1732.40	1412	UMTS 1750	RMC	24.2	24.10	0.07	Right	Tilt	51592	1:1	0.190	1.023	0.194	
1732.40	1412	UMTS 1750	RMC	24.2	24.10	0.01	Left	Cheek	51592	1:1	0.364	1.023	0.372	A4
1732.40	1412	UMTS 1750	RMC	24.2	24.10	0.12	Left	Tilt	51592	1:1	0.211	1.023	0.216	
ANSI / IEEE C95.1 1992 - SAFETY LIMIT Spatial Peak Uncontrolled Exposure/General Population							Head 1.6 W/kg (mW/g) averaged over 1 gram							

**Table 11-5
UMTS 1900 Head SAR**

MEASUREMENT RESULTS														
FREQUENCY		Mode/Band	Service	Maximum Allowed Power [dBm]	Conducted Power [dBm]	Power Drift [dB]	Side	Test Position	Device Serial Number	Duty Cycle	SAR (1g)	Scaling Factor	Reported SAR (1g)	Plot #
MHz	Ch.										(W/kg)		(W/kg)	
1880.00	9400	UMTS 1900	RMC	24.4	23.99	0.21	Right	Cheek	51576	1:1	0.307	1.099	0.337	
1880.00	9400	UMTS 1900	RMC	24.4	23.99	0.07	Right	Tilt	51576	1:1	0.178	1.099	0.196	
1880.00	9400	UMTS 1900	RMC	24.4	23.99	0.01	Left	Cheek	51576	1:1	0.508	1.099	0.558	A5
1880.00	9400	UMTS 1900	RMC	24.4	23.99	-0.07	Left	Tilt	51576	1:1	0.159	1.099	0.175	
ANSI / IEEE C95.1 1992 - SAFETY LIMIT Spatial Peak Uncontrolled Exposure/General Population							Head 1.6 W/kg (mW/g) averaged over 1 gram							

FCC ID: ZNFX420AS		SAR EVALUATION REPORT		Approved by: Quality Manager
Document S/N: 1M1905090070-01-R2.ZNF	Test Dates: 05/08/19 - 05/16/19	DUT Type: Portable Handset		Page 57 of 84

**Table 11-6
LTE Band 12 Head SAR**



MEASUREMENT RESULTS																			
FREQUENCY		Mode	Bandwidth [MHz]	Maximum Allowed Power [dBm]	Conducted Power [dBm]	Power Drift [dB]	MPR [dB]	Side	Test Position	Modulation	RB Size	RB Offset	Device Serial Number	Duty Cycle	SAR (1g)	Scaling Factor	Reported SAR (1g)	Plot #	
MHz	Ch.														(W/kg)		(W/kg)		
707.50	23095	Mid	LTE Band 12	10	25.2	24.94	-0.03	0	Right	Cheek	QPSK	1	0	51576	1:1	0.295	1.062	0.313	A6
707.50	23095	Mid	LTE Band 12	10	24.2	23.97	0.05	1	Right	Cheek	QPSK	25	12	51576	1:1	0.255	1.054	0.269	
707.50	23095	Mid	LTE Band 12	10	25.2	24.94	-0.05	0	Right	Tilt	QPSK	1	0	51576	1:1	0.145	1.062	0.154	
707.50	23095	Mid	LTE Band 12	10	24.2	23.97	-0.05	1	Right	Tilt	QPSK	25	12	51576	1:1	0.134	1.054	0.141	
707.50	23095	Mid	LTE Band 12	10	25.2	24.94	-0.07	0	Left	Cheek	QPSK	1	0	51576	1:1	0.294	1.062	0.312	
707.50	23095	Mid	LTE Band 12	10	24.2	23.97	0.05	1	Left	Cheek	QPSK	25	12	51576	1:1	0.241	1.054	0.254	
707.50	23095	Mid	LTE Band 12	10	25.2	24.94	0.00	0	Left	Tilt	QPSK	1	0	51576	1:1	0.156	1.062	0.166	
707.50	23095	Mid	LTE Band 12	10	24.2	23.97	0.04	1	Left	Tilt	QPSK	25	12	51576	1:1	0.138	1.054	0.145	
ANSI / IEEE C95.1 1992 - SAFETY LIMIT Spatial Peak Uncontrolled Exposure/General Population										Head 1.6 W/kg (mW/g) averaged over 1 gram									

**Table 11-7
LTE Band 14 Head SAR**

MEASUREMENT RESULTS																			
FREQUENCY		Mode	Bandwidth [MHz]	Maximum Allowed Power [dBm]	Conducted Power [dBm]	Power Drift [dB]	MPR [dB]	Side	Test Position	Modulation	RB Size	RB Offset	Device Serial Number	Duty Cycle	SAR (1g)	Scaling Factor	Reported SAR (1g)	Plot #	
MHz	Ch.														(W/kg)		(W/kg)		
793.00	23330	Mid	LTE Band 14	10	23.2	22.95	0.00	0	Right	Cheek	QPSK	1	25	51576	1:1	0.244	1.059	0.258	A7
793.00	23330	Mid	LTE Band 14	10	22.2	22.00	0.02	1	Right	Cheek	QPSK	25	25	51576	1:1	0.196	1.047	0.205	
793.00	23330	Mid	LTE Band 14	10	23.2	22.95	0.01	0	Right	Tilt	QPSK	1	25	51576	1:1	0.149	1.059	0.158	
793.00	23330	Mid	LTE Band 14	10	22.2	22.00	0.04	1	Right	Tilt	QPSK	25	25	51576	1:1	0.116	1.047	0.121	
793.00	23330	Mid	LTE Band 14	10	23.2	22.95	0.17	0	Left	Cheek	QPSK	1	25	51576	1:1	0.224	1.059	0.237	
793.00	23330	Mid	LTE Band 14	10	22.2	22.00	0.00	1	Left	Cheek	QPSK	25	25	51576	1:1	0.176	1.047	0.184	
793.00	23330	Mid	LTE Band 14	10	23.2	22.95	0.12	0	Left	Tilt	QPSK	1	25	51576	1:1	0.158	1.059	0.167	
793.00	23330	Mid	LTE Band 14	10	22.2	22.00	0.09	1	Left	Tilt	QPSK	25	25	51576	1:1	0.126	1.047	0.132	
ANSI / IEEE C95.1 1992 - SAFETY LIMIT Spatial Peak Uncontrolled Exposure/General Population										Head 1.6 W/kg (mW/g) averaged over 1 gram									

**Table 11-8
LTE Band 5 (Cell) Head SAR**

MEASUREMENT RESULTS																			
FREQUENCY		Mode	Bandwidth [MHz]	Maximum Allowed Power [dBm]	Conducted Power [dBm]	Power Drift [dB]	MPR [dB]	Side	Test Position	Modulation	RB Size	RB Offset	Device Serial Number	Duty Cycle	SAR (1g)	Scaling Factor	Reported SAR (1g)	Plot #	
MHz	Ch.														(W/kg)		(W/kg)		
836.50	20525	Mid	LTE Band 5 (Cell)	10	25.2	25.10	0.05	0	Right	Cheek	QPSK	1	25	51576	1:1	0.512	1.023	0.524	A8
836.50	20525	Mid	LTE Band 5 (Cell)	10	24.2	24.08	0.05	1	Right	Cheek	QPSK	25	25	51576	1:1	0.418	1.028	0.430	
836.50	20525	Mid	LTE Band 5 (Cell)	10	25.2	25.10	0.12	0	Right	Tilt	QPSK	1	25	51576	1:1	0.330	1.023	0.338	
836.50	20525	Mid	LTE Band 5 (Cell)	10	24.2	24.08	0.05	1	Right	Tilt	QPSK	25	25	51576	1:1	0.262	1.028	0.269	
836.50	20525	Mid	LTE Band 5 (Cell)	10	25.2	25.10	0.11	0	Left	Cheek	QPSK	1	25	51576	1:1	0.425	1.023	0.435	
836.50	20525	Mid	LTE Band 5 (Cell)	10	24.2	24.08	0.09	1	Left	Cheek	QPSK	25	25	51576	1:1	0.322	1.028	0.331	
836.50	20525	Mid	LTE Band 5 (Cell)	10	25.2	25.10	0.02	0	Left	Tilt	QPSK	1	25	51576	1:1	0.319	1.023	0.326	
836.50	20525	Mid	LTE Band 5 (Cell)	10	24.2	24.08	0.07	1	Left	Tilt	QPSK	25	25	51576	1:1	0.241	1.028	0.248	
ANSI / IEEE C95.1 1992 - SAFETY LIMIT Spatial Peak Uncontrolled Exposure/General Population										Head 1.6 W/kg (mW/g) averaged over 1 gram									

FCC ID: ZNFX420AS		SAR EVALUATION REPORT		Approved by: Quality Manager
Document S/N: 1M1905090070-01-R2.ZNF	Test Dates: 05/08/19 - 05/16/19	DUT Type: Portable Handset	Page 58 of 84	

**Table 11-9
LTE Band 66 (AWS) Head SAR**



MEASUREMENT RESULTS																			
FREQUENCY		Mode	Bandwidth [MHz]	Maximum Allowed Power [dBm]	Conducted Power [dBm]	Power Drift [dB]	MPR [dB]	Side	Test Position	Modulation	RB Size	RB Offset	Device Serial Number	Duty Cycle	SAR (1g)	Scaling Factor	Reported SAR (1g)	Plot #	
MHz	Ch.														(W/kg)		(W/kg)		
1720.00	132072	Low	LTE Band 66 (AWS)	20	24.4	24.17	0.00	0	Right	Cheek	QPSK	1	50	51592	1:1	0.289	1.054	0.305	
1745.00	132322	Mid	LTE Band 66 (AWS)	20	23.4	23.22	0.08	1	Right	Cheek	QPSK	50	50	51592	1:1	0.211	1.042	0.220	
1720.00	132072	Low	LTE Band 66 (AWS)	20	24.4	24.17	0.10	0	Right	Tilt	QPSK	1	50	51592	1:1	0.177	1.054	0.187	
1745.00	132322	Mid	LTE Band 66 (AWS)	20	23.4	23.22	0.03	1	Right	Tilt	QPSK	50	50	51592	1:1	0.211	1.042	0.220	
1720.00	132072	Low	LTE Band 66 (AWS)	20	24.4	24.17	-0.02	0	Left	Cheek	QPSK	1	50	51592	1:1	0.391	1.054	0.412	A9
1745.00	132322	Mid	LTE Band 66 (AWS)	20	23.4	23.22	0.06	1	Left	Cheek	QPSK	50	50	51592	1:1	0.346	1.042	0.361	
1720.00	132072	Low	LTE Band 66 (AWS)	20	24.4	24.17	0.04	0	Left	Tilt	QPSK	1	50	51592	1:1	0.233	1.054	0.246	
1745.00	132322	Mid	LTE Band 66 (AWS)	20	23.4	23.22	0.09	1	Left	Tilt	QPSK	50	50	51592	1:1	0.188	1.042	0.196	
ANSI / IEEE C95.1 1992 - SAFETY LIMIT Spatial Peak Uncontrolled Exposure/General Population										Head 1.6 W/kg (mW/g) averaged over 1 gram									

**Table 11-10
LTE Band 2 (PCS) Head SAR**

MEASUREMENT RESULTS																			
FREQUENCY		Mode	Bandwidth [MHz]	Maximum Allowed Power [dBm]	Conducted Power [dBm]	Power Drift [dB]	MPR [dB]	Side	Test Position	Modulation	RB Size	RB Offset	Device Serial Number	Duty Cycle	SAR (1g)	Scaling Factor	Reported SAR (1g)	Plot #	
MHz	Ch.														(W/kg)		(W/kg)		
1900.00	19100	High	LTE Band 2 (PCS)	20	24.4	24.26	0.07	0	Right	Cheek	QPSK	1	50	51576	1:1	0.318	1.033	0.328	
1900.00	19100	High	LTE Band 2 (PCS)	20	23.4	23.37	0.06	1	Right	Cheek	QPSK	50	25	51576	1:1	0.257	1.007	0.259	
1900.00	19100	High	LTE Band 2 (PCS)	20	24.4	24.26	-0.18	0	Right	Tilt	QPSK	1	50	51576	1:1	0.213	1.033	0.220	
1900.00	19100	High	LTE Band 2 (PCS)	20	23.4	23.37	0.07	1	Right	Tilt	QPSK	50	25	51576	1:1	0.160	1.007	0.161	
1900.00	19100	High	LTE Band 2 (PCS)	20	24.4	24.26	0.02	0	Left	Cheek	QPSK	1	50	51576	1:1	0.552	1.033	0.570	A10
1900.00	19100	High	LTE Band 2 (PCS)	20	23.4	23.37	0.07	1	Left	Cheek	QPSK	50	25	51576	1:1	0.413	1.007	0.416	
1900.00	19100	High	LTE Band 2 (PCS)	20	24.4	24.26	-0.12	0	Left	Tilt	QPSK	1	50	51576	1:1	0.178	1.033	0.184	
1900.00	19100	High	LTE Band 2 (PCS)	20	23.4	23.37	-0.01	1	Left	Tilt	QPSK	50	25	51576	1:1	0.140	1.007	0.141	
ANSI / IEEE C95.1 1992 - SAFETY LIMIT Spatial Peak Uncontrolled Exposure/General Population										Head 1.6 W/kg (mW/g) averaged over 1 gram									

**Table 11-11
LTE Band 30 Head SAR**

MEASUREMENT RESULTS																			
FREQUENCY		Mode	Bandwidth [MHz]	Maximum Allowed Power [dBm]	Conducted Power [dBm]	Power Drift [dB]	MPR [dB]	Side	Test Position	Modulation	RB Size	RB Offset	Device Serial Number	Duty Cycle	SAR (1g)	Scaling Factor	Reported SAR (1g)	Plot #	
MHz	Ch.														(W/kg)		(W/kg)		
2310.00	27710	Mid	LTE Band 30	10	23.0	22.71	-0.12	0	Right	Cheek	QPSK	1	25	51543	1:1	0.197	1.069	0.211	A11
2310.00	27710	Mid	LTE Band 30	10	22.0	21.74	0.06	1	Right	Cheek	QPSK	25	0	51543	1:1	0.158	1.062	0.168	
2310.00	27710	Mid	LTE Band 30	10	23.0	22.71	-0.13	0	Right	Tilt	QPSK	1	25	51543	1:1	0.115	1.069	0.123	
2310.00	27710	Mid	LTE Band 30	10	22.0	21.74	0.16	1	Right	Tilt	QPSK	25	0	51543	1:1	0.085	1.062	0.090	
2310.00	27710	Mid	LTE Band 30	10	23.0	22.71	0.21	0	Left	Cheek	QPSK	1	25	51543	1:1	0.162	1.069	0.173	
2310.00	27710	Mid	LTE Band 30	10	22.0	21.74	0.13	1	Left	Cheek	QPSK	25	0	51543	1:1	0.131	1.062	0.139	
2310.00	27710	Mid	LTE Band 30	10	23.0	22.71	-0.17	0	Left	Tilt	QPSK	1	25	51543	1:1	0.076	1.069	0.081	
2310.00	27710	Mid	LTE Band 30	10	22.0	21.74	-0.11	1	Left	Tilt	QPSK	25	0	51543	1:1	0.048	1.062	0.051	
ANSI / IEEE C95.1 1992 - SAFETY LIMIT Spatial Peak Uncontrolled Exposure/General Population										Head 1.6 W/kg (mW/g) averaged over 1 gram									



FCC ID: ZNFX420AS		SAR EVALUATION REPORT		Approved by: Quality Manager
Document S/N: 1M1905090070-01-R2.ZNF	Test Dates: 05/08/19 - 05/16/19	DUT Type: Portable Handset		Page 59 of 84

**Table 11-12
DTS Head SAR**

MEASUREMENT RESULTS																		
FREQUENCY		Mode	Service	Bandwidth [MHz]	Maximum Allowed Power [dBm]	Conducted Power [dBm]	Power Drift [dB]	Side	Test Position	Device Serial Number	Data Rate (Mbps)	Duty Cycle (%)	Peak SAR of Area Scan	SAR (1g)	Scaling Factor (Power)	Scaling Factor (Duty Cycle)	Reported SAR (1g)	Plot #
MHz	Ch.												W/kg	(W/kg)			(W/kg)	
2412	1	802.11b	DSSS	22	15.0	14.98	-0.03	Right	Cheek	51618	1	96.7	1.050	0.695	1.005	1.034	0.722	A12
2437	6	802.11b	DSSS	22	15.0	14.68	0.12	Right	Cheek	51618	1	96.7	0.941	0.626	1.076	1.034	0.696	
2462	11	802.11b	DSSS	22	15.0	14.46	0.09	Right	Cheek	51618	1	96.7	0.848	0.550	1.132	1.034	0.644	
2412	1	802.11b	DSSS	22	15.0	14.98	-0.01	Right	Tilt	51618	1	96.7	0.817	0.478	1.005	1.034	0.497	
2412	1	802.11b	DSSS	22	15.0	14.98	0.11	Left	Cheek	51618	1	96.7	0.439	-	1.005	1.034	-	
2412	1	802.11b	DSSS	22	15.0	14.98	-0.01	Left	Tilt	51618	1	96.7	0.413	-	1.005	1.034	-	
ANSI / IEEE C95.1 1992 - SAFETY LIMIT Spatial Peak Uncontrolled Exposure/General Population									Head 1.6 W/kg (mW/g) averaged over 1 gram									

**Table 11-13
DSS Head SAR**

MEASUREMENT RESULTS																	
FREQUENCY		Mode	Service	Maximum Allowed Power [dBm]	Conducted Power [dBm]	Power Drift [dB]	Side	Test Position	Device Serial Number	Data Rate (Mbps)	Duty Cycle (%)	SAR (1g)	Scaling Factor (Cond Power)	Scaling Factor (Duty Cycle)	Reported SAR (1g)	Plot #	
MHz	Ch.											(W/kg)			(W/kg)		
2441.00	39	Bluetooth	FHSS	10.0	9.48	0.13	Right	Cheek	51618	1	76.8	0.145	1.127	1.302	0.213	A13	
2441.00	39	Bluetooth	FHSS	10.0	9.48	0.16	Right	Tilt	51618	1	76.8	0.110	1.127	1.302	0.161		
2441.00	39	Bluetooth	FHSS	10.0	9.48	0.12	Left	Cheek	51618	1	76.8	0.086	1.127	1.302	0.126		
2441.00	39	Bluetooth	FHSS	10.0	9.48	0.12	Left	Tilt	51618	1	76.8	0.067	1.127	1.302	0.098		
ANSI / IEEE C95.1 1992 - SAFETY LIMIT Spatial Peak Uncontrolled Exposure/General Population									Head 1.6 W/kg (mW/g) averaged over 1 gram								



FCC ID: ZNFX420AS		SAR EVALUATION REPORT		Approved by: Quality Manager
Document S/N: 1M1905090070-01-R2.ZNF	Test Dates: 05/08/19 - 05/16/19	DUT Type: Portable Handset		Page 60 of 84

11.2 Standalone Body-Worn SAR Data

**Table 11-14
GSM/UMTS Body-Worn SAR Data**

MEASUREMENT RESULTS															
FREQUENCY		Mode	Service	Maximum Allowed Power [dBm]	Conducted Power [dBm]	Power Drift [dB]	Spacing	Device Serial Number	# of Time Slots	Duty Cycle	Side	SAR (1g)	Scaling Factor	Reported SAR (1g)	Plot #
MHz	Ch.											(W/kg)		(W/kg)	
836.60	190	GSM 850	GSM	32.7	32.68	-0.04	10 mm	51501	1	1:8.3	back	0.402	1.005	0.404	
836.60	190	GSM 850	GPRS	30.7	30.57	-0.03	10 mm	51501	2	1:4.15	back	0.470	1.030	0.484	A14
1880.00	661	GSM 1900	GSM	29.7	29.68	-0.10	10 mm	51592	1	1:8.3	back	0.269	1.005	0.270	
1880.00	661	GSM 1900	GPRS	28.2	28.10	-0.02	10 mm	51592	2	1:4.15	back	0.354	1.023	0.362	A16
836.60	4183	UMTS 850	RMC	25.2	25.16	0.03	10 mm	51501	N/A	1:1	back	0.572	1.009	0.577	A17
1712.40	1312	UMTS 1750	RMC	24.2	23.98	-0.15	10 mm	51592	N/A	1:1	back	0.988	1.052	1.039	
1732.40	1412	UMTS 1750	RMC	24.2	24.10	-0.10	10 mm	51592	N/A	1:1	back	1.010	1.023	1.033	A19
1752.60	1513	UMTS 1750	RMC	24.2	24.01	-0.07	10 mm	51592	N/A	1:1	back	0.827	1.045	0.864	
1852.40	9262	UMTS 1900	RMC	24.4	23.97	-0.15	10 mm	51543	N/A	1:1	back	0.790	1.104	0.872	
1880.00	9400	UMTS 1900	RMC	24.4	23.99	-0.15	10 mm	51543	N/A	1:1	back	0.846	1.099	0.930	A20
1907.60	9538	UMTS 1900	RMC	24.4	24.04	-0.10	10 mm	51543	N/A	1:1	back	0.845	1.086	0.918	
1880.00	9400	UMTS 1900	RMC	24.4	23.99	-0.15	10 mm	51543	N/A	1:1	back	0.836	1.099	0.919	
ANSI / IEEE C95.1 1992 - SAFETY LIMIT Spatial Peak Uncontrolled Exposure/General Population							Body 1.6 W/kg (mW/g) averaged over 1 gram								

Note: Blue entry indicated variability measurement

FCC ID: ZNFX420AS		SAR EVALUATION REPORT		Approved by: Quality Manager
Document S/N: 1M1905090070-01-R2.ZNF	Test Dates: 05/08/19 - 05/16/19	DUT Type: Portable Handset		Page 61 of 84



**Table 11-15
LTE Body-Worn SAR**

MEASUREMENT RESULTS																			
FREQUENCY		Mode	Bandwidth [MHz]	Maximum Allowed Power [dBm]	Conducted Power [dBm]	Power Drift [dB]	MPR [dB]	Device Serial Number	Modulation	RB Size	RB Offset	Spacing	Side	Duty Cycle	SAR (1g)	Scaling Factor	Reported SAR (1g)	Plot #	
MHz	Ch.														(W/kg)		(W/kg)		
707.50	23095	Mid	LTE Band 12	10	25.2	24.94	0.04	0	51543	QPSK	1	0	10 mm	back	1:1	0.542	1.062	0.576	A21
707.50	23095	Mid	LTE Band 12	10	24.2	23.97	0.03	1	51543	QPSK	25	12	10 mm	back	1:1	0.462	1.054	0.487	
793.00	23330	Mid	LTE Band 14	10	23.2	22.95	0.04	0	51543	QPSK	1	25	10 mm	back	1:1	0.318	1.059	0.337	A23
793.00	23330	Mid	LTE Band 14	10	22.2	22.00	0.04	1	51543	QPSK	25	25	10 mm	back	1:1	0.256	1.047	0.268	
836.50	20525	Mid	LTE Band 5 (Cell)	10	25.2	25.10	-0.03	0	51501	QPSK	1	25	10 mm	back	1:1	0.539	1.023	0.551	A25
836.50	20525	Mid	LTE Band 5 (Cell)	10	24.2	24.08	-0.01	1	51501	QPSK	25	25	10 mm	back	1:1	0.427	1.028	0.439	
1720.00	132072	Low	LTE Band 66 (AWS)	20	24.4	24.17	0.03	0	51592	QPSK	1	50	10 mm	back	1:1	1.030	1.054	1.086	A27
1745.00	132322	Mid	LTE Band 66 (AWS)	20	24.4	24.15	0.02	0	51592	QPSK	1	50	10 mm	back	1:1	1.020	1.059	1.080	
1770.00	132572	High	LTE Band 66 (AWS)	20	24.4	24.16	0.02	0	51592	QPSK	1	50	10 mm	back	1:1	0.911	1.057	0.963	
1720.00	132072	Low	LTE Band 66 (AWS)	20	23.4	23.19	-0.01	1	51592	QPSK	50	25	10 mm	back	1:1	0.848	1.050	0.890	
1745.00	132322	Mid	LTE Band 66 (AWS)	20	23.4	23.22	0.01	1	51592	QPSK	50	50	10 mm	back	1:1	0.752	1.042	0.784	
1770.00	132572	High	LTE Band 66 (AWS)	20	23.4	23.19	0.00	1	51592	QPSK	50	25	10 mm	back	1:1	0.726	1.050	0.762	
1745.00	132322	Mid	LTE Band 66 (AWS)	20	23.4	23.15	0.00	1	51592	QPSK	100	0	10 mm	back	1:1	0.795	1.059	0.842	
1720.00	132072	Low	LTE Band 66 (AWS)	20	24.4	24.17	-0.02	0	51592	QPSK	1	50	10 mm	back	1:1	0.916	1.054	0.965	
1860.00	18700	Low	LTE Band 2 (PCS)	20	24.4	24.14	0.01	0	51543	QPSK	1	50	10 mm	back	1:1	0.754	1.062	0.801	
1880.00	18900	Mid	LTE Band 2 (PCS)	20	24.4	24.18	0.01	0	51543	QPSK	1	50	10 mm	back	1:1	0.779	1.052	0.820	
1900.00	19100	High	LTE Band 2 (PCS)	20	24.4	24.26	0.00	0	51543	QPSK	1	50	10 mm	back	1:1	0.780	1.033	0.806	A28
1900.00	19100	High	LTE Band 2 (PCS)	20	23.4	23.37	0.02	1	51543	QPSK	50	25	10 mm	back	1:1	0.636	1.007	0.640	
1880.00	18900	Mid	LTE Band 2 (PCS)	20	23.4	23.30	0.01	1	51543	QPSK	100	0	10 mm	back	1:1	0.624	1.023	0.638	
2310.00	27710	Mid	LTE Band 30	10	23.0	22.71	-0.13	0	51501	QPSK	1	25	10 mm	back	1:1	0.769	1.069	0.822	A29
2310.00	27710	Mid	LTE Band 30	10	22.0	21.74	0.11	1	51501	QPSK	25	0	10 mm	back	1:1	0.576	1.062	0.612	
2310.00	27710	Mid	LTE Band 30	10	22.0	21.56	0.07	1	51501	QPSK	50	0	10 mm	back	1:1	0.589	1.107	0.652	
ANSI / IEEE C95.1 1992 - SAFETY LIMIT Spatial Peak Uncontrolled Exposure/General Population										Body 1.6 W/kg (mW/g) averaged over 1 gram									

Note: Blue entry indicated variability measurement

**Table 11-16
DTS Body-Worn SAR**

MEASUREMENT RESULTS																		
FREQUENCY		Mode	Service	Bandwidth [MHz]	Maximum Allowed Power [dBm]	Conducted Power [dBm]	Power Drift [dB]	Spacing	Device Serial Number	Data Rate (Mbps)	Side	Duty Cycle (%)	Peak SAR of Area Scan	SAR (1g)	Scaling Factor (Power)	Scaling Factor (Duty Cycle)	Reported SAR (1g)	Plot #
MHz	Ch.												W/kg	(W/kg)			(W/kg)	
2412	1	802.11b	DSSS	22	15.0	14.98	-0.07	10 mm	51626	1	back	96.7	0.188	0.124	1.005	1.034	0.129	A31
ANSI / IEEE C95.1 1992 - SAFETY LIMIT Spatial Peak Uncontrolled Exposure/General Population										Body 1.6 W/kg (mW/g) averaged over 1 gram								



FCC ID: ZNFX420AS		SAR EVALUATION REPORT		Approved by: Quality Manager
Document S/N: 1M1905090070-01-R2.ZNF	Test Dates: 05/08/19 - 05/16/19	DUT Type: Portable Handset	Page 62 of 84	

11.3 Standalone Hotspot SAR Data

**Table 11-17
GPRS/UMTS Hotspot SAR Data**

MEASUREMENT RESULTS															
FREQUENCY		Mode	Service	Maximum Allowed Power [dBm]	Conducted Power [dBm]	Power Drift [dB]	Spacing	Device Serial Number	# of GPRS Slots	Duty Cycle	Side	SAR (1g)	Scaling Factor	Reported SAR (1g)	Plot #
MHz	Ch.											(W/kg)		(W/kg)	
836.60	190	GSM 850	GPRS	30.7	30.57	-0.03	10 mm	51501	2	1:4.15	back	0.470	1.030	0.484	
836.60	190	GSM 850	GPRS	30.7	30.57	-0.03	10 mm	51501	2	1:4.15	front	0.304	1.030	0.313	
836.60	190	GSM 850	GPRS	30.7	30.57	-0.12	10 mm	51501	2	1:4.15	bottom	0.242	1.030	0.249	
836.60	190	GSM 850	GPRS	30.7	30.57	0.04	10 mm	51501	2	1:4.15	right	0.489	1.030	0.504	A15
836.60	190	GSM 850	GPRS	30.7	30.57	-0.08	10 mm	51501	2	1:4.15	left	0.257	1.030	0.265	
1880.00	661	GSM 1900	GPRS	28.2	28.10	-0.02	10 mm	51592	2	1:4.15	back	0.354	1.023	0.362	A16
1880.00	661	GSM 1900	GPRS	28.2	28.10	-0.06	10 mm	51592	2	1:4.15	front	0.336	1.023	0.344	
1880.00	661	GSM 1900	GPRS	28.2	28.10	0.01	10 mm	51592	2	1:4.15	bottom	0.342	1.023	0.350	
1880.00	661	GSM 1900	GPRS	28.2	28.10	-0.03	10 mm	51592	2	1:4.15	left	0.348	1.023	0.356	
836.60	4183	UMTS 850	RMC	25.2	25.16	0.03	10 mm	51501	N/A	1:1	back	0.572	1.009	0.577	
836.60	4183	UMTS 850	RMC	25.2	25.16	0.02	10 mm	51501	N/A	1:1	front	0.516	1.009	0.521	
836.60	4183	UMTS 850	RMC	25.2	25.16	-0.04	10 mm	51501	N/A	1:1	bottom	0.344	1.009	0.347	
826.40	4132	UMTS 850	RMC	25.2	25.08	-0.02	10 mm	51501	N/A	1:1	right	0.709	1.028	0.729	A18
836.60	4183	UMTS 850	RMC	25.2	25.16	-0.02	10 mm	51501	N/A	1:1	right	0.701	1.009	0.707	
846.60	4233	UMTS 850	RMC	25.2	25.06	0.02	10 mm	51501	N/A	1:1	right	0.603	1.033	0.623	
836.60	4183	UMTS 850	RMC	25.2	25.16	0.13	10 mm	51501	N/A	1:1	left	0.301	1.009	0.304	
1712.40	1312	UMTS 1750	RMC	24.2	23.98	-0.15	10 mm	51592	N/A	1:1	back	0.988	1.052	1.039	
1732.40	1412	UMTS 1750	RMC	24.2	24.10	-0.10	10 mm	51592	N/A	1:1	back	1.010	1.023	1.033	A19
1752.60	1513	UMTS 1750	RMC	24.2	24.01	-0.07	10 mm	51592	N/A	1:1	back	0.827	1.045	0.864	
1732.40	1412	UMTS 1750	RMC	24.2	24.10	0.08	10 mm	51592	N/A	1:1	front	0.730	1.023	0.747	
1732.40	1412	UMTS 1750	RMC	24.2	24.10	-0.04	10 mm	51592	N/A	1:1	bottom	0.289	1.023	0.296	
1712.40	1312	UMTS 1750	RMC	24.2	23.98	0.11	10 mm	51592	N/A	1:1	left	0.965	1.052	1.015	
1732.40	1412	UMTS 1750	RMC	24.2	24.10	0.05	10 mm	51592	N/A	1:1	left	0.892	1.023	0.913	
1752.60	1513	UMTS 1750	RMC	24.2	24.01	0.00	10 mm	51592	N/A	1:1	left	0.745	1.045	0.779	
1852.40	9262	UMTS 1900	RMC	24.4	23.97	-0.15	10 mm	51543	N/A	1:1	back	0.790	1.104	0.872	
1880.00	9400	UMTS 1900	RMC	24.4	23.99	-0.15	10 mm	51543	N/A	1:1	back	0.846	1.099	0.930	A20
1907.60	9538	UMTS 1900	RMC	24.4	24.04	-0.10	10 mm	51543	N/A	1:1	back	0.845	1.086	0.918	
1880.00	9400	UMTS 1900	RMC	24.4	23.99	-0.06	10 mm	51543	N/A	1:1	front	0.691	1.099	0.759	
1852.40	9262	UMTS 1900	RMC	24.4	23.97	-0.14	10 mm	51543	N/A	1:1	bottom	0.603	1.104	0.666	
1880.00	9400	UMTS 1900	RMC	24.4	23.99	0.00	10 mm	51543	N/A	1:1	bottom	0.739	1.099	0.812	
1907.60	9538	UMTS 1900	RMC	24.4	24.04	0.02	10 mm	51543	N/A	1:1	bottom	0.844	1.086	0.917	
1880.00	9400	UMTS 1900	RMC	24.4	23.99	-0.03	10 mm	51543	N/A	1:1	left	0.665	1.099	0.731	
1880.00	9400	UMTS 1900	RMC	24.4	23.99	-0.15	10 mm	51543	N/A	1:1	back	0.836	1.099	0.919	
ANSI / IEEE C95.1 1992 - SAFETY LIMIT Spatial Peak								Body 1.6 W/kg (mW/g) averaged over 1 gram							
Uncontrolled Exposure/General Population															

Note: Blue entry indicated variability measurement

FCC ID: ZNFX420AS		SAR EVALUATION REPORT		Approved by: Quality Manager
Document S/N: 1M1905090070-01-R2.ZNF	Test Dates: 05/08/19 - 05/16/19	DUT Type: Portable Handset	Page 63 of 84	

**Table 11-18
LTE Band 12 Hotspot SAR**



MEASUREMENT RESULTS																			
FREQUENCY		Mode	Bandwidth [MHz]	Maximum Allowed Power [dBm]	Conducted Power [dBm]	Power Drift [dB]	MPR [dB]	Device Serial Number	Modulation	RB Size	RB Offset	Spacing	Side	Duty Cycle	SAR (1g) (W/kg)	Scaling Factor	Reported SAR (1g) (W/kg)	Plot #	
MHz	Ch.																		
707.50	23095	Mid	LTE Band 12	10	25.2	24.94	0.04	0	51543	QPSK	1	0	10 mm	back	1:1	0.542	1.062	0.576	
707.50	23095	Mid	LTE Band 12	10	24.2	23.97	0.03	1	51543	QPSK	25	12	10 mm	back	1:1	0.462	1.054	0.487	
707.50	23095	Mid	LTE Band 12	10	25.2	24.94	0.01	0	51543	QPSK	1	0	10 mm	front	1:1	0.517	1.062	0.549	
707.50	23095	Mid	LTE Band 12	10	24.2	23.97	0.00	1	51543	QPSK	25	12	10 mm	front	1:1	0.438	1.054	0.462	
707.50	23095	Mid	LTE Band 12	10	25.2	24.94	-0.01	0	51543	QPSK	1	0	10 mm	bottom	1:1	0.163	1.062	0.173	
707.50	23095	Mid	LTE Band 12	10	24.2	23.97	0.06	1	51543	QPSK	25	12	10 mm	bottom	1:1	0.137	1.054	0.144	
707.50	23095	Mid	LTE Band 12	10	25.2	24.94	0.01	0	51543	QPSK	1	0	10 mm	right	1:1	0.551	1.062	0.585	A22
707.50	23095	Mid	LTE Band 12	10	24.2	23.97	0.04	1	51543	QPSK	25	12	10 mm	right	1:1	0.458	1.054	0.483	
707.50	23095	Mid	LTE Band 12	10	25.2	24.94	-0.02	0	51543	QPSK	1	0	10 mm	left	1:1	0.386	1.062	0.410	
707.50	23095	Mid	LTE Band 12	10	24.2	23.97	-0.01	1	51543	QPSK	25	12	10 mm	left	1:1	0.326	1.054	0.344	
ANSI / IEEE C95.1 1992 - SAFETY LIMIT Spatial Peak Uncontrolled Exposure/General Population										Body 1.6 W/kg (mW/g) averaged over 1 gram									

**Table 11-19
LTE Band 14 Hotspot SAR**

MEASUREMENT RESULTS																			
FREQUENCY		Mode	Bandwidth [MHz]	Maximum Allowed Power [dBm]	Conducted Power [dBm]	Power Drift [dB]	MPR [dB]	Device Serial Number	Modulation	RB Size	RB Offset	Spacing	Side	Duty Cycle	SAR (1g) (W/kg)	Scaling Factor	Reported SAR (1g) (W/kg)	Plot #	
MHz	Ch.																		
793.00	23330	Mid	LTE Band 14	10	23.2	22.95	0.04	0	51543	QPSK	1	25	10 mm	back	1:1	0.318	1.059	0.337	
793.00	23330	Mid	LTE Band 14	10	22.2	22.00	0.04	1	51543	QPSK	25	25	10 mm	back	1:1	0.256	1.047	0.268	
793.00	23330	Mid	LTE Band 14	10	23.2	22.95	0.03	0	51543	QPSK	1	25	10 mm	front	1:1	0.298	1.059	0.316	
793.00	23330	Mid	LTE Band 14	10	22.2	22.00	0.02	1	51543	QPSK	25	25	10 mm	front	1:1	0.240	1.047	0.251	
793.00	23330	Mid	LTE Band 14	10	23.2	22.95	0.08	0	51543	QPSK	1	25	10 mm	bottom	1:1	0.137	1.059	0.145	
793.00	23330	Mid	LTE Band 14	10	22.2	22.00	0.07	1	51543	QPSK	25	25	10 mm	bottom	1:1	0.118	1.047	0.124	
793.00	23330	Mid	LTE Band 14	10	23.2	22.95	0.04	0	51543	QPSK	1	25	10 mm	right	1:1	0.362	1.059	0.383	A24
793.00	23330	Mid	LTE Band 14	10	22.2	22.00	0.01	1	51543	QPSK	25	25	10 mm	right	1:1	0.291	1.047	0.305	
793.00	23330	Mid	LTE Band 14	10	23.2	22.95	0.04	0	51543	QPSK	1	25	10 mm	left	1:1	0.207	1.059	0.219	
793.00	23330	Mid	LTE Band 14	10	22.2	22.00	0.01	1	51543	QPSK	25	25	10 mm	left	1:1	0.163	1.047	0.171	
ANSI / IEEE C95.1 1992 - SAFETY LIMIT Spatial Peak Uncontrolled Exposure/General Population										Body 1.6 W/kg (mW/g) averaged over 1 gram									

**Table 11-20
LTE Band 5 (Cell) Hotspot SAR**

MEASUREMENT RESULTS																			
FREQUENCY		Mode	Bandwidth [MHz]	Maximum Allowed Power [dBm]	Conducted Power [dBm]	Power Drift [dB]	MPR [dB]	Device Serial Number	Modulation	RB Size	RB Offset	Spacing	Side	Duty Cycle	SAR (1g) (W/kg)	Scaling Factor	Reported SAR (1g) (W/kg)	Plot #	
MHz	Ch.																		
836.50	20525	Mid	LTE Band 5 (Cell)	10	25.2	25.10	-0.03	0	51501	QPSK	1	25	10 mm	back	1:1	0.539	1.023	0.551	
836.50	20525	Mid	LTE Band 5 (Cell)	10	24.2	24.08	-0.01	1	51501	QPSK	25	25	10 mm	back	1:1	0.427	1.028	0.439	
836.50	20525	Mid	LTE Band 5 (Cell)	10	25.2	25.10	0.01	0	51501	QPSK	1	25	10 mm	front	1:1	0.442	1.023	0.452	
836.50	20525	Mid	LTE Band 5 (Cell)	10	24.2	24.08	0.03	1	51501	QPSK	25	25	10 mm	front	1:1	0.354	1.028	0.364	
836.50	20525	Mid	LTE Band 5 (Cell)	10	25.2	25.10	-0.10	0	51501	QPSK	1	25	10 mm	bottom	1:1	0.308	1.023	0.315	
836.50	20525	Mid	LTE Band 5 (Cell)	10	24.2	24.08	-0.09	1	51501	QPSK	25	25	10 mm	bottom	1:1	0.249	1.028	0.256	
836.50	20525	Mid	LTE Band 5 (Cell)	10	25.2	25.10	0.00	0	51501	QPSK	1	25	10 mm	right	1:1	0.619	1.023	0.633	A26
836.50	20525	Mid	LTE Band 5 (Cell)	10	24.2	24.08	0.01	1	51501	QPSK	25	25	10 mm	right	1:1	0.480	1.028	0.493	
836.50	20525	Mid	LTE Band 5 (Cell)	10	25.2	25.10	0.03	0	51501	QPSK	1	25	10 mm	left	1:1	0.274	1.023	0.280	
836.50	20525	Mid	LTE Band 5 (Cell)	10	24.2	24.08	-0.01	1	51501	QPSK	25	25	10 mm	left	1:1	0.216	1.028	0.222	
ANSI / IEEE C95.1 1992 - SAFETY LIMIT Spatial Peak Uncontrolled Exposure/General Population										Body 1.6 W/kg (mW/g) averaged over 1 gram									

FCC ID: ZNFX420AS		SAR EVALUATION REPORT		Approved by: Quality Manager
Document S/N: 1M1905090070-01-R2.ZNF	Test Dates: 05/08/19 - 05/16/19	DUT Type: Portable Handset	Page 64 of 84	



**Table 11-21
LTE Band 66 (AWS) Hotspot SAR**

MEASUREMENT RESULTS																			
FREQUENCY		Mode	Bandwidth [MHz]	Maximum Allowed Power [dBm]	Conducted Power [dBm]	Power Drift [dB]	MPR [dB]	Device Serial Number	Modulation	RB Size	RB Offset	Spacing	Side	Duty Cycle	SAR (1g)	Scaling Factor	Reported SAR (1g)	Plot #	
MHz	Ch.														(W/kg)		(W/kg)		
1720.00	132072	Low	LTE Band 66 (AWS)	20	24.4	24.17	0.03	0	51592	QPSK	1	50	10 mm	back	1:1	1.030	1.054	1.086	A27
1745.00	132322	Mid	LTE Band 66 (AWS)	20	24.4	24.15	0.02	0	51592	QPSK	1	50	10 mm	back	1:1	1.020	1.059	1.080	
1770.00	132572	High	LTE Band 66 (AWS)	20	24.4	24.16	0.02	0	51592	QPSK	1	50	10 mm	back	1:1	0.911	1.057	0.963	
1720.00	132072	Low	LTE Band 66 (AWS)	20	23.4	23.19	-0.01	1	51592	QPSK	50	25	10 mm	back	1:1	0.848	1.050	0.890	
1745.00	132322	Mid	LTE Band 66 (AWS)	20	23.4	23.22	0.01	1	51592	QPSK	50	50	10 mm	back	1:1	0.752	1.042	0.784	
1770.00	132572	High	LTE Band 66 (AWS)	20	23.4	23.19	0.00	1	51592	QPSK	50	25	10 mm	back	1:1	0.726	1.050	0.762	
1745.00	132322	Mid	LTE Band 66 (AWS)	20	23.4	23.15	0.00	1	51592	QPSK	100	0	10 mm	back	1:1	0.795	1.059	0.842	
1720.00	132072	Low	LTE Band 66 (AWS)	20	24.4	24.17	0.07	0	51592	QPSK	1	50	10 mm	front	1:1	0.750	1.054	0.791	
1745.00	132322	Mid	LTE Band 66 (AWS)	20	23.4	23.22	0.07	1	51592	QPSK	50	50	10 mm	front	1:1	0.567	1.042	0.591	
1720.00	132072	Low	LTE Band 66 (AWS)	20	24.4	24.17	0.04	0	51592	QPSK	1	50	10 mm	bottom	1:1	0.285	1.054	0.300	
1745.00	132322	Mid	LTE Band 66 (AWS)	20	23.4	23.22	0.07	1	51592	QPSK	50	50	10 mm	bottom	1:1	0.255	1.042	0.266	
1720.00	132072	Low	LTE Band 66 (AWS)	20	24.4	24.17	0.05	0	51592	QPSK	1	50	10 mm	left	1:1	0.868	1.054	0.915	
1745.00	132322	Mid	LTE Band 66 (AWS)	20	24.4	24.15	0.04	0	51592	QPSK	1	50	10 mm	left	1:1	0.796	1.059	0.843	
1770.00	132572	High	LTE Band 66 (AWS)	20	24.4	24.16	0.05	0	51592	QPSK	1	50	10 mm	left	1:1	0.729	1.057	0.771	
1720.00	132072	Low	LTE Band 66 (AWS)	20	23.4	23.19	0.02	1	51592	QPSK	50	25	10 mm	left	1:1	0.687	1.050	0.721	
1745.00	132322	Mid	LTE Band 66 (AWS)	20	23.4	23.22	0.05	1	51592	QPSK	50	50	10 mm	left	1:1	0.636	1.042	0.663	
1770.00	132572	High	LTE Band 66 (AWS)	20	23.4	23.19	0.05	1	51592	QPSK	50	25	10 mm	left	1:1	0.598	1.050	0.628	
1745.00	132322	Mid	LTE Band 66 (AWS)	20	23.4	23.15	-0.02	1	51592	QPSK	100	0	10 mm	left	1:1	0.637	1.059	0.675	
1720.00	132072	Low	LTE Band 66 (AWS)	20	24.4	24.17	-0.02	0	51592	QPSK	1	50	10 mm	back	1:1	0.916	1.054	0.965	
ANSI / IEEE C95.1 1992 - SAFETY LIMIT										Body									
Spatial Peak										1.6 W/kg (mW/g)									
Uncontrolled Exposure/General Population										averaged over 1 gram									

Note: Blue entry indicated variability measurement

**Table 11-22
LTE Band 2 (PCS) Hotspot SAR**

MEASUREMENT RESULTS																			
FREQUENCY		Mode	Bandwidth [MHz]	Maximum Allowed Power [dBm]	Conducted Power [dBm]	Power Drift [dB]	MPR [dB]	Device Serial Number	Modulation	RB Size	RB Offset	Spacing	Side	Duty Cycle	SAR (1g)	Scaling Factor	Reported SAR (1g)	Plot #	
MHz	Ch.														(W/kg)		(W/kg)		
1860.00	18700	Low	LTE Band 2 (PCS)	20	24.4	24.14	0.01	0	51543	QPSK	1	50	10 mm	back	1:1	0.754	1.062	0.801	
1880.00	18900	Mid	LTE Band 2 (PCS)	20	24.4	24.18	0.01	0	51543	QPSK	1	50	10 mm	back	1:1	0.779	1.052	0.820	
1900.00	19100	High	LTE Band 2 (PCS)	20	24.4	24.26	0.00	0	51543	QPSK	1	50	10 mm	back	1:1	0.780	1.033	0.806	A28
1900.00	19100	High	LTE Band 2 (PCS)	20	23.4	23.37	0.02	1	51543	QPSK	50	25	10 mm	back	1:1	0.636	1.007	0.640	
1880.00	18900	Mid	LTE Band 2 (PCS)	20	23.4	23.30	0.01	1	51543	QPSK	100	0	10 mm	back	1:1	0.624	1.023	0.638	
1900.00	19100	High	LTE Band 2 (PCS)	20	24.4	24.26	0.05	0	51543	QPSK	1	50	10 mm	front	1:1	0.665	1.033	0.687	
1900.00	19100	High	LTE Band 2 (PCS)	20	23.4	23.37	0.03	1	51543	QPSK	50	25	10 mm	front	1:1	0.544	1.007	0.548	
1900.00	19100	High	LTE Band 2 (PCS)	20	24.4	24.26	-0.04	0	51543	QPSK	1	50	10 mm	bottom	1:1	0.739	1.033	0.763	
1900.00	19100	High	LTE Band 2 (PCS)	20	23.4	23.37	-0.02	1	51543	QPSK	50	25	10 mm	bottom	1:1	0.597	1.007	0.601	
1900.00	19100	High	LTE Band 2 (PCS)	20	24.4	24.26	-0.01	0	51543	QPSK	1	50	10 mm	left	1:1	0.672	1.033	0.694	
1900.00	19100	High	LTE Band 2 (PCS)	20	23.4	23.37	0.01	1	51543	QPSK	50	25	10 mm	left	1:1	0.549	1.007	0.553	
ANSI / IEEE C95.1 1992 - SAFETY LIMIT										Body									
Spatial Peak										1.6 W/kg (mW/g)									
Uncontrolled Exposure/General Population										averaged over 1 gram									

FCC ID: ZNFX420AS		SAR EVALUATION REPORT		Approved by: Quality Manager
Document S/N: 1M1905090070-01-R2.ZNF	Test Dates: 05/08/19 - 05/16/19	DUT Type: Portable Handset		Page 65 of 84



**Table 11-23
LTE Band 30 Hotspot SAR**

MEASUREMENT RESULTS																			
FREQUENCY		Mode	Bandwidth [MHz]	Maximum Allowed Power [dBm]	Conducted Power [dBm]	Power Drift [dB]	MPR [dB]	Device Serial Number	Modulation	RB Size	RB Offset	Spacing	Side	Duty Cycle	SAR (1g)	Scaling Factor	Reported SAR (1g)	Plot #	
MHz	Ch.														(W/kg)		(W/kg)		
2310.00	27710	Mid	LTE Band 30	10	23.0	22.71	-0.13	0	51501	QPSK	1	25	10 mm	back	1:1	0.769	1.069	0.822	
2310.00	27710	Mid	LTE Band 30	10	22.0	21.74	0.11	1	51501	QPSK	25	0	10 mm	back	1:1	0.576	1.062	0.612	
2310.00	27710	Mid	LTE Band 30	10	22.0	21.56	0.07	1	51501	QPSK	50	0	10 mm	back	1:1	0.589	1.107	0.652	
2310.00	27710	Mid	LTE Band 30	10	23.0	22.71	-0.15	0	51501	QPSK	1	25	10 mm	front	1:1	0.599	1.069	0.640	
2310.00	27710	Mid	LTE Band 30	10	22.0	21.74	0.06	1	51501	QPSK	25	0	10 mm	front	1:1	0.503	1.062	0.534	
2310.00	27710	Mid	LTE Band 30	10	23.0	22.71	0.01	0	51501	QPSK	1	25	10 mm	bottom	1:1	1.040	1.069	1.112	A30
2310.00	27710	Mid	LTE Band 30	10	22.0	21.74	-0.03	1	51501	QPSK	25	0	10 mm	bottom	1:1	0.812	1.062	0.862	
2310.00	27710	Mid	LTE Band 30	10	22.0	21.56	-0.04	1	51501	QPSK	50	0	10 mm	bottom	1:1	0.799	1.107	0.884	
2310.00	27710	Mid	LTE Band 30	10	23.0	22.71	0.11	0	51501	QPSK	1	25	10 mm	right	1:1	0.190	1.069	0.203	
2310.00	27710	Mid	LTE Band 30	10	22.0	21.74	0.09	1	51501	QPSK	25	0	10 mm	right	1:1	0.154	1.062	0.164	
2310.00	27710	Mid	LTE Band 30	10	23.0	22.71	0.08	0	51501	QPSK	1	25	10 mm	left	1:1	0.122	1.069	0.130	
2310.00	27710	Mid	LTE Band 30	10	22.0	21.74	0.12	1	51501	QPSK	25	0	10 mm	left	1:1	0.093	1.062	0.099	
2310.00	27710	Mid	LTE Band 30	10	23.0	22.71	0.13	0	51501	QPSK	1	25	10 mm	bottom	1:1	1.020	1.069	1.090	
ANSI / IEEE C95.1 1992 - SAFETY LIMIT Spatial Peak Uncontrolled Exposure/General Population								Body 1.6 W/kg (mW/g) averaged over 1 gram											

Note: Blue entry indicated variability measurement

**Table 11-24
WLAN Hotspot SAR**

MEASUREMENT RESULTS																		
FREQUENCY		Mode	Service	Bandwidth [MHz]	Maximum Allowed Power [dBm]	Conducted Power [dBm]	Power Drift [dB]	Spacing	Device Serial Number	Data Rate (Mbps)	Side	Duty Cycle (%)	Peak SAR of Area Scan	SAR (1g)	Scaling Factor (Power)	Scaling Factor (Duty Cycle)	Reported SAR (1g)	Plot #
MHz	Ch.												(W/kg)	(W/kg)			(W/kg)	
2412	1	802.11b	DSSS	22	15.0	14.98	-0.07	10 mm	51626	1	back	96.7	0.188	0.124	1.005	1.034	0.129	A31
2412	1	802.11b	DSSS	22	15.0	14.98	-0.13	10 mm	51626	1	front	96.7	0.151	-	1.005	1.034	-	
2412	1	802.11b	DSSS	22	15.0	14.98	-0.05	10 mm	51626	1	top	96.7	0.114	-	1.005	1.034	-	
2412	1	802.11b	DSSS	22	15.0	14.98	0.04	10 mm	51626	1	left	96.7	0.139	-	1.005	1.034	-	
ANSI / IEEE C95.1 1992 - SAFETY LIMIT Spatial Peak Uncontrolled Exposure/General Population								Body 1.6 W/kg (mW/g) averaged over 1 gram										



FCC ID: ZNFX420AS		SAR EVALUATION REPORT		Approved by: Quality Manager
Document S/N: 1M1905090070-01-R2.ZNF	Test Dates: 05/08/19 - 05/16/19	DUT Type: Portable Handset	Page 66 of 84	

11.4 Standalone Phablet SAR Data

Table 11-25
UMTS Phablet SAR Data



MEASUREMENT RESULTS														
FREQUENCY		Mode	Service	Maximum Allowed Power [dBm]	Conducted Power [dBm]	Power Drift [dB]	Spacing	Device Serial Number	Duty Cycle	Side	SAR (10g)	Scaling Factor	Reported SAR (10g)	Plot #
MHz	Ch.										(W/kg)		(W/kg)	
1732.40	1412	UMTS 1750	RMC	24.2	24.10	0.00	3 mm	51592	1:1	back	1.830	1.023	1.872	
1732.40	1412	UMTS 1750	RMC	24.2	24.10	0.13	3 mm	51592	1:1	front	1.440	1.023	1.473	
1732.40	1412	UMTS 1750	RMC	24.2	24.10	-0.01	4 mm	51592	1:1	bottom	0.485	1.023	0.496	
1712.40	1312	UMTS 1750	RMC	24.2	23.98	-0.04	0 mm	51592	1:1	left	2.960	1.052	3.114	
1732.40	1412	UMTS 1750	RMC	24.2	24.10	-0.03	0 mm	51592	1:1	left	3.050	1.023	3.120	
1752.60	1513	UMTS 1750	RMC	24.2	24.01	-0.04	0 mm	51592	1:1	left	2.990	1.045	3.125	
1712.40	1312	UMTS 1750	RMC	22.7	22.67	-0.01	0 mm	51501	1:1	back	3.080	1.007	3.102	A32
1732.40	1412	UMTS 1750	RMC	22.7	22.70	0.00	0 mm	51501	1:1	back	3.050	1.000	3.050	
1752.60	1513	UMTS 1750	RMC	22.7	22.68	0.01	0 mm	51501	1:1	back	2.980	1.005	2.995	
1712.40	1312	UMTS 1750	RMC	22.7	22.67	0.13	0 mm	51501	1:1	front	2.540	1.007	2.558	
1732.40	1412	UMTS 1750	RMC	22.7	22.70	0.13	0 mm	51501	1:1	front	2.690	1.000	2.690	
1752.60	1513	UMTS 1750	RMC	22.7	22.68	0.13	0 mm	51501	1:1	front	2.660	1.005	2.673	
1732.40	1412	UMTS 1750	RMC	22.7	22.70	0.06	0 mm	51501	1:1	bottom	0.817	1.000	0.817	
1712.40	1312	UMTS 1750	RMC	22.7	22.67	0.01	0 mm	51501	1:1	back	2.760	1.007	2.779	
1852.40	9262	UMTS 1900	RMC	24.4	23.97	-0.07	3 mm	51543	1:1	back	1.890	1.104	2.087	
1880.00	9400	UMTS 1900	RMC	24.4	23.99	-0.14	3 mm	51543	1:1	back	1.970	1.099	2.165	
1907.60	9538	UMTS 1900	RMC	24.4	24.04	0.04	3 mm	51543	1:1	back	1.960	1.086	2.129	
1880.00	9400	UMTS 1900	RMC	24.4	23.99	-0.01	3 mm	51543	1:1	front	1.510	1.099	1.659	
1880.00	9400	UMTS 1900	RMC	24.4	23.99	-0.03	4 mm	51543	1:1	bottom	1.020	1.099	1.121	
1852.40	9262	UMTS 1900	RMC	24.4	23.97	0.00	0 mm	51501	1:1	left	2.670	1.104	2.948	
1880.00	9400	UMTS 1900	RMC	24.4	23.99	0.00	0 mm	51501	1:1	left	2.700	1.099	2.967	
1907.60	9538	UMTS 1900	RMC	24.4	24.04	0.01	0 mm	51501	1:1	left	2.830	1.086	3.073	A33
1852.40	9262	UMTS 1900	RMC	22.9	22.68	-0.04	0 mm	51543	1:1	back	2.680	1.052	2.819	
1880.00	9400	UMTS 1900	RMC	22.9	22.74	-0.03	0 mm	51543	1:1	back	2.700	1.038	2.803	
1907.60	9538	UMTS 1900	RMC	22.9	22.73	-0.02	0 mm	51543	1:1	back	2.810	1.040	2.922	
1852.40	9262	UMTS 1900	RMC	22.9	22.68	0.02	0 mm	51543	1:1	front	2.360	1.052	2.483	
1880.00	9400	UMTS 1900	RMC	22.9	22.74	0.00	0 mm	51543	1:1	front	2.340	1.038	2.429	
1907.60	9538	UMTS 1900	RMC	22.9	22.73	-0.01	0 mm	51543	1:1	front	2.400	1.040	2.496	
1880.00	9400	UMTS 1900	RMC	22.9	22.74	0.01	0 mm	51543	1:1	bottom	1.230	1.038	1.277	
ANSI / IEEE C95.1 1992 - SAFETY LIMIT Spatial Peak Uncontrolled Exposure/General Population							Phablet 4.0 W/kg (mW/g) averaged over 10 grams							

Note: Blue entry indicated variability measurement

FCC ID: ZNFX420AS		SAR EVALUATION REPORT		Approved by: Quality Manager
Document S/N: 1M1905090070-01-R2.ZNF	Test Dates: 05/08/19 - 05/16/19	DUT Type: Portable Handset		Page 67 of 84

**Table 11-26
LTE Band 66 Phablet SAR**



MEASUREMENT RESULTS																			
FREQUENCY		Mode	Bandwidth [MHz]	Maximum Allowed Power [dBm]	Conducted Power [dBm]	Power Drift [dB]	MPR [dB]	Device Serial Number	Modulation	RB Size	RB Offset	Spacing	Side	Duty Cycle	SAR (10g) (W/kg)	Scaling Factor	Reported SAR (10g) (W/kg)	Plot #	
MHz	Ch.																		
1720.00	132072	Low	LTE Band 66 (AWS)	20	24.4	24.17	0.01	0	51592	QPSK	1	50	3 mm	back	1:1	2.210	1.054	2.329	
1745.00	132322	Mid	LTE Band 66 (AWS)	20	24.4	24.15	0.01	0	51592	QPSK	1	50	3 mm	back	1:1	2.140	1.059	2.266	
1770.00	132572	High	LTE Band 66 (AWS)	20	24.4	24.16	0.03	0	51592	QPSK	1	50	3 mm	back	1:1	2.380	1.057	2.516	
1720.00	132072	Low	LTE Band 66 (AWS)	20	23.4	23.19	-0.03	1	51592	QPSK	50	25	3 mm	back	1:1	1.990	1.050	2.090	
1745.00	132322	Mid	LTE Band 66 (AWS)	20	23.4	23.22	0.00	1	51592	QPSK	50	50	3 mm	back	1:1	2.040	1.042	2.126	
1770.00	132572	High	LTE Band 66 (AWS)	20	23.4	23.19	0.01	1	51592	QPSK	50	25	3 mm	back	1:1	1.930	1.050	2.027	
1745.00	132322	Mid	LTE Band 66 (AWS)	20	23.4	23.15	0.01	1	51592	QPSK	100	0	3 mm	back	1:1	2.020	1.059	2.139	
1720.00	132072	Low	LTE Band 66 (AWS)	20	24.4	24.17	0.15	0	51592	QPSK	1	50	3 mm	front	1:1	1.440	1.054	1.518	
1745.00	132322	Mid	LTE Band 66 (AWS)	20	23.4	23.22	0.19	1	51592	QPSK	50	50	3 mm	front	1:1	1.140	1.042	1.188	
1720.00	132072	Low	LTE Band 66 (AWS)	20	24.4	24.17	0.01	0	51592	QPSK	1	50	4 mm	bottom	1:1	0.521	1.054	0.549	
1745.00	132322	Mid	LTE Band 66 (AWS)	20	23.4	23.22	-0.01	1	51592	QPSK	50	50	4 mm	bottom	1:1	0.457	1.042	0.476	
1720.00	132072	Low	LTE Band 66 (AWS)	20	24.4	24.17	0.00	0	51592	QPSK	1	50	0 mm	left	1:1	2.690	1.054	2.835	
1745.00	132322	Mid	LTE Band 66 (AWS)	20	24.4	24.15	0.06	0	51592	QPSK	1	50	0 mm	left	1:1	2.780	1.059	2.944	
1770.00	132572	High	LTE Band 66 (AWS)	20	24.4	24.16	0.07	0	51592	QPSK	1	50	0 mm	left	1:1	2.760	1.057	2.917	
1720.00	132072	Low	LTE Band 66 (AWS)	20	23.4	23.19	0.05	1	51592	QPSK	50	25	0 mm	left	1:1	2.120	1.050	2.226	
1745.00	132322	Mid	LTE Band 66 (AWS)	20	23.4	23.22	0.04	1	51592	QPSK	50	50	0 mm	left	1:1	2.220	1.042	2.313	
1770.00	132572	High	LTE Band 66 (AWS)	20	23.4	23.19	0.06	1	51592	QPSK	50	25	0 mm	left	1:1	2.200	1.050	2.310	
1745.00	132322	Mid	LTE Band 66 (AWS)	20	23.4	23.15	0.05	1	51592	QPSK	100	0	0 mm	left	1:1	2.190	1.059	2.319	
1720.00	132072	Low	LTE Band 66 (AWS)	20	22.9	22.70	-0.02	0	51501	QPSK	1	50	0 mm	back	1:1	2.960	1.047	3.099	
1745.00	132322	Mid	LTE Band 66 (AWS)	20	22.9	22.73	0.00	0	51501	QPSK	1	50	0 mm	back	1:1	2.960	1.040	3.078	
1770.00	132572	High	LTE Band 66 (AWS)	20	22.9	22.70	0.00	0	51501	QPSK	1	50	0 mm	back	1:1	2.850	1.047	2.984	
1720.00	132072	Low	LTE Band 66 (AWS)	20	22.9	22.65	0.00	0	51501	QPSK	50	25	0 mm	back	1:1	2.990	1.059	3.166	A34
1745.00	132322	Mid	LTE Band 66 (AWS)	20	22.9	22.73	-0.01	0	51501	QPSK	50	50	0 mm	back	1:1	2.950	1.040	3.068	
1770.00	132572	High	LTE Band 66 (AWS)	20	22.9	22.66	0.01	0	51501	QPSK	50	25	0 mm	back	1:1	2.880	1.057	3.044	
1745.00	132322	Mid	LTE Band 66 (AWS)	20	22.9	22.65	0.00	0	51501	QPSK	100	0	0 mm	back	1:1	2.970	1.059	3.145	
1720.00	132072	Low	LTE Band 66 (AWS)	20	22.9	22.70	0.01	0	51501	QPSK	1	50	0 mm	front	1:1	2.460	1.047	2.576	
1745.00	132322	Mid	LTE Band 66 (AWS)	20	22.9	22.73	-0.12	0	51501	QPSK	1	50	0 mm	front	1:1	2.580	1.040	2.683	
1770.00	132572	High	LTE Band 66 (AWS)	20	22.9	22.70	0.13	0	51501	QPSK	1	50	0 mm	front	1:1	2.560	1.047	2.680	
1720.00	132072	Low	LTE Band 66 (AWS)	20	22.9	22.65	-0.10	0	51501	QPSK	50	25	0 mm	front	1:1	2.480	1.059	2.626	
1745.00	132322	Mid	LTE Band 66 (AWS)	20	22.9	22.73	-0.01	0	51501	QPSK	50	50	0 mm	front	1:1	2.580	1.040	2.683	
1770.00	132572	High	LTE Band 66 (AWS)	20	22.9	22.66	0.13	0	51501	QPSK	50	25	0 mm	front	1:1	2.570	1.057	2.716	
1745.00	132322	Mid	LTE Band 66 (AWS)	20	22.9	22.65	-0.03	0	51501	QPSK	100	0	0 mm	front	1:1	2.560	1.059	2.711	
1745.00	132322	Mid	LTE Band 66 (AWS)	20	22.9	22.73	0.04	0	51501	QPSK	1	50	0 mm	bottom	1:1	0.918	1.040	0.955	
1745.00	132322	Mid	LTE Band 66 (AWS)	20	22.9	22.73	0.01	0	51501	QPSK	50	50	0 mm	bottom	1:1	0.900	1.040	0.936	
ANSI / IEEE C95.1 1992 - SAFETY LIMIT Spatial Peak Uncontrolled Exposure/General Population									Phablet 4.0 W/kg (mW/g) averaged over 10 grams										

FCC ID: ZNFX420AS		SAR EVALUATION REPORT		Approved by: Quality Manager
Document S/N: 1M1905090070-01-R2.ZNF	Test Dates: 05/08/19 - 05/16/19	DUT Type: Portable Handset	Page 68 of 84	

**Table 11-27
LTE Band 2 Phablet SAR**

MEASUREMENT RESULTS																			
FREQUENCY		Mode	Bandwidth [MHz]	Maximum Allowed Power [dBm]	Conducted Power [dBm]	Power Drift [dB]	MPR [dB]	Device Serial Number	Modulation	RB Size	RB Offset	Spacing	Side	Duty Cycle	SAR (10g) (W/kg)	Scaling Factor	Reported SAR (10g) (W/kg)	Plot #	
MHz	Ch.																		
1900.00	19100	High	LTE Band 2 (PCS)	20	24.4	24.26	-0.17	0	51543	QPSK	1	50	3 mm	back	1:1	1.710	1.033	1.766	
1900.00	19100	High	LTE Band 2 (PCS)	20	23.4	23.37	0.07	1	51543	QPSK	50	25	3 mm	back	1:1	1.400	1.007	1.410	
1900.00	19100	High	LTE Band 2 (PCS)	20	24.4	24.26	0.00	0	51543	QPSK	1	50	3 mm	front	1:1	1.350	1.033	1.395	
1900.00	19100	High	LTE Band 2 (PCS)	20	23.4	23.37	-0.02	1	51543	QPSK	50	25	3 mm	front	1:1	1.100	1.007	1.108	
1900.00	19100	High	LTE Band 2 (PCS)	20	24.4	24.26	-0.04	0	51543	QPSK	1	50	4 mm	bottom	1:1	0.982	1.033	1.014	
1900.00	19100	High	LTE Band 2 (PCS)	20	23.4	23.37	-0.03	1	51543	QPSK	50	25	4 mm	bottom	1:1	0.794	1.007	0.800	
1860.00	18700	Low	LTE Band 2 (PCS)	20	24.4	24.14	-0.07	0	51501	QPSK	1	50	0 mm	left	1:1	2.820	1.062	2.995	
1880.00	18900	Mid	LTE Band 2 (PCS)	20	24.4	24.18	-0.11	0	51501	QPSK	1	50	0 mm	left	1:1	2.890	1.052	3.040	
1900.00	19100	High	LTE Band 2 (PCS)	20	24.4	24.26	-0.06	0	51501	QPSK	1	50	0 mm	left	1:1	2.950	1.033	3.047	
1860.00	18700	Low	LTE Band 2 (PCS)	20	23.4	23.24	-0.10	1	51501	QPSK	50	25	0 mm	left	1:1	2.250	1.038	2.336	
1880.00	18900	Mid	LTE Band 2 (PCS)	20	23.4	23.31	-0.11	1	51501	QPSK	50	50	0 mm	left	1:1	2.300	1.021	2.348	
1900.00	19100	High	LTE Band 2 (PCS)	20	23.4	23.37	-0.05	1	51501	QPSK	50	25	0 mm	left	1:1	2.400	1.007	2.417	
1880.00	18900	Mid	LTE Band 2 (PCS)	20	23.4	23.30	-0.11	1	51501	QPSK	100	0	0 mm	left	1:1	2.230	1.023	2.281	
1860.00	18700	Low	LTE Band 2 (PCS)	20	22.9	22.79	-0.01	0	51543	QPSK	1	50	0 mm	back	1:1	2.450	1.026	2.514	
1880.00	18900	Mid	LTE Band 2 (PCS)	20	22.9	22.81	-0.03	0	51543	QPSK	1	50	0 mm	back	1:1	2.500	1.021	2.553	
1900.00	19100	High	LTE Band 2 (PCS)	20	22.9	22.88	-0.02	0	51543	QPSK	1	50	0 mm	back	1:1	2.610	1.005	2.623	
1860.00	18700	Low	LTE Band 2 (PCS)	20	22.9	22.74	-0.02	0	51543	QPSK	50	25	0 mm	back	1:1	2.460	1.038	2.553	
1880.00	18900	Mid	LTE Band 2 (PCS)	20	22.9	22.80	-0.05	0	51543	QPSK	50	50	0 mm	back	1:1	2.510	1.023	2.568	
1900.00	19100	High	LTE Band 2 (PCS)	20	22.9	22.85	-0.02	0	51543	QPSK	50	25	0 mm	back	1:1	2.650	1.012	2.682	
1880.00	18900	Mid	LTE Band 2 (PCS)	20	22.9	22.79	0.01	0	51543	QPSK	100	0	0 mm	back	1:1	2.580	1.026	2.647	
1860.00	18700	Low	LTE Band 2 (PCS)	20	22.9	22.79	-0.03	0	51543	QPSK	1	50	0 mm	front	1:1	2.440	1.026	2.503	
1880.00	18900	Mid	LTE Band 2 (PCS)	20	22.9	22.81	0.01	0	51543	QPSK	1	50	0 mm	front	1:1	2.480	1.021	2.532	
1900.00	19100	High	LTE Band 2 (PCS)	20	22.9	22.88	-0.01	0	51543	QPSK	1	50	0 mm	front	1:1	2.510	1.005	2.523	
1860.00	18700	Low	LTE Band 2 (PCS)	20	22.9	22.74	-0.01	0	51543	QPSK	50	25	0 mm	front	1:1	2.470	1.038	2.564	
1880.00	18900	Mid	LTE Band 2 (PCS)	20	22.9	22.80	-0.03	0	51543	QPSK	50	50	0 mm	front	1:1	2.440	1.023	2.496	
1900.00	19100	High	LTE Band 2 (PCS)	20	22.9	22.85	-0.01	0	51543	QPSK	50	25	0 mm	front	1:1	2.540	1.012	2.570	
1880.00	18900	Mid	LTE Band 2 (PCS)	20	22.9	22.79	0.00	0	51543	QPSK	100	0	0 mm	front	1:1	2.440	1.026	2.503	
1900.00	19100	High	LTE Band 2 (PCS)	20	22.9	22.88	0.09	0	51543	QPSK	1	50	0 mm	bottom	1:1	1.180	1.005	1.186	
1900.00	19100	High	LTE Band 2 (PCS)	20	22.9	22.85	0.02	0	51543	QPSK	50	25	0 mm	bottom	1:1	1.190	1.012	1.204	
1900.00	19100	High	LTE Band 2 (PCS)	20	24.4	24.26	-0.06	0	51501	QPSK	1	50	0 mm	left	1:1	2.980	1.033	3.078	A35
ANSI / IEEE C95.1 1992 - SAFETY LIMIT Spatial Peak Uncontrolled Exposure/General Population									Phablet 4.0 W/kg (mW/g) averaged over 10 grams										

Note: Blue entry indicated variability measurement

FCC ID: ZNFX420AS		SAR EVALUATION REPORT		Approved by: Quality Manager
Document S/N: 1M1905090070-01-R2.ZNF	Test Dates: 05/08/19 - 05/16/19	DUT Type: Portable Handset		Page 69 of 84



**Table 11-28
LTE Band 30 Phablet SAR**

MEASUREMENT RESULTS																			
FREQUENCY		Mode	Bandwidth [MHz]	Maximum Allowed Power [dBm]	Conducted Power [dBm]	Power Drift [dB]	MPR [dB]	Device Serial Number	Modulation	RB Size	RB Offset	Spacing	Side	Duty Cycle	SAR (10g)	Scaling Factor	Reported SAR (10g)	Plot #	
MHz	Ch.														(W/kg)		(W/kg)		
2310.00	27710	Mid	LTE Band 30	10	23.0	22.71	-0.15	0	51501	QPSK	1	25	3 mm	back	1:1	1.290	1.069	1.379	
2310.00	27710	Mid	LTE Band 30	10	22.0	21.74	-0.13	1	51501	QPSK	25	0	3 mm	back	1:1	1.040	1.062	1.104	
2310.00	27710	Mid	LTE Band 30	10	23.0	22.71	-0.07	0	51501	QPSK	1	25	3 mm	front	1:1	1.100	1.069	1.176	
2310.00	27710	Mid	LTE Band 30	10	22.0	21.74	0.00	1	51501	QPSK	25	0	3 mm	front	1:1	0.886	1.062	0.941	
2310.00	27710	Mid	LTE Band 30	10	23.0	22.71	0.03	0	51501	QPSK	1	25	4 mm	bottom	1:1	1.240	1.069	1.326	
2310.00	27710	Mid	LTE Band 30	10	22.0	21.74	0.01	1	51501	QPSK	25	0	4 mm	bottom	1:1	0.992	1.062	1.054	
2310.00	27710	Mid	LTE Band 30	10	23.0	22.71	-0.04	0	51501	QPSK	1	25	0 mm	right	1:1	0.564	1.069	0.603	
2310.00	27710	Mid	LTE Band 30	10	22.0	21.74	0.05	1	51501	QPSK	25	0	0 mm	right	1:1	0.464	1.062	0.493	
2310.00	27710	Mid	LTE Band 30	10	23.0	22.71	0.04	0	51501	QPSK	1	25	0 mm	left	1:1	0.362	1.069	0.387	
2310.00	27710	Mid	LTE Band 30	10	22.0	21.74	-0.04	1	51501	QPSK	25	0	0 mm	left	1:1	0.285	1.062	0.303	
2310.00	27710	Mid	LTE Band 30	10	21.5	21.31	-0.17	0	51576	QPSK	1	25	0 mm	back	1:1	1.720	1.045	1.797	A36
2310.00	27710	Mid	LTE Band 30	10	21.5	21.27	-0.09	0	51576	QPSK	25	0	0 mm	back	1:1	1.630	1.054	1.718	
2310.00	27710	Mid	LTE Band 30	10	21.5	21.31	-0.21	0	51576	QPSK	1	25	0 mm	front	1:1	1.640	1.045	1.714	
2310.00	27710	Mid	LTE Band 30	10	21.5	21.27	-0.12	0	51576	QPSK	25	0	0 mm	front	1:1	1.660	1.054	1.750	
2310.00	27710	Mid	LTE Band 30	10	21.5	21.31	-0.16	0	51576	QPSK	1	25	0 mm	bottom	1:1	1.030	1.045	1.076	
2310.00	27710	Mid	LTE Band 30	10	21.5	21.27	-0.17	0	51576	QPSK	25	0	0 mm	bottom	1:1	1.040	1.054	1.096	
ANSI / IEEE C95.1 1992 - SAFETY LIMIT Spatial Peak Uncontrolled Exposure/General Population									Phablet 4.0 W/kg (mW/g) averaged over 10 grams										

11.5 SAR Test Notes

General Notes:

- The test data reported are the worst-case SAR values according to test procedures specified in IEEE 1528-2013, and FCC KDB Publication 447498 D01v06.
- Batteries are fully charged at the beginning of the SAR measurements.
- Liquid tissue depth was at least 15.0 cm for all frequencies.
- The manufacturer has confirmed that the device(s) tested have the same physical, mechanical and thermal characteristics and are within operational tolerances expected for production units.
- SAR results were scaled to the maximum allowed power to demonstrate compliance per FCC KDB Publication 447498 D01v06.
- Device was tested using a fixed spacing for body-worn accessory testing. A separation distance of 10 mm was considered because the manufacturer has determined that there will be body-worn accessories available in the marketplace for users to support this separation distance.
- Per FCC KDB Publication 648474 D04v01r03, body-worn SAR was evaluated without a headset connected to the device. Since the standalone reported body-worn SAR was ≤ 1.2 W/kg, no additional body-worn SAR evaluations using a headset cable were required.
- Per FCC KDB 865664 D01v01r04, variability SAR tests were performed when the measured SAR results for a frequency band were greater than or equal to 0.8 W/kg. Repeated SAR measurements are highlighted in the tables above for clarity. Please see Section 13 for variability analysis.
- During SAR Testing for the Wireless Router conditions per FCC KDB Publication 941225 D06v02r01, the actual Portable Hotspot operation (with actual simultaneous transmission of a transmitter with WIFI) was not activated (See Section 6.7 for more details).
- Per FCC KDB Publication 648474 D04v01r03, this device is considered a "phablet" since the diagonal dimension is > 160 mm and < 200 mm. Therefore, phablet SAR tests are required when wireless router mode does not apply or if wireless router 1g SAR > 1.2 W/kg. Additional SAR tests for phablet SAR were evaluated per KDB 616217 Section 6 (See Section 6.9 for more information.)

FCC ID: ZNFX420AS		SAR EVALUATION REPORT		Approved by: Quality Manager
Document S/N: 1M1905090070-01-R2-ZNF	Test Dates: 05/08/19 - 05/16/19	DUT Type: Portable Handset		Page 70 of 84

11. This device utilizes power reduction for some wireless modes and technologies, as outlined in Section 1.3. The maximum output power allowed for each transmitter and exposure condition was evaluated for SAR compliance based on expected use conditions and simultaneous transmission scenarios.
12. Unless otherwise noted, when 10g SAR measurement is considered, a factor of 2.5 is applied to the thresholds below.

GSM Test Notes:

1. Body-Worn accessory testing is typically associated with voice operations. Therefore, GSM voice was evaluated for body-worn SAR.
2. Justification for reduced test configurations per KDB Publication 941225 D01v03r01 and October 2013 TCB Workshop Notes: The source-based frame-averaged output power was evaluated for all GPRS/EDGE slot configurations. The configuration with the highest target frame averaged output power was evaluated for hotspot SAR. When the maximum frame-averaged powers are equivalent across two or more slots (within 0.25 dB), the configuration with the most number of time slots was tested.
3. Per FCC KDB Publication 447498 D01v06, if the reported (scaled) SAR measured at the middle channel or highest output power channel for each test configuration is ≤ 0.8 W/kg for 1g evaluations then testing at the other channels is not required for such test configuration(s). When the maximum output power variation across the required test channels is $> \frac{1}{2}$ dB, instead of the middle channel, the highest output power channel was used.
4. GPRS was additionally evaluated for head and body-worn exposure conditions to address possible VoIP scenarios.

UMTS Notes:



1. UMTS mode in was tested under RMC 12.2 kbps with HSPA Inactive per KDB Publication 941225 D01v03r01. AMR and HSPA SAR was not required per the 3G Test Reduction Procedure in KDB Publication 941225 D01v03r01.
2. Per FCC KDB Publication 447498 D01v06, if the reported (scaled) SAR measured at the middle channel or highest output power channel for each test configuration is ≤ 0.8 W/kg for 1g evaluations then testing at the other channels is not required for such test configuration(s). When the maximum output power variation across the required test channels is $> \frac{1}{2}$ dB, instead of the middle channel, the highest output power channel was used.

LTE Notes:

1. LTE Considerations: LTE test configurations are determined according to SAR Evaluation Considerations for LTE Devices in FCC KDB Publication 941225 D05v02r04. The general test procedures used for testing can be found in Section 8.5.4.
2. MPR is permanently implemented for this device by the manufacturer. The specific manufacturer target MPR is indicated alongside the SAR results. MPR is enabled for this device, according to 3GPP TS36.101 Section 6.2.3 – 6.2.5 under Table 6.2.3-1.
3. A-MPR was disabled for all SAR tests by setting NS=01 on the base station simulator. SAR tests were performed with the same number of RB and RB offsets transmitting on all TTI frames (maximum TTI).
4. Per KDB Publication 941225 D05Av01r02, SAR for downlink only LTE CA operations was not needed since the maximum average output power in LTE CA mode was not >0.25 dB higher than the maximum output power when downlink carrier aggregation was inactive.

WLAN Notes:

1. For held-to-ear and hotspot operations, the initial test position procedures were applied. The test position with the highest extrapolated peak SAR will be used as the initial test position. When reported SAR for the initial test position is ≤ 0.4 W/kg for 1g evaluations, no additional testing for the remaining test



FCC ID: ZNFX420AS	 SAR EVALUATION REPORT 		Approved by: Quality Manager
Document S/N: 1M1905090070-01-R2.ZNF	Test Dates: 05/08/19 - 05/16/19	DUT Type: Portable Handset	Page 71 of 84

positions was required. Otherwise, SAR is evaluated at the subsequent highest peak SAR positions until the reported SAR result is ≤ 0.8 W/kg or all test positions are measured.

2. Justification for test configurations for WLAN per KDB Publication 248227 D01v02r02 for 2.4 GHz WIFI operations, the highest measured maximum output power channel for DSSS was selected for SAR measurement. SAR for OFDM modes (2.4 GHz 802.11g/n) was not required due to the maximum allowed powers and the highest reported DSSS SAR. See Section 8.6.3 for more information.
3. When the maximum reported 1g averaged SAR is ≤ 0.8 W/kg, SAR testing on additional channels was not required. Otherwise, SAR for the next highest output power channel was required until the reported SAR result was ≤ 1.20 W/kg for 1g evaluations or all test channels were measured.
4. The device was configured to transmit continuously at the required data rate, channel bandwidth and signal modulation, using the highest transmission duty factor supported by the test mode tools. The reported SAR was scaled to the 100% transmission duty factor to determine compliance. Procedures used to measure the duty factor are identical to that in the associated EMC test reports.

Bluetooth Notes

1. Bluetooth SAR was measured with the device connected to a call box with hopping disabled with DH5 operation and Tx Tests test mode type. Per October 2016 TCB Workshop Notes, the reported SAR was scaled to the 100% transmission duty factor to determine compliance. See Section 9.5 for the time domain plot and calculation for the duty factor of the device.
2. Head Bluetooth SAR were evaluated for BT BR tethering applications.

FCC ID: ZNFX420AS	 SAR EVALUATION REPORT 		Approved by: Quality Manager
Document S/N: 1M1905090070-01-R2.ZNF	Test Dates: 05/08/19 - 05/16/19	DUT Type: Portable Handset	Page 72 of 84

12 FCC MULTI-TX AND ANTENNA SAR CONSIDERATIONS

12.1 Introduction

The following procedures adopted from FCC KDB Publication 447498 D01v06 are applicable to devices with built-in unlicensed transmitters such as 802.11 and Bluetooth devices which may simultaneously transmit with the licensed transmitter.

12.2 Simultaneous Transmission Procedures

This device contains transmitters that may operate simultaneously. Therefore, simultaneous transmission analysis is required. Per FCC KDB Publication 447498 D01v06 4.3.2 and IEEE 1528-2013 Section 6.3.4.1.2, simultaneous transmission SAR test exclusion may be applied when the sum of the 1g SAR for all the simultaneous transmitting antennas in a specific physical test configuration is ≤ 1.6 W/kg. The different test positions in an exposure condition may be considered collectively to determine SAR test exclusion according to the sum of 1g or 10g SAR.

When standalone SAR is not required to be measured, per FCC KDB 447498 D01v06 4.3.2 b), the following equation must be used to estimate the standalone 1g SAR for simultaneous transmission assessment involving that transmitter.

$$\text{Estimated SAR} = \frac{\sqrt{f(\text{GHz})}}{7.5} * \frac{(\text{Max Power of channel, mW})}{\text{Min. Separation Distance, mm}}$$



When standalone SAR is not required to be measured, per FCC KDB 447498 D01v06 4.3.2 b), the following equation must be used to estimate the standalone 10g SAR for simultaneous transmission assessment involving that transmitter.

$$\text{Estimated SAR} = \frac{\sqrt{f(\text{GHz})}}{18.75} * \frac{(\text{Max Power of channel, mW})}{\text{Min. Separation Distance, mm}}$$

**Table 12-1
Estimated SAR**

Mode	Frequency	Maximum Allowed Power	Separation Distance (Body)	Estimated SAR (Body)	Separation Distance (Phablet)	Estimated SAR (Phablet)
	[MHz]	[dBm]	[mm]	[W/kg]	[mm]	[W/kg]
Bluetooth	2480	10.00	10	0.210	5	0.168

Note: Per KDB Publication 447498 D01v06, the maximum power of the channel was rounded to the nearest mW before calculation.

FCC ID: ZNFX420AS		SAR EVALUATION REPORT		Approved by: Quality Manager
Document S/N: 1M1905090070-01-R2.ZNF	Test Dates: 05/08/19 - 05/16/19	DUT Type: Portable Handset		Page 73 of 84



12.3 Head SAR Simultaneous Transmission Analysis

Table 12-2
Simultaneous Transmission Scenario with 2.4 GHz WLAN (Held to Ear)

Exposure Condition	Mode	2G/3G/4G SAR (W/kg)	2.4 GHz WLAN SAR (W/kg)	Σ SAR (W/kg)
		1	2	1+2
Head SAR	GSM/GPRS 850	0.446	0.722	1.168
	GSM/GPRS 1900	0.248	0.722	0.970
	UMTS 850	0.485	0.722	1.207
	UMTS 1750	0.372	0.722	1.094
	UMTS 1900	0.558	0.722	1.280
	LTE Band 12	0.313	0.722	1.035
	LTE Band 14	0.258	0.722	0.980
	LTE Band 5 (Cell)	0.524	0.722	1.246
	LTE Band 66 (AWS)	0.412	0.722	1.134
	LTE Band 2 (PCS)	0.570	0.722	1.292
	LTE Band 30	0.211	0.722	0.933

Table 12-3
Simultaneous Transmission Scenario with Bluetooth (Held to Ear)

Exposure Condition	Mode	2G/3G/4G SAR (W/kg)	Bluetooth SAR (W/kg)	Σ SAR (W/kg)
		1	2	1+2
Head SAR	GSM/GPRS 850	0.446	0.213	0.659
	GSM/GPRS 1900	0.248	0.213	0.461
	UMTS 850	0.485	0.213	0.698
	UMTS 1750	0.372	0.213	0.585
	UMTS 1900	0.558	0.213	0.771
	LTE Band 12	0.313	0.213	0.526
	LTE Band 14	0.258	0.213	0.471
	LTE Band 5 (Cell)	0.524	0.213	0.737
	LTE Band 66 (AWS)	0.412	0.213	0.625
	LTE Band 2 (PCS)	0.570	0.213	0.783
	LTE Band 30	0.211	0.213	0.424

FCC ID: ZNFX420AS	 PCTEST ENGINEERING LABORATORY, INC.	SAR EVALUATION REPORT		Approved by: Quality Manager
Document S/N: 1M1905090070-01-R2.ZNF	Test Dates: 05/08/19 - 05/16/19	DUT Type: Portable Handset	Page 74 of 84	

12.4 Body-Worn Simultaneous Transmission Analysis



Table 12-4
Simultaneous Transmission Scenario with 2.4 GHz WLAN (Body-Worn at 1.0 cm)

Exposure Condition	Mode	2G/3G/4G SAR (W/kg)	2.4 GHz WLAN SAR (W/kg)	Σ SAR (W/kg)
		1	2	1+2
Body-Worn	GSM/GPRS 850	0.484	0.129	0.613
	GSM/GPRS 1900	0.362	0.129	0.491
	UMTS 850	0.577	0.129	0.706
	UMTS 1750	1.039	0.129	1.168
	UMTS 1900	0.930	0.129	1.059
	LTE Band 12	0.576	0.129	0.705
	LTE Band 14	0.337	0.129	0.466
	LTE Band 5 (Cell)	0.551	0.129	0.680
	LTE Band 66 (AWS)	1.086	0.129	1.215
	LTE Band 2 (PCS)	0.820	0.129	0.949
	LTE Band 30	0.822	0.129	0.951

Table 12-5
Simultaneous Transmission Scenario with Bluetooth (Body-Worn at 1.0 cm)

Exposure Condition	Mode	2G/3G/4G SAR (W/kg)	Bluetooth SAR (W/kg)	Σ SAR (W/kg)
		1	2	1+2
Body-Worn	GSM/GPRS 850	0.484	0.210	0.694
	GSM/GPRS 1900	0.362	0.210	0.572
	UMTS 850	0.577	0.210	0.787
	UMTS 1750	1.039	0.210	1.249
	UMTS 1900	0.930	0.210	1.140
	LTE Band 12	0.576	0.210	0.786
	LTE Band 14	0.337	0.210	0.547
	LTE Band 5 (Cell)	0.551	0.210	0.761
	LTE Band 66 (AWS)	1.086	0.210	1.296
	LTE Band 2 (PCS)	0.820	0.210	1.030
	LTE Band 30	0.822	0.210	1.032

Note: Bluetooth SAR was not required to be measured per FCC KDB Publication 447498 D01v06. Estimated SAR results were used in the above table to determine simultaneous transmission SAR test exclusion.

FCC ID: ZNFX420AS	 PCTEST ENGINEERING LABORATORY, INC.	SAR EVALUATION REPORT		Approved by: Quality Manager
Document S/N: 1M1905090070-01-R2.ZNF	Test Dates: 05/08/19 - 05/16/19	DUT Type: Portable Handset	Page 75 of 84	

12.5 Hotspot SAR Simultaneous Transmission Analysis



Table 12-6
Simultaneous Transmission Scenario with 2.4 GHz WLAN (Hotspot at 1.0 cm)

Exposure Condition	Mode	2G/3G/4G SAR (W/kg)	2.4 GHz WLAN SAR (W/kg)	Σ SAR (W/kg)
		1	2	1+2
Hotspot SAR	GPRS 850	0.504	0.129	0.633
	GPRS 1900	0.362	0.129	0.491
	UMTS 850	0.729	0.129	0.858
	UMTS 1750	1.039	0.129	1.168
	UMTS 1900	0.930	0.129	1.059
	LTE Band 12	0.585	0.129	0.714
	LTE Band 14	0.383	0.129	0.512
	LTE Band 5 (Cell)	0.633	0.129	0.762
	LTE Band 66 (AWS)	1.086	0.129	1.215
	LTE Band 2 (PCS)	0.820	0.129	0.949
	LTE Band 30	1.112	0.129	1.241

Table 12-7
Simultaneous Transmission Scenario with Bluetooth (Hotspot at 1.0 cm)

Exposure Condition	Mode	2G/3G/4G SAR (W/kg)	Bluetooth SAR (W/kg)	Σ SAR (W/kg)
		1	2	1+2
Hotspot SAR	GPRS 850	0.504	0.210	0.714
	GPRS 1900	0.362	0.210	0.572
	UMTS 850	0.729	0.210	0.939
	UMTS 1750	1.039	0.210	1.249
	UMTS 1900	0.930	0.210	1.140
	LTE Band 12	0.585	0.210	0.795
	LTE Band 14	0.383	0.210	0.593
	LTE Band 5 (Cell)	0.633	0.210	0.843
	LTE Band 66 (AWS)	1.086	0.210	1.296
	LTE Band 2 (PCS)	0.820	0.210	1.030
	LTE Band 30	1.112	0.210	1.322

Note: Bluetooth SAR was not required to be measured per FCC KDB Publication 447498 D01v06. Estimated SAR results were used in the above table to determine simultaneous transmission SAR test exclusion.

FCC ID: ZNFX420AS	 PCTEST ENGINEERING LABORATORY, INC.	SAR EVALUATION REPORT			Approved by: Quality Manager
Document S/N: 1M1905090070-01-R2.ZNF	Test Dates: 05/08/19 - 05/16/19	DUT Type: Portable Handset		Page 76 of 84	

12.6 Phablet Simultaneous Transmission Analysis

Per FCC KDB Publication 648474 D04 Handset SAR, Phablet SAR tests were not required if wireless router 1g SAR (scaled to the maximum output power, including tolerance) < 1.2 W/kg. Therefore, no further analysis beyond the tables included in this section was required to determine that possible simultaneous transmission scenarios would not exceed the SAR limit.

For SAR summation, the highest reported SAR across all test distances was used as the most conservative evaluation for simultaneous transmission analysis for each device edge.



**Table 12-8
Simultaneous Transmission Scenario with Bluetooth (Phablet)**

Mode	3G/4G SAR (W/kg)	Bluetooth SAR (W/kg)	Σ SAR (W/kg)
	1	2	1+2
UMTS 1750	3.125	0.168	3.293
UMTS 1900	3.073	0.168	3.241
LTE Band 66 (AWS)	3.166	0.168	3.334
LTE Band 2 (PCS)	3.078	0.168	3.246
LTE Band 30	1.797	0.168	1.965

Note: Bluetooth SAR was not required to be measured per FCC KDB Publication 447498 D01v06. Estimated SAR results were used in the above table to determine simultaneous transmission SAR test exclusion.

12.7 Simultaneous Transmission Conclusion

The above numerical summed SAR results for all the worst-case simultaneous transmission conditions were below the SAR limit. Therefore, the above analysis is sufficient to determine that simultaneous transmission cases will not exceed the SAR limit and therefore no measured volumetric simultaneous SAR summation is required per FCC KDB Publication 447498 D01v06 and IEEE 1528-2013 Section 6.3.4.1.2.

FCC ID: ZNFX420AS	 PCTEST ENGINEERING LABORATORY, INC.	SAR EVALUATION REPORT	 LG	Approved by: Quality Manager
Document S/N: 1M1905090070-01-R2.ZNF	Test Dates: 05/08/19 - 05/16/19	DUT Type: Portable Handset	Page 77 of 84	

13 SAR MEASUREMENT VARIABILITY

13.1 Measurement Variability



Per FCC KDB Publication 865664 D01v01r04, SAR measurement variability was assessed for each frequency band, which was determined by the SAR probe calibration point and tissue-equivalent medium used for the device measurements. When both head and body tissue-equivalent media were required for SAR measurements in a frequency band, the variability measurement procedures were applied to the tissue medium with the highest measured SAR, using the highest measured SAR configuration for that tissue-equivalent medium. These additional measurements were repeated after the completion of all measurements requiring the same head or body tissue-equivalent medium in a frequency band. The test device was returned to ambient conditions (normal room temperature) with the battery fully charged before it was re-mounted on the device holder for the repeated measurement(s) to minimize any unexpected variations in the repeated results.

SAR Measurement Variability was assessed using the following procedures for each frequency band:

- 1) When the original highest measured SAR is ≥ 0.80 W/kg, the measurement was repeated once.
- 2) A second repeated measurement was performed only if the ratio of largest to smallest SAR for the original and first repeated measurements was > 1.20 or when the original or repeated measurement was ≥ 1.45 W/kg (~ 10% from the 1g SAR limit).
- 3) A third repeated measurement was performed only if the original, first or second repeated measurement was ≥ 1.5 W/kg and the ratio of largest to smallest SAR for the original, first and second repeated measurements is > 1.20 .
- 4) Repeated measurements are not required when the original highest measured SAR is < 0.80 W/kg
- 5) When 10g SAR measurement is considered, a factor of 2.5 is applied to the thresholds above.

**Table 13-1
Body SAR Measurement Variability Results**

BODY VARIABILITY RESULTS													
Band	FREQUENCY		Mode	Service	Side	Spacing	Measured SAR (1g)	1st Repeated SAR (1g)	Ratio	2nd Repeated SAR (1g)	Ratio	3rd Repeated SAR (1g)	Ratio
	MHz	Ch.					(W/kg)	(W/kg)		(W/kg)		(W/kg)	
1750	1720.00	132072	LTE Band 66 (AWS), 20 MHz Bandwidth	QPSK, 1, 50 RB Offset	back	10 mm	1.030	0.916	1.12	N/A	N/A	N/A	N/A
1900	1880.00	9400	UMTS 1900	RMC	back	10 mm	0.846	0.836	1.01	N/A	N/A	N/A	N/A
2300	2310.00	27710	LTE Band 30, 10 MHz Bandwidth	QPSK, 1 RB, 25 RB Offset	bottom	10 mm	1.040	1.020	1.02	N/A	N/A	N/A	N/A
ANSI / IEEE C95.1 1992 - SAFETY LIMIT Spatial Peak Uncontrolled Exposure/General Population						Body 1.6 W/kg (mW/g) averaged over 1 gram							



FCC ID: ZNFX420AS			SAR EVALUATION REPORT			Approved by: Quality Manager
Document S/N: 1M1905090070-01-R2.ZNF	Test Dates: 05/08/19 - 05/16/19	DUT Type: Portable Handset		Page 78 of 84		

**Table 13-2
Phablet SAR Measurement Variability Results**

PHABLET VARIABILITY RESULTS													
Band	FREQUENCY		Mode	Service	Side	Spacing	Measured SAR (10g)	1st Repeated SAR (10g)	Ratio	2nd Repeated SAR (10g)	Ratio	3rd Repeated SAR (10g)	Ratio
	MHz	Ch.					(W/kg)	(W/kg)		(W/kg)		(W/kg)	
1750	1712.40	1312	UMTS 1750	RMC	back	0 mm	3.080	2.760	1.12	N/A	N/A	N/A	N/A
1900	1900.00	19100	LTE Band 2 (PCS), 20 MHz Bandwidth	QPSK, 1 RB, 50 RB Offset	left	0 mm	2.950	2.980	1.01	N/A	N/A	N/A	N/A
ANSI / IEEE C95.1 1992 - SAFETY LIMIT Spatial Peak Uncontrolled Exposure/General Population						Phablet 4.0 W/kg (mW/g) averaged over 10 grams							

13.2 Measurement Uncertainty



The measured SAR was <1.5 W/kg for 1g and <3.75 W/kg for 10g for all frequency bands. Therefore, per KDB Publication 865664 D01v01r04, the extended measurement uncertainty analysis per IEEE 1528-2013 was not required.

FCC ID: ZNFX420AS		SAR EVALUATION REPORT		Approved by: Quality Manager
Document S/N: 1M1905090070-01-R2.ZNF	Test Dates: 05/08/19 - 05/16/19	DUT Type: Portable Handset		Page 79 of 84

14 EQUIPMENT LIST



Manufacturer	Model	Description	Cal Date	Cal Interval	Cal Due	Serial Number
Agilent	8753E	(30kHz-6GHz) Network Analyzer	9/28/2018	Annual	9/28/2019	JP38020182
Agilent	E4438C	ESG Vector Signal Generator	6/22/2018	Annual	6/22/2019	MY53401181
Agilent	N5182A	MXG Vector Signal Generator	11/28/2018	Annual	11/28/2019	MY47420603
Agilent	8753ES	S-Parameter Network Analyzer	3/11/2019	Annual	3/11/2020	US39170122
Agilent	8753ES	S-Parameter Vector Network Analyzer	8/30/2018	Annual	8/30/2019	MY40003841
Agilent	E5515C	Wireless Communications Test Set	2/28/2018	Biennial	2/28/2020	GB41450275
Agilent	N4010A	Wireless Connectivity Test Set	N/A	N/A	N/A	GB46170464
Amplifier Research	1551G6	Amplifier	CBT	N/A	CBT	433971
Amplifier Research	1551G6	Amplifier	CBT	N/A	CBT	433972
Amplifier Research	1551G6	Amplifier	CBT	N/A	CBT	433974
Anritsu	ML2496A	Power Meter	6/19/2018	Annual	6/19/2019	1306009
Anritsu	MT8821C	Radio Communication Analyzer	11/6/2018	Annual	11/6/2019	6200901190
Anritsu	MT8820C	Radio Communication Analyzer	6/27/2018	Annual	6/27/2019	6201240328
Anritsu	MT8820C	Radio Communication Analyzer	3/29/2019	Annual	3/29/2020	6201300731
Anritsu	MA24106A	USB Power Sensor	6/5/2018	Annual	6/5/2019	1231538
Anritsu	MA24106A	USB Power Sensor	6/5/2018	Annual	6/5/2019	1231535
Anritsu	MT8862A	Wireless Connectivity Test Set	7/3/2018	Annual	7/3/2019	6261782395
Anritsu	MA2411B	Pulse Power Sensor	10/30/2018	Annual	10/30/2019	1126066
Anritsu	ML2495A	Power Meter	10/21/2018	Annual	10/21/2019	941001
COMTECH	AR85729-5/5759B	Solid State Amplifier	CBT	N/A	CBT	M3W1A00-1002
COMTECH	AR85729-5	Solid State Amplifier	CBT	N/A	CBT	M155A00-009
Control Company	4040	Therm./ Clock/ Humidity Monitor	1/8/2019	Annual	1/8/2020	160574418
Control Company	4352	Ultra Long Stem Thermometer	5/21/2018	Biennial	5/21/2020	181292061
Keysight	772D	Dual Directional Coupler	CBT	N/A	CBT	MY52180215
Keysight Technologies	85033E	Standard Mechanical Calibration Kit (DC to 9GHz, 3.5mm)	6/4/2018	Annual	6/4/2019	MY53401181
MCL	BW-N6W5+	6dB Attenuator	CBT	N/A	CBT	1139
MiniCircuits	SLP-2400+	Low Pass Filter	CBT	N/A	CBT	R8979500903
MiniCircuits	VLf-6000+	Low Pass Filter	CBT	N/A	CBT	N/A
MiniCircuits	VLf-6000+	Low Pass Filter	CBT	N/A	CBT	N/A
Mini-Circuits	BW-N20W5+	DC to 18 GHz Precision Fixed 20 dB Attenuator	CBT	N/A	CBT	N/A
Mini-Circuits	NLP-1200+	Low Pass Filter DC to 1000 MHz	CBT	N/A	CBT	N/A
Mini-Circuits	NLP-2950+	Low Pass Filter DC to 2700 MHz	CBT	N/A	CBT	N/A
Narda	4014C-6	4 - 8 GHz SMA 6 dB Directional Coupler	CBT	N/A	CBT	N/A
Narda	4772-3	Attenuator (3dB)	CBT	N/A	CBT	9406
Narda	BW-S3W2	Attenuator (3dB)	CBT	N/A	CBT	120
NI	4474	Data Acquisition Card	CBT	N/A	CBT	N/A
Pasternack	PE2208-6	Bidirectional Coupler	CBT	N/A	CBT	N/A
Pasternack	PE2209-10	Bidirectional Coupler	CBT	N/A	CBT	N/A
Pasternack	NC-100	Torque Wrench	11/1/2017	Biennial	11/1/2019	N/A
Rohde & Schwarz	CMW500	Radio Communication Tester	11/14/2018	Annual	11/14/2019	100976
Rohde & Schwarz	CMW500	Radio Communication Tester	6/8/2018	Annual	6/8/2019	112347
Rohde & Schwarz	CMU200	Base Station Simulator	5/18/2018	Annual	5/18/2019	109892
SPEAG	D1765V2	1765 MHz SAR Dipole	5/23/2018	Annual	5/23/2019	1008
SPEAG	D1900V2	1900 MHz SAR Dipole	10/23/2018	Annual	10/23/2019	5d080
SPEAG	D1900V2	1900 MHz SAR Dipole	10/23/2018	Annual	10/23/2019	5d149
SPEAG	D2300V2	2300 MHz SAR Dipole	11/8/2017	Biennial	11/8/2019	1064
SPEAG	D2300V2	2300 MHz SAR Dipole	8/13/2018	Annual	8/13/2019	1073
SPEAG	D2450V2	2450 MHz SAR Dipole	8/17/2017	Biennial	8/17/2019	719
SPEAG	D2450V2	2450 MHz SAR Dipole	8/16/2018	Annual	8/16/2019	981
SPEAG	D750V3	750 MHz SAR Dipole	1/15/2018	Biennial	1/15/2020	1003
SPEAG	D750V3	750 MHz SAR Dipole	10/19/2018	Annual	10/19/2019	1161
SPEAG	D835V2	835 MHz SAR Dipole	1/22/2019	Annual	1/22/2020	4d132
SPEAG	D835V2	835 MHz SAR Dipole	10/19/2018	Annual	10/19/2019	4d133
SPEAG	DAE4	Dasy Data Acquisition Electronics	2/13/2019	Annual	2/13/2020	665
SPEAG	DAE4	Dasy Data Acquisition Electronics	2/14/2019	Annual	2/14/2020	1272
SPEAG	DAE4	Dasy Data Acquisition Electronics	6/18/2018	Annual	6/18/2019	1334
SPEAG	DAE4	Dasy Data Acquisition Electronics	4/18/2019	Annual	4/18/2020	1407
SPEAG	DAE4	Dasy Data Acquisition Electronics	7/11/2018	Annual	7/11/2019	1322
SPEAG	DAE4	Dasy Data Acquisition Electronics	8/22/2018	Annual	8/22/2019	1450
SPEAG	DAE4	Dasy Data Acquisition Electronics	10/3/2018	Annual	10/3/2019	1558
SPEAG	DAE4	Dasy Data Acquisition Electronics	1/15/2019	Annual	1/15/2020	1530
SPEAG	DAK-3.5	Dielectric Assessment Kit	9/11/2018	Annual	9/11/2019	1091
SPEAG	EX3DV4	SAR Probe	1/25/2019	Annual	1/25/2020	3589
SPEAG	EX3DV4	SAR Probe	2/19/2019	Annual	2/19/2020	3914
SPEAG	EX3DV4	SAR Probe	8/23/2018	Annual	8/23/2019	7308
SPEAG	EX3DV4	SAR Probe	4/24/2019	Annual	4/24/2020	7357
SPEAG	EX3DV4	SAR Probe	1/24/2019	Annual	1/24/2020	7488
SPEAG	EX3DV4	SAR Probe	6/25/2018	Annual	6/25/2019	7409
SPEAG	EX3DV4	SAR Probe	7/20/2018	Annual	7/20/2019	7410
SPEAG	EX3DV4	SAR Probe	2/19/2019	Annual	2/19/2020	7417

Note 1: CBT (Calibrated Before Testing). Prior to testing, the measurement paths containing a cable, amplifier, attenuator, coupler or filter were connected to a calibrated source (i.e. a signal generator) to determine the losses of the measurement path. The power meter offset was then adjusted to compensate for the measurement system losses. This level offset is stored within the power meter before measurements are made. This calibration verification procedure applies to the system verification and output power measurements. The calibrated reading is then taken directly from the power meter after compensation of the losses for all final power measurements.

FCC ID: ZNFX420AS		SAR EVALUATION REPORT		Approved by: Quality Manager
Document S/N: 1M1905090070-01-R2-ZNF	Test Dates: 05/08/19 - 05/16/19	DUT Type: Portable Handset		Page 80 of 84

15 MEASUREMENT UNCERTAINTIES

a	c	d	e= f(d,k)	f	g	h = c x f/e	i = c x g/e	k
Uncertainty Component	Tol. (± %)	Prob. Dist.	Div.	c _i 1gm	c _i 10 gms	1gm u _i (± %)	10gms u _i (± %)	v _i
Measurement System								
Probe Calibration	6.55	N	1	1.0	1.0	6.6	6.6	∞
Axial Isotropy	0.25	N	1	0.7	0.7	0.2	0.2	∞
Hemishperical Isotropy	1.3	N	1	0.7	0.7	0.9	0.9	∞
Boundary Effect	2.0	R	1.73	1.0	1.0	1.2	1.2	∞
Linearity	0.3	N	1	1.0	1.0	0.3	0.3	∞
System Detection Limits	0.25	R	1.73	1.0	1.0	0.1	0.1	∞
Readout Electronics	0.3	N	1	1.0	1.0	0.3	0.3	∞
Response Time	0.8	R	1.73	1.0	1.0	0.5	0.5	∞
Integration Time	2.6	R	1.73	1.0	1.0	1.5	1.5	∞
RF Ambient Conditions - Noise	3.0	R	1.73	1.0	1.0	1.7	1.7	∞
RF Ambient Conditions - Reflections	3.0	R	1.73	1.0	1.0	1.7	1.7	∞
Probe Positioner Mechanical Tolerance	0.4	R	1.73	1.0	1.0	0.2	0.2	∞
Probe Positioning w/ respect to Phantom	6.7	R	1.73	1.0	1.0	3.9	3.9	∞
Extrapolation, Interpolation & Integration algorithms for Max. SAR Evaluation	4.0	R	1.73	1.0	1.0	2.3	2.3	∞
Test Sample Related								
Test Sample Positioning	2.7	N	1	1.0	1.0	2.7	2.7	35
Device Holder Uncertainty	1.67	N	1	1.0	1.0	1.7	1.7	5
Output Power Variation - SAR drift measurement	5.0	R	1.73	1.0	1.0	2.9	2.9	∞
SAR Scaling	0.0	R	1.73	1.0	1.0	0.0	0.0	∞
Phantom & Tissue Parameters								
Phantom Uncertainty (Shape & Thickness tolerances)	7.6	R	1.73	1.0	1.0	4.4	4.4	∞
Liquid Conductivity - measurement uncertainty	4.2	N	1	0.78	0.71	3.3	3.0	10
Liquid Permittivity - measurement uncertainty	4.1	N	1	0.23	0.26	1.0	1.1	10
Liquid Conductivity - Temperature Uncertainty	3.4	R	1.73	0.78	0.71	1.5	1.4	∞
Liquid Permittivity - Temperature Uncertainty	0.6	R	1.73	0.23	0.26	0.1	0.1	∞
Liquid Conductivity - deviation from target values	5.0	R	1.73	0.64	0.43	1.8	1.2	∞
Liquid Permittivity - deviation from target values	5.0	R	1.73	0.60	0.49	1.7	1.4	∞
Combined Standard Uncertainty (k=1)	RSS					11.5	11.3	60
Expanded Uncertainty (95% CONFIDENCE LEVEL)	k=2					23.0	22.6	



FCC ID: ZNFX420AS	 SAR EVALUATION REPORT 		Approved by: Quality Manager
Document S/N: 1M1905090070-01-R2.ZNF	Test Dates: 05/08/19 - 05/16/19	DUT Type: Portable Handset	Page 81 of 84

16 CONCLUSION

16.1 Measurement Conclusion



The SAR evaluation indicates that the EUT complies with the RF radiation exposure limits of the FCC and Innovation, Science, and Economic Development Canada, with respect to all parameters subject to this test. These measurements were taken to simulate the RF effects of RF exposure under worst-case conditions. Precise laboratory measures were taken to assure repeatability of the tests. The results and statements relate only to the item(s) tested.

Please note that the absorption and distribution of electromagnetic energy in the body are very complex phenomena that depend on the mass, shape, and size of the body, the orientation of the body with respect to the field vectors, and the electrical properties of both the body and the environment. Other variables that may play a substantial role in possible biological effects are those that characterize the environment (e.g. ambient temperature, air velocity, relative humidity, and body insulation) and those that characterize the individual (e.g. age, gender, activity level, debilitation, or disease). Because various factors may interact with one another to vary the specific biological outcome of an exposure to electromagnetic fields, any protection guide should consider maximal amplification of biological effects as a result of field-body interactions, environmental conditions, and physiological variables. [3]



FCC ID: ZNFX420AS	 PCTEST ENGINEERING LABORATORY, INC.	SAR EVALUATION REPORT	 LG	Approved by: Quality Manager
Document S/N: 1M1905090070-01-R2.ZNF	Test Dates: 05/08/19 - 05/16/19	DUT Type: Portable Handset		Page 82 of 84

17 REFERENCES

- [1] Federal Communications Commission, ET Docket 93-62, Guidelines for Evaluating the Environmental Effects of Radiofrequency Radiation, Aug. 1996.
- [2] ANSI/IEEE C95.1-2005, American National Standard safety levels with respect to human exposure to radio frequency electromagnetic fields, 3kHz to 300GHz, New York: IEEE, 2006.
- [3] ANSI/IEEE C95.1-1992, American National Standard safety levels with respect to human exposure to radio frequency electromagnetic fields, 3kHz to 300GHz, New York: IEEE, Sept. 1992.
- [4] ANSI/IEEE C95.3-2002, IEEE Recommended Practice for the Measurement of Potentially Hazardous Electromagnetic Fields - RF and Microwave, New York: IEEE, December 2002.
- [5] IEEE Standards Coordinating Committee 39 –Standards Coordinating Committee 34 – IEEE Std. 1528-2013, IEEE Recommended Practice for Determining the Peak Spatial-Average Specific Absorption Rate (SAR) in the Human Head from Wireless Communications Devices: Measurement Techniques.
- [6] NCRP, National Council on Radiation Protection and Measurements, Biological Effects and Exposure Criteria for RadioFrequency Electromagnetic Fields, NCRP Report No. 86, 1986. Reprinted Feb. 1995.
- [7] T. Schmid, O. Egger, N. Kuster, Automated E-field scanning system for dosimetric assessments, IEEE Transaction on Microwave Theory and Techniques, vol. 44, Jan. 1996, pp. 105-113.
- [8] K. Pokovic, T. Schmid, N. Kuster, Robust setup for precise calibration of E-field probes in tissue simulating liquids at mobile communications frequencies, ICECOM97, Oct. 1997, pp. 1 -124.
- [9] K. Pokovic, T. Schmid, and N. Kuster, E-field Probe with improved isotropy in brain simulating liquids, Proceedings of the ELMAR, Zadar, Croatia, June 23-25, 1996, pp. 172-175.
- [10] Schmid & Partner Engineering AG, Application Note: Data Storage and Evaluation, June 1998, p2.
- [11] V. Hombach, K. Meier, M. Burkhardt, E. Kuhn, N. Kuster, The Dependence of EM Energy Absorption upon Human Modeling at 900 MHz, IEEE Transaction on Microwave Theory and Techniques, vol. 44 no. 10, Oct. 1996, pp. 1865-1873.
- [12] N. Kuster and Q. Balzano, Energy absorption mechanism by biological bodies in the near field of dipole antennas above 300MHz, IEEE Transaction on Vehicular Technology, vol. 41, no. 1, Feb. 1992, pp. 17-23.
- [13] G. Hartsgrove, A. Kraszewski, A. Surowiec, Simulated Biological Materials for Electromagnetic Radiation Absorption Studies, University of Ottawa, Bioelectromagnetics, Canada: 1987, pp. 29-36.
- [14] Q. Balzano, O. Garay, T. Manning Jr., Electromagnetic Energy Exposure of Simulated Users of Portable Cellular Telephones, IEEE Transactions on Vehicular Technology, vol. 44, no.3, Aug. 1995.
- [15] W. Gander, Computermathematick, Birkhaeuser, Basel, 1992.
- [16] W.H. Press, S.A. Teukolsky, W.T. Vetterling, and B.P. Flannery, Numerical Recipes in C, The Art of Scientific Computing, Second edition, Cambridge University Press, 1992.
- [17] N. Kuster, R. Kastle, T. Schmid, Dosimetric evaluation of mobile communications equipment with known precision, IEEE Transaction on Communications, vol. E80-B, no. 5, May 1997, pp. 645-652.

FCC ID: ZNFX420AS	 PCTEST <small>ENGINEERING LABORATORY, INC.</small>		SAR EVALUATION REPORT		Approved by: Quality Manager
Document S/N: 1M1905090070-01-R2.ZNF	Test Dates: 05/08/19 - 05/16/19	DUT Type: Portable Handset		Page 83 of 84	

- [18] CENELEC CLC/SC111B, European Prestandard (prENV 50166-2), Human Exposure to Electromagnetic Fields High-frequency: 10kHz-300GHz, Jan. 1995.
- [19] Prof. Dr. Niels Kuster, ETH, Eidgenössische Technische Hochschule Zürich, Dosimetric Evaluation of the Cellular Phone.
- [20] IEC 62209-1, Measurement procedure for the assessment of specific absorption rate of human exposure to radio frequency fields from hand-held and body-mounted wireless communication devices - Part 1: Devices used next to the ear (Frequency range of 300 MHz to 6 GHz), July 2016.
- [21] Innovation, Science, Economic Development Canada RSS-102 Radio Frequency Exposure Compliance of Radiocommunication Apparatus (All Frequency Bands) Issue 5, March 2015.
- [22] Health Canada Safety Code 6 Limits of Human Exposure to Radio Frequency Electromagnetic Fields in the Frequency Range from 3 kHz – 300 GHz, 2015
- [23] FCC SAR Test Procedures for 2G-3G Devices, Mobile Hotspot and UMPC Devices KDB Publications 941225, D01-D07
- [24] SAR Measurement Guidance for IEEE 802.11 Transmitters, KDB Publication 248227 D01
- [25] FCC SAR Considerations for Handsets with Multiple Transmitters and Antennas, KDB Publications 648474 D03-D04
- [26] FCC SAR Evaluation Considerations for Laptop, Notebook, Netbook and Tablet Computers, FCC KDB Publication 616217 D04
- [27] FCC SAR Measurement and Reporting Requirements for 100MHz – 6 GHz, KDB Publications 865664 D01-D02
- [28] FCC General RF Exposure Guidance and SAR Procedures for Dongles, KDB Publication 447498, D01-D02
- [29] Anexo à Resolução No. 533, de 10 de Setembro de 2009.
- [30] IEC 62209-2, Human exposure to radio frequency fields from hand-held and body-mounted wireless communication devices - Human models, instrumentation, and procedures - Part 2: Procedure to determine the specific absorption rate (SAR) for wireless communication devices used in close proximity to the human body (frequency range of 30 MHz to 6 GHz), Mar. 2010.

FCC ID: ZNFX420AS	 SAR EVALUATION REPORT 		Approved by: Quality Manager
Document S/N: 1M1905090070-01-R2.ZNF	Test Dates: 05/08/19 - 05/16/19	DUT Type: Portable Handset	Page 84 of 84

APPENDIX A: SAR TEST DATA

PCTEST ENGINEERING LABORATORY, INC.

DUT: ZNFX420AS; Type: Portable Handset; Serial: 51576

Communication System: UID 0, _GSM GPRS; 2 Tx slots; Frequency: 836.6 MHz; Duty Cycle: 1:4.15

Medium: 835 Head Medium parameters used (interpolated):

$f = 836.6 \text{ MHz}$; $\sigma = 0.902 \text{ S/m}$; $\epsilon_r = 40.74$; $\rho = 1000 \text{ kg/m}^3$

Phantom section: Right Section

Test Date: 05-14-2019; Ambient Temp: 22.0°C; Tissue Temp: 20.8°C

Probe: EX3DV4 - SN3589; ConvF(8.39, 8.39, 8.39); Calibrated: 1/25/2019;

Sensor-Surface: 1.4mm (Mechanical Surface Detection)

Electronics: DAE4 Sn1450; Calibrated: 8/22/2018

Phantom: SAM 5.0 front; Type: QD000P40CD; Serial: 1648

Measurement SW: DASY52, Version 52.10 (2);SEMCAD X Version 14.6.12 (7450)

Mode: GPRS 850, Right Head, Cheek, Mid.ch, 2 Tx slots

Area Scan (9x15x1): Measurement grid: dx=15mm, dy=15mm

Zoom Scan (6x5x7)/Cube 0: Measurement grid: dx=8mm, dy=8mm, dz=5mm

Reference Value = 22.00 V/m; Power Drift = -0.04 dB

Peak SAR (extrapolated) = 0.554 W/kg

SAR(1 g) = 0.433 W/kg

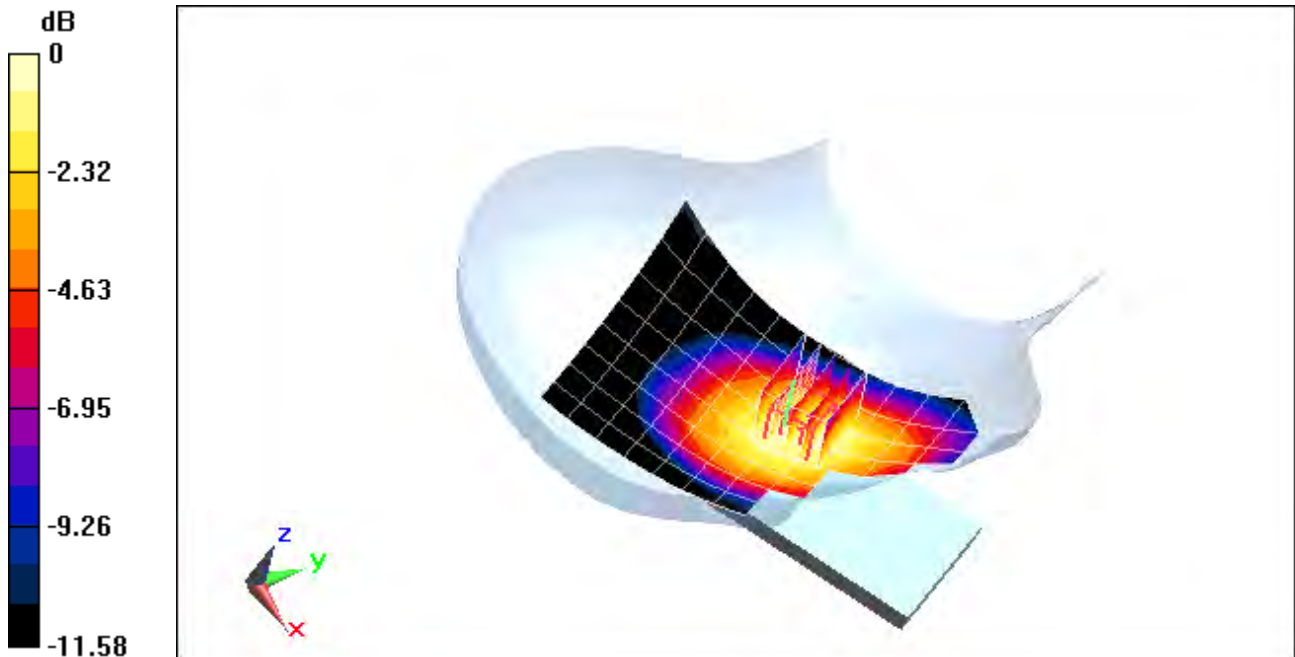

0 dB = 0.516 W/kg = -2.87 dBW/kg

PCTEST ENGINEERING LABORATORY, INC.

DUT: ZNFX420AS; Type: Portable Handset; Serial: 51576

Communication System: UID 0, _GSM GPRS; 2 Tx slots; Frequency: 1880 MHz; Duty Cycle: 1:4.15

Medium: 1900 Head Medium parameters used:

$f = 1880 \text{ MHz}$; $\sigma = 1.437 \text{ S/m}$; $\epsilon_r = 38.657$; $\rho = 1000 \text{ kg/m}^3$

Phantom section: Left Section

Test Date: 05-12-2019; Ambient Temp: 21.3°C; Tissue Temp: 21.1°C

Probe: EX3DV4 - SN7410; ConvF(8.16, 8.16, 8.16); Calibrated: 7/20/2018;

Sensor-Surface: 1.4mm (Mechanical Surface Detection)

Electronics: DAE4 Sn1322; Calibrated: 7/11/2018

Phantom: Front; Type: QD 000 P40 CD; Serial: 1686

Measurement SW: DASY52, Version 52.10 (2);SEMCAD X Version 14.6.12 (7450)

Mode: GPRS 1900, Left Head, Cheek, Mid.ch, 2 Tx slots

Area Scan (9x15x1): Measurement grid: dx=15mm, dy=15mm

Zoom Scan (5x5x7)/Cube 0: Measurement grid: dx=8mm, dy=8mm, dz=5mm

Reference Value = 13.52 V/m; Power Drift = 0.06 dB

Peak SAR (extrapolated) = 0.364 W/kg

SAR(1 g) = 0.242 W/kg

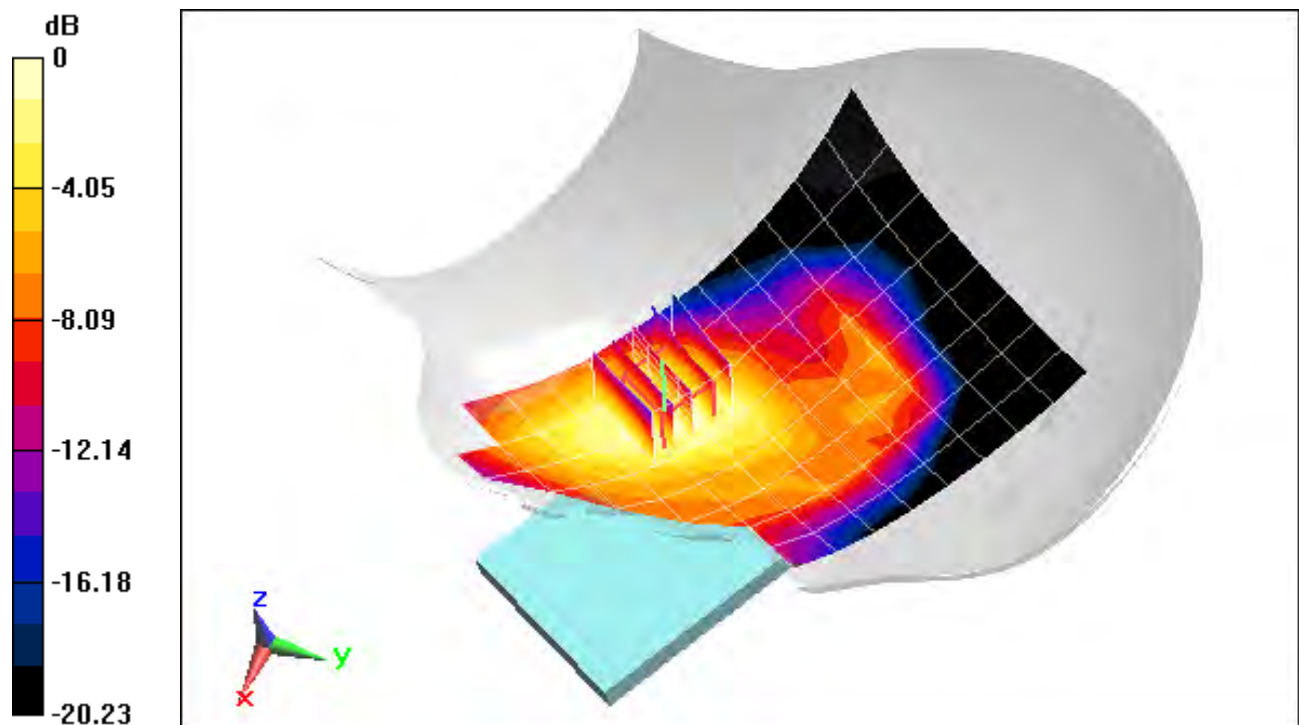

0 dB = 0.319 W/kg = -4.96 dBW/kg

PCTEST ENGINEERING LABORATORY, INC.

DUT: ZNFX420AS; Type: Portable Handset; Serial: 51576

Communication System: UID 0, UMTS; Frequency: 836.6 MHz; Duty Cycle: 1:1
Medium: 835 Head Medium parameters used (interpolated):
 $f = 836.6 \text{ MHz}$; $\sigma = 0.902 \text{ S/m}$; $\epsilon_r = 40.74$; $\rho = 1000 \text{ kg/m}^3$
Phantom section: Right Section

Test Date: 05-14-2019; Ambient Temp: 22.0°C; Tissue Temp: 20.8°C

Probe: EX3DV4 - SN3589; ConvF(8.39, 8.39, 8.39); Calibrated: 1/25/2019;
Sensor-Surface: 1.4mm (Mechanical Surface Detection)
Electronics: DAE4 Sn1450; Calibrated: 8/22/2018
Phantom: SAM 5.0 front; Type: QD000P40CD; Serial: 1648
Measurement SW: DASY52, Version 52.10 (2);SEMCAD X Version 14.6.12 (7450)

Mode: UMTS 850, Right Head, Cheek, Mid.ch

Area Scan (9x15x1): Measurement grid: dx=15mm, dy=15mm

Zoom Scan (6x5x7)/Cube 0: Measurement grid: dx=8mm, dy=8mm, dz=5mm

Reference Value = 23.24 V/m; Power Drift = 0.00 dB

Peak SAR (extrapolated) = 0.630 W/kg

SAR(1 g) = 0.481 W/kg

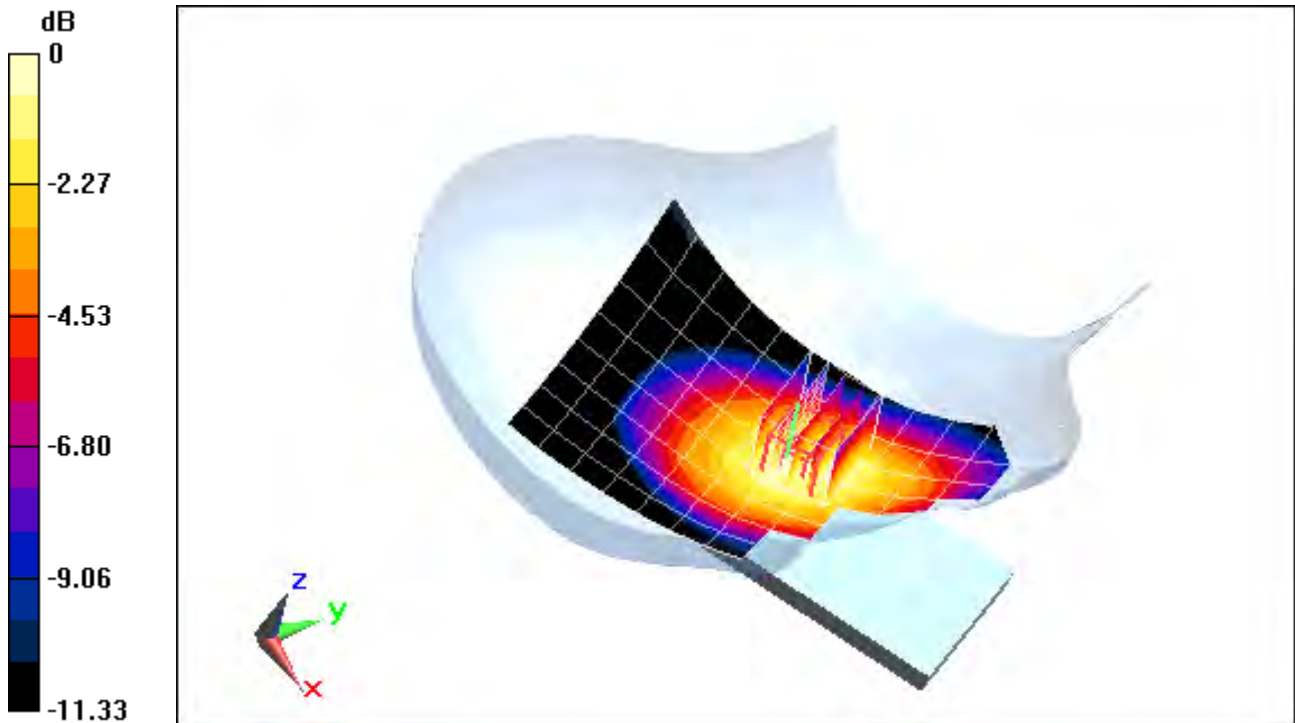

0 dB = 0.581 W/kg = -2.36 dBW/kg

PCTEST ENGINEERING LABORATORY, INC.

DUT: ZNFX420AS; Type: Portable Handset; Serial: 51592

Communication System: UID 0, UMTS; Frequency: 1732.4 MHz; Duty Cycle: 1:1
Medium: 1750 Head Medium parameters used (interpolated):
 $f = 1732.4 \text{ MHz}$; $\sigma = 1.36 \text{ S/m}$; $\epsilon_r = 42.093$; $\rho = 1000 \text{ kg/m}^3$
Phantom section: Left Section

Test Date: 05-14-2019; Ambient Temp: 20.2°C; Tissue Temp: 20.4°C

Probe: EX3DV4 - SN7409; ConvF(8.43, 8.43, 8.43); Calibrated: 6/25/2018;
Sensor-Surface: 1.4mm (Mechanical Surface Detection)
Electronics: DAE4 Sn1334; Calibrated: 6/18/2018

Phantom: SAM 30 with CRP v5.0 right; Type: QD000P40CD; Serial: TP:1759
Measurement SW: DASY52, Version 52.10 (2);SEMCAD X Version 14.6.12 (7450)

Mode: UMTS 1750, Left Head, Cheek, Mid.ch

Area Scan (9x15x1): Measurement grid: dx=15mm, dy=15mm

Zoom Scan (5x5x7)/Cube 0: Measurement grid: dx=8mm, dy=8mm, dz=5mm

Reference Value = 16.85 V/m; Power Drift = 0.01 dB

Peak SAR (extrapolated) = 0.550 W/kg

SAR(1 g) = 0.364 W/kg

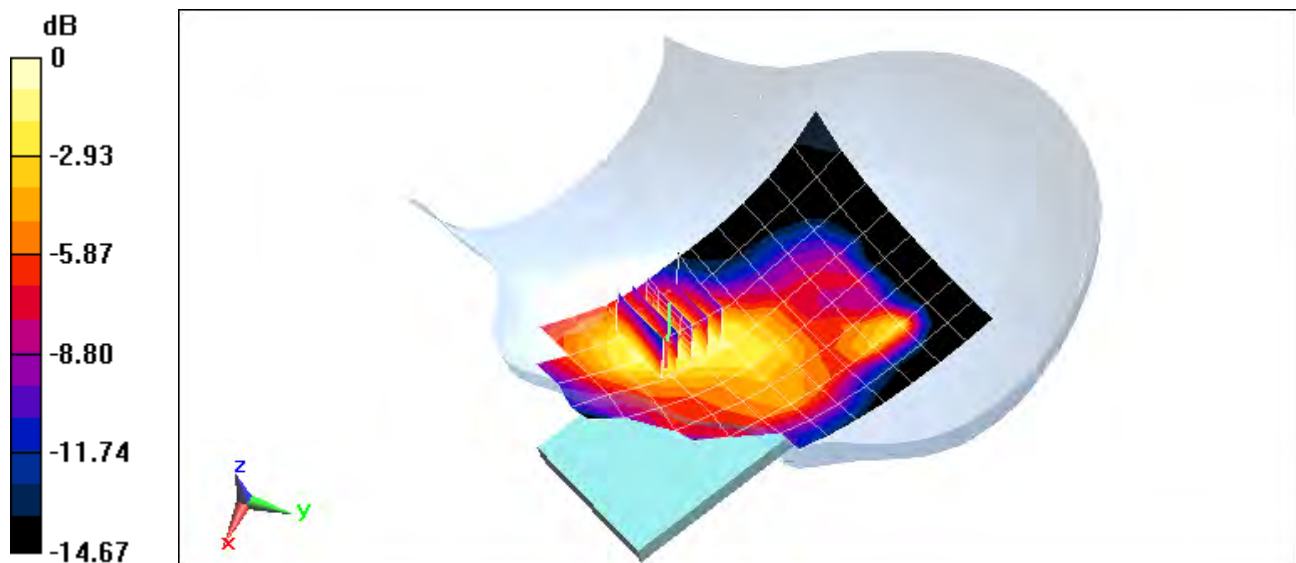

0 dB = 0.484 W/kg = -3.15 dBW/kg

PCTEST ENGINEERING LABORATORY, INC.

DUT: ZNFX420AS; Type: Portable Handset; Serial: 51576

Communication System: UID 0, UMTS; Frequency: 1880 MHz; Duty Cycle: 1:1
Medium: 1900 Head Medium parameters used:
 $f = 1880 \text{ MHz}$; $\sigma = 1.437 \text{ S/m}$; $\epsilon_r = 38.657$; $\rho = 1000 \text{ kg/m}^3$
Phantom section: Left Section

Test Date: 05-12-2019; Ambient Temp: 21.3°C; Tissue Temp: 21.1°C

Probe: EX3DV4 - SN7410; ConvF(8.16, 8.16, 8.16); Calibrated: 7/20/2018;
Sensor-Surface: 1.4mm (Mechanical Surface Detection)
Electronics: DAE4 Sn1322; Calibrated: 7/11/2018
Phantom: Front; Type: QD 000 P40 CD; Serial: 1686
Measurement SW: DASY52, Version 52.10 (2);SEMCAD X Version 14.6.12 (7450)

Mode: UMTS 1900, Left Head, Cheek, Mid.ch

Area Scan (9x15x1): Measurement grid: dx=15mm, dy=15mm

Zoom Scan (5x5x7)/Cube 0: Measurement grid: dx=8mm, dy=8mm, dz=5mm

Reference Value = 19.61 V/m; Power Drift = 0.01 dB

Peak SAR (extrapolated) = 0.789 W/kg

SAR(1 g) = 0.508 W/kg

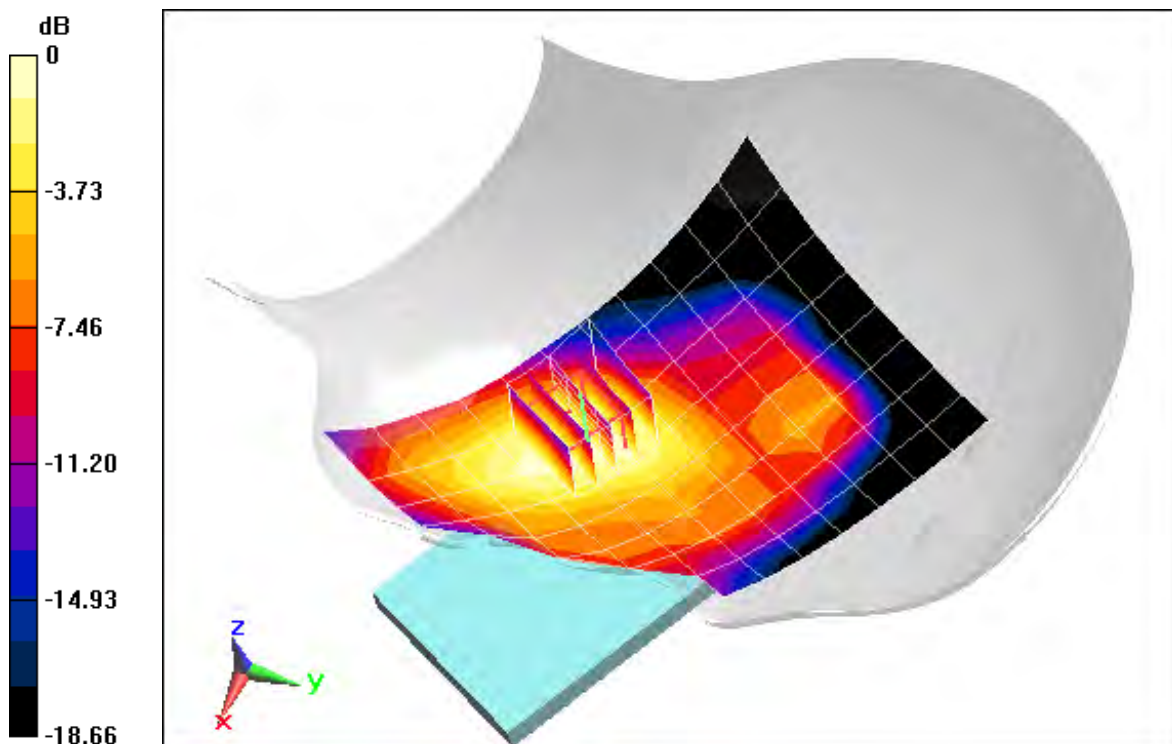

0 dB = 0.658 W/kg = -1.82 dBW/kg

PCTEST ENGINEERING LABORATORY, INC.

DUT: ZNFX420AS; Type: Portable Handset; Serial: 51576

Communication System: UID 0, LTE Band 12; Frequency: 707.5 MHz; Duty Cycle: 1:1

Medium: 750 Head Medium parameters used (interpolated):

$f = 707.5$ MHz; $\sigma = 0.903$ S/m; $\epsilon_r = 43.005$; $\rho = 1000$ kg/m³

Phantom section: Right Section

Test Date: 05-09-2019; Ambient Temp: 23.1°C; Tissue Temp: 22.3°C

Probe: EX3DV4 - SN3914; ConvF(10, 10, 10); Calibrated: 2/19/2019;

Sensor-Surface: 1.4mm (Mechanical Surface Detection)

Electronics: DAE4 Sn1272; Calibrated: 2/14/2019

Phantom: Left For Head SAM with CRP v5.0; Type: QD000P40CD; Serial: TP:1687

Measurement SW: DASY52, Version 52.10 (2);SEMCAD X Version 14.6.12 (7450)

**Mode: LTE Band 12, Right Head, Cheek, Mid.ch,
10 MHz Bandwidth, QPSK, 1 RB, 0 RB Offset**

Area Scan (9x14x1): Measurement grid: dx=15mm, dy=15mm

Zoom Scan (5x5x7)/Cube 0: Measurement grid: dx=8mm, dy=8mm, dz=5mm

Reference Value = 19.05 V/m; Power Drift = -0.03 dB

Peak SAR (extrapolated) = 0.369 W/kg

SAR(1 g) = 0.295 W/kg

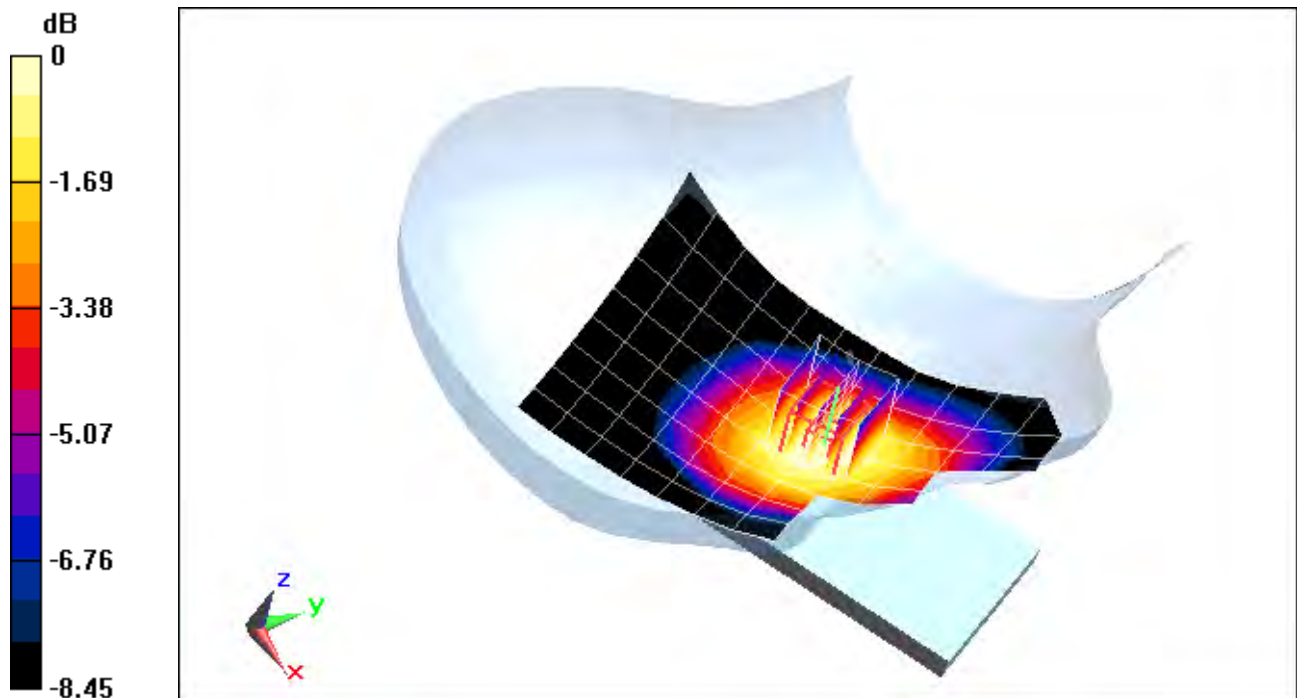

0 dB = 0.346 W/kg = -4.61 dBW/kg

PCTEST ENGINEERING LABORATORY, INC.

DUT: ZNFX420AS; Type: Portable Handset; Serial: 51576

Communication System: UID 0, LTE Band 14; Frequency: 793 MHz; Duty Cycle: 1:1

Medium: 750 Head Medium parameters used (interpolated):

$f = 793 \text{ MHz}$; $\sigma = 0.933 \text{ S/m}$; $\epsilon_r = 42.754$; $\rho = 1000 \text{ kg/m}^3$

Phantom section: Right Section

Test Date: 05-09-2019; Ambient Temp: 23.1°C; Tissue Temp: 22.3°C

Probe: EX3DV4 - SN3914; ConvF(10, 10, 10); Calibrated: 2/19/2019;

Sensor-Surface: 1.4mm (Mechanical Surface Detection)

Electronics: DAE4 Sn1272; Calibrated: 2/14/2019

Phantom: Left For Head SAM with CRP v5.0; Type: QD000P40CD; Serial: TP:1687

Measurement SW: DASY52, Version 52.10 (2);SEMCAD X Version 14.6.12 (7450)

**Mode: LTE Band 14, Right Head, Cheek, Mid.ch,
10 MHz Bandwidth, QPSK, 1 RB, 25 RB Offset**

Area Scan (9x14x1): Measurement grid: dx=15mm, dy=15mm

Zoom Scan (6x5x7)/Cube 0: Measurement grid: dx=8mm, dy=8mm, dz=5mm

Reference Value = 16.95 V/m; Power Drift = 0.00 dB

Peak SAR (extrapolated) = 0.312 W/kg

SAR(1 g) = 0.244 W/kg

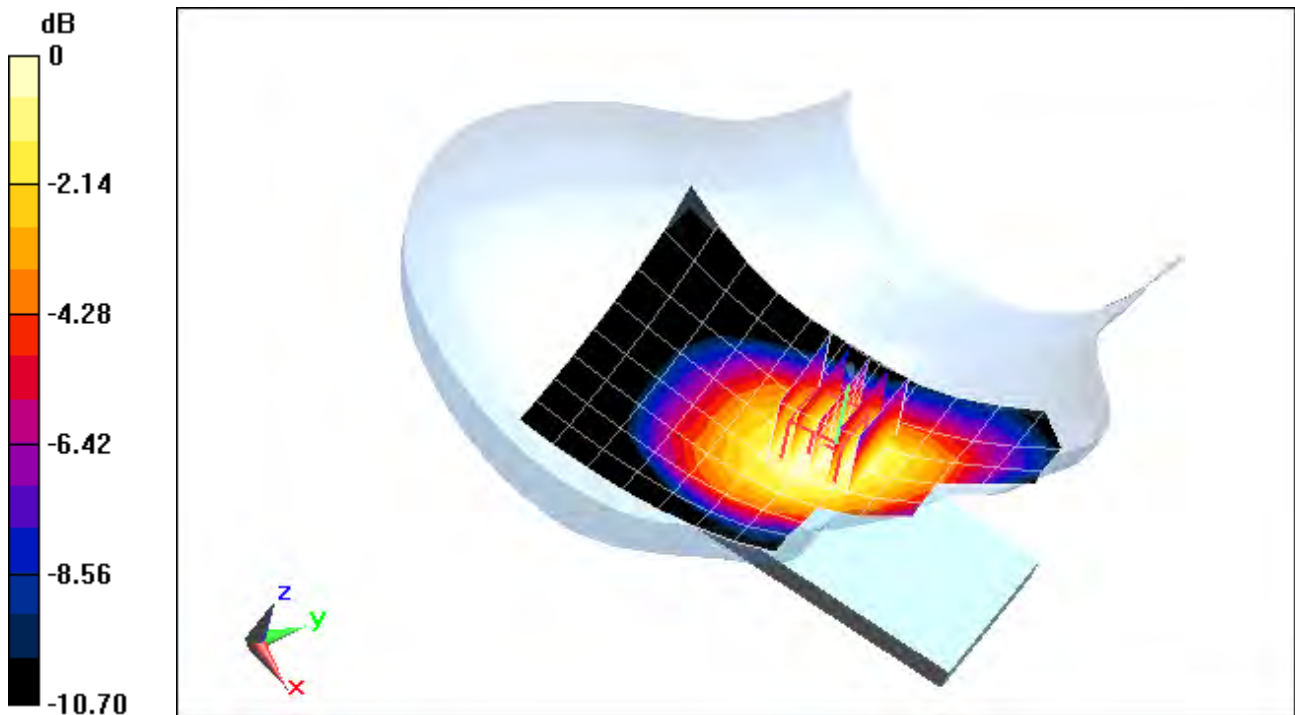

0 dB = 0.288 W/kg = -5.41 dBW/kg

PCTEST ENGINEERING LABORATORY, INC.

DUT: ZNFX420AS; Type: Portable Handset; Serial: 51576

Communication System: UID 0, LTE Band 5 (Cell.); Frequency: 836.5 MHz; Duty Cycle: 1:1
Medium: 835 Head Medium parameters used (interpolated):
 $f = 836.5$ MHz; $\sigma = 0.902$ S/m; $\epsilon_r = 40.741$; $\rho = 1000$ kg/m³
Phantom section: Right Section

Test Date: 05-14-2019; Ambient Temp: 22.0°C; Tissue Temp: 20.8°C

Probe: EX3DV4 - SN3589; ConvF(8.39, 8.39, 8.39); Calibrated: 1/25/2019;
Sensor-Surface: 1.4mm (Mechanical Surface Detection)
Electronics: DAE4 Sn1450; Calibrated: 8/22/2018
Phantom: SAM 5.0 front; Type: QD000P40CD; Serial: 1648
Measurement SW: DASY52, Version 52.10 (2);SEMCAD X Version 14.6.12 (7450)

**Mode: LTE Band 5 (Cell.), Right Head, Cheek, Mid.ch,
10 MHz Bandwidth, QPSK, 1 RB, 25 RB Offset**

Area Scan (9x15x1): Measurement grid: dx=15mm, dy=15mm

Zoom Scan (5x5x7)/Cube 0: Measurement grid: dx=8mm, dy=8mm, dz=5mm

Reference Value = 25.20 V/m; Power Drift = 0.05 dB

Peak SAR (extrapolated) = 0.696 W/kg

SAR(1 g) = 0.512 W/kg

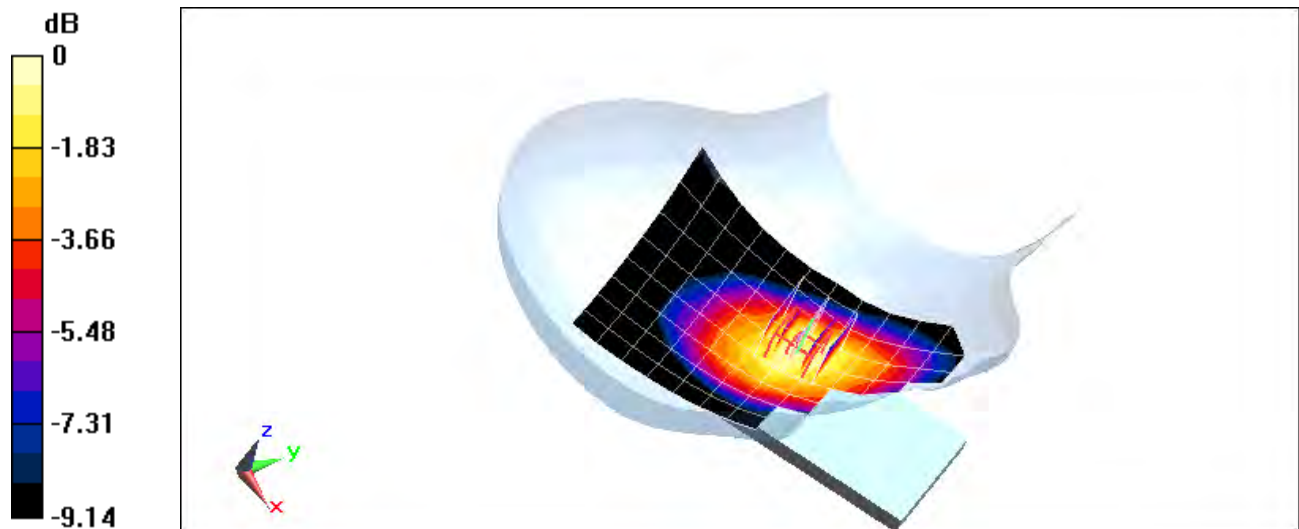

0 dB = 0.645 W/kg = -1.90 dBW/kg

PCTEST ENGINEERING LABORATORY, INC.

DUT: ZNFX420AS; Type: Portable Handset; Serial: 51592

Communication System: UID 0, LTE Band 66 (AWS); Frequency: 1720 MHz; Duty Cycle: 1:1

Medium: 1750 Head Medium parameters used (interpolated):

$f = 1720 \text{ MHz}$; $\sigma = 1.352 \text{ S/m}$; $\epsilon_r = 42.11$; $\rho = 1000 \text{ kg/m}^3$

Phantom section: Left Section

Test Date: 05-14-2019; Ambient Temp: 20.2°C; Tissue Temp: 20.4°C

Probe: EX3DV4 - SN7409; ConvF(8.43, 8.43, 8.43); Calibrated: 6/25/2018;

Sensor-Surface: 1.4mm (Mechanical Surface Detection)

Electronics: DAE4 Sn1334; Calibrated: 6/18/2018

Phantom: SAM 30 with CRP v5.0 right; Type: QD000P40CD; Serial: TP:1759

Measurement SW: DASY52, Version 52.10 (2);SEMCAD X Version 14.6.12 (7450)

**Mode: LTE Band 66 (AWS), Left Head, Cheek, Low.ch,
20 MHz Bandwidth, QPSK, 1 RB, 50 RB Offset**

Area Scan (9x15x1): Measurement grid: dx=15mm, dy=15mm

Zoom Scan (5x5x7)/Cube 0: Measurement grid: dx=8mm, dy=8mm, dz=5mm

Reference Value = 18.47 V/m; Power Drift = -0.02 dB

Peak SAR (extrapolated) = 0.614 W/kg

SAR(1 g) = 0.391 W/kg

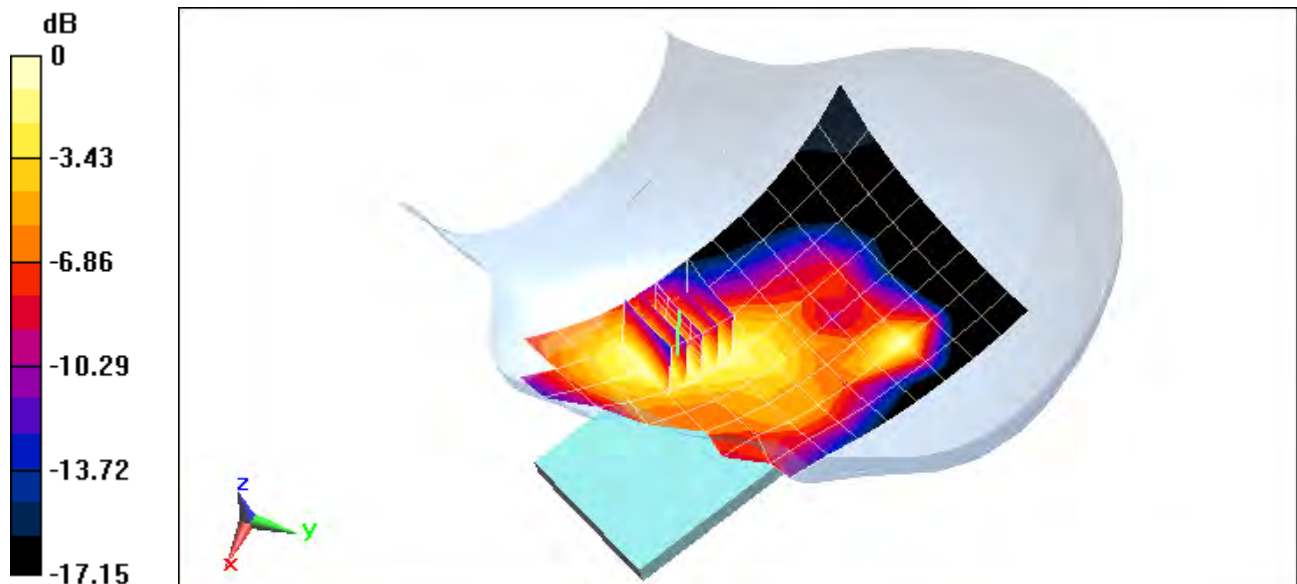

0 dB = 0.527 W/kg = -2.78 dBW/kg

PCTEST ENGINEERING LABORATORY, INC.

DUT: ZNFX420AS; Type: Portable Handset; Serial: 51576

Communication System: UID 0, _LTE Band 2 (PCS); Frequency: 1900 MHz; Duty Cycle: 1:1
Medium: 1900 Head Medium parameters used (interpolated):
 $f = 1900 \text{ MHz}$; $\sigma = 1.458 \text{ S/m}$; $\epsilon_r = 38.566$; $\rho = 1000 \text{ kg/m}^3$
Phantom section: Left Section

Test Date: 05-12-2019; Ambient Temp: 21.3°C; Tissue Temp: 21.1°C

Probe: EX3DV4 - SN7410; ConvF(8.16, 8.16, 8.16); Calibrated: 7/20/2018;
Sensor-Surface: 1.4mm (Mechanical Surface Detection)
Electronics: DAE4 Sn1322; Calibrated: 7/11/2018
Phantom: Front; Type: QD 000 P40 CD; Serial: 1686
Measurement SW: DASY52, Version 52.10 (2);SEMCAD X Version 14.6.12 (7450)

**Mode: LTE Band 2 (PCS), Left Head, Cheek, High.ch,
20 MHz Bandwidth, QPSK, 1 RB, 50 RB Offset**

Area Scan (9x14x1): Measurement grid: dx=15mm, dy=15mm
Zoom Scan (5x5x7)/Cube 0: Measurement grid: dx=8mm, dy=8mm, dz=5mm
Reference Value = 21.19 V/m; Power Drift = 0.02 dB
Peak SAR (extrapolated) = 0.850 W/kg
SAR(1 g) = 0.552 W/kg

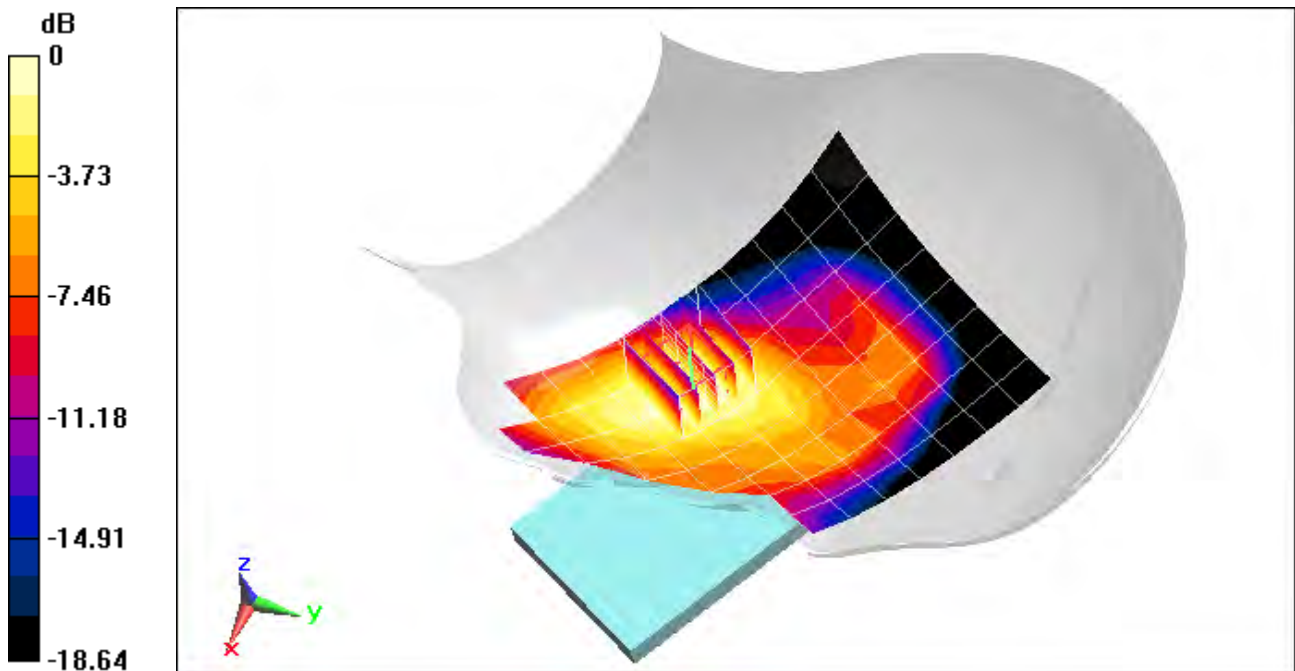

0 dB = 0.704 W/kg = -1.52 dBW/kg

PCTEST ENGINEERING LABORATORY, INC.

DUT: ZNFX420AS; Type: Portable Handset; Serial: 51543

Communication System: UID 0, LTE Band 30; Frequency: 2310 MHz; Duty Cycle: 1:1

Medium: 2450 Head; Medium parameters used:

$f = 2310$ MHz; $\sigma = 1.717$ S/m; $\epsilon_r = 38.545$; $\rho = 1000$ kg/m³

Phantom section: Right Section

Test Date: 05-10-2019; Ambient Temp: 22.6°C; Tissue Temp: 21.7°C

Probe: EX3DV4 - SN7409; ConvF(7.57, 7.57, 7.57); Calibrated: 6/25/2018;

Sensor-Surface: 1.4mm (Mechanical Surface Detection)

Electronics: DAE4 Sn1334; Calibrated: 6/18/2018

Phantom: SAM 30 with CRP v5.0 right; Type: QD000P40CD; Serial: TP:1759

Measurement SW: DASY52, Version 52.10 (2);SEMCAD X Version 14.6.12 (7450)

**Mode: LTE Band 30, Right Head, Cheek, Mid.ch,
10 MHz Bandwidth, QPSK, 1 RB, 25 RB Offset**

Area Scan (11x18x1): Measurement grid: dx=12mm, dy=12mm

Zoom Scan (8x8x7)/Cube 0: Measurement grid: dx=5mm, dy=5mm, dz=5mm

Reference Value = 11.91 V/m; Power Drift = -0.12 dB

Peak SAR (extrapolated) = 0.348 W/kg

SAR(1 g) = 0.197 W/kg

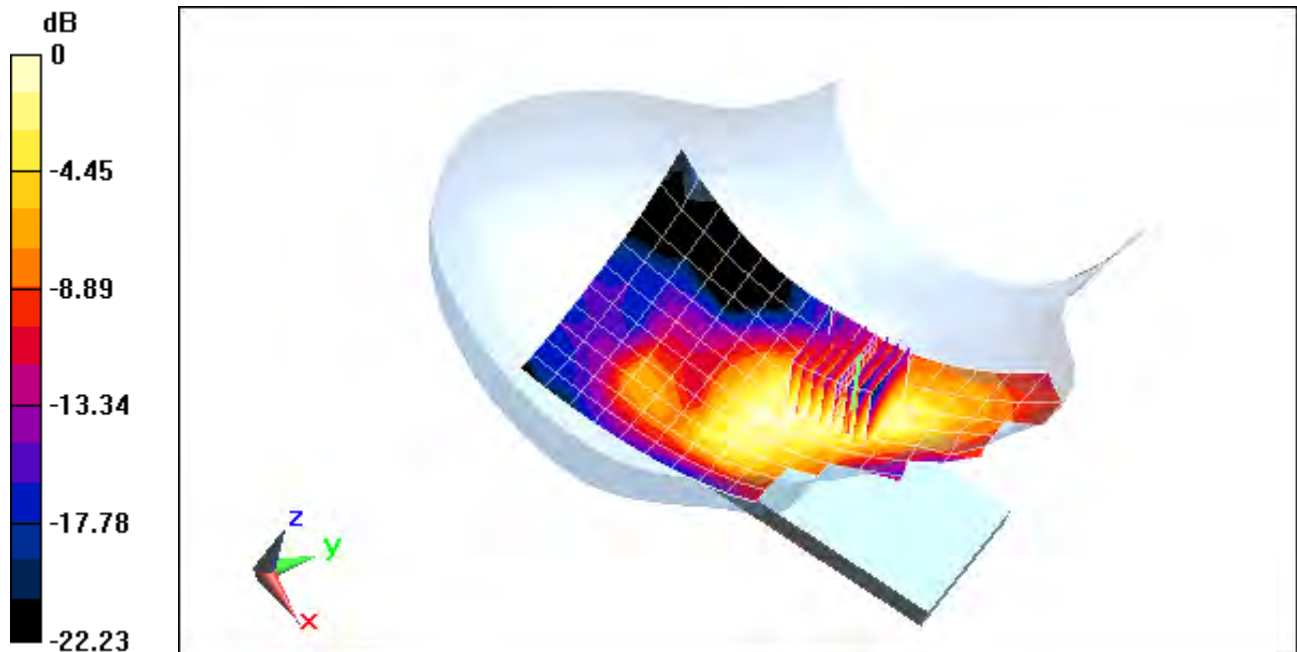

0 dB = 0.287 W/kg = -5.42 dBW/kg

PCTEST ENGINEERING LABORATORY, INC.

DUT: ZNFX420AS; Type: Portable Handset; Serial: 51618

Communication System: UID 0, _IEEE 802.11b; Frequency: 2412 MHz; Duty Cycle: 1:1
Medium: 2450 Head Medium parameters used (interpolated):
 $f = 2412 \text{ MHz}$; $\sigma = 1.844 \text{ S/m}$; $\epsilon_r = 38.993$; $\rho = 1000 \text{ kg/m}^3$
Phantom section: Right Section

Test Date: 05-13-2019; Ambient Temp: 21.2°C; Tissue Temp: 19.5°C

Probe: EX3DV4 - SN3589; ConvF(6.46, 6.46, 6.46); Calibrated: 1/25/2019;
Sensor-Surface: 1.4mm (Mechanical Surface Detection)
Electronics: DAE4 Sn1450; Calibrated: 8/22/2018

Phantom: Twin-SAM V5.0 (30); Type: QD 000 P40 CD; Serial: 1647
Measurement SW: DASY52, Version 52.10 (2);SEMCAD X Version 14.6.12 (7450)

Mode: IEEE 802.11b, 22 MHz Bandwidth, Right Head, Cheek, Ch 1, 1 Mbps

Area Scan (11x18x1): Measurement grid: $dx=12\text{mm}$, $dy=12\text{mm}$

Zoom Scan (8x7x7)/Cube 0: Measurement grid: $dx=5\text{mm}$, $dy=5\text{mm}$, $dz=5\text{mm}$

Reference Value = 11.35 V/m; Power Drift = -0.03 dB

Peak SAR (extrapolated) = 1.65 W/kg

SAR(1 g) = 0.695 W/kg

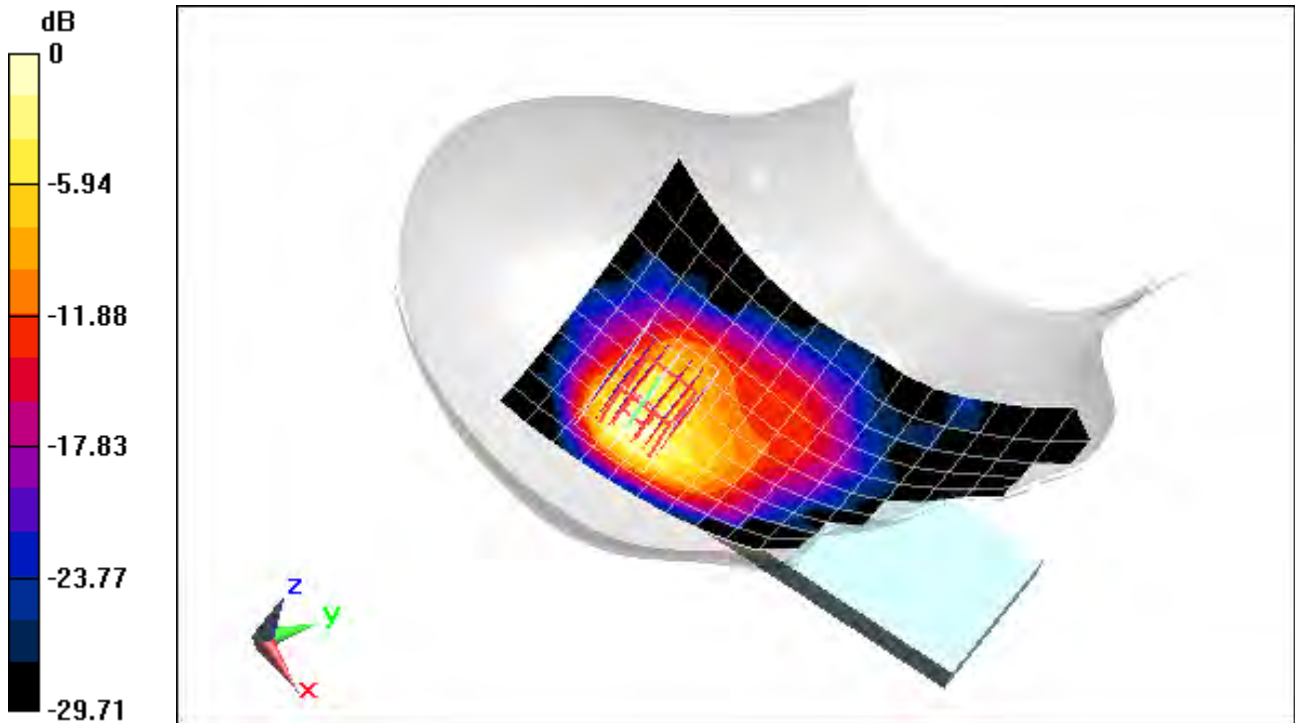

0 dB = 1.20 W/kg = 0.79 dBW/kg

PCTEST ENGINEERING LABORATORY, INC.

DUT: ZNFX420AS; Type: Portable Handset; Serial: 51618

Communication System: UID 0, Bluetooth; Frequency: 2441 MHz; Duty Cycle: 1:1.302

Medium: 2450 Head Medium parameters used (interpolated):

$f = 2441$ MHz; $\sigma = 1.868$ S/m; $\epsilon_r = 38.934$; $\rho = 1000$ kg/m³

Phantom section: Right Section

Test Date: 05-13-2019; Ambient Temp: 21.2°C; Tissue Temp: 19.5°C

Probe: EX3DV4 - SN3589; ConvF(6.46, 6.46, 6.46); Calibrated: 1/25/2019;

Sensor-Surface: 1.4mm (Mechanical Surface Detection)

Electronics: DAE4 Sn1450; Calibrated: 8/22/2018

Phantom: Twin-SAM V5.0 (30); Type: QD 000 P40 CD; Serial: 1647

Measurement SW: DASY52, Version 52.10 (2);SEMCAD X Version 14.6.12 (7450)

Mode: Bluetooth, Right Head, Cheek, Ch 39, 1Mbps

Area Scan (11x19x1): Measurement grid: dx=12mm, dy=12mm

Zoom Scan (7x7x7)/Cube 0: Measurement grid: dx=5mm, dy=5mm, dz=5mm

Reference Value = 9.201 V/m; Power Drift = 0.13 dB

Peak SAR (extrapolated) = 0.350 W/kg

SAR(1 g) = 0.145 W/kg

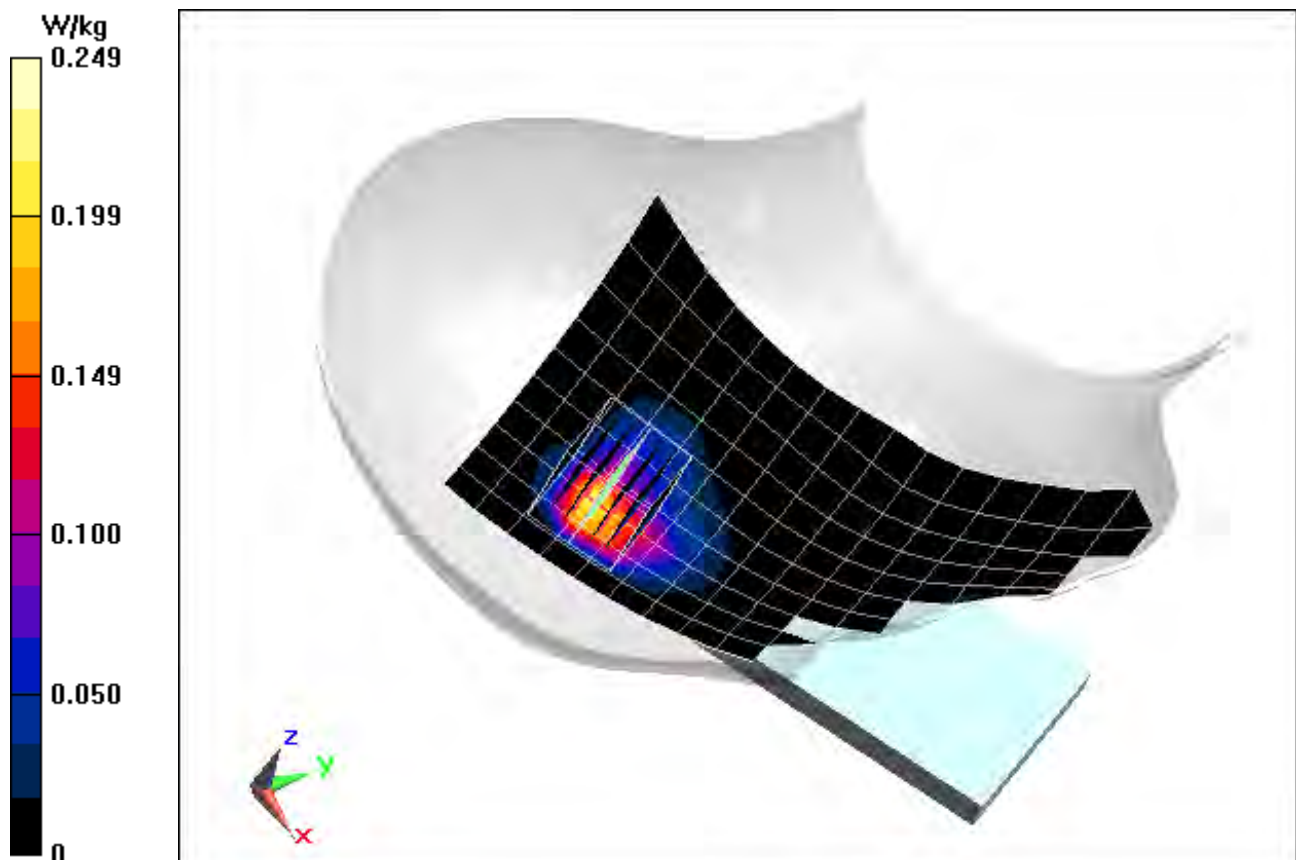

PCTEST ENGINEERING LABORATORY, INC.

DUT: ZNFX420AS; Type: Portable Handset; Serial: 51501

Communication System: UID 0, GSM GPRS; 2 Tx slots; Frequency: 836.6 MHz; Duty Cycle: 1:4.15
Medium: 835 Body Medium parameters used (interpolated):
 $f = 836.6 \text{ MHz}$; $\sigma = 0.979 \text{ S/m}$; $\epsilon_r = 53.678$; $\rho = 1000 \text{ kg/m}^3$
Phantom section: Flat Section; Space: 1.0 cm

Test Date: 5-13-2019; Ambient Temp: 19.7°C; Tissue Temp: 19.2°C

Probe: EX3DV4 - SN7488; ConvF(11.03, 11.03, 11.03); Calibrated: 1/24/2019;
Sensor-Surface: 1.4mm (Mechanical Surface Detection)
Electronics: DAE4 Sn1530; Calibrated: 1/15/2019
Phantom: Twin-SAM V5.0; Type: QD 000 P40 CD; Serial: 1800
Measurement SW: DASY52, Version 52.10 (2);SEMCAD X Version 14.6.12 (7450)

Mode: GPRS 850, Body SAR, Back side, Mid.ch, 2 Tx Slots

Area Scan (9x15x1): Measurement grid: dx=15mm, dy=15mm
Zoom Scan (5x5x7)/Cube 0: Measurement grid: dx=8mm, dy=8mm, dz=5mm
Reference Value = 22.20 V/m; Power Drift = -0.03 dB
Peak SAR (extrapolated) = 0.632 W/kg
SAR(1 g) = 0.470 W/kg

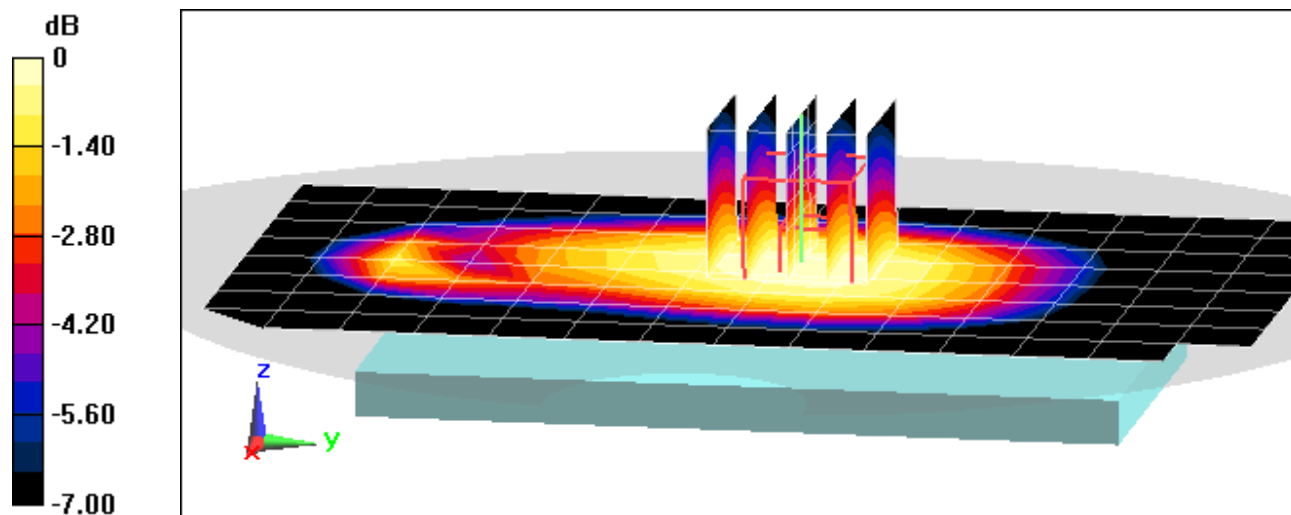

0 dB = 0.575 W/kg = -2.40 dBW/kg

PCTEST ENGINEERING LABORATORY, INC.

DUT: ZNFX420AS; Type: Portable Handset; Serial: 51501

Communication System: UID 0, GSM GPRS; 2 Tx slots; Frequency: 836.6 MHz; Duty Cycle: 1:4.15
Medium: 835 Body Medium parameters used (interpolated):
 $f = 836.6 \text{ MHz}$; $\sigma = 0.979 \text{ S/m}$; $\epsilon_r = 53.678$; $\rho = 1000 \text{ kg/m}^3$
Phantom section: Flat Section; Space: 1.0 cm

Test Date: 5-13-2019; Ambient Temp: 19.7°C; Tissue Temp: 19.2°C

Probe: EX3DV4 - SN7488; ConvF(11.03, 11.03, 11.03); Calibrated: 1/24/2019;
Sensor-Surface: 1.4mm (Mechanical Surface Detection)
Electronics: DAE4 Sn1530; Calibrated: 1/15/2019
Phantom: Twin-SAM V5.0; Type: QD 000 P40 CD; Serial: 1800
Measurement SW: DASY52, Version 52.10 (2);SEMCAD X Version 14.6.12 (7450)

Mode: GPRS 850, Body SAR, Right Edge, Mid.ch, 2 Tx Slots

Area Scan (10x14x1): Measurement grid: dx=5mm, dy=15mm
Zoom Scan (5x5x7)/Cube 0: Measurement grid: dx=8mm, dy=8mm, dz=5mm
Reference Value = 22.81 V/m; Power Drift = 0.04 dB
Peak SAR (extrapolated) = 0.736 W/kg
SAR(1 g) = 0.489 W/kg

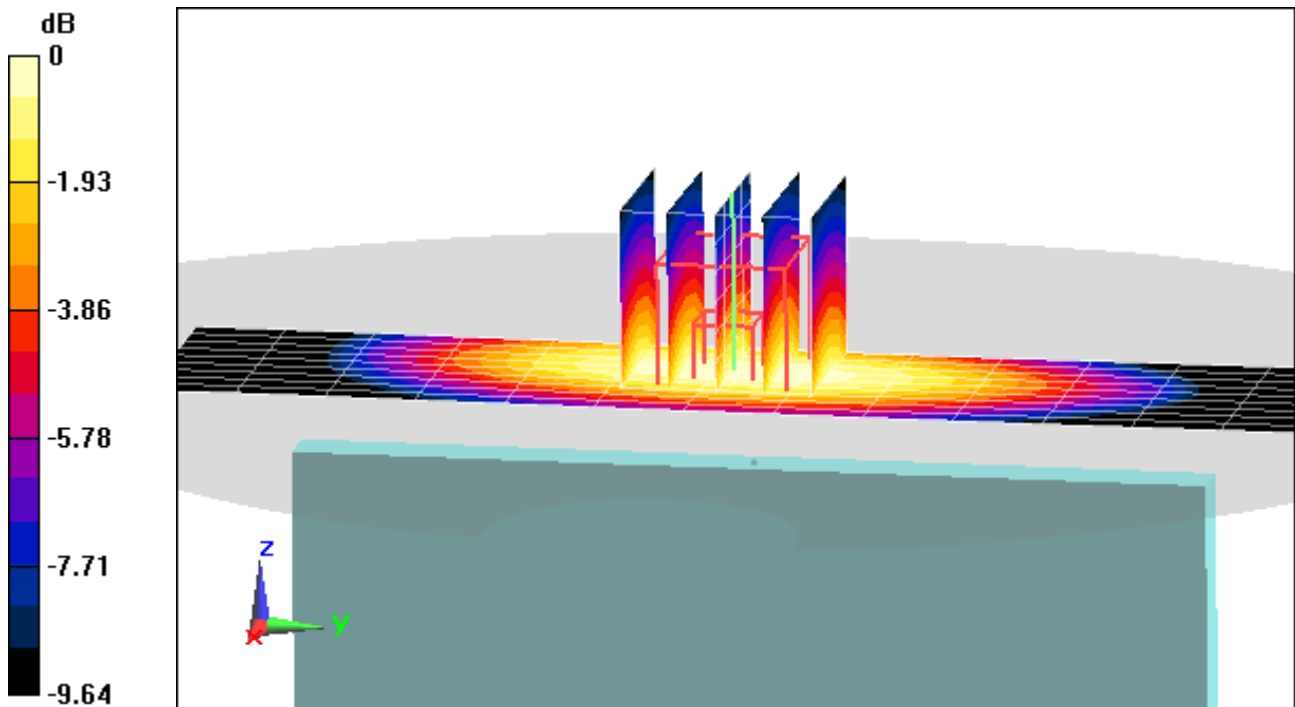

0 dB = 0.648 W/kg = -1.88 dBW/kg

PCTEST ENGINEERING LABORATORY, INC.

DUT: ZNFX420AS; Type: Portable Handset; Serial: 51592

Communication System: UID 0, GSM GPRS; 2 Tx slots; Frequency: 1880 MHz; Duty Cycle: 1:4.15

Medium: 1900 Body Medium parameters used:

$f = 1880 \text{ MHz}$; $\sigma = 1.518 \text{ S/m}$; $\epsilon_r = 51.958$; $\rho = 1000 \text{ kg/m}^3$

Phantom section: Flat Section; Space: 1.0 cm

Test Date: 05-08-2019; Ambient Temp: 23.5°C; Tissue Temp: 21.6°C

Probe: EX3DV4 - SN7357; ConvF(7.93, 7.93, 7.93); Calibrated: 4/24/2019;

Sensor-Surface: 1.4mm (Mechanical Surface Detection)

Electronics: DAE4 Sn1407; Calibrated: 4/18/2019

Phantom: Twin-SAM V4.0 Front Right; Type: QD 000 P40 CC; Serial: 1167

Measurement SW: DASY52, Version 52.10 (2);SEMCAD X Version 14.6.12 (7450)

Mode: GPRS 1900, Body SAR, Back side, Mid.ch, 2 Tx Slots

Area Scan (9x14x1): Measurement grid: dx=15mm, dy=15mm

Zoom Scan (5x5x7)/Cube 0: Measurement grid: dx=8mm, dy=8mm, dz=5mm

Reference Value = 16.15 V/m; Power Drift = -0.02 dB

Peak SAR (extrapolated) = 0.691 W/kg

SAR(1 g) = 0.354 W/kg

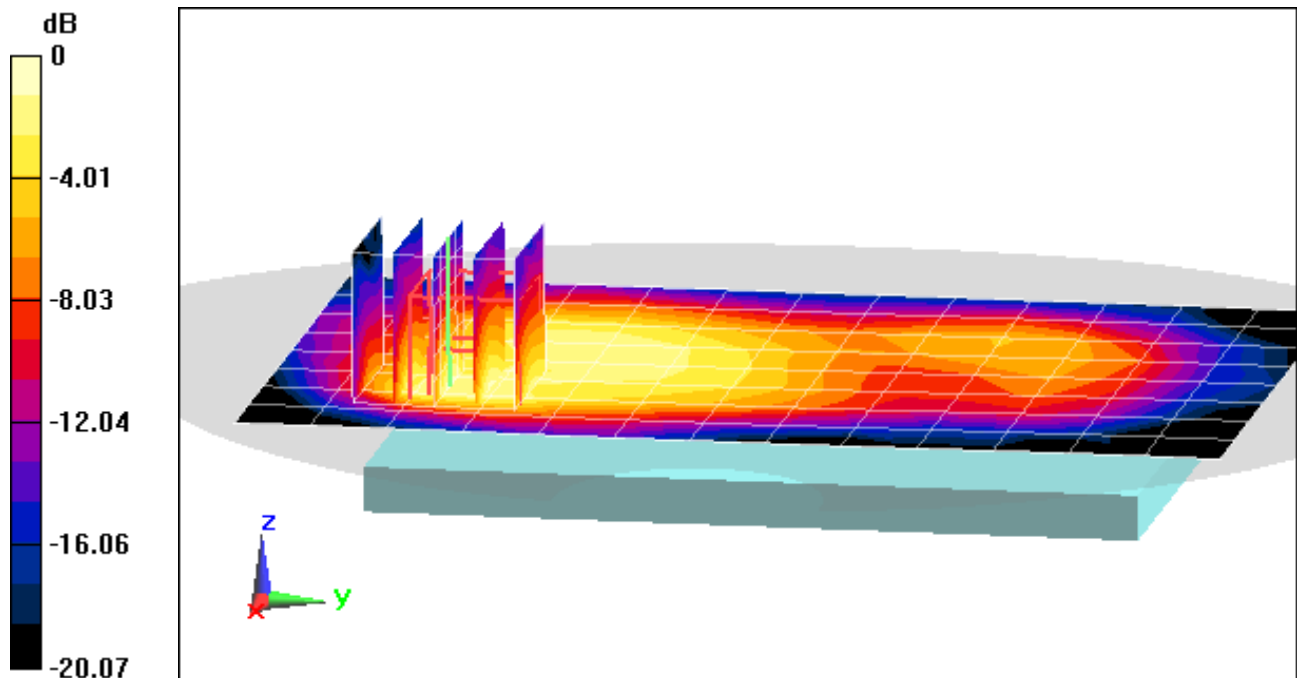

0 dB = 0.555 W/kg = -2.56 dBW/kg

PCTEST ENGINEERING LABORATORY, INC.

DUT: ZNFX420AS; Type: Portable Handset; Serial: 51501

Communication System: UID 0, UMTS; Frequency: 836.6 MHz; Duty Cycle: 1:1
Medium: 835 Body Medium parameters used (interpolated):
 $f = 836.6 \text{ MHz}$; $\sigma = 0.979 \text{ S/m}$; $\epsilon_r = 53.678$; $\rho = 1000 \text{ kg/m}^3$
Phantom section: Flat Section; Space: 1.0 cm

Test Date: 5-13-2019; Ambient Temp: 19.7°C; Tissue Temp: 19.2°C

Probe: EX3DV4 - SN7488; ConvF(11.03, 11.03, 11.03); Calibrated: 1/24/2019;
Sensor-Surface: 1.4mm (Mechanical Surface Detection)
Electronics: DAE4 Sn1530; Calibrated: 1/15/2019
Phantom: Twin-SAM V5.0; Type: QD 000 P40 CD; Serial: 1800
Measurement SW: DASY52, Version 52.10 (2);SEMCAD X Version 14.6.12 (7450)

Mode: UMTS 850, Body SAR, Back side, Mid.ch

Area Scan (9x15x1): Measurement grid: dx=15mm, dy=15mm

Zoom Scan (5x5x7)/Cube 0: Measurement grid: dx=8mm, dy=8mm, dz=5mm

Reference Value = 24.27 V/m; Power Drift = 0.03 dB

Peak SAR (extrapolated) = 0.767 W/kg

SAR(1 g) = 0.572 W/kg

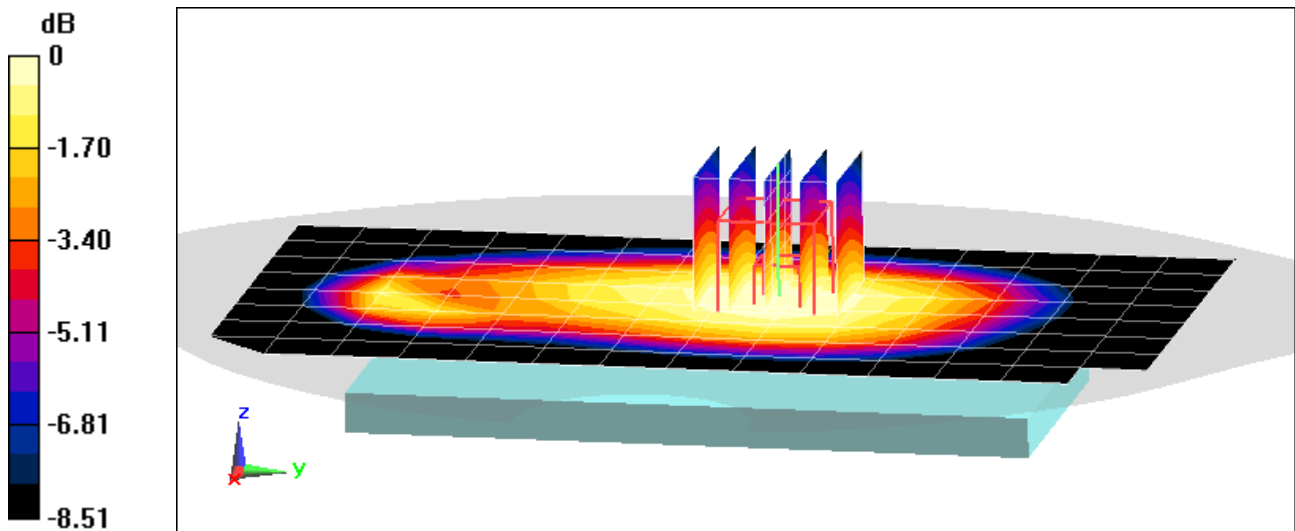

0 dB = 0.698 W/kg = -1.56 dBW/kg

PCTEST ENGINEERING LABORATORY, INC.

DUT: ZNFX420AS; Type: Portable Handset; Serial: 51501

Communication System: UID 0, _UMTS; Frequency: 826.4 MHz; Duty Cycle: 1:1
Medium: 835 Body Medium parameters used (interpolated):
 $f = 826.4 \text{ MHz}$; $\sigma = 0.975 \text{ S/m}$; $\epsilon_r = 53.702$; $\rho = 1000 \text{ kg/m}^3$
Phantom section: Flat Section; Space: 1.0 cm

Test Date: 5-13-2019; Ambient Temp: 19.7°C; Tissue Temp: 19.2°C

Probe: EX3DV4 - SN7488; ConvF(11.03, 11.03, 11.03); Calibrated: 1/24/2019;
Sensor-Surface: 1.4mm (Mechanical Surface Detection)
Electronics: DAE4 Sn1530; Calibrated: 1/15/2019
Phantom: Twin-SAM V5.0; Type: QD 000 P40 CD; Serial: 1800
Measurement SW: DASY52, Version 52.10 (2);SEMCAD X Version 14.6.12 (7450)

Mode: UMTS 850, Body SAR, Right Edge, Low.ch

Area Scan (10x13x1): Measurement grid: dx=5mm, dy=15mm

Zoom Scan (5x5x7)/Cube 0: Measurement grid: dx=8mm, dy=8mm, dz=5mm

Reference Value = 27.75 V/m; Power Drift = -0.02 dB

Peak SAR (extrapolated) = 1.06 W/kg

SAR(1 g) = 0.709 W/kg

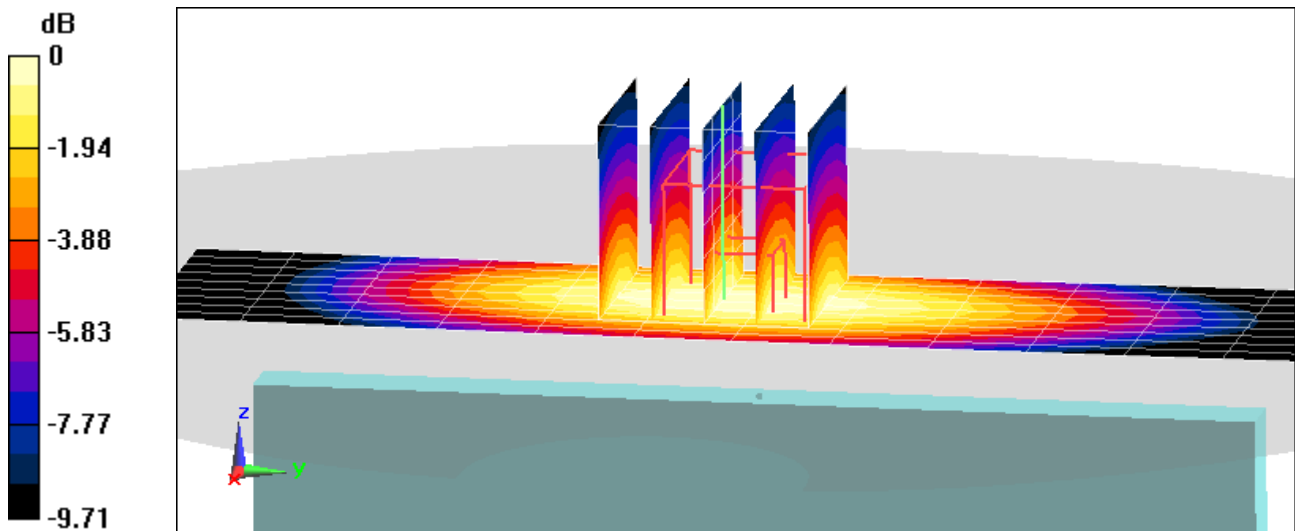

0 dB = 0.933 W/kg = -0.30 dBW/kg

PCTEST ENGINEERING LABORATORY, INC.

DUT: ZNFX420AS; Type: Portable Handset; Serial: 51592

Communication System: UID 0, UMTS; Frequency: 1732.4 MHz; Duty Cycle: 1:1
Medium: 1750 Body Medium parameters used (interpolated):
 $f = 1732.4 \text{ MHz}$; $\sigma = 1.481 \text{ S/m}$; $\epsilon_r = 52.103$; $\rho = 1000 \text{ kg/m}^3$
Phantom section: Flat Section; Space: 1.0 cm

Test Date: 05-13-2019; Ambient Temp: 21.3°C; Tissue Temp: 20.5°C

Probe: EX3DV4 - SN3914; ConvF(7.89, 7.89, 7.89); Calibrated: 2/19/2019;
Sensor-Surface: 1.4mm (Mechanical Surface Detection)
Electronics: DAE4 Sn1272; Calibrated: 2/14/2019

Phantom: SAM with CRP v5.0 Front; Type: QD000P40CD; Serial: 1646
Measurement SW: DASY52, Version 52.10 (2);SEMCAD X Version 14.6.12 (7450)

Mode: UMTS 1750, Body SAR, Back side, Mid.ch

Area Scan (9x15x1): Measurement grid: dx=15mm, dy=15mm

Zoom Scan (6x6x7)/Cube 0: Measurement grid: dx=8mm, dy=8mm, dz=5mm

Reference Value = 27.06 V/m; Power Drift = -0.10 dB

Peak SAR (extrapolated) = 1.82 W/kg

SAR(1 g) = 1.01 W/kg

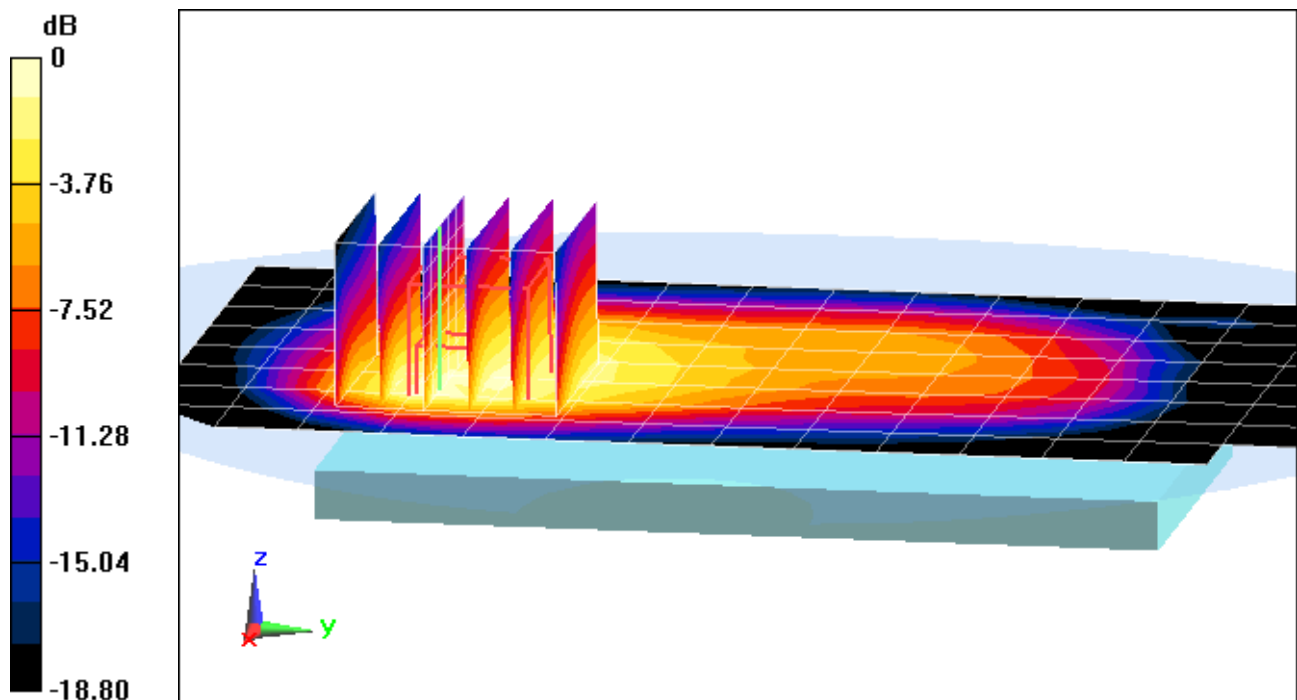

0 dB = 1.49 W/kg = 1.73 dBW/kg

PCTEST ENGINEERING LABORATORY, INC.

DUT: ZNFX420AS; Type: Portable Handset; Serial: 51543

Communication System: UID 0, UMTS; Frequency: 1880 MHz; Duty Cycle: 1:1
Medium: 1900 Body Medium parameters used:
 $f = 1880 \text{ MHz}$; $\sigma = 1.518 \text{ S/m}$; $\epsilon_r = 51.958$; $\rho = 1000 \text{ kg/m}^3$
Phantom section: Flat Section; Space: 1.0 cm

Test Date: 05-08-2019; Ambient Temp: 23.5°C; Tissue Temp: 21.6°C

Probe: EX3DV4 - SN7357; ConvF(7.93, 7.93, 7.93); Calibrated: 4/24/2019;
Sensor-Surface: 1.4mm (Mechanical Surface Detection)
Electronics: DAE4 Sn1407; Calibrated: 4/18/2019

Phantom: Twin-SAM V4.0 Front Right; Type: QD 000 P40 CC; Serial: 1167
Measurement SW: DASY52, Version 52.10 (2);SEMCAD X Version 14.6.12 (7450)

Mode: UMTS 1900, Body SAR, Back side, Mid.ch

Area Scan (9x15x1): Measurement grid: dx=15mm, dy=15mm

Zoom Scan (5x5x7)/Cube 0: Measurement grid: dx=8mm, dy=8mm, dz=5mm

Reference Value = 24.80 V/m; Power Drift = -0.15 dB

Peak SAR (extrapolated) = 1.62 W/kg

SAR(1 g) = 0.846 W/kg

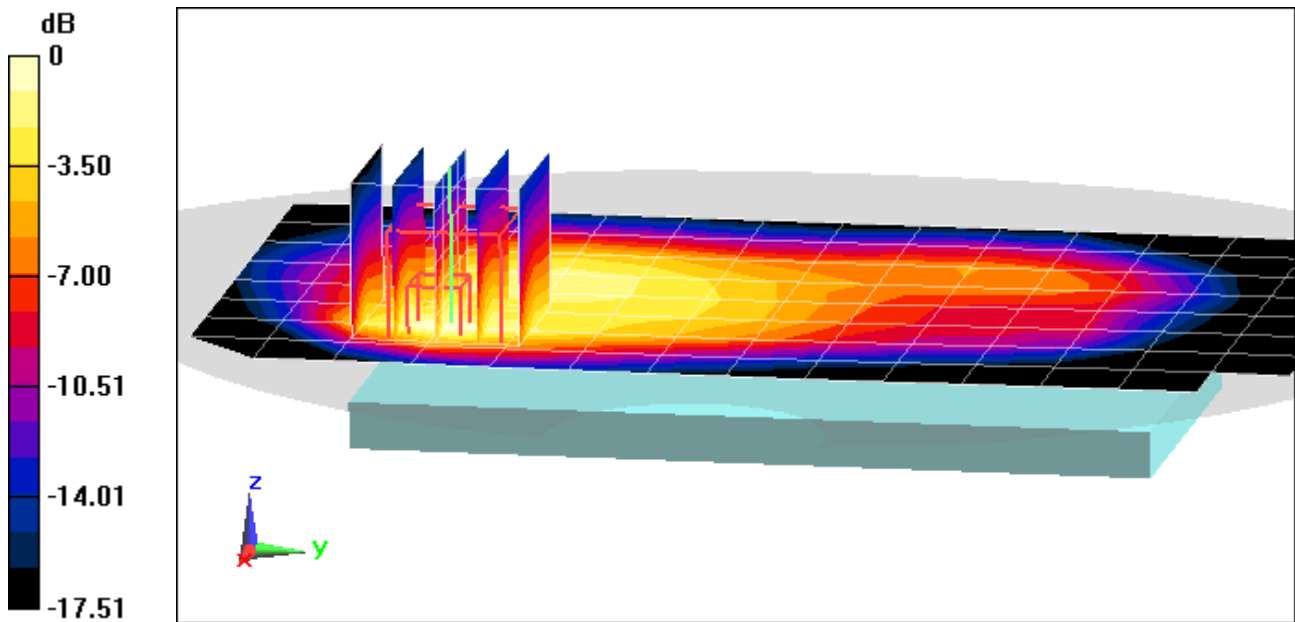

0 dB = 1.28 W/kg = 1.07 dBW/kg

PCTEST ENGINEERING LABORATORY, INC.

DUT: ZNFX420AS; Type: Portable Handset; Serial: 51543

Communication System: UID 0, LTE Band 12; Frequency: 707.5 MHz; Duty Cycle: 1:1

Medium: 750 Body Medium parameters used (interpolated):

$f = 707.5$ MHz; $\sigma = 0.922$ S/m; $\epsilon_r = 56.657$; $\rho = 1000$ kg/m³

Phantom section: Flat Section; Space: 1.0 cm

Test Date: 05-16-2019; Ambient Temp: 22.8°C; Tissue Temp: 22.1°C

Probe: EX3DV4 - SN7357; ConvF(10.19, 10.19, 10.19); Calibrated: 4/24/2019;

Sensor-Surface: 1.4mm (Mechanical Surface Detection)

Electronics: DAE4 Sn1407; Calibrated: 4/18/2019

Phantom: Twin-SAM V4.0 Front Right; Type: QD 000 P40 CC; Serial: 1167

Measurement SW: DASY52, Version 52.10 (2);SEMCAD X Version 14.6.12 (7450)

**Mode: LTE Band 12, Body SAR, Back side, Mid.ch,
10 MHz Bandwidth, QPSK, 1 RB, 0 RB Offset**

Area Scan (9x14x1): Measurement grid: dx=15mm, dy=15mm

Zoom Scan (5x5x7)/Cube 0: Measurement grid: dx=8mm, dy=8mm, dz=5mm

Reference Value = 24.38 V/m; Power Drift = 0.04 dB

Peak SAR (extrapolated) = 0.711 W/kg

SAR(1 g) = 0.542 W/kg

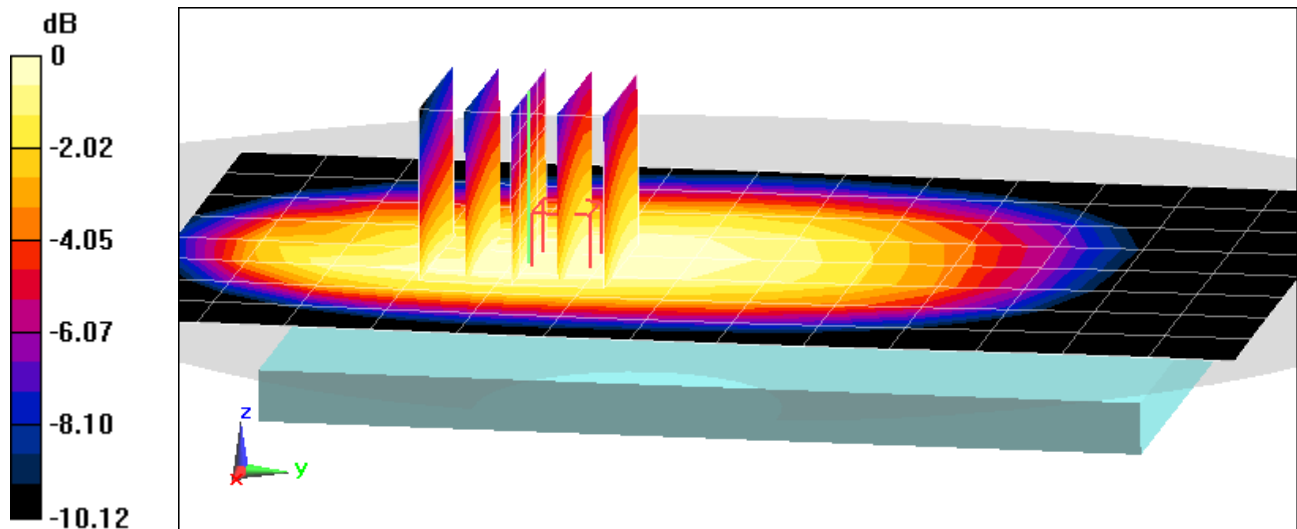

0 dB = 0.648 W/kg = -1.88 dBW/kg

PCTEST ENGINEERING LABORATORY, INC.

DUT: ZNFX420AS; Type: Portable Handset; Serial: 51543

Communication System: UID 0, LTE Band 12; Frequency: 707.5 MHz; Duty Cycle: 1:1
Medium: 750 Body Medium parameters used (interpolated):
 $f = 707.5 \text{ MHz}$; $\sigma = 0.922 \text{ S/m}$; $\epsilon_r = 56.657$; $\rho = 1000 \text{ kg/m}^3$
Phantom section: Flat Section; Space: 1.0 cm

Test Date: 05-16-2019; Ambient Temp: 22.8°C; Tissue Temp: 22.1°C

Probe: EX3DV4 - SN7357; ConvF(10.19, 10.19, 10.19); Calibrated: 4/24/2019;

Sensor-Surface: 1.4mm (Mechanical Surface Detection)

Electronics: DAE4 Sn1407; Calibrated: 4/18/2019

Phantom: Twin-SAM V4.0 Front Right; Type: QD 000 P40 CC; Serial: 1167

Measurement SW: DASY52, Version 52.10 (2);SEMCAD X Version 14.6.12 (7450)

**Mode: LTE Band 12, Body SAR, Right Edge, Mid.ch,
10 MHz Bandwidth, QPSK, 1 RB, 0 RB Offset**

Area Scan (13x14x1): Measurement grid: dx=5mm, dy=15mm

Zoom Scan (5x5x7)/Cube 0: Measurement grid: dx=8mm, dy=8mm, dz=5mm

Reference Value = 24.97 V/m; Power Drift = 0.01 dB

Peak SAR (extrapolated) = 0.797 W/kg

SAR(1 g) = 0.551 W/kg

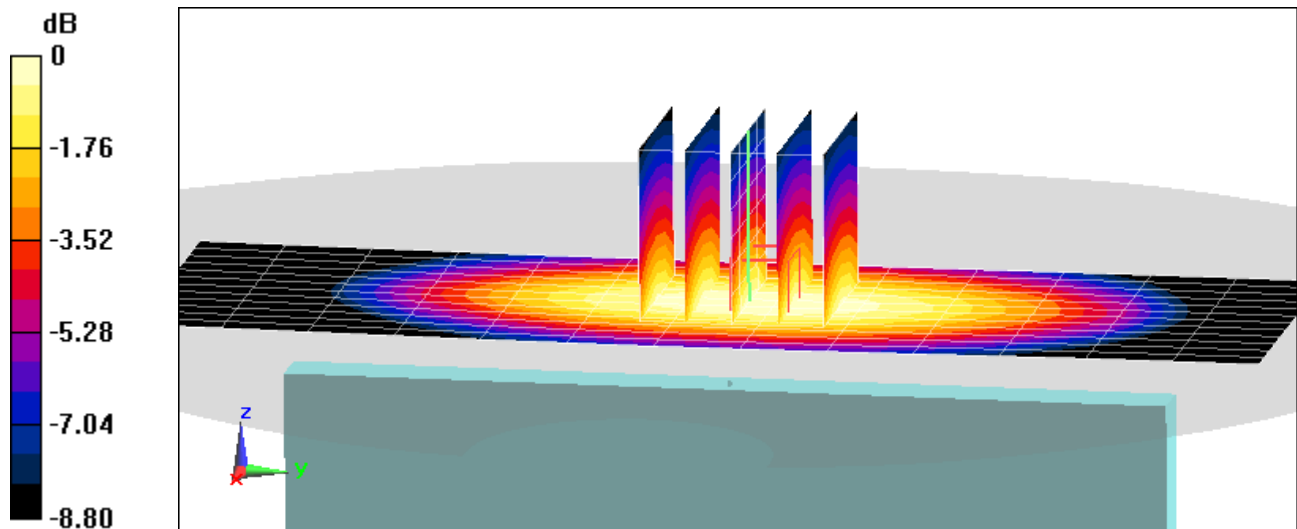

0 dB = 0.707 W/kg = -1.51 dBW/kg

PCTEST ENGINEERING LABORATORY, INC.

DUT: ZNFX420AS; Type: Portable Handset; Serial: 51543

Communication System: UID 0, LTE Band 14; Frequency: 793 MHz; Duty Cycle: 1:1
Medium: 750 Body Medium parameters used (interpolated):
 $f = 793 \text{ MHz}$; $\sigma = 0.952 \text{ S/m}$; $\epsilon_r = 56.456$; $\rho = 1000 \text{ kg/m}^3$
Phantom section: Flat Section; Space: 1.0 cm

Test Date: 05-16-2019; Ambient Temp: 22.8°C; Tissue Temp: 22.1°C

Probe: EX3DV4 - SN7357; ConvF(10.19, 10.19, 10.19); Calibrated: 4/24/2019;
Sensor-Surface: 1.4mm (Mechanical Surface Detection)
Electronics: DAE4 Sn1407; Calibrated: 4/18/2019

Phantom: Twin-SAM V4.0 Front Right; Type: QD 000 P40 CC; Serial: 1167
Measurement SW: DASY52, Version 52.10 (2);SEMCAD X Version 14.6.12 (7450)

**Mode: LTE Band 14, Body SAR, Back side, Mid.ch,
10 MHz Bandwidth, QPSK, 1 RB, 25 RB Offset**

Area Scan (9x14x1): Measurement grid: $dx=15\text{mm}$, $dy=15\text{mm}$

Zoom Scan (5x5x7)/Cube 0: Measurement grid: $dx=8\text{mm}$, $dy=8\text{mm}$, $dz=5\text{mm}$

Reference Value = 18.34 V/m; Power Drift = 0.04 dB

Peak SAR (extrapolated) = 0.413 W/kg

SAR(1 g) = 0.318 W/kg

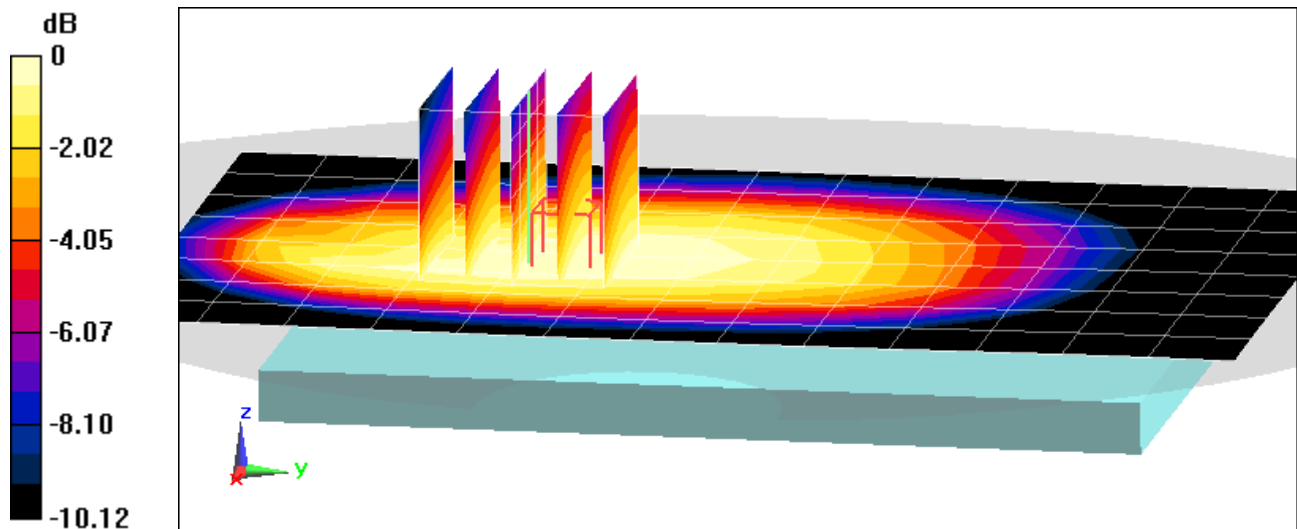

0 dB = 0.648 W/kg = -1.88 dBW/kg

PCTEST ENGINEERING LABORATORY, INC.

DUT: ZNFX420AS; Type: Portable Handset; Serial: 51543

Communication System: UID 0, LTE Band 14; Frequency: 793 MHz; Duty Cycle: 1:1

Medium: 750 Body Medium parameters used (interpolated):

$f = 793 \text{ MHz}$; $\sigma = 0.952 \text{ S/m}$; $\epsilon_r = 56.456$; $\rho = 1000 \text{ kg/m}^3$

Phantom section: Flat Section; Space: 1.0 cm

Test Date: 05-16-2019; Ambient Temp: 22.8°C; Tissue Temp: 22.1°C

Probe: EX3DV4 - SN7357; ConvF(10.19, 10.19, 10.19); Calibrated: 4/24/2019;

Sensor-Surface: 1.4mm (Mechanical Surface Detection)

Electronics: DAE4 Sn1407; Calibrated: 4/18/2019

Phantom: Twin-SAM V4.0 Front Right; Type: QD 000 P40 CC; Serial: 1167

Measurement SW: DASY52, Version 52.10 (2);SEMCAD X Version 14.6.12 (7450)

**Mode: LTE Band 14, Body SAR, Right Edge, Mid.ch,
10 MHz Bandwidth, QPSK, 1 RB, 25 RB Offset**

Area Scan (13x14x1): Measurement grid: dx=5mm, dy=15mm

Zoom Scan (5x5x7)/Cube 0: Measurement grid: dx=8mm, dy=8mm, dz=5mm

Reference Value = 19.90 V/m; Power Drift = 0.04 dB

Peak SAR (extrapolated) = 0.531 W/kg

SAR(1 g) = 0.362 W/kg

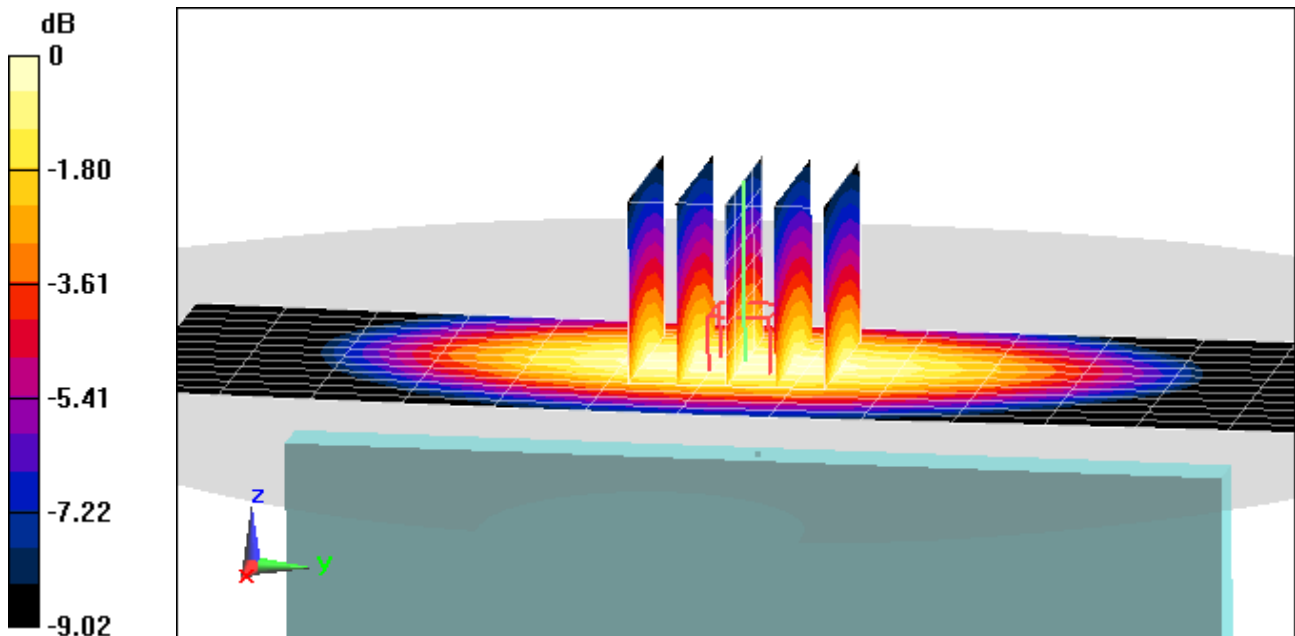

0 dB = 0.470 W/kg = -3.28 dBW/kg

PCTEST ENGINEERING LABORATORY, INC.

DUT: ZNFX420AS; Type: Portable Handset; Serial: 51501

Communication System: UID 0, LTE Band 5; Frequency: 836.5 MHz; Duty Cycle: 1:1

Medium: 835 Body Medium parameters used (interpolated):

$f = 836.5$ MHz; $\sigma = 0.979$ S/m; $\epsilon_r = 53.679$; $\rho = 1000$ kg/m³

Phantom section: Flat Section; Space: 1.0 cm

Test Date: 5-13-2019; Ambient Temp: 19.7°C; Tissue Temp: 19.2°C

Probe: EX3DV4 - SN7488; ConvF(11.03, 11.03, 11.03); Calibrated: 1/24/2019;

Sensor-Surface: 1.4mm (Mechanical Surface Detection)

Electronics: DAE4 Sn1530; Calibrated: 1/15/2019

Phantom: Twin-SAM V5.0; Type: QD 000 P40 CD; Serial: 1800

Measurement SW: DASY52, Version 52.10 (2);SEMCAD X Version 14.6.12 (7450)

**Mode: LTE Band 5 (Cell.), Body SAR, Back side, Mid.ch,
10 MHz Bandwidth, QPSK, 1 RB, 25 RB Offset**

Area Scan (9x15x1): Measurement grid: dx=15mm, dy=15mm

Zoom Scan (5x5x7)/Cube 0: Measurement grid: dx=8mm, dy=8mm, dz=5mm

Reference Value = 23.77 V/m; Power Drift = -0.03 dB

Peak SAR (extrapolated) = 0.728 W/kg

SAR(1 g) = 0.539 W/kg

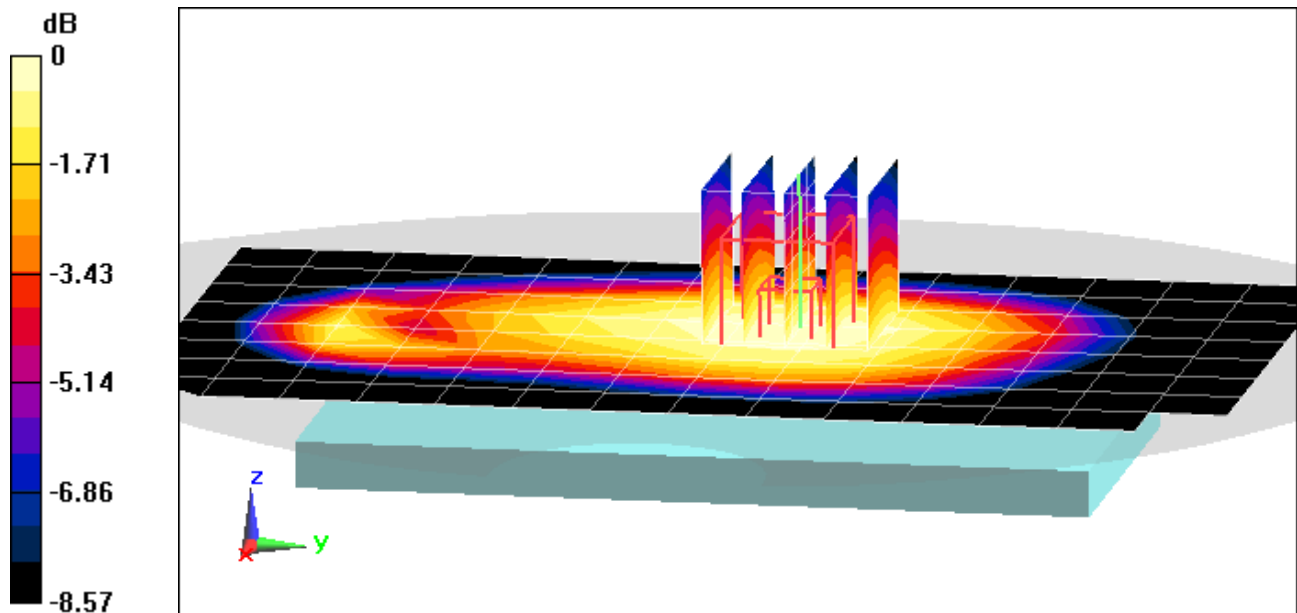

0 dB = 0.660 W/kg = -1.80 dBW/kg

PCTEST ENGINEERING LABORATORY, INC.

DUT: ZNFX420AS; Type: Portable Handset; Serial: 51501

Communication System: UID 0, LTE Band 5; Frequency: 836.5 MHz; Duty Cycle: 1:1

Medium: 835 Body Medium parameters used (interpolated):

$f = 836.5$ MHz; $\sigma = 0.979$ S/m; $\epsilon_r = 53.679$; $\rho = 1000$ kg/m³

Phantom section: Flat Section; Space: 1.0 cm

Test Date: 5-13-2019; Ambient Temp: 19.7°C; Tissue Temp: 19.2°C

Probe: EX3DV4 - SN7488; ConvF(11.03, 11.03, 11.03); Calibrated: 1/24/2019;

Sensor-Surface: 1.4mm (Mechanical Surface Detection)

Electronics: DAE4 Sn1530; Calibrated: 1/15/2019

Phantom: Twin-SAM V5.0; Type: QD 000 P40 CD; Serial: 1800

Measurement SW: DASY52, Version 52.10 (2);SEMCAD X Version 14.6.12 (7450)

**Mode: LTE Band 5 (Cell.), Body SAR, Right Edge, Mid.ch,
10 MHz Bandwidth, QPSK, 1 RB, 25 RB Offset**

Area Scan (11x13x1): Measurement grid: dx=5mm, dy=15mm

Zoom Scan (5x5x7)/Cube 0: Measurement grid: dx=8mm, dy=8mm, dz=5mm

Reference Value = 25.63 V/m; Power Drift = 0.00 dB

Peak SAR (extrapolated) = 0.929 W/kg

SAR(1 g) = 0.619 W/kg

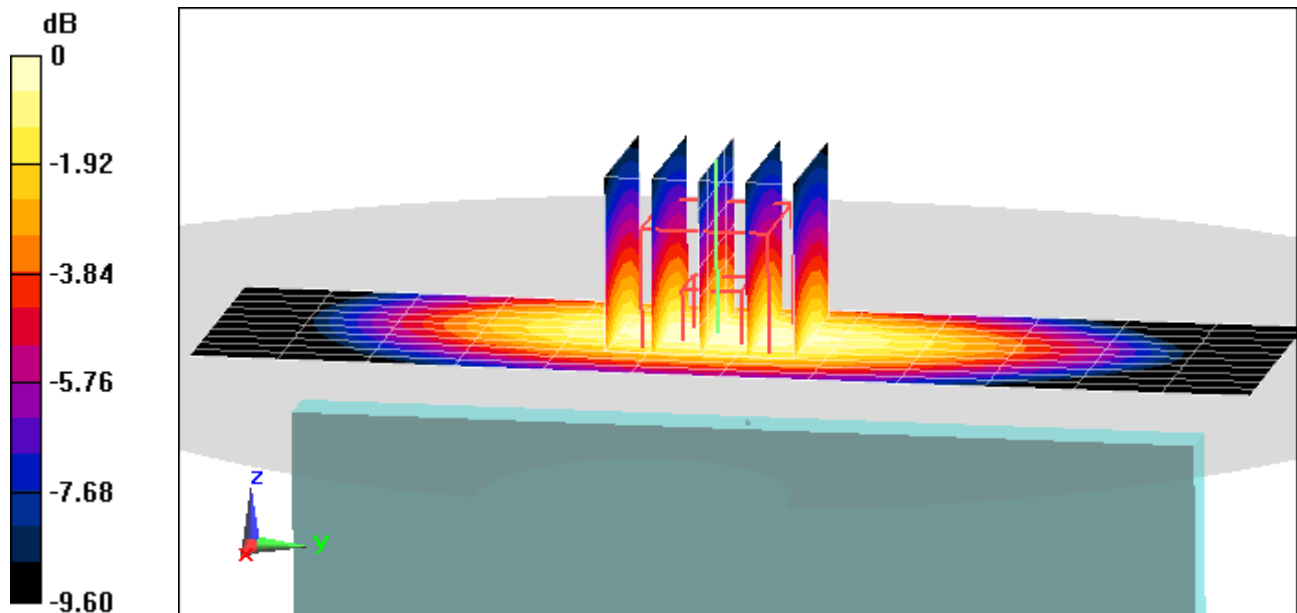

0 dB = 0.819 W/kg = -0.87 dBW/kg

PCTEST ENGINEERING LABORATORY, INC.

DUT: ZNFX420AS; Type: Portable Handset; Serial: 51592

Communication System: UID 0, LTE Band 66 (AWS); Frequency: 1720 MHz; Duty Cycle: 1:1
Medium: 1750 Body Medium parameters used (interpolated):
 $f = 1720 \text{ MHz}$; $\sigma = 1.472 \text{ S/m}$; $\epsilon_r = 52.122$; $\rho = 1000 \text{ kg/m}^3$
Phantom section: Flat Section; Space: 1.0 cm

Test Date: 05-13-2019; Ambient Temp: 21.3°C; Tissue Temp: 20.5°C

Probe: EX3DV4 - SN3914; ConvF(7.89, 7.89, 7.89); Calibrated: 2/19/2019;
Sensor-Surface: 1.4mm (Mechanical Surface Detection)
Electronics: DAE4 Sn1272; Calibrated: 2/14/2019

Phantom: SAM with CRP v5.0 Front; Type: QD000P40CD; Serial: 1646
Measurement SW: DASY52, Version 52.10 (2);SEMCAD X Version 14.6.12 (7450)

**Mode: LTE Band 66 (AWS), Body SAR, Back side, Low.ch,
20 MHz Bandwidth, QPSK, 1 RB, 50 RB Offset**

Area Scan (9x15x1): Measurement grid: dx=15mm, dy=15mm

Zoom Scan (5x5x7)/Cube 0: Measurement grid: dx=8mm, dy=8mm, dz=5mm

Reference Value = 27.48 V/m; Power Drift = 0.03 dB

Peak SAR (extrapolated) = 1.84 W/kg

SAR(1 g) = 1.03 W/kg

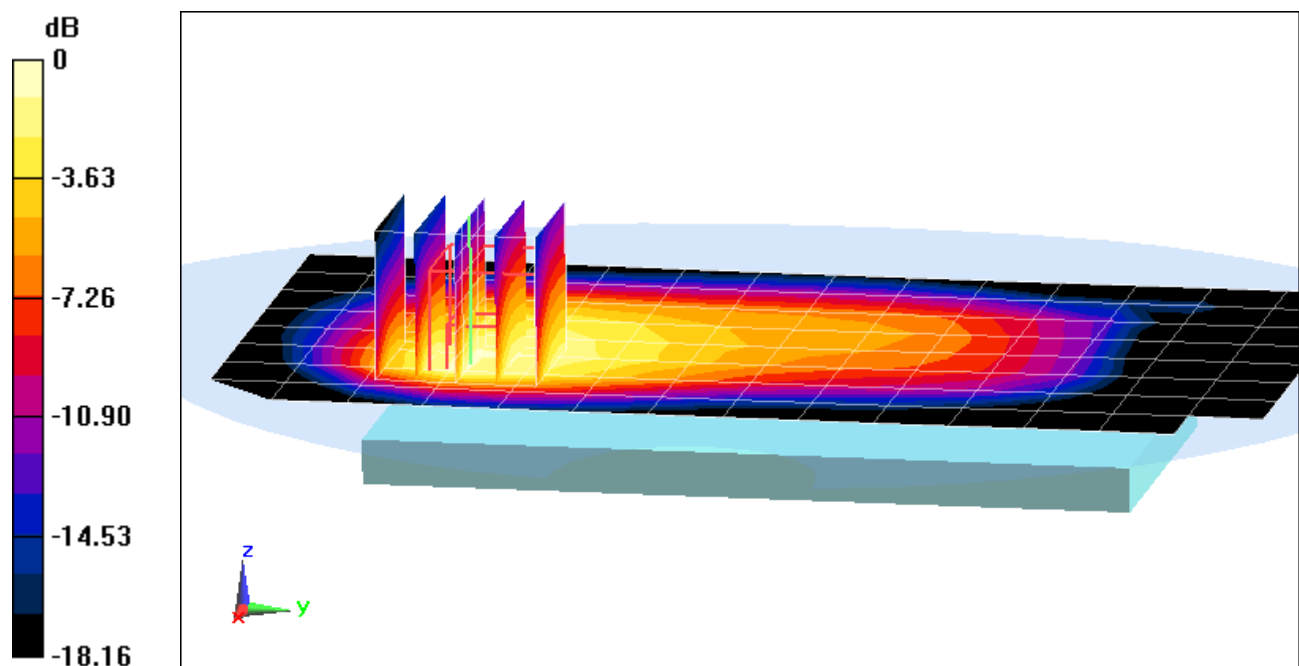

0 dB = 1.53 W/kg = 1.85 dBW/kg

PCTEST ENGINEERING LABORATORY, INC.

DUT: ZNFX420AS; Type: Portable Handset; Serial: 51543

Communication System: UID 0, LTE Band 2 (PCS); Frequency: 1900 MHz; Duty Cycle: 1:1

Medium: 1900 Body Medium parameters used (interpolated):

$f = 1900$ MHz; $\sigma = 1.541$ S/m; $\epsilon_r = 51.899$; $\rho = 1000$ kg/m³

Phantom section: Flat Section; Space: 1.0 cm

Test Date: 05-08-2019; Ambient Temp: 23.5°C; Tissue Temp: 21.6°C

Probe: EX3DV4 - SN7357; ConvF(7.93, 7.93, 7.93); Calibrated: 4/24/2019;

Sensor-Surface: 1.4mm (Mechanical Surface Detection)

Electronics: DAE4 Sn1407; Calibrated: 4/18/2019

Phantom: Twin-SAM V4.0 Front Right; Type: QD 000 P40 CC; Serial: 1167

Measurement SW: DASY52, Version 52.10 (2);SEMCAD X Version 14.6.12 (7450)

**Mode: LTE Band 2 (PCS), Body SAR, Back side, High.ch,
20 MHz Bandwidth, QPSK, 1 RB, 50 RB Offset**

Area Scan (9x15x1): Measurement grid: dx=15mm, dy=15mm

Zoom Scan (5x5x7)/Cube 0: Measurement grid: dx=8mm, dy=8mm, dz=5mm

Reference Value = 23.71 V/m; Power Drift = 0.00 dB

Peak SAR (extrapolated) = 1.51 W/kg

SAR(1 g) = 0.780 W/kg

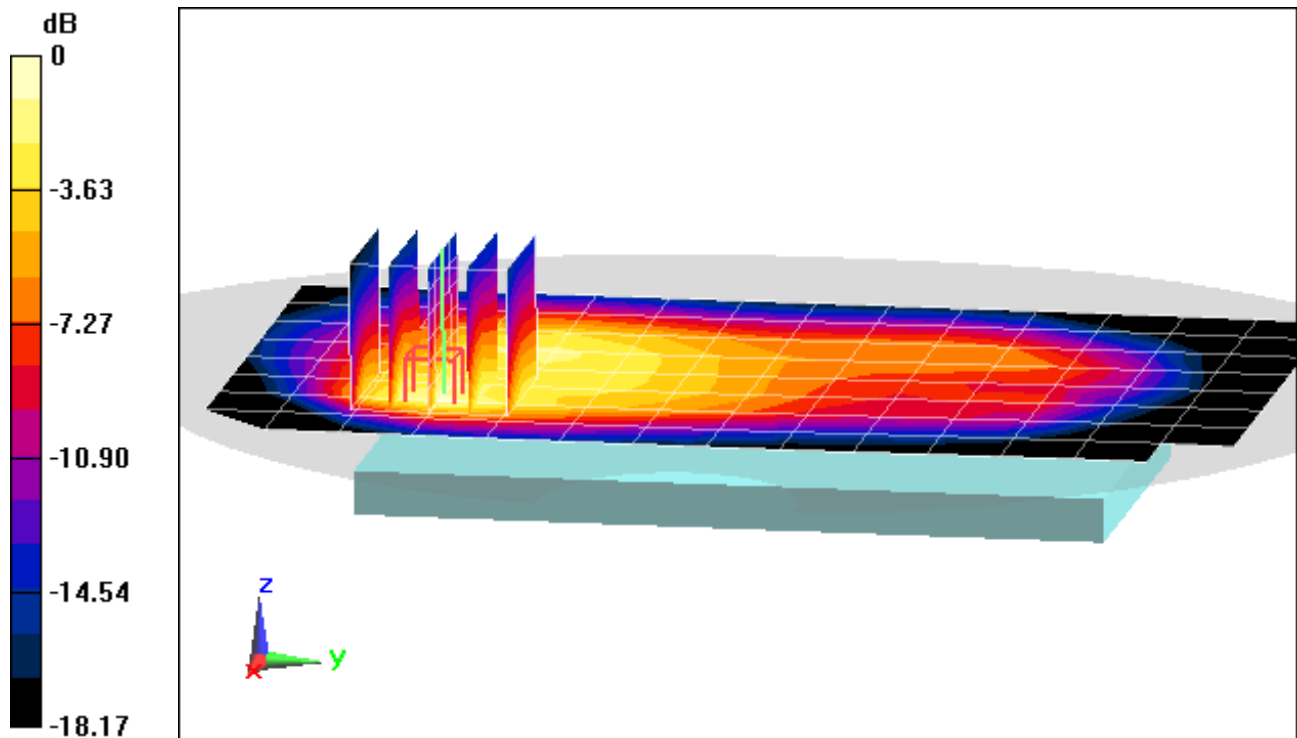

0 dB = 1.23 W/kg = 0.90 dBW/kg

PCTEST ENGINEERING LABORATORY, INC.

DUT: ZNFX420AS; Type: Portable Handset; Serial: 51501

Communication System: UID 0, LTE Band 30; Frequency: 2310 MHz; Duty Cycle: 1:1

Medium: 2450 Body Medium parameters used:

$f = 2310$ MHz; $\sigma = 1.877$ S/m; $\epsilon_r = 52.465$; $\rho = 1000$ kg/m³

Phantom section: Flat Section; Space: 1.0 cm

Test Date: 05-16-2019; Ambient Temp: 23.4°C; Tissue Temp: 22.8°C

Probe: EX3DV4 - SN7417; ConvF(7.64, 7.64, 7.64); Calibrated: 2/19/2019;

Sensor-Surface: 1.4mm (Mechanical Surface Detection)

Electronics: DAE4 Sn665; Calibrated: 2/13/2019

Phantom: Right Twin-SAM V5.0; Type: QD 000 P40 CD; Serial: 1797

Measurement SW: DASY52, Version 52.10 (2);SEMCAD X Version 14.6.12 (7450)

**Mode: LTE Band 30, Body SAR, Back side, Mid.ch,
10 MHz Bandwidth, QPSK, 1 RB, 25 RB Offset**

Area Scan (11x18x1): Measurement grid: dx=12mm, dy=12mm

Zoom Scan (7x7x7)/Cube 0: Measurement grid: dx=5mm, dy=5mm, dz=5mm

Reference Value = 21.88 V/m; Power Drift = -0.13 dB

Peak SAR (extrapolated) = 1.49 W/kg

SAR(1 g) = 0.769 W/kg

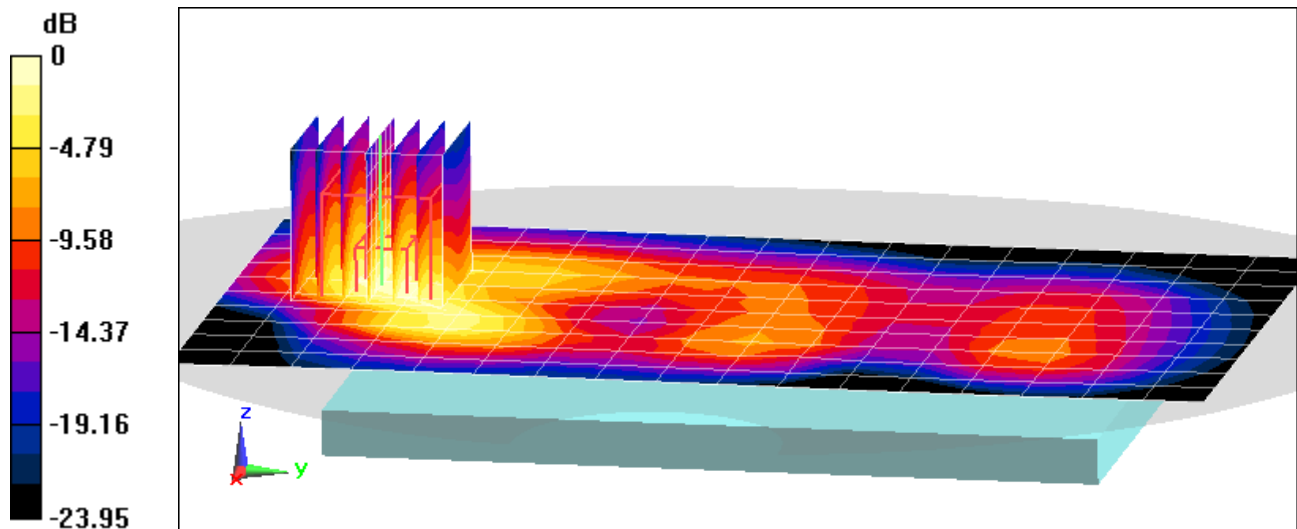

0 dB = 1.21 W/kg = 0.83 dBW/kg

PCTEST ENGINEERING LABORATORY, INC.

DUT: ZNFX420AS; Type: Portable Handset; Serial: 51501

Communication System: UID 0, LTE Band 30; Frequency: 2310 MHz; Duty Cycle: 1:1

Medium: 2450 Body Medium parameters used:

$f = 2310$ MHz; $\sigma = 1.877$ S/m; $\epsilon_r = 52.465$; $\rho = 1000$ kg/m³

Phantom section: Flat Section; Space: 1.0 cm

Test Date: 05-16-2019; Ambient Temp: 23.4°C; Tissue Temp: 22.8°C

Probe: EX3DV4 - SN7417; ConvF(7.64, 7.64, 7.64); Calibrated: 2/19/2019;

Sensor-Surface: 1.4mm (Mechanical Surface Detection)

Electronics: DAE4 Sn665; Calibrated: 2/13/2019

Phantom: Right Twin-SAM V5.0; Type: QD 000 P40 CD; Serial: 1797

Measurement SW: DASY52, Version 52.10 (2);SEMCAD X Version 14.6.12 (7450)

**Mode: LTE Band 30, Body SAR, Bottom Edge, Mid.ch,
10 MHz Bandwidth, QPSK, 1 RB, 25 RB Offset**

Area Scan (11x10x1): Measurement grid: dx=5mm, dy=12mm

Zoom Scan (7x7x7)/Cube 0: Measurement grid: dx=5mm, dy=5mm, dz=5mm

Reference Value = 25.22 V/m; Power Drift = 0.01 dB

Peak SAR (extrapolated) = 2.08 W/kg

SAR(1 g) = 1.04 W/kg

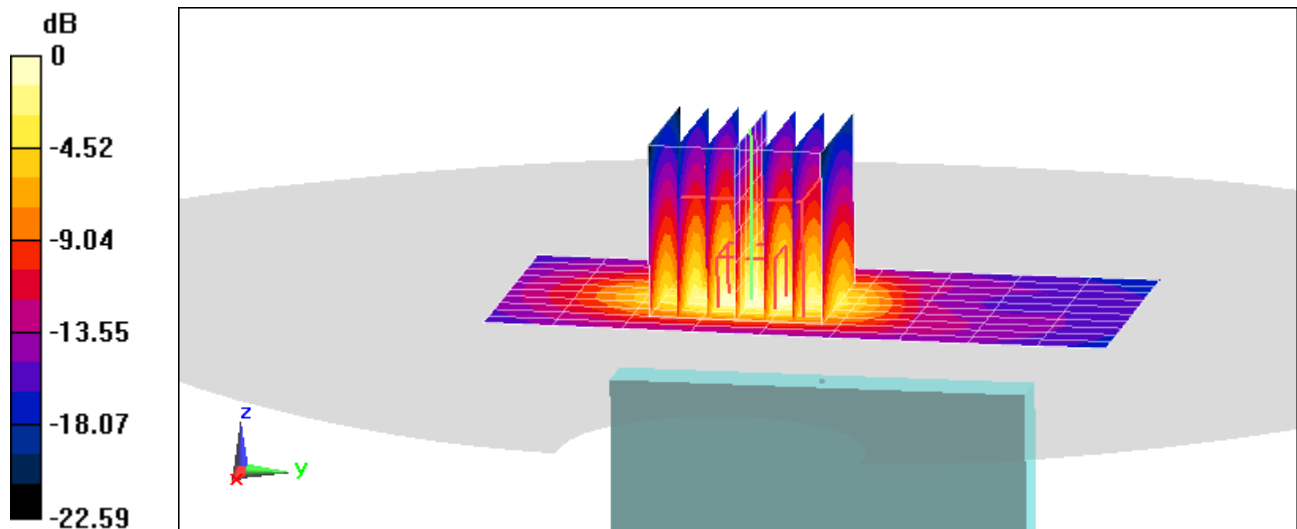

0 dB = 1.70 W/kg = 2.30 dBW/kg

PCTEST ENGINEERING LABORATORY, INC.

DUT: ZNFX420AS; Type: Portable Handset; Serial: 51626

Communication System: UID 0, _IEEE 802.11b; Frequency: 2412 MHz; Duty Cycle: 1:1

Medium: 2450 Body Medium parameters used (interpolated):

$f = 2412 \text{ MHz}$; $\sigma = 1.995 \text{ S/m}$; $\epsilon_r = 52.72$; $\rho = 1000 \text{ kg/m}^3$

Phantom section: Flat Section; Space: 1.0 cm

Test Date: 05-15-2019; Ambient Temp: 21.6°C; Tissue Temp: 20.2°C

Probe: EX3DV4 - SN7308; ConvF(7.57, 7.57, 7.57); Calibrated: 8/23/2018;

Sensor-Surface: 1.4mm (Mechanical Surface Detection)

Electronics: DAE4 Sn1558; Calibrated: 10/3/2018

Phantom: Twin-SAM V5.0; Type: QD 000 P40 CD; Serial: 1630

Measurement SW: DASY52, Version 52.10 (2);SEMCAD X Version 14.6.12 (7450)

Mode: IEEE 802.11b, 22 MHz Bandwidth, Body SAR, Ch 1, 1 Mbps, Back Side

Area Scan (10x16x1): Measurement grid: dx=12mm, dy=12mm

Zoom Scan (7x7x7)/Cube 0: Measurement grid: dx=5mm, dy=5mm, dz=5mm

Reference Value = 8.198 V/m; Power Drift = -0.07 dB

Peak SAR (extrapolated) = 0.263 W/kg

SAR(1 g) = 0.124 W/kg

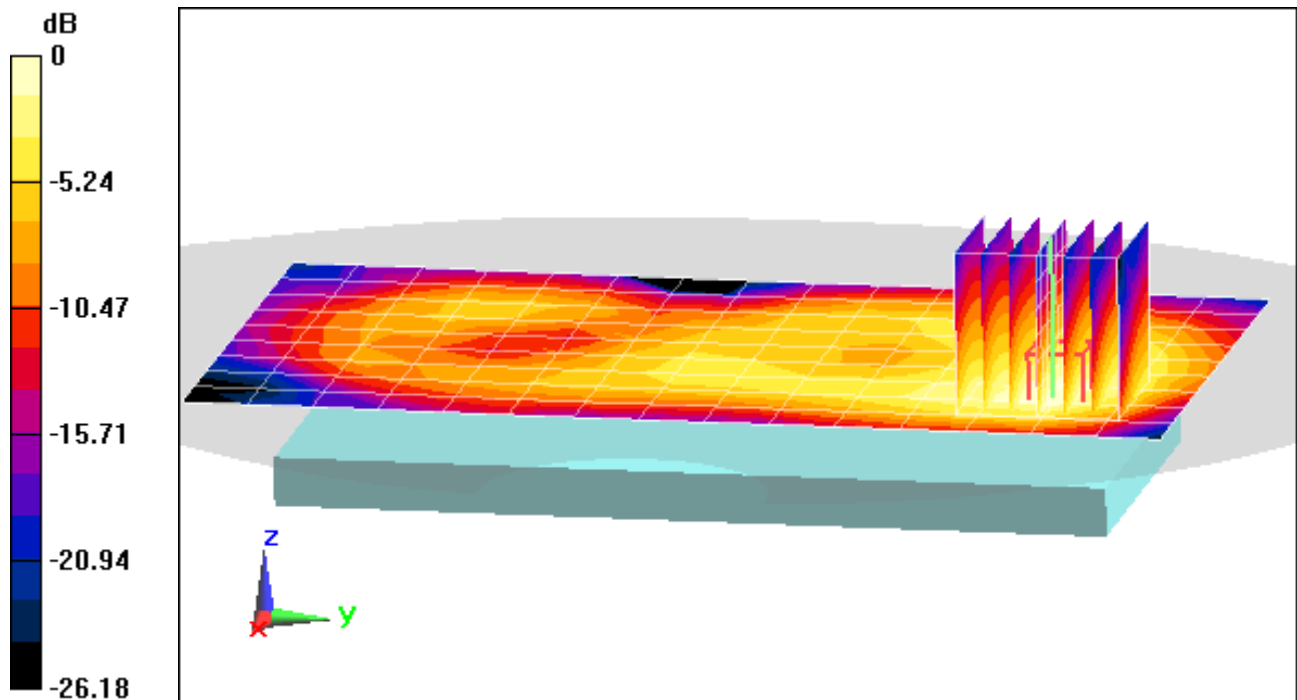

0 dB = 0.204 W/kg = -6.90 dBW/kg

PCTEST ENGINEERING LABORATORY, INC.

DUT: ZNFX420AS; Type: Portable Handset; Serial: 51501

Communication System: UID 0, UMTS; Frequency: 1712.4 MHz; Duty Cycle: 1:1
Medium: 1750 Body Medium parameters used (interpolated):
 $f = 1712.4$ MHz; $\sigma = 1.467$ S/m; $\epsilon_r = 52.133$; $\rho = 1000$ kg/m³
Phantom section: Flat Section; Space: 0.0 cm

Test Date: 05-13-2019; Ambient Temp: 21.3°C; Tissue Temp: 20.5°C

Probe: EX3DV4 - SN3914; ConvF(7.89, 7.89, 7.89); Calibrated: 2/19/2019;
Sensor-Surface: 1.4mm (Mechanical Surface Detection)
Electronics: DAE4 Sn1272; Calibrated: 2/14/2019

Phantom: SAM with CRP v5.0 Front; Type: QD000P40CD; Serial: 1646
Measurement SW: DASY52, Version 52.10 (2);SEMCAD X Version 14.6.12 (7450)

Mode: UMTS 1750, Phablet SAR, Back side, Low.ch

Area Scan (9x13x1): Measurement grid: dx=15mm, dy=15mm

Zoom Scan (5x5x7)/Cube 0: Measurement grid: dx=8mm, dy=8mm, dz=5mm

Reference Value = 72.41 V/m; Power Drift = -0.01 dB

Peak SAR (extrapolated) = 15.7 W/kg

SAR(10 g) = 3.08 W/kg

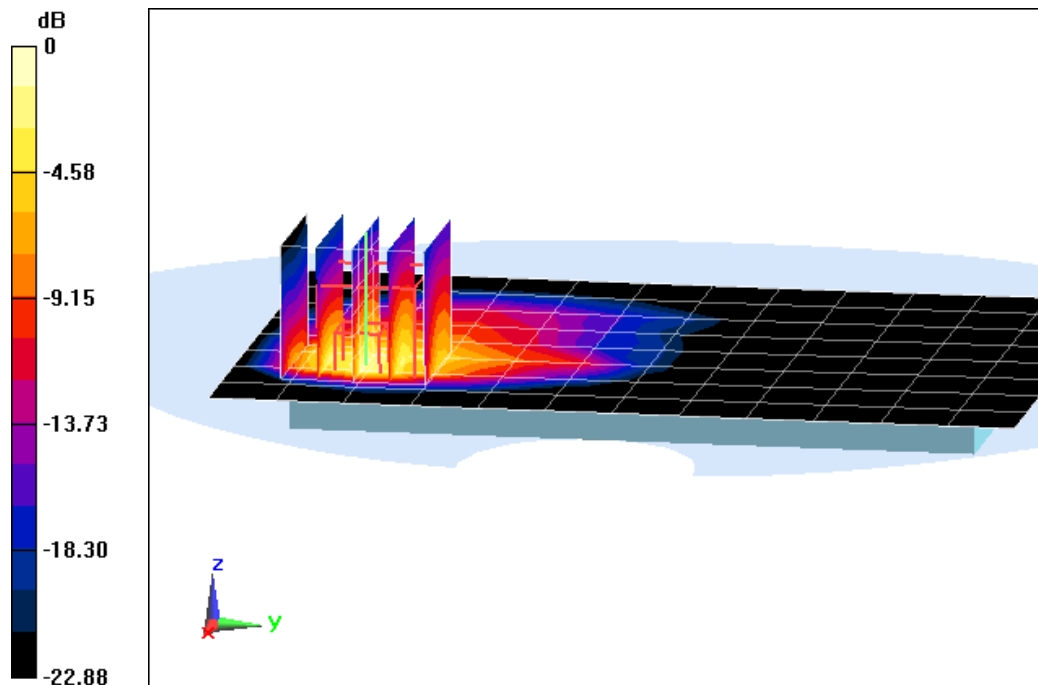

0 dB = 11.9 W/kg = 10.76 dBW/kg

PCTEST ENGINEERING LABORATORY, INC.

DUT: ZNFX420AS; Type: Portable Handset; Serial: 51501

Communication System: UID 0, UMTS, Frequency: 1907.6 MHz; Duty Cycle: 1:1
Medium: 1900 Body Medium parameters used (interpolated):
 $f = 1907.6 \text{ MHz}$; $\sigma = 1.583 \text{ S/m}$; $\epsilon_r = 51.953$; $\rho = 1000 \text{ kg/m}^3$
Phantom section: Flat Section; Space: 0.0 cm

Test Date: 05-15-2019; Ambient Temp: 22.8°C; Tissue Temp: 21.7°C

Probe: EX3DV4 - SN7410; ConvF(7.78, 7.78, 7.78); Calibrated: 7/20/2018;
Sensor-Surface: 1.4mm (Mechanical Surface Detection)
Electronics: DAE4 Sn1322; Calibrated: 7/11/2018
Phantom: Front; Type: QD 000 P40 CD; Serial: 1686
Measurement SW: DASY52, Version 52.10 (2);SEMCAD X Version 14.6.12 (7450)

Mode: UMTS 1900, Phablet SAR, Left Edge, High.ch

Area Scan (11x13x1): Measurement grid: dx=5mm, dy=15mm
Zoom Scan (5x5x7)/Cube 0: Measurement grid: dx=8mm, dy=8mm, dz=5mm
Reference Value = 68.93 V/m; Power Drift = 0.01 dB
Peak SAR (extrapolated) = 17.9 W/kg
SAR(10 g) = 2.83 W/kg

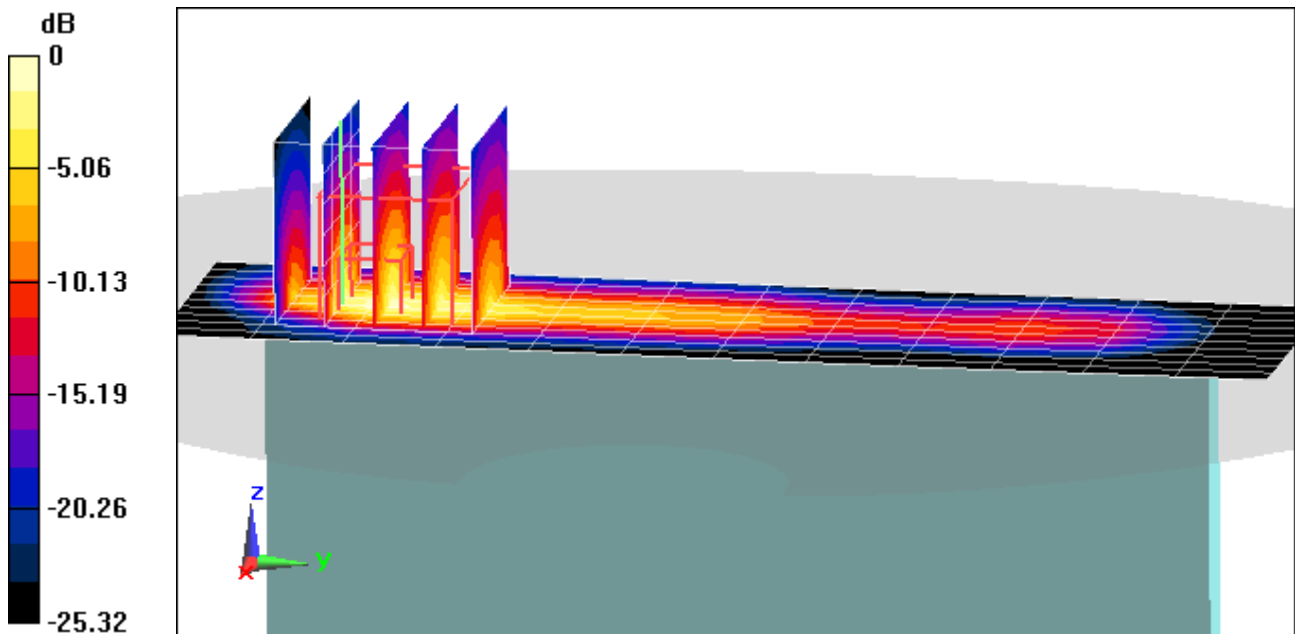

0 dB = 13.1 W/kg = 11.17 dBW/kg

PCTEST ENGINEERING LABORATORY, INC.

DUT: ZNFX420AS; Type: Portable Handset; Serial: 51501

Communication System: UID 0, LTE Band 66 (AWS); Frequency: 1720 MHz; Duty Cycle: 1:1

Medium: 1750 Body Medium parameters used (interpolated):

$f = 1720 \text{ MHz}$; $\sigma = 1.472 \text{ S/m}$; $\epsilon_r = 52.122$; $\rho = 1000 \text{ kg/m}^3$

Phantom section: Flat Section; Space: 0.0 cm

Test Date: 05-13-2019; Ambient Temp: 21.3°C; Tissue Temp: 20.5°C

Probe: EX3DV4 - SN3914; ConvF(7.89, 7.89, 7.89); Calibrated: 2/19/2019;

Sensor-Surface: 1.4mm (Mechanical Surface Detection)

Electronics: DAE4 Sn1272; Calibrated: 2/14/2019

Phantom: SAM with CRP v5.0 Front; Type: QD000P40CD; Serial: 1646

Measurement SW: DASY52, Version 52.10 (2);SEMCAD X Version 14.6.12 (7450)

**Mode: LTE Band 66 (AWS), Phablet SAR, Back side, Low.ch,
20 MHz Bandwidth, QPSK, 50 RB, 25 RB Offset**

Area Scan (9x15x1): Measurement grid: dx=15mm, dy=15mm

Zoom Scan (5x5x7)/Cube 0: Measurement grid: dx=8mm, dy=8mm, dz=5mm

Reference Value = 72.64 V/m; Power Drift = 0.00 dB

Peak SAR (extrapolated) = 15.7 W/kg

SAR(10 g) = 2.99 W/kg

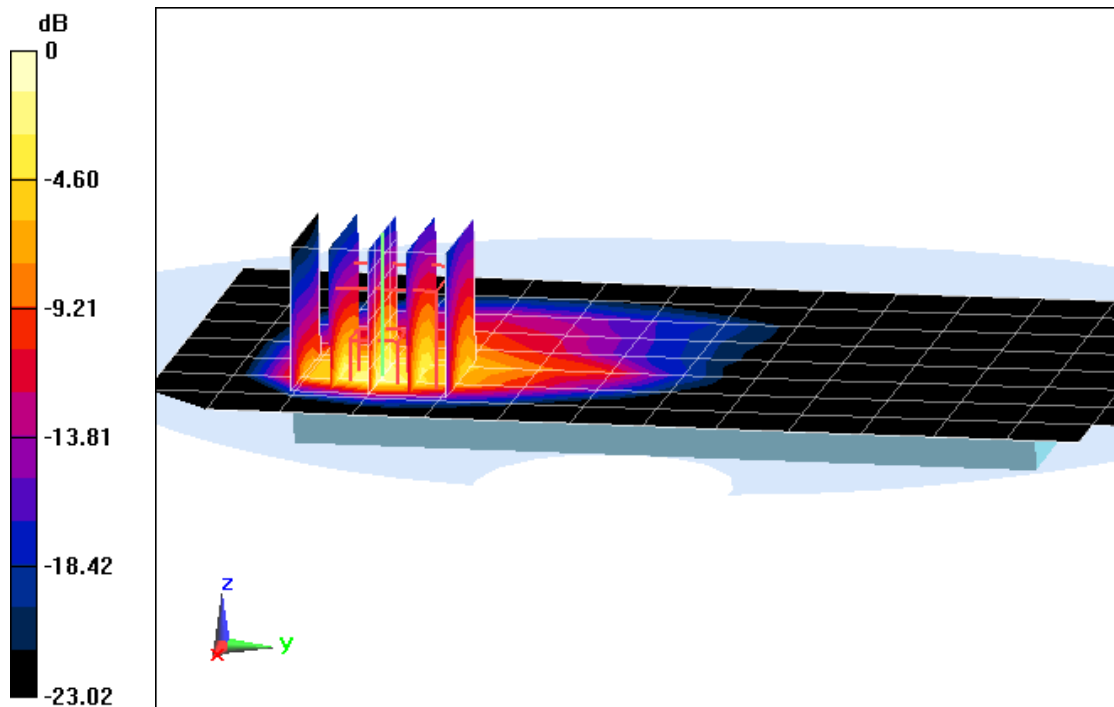

0 dB = 12.2 W/kg = 10.86 dBW/kg

PCTEST ENGINEERING LABORATORY, INC.

DUT: ZNFX420AS; Type: Portable Handset; Serial: 51501

Communication System: UID 0, _LTE Band 2 (PCS); Frequency: 1900 MHz; Duty Cycle: 1:1
Medium: 1900 Body Medium parameters used (interpolated):
 $f = 1900 \text{ MHz}$; $\sigma = 1.575 \text{ S/m}$; $\epsilon_r = 51.974$; $\rho = 1000 \text{ kg/m}^3$
Phantom section: Flat Section; Space: 0.0 cm

Test Date: 05-15-2019; Ambient Temp: 22.8°C; Tissue Temp: 21.7°C

Probe: EX3DV4 - SN7410; ConvF(7.78, 7.78, 7.78); Calibrated: 7/20/2018;
Sensor-Surface: 1.4mm (Mechanical Surface Detection)
Electronics: DAE4 Sn1322; Calibrated: 7/11/2018
Phantom: Front; Type: QD 000 P40 CD; Serial: 1686
Measurement SW: DASY52, Version 52.10 (2);SEMCAD X Version 14.6.12 (7450)

**Mode: LTE Band 2 (PCS), Phablet SAR, Left Edge, High.ch,
20 MHz Bandwidth, QPSK, 1 RB, 50 RB Offset**

Area Scan (11x13x1): Measurement grid: dx=5mm, dy=15mm
Zoom Scan (5x5x7)/Cube 0: Measurement grid: dx=8mm, dy=8mm, dz=5mm
Reference Value = 70.67 V/m; Power Drift = -0.06 dB
Peak SAR (extrapolated) = 17.7 W/kg
SAR(10 g) = 2.98 W/kg

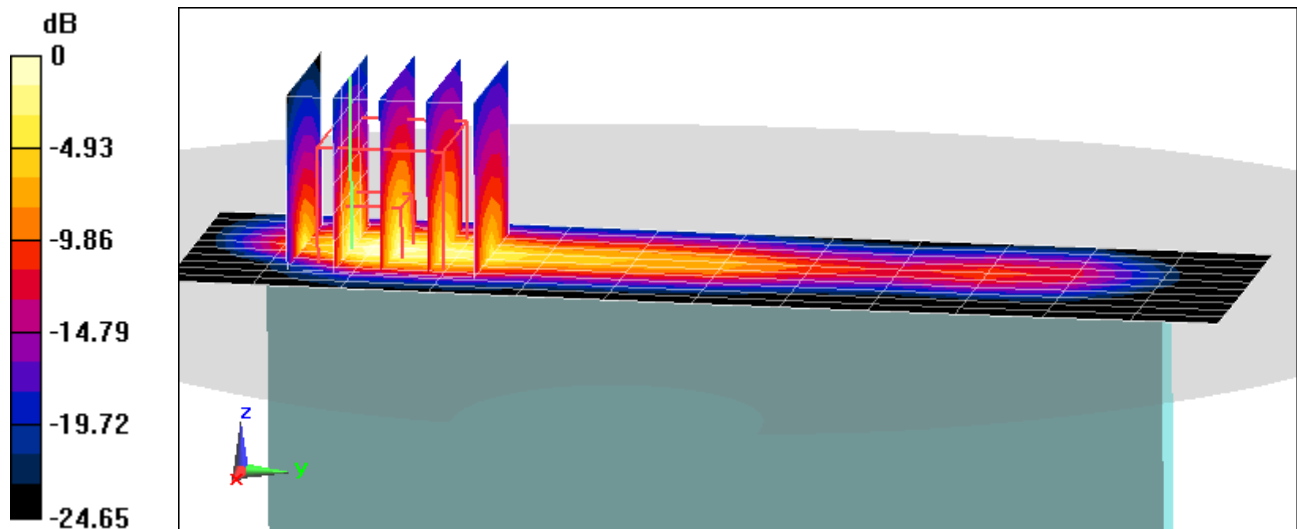

0 dB = 13.7 W/kg = 11.37 dBW/kg

PCTEST ENGINEERING LABORATORY, INC.

DUT: ZNFX420AS; Type: Portable Handset; Serial: 51576

Communication System: UID 0, LTE Band 30; Frequency: 2310 MHz; Duty Cycle: 1:1

Medium: 2450 Body Medium parameters used:

$f = 2310$ MHz; $\sigma = 1.877$ S/m; $\epsilon_r = 52.465$; $\rho = 1000$ kg/m³

Phantom section: Flat Section; Space: 0.0 cm

Test Date: 05-16-2019; Ambient Temp: 23.4°C; Tissue Temp: 22.8°C

Probe: EX3DV4 - SN7417; ConvF(7.64, 7.64, 7.64); Calibrated: 2/19/2019;

Sensor-Surface: 1.4mm (Mechanical Surface Detection)

Electronics: DAE4 Sn665; Calibrated: 2/13/2019

Phantom: Right Twin-SAM V5.0; Type: QD 000 P40 CD; Serial: 1797

Measurement SW: DASY52, Version 52.10 (2);SEMCAD X Version 14.6.12 (7450)

**Mode: LTE Band 30, Phablet SAR, Back side, Mid.ch,
10 MHz Bandwidth, QPSK, 1 RB, 25 RB Offset**

Area Scan (10x17x1): Measurement grid: dx=12mm, dy=12mm

Zoom Scan (7x7x7)/Cube 1: Measurement grid: dx=5mm, dy=5mm, dz=5mm

Reference Value = 47.00 V/m; Power Drift = -0.17 dB

Peak SAR (extrapolated) = 12.7 W/kg

SAR(10 g) = 1.72 W/kg

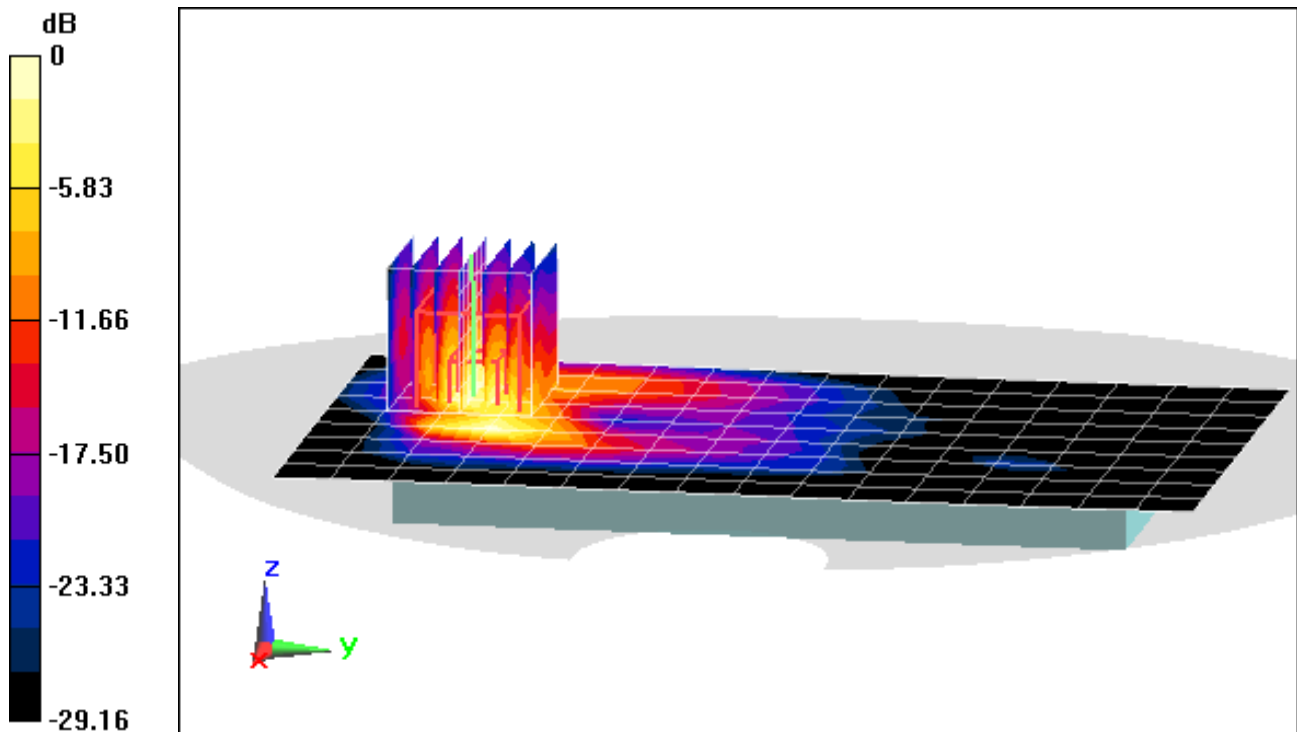

0 dB = 9.18 W/kg = 9.63 dBW/kg

APPENDIX B: SYSTEM VERIFICATION

PCTEST ENGINEERING LABORATORY, INC.

DUT: Dipole 750 MHz; Type: D750V3; Serial: 1161

Communication System: UID 0, CW; Frequency: 750 MHz; Duty Cycle: 1:1

Medium: 750 Head Medium parameters used (interpolated):

$f = 750 \text{ MHz}$; $\sigma = 0.918 \text{ S/m}$; $\epsilon_r = 42.895$; $\rho = 1000 \text{ kg/m}^3$

Phantom section: Flat Section; Space: 1.5 cm

Test Date: 05-09-2019; Ambient Temp: 23.1°C; Tissue Temp: 22.3°C

Probe: EX3DV4 - SN3914; ConvF(10, 10, 10); Calibrated: 2/19/2019

Sensor-Surface: 1.4mm (Mechanical Surface Detection)

Electronics: DAE4 Sn1272; Calibrated: 2/14/2019

Phantom: Left For Head SAM with CRP v5.0; Type: QD000P40CD; Serial: TP:1687

Measurement SW: DASY52, Version 52.10 (2);SEMCAD X Version 14.6.12 (7450)

750 MHz System Verification at 23.0 dBm (200 mW)

Area Scan (7x15x1): Measurement grid: dx=15mm, dy=15mm

Zoom Scan (5x5x7)/Cube 0: Measurement grid: dx=8mm, dy=8mm, dz=5mm

Peak SAR (extrapolated) = 2.77 W/kg

SAR(1 g) = 1.73 W/kg

Deviation(1 g) = 7.72%

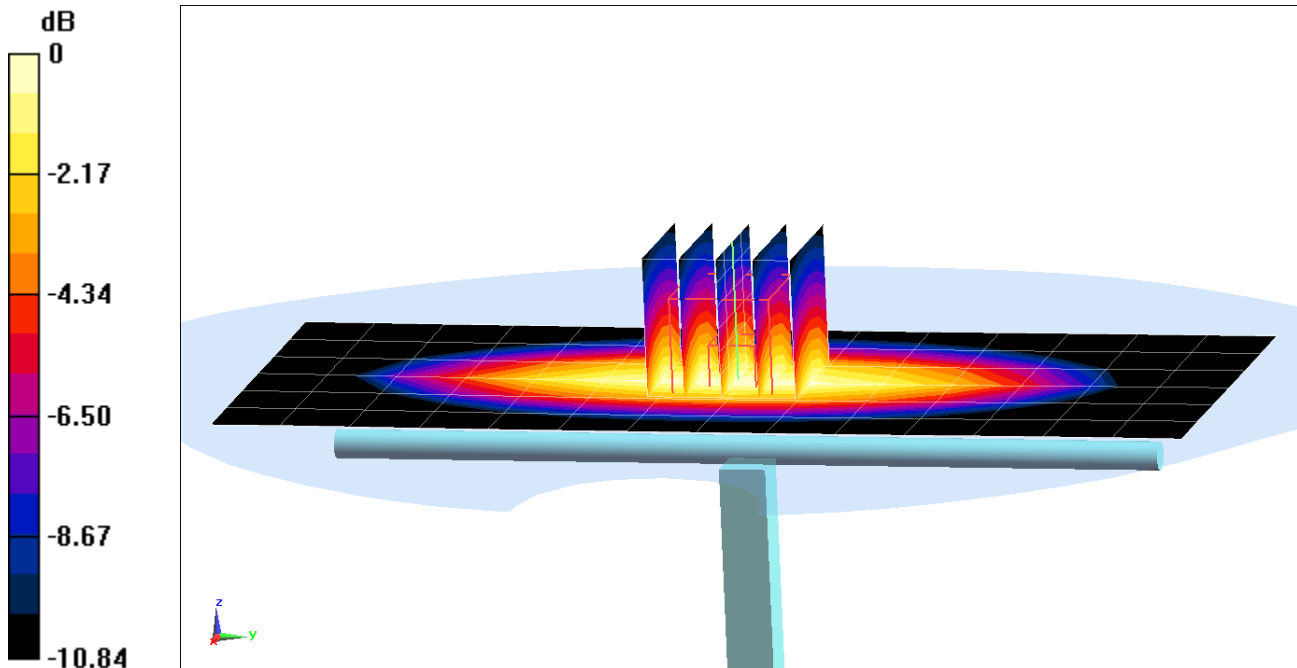

0 dB = 2.38 W/kg = 3.77 dBW/kg

PCTEST ENGINEERING LABORATORY, INC.

DUT: Dipole 835 MHz; Type: D835V2; Serial: 4d132

Communication System: UID 0, CW; Frequency: 835 MHz; Duty Cycle: 1:1

Medium: 835 Head Medium parameters used:

$f = 835 \text{ MHz}$; $\sigma = 0.9 \text{ S/m}$; $\epsilon_r = 40.761$; $\rho = 1000 \text{ kg/m}^3$

Phantom section: Flat Section; Space: 1.5 cm

Test Date: 05-14-2019; Ambient Temp: 22.0°C; Tissue Temp: 20.8°C

Probe: EX3DV4 - SN3589; ConvF(8.39, 8.39, 8.39); Calibrated: 1/25/2019

Sensor-Surface: 1.4mm (Mechanical Surface Detection)

Electronics: DAE4 Sn1450; Calibrated: 8/22/2018

Phantom: SAM 5.0 front; Type: QD000P40CD; Serial: 1648

Measurement SW: DASY52, Version 52.10 (2);SEMCAD X Version 14.6.12 (7450)

835 MHz System Verification at 23.0 dBm (200 mW)

Area Scan (7x14x1): Measurement grid: dx=15mm, dy=15mm

Zoom Scan (5x5x7)/Cube 0: Measurement grid: dx=8mm, dy=8mm, dz=5mm

Peak SAR (extrapolated) = 3.14 W/kg

SAR(1 g) = 2.02 W/kg

Deviation(1 g) = 5.32%

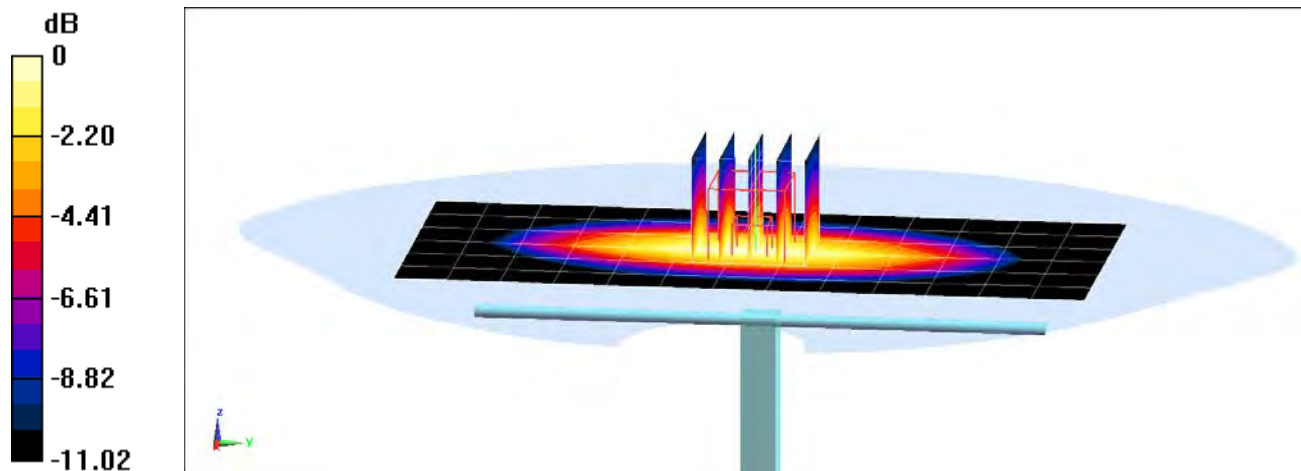

0 dB = 2.76 W/kg = 4.41 dBW/kg

PCTEST ENGINEERING LABORATORY, INC.

DUT: Dipole 1750 MHz; Type: D1765V2; Serial: 1008

Communication System: UID 0, CW; Frequency: 1750 MHz; Duty Cycle: 1:1

Medium: 1750 Head Medium parameters used:

$f = 1750$ MHz; $\sigma = 1.371$ S/m; $\epsilon_r = 42.068$; $\rho = 1000$ kg/m³

Phantom section: Flat Section; Space: 1.0 cm

Test Date: 05-14-2019; Ambient Temp: 20.2°C; Tissue Temp: 20.4°C

Probe: EX3DV4 - SN7409; ConvF(8.43, 8.43, 8.43); Calibrated: 6/25/2018

Sensor-Surface: 1.4mm (Mechanical Surface Detection)

Electronics: DAE4 Sn1334; Calibrated: 6/18/2018

Phantom: SAM 30 with CRP v5.0 right; Type: QD000P40CD; Serial: TP:1759

Measurement SW: DASY52, Version 52.10 (2);SEMCAD X Version 14.6.12 (7450)

1750 MHz System Verification at 20.0 dBm (100 mW)

Area Scan (7x9x1): Measurement grid: dx=15mm, dy=15mm

Zoom Scan (5x5x7)/Cube 0: Measurement grid: dx=8mm, dy=8mm, dz=5mm

Peak SAR (extrapolated) = 6.56 W/kg

SAR(1 g) = 3.53 W/kg

Deviation(1 g) = -2.49%

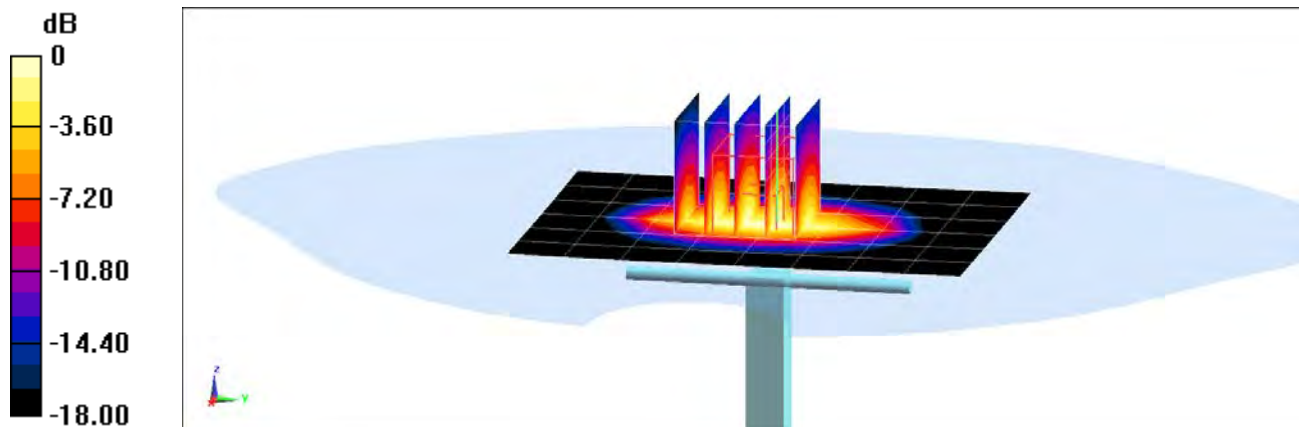

0 dB = 5.39 W/kg = 7.32 dBW/kg

PCTEST ENGINEERING LABORATORY, INC.

DUT: Dipole 1900 MHz; Type: D1900V2; Serial: 5d149

Communication System: UID 0, CW; Frequency: 1900 MHz; Duty Cycle: 1:1

Medium: 1900 Head Medium parameters used (interpolated):

$f = 1900 \text{ MHz}$; $\sigma = 1.458 \text{ S/m}$; $\epsilon_r = 38.566$; $\rho = 1000 \text{ kg/m}^3$

Phantom section: Flat Section; Space: 1.0 cm

Test Date: 05-12-2019; Ambient Temp: 21.3°C; Tissue Temp: 21.1°C

Probe: EX3DV4 - SN7410; ConvF(8.16, 8.16, 8.16); Calibrated: 7/20/2018

Sensor-Surface: 1.4mm (Mechanical Surface Detection)

Electronics: DAE4 Sn1322; Calibrated: 7/11/2018

Phantom: Front; Type: QD 000 P40 CD; Serial: 1686

Measurement SW: DASY52, Version 52.10 (2);SEMCAD X Version 14.6.12 (7450)

1900 MHz System Verification at 20.0 dBm (100 mW)

Area Scan (7x11x1): Measurement grid: dx=15mm, dy=15mm

Zoom Scan (5x5x7)/Cube 0: Measurement grid: dx=8mm, dy=8mm, dz=5mm

Peak SAR (extrapolated) = 7.68 W/kg

SAR(1 g) = 4.24 W/kg

Deviation(1 g) = 7.89%

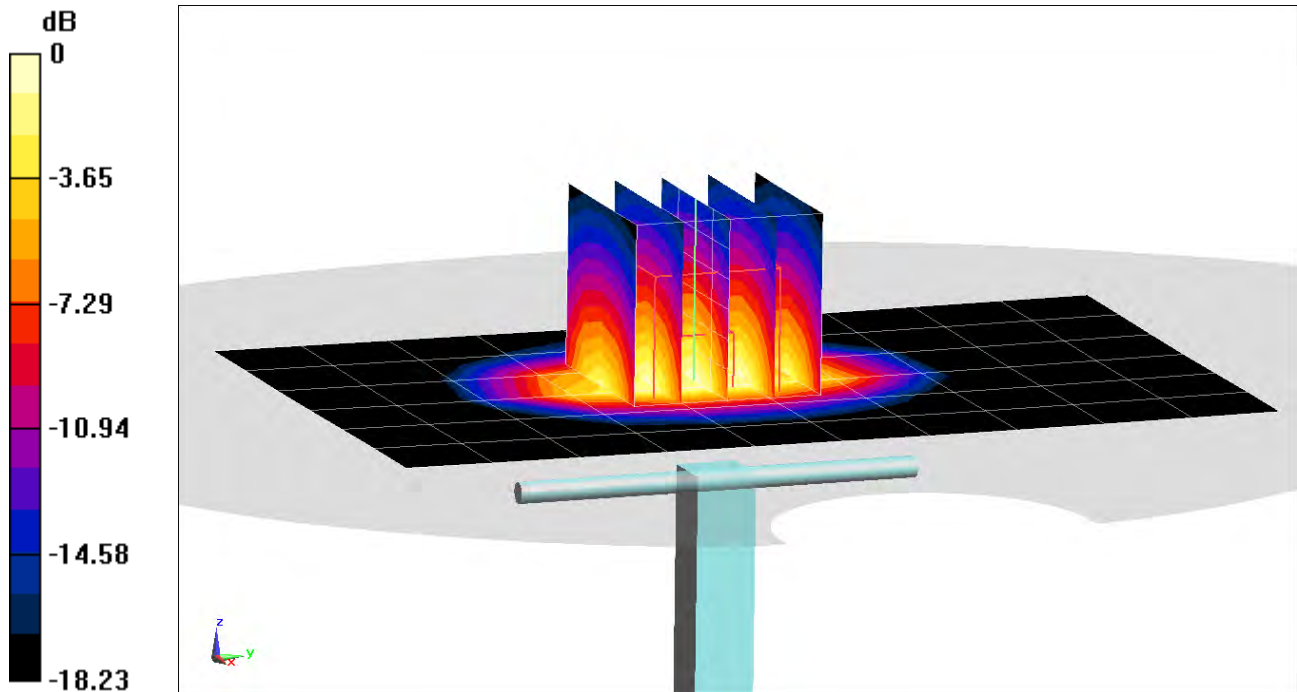

0 dB = 6.59 W/kg = 8.19 dBW/kg

PCTEST ENGINEERING LABORATORY, INC.

DUT: Dipole 2300 MHz; Type: D2300V2; Serial: 1064

Communication System: UID 0, CW; Frequency: 2300 MHz; Duty Cycle: 1:1

Medium: 2450 Head; Medium parameters used:

$f = 2300$ MHz; $\sigma = 1.71$ S/m; $\epsilon_r = 38.55$; $\rho = 1000$ kg/m³

Phantom section: Flat Section; Space: 1.0 cm

Test Date: 05-10-2019; Ambient Temp: 22.6°C; Tissue Temp: 21.7°C

Probe: EX3DV4 - SN7409; ConvF(7.57, 7.57, 7.57); Calibrated: 6/25/2018

Sensor-Surface: 1.4mm (Mechanical Surface Detection)

Electronics: DAE4 Sn1334; Calibrated: 6/18/2018

Phantom: SAM 30 with CRP v5.0 right; Type: QD000P40CD; Serial: TP:1759

Measurement SW: DASY52, Version 52.10 (2);SEMCAD X Version 14.6.12 (7450)

2300 MHz System Verification at 20.0 dBm (100 mW)

Area Scan (8x9x1): Measurement grid: dx=12mm, dy=12mm

Zoom Scan (7x7x7)/Cube 0: Measurement grid: dx=5mm, dy=5mm, dz=5mm

Peak SAR (extrapolated) = 10.6 W/kg

SAR(1 g) = 5.05 W/kg

Deviation(1 g) = 6.09%

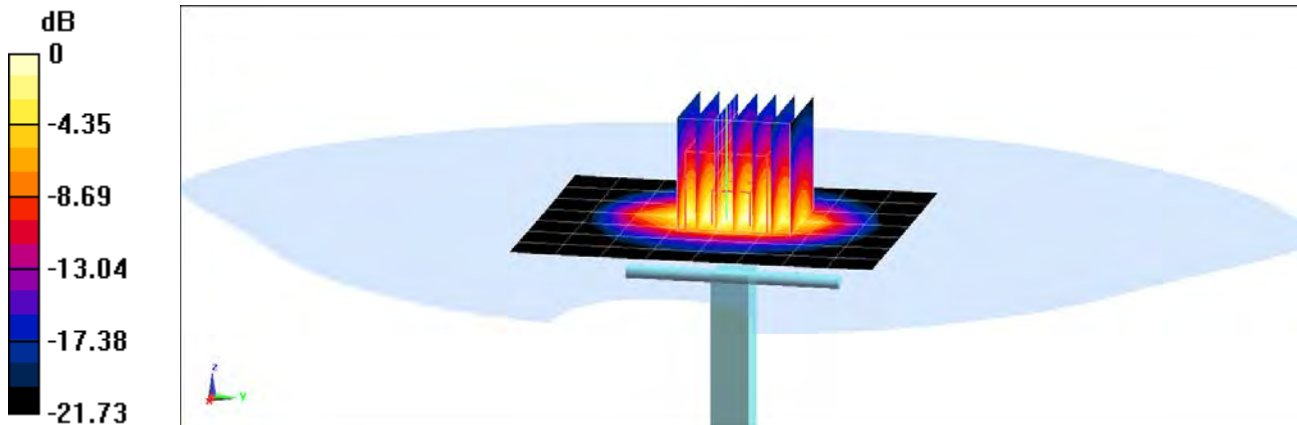

0 dB = 8.44 W/kg = 9.26 dBW/kg

PCTEST ENGINEERING LABORATORY, INC.

DUT: Dipole 2450 MHz; Type: D2450V2; Serial: 981

Communication System: UID 0, CW; Frequency: 2450 MHz; Duty Cycle: 1:1

Medium: 2450 Head Medium parameters used:

$f = 2450$ MHz; $\sigma = 1.876$ S/m; $\epsilon_r = 38.916$; $\rho = 1000$ kg/m³

Phantom section: Flat Section; Space: 1.0 cm

Test Date: 05-13-2019; Ambient Temp: 21.2°C; Tissue Temp: 19.5°C

Probe: EX3DV4 - SN3589; ConvF(6.46, 6.46, 6.46); Calibrated: 1/25/2019

Sensor-Surface: 1.4mm (Mechanical Surface Detection)

Electronics: DAE4 Sn1450; Calibrated: 8/22/2018

Phantom: Twin-SAM V5.0 (30); Type: QD 000 P40 CD; Serial: 1647

Measurement SW: DASY52, Version 52.10 (2); SEMCAD X Version 14.6.12 (7450)

2450 MHz System Verification at 20.0 dBm (100 mW)

Area Scan (8x9x1): Measurement grid: dx=12mm, dy=12mm

Zoom Scan (7x7x7)/Cube 0: Measurement grid: dx=5mm, dy=5mm, dz=5mm

Peak SAR (extrapolated) = 11.6 W/kg

SAR(1 g) = 5.34 W/kg

Deviation(1 g) = 2.10%

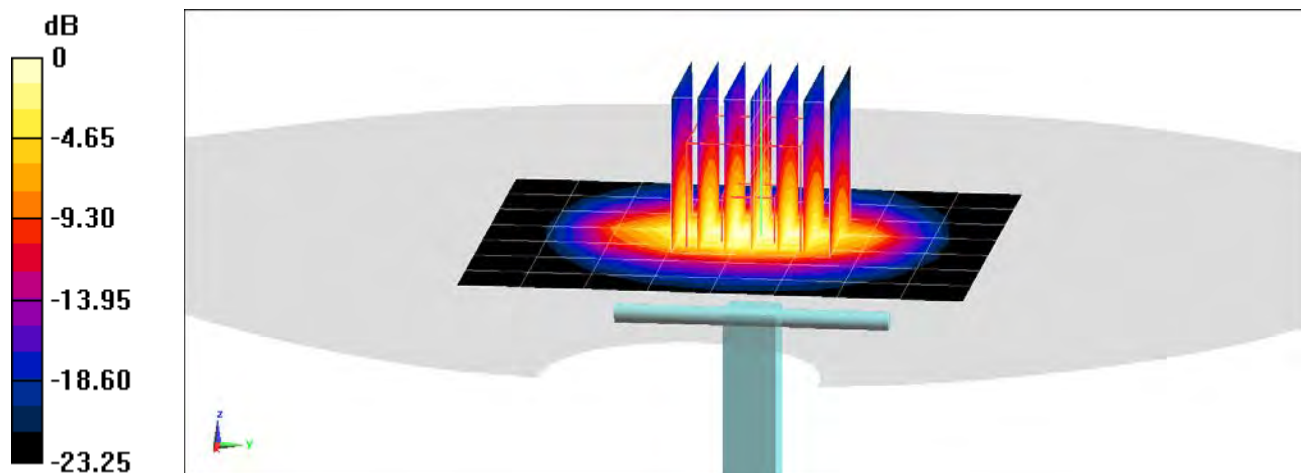

0 dB = 9.03 W/kg = 9.56 dBW/kg

PCTEST ENGINEERING LABORATORY, INC.

DUT: Dipole 750 MHz; Type: D750V3; Serial: 1003

Communication System: UID 0, CW; Frequency: 750 MHz; Duty Cycle: 1:1

Medium: 750 Body; Medium parameters used (interpolated):

$f = 750 \text{ MHz}$; $\sigma = 0.937 \text{ S/m}$; $\epsilon_r = 56.547$; $\rho = 1000 \text{ kg/m}^3$

Phantom section: Flat Section; Space: 1.5 cm

Test Date: 05-16-2019; Ambient Temp: 22.8°C; Tissue Temp: 22.1°C

Probe: EX3DV4 - SN7357; ConvF(10.19, 10.19, 10.19); Calibrated: 4/24/2019

Sensor-Surface: 1.4mm (Mechanical Surface Detection)

Electronics: DAE4 Sn1407; Calibrated: 4/18/2019

Phantom: Twin-SAM V4.0 Front Right; Type: QD 000 P40 CC; Serial: 1167

Measurement SW: DASY52, Version 52.10 (2);SEMCAD X Version 14.6.12 (7450)

750 MHz System Verification at 23.0 dBm (200 mW)

Area Scan (7x15x1): Measurement grid: dx=15mm, dy=15mm

Zoom Scan (5x5x7)/Cube 0: Measurement grid: dx=8mm, dy=8mm, dz=5mm

Peak SAR (extrapolated) = 2.52 W/kg

SAR(1 g) = 1.7 W/kg

Deviation(1 g) = -0.93%

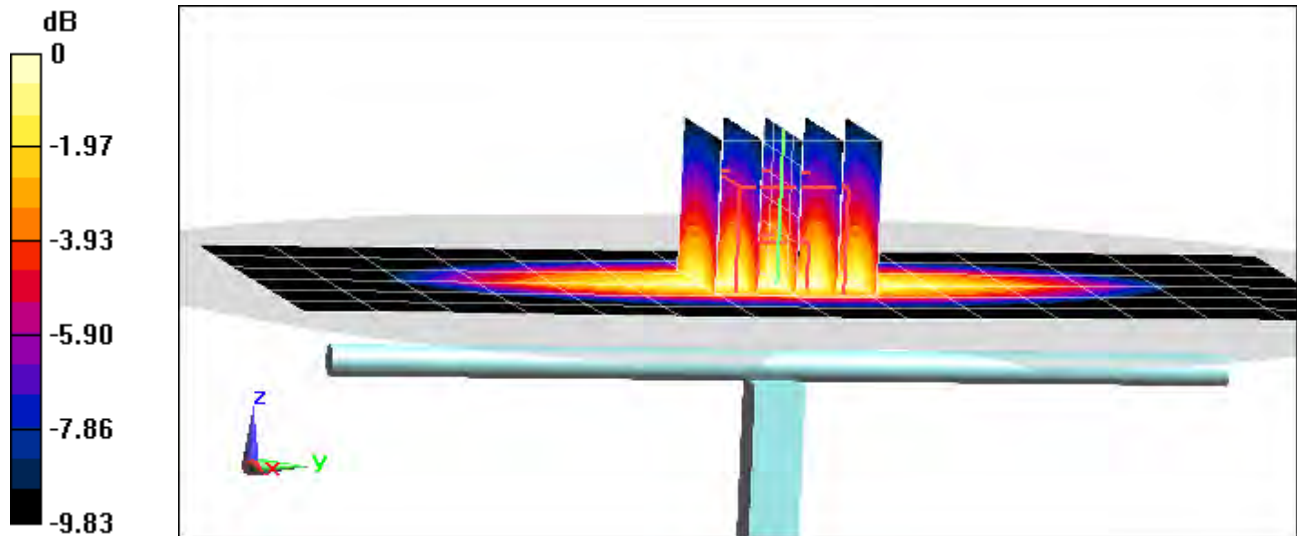

0 dB = 2.25 W/kg = 3.52 dBW/kg

PCTEST ENGINEERING LABORATORY, INC.

DUT: Dipole 835 MHz; Type: D835V2; Serial: 4d133

Communication System: UID 0, CW; Frequency: 835 MHz; Duty Cycle: 1:1

Medium: 835 Body Medium parameters used:

$f = 835 \text{ MHz}$; $\sigma = 0.978 \text{ S/m}$; $\epsilon_r = 53.681$; $\rho = 1000 \text{ kg/m}^3$

Phantom section: Flat Section; Space: 1.5 cm

Test Date: 5-13-2019; Ambient Temp: 19.7°C; Tissue Temp: 19.2°C

Probe: EX3DV4 - SN7488; ConvF(11.03, 11.03, 11.03); Calibrated: 1/24/2019

Sensor-Surface: 1.4mm (Mechanical Surface Detection)

Electronics: DAE4 Sn1530; Calibrated: 1/15/2019

Phantom: Twin-SAM V5.0; Type: QD 000 P40 CD; Serial: 1800

Measurement SW: DASY52, Version 52.10 (2); SEMCAD X Version 14.6.12 (7450)

835 MHz System Verification at 23.0 dBm (200 mW)

Area Scan (7x14x1): Measurement grid: dx=15mm, dy=15mm

Zoom Scan (5x5x7)/Cube 0: Measurement grid: dx=8mm, dy=8mm, dz=5mm

Peak SAR (extrapolated) = 3.02 W/kg

SAR(1 g) = 1.86 W/kg

Deviation(1 g) = -4.62%

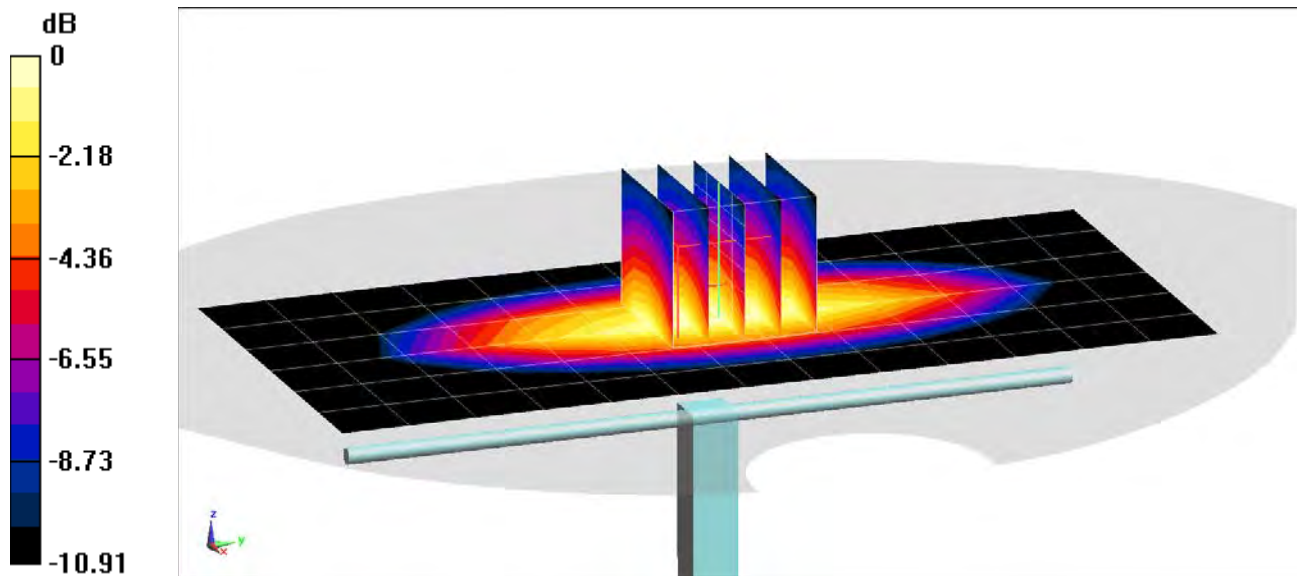

0 dB = 2.57 W/kg = 4.10 dBW/kg

PCTEST ENGINEERING LABORATORY, INC.

DUT: Dipole 1750 MHz; Type: D1765V2; Serial: 1008

Communication System: UID 0, CW; Frequency: 1750 MHz; Duty Cycle: 1:1

Medium: 1750 Body Medium parameters used:

$f = 1750 \text{ MHz}$; $\sigma = 1.493 \text{ S/m}$; $\epsilon_r = 52.076$; $\rho = 1000 \text{ kg/m}^3$

Phantom section: Flat Section; Space: 1.0 cm

Test Date: 05-13-2019; Ambient Temp: 21.3°C; Tissue Temp: 20.5°C

Probe: EX3DV4 - SN3914; ConvF(7.89, 7.89, 7.89); Calibrated: 2/19/2019

Sensor-Surface: 1.4mm (Mechanical Surface Detection)

Electronics: DAE4 Sn1272; Calibrated: 2/14/2019

Phantom: SAM with CRP v5.0 Front; Type: QD000P40CD; Serial: 1646

Measurement SW: DASY52, Version 52.10 (2);SEMCAD X Version 14.6.12 (7450)

1750 MHz System Verification at 20.0 dBm (100 mW)

Area Scan (7x9x1): Measurement grid: dx=15mm, dy=15mm

Zoom Scan (5x5x7)/Cube 0: Measurement grid: dx=8mm, dy=8mm, dz=5mm

Peak SAR (extrapolated) = 7.34 W/kg

SAR(1 g) = 3.92 W/kg; SAR(10 g) = 2.05 W/kg

Deviation(1 g) = 4.81%; Deviation(10 g) = 3.02%

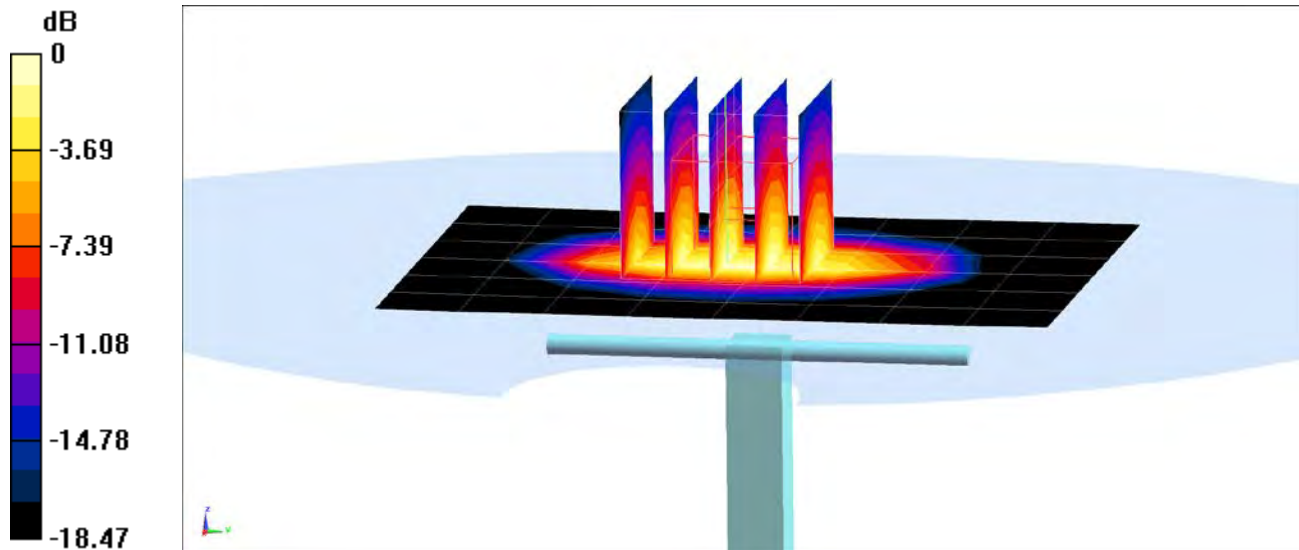

0 dB = 6.02 W/kg = 7.80 dBW/kg

PCTEST ENGINEERING LABORATORY, INC.

DUT: Dipole 1750 MHz; Type: D1765V2; Serial: 1008

Communication System: UID 0, CW; Frequency: 1750 MHz; Duty Cycle: 1:1

Medium: 1750 Body Medium parameters used:

$f = 1750 \text{ MHz}$; $\sigma = 1.484 \text{ S/m}$; $\epsilon_r = 51.57$; $\rho = 1000 \text{ kg/m}^3$

Phantom section: Flat Section; Space: 1.0 cm

Test Date: 05-15-2019; Ambient Temp: 23.1°C; Tissue Temp: 22.0°C

Probe: EX3DV4 - SN3914; ConvF(7.89, 7.89, 7.89); Calibrated: 2/19/2019

Sensor-Surface: 1.4mm (Mechanical Surface Detection)

Electronics: DAE4 Sn1272; Calibrated: 2/14/2019

Phantom: SAM with CRP v5.0 Front; Type: QD000P40CD; Serial: 1646

Measurement SW: DASY52, Version 52.10 (2);SEMCAD X Version 14.6.12 (7450)

1750 MHz System Verification at 20.0 dBm (100 mW)

Area Scan (7x9x1): Measurement grid: dx=15mm, dy=15mm

Zoom Scan (5x5x7)/Cube 0: Measurement grid: dx=8mm, dy=8mm, dz=5mm

Peak SAR (extrapolated) = 7.26 W/kg

SAR(1 g) = 3.92 W/kg; SAR(10 g) = 2.06 W/kg

Deviation(1 g) = 4.81%; Deviation(10 g) = 3.52%

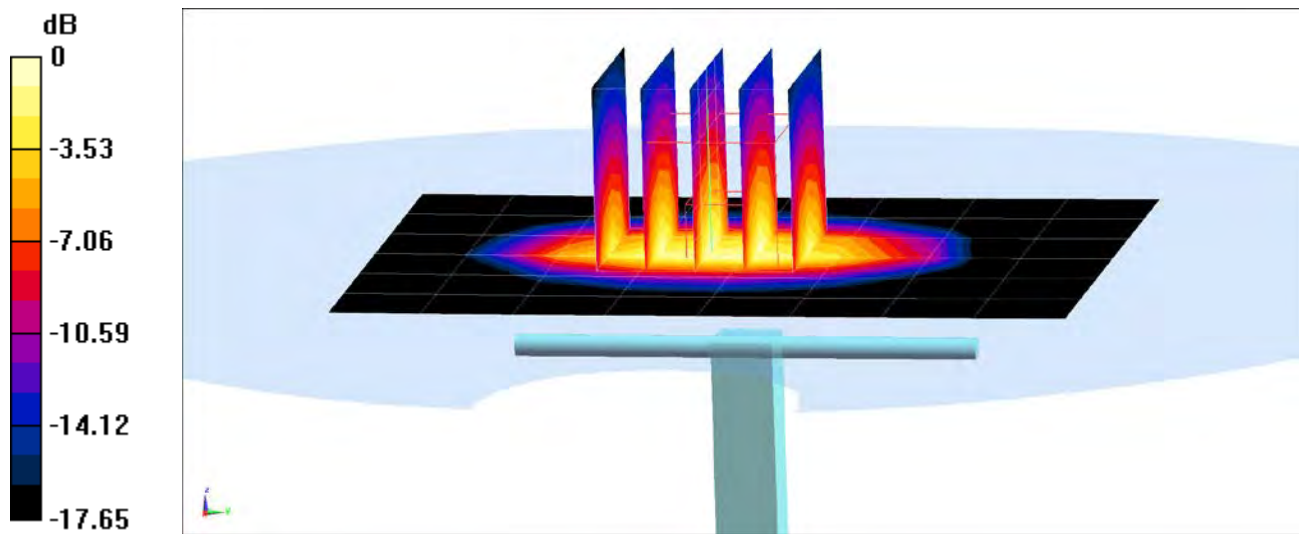

0 dB = 6.08 W/kg = 7.84 dBW/kg

PCTEST ENGINEERING LABORATORY, INC.

DUT: Dipole 1900 MHz; Type: D1900V2; Serial: 5d149

Communication System: UID 0, CW; Frequency: 1900 MHz; Duty Cycle: 1:1

Medium: 1900 Body; Medium parameters used (interpolated):

$f = 1900 \text{ MHz}$; $\sigma = 1.541 \text{ S/m}$; $\epsilon_r = 51.899$; $\rho = 1000 \text{ kg/m}^3$

Phantom section: Flat Section; Space: 1.0 cm

Test Date: 05-08-2019; Ambient Temp: 23.5°C; Tissue Temp: 21.6°C

Probe: EX3DV4 - SN7357; ConvF(7.93, 7.93, 7.93); Calibrated: 4/24/2019

Sensor-Surface: 1.4mm (Mechanical Surface Detection)

Electronics: DAE4 Sn1407; Calibrated: 4/18/2019

Phantom: Twin-SAM V4.0 Front Right; Type: QD 000 P40 CC; Serial: 1167

Measurement SW: DASY52, Version 52.10 (2);SEMCAD X Version 14.6.12 (7450)

1900 MHz System Verification at 20.0 dBm (100 mW)

Area Scan (7x11x1): Measurement grid: dx=15mm, dy=15mm

Zoom Scan (5x5x7)/Cube 0: Measurement grid: dx=8mm, dy=8mm, dz=5mm

Peak SAR (extrapolated) = 7.80 W/kg

SAR(1 g) = 4.2 W/kg

Deviation(1 g) = 6.60%

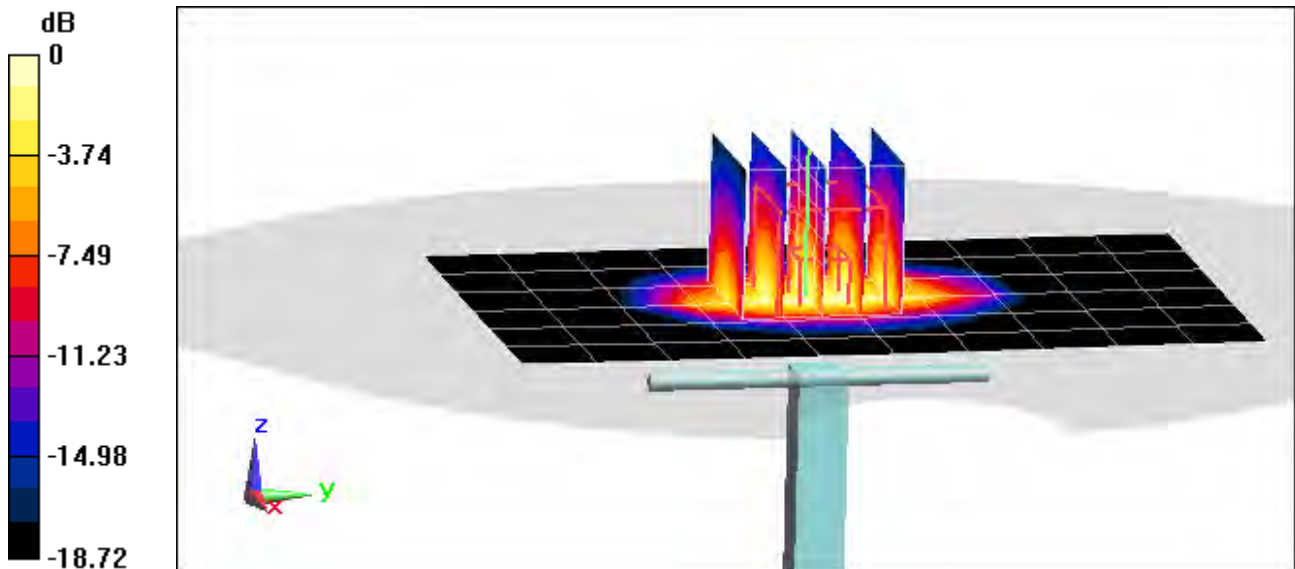

0 dB = 6.55 W/kg = 8.16 dBW/kg

PCTEST ENGINEERING LABORATORY, INC.

DUT: Dipole 1900 MHz; Type: D1900V2; Serial: 5d080

Communication System: UID 0, CW; Frequency: 1900 MHz; Duty Cycle: 1:1

Medium: 1900 Body Medium parameters used (interpolated):

$f = 1900$ MHz; $\sigma = 1.575$ S/m; $\epsilon_r = 51.974$; $\rho = 1000$ kg/m³

Phantom section: Flat Section; Space: 1.0 cm

Test Date: 05-15-2019; Ambient Temp: 22.8°C; Tissue Temp: 21.7°C

Probe: EX3DV4 - SN7410; ConvF(7.78, 7.78, 7.78); Calibrated: 7/20/2018

Sensor-Surface: 1.4mm (Mechanical Surface Detection)

Electronics: DAE4 Sn1322; Calibrated: 7/11/2018

Phantom: Front; Type: QD 000 P40 CD; Serial: 1686

Measurement SW: DASY52, Version 52.10 (2);SEMCAD X Version 14.6.12 (7450)

1900 MHz System Verification at 20.0 dBm (100 mW)

Area Scan (7x11x1): Measurement grid: dx=15mm, dy=15mm

Zoom Scan (5x5x7)/Cube 0: Measurement grid: dx=8mm, dy=8mm, dz=5mm

Peak SAR (extrapolated) = 7.70 W/kg

SAR(1 g) = 4.18 W/kg; SAR(10 g) = 2.15 W/kg

Deviation(1 g) = 6.63%; Deviation(10 g) = 4.37%

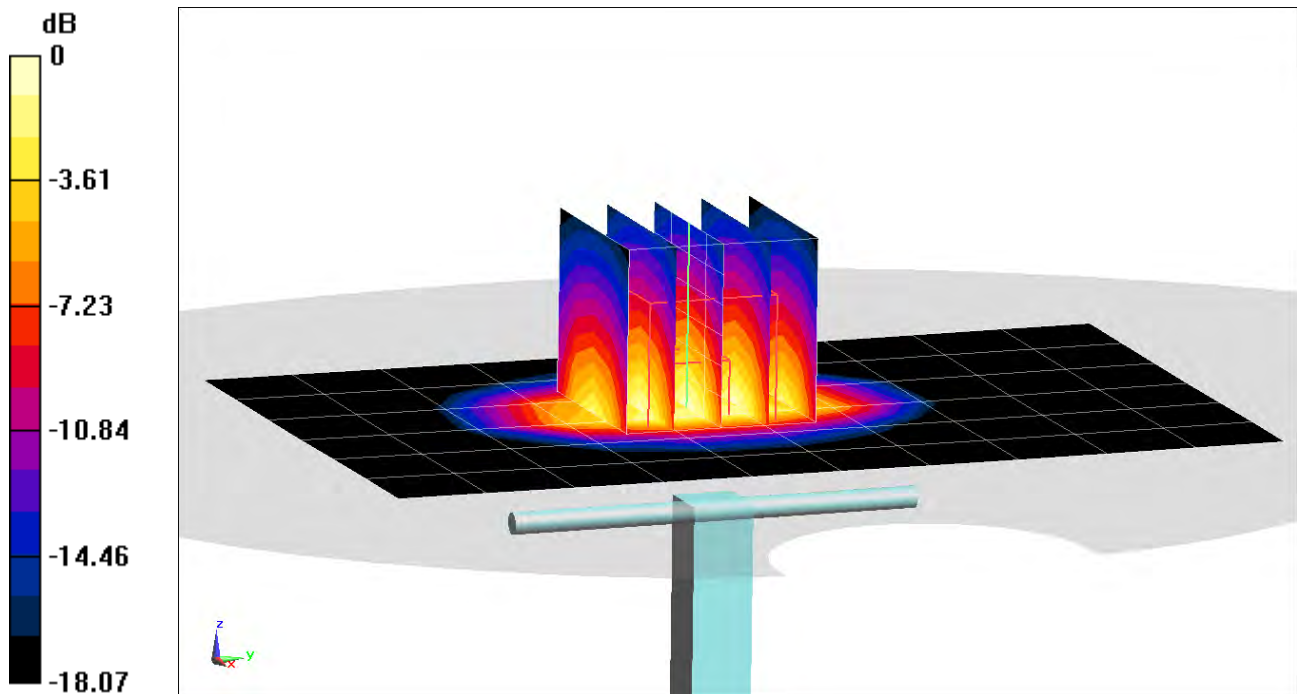

0 dB = 6.54 W/kg = 8.16 dBW/kg

PCTEST ENGINEERING LABORATORY, INC.

DUT: Dipole 2300 MHz; Type: D2300V2; Serial: 1073

Communication System: UID 0, CW; Frequency: 2300 MHz; Duty Cycle: 1:1

Medium: 2450 Body; Medium parameters used:

$f = 2300$ MHz; $\sigma = 1.866$ S/m; $\epsilon_r = 52.492$; $\rho = 1000$ kg/m³

Phantom section: Flat Section; Space: 1.0 cm

Test Date: 05-16-2019; Ambient Temp: 23.4°C; Tissue Temp: 22.8°C

Probe: EX3DV4 - SN7417; ConvF(7.64, 7.64, 7.64); Calibrated: 2/19/2019

Sensor-Surface: 1.4mm (Mechanical Surface Detection)

Electronics: DAE4 Sn665; Calibrated: 2/13/2019

Phantom: Right Twin-SAM V5.0; Type: QD 000 P40 CD; Serial: 1797

Measurement SW: DASY52, Version 52.10 (2);SEMCAD X Version 14.6.12 (7450)

2300 MHz System Verification at 20.0 dBm (100 mW)

Area Scan (8x9x1): Measurement grid: dx=12mm, dy=12mm

Zoom Scan (7x7x7)/Cube 0: Measurement grid: dx=5mm, dy=5mm, dz=5mm

Peak SAR (extrapolated) = 10.2 W/kg

SAR(1 g) = 5.08 W/kg; SAR(10 g) = 2.41 W/kg

Deviation(1 g) = 6.50%; Deviation(10 g) = 3.88%

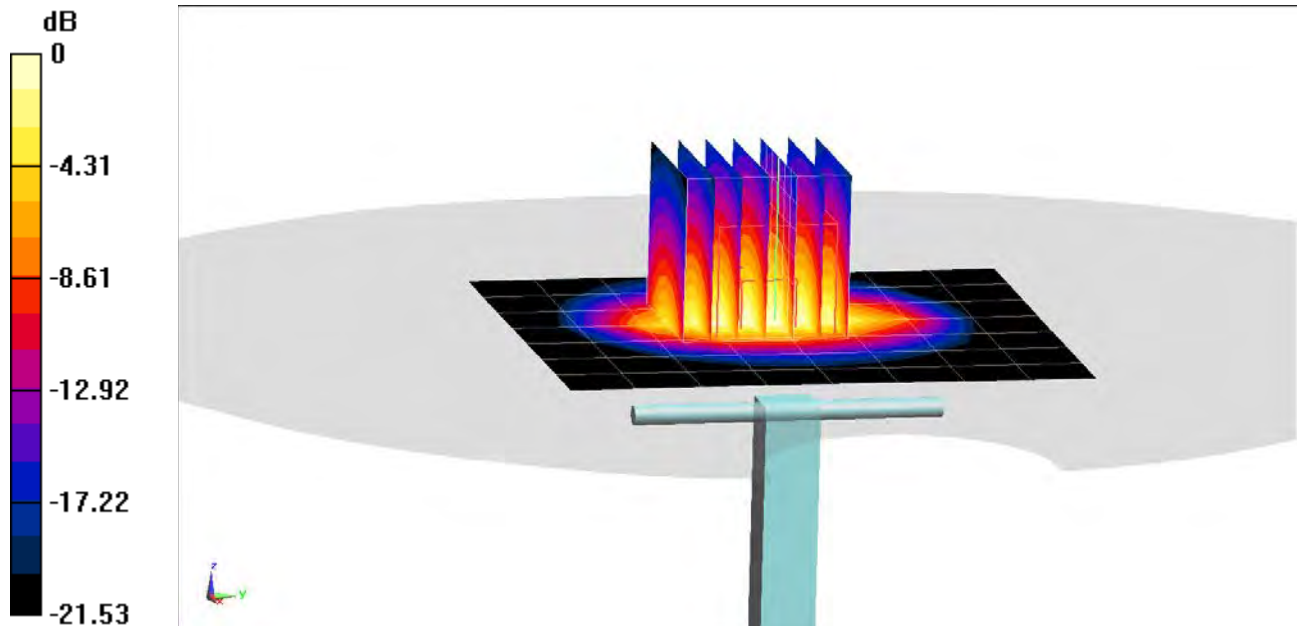

0 dB = 8.28 W/kg = 9.18 dBW/kg

PCTEST ENGINEERING LABORATORY, INC.

DUT: Dipole 2450 MHz; Type: D2450V2; Serial: 719

Communication System: UID 0, CW; Frequency: 2450 MHz; Duty Cycle: 1:1

Medium: 2450 Body Medium parameters used:

$f = 2450 \text{ MHz}$; $\sigma = 2.031 \text{ S/m}$; $\epsilon_r = 52.652$; $\rho = 1000 \text{ kg/m}^3$

Phantom section: Flat Section; Space: 1.0 cm

Test Date: 05-15-2019; Ambient Temp: 21.6°C; Tissue Temp: 20.2°C

Probe: EX3DV4 - SN7308; ConvF(7.57, 7.57, 7.57); Calibrated: 8/23/2018

Sensor-Surface: 1.4mm (Mechanical Surface Detection)

Electronics: DAE4 Sn1558; Calibrated: 10/3/2018

Phantom: Twin-SAM V5.0; Type: QD 000 P40 CD; Serial: 1630

Measurement SW: DASY52, Version 52.10 (2);SEMCAD X Version 14.6.12 (7450)

2450 MHz System Verification at 20.0 dBm (100 mW)

Area Scan (8x9x1): Measurement grid: dx=12mm, dy=12mm

Zoom Scan (7x7x7)/Cube 0: Measurement grid: dx=5mm, dy=5mm, dz=5mm

Peak SAR (extrapolated) = 10.4 W/kg

SAR(1 g) = 4.96 W/kg

Deviation(1 g) = -1.00%;

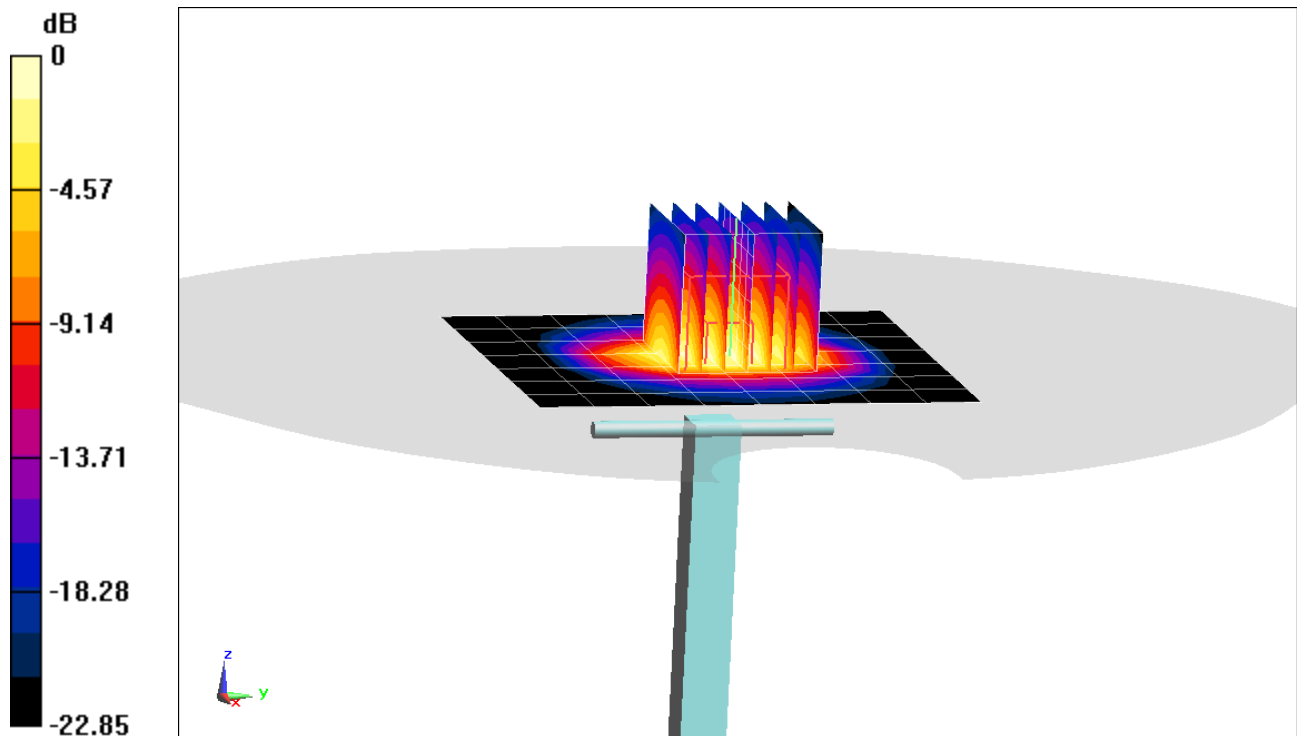

0 dB = 8.30 W/kg = 9.19 dBW/kg

APPENDIX C: PROBE CALIBRATION



Accredited by the Swiss Accreditation Service (SAS)
The Swiss Accreditation Service is one of the signatories to the EA
Multilateral Agreement for the recognition of calibration certificates

Accreditation No.: **SCS 0108**

Client **PC Test**

Certificate No: **EX3-7417_Feb19**

CALIBRATION CERTIFICATE

Object **EX3DV4 - SN:7417**

Calibration procedure(s) **QA CAL-01-19 QA CAL-23-16 QA CAL-25-17
Calibration procedure for dielectric E-field probes**

Calibration date: **February 19, 2019**

HN
02-26-2019

This calibration certificate documents the traceability to national standards, which realize the physical units of measurements (SI).
The measurements and the uncertainties with confidence probability are given on the following pages and are part of the certificate.

All calibrations have been conducted in the closed laboratory facility: environment temperature (22 ± 3)°C and humidity < 70%.

Calibration Equipment used (M&TE critical for calibration)

Primary Standards	ID	Cal Date (Certificate No.)	Scheduled Calibration
Power meter NRP	SN: 104778	04-Apr-18 (No. 217-02672/02673)	Apr-19
Power sensor NRP-Z91	SN: 103244	04-Apr-18 (No. 217-02672)	Apr-19
Power sensor NRP-Z91	SN: 103245	04-Apr-18 (No. 217-02673)	Apr-19
Reference 20 dB Attenuator	SN: S5277 (20x)	04-Apr-18 (No. 217-02682)	Apr-19
DAE4	SN: 660	19-Dec-18 (No. DAE4-660_Dec18)	Dec-19
Reference Probe ES3DV2	SN: 3013	31-Dec-18 (No. ES3-3013_Dec18)	Dec-19
Secondary Standards	ID	Check Date (in house)	Scheduled Check
Power meter E4419B	SN: GB41293874	06-Apr-16 (in house check Jun-18)	In house check: Jun-20
Power sensor E4412A	SN: MY41498087	06-Apr-16 (in house check Jun-18)	In house check: Jun-20
Power sensor E4412A	SN: 000110210	06-Apr-16 (in house check Jun-18)	In house check: Jun-20
RF generator HP 8648C	SN: US3642U01700	04-Aug-99 (in house check Jun-18)	In house check: Jun-20
Network Analyzer E8358A	SN: US41080477	31-Mar-14 (in house check Oct-18)	In house check: Oct-19

Calibrated by:	Name Claudio Leubler	Function Laboratory Technician	Signature
Approved by:	Name Katja Pokovic	Function Technical Manager	Signature

Issued: February 20, 2019

This calibration certificate shall not be reproduced except in full without written approval of the laboratory.



Accredited by the Swiss Accreditation Service (SAS)

Accreditation No.: **SCS 0108**

The Swiss Accreditation Service is one of the signatories to the EA Multilateral Agreement for the recognition of calibration certificates

Glossary:

TSL	tissue simulating liquid
NORM _{x,y,z}	sensitivity in free space
ConvF	sensitivity in TSL / NORM _{x,y,z}
DCP	diode compression point
CF	crest factor (1/duty_cycle) of the RF signal
A, B, C, D	modulation dependent linearization parameters
Polarization φ	φ rotation around probe axis
Polarization §	§ rotation around an axis that is in the plane normal to probe axis (at measurement center), i.e., § = 0 is normal to probe axis
Connector Angle	information used in DASY system to align probe sensor X to the robot coordinate system

Calibration is Performed According to the Following Standards:

- a) IEEE Std 1528-2013, "IEEE Recommended Practice for Determining the Peak Spatial-Averaged Specific Absorption Rate (SAR) in the Human Head from Wireless Communications Devices: Measurement Techniques", June 2013
- b) IEC 62209-1, "Measurement procedure for the assessment of Specific Absorption Rate (SAR) from hand-held and body-mounted devices used next to the ear (frequency range of 300 MHz to 6 GHz)", July 2016
- c) IEC 62209-2, "Procedure to determine the Specific Absorption Rate (SAR) for wireless communication devices used in close proximity to the human body (frequency range of 30 MHz to 6 GHz)", March 2010
- d) KDB 865664, "SAR Measurement Requirements for 100 MHz to 6 GHz"

Methods Applied and Interpretation of Parameters:

- *NORM_{x,y,z}*: Assessed for E-field polarization § = 0 (f ≤ 900 MHz in TEM-cell; f > 1800 MHz: R22 waveguide). *NORM_{x,y,z}* are only intermediate values, i.e., the uncertainties of *NORM_{x,y,z}* does not affect the E²-field uncertainty inside TSL (see below *ConvF*).
- *NORM(f)_{x,y,z}* = *NORM_{x,y,z}* * *frequency_response* (see Frequency Response Chart). This linearization is implemented in DASY4 software versions later than 4.2. The uncertainty of the frequency response is included in the stated uncertainty of *ConvF*.
- *DCP_{x,y,z}*: DCP are numerical linearization parameters assessed based on the data of power sweep with CW signal (no uncertainty required). DCP does not depend on frequency nor media.
- *PAR*: PAR is the Peak to Average Ratio that is not calibrated but determined based on the signal characteristics
- *A_{x,y,z}*; *B_{x,y,z}*; *C_{x,y,z}*; *D_{x,y,z}*; *VR_{x,y,z}*: *A, B, C, D* are numerical linearization parameters assessed based on the data of power sweep for specific modulation signal. The parameters do not depend on frequency nor media. *VR* is the maximum calibration range expressed in RMS voltage across the diode.
- *ConvF and Boundary Effect Parameters*: Assessed in flat phantom using E-field (or Temperature Transfer Standard for f ≤ 800 MHz) and inside waveguide using analytical field distributions based on power measurements for f > 800 MHz. The same setups are used for assessment of the parameters applied for boundary compensation (alpha, depth) of which typical uncertainty values are given. These parameters are used in DASY4 software to improve probe accuracy close to the boundary. The sensitivity in TSL corresponds to *NORM_{x,y,z}* * *ConvF* whereby the uncertainty corresponds to that given for *ConvF*. A frequency dependent *ConvF* is used in DASY version 4.4 and higher which allows extending the validity from ± 50 MHz to ± 100 MHz.
- *Spherical isotropy (3D deviation from isotropy)*: in a field of low gradients realized using a flat phantom exposed by a patch antenna.
- *Sensor Offset*: The sensor offset corresponds to the offset of virtual measurement center from the probe tip (on probe axis). No tolerance required.
- *Connector Angle*: The angle is assessed using the information gained by determining the *NORM_x* (no uncertainty required).

DASY/EASY - Parameters of Probe: EX3DV4 - SN:7417

Basic Calibration Parameters

	Sensor X	Sensor Y	Sensor Z	Unc (k=2)
Norm ($\mu\text{V}/(\text{V}/\text{m})^2$) ^A	0.54	0.43	0.53	± 10.1 %
DCP (mV) ^B	98.7	97.4	100.4	

Calibration Results for Modulation Response

UID	Communication System Name		A dB	B dB $\sqrt{\mu\text{V}}$	C	D dB	VR mV	Max dev.	Max Unc ^E (k=2)
0	CW	X	0.00	0.00	1.00	0.00	144.6	± 3.3 %	± 4.7 %
		Y	0.00	0.00	1.00		149.7		
		Z	0.00	0.00	1.00		143.1		
10352-AAA	Pulse Waveform (200Hz, 10%)	X	15.00	88.38	19.65	10.00	60.0	± 3.3 %	± 9.6 %
		Y	4.33	71.38	13.30		60.0		
		Z	7.40	77.44	14.95		60.0		
10353-AAA	Pulse Waveform (200Hz, 20%)	X	15.00	92.19	20.43	6.99	80.0	± 2.2 %	± 9.6 %
		Y	5.53	76.01	13.64		80.0		
		Z	15.00	85.74	16.43		80.0		
10354-AAA	Pulse Waveform (200Hz, 40%)	X	15.00	107.68	26.54	3.98	95.0	± 1.3 %	± 9.6 %
		Y	9.05	79.53	12.66		95.0		
		Z	15.00	90.71	17.41		95.0		
10355-AAA	Pulse Waveform (200Hz, 60%)	X	15.00	127.17	33.83	2.22	120.0	± 1.2 %	± 9.6 %
		Y	0.26	60.00	4.45		120.0		
		Z	15.00	99.84	20.30		120.0		
10387-AAA	QPSK Waveform, 1 MHz	X	0.56	60.62	7.74	0.00	150.0	± 3.6 %	± 9.6 %
		Y	0.42	60.00	4.69		150.0		
		Z	0.44	60.00	5.48		150.0		
10388-AAA	QPSK Waveform, 10 MHz	X	2.27	69.09	16.46	0.00	150.0	± 1.3 %	± 9.6 %
		Y	1.94	67.43	15.43		150.0		
		Z	2.06	68.27	16.05		150.0		
10396-AAA	64-QAM Waveform, 100 kHz	X	3.15	72.71	19.95	3.01	150.0	± 2.5 %	± 9.6 %
		Y	2.04	67.08	18.19		150.0		
		Z	2.07	66.03	16.88		150.0		
10399-AAA	64-QAM Waveform, 40 MHz	X	3.52	67.53	16.10	0.00	150.0	± 2.4 %	± 9.6 %
		Y	3.32	66.83	15.68		150.0		
		Z	3.38	67.15	15.89		150.0		
10414-AAA	WLAN CCDF, 64-QAM, 40MHz	X	4.80	65.90	15.74	0.00	150.0	± 4.4 %	± 9.6 %
		Y	4.58	65.58	15.59		150.0		
		Z	4.60	65.76	15.65		150.0		

Note: For details on UID parameters see Appendix

The reported uncertainty of measurement is stated as the standard uncertainty of measurement multiplied by the coverage factor k=2, which for a normal distribution corresponds to a coverage probability of approximately 95%.

^A The uncertainties of Norm X,Y,Z do not affect the E²-field uncertainty inside TSL (see Pages 5 and 6).

^B Numerical linearization parameter: uncertainty not required.

^E Uncertainty is determined using the max. deviation from linear response applying rectangular distribution and is expressed for the square of the field value.

DASY/EASY - Parameters of Probe: EX3DV4 - SN:7417

Sensor Model Parameters

	C1 fF	C2 fF	α V ⁻¹	T1 ms.V ⁻²	T2 ms.V ⁻¹	T3 ms	T4 V ⁻²	T5 V ⁻¹	T6
X	37.6	279.10	35.33	9.45	0.00	5.09	1.69	0.14	1.01
Y	29.6	227.60	37.50	5.19	0.43	5.04	0.00	0.16	1.01
Z	28.8	214.34	35.37	6.91	0.00	5.04	0.00	0.24	1.00

Other Probe Parameters

Sensor Arrangement	Triangular
Connector Angle (°)	120.5
Mechanical Surface Detection Mode	enabled
Optical Surface Detection Mode	disabled
Probe Overall Length	337 mm
Probe Body Diameter	10 mm
Tip Length	9 mm
Tip Diameter	2.5 mm
Probe Tip to Sensor X Calibration Point	1 mm
Probe Tip to Sensor Y Calibration Point	1 mm
Probe Tip to Sensor Z Calibration Point	1 mm
Recommended Measurement Distance from Surface	1.4 mm

DASY/EASY - Parameters of Probe: EX3DV4 - SN:7417

Calibration Parameter Determined in Head Tissue Simulating Media

f (MHz) ^c	Relative Permittivity ^F	Conductivity (S/m) ^F	ConvF X	ConvF Y	ConvF Z	Alpha ^G	Depth ^G (mm)	Unc (k=2)
750	41.9	0.89	10.36	10.36	10.36	0.54	0.99	± 12.0 %
835	41.5	0.90	10.07	10.07	10.07	0.48	0.84	± 12.0 %
1750	40.1	1.37	8.39	8.39	8.39	0.38	0.85	± 12.0 %
1900	40.0	1.40	8.11	8.11	8.11	0.39	0.84	± 12.0 %
2300	39.5	1.67	7.73	7.73	7.73	0.30	0.93	± 12.0 %
2450	39.2	1.80	7.46	7.46	7.46	0.39	0.95	± 12.0 %
2600	39.0	1.96	7.17	7.17	7.17	0.31	1.05	± 12.0 %

^c Frequency validity above 300 MHz of ± 100 MHz only applies for DASY v4.4 and higher (see Page 2), else it is restricted to ± 50 MHz. The uncertainty is the RSS of the ConvF uncertainty at calibration frequency and the uncertainty for the indicated frequency band. Frequency validity below 300 MHz is ± 10, 25, 40, 50 and 70 MHz for ConvF assessments at 30, 64, 128, 150 and 220 MHz respectively. Validity of ConvF assessed at 6 MHz is 4-9 MHz, and ConvF assessed at 13 MHz is 9-19 MHz. Above 5 GHz frequency validity can be extended to ± 110 MHz.

^F At frequencies below 3 GHz, the validity of tissue parameters (ϵ and σ) can be relaxed to ± 10% if liquid compensation formula is applied to measured SAR values. At frequencies above 3 GHz, the validity of tissue parameters (ϵ and σ) is restricted to ± 5%. The uncertainty is the RSS of the ConvF uncertainty for indicated target tissue parameters.

^G Alpha/Depth are determined during calibration. SPEAG warrants that the remaining deviation due to the boundary effect after compensation is always less than ± 1% for frequencies below 3 GHz and below ± 2% for frequencies between 3-6 GHz at any distance larger than half the probe tip diameter from the boundary.

DASY/EASY - Parameters of Probe: EX3DV4 - SN:7417

Calibration Parameter Determined in Body Tissue Simulating Media

f (MHz) ^C	Relative Permittivity ^F	Conductivity (S/m) ^F	ConvF X	ConvF Y	ConvF Z	Alpha ^G	Depth ^G (mm)	Unc (k=2)
750	55.5	0.96	10.35	10.35	10.35	0.63	0.84	± 12.0 %
835	55.2	0.97	10.11	10.11	10.11	0.43	0.84	± 12.0 %
1750	53.4	1.49	8.21	8.21	8.21	0.43	0.88	± 12.0 %
1900	53.3	1.52	7.86	7.86	7.86	0.43	0.87	± 12.0 %
2300	52.9	1.81	7.64	7.64	7.64	0.41	0.93	± 12.0 %
2450	52.7	1.95	7.51	7.51	7.51	0.40	0.95	± 12.0 %
2600	52.5	2.16	7.37	7.37	7.37	0.33	1.05	± 12.0 %

^C Frequency validity above 300 MHz of ± 100 MHz only applies for DASY v4.4 and higher (see Page 2), else it is restricted to ± 50 MHz. The uncertainty is the RSS of the ConvF uncertainty at calibration frequency and the uncertainty for the indicated frequency band. Frequency validity below 300 MHz is ± 10, 25, 40, 50 and 70 MHz for ConvF assessments at 30, 64, 128, 150 and 220 MHz respectively. Validity of ConvF assessed at 6 MHz is 4-9 MHz, and ConvF assessed at 13 MHz is 9-19 MHz. Above 5 GHz frequency validity can be extended to ± 110 MHz.

^F At frequencies below 3 GHz, the validity of tissue parameters (ϵ and σ) can be relaxed to ± 10% if liquid compensation formula is applied to measured SAR values. At frequencies above 3 GHz, the validity of tissue parameters (ϵ and σ) is restricted to ± 5%. The uncertainty is the RSS of the ConvF uncertainty for indicated target tissue parameters.

^G Alpha/Depth are determined during calibration. SPEAG warrants that the remaining deviation due to the boundary effect after compensation is always less than ± 1% for frequencies below 3 GHz and below ± 2% for frequencies between 3-6 GHz at any distance larger than half the probe tip diameter from the boundary.

Frequency Response of E-Field (TEM-Cell:ifi110 EXX, Waveguide: R22)

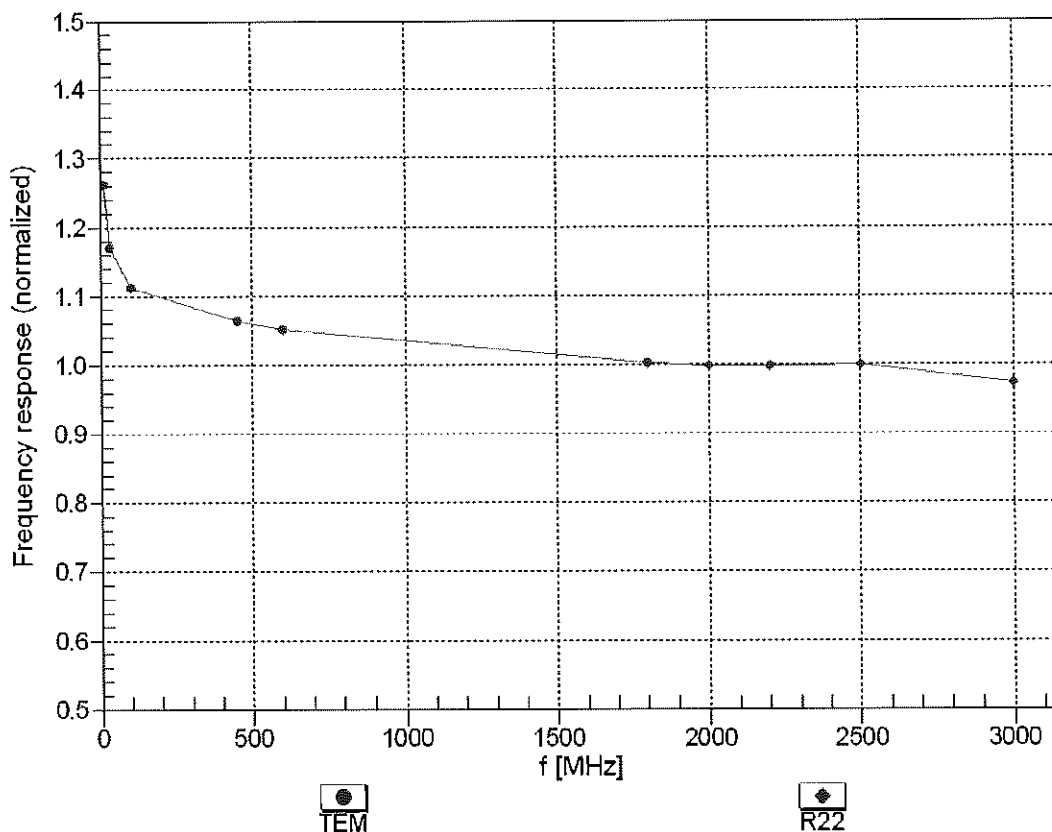

Uncertainty of Frequency Response of E-field: $\pm 6.3\%$ (k=2)

Receiving Pattern (ϕ), $\theta = 0^\circ$

f=600 MHz, TEM

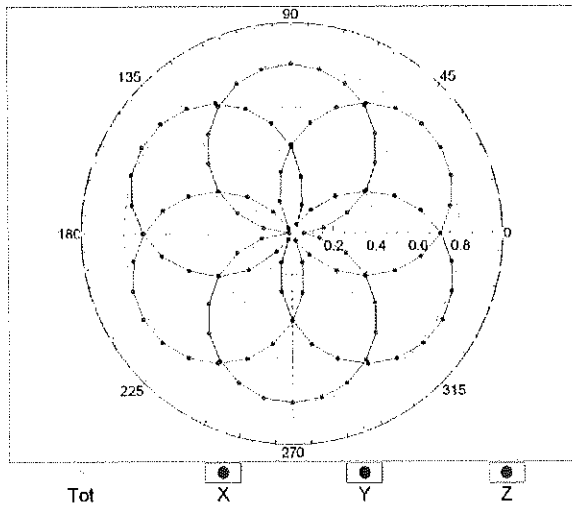

f=1800 MHz, R22

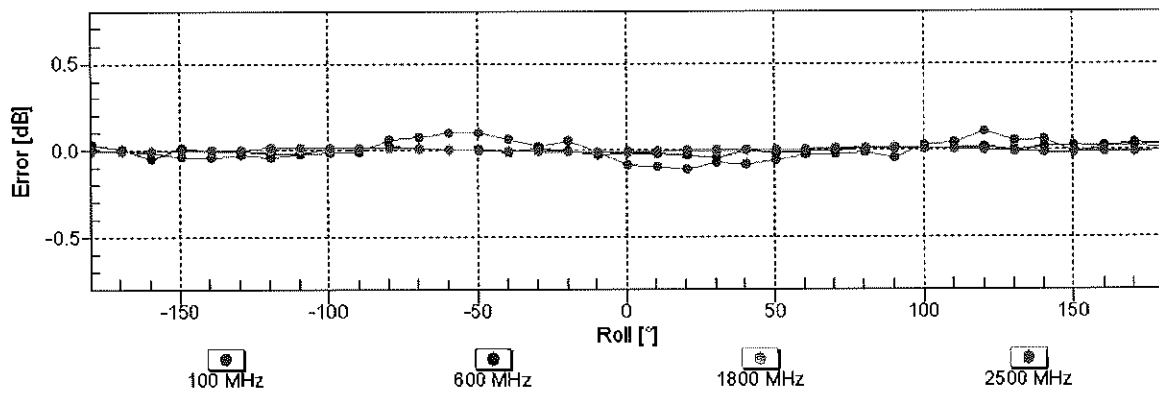
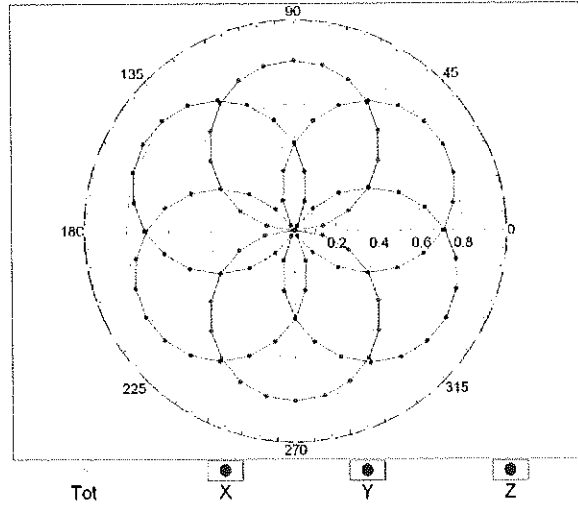

Uncertainty of Axial Isotropy Assessment: $\pm 0.5\%$ (k=2)

Dynamic Range f(SAR_{head}) (TEM cell , f_{eval}= 1900 MHz)

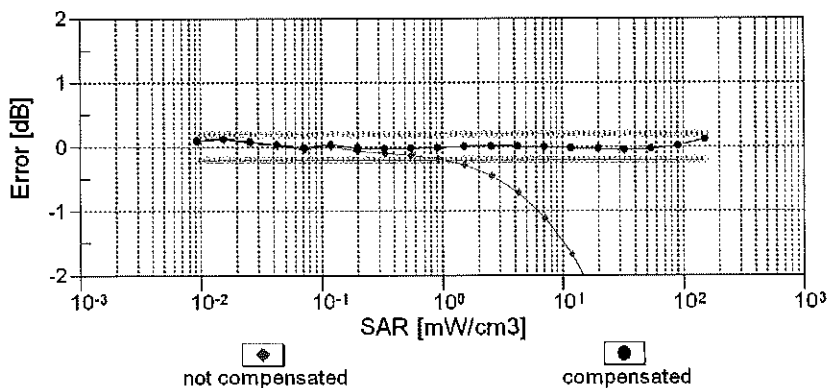
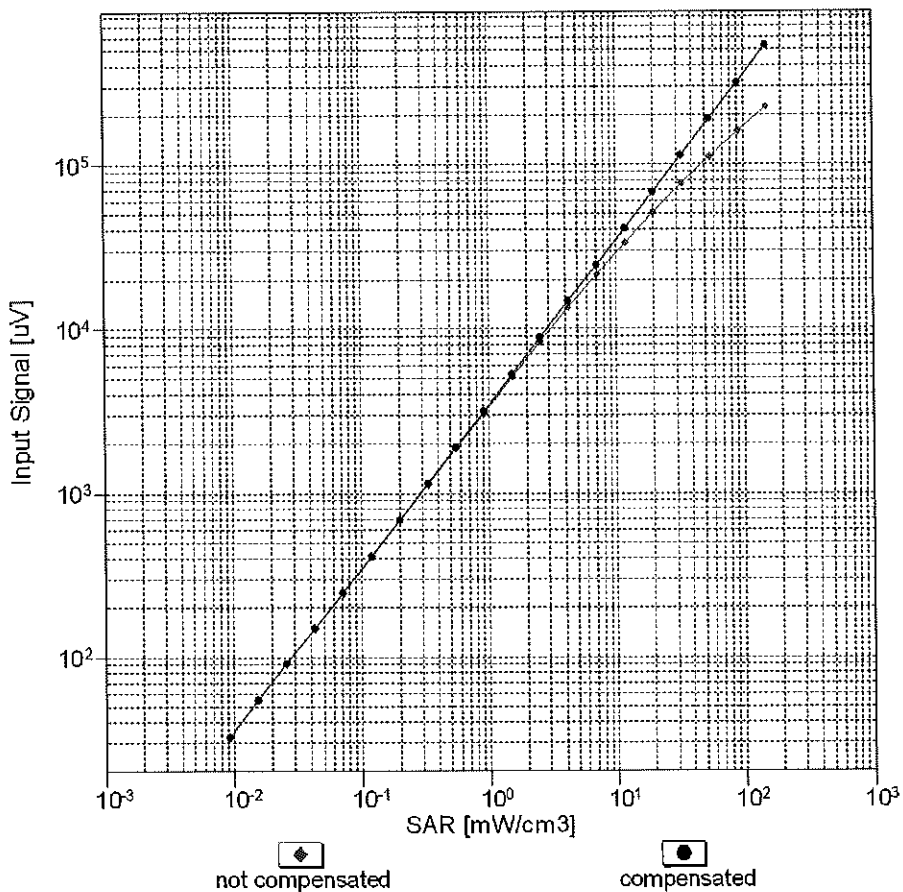

Uncertainty of Linearity Assessment: ± 0.6% (k=2)

Conversion Factor Assessment

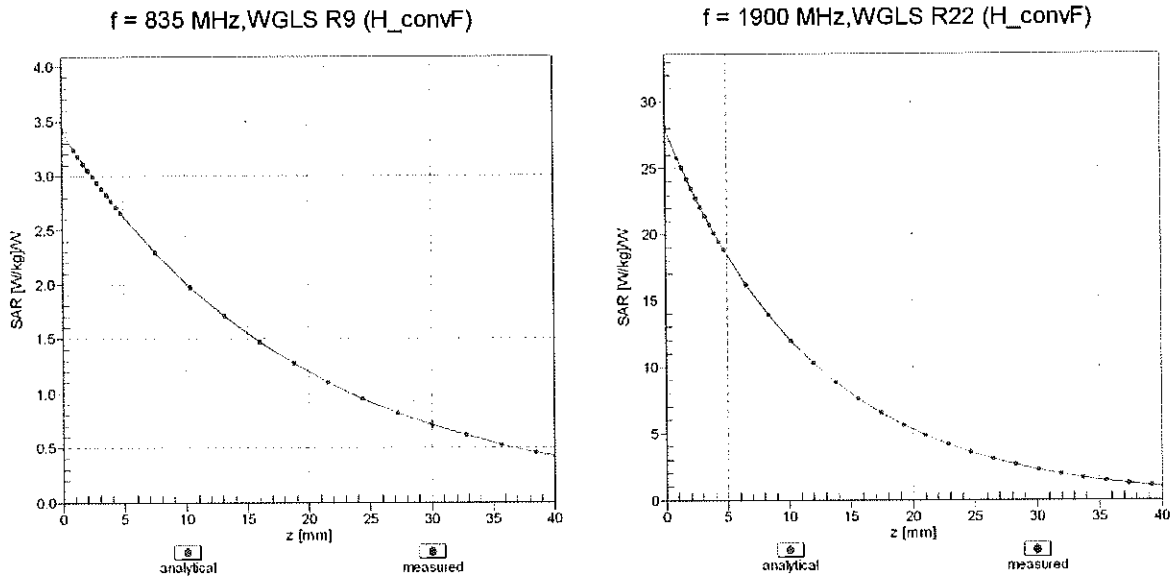

Deviation from Isotropy in Liquid

Error (ϕ, θ), f = 900 MHz

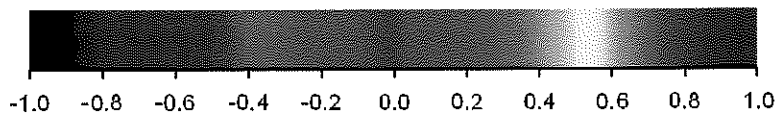
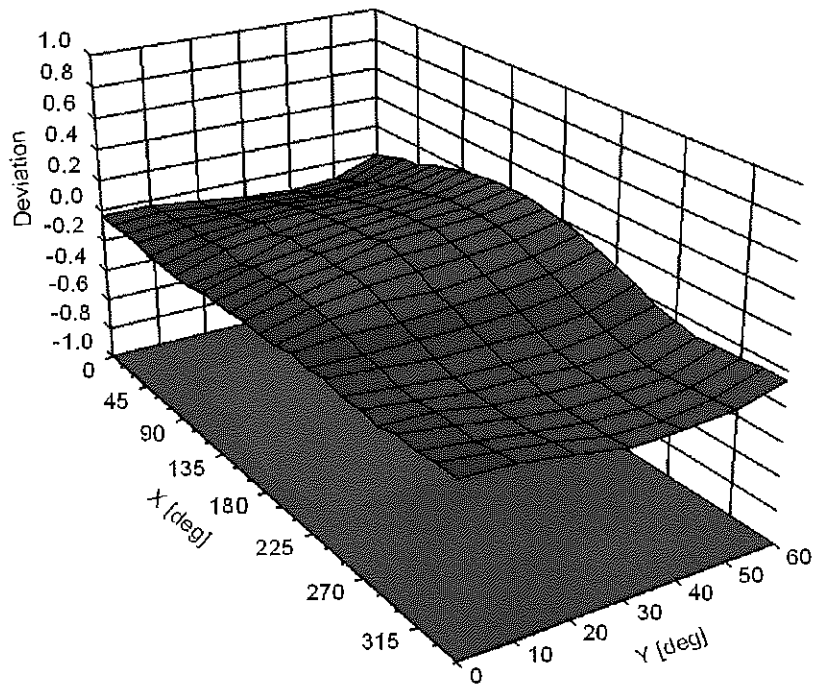

Uncertainty of Spherical Isotropy Assessment: $\pm 2.6\%$ (k=2)

Appendix: Modulation Calibration Parameters

UID	Rev	Communication System Name	Group	PAR (dB)	Unc ^F (k=2)
0		CW	CW	0.00	± 4.7 %
10010	CAA	SAR Validation (Square, 100ms, 10ms)	Test	10.00	± 9.6 %
10011	CAB	UMTS-FDD (WCDMA)	WCDMA	2.91	± 9.6 %
10012	CAB	IEEE 802.11b WiFi 2.4 GHz (DSSS, 1 Mbps)	WLAN	1.87	± 9.6 %
10013	CAB	IEEE 802.11g WiFi 2.4 GHz (DSSS-OFDM, 6 Mbps)	WLAN	9.46	± 9.6 %
10021	DAC	GSM-FDD (TDMA, GMSK)	GSM	9.39	± 9.6 %
10023	DAC	GPRS-FDD (TDMA, GMSK, TN 0)	GSM	9.57	± 9.6 %
10024	DAC	GPRS-FDD (TDMA, GMSK, TN 0-1)	GSM	6.56	± 9.6 %
10025	DAC	EDGE-FDD (TDMA, 8PSK, TN 0)	GSM	12.62	± 9.6 %
10026	DAC	EDGE-FDD (TDMA, 8PSK, TN 0-1)	GSM	9.55	± 9.6 %
10027	DAC	GPRS-FDD (TDMA, GMSK, TN 0-1-2)	GSM	4.80	± 9.6 %
10028	DAC	GPRS-FDD (TDMA, GMSK, TN 0-1-2-3)	GSM	3.55	± 9.6 %
10029	DAC	EDGE-FDD (TDMA, 8PSK, TN 0-1-2)	GSM	7.78	± 9.6 %
10030	CAA	IEEE 802.15.1 Bluetooth (GFSK, DH1)	Bluetooth	5.30	± 9.6 %
10031	CAA	IEEE 802.15.1 Bluetooth (GFSK, DH3)	Bluetooth	1.87	± 9.6 %
10032	CAA	IEEE 802.15.1 Bluetooth (GFSK, DH5)	Bluetooth	1.16	± 9.6 %
10033	CAA	IEEE 802.15.1 Bluetooth (PI/4-DQPSK, DH1)	Bluetooth	7.74	± 9.6 %
10034	CAA	IEEE 802.15.1 Bluetooth (PI/4-DQPSK, DH3)	Bluetooth	4.53	± 9.6 %
10035	CAA	IEEE 802.15.1 Bluetooth (PI/4-DQPSK, DH5)	Bluetooth	3.83	± 9.6 %
10036	CAA	IEEE 802.15.1 Bluetooth (8-DPSK, DH1)	Bluetooth	8.01	± 9.6 %
10037	CAA	IEEE 802.15.1 Bluetooth (8-DPSK, DH3)	Bluetooth	4.77	± 9.6 %
10038	CAA	IEEE 802.15.1 Bluetooth (8-DPSK, DH5)	Bluetooth	4.10	± 9.6 %
10039	CAB	CDMA2000 (1xRTT, RC1)	CDMA2000	4.57	± 9.6 %
10042	CAB	IS-54 / IS-136 FDD (TDMA/FDM, PI/4-DQPSK, Halfrate)	AMPS	7.78	± 9.6 %
10044	CAA	IS-91/EIA/TIA-553 FDD (FDMA, FM)	AMPS	0.00	± 9.6 %
10048	CAA	DECT (TDD, TDMA/FDM, GFSK, Full Slot, 24)	DECT	13.80	± 9.6 %
10049	CAA	DECT (TDD, TDMA/FDM, GFSK, Double Slot, 12)	DECT	10.79	± 9.6 %
10056	CAA	UMTS-TDD (TD-SCDMA, 1.28 Mcps)	TD-SCDMA	11.01	± 9.6 %
10058	DAC	EDGE-FDD (TDMA, 8PSK, TN 0-1-2-3)	GSM	6.52	± 9.6 %
10059	CAB	IEEE 802.11b WiFi 2.4 GHz (DSSS, 2 Mbps)	WLAN	2.12	± 9.6 %
10060	CAB	IEEE 802.11b WiFi 2.4 GHz (DSSS, 5.5 Mbps)	WLAN	2.83	± 9.6 %
10061	CAB	IEEE 802.11b WiFi 2.4 GHz (DSSS, 11 Mbps)	WLAN	3.60	± 9.6 %
10062	CAC	IEEE 802.11a/h WiFi 5 GHz (OFDM, 6 Mbps)	WLAN	8.68	± 9.6 %
10063	CAC	IEEE 802.11a/h WiFi 5 GHz (OFDM, 9 Mbps)	WLAN	8.63	± 9.6 %
10064	CAC	IEEE 802.11a/h WiFi 5 GHz (OFDM, 12 Mbps)	WLAN	9.09	± 9.6 %
10065	CAC	IEEE 802.11a/h WiFi 5 GHz (OFDM, 18 Mbps)	WLAN	9.00	± 9.6 %
10066	CAC	IEEE 802.11a/h WiFi 5 GHz (OFDM, 24 Mbps)	WLAN	9.38	± 9.6 %
10067	CAC	IEEE 802.11a/h WiFi 5 GHz (OFDM, 36 Mbps)	WLAN	10.12	± 9.6 %
10068	CAC	IEEE 802.11a/h WiFi 5 GHz (OFDM, 48 Mbps)	WLAN	10.24	± 9.6 %
10069	CAC	IEEE 802.11a/h WiFi 5 GHz (OFDM, 54 Mbps)	WLAN	10.56	± 9.6 %
10071	CAB	IEEE 802.11g WiFi 2.4 GHz (DSSS/OFDM, 9 Mbps)	WLAN	9.83	± 9.6 %
10072	CAB	IEEE 802.11g WiFi 2.4 GHz (DSSS/OFDM, 12 Mbps)	WLAN	9.62	± 9.6 %
10073	CAB	IEEE 802.11g WiFi 2.4 GHz (DSSS/OFDM, 18 Mbps)	WLAN	9.94	± 9.6 %
10074	CAB	IEEE 802.11g WiFi 2.4 GHz (DSSS/OFDM, 24 Mbps)	WLAN	10.30	± 9.6 %
10075	CAB	IEEE 802.11g WiFi 2.4 GHz (DSSS/OFDM, 36 Mbps)	WLAN	10.77	± 9.6 %
10076	CAB	IEEE 802.11g WiFi 2.4 GHz (DSSS/OFDM, 48 Mbps)	WLAN	10.94	± 9.6 %
10077	CAB	IEEE 802.11g WiFi 2.4 GHz (DSSS/OFDM, 54 Mbps)	WLAN	11.00	± 9.6 %
10081	CAB	CDMA2000 (1xRTT, RC3)	CDMA2000	3.97	± 9.6 %
10082	CAB	IS-54 / IS-136 FDD (TDMA/FDM, PI/4-DQPSK, Fullrate)	AMPS	4.77	± 9.6 %
10090	DAC	GPRS-FDD (TDMA, GMSK, TN 0-4)	GSM	6.56	± 9.6 %
10097	CAB	UMTS-FDD (HSDPA)	WCDMA	3.98	± 9.6 %
10098	CAB	UMTS-FDD (HSUPA, Subtest 2)	WCDMA	3.98	± 9.6 %
10099	DAC	EDGE-FDD (TDMA, 8PSK, TN 0-4)	GSM	9.55	± 9.6 %
10100	CAE	LTE-FDD (SC-FDMA, 100% RB, 20 MHz, QPSK)	LTE-FDD	5.67	± 9.6 %
10101	CAE	LTE-FDD (SC-FDMA, 100% RB, 20 MHz, 16-QAM)	LTE-FDD	6.42	± 9.6 %
10102	CAE	LTE-FDD (SC-FDMA, 100% RB, 20 MHz, 64-QAM)	LTE-FDD	6.60	± 9.6 %
10103	CAG	LTE-TDD (SC-FDMA, 100% RB, 20 MHz, QPSK)	LTE-TDD	9.29	± 9.6 %
10104	CAG	LTE-TDD (SC-FDMA, 100% RB, 20 MHz, 16-QAM)	LTE-TDD	9.97	± 9.6 %
10105	CAG	LTE-TDD (SC-FDMA, 100% RB, 20 MHz, 64-QAM)	LTE-TDD	10.01	± 9.6 %
10108	CAG	LTE-FDD (SC-FDMA, 100% RB, 10 MHz, QPSK)	LTE-FDD	5.80	± 9.6 %

10109	CAG	LTE-FDD (SC-FDMA, 100% RB, 10 MHz, 16-QAM)	LTE-FDD	6.43	± 9.6 %
10110	CAG	LTE-FDD (SC-FDMA, 100% RB, 5 MHz, QPSK)	LTE-FDD	5.75	± 9.6 %
10111	CAG	LTE-FDD (SC-FDMA, 100% RB, 5 MHz, 16-QAM)	LTE-FDD	6.44	± 9.6 %
10112	CAG	LTE-FDD (SC-FDMA, 100% RB, 10 MHz, 64-QAM)	LTE-FDD	6.59	± 9.6 %
10113	CAG	LTE-FDD (SC-FDMA, 100% RB, 5 MHz, 64-QAM)	LTE-FDD	6.62	± 9.6 %
10114	CAC	IEEE 802.11n (HT Greenfield, 13.5 Mbps, BPSK)	WLAN	8.10	± 9.6 %
10115	CAC	IEEE 802.11n (HT Greenfield, 81 Mbps, 16-QAM)	WLAN	8.46	± 9.6 %
10116	CAC	IEEE 802.11n (HT Greenfield, 135 Mbps, 64-QAM)	WLAN	8.15	± 9.6 %
10117	CAC	IEEE 802.11n (HT Mixed, 13.5 Mbps, BPSK)	WLAN	8.07	± 9.6 %
10118	CAC	IEEE 802.11n (HT Mixed, 81 Mbps, 16-QAM)	WLAN	8.59	± 9.6 %
10119	CAC	IEEE 802.11n (HT Mixed, 135 Mbps, 64-QAM)	WLAN	8.13	± 9.6 %
10140	CAE	LTE-FDD (SC-FDMA, 100% RB, 15 MHz, 16-QAM)	LTE-FDD	6.49	± 9.6 %
10141	CAE	LTE-FDD (SC-FDMA, 100% RB, 15 MHz, 64-QAM)	LTE-FDD	6.53	± 9.6 %
10142	CAE	LTE-FDD (SC-FDMA, 100% RB, 3 MHz, QPSK)	LTE-FDD	5.73	± 9.6 %
10143	CAE	LTE-FDD (SC-FDMA, 100% RB, 3 MHz, 16-QAM)	LTE-FDD	6.35	± 9.6 %
10144	CAE	LTE-FDD (SC-FDMA, 100% RB, 3 MHz, 64-QAM)	LTE-FDD	6.65	± 9.6 %
10145	CAF	LTE-FDD (SC-FDMA, 100% RB, 1.4 MHz, QPSK)	LTE-FDD	5.76	± 9.6 %
10146	CAF	LTE-FDD (SC-FDMA, 100% RB, 1.4 MHz, 16-QAM)	LTE-FDD	6.41	± 9.6 %
10147	CAF	LTE-FDD (SC-FDMA, 100% RB, 1.4 MHz, 64-QAM)	LTE-FDD	6.72	± 9.6 %
10149	CAE	LTE-FDD (SC-FDMA, 50% RB, 20 MHz, 16-QAM)	LTE-FDD	6.42	± 9.6 %
10150	CAE	LTE-FDD (SC-FDMA, 50% RB, 20 MHz, 64-QAM)	LTE-FDD	6.60	± 9.6 %
10151	CAG	LTE-TDD (SC-FDMA, 50% RB, 20 MHz, QPSK)	LTE-TDD	9.28	± 9.6 %
10152	CAG	LTE-TDD (SC-FDMA, 50% RB, 20 MHz, 16-QAM)	LTE-TDD	9.92	± 9.6 %
10153	CAG	LTE-TDD (SC-FDMA, 50% RB, 20 MHz, 64-QAM)	LTE-TDD	10.05	± 9.6 %
10154	CAG	LTE-FDD (SC-FDMA, 50% RB, 10 MHz, QPSK)	LTE-FDD	5.75	± 9.6 %
10155	CAG	LTE-FDD (SC-FDMA, 50% RB, 10 MHz, 16-QAM)	LTE-FDD	6.43	± 9.6 %
10156	CAG	LTE-FDD (SC-FDMA, 50% RB, 5 MHz, QPSK)	LTE-FDD	5.79	± 9.6 %
10157	CAG	LTE-FDD (SC-FDMA, 50% RB, 5 MHz, 16-QAM)	LTE-FDD	6.49	± 9.6 %
10158	CAG	LTE-FDD (SC-FDMA, 50% RB, 10 MHz, 64-QAM)	LTE-FDD	6.62	± 9.6 %
10159	CAG	LTE-FDD (SC-FDMA, 50% RB, 5 MHz, 64-QAM)	LTE-FDD	6.56	± 9.6 %
10160	CAE	LTE-FDD (SC-FDMA, 50% RB, 15 MHz, QPSK)	LTE-FDD	5.82	± 9.6 %
10161	CAE	LTE-FDD (SC-FDMA, 50% RB, 15 MHz, 16-QAM)	LTE-FDD	6.43	± 9.6 %
10162	CAE	LTE-FDD (SC-FDMA, 50% RB, 15 MHz, 64-QAM)	LTE-FDD	6.58	± 9.6 %
10166	CAF	LTE-FDD (SC-FDMA, 50% RB, 1.4 MHz, QPSK)	LTE-FDD	5.46	± 9.6 %
10167	CAF	LTE-FDD (SC-FDMA, 50% RB, 1.4 MHz, 16-QAM)	LTE-FDD	6.21	± 9.6 %
10168	CAF	LTE-FDD (SC-FDMA, 50% RB, 1.4 MHz, 64-QAM)	LTE-FDD	6.79	± 9.6 %
10169	CAE	LTE-FDD (SC-FDMA, 1 RB, 20 MHz, QPSK)	LTE-FDD	5.73	± 9.6 %
10170	CAE	LTE-FDD (SC-FDMA, 1 RB, 20 MHz, 16-QAM)	LTE-FDD	6.52	± 9.6 %
10171	AAE	LTE-FDD (SC-FDMA, 1 RB, 20 MHz, 64-QAM)	LTE-FDD	6.49	± 9.6 %
10172	CAG	LTE-TDD (SC-FDMA, 1 RB, 20 MHz, QPSK)	LTE-TDD	9.21	± 9.6 %
10173	CAG	LTE-TDD (SC-FDMA, 1 RB, 20 MHz, 16-QAM)	LTE-TDD	9.48	± 9.6 %
10174	CAG	LTE-TDD (SC-FDMA, 1 RB, 20 MHz, 64-QAM)	LTE-TDD	10.25	± 9.6 %
10175	CAG	LTE-FDD (SC-FDMA, 1 RB, 10 MHz, QPSK)	LTE-FDD	5.72	± 9.6 %
10176	CAG	LTE-FDD (SC-FDMA, 1 RB, 10 MHz, 16-QAM)	LTE-FDD	6.52	± 9.6 %
10177	CAI	LTE-FDD (SC-FDMA, 1 RB, 5 MHz, QPSK)	LTE-FDD	5.73	± 9.6 %
10178	CAG	LTE-FDD (SC-FDMA, 1 RB, 5 MHz, 16-QAM)	LTE-FDD	6.52	± 9.6 %
10179	CAG	LTE-FDD (SC-FDMA, 1 RB, 10 MHz, 64-QAM)	LTE-FDD	6.50	± 9.6 %
10180	CAG	LTE-FDD (SC-FDMA, 1 RB, 5 MHz, 64-QAM)	LTE-FDD	6.50	± 9.6 %
10181	CAE	LTE-FDD (SC-FDMA, 1 RB, 15 MHz, QPSK)	LTE-FDD	5.72	± 9.6 %
10182	CAE	LTE-FDD (SC-FDMA, 1 RB, 15 MHz, 16-QAM)	LTE-FDD	6.52	± 9.6 %
10183	AAD	LTE-FDD (SC-FDMA, 1 RB, 15 MHz, 64-QAM)	LTE-FDD	6.50	± 9.6 %
10184	CAE	LTE-FDD (SC-FDMA, 1 RB, 3 MHz, QPSK)	LTE-FDD	5.73	± 9.6 %
10185	CAE	LTE-FDD (SC-FDMA, 1 RB, 3 MHz, 16-QAM)	LTE-FDD	6.51	± 9.6 %
10186	AAE	LTE-FDD (SC-FDMA, 1 RB, 3 MHz, 64-QAM)	LTE-FDD	6.50	± 9.6 %
10187	CAF	LTE-FDD (SC-FDMA, 1 RB, 1.4 MHz, QPSK)	LTE-FDD	5.73	± 9.6 %
10188	CAF	LTE-FDD (SC-FDMA, 1 RB, 1.4 MHz, 16-QAM)	LTE-FDD	6.52	± 9.6 %
10189	AAF	LTE-FDD (SC-FDMA, 1 RB, 1.4 MHz, 64-QAM)	LTE-FDD	6.50	± 9.6 %
10193	CAC	IEEE 802.11n (HT Greenfield, 6.5 Mbps, BPSK)	WLAN	8.09	± 9.6 %
10194	CAC	IEEE 802.11n (HT Greenfield, 39 Mbps, 16-QAM)	WLAN	8.12	± 9.6 %
10195	CAC	IEEE 802.11n (HT Greenfield, 65 Mbps, 64-QAM)	WLAN	8.21	± 9.6 %
10196	CAC	IEEE 802.11n (HT Mixed, 6.5 Mbps, BPSK)	WLAN	8.10	± 9.6 %
10197	CAC	IEEE 802.11n (HT Mixed, 39 Mbps, 16-QAM)	WLAN	8.13	± 9.6 %
10198	CAC	IEEE 802.11n (HT Mixed, 65 Mbps, 64-QAM)	WLAN	8.27	± 9.6 %
10219	CAC	IEEE 802.11n (HT Mixed, 7.2 Mbps, BPSK)	WLAN	8.03	± 9.6 %

10220	CAC	IEEE 802.11n (HT Mixed, 43.3 Mbps, 16-QAM)	WLAN	8.13	±9.6 %
10221	CAC	IEEE 802.11n (HT Mixed, 72.2 Mbps, 64-QAM)	WLAN	8.27	±9.6 %
10222	CAC	IEEE 802.11n (HT Mixed, 15 Mbps, BPSK)	WLAN	8.06	±9.6 %
10223	CAC	IEEE 802.11n (HT Mixed, 90 Mbps, 16-QAM)	WLAN	8.48	±9.6 %
10224	CAC	IEEE 802.11n (HT Mixed, 150 Mbps, 64-QAM)	WLAN	8.08	±9.6 %
10225	CAB	UMTS-FDD (HSPA+)	WCDMA	5.97	±9.6 %
10226	CAA	LTE-TDD (SC-FDMA, 1 RB, 1.4 MHz, 16-QAM)	LTE-TDD	9.49	±9.6 %
10227	CAA	LTE-TDD (SC-FDMA, 1 RB, 1.4 MHz, 64-QAM)	LTE-TDD	10.26	±9.6 %
10228	CAA	LTE-TDD (SC-FDMA, 1 RB, 1.4 MHz, QPSK)	LTE-TDD	9.22	±9.6 %
10229	CAC	LTE-TDD (SC-FDMA, 1 RB, 3 MHz, 16-QAM)	LTE-TDD	9.48	±9.6 %
10230	CAC	LTE-TDD (SC-FDMA, 1 RB, 3 MHz, 64-QAM)	LTE-TDD	10.25	±9.6 %
10231	CAC	LTE-TDD (SC-FDMA, 1 RB, 3 MHz, QPSK)	LTE-TDD	9.19	±9.6 %
10232	CAF	LTE-TDD (SC-FDMA, 1 RB, 5 MHz, 16-QAM)	LTE-TDD	9.48	±9.6 %
10233	CAF	LTE-TDD (SC-FDMA, 1 RB, 5 MHz, 64-QAM)	LTE-TDD	10.25	±9.6 %
10234	CAF	LTE-TDD (SC-FDMA, 1 RB, 5 MHz, QPSK)	LTE-TDD	9.21	±9.6 %
10235	CAF	LTE-TDD (SC-FDMA, 1 RB, 10 MHz, 16-QAM)	LTE-TDD	9.48	±9.6 %
10236	CAF	LTE-TDD (SC-FDMA, 1 RB, 10 MHz, 64-QAM)	LTE-TDD	10.25	±9.6 %
10237	CAF	LTE-TDD (SC-FDMA, 1 RB, 10 MHz, QPSK)	LTE-TDD	9.21	±9.6 %
10238	CAF	LTE-TDD (SC-FDMA, 1 RB, 15 MHz, 16-QAM)	LTE-TDD	9.48	±9.6 %
10239	CAF	LTE-TDD (SC-FDMA, 1 RB, 15 MHz, 64-QAM)	LTE-TDD	10.25	±9.6 %
10240	CAF	LTE-TDD (SC-FDMA, 1 RB, 15 MHz, QPSK)	LTE-TDD	9.21	±9.6 %
10241	CAA	LTE-TDD (SC-FDMA, 50% RB, 1.4 MHz, 16-QAM)	LTE-TDD	9.82	±9.6 %
10242	CAA	LTE-TDD (SC-FDMA, 50% RB, 1.4 MHz, 64-QAM)	LTE-TDD	9.86	±9.6 %
10243	CAA	LTE-TDD (SC-FDMA, 50% RB, 1.4 MHz, QPSK)	LTE-TDD	9.46	±9.6 %
10244	CAC	LTE-TDD (SC-FDMA, 50% RB, 3 MHz, 16-QAM)	LTE-TDD	10.06	±9.6 %
10245	CAC	LTE-TDD (SC-FDMA, 50% RB, 3 MHz, 64-QAM)	LTE-TDD	10.06	±9.6 %
10246	CAC	LTE-TDD (SC-FDMA, 50% RB, 3 MHz, QPSK)	LTE-TDD	9.30	±9.6 %
10247	CAF	LTE-TDD (SC-FDMA, 50% RB, 5 MHz, 16-QAM)	LTE-TDD	9.91	±9.6 %
10248	CAF	LTE-TDD (SC-FDMA, 50% RB, 5 MHz, 64-QAM)	LTE-TDD	10.09	±9.6 %
10249	CAF	LTE-TDD (SC-FDMA, 50% RB, 5 MHz, QPSK)	LTE-TDD	9.29	±9.6 %
10250	CAF	LTE-TDD (SC-FDMA, 50% RB, 10 MHz, 16-QAM)	LTE-TDD	9.81	±9.6 %
10251	CAF	LTE-TDD (SC-FDMA, 50% RB, 10 MHz, 64-QAM)	LTE-TDD	10.17	±9.6 %
10252	CAF	LTE-TDD (SC-FDMA, 50% RB, 10 MHz, QPSK)	LTE-TDD	9.24	±9.6 %
10253	CAF	LTE-TDD (SC-FDMA, 50% RB, 15 MHz, 16-QAM)	LTE-TDD	9.90	±9.6 %
10254	CAF	LTE-TDD (SC-FDMA, 50% RB, 15 MHz, 64-QAM)	LTE-TDD	10.14	±9.6 %
10255	CAF	LTE-TDD (SC-FDMA, 50% RB, 15 MHz, QPSK)	LTE-TDD	9.20	±9.6 %
10256	CAA	LTE-TDD (SC-FDMA, 100% RB, 1.4 MHz, 16-QAM)	LTE-TDD	9.96	±9.6 %
10257	CAA	LTE-TDD (SC-FDMA, 100% RB, 1.4 MHz, 64-QAM)	LTE-TDD	10.08	±9.6 %
10258	CAA	LTE-TDD (SC-FDMA, 100% RB, 1.4 MHz, QPSK)	LTE-TDD	9.34	±9.6 %
10259	CAC	LTE-TDD (SC-FDMA, 100% RB, 3 MHz, 16-QAM)	LTE-TDD	9.98	±9.6 %
10260	CAC	LTE-TDD (SC-FDMA, 100% RB, 3 MHz, 64-QAM)	LTE-TDD	9.97	±9.6 %
10261	CAC	LTE-TDD (SC-FDMA, 100% RB, 3 MHz, QPSK)	LTE-TDD	9.24	±9.6 %
10262	CAF	LTE-TDD (SC-FDMA, 100% RB, 5 MHz, 16-QAM)	LTE-TDD	9.83	±9.6 %
10263	CAF	LTE-TDD (SC-FDMA, 100% RB, 5 MHz, 64-QAM)	LTE-TDD	10.16	±9.6 %
10264	CAF	LTE-TDD (SC-FDMA, 100% RB, 5 MHz, QPSK)	LTE-TDD	9.23	±9.6 %
10265	CAF	LTE-TDD (SC-FDMA, 100% RB, 10 MHz, 16-QAM)	LTE-TDD	9.92	±9.6 %
10266	CAF	LTE-TDD (SC-FDMA, 100% RB, 10 MHz, 64-QAM)	LTE-TDD	10.07	±9.6 %
10267	CAF	LTE-TDD (SC-FDMA, 100% RB, 10 MHz, QPSK)	LTE-TDD	9.30	±9.6 %
10268	CAF	LTE-TDD (SC-FDMA, 100% RB, 15 MHz, 16-QAM)	LTE-TDD	10.06	±9.6 %
10269	CAF	LTE-TDD (SC-FDMA, 100% RB, 15 MHz, 64-QAM)	LTE-TDD	10.13	±9.6 %
10270	CAF	LTE-TDD (SC-FDMA, 100% RB, 15 MHz, QPSK)	LTE-TDD	9.58	±9.6 %
10274	CAB	UMTS-FDD (HSUPA, Subtest 5, 3GPP Rel8.10)	WCDMA	4.87	±9.6 %
10275	CAB	UMTS-FDD (HSUPA, Subtest 5, 3GPP Rel8.4)	WCDMA	3.96	±9.6 %
10277	CAA	PHS (QPSK)	PHS	11.81	±9.6 %
10278	CAA	PHS (QPSK, BW 884MHz, Rolloff 0.5)	PHS	11.81	±9.6 %
10279	CAA	PHS (QPSK, BW 884MHz, Rolloff 0.38)	PHS	12.18	±9.6 %
10290	AAB	CDMA2000, RC1, SO55, Full Rate	CDMA2000	3.91	±9.6 %
10291	AAB	CDMA2000, RC3, SO55, Full Rate	CDMA2000	3.46	±9.6 %
10292	AAB	CDMA2000, RC3, SO32, Full Rate	CDMA2000	3.39	±9.6 %
10293	AAB	CDMA2000, RC3, SO3, Full Rate	CDMA2000	3.50	±9.6 %
10295	AAB	CDMA2000, RC1, SO3, 1/8th Rate 25 fr.	CDMA2000	12.49	±9.6 %
10297	AAD	LTE-FDD (SC-FDMA, 50% RB, 20 MHz, QPSK)	LTE-FDD	5.81	±9.6 %
10298	AAD	LTE-FDD (SC-FDMA, 50% RB, 3 MHz, QPSK)	LTE-FDD	5.72	±9.6 %
10299	AAD	LTE-FDD (SC-FDMA, 50% RB, 3 MHz, 16-QAM)	LTE-FDD	6.39	±9.6 %

10300	AAD	LTE-FDD (SC-FDMA, 50% RB, 3 MHz, 64-QAM)	LTE-FDD	6.60	± 9.6 %
10301	AAA	IEEE 802.16e WiMAX (29:18, 5ms, 10MHz, QPSK, PUSC)	WiMAX	12.03	± 9.6 %
10302	AAA	IEEE 802.16e WiMAX (29:18, 5ms, 10MHz, QPSK, PUSC, 3 CTRL symbols)	WiMAX	12.57	± 9.6 %
10303	AAA	IEEE 802.16e WiMAX (31:15, 5ms, 10MHz, 64QAM, PUSC)	WiMAX	12.52	± 9.6 %
10304	AAA	IEEE 802.16e WiMAX (29:18, 5ms, 10MHz, 64QAM, PUSC)	WiMAX	11.86	± 9.6 %
10305	AAA	IEEE 802.16e WiMAX (31:15, 10ms, 10MHz, 64QAM, PUSC, 15 symbols)	WiMAX	15.24	± 9.6 %
10306	AAA	IEEE 802.16e WiMAX (29:18, 10ms, 10MHz, 64QAM, PUSC, 18 symbols)	WiMAX	14.67	± 9.6 %
10307	AAA	IEEE 802.16e WiMAX (29:18, 10ms, 10MHz, QPSK, PUSC, 18 symbols)	WiMAX	14.49	± 9.6 %
10308	AAA	IEEE 802.16e WiMAX (29:18, 10ms, 10MHz, 16QAM, PUSC)	WiMAX	14.46	± 9.6 %
10309	AAA	IEEE 802.16e WiMAX (29:18, 10ms, 10MHz, 16QAM, AMC 2x3, 18 symbols)	WiMAX	14.58	± 9.6 %
10310	AAA	IEEE 802.16e WiMAX (29:18, 10ms, 10MHz, QPSK, AMC 2x3, 18 symbols)	WiMAX	14.57	± 9.6 %
10311	AAD	LTE-FDD (SC-FDMA, 100% RB, 15 MHz, QPSK)	LTE-FDD	6.06	± 9.6 %
10313	AAA	iDEN 1:3	iDEN	10.51	± 9.6 %
10314	AAA	iDEN 1:6	iDEN	13.48	± 9.6 %
10315	AAB	IEEE 802.11b WiFi 2.4 GHz (DSSS, 1 Mbps, 96pc duty cycle)	WLAN	1.71	± 9.6 %
10316	AAB	IEEE 802.11g WiFi 2.4 GHz (ERP-OFDM, 6 Mbps, 96pc duty cycle)	WLAN	8.36	± 9.6 %
10317	AAC	IEEE 802.11a WiFi 5 GHz (OFDM, 6 Mbps, 96pc duty cycle)	WLAN	8.36	± 9.6 %
10352	AAA	Pulse Waveform (200Hz, 10%)	Generic	10.00	± 9.6 %
10353	AAA	Pulse Waveform (200Hz, 20%)	Generic	6.99	± 9.6 %
10354	AAA	Pulse Waveform (200Hz, 40%)	Generic	3.98	± 9.6 %
10355	AAA	Pulse Waveform (200Hz, 60%)	Generic	2.22	± 9.6 %
10356	AAA	Pulse Waveform (200Hz, 80%)	Generic	0.97	± 9.6 %
10387	AAA	QPSK Waveform, 1 MHz	Generic	5.10	± 9.6 %
10388	AAA	QPSK Waveform, 10 MHz	Generic	5.22	± 9.6 %
10396	AAA	64-QAM Waveform, 100 kHz	Generic	6.27	± 9.6 %
10399	AAA	64-QAM Waveform, 40 MHz	Generic	6.27	± 9.6 %
10400	AAD	IEEE 802.11ac WiFi (20MHz, 64-QAM, 99pc duty cycle)	WLAN	8.37	± 9.6 %
10401	AAD	IEEE 802.11ac WiFi (40MHz, 64-QAM, 99pc duty cycle)	WLAN	8.60	± 9.6 %
10402	AAD	IEEE 802.11ac WiFi (80MHz, 64-QAM, 99pc duty cycle)	WLAN	8.53	± 9.6 %
10403	AAB	CDMA2000 (1xEV-DO, Rev. 0)	CDMA2000	3.76	± 9.6 %
10404	AAB	CDMA2000 (1xEV-DO, Rev. A)	CDMA2000	3.77	± 9.6 %
10406	AAB	CDMA2000, RC3, SO32, SCH0, Full Rate	CDMA2000	5.22	± 9.6 %
10410	AAF	LTE-TDD (SC-FDMA, 1 RB, 10 MHz, QPSK, UL Subframe=2,3,4,7,8,9, Subframe Conf=4)	LTE-TDD	7.82	± 9.6 %
10414	AAA	WLAN CCDF, 64-QAM, 40MHz	Generic	8.54	± 9.6 %
10415	AAA	IEEE 802.11b WiFi 2.4 GHz (DSSS, 1 Mbps, 99pc duty cycle)	WLAN	1.54	± 9.6 %
10416	AAA	IEEE 802.11g WiFi 2.4 GHz (ERP-OFDM, 6 Mbps, 99pc duty cycle)	WLAN	8.23	± 9.6 %
10417	AAB	IEEE 802.11a/h WiFi 5 GHz (OFDM, 6 Mbps, 99pc duty cycle)	WLAN	8.23	± 9.6 %
10418	AAA	IEEE 802.11g WiFi 2.4 GHz (DSSS-OFDM, 6 Mbps, 99pc duty cycle, Long preamble)	WLAN	8.14	± 9.6 %
10419	AAA	IEEE 802.11g WiFi 2.4 GHz (DSSS-OFDM, 6 Mbps, 99pc duty cycle, Short preamble)	WLAN	8.19	± 9.6 %
10422	AAB	IEEE 802.11n (HT Greenfield, 7.2 Mbps, BPSK)	WLAN	8.32	± 9.6 %
10423	AAB	IEEE 802.11n (HT Greenfield, 43.3 Mbps, 16-QAM)	WLAN	8.47	± 9.6 %
10424	AAB	IEEE 802.11n (HT Greenfield, 72.2 Mbps, 64-QAM)	WLAN	8.40	± 9.6 %
10425	AAB	IEEE 802.11n (HT Greenfield, 15 Mbps, BPSK)	WLAN	8.41	± 9.6 %
10426	AAB	IEEE 802.11n (HT Greenfield, 90 Mbps, 16-QAM)	WLAN	8.45	± 9.6 %
10427	AAB	IEEE 802.11n (HT Greenfield, 150 Mbps, 64-QAM)	WLAN	8.41	± 9.6 %
10430	AAD	LTE-FDD (OFDMA, 5 MHz, E-TM 3.1)	LTE-FDD	8.28	± 9.6 %
10431	AAD	LTE-FDD (OFDMA, 10 MHz, E-TM 3.1)	LTE-FDD	8.38	± 9.6 %
10432	AAC	LTE-FDD (OFDMA, 15 MHz, E-TM 3.1)	LTE-FDD	8.34	± 9.6 %
10433	AAC	LTE-FDD (OFDMA, 20 MHz, E-TM 3.1)	LTE-FDD	8.34	± 9.6 %
10434	AAA	W-CDMA (BS Test Model 1, 64 DPCH)	WCDMA	8.60	± 9.6 %
10435	AAF	LTE-TDD (SC-FDMA, 1 RB, 20 MHz, QPSK, UL Subframe=2,3,4,7,8,9)	LTE-TDD	7.82	± 9.6 %
10447	AAD	LTE-FDD (OFDMA, 5 MHz, E-TM 3.1, Clipping 44%)	LTE-FDD	7.56	± 9.6 %
10448	AAD	LTE-FDD (OFDMA, 10 MHz, E-TM 3.1, Clipping 44%)	LTE-FDD	7.53	± 9.6 %
10449	AAC	LTE-FDD (OFDMA, 15 MHz, E-TM 3.1, Clipping 44%)	LTE-FDD	7.51	± 9.6 %
10450	AAC	LTE-FDD (OFDMA, 20 MHz, E-TM 3.1, Clipping 44%)	LTE-FDD	7.48	± 9.6 %

10451	AAA	W-CDMA (BS Test Model 1, 64 DPCH, Clipping 44%)	WCDMA	7.59	± 9.6 %
10456	AAB	IEEE 802.11ac WiFi (160MHz, 64-QAM, 99pc duty cycle)	WLAN	8.63	± 9.6 %
10457	AAA	UMTS-FDD (DC-HSDPA)	WCDMA	6.62	± 9.6 %
10458	AAA	CDMA2000 (1xEV-DO, Rev. B, 2 carriers)	CDMA2000	6.55	± 9.6 %
10459	AAA	CDMA2000 (1xEV-DO, Rev. B, 3 carriers)	CDMA2000	8.25	± 9.6 %
10460	AAA	UMTS-FDD (WCDMA, AMR)	WCDMA	2.39	± 9.6 %
10461	AAA	LTE-TDD (SC-FDMA, 1 RB, 1.4 MHz, QPSK, UL Subframe=2,3,4,7,8,9)	LTE-TDD	7.82	± 9.6 %
10462	AAA	LTE-TDD (SC-FDMA, 1 RB, 1.4 MHz, 16-QAM, UL Subframe=2,3,4,7,8,9)	LTE-TDD	8.30	± 9.6 %
10463	AAA	LTE-TDD (SC-FDMA, 1 RB, 1.4 MHz, 64-QAM, UL Subframe=2,3,4,7,8,9)	LTE-TDD	8.56	± 9.6 %
10464	AAB	LTE-TDD (SC-FDMA, 1 RB, 3 MHz, QPSK, UL Subframe=2,3,4,7,8,9)	LTE-TDD	7.82	± 9.6 %
10465	AAB	LTE-TDD (SC-FDMA, 1 RB, 3 MHz, 16-QAM, UL Subframe=2,3,4,7,8,9)	LTE-TDD	8.32	± 9.6 %
10466	AAB	LTE-TDD (SC-FDMA, 1 RB, 3 MHz, 64-QAM, UL Subframe=2,3,4,7,8,9)	LTE-TDD	8.57	± 9.6 %
10467	AAE	LTE-TDD (SC-FDMA, 1 RB, 5 MHz, QPSK, UL Subframe=2,3,4,7,8,9)	LTE-TDD	7.82	± 9.6 %
10468	AAE	LTE-TDD (SC-FDMA, 1 RB, 5 MHz, 16-QAM, UL Subframe=2,3,4,7,8,9)	LTE-TDD	8.32	± 9.6 %
10469	AAE	LTE-TDD (SC-FDMA, 1 RB, 5 MHz, 64-QAM, UL Subframe=2,3,4,7,8,9)	LTE-TDD	8.56	± 9.6 %
10470	AAE	LTE-TDD (SC-FDMA, 1 RB, 10 MHz, QPSK, UL Subframe=2,3,4,7,8,9)	LTE-TDD	7.82	± 9.6 %
10471	AAE	LTE-TDD (SC-FDMA, 1 RB, 10 MHz, 16-QAM, UL Subframe=2,3,4,7,8,9)	LTE-TDD	8.32	± 9.6 %
10472	AAE	LTE-TDD (SC-FDMA, 1 RB, 10 MHz, 64-QAM, UL Subframe=2,3,4,7,8,9)	LTE-TDD	8.57	± 9.6 %
10473	AAE	LTE-TDD (SC-FDMA, 1 RB, 15 MHz, QPSK, UL Subframe=2,3,4,7,8,9)	LTE-TDD	7.82	± 9.6 %
10474	AAE	LTE-TDD (SC-FDMA, 1 RB, 15 MHz, 16-QAM, UL Subframe=2,3,4,7,8,9)	LTE-TDD	8.32	± 9.6 %
10475	AAE	LTE-TDD (SC-FDMA, 1 RB, 15 MHz, 64-QAM, UL Subframe=2,3,4,7,8,9)	LTE-TDD	8.57	± 9.6 %
10477	AAF	LTE-TDD (SC-FDMA, 1 RB, 20 MHz, 16-QAM, UL Subframe=2,3,4,7,8,9)	LTE-TDD	8.32	± 9.6 %
10478	AAF	LTE-TDD (SC-FDMA, 1 RB, 20 MHz, 64-QAM, UL Subframe=2,3,4,7,8,9)	LTE-TDD	8.57	± 9.6 %
10479	AAA	LTE-TDD (SC-FDMA, 50% RB, 1.4 MHz, QPSK, UL Subframe=2,3,4,7,8,9)	LTE-TDD	7.74	± 9.6 %
10480	AAA	LTE-TDD (SC-FDMA, 50% RB, 1.4 MHz, 16-QAM, UL Subframe=2,3,4,7,8,9)	LTE-TDD	8.18	± 9.6 %
10481	AAA	LTE-TDD (SC-FDMA, 50% RB, 1.4 MHz, 64-QAM, UL Subframe=2,3,4,7,8,9)	LTE-TDD	8.45	± 9.6 %
10482	AAB	LTE-TDD (SC-FDMA, 50% RB, 3 MHz, QPSK, UL Subframe=2,3,4,7,8,9)	LTE-TDD	7.71	± 9.6 %
10483	AAB	LTE-TDD (SC-FDMA, 50% RB, 3 MHz, 16-QAM, UL Subframe=2,3,4,7,8,9)	LTE-TDD	8.39	± 9.6 %
10484	AAB	LTE-TDD (SC-FDMA, 50% RB, 3 MHz, 64-QAM, UL Subframe=2,3,4,7,8,9)	LTE-TDD	8.47	± 9.6 %
10485	AAE	LTE-TDD (SC-FDMA, 50% RB, 5 MHz, QPSK, UL Subframe=2,3,4,7,8,9)	LTE-TDD	7.59	± 9.6 %
10486	AAE	LTE-TDD (SC-FDMA, 50% RB, 5 MHz, 16-QAM, UL Subframe=2,3,4,7,8,9)	LTE-TDD	8.38	± 9.6 %
10487	AAE	LTE-TDD (SC-FDMA, 50% RB, 5 MHz, 64-QAM, UL Subframe=2,3,4,7,8,9)	LTE-TDD	8.60	± 9.6 %
10488	AAE	LTE-TDD (SC-FDMA, 50% RB, 10 MHz, QPSK, UL Subframe=2,3,4,7,8,9)	LTE-TDD	7.70	± 9.6 %
10489	AAE	LTE-TDD (SC-FDMA, 50% RB, 10 MHz, 16-QAM, UL Subframe=2,3,4,7,8,9)	LTE-TDD	8.31	± 9.6 %
10490	AAE	LTE-TDD (SC-FDMA, 50% RB, 10 MHz, 64-QAM, UL Subframe=2,3,4,7,8,9)	LTE-TDD	8.54	± 9.6 %
10491	AAE	LTE-TDD (SC-FDMA, 50% RB, 15 MHz, QPSK, UL Subframe=2,3,4,7,8,9)	LTE-TDD	7.74	± 9.6 %

10492	AAE	LTE-TDD (SC-FDMA, 50% RB, 15 MHz, 16-QAM, UL Subframe=2,3,4,7,8,9)	LTE-TDD	8.41	± 9.6 %
10493	AAE	LTE-TDD (SC-FDMA, 50% RB, 15 MHz, 64-QAM, UL Subframe=2,3,4,7,8,9)	LTE-TDD	8.55	± 9.6 %
10494	AAF	LTE-TDD (SC-FDMA, 50% RB, 20 MHz, QPSK, UL Subframe=2,3,4,7,8,9)	LTE-TDD	7.74	± 9.6 %
10495	AAF	LTE-TDD (SC-FDMA, 50% RB, 20 MHz, 16-QAM, UL Subframe=2,3,4,7,8,9)	LTE-TDD	8.37	± 9.6 %
10496	AAF	LTE-TDD (SC-FDMA, 50% RB, 20 MHz, 64-QAM, UL Subframe=2,3,4,7,8,9)	LTE-TDD	8.54	± 9.6 %
10497	AAA	LTE-TDD (SC-FDMA, 100% RB, 1.4 MHz, QPSK, UL Subframe=2,3,4,7,8,9)	LTE-TDD	7.67	± 9.6 %
10498	AAA	LTE-TDD (SC-FDMA, 100% RB, 1.4 MHz, 16-QAM, UL Subframe=2,3,4,7,8,9)	LTE-TDD	8.40	± 9.6 %
10499	AAA	LTE-TDD (SC-FDMA, 100% RB, 1.4 MHz, 64-QAM, UL Subframe=2,3,4,7,8,9)	LTE-TDD	8.68	± 9.6 %
10500	AAB	LTE-TDD (SC-FDMA, 100% RB, 3 MHz, QPSK, UL Subframe=2,3,4,7,8,9)	LTE-TDD	7.67	± 9.6 %
10501	AAB	LTE-TDD (SC-FDMA, 100% RB, 3 MHz, 16-QAM, UL Subframe=2,3,4,7,8,9)	LTE-TDD	8.44	± 9.6 %
10502	AAB	LTE-TDD (SC-FDMA, 100% RB, 3 MHz, 64-QAM, UL Subframe=2,3,4,7,8,9)	LTE-TDD	8.52	± 9.6 %
10503	AAE	LTE-TDD (SC-FDMA, 100% RB, 5 MHz, QPSK, UL Subframe=2,3,4,7,8,9)	LTE-TDD	7.72	± 9.6 %
10504	AAE	LTE-TDD (SC-FDMA, 100% RB, 5 MHz, 16-QAM, UL Subframe=2,3,4,7,8,9)	LTE-TDD	8.31	± 9.6 %
10505	AAE	LTE-TDD (SC-FDMA, 100% RB, 5 MHz, 64-QAM, UL Subframe=2,3,4,7,8,9)	LTE-TDD	8.54	± 9.6 %
10506	AAE	LTE-TDD (SC-FDMA, 100% RB, 10 MHz, QPSK, UL Subframe=2,3,4,7,8,9)	LTE-TDD	7.74	± 9.6 %
10507	AAE	LTE-TDD (SC-FDMA, 100% RB, 10 MHz, 16-QAM, UL Subframe=2,3,4,7,8,9)	LTE-TDD	8.36	± 9.6 %
10508	AAE	LTE-TDD (SC-FDMA, 100% RB, 10 MHz, 64-QAM, UL Subframe=2,3,4,7,8,9)	LTE-TDD	8.55	± 9.6 %
10509	AAE	LTE-TDD (SC-FDMA, 100% RB, 15 MHz, QPSK, UL Subframe=2,3,4,7,8,9)	LTE-TDD	7.99	± 9.6 %
10510	AAE	LTE-TDD (SC-FDMA, 100% RB, 15 MHz, 16-QAM, UL Subframe=2,3,4,7,8,9)	LTE-TDD	8.49	± 9.6 %
10511	AAE	LTE-TDD (SC-FDMA, 100% RB, 15 MHz, 64-QAM, UL Subframe=2,3,4,7,8,9)	LTE-TDD	8.51	± 9.6 %
10512	AAF	LTE-TDD (SC-FDMA, 100% RB, 20 MHz, QPSK, UL Subframe=2,3,4,7,8,9)	LTE-TDD	7.74	± 9.6 %
10513	AAF	LTE-TDD (SC-FDMA, 100% RB, 20 MHz, 16-QAM, UL Subframe=2,3,4,7,8,9)	LTE-TDD	8.42	± 9.6 %
10514	AAF	LTE-TDD (SC-FDMA, 100% RB, 20 MHz, 64-QAM, UL Subframe=2,3,4,7,8,9)	LTE-TDD	8.45	± 9.6 %
10515	AAA	IEEE 802.11b WiFi 2.4 GHz (DSSS, 2 Mbps, 99pc duty cycle)	WLAN	1.58	± 9.6 %
10516	AAA	IEEE 802.11b WiFi 2.4 GHz (DSSS, 5.5 Mbps, 99pc duty cycle)	WLAN	1.57	± 9.6 %
10517	AAA	IEEE 802.11b WiFi 2.4 GHz (DSSS, 11 Mbps, 99pc duty cycle)	WLAN	1.58	± 9.6 %
10518	AAB	IEEE 802.11a/h WiFi 5 GHz (OFDM, 9 Mbps, 99pc duty cycle)	WLAN	8.23	± 9.6 %
10519	AAB	IEEE 802.11a/h WiFi 5 GHz (OFDM, 12 Mbps, 99pc duty cycle)	WLAN	8.39	± 9.6 %
10520	AAB	IEEE 802.11a/h WiFi 5 GHz (OFDM, 18 Mbps, 99pc duty cycle)	WLAN	8.12	± 9.6 %
10521	AAB	IEEE 802.11a/h WiFi 5 GHz (OFDM, 24 Mbps, 99pc duty cycle)	WLAN	7.97	± 9.6 %
10522	AAB	IEEE 802.11a/h WiFi 5 GHz (OFDM, 36 Mbps, 99pc duty cycle)	WLAN	8.45	± 9.6 %
10523	AAB	IEEE 802.11a/h WiFi 5 GHz (OFDM, 48 Mbps, 99pc duty cycle)	WLAN	8.08	± 9.6 %
10524	AAB	IEEE 802.11a/h WiFi 5 GHz (OFDM, 54 Mbps, 99pc duty cycle)	WLAN	8.27	± 9.6 %
10525	AAB	IEEE 802.11ac WiFi (20MHz, MCS0, 99pc duty cycle)	WLAN	8.36	± 9.6 %
10526	AAB	IEEE 802.11ac WiFi (20MHz, MCS1, 99pc duty cycle)	WLAN	8.42	± 9.6 %
10527	AAB	IEEE 802.11ac WiFi (20MHz, MCS2, 99pc duty cycle)	WLAN	8.21	± 9.6 %
10528	AAB	IEEE 802.11ac WiFi (20MHz, MCS3, 99pc duty cycle)	WLAN	8.36	± 9.6 %
10529	AAB	IEEE 802.11ac WiFi (20MHz, MCS4, 99pc duty cycle)	WLAN	8.36	± 9.6 %
10531	AAB	IEEE 802.11ac WiFi (20MHz, MCS6, 99pc duty cycle)	WLAN	8.43	± 9.6 %
10532	AAB	IEEE 802.11ac WiFi (20MHz, MCS7, 99pc duty cycle)	WLAN	8.29	± 9.6 %
10533	AAB	IEEE 802.11ac WiFi (20MHz, MCS8, 99pc duty cycle)	WLAN	8.38	± 9.6 %
10534	AAB	IEEE 802.11ac WiFi (40MHz, MCS0, 99pc duty cycle)	WLAN	8.45	± 9.6 %

10535	AAB	IEEE 802.11ac WiFi (40MHz, MCS1, 99pc duty cycle)	WLAN	8.45	± 9.6 %
10536	AAB	IEEE 802.11ac WiFi (40MHz, MCS2, 99pc duty cycle)	WLAN	8.32	± 9.6 %
10537	AAB	IEEE 802.11ac WiFi (40MHz, MCS3, 99pc duty cycle)	WLAN	8.44	± 9.6 %
10538	AAB	IEEE 802.11ac WiFi (40MHz, MCS4, 99pc duty cycle)	WLAN	8.54	± 9.6 %
10540	AAB	IEEE 802.11ac WiFi (40MHz, MCS6, 99pc duty cycle)	WLAN	8.39	± 9.6 %
10541	AAB	IEEE 802.11ac WiFi (40MHz, MCS7, 99pc duty cycle)	WLAN	8.46	± 9.6 %
10542	AAB	IEEE 802.11ac WiFi (40MHz, MCS8, 99pc duty cycle)	WLAN	8.65	± 9.6 %
10543	AAB	IEEE 802.11ac WiFi (40MHz, MCS9, 99pc duty cycle)	WLAN	8.65	± 9.6 %
10544	AAB	IEEE 802.11ac WiFi (80MHz, MCS0, 99pc duty cycle)	WLAN	8.47	± 9.6 %
10545	AAB	IEEE 802.11ac WiFi (80MHz, MCS1, 99pc duty cycle)	WLAN	8.55	± 9.6 %
10546	AAB	IEEE 802.11ac WiFi (80MHz, MCS2, 99pc duty cycle)	WLAN	8.35	± 9.6 %
10547	AAB	IEEE 802.11ac WiFi (80MHz, MCS3, 99pc duty cycle)	WLAN	8.49	± 9.6 %
10548	AAB	IEEE 802.11ac WiFi (80MHz, MCS4, 99pc duty cycle)	WLAN	8.37	± 9.6 %
10550	AAB	IEEE 802.11ac WiFi (80MHz, MCS6, 99pc duty cycle)	WLAN	8.38	± 9.6 %
10551	AAB	IEEE 802.11ac WiFi (80MHz, MCS7, 99pc duty cycle)	WLAN	8.50	± 9.6 %
10552	AAB	IEEE 802.11ac WiFi (80MHz, MCS8, 99pc duty cycle)	WLAN	8.42	± 9.6 %
10553	AAB	IEEE 802.11ac WiFi (80MHz, MCS9, 99pc duty cycle)	WLAN	8.45	± 9.6 %
10554	AAC	IEEE 802.11ac WiFi (160MHz, MCS0, 99pc duty cycle)	WLAN	8.48	± 9.6 %
10555	AAC	IEEE 802.11ac WiFi (160MHz, MCS1, 99pc duty cycle)	WLAN	8.47	± 9.6 %
10556	AAC	IEEE 802.11ac WiFi (160MHz, MCS2, 99pc duty cycle)	WLAN	8.50	± 9.6 %
10557	AAC	IEEE 802.11ac WiFi (160MHz, MCS3, 99pc duty cycle)	WLAN	8.52	± 9.6 %
10558	AAC	IEEE 802.11ac WiFi (160MHz, MCS4, 99pc duty cycle)	WLAN	8.61	± 9.6 %
10560	AAC	IEEE 802.11ac WiFi (160MHz, MCS6, 99pc duty cycle)	WLAN	8.73	± 9.6 %
10561	AAC	IEEE 802.11ac WiFi (160MHz, MCS7, 99pc duty cycle)	WLAN	8.56	± 9.6 %
10562	AAC	IEEE 802.11ac WiFi (160MHz, MCS8, 99pc duty cycle)	WLAN	8.69	± 9.6 %
10563	AAC	IEEE 802.11ac WiFi (160MHz, MCS9, 99pc duty cycle)	WLAN	8.77	± 9.6 %
10564	AAA	IEEE 802.11g WiFi 2.4 GHz (DSSS-OFDM, 9 Mbps, 99pc duty cycle)	WLAN	8.25	± 9.6 %
10565	AAA	IEEE 802.11g WiFi 2.4 GHz (DSSS-OFDM, 12 Mbps, 99pc duty cycle)	WLAN	8.45	± 9.6 %
10566	AAA	IEEE 802.11g WiFi 2.4 GHz (DSSS-OFDM, 18 Mbps, 99pc duty cycle)	WLAN	8.13	± 9.6 %
10567	AAA	IEEE 802.11g WiFi 2.4 GHz (DSSS-OFDM, 24 Mbps, 99pc duty cycle)	WLAN	8.00	± 9.6 %
10568	AAA	IEEE 802.11g WiFi 2.4 GHz (DSSS-OFDM, 36 Mbps, 99pc duty cycle)	WLAN	8.37	± 9.6 %
10569	AAA	IEEE 802.11g WiFi 2.4 GHz (DSSS-OFDM, 48 Mbps, 99pc duty cycle)	WLAN	8.10	± 9.6 %
10570	AAA	IEEE 802.11g WiFi 2.4 GHz (DSSS-OFDM, 54 Mbps, 99pc duty cycle)	WLAN	8.30	± 9.6 %
10571	AAA	IEEE 802.11b WiFi 2.4 GHz (DSSS, 1 Mbps, 90pc duty cycle)	WLAN	1.99	± 9.6 %
10572	AAA	IEEE 802.11b WiFi 2.4 GHz (DSSS, 2 Mbps, 90pc duty cycle)	WLAN	1.99	± 9.6 %
10573	AAA	IEEE 802.11b WiFi 2.4 GHz (DSSS, 5.5 Mbps, 90pc duty cycle)	WLAN	1.98	± 9.6 %
10574	AAA	IEEE 802.11b WiFi 2.4 GHz (DSSS, 11 Mbps, 90pc duty cycle)	WLAN	1.98	± 9.6 %
10575	AAA	IEEE 802.11g WiFi 2.4 GHz (DSSS-OFDM, 6 Mbps, 90pc duty cycle)	WLAN	8.59	± 9.6 %
10576	AAA	IEEE 802.11g WiFi 2.4 GHz (DSSS-OFDM, 9 Mbps, 90pc duty cycle)	WLAN	8.60	± 9.6 %
10577	AAA	IEEE 802.11g WiFi 2.4 GHz (DSSS-OFDM, 12 Mbps, 90pc duty cycle)	WLAN	8.70	± 9.6 %
10578	AAA	IEEE 802.11g WiFi 2.4 GHz (DSSS-OFDM, 18 Mbps, 90pc duty cycle)	WLAN	8.49	± 9.6 %
10579	AAA	IEEE 802.11g WiFi 2.4 GHz (DSSS-OFDM, 24 Mbps, 90pc duty cycle)	WLAN	8.36	± 9.6 %
10580	AAA	IEEE 802.11g WiFi 2.4 GHz (DSSS-OFDM, 36 Mbps, 90pc duty cycle)	WLAN	8.76	± 9.6 %
10581	AAA	IEEE 802.11g WiFi 2.4 GHz (DSSS-OFDM, 48 Mbps, 90pc duty cycle)	WLAN	8.35	± 9.6 %
10582	AAA	IEEE 802.11g WiFi 2.4 GHz (DSSS-OFDM, 54 Mbps, 90pc duty cycle)	WLAN	8.67	± 9.6 %
10583	AAB	IEEE 802.11a/h WiFi 5 GHz (OFDM, 6 Mbps, 90pc duty cycle)	WLAN	8.59	± 9.6 %
10584	AAB	IEEE 802.11a/h WiFi 5 GHz (OFDM, 9 Mbps, 90pc duty cycle)	WLAN	8.60	± 9.6 %
10585	AAB	IEEE 802.11a/h WiFi 5 GHz (OFDM, 12 Mbps, 90pc duty cycle)	WLAN	8.70	± 9.6 %
10586	AAB	IEEE 802.11a/h WiFi 5 GHz (OFDM, 18 Mbps, 90pc duty cycle)	WLAN	8.49	± 9.6 %
10587	AAB	IEEE 802.11a/h WiFi 5 GHz (OFDM, 24 Mbps, 90pc duty cycle)	WLAN	8.36	± 9.6 %

10588	AAB	IEEE 802.11a/h WiFi 5 GHz (OFDM, 36 Mbps, 90pc duty cycle)	WLAN	8.76	± 9.6 %
10589	AAB	IEEE 802.11a/h WiFi 5 GHz (OFDM, 48 Mbps, 90pc duty cycle)	WLAN	8.35	± 9.6 %
10590	AAB	IEEE 802.11a/h WiFi 5 GHz (OFDM, 54 Mbps, 90pc duty cycle)	WLAN	8.67	± 9.6 %
10591	AAB	IEEE 802.11n (HT Mixed, 20MHz, MCS0, 90pc duty cycle)	WLAN	8.63	± 9.6 %
10592	AAB	IEEE 802.11n (HT Mixed, 20MHz, MCS1, 90pc duty cycle)	WLAN	8.79	± 9.6 %
10593	AAB	IEEE 802.11n (HT Mixed, 20MHz, MCS2, 90pc duty cycle)	WLAN	8.64	± 9.6 %
10594	AAB	IEEE 802.11n (HT Mixed, 20MHz, MCS3, 90pc duty cycle)	WLAN	8.74	± 9.6 %
10595	AAB	IEEE 802.11n (HT Mixed, 20MHz, MCS4, 90pc duty cycle)	WLAN	8.74	± 9.6 %
10596	AAB	IEEE 802.11n (HT Mixed, 20MHz, MCS5, 90pc duty cycle)	WLAN	8.71	± 9.6 %
10597	AAB	IEEE 802.11n (HT Mixed, 20MHz, MCS6, 90pc duty cycle)	WLAN	8.72	± 9.6 %
10598	AAB	IEEE 802.11n (HT Mixed, 20MHz, MCS7, 90pc duty cycle)	WLAN	8.50	± 9.6 %
10599	AAB	IEEE 802.11n (HT Mixed, 40MHz, MCS0, 90pc duty cycle)	WLAN	8.79	± 9.6 %
10600	AAB	IEEE 802.11n (HT Mixed, 40MHz, MCS1, 90pc duty cycle)	WLAN	8.88	± 9.6 %
10601	AAB	IEEE 802.11n (HT Mixed, 40MHz, MCS2, 90pc duty cycle)	WLAN	8.82	± 9.6 %
10602	AAB	IEEE 802.11n (HT Mixed, 40MHz, MCS3, 90pc duty cycle)	WLAN	8.94	± 9.6 %
10603	AAB	IEEE 802.11n (HT Mixed, 40MHz, MCS4, 90pc duty cycle)	WLAN	9.03	± 9.6 %
10604	AAB	IEEE 802.11n (HT Mixed, 40MHz, MCS5, 90pc duty cycle)	WLAN	8.76	± 9.6 %
10605	AAB	IEEE 802.11n (HT Mixed, 40MHz, MCS6, 90pc duty cycle)	WLAN	8.97	± 9.6 %
10606	AAB	IEEE 802.11n (HT Mixed, 40MHz, MCS7, 90pc duty cycle)	WLAN	8.82	± 9.6 %
10607	AAB	IEEE 802.11ac WiFi (20MHz, MCS0, 90pc duty cycle)	WLAN	8.64	± 9.6 %
10608	AAB	IEEE 802.11ac WiFi (20MHz, MCS1, 90pc duty cycle)	WLAN	8.77	± 9.6 %
10609	AAB	IEEE 802.11ac WiFi (20MHz, MCS2, 90pc duty cycle)	WLAN	8.57	± 9.6 %
10610	AAB	IEEE 802.11ac WiFi (20MHz, MCS3, 90pc duty cycle)	WLAN	8.78	± 9.6 %
10611	AAB	IEEE 802.11ac WiFi (20MHz, MCS4, 90pc duty cycle)	WLAN	8.70	± 9.6 %
10612	AAB	IEEE 802.11ac WiFi (20MHz, MCS5, 90pc duty cycle)	WLAN	8.77	± 9.6 %
10613	AAB	IEEE 802.11ac WiFi (20MHz, MCS6, 90pc duty cycle)	WLAN	8.94	± 9.6 %
10614	AAB	IEEE 802.11ac WiFi (20MHz, MCS7, 90pc duty cycle)	WLAN	8.59	± 9.6 %
10615	AAB	IEEE 802.11ac WiFi (20MHz, MCS8, 90pc duty cycle)	WLAN	8.82	± 9.6 %
10616	AAB	IEEE 802.11ac WiFi (40MHz, MCS0, 90pc duty cycle)	WLAN	8.82	± 9.6 %
10617	AAB	IEEE 802.11ac WiFi (40MHz, MCS1, 90pc duty cycle)	WLAN	8.81	± 9.6 %
10618	AAB	IEEE 802.11ac WiFi (40MHz, MCS2, 90pc duty cycle)	WLAN	8.58	± 9.6 %
10619	AAB	IEEE 802.11ac WiFi (40MHz, MCS3, 90pc duty cycle)	WLAN	8.86	± 9.6 %
10620	AAB	IEEE 802.11ac WiFi (40MHz, MCS4, 90pc duty cycle)	WLAN	8.87	± 9.6 %
10621	AAB	IEEE 802.11ac WiFi (40MHz, MCS5, 90pc duty cycle)	WLAN	8.77	± 9.6 %
10622	AAB	IEEE 802.11ac WiFi (40MHz, MCS6, 90pc duty cycle)	WLAN	8.68	± 9.6 %
10623	AAB	IEEE 802.11ac WiFi (40MHz, MCS7, 90pc duty cycle)	WLAN	8.82	± 9.6 %
10624	AAB	IEEE 802.11ac WiFi (40MHz, MCS8, 90pc duty cycle)	WLAN	8.96	± 9.6 %
10625	AAB	IEEE 802.11ac WiFi (40MHz, MCS9, 90pc duty cycle)	WLAN	8.96	± 9.6 %
10626	AAB	IEEE 802.11ac WiFi (80MHz, MCS0, 90pc duty cycle)	WLAN	8.83	± 9.6 %
10627	AAB	IEEE 802.11ac WiFi (80MHz, MCS1, 90pc duty cycle)	WLAN	8.88	± 9.6 %
10628	AAB	IEEE 802.11ac WiFi (80MHz, MCS2, 90pc duty cycle)	WLAN	8.71	± 9.6 %
10629	AAB	IEEE 802.11ac WiFi (80MHz, MCS3, 90pc duty cycle)	WLAN	8.85	± 9.6 %
10630	AAB	IEEE 802.11ac WiFi (80MHz, MCS4, 90pc duty cycle)	WLAN	8.72	± 9.6 %
10631	AAB	IEEE 802.11ac WiFi (80MHz, MCS5, 90pc duty cycle)	WLAN	8.81	± 9.6 %
10632	AAB	IEEE 802.11ac WiFi (80MHz, MCS6, 90pc duty cycle)	WLAN	8.74	± 9.6 %
10633	AAB	IEEE 802.11ac WiFi (80MHz, MCS7, 90pc duty cycle)	WLAN	8.83	± 9.6 %
10634	AAB	IEEE 802.11ac WiFi (80MHz, MCS8, 90pc duty cycle)	WLAN	8.80	± 9.6 %
10635	AAB	IEEE 802.11ac WiFi (80MHz, MCS9, 90pc duty cycle)	WLAN	8.81	± 9.6 %
10636	AAC	IEEE 802.11ac WiFi (160MHz, MCS0, 90pc duty cycle)	WLAN	8.83	± 9.6 %
10637	AAC	IEEE 802.11ac WiFi (160MHz, MCS1, 90pc duty cycle)	WLAN	8.79	± 9.6 %
10638	AAC	IEEE 802.11ac WiFi (160MHz, MCS2, 90pc duty cycle)	WLAN	8.86	± 9.6 %
10639	AAC	IEEE 802.11ac WiFi (160MHz, MCS3, 90pc duty cycle)	WLAN	8.85	± 9.6 %
10640	AAC	IEEE 802.11ac WiFi (160MHz, MCS4, 90pc duty cycle)	WLAN	8.98	± 9.6 %
10641	AAC	IEEE 802.11ac WiFi (160MHz, MCS5, 90pc duty cycle)	WLAN	9.06	± 9.6 %
10642	AAC	IEEE 802.11ac WiFi (160MHz, MCS6, 90pc duty cycle)	WLAN	9.06	± 9.6 %
10643	AAC	IEEE 802.11ac WiFi (160MHz, MCS7, 90pc duty cycle)	WLAN	8.89	± 9.6 %
10644	AAC	IEEE 802.11ac WiFi (160MHz, MCS8, 90pc duty cycle)	WLAN	9.05	± 9.6 %
10645	AAC	IEEE 802.11ac WiFi (160MHz, MCS9, 90pc duty cycle)	WLAN	9.11	± 9.6 %
10646	AAF	LTE-TDD (SC-FDMA, 1 RB, 5 MHz, QPSK, UL Subframe=2,7)	LTE-TDD	11.96	± 9.6 %
10647	AAF	LTE-TDD (SC-FDMA, 1 RB, 20 MHz, QPSK, UL Subframe=2,7)	LTE-TDD	11.96	± 9.6 %
10648	AAA	CDMA2000 (1x Advanced)	CDMA2000	3.45	± 9.6 %
10652	AAD	LTE-TDD (OFDMA, 5 MHz, E-TM 3.1, Clipping 44%)	LTE-TDD	6.91	± 9.6 %
10653	AAD	LTE-TDD (OFDMA, 10 MHz, E-TM 3.1, Clipping 44%)	LTE-TDD	7.42	± 9.6 %
10654	AAD	LTE-TDD (OFDMA, 15 MHz, E-TM 3.1, Clipping 44%)	LTE-TDD	6.96	± 9.6 %

10655	AAE	LTE-TDD (OFDMA, 20 MHz, E-TM 3.1, Clipping 44%)	LTE-TDD	7.21	± 9.6 %
10658	AAA	Pulse Waveform (200Hz, 10%)	Test	10.00	± 9.6 %
10659	AAA	Pulse Waveform (200Hz, 20%)	Test	6.99	± 9.6 %
10660	AAA	Pulse Waveform (200Hz, 40%)	Test	3.98	± 9.6 %
10661	AAA	Pulse Waveform (200Hz, 60%)	Test	2.22	± 9.6 %
10662	AAA	Pulse Waveform (200Hz, 80%)	Test	0.97	± 9.6 %
10670	AAA	Bluetooth Low Energy	Bluetooth	2.19	± 9.6 %

^E Uncertainty is determined using the max. deviation from linear response applying rectangular distribution and is expressed for the square of the field value.



Accredited by the Swiss Accreditation Service (SAS)
The Swiss Accreditation Service is one of the signatories to the EA
Multilateral Agreement for the recognition of calibration certificates

Accreditation No.: **SCS 0108**

Client **PC Test**

Certificate No: **D2450V2-981_Aug18**

CALIBRATION CERTIFICATE

Object **D2450V2 - SN:981**

Calibration procedure(s) **QA CAL-05.v10
Calibration procedure for dipole validation kits above 700 MHz**

Calibration date: **August 16, 2018**

*BN ✓
09-26/2018*

This calibration certificate documents the traceability to national standards, which realize the physical units of measurements (SI).
The measurements and the uncertainties with confidence probability are given on the following pages and are part of the certificate.

All calibrations have been conducted in the closed laboratory facility: environment temperature (22 ± 3)°C and humidity < 70%.

Calibration Equipment used (M&TE critical for calibration)

Primary Standards	ID #	Cal Date (Certificate No.)	Scheduled Calibration
Power meter NRP	SN: 104778	04-Apr-18 (No. 217-02672/02673)	Apr-19
Power sensor NRP-Z91	SN: 103244	04-Apr-18 (No. 217-02672)	Apr-19
Power sensor NRP-Z91	SN: 103245	04-Apr-18 (No. 217-02673)	Apr-19
Reference 20 dB Attenuator	SN: 5058 (20k)	04-Apr-18 (No. 217-02682)	Apr-19
Type-N mismatch combination	SN: 5047.2 / 06327	04-Apr-18 (No. 217-02683)	Apr-19
Reference Probe EX3DV4	SN: 7349	30-Dec-17 (No. EX3-7349_Dec17)	Dec-18
DAE4	SN: 601	26-Oct-17 (No. DAE4-601_Oct17)	Oct-18
Secondary Standards	ID #	Check Date (in house)	Scheduled Check
Power meter EPM-442A	SN: GB37480704	07-Oct-15 (in house check Oct-16)	In house check: Oct-18
Power sensor HP 8481A	SN: US37292783	07-Oct-15 (in house check Oct-16)	In house check: Oct-18
Power sensor HP 8481A	SN: MY41092317	07-Oct-15 (in house check Oct-16)	In house check: Oct-18
RF generator R&S SMT-06	SN: 100972	15-Jun-15 (in house check Oct-16)	In house check: Oct-18
Network Analyzer Agilent E8358A	SN: US41080477	31-Mar-14 (in house check Oct-17)	In house check: Oct-18

Calibrated by: **Leif Klysner** Function: **Laboratory Technician**

Approved by: **Katja Pokovic** Technical Manager

Signature
Leif Klysner

Katja Pokovic

Issued: August 23, 2018

This calibration certificate shall not be reproduced except in full without written approval of the laboratory.



Accredited by the Swiss Accreditation Service (SAS)
The Swiss Accreditation Service is one of the signatories to the EA
Multilateral Agreement for the recognition of calibration certificates

Accreditation No.: **SCS 0108**

Glossary:

TSL	tissue simulating liquid
ConvF	sensitivity in TSL / NORM x,y,z
N/A	not applicable or not measured

Calibration is Performed According to the Following Standards:

- a) IEEE Std 1528-2013, "IEEE Recommended Practice for Determining the Peak Spatial-Averaged Specific Absorption Rate (SAR) in the Human Head from Wireless Communications Devices: Measurement Techniques", June 2013
- b) IEC 62209-1, "Measurement procedure for the assessment of Specific Absorption Rate (SAR) from hand-held and body-mounted devices used next to the ear (frequency range of 300 MHz to 6 GHz)", July 2016
- c) IEC 62209-2, "Procedure to determine the Specific Absorption Rate (SAR) for wireless communication devices used in close proximity to the human body (frequency range of 30 MHz to 6 GHz)", March 2010
- d) KDB 865664, "SAR Measurement Requirements for 100 MHz to 6 GHz"

Additional Documentation:

- e) DASy4/5 System Handbook

Methods Applied and Interpretation of Parameters:

- *Measurement Conditions:* Further details are available from the Validation Report at the end of the certificate. All figures stated in the certificate are valid at the frequency indicated.
- *Antenna Parameters with TSL:* The dipole is mounted with the spacer to position its feed point exactly below the center marking of the flat phantom section, with the arms oriented parallel to the body axis.
- *Feed Point Impedance and Return Loss:* These parameters are measured with the dipole positioned under the liquid filled phantom. The impedance stated is transformed from the measurement at the SMA connector to the feed point. The Return Loss ensures low reflected power. No uncertainty required.
- *Electrical Delay:* One-way delay between the SMA connector and the antenna feed point. No uncertainty required.
- *SAR measured:* SAR measured at the stated antenna input power.
- *SAR normalized:* SAR as measured, normalized to an input power of 1 W at the antenna connector.
- *SAR for nominal TSL parameters:* The measured TSL parameters are used to calculate the nominal SAR result.

The reported uncertainty of measurement is stated as the standard uncertainty of measurement multiplied by the coverage factor $k=2$, which for a normal distribution corresponds to a coverage probability of approximately 95%.

Measurement Conditions

DASY system configuration, as far as not given on page 1.

DASY Version	DASY5	V52.10.1
Extrapolation	Advanced Extrapolation	
Phantom	Modular Flat Phantom	
Distance Dipole Center - TSL	10 mm	with Spacer
Zoom Scan Resolution	dx, dy, dz = 5.0 mm	
Frequency	2450 MHz \pm 1 MHz	

Head TSL parameters

The following parameters and calculations were applied.

	Temperature	Permittivity	Conductivity
Nominal Head TSL parameters	22.0 °C	39.2	1.80 mho/m
Measured Head TSL parameters	(22.0 \pm 0.2) °C	37.7 \pm 6 %	1.86 mho/m \pm 6 %
Head TSL temperature change during test	< 0.5 °C	----	----

SAR result with Head TSL

SAR averaged over 1 cm ³ (1 g) of Head TSL	Condition	
SAR measured	250 mW input power	13.4 W/kg
SAR for nominal Head TSL parameters	normalized to 1W	52.3 W/kg \pm 17.0 % (k=2)

SAR averaged over 10 cm ³ (10 g) of Head TSL	condition	
SAR measured	250 mW input power	6.20 W/kg
SAR for nominal Head TSL parameters	normalized to 1W	24.4 W/kg \pm 16.5 % (k=2)

Body TSL parameters

The following parameters and calculations were applied.

	Temperature	Permittivity	Conductivity
Nominal Body TSL parameters	22.0 °C	52.7	1.95 mho/m
Measured Body TSL parameters	(22.0 \pm 0.2) °C	51.8 \pm 6 %	2.02 mho/m \pm 6 %
Body TSL temperature change during test	< 0.5 °C	----	----

SAR result with Body TSL

SAR averaged over 1 cm ³ (1 g) of Body TSL	Condition	
SAR measured	250 mW input power	13.0 W/kg
SAR for nominal Body TSL parameters	normalized to 1W	50.9 W/kg \pm 17.0 % (k=2)

SAR averaged over 10 cm ³ (10 g) of Body TSL	condition	
SAR measured	250 mW input power	6.11 W/kg
SAR for nominal Body TSL parameters	normalized to 1W	24.2 W/kg \pm 16.5 % (k=2)

Appendix (Additional assessments outside the scope of SCS 0108)

Antenna Parameters with Head TSL

Impedance, transformed to feed point	55.0 Ω + 2.3 j Ω
Return Loss	- 25.6 dB

Antenna Parameters with Body TSL

Impedance, transformed to feed point	50.2 Ω + 4.7 j Ω
Return Loss	- 26.6 dB

General Antenna Parameters and Design

Electrical Delay (one direction)	1.162 ns
----------------------------------	----------

After long term use with 100W radiated power, only a slight warming of the dipole near the feedpoint can be measured.

The dipole is made of standard semirigid coaxial cable. The center conductor of the feeding line is directly connected to the second arm of the dipole. The antenna is therefore short-circuited for DC-signals. On some of the dipoles, small end caps are added to the dipole arms in order to improve matching when loaded according to the position as explained in the "Measurement Conditions" paragraph. The SAR data are not affected by this change. The overall dipole length is still according to the Standard.

No excessive force must be applied to the dipole arms, because they might bend or the soldered connections near the feedpoint may be damaged.

Additional EUT Data

Manufactured by	SPEAG
Manufactured on	December 30, 2014

Appendix (Additional assessments outside the scope of SCS 0108)

Measurement Conditions

DASY system configuration, as far as not given on page 1 and 3.

Phantom	SAM Head Phantom	For usage with cSAR3DV2-R/L
---------	------------------	-----------------------------

SAR result with SAM Head (Top)

SAR averaged over 1 cm ³ (1 g) of Head TSL	Condition	
SAR measured	250 mW input power	13.6 W/kg
SAR for nominal Head TSL parameters	normalized to 1W	54.0 W/kg ± 17.5 % (k=2)

SAR averaged over 10 cm ³ (10 g) of Head TSL	condition	
SAR measured	250 mW input power	6.33 W/kg
SAR for nominal Head TSL parameters	normalized to 1W	25.2 W/kg ± 16.9 % (k=2)

SAR result with SAM Head (Mouth)

SAR averaged over 1 cm ³ (1 g) of Head TSL	Condition	
SAR measured	250 mW input power	13.6 W/kg
SAR for nominal Head TSL parameters	normalized to 1W	54.0 W/kg ± 17.5 % (k=2)

SAR averaged over 10 cm ³ (10 g) of Head TSL	condition	
SAR measured	250 mW input power	6.35 W/kg
SAR for nominal Head TSL parameters	normalized to 1W	25.3 W/kg ± 16.9 % (k=2)

SAR result with SAM Head (Neck)

SAR averaged over 1 cm ³ (1 g) of Head TSL	Condition	
SAR measured	250 mW input power	12.9 W/kg
SAR for nominal Head TSL parameters	normalized to 1W	51.2 W/kg ± 17.5 % (k=2)

SAR averaged over 10 cm ³ (10 g) of Head TSL	condition	
SAR measured	250 mW input power	6.11 W/kg
SAR for nominal Head TSL parameters	normalized to 1W	24.4 W/kg ± 16.9 % (k=2)

SAR result with SAM Head (Ear)

SAR averaged over 1 cm ³ (1 g) of Head TSL	Condition	
SAR measured	250 mW input power	8.74 W/kg
SAR for nominal Head TSL parameters	normalized to 1W	34.7 W/kg ± 17.5 % (k=2)

SAR averaged over 10 cm ³ (10 g) of Head TSL	condition	
SAR measured	250 mW input power	4.40 W/kg
SAR for nominal Head TSL parameters	normalized to 1W	17.5 W/kg ± 16.9 % (k=2)

DASY5 Validation Report for Head TSL

Date: 13.08.2018

Test Laboratory: SPEAG, Zurich, Switzerland

DUT: Dipole 2450 MHz; Type: D2450V2; Serial: D2450V2 - SN:981

Communication System: UID 0 - CW; Frequency: 2450 MHz

Medium parameters used: $f = 2450$ MHz; $\sigma = 1.86$ S/m; $\epsilon_r = 37.7$; $\rho = 1000$ kg/m³

Phantom section: Flat Section

Measurement Standard: DASY5 (IEEE/IEC/ANSI C63.19-2011)

DASY52 Configuration:

- Probe: EX3DV4 - SN7349; ConvF(7.88, 7.88, 7.88) @ 2450 MHz; Calibrated: 30.12.2017
- Sensor-Surface: 1.4mm (Mechanical Surface Detection)
- Electronics: DAE4 Sn601; Calibrated: 26.10.2017
- Phantom: Flat Phantom 5.0 (front); Type: QD 000 P50 AA; Serial: 1001
- DASY52 52.10.1(1476); SEMCAD X 14.6.11(7439)

Dipole Calibration for Head Tissue/Pin=250 mW, d=10mm/Zoom Scan (7x7x7)/Cube 0:

Measurement grid: dx=5mm, dy=5mm, dz=5mm

Reference Value = 116.6 V/m; Power Drift = -0.03 dB

Peak SAR (extrapolated) = 26.7 W/kg

SAR(1 g) = 13.4 W/kg; SAR(10 g) = 6.2 W/kg

Maximum value of SAR (measured) = 22.1 W/kg



Impedance Measurement Plot for Head TSL

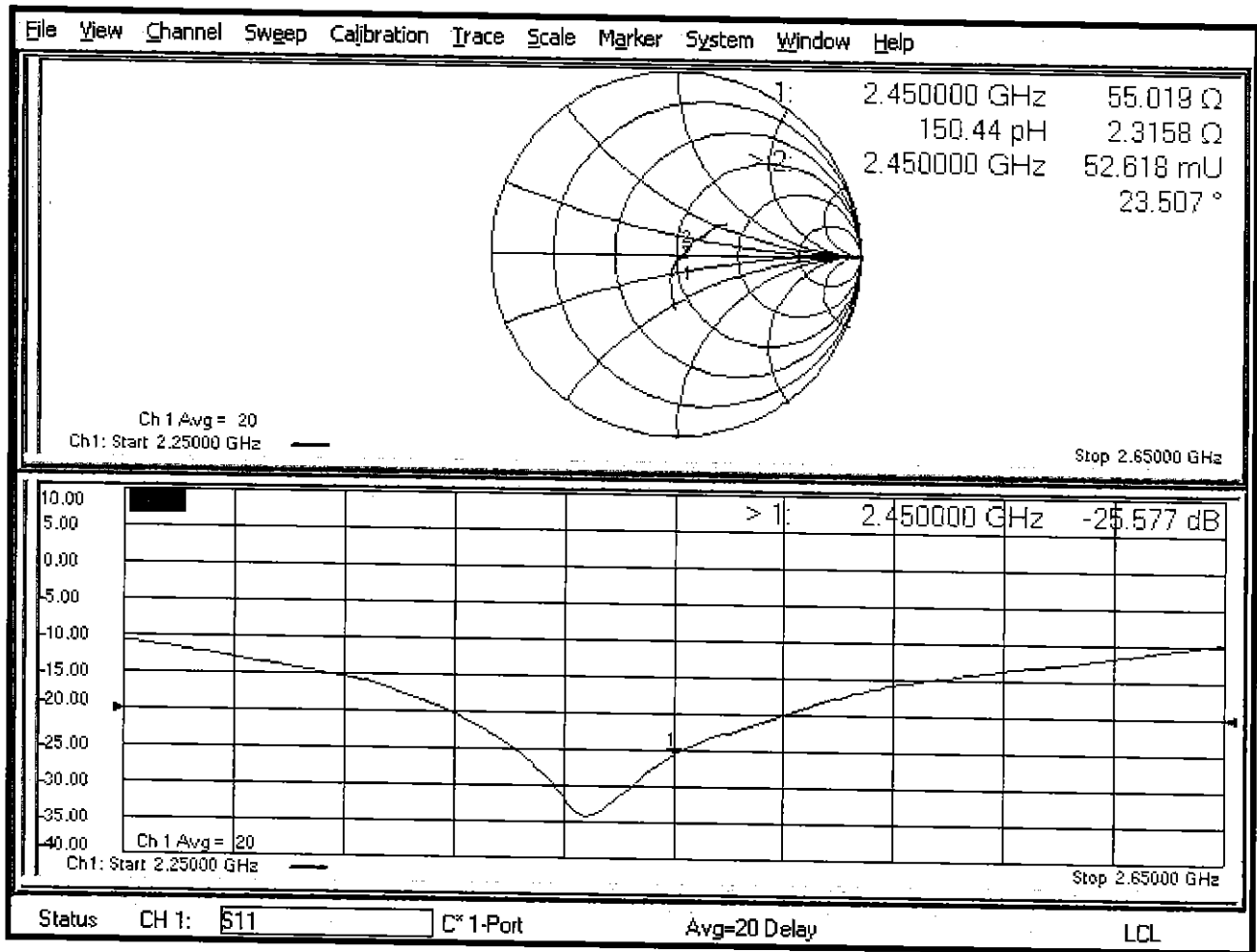

DASY5 Validation Report for Body TSL

Date: 13.08.2018

Test Laboratory: SPEAG, Zurich, Switzerland

DUT: Dipole 2450 MHz; Type: D2450V2; Serial: D2450V2 - SN:981

Communication System: UID 0 - CW; Frequency: 2450 MHz

Medium parameters used: $f = 2450$ MHz; $\sigma = 2.02$ S/m; $\epsilon_r = 51.8$; $\rho = 1000$ kg/m³

Phantom section: Flat Section

Measurement Standard: DASY5 (IEEE/IEC/ANSI C63.19-2011)

DASY52 Configuration:

- Probe: EX3DV4 - SN7349; ConvF(8.01, 8.01, 8.01) @ 2450 MHz; Calibrated: 30.12.2017
- Sensor-Surface: 1.4mm (Mechanical Surface Detection)
- Electronics: DAE4 Sn601; Calibrated: 26.10.2017
- Phantom: Flat Phantom 5.0 (back); Type: QD 000 P50 AA; Serial: 1002
- DASY52 52.10.1(1476); SEMCAD X 14.6.11(7439)

Dipole Calibration for Body Tissue/Pin=250 mW, d=10mm/Zoom Scan (7x7x7)/Cube 0:

Measurement grid: dx=5mm, dy=5mm, dz=5mm

Reference Value = 107.0 V/m; Power Drift = -0.08 dB

Peak SAR (extrapolated) = 25.3 W/kg

SAR(1 g) = 13 W/kg; SAR(10 g) = 6.11 W/kg

Maximum value of SAR (measured) = 20.7 W/kg



0 dB = 20.7 W/kg = 13.16 dBW/kg

Impedance Measurement Plot for Body TSL

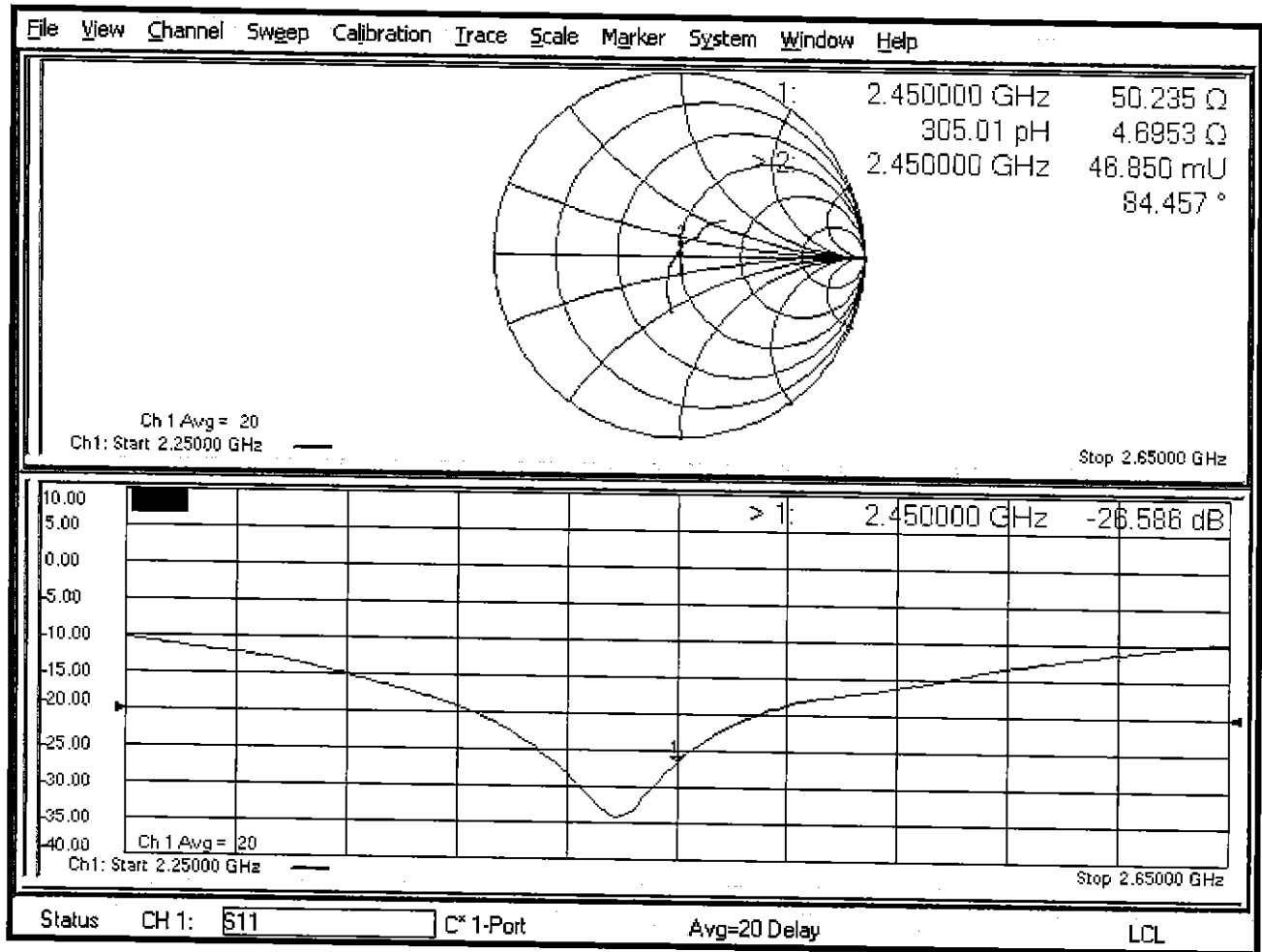

DASY5 Validation Report for SAM Head

Date: 16.08.2018

Test Laboratory: SPEAG, Zurich, Switzerland

DUT: Dipole 2450 MHz; Type: D2450V2; Serial: D2450V2 - SN:981

Communication System: UID 0 - CW ; Frequency: 2450 MHz

Medium parameters used: $f = 2450$ MHz; $\sigma = 1.85$ S/m; $\epsilon_r = 40.2$; $\rho = 1000$ kg/m³

Measurement Standard: DASY5 (IEEE/IEC/ANSI C63.19-2011)

DASY52 Configuration:

- Probe: EX3DV4 - SN7349; ConvF(7.88, 7.88, 7.88) @ 2450 MHz; Calibrated: 30.12.2017
- Sensor-Surface: 1.4mm (Mechanical Surface Detection)
- Electronics: DAE4 Sn601; Calibrated: 26.10.2017
- Phantom: SAM Head
- DASY52 52.10.1(1476); SEMCAD X 14.6.11(7439)

SAM Head Top/Zoom Scan (7x7x7)/Cube 0: Measurement grid: dx=5mm, dy=5mm, dz=5mm

Reference Value = 116.2 V/m; Power Drift = 0.00 dB

Peak SAR (extrapolated) = 26.4 W/kg

SAR(1 g) = 13.6 W/kg; SAR(10 g) = 6.33 W/kg

Maximum value of SAR (measured) = 22.0 W/kg

SAM Head Mouth/Zoom Scan (7x7x7)/Cube 0: Measurement grid: dx=5mm, dy=5mm, dz=5mm

Reference Value = 116.9 V/m; Power Drift = 0.01 dB

Peak SAR (extrapolated) = 26.3 W/kg

SAR(1 g) = 13.6 W/kg; SAR(10 g) = 6.35 W/kg

Maximum value of SAR (measured) = 21.7 W/kg

SAM Head Neck/Zoom Scan (7x7x7)/Cube 0: Measurement grid: dx=5mm, dy=5mm, dz=5mm

Reference Value = 112.0 V/m; Power Drift = 0.03 dB

Peak SAR (extrapolated) = 24.1 W/kg

SAR(1 g) = 12.9 W/kg; SAR(10 g) = 6.11 W/kg

Maximum value of SAR (measured) = 20.5 W/kg

SAM Head Ear/Zoom Scan (7x7x7)/Cube 0: Measurement grid: dx=5mm, dy=5mm, dz=5mm

Reference Value = 91.03 V/m; Power Drift = -0.01 dB

Peak SAR (extrapolated) = 15.8 W/kg

SAR(1 g) = 8.74 W/kg; SAR(10 g) = 4.4 W/kg

Maximum value of SAR (measured) = 13.5 W/kg

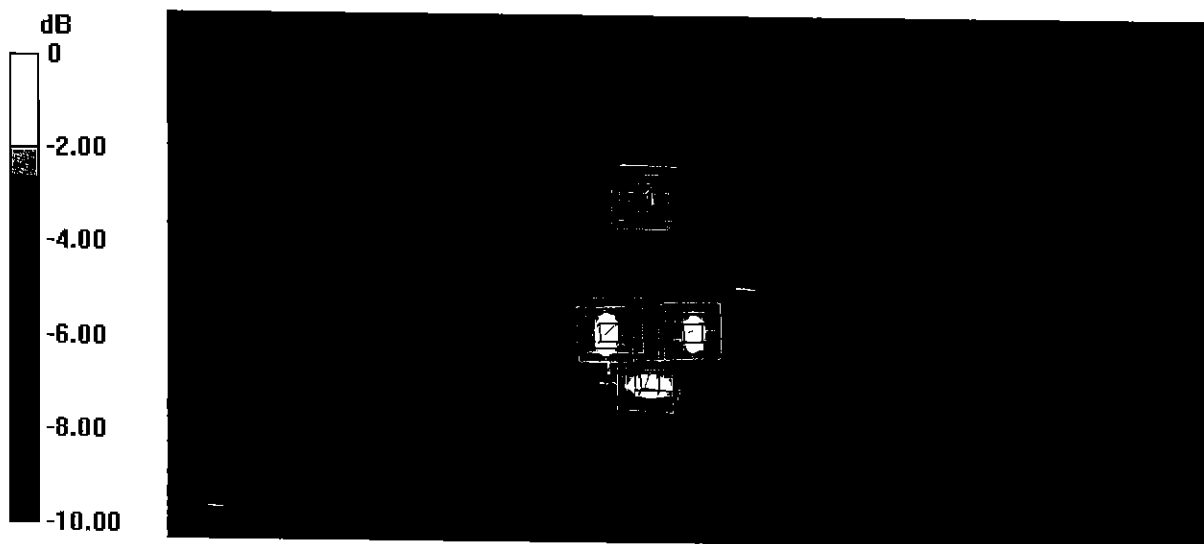

0 dB = 22.0 W/kg = 13.42 dBW/kg



Accredited by the Swiss Accreditation Service (SAS)
The Swiss Accreditation Service is one of the signatories to the EA
Multilateral Agreement for the recognition of calibration certificates

Accreditation No.: **SCS 0108**

Client **PC Test**

Certificate No: **D1765V2-1008_May18**

CALIBRATION CERTIFICATE

Object **D1765V2 - SN:1008**

Calibration procedure(s) **QA CAL-05.v10
Calibration procedure for dipole validation kits above 700 MHz**

*BNW
7/11/2018*

Calibration date: **May 23, 2018**

This calibration certificate documents the traceability to national standards, which realize the physical units of measurements (SI).
The measurements and the uncertainties with confidence probability are given on the following pages and are part of the certificate.

All calibrations have been conducted in the closed laboratory facility: environment temperature (22 ± 3)°C and humidity < 70%.

Calibration Equipment used (M&TE critical for calibration)

Primary Standards	ID #	Cal Date (Certificate No.)	Scheduled Calibration
Power meter NRP	SN: 104778	04-Apr-18 (No. 217-02672/02673)	Apr-19
Power sensor NRP-Z91	SN: 103244	04-Apr-18 (No. 217-02672)	Apr-19
Power sensor NRP-Z91	SN: 103245	04-Apr-18 (No. 217-02673)	Apr-19
Reference 20 dB Attenuator	SN: 5058 (20k)	04-Apr-18 (No. 217-02682)	Apr-19
Type-N mismatch combination	SN: 5047.2 / 06327	04-Apr-18 (No. 217-02683)	Apr-19
Reference Probe EX3DV4	SN: 7349	30-Dec-17 (No. EX3-7349_Dec17)	Dec-18
DAE4	SN: 601	26-Oct-17 (No. DAE4-601_Oct17)	Oct-18

Secondary Standards	ID #	Check Date (in house)	Scheduled Check
Power meter EPM-442A	SN: GB37480704	07-Oct-15 (in house check Oct-16)	In house check: Oct-18
Power sensor HP 8481A	SN: US37292783	07-Oct-15 (in house check Oct-16)	In house check: Oct-18
Power sensor HP 8481A	SN: MY41092317	07-Oct-15 (in house check Oct-16)	In house check: Oct-18
RF generator R&S SMT-06	SN: 100972	15-Jun-15 (in house check Oct-16)	In house check: Oct-18
Network Analyzer HP 8753E	SN: US37390585	18-Oct-01 (in house check Oct-17)	In house check: Oct-18

Calibrated by: **Manu Seltz** Name: **Manu Seltz** Function: **Laboratory Technician**

Signature *[Handwritten Signature]*

Approved by: **Katja Pokovic** Name: **Katja Pokovic** Function: **Technical Manager**

Signature *[Handwritten Signature]*

Issued: May 23, 2018

This calibration certificate shall not be reproduced except in full without written approval of the laboratory.



Accredited by the Swiss Accreditation Service (SAS)
The Swiss Accreditation Service is one of the signatories to the EA
Multilateral Agreement for the recognition of calibration certificates

Accreditation No.: **SCS 0108**

Glossary:

TSL	tissue simulating liquid
ConvF	sensitivity in TSL / NORM x,y,z
N/A	not applicable or not measured

Calibration is Performed According to the Following Standards:

- IEEE Std 1528-2013, "IEEE Recommended Practice for Determining the Peak Spatial-Averaged Specific Absorption Rate (SAR) in the Human Head from Wireless Communications Devices: Measurement Techniques", June 2013
- IEC 62209-1, "Measurement procedure for the assessment of Specific Absorption Rate (SAR) from hand-held and body-mounted devices used next to the ear (frequency range of 300 MHz to 6 GHz)", July 2016
- IEC 62209-2, "Procedure to determine the Specific Absorption Rate (SAR) for wireless communication devices used in close proximity to the human body (frequency range of 30 MHz to 6 GHz)", March 2010
- KDB 865664, "SAR Measurement Requirements for 100 MHz to 6 GHz"

Additional Documentation:

- DASY4/5 System Handbook

Methods Applied and Interpretation of Parameters:

- Measurement Conditions:** Further details are available from the Validation Report at the end of the certificate. All figures stated in the certificate are valid at the frequency indicated.
- Antenna Parameters with TSL:** The dipole is mounted with the spacer to position its feed point exactly below the center marking of the flat phantom section, with the arms oriented parallel to the body axis.
- Feed Point Impedance and Return Loss:** These parameters are measured with the dipole positioned under the liquid filled phantom. The impedance stated is transformed from the measurement at the SMA connector to the feed point. The Return Loss ensures low reflected power. No uncertainty required.
- Electrical Delay:** One-way delay between the SMA connector and the antenna feed point. No uncertainty required.
- SAR measured:** SAR measured at the stated antenna input power.
- SAR normalized:** SAR as measured, normalized to an input power of 1 W at the antenna connector.
- SAR for nominal TSL parameters:** The measured TSL parameters are used to calculate the nominal SAR result.

The reported uncertainty of measurement is stated as the standard uncertainty of measurement multiplied by the coverage factor $k=2$, which for a normal distribution corresponds to a coverage probability of approximately 95%.

Measurement Conditions

DASY system configuration, as far as not given on page 1.

DASY Version	DASY5	V52.10.1
Extrapolation	Advanced Extrapolation	
Phantom	Modular Flat Phantom	
Distance Dipole Center - TSL	10 mm	with Spacer
Zoom Scan Resolution	dx, dy, dz = 5.0 mm	
Frequency	1750 MHz \pm 1 MHz	

Head TSL parameters

The following parameters and calculations were applied.

	Temperature	Permittivity	Conductivity
Nominal Head TSL parameters	22.0 °C	40.1	1.37 mho/m
Measured Head TSL parameters	(22.0 \pm 0.2) °C	39.0 \pm 6 %	1.34 mho/m \pm 6 %
Head TSL temperature change during test	< 0.5 °C	----	----

SAR result with Head TSL

SAR averaged over 1 cm³ (1 g) of Head TSL	Condition	
SAR measured	250 mW input power	8.94 W/kg
SAR for nominal Head TSL parameters	normalized to 1W	36.2 W/kg \pm 17.0 % (k=2)

SAR averaged over 10 cm³ (10 g) of Head TSL	condition	
SAR measured	250 mW input power	4.71 W/kg
SAR for nominal Head TSL parameters	normalized to 1W	19.0 W/kg \pm 16.5 % (k=2)

Body TSL parameters

The following parameters and calculations were applied.

	Temperature	Permittivity	Conductivity
Nominal Body TSL parameters	22.0 °C	53.4	1.49 mho/m
Measured Body TSL parameters	(22.0 \pm 0.2) °C	53.2 \pm 6 %	1.46 mho/m \pm 6 %
Body TSL temperature change during test	< 0.5 °C	----	----

SAR result with Body TSL

SAR averaged over 1 cm³ (1 g) of Body TSL	Condition	
SAR measured	250 mW input power	9.21 W/kg
SAR for nominal Body TSL parameters	normalized to 1W	37.4 W/kg \pm 17.0 % (k=2)

SAR averaged over 10 cm³ (10 g) of Body TSL	condition	
SAR measured	250 mW input power	4.92 W/kg
SAR for nominal Body TSL parameters	normalized to 1W	19.9 W/kg \pm 16.5 % (k=2)

Appendix (Additional assessments outside the scope of SCS 0108)

Antenna Parameters with Head TSL

Impedance, transformed to feed point	47.7 Ω - 6.5 j Ω
Return Loss	- 23.0 dB

Antenna Parameters with Body TSL

Impedance, transformed to feed point	43.3 Ω - 6.0 j Ω
Return Loss	- 20.3 dB

General Antenna Parameters and Design

Electrical Delay (one direction)	1.210 ns
----------------------------------	----------

After long term use with 100W radiated power, only a slight warming of the dipole near the feedpoint can be measured.

The dipole is made of standard semirigid coaxial cable. The center conductor of the feeding line is directly connected to the second arm of the dipole. The antenna is therefore short-circuited for DC-signals. On some of the dipoles, small end caps are added to the dipole arms in order to improve matching when loaded according to the position as explained in the "Measurement Conditions" paragraph. The SAR data are not affected by this change. The overall dipole length is still according to the Standard.

No excessive force must be applied to the dipole arms, because they might bend or the soldered connections near the feedpoint may be damaged.

Additional EUT Data

Manufactured by	SPEAG
Manufactured on	October 06, 2005

Appendix (Additional assessments outside the scope of SCS 0108)

Measurement Conditions

DASY system configuration, as far as not given on page 1 and 3.

Phantom	SAM Head Phantom	For usage with cSAR3DV2-R/L
---------	------------------	-----------------------------

SAR result with SAM Head (Top)

SAR averaged over 1 cm ³ (1 g) of Head TSL	Condition	
SAR measured	250 mW input power	9.26 W/kg
SAR for nominal Head TSL parameters	normalized to 1W	37.4 W/kg ± 17.5 % (k=2)

SAR averaged over 10 cm ³ (10 g) of Head TSL	condition	
SAR measured	250 mW input power	4.95 W/kg
SAR for nominal Head TSL parameters	normalized to 1W	19.9 W/kg ± 16.9 % (k=2)

SAR result with SAM Head (Mouth)

SAR averaged over 1 cm ³ (1 g) of Head TSL	Condition	
SAR measured	250 mW input power	9.47 W/kg
SAR for nominal Head TSL parameters	normalized to 1W	38.2 W/kg ± 17.5 % (k=2)

SAR averaged over 10 cm ³ (10 g) of Head TSL	condition	
SAR measured	250 mW input power	5.06 W/kg
SAR for nominal Head TSL parameters	normalized to 1W	20.4 W/kg ± 16.9 % (k=2)

SAR result with SAM Head (Neck)

SAR averaged over 1 cm ³ (1 g) of Head TSL	Condition	
SAR measured	250 mW input power	9.26 W/kg
SAR for nominal Head TSL parameters	normalized to 1W	37.4 W/kg ± 17.5 % (k=2)

SAR averaged over 10 cm ³ (10 g) of Head TSL	condition	
SAR measured	250 mW input power	5.02 W/kg
SAR for nominal Head TSL parameters	normalized to 1W	20.2 W/kg ± 16.9 % (k=2)

SAR result with SAM Head (Ear)

SAR averaged over 1 cm ³ (1 g) of Head TSL	Condition	
SAR measured	250 mW input power	7.12 W/kg
SAR for nominal Head TSL parameters	normalized to 1W	28.7 W/kg ± 17.5 % (k=2)

SAR averaged over 10 cm ³ (10 g) of Head TSL	condition	
SAR measured	250 mW input power	4.01 W/kg
SAR for nominal Head TSL parameters	normalized to 1W	16.1 W/kg ± 16.9 % (k=2)

DASY5 Validation Report for Head TSL

Date: 15.05.2018

Test Laboratory: SPEAG, Zurich, Switzerland

DUT: Dipole 1765 MHz; Type: D1765V2; Serial: D1765V2 - SN:1008

Communication System: UID 0 - CW; Frequency: 1750 MHz

Medium parameters used: $f = 1750$ MHz; $\sigma = 1.34$ S/m; $\epsilon_r = 39$; $\rho = 1000$ kg/m³

Phantom section: Flat Section

Measurement Standard: DASY5 (IEEE/IEC/ANSI C63.19-2011)

DASY52 Configuration:

- Probe: EX3DV4 - SN7349; ConvF(8.5, 8.5, 8.5) @ 1750 MHz; Calibrated: 30.12.2017
- Sensor-Surface: 1.4mm (Mechanical Surface Detection)
- Electronics: DAE4 Sn601; Calibrated: 26.10.2017
- Phantom: Flat Phantom 5.0 (front); Type: QD 000 P50 AA; Serial: 1001
- DASY52 52.10.1(1476); SEMCAD X 14.6.11(7439)

Dipole Calibration for Head Tissue/Pin=250 mW, d=10mm/Zoom Scan (7x7x7)/Cube 0:

Measurement grid: dx=5mm, dy=5mm, dz=5mm

Reference Value = 106.6 V/m; Power Drift = -0.02 dB

Peak SAR (extrapolated) = 16.4 W/kg

SAR(1 g) = 8.94 W/kg; SAR(10 g) = 4.71 W/kg

Maximum value of SAR (measured) = 13.8 W/kg

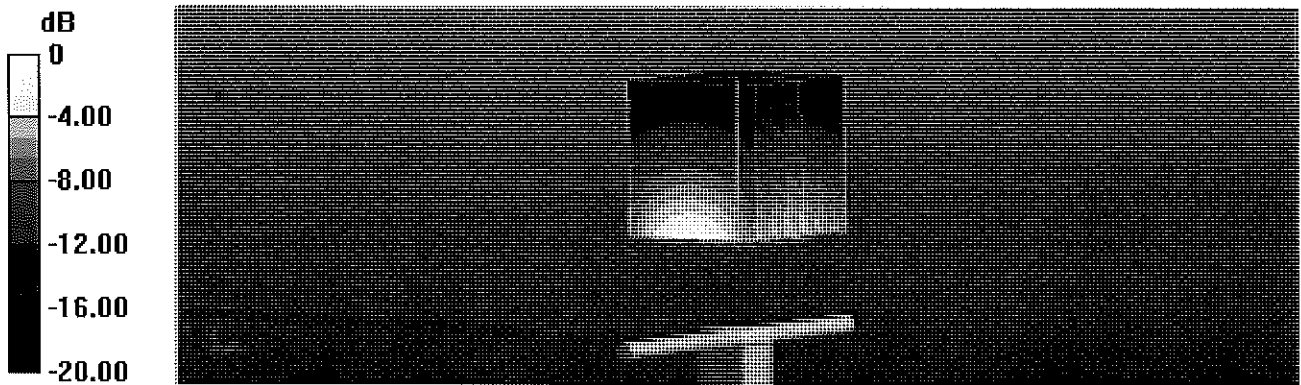

Impedance Measurement Plot for Head TSL

15 May 2018 11:19:20

CH1 S11 1 U FS 1: 47.658 Ω -6.5039 Ω 13.983 pF 1 750.000 000 MHz

*
De1
CA
Avg
16
H1d

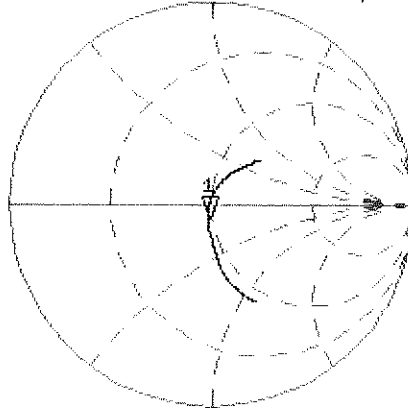

CH2 S11 LOG 5 dB/REF -20 dB 1:-23.017 dB 1 750.000 000 MHz

CA
Avg
16
H1d

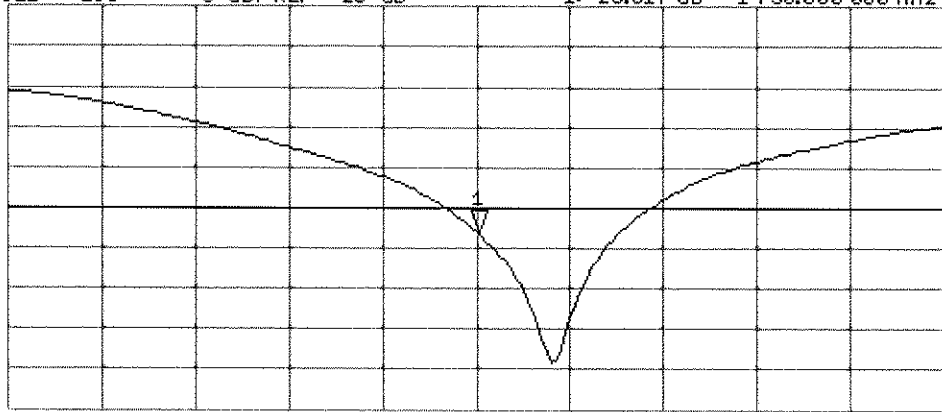

START 1 550.000 000 MHz

STOP 1 950.000 000 MHz

DASY5 Validation Report for Body TSL

Date: 15.05.2018

Test Laboratory: SPEAG, Zurich, Switzerland

DUT: Dipole 1765 MHz; Type: D1765V2; Serial: D1765V2 - SN:1008

Communication System: UID 0 - CW; Frequency: 1750 MHz

Medium parameters used: $f = 1750$ MHz; $\sigma = 1.46$ S/m; $\epsilon_r = 53.2$; $\rho = 1000$ kg/m³

Phantom section: Flat Section

Measurement Standard: DASY5 (IEEE/IEC/ANSI C63.19-2011)

DASY52 Configuration:

- Probe: EX3DV4 - SN7349; ConvF(8.35, 8.35, 8.35) @ 1750 MHz; Calibrated: 30.12.2017
- Sensor-Surface: 1.4mm (Mechanical Surface Detection)
- Electronics: DAE4 Sn601; Calibrated: 26.10.2017
- Phantom: Flat Phantom 5.0 (back); Type: QD 000 P50 AA; Serial: 1002
- DASY52 52.10.1(1476); SEMCAD X 14.6.11(7439)

Dipole Calibration for Body Tissue/Pin=250 mW, d=10mm/Zoom Scan (7x7x7)/Cube 0:

Measurement grid: dx=5mm, dy=5mm, dz=5mm

Reference Value = 102.4 V/m; Power Drift = -0.06 dB

Peak SAR (extrapolated) = 16.1 W/kg

SAR(1 g) = 9.21 W/kg; SAR(10 g) = 4.92 W/kg

Maximum value of SAR (measured) = 13.7 W/kg

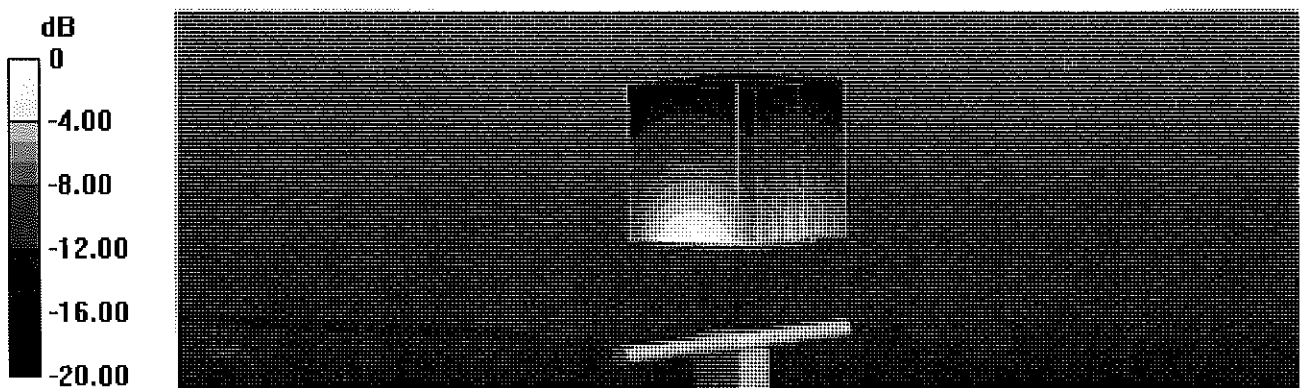

0 dB = 13.7 W/kg = 11.37 dBW/kg

Impedance Measurement Plot for Body TSL

15 May 2018 11:18:17

CH1 S11 1 U FS 1: 43.322 Ω -6.0117 Ω 15.128 pF 1 750.000 000 MHz

*
De1
CA
Avg
16
H1d

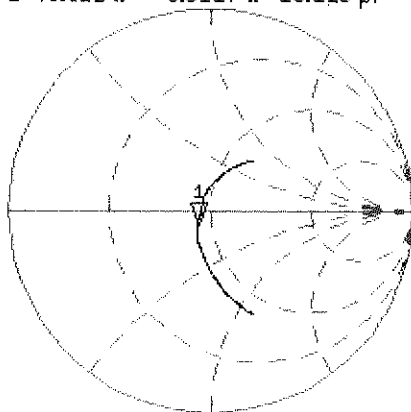

CH2 S11 LOG 5 dB/REF -20 dB 1:-20.349 dB 1 750.000 000 MHz

CA
Avg
16
H1d

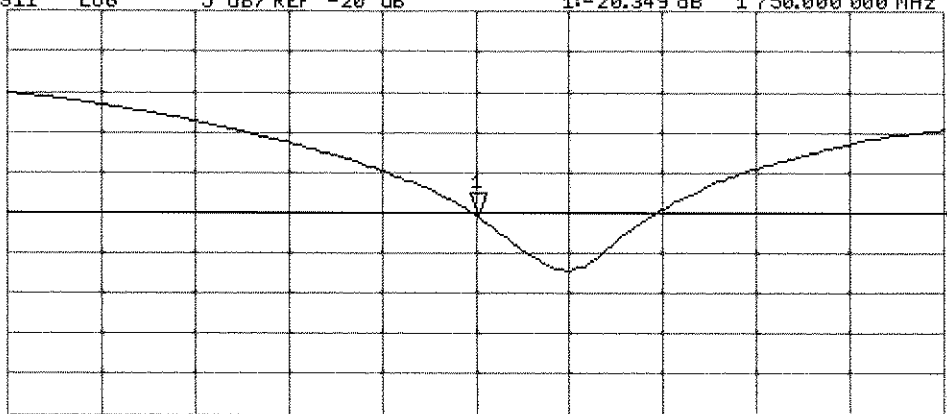

START 1 550.000 000 MHz

STOP 1 950.000 000 MHz

DASY5 Validation Report for SAM Head

Date: 23.05.2018

Test Laboratory: SPEAG, Zurich, Switzerland

DUT: Dipole 1765 MHz; Type: D1765V2; Serial: D1765V2 - SN:1008

Communication System: UID 0 - CW; Frequency: 1750 MHz

Medium parameters used: $f = 1750$ MHz; $\sigma = 1.37$ S/m; $\epsilon_r = 41.8$; $\rho = 1000$ kg/m³

Measurement Standard: DASY5 (IEEE/IEC/ANSI C63.19-2011)

DASY52 Configuration:

- Probe: EX3DV4 - SN7349; ConvF(8.5, 8.5, 8.5) @ 1750 MHz; Calibrated: 30.12.2017
- Sensor-Surface: 1.4mm (Mechanical Surface Detection)
- Electronics: DAE4 Sn601; Calibrated: 26.10.2017
- Phantom: SAM Head
- DASY52 52.10.1(1476); SEMCAD X 14.6.11(7439)

SAM/Head/Top/Zoom Scan (7x7x7)/Cube 0: Measurement grid: dx=5mm, dy=5mm, dz=5mm

Reference Value = 105.8 V/m; Power Drift = 0.02 dB

Peak SAR (extrapolated) = 16.4 W/kg

SAR(1 g) = 9.26 W/kg; SAR(10 g) = 4.95 W/kg

Maximum value of SAR (measured) = 13.9 W/kg

SAM/Head/Mouth/Zoom Scan (7x7x7)/Cube 0: Measurement grid: dx=5mm, dy=5mm, dz=5mm

Reference Value = 104.2 V/m; Power Drift = -0.04 dB

Peak SAR (extrapolated) = 16.6 W/kg

SAR(1 g) = 9.47 W/kg; SAR(10 g) = 5.06 W/kg

Maximum value of SAR (measured) = 13.7 W/kg

SAM/Head/Neck/Zoom Scan (7x7x7)/Cube 0: Measurement grid: dx=5mm, dy=5mm, dz=5mm

Reference Value = 104.7 V/m; Power Drift = 0.02 dB

Peak SAR (extrapolated) = 15.8 W/kg

SAR(1 g) = 9.26 W/kg; SAR(10 g) = 5.02 W/kg

Maximum value of SAR (measured) = 13.8 W/kg

SAM/Head/Ear/Zoom Scan (7x7x7)/Cube 0: Measurement grid: dx=5mm, dy=5mm, dz=5mm

Reference Value = 90.46 V/m; Power Drift = -0.02 dB

Peak SAR (extrapolated) = 11.8 W/kg

SAR(1 g) = 7.12 W/kg; SAR(10 g) = 4.01 W/kg

Maximum value of SAR (measured) = 10.3 W/kg

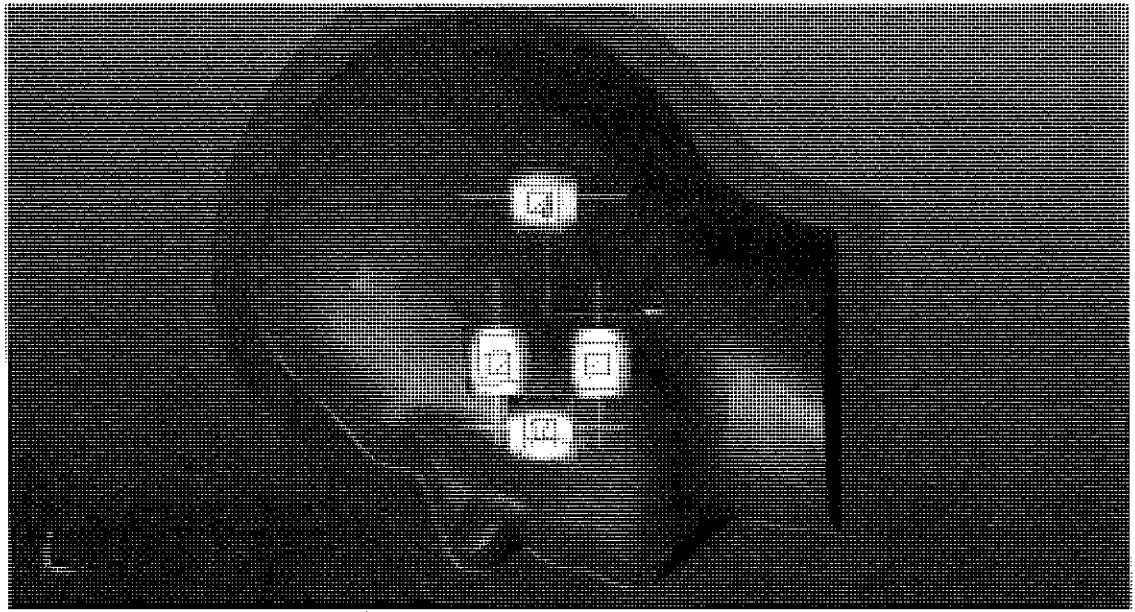
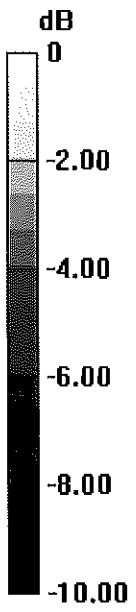

0 dB = 10.3 W/kg = 10.13 dBW/kg



Accredited by the Swiss Accreditation Service (SAS)
The Swiss Accreditation Service is one of the signatories to the EA
Multilateral Agreement for the recognition of calibration certificates

Accreditation No.: **SCS 0108**

Client **PC Test**

Certificate No: **D750V3-1003_Jan18**

CALIBRATION CERTIFICATE

Object **D750V3 - SN:1003**

Calibration procedure(s) **QA CAL-05.v9
Calibration procedure for dipole validation kits above 700 MHz**

Calibration date: **January 15, 2018**

BN ✓
01-25-2018
BN ✓
02/06/2019

This calibration certificate documents the traceability to national standards, which realize the physical units of measurements (SI).
The measurements and the uncertainties with confidence probability are given on the following pages and are part of the certificate.

All calibrations have been conducted in the closed laboratory facility; environment temperature (22 ± 3)°C and humidity < 70%.

Calibration Equipment used (M&TE critical for calibration)

Primary Standards	ID #	Cal Date (Certificate No.)	Scheduled Calibration
Power meter NRP	SN: 104778	04-Apr-17 (No. 217-02521/02522)	Apr-18
Power sensor NRP-Z91	SN: 103244	04-Apr-17 (No. 217-02521)	Apr-18
Power sensor NRP-Z91	SN: 103245	04-Apr-17 (No. 217-02522)	Apr-18
Reference 20 dB Attenuator	SN: 5058 (20k)	07-Apr-17 (No. 217-02528)	Apr-18
Type-N mismatch combination	SN: 5047.2 / 06327	07-Apr-17 (No. 217-02529)	Apr-18
Reference Probe EX3DV4	SN: 7349	30-Dec-17 (No. EX3-7349_Dec17)	Dec-18
DAE4	SN: 601	26-Oct-17 (No. DAE4-601_Oct17)	Oct-18

Secondary Standards	ID #	Check Date (in house)	Scheduled Check
Power meter EPM-442A	SN: GB37480704	07-Oct-15 (in house check Oct-16)	In house check: Oct-18
Power sensor HP 8481A	SN: US37292783	07-Oct-15 (in house check Oct-16)	In house check: Oct-18
Power sensor HP 8481A	SN: MY41092317	07-Oct-15 (in house check Oct-16)	In house check: Oct-18
RF generator R&S SMT-06	SN: 100972	15-Jun-15 (in house check Oct-16)	In house check: Oct-18
Network Analyzer HP 8753E	SN: US37390585	18-Oct-01 (in house check Oct-17)	In house check: Oct-18

Calibrated by:	Name Lefi Klysner	Function Laboratory Technician	Signature <i>Lefi Klysner</i>
Approved by:	Name Katja Pokovic	Technical Manager	<i>Katja Pokovic</i>

Issued: January 15, 2018

This calibration certificate shall not be reproduced except in full without written approval of the laboratory.



Accredited by the Swiss Accreditation Service (SAS)

Accreditation No.: **SCS 0108**

The Swiss Accreditation Service is one of the signatories to the EA
Multilateral Agreement for the recognition of calibration certificates

Glossary:

TSL	tissue simulating liquid
ConvF	sensitivity in TSL / NORM x,y,z
N/A	not applicable or not measured

Calibration is Performed According to the Following Standards:

- IEEE Std 1528-2013, "IEEE Recommended Practice for Determining the Peak Spatial-Averaged Specific Absorption Rate (SAR) in the Human Head from Wireless Communications Devices: Measurement Techniques", June 2013
- IEC 62209-1, "Measurement procedure for the assessment of Specific Absorption Rate (SAR) from hand-held and body-mounted devices used next to the ear (frequency range of 300 MHz to 6 GHz)", July 2016
- IEC 62209-2, "Procedure to determine the Specific Absorption Rate (SAR) for wireless communication devices used in close proximity to the human body (frequency range of 30 MHz to 6 GHz)", March 2010
- KDB 865664, "SAR Measurement Requirements for 100 MHz to 6 GHz"

Additional Documentation:

- DASY4/5 System Handbook

Methods Applied and Interpretation of Parameters:

- Measurement Conditions:** Further details are available from the Validation Report at the end of the certificate. All figures stated in the certificate are valid at the frequency indicated.
- Antenna Parameters with TSL:** The dipole is mounted with the spacer to position its feed point exactly below the center marking of the flat phantom section, with the arms oriented parallel to the body axis.
- Feed Point Impedance and Return Loss:** These parameters are measured with the dipole positioned under the liquid filled phantom. The impedance stated is transformed from the measurement at the SMA connector to the feed point. The Return Loss ensures low reflected power. No uncertainty required.
- Electrical Delay:** One-way delay between the SMA connector and the antenna feed point. No uncertainty required.
- SAR measured:** SAR measured at the stated antenna input power.
- SAR normalized:** SAR as measured, normalized to an input power of 1 W at the antenna connector.
- SAR for nominal TSL parameters:** The measured TSL parameters are used to calculate the nominal SAR result.

The reported uncertainty of measurement is stated as the standard uncertainty of measurement multiplied by the coverage factor $k=2$, which for a normal distribution corresponds to a coverage probability of approximately 95%.

Measurement Conditions

DASY system configuration, as far as not given on page 1.

DASY Version	DASY5	V52.10.0
Extrapolation	Advanced Extrapolation	
Phantom	Modular Flat Phantom	
Distance Dipole Center - TSL	15 mm	with Spacer
Zoom Scan Resolution	dx, dy, dz = 5.0 mm	
Frequency	750 MHz ± 1 MHz	

Head TSL parameters

The following parameters and calculations were applied.

	Temperature	Permittivity	Conductivity
Nominal Head TSL parameters	22.0 °C	41.9	0.89 mho/m
Measured Head TSL parameters	(22.0 ± 0.2) °C	40.9 ± 6 %	0.90 mho/m ± 6 %
Head TSL temperature change during test	< 0.5 °C	----	----

SAR result with Head TSL

SAR averaged over 1 cm³ (1 g) of Head TSL	Condition	
SAR measured	250 mW input power	2.10 W/kg
SAR for nominal Head TSL parameters	normalized to 1W	8.28 W/kg ± 17.0 % (k=2)

SAR averaged over 10 cm³ (10 g) of Head TSL	condition	
SAR measured	250 mW input power	1.37 W/kg
SAR for nominal Head TSL parameters	normalized to 1W	5.42 W/kg ± 16.5 % (k=2)

Body TSL parameters

The following parameters and calculations were applied.

	Temperature	Permittivity	Conductivity
Nominal Body TSL parameters	22.0 °C	55.5	0.96 mho/m
Measured Body TSL parameters	(22.0 ± 0.2) °C	55.0 ± 6 %	0.96 mho/m ± 6 %
Body TSL temperature change during test	< 0.5 °C	----	----

SAR result with Body TSL

SAR averaged over 1 cm³ (1 g) of Body TSL	Condition	
SAR measured	250 mW input power	2.15 W/kg
SAR for nominal Body TSL parameters	normalized to 1W	8.58 W/kg ± 17.0 % (k=2)

SAR averaged over 10 cm³ (10 g) of Body TSL	condition	
SAR measured	250 mW input power	1.43 W/kg
SAR for nominal Body TSL parameters	normalized to 1W	5.71 W/kg ± 16.5 % (k=2)

Appendix (Additional assessments outside the scope of SCS 0108)

Antenna Parameters with Head TSL

Impedance, transformed to feed point	53.8 Ω - 2.1 j Ω
Return Loss	- 27.6 dB

Antenna Parameters with Body TSL

Impedance, transformed to feed point	49.2 Ω - 6.2 j Ω
Return Loss	- 24.0 dB

General Antenna Parameters and Design

Electrical Delay (one direction)	1.043 ns
----------------------------------	----------

After long term use with 100W radiated power, only a slight warming of the dipole near the feedpoint can be measured.

The dipole is made of standard semirigid coaxial cable. The center conductor of the feeding line is directly connected to the second arm of the dipole. The antenna is therefore short-circuited for DC-signals. On some of the dipoles, small end caps are added to the dipole arms in order to improve matching when loaded according to the position as explained in the "Measurement Conditions" paragraph. The SAR data are not affected by this change. The overall dipole length is still according to the Standard.

No excessive force must be applied to the dipole arms, because they might bend or the soldered connections near the feedpoint may be damaged.

Additional EUT Data

Manufactured by	SPEAG
Manufactured on	January 21, 2009

Appendix (Additional assessments outside the scope of SCS 0108)

Measurement Conditions

DASY system configuration, as far as not given on page 1 and 3.

Phantom	SAM Head Phantom	For usage with cSAR3DV2-R/L
---------	------------------	-----------------------------

SAR result with SAM Head (Top)

SAR averaged over 1 cm ³ (1 g) of Head TSL	Condition	
SAR measured	250 mW input power	1.98 W/kg
SAR for nominal Head TSL parameters	normalized to 1W	7.94 W/kg ± 17.5 % (k=2)

SAR averaged over 10 cm ³ (10 g) of Head TSL	condition	
SAR measured	250 mW input power	1.33 W/kg
SAR for nominal Head TSL parameters	normalized to 1W	5.32 W/kg ± 16.9 % (k=2)

SAR result with SAM Head (Mouth)

SAR averaged over 1 cm ³ (1 g) of Head TSL	Condition	
SAR measured	250 mW input power	2.05 W/kg
SAR for nominal Head TSL parameters	normalized to 1W	8.22 W/kg ± 17.5 % (k=2)

SAR averaged over 10 cm ³ (10 g) of Head TSL	condition	
SAR measured	250 mW input power	1.38 W/kg
SAR for nominal Head TSL parameters	normalized to 1W	5.52 W/kg ± 16.9 % (k=2)

SAR result with SAM Head (Neck)

SAR averaged over 1 cm ³ (1 g) of Head TSL	Condition	
SAR measured	250 mW input power	2.01 W/kg
SAR for nominal Head TSL parameters	normalized to 1W	8.06 W/kg ± 17.5 % (k=2)

SAR averaged over 10 cm ³ (10 g) of Head TSL	condition	
SAR measured	250 mW input power	1.38 W/kg
SAR for nominal Head TSL parameters	normalized to 1W	5.52 W/kg ± 16.9 % (k=2)

SAR result with SAM Head (Ear)

SAR averaged over 1 cm ³ (1 g) of Head TSL	Condition	
SAR measured	250 mW input power	1.67 W/kg
SAR for nominal Head TSL parameters	normalized to 1W	6.70 W/kg ± 17.5 % (k=2)

SAR averaged over 10 cm ³ (10 g) of Head TSL	condition	
SAR measured	250 mW input power	1.15 W/kg
SAR for nominal Head TSL parameters	normalized to 1W	4.60 W/kg ± 16.9 % (k=2)

DASY5 Validation Report for Head TSL

Date: 12.01.2018

Test Laboratory: SPEAG, Zurich, Switzerland

DUT: Dipole 750 MHz; Type: D750V3; Serial: D750V3 - SN:1003

Communication System: UID 0 - CW; Frequency: 750 MHz

Medium parameters used: $f = 750$ MHz; $\sigma = 0.9$ S/m; $\epsilon_r = 40.9$; $\rho = 1000$ kg/m³

Phantom section: Flat Section

Measurement Standard: DASY5 (IEEE/IEC/ANSI C63.19-2011)

DASY52 Configuration:

- Probe: EX3DV4 - SN7349; ConvF(10.22, 10.22, 10.22); Calibrated: 30.12.2017;
- Sensor-Surface: 1.4mm (Mechanical Surface Detection)
- Electronics: DAE4 Sn601; Calibrated: 26.10.2017
- Phantom: Flat Phantom 4.9 (front); Type: QD 00L P49 AA; Serial: 1001
- DASY52 52.10.0(1446); SEMCAD X 14.6.10(7417)

Dipole Calibration for Head Tissue/Pin=250 mW, d=15mm/Zoom Scan (7x7x7)/Cube 0:

Measurement grid: dx=5mm, dy=5mm, dz=5mm

Reference Value = 59.11 V/m; Power Drift = -0.04 dB

Peak SAR (extrapolated) = 3.15 W/kg

SAR(1 g) = 2.1 W/kg; SAR(10 g) = 1.37 W/kg

Maximum value of SAR (measured) = 2.80 W/kg

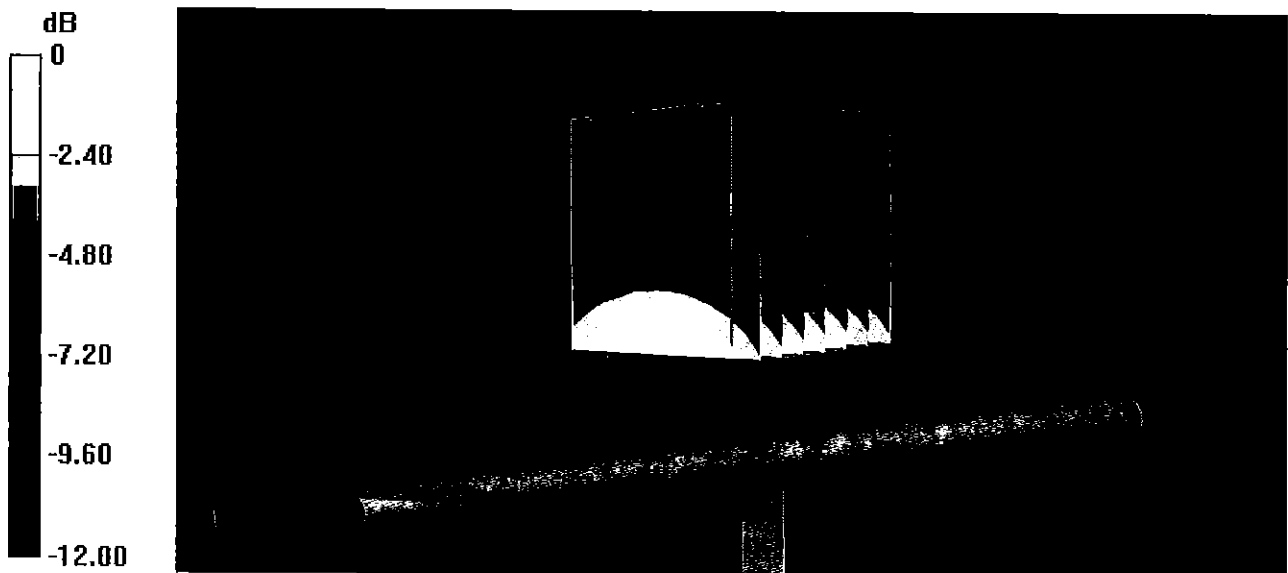

0 dB = 2.80 W/kg = 4.47 dBW/kg

Impedance Measurement Plot for Head TSL

12 Jan 2018 13:14:07
CH1 S11 1 U FS 1: 53.754 Ω -2.0996 Ω 101.07 pF 750.000 000 MHz

*
Del
CA

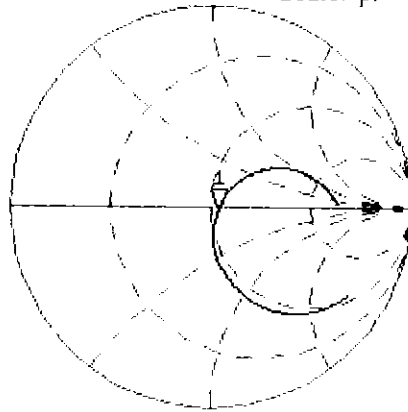

Avg
16

H1d

CH2 S11 LOG 5 dB/REF -20 dB 1: -27.643 dB 750.000 000 MHz

CA

Avg
16

H1d

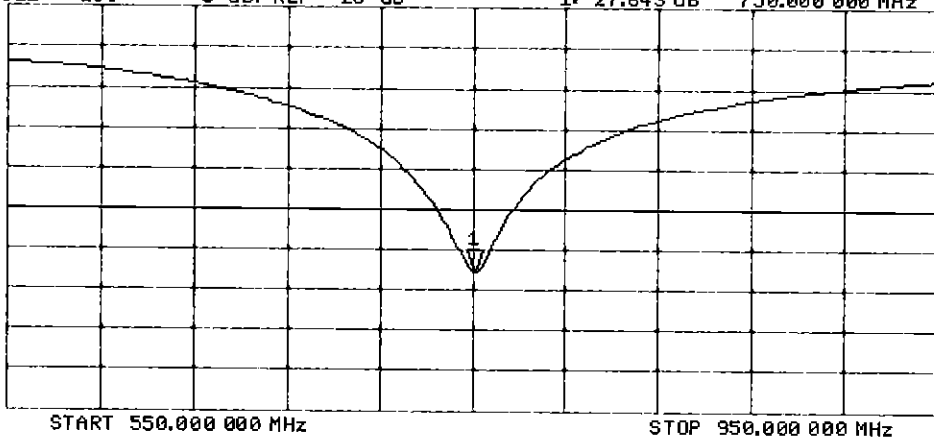

DASY5 Validation Report for Body TSL

Date: 12.01.2018

Test Laboratory: SPEAG, Zurich, Switzerland

DUT: Dipole 750 MHz; Type: D750V3; Serial: D750V3 - SN:1003

Communication System: UID 0 - CW; Frequency: 750 MHz

Medium parameters used: $f = 750$ MHz; $\sigma = 0.96$ S/m; $\epsilon_r = 55$; $\rho = 1000$ kg/m³

Phantom section: Flat Section

Measurement Standard: DASY5 (IEEE/IEC/ANSI C63.19-2011)

DASY52 Configuration:

- Probe: EX3DV4 - SN7349; ConvF(10.19, 10.19, 10.19); Calibrated: 30.12.2017;
- Sensor-Surface: 1.4mm (Mechanical Surface Detection)
- Electronics: DAE4 Sn601; Calibrated: 26.10.2017
- Phantom: Flat Phantom 4.9 (Back); Type: QD 00R P49 AA; Serial: 1005
- DASY52 52.10.0(1446); SEMCAD X 14.6.10(7417)

Dipole Calibration for Body Tissue/Pin=250 mW, d=15mm/Zoom Scan (7x8x7)/Cube 0:

Measurement grid: dx=5mm, dy=5mm, dz=5mm

Reference Value = 57.31 V/m; Power Drift = -0.01 dB

Peak SAR (extrapolated) = 3.17 W/kg

SAR(1 g) = 2.15 W/kg; SAR(10 g) = 1.43 W/kg

Maximum value of SAR (measured) = 2.83 W/kg

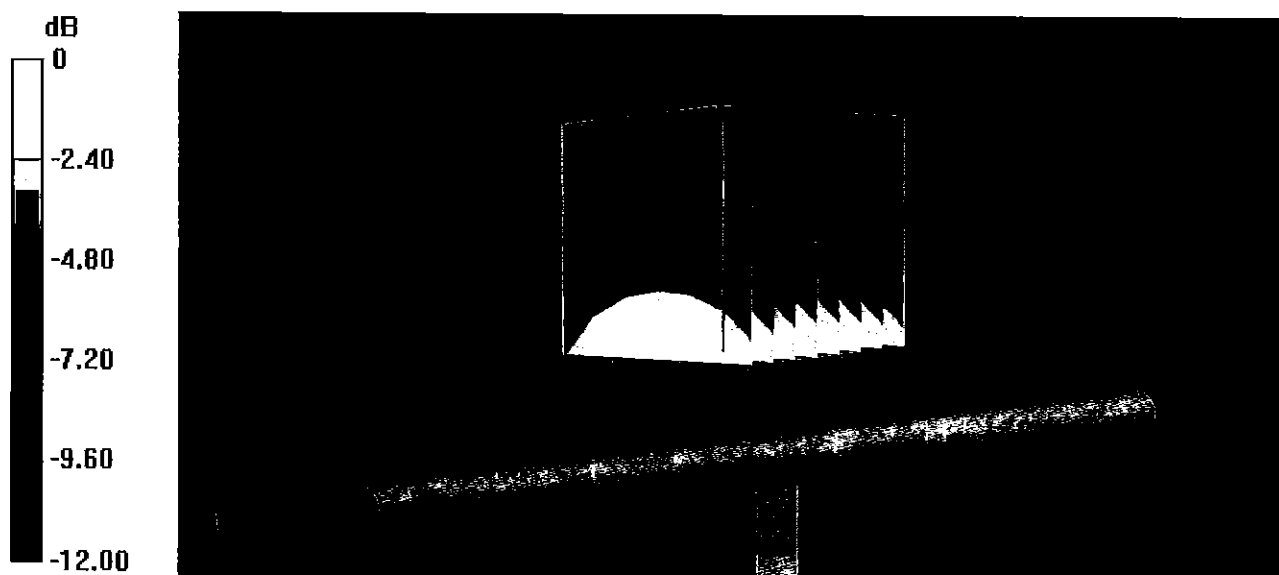

Impedance Measurement Plot for Body TSL

12 Jan 2018 13:13:21
CH1 S11 1 U FS 1: 49.234 Ω -6.1934 Ω 34.264 pF 750.000 000 MHz

*
 De1

CA

Avg
 16

H1d

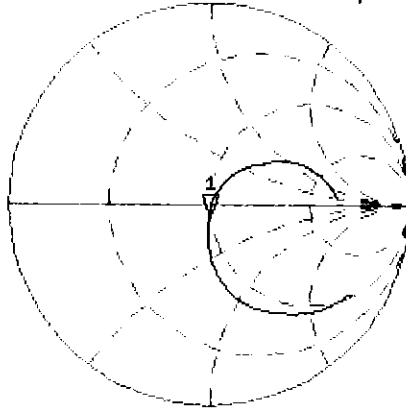

CH2 S11 LOG 5 dB/REF -20 dB 1:-24.047 dB 750.000 000 MHz

CA

Avg
 16

H1d

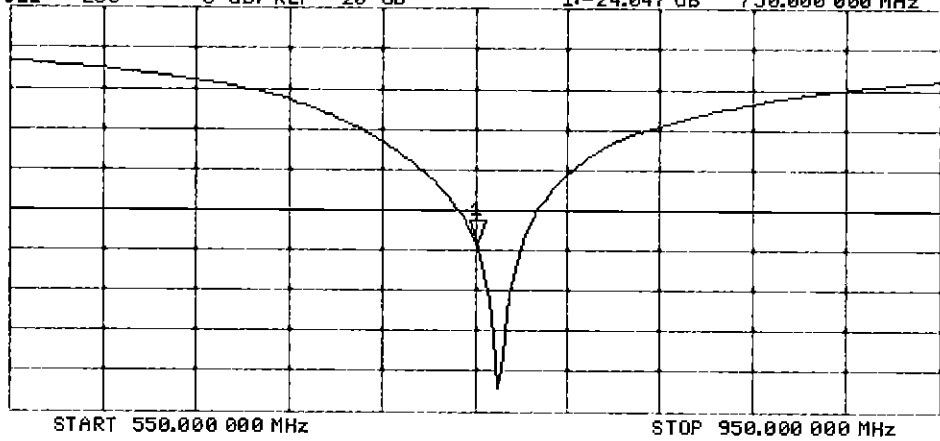

DASY5 Validation Report for SAM Head

Date: 15.01.2018

Test Laboratory: SPEAG, Zurich, Switzerland

DUT: Dipole 750 MHz; Type: D750V3; Serial: D750V3 - SN:1003

Communication System: UID 0 - CW; Frequency: 750 MHz

Medium parameters used: $f = 750$ MHz; $\sigma = 0.9$ S/m; $\epsilon_r = 44.2$; $\rho = 1000$ kg/m³

Measurement Standard: DASY5 (IEEE/IEC/ANSI C63.19-2011)

DASY52 Configuration:

- Probe: EX3DV4 - SN7349; ConvF(10.22, 10.22, 10.22); Calibrated: 30.12.2017;
- Sensor-Surface: 1.4mm (Mechanical Surface Detection)
- Electronics: DAE4 Sn601; Calibrated: 26.10.2017
- Phantom: SAM Head
- DASY52 52.10.0(1446); SEMCAD X 14.6.10(7417)

SAM Head/Top/Zoom Scan (7x7x7)/Cube 0: Measurement grid: dx=5mm, dy=5mm, dz=5mm

Reference Value = 56.79 V/m; Power Drift = -0.01 dB

Peak SAR (extrapolated) = 2.89 W/kg

SAR(1 g) = 1.98 W/kg; SAR(10 g) = 1.33 W/kg

Maximum value of SAR (measured) = 2.58 W/kg

SAM Head/Mouth/Zoom Scan (7x7x7)/Cube 0: Measurement grid: dx=5mm, dy=5mm, dz=5mm

Reference Value = 56.85 V/m; Power Drift = -0.06 dB

Peak SAR (extrapolated) = 2.94 W/kg

SAR(1 g) = 2.05 W/kg; SAR(10 g) = 1.38 W/kg

Maximum value of SAR (measured) = 2.62 W/kg

SAM Head/Neck/Zoom Scan (7x7x7)/Cube 0: Measurement grid: dx=5mm, dy=5mm, dz=5mm

Reference Value = 56.29 V/m; Power Drift = 0.04 dB

Peak SAR (extrapolated) = 2.78 W/kg

SAR(1 g) = 2.01 W/kg; SAR(10 g) = 1.38 W/kg

Maximum value of SAR (measured) = 2.56 W/kg

SAM Head/Ear/Zoom Scan (7x7x7)/Cube 0: Measurement grid: dx=5mm, dy=5mm, dz=5mm

Reference Value = 51.01 V/m; Power Drift = 0.02 dB

Peak SAR (extrapolated) = 2.31 W/kg

SAR(1 g) = 1.67 W/kg; SAR(10 g) = 1.15 W/kg

Maximum value of SAR (measured) = 2.11 W/kg

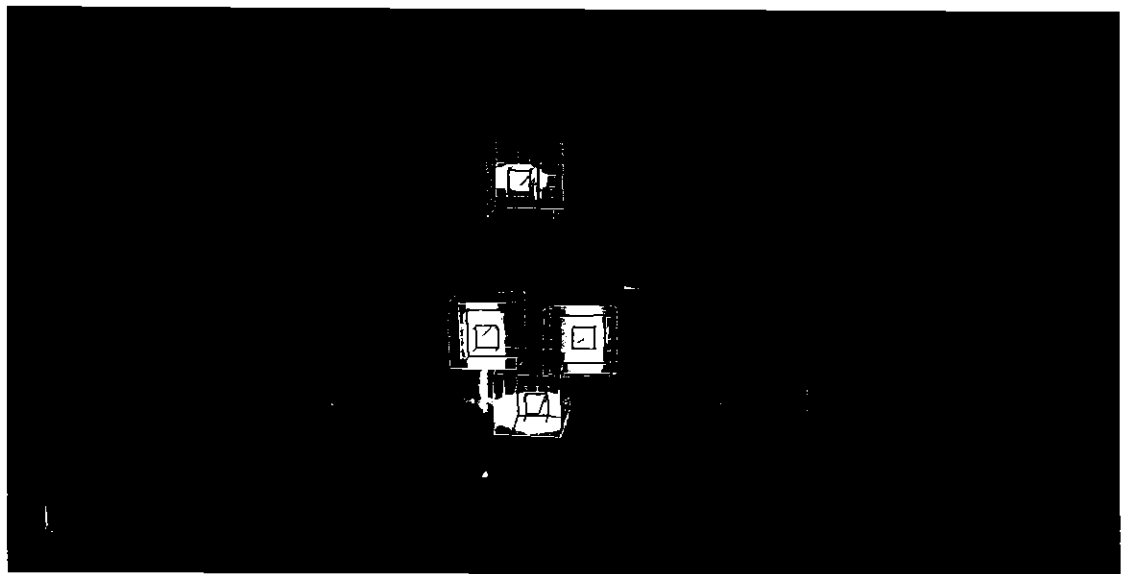
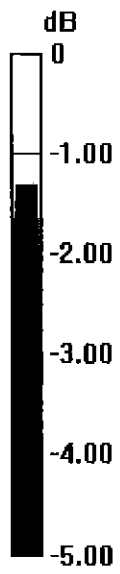

0 dB = 2.58 W/kg = 4.12 dBW/kg

Certification of Calibration

Object: D750V3 – SN: 1003

Calibration procedure(s): Procedure for Calibration Extension for SAR Dipoles.

Extension Calibration date: 1/15/2019

Description: SAR Validation Dipole at 750 MHz.

Calibration Equipment used:

Manufacturer	Model	Description	Cal Date	Cal Interval	Cal Due	Serial Number
Agilent	8753ES	S-Parameter Network Analyzer	2/8/2018	Annual	2/8/2019	US39170122
Agilent	N5182A	MXG Vector Signal Generator	4/18/2018	Annual	4/18/2019	MY47420800
Amplifier Research	15S1G6	Amplifier	CBT	N/A	CBT	433971
Anritsu	MA2411B	Pulse Power Sensor	3/2/2018	Annual	3/2/2019	1207364
Anritsu	MA2411B	Pulse Power Sensor	3/2/2018	Annual	3/2/2019	1339018
Anritsu	ML2495A	Power Meter	10/21/2018	Annual	10/21/2019	941001
Control Company	4040	Therm./Clock/Humidity Monitor	3/31/2017	Biennial	3/31/2019	170232394
Control Company	4352	Ultra Long Stem Thermometer	5/2/2017	Biennial	5/2/2019	170330156
Keysight	772D	Dual Directional Coupler	CBT	N/A	CBT	MY52180215
Keysight Technologies	85033E	Standard Mechanical Calibration Kit (DC to 9GHz, 3.5mm)	6/4/2018	Annual	6/4/2019	MY53401181
MiniCircuits	VLF-6000+	Low Pass Filter	CBT	N/A	CBT	N/A
Mini-Circuits	BW-N20W5+	DC to 18 GHz Precision Fixed 20 dB Attenuator	CBT	N/A	CBT	N/A
Narda	4772-3	Attenuator (3dB)	CBT	N/A	CBT	9406
Pasternack	PE2208-6	Bidirectional Coupler	CBT	N/A	CBT	N/A
Seekonk	NC-100	Torque Wrench	7/11/2018	Annual	7/11/2019	N/A
SPEAG	DAE4	Dasy Data Acquisition Electronics	10/3/2018	Annual	10/3/2019	1558
SPEAG	DAE4	Dasy Data Acquisition Electronics	6/18/2018	Annual	6/18/2019	1334
SPEAG	DAK-3.5	Dielectric Assessment Kit	9/11/2018	Annual	9/11/2019	1091
SPEAG	EX3DV4	SAR Probe	8/23/2018	Annual	8/23/2019	7308
SPEAG	EX3DV4	SAR Probe	6/25/2018	Annual	6/25/2019	7409

Measurement Uncertainty = $\pm 23\%$ (k=2)

	Name	Function	Signature
Calibrated By:	Brodie Halfoster	Test Engineer	<i>BRODIE HALFOSTER</i>
Approved By:	Kaitlin O'Keefe	Senior Technical Manager	<i>KOK</i>

DIPOLE CALIBRATION EXTENSION

Per KDB 865664 D01, calibration intervals of up to three years may be considered for reference dipoles when it is demonstrated that the SAR target, impedance and return loss of a dipole have remained stable according to the following requirements:

1. The measured SAR does not deviate more than 10% from the target on the calibration certificate.
2. The return-loss does not deviate more than 20% from the previous measurement and meets the required 20dB minimum return-loss requirement.
3. The measurement of real or imaginary parts of impedance does not deviate more than 5Ω from the previous measurement.

The following dipole was checked to pass the above 3 requirements to have 2-year calibration period from the calibration date:

Calibration Date	Extension Date	Certificate Electrical Delay (ns)	Certificate SAR Target Head (1g) W/kg @ 23.0 dBm	Measured Head SAR (1g) W/kg @ 23.0 dBm	Deviation 1g (%)	Certificate SAR Target Head (10g) W/kg @ 23.0 dBm	Measured Head SAR (10g) W/kg @ 23.0 dBm	Deviation 10g (%)	Certificate Impedance Head (Ohm) Real	Measured Impedance Head (Ohm) Real	Difference (Ohm) Real	Certificate Impedance Head (Ohm) Imaginary	Measured Impedance Head (Ohm) Imaginary	Difference (Ohm) Imaginary	Certificate Return Loss Head (dB)	Measured Return Loss Head (dB)	Deviation (%)	PASS/FAIL
1/15/2018	1/15/2019	1.043	1.656	1.75	5.86%	1.08	1.15	6.09%	53.8	54.8	1	-2.1	-2.2	0.1	-27.6	-25.8	6.50%	PASS
Calibration Date	Extension Date	Certificate Electrical Delay (ns)	Certificate SAR Target Body (1g) W/kg @ 23.0 dBm	Measured Body SAR (1g) W/kg @ 23.0 dBm	Deviation 1g (%)	Certificate SAR Target Body (10g) W/kg @ 23.0 dBm	Measured Body SAR (10g) W/kg @ 23.0 dBm	Deviation 10g (%)	Certificate Impedance Body (Ohm) Real	Measured Impedance Body (Ohm) Real	Difference (Ohm) Real	Certificate Impedance Body (Ohm) Imaginary	Measured Impedance Body (Ohm) Imaginary	Difference (Ohm) Imaginary	Certificate Return Loss Body (dB)	Measured Return Loss Body (dB)	Deviation (%)	PASS/FAIL
1/15/2018	1/15/2019	1.043	1.716	1.84	7.23%	1.14	1.23	7.71%	49.2	49	0.2	-6.2	-5.1	1.1	-24	-25.6	-6.80%	PASS

Impedance & Return-Loss Measurement Plot for Head TSL

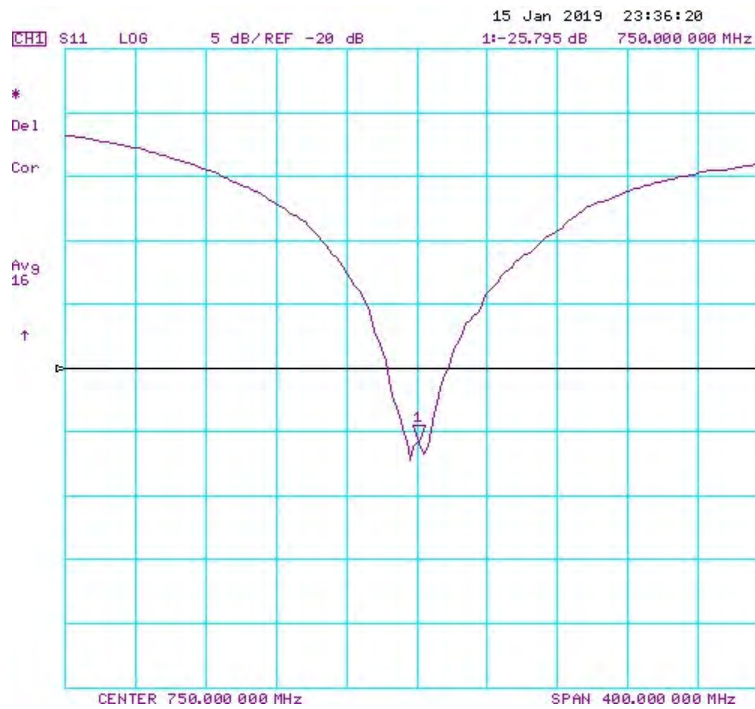
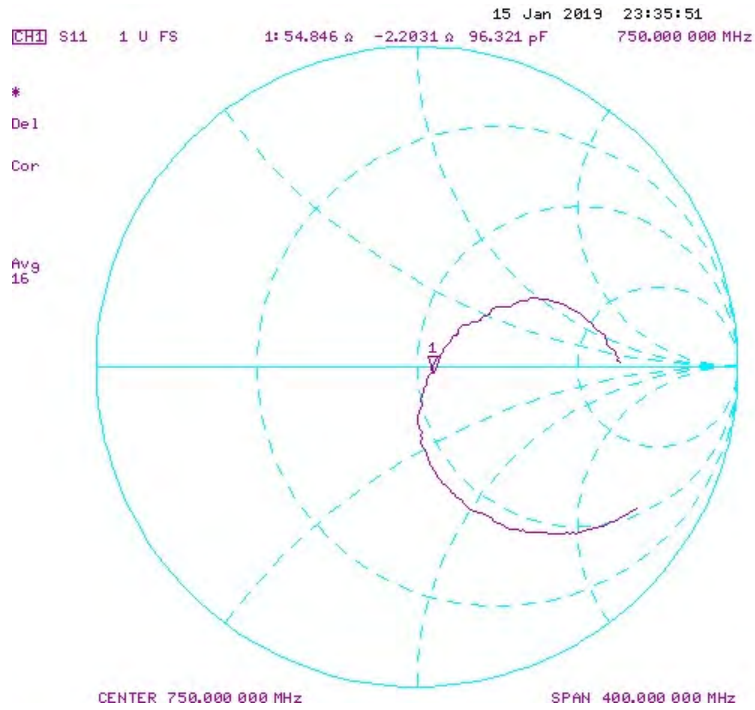

Impedance & Return-Loss Measurement Plot for Body TSL

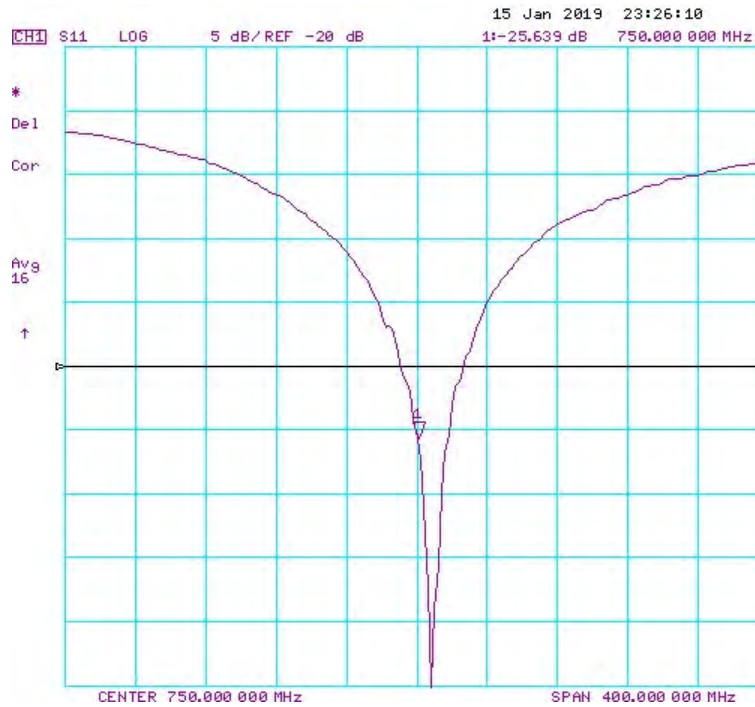
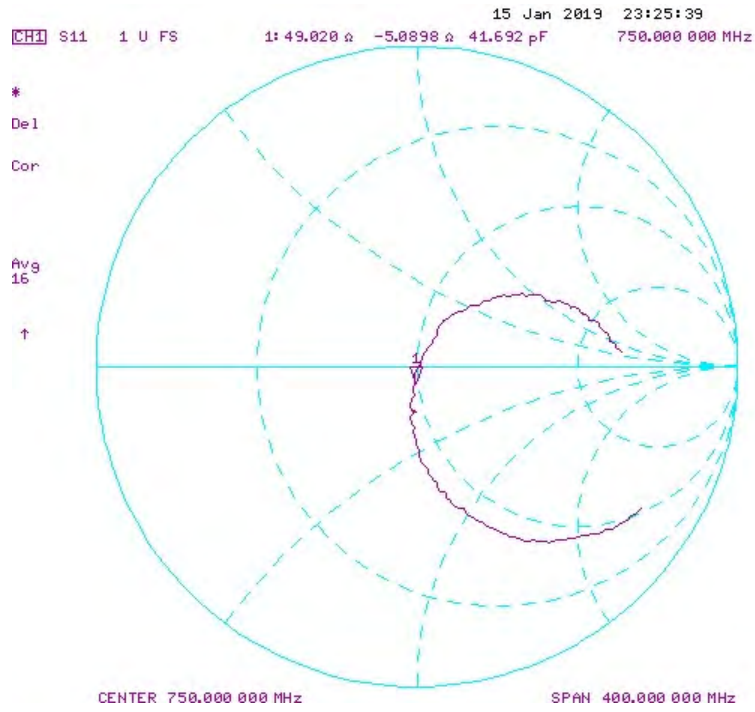



Accredited by the Swiss Accreditation Service (SAS)
The Swiss Accreditation Service is one of the signatories to the EA
Multilateral Agreement for the recognition of calibration certificates

Accreditation No.: **SCS 0108**

Client **PC Test**

Certificate No: **D750V3-1161_Oct18**

CALIBRATION CERTIFICATE

Object **D750V3 - SN:1161**

Calibration procedure(s) **QA CAL-05.v10
Calibration procedure for dipole validation kits above 700 MHz**

Calibration date: **October 19, 2018**

*BN ✓
10-30-2018*

This calibration certificate documents the traceability to national standards, which realize the physical units of measurements (SI).
The measurements and the uncertainties with confidence probability are given on the following pages and are part of the certificate.

All calibrations have been conducted in the closed laboratory facility: environment temperature (22 ± 3)°C and humidity < 70%.

Calibration Equipment used (M&TE critical for calibration)

Primary Standards	ID #	Cal Date (Certificate No.)	Scheduled Calibration
Power meter NRP	SN: 104778	04-Apr-18 (No. 217-02672/02673)	Apr-19
Power sensor NRP-Z91	SN: 103244	04-Apr-18 (No. 217-02672)	Apr-19
Power sensor NRP-Z91	SN: 103245	04-Apr-18 (No. 217-02673)	Apr-19
Reference 20 dB Attenuator	SN: 5058 (20k)	04-Apr-18 (No. 217-02682)	Apr-19
Type-N mismatch combination	SN: 5047.2 / 06327	04-Apr-18 (No. 217-02683)	Apr-19
Reference Probe EX3DV4	SN: 7349	30-Dec-17 (No. EX3-7349_Dec17)	Dec-18
DAE4	SN: 601	04-Oct-18 (No. DAE4-601_Oct18)	Oct-19

Secondary Standards	ID #	Check Date (in house)	Scheduled Check
Power meter EPM-442A	SN: GB37480704	07-Oct-15 (in house check Oct-18)	In house check: Oct-20
Power sensor HP 8481A	SN: US37292783	07-Oct-15 (in house check Oct-18)	In house check: Oct-20
Power sensor HP 8481A	SN: MY41092317	07-Oct-15 (in house check Oct-18)	In house check: Oct-20
RF generator R&S SMT-06	SN: 100972	15-Jun-15 (in house check Oct-18)	In house check: Oct-20
Network Analyzer Agilent E8358A	SN: US41080477	31-Mar-14 (in house check Oct-18)	In house check: Oct-19

Calibrated by: **Manu Seitz** Name: **Manu Seitz** Function: **Laboratory Technician**

Approved by: **Katja Pokovic** Name: **Katja Pokovic** Function: **Technical Manager**

Issued: October 22, 2018

This calibration certificate shall not be reproduced except in full without written approval of the laboratory.



Accredited by the Swiss Accreditation Service (SAS)
The Swiss Accreditation Service is one of the signatories to the EA
Multilateral Agreement for the recognition of calibration certificates

Accreditation No.: **SCS 0108**

Glossary:

TSL	tissue simulating liquid
ConvF	sensitivity in TSL / NORM x,y,z
N/A	not applicable or not measured

Calibration is Performed According to the Following Standards:

- IEEE Std 1528-2013, "IEEE Recommended Practice for Determining the Peak Spatial-Averaged Specific Absorption Rate (SAR) in the Human Head from Wireless Communications Devices: Measurement Techniques", June 2013
- IEC 62209-1, "Measurement procedure for the assessment of Specific Absorption Rate (SAR) from hand-held and body-mounted devices used next to the ear (frequency range of 300 MHz to 6 GHz)", July 2016
- IEC 62209-2, "Procedure to determine the Specific Absorption Rate (SAR) for wireless communication devices used in close proximity to the human body (frequency range of 30 MHz to 6 GHz)", March 2010
- KDB 865664, "SAR Measurement Requirements for 100 MHz to 6 GHz"

Additional Documentation:

- DASY4/5 System Handbook

Methods Applied and Interpretation of Parameters:

- Measurement Conditions:** Further details are available from the Validation Report at the end of the certificate. All figures stated in the certificate are valid at the frequency indicated.
- Antenna Parameters with TSL:** The dipole is mounted with the spacer to position its feed point exactly below the center marking of the flat phantom section, with the arms oriented parallel to the body axis.
- Feed Point Impedance and Return Loss:** These parameters are measured with the dipole positioned under the liquid filled phantom. The impedance stated is transformed from the measurement at the SMA connector to the feed point. The Return Loss ensures low reflected power. No uncertainty required.
- Electrical Delay:** One-way delay between the SMA connector and the antenna feed point. No uncertainty required.
- SAR measured:** SAR measured at the stated antenna input power.
- SAR normalized:** SAR as measured, normalized to an input power of 1 W at the antenna connector.
- SAR for nominal TSL parameters:** The measured TSL parameters are used to calculate the nominal SAR result.

The reported uncertainty of measurement is stated as the standard uncertainty of measurement multiplied by the coverage factor $k=2$, which for a normal distribution corresponds to a coverage probability of approximately 95%.

Measurement Conditions

DASY system configuration, as far as not given on page 1.

DASY Version	DASY5	V52.10.2
Extrapolation	Advanced Extrapolation	
Phantom	Modular Flat Phantom	
Distance Dipole Center - TSL	15 mm	with Spacer
Zoom Scan Resolution	dx, dy, dz = 5 mm	
Frequency	750 MHz \pm 1 MHz	

Head TSL parameters

The following parameters and calculations were applied.

	Temperature	Permittivity	Conductivity
Nominal Head TSL parameters	22.0 °C	41.9	0.89 mho/m
Measured Head TSL parameters	(22.0 \pm 0.2) °C	40.8 \pm 6 %	0.89 mho/m \pm 6 %
Head TSL temperature change during test	< 0.5 °C	----	----

SAR result with Head TSL

SAR averaged over 1 cm³ (1 g) of Head TSL	Condition	
SAR measured	250 mW input power	2.02 W/kg
SAR for nominal Head TSL parameters	normalized to 1W	8.03 W/kg \pm 17.0 % (k=2)

SAR averaged over 10 cm³ (10 g) of Head TSL	condition	
SAR measured	250 mW input power	1.32 W/kg
SAR for nominal Head TSL parameters	normalized to 1W	5.26 W/kg \pm 16.5 % (k=2)

Body TSL parameters

The following parameters and calculations were applied.

	Temperature	Permittivity	Conductivity
Nominal Body TSL parameters	22.0 °C	55.5	0.96 mho/m
Measured Body TSL parameters	(22.0 \pm 0.2) °C	55.1 \pm 6 %	0.96 mho/m \pm 6 %
Body TSL temperature change during test	< 0.5 °C	----	----

SAR result with Body TSL

SAR averaged over 1 cm³ (1 g) of Body TSL	Condition	
SAR measured	250 mW input power	2.11 W/kg
SAR for nominal Body TSL parameters	normalized to 1W	8.43 W/kg \pm 17.0 % (k=2)

SAR averaged over 10 cm³ (10 g) of Body TSL	condition	
SAR measured	250 mW input power	1.39 W/kg
SAR for nominal Body TSL parameters	normalized to 1W	5.55 W/kg \pm 16.5 % (k=2)

Appendix (Additional assessments outside the scope of SCS 0108)

Antenna Parameters with Head TSL

Impedance, transformed to feed point	55.6 Ω - 1.9 j Ω
Return Loss	- 25.0 dB

Antenna Parameters with Body TSL

Impedance, transformed to feed point	50.6 Ω - 4.2 j Ω
Return Loss	- 27.6 dB

General Antenna Parameters and Design

Electrical Delay (one direction)	1.032 ns
----------------------------------	----------

After long term use with 100W radiated power, only a slight warming of the dipole near the feedpoint can be measured.

The dipole is made of standard semirigid coaxial cable. The center conductor of the feeding line is directly connected to the second arm of the dipole. The antenna is therefore short-circuited for DC-signals. On some of the dipoles, small end caps are added to the dipole arms in order to improve matching when loaded according to the position as explained in the "Measurement Conditions" paragraph. The SAR data are not affected by this change. The overall dipole length is still according to the Standard.

No excessive force must be applied to the dipole arms, because they might bend or the soldered connections near the feedpoint may be damaged.

Additional EUT Data

Manufactured by	SPEAG
Manufactured on	November 19, 2015

DASY5 Validation Report for Head TSL

Date: 19.10.2018

Test Laboratory: SPEAG, Zurich, Switzerland

DUT: Dipole 750 MHz; Type: D750V3; Serial: D750V3 - SN:1161

Communication System: UID 0 - CW; Frequency: 750 MHz

Medium parameters used: $f = 750$ MHz; $\sigma = 0.89$ S/m; $\epsilon_r = 40.8$; $\rho = 1000$ kg/m³

Phantom section: Flat Section

Measurement Standard: DASY5 (IEEE/IEC/ANSI C63.19-2011)

DASY52 Configuration:

- Probe: EX3DV4 - SN7349; ConvF(10.22, 10.22, 10.22) @ 750 MHz; Calibrated: 30.12.2017
- Sensor-Surface: 1.4mm (Mechanical Surface Detection)
- Electronics: DAE4 Sn601; Calibrated: 04.10.2018
- Phantom: Flat Phantom 4.9 (front); Type: QD 00L P49 AA; Serial: 1001
- DASY52 52.10.2(1495); SEMCAD X 14.6.12(7450)

Dipole Calibration for Head Tissue/Pin=250 mW, d=15mm/Zoom Scan (7x7x7)/Cube 0:

Measurement grid: dx=5mm, dy=5mm, dz=5mm

Reference Value = 58.51 V/m; Power Drift = -0.04 dB

Peak SAR (extrapolated) = 3.04 W/kg

SAR(1 g) = 2.02 W/kg; SAR(10 g) = 1.32 W/kg

Maximum value of SAR (measured) = 2.70 W/kg

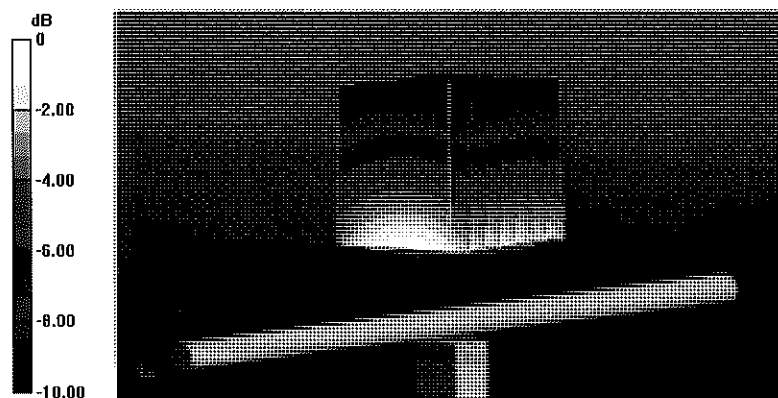

0 dB = 2.70 W/kg = 4.31 dBW/kg

Impedance Measurement Plot for Head TSL

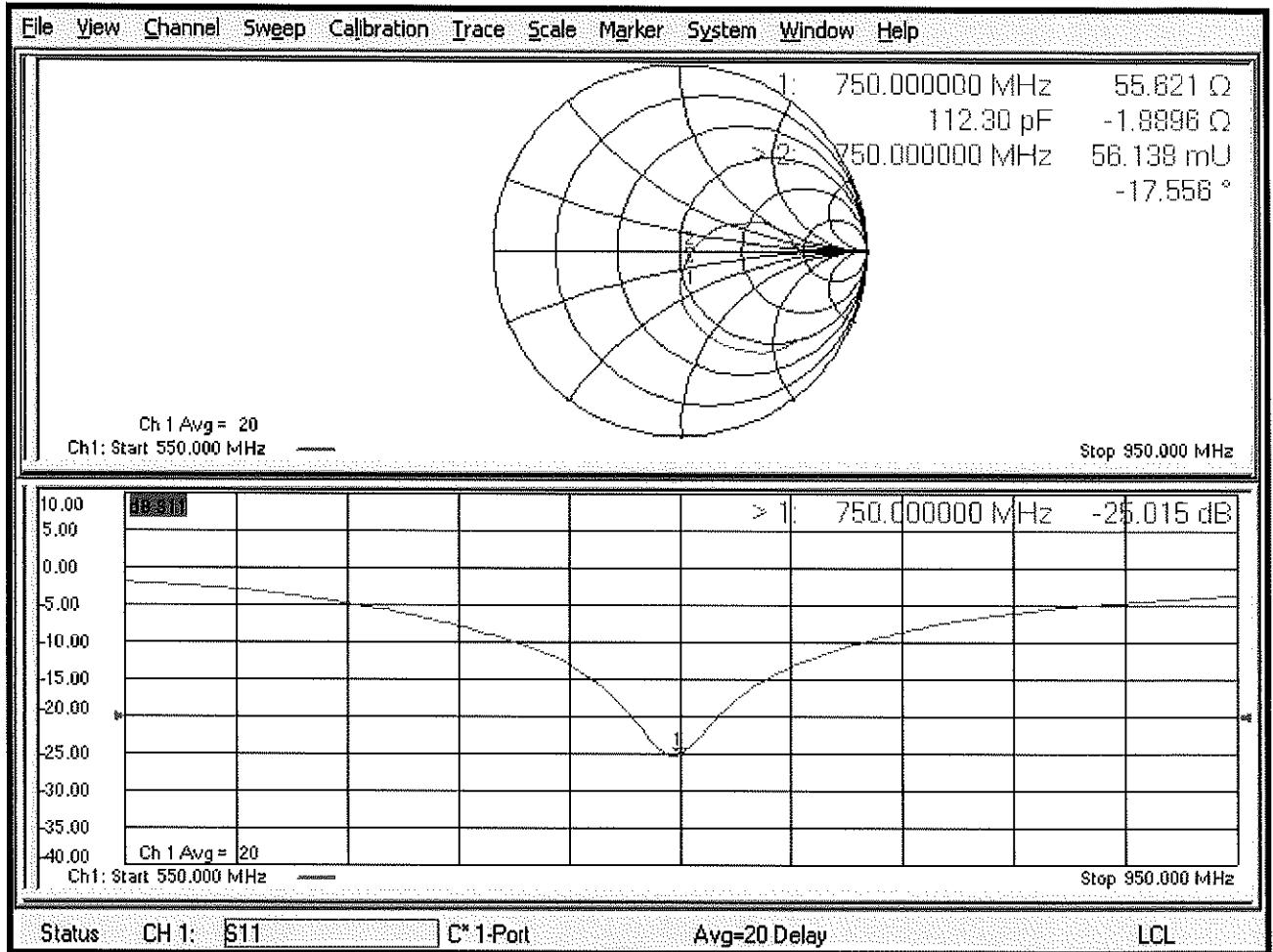

DASY5 Validation Report for Body TSL

Date: 19.10.2018

Test Laboratory: SPEAG, Zurich, Switzerland

DUT: Dipole 750 MHz; Type: D750V3; Serial: D750V3 - SN:1161

Communication System: UID 0 - CW; Frequency: 750 MHz

Medium parameters used: $f = 750$ MHz; $\sigma = 0.96$ S/m; $\epsilon_r = 55.1$; $\rho = 1000$ kg/m³

Phantom section: Flat Section

Measurement Standard: DASY5 (IEEE/IEC/ANSI C63.19-2011)

DASY52 Configuration:

- Probe: EX3DV4 - SN7349; ConvF(10.19, 10.19, 10.19) @ 750 MHz; Calibrated: 30.12.2017
- Sensor-Surface: 1.4mm (Mechanical Surface Detection)
- Electronics: DAE4 Sn601; Calibrated: 04.10.2018
- Phantom: Flat Phantom 4.9 (Back); Type: QD 00R P49 AA; Serial: 1005
- DASY52 52.10.2(1495); SEMCAD X 14.6.12(7450)

Dipole Calibration for Body Tissue/Pin=250 mW, d=15mm/Zoom Scan (7x7x7)/Cube 0:

Measurement grid: dx=5mm, dy=5mm, dz=5mm

Reference Value = 57.57 V/m; Power Drift = -0.02 dB

Peak SAR (extrapolated) = 3.18 W/kg

SAR(1 g) = 2.11 W/kg; SAR(10 g) = 1.39 W/kg

Maximum value of SAR (measured) = 2.83 W/kg

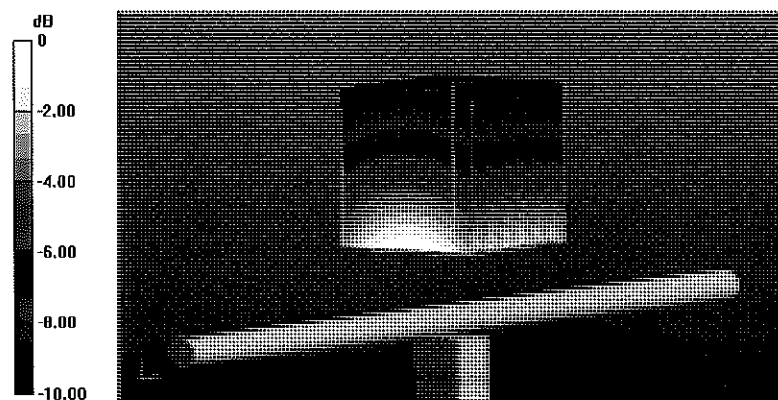

0 dB = 2.83 W/kg = 4.52 dBW/kg

Impedance Measurement Plot for Body TSL

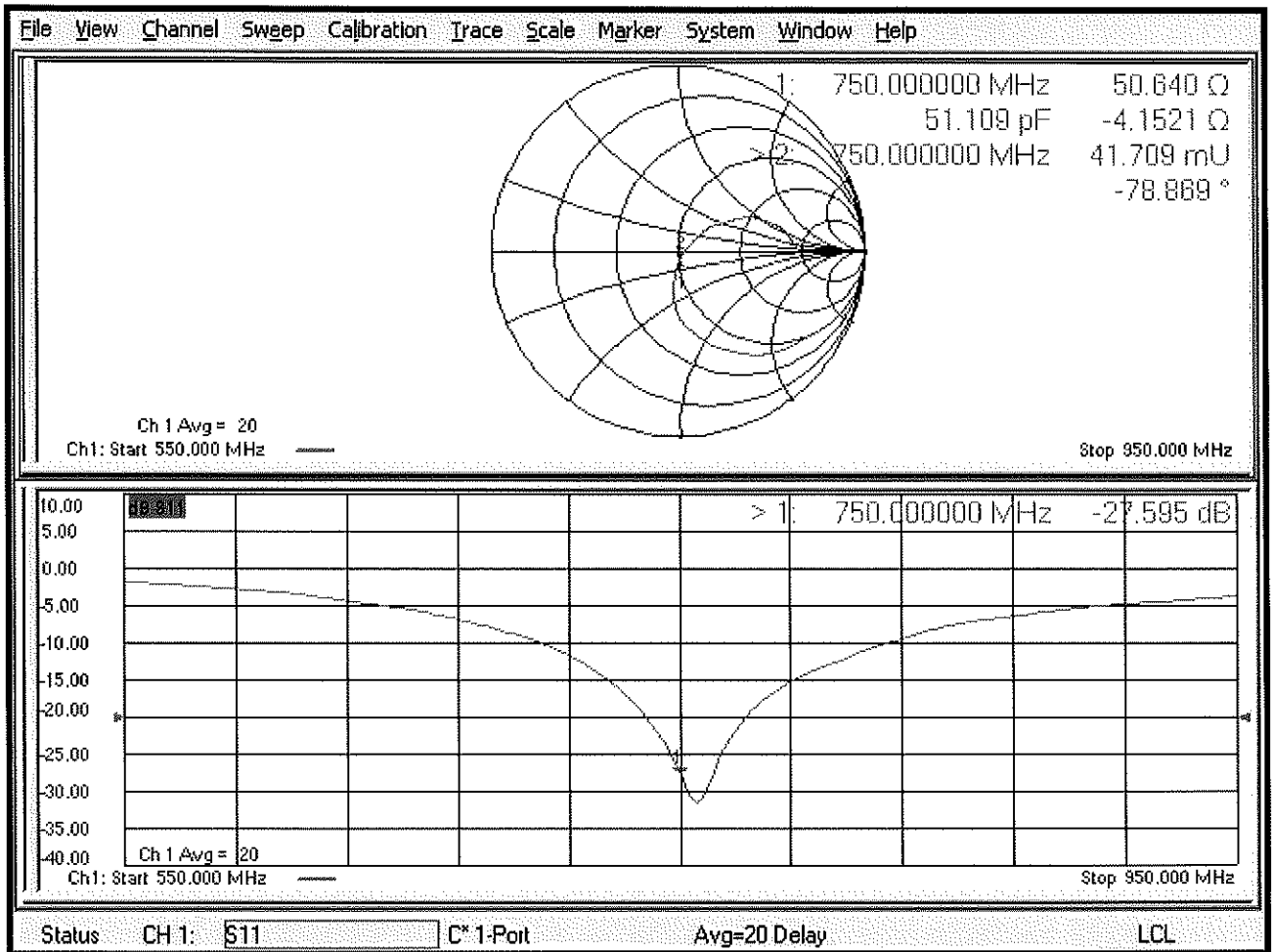



Accredited by the Swiss Accreditation Service (SAS)
The Swiss Accreditation Service is one of the signatories to the EA
Multilateral Agreement for the recognition of calibration certificates

Accreditation No.: **SCS 0108**

Client **PC Test**

Certificate No: **D835V2-4d132_Jan19**

CALIBRATION CERTIFICATE

Object **D835V2 - SN:4d132**

Calibration procedure(s) **QA CAL-05.v11
Calibration Procedure for SAR Validation Sources between 0.7-3 GHz**

*BN ✓
02/06/2019*

Calibration date: **January 22, 2019**

This calibration certificate documents the traceability to national standards, which realize the physical units of measurements (SI).
The measurements and the uncertainties with confidence probability are given on the following pages and are part of the certificate.

All calibrations have been conducted in the closed laboratory facility: environment temperature (22 ± 3)°C and humidity < 70%.

Calibration Equipment used (M&TE critical for calibration)

Primary Standards	ID #	Cal Date (Certificate No.)	Scheduled Calibration
Power meter NRP	SN: 104778	04-Apr-18 (No. 217-02672/02673)	Apr-19
Power sensor NRP-Z91	SN: 103244	04-Apr-18 (No. 217-02672)	Apr-19
Power sensor NRP-Z91	SN: 103245	04-Apr-18 (No. 217-02673)	Apr-19
Reference 20 dB Attenuator	SN: 5058 (20k)	04-Apr-18 (No. 217-02682)	Apr-19
Type-N mismatch combination	SN: 5047.2 / 06327	04-Apr-18 (No. 217-02683)	Apr-19
Reference Probe EX3DV4	SN: 7349	31-Dec-18 (No. EX3-7349_Dec18)	Dec-19
DAE4	SN: 601	04-Oct-18 (No. DAE4-601_Oct18)	Oct-19

Secondary Standards	ID #	Check Date (in house)	Scheduled Check
Power meter EPM-442A	SN: GB37480704	07-Oct-15 (in house check Oct-18)	In house check: Oct-20
Power sensor HP 8481A	SN: US37292783	07-Oct-15 (in house check Oct-18)	In house check: Oct-20
Power sensor HP 8481A	SN: MY41092317	07-Oct-15 (in house check Oct-18)	In house check: Oct-20
RF generator R&S SMT-06	SN: 100972	15-Jun-15 (in house check Oct-18)	In house check: Oct-20
Network Analyzer Agilent E8358A	SN: US41080477	31-Mar-14 (in house check Oct-18)	In house check: Oct-19

Calibrated by: **Leif Klysner** Name: **Leif Klysner** Function: **Laboratory Technician**

Signature

Approved by: **Katja Pokovic** Name: **Katja Pokovic** Function: **Technical Manager**

Issued: January 22, 2019

This calibration certificate shall not be reproduced except in full without written approval of the laboratory.



Accredited by the Swiss Accreditation Service (SAS)
The Swiss Accreditation Service is one of the signatories to the EA
Multilateral Agreement for the recognition of calibration certificates

Accreditation No.: **SCS 0108**

Glossary:

TSL	tissue simulating liquid
ConvF	sensitivity in TSL / NORM x,y,z
N/A	not applicable or not measured

Calibration is Performed According to the Following Standards:

- IEEE Std 1528-2013, "IEEE Recommended Practice for Determining the Peak Spatial-Averaged Specific Absorption Rate (SAR) in the Human Head from Wireless Communications Devices: Measurement Techniques", June 2013
- IEC 62209-1, "Measurement procedure for the assessment of Specific Absorption Rate (SAR) from hand-held and body-mounted devices used next to the ear (frequency range of 300 MHz to 6 GHz)", July 2016
- IEC 62209-2, "Procedure to determine the Specific Absorption Rate (SAR) for wireless communication devices used in close proximity to the human body (frequency range of 30 MHz to 6 GHz)", March 2010
- KDB 865664, "SAR Measurement Requirements for 100 MHz to 6 GHz"

Additional Documentation:

- DASY4/5 System Handbook

Methods Applied and Interpretation of Parameters:

- Measurement Conditions:** Further details are available from the Validation Report at the end of the certificate. All figures stated in the certificate are valid at the frequency indicated.
- Antenna Parameters with TSL:** The dipole is mounted with the spacer to position its feed point exactly below the center marking of the flat phantom section, with the arms oriented parallel to the body axis.
- Feed Point Impedance and Return Loss:** These parameters are measured with the dipole positioned under the liquid filled phantom. The impedance stated is transformed from the measurement at the SMA connector to the feed point. The Return Loss ensures low reflected power. No uncertainty required.
- Electrical Delay:** One-way delay between the SMA connector and the antenna feed point. No uncertainty required.
- SAR measured:** SAR measured at the stated antenna input power.
- SAR normalized:** SAR as measured, normalized to an input power of 1 W at the antenna connector.
- SAR for nominal TSL parameters:** The measured TSL parameters are used to calculate the nominal SAR result.

The reported uncertainty of measurement is stated as the standard uncertainty of measurement multiplied by the coverage factor $k=2$, which for a normal distribution corresponds to a coverage probability of approximately 95%.

Measurement Conditions

DASY system configuration, as far as not given on page 1.

DASY Version	DASY5	V52.10.2
Extrapolation	Advanced Extrapolation	
Phantom	Modular Flat Phantom	
Distance Dipole Center - TSL	15 mm	with Spacer
Zoom Scan Resolution	dx, dy, dz = 5.0 mm	
Frequency	835 MHz \pm 1 MHz	

Head TSL parameters

The following parameters and calculations were applied.

	Temperature	Permittivity	Conductivity
Nominal Head TSL parameters	22.0 °C	41.5	0.90 mho/m
Measured Head TSL parameters	(22.0 \pm 0.2) °C	41.3 \pm 6 %	0.92 mho/m \pm 6 %
Head TSL temperature change during test	< 0.5 °C	----	----

SAR result with Head TSL

SAR averaged over 1 cm³ (1 g) of Head TSL	Condition	
SAR measured	250 mW input power	2.44 W/kg
SAR for nominal Head TSL parameters	normalized to 1W	9.59 W/kg \pm 17.0 % (k=2)

SAR averaged over 10 cm³ (10 g) of Head TSL	condition	
SAR measured	250 mW input power	1.58 W/kg
SAR for nominal Head TSL parameters	normalized to 1W	6.23 W/kg \pm 16.5 % (k=2)

Body TSL parameters

The following parameters and calculations were applied.

	Temperature	Permittivity	Conductivity
Nominal Body TSL parameters	22.0 °C	55.2	0.97 mho/m
Measured Body TSL parameters	(22.0 \pm 0.2) °C	54.6 \pm 6 %	0.99 mho/m \pm 6 %
Body TSL temperature change during test	< 0.5 °C	----	----

SAR result with Body TSL

SAR averaged over 1 cm³ (1 g) of Body TSL	Condition	
SAR measured	250 mW input power	2.46 W/kg
SAR for nominal Body TSL parameters	normalized to 1W	9.67 W/kg \pm 17.0 % (k=2)

SAR averaged over 10 cm³ (10 g) of Body TSL	condition	
SAR measured	250 mW input power	1.61 W/kg
SAR for nominal Body TSL parameters	normalized to 1W	6.35 W/kg \pm 16.5 % (k=2)

Appendix (Additional assessments outside the scope of SCS 0108)

Antenna Parameters with Head TSL

Impedance, transformed to feed point	49.6 Ω - 3.6 j Ω
Return Loss	- 28.7 dB

Antenna Parameters with Body TSL

Impedance, transformed to feed point	47.4 Ω - 6.2 j Ω
Return Loss	- 23.2 dB

General Antenna Parameters and Design

Electrical Delay (one direction)	1.387 ns
----------------------------------	----------

After long term use with 100W radiated power, only a slight warming of the dipole near the feedpoint can be measured.

The dipole is made of standard semirigid coaxial cable. The center conductor of the feeding line is directly connected to the second arm of the dipole. The antenna is therefore short-circuited for DC-signals. On some of the dipoles, small end caps are added to the dipole arms in order to improve matching when loaded according to the position as explained in the "Measurement Conditions" paragraph. The SAR data are not affected by this change. The overall dipole length is still according to the Standard.

No excessive force must be applied to the dipole arms, because they might bend or the soldered connections near the feedpoint may be damaged.

Additional EUT Data

Manufactured by	SPEAG
-----------------	-------

Appendix (Additional assessments outside the scope of SCS 0108)

Measurement Conditions

DASY system configuration, as far as not given on page 1 and 3.

Phantom	SAM Head Phantom	For usage with cSAR3DV2-R/L
---------	------------------	-----------------------------

SAR result with SAM Head (Top)

SAR averaged over 1 cm ³ (1 g) of Head TSL	Condition	
SAR measured	250 mW input power	2.35 W/kg
SAR for nominal Head TSL parameters	normalized to 1W	9.38 W/kg ± 17.5 % (k=2)

SAR averaged over 10 cm ³ (10 g) of Head TSL	condition	
SAR measured	250 mW input power	1.57 W/kg
SAR for nominal Head TSL parameters	normalized to 1W	6.26 W/kg ± 16.9 % (k=2)

SAR result with SAM Head (Mouth)

SAR averaged over 1 cm ³ (1 g) of Head TSL	Condition	
SAR measured	250 mW input power	2.47 W/kg
SAR for nominal Head TSL parameters	normalized to 1W	9.86 W/kg ± 17.5 % (k=2)

SAR averaged over 10 cm ³ (10 g) of Head TSL	condition	
SAR measured	250 mW input power	1.65 W/kg
SAR for nominal Head TSL parameters	normalized to 1W	6.58 W/kg ± 16.9 % (k=2)

SAR result with SAM Head (Neck)

SAR averaged over 1 cm ³ (1 g) of Head TSL	Condition	
SAR measured	250 mW input power	2.36 W/kg
SAR for nominal Head TSL parameters	normalized to 1W	9.42 W/kg ± 17.5 % (k=2)

SAR averaged over 10 cm ³ (10 g) of Head TSL	condition	
SAR measured	250 mW input power	1.60 W/kg
SAR for nominal Head TSL parameters	normalized to 1W	6.38 W/kg ± 16.9 % (k=2)

SAR result with SAM Head (Ear)

SAR averaged over 1 cm ³ (1 g) of Head TSL	Condition	
SAR measured	250 mW input power	2.02 W/kg
SAR for nominal Head TSL parameters	normalized to 1W	8.06 W/kg ± 17.5 % (k=2)

SAR averaged over 10 cm ³ (10 g) of Head TSL	condition	
SAR measured	250 mW input power	1.36 W/kg
SAR for nominal Head TSL parameters	normalized to 1W	5.42 W/kg ± 16.9 % (k=2)

DASY5 Validation Report for Head TSL

Date: 17.01.2019

Test Laboratory: SPEAG, Zurich, Switzerland

DUT: Dipole 835 MHz; Type: D835V2; Serial: D835V2 - SN:4d132

Communication System: UID 0 - CW; Frequency: 835 MHz

Medium parameters used: $f = 835$ MHz; $\sigma = 0.92$ S/m; $\epsilon_r = 41.3$; $\rho = 1000$ kg/m³

Phantom section: Flat Section

Measurement Standard: DASY5 (IEEE/IEC/ANSI C63.19-2011)

DASY52 Configuration:

- Probe: EX3DV4 - SN7349; ConvF(10, 10, 10) @ 835 MHz; Calibrated: 31.12.2018
- Sensor-Surface: 1.4mm (Mechanical Surface Detection)
- Electronics: DAE4 Sn601; Calibrated: 04.10.2018
- Phantom: Flat Phantom 4.9 (front); Type: QD 00L P49 AA; Serial: 1001
- DASY52 52.10.2(1495); SEMCAD X 14.6.12(7450)

Dipole Calibration for Head Tissue/Pin=250 mW, d=15mm/Zoom Scan (7x7x7)/Cube 0:

Measurement grid: dx=5mm, dy=5mm, dz=5mm

Reference Value = 34.24 V/m; Power Drift = -0.00 dB

Peak SAR (extrapolated) = 3.73 W/kg

SAR(1 g) = 2.44 W/kg; SAR(10 g) = 1.58 W/kg

Maximum value of SAR (measured) = 3.28 W/kg

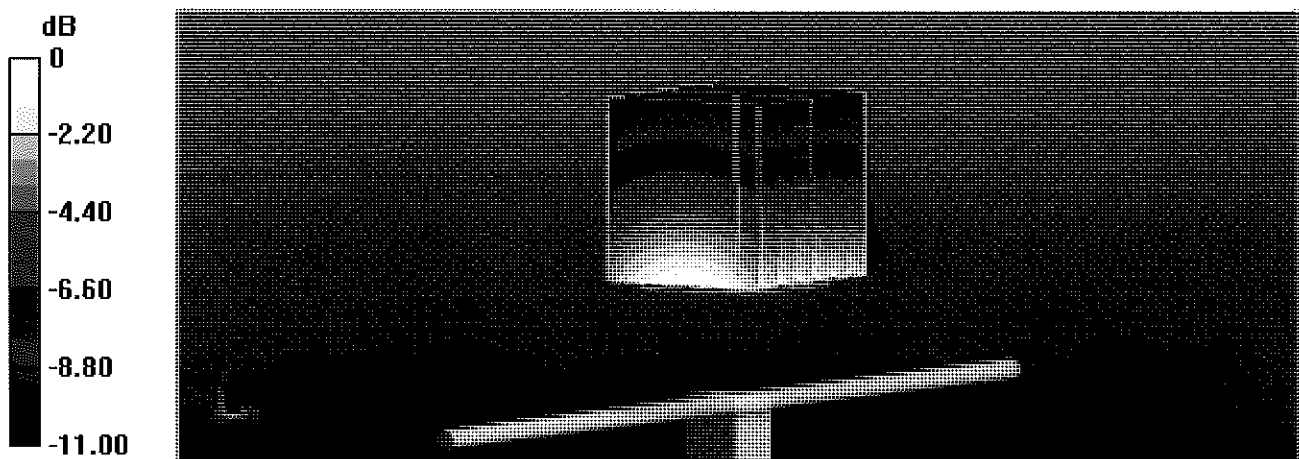

0 dB = 3.28 W/kg = 5.16 dBW/kg

Impedance Measurement Plot for Head TSL

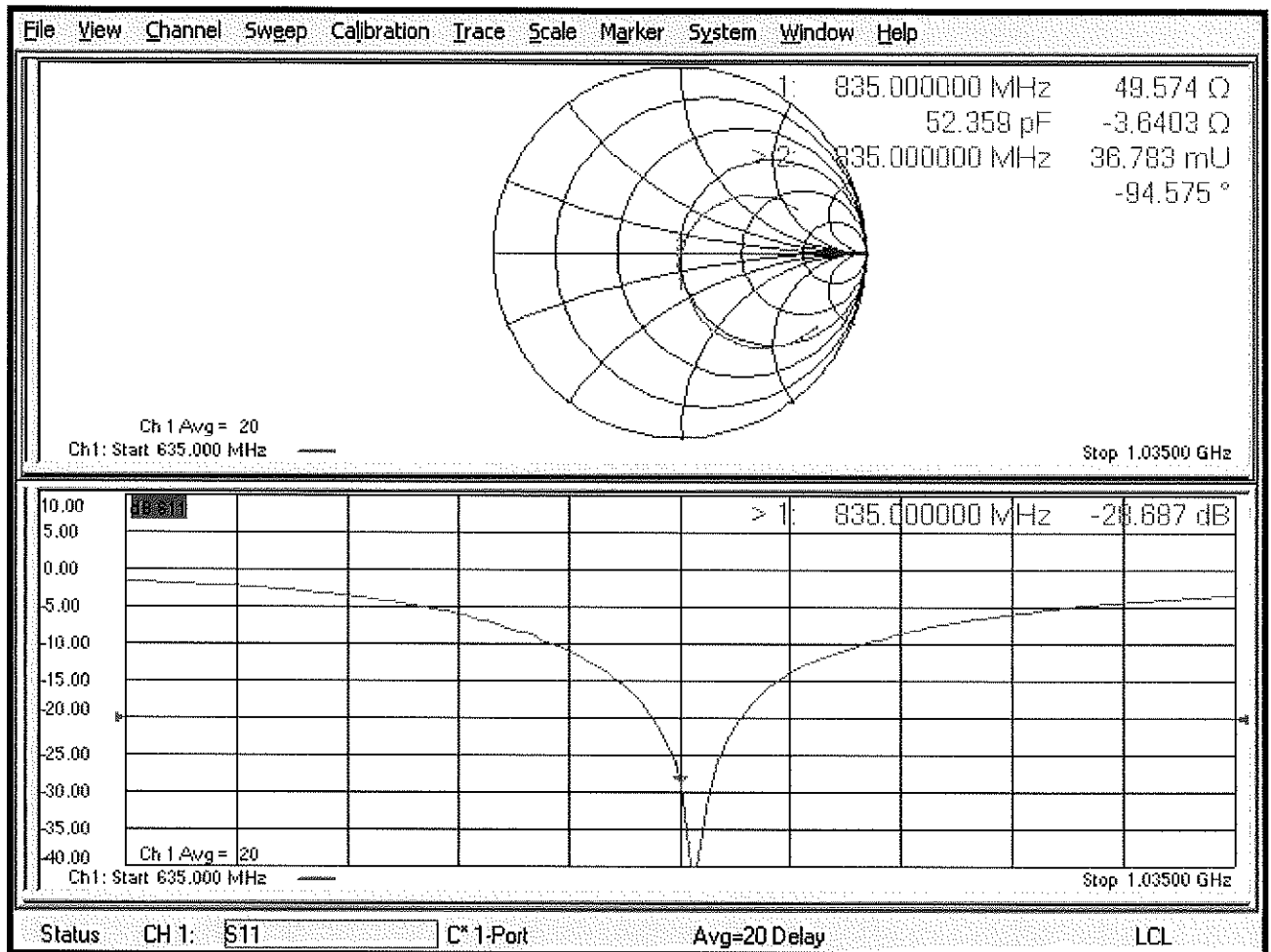

DASY5 Validation Report for Body TSL

Date: 17.01.2019

Test Laboratory: SPEAG, Zurich, Switzerland

DUT: Dipole 835 MHz; Type: D835V2; Serial: D835V2 - SN:4d132

Communication System: UID 0 - CW; Frequency: 835 MHz

Medium parameters used: $f = 835$ MHz; $\sigma = 0.99$ S/m; $\epsilon_r = 54.6$; $\rho = 1000$ kg/m³

Phantom section: Flat Section

Measurement Standard: DASY5 (IEEE/IEC/ANSI C63.19-2011)

DASY52 Configuration:

- Probe: EX3DV4 - SN7349; ConvF(10.15, 10.15, 10.15) @ 835 MHz; Calibrated: 31.12.2018
- Sensor-Surface: 1.4mm (Mechanical Surface Detection)
- Electronics: DAE4 Sn601; Calibrated: 04.10.2018
- Phantom: Flat Phantom 4.9 (Back); Type: QD 00R P49 AA; Serial: 1005
- DASY52 52.10.2(1495); SEMCAD X 14.6.12(7450)

Dipole Calibration for Body Tissue/Pin=250 mW, d=15mm/Zoom Scan (7x7x7)/Cube 0:

Measurement grid: dx=5mm, dy=5mm, dz=5mm

Reference Value = 63.32 V/m; Power Drift = -0.07 dB

Peak SAR (extrapolated) = 3.64 W/kg

SAR(1 g) = 2.46 W/kg; SAR(10 g) = 1.61 W/kg

Maximum value of SAR (measured) = 3.26 W/kg

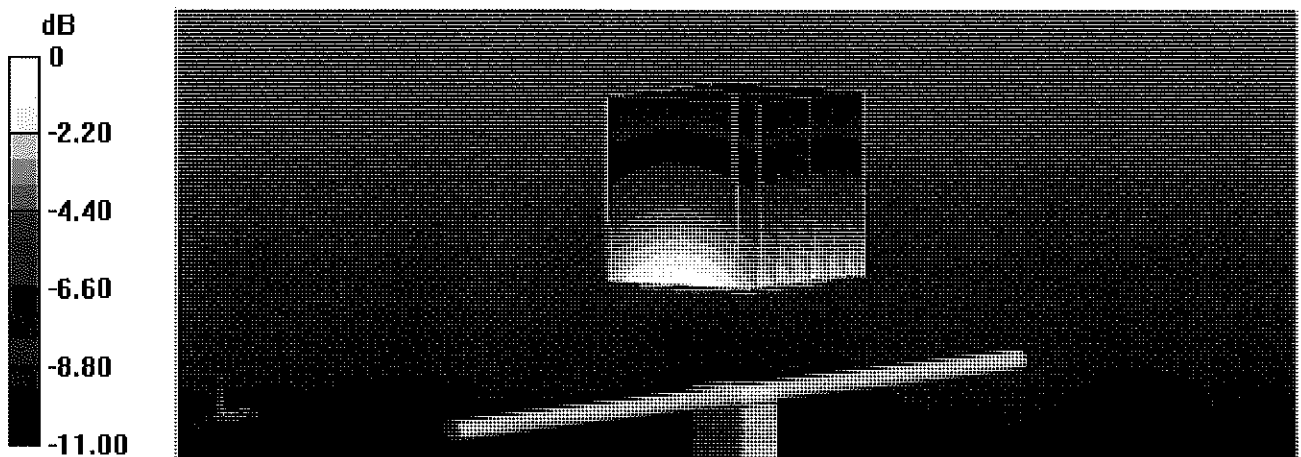

Impedance Measurement Plot for Body TSL

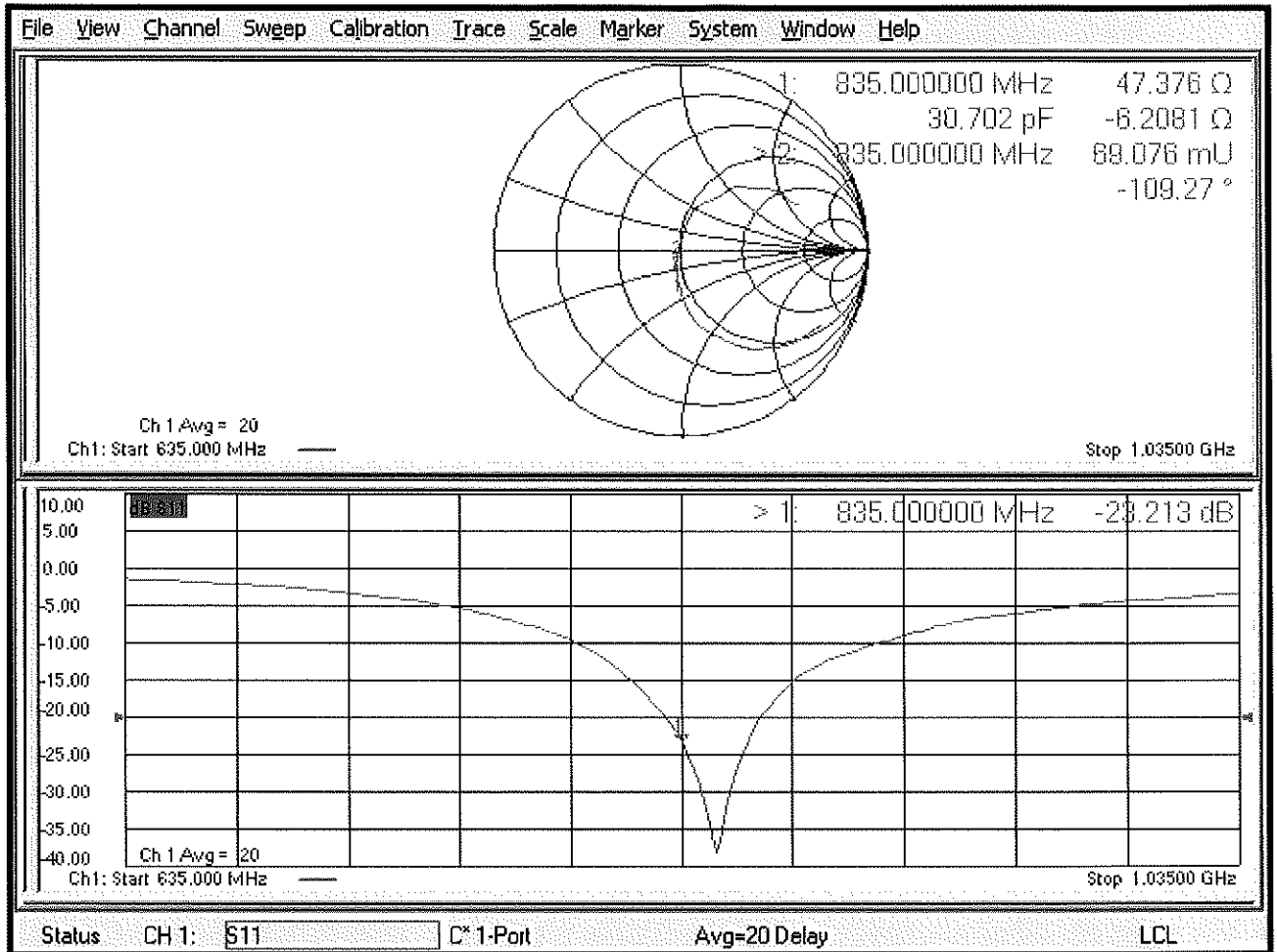

DASY5 Validation Report for SAM Head

Date: 22.01.2019

Test Laboratory: SPEAG, Zurich, Switzerland

DUT: Dipole 835 MHz; Type: D835V2; Serial: D835V2 - SN:4d132

Communication System: UID 0 - CW; Frequency: 835 MHz

Medium parameters used: $f = 835$ MHz; $\sigma = 0.92$ S/m; $\epsilon_r = 44.4$; $\rho = 1000$ kg/m³

Measurement Standard: DASY5 (IEEE/IEC/ANSI C63.19-2011)

DASY52 Configuration:

- Probe: EX3DV4 - SN7349; ConvF(10, 10, 10) @ 835 MHz; Calibrated: 31.12.2018
- Sensor-Surface: 1.4mm (Mechanical Surface Detection)
- Electronics: DAE4 Sn601; Calibrated: 04.10.2018
- Phantom: SAM Head
- DASY52 52.10.2(1495); SEMCAD X 14.6.12(7450)

SAM/Head/Top/Zoom Scan (7x7x7)/Cube 0: Measurement grid: dx=5mm, dy=5mm, dz=5mm

Reference Value = 61.32 V/m; Power Drift = -0.04 dB

Peak SAR (extrapolated) = 3.51 W/kg

SAR(1 g) = 2.35 W/kg; SAR(10 g) = 1.57 W/kg

Maximum value of SAR (measured) = 3.12 W/kg

SAM/Head/Mouth/Zoom Scan (7x7x7)/Cube 0: Measurement grid: dx=5mm, dy=5mm, dz=5mm

Reference Value = 62.25 V/m; Power Drift = 0.01 dB

Peak SAR (extrapolated) = 3.67 W/kg

SAR(1 g) = 2.47 W/kg; SAR(10 g) = 1.65 W/kg

Maximum value of SAR (measured) = 3.24 W/kg

SAM/Head/Neck/Zoom Scan (7x7x7)/Cube 0: Measurement grid: dx=5mm, dy=5mm, dz=5mm

Reference Value = 60.69 V/m; Power Drift = 0.05 dB

Peak SAR (extrapolated) = 3.43 W/kg

SAR(1 g) = 2.36 W/kg; SAR(10 g) = 1.6 W/kg

Maximum value of SAR (measured) = 3.08 W/kg

SAM/Head/Ear/Zoom Scan (8x7x7)/Cube 0: Measurement grid: dx=5mm, dy=5mm, dz=5mm

Reference Value = 55.79 V/m; Power Drift = 0.05 dB

Peak SAR (extrapolated) = 2.94 W/kg

SAR(1 g) = 2.02 W/kg; SAR(10 g) = 1.36 W/kg

Maximum value of SAR (measured) = 2.62 W/kg

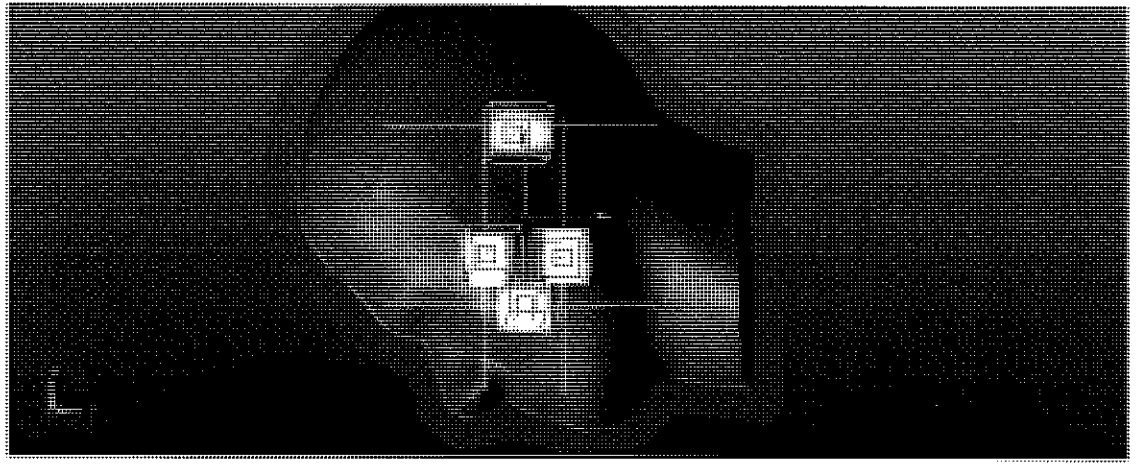
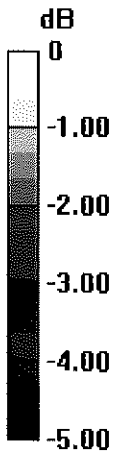

0 dB = 2.62 W/kg = 4.18 dBW/kg



Accredited by the Swiss Accreditation Service (SAS)
The Swiss Accreditation Service is one of the signatories to the EA
Multilateral Agreement for the recognition of calibration certificates

Accreditation No.: **SCS 0108**

Client **PC Test**

Certificate No: **D835V2-4d133_Oct18**

CALIBRATION CERTIFICATE

Object **D835V2 - SN:4d133**

Calibration procedure(s) **QA CAL-05.v10
Calibration procedure for dipole validation kits above 700 MHz**

*BN ✓
10/30/2018*

Calibration date: **October 19, 2018**

This calibration certificate documents the traceability to national standards, which realize the physical units of measurements (SI).
The measurements and the uncertainties with confidence probability are given on the following pages and are part of the certificate.

All calibrations have been conducted in the closed laboratory facility: environment temperature (22 ± 3)°C and humidity < 70%.

Calibration Equipment used (M&TE critical for calibration)

Primary Standards	ID #	Cal Date (Certificate No.)	Scheduled Calibration
Power meter NRP	SN: 104778	04-Apr-18 (No. 217-02672/02673)	Apr-19
Power sensor NRP-Z91	SN: 103244	04-Apr-18 (No. 217-02672)	Apr-19
Power sensor NRP-Z91	SN: 103245	04-Apr-18 (No. 217-02673)	Apr-19
Reference 20 dB Attenuator	SN: 5058 (20k)	04-Apr-18 (No. 217-02682)	Apr-19
Type-N mismatch combination	SN: 5047.2 / 06327	04-Apr-18 (No. 217-02683)	Apr-19
Reference Probe EX3DV4	SN: 7349	30-Dec-17 (No. EX3-7349_Dec17)	Dec-18
DAE4	SN: 601	04-Oct-18 (No. DAE4-601_Oct18)	Oct-19

Secondary Standards	ID #	Check Date (in house)	Scheduled Check
Power meter EPM-442A	SN: GB37480704	07-Oct-15 (in house check Oct-18)	In house check: Oct-20
Power sensor HP 8481A	SN: US37292783	07-Oct-15 (in house check Oct-18)	In house check: Oct-20
Power sensor HP 8481A	SN: MY41092317	07-Oct-15 (in house check Oct-18)	In house check: Oct-20
RF generator R&S SMT-06	SN: 100972	15-Jun-15 (in house check Oct-18)	In house check: Oct-20
Network Analyzer Agilent E8358A	SN: US41080477	31-Mar-14 (in house check Oct-18)	In house check: Oct-19

Calibrated by: **Manu Seitz** Name: **Manu Seitz** Function: **Laboratory Technician** Signature: *[Signature]*

Approved by: **Katja Pokovic** Name: **Katja Pokovic** Function: **Technical Manager** Signature: *[Signature]*

Issued: October 22, 2018

This calibration certificate shall not be reproduced except in full without written approval of the laboratory.



Accredited by the Swiss Accreditation Service (SAS)

The Swiss Accreditation Service is one of the signatories to the EA Multilateral Agreement for the recognition of calibration certificates

Accreditation No.: **SCS 0108**

Glossary:

TSL	tissue simulating liquid
ConvF	sensitivity in TSL / NORM x,y,z
N/A	not applicable or not measured

Calibration is Performed According to the Following Standards:

- IEEE Std 1528-2013, "IEEE Recommended Practice for Determining the Peak Spatial-Averaged Specific Absorption Rate (SAR) in the Human Head from Wireless Communications Devices: Measurement Techniques", June 2013
- IEC 62209-1, "Measurement procedure for the assessment of Specific Absorption Rate (SAR) from hand-held and body-mounted devices used next to the ear (frequency range of 300 MHz to 6 GHz)", July 2016
- IEC 62209-2, "Procedure to determine the Specific Absorption Rate (SAR) for wireless communication devices used in close proximity to the human body (frequency range of 30 MHz to 6 GHz)", March 2010
- KDB 865664, "SAR Measurement Requirements for 100 MHz to 6 GHz"

Additional Documentation:

- DASY4/5 System Handbook

Methods Applied and Interpretation of Parameters:

- Measurement Conditions:** Further details are available from the Validation Report at the end of the certificate. All figures stated in the certificate are valid at the frequency indicated.
- Antenna Parameters with TSL:** The dipole is mounted with the spacer to position its feed point exactly below the center marking of the flat phantom section, with the arms oriented parallel to the body axis.
- Feed Point Impedance and Return Loss:** These parameters are measured with the dipole positioned under the liquid filled phantom. The impedance stated is transformed from the measurement at the SMA connector to the feed point. The Return Loss ensures low reflected power. No uncertainty required.
- Electrical Delay:** One-way delay between the SMA connector and the antenna feed point. No uncertainty required.
- SAR measured:** SAR measured at the stated antenna input power.
- SAR normalized:** SAR as measured, normalized to an input power of 1 W at the antenna connector.
- SAR for nominal TSL parameters:** The measured TSL parameters are used to calculate the nominal SAR result.

The reported uncertainty of measurement is stated as the standard uncertainty of measurement multiplied by the coverage factor $k=2$, which for a normal distribution corresponds to a coverage probability of approximately 95%.

Measurement Conditions

DASY system configuration, as far as not given on page 1.

DASY Version	DASY5	V52.10.2
Extrapolation	Advanced Extrapolation	
Phantom	Modular Flat Phantom	
Distance Dipole Center - TSL	15 mm	with Spacer
Zoom Scan Resolution	dx, dy, dz = 5 mm	
Frequency	835 MHz \pm 1 MHz	

Head TSL parameters

The following parameters and calculations were applied.

	Temperature	Permittivity	Conductivity
Nominal Head TSL parameters	22.0 °C	41.5	0.90 mho/m
Measured Head TSL parameters	(22.0 \pm 0.2) °C	40.6 \pm 6 %	0.91 mho/m \pm 6 %
Head TSL temperature change during test	< 0.5 °C	----	----

SAR result with Head TSL

SAR averaged over 1 cm³ (1 g) of Head TSL	Condition	
SAR measured	250 mW input power	2.39 W/kg
SAR for nominal Head TSL parameters	normalized to 1W	9.43 W/kg \pm 17.0 % (k=2)

SAR averaged over 10 cm³ (10 g) of Head TSL	condition	
SAR measured	250 mW input power	1.54 W/kg
SAR for nominal Head TSL parameters	normalized to 1W	6.10 W/kg \pm 16.5 % (k=2)

Body TSL parameters

The following parameters and calculations were applied.

	Temperature	Permittivity	Conductivity
Nominal Body TSL parameters	22.0 °C	55.2	0.97 mho/m
Measured Body TSL parameters	(22.0 \pm 0.2) °C	54.9 \pm 6 %	0.98 mho/m \pm 6 %
Body TSL temperature change during test	< 0.5 °C	----	----

SAR result with Body TSL

SAR averaged over 1 cm³ (1 g) of Body TSL	Condition	
SAR measured	250 mW input power	2.46 W/kg
SAR for nominal Body TSL parameters	normalized to 1W	9.75 W/kg \pm 17.0 % (k=2)

SAR averaged over 10 cm³ (10 g) of Body TSL	condition	
SAR measured	250 mW input power	1.61 W/kg
SAR for nominal Body TSL parameters	normalized to 1W	6.40 W/kg \pm 16.5 % (k=2)

Appendix (Additional assessments outside the scope of SCS 0108)

Antenna Parameters with Head TSL

Impedance, transformed to feed point	50.6 Ω - 2.4 j Ω
Return Loss	- 32.2 dB

Antenna Parameters with Body TSL

Impedance, transformed to feed point	45.0 Ω - 6.7 j Ω
Return Loss	- 21.1 dB

General Antenna Parameters and Design

Electrical Delay (one direction)	1.397 ns
----------------------------------	----------

After long term use with 100W radiated power, only a slight warming of the dipole near the feedpoint can be measured.

The dipole is made of standard semirigid coaxial cable. The center conductor of the feeding line is directly connected to the second arm of the dipole. The antenna is therefore short-circuited for DC-signals. On some of the dipoles, small end caps are added to the dipole arms in order to improve matching when loaded according to the position as explained in the "Measurement Conditions" paragraph. The SAR data are not affected by this change. The overall dipole length is still according to the Standard.

No excessive force must be applied to the dipole arms, because they might bend or the soldered connections near the feedpoint may be damaged.

Additional EUT Data

Manufactured by	SPEAG
Manufactured on	July 22, 2011

DASY5 Validation Report for Head TSL

Date: 19.10.2018

Test Laboratory: The name of your organization

DUT: Dipole 835 MHz; Type: D835V2; Serial: D835V2 - SN:4d133

Communication System: UID 0 - CW; Frequency: 835 MHz

Medium parameters used: $f = 835$ MHz; $\sigma = 0.91$ S/m; $\epsilon_r = 40.6$; $\rho = 1000$ kg/m³

Phantom section: Flat Section

Measurement Standard: DASY5 (IEEE/IEC/ANSI C63.19-2011)

DASY52 Configuration:

- Probe: EX3DV4 - SN7349; ConvF(9.9, 9.9, 9.9) @ 835 MHz; Calibrated: 30.12.2017
- Sensor-Surface: 1.4mm (Mechanical Surface Detection)
- Electronics: DAE4 Sn601; Calibrated: 04.10.2018
- Phantom: Flat Phantom 4.9 (front); Type: QD 00L P49 AA; Serial: 1001
- DASY52 52.10.2(1495); SEMCAD X 14.6.12(7450)

Dipole Calibration for Head Tissue/Pin=250 mW, d=15mm/Zoom Scan (7x7x7)/Cube 0:

Measurement grid: dx=5mm, dy=5mm, dz=5mm

Reference Value = 63.02 V/m; Power Drift = -0.02 dB

Peak SAR (extrapolated) = 3.68 W/kg

SAR(1 g) = 2.39 W/kg; SAR(10 g) = 1.54 W/kg

Maximum value of SAR (measured) = 3.24 W/kg

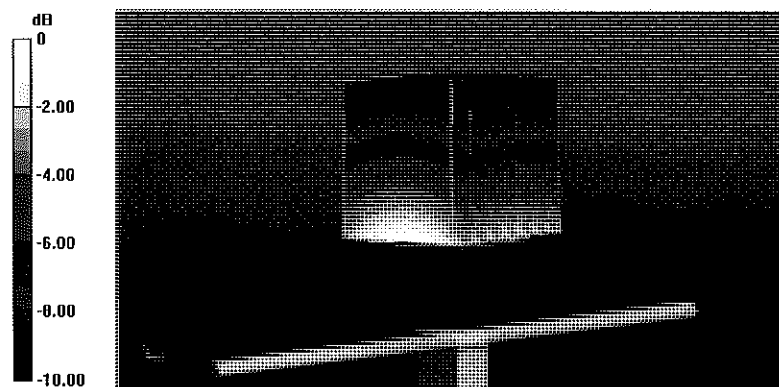

0 dB = 3.24 W/kg = 5.11 dBW/kg

Impedance Measurement Plot for Head TSL

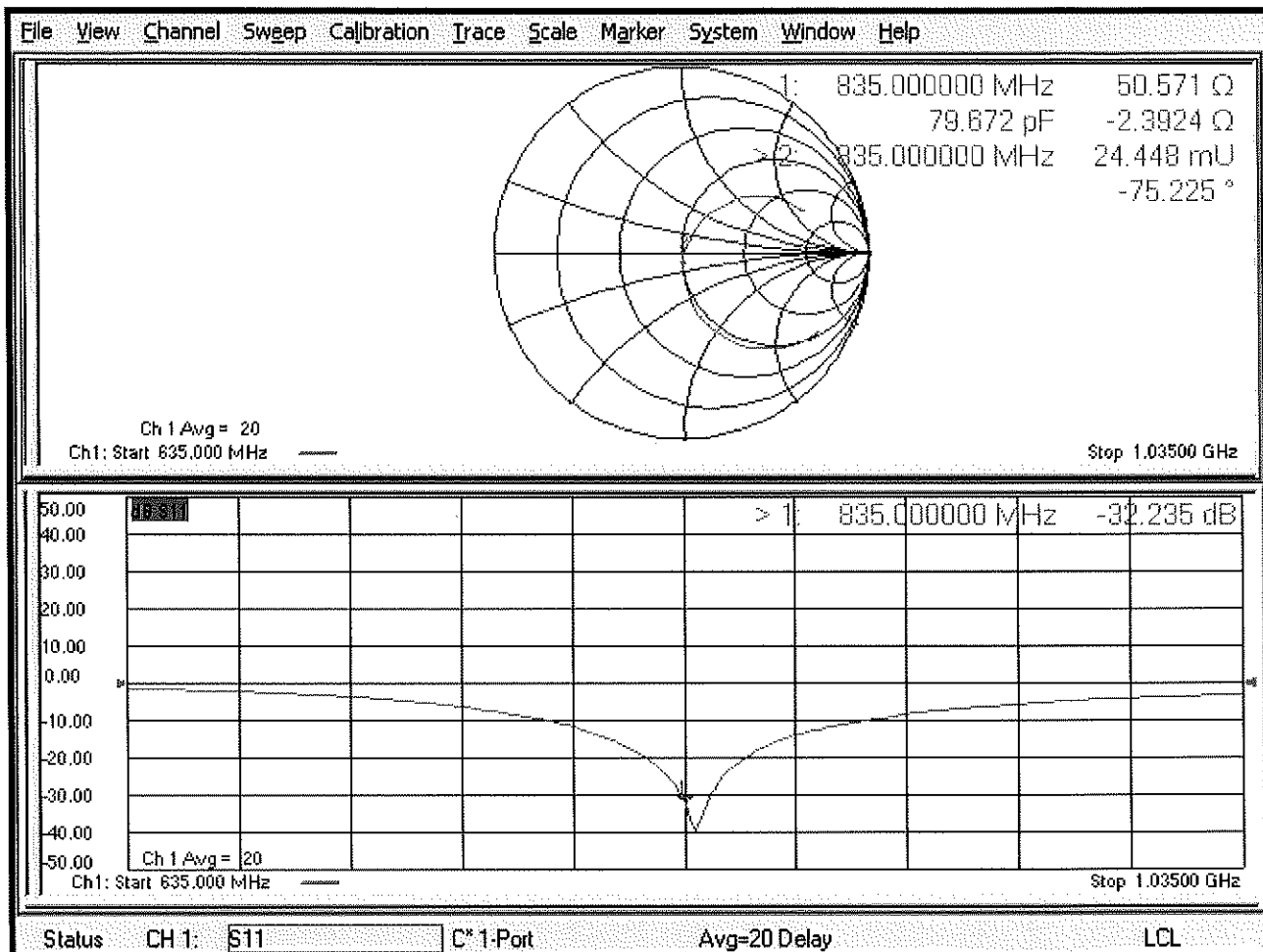

DASY5 Validation Report for Body TSL

Date: 19.10.2018

Test Laboratory: SPEAG, Zurich, Switzerland

DUT: Dipole 835 MHz; Type: D835V2; Serial: D835V2 - SN:4d133

Communication System: UID 0 - CW; Frequency: 835 MHz

Medium parameters used: $f = 835$ MHz; $\sigma = 0.98$ S/m; $\epsilon_r = 54.9$; $\rho = 1000$ kg/m³

Phantom section: Flat Section

Measurement Standard: DASY5 (IEEE/IEC/ANSI C63.19-2011)

DASY52 Configuration:

- Probe: EX3DV4 - SN7349; ConvF(10.05, 10.05, 10.05) @ 835 MHz; Calibrated: 30.12.2017
- Sensor-Surface: 1.4mm (Mechanical Surface Detection)
- Electronics: DAE4 Sn601; Calibrated: 04.10.2018
- Phantom: Flat Phantom 4.9 (Back); Type: QD 00R P49 AA; Serial: 1005
- DASY52 52.10.2(1495); SEMCAD X 14.6.12(7450)

Dipole Calibration for Body Tissue/Pin=250 mW, d=15mm/Zoom Scan (7x7x7)/Cube 0:

Measurement grid: dx=5mm, dy=5mm, dz=5mm

Reference Value = 61.61 V/m; Power Drift = -0.02 dB

Peak SAR (extrapolated) = 3.69 W/kg

SAR(1 g) = 2.46 W/kg; SAR(10 g) = 1.61 W/kg

Maximum value of SAR (measured) = 3.28 W/kg

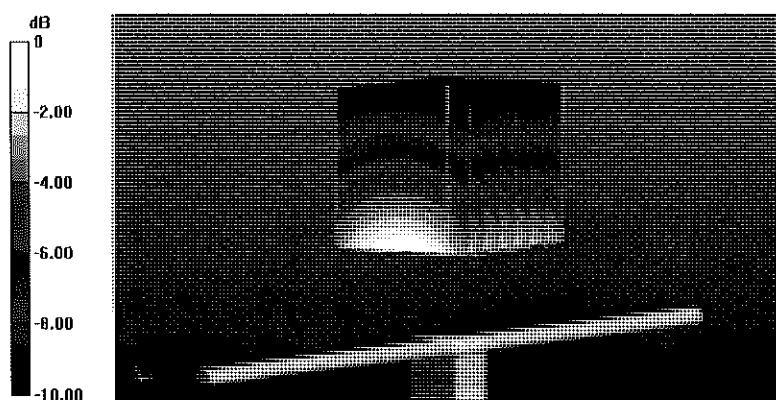

0 dB = 3.28 W/kg = 5.16 dBW/kg

Impedance Measurement Plot for Body TSL

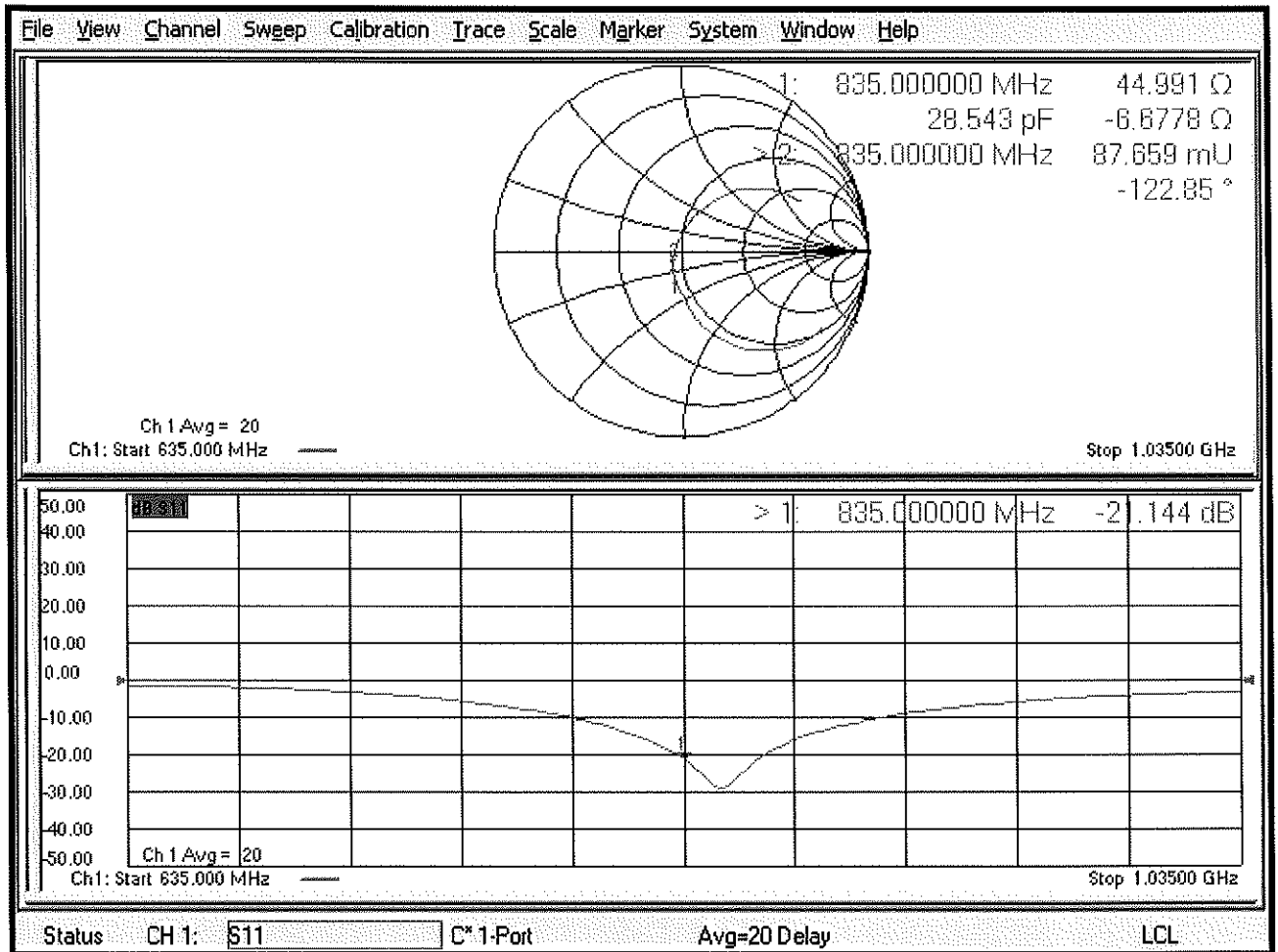



Accredited by the Swiss Accreditation Service (SAS)
The Swiss Accreditation Service is one of the signatories to the EA
Multilateral Agreement for the recognition of calibration certificates

Accreditation No.: **SCS 0108**

Client **PC Test**

Certificate No: **D1900V2-5d080_Oct18**

CALIBRATION CERTIFICATE

Object **D1900V2 - SN:5d080**

Calibration procedure(s) **QA CAL-05.v10
Calibration procedure for dipole validation kits above 700 MHz**

Calibration date: **October 23, 2018**

*BN ✓
10-30-2018*

This calibration certificate documents the traceability to national standards, which realize the physical units of measurements (SI).
The measurements and the uncertainties with confidence probability are given on the following pages and are part of the certificate.

All calibrations have been conducted in the closed laboratory facility: environment temperature (22 ± 3)°C and humidity < 70%.

Calibration Equipment used (M&TE critical for calibration)

Primary Standards	ID #	Cal Date (Certificate No.)	Scheduled Calibration
Power meter NRP	SN: 104778	04-Apr-18 (No. 217-02672/02673)	Apr-19
Power sensor NRP-Z91	SN: 103244	04-Apr-18 (No. 217-02672)	Apr-19
Power sensor NRP-Z91	SN: 103245	04-Apr-18 (No. 217-02673)	Apr-19
Reference 20 dB Attenuator	SN: 5058 (20k)	04-Apr-18 (No. 217-02682)	Apr-19
Type-N mismatch combination	SN: 5047.2 / 06327	04-Apr-18 (No. 217-02683)	Apr-19
Reference Probe EX3DV4	SN: 7349	30-Dec-17 (No. EX3-7349_Dec17)	Dec-18
DAE4	SN: 601	04-Oct-18 (No. DAE4-601_Oct18)	Oct-19
Secondary Standards	ID #	Check Date (in house)	Scheduled Check
Power meter EPM-442A	SN: GB37480704	07-Oct-15 (in house check Oct-18)	In house check: Oct-20
Power sensor HP 8481A	SN: US37292783	07-Oct-15 (in house check Oct-18)	In house check: Oct-20
Power sensor HP 8481A	SN: MY41092317	07-Oct-15 (in house check Oct-18)	In house check: Oct-20
RF generator R&S SMT-06	SN: 100972	15-Jun-15 (in house check Oct-18)	In house check: Oct-20
Network Analyzer Agilent E8358A	SN: US41080477	31-Mar-14 (in house check Oct-18)	In house check: Oct-19

Calibrated by:	Jeton Kastrati	Function Laboratory Technician	Signature
Approved by:	Katja Pokovic	Technical Manager	

Issued: October 23, 2018

This calibration certificate shall not be reproduced except in full without written approval of the laboratory.



Accredited by the Swiss Accreditation Service (SAS)

The Swiss Accreditation Service is one of the signatories to the EA Multilateral Agreement for the recognition of calibration certificates

Accreditation No.: **SCS 0108**

Glossary:

TSL	tissue simulating liquid
ConvF	sensitivity in TSL / NORM x,y,z
N/A	not applicable or not measured

Calibration is Performed According to the Following Standards:

- IEEE Std 1528-2013, "IEEE Recommended Practice for Determining the Peak Spatial-Averaged Specific Absorption Rate (SAR) in the Human Head from Wireless Communications Devices: Measurement Techniques", June 2013
- IEC 62209-1, "Measurement procedure for the assessment of Specific Absorption Rate (SAR) from hand-held and body-mounted devices used next to the ear (frequency range of 300 MHz to 6 GHz)", July 2016
- IEC 62209-2, "Procedure to determine the Specific Absorption Rate (SAR) for wireless communication devices used in close proximity to the human body (frequency range of 30 MHz to 6 GHz)", March 2010
- KDB 865664, "SAR Measurement Requirements for 100 MHz to 6 GHz"

Additional Documentation:

- DASY4/5 System Handbook

Methods Applied and Interpretation of Parameters:

- Measurement Conditions:** Further details are available from the Validation Report at the end of the certificate. All figures stated in the certificate are valid at the frequency indicated.
- Antenna Parameters with TSL:** The dipole is mounted with the spacer to position its feed point exactly below the center marking of the flat phantom section, with the arms oriented parallel to the body axis.
- Feed Point Impedance and Return Loss:** These parameters are measured with the dipole positioned under the liquid filled phantom. The impedance stated is transformed from the measurement at the SMA connector to the feed point. The Return Loss ensures low reflected power. No uncertainty required.
- Electrical Delay:** One-way delay between the SMA connector and the antenna feed point. No uncertainty required.
- SAR measured:** SAR measured at the stated antenna input power.
- SAR normalized:** SAR as measured, normalized to an input power of 1 W at the antenna connector.
- SAR for nominal TSL parameters:** The measured TSL parameters are used to calculate the nominal SAR result.

The reported uncertainty of measurement is stated as the standard uncertainty of measurement multiplied by the coverage factor $k=2$, which for a normal distribution corresponds to a coverage probability of approximately 95%.

Measurement Conditions

DASY system configuration, as far as not given on page 1.

DASY Version	DASY5	V52.10.2
Extrapolation	Advanced Extrapolation	
Phantom	Modular Flat Phantom	
Distance Dipole Center - TSL	10 mm	with Spacer
Zoom Scan Resolution	dx, dy, dz = 5 mm	
Frequency	1900 MHz \pm 1 MHz	

Head TSL parameters

The following parameters and calculations were applied.

	Temperature	Permittivity	Conductivity
Nominal Head TSL parameters	22.0 °C	40.0	1.40 mho/m
Measured Head TSL parameters	(22.0 \pm 0.2) °C	40.3 \pm 6 %	1.40 mho/m \pm 6 %
Head TSL temperature change during test	< 0.5 °C	----	----

SAR result with Head TSL

SAR averaged over 1 cm³ (1 g) of Head TSL	Condition	
SAR measured	250 mW input power	9.93 W/kg
SAR for nominal Head TSL parameters	normalized to 1W	39.8 W/kg \pm 17.0 % (k=2)

SAR averaged over 10 cm³ (10 g) of Head TSL	condition	
SAR measured	250 mW input power	5.18 W/kg
SAR for nominal Head TSL parameters	normalized to 1W	20.7 W/kg \pm 16.5 % (k=2)

Body TSL parameters

The following parameters and calculations were applied.

	Temperature	Permittivity	Conductivity
Nominal Body TSL parameters	22.0 °C	53.3	1.52 mho/m
Measured Body TSL parameters	(22.0 \pm 0.2) °C	52.9 \pm 6 %	1.47 mho/m \pm 6 %
Body TSL temperature change during test	< 0.5 °C	----	----

SAR result with Body TSL

SAR averaged over 1 cm³ (1 g) of Body TSL	Condition	
SAR measured	250 mW input power	9.62 W/kg
SAR for nominal Body TSL parameters	normalized to 1W	39.2 W/kg \pm 17.0 % (k=2)

SAR averaged over 10 cm³ (10 g) of Body TSL	condition	
SAR measured	250 mW input power	5.09 W/kg
SAR for nominal Body TSL parameters	normalized to 1W	20.6 W/kg \pm 16.5 % (k=2)

Appendix (Additional assessments outside the scope of SCS 0108)

Antenna Parameters with Head TSL

Impedance, transformed to feed point	$52.5 \Omega + 7.9 j\Omega$
Return Loss	- 21.8 dB

Antenna Parameters with Body TSL

Impedance, transformed to feed point	$48.1 \Omega + 8.1 j\Omega$
Return Loss	- 21.5 dB

General Antenna Parameters and Design

Electrical Delay (one direction)	1.193 ns
----------------------------------	----------

After long term use with 100W radiated power, only a slight warming of the dipole near the feedpoint can be measured.

The dipole is made of standard semirigid coaxial cable. The center conductor of the feeding line is directly connected to the second arm of the dipole. The antenna is therefore short-circuited for DC-signals. On some of the dipoles, small end caps are added to the dipole arms in order to improve matching when loaded according to the position as explained in the "Measurement Conditions" paragraph. The SAR data are not affected by this change. The overall dipole length is still according to the Standard.

No excessive force must be applied to the dipole arms, because they might bend or the soldered connections near the feedpoint may be damaged.

Additional EUT Data

Manufactured by	SPEAG
Manufactured on	June 28, 2006

DASY5 Validation Report for Head TSL

Date: 23.10.2018

Test Laboratory: SPEAG, Zurich, Switzerland

DUT: Dipole 1900 MHz; Type: D1900V2; Serial: D1900V2 - SN:5d080

Communication System: UID 0 - CW; Frequency: 1900 MHz

Medium parameters used: $f = 1900$ MHz; $\sigma = 1.4$ S/m; $\epsilon_r = 40.3$; $\rho = 1000$ kg/m³

Phantom section: Flat Section

Measurement Standard: DASY5 (IEEE/IEC/ANSI C63.19-2011)

DASY52 Configuration:

- Probe: EX3DV4 - SN7349; ConvF(8.18, 8.18, 8.18) @ 1900 MHz; Calibrated: 30.12.2017
- Sensor-Surface: 1.4mm (Mechanical Surface Detection)
- Electronics: DAE4 Sn601; Calibrated: 04.10.2018
- Phantom: Flat Phantom 5.0 (front); Type: QD 000 P50 AA; Serial: 1001
- DASY52 52.10.2(1495); SEMCAD X 14.6.12(7450)

Dipole Calibration for Head Tissue/Pin=250 mW, d=10mm/Zoom Scan (7x7x7)/Cube 0:

Measurement grid: dx=5mm, dy=5mm, dz=5mm

Reference Value = 110.0 V/m; Power Drift = -0.05 dB

Peak SAR (extrapolated) = 18.7 W/kg

SAR(1 g) = 9.93 W/kg; SAR(10 g) = 5.18 W/kg

Maximum value of SAR (measured) = 15.6 W/kg

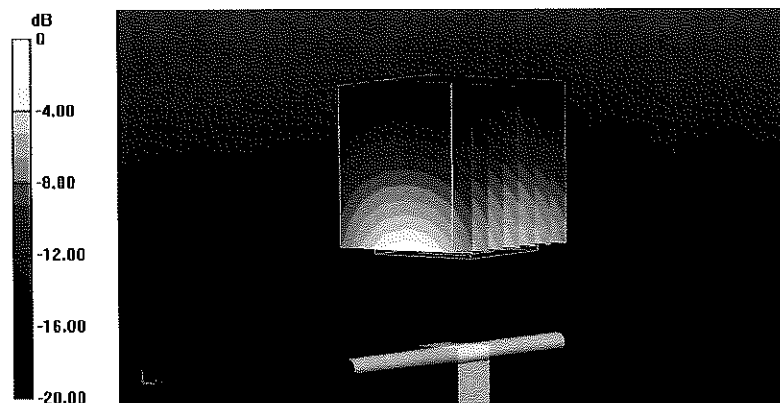

0 dB = 15.6 W/kg = 11.93 dBW/kg

Impedance Measurement Plot for Head TSL

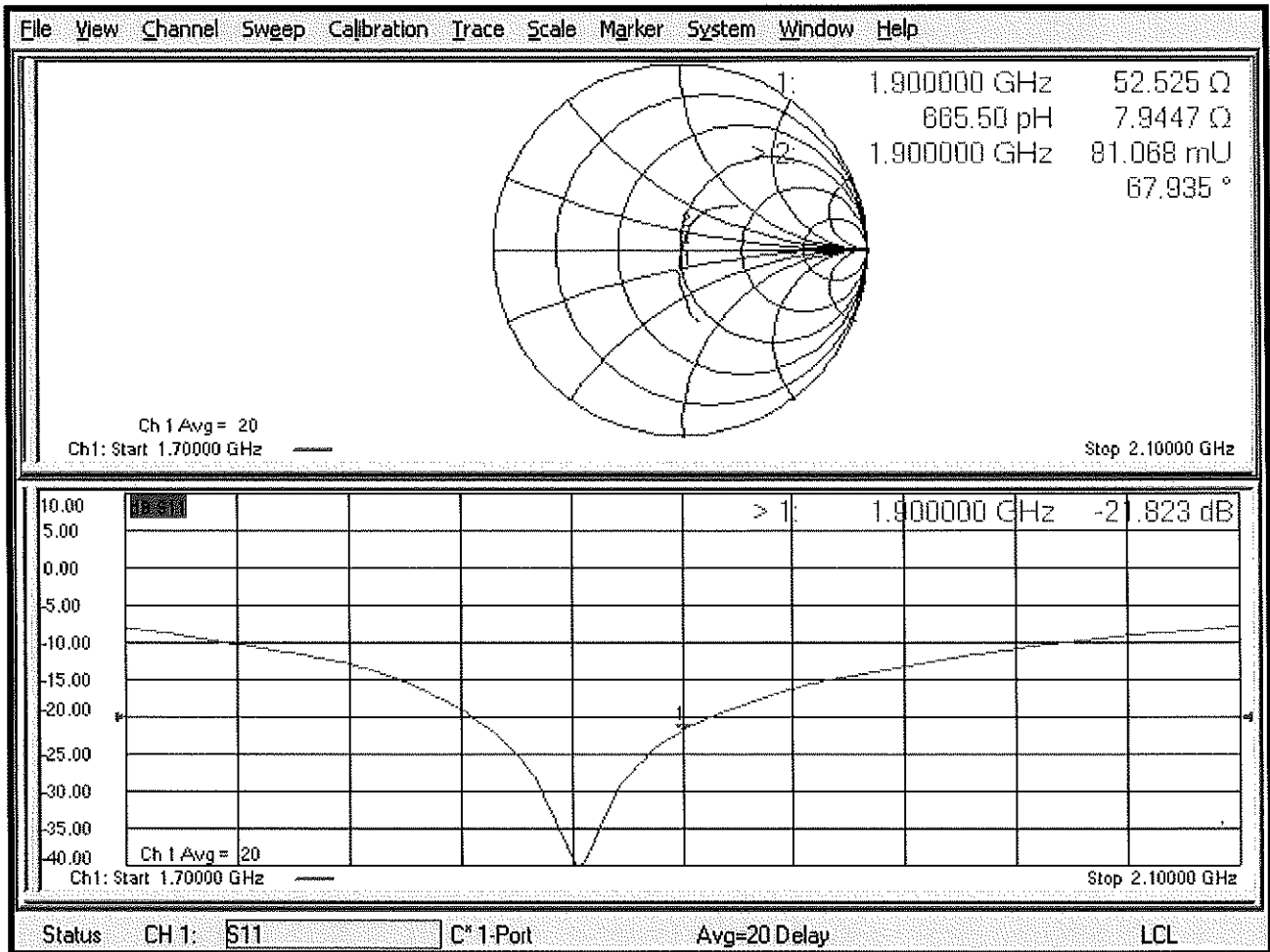

DASY5 Validation Report for Body TSL

Date: 23.10.2018

Test Laboratory: SPEAG, Zurich, Switzerland

DUT: Dipole 1900 MHz; Type: D1900V2; Serial: D1900V2 - SN:5d080

Communication System: UID 0 - CW; Frequency: 1900 MHz

Medium parameters used: $f = 1900$ MHz; $\sigma = 1.47$ S/m; $\epsilon_r = 52.9$; $\rho = 1000$ kg/m³

Phantom section: Flat Section

Measurement Standard: DASY5 (IEEE/IEC/ANSI C63.19-2011)

DASY52 Configuration:

- Probe: EX3DV4 - SN7349; ConvF(8.15, 8.15, 8.15) @ 1900 MHz; Calibrated: 30.12.2017
- Sensor-Surface: 1.4mm (Mechanical Surface Detection)
- Electronics: DAE4 Sn601; Calibrated: 04.10.2018
- Phantom: Flat Phantom 5.0 (back); Type: QD 000 P50 AA; Serial: 1002
- DASY52 52.10.2(1495); SEMCAD X 14.6.12(7450)

Dipole Calibration for Body Tissue/Pin=250 mW, d=10mm/Zoom Scan (7x7x7)/Cube 0:

Measurement grid: dx=5mm, dy=5mm, dz=5mm

Reference Value = 99.86 V/m; Power Drift = 0.00 dB

Peak SAR (extrapolated) = 17.3 W/kg

SAR(1 g) = 9.62 W/kg; SAR(10 g) = 5.09 W/kg

Maximum value of SAR (measured) = 14.1 W/kg

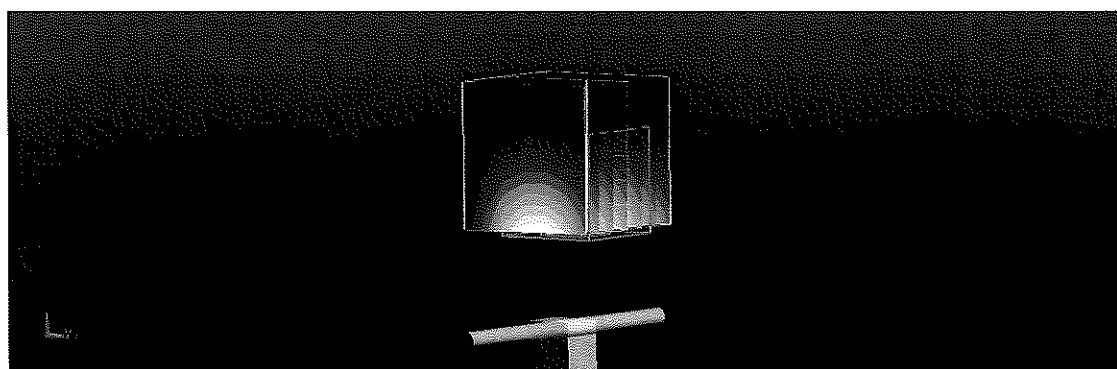
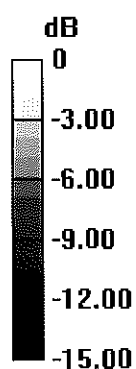

0 dB = 14.1 W/kg = 11.49 dBW/kg



Accredited by the Swiss Accreditation Service (SAS)
The Swiss Accreditation Service is one of the signatories to the EA
Multilateral Agreement for the recognition of calibration certificates

Accreditation No.: **SCS 0108**

Client **PC Test**

Certificate No: **D1900V2-5d149_Oct18**

CALIBRATION CERTIFICATE

Object **D1900V2 - SN:5d149**

Calibration procedure(s) **QA CAL-05.v10
Calibration procedure for dipole validation kits above 700 MHz**

Calibration date: **October 23, 2018**

*BNV
10-30-2018*

This calibration certificate documents the traceability to national standards, which realize the physical units of measurements (SI).
The measurements and the uncertainties with confidence probability are given on the following pages and are part of the certificate.

All calibrations have been conducted in the closed laboratory facility: environment temperature $(22 \pm 3)^\circ\text{C}$ and humidity $< 70\%$.

Calibration Equipment used (M&TE critical for calibration)

Primary Standards	ID #	Cal Date (Certificate No.)	Scheduled Calibration
Power meter NRP	SN: 104778	04-Apr-18 (No. 217-02672/02673)	Apr-19
Power sensor NRP-Z91	SN: 103244	04-Apr-18 (No. 217-02672)	Apr-19
Power sensor NRP-Z91	SN: 103245	04-Apr-18 (No. 217-02673)	Apr-19
Reference 20 dB Attenuator	SN: 5058 (20k)	04-Apr-18 (No. 217-02682)	Apr-19
Type-N mismatch combination	SN: 5047.2 / 06327	04-Apr-18 (No. 217-02683)	Apr-19
Reference Probe EX3DV4	SN: 7349	30-Dec-17 (No. EX3-7349_Dec17)	Dec-18
DAE4	SN: 601	04-Oct-18 (No. DAE4-601_Oct18)	Oct-19

Secondary Standards	ID #	Check Date (in house)	Scheduled Check
Power meter EPM-442A	SN: GB37480704	07-Oct-15 (in house check Oct-18)	In house check: Oct-20
Power sensor HP 8481A	SN: US37292783	07-Oct-15 (in house check Oct-18)	In house check: Oct-20
Power sensor HP 8481A	SN: MY41092317	07-Oct-15 (in house check Oct-18)	In house check: Oct-20
RF generator R&S SMT-06	SN: 100972	15-Jun-15 (in house check Oct-18)	In house check: Oct-20
Network Analyzer Agilent E8358A	SN: US41080477	31-Mar-14 (in house check Oct-18)	In house check: Oct-19

Calibrated by: **Jeton Kastrati** **Function: Laboratory Technician** **Signature:**

Approved by: **Katja Pokovic** **Technical Manager**

[Handwritten signatures]

Issued: October 23, 2018

This calibration certificate shall not be reproduced except in full without written approval of the laboratory.



Accredited by the Swiss Accreditation Service (SAS)
The Swiss Accreditation Service is one of the signatories to the EA
Multilateral Agreement for the recognition of calibration certificates

Accreditation No.: **SCS 0108**

Glossary:

TSL	tissue simulating liquid
ConvF	sensitivity in TSL / NORM x,y,z
N/A	not applicable or not measured

Calibration is Performed According to the Following Standards:

- IEEE Std 1528-2013, "IEEE Recommended Practice for Determining the Peak Spatial-Averaged Specific Absorption Rate (SAR) in the Human Head from Wireless Communications Devices: Measurement Techniques", June 2013
- IEC 62209-1, "Measurement procedure for the assessment of Specific Absorption Rate (SAR) from hand-held and body-mounted devices used next to the ear (frequency range of 300 MHz to 6 GHz)", July 2016
- IEC 62209-2, "Procedure to determine the Specific Absorption Rate (SAR) for wireless communication devices used in close proximity to the human body (frequency range of 30 MHz to 6 GHz)", March 2010
- KDB 865664, "SAR Measurement Requirements for 100 MHz to 6 GHz"

Additional Documentation:

- DASY4/5 System Handbook

Methods Applied and Interpretation of Parameters:

- Measurement Conditions:* Further details are available from the Validation Report at the end of the certificate. All figures stated in the certificate are valid at the frequency indicated.
- Antenna Parameters with TSL:* The dipole is mounted with the spacer to position its feed point exactly below the center marking of the flat phantom section, with the arms oriented parallel to the body axis.
- Feed Point Impedance and Return Loss:* These parameters are measured with the dipole positioned under the liquid filled phantom. The impedance stated is transformed from the measurement at the SMA connector to the feed point. The Return Loss ensures low reflected power. No uncertainty required.
- Electrical Delay:* One-way delay between the SMA connector and the antenna feed point. No uncertainty required.
- SAR measured:* SAR measured at the stated antenna input power.
- SAR normalized:* SAR as measured, normalized to an input power of 1 W at the antenna connector.
- SAR for nominal TSL parameters:* The measured TSL parameters are used to calculate the nominal SAR result.

The reported uncertainty of measurement is stated as the standard uncertainty of measurement multiplied by the coverage factor $k=2$, which for a normal distribution corresponds to a coverage probability of approximately 95%.

Measurement Conditions

DASY system configuration, as far as not given on page 1.

DASY Version	DASY5	V52.10.2
Extrapolation	Advanced Extrapolation	
Phantom	Modular Flat Phantom	
Distance Dipole Center - TSL	10 mm	with Spacer
Zoom Scan Resolution	dx, dy, dz = 5 mm	
Frequency	1900 MHz \pm 1 MHz	

Head TSL parameters

The following parameters and calculations were applied.

	Temperature	Permittivity	Conductivity
Nominal Head TSL parameters	22.0 °C	40.0	1.40 mho/m
Measured Head TSL parameters	(22.0 \pm 0.2) °C	40.3 \pm 6 %	1.40 mho/m \pm 6 %
Head TSL temperature change during test	< 0.5 °C	----	----

SAR result with Head TSL

SAR averaged over 1 cm³ (1 g) of Head TSL	Condition	
SAR measured	250 mW input power	9.80 W/kg
SAR for nominal Head TSL parameters	normalized to 1W	39.3 W/kg \pm 17.0 % (k=2)

SAR averaged over 10 cm³ (10 g) of Head TSL	condition	
SAR measured	250 mW input power	5.11 W/kg
SAR for nominal Head TSL parameters	normalized to 1W	20.5 W/kg \pm 16.5 % (k=2)

Body TSL parameters

The following parameters and calculations were applied.

	Temperature	Permittivity	Conductivity
Nominal Body TSL parameters	22.0 °C	53.3	1.52 mho/m
Measured Body TSL parameters	(22.0 \pm 0.2) °C	52.9 \pm 6 %	1.47 mho/m \pm 6 %
Body TSL temperature change during test	< 0.5 °C	----	----

SAR result with Body TSL

SAR averaged over 1 cm³ (1 g) of Body TSL	Condition	
SAR measured	250 mW input power	9.68 W/kg
SAR for nominal Body TSL parameters	normalized to 1W	39.4 W/kg \pm 17.0 % (k=2)

SAR averaged over 10 cm³ (10 g) of Body TSL	condition	
SAR measured	250 mW input power	5.11 W/kg
SAR for nominal Body TSL parameters	normalized to 1W	20.7 W/kg \pm 16.5 % (k=2)

Appendix (Additional assessments outside the scope of SCS 0108)

Antenna Parameters with Head TSL

Impedance, transformed to feed point	$52.9 \Omega + 6.3 j\Omega$
Return Loss	- 23.4 dB

Antenna Parameters with Body TSL

Impedance, transformed to feed point	$48.5 \Omega + 8.2 j\Omega$
Return Loss	- 21.5 dB

General Antenna Parameters and Design

Electrical Delay (one direction)	1.193 ns
----------------------------------	----------

After long term use with 100W radiated power, only a slight warming of the dipole near the feedpoint can be measured.

The dipole is made of standard semirigid coaxial cable. The center conductor of the feeding line is directly connected to the second arm of the dipole. The antenna is therefore short-circuited for DC-signals. On some of the dipoles, small end caps are added to the dipole arms in order to improve matching when loaded according to the position as explained in the "Measurement Conditions" paragraph. The SAR data are not affected by this change. The overall dipole length is still according to the Standard.

No excessive force must be applied to the dipole arms, because they might bend or the soldered connections near the feedpoint may be damaged.

Additional EUT Data

Manufactured by	SPEAG
Manufactured on	March 11, 2011

DASY5 Validation Report for Head TSL

Date: 23.10.2018

Test Laboratory: SPEAG, Zurich, Switzerland

DUT: Dipole 1900 MHz; Type: D1900V2; Serial: D1900V2 - SN:5d149

Communication System: UID 0 - CW; Frequency: 1900 MHz

Medium parameters used: $f = 1900$ MHz; $\sigma = 1.4$ S/m; $\epsilon_r = 40.3$; $\rho = 1000$ kg/m³

Phantom section: Flat Section

Measurement Standard: DASY5 (IEEE/IEC/ANSI C63.19-2011)

DASY52 Configuration:

- Probe: EX3DV4 - SN7349; ConvF(8.18, 8.18, 8.18) @ 1900 MHz; Calibrated: 30.12.2017
- Sensor-Surface: 1.4mm (Mechanical Surface Detection)
- Electronics: DAE4 Sn601; Calibrated: 04.10.2018
- Phantom: Flat Phantom 5.0 (front); Type: QD 000 P50 AA; Serial: 1001
- DASY52 52.10.2(1495); SEMCAD X 14.6.12(7450)

Dipole Calibration for Head Tissue/Pin=250 mW, d=10mm/Zoom Scan (7x7x7)/Cube 0:

Measurement grid: dx=5mm, dy=5mm, dz=5mm

Reference Value = 110.0 V/m; Power Drift = -0.03 dB

Peak SAR (extrapolated) = 18.5 W/kg

SAR(1 g) = 9.8 W/kg; SAR(10 g) = 5.11 W/kg

Maximum value of SAR (measured) = 15.4 W/kg

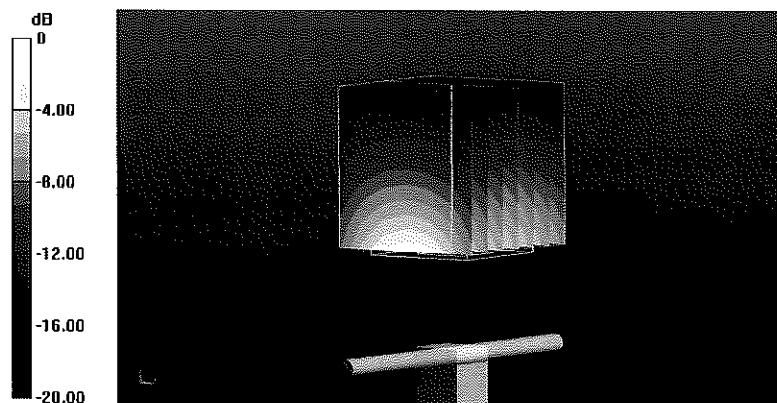

0 dB = 15.4 W/kg = 11.88 dBW/kg

Impedance Measurement Plot for Head TSL

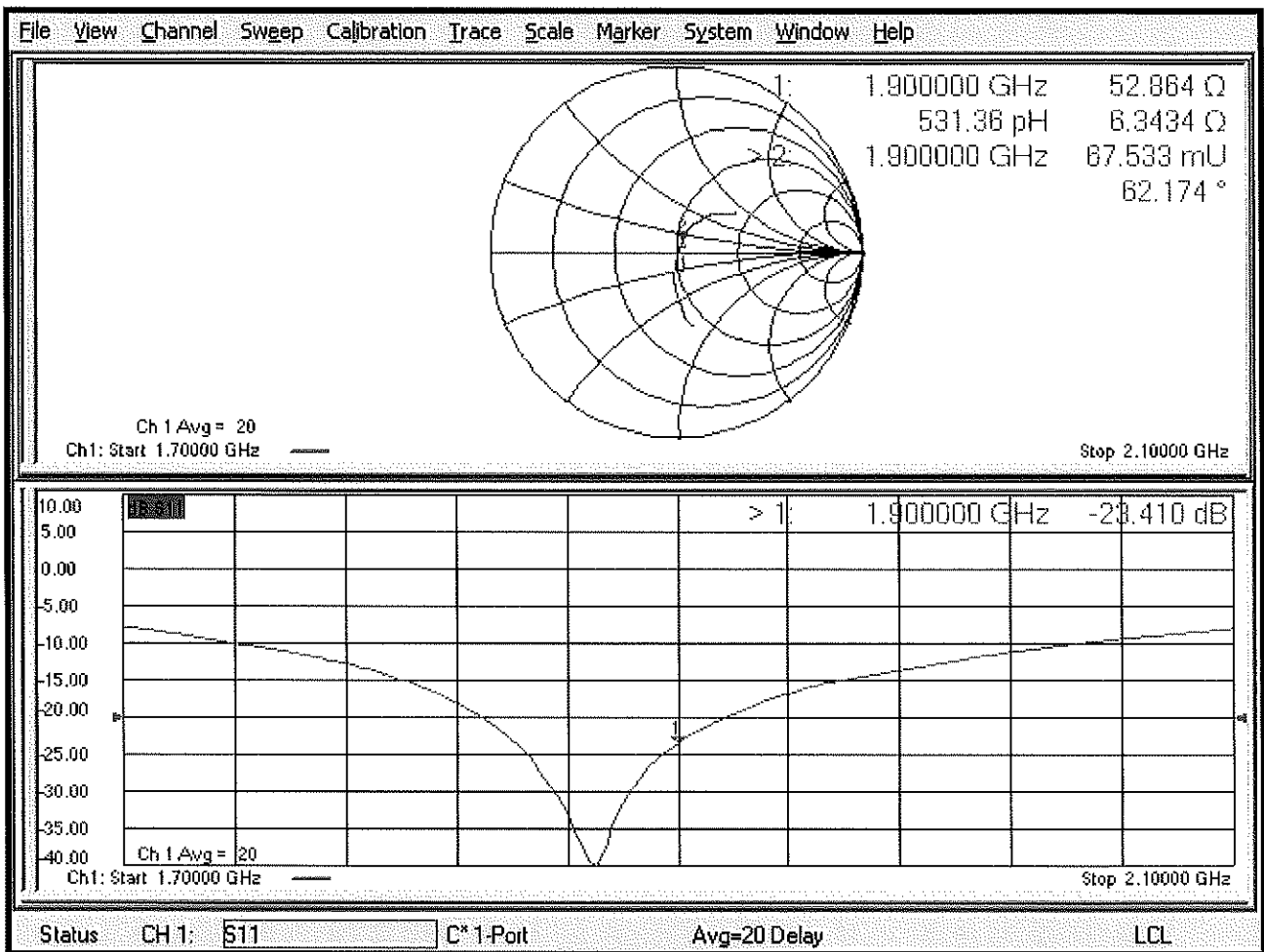

DASY5 Validation Report for Body TSL

Date: 23.10.2018

Test Laboratory: SPEAG, Zurich, Switzerland

DUT: Dipole 1900 MHz; Type: D1900V2; Serial: D1900V2 - SN:5d149

Communication System: UID 0 - CW; Frequency: 1900 MHz

Medium parameters used: $f = 1900$ MHz; $\sigma = 1.47$ S/m; $\epsilon_r = 52.9$; $\rho = 1000$ kg/m³

Phantom section: Flat Section

Measurement Standard: DASY5 (IEEE/IEC/ANSI C63.19-2011)

DASY52 Configuration:

- Probe: EX3DV4 - SN7349; ConvF(8.15, 8.15, 8.15) @ 1900 MHz; Calibrated: 30.12.2017
- Sensor-Surface: 1.4mm (Mechanical Surface Detection)
- Electronics: DAE4 Sn601; Calibrated: 04.10.2018
- Phantom: Flat Phantom 5.0 (back); Type: QD 000 P50 AA; Serial: 1002
- DASY52 52.10.2(1495); SEMCAD X 14.6.12(7450)

Dipole Calibration for Body Tissue/Pin=250 mW, d=10mm/Zoom Scan (7x7x7)/Cube 0:

Measurement grid: dx=5mm, dy=5mm, dz=5mm

Reference Value = 103.1 V/m; Power Drift = -0.03 dB

Peak SAR (extrapolated) = 17.5 W/kg

SAR(1 g) = 9.68 W/kg; SAR(10 g) = 5.11 W/kg

Maximum value of SAR (measured) = 14.2 W/kg

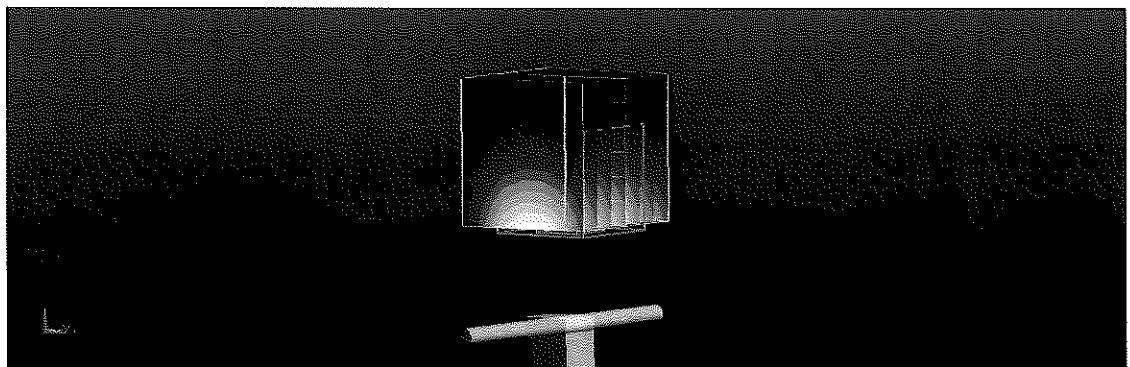
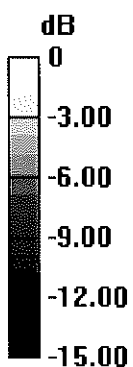

0 dB = 14.2 W/kg = 11.52 dBW/kg

Impedance Measurement Plot for Body TSL

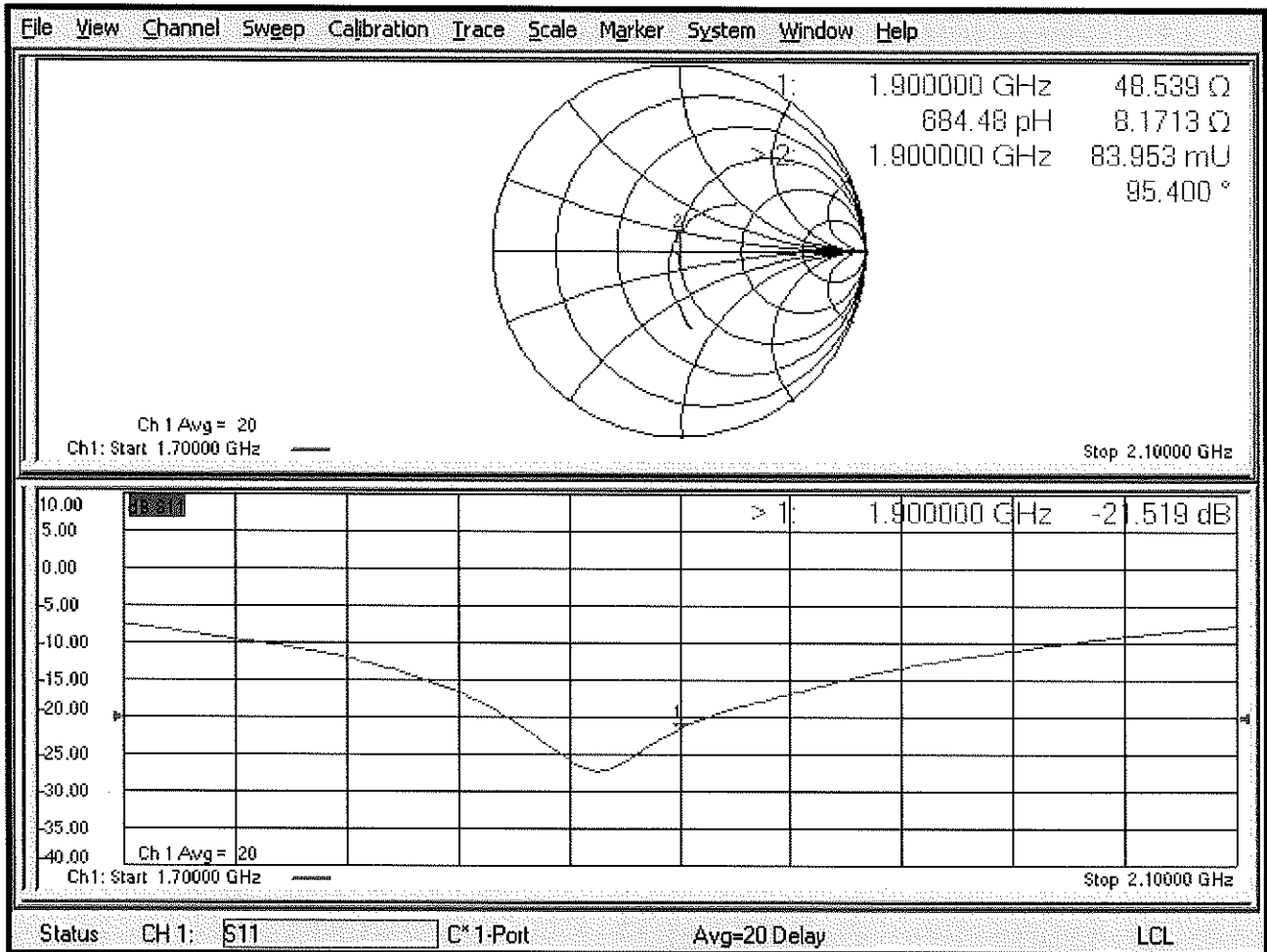



Accredited by the Swiss Accreditation Service (SAS)
The Swiss Accreditation Service is one of the signatories to the EA
Multilateral Agreement for the recognition of calibration certificates

Accreditation No.: **SCS 0108**

Client **PC Test**

Certificate No: **D2300V2-1064_Nov17**

CALIBRATION CERTIFICATE

Object **D2300V2 - SN:1064**

Calibration procedure(s) **QA CAL-05.V9
Calibration procedure for dipole validation kits above 700 MHz**

Calibration date: **November 08, 2017** PN ✓
02/04/2017

This calibration certificate documents the traceability to national standards, which realize the physical units of measurements (SI).
The measurements and the uncertainties with confidence probability are given on the following pages and are part of the certificate. PN ✓
11/21/2018

All calibrations have been conducted in the closed laboratory facility: environment temperature (22 ± 3)°C and humidity < 70%.

Calibration Equipment used (M&TE critical for calibration)

Primary Standards	ID #	Cal Date (Certificate No.)	Scheduled Calibration
Power meter NRP	SN: 104778	04-Apr-17 (No. 217-02521/02522)	Apr-18
Power sensor NRP-Z91	SN: 103244	04-Apr-17 (No. 217-02521)	Apr-18
Power sensor NRP-Z91	SN: 103245	04-Apr-17 (No. 217-02522)	Apr-18
Reference 20 dB Attenuator	SN: 5058 (20k)	07-Apr-17 (No. 217-02528)	Apr-18
Type-N mismatch combination	SN: 5047.2 / 06327	07-Apr-17 (No. 217-02529)	Apr-18
Reference Probe EX3DV4	SN: 7349	31-May-17 (No. EX3-7349_May17)	May-18
DAE4	SN: 601	26-Oct-17 (No. DAE4-601_Oct17)	Oct-18
Secondary Standards	ID #	Check Date (in house)	Scheduled Check
Power meter EPM-442A	SN: GB37480704	07-Oct-15 (in house check Oct-16)	In house check: Oct-18
Power sensor HP 8481A	SN: US37292783	07-Oct-15 (in house check Oct-16)	In house check: Oct-18
Power sensor HP 8481A	SN: MY41092317	07-Oct-15 (in house check Oct-16)	In house check: Oct-18
RF generator R&S SMT-06	SN: 100972	15-Jun-15 (in house check Oct-16)	In house check: Oct-18
Network Analyzer HP 8753E	SN: US37390585	18-Oct-01 (in house check Oct-17)	In house check: Oct-18

	Name	Function	Signature
Calibrated by:	Jeton Kastrati	Laboratory Technician	
Approved by:	Katja Pokovic	Technical Manager	

Issued: November 8, 2017

This calibration certificate shall not be reproduced except in full without written approval of the laboratory.



Accredited by the Swiss Accreditation Service (SAS)
The Swiss Accreditation Service is one of the signatories to the EA
Multilateral Agreement for the recognition of calibration certificates

Accreditation No.: **SCS 0108**

Glossary:

TSL tissue simulating liquid
ConvF sensitivity in TSL / NORM x,y,z
N/A not applicable or not measured

Calibration is Performed According to the Following Standards:

- a) IEEE Std 1528-2013, "IEEE Recommended Practice for Determining the Peak Spatial-Averaged Specific Absorption Rate (SAR) in the Human Head from Wireless Communications Devices: Measurement Techniques", June 2013
- b) IEC 62209-1, "Measurement procedure for the assessment of Specific Absorption Rate (SAR) from hand-held and body-mounted devices used next to the ear (frequency range of 300 MHz to 6 GHz)", July 2016
- c) IEC 62209-2, "Procedure to determine the Specific Absorption Rate (SAR) for wireless communication devices used in close proximity to the human body (frequency range of 30 MHz to 6 GHz)", March 2010
- d) KDB 865664, "SAR Measurement Requirements for 100 MHz to 6 GHz"

Additional Documentation:

- e) DASY4/5 System Handbook

Methods Applied and Interpretation of Parameters:

- *Measurement Conditions:* Further details are available from the Validation Report at the end of the certificate. All figures stated in the certificate are valid at the frequency indicated.
- *Antenna Parameters with TSL:* The dipole is mounted with the spacer to position its feed point exactly below the center marking of the flat phantom section, with the arms oriented parallel to the body axis.
- *Feed Point Impedance and Return Loss:* These parameters are measured with the dipole positioned under the liquid filled phantom. The impedance stated is transformed from the measurement at the SMA connector to the feed point. The Return Loss ensures low reflected power. No uncertainty required.
- *Electrical Delay:* One-way delay between the SMA connector and the antenna feed point. No uncertainty required.
- *SAR measured:* SAR measured at the stated antenna input power.
- *SAR normalized:* SAR as measured, normalized to an input power of 1 W at the antenna connector.
- *SAR for nominal TSL parameters:* The measured TSL parameters are used to calculate the nominal SAR result.

The reported uncertainty of measurement is stated as the standard uncertainty of measurement multiplied by the coverage factor $k=2$, which for a normal distribution corresponds to a coverage probability of approximately 95%.

Measurement Conditions

DASY system configuration, as far as not given on page 1.

DASY Version	DASY5	V52.10.0
Extrapolation	Advanced Extrapolation	
Phantom	Modular Flat Phantom	
Distance Dipole Center - TSL	10 mm	with Spacer
Zoom Scan Resolution	dx, dy, dz = 5 mm	
Frequency	2300 MHz ± 1 MHz	

Head TSL parameters

The following parameters and calculations were applied.

	Temperature	Permittivity	Conductivity
Nominal Head TSL parameters	22.0 °C	39.5	1.67 mho/m
Measured Head TSL parameters	(22.0 ± 0.2) °C	38.3 ± 6 %	1.70 mho/m ± 6 %
Head TSL temperature change during test	< 0.5 °C	----	----

SAR result with Head TSL

SAR averaged over 1 cm³ (1 g) of Head TSL	Condition	
SAR measured	250 mW input power	12.1 W/kg
SAR for nominal Head TSL parameters	normalized to 1W	47.6 W/kg ± 17.0 % (k=2)

SAR averaged over 10 cm³ (10 g) of Head TSL	condition	
SAR measured	250 mW input power	5.84 W/kg
SAR for nominal Head TSL parameters	normalized to 1W	23.1 W/kg ± 16.5 % (k=2)

Body TSL parameters

The following parameters and calculations were applied.

	Temperature	Permittivity	Conductivity
Nominal Body TSL parameters	22.0 °C	52.9	1.81 mho/m
Measured Body TSL parameters	(22.0 ± 0.2) °C	51.9 ± 6 %	1.85 mho/m ± 6 %
Body TSL temperature change during test	< 0.5 °C	----	----

SAR result with Body TSL

SAR averaged over 1 cm³ (1 g) of Body TSL	Condition	
SAR measured	250 mW input power	11.8 W/kg
SAR for nominal Body TSL parameters	normalized to 1W	46.5 W/kg ± 17.0 % (k=2)

SAR averaged over 10 cm³ (10 g) of Body TSL	condition	
SAR measured	250 mW input power	5.69 W/kg
SAR for nominal Body TSL parameters	normalized to 1W	22.6 W/kg ± 16.5 % (k=2)

Appendix (Additional assessments outside the scope of SCS 0108)

Antenna Parameters with Head TSL

Impedance, transformed to feed point	48.4 Ω - 5.2 j Ω
Return Loss	- 25.1 dB

Antenna Parameters with Body TSL

Impedance, transformed to feed point	45.1 Ω - 4.1 j Ω
Return Loss	- 23.5 dB

General Antenna Parameters and Design

Electrical Delay (one direction)	1.168 ns
----------------------------------	----------

After long term use with 100W radiated power, only a slight warming of the dipole near the feedpoint can be measured.

The dipole is made of standard semirigid coaxial cable. The center conductor of the feeding line is directly connected to the second arm of the dipole. The antenna is therefore short-circuited for DC-signals. On some of the dipoles, small end caps are added to the dipole arms in order to improve matching when loaded according to the position as explained in the "Measurement Conditions" paragraph. The SAR data are not affected by this change. The overall dipole length is still according to the Standard.

No excessive force must be applied to the dipole arms, because they might bend or the soldered connections near the feedpoint may be damaged.

Additional EUT Data

Manufactured by	SPEAG
Manufactured on	August 20, 2015

DASY5 Validation Report for Head TSL

Date: 08.11.2017

Test Laboratory: SPEAG, Zurich, Switzerland

DUT: Dipole 2300 MHz; Type: D2300V2; Serial: D2300V2 - SN:1064

Communication System: UID 0 - CW; Frequency: 2300 MHz

Medium parameters used: $f = 2300$ MHz; $\sigma = 1.7$ S/m; $\epsilon_r = 38.3$; $\rho = 1000$ kg/m³

Phantom section: Flat Section

Measurement Standard: DASY5 (IEEE/IEC/ANSI C63.19-2011)

DASY52 Configuration:

- Probe: EX3DV4 - SN7349; ConvF(8.31, 8.31, 8.31); Calibrated: 31.05.2017;
- Sensor-Surface: 1.4mm (Mechanical Surface Detection)
- Electronics: DAE4 Sn601; Calibrated: 26.10.2017
- Phantom: Flat Phantom 5.0 (front); Type: QD 000 P50 AA; Serial: 1001
- DASY52 52.10.0(1446); SEMCAD X 14.6.10(7417)

Dipole Calibration for Head Tissue/ $P_{in}=250$ mW, $d=10$ mm/Zoom Scan (7x7x7)/Cube 0:

Measurement grid: $dx=5$ mm, $dy=5$ mm, $dz=5$ mm

Reference Value = 112.6 V/m; Power Drift = 0.04 dB

Peak SAR (extrapolated) = 23.8 W/kg

SAR(1 g) = 12.1 W/kg; SAR(10 g) = 5.84 W/kg

Maximum value of SAR (measured) = 19.5 W/kg

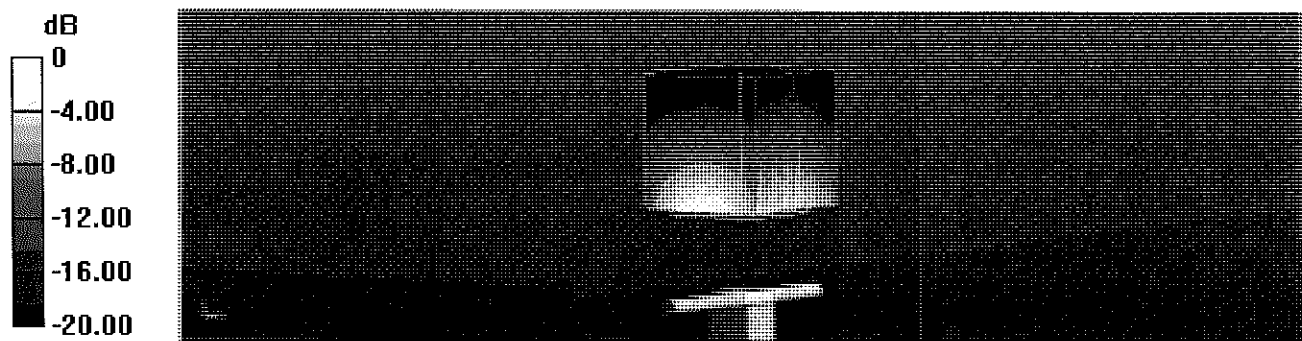

0 dB = 19.5 W/kg = 12.90 dBW/kg

Impedance Measurement Plot for Head TSL

CH1 S11 1 U FS 8 Nov 2017 15:26:40
1: 48.379 Ω -5.2344 Ω 13.220 pF 2 300.000 000 MHz

*
De1

CΔ

Avg
15

H1d

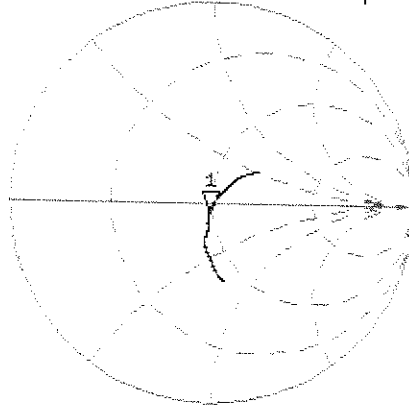

CH2 S11 LOG 5 dB/REF -20 dB 1: -25.097 dB 2 300.000 000 MHz

CΔ

Avg
15

H1d

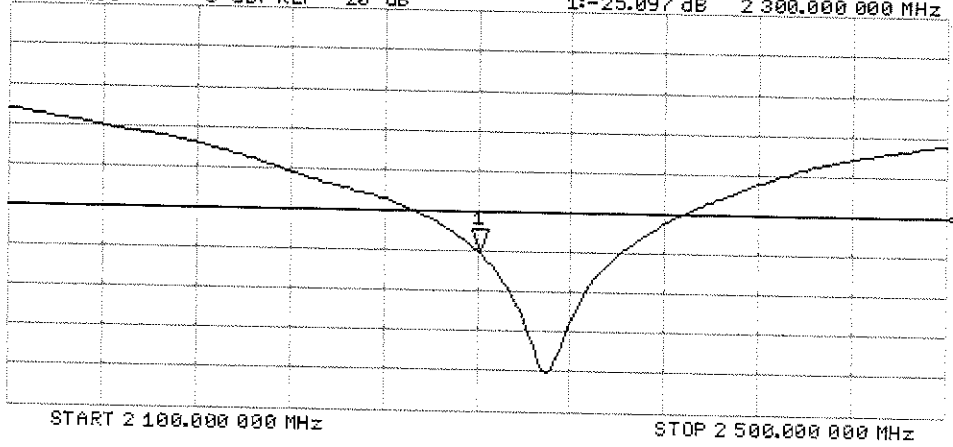

DASY5 Validation Report for Body TSL

Date: 08.11.2017

Test Laboratory: SPEAG, Zurich, Switzerland

DUT: Dipole 2300 MHz; Type: D2300V2; Serial: D2300V2 - SN:1064

Communication System: UID 0 - CW; Frequency: 2300 MHz

Medium parameters used: $f = 2300$ MHz; $\sigma = 1.85$ S/m; $\epsilon_r = 51.9$; $\rho = 1000$ kg/m³

Phantom section: Flat Section

Measurement Standard: DASY5 (IEEE/IEC/ANSI C63.19-2011)

DASY52 Configuration:

- Probe: EX3DV4 - SN7349; ConvF(8.22, 8.22, 8.22); Calibrated: 31.05.2017;
- Sensor-Surface: 1.4mm (Mechanical Surface Detection)
- Electronics: DAE4 Sn601; Calibrated: 26.10.2017
- Phantom: Flat Phantom 5.0 (back); Type: QD 000 P50 AA; Serial: 1002
- DASY52 52.10.0(1446); SEMCAD X 14.6.10(7417)

Dipole Calibration for Body Tissue/ $P_{in}=250$ mW, $d=10$ mm/Zoom Scan (7x7x7)/Cube 0:

Measurement grid: $dx=5$ mm, $dy=5$ mm, $dz=5$ mm

Reference Value = 105.6 V/m; Power Drift = -0.07 dB

Peak SAR (extrapolated) = 22.6 W/kg

SAR(1 g) = 11.8 W/kg; SAR(10 g) = 5.69 W/kg

Maximum value of SAR (measured) = 18.4 W/kg

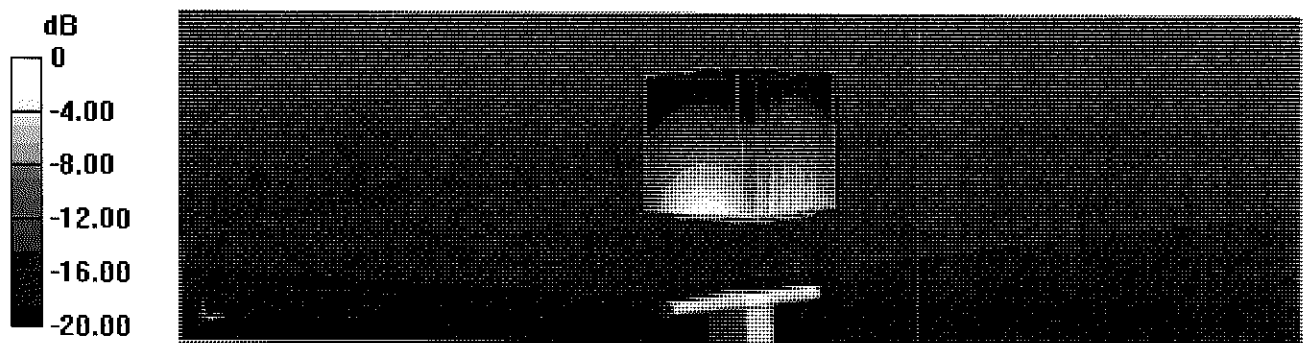

0 dB = 18.4 W/kg = 12.65 dBW/kg

Impedance Measurement Plot for Body TSL

8 Nov 2017 15:26:06
CH1 S11 1 U FS 1: 45.111 Ω -4.0645 Ω 17.025 pF 2 300.000 000 MHz

*
De1
CA
Avg
16
H1d

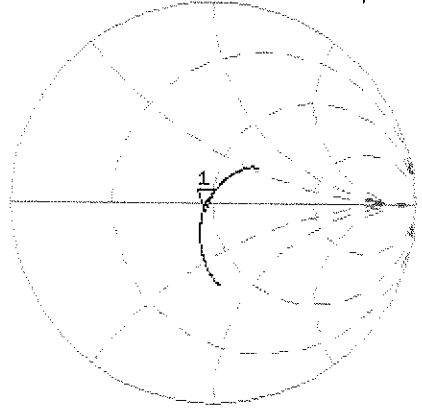

CH2 S11 LOG 5 dB/REF -20 dB 1: -23.504 dB 2 300.000 000 MHz

CA
Avg
16
H1d

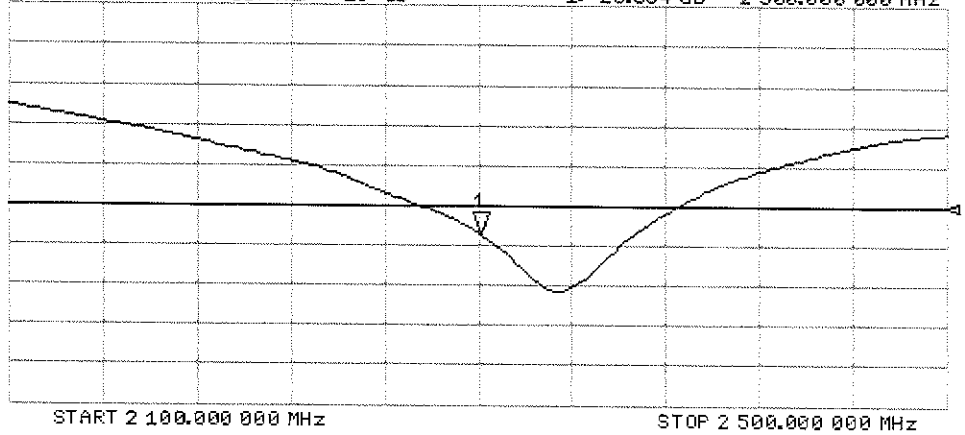

Certification of Calibration

Object: D2300V2 – SN: 1064

Calibration procedure(s): Procedure for Calibration Extension for SAR Dipoles.

Extended Calibration date: November 20, 2018

Description: SAR Validation Dipole at 2300 MHz.

Calibration Equipment used:

Manufacturer	Model	Description	Cal Date	Cal Interval	Cal Due	Serial Number
Agilent	8753ES	S-Parameter Vector Network Analyzer	8/30/2018	Annual	8/30/2019	MY40003841
Agilent	N5182A	MXG Vector Signal Generator	4/18/2018	Annual	4/18/2019	MY47420800
Amplifier Research	15S1G6	Amplifier	CBT	N/A	CBT	433971
Anritsu	MA2411B	Pulse Power Sensor	3/2/2018	Annual	3/2/2019	1207364
Anritsu	MA2411B	Pulse Power Sensor	3/2/2018	Annual	3/2/2019	1339018
Anritsu	ML2495A	Power Meter	10/22/2017	Annual	10/22/2018	1328004
Control Company	4040	Therm./Clock/Humidity Monitor	3/31/2017	Biennial	3/31/2019	170232394
Control Company	4352	Ultra Long Stem Thermometer	5/2/2017	Biennial	5/2/2019	170330156
Keysight	772D	Dual Directional Coupler	CBT	N/A	CBT	MY52180215
Keysight Technologies	85033E	Standard Mechanical Calibration Kit (DC to 9GHz, 3.5mm)	6/4/2018	Annual	6/4/2019	MY53401181
MiniCircuits	VLF-6000+	Low Pass Filter	CBT	N/A	CBT	N/A
Mini-Circuits	BW-N20W5+	DC to 18 GHz Precision Fixed 20 dB Attenuator	CBT	N/A	CBT	N/A
Narda	4772-3	Attenuator (3dB)	CBT	N/A	CBT	9406
Seekonk	NC-100	Torque Wrench	7/11/2018	Annual	7/11/2019	N/A
SPEAG	DAE4	Dasy Data Acquisition Electronics	6/18/2018	Annual	6/18/2019	1334
SPEAG	DAE4	Dasy Data Acquisition Electronics	7/11/2018	Annual	7/11/2019	1322
SPEAG	DAK-3.5	Dielectric Assessment Kit	5/15/2018	Annual	5/15/2019	1070
SPEAG	EX3DV4	SAR Probe	6/25/2018	Annual	6/25/2019	7409
SPEAG	EX3DV4	SAR Probe	7/20/2018	Annual	7/20/2019	7410

Measurement Uncertainty = $\pm 23\%$ (k=2)

	Name	Function	Signature
Calibrated By:	Brodie Halbfoster	SAR Test Engineer	<i>BRODIE HALBFOSTER</i>
Approved By:	Kaitlin O'Keefe	Senior Technical Manager	<i>KOK</i>

DIPOLE CALIBRATION EXTENSION

Per KDB 865664 D01, calibration intervals of up to three years may be considered for reference dipoles when it is demonstrated that the SAR target, impedance and return loss of a dipole have remained stable according to the following requirements:

1. The measured SAR does not deviate more than 10% from the target on the calibration certificate.
2. The return-loss does not deviate more than 20% from the previous measurement and meets the required 20dB minimum return-loss requirement.
3. The measurement of real or imaginary parts of impedance does not deviate more than 5Ω from the previous measurement.

The following dipole was checked to pass the above 3 requirements to have 2-year calibration period from the calibration date:

Calibration Date	Extension Date	Certificate Electrical Delay (ns)	Certificate SAR Target Head (1g) W/kg @ 20.0 dBm	Measured Head SAR (1g) W/kg @ 20.0 dBm	Deviation 1g (%)	Certificate SAR Target Head (10g) W/kg @ 20.0 dBm	Measured Head SAR (10g) W/kg @ 20.0 dBm	Deviation 10g (%)	Certificate Impedance Head (Ohm) Real	Measured Impedance Head (Ohm) Real	Difference (Ohm) Real	Certificate Impedance Head (Ohm) Imaginary	Measured Impedance Head (Ohm) Imaginary	Difference (Ohm) Imaginary	Certificate Return Loss Head (dB)	Measured Return Loss Head (dB)	Deviation (%)	PASS/FAIL
11/8/2017	11/20/2018	1.168	4.76	4.69	-1.47%	2.31	2.24	-3.03%	48.4	46.3	2.1	-5.2	-3.3	1.9	-25.1	-25.7	-2.20%	PASS
Calibration Date	Extension Date	Certificate Electrical Delay (ns)	Certificate SAR Target Body (1g) W/kg @ 20.0 dBm	Measured Body SAR (1g) W/kg @ 20.0 dBm	Deviation 1g (%)	Certificate SAR Target Body (10g) W/kg @ 20.0 dBm	Measured Body SAR (10g) W/kg @ 20.0 dBm	Deviation 10g (%)	Certificate Impedance Body (Ohm) Real	Measured Impedance Body (Ohm) Real	Difference (Ohm) Real	Certificate Impedance Body (Ohm) Imaginary	Measured Impedance Body (Ohm) Imaginary	Difference (Ohm) Imaginary	Certificate Return Loss Body (dB)	Measured Return Loss Body (dB)	Deviation (%)	PASS/FAIL
11/8/2017	11/20/2018	1.168	4.65	4.83	3.87%	2.26	2.29	1.33%	45.1	45.2	0.1	-4.1	-3.4	0.7	-23.5	-24.1	-2.40%	PASS

Impedance & Return-Loss Measurement Plot for Head TSL

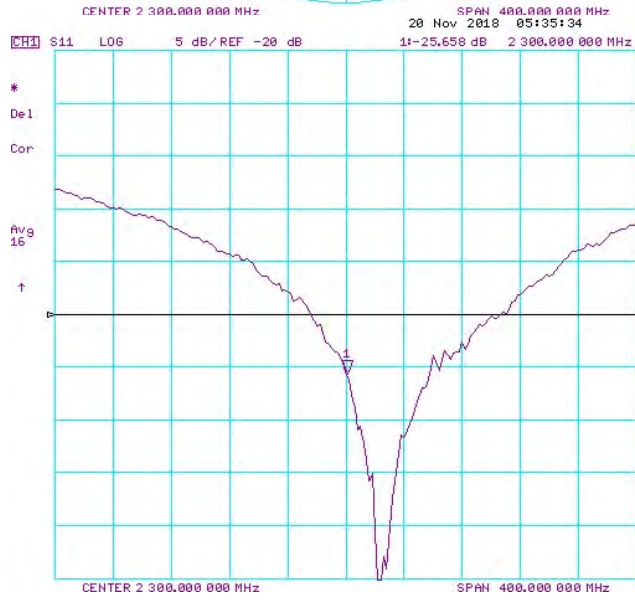
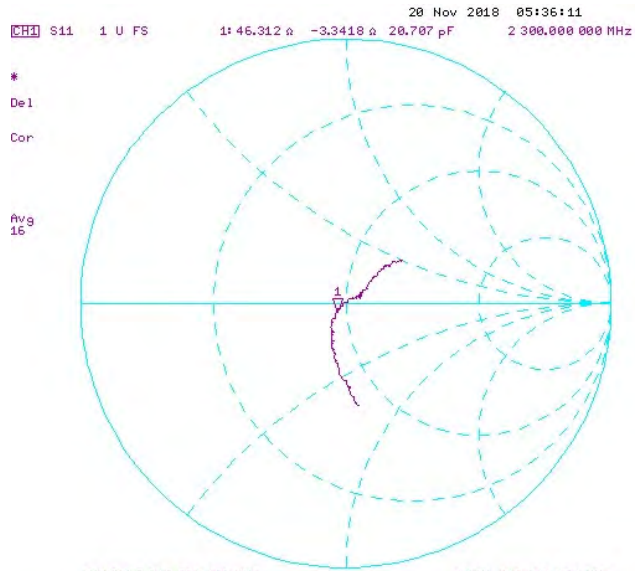

Impedance & Return-Loss Measurement Plot for Body TSL

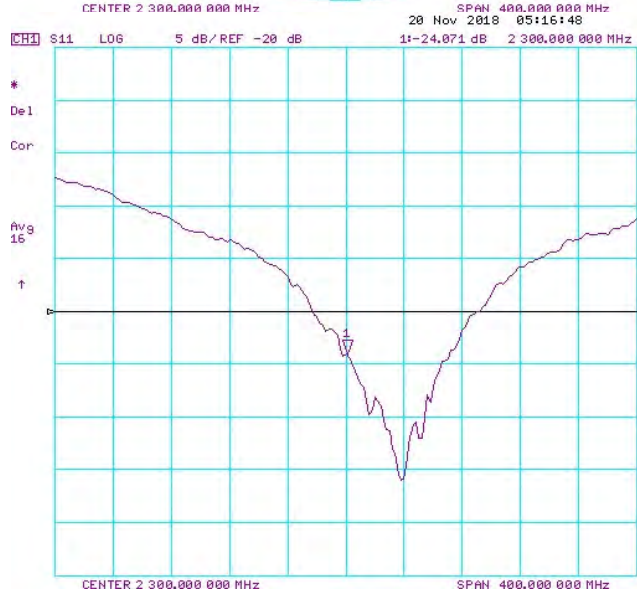
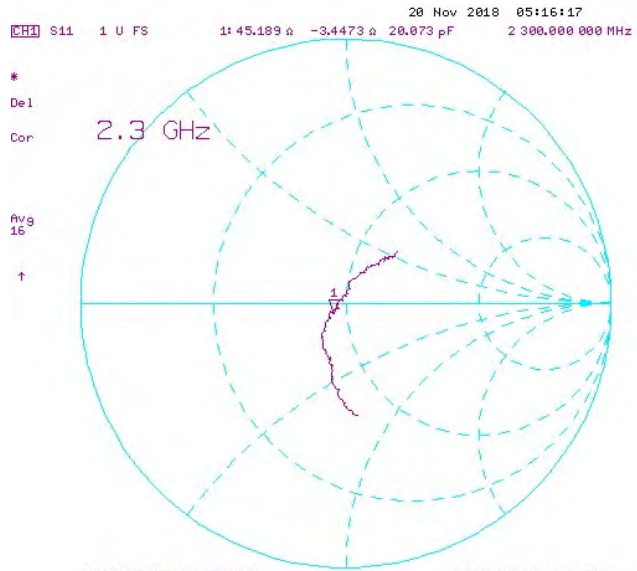



Accredited by the Swiss Accreditation Service (SAS)
The Swiss Accreditation Service is one of the signatories to the EA
Multilateral Agreement for the recognition of calibration certificates

Accreditation No.: **SCS 0108**

Client **PC Test**

Certificate No: **D2300V2-1073_Aug18**

CALIBRATION CERTIFICATE

BW
09-06-2018

Object **D2300V2 - SN:1073**

Calibration procedure(s) **QA CAL-05.v10**
Calibration procedure for dipole validation kits above 700 MHz

Calibration date: **August 13, 2018**

This calibration certificate documents the traceability to national standards, which realize the physical units of measurements (SI).
The measurements and the uncertainties with confidence probability are given on the following pages and are part of the certificate.

All calibrations have been conducted in the closed laboratory facility: environment temperature (22 ± 3)°C and humidity < 70%.

Calibration Equipment used (M&TE critical for calibration)

Primary Standards	ID #	Cal Date (Certificate No.)	Scheduled Calibration
Power meter NRP	SN: 104778	04-Apr-18 (No. 217-02672/02673)	Apr-19
Power sensor NRP-Z91	SN: 103244	04-Apr-18 (No. 217-02672)	Apr-19
Power sensor NRP-Z91	SN: 103245	04-Apr-18 (No. 217-02673)	Apr-19
Reference 20 dB Attenuator	SN: 5058 (20k)	04-Apr-18 (No. 217-02682)	Apr-19
Type-N mismatch combination	SN: 5047.2 / 06327	04-Apr-18 (No. 217-02683)	Apr-19
Reference Probe EX3DV4	SN: 7349	30-Dec-17 (No. EX3-7349_Dec17)	Dec-18
DAE4	SN: 601	26-Oct-17 (No. DAE4-601_Oct17)	Oct-18
Secondary Standards	ID #	Check Date (in house)	Scheduled Check
Power meter EPM-442A	SN: GB37480704	07-Oct-15 (in house check Oct-16)	In house check: Oct-18
Power sensor HP 8481A	SN: US37292783	07-Oct-15 (in house check Oct-16)	In house check: Oct-18
Power sensor HP 8481A	SN: MY41092317	07-Oct-15 (in house check Oct-16)	In house check: Oct-18
RF generator R&S SMT-06	SN: 100972	15-Jun-15 (in house check Oct-16)	In house check: Oct-18
Network Analyzer Agilent E8358A	SN: US41080477	31-Mar-14 (in house check Oct-17)	In house check: Oct-18

Calibrated by: **Name** Michael Weber **Function** Laboratory Technician

Signature *M. Weber*

Approved by: **Name** Katja Pokovic **Function** Technical Manager

Signature *K. Pokovic*

Issued: August 13, 2018

This calibration certificate shall not be reproduced except in full without written approval of the laboratory.



Accredited by the Swiss Accreditation Service (SAS)

The Swiss Accreditation Service is one of the signatories to the EA
Multilateral Agreement for the recognition of calibration certificates

Accreditation No.: **SCS 0108**

Glossary:

TSL	tissue simulating liquid
ConvF	sensitivity in TSL / NORM x,y,z
N/A	not applicable or not measured

Calibration is Performed According to the Following Standards:

- IEEE Std 1528-2013, "IEEE Recommended Practice for Determining the Peak Spatial-Averaged Specific Absorption Rate (SAR) in the Human Head from Wireless Communications Devices: Measurement Techniques", June 2013
- IEC 62209-1, "Measurement procedure for the assessment of Specific Absorption Rate (SAR) from hand-held and body-mounted devices used next to the ear (frequency range of 300 MHz to 6 GHz)", July 2016
- IEC 62209-2, "Procedure to determine the Specific Absorption Rate (SAR) for wireless communication devices used in close proximity to the human body (frequency range of 30 MHz to 6 GHz)", March 2010
- KDB 865664, "SAR Measurement Requirements for 100 MHz to 6 GHz"

Additional Documentation:

- DASY4/5 System Handbook

Methods Applied and Interpretation of Parameters:

- Measurement Conditions:** Further details are available from the Validation Report at the end of the certificate. All figures stated in the certificate are valid at the frequency indicated.
- Antenna Parameters with TSL:** The dipole is mounted with the spacer to position its feed point exactly below the center marking of the flat phantom section, with the arms oriented parallel to the body axis.
- Feed Point Impedance and Return Loss:** These parameters are measured with the dipole positioned under the liquid filled phantom. The impedance stated is transformed from the measurement at the SMA connector to the feed point. The Return Loss ensures low reflected power. No uncertainty required.
- Electrical Delay:** One-way delay between the SMA connector and the antenna feed point. No uncertainty required.
- SAR measured:** SAR measured at the stated antenna input power.
- SAR normalized:** SAR as measured, normalized to an input power of 1 W at the antenna connector.
- SAR for nominal TSL parameters:** The measured TSL parameters are used to calculate the nominal SAR result.

The reported uncertainty of measurement is stated as the standard uncertainty of measurement multiplied by the coverage factor $k=2$, which for a normal distribution corresponds to a coverage probability of approximately 95%.

Measurement Conditions

DASY system configuration, as far as not given on page 1.

DASY Version	DASY5	V52.10.1
Extrapolation	Advanced Extrapolation	
Phantom	Modular Flat Phantom	
Distance Dipole Center - TSL	10 mm	with Spacer
Zoom Scan Resolution	dx, dy, dz = 5 mm	
Frequency	2300 MHz \pm 1 MHz	

Head TSL parameters

The following parameters and calculations were applied.

	Temperature	Permittivity	Conductivity
Nominal Head TSL parameters	22.0 °C	39.5	1.67 mho/m
Measured Head TSL parameters	(22.0 \pm 0.2) °C	38.2 \pm 6 %	1.70 mho/m \pm 6 %
Head TSL temperature change during test	< 0.5 °C	----	----

SAR result with Head TSL

SAR averaged over 1 cm³ (1 g) of Head TSL	Condition	
SAR measured	250 mW input power	12.5 W/kg
SAR for nominal Head TSL parameters	normalized to 1W	49.2 W/kg \pm 17.0 % (k=2)

SAR averaged over 10 cm³ (10 g) of Head TSL	condition	
SAR measured	250 mW input power	6.02 W/kg
SAR for nominal Head TSL parameters	normalized to 1W	23.8 W/kg \pm 16.5 % (k=2)

Body TSL parameters

The following parameters and calculations were applied.

	Temperature	Permittivity	Conductivity
Nominal Body TSL parameters	22.0 °C	52.9	1.81 mho/m
Measured Body TSL parameters	(22.0 \pm 0.2) °C	52.2 \pm 6 %	1.85 mho/m \pm 6 %
Body TSL temperature change during test	< 0.5 °C	----	----

SAR result with Body TSL

SAR averaged over 1 cm³ (1 g) of Body TSL	Condition	
SAR measured	250 mW input power	12.1 W/kg
SAR for nominal Body TSL parameters	normalized to 1W	47.7 W/kg \pm 17.0 % (k=2)

SAR averaged over 10 cm³ (10 g) of Body TSL	condition	
SAR measured	250 mW input power	5.86 W/kg
SAR for nominal Body TSL parameters	normalized to 1W	23.2 W/kg \pm 16.5 % (k=2)

Appendix (Additional assessments outside the scope of SCS 0108)

Antenna Parameters with Head TSL

Impedance, transformed to feed point	50.1 Ω - 5.2 j Ω
Return Loss	- 25.7 dB

Antenna Parameters with Body TSL

Impedance, transformed to feed point	45.5 Ω - 4.1 j Ω
Return Loss	- 23.9 dB

General Antenna Parameters and Design

Electrical Delay (one direction)	1.171 ns
----------------------------------	----------

After long term use with 100W radiated power, only a slight warming of the dipole near the feedpoint can be measured.

The dipole is made of standard semirigid coaxial cable. The center conductor of the feeding line is directly connected to the second arm of the dipole. The antenna is therefore short-circuited for DC-signals. On some of the dipoles, small end caps are added to the dipole arms in order to improve matching when loaded according to the position as explained in the "Measurement Conditions" paragraph. The SAR data are not affected by this change. The overall dipole length is still according to the Standard.

No excessive force must be applied to the dipole arms, because they might bend or the soldered connections near the feedpoint may be damaged.

Additional EUT Data

Manufactured by	SPEAG
Manufactured on	November 16, 2015

DASY5 Validation Report for Head TSL

Date: 13.08.2018

Test Laboratory: SPEAG, Zurich, Switzerland

DUT: Dipole 2300 MHz; Type: D2300V2; Serial: D2300V2 - SN: 1073

Communication System: UID 0 - CW; Frequency: 2300 MHz

Medium parameters used: $f = 2300$ MHz; $\sigma = 1.7$ S/m; $\epsilon_r = 38.2$; $\rho = 1000$ kg/m³

Phantom section: Flat Section

Measurement Standard: DASY5 (IEEE/IEC/ANSI C63.19-2011)

DASY52 Configuration:

- Probe: EX3DV4 - SN7349; ConvF(8.08, 8.08, 8.08) @ 2300 MHz; Calibrated: 30.12.2017
- Sensor-Surface: 1.4mm (Mechanical Surface Detection)
- Electronics: DAE4 Sn601; Calibrated: 26.10.2017
- Phantom: Flat Phantom 5.0 (front); Type: QD 000 P50 AA; Serial: 1001
- DASY52 52.10.1(1476); SEMCAD X 14.6.11(7439)

Dipole Calibration for Head Tissue/Pin=250 mW, d=10mm/Zoom Scan (7x7x7)/Cube 0:

Measurement grid: $dx=5$ mm, $dy=5$ mm, $dz=5$ mm

Reference Value = 115.9 V/m; Power Drift = -0.05 dB

Peak SAR (extrapolated) = 24.1 W/kg

SAR(1 g) = 12.5 W/kg; SAR(10 g) = 6.02 W/kg

Maximum value of SAR (measured) = 20.2 W/kg

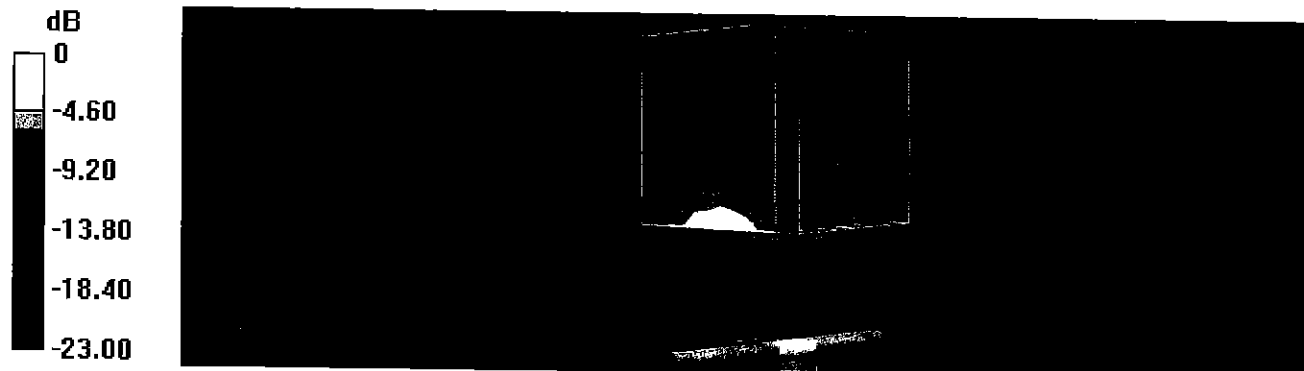

0 dB = 20.2 W/kg = 13.05 dBW/kg

Impedance Measurement Plot for Head TSL

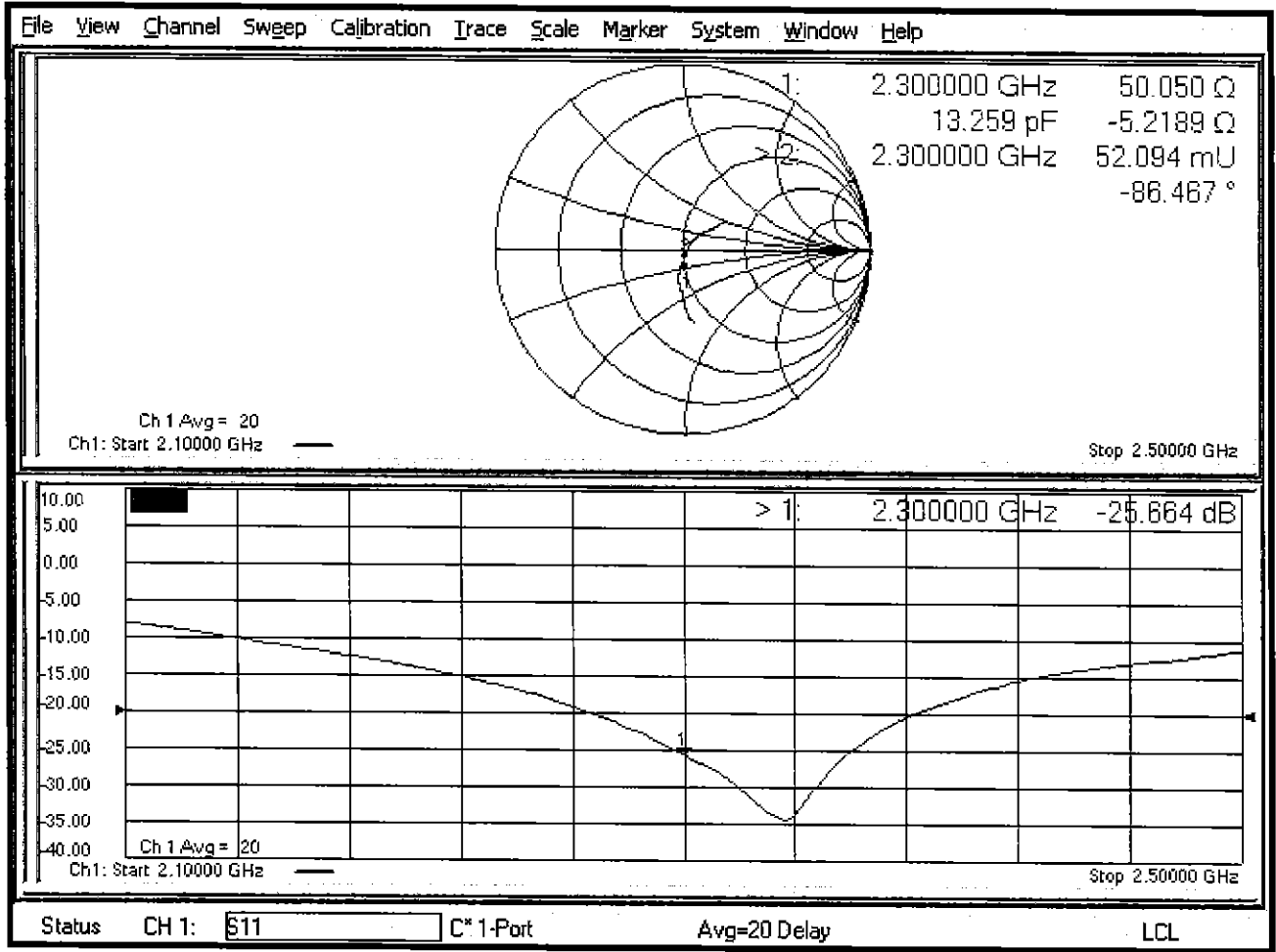

DASY5 Validation Report for Body TSL

Date: 13.08.2018

Test Laboratory: SPEAG, Zurich, Switzerland

DUT: Dipole 2300 MHz; Type: D2300V2; Serial: D2300V2 - SN: 1073

Communication System: UID 0 - CW; Frequency: 2300 MHz

Medium parameters used: $f = 2300$ MHz; $\sigma = 1.85$ S/m; $\epsilon_r = 52.2$; $\rho = 1000$ kg/m³

Phantom section: Flat Section

Measurement Standard: DASY5 (IEEE/IEC/ANSI C63.19-2011)

DASY52 Configuration:

- Probe: EX3DV4 - SN7349; ConvF(8.08, 8.08, 8.08) @ 2300 MHz; Calibrated: 30.12.2017
- Sensor-Surface: 1.4mm (Mechanical Surface Detection)
- Electronics: DAE4 Sn601; Calibrated: 26.10.2017
- Phantom: Flat Phantom 5.0 (back); Type: QD 000 P50 AA; Serial: 1002
- DASY52 52.10.1(1476); SEMCAD X 14.6.11(7439)

Dipole Calibration for Body Tissue/Pin=250 mW, d=10mm/Zoom Scan (7x7x7)/Cube 0:

Measurement grid: dx=5mm, dy=5mm, dz=5mm

Reference Value = 107.5 V/m; Power Drift = -0.08 dB

Peak SAR (extrapolated) = 22.9 W/kg

SAR(1 g) = 12.1 W/kg; SAR(10 g) = 5.86 W/kg

Maximum value of SAR (measured) = 19.1 W/kg

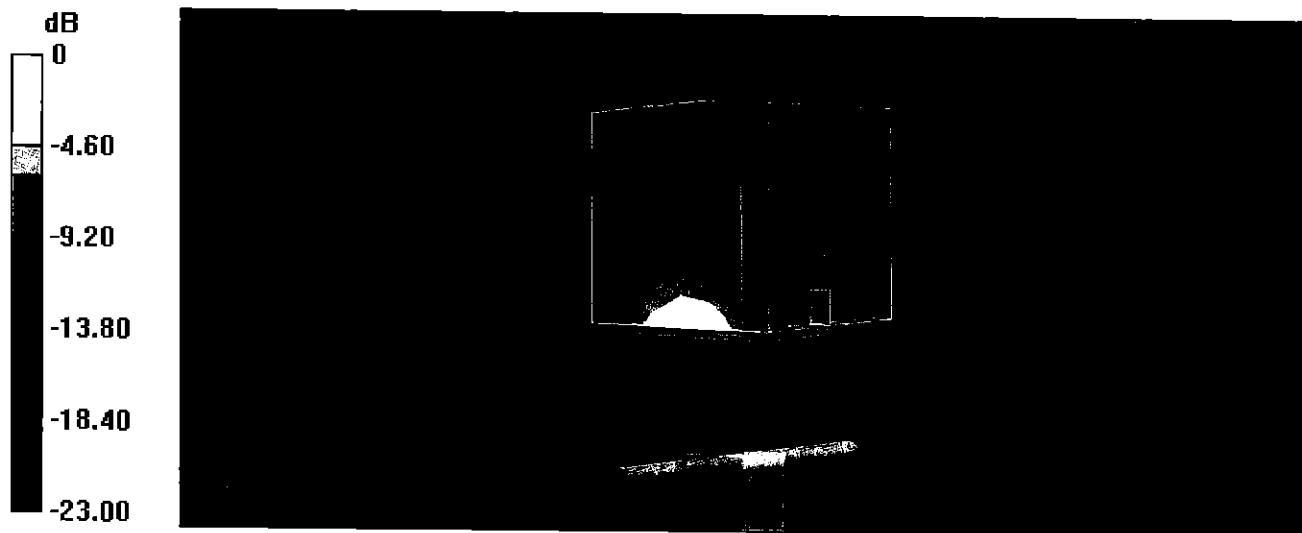

Impedance Measurement Plot for Body TSL

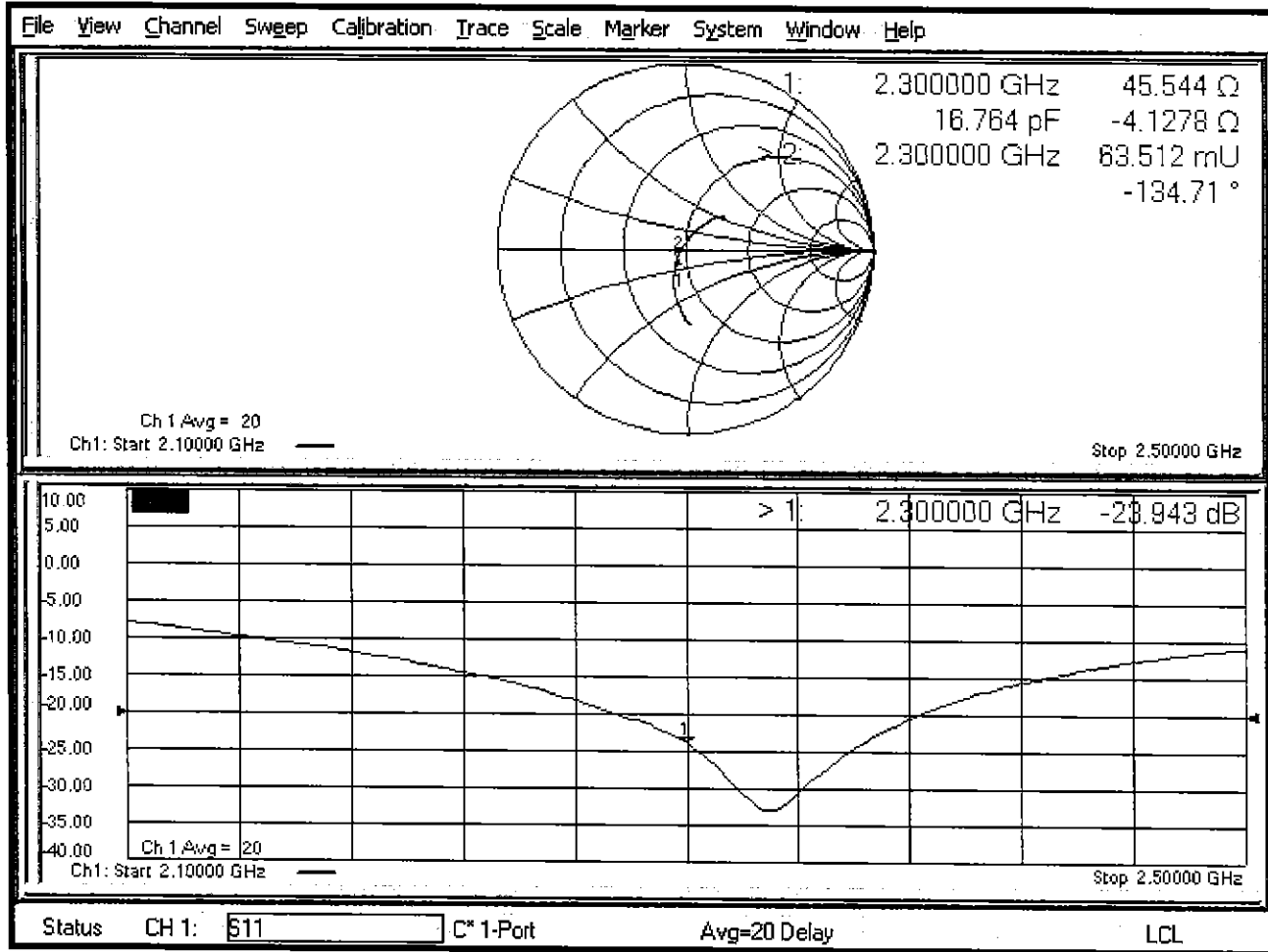

**Calibration Laboratory of
Schmid & Partner
Engineering AG**
Zeughausstrasse 43, 8004 Zurich, Switzerland



S Schweizerischer Kalibrierdienst
C Service suisse d'étalonnage
S Servizio svizzero di taratura
S Swiss Calibration Service

Accredited by the Swiss Accreditation Service (SAS)
The Swiss Accreditation Service is one of the signatories to the EA
Multilateral Agreement for the recognition of calibration certificates

Accreditation No.: **SCS 0108**

Client **PC Test**

Certificate No: **D2450V2-719_Aug17**

CALIBRATION CERTIFICATE

Object **D2450V2 - SN:719**

Calibration procedure(s) **QA CAL-05.v9**
Calibration procedure for dipole validation kits above 700 MHz

Calibration date: **August 17, 2017**

PMV ✓
8/27/17
Extended
BN ✓
7/19/2018

This calibration certificate documents the traceability to national standards, which realize the physical units of measurements (SI). The measurements and the uncertainties with confidence probability are given on the following pages and are part of the certificate.

All calibrations have been conducted in the closed laboratory facility: environment temperature (22 ± 3)°C and humidity < 70%.

Calibration Equipment used (M&TE critical for calibration)

Primary Standards	ID #	Cal Date (Certificate No.)	Scheduled Calibration
Power meter NRP	SN: 104778	04-Apr-17 (No. 217-02521/02522)	Apr-18
Power sensor NRP-Z91	SN: 103244	04-Apr-17 (No. 217-02521)	Apr-18
Power sensor NRP-Z91	SN: 103245	04-Apr-17 (No. 217-02522)	Apr-18
Reference 20 dB Attenuator	SN: 5058 (20K)	07-Apr-17 (No. 217-02528)	Apr-18
Type-N mismatch combination	SN: 5047.2 / 06327	07-Apr-17 (No. 217-02529)	Apr-18
Reference Probe EX3DV4	SN: 7349	31-May-17 (No. EX3-7349_May17)	May-18
DAE4	SN: 601	28-Mar-17 (No. DAE4-601_Mar17)	Mar-18

Secondary Standards	ID #	Check Date (in house)	Scheduled Check
Power meter EPM-442A	SN: GB37480704	07-Oct-15 (in house check Oct-16)	In house check: Oct-18
Power sensor HP 8481A	SN: US37292783	07-Oct-15 (in house check Oct-16)	In house check: Oct-18
Power sensor HP 8481A	SN: MY41092317	07-Oct-15 (in house check Oct-16)	In house check: Oct-18
RF generator R&S SMT-06	SN: 100972	15-Jun-15 (in house check Oct-16)	In house check: Oct-18
Network Analyzer HP 8753E	SN: US37390585	18-Oct-01 (in house check Oct-16)	In house check: Oct-17

Calibrated by: **Michael Weber** Name: Michael Weber Function: Laboratory Technician Signature: *M. Weber*

Approved by: **Katja Pokovic** Name: Katja Pokovic Function: Technical Manager Signature: *K. Pokovic*

Issued: August 17, 2017

This calibration certificate shall not be reproduced except in full without written approval of the laboratory.



Accredited by the Swiss Accreditation Service (SAS)

The Swiss Accreditation Service is one of the signatories to the EA
Multilateral Agreement for the recognition of calibration certificates

Accreditation No.: **SCS 0108**

Glossary:

TSL	tissue simulating liquid
ConvF	sensitivity in TSL / NORM x,y,z
N/A	not applicable or not measured

Calibration is Performed According to the Following Standards:

- IEEE Std 1528-2013, "IEEE Recommended Practice for Determining the Peak Spatial-Averaged Specific Absorption Rate (SAR) in the Human Head from Wireless Communications Devices: Measurement Techniques", June 2013
- IEC 62209-1, "Measurement procedure for the assessment of Specific Absorption Rate (SAR) from hand-held and body-mounted devices used next to the ear (frequency range of 300 MHz to 6 GHz)", July 2016
- IEC 62209-2, "Procedure to determine the Specific Absorption Rate (SAR) for wireless communication devices used in close proximity to the human body (frequency range of 30 MHz to 6 GHz)", March 2010
- KDB 865664, "SAR Measurement Requirements for 100 MHz to 6 GHz"

Additional Documentation:

- DASY4/5 System Handbook

Methods Applied and Interpretation of Parameters:

- Measurement Conditions:** Further details are available from the Validation Report at the end of the certificate. All figures stated in the certificate are valid at the frequency indicated.
- Antenna Parameters with TSL:** The dipole is mounted with the spacer to position its feed point exactly below the center marking of the flat phantom section, with the arms oriented parallel to the body axis.
- Feed Point Impedance and Return Loss:** These parameters are measured with the dipole positioned under the liquid filled phantom. The impedance stated is transformed from the measurement at the SMA connector to the feed point. The Return Loss ensures low reflected power. No uncertainty required.
- Electrical Delay:** One-way delay between the SMA connector and the antenna feed point. No uncertainty required.
- SAR measured:** SAR measured at the stated antenna input power.
- SAR normalized:** SAR as measured, normalized to an input power of 1 W at the antenna connector.
- SAR for nominal TSL parameters:** The measured TSL parameters are used to calculate the nominal SAR result.

The reported uncertainty of measurement is stated as the standard uncertainty of measurement multiplied by the coverage factor $k=2$, which for a normal distribution corresponds to a coverage probability of approximately 95%.

Measurement Conditions

DASY system configuration, as far as not given on page 1.

DASY Version	DASY5	V52.10.0
Extrapolation	Advanced Extrapolation	
Phantom	Modular Flat Phantom	
Distance Dipole Center - TSL	10 mm	with Spacer
Zoom Scan Resolution	dx, dy, dz = 5 mm	
Frequency	2450 MHz ± 1 MHz	

Head TSL parameters

The following parameters and calculations were applied.

	Temperature	Permittivity	Conductivity
Nominal Head TSL parameters	22.0 °C	39.2	1.80 mho/m
Measured Head TSL parameters	(22.0 ± 0.2) °C	37.8 ± 6 %	1.86 mho/m ± 6 %
Head TSL temperature change during test	< 0.5 °C	----	----

SAR result with Head TSL

SAR averaged over 1 cm³ (1 g) of Head TSL	Condition	
SAR measured	250 mW input power	13.3 W/kg
SAR for nominal Head TSL parameters	normalized to 1W	51.9 W/kg ± 17.0 % (k=2)

SAR averaged over 10 cm³ (10 g) of Head TSL	condition	
SAR measured	250 mW input power	6.15 W/kg
SAR for nominal Head TSL parameters	normalized to 1W	24.3 W/kg ± 16.5 % (k=2)

Body TSL parameters

The following parameters and calculations were applied.

	Temperature	Permittivity	Conductivity
Nominal Body TSL parameters	22.0 °C	52.7	1.95 mho/m
Measured Body TSL parameters	(22.0 ± 0.2) °C	51.9 ± 6 %	2.03 mho/m ± 6 %
Body TSL temperature change during test	< 0.5 °C	----	----

SAR result with Body TSL

SAR averaged over 1 cm³ (1 g) of Body TSL	Condition	
SAR measured	250 mW input power	12.8 W/kg
SAR for nominal Body TSL parameters	normalized to 1W	50.1 W/kg ± 17.0 % (k=2)

SAR averaged over 10 cm³ (10 g) of Body TSL	condition	
SAR measured	250 mW input power	6.00 W/kg
SAR for nominal Body TSL parameters	normalized to 1W	23.7 W/kg ± 16.5 % (k=2)

Appendix (Additional assessments outside the scope of SCS 0108)

Antenna Parameters with Head TSL

Impedance, transformed to feed point	55.7 Ω + 7.0 j Ω
Return Loss	- 21.4 dB

Antenna Parameters with Body TSL

Impedance, transformed to feed point	51.4 Ω + 8.1 j Ω
Return Loss	- 21.8 dB

General Antenna Parameters and Design

Electrical Delay (one direction)	1.150 ns
----------------------------------	----------

After long term use with 100W radiated power, only a slight warming of the dipole near the feedpoint can be measured.

The dipole is made of standard semirigid coaxial cable. The center conductor of the feeding line is directly connected to the second arm of the dipole. The antenna is therefore short-circuited for DC-signals. On some of the dipoles, small end caps are added to the dipole arms in order to improve matching when loaded according to the position as explained in the "Measurement Conditions" paragraph. The SAR data are not affected by this change. The overall dipole length is still according to the Standard.

No excessive force must be applied to the dipole arms, because they might bend or the soldered connections near the feedpoint may be damaged.

Additional EUT Data

Manufactured by	SPEAG
Manufactured on	September 10, 2002

DASY5 Validation Report for Head TSL

Date: 17.08.2017

Test Laboratory: SPEAG, Zurich, Switzerland

DUT: Dipole 2450 MHz; Type: D2450V2; Serial: D2450V2 - SN: 719

Communication System: UID 0 - CW; Frequency: 2450 MHz

Medium parameters used: $f = 2450$ MHz; $\sigma = 1.86$ S/m; $\epsilon_r = 37.8$; $\rho = 1000$ kg/m³

Phantom section: Flat Section

Measurement Standard: DASY5 (IEEE/IEC/ANSI C63.19-2011)

DASY52 Configuration:

- Probe: EX3DV4 - SN7349; ConvF(8.12, 8.12, 8.12); Calibrated: 31.05.2017;
- Sensor-Surface: 1.4mm (Mechanical Surface Detection)
- Electronics: DAE4 Sn601; Calibrated: 28.03.2017
- Phantom: Flat Phantom 5.0 (front); Type: QD 000 P50 AA; Serial: 1001
- DASY52 52.10.0(1446); SEMCAD X 14.6.10(7417)

Dipole Calibration for Head Tissue/Pin=250 mW, d=10mm/Zoom Scan (7x7x7)/Cube 0:

Measurement grid: dx=5mm, dy=5mm, dz=5mm

Reference Value = 112.8 V/m; Power Drift = -0.01 dB

Peak SAR (extrapolated) = 26.9 W/kg

SAR(1 g) = 13.3 W/kg; SAR(10 g) = 6.15 W/kg

Maximum value of SAR (measured) = 21.6 W/kg

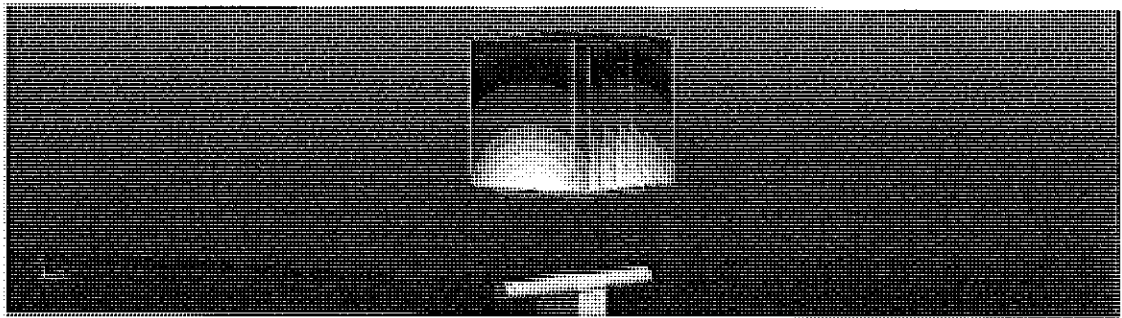
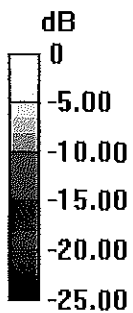

0 dB = 21.6 W/kg = 13.34 dBW/kg

Impedance Measurement Plot for Head TSL

17 Aug 2017 12:38:03
CH1 S11 1 U FS 1: 55.682 Ω 6.9766 Ω 453.21 μH 2 450.000 000 MHz

*
Oe1
CA

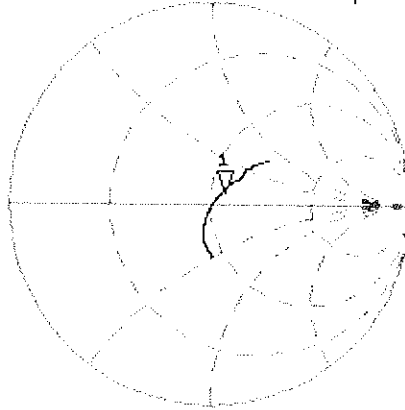

Avg
16

H1d

CH2 S11 LOG 5 dB/REF -20 dB 1: -21.413 dB 2 450.000 000 MHz

CA

Avg
16

H1d

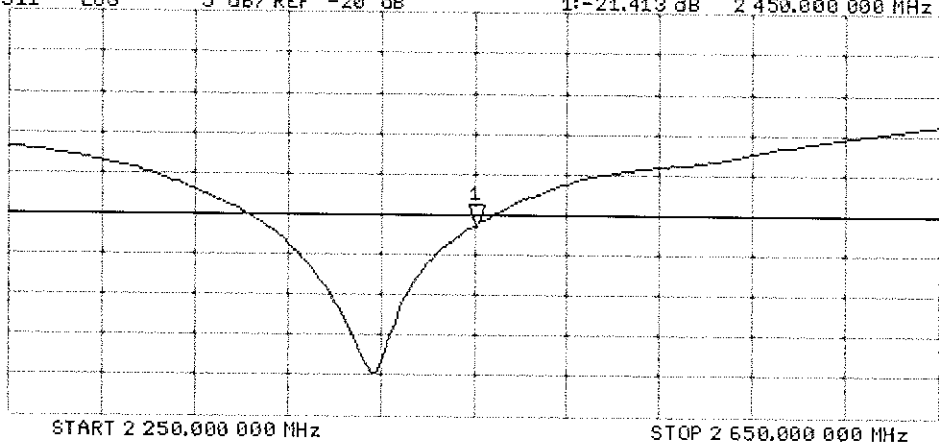

DASY5 Validation Report for Body TSL

Date: 17.08.2017

Test Laboratory: SPEAG, Zurich, Switzerland

DUT: Dipole 2450 MHz; Type: D2450V2; Serial: D2450V2 - SN: 719

Communication System: UID 0 - CW; Frequency: 2450 MHz

Medium parameters used: $f = 2450$ MHz; $\sigma = 2.03$ S/m; $\epsilon_r = 51.9$; $\rho = 1000$ kg/m³

Phantom section: Flat Section

Measurement Standard: DASY5 (IEEE/IEC/ANSI C63.19-2011)

DASY52 Configuration:

- Probe: EX3DV4 - SN7349; ConvF(8.1, 8.1, 8.1); Calibrated: 31.05.2017;
- Sensor-Surface: 1.4mm (Mechanical Surface Detection)
- Electronics: DAE4 Sn601; Calibrated: 28.03.2017
- Phantom: Flat Phantom 5.0 (back); Type: QD 000 P50 AA; Serial: 1002
- DASY52 52.10.0(1446); SEMCAD X 14.6.10(7417)

Dipole Calibration for Body Tissue/Pin=250 mW, d=10mm/Zoom Scan (7x7x7)/Cube 0:

Measurement grid: dx=5mm, dy=5mm, dz=5mm

Reference Value = 103.0 V/m; Power Drift = -0.07 dB

Peak SAR (extrapolated) = 25.2 W/kg

SAR(1 g) = 12.8 W/kg; SAR(10 g) = 6 W/kg

Maximum value of SAR (measured) = 19.8 W/kg

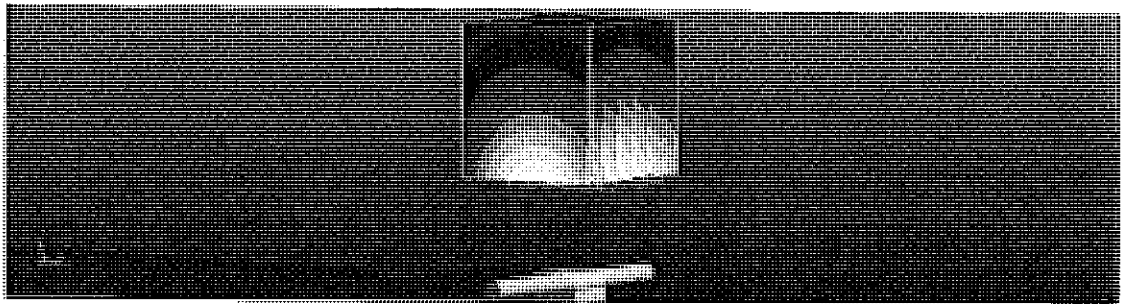
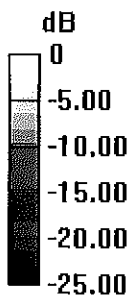

0 dB = 19.8 W/kg = 12.97 dBW/kg

Impedance Measurement Plot for Body TSL

17 Aug 2017 12:37:27
[CH1] S11 1 U FS 1: 51.379 Ω 8.1367 Ω 528.57 pF 2 450.000 000 MHz

*
De1
C4

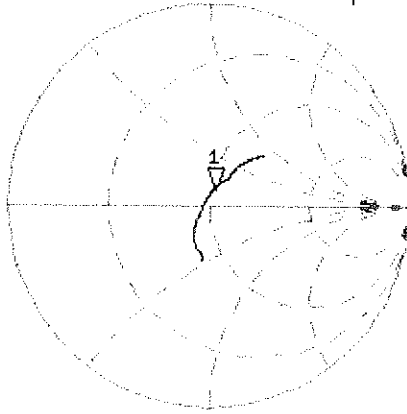

Avg
16

H1d

CH2 S11 LOG 5 dB/REF -20 dB 1: -21.809 dB 2 450.000 000 MHz

C4

Avg
16

H1d

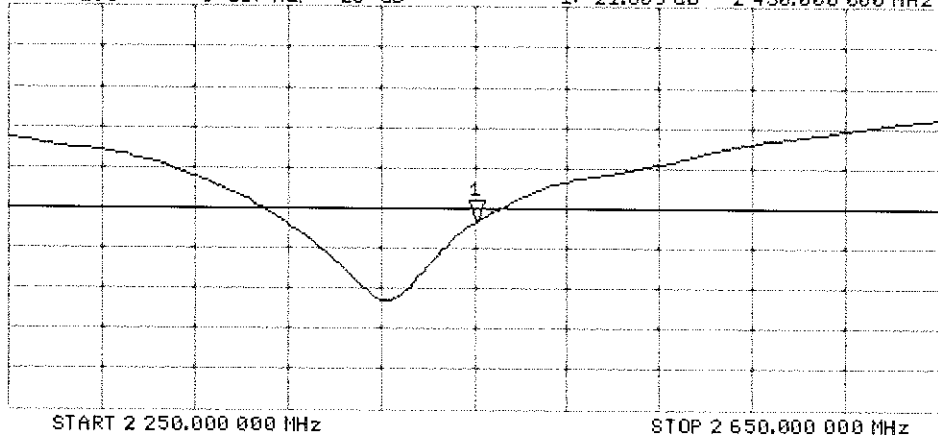

Certification of Calibration

Object: D2450V2 – SN: 719

Calibration procedure(s): Procedure for Calibration Extension for SAR Dipoles.

Extended Calibration date: 07/18/2018

Description: SAR Validation Dipole at 2450 MHz.

Calibration Equipment used:

Manufacturer	Model	Description	Cal Date	Cal Interval	Cal Due	Serial Number
Agilent	E4438C	ESG Vector Signal Generator	3/24/2017	Biennial	3/24/2019	MY42082385
Agilent	8753ES	S-Parameter Network Analyzer	9/14/2017	Annual	9/14/2018	US39170118
Amplifier Research	15S1G6	Amplifier	CBT	N/A	CBT	433971
Anritsu	ML2495A	Power Meter	11/28/2017	Annual	11/28/2018	1039008
Anritsu	MA2411B	Pulse Power Sensor	3/2/2018	Annual	3/2/2019	1207364
Anritsu	MA2411B	Pulse Power Sensor	11/15/2017	Annual	11/15/2018	1339007
Control Company	4040	Therm./Clock/Humidity Monitor	3/31/2017	Biennial	3/31/2019	170232394
Control Company	4352	Ultra Long Stem Thermometer	5/2/2017	Biennial	5/2/2019	170330156
Keysight	772D	Dual Directional Coupler	CBT	N/A	CBT	MY52180215
Keysight Technologies	85033E	Standard Mechanical Calibration Kit (DC to 9GHz, 3.5mm)	6/4/2018	Annual	6/4/2019	MY53401181
Mini-Circuits	BW-N20W5+	DC to 18 GHz Precision Fixed 20 dB Attenuator	CBT	N/A	CBT	N/A
Mini-Circuits	NLP-2950+	Low Pass Filter DC to 2700 MHz	CBT	N/A	CBT	N/A
Narda	4772-3	Attenuator (3dB)	CBT	N/A	CBT	9406
Pasternack	PE2209-10	Bidirectional Coupler	CBT	N/A	CBT	N/A
Pasternack	PE5011-1	Torque Wrench	7/19/2017	Biennial	7/19/2019	N/A
SPEAG	DAE4	Dasy Data Acquisition Electronics	3/7/2018	Annual	3/7/2019	1368
SPEAG	DAE4	Dasy Data Acquisition Electronics	8/9/2017	Annual	8/9/2018	1323
SPEAG	DAK-3.5	Dielectric Assessment Kit	9/12/2017	Annual	9/12/2018	1091
SPEAG	ES3DV3	SAR Probe	3/13/2018	Annual	3/13/2019	3319
SPEAG	ES3DV3	SAR Probe	8/14/2017	Annual	8/14/2018	3332

Measurement Uncertainty = $\pm 23\%$ (k=2)

	Name	Function	Signature
Calibrated By:	Brodie Halfoster	Test Engineer	<i>BRODIE HALFOSTER</i>
Approved By:	Kaitlin O'Keefe	Senior Technical Manager	<i>KOK</i>

DIPOLE CALIBRATION EXTENSION

Per KDB 865664 D01, calibration intervals of up to three years may be considered for reference dipoles when it is demonstrated that the SAR target, impedance and return loss of a dipole have remained stable according to the following requirements:

1. The measured SAR does not deviate more than 10% from the target on the calibration certificate.
2. The return-loss does not deviate more than 20% from the previous measurement and meets the required 20dB minimum return-loss requirement.
3. The measurement of real or imaginary parts of impedance does not deviate more than 5Ω from the previous measurement.

The following dipole was checked to pass the above 3 requirements to have 2-year calibration period from the calibration date:

Calibration Date	Extension Date	Certificate Electrical Delay (ns)	Certificate SAR Target Head (1g) W/kg @ 20.0 dBm	Measured Head SAR (1g) W/kg @ 20.0 dBm	Deviation 1g (%)	Certificate SAR Target Head (10g) W/kg @ 20.0 dBm	Measured Head SAR (10g) W/kg @ 20.0 dBm	Deviation 10g (%)	Certificate Impedance Head (Ohm) Real	Measured Impedance Head (Ohm) Real	Difference (Ohm) Real	Certificate Impedance Head (Ohm) Imaginary	Measured Impedance Head (Ohm) Imaginary	Difference (Ohm) Imaginary	Certificate Return Loss Head (dB)	Measured Return Loss Head (dB)	Deviation (%)	PASS/FAIL
8/17/2017	7/18/2018	1.150	5.19	5.46	5.20%	2.43	2.51	3.29%	55.7	53.9	1.8	7.0	2.9	4.1	-21.4	-25.4	-18.70%	PASS
Calibration Date	Extension Date	Certificate Electrical Delay (ns)	Certificate SAR Target Body (1g) W/kg @ 20.0 dBm	Measured Body SAR (1g) W/kg @ 20.0 dBm	Deviation 1g (%)	Certificate SAR Target Body (10g) W/kg @ 20.0 dBm	Measured Body SAR (10g) W/kg @ 20.0 dBm	Deviation 10g (%)	Certificate Impedance Body (Ohm) Real	Measured Impedance Body (Ohm) Real	Difference (Ohm) Real	Certificate Impedance Body (Ohm) Imaginary	Measured Impedance Body (Ohm) Imaginary	Difference (Ohm) Imaginary	Certificate Return Loss Body (dB)	Measured Return Loss Body (dB)	Deviation (%)	PASS/FAIL
8/17/2017	7/18/2018	1.150	5.01	5.19	3.59%	2.37	2.38	0.42%	51.4	50.2	1.2	8.1	5.9	2.2	-21.8	-24.6	-12.80%	PASS

Impedance & Return-Loss Measurement Plot for Head TSL

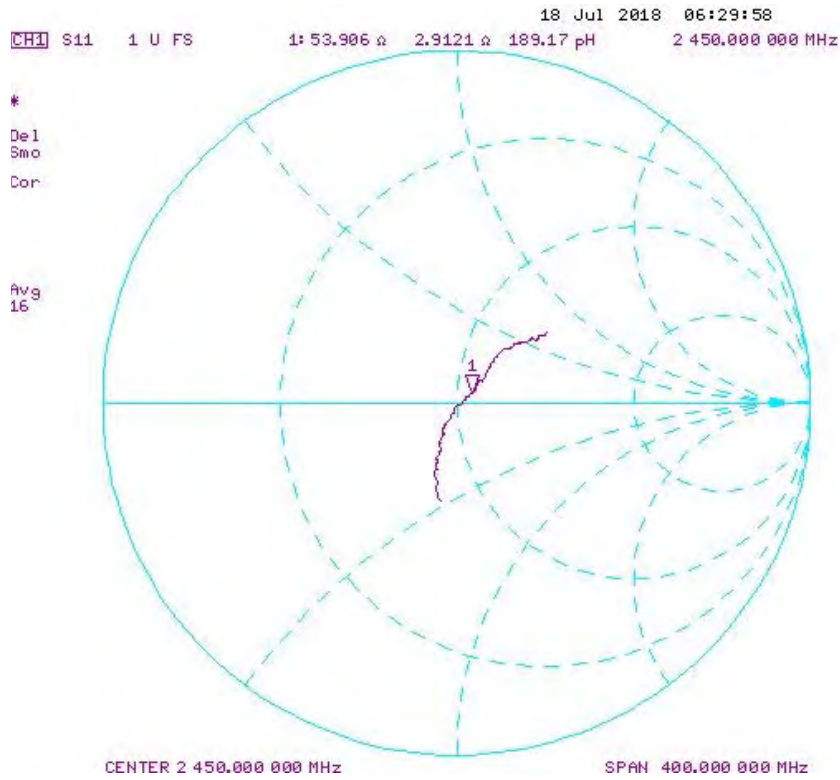

Impedance & Return-Loss Measurement Plot for Body TSL

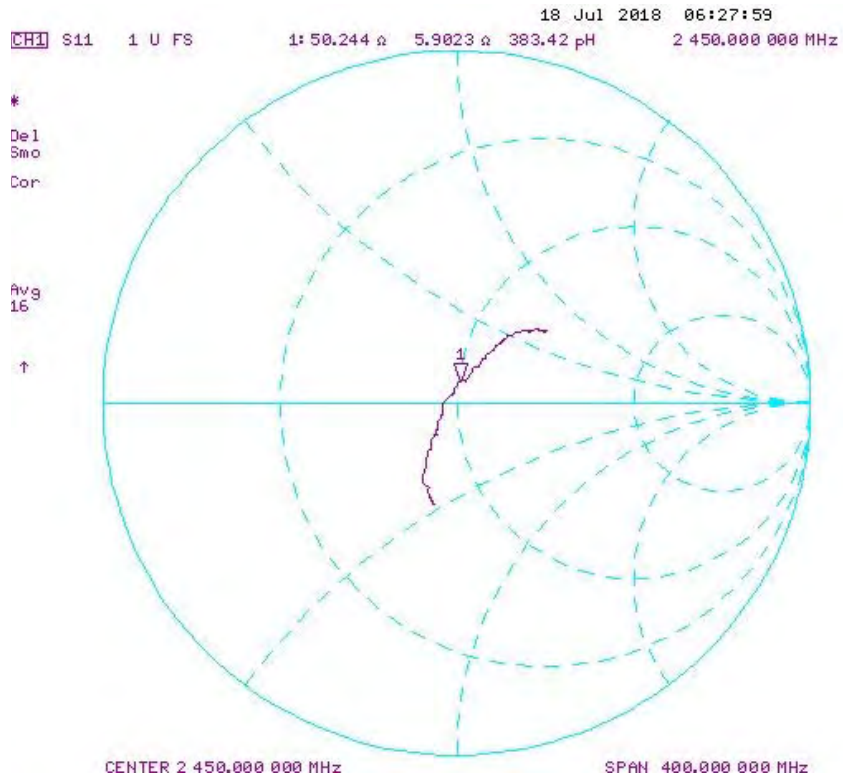



Accredited by the Swiss Accreditation Service (SAS)
The Swiss Accreditation Service is one of the signatories to the EA
Multilateral Agreement for the recognition of calibration certificates

Accreditation No.: **SCS 0108**

Client **PC Test**

Certificate No: **EX3-3589_Jan19**

CALIBRATION CERTIFICATE

Object **EX3DV4 - SN:3589**

Calibration procedure(s) **QA CAL-01.v9, QA CAL-14.v5, QA CAL-23.v5, QA CAL-25.v7
Calibration procedure for dosimetric E-field probes**

*BN ✓
02-06-2019*

Calibration date: **January 25, 2019**

This calibration certificate documents the traceability to national standards, which realize the physical units of measurements (SI).
The measurements and the uncertainties with confidence probability are given on the following pages and are part of the certificate.

All calibrations have been conducted in the closed laboratory facility: environment temperature (22 ± 3)°C and humidity < 70%.

Calibration Equipment used (M&TE critical for calibration)

Primary Standards	ID	Cal Date (Certificate No.)	Scheduled Calibration
Power meter NRP	SN: 104778	04-Apr-18 (No. 217-02672/02673)	Apr-19
Power sensor NRP-Z91	SN: 103244	04-Apr-18 (No. 217-02672)	Apr-19
Power sensor NRP-Z91	SN: 103245	04-Apr-18 (No. 217-02673)	Apr-19
Reference 20 dB Attenuator	SN: S5277 (20x)	04-Apr-18 (No. 217-02682)	Apr-19
DAE4	SN: 660	19-Dec-18 (No. DAE4-660_Dec18)	Dec-19
Reference Probe ES3DV2	SN: 3013	31-Dec-18 (No. ES3-3013_Dec18)	Dec-19
Secondary Standards	ID	Check Date (in house)	Scheduled Check
Power meter E4419B	SN: GB41293874	06-Apr-16 (in house check Jun-18)	In house check: Jun-20
Power sensor E4412A	SN: MY41498087	06-Apr-16 (in house check Jun-18)	In house check: Jun-20
Power sensor E4412A	SN: 000110210	06-Apr-16 (in house check Jun-18)	In house check: Jun-20
RF generator HP 8648C	SN: US3642U01700	04-Aug-99 (in house check Jun-18)	In house check: Jun-20
Network Analyzer E8358A	SN: US41080477	31-Mar-14 (in house check Oct-18)	In house check: Oct-19

Calibrated by:	Name Jeton Kastrati	Function Laboratory Technician	Signature
Approved by:	Name Katja Pokovic	Function Technical Manager	

Issued: January 29, 2019

This calibration certificate shall not be reproduced except in full without written approval of the laboratory.



Accredited by the Swiss Accreditation Service (SAS)

Accreditation No.: **SCS 0108**

The Swiss Accreditation Service is one of the signatories to the EA
Multilateral Agreement for the recognition of calibration certificates

Glossary:

TSL	tissue simulating liquid
NORM _{x,y,z}	sensitivity in free space
ConvF	sensitivity in TSL / NORM _{x,y,z}
DCP	diode compression point
CF	crest factor (1/duty_cycle) of the RF signal
A, B, C, D	modulation dependent linearization parameters
Polarization φ	φ rotation around probe axis
Polarization ϑ	ϑ rotation around an axis that is in the plane normal to probe axis (at measurement center), i.e., $\vartheta = 0$ is normal to probe axis
Connector Angle	information used in DASY system to align probe sensor X to the robot coordinate system

Calibration is Performed According to the Following Standards:

- IEEE Std 1528-2013, "IEEE Recommended Practice for Determining the Peak Spatial-Averaged Specific Absorption Rate (SAR) in the Human Head from Wireless Communications Devices: Measurement Techniques", June 2013
- IEC 62209-1, "Measurement procedure for the assessment of Specific Absorption Rate (SAR) from hand-held and body-mounted devices used next to the ear (frequency range of 300 MHz to 6 GHz)", July 2016
- IEC 62209-2, "Procedure to determine the Specific Absorption Rate (SAR) for wireless communication devices used in close proximity to the human body (frequency range of 30 MHz to 6 GHz)", March 2010
- KDB 865664, "SAR Measurement Requirements for 100 MHz to 6 GHz"

Methods Applied and Interpretation of Parameters:

- NORM_{x,y,z}**: Assessed for E-field polarization $\vartheta = 0$ ($f \leq 900$ MHz in TEM-cell; $f > 1800$ MHz: R22 waveguide). NORM_{x,y,z} are only intermediate values, i.e., the uncertainties of NORM_{x,y,z} does not affect the E^2 -field uncertainty inside TSL (see below ConvF).
- NORM(f)_{x,y,z}** = NORM_{x,y,z} * frequency_response (see Frequency Response Chart). This linearization is implemented in DASY4 software versions later than 4.2. The uncertainty of the frequency response is included in the stated uncertainty of ConvF.
- DCP_{x,y,z}**: DCP are numerical linearization parameters assessed based on the data of power sweep with CW signal (no uncertainty required). DCP does not depend on frequency nor media.
- PAR**: PAR is the Peak to Average Ratio that is not calibrated but determined based on the signal characteristics
- A_{x,y,z}; B_{x,y,z}; C_{x,y,z}; D_{x,y,z}; VR_{x,y,z}**: A, B, C, D are numerical linearization parameters assessed based on the data of power sweep for specific modulation signal. The parameters do not depend on frequency nor media. VR is the maximum calibration range expressed in RMS voltage across the diode.
- ConvF and Boundary Effect Parameters**: Assessed in flat phantom using E-field (or Temperature Transfer Standard for $f \leq 800$ MHz) and inside waveguide using analytical field distributions based on power measurements for $f > 800$ MHz. The same setups are used for assessment of the parameters applied for boundary compensation (alpha, depth) of which typical uncertainty values are given. These parameters are used in DASY4 software to improve probe accuracy close to the boundary. The sensitivity in TSL corresponds to NORM_{x,y,z} * ConvF whereby the uncertainty corresponds to that given for ConvF. A frequency dependent ConvF is used in DASY version 4.4 and higher which allows extending the validity from ± 50 MHz to ± 100 MHz.
- Spherical isotropy (3D deviation from isotropy)**: in a field of low gradients realized using a flat phantom exposed by a patch antenna.
- Sensor Offset**: The sensor offset corresponds to the offset of virtual measurement center from the probe tip (on probe axis). No tolerance required.
- Connector Angle**: The angle is assessed using the information gained by determining the NORM_x (no uncertainty required).

DASY/EASY - Parameters of Probe: EX3DV4 - SN:3589

Basic Calibration Parameters

	Sensor X	Sensor Y	Sensor Z	Unc (k=2)
Norm ($\mu\text{V}/(\text{V}/\text{m})^2$) ^A	0.44	0.40	0.39	± 10.1 %
DCP (mV) ^B	104.1	102.3	101.6	

Calibration Results for Modulation Response

UID	Communication System Name		A dB	B dB $\sqrt{\mu\text{V}}$	C	D dB	VR mV	Max dev.	Max Unc ^E (k=2)
0	CW	X	0.00	0.00	1.00	0.00	161.0	± 2.2 %	± 4.7 %
		Y	0.00	0.00	1.00		172.8		
		Z	0.00	0.00	1.00		161.9		
10352- AAA	Pulse Waveform (200Hz, 10%)	X	15.00	89.05	22.73	10.00	60.0	± 1.8 %	± 9.6 %
		Y	15.00	87.03	21.09		60.0		
		Z	15.00	88.89	22.24		60.0		
10353- AAA	Pulse Waveform (200Hz, 20%)	X	15.00	89.55	21.62	6.99	80.0	± 0.9 %	± 9.6 %
		Y	15.00	87.28	19.70		80.0		
		Z	15.00	89.25	21.07		80.0		
10354- AAA	Pulse Waveform (200Hz, 40%)	X	15.00	91.62	21.02	3.98	95.0	± 0.9 %	± 9.6 %
		Y	15.00	87.00	17.73		95.0		
		Z	15.00	91.02	20.33		95.0		
10355- AAA	Pulse Waveform (200Hz, 60%)	X	15.00	97.72	22.56	2.22	120.0	± 1.3 %	± 9.6 %
		Y	15.00	85.70	15.52		120.0		
		Z	15.00	94.39	20.55		120.0		
10387- AAA	QPSK Waveform, 1 MHz	X	0.93	64.13	11.59	0.00	150.0	± 3.0 %	± 9.6 %
		Y	0.57	60.00	7.45		150.0		
		Z	0.83	63.49	10.36		150.0		
10388- AAA	QPSK Waveform, 10 MHz	X	2.36	68.76	16.09	0.00	150.0	± 1.5 %	± 9.6 %
		Y	1.95	66.09	14.43		150.0		
		Z	2.37	69.14	16.27		150.0		
10396- AAA	64-QAM Waveform, 100 kHz	X	3.76	72.95	19.72	3.01	150.0	± 0.7 %	± 9.6 %
		Y	3.11	69.51	18.06		150.0		
		Z	4.24	75.35	20.59		150.0		
10399- AAA	64-QAM Waveform, 40 MHz	X	3.57	67.40	15.92	0.00	150.0	± 2.7 %	± 9.6 %
		Y	3.33	66.26	15.18		150.0		
		Z	3.47	67.09	15.77		150.0		
10414- AAA	WLAN CCDF, 64-QAM, 40MHz	X	4.95	65.72	15.56	0.00	150.0	± 4.8 %	± 9.6 %
		Y	4.74	65.16	15.23		150.0		
		Z	4.81	65.57	15.48		150.0		

Note: For details on UID parameters see Appendix

The reported uncertainty of measurement is stated as the standard uncertainty of measurement multiplied by the coverage factor k=2, which for a normal distribution corresponds to a coverage probability of approximately 95%.

^A The uncertainties of Norm X,Y,Z do not affect the E²-field uncertainty inside TSL (see Pages 5 and 6).

^B Numerical linearization parameter: uncertainty not required.

^E Uncertainty is determined using the max. deviation from linear response applying rectangular distribution and is expressed for the square of the field value.

DASY/EASY - Parameters of Probe: EX3DV4 - SN:3589

Sensor Model Parameters

	C1 fF	C2 fF	α V ⁻¹	T1 ms.V ⁻²	T2 ms.V ⁻¹	T3 ms	T4 V ⁻²	T5 V ⁻¹	T6
X	55.3	407.97	34.85	27.50	1.34	5.10	1.23	0.50	1.01
Y	46.7	357.99	37.12	21.71	1.59	5.07	0.00	0.73	1.01
Z	46.1	339.04	34.64	23.94	1.27	5.07	1.73	0.40	1.01

Other Probe Parameters

Sensor Arrangement	Triangular
Connector Angle (°)	-30.3
Mechanical Surface Detection Mode	enabled
Optical Surface Detection Mode	disabled
Probe Overall Length	337 mm
Probe Body Diameter	10 mm
Tip Length	9 mm
Tip Diameter	2.5 mm
Probe Tip to Sensor X Calibration Point	1 mm
Probe Tip to Sensor Y Calibration Point	1 mm
Probe Tip to Sensor Z Calibration Point	1 mm
Recommended Measurement Distance from Surface	1.4 mm

DASY/EASY - Parameters of Probe: EX3DV4 - SN:3589

Calibration Parameter Determined in Head Tissue Simulating Media

f (MHz) ^C	Relative Permittivity ^F	Conductivity (S/m) ^F	ConvF X	ConvF Y	ConvF Z	Alpha ^G	Depth (mm) ^G	Unc (k=2)
750	41.9	0.89	8.67	8.67	8.67	0.70	0.80	± 12.0 %
835	41.5	0.90	8.39	8.39	8.39	0.63	0.81	± 12.0 %
1750	40.1	1.37	7.31	7.31	7.31	0.40	0.80	± 12.0 %
1900	40.0	1.40	7.08	7.08	7.08	0.39	0.80	± 12.0 %
2300	39.5	1.67	6.77	6.77	6.77	0.31	0.85	± 12.0 %
2450	39.2	1.80	6.46	6.46	6.46	0.30	0.85	± 12.0 %
2600	39.0	1.96	6.25	6.25	6.25	0.40	0.83	± 12.0 %
3500	37.9	2.91	6.16	6.16	6.16	0.26	1.20	± 13.1 %
3700	37.7	3.12	6.02	6.02	6.02	0.26	1.20	± 13.1 %

^C Frequency validity above 300 MHz of ± 100 MHz only applies for DASY v4.4 and higher (see Page 2), else it is restricted to ± 50 MHz. The uncertainty is the RSS of the ConvF uncertainty at calibration frequency and the uncertainty for the indicated frequency band. Frequency validity below 300 MHz is ± 10, 25, 40, 50 and 70 MHz for ConvF assessments at 30, 64, 128, 150 and 220 MHz respectively. Validity of ConvF assessed at 6 MHz is 4-9 MHz, and ConvF assessed at 13 MHz is 9-19 MHz. Above 5 GHz frequency validity can be extended to ± 110 MHz.

^F At frequencies below 3 GHz, the validity of tissue parameters (ϵ and σ) can be relaxed to ± 10% if liquid compensation formula is applied to measured SAR values. At frequencies above 3 GHz, the validity of tissue parameters (ϵ and σ) is restricted to ± 5%. The uncertainty is the RSS of the ConvF uncertainty for indicated target tissue parameters.

^G Alpha/Depth are determined during calibration. SPEAG warrants that the remaining deviation due to the boundary effect after compensation is always less than ± 1% for frequencies below 3 GHz and below ± 2% for frequencies between 3-6 GHz at any distance larger than half the probe tip diameter from the boundary.

DASY/EASY - Parameters of Probe: EX3DV4 - SN:3589

Calibration Parameter Determined in Body Tissue Simulating Media

f (MHz) ^C	Relative Permittivity ^F	Conductivity (S/m) ^F	ConvF X	ConvF Y	ConvF Z	Alpha ^G	Depth ^G (mm)	Unc (k=2)
750	55.5	0.96	8.34	8.34	8.34	0.42	0.84	± 12.0 %
835	55.2	0.97	8.29	8.29	8.29	0.41	0.84	± 12.0 %
1750	53.4	1.49	6.82	6.82	6.82	0.43	0.80	± 12.0 %
1900	53.3	1.52	6.75	6.75	6.75	0.35	0.85	± 12.0 %
2300	52.9	1.81	6.71	6.71	6.71	0.36	0.87	± 12.0 %
2450	52.7	1.95	6.66	6.66	6.66	0.34	0.88	± 12.0 %
2600	52.5	2.16	6.47	6.47	6.47	0.28	0.95	± 12.0 %
3500	51.3	3.31	6.21	6.21	6.21	0.25	1.25	± 13.1 %
3700	51.0	3.55	6.13	6.13	6.13	0.20	1.25	± 13.1 %

^C Frequency validity above 300 MHz of ± 100 MHz only applies for DASY v4.4 and higher (see Page 2), else it is restricted to ± 50 MHz. The uncertainty is the RSS of the ConvF uncertainty at calibration frequency and the uncertainty for the indicated frequency band. Frequency validity below 300 MHz is ± 10, 25, 40, 50 and 70 MHz for ConvF assessments at 30, 64, 128, 150 and 220 MHz respectively. Validity of ConvF assessed at 6 MHz is 4-9 MHz, and ConvF assessed at 13 MHz is 9-19 MHz. Above 5 GHz frequency validity can be extended to ± 110 MHz.

^F At frequencies below 3 GHz, the validity of tissue parameters (ϵ and σ) can be relaxed to ± 10% if liquid compensation formula is applied to measured SAR values. At frequencies above 3 GHz, the validity of tissue parameters (ϵ and σ) is restricted to ± 5%. The uncertainty is the RSS of the ConvF uncertainty for indicated target tissue parameters.

^G Alpha/Depth are determined during calibration. SPEAG warrants that the remaining deviation due to the boundary effect after compensation is always less than ± 1% for frequencies below 3 GHz and below ± 2% for frequencies between 3-6 GHz at any distance larger than half the probe tip diameter from the boundary.

Frequency Response of E-Field (TEM-Cell:ifi110 EXX, Waveguide: R22)

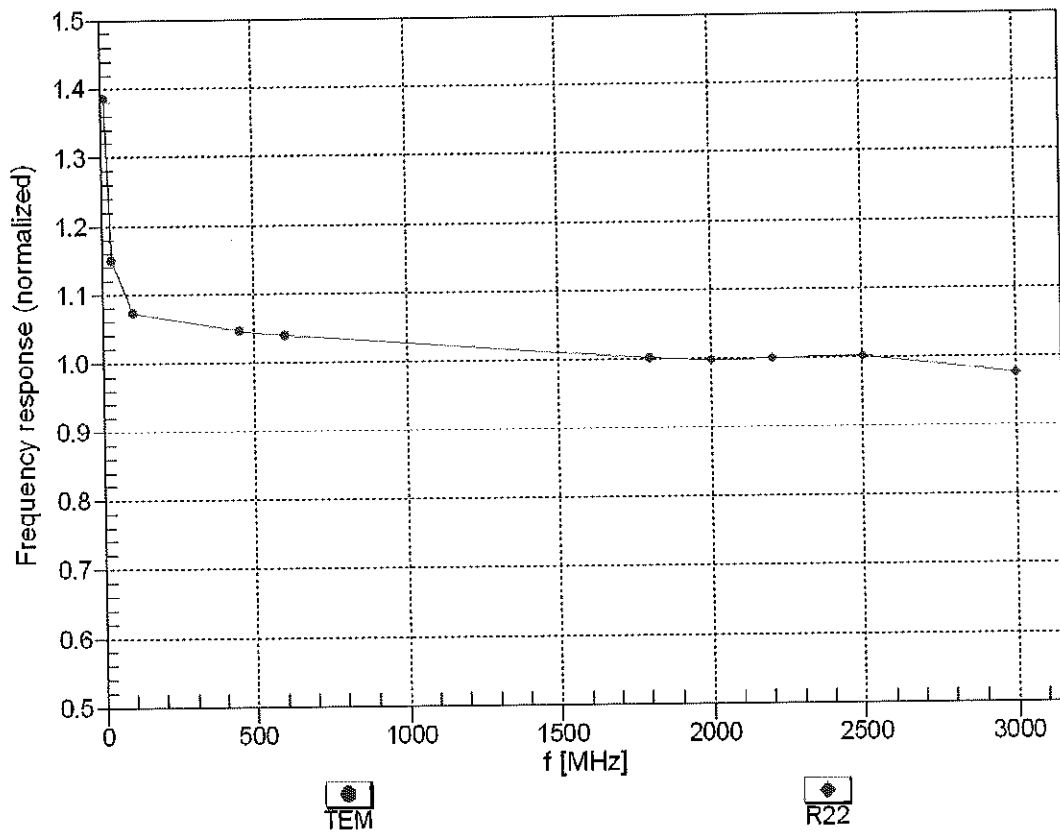

Uncertainty of Frequency Response of E-field: $\pm 6.3\%$ (k=2)

Receiving Pattern (ϕ), $\vartheta = 0^\circ$

f=600 MHz, TEM

f=1800 MHz, R22

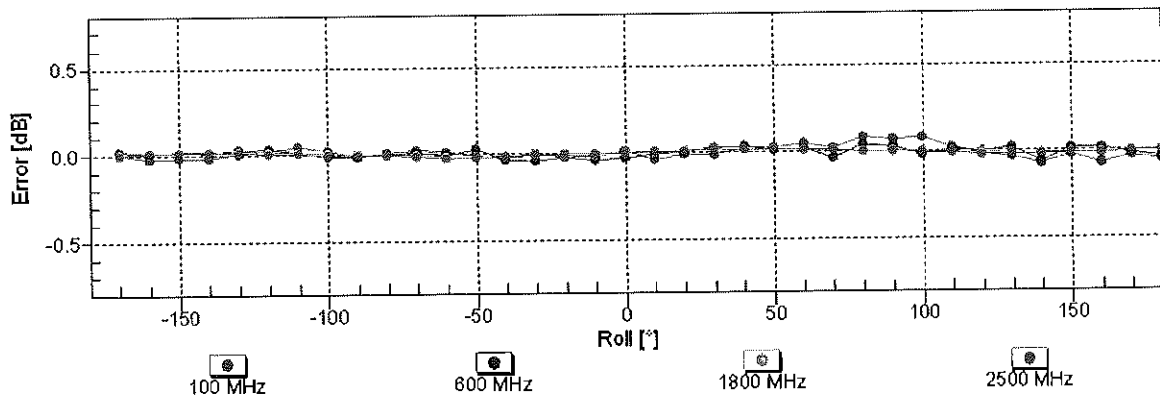
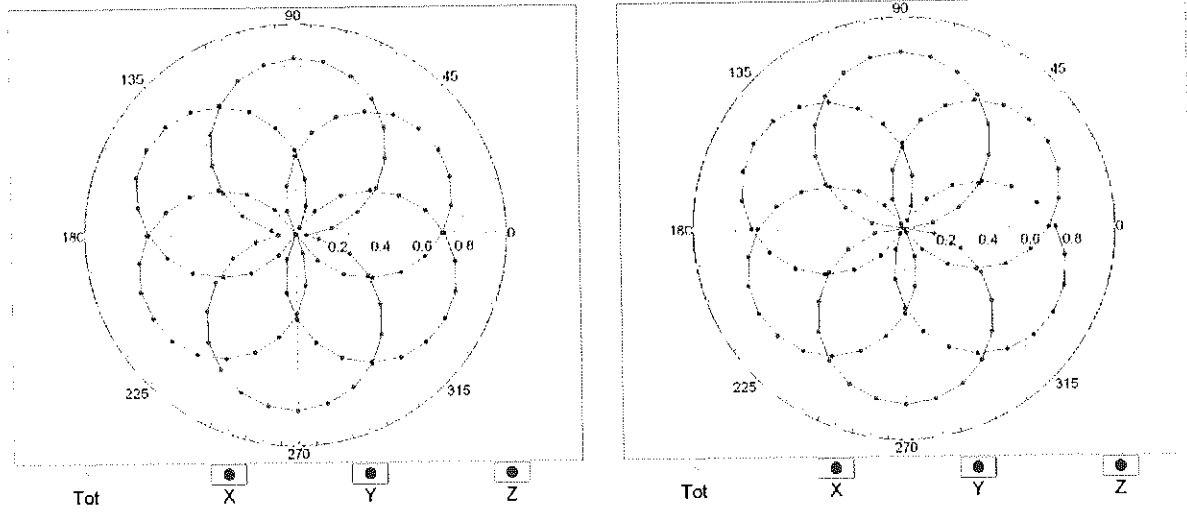

Uncertainty of Axial Isotropy Assessment: $\pm 0.5\%$ ($k=2$)

Dynamic Range f(SAR_{head}) (TEM cell , f_{eval}= 1900 MHz)

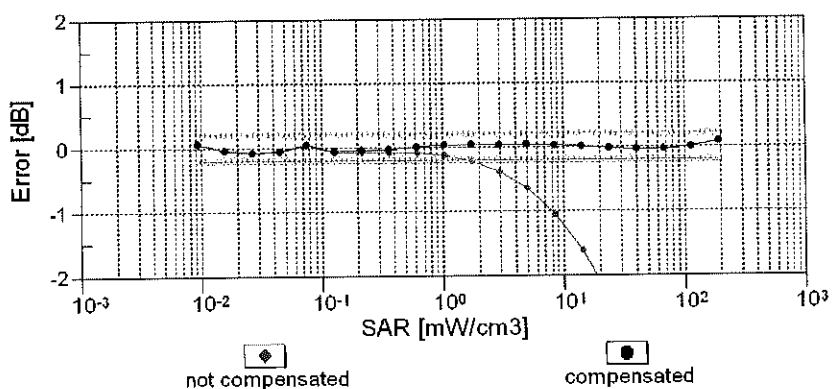
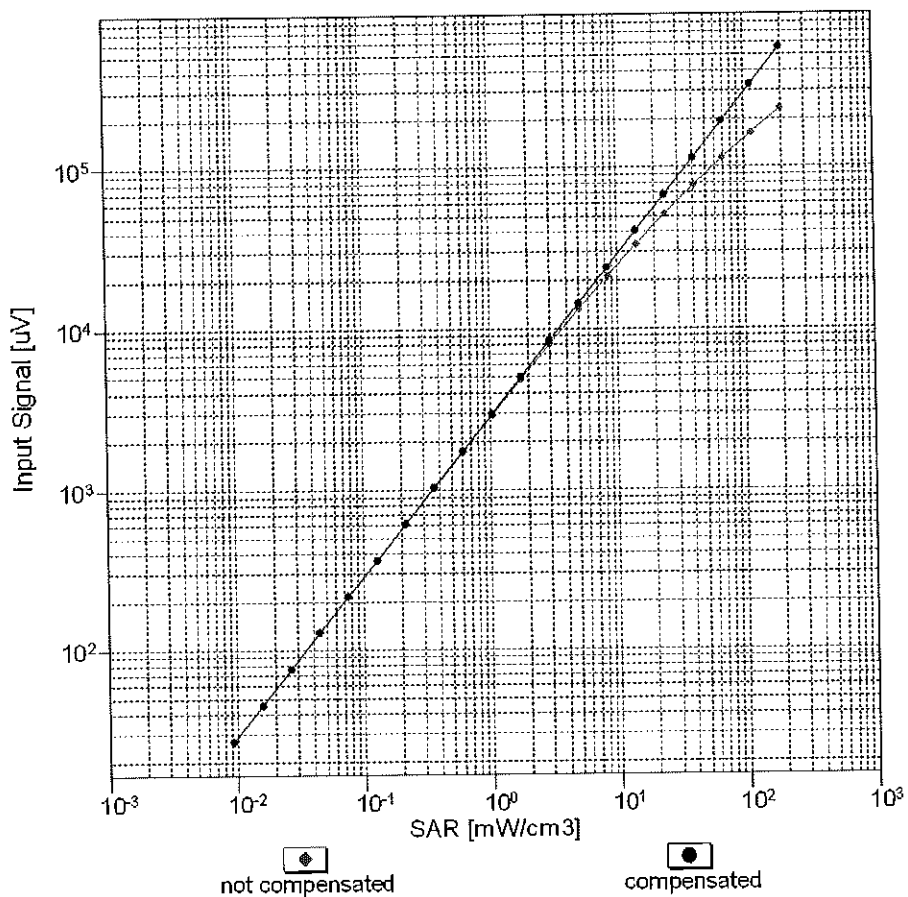

Uncertainty of Linearity Assessment: ± 0.6% (k=2)

Conversion Factor Assessment

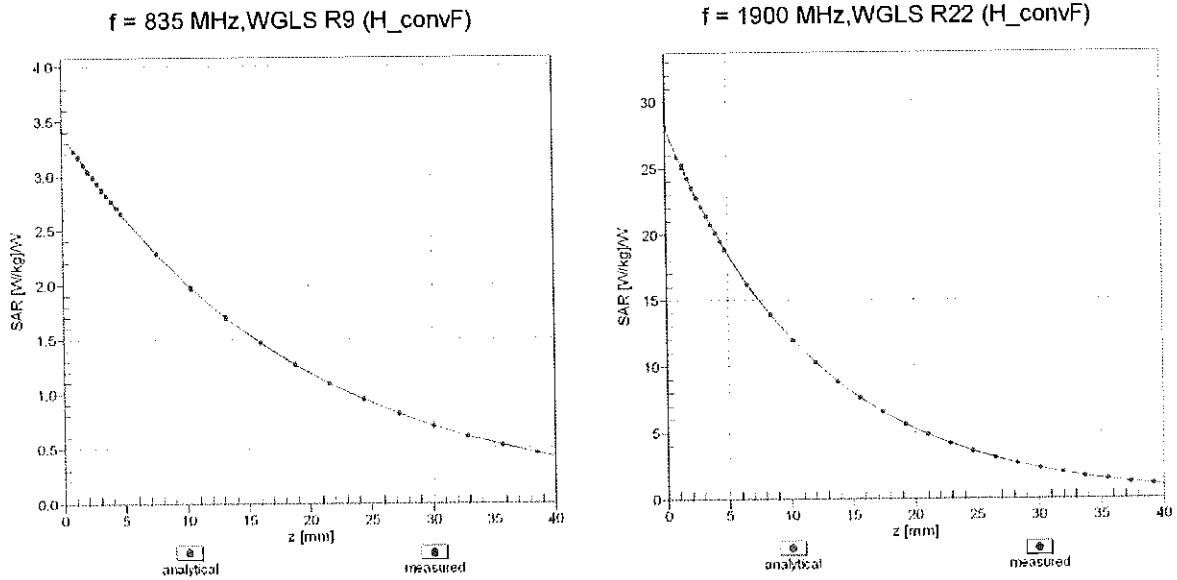

Deviation from Isotropy in Liquid Error (ϕ, θ), f = 900 MHz

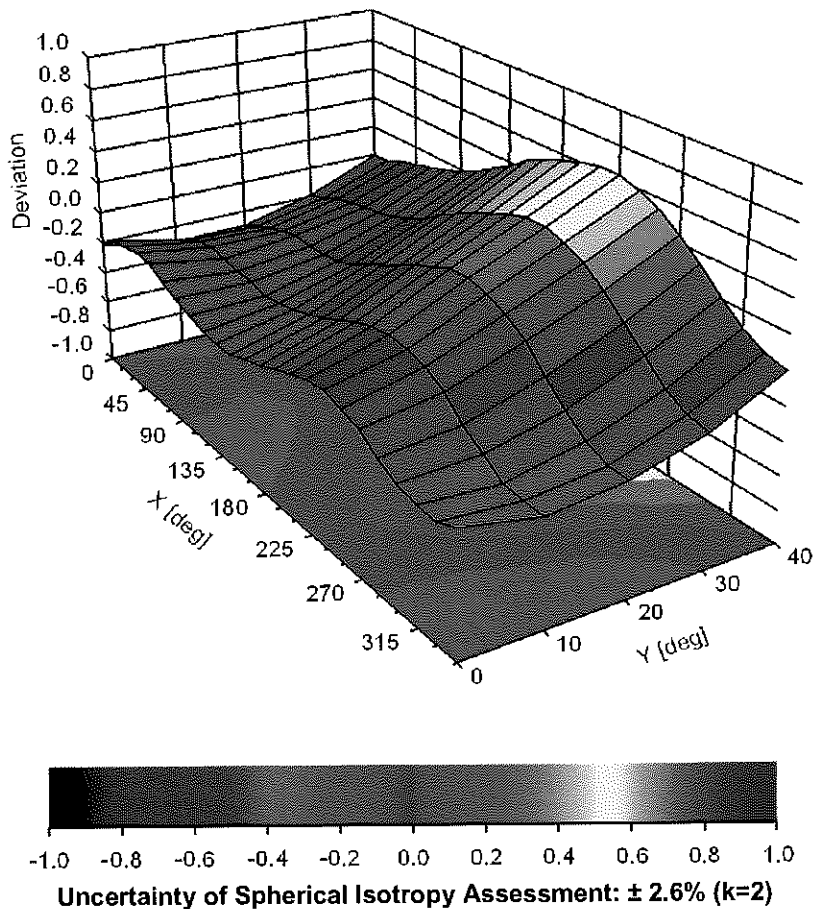

Appendix: Modulation Calibration Parameters

UID	Rev	Communication System Name	Group	PAR (dB)	Unc ^E (k=2)
0		CW	CW	0.00	± 4.7 %
10010	CAA	SAR Validation (Square, 100ms, 10ms)	Test	10.00	± 9.6 %
10011	CAB	UMTS-FDD (WCDMA)	WCDMA	2.91	± 9.6 %
10012	CAB	IEEE 802.11b WiFi 2.4 GHz (DSSS, 1 Mbps)	WLAN	1.87	± 9.6 %
10013	CAB	IEEE 802.11g WiFi 2.4 GHz (DSSS-OFDM, 6 Mbps)	WLAN	9.46	± 9.6 %
10021	DAC	GSM-FDD (TDMA, GMSK)	GSM	9.39	± 9.6 %
10023	DAC	GPRS-FDD (TDMA, GMSK, TN 0)	GSM	9.57	± 9.6 %
10024	DAC	GPRS-FDD (TDMA, GMSK, TN 0-1)	GSM	6.56	± 9.6 %
10025	DAC	EDGE-FDD (TDMA, 8PSK, TN 0)	GSM	12.62	± 9.6 %
10026	DAC	EDGE-FDD (TDMA, 8PSK, TN 0-1)	GSM	9.55	± 9.6 %
10027	DAC	GPRS-FDD (TDMA, GMSK, TN 0-1-2)	GSM	4.80	± 9.6 %
10028	DAC	GPRS-FDD (TDMA, GMSK, TN 0-1-2-3)	GSM	3.55	± 9.6 %
10029	DAC	EDGE-FDD (TDMA, 8PSK, TN 0-1-2)	GSM	7.78	± 9.6 %
10030	CAA	IEEE 802.15.1 Bluetooth (GFSK, DH1)	Bluetooth	5.30	± 9.6 %
10031	CAA	IEEE 802.15.1 Bluetooth (GFSK, DH3)	Bluetooth	1.87	± 9.6 %
10032	CAA	IEEE 802.15.1 Bluetooth (GFSK, DH5)	Bluetooth	1.16	± 9.6 %
10033	CAA	IEEE 802.15.1 Bluetooth (PI/4-DQPSK, DH1)	Bluetooth	7.74	± 9.6 %
10034	CAA	IEEE 802.15.1 Bluetooth (PI/4-DQPSK, DH3)	Bluetooth	4.53	± 9.6 %
10035	CAA	IEEE 802.15.1 Bluetooth (PI/4-DQPSK, DH5)	Bluetooth	3.83	± 9.6 %
10036	CAA	IEEE 802.15.1 Bluetooth (8-DPSK, DH1)	Bluetooth	8.01	± 9.6 %
10037	CAA	IEEE 802.15.1 Bluetooth (8-DPSK, DH3)	Bluetooth	4.77	± 9.6 %
10038	CAA	IEEE 802.15.1 Bluetooth (8-DPSK, DH5)	Bluetooth	4.10	± 9.6 %
10039	CAB	CDMA2000 (1xRTT, RC1)	CDMA2000	4.57	± 9.6 %
10042	CAB	IS-54 / IS-136 FDD (TDMA/FDM, PI/4-DQPSK, Halfrate)	AMPS	7.78	± 9.6 %
10044	CAA	IS-91/EIA/TIA-553 FDD (FDMA, FM)	AMPS	0.00	± 9.6 %
10048	CAA	DECT (TDD, TDMA/FDM, GFSK, Full Slot, 24)	DECT	13.80	± 9.6 %
10049	CAA	DECT (TDD, TDMA/FDM, GFSK, Double Slot, 12)	DECT	10.79	± 9.6 %
10056	CAA	UMTS-TDD (TD-SCDMA, 1.28 Mcps)	TD-SCDMA	11.01	± 9.6 %
10058	DAC	EDGE-FDD (TDMA, 8PSK, TN 0-1-2-3)	GSM	6.52	± 9.6 %
10059	CAB	IEEE 802.11b WiFi 2.4 GHz (DSSS, 2 Mbps)	WLAN	2.12	± 9.6 %
10060	CAB	IEEE 802.11b WiFi 2.4 GHz (DSSS, 5.5 Mbps)	WLAN	2.83	± 9.6 %
10061	CAB	IEEE 802.11b WiFi 2.4 GHz (DSSS, 11 Mbps)	WLAN	3.60	± 9.6 %
10062	CAC	IEEE 802.11a/h WiFi 5 GHz (OFDM, 6 Mbps)	WLAN	8.68	± 9.6 %
10063	CAC	IEEE 802.11a/h WiFi 5 GHz (OFDM, 9 Mbps)	WLAN	8.63	± 9.6 %
10064	CAC	IEEE 802.11a/h WiFi 5 GHz (OFDM, 12 Mbps)	WLAN	9.09	± 9.6 %
10065	CAC	IEEE 802.11a/h WiFi 5 GHz (OFDM, 18 Mbps)	WLAN	9.00	± 9.6 %
10066	CAC	IEEE 802.11a/h WiFi 5 GHz (OFDM, 24 Mbps)	WLAN	9.38	± 9.6 %
10067	CAC	IEEE 802.11a/h WiFi 5 GHz (OFDM, 36 Mbps)	WLAN	10.12	± 9.6 %
10068	CAC	IEEE 802.11a/h WiFi 5 GHz (OFDM, 48 Mbps)	WLAN	10.24	± 9.6 %
10069	CAC	IEEE 802.11a/h WiFi 5 GHz (OFDM, 54 Mbps)	WLAN	10.56	± 9.6 %
10071	CAB	IEEE 802.11g WiFi 2.4 GHz (DSSS/OFDM, 9 Mbps)	WLAN	9.83	± 9.6 %
10072	CAB	IEEE 802.11g WiFi 2.4 GHz (DSSS/OFDM, 12 Mbps)	WLAN	9.62	± 9.6 %
10073	CAB	IEEE 802.11g WiFi 2.4 GHz (DSSS/OFDM, 18 Mbps)	WLAN	9.94	± 9.6 %
10074	CAB	IEEE 802.11g WiFi 2.4 GHz (DSSS/OFDM, 24 Mbps)	WLAN	10.30	± 9.6 %
10075	CAB	IEEE 802.11g WiFi 2.4 GHz (DSSS/OFDM, 36 Mbps)	WLAN	10.77	± 9.6 %
10076	CAB	IEEE 802.11g WiFi 2.4 GHz (DSSS/OFDM, 48 Mbps)	WLAN	10.94	± 9.6 %
10077	CAB	IEEE 802.11g WiFi 2.4 GHz (DSSS/OFDM, 54 Mbps)	WLAN	11.00	± 9.6 %
10081	CAB	CDMA2000 (1xRTT, RC3)	CDMA2000	3.97	± 9.6 %
10082	CAB	IS-54 / IS-136 FDD (TDMA/FDM, PI/4-DQPSK, Fullrate)	AMPS	4.77	± 9.6 %
10090	DAC	GPRS-FDD (TDMA, GMSK, TN 0-4)	GSM	6.56	± 9.6 %
10097	CAB	UMTS-FDD (HSDPA)	WCDMA	3.98	± 9.6 %
10098	CAB	UMTS-FDD (HSUPA, Subtest 2)	WCDMA	3.98	± 9.6 %
10099	DAC	EDGE-FDD (TDMA, 8PSK, TN 0-4)	GSM	9.55	± 9.6 %
10100	CAE	LTE-FDD (SC-FDMA, 100% RB, 20 MHz, QPSK)	LTE-FDD	5.67	± 9.6 %
10101	CAE	LTE-FDD (SC-FDMA, 100% RB, 20 MHz, 16-QAM)	LTE-FDD	6.42	± 9.6 %
10102	CAE	LTE-FDD (SC-FDMA, 100% RB, 20 MHz, 64-QAM)	LTE-FDD	6.60	± 9.6 %
10103	CAG	LTE-TDD (SC-FDMA, 100% RB, 20 MHz, QPSK)	LTE-TDD	9.29	± 9.6 %
10104	CAG	LTE-TDD (SC-FDMA, 100% RB, 20 MHz, 16-QAM)	LTE-TDD	9.97	± 9.6 %
10105	CAG	LTE-TDD (SC-FDMA, 100% RB, 20 MHz, 64-QAM)	LTE-TDD	10.01	± 9.6 %
10108	CAG	LTE-FDD (SC-FDMA, 100% RB, 10 MHz, QPSK)	LTE-FDD	5.80	± 9.6 %

10109	CAG	LTE-FDD (SC-FDMA, 100% RB, 10 MHz, 16-QAM)	LTE-FDD	6.43	± 9.6 %
10110	CAG	LTE-FDD (SC-FDMA, 100% RB, 5 MHz, QPSK)	LTE-FDD	5.75	± 9.6 %
10111	CAG	LTE-FDD (SC-FDMA, 100% RB, 5 MHz, 16-QAM)	LTE-FDD	6.44	± 9.6 %
10112	CAG	LTE-FDD (SC-FDMA, 100% RB, 10 MHz, 64-QAM)	LTE-FDD	6.59	± 9.6 %
10113	CAG	LTE-FDD (SC-FDMA, 100% RB, 5 MHz, 64-QAM)	LTE-FDD	6.62	± 9.6 %
10114	CAC	IEEE 802.11n (HT Greenfield, 13.5 Mbps, BPSK)	WLAN	8.10	± 9.6 %
10115	CAC	IEEE 802.11n (HT Greenfield, 81 Mbps, 16-QAM)	WLAN	8.46	± 9.6 %
10116	CAC	IEEE 802.11n (HT Greenfield, 135 Mbps, 64-QAM)	WLAN	8.15	± 9.6 %
10117	CAC	IEEE 802.11n (HT Mixed, 13.5 Mbps, BPSK)	WLAN	8.07	± 9.6 %
10118	CAC	IEEE 802.11n (HT Mixed, 81 Mbps, 16-QAM)	WLAN	8.59	± 9.6 %
10119	CAC	IEEE 802.11n (HT Mixed, 135 Mbps, 64-QAM)	WLAN	8.13	± 9.6 %
10140	CAE	LTE-FDD (SC-FDMA, 100% RB, 15 MHz, 16-QAM)	LTE-FDD	6.49	± 9.6 %
10141	CAE	LTE-FDD (SC-FDMA, 100% RB, 15 MHz, 64-QAM)	LTE-FDD	6.53	± 9.6 %
10142	CAE	LTE-FDD (SC-FDMA, 100% RB, 3 MHz, QPSK)	LTE-FDD	5.73	± 9.6 %
10143	CAE	LTE-FDD (SC-FDMA, 100% RB, 3 MHz, 16-QAM)	LTE-FDD	6.35	± 9.6 %
10144	CAE	LTE-FDD (SC-FDMA, 100% RB, 3 MHz, 64-QAM)	LTE-FDD	6.65	± 9.6 %
10145	CAF	LTE-FDD (SC-FDMA, 100% RB, 1.4 MHz, QPSK)	LTE-FDD	5.76	± 9.6 %
10146	CAF	LTE-FDD (SC-FDMA, 100% RB, 1.4 MHz, 16-QAM)	LTE-FDD	6.41	± 9.6 %
10147	CAF	LTE-FDD (SC-FDMA, 100% RB, 1.4 MHz, 64-QAM)	LTE-FDD	6.72	± 9.6 %
10149	CAE	LTE-FDD (SC-FDMA, 50% RB, 20 MHz, 16-QAM)	LTE-FDD	6.42	± 9.6 %
10150	CAE	LTE-FDD (SC-FDMA, 50% RB, 20 MHz, 64-QAM)	LTE-FDD	6.60	± 9.6 %
10151	CAG	LTE-TDD (SC-FDMA, 50% RB, 20 MHz, QPSK)	LTE-TDD	9.28	± 9.6 %
10152	CAG	LTE-TDD (SC-FDMA, 50% RB, 20 MHz, 16-QAM)	LTE-TDD	9.92	± 9.6 %
10153	CAG	LTE-TDD (SC-FDMA, 50% RB, 20 MHz, 64-QAM)	LTE-TDD	10.05	± 9.6 %
10154	CAG	LTE-FDD (SC-FDMA, 50% RB, 10 MHz, QPSK)	LTE-FDD	5.75	± 9.6 %
10155	CAG	LTE-FDD (SC-FDMA, 50% RB, 10 MHz, 16-QAM)	LTE-FDD	6.43	± 9.6 %
10156	CAG	LTE-FDD (SC-FDMA, 50% RB, 5 MHz, QPSK)	LTE-FDD	5.79	± 9.6 %
10157	CAG	LTE-FDD (SC-FDMA, 50% RB, 5 MHz, 16-QAM)	LTE-FDD	6.49	± 9.6 %
10158	CAG	LTE-FDD (SC-FDMA, 50% RB, 10 MHz, 64-QAM)	LTE-FDD	6.62	± 9.6 %
10159	CAG	LTE-FDD (SC-FDMA, 50% RB, 5 MHz, 64-QAM)	LTE-FDD	6.56	± 9.6 %
10160	CAE	LTE-FDD (SC-FDMA, 50% RB, 15 MHz, QPSK)	LTE-FDD	5.82	± 9.6 %
10161	CAE	LTE-FDD (SC-FDMA, 50% RB, 15 MHz, 16-QAM)	LTE-FDD	6.43	± 9.6 %
10162	CAE	LTE-FDD (SC-FDMA, 50% RB, 15 MHz, 64-QAM)	LTE-FDD	6.58	± 9.6 %
10166	CAF	LTE-FDD (SC-FDMA, 50% RB, 1.4 MHz, QPSK)	LTE-FDD	5.46	± 9.6 %
10167	CAF	LTE-FDD (SC-FDMA, 50% RB, 1.4 MHz, 16-QAM)	LTE-FDD	6.21	± 9.6 %
10168	CAF	LTE-FDD (SC-FDMA, 50% RB, 1.4 MHz, 64-QAM)	LTE-FDD	6.79	± 9.6 %
10169	CAE	LTE-FDD (SC-FDMA, 1 RB, 20 MHz, QPSK)	LTE-FDD	5.73	± 9.6 %
10170	CAE	LTE-FDD (SC-FDMA, 1 RB, 20 MHz, 16-QAM)	LTE-FDD	6.52	± 9.6 %
10171	AAE	LTE-FDD (SC-FDMA, 1 RB, 20 MHz, 64-QAM)	LTE-FDD	6.49	± 9.6 %
10172	CAG	LTE-TDD (SC-FDMA, 1 RB, 20 MHz, QPSK)	LTE-TDD	9.21	± 9.6 %
10173	CAG	LTE-TDD (SC-FDMA, 1 RB, 20 MHz, 16-QAM)	LTE-TDD	9.48	± 9.6 %
10174	CAG	LTE-TDD (SC-FDMA, 1 RB, 20 MHz, 64-QAM)	LTE-TDD	10.25	± 9.6 %
10175	CAG	LTE-FDD (SC-FDMA, 1 RB, 10 MHz, QPSK)	LTE-FDD	5.72	± 9.6 %
10176	CAG	LTE-FDD (SC-FDMA, 1 RB, 10 MHz, 16-QAM)	LTE-FDD	6.52	± 9.6 %
10177	CAI	LTE-FDD (SC-FDMA, 1 RB, 5 MHz, QPSK)	LTE-FDD	5.73	± 9.6 %
10178	CAG	LTE-FDD (SC-FDMA, 1 RB, 5 MHz, 16-QAM)	LTE-FDD	6.52	± 9.6 %
10179	CAG	LTE-FDD (SC-FDMA, 1 RB, 10 MHz, 64-QAM)	LTE-FDD	6.50	± 9.6 %
10180	CAG	LTE-FDD (SC-FDMA, 1 RB, 5 MHz, 64-QAM)	LTE-FDD	6.50	± 9.6 %
10181	CAE	LTE-FDD (SC-FDMA, 1 RB, 15 MHz, QPSK)	LTE-FDD	5.72	± 9.6 %
10182	CAE	LTE-FDD (SC-FDMA, 1 RB, 15 MHz, 16-QAM)	LTE-FDD	6.52	± 9.6 %
10183	AAD	LTE-FDD (SC-FDMA, 1 RB, 15 MHz, 64-QAM)	LTE-FDD	6.50	± 9.6 %
10184	CAE	LTE-FDD (SC-FDMA, 1 RB, 3 MHz, QPSK)	LTE-FDD	5.73	± 9.6 %
10185	CAE	LTE-FDD (SC-FDMA, 1 RB, 3 MHz, 16-QAM)	LTE-FDD	6.51	± 9.6 %
10186	AAE	LTE-FDD (SC-FDMA, 1 RB, 3 MHz, 64-QAM)	LTE-FDD	6.50	± 9.6 %
10187	CAF	LTE-FDD (SC-FDMA, 1 RB, 1.4 MHz, QPSK)	LTE-FDD	5.73	± 9.6 %
10188	CAF	LTE-FDD (SC-FDMA, 1 RB, 1.4 MHz, 16-QAM)	LTE-FDD	6.52	± 9.6 %
10189	AAF	LTE-FDD (SC-FDMA, 1 RB, 1.4 MHz, 64-QAM)	LTE-FDD	6.50	± 9.6 %
10193	CAC	IEEE 802.11n (HT Greenfield, 6.5 Mbps, BPSK)	WLAN	8.09	± 9.6 %
10194	CAC	IEEE 802.11n (HT Greenfield, 39 Mbps, 16-QAM)	WLAN	8.12	± 9.6 %
10195	CAC	IEEE 802.11n (HT Greenfield, 65 Mbps, 64-QAM)	WLAN	8.21	± 9.6 %
10196	CAC	IEEE 802.11n (HT Mixed, 6.5 Mbps, BPSK)	WLAN	8.10	± 9.6 %
10197	CAC	IEEE 802.11n (HT Mixed, 39 Mbps, 16-QAM)	WLAN	8.13	± 9.6 %
10198	CAC	IEEE 802.11n (HT Mixed, 65 Mbps, 64-QAM)	WLAN	8.27	± 9.6 %
10219	CAC	IEEE 802.11n (HT Mixed, 7.2 Mbps, BPSK)	WLAN	8.03	± 9.6 %

10220	CAC	IEEE 802.11n (HT Mixed, 43.3 Mbps, 16-QAM)	WLAN	8.13	± 9.6 %
10221	CAC	IEEE 802.11n (HT Mixed, 72.2 Mbps, 64-QAM)	WLAN	8.27	± 9.6 %
10222	CAC	IEEE 802.11n (HT Mixed, 15 Mbps, BPSK)	WLAN	8.06	± 9.6 %
10223	CAC	IEEE 802.11n (HT Mixed, 90 Mbps, 16-QAM)	WLAN	8.48	± 9.6 %
10224	CAC	IEEE 802.11n (HT Mixed, 150 Mbps, 64-QAM)	WLAN	8.08	± 9.6 %
10225	CAB	UMTS-FDD (HSPA+)	WCDMA	5.97	± 9.6 %
10226	CAA	LTE-TDD (SC-FDMA, 1 RB, 1.4 MHz, 16-QAM)	LTE-TDD	9.49	± 9.6 %
10227	CAA	LTE-TDD (SC-FDMA, 1 RB, 1.4 MHz, 64-QAM)	LTE-TDD	10.26	± 9.6 %
10228	CAA	LTE-TDD (SC-FDMA, 1 RB, 1.4 MHz, QPSK)	LTE-TDD	9.22	± 9.6 %
10229	CAC	LTE-TDD (SC-FDMA, 1 RB, 3 MHz, 16-QAM)	LTE-TDD	9.48	± 9.6 %
10230	CAC	LTE-TDD (SC-FDMA, 1 RB, 3 MHz, 64-QAM)	LTE-TDD	10.25	± 9.6 %
10231	CAC	LTE-TDD (SC-FDMA, 1 RB, 3 MHz, QPSK)	LTE-TDD	9.19	± 9.6 %
10232	CAF	LTE-TDD (SC-FDMA, 1 RB, 5 MHz, 16-QAM)	LTE-TDD	9.48	± 9.6 %
10233	CAF	LTE-TDD (SC-FDMA, 1 RB, 5 MHz, 64-QAM)	LTE-TDD	10.25	± 9.6 %
10234	CAF	LTE-TDD (SC-FDMA, 1 RB, 5 MHz, QPSK)	LTE-TDD	9.21	± 9.6 %
10235	CAF	LTE-TDD (SC-FDMA, 1 RB, 10 MHz, 16-QAM)	LTE-TDD	9.48	± 9.6 %
10236	CAF	LTE-TDD (SC-FDMA, 1 RB, 10 MHz, 64-QAM)	LTE-TDD	10.25	± 9.6 %
10237	CAF	LTE-TDD (SC-FDMA, 1 RB, 10 MHz, QPSK)	LTE-TDD	9.21	± 9.6 %
10238	CAF	LTE-TDD (SC-FDMA, 1 RB, 15 MHz, 16-QAM)	LTE-TDD	9.48	± 9.6 %
10239	CAF	LTE-TDD (SC-FDMA, 1 RB, 15 MHz, 64-QAM)	LTE-TDD	10.25	± 9.6 %
10240	CAF	LTE-TDD (SC-FDMA, 1 RB, 15 MHz, QPSK)	LTE-TDD	9.21	± 9.6 %
10241	CAA	LTE-TDD (SC-FDMA, 50% RB, 1.4 MHz, 16-QAM)	LTE-TDD	9.82	± 9.6 %
10242	CAA	LTE-TDD (SC-FDMA, 50% RB, 1.4 MHz, 64-QAM)	LTE-TDD	9.86	± 9.6 %
10243	CAA	LTE-TDD (SC-FDMA, 50% RB, 1.4 MHz, QPSK)	LTE-TDD	9.46	± 9.6 %
10244	CAC	LTE-TDD (SC-FDMA, 50% RB, 3 MHz, 16-QAM)	LTE-TDD	10.06	± 9.6 %
10245	CAC	LTE-TDD (SC-FDMA, 50% RB, 3 MHz, 64-QAM)	LTE-TDD	10.06	± 9.6 %
10246	CAC	LTE-TDD (SC-FDMA, 50% RB, 3 MHz, QPSK)	LTE-TDD	9.30	± 9.6 %
10247	CAF	LTE-TDD (SC-FDMA, 50% RB, 5 MHz, 16-QAM)	LTE-TDD	9.91	± 9.6 %
10248	CAF	LTE-TDD (SC-FDMA, 50% RB, 5 MHz, 64-QAM)	LTE-TDD	10.09	± 9.6 %
10249	CAF	LTE-TDD (SC-FDMA, 50% RB, 5 MHz, QPSK)	LTE-TDD	9.29	± 9.6 %
10250	CAF	LTE-TDD (SC-FDMA, 50% RB, 10 MHz, 16-QAM)	LTE-TDD	9.81	± 9.6 %
10251	CAF	LTE-TDD (SC-FDMA, 50% RB, 10 MHz, 64-QAM)	LTE-TDD	10.17	± 9.6 %
10252	CAF	LTE-TDD (SC-FDMA, 50% RB, 10 MHz, QPSK)	LTE-TDD	9.24	± 9.6 %
10253	CAF	LTE-TDD (SC-FDMA, 50% RB, 15 MHz, 16-QAM)	LTE-TDD	9.90	± 9.6 %
10254	CAF	LTE-TDD (SC-FDMA, 50% RB, 15 MHz, 64-QAM)	LTE-TDD	10.14	± 9.6 %
10255	CAF	LTE-TDD (SC-FDMA, 50% RB, 15 MHz, QPSK)	LTE-TDD	9.20	± 9.6 %
10256	CAA	LTE-TDD (SC-FDMA, 100% RB, 1.4 MHz, 16-QAM)	LTE-TDD	9.96	± 9.6 %
10257	CAA	LTE-TDD (SC-FDMA, 100% RB, 1.4 MHz, 64-QAM)	LTE-TDD	10.08	± 9.6 %
10258	CAA	LTE-TDD (SC-FDMA, 100% RB, 1.4 MHz, QPSK)	LTE-TDD	9.34	± 9.6 %
10259	CAC	LTE-TDD (SC-FDMA, 100% RB, 3 MHz, 16-QAM)	LTE-TDD	9.98	± 9.6 %
10260	CAC	LTE-TDD (SC-FDMA, 100% RB, 3 MHz, 64-QAM)	LTE-TDD	9.97	± 9.6 %
10261	CAC	LTE-TDD (SC-FDMA, 100% RB, 3 MHz, QPSK)	LTE-TDD	9.24	± 9.6 %
10262	CAF	LTE-TDD (SC-FDMA, 100% RB, 5 MHz, 16-QAM)	LTE-TDD	9.83	± 9.6 %
10263	CAF	LTE-TDD (SC-FDMA, 100% RB, 5 MHz, 64-QAM)	LTE-TDD	10.16	± 9.6 %
10264	CAF	LTE-TDD (SC-FDMA, 100% RB, 5 MHz, QPSK)	LTE-TDD	9.23	± 9.6 %
10265	CAF	LTE-TDD (SC-FDMA, 100% RB, 10 MHz, 16-QAM)	LTE-TDD	9.92	± 9.6 %
10266	CAF	LTE-TDD (SC-FDMA, 100% RB, 10 MHz, 64-QAM)	LTE-TDD	10.07	± 9.6 %
10267	CAF	LTE-TDD (SC-FDMA, 100% RB, 10 MHz, QPSK)	LTE-TDD	9.30	± 9.6 %
10268	CAF	LTE-TDD (SC-FDMA, 100% RB, 15 MHz, 16-QAM)	LTE-TDD	10.06	± 9.6 %
10269	CAF	LTE-TDD (SC-FDMA, 100% RB, 15 MHz, 64-QAM)	LTE-TDD	10.13	± 9.6 %
10270	CAF	LTE-TDD (SC-FDMA, 100% RB, 15 MHz, QPSK)	LTE-TDD	9.58	± 9.6 %
10274	CAB	UMTS-FDD (HSUPA, Subtest 5, 3GPP Rel8.10)	WCDMA	4.87	± 9.6 %
10275	CAB	UMTS-FDD (HSUPA, Subtest 5, 3GPP Rel8.4)	WCDMA	3.96	± 9.6 %
10277	CAA	PHS (QPSK)	PHS	11.81	± 9.6 %
10278	CAA	PHS (QPSK, BW 884MHz, Rolloff 0.5)	PHS	11.81	± 9.6 %
10279	CAA	PHS (QPSK, BW 884MHz, Rolloff 0.38)	PHS	12.18	± 9.6 %
10290	AAB	CDMA2000, RC1, SO55, Full Rate	CDMA2000	3.91	± 9.6 %
10291	AAB	CDMA2000, RC3, SO55, Full Rate	CDMA2000	3.46	± 9.6 %
10292	AAB	CDMA2000, RC3, SO32, Full Rate	CDMA2000	3.39	± 9.6 %
10293	AAB	CDMA2000, RC3, SO3, Full Rate	CDMA2000	3.50	± 9.6 %
10295	AAB	CDMA2000, RC1, SO3, 1/8th Rate 25 fr.	CDMA2000	12.49	± 9.6 %
10297	AAD	LTE-FDD (SC-FDMA, 50% RB, 20 MHz, QPSK)	LTE-FDD	5.81	± 9.6 %
10298	AAD	LTE-FDD (SC-FDMA, 50% RB, 3 MHz, QPSK)	LTE-FDD	5.72	± 9.6 %
10299	AAD	LTE-FDD (SC-FDMA, 50% RB, 3 MHz, 16-QAM)	LTE-FDD	6.39	± 9.6 %

10300	AAD	LTE-FDD (SC-FDMA, 50% RB, 3 MHz, 64-QAM)	LTE-FDD	6.60	± 9.6 %
10301	AAA	IEEE 802.16e WiMAX (29:18, 5ms, 10MHz, QPSK, PUSC)	WiMAX	12.03	± 9.6 %
10302	AAA	IEEE 802.16e WiMAX (29:18, 5ms, 10MHz, QPSK, PUSC, 3 CTRL symbols)	WiMAX	12.57	± 9.6 %
10303	AAA	IEEE 802.16e WiMAX (31:15, 5ms, 10MHz, 64QAM, PUSC)	WiMAX	12.52	± 9.6 %
10304	AAA	IEEE 802.16e WiMAX (29:18, 5ms, 10MHz, 64QAM, PUSC)	WiMAX	11.86	± 9.6 %
10305	AAA	IEEE 802.16e WiMAX (31:15, 10ms, 10MHz, 64QAM, PUSC, 15 symbols)	WiMAX	15.24	± 9.6 %
10306	AAA	IEEE 802.16e WiMAX (29:18, 10ms, 10MHz, 64QAM, PUSC, 18 symbols)	WiMAX	14.67	± 9.6 %
10307	AAA	IEEE 802.16e WiMAX (29:18, 10ms, 10MHz, QPSK, PUSC, 18 symbols)	WiMAX	14.49	± 9.6 %
10308	AAA	IEEE 802.16e WiMAX (29:18, 10ms, 10MHz, 16QAM, PUSC)	WiMAX	14.46	± 9.6 %
10309	AAA	IEEE 802.16e WiMAX (29:18, 10ms, 10MHz, 16QAM, AMC 2x3, 18 symbols)	WiMAX	14.58	± 9.6 %
10310	AAA	IEEE 802.16e WiMAX (29:18, 10ms, 10MHz, QPSK, AMC 2x3, 18 symbols)	WiMAX	14.57	± 9.6 %
10311	AAD	LTE-FDD (SC-FDMA, 100% RB, 15 MHz, QPSK)	LTE-FDD	6.06	± 9.6 %
10313	AAA	iDEN 1:3	iDEN	10.51	± 9.6 %
10314	AAA	iDEN 1:6	iDEN	13.48	± 9.6 %
10315	AAB	IEEE 802.11b WiFi 2.4 GHz (DSSS, 1 Mbps, 96pc duty cycle)	WLAN	1.71	± 9.6 %
10316	AAB	IEEE 802.11g WiFi 2.4 GHz (ERP-OFDM, 6 Mbps, 96pc duty cycle)	WLAN	8.36	± 9.6 %
10317	AAC	IEEE 802.11a WiFi 5 GHz (OFDM, 6 Mbps, 96pc duty cycle)	WLAN	8.36	± 9.6 %
10352	AAA	Pulse Waveform (200Hz, 10%)	Generic	10.00	± 9.6 %
10353	AAA	Pulse Waveform (200Hz, 20%)	Generic	6.99	± 9.6 %
10354	AAA	Pulse Waveform (200Hz, 40%)	Generic	3.98	± 9.6 %
10355	AAA	Pulse Waveform (200Hz, 60%)	Generic	2.22	± 9.6 %
10356	AAA	Pulse Waveform (200Hz, 80%)	Generic	0.97	± 9.6 %
10387	AAA	QPSK Waveform, 1 MHz	Generic	5.10	± 9.6 %
10388	AAA	QPSK Waveform, 10 MHz	Generic	5.22	± 9.6 %
10396	AAA	64-QAM Waveform, 100 kHz	Generic	6.27	± 9.6 %
10399	AAA	64-QAM Waveform, 40 MHz	Generic	6.27	± 9.6 %
10400	AAD	IEEE 802.11ac WiFi (20MHz, 64-QAM, 99pc duty cycle)	WLAN	8.37	± 9.6 %
10401	AAD	IEEE 802.11ac WiFi (40MHz, 64-QAM, 99pc duty cycle)	WLAN	8.60	± 9.6 %
10402	AAD	IEEE 802.11ac WiFi (80MHz, 64-QAM, 99pc duty cycle)	WLAN	8.53	± 9.6 %
10403	AAB	CDMA2000 (1xEV-DO, Rev. 0)	CDMA2000	3.76	± 9.6 %
10404	AAB	CDMA2000 (1xEV-DO, Rev. A)	CDMA2000	3.77	± 9.6 %
10406	AAB	CDMA2000, RC3, SO32, SCH0, Full Rate	CDMA2000	5.22	± 9.6 %
10410	AAF	LTE-TDD (SC-FDMA, 1 RB, 10 MHz, QPSK, UL Subframe=2,3,4,7,8,9, Subframe Conf=4)	LTE-TDD	7.82	± 9.6 %
10414	AAA	WLAN CCDF, 64-QAM, 40MHz	Generic	8.54	± 9.6 %
10415	AAA	IEEE 802.11b WiFi 2.4 GHz (DSSS, 1 Mbps, 99pc duty cycle)	WLAN	1.54	± 9.6 %
10416	AAA	IEEE 802.11g WiFi 2.4 GHz (ERP-OFDM, 6 Mbps, 99pc duty cycle)	WLAN	8.23	± 9.6 %
10417	AAB	IEEE 802.11a/h WiFi 5 GHz (OFDM, 6 Mbps, 99pc duty cycle)	WLAN	8.23	± 9.6 %
10418	AAA	IEEE 802.11g WiFi 2.4 GHz (DSSS-OFDM, 6 Mbps, 99pc duty cycle, Long preamble)	WLAN	8.14	± 9.6 %
10419	AAA	IEEE 802.11g WiFi 2.4 GHz (DSSS-OFDM, 6 Mbps, 99pc duty cycle, Short preamble)	WLAN	8.19	± 9.6 %
10422	AAB	IEEE 802.11n (HT Greenfield, 7.2 Mbps, BPSK)	WLAN	8.32	± 9.6 %
10423	AAB	IEEE 802.11n (HT Greenfield, 43.3 Mbps, 16-QAM)	WLAN	8.47	± 9.6 %
10424	AAB	IEEE 802.11n (HT Greenfield, 72.2 Mbps, 64-QAM)	WLAN	8.40	± 9.6 %
10425	AAB	IEEE 802.11n (HT Greenfield, 15 Mbps, BPSK)	WLAN	8.41	± 9.6 %
10426	AAB	IEEE 802.11n (HT Greenfield, 90 Mbps, 16-QAM)	WLAN	8.45	± 9.6 %
10427	AAB	IEEE 802.11n (HT Greenfield, 150 Mbps, 64-QAM)	WLAN	8.41	± 9.6 %
10430	AAD	LTE-FDD (OFDMA, 5 MHz, E-TM 3.1)	LTE-FDD	8.28	± 9.6 %
10431	AAD	LTE-FDD (OFDMA, 10 MHz, E-TM 3.1)	LTE-FDD	8.38	± 9.6 %
10432	AAC	LTE-FDD (OFDMA, 15 MHz, E-TM 3.1)	LTE-FDD	8.34	± 9.6 %
10433	AAC	LTE-FDD (OFDMA, 20 MHz, E-TM 3.1)	LTE-FDD	8.34	± 9.6 %
10434	AAA	W-CDMA (BS Test Model 1, 64 DPCH)	WCDMA	8.60	± 9.6 %
10435	AAF	LTE-TDD (SC-FDMA, 1 RB, 20 MHz, QPSK, UL Subframe=2,3,4,7,8,9)	LTE-TDD	7.82	± 9.6 %
10447	AAD	LTE-FDD (OFDMA, 5 MHz, E-TM 3.1, Clipping 44%)	LTE-FDD	7.56	± 9.6 %
10448	AAD	LTE-FDD (OFDMA, 10 MHz, E-TM 3.1, Clipping 44%)	LTE-FDD	7.53	± 9.6 %
10449	AAC	LTE-FDD (OFDMA, 15 MHz, E-TM 3.1, Clipping 44%)	LTE-FDD	7.51	± 9.6 %
10450	AAC	LTE-FDD (OFDMA, 20 MHz, E-TM 3.1, Clipping 44%)	LTE-FDD	7.48	± 9.6 %

10451	AAA	W-CDMA (BS Test Model 1, 64 DPCH, Clipping 44%)	WCDMA	7.59	± 9.6 %
10456	AAB	IEEE 802.11ac WiFi (160MHz, 64-QAM, 99pc duty cycle)	WLAN	8.63	± 9.6 %
10457	AAA	UMTS-FDD (DC-HSDPA)	WCDMA	6.62	± 9.6 %
10458	AAA	CDMA2000 (1xEV-DO, Rev. B, 2 carriers)	CDMA2000	6.55	± 9.6 %
10459	AAA	CDMA2000 (1xEV-DO, Rev. B, 3 carriers)	CDMA2000	8.25	± 9.6 %
10460	AAA	UMTS-FDD (WCDMA, AMR)	WCDMA	2.39	± 9.6 %
10461	AAA	LTE-TDD (SC-FDMA, 1 RB, 1.4 MHz, QPSK, UL Subframe=2,3,4,7,8,9)	LTE-TDD	7.82	± 9.6 %
10462	AAA	LTE-TDD (SC-FDMA, 1 RB, 1.4 MHz, 16-QAM, UL Subframe=2,3,4,7,8,9)	LTE-TDD	8.30	± 9.6 %
10463	AAA	LTE-TDD (SC-FDMA, 1 RB, 1.4 MHz, 64-QAM, UL Subframe=2,3,4,7,8,9)	LTE-TDD	8.56	± 9.6 %
10464	AAB	LTE-TDD (SC-FDMA, 1 RB, 3 MHz, QPSK, UL Subframe=2,3,4,7,8,9)	LTE-TDD	7.82	± 9.6 %
10465	AAB	LTE-TDD (SC-FDMA, 1 RB, 3 MHz, 16-QAM, UL Subframe=2,3,4,7,8,9)	LTE-TDD	8.32	± 9.6 %
10466	AAB	LTE-TDD (SC-FDMA, 1 RB, 3 MHz, 64-QAM, UL Subframe=2,3,4,7,8,9)	LTE-TDD	8.57	± 9.6 %
10467	AAE	LTE-TDD (SC-FDMA, 1 RB, 5 MHz, QPSK, UL Subframe=2,3,4,7,8,9)	LTE-TDD	7.82	± 9.6 %
10468	AAE	LTE-TDD (SC-FDMA, 1 RB, 5 MHz, 16-QAM, UL Subframe=2,3,4,7,8,9)	LTE-TDD	8.32	± 9.6 %
10469	AAE	LTE-TDD (SC-FDMA, 1 RB, 5 MHz, 64-QAM, UL Subframe=2,3,4,7,8,9)	LTE-TDD	8.56	± 9.6 %
10470	AAE	LTE-TDD (SC-FDMA, 1 RB, 10 MHz, QPSK, UL Subframe=2,3,4,7,8,9)	LTE-TDD	7.82	± 9.6 %
10471	AAE	LTE-TDD (SC-FDMA, 1 RB, 10 MHz, 16-QAM, UL Subframe=2,3,4,7,8,9)	LTE-TDD	8.32	± 9.6 %
10472	AAE	LTE-TDD (SC-FDMA, 1 RB, 10 MHz, 64-QAM, UL Subframe=2,3,4,7,8,9)	LTE-TDD	8.57	± 9.6 %
10473	AAE	LTE-TDD (SC-FDMA, 1 RB, 15 MHz, QPSK, UL Subframe=2,3,4,7,8,9)	LTE-TDD	7.82	± 9.6 %
10474	AAE	LTE-TDD (SC-FDMA, 1 RB, 15 MHz, 16-QAM, UL Subframe=2,3,4,7,8,9)	LTE-TDD	8.32	± 9.6 %
10475	AAE	LTE-TDD (SC-FDMA, 1 RB, 15 MHz, 64-QAM, UL Subframe=2,3,4,7,8,9)	LTE-TDD	8.57	± 9.6 %
10477	AAF	LTE-TDD (SC-FDMA, 1 RB, 20 MHz, 16-QAM, UL Subframe=2,3,4,7,8,9)	LTE-TDD	8.32	± 9.6 %
10478	AAF	LTE-TDD (SC-FDMA, 1 RB, 20 MHz, 64-QAM, UL Subframe=2,3,4,7,8,9)	LTE-TDD	8.57	± 9.6 %
10479	AAA	LTE-TDD (SC-FDMA, 50% RB, 1.4 MHz, QPSK, UL Subframe=2,3,4,7,8,9)	LTE-TDD	7.74	± 9.6 %
10480	AAA	LTE-TDD (SC-FDMA, 50% RB, 1.4 MHz, 16-QAM, UL Subframe=2,3,4,7,8,9)	LTE-TDD	8.18	± 9.6 %
10481	AAA	LTE-TDD (SC-FDMA, 50% RB, 1.4 MHz, 64-QAM, UL Subframe=2,3,4,7,8,9)	LTE-TDD	8.45	± 9.6 %
10482	AAB	LTE-TDD (SC-FDMA, 50% RB, 3 MHz, QPSK, UL Subframe=2,3,4,7,8,9)	LTE-TDD	7.71	± 9.6 %
10483	AAB	LTE-TDD (SC-FDMA, 50% RB, 3 MHz, 16-QAM, UL Subframe=2,3,4,7,8,9)	LTE-TDD	8.39	± 9.6 %
10484	AAB	LTE-TDD (SC-FDMA, 50% RB, 3 MHz, 64-QAM, UL Subframe=2,3,4,7,8,9)	LTE-TDD	8.47	± 9.6 %
10485	AAE	LTE-TDD (SC-FDMA, 50% RB, 5 MHz, QPSK, UL Subframe=2,3,4,7,8,9)	LTE-TDD	7.59	± 9.6 %
10486	AAE	LTE-TDD (SC-FDMA, 50% RB, 5 MHz, 16-QAM, UL Subframe=2,3,4,7,8,9)	LTE-TDD	8.38	± 9.6 %
10487	AAE	LTE-TDD (SC-FDMA, 50% RB, 5 MHz, 64-QAM, UL Subframe=2,3,4,7,8,9)	LTE-TDD	8.60	± 9.6 %
10488	AAE	LTE-TDD (SC-FDMA, 50% RB, 10 MHz, QPSK, UL Subframe=2,3,4,7,8,9)	LTE-TDD	7.70	± 9.6 %
10489	AAE	LTE-TDD (SC-FDMA, 50% RB, 10 MHz, 16-QAM, UL Subframe=2,3,4,7,8,9)	LTE-TDD	8.31	± 9.6 %
10490	AAE	LTE-TDD (SC-FDMA, 50% RB, 10 MHz, 64-QAM, UL Subframe=2,3,4,7,8,9)	LTE-TDD	8.54	± 9.6 %
10491	AAE	LTE-TDD (SC-FDMA, 50% RB, 15 MHz, QPSK, UL Subframe=2,3,4,7,8,9)	LTE-TDD	7.74	± 9.6 %

10492	AAE	LTE-TDD (SC-FDMA, 50% RB, 15 MHz, 16-QAM, UL Subframe=2,3,4,7,8,9)	LTE-TDD	8.41	± 9.6 %
10493	AAE	LTE-TDD (SC-FDMA, 50% RB, 15 MHz, 64-QAM, UL Subframe=2,3,4,7,8,9)	LTE-TDD	8.55	± 9.6 %
10494	AAF	LTE-TDD (SC-FDMA, 50% RB, 20 MHz, QPSK, UL Subframe=2,3,4,7,8,9)	LTE-TDD	7.74	± 9.6 %
10495	AAF	LTE-TDD (SC-FDMA, 50% RB, 20 MHz, 16-QAM, UL Subframe=2,3,4,7,8,9)	LTE-TDD	8.37	± 9.6 %
10496	AAF	LTE-TDD (SC-FDMA, 50% RB, 20 MHz, 64-QAM, UL Subframe=2,3,4,7,8,9)	LTE-TDD	8.54	± 9.6 %
10497	AAA	LTE-TDD (SC-FDMA, 100% RB, 1.4 MHz, QPSK, UL Subframe=2,3,4,7,8,9)	LTE-TDD	7.67	± 9.6 %
10498	AAA	LTE-TDD (SC-FDMA, 100% RB, 1.4 MHz, 16-QAM, UL Subframe=2,3,4,7,8,9)	LTE-TDD	8.40	± 9.6 %
10499	AAA	LTE-TDD (SC-FDMA, 100% RB, 1.4 MHz, 64-QAM, UL Subframe=2,3,4,7,8,9)	LTE-TDD	8.68	± 9.6 %
10500	AAB	LTE-TDD (SC-FDMA, 100% RB, 3 MHz, QPSK, UL Subframe=2,3,4,7,8,9)	LTE-TDD	7.67	± 9.6 %
10501	AAB	LTE-TDD (SC-FDMA, 100% RB, 3 MHz, 16-QAM, UL Subframe=2,3,4,7,8,9)	LTE-TDD	8.44	± 9.6 %
10502	AAB	LTE-TDD (SC-FDMA, 100% RB, 3 MHz, 64-QAM, UL Subframe=2,3,4,7,8,9)	LTE-TDD	8.52	± 9.6 %
10503	AAE	LTE-TDD (SC-FDMA, 100% RB, 5 MHz, QPSK, UL Subframe=2,3,4,7,8,9)	LTE-TDD	7.72	± 9.6 %
10504	AAE	LTE-TDD (SC-FDMA, 100% RB, 5 MHz, 16-QAM, UL Subframe=2,3,4,7,8,9)	LTE-TDD	8.31	± 9.6 %
10505	AAE	LTE-TDD (SC-FDMA, 100% RB, 5 MHz, 64-QAM, UL Subframe=2,3,4,7,8,9)	LTE-TDD	8.54	± 9.6 %
10506	AAE	LTE-TDD (SC-FDMA, 100% RB, 10 MHz, QPSK, UL Subframe=2,3,4,7,8,9)	LTE-TDD	7.74	± 9.6 %
10507	AAE	LTE-TDD (SC-FDMA, 100% RB, 10 MHz, 16-QAM, UL Subframe=2,3,4,7,8,9)	LTE-TDD	8.36	± 9.6 %
10508	AAE	LTE-TDD (SC-FDMA, 100% RB, 10 MHz, 64-QAM, UL Subframe=2,3,4,7,8,9)	LTE-TDD	8.55	± 9.6 %
10509	AAE	LTE-TDD (SC-FDMA, 100% RB, 15 MHz, QPSK, UL Subframe=2,3,4,7,8,9)	LTE-TDD	7.99	± 9.6 %
10510	AAE	LTE-TDD (SC-FDMA, 100% RB, 15 MHz, 16-QAM, UL Subframe=2,3,4,7,8,9)	LTE-TDD	8.49	± 9.6 %
10511	AAE	LTE-TDD (SC-FDMA, 100% RB, 15 MHz, 64-QAM, UL Subframe=2,3,4,7,8,9)	LTE-TDD	8.51	± 9.6 %
10512	AAF	LTE-TDD (SC-FDMA, 100% RB, 20 MHz, QPSK, UL Subframe=2,3,4,7,8,9)	LTE-TDD	7.74	± 9.6 %
10513	AAF	LTE-TDD (SC-FDMA, 100% RB, 20 MHz, 16-QAM, UL Subframe=2,3,4,7,8,9)	LTE-TDD	8.42	± 9.6 %
10514	AAF	LTE-TDD (SC-FDMA, 100% RB, 20 MHz, 64-QAM, UL Subframe=2,3,4,7,8,9)	LTE-TDD	8.45	± 9.6 %
10515	AAA	IEEE 802.11b WiFi 2.4 GHz (DSSS, 2 Mbps, 99pc duty cycle)	WLAN	1.58	± 9.6 %
10516	AAA	IEEE 802.11b WiFi 2.4 GHz (DSSS, 5.5 Mbps, 99pc duty cycle)	WLAN	1.57	± 9.6 %
10517	AAA	IEEE 802.11b WiFi 2.4 GHz (DSSS, 11 Mbps, 99pc duty cycle)	WLAN	1.58	± 9.6 %
10518	AAB	IEEE 802.11a/h WiFi 5 GHz (OFDM, 9 Mbps, 99pc duty cycle)	WLAN	8.23	± 9.6 %
10519	AAB	IEEE 802.11a/h WiFi 5 GHz (OFDM, 12 Mbps, 99pc duty cycle)	WLAN	8.39	± 9.6 %
10520	AAB	IEEE 802.11a/h WiFi 5 GHz (OFDM, 18 Mbps, 99pc duty cycle)	WLAN	8.12	± 9.6 %
10521	AAB	IEEE 802.11a/h WiFi 5 GHz (OFDM, 24 Mbps, 99pc duty cycle)	WLAN	7.97	± 9.6 %
10522	AAB	IEEE 802.11a/h WiFi 5 GHz (OFDM, 36 Mbps, 99pc duty cycle)	WLAN	8.45	± 9.6 %
10523	AAB	IEEE 802.11a/h WiFi 5 GHz (OFDM, 48 Mbps, 99pc duty cycle)	WLAN	8.08	± 9.6 %
10524	AAB	IEEE 802.11a/h WiFi 5 GHz (OFDM, 54 Mbps, 99pc duty cycle)	WLAN	8.27	± 9.6 %
10525	AAB	IEEE 802.11ac WiFi (20MHz, MCS0, 99pc duty cycle)	WLAN	8.36	± 9.6 %
10526	AAB	IEEE 802.11ac WiFi (20MHz, MCS1, 99pc duty cycle)	WLAN	8.42	± 9.6 %
10527	AAB	IEEE 802.11ac WiFi (20MHz, MCS2, 99pc duty cycle)	WLAN	8.21	± 9.6 %
10528	AAB	IEEE 802.11ac WiFi (20MHz, MCS3, 99pc duty cycle)	WLAN	8.36	± 9.6 %
10529	AAB	IEEE 802.11ac WiFi (20MHz, MCS4, 99pc duty cycle)	WLAN	8.36	± 9.6 %
10531	AAB	IEEE 802.11ac WiFi (20MHz, MCS6, 99pc duty cycle)	WLAN	8.43	± 9.6 %
10532	AAB	IEEE 802.11ac WiFi (20MHz, MCS7, 99pc duty cycle)	WLAN	8.29	± 9.6 %
10533	AAB	IEEE 802.11ac WiFi (20MHz, MCS8, 99pc duty cycle)	WLAN	8.38	± 9.6 %
10534	AAB	IEEE 802.11ac WiFi (40MHz, MCS0, 99pc duty cycle)	WLAN	8.45	± 9.6 %

10535	AAB	IEEE 802.11ac WiFi (40MHz, MCS1, 99pc duty cycle)	WLAN	8.45	± 9.6 %
10536	AAB	IEEE 802.11ac WiFi (40MHz, MCS2, 99pc duty cycle)	WLAN	8.32	± 9.6 %
10537	AAB	IEEE 802.11ac WiFi (40MHz, MCS3, 99pc duty cycle)	WLAN	8.44	± 9.6 %
10538	AAB	IEEE 802.11ac WiFi (40MHz, MCS4, 99pc duty cycle)	WLAN	8.54	± 9.6 %
10540	AAB	IEEE 802.11ac WiFi (40MHz, MCS6, 99pc duty cycle)	WLAN	8.39	± 9.6 %
10541	AAB	IEEE 802.11ac WiFi (40MHz, MCS7, 99pc duty cycle)	WLAN	8.46	± 9.6 %
10542	AAB	IEEE 802.11ac WiFi (40MHz, MCS8, 99pc duty cycle)	WLAN	8.65	± 9.6 %
10543	AAB	IEEE 802.11ac WiFi (40MHz, MCS9, 99pc duty cycle)	WLAN	8.65	± 9.6 %
10544	AAB	IEEE 802.11ac WiFi (80MHz, MCS0, 99pc duty cycle)	WLAN	8.47	± 9.6 %
10545	AAB	IEEE 802.11ac WiFi (80MHz, MCS1, 99pc duty cycle)	WLAN	8.55	± 9.6 %
10546	AAB	IEEE 802.11ac WiFi (80MHz, MCS2, 99pc duty cycle)	WLAN	8.35	± 9.6 %
10547	AAB	IEEE 802.11ac WiFi (80MHz, MCS3, 99pc duty cycle)	WLAN	8.49	± 9.6 %
10548	AAB	IEEE 802.11ac WiFi (80MHz, MCS4, 99pc duty cycle)	WLAN	8.37	± 9.6 %
10550	AAB	IEEE 802.11ac WiFi (80MHz, MCS6, 99pc duty cycle)	WLAN	8.38	± 9.6 %
10551	AAB	IEEE 802.11ac WiFi (80MHz, MCS7, 99pc duty cycle)	WLAN	8.50	± 9.6 %
10552	AAB	IEEE 802.11ac WiFi (80MHz, MCS8, 99pc duty cycle)	WLAN	8.42	± 9.6 %
10553	AAB	IEEE 802.11ac WiFi (80MHz, MCS9, 99pc duty cycle)	WLAN	8.45	± 9.6 %
10554	AAC	IEEE 802.11ac WiFi (160MHz, MCS0, 99pc duty cycle)	WLAN	8.48	± 9.6 %
10555	AAC	IEEE 802.11ac WiFi (160MHz, MCS1, 99pc duty cycle)	WLAN	8.47	± 9.6 %
10556	AAC	IEEE 802.11ac WiFi (160MHz, MCS2, 99pc duty cycle)	WLAN	8.50	± 9.6 %
10557	AAC	IEEE 802.11ac WiFi (160MHz, MCS3, 99pc duty cycle)	WLAN	8.52	± 9.6 %
10558	AAC	IEEE 802.11ac WiFi (160MHz, MCS4, 99pc duty cycle)	WLAN	8.61	± 9.6 %
10560	AAC	IEEE 802.11ac WiFi (160MHz, MCS6, 99pc duty cycle)	WLAN	8.73	± 9.6 %
10561	AAC	IEEE 802.11ac WiFi (160MHz, MCS7, 99pc duty cycle)	WLAN	8.56	± 9.6 %
10562	AAC	IEEE 802.11ac WiFi (160MHz, MCS8, 99pc duty cycle)	WLAN	8.69	± 9.6 %
10563	AAC	IEEE 802.11ac WiFi (160MHz, MCS9, 99pc duty cycle)	WLAN	8.77	± 9.6 %
10564	AAA	IEEE 802.11g WiFi 2.4 GHz (DSSS-OFDM, 9 Mbps, 99pc duty cycle)	WLAN	8.25	± 9.6 %
10565	AAA	IEEE 802.11g WiFi 2.4 GHz (DSSS-OFDM, 12 Mbps, 99pc duty cycle)	WLAN	8.45	± 9.6 %
10566	AAA	IEEE 802.11g WiFi 2.4 GHz (DSSS-OFDM, 18 Mbps, 99pc duty cycle)	WLAN	8.13	± 9.6 %
10567	AAA	IEEE 802.11g WiFi 2.4 GHz (DSSS-OFDM, 24 Mbps, 99pc duty cycle)	WLAN	8.00	± 9.6 %
10568	AAA	IEEE 802.11g WiFi 2.4 GHz (DSSS-OFDM, 36 Mbps, 99pc duty cycle)	WLAN	8.37	± 9.6 %
10569	AAA	IEEE 802.11g WiFi 2.4 GHz (DSSS-OFDM, 48 Mbps, 99pc duty cycle)	WLAN	8.10	± 9.6 %
10570	AAA	IEEE 802.11g WiFi 2.4 GHz (DSSS-OFDM, 54 Mbps, 99pc duty cycle)	WLAN	8.30	± 9.6 %
10571	AAA	IEEE 802.11b WiFi 2.4 GHz (DSSS, 1 Mbps, 90pc duty cycle)	WLAN	1.99	± 9.6 %
10572	AAA	IEEE 802.11b WiFi 2.4 GHz (DSSS, 2 Mbps, 90pc duty cycle)	WLAN	1.99	± 9.6 %
10573	AAA	IEEE 802.11b WiFi 2.4 GHz (DSSS, 5.5 Mbps, 90pc duty cycle)	WLAN	1.98	± 9.6 %
10574	AAA	IEEE 802.11b WiFi 2.4 GHz (DSSS, 11 Mbps, 90pc duty cycle)	WLAN	1.98	± 9.6 %
10575	AAA	IEEE 802.11g WiFi 2.4 GHz (DSSS-OFDM, 6 Mbps, 90pc duty cycle)	WLAN	8.59	± 9.6 %
10576	AAA	IEEE 802.11g WiFi 2.4 GHz (DSSS-OFDM, 9 Mbps, 90pc duty cycle)	WLAN	8.60	± 9.6 %
10577	AAA	IEEE 802.11g WiFi 2.4 GHz (DSSS-OFDM, 12 Mbps, 90pc duty cycle)	WLAN	8.70	± 9.6 %
10578	AAA	IEEE 802.11g WiFi 2.4 GHz (DSSS-OFDM, 18 Mbps, 90pc duty cycle)	WLAN	8.49	± 9.6 %
10579	AAA	IEEE 802.11g WiFi 2.4 GHz (DSSS-OFDM, 24 Mbps, 90pc duty cycle)	WLAN	8.36	± 9.6 %
10580	AAA	IEEE 802.11g WiFi 2.4 GHz (DSSS-OFDM, 36 Mbps, 90pc duty cycle)	WLAN	8.76	± 9.6 %
10581	AAA	IEEE 802.11g WiFi 2.4 GHz (DSSS-OFDM, 48 Mbps, 90pc duty cycle)	WLAN	8.35	± 9.6 %
10582	AAA	IEEE 802.11g WiFi 2.4 GHz (DSSS-OFDM, 54 Mbps, 90pc duty cycle)	WLAN	8.67	± 9.6 %
10583	AAB	IEEE 802.11a/h WiFi 5 GHz (OFDM, 6 Mbps, 90pc duty cycle)	WLAN	8.59	± 9.6 %
10584	AAB	IEEE 802.11a/h WiFi 5 GHz (OFDM, 9 Mbps, 90pc duty cycle)	WLAN	8.60	± 9.6 %
10585	AAB	IEEE 802.11a/h WiFi 5 GHz (OFDM, 12 Mbps, 90pc duty cycle)	WLAN	8.70	± 9.6 %
10586	AAB	IEEE 802.11a/h WiFi 5 GHz (OFDM, 18 Mbps, 90pc duty cycle)	WLAN	8.49	± 9.6 %
10587	AAB	IEEE 802.11a/h WiFi 5 GHz (OFDM, 24 Mbps, 90pc duty cycle)	WLAN	8.36	± 9.6 %

10588	AAB	IEEE 802.11a/h WiFi 5 GHz (OFDM, 36 Mbps, 90pc duty cycle)	WLAN	8.76	± 9.6 %
10589	AAB	IEEE 802.11a/h WiFi 5 GHz (OFDM, 48 Mbps, 90pc duty cycle)	WLAN	8.35	± 9.6 %
10590	AAB	IEEE 802.11a/h WiFi 5 GHz (OFDM, 54 Mbps, 90pc duty cycle)	WLAN	8.67	± 9.6 %
10591	AAB	IEEE 802.11n (HT Mixed, 20MHz, MCS0, 90pc duty cycle)	WLAN	8.63	± 9.6 %
10592	AAB	IEEE 802.11n (HT Mixed, 20MHz, MCS1, 90pc duty cycle)	WLAN	8.79	± 9.6 %
10593	AAB	IEEE 802.11n (HT Mixed, 20MHz, MCS2, 90pc duty cycle)	WLAN	8.64	± 9.6 %
10594	AAB	IEEE 802.11n (HT Mixed, 20MHz, MCS3, 90pc duty cycle)	WLAN	8.74	± 9.6 %
10595	AAB	IEEE 802.11n (HT Mixed, 20MHz, MCS4, 90pc duty cycle)	WLAN	8.74	± 9.6 %
10596	AAB	IEEE 802.11n (HT Mixed, 20MHz, MCS5, 90pc duty cycle)	WLAN	8.71	± 9.6 %
10597	AAB	IEEE 802.11n (HT Mixed, 20MHz, MCS6, 90pc duty cycle)	WLAN	8.72	± 9.6 %
10598	AAB	IEEE 802.11n (HT Mixed, 20MHz, MCS7, 90pc duty cycle)	WLAN	8.50	± 9.6 %
10599	AAB	IEEE 802.11n (HT Mixed, 40MHz, MCS0, 90pc duty cycle)	WLAN	8.79	± 9.6 %
10600	AAB	IEEE 802.11n (HT Mixed, 40MHz, MCS1, 90pc duty cycle)	WLAN	8.88	± 9.6 %
10601	AAB	IEEE 802.11n (HT Mixed, 40MHz, MCS2, 90pc duty cycle)	WLAN	8.82	± 9.6 %
10602	AAB	IEEE 802.11n (HT Mixed, 40MHz, MCS3, 90pc duty cycle)	WLAN	8.94	± 9.6 %
10603	AAB	IEEE 802.11n (HT Mixed, 40MHz, MCS4, 90pc duty cycle)	WLAN	9.03	± 9.6 %
10604	AAB	IEEE 802.11n (HT Mixed, 40MHz, MCS5, 90pc duty cycle)	WLAN	8.76	± 9.6 %
10605	AAB	IEEE 802.11n (HT Mixed, 40MHz, MCS6, 90pc duty cycle)	WLAN	8.97	± 9.6 %
10606	AAB	IEEE 802.11n (HT Mixed, 40MHz, MCS7, 90pc duty cycle)	WLAN	8.82	± 9.6 %
10607	AAB	IEEE 802.11ac WiFi (20MHz, MCS0, 90pc duty cycle)	WLAN	8.64	± 9.6 %
10608	AAB	IEEE 802.11ac WiFi (20MHz, MCS1, 90pc duty cycle)	WLAN	8.77	± 9.6 %
10609	AAB	IEEE 802.11ac WiFi (20MHz, MCS2, 90pc duty cycle)	WLAN	8.57	± 9.6 %
10610	AAB	IEEE 802.11ac WiFi (20MHz, MCS3, 90pc duty cycle)	WLAN	8.78	± 9.6 %
10611	AAB	IEEE 802.11ac WiFi (20MHz, MCS4, 90pc duty cycle)	WLAN	8.70	± 9.6 %
10612	AAB	IEEE 802.11ac WiFi (20MHz, MCS5, 90pc duty cycle)	WLAN	8.77	± 9.6 %
10613	AAB	IEEE 802.11ac WiFi (20MHz, MCS6, 90pc duty cycle)	WLAN	8.94	± 9.6 %
10614	AAB	IEEE 802.11ac WiFi (20MHz, MCS7, 90pc duty cycle)	WLAN	8.59	± 9.6 %
10615	AAB	IEEE 802.11ac WiFi (20MHz, MCS8, 90pc duty cycle)	WLAN	8.82	± 9.6 %
10616	AAB	IEEE 802.11ac WiFi (40MHz, MCS0, 90pc duty cycle)	WLAN	8.82	± 9.6 %
10617	AAB	IEEE 802.11ac WiFi (40MHz, MCS1, 90pc duty cycle)	WLAN	8.81	± 9.6 %
10618	AAB	IEEE 802.11ac WiFi (40MHz, MCS2, 90pc duty cycle)	WLAN	8.58	± 9.6 %
10619	AAB	IEEE 802.11ac WiFi (40MHz, MCS3, 90pc duty cycle)	WLAN	8.86	± 9.6 %
10620	AAB	IEEE 802.11ac WiFi (40MHz, MCS4, 90pc duty cycle)	WLAN	8.87	± 9.6 %
10621	AAB	IEEE 802.11ac WiFi (40MHz, MCS5, 90pc duty cycle)	WLAN	8.77	± 9.6 %
10622	AAB	IEEE 802.11ac WiFi (40MHz, MCS6, 90pc duty cycle)	WLAN	8.68	± 9.6 %
10623	AAB	IEEE 802.11ac WiFi (40MHz, MCS7, 90pc duty cycle)	WLAN	8.82	± 9.6 %
10624	AAB	IEEE 802.11ac WiFi (40MHz, MCS8, 90pc duty cycle)	WLAN	8.96	± 9.6 %
10625	AAB	IEEE 802.11ac WiFi (40MHz, MCS9, 90pc duty cycle)	WLAN	8.96	± 9.6 %
10626	AAB	IEEE 802.11ac WiFi (80MHz, MCS0, 90pc duty cycle)	WLAN	8.83	± 9.6 %
10627	AAB	IEEE 802.11ac WiFi (80MHz, MCS1, 90pc duty cycle)	WLAN	8.88	± 9.6 %
10628	AAB	IEEE 802.11ac WiFi (80MHz, MCS2, 90pc duty cycle)	WLAN	8.71	± 9.6 %
10629	AAB	IEEE 802.11ac WiFi (80MHz, MCS3, 90pc duty cycle)	WLAN	8.85	± 9.6 %
10630	AAB	IEEE 802.11ac WiFi (80MHz, MCS4, 90pc duty cycle)	WLAN	8.72	± 9.6 %
10631	AAB	IEEE 802.11ac WiFi (80MHz, MCS5, 90pc duty cycle)	WLAN	8.81	± 9.6 %
10632	AAB	IEEE 802.11ac WiFi (80MHz, MCS6, 90pc duty cycle)	WLAN	8.74	± 9.6 %
10633	AAB	IEEE 802.11ac WiFi (80MHz, MCS7, 90pc duty cycle)	WLAN	8.83	± 9.6 %
10634	AAB	IEEE 802.11ac WiFi (80MHz, MCS8, 90pc duty cycle)	WLAN	8.80	± 9.6 %
10635	AAB	IEEE 802.11ac WiFi (80MHz, MCS9, 90pc duty cycle)	WLAN	8.81	± 9.6 %
10636	AAC	IEEE 802.11ac WiFi (160MHz, MCS0, 90pc duty cycle)	WLAN	8.83	± 9.6 %
10637	AAC	IEEE 802.11ac WiFi (160MHz, MCS1, 90pc duty cycle)	WLAN	8.79	± 9.6 %
10638	AAC	IEEE 802.11ac WiFi (160MHz, MCS2, 90pc duty cycle)	WLAN	8.86	± 9.6 %
10639	AAC	IEEE 802.11ac WiFi (160MHz, MCS3, 90pc duty cycle)	WLAN	8.85	± 9.6 %
10640	AAC	IEEE 802.11ac WiFi (160MHz, MCS4, 90pc duty cycle)	WLAN	8.98	± 9.6 %
10641	AAC	IEEE 802.11ac WiFi (160MHz, MCS5, 90pc duty cycle)	WLAN	9.06	± 9.6 %
10642	AAC	IEEE 802.11ac WiFi (160MHz, MCS6, 90pc duty cycle)	WLAN	9.06	± 9.6 %
10643	AAC	IEEE 802.11ac WiFi (160MHz, MCS7, 90pc duty cycle)	WLAN	8.89	± 9.6 %
10644	AAC	IEEE 802.11ac WiFi (160MHz, MCS8, 90pc duty cycle)	WLAN	9.05	± 9.6 %
10645	AAC	IEEE 802.11ac WiFi (160MHz, MCS9, 90pc duty cycle)	WLAN	9.11	± 9.6 %
10646	AAF	LTE-TDD (SC-FDMA, 1 RB, 5 MHz, QPSK, UL Subframe=2,7)	LTE-TDD	11.96	± 9.6 %
10647	AAF	LTE-TDD (SC-FDMA, 1 RB, 20 MHz, QPSK, UL Subframe=2,7)	LTE-TDD	11.96	± 9.6 %
10648	AAA	CDMA2000 (1x Advanced)	CDMA2000	3.45	± 9.6 %
10652	AAD	LTE-TDD (OFDMA, 5 MHz, E-TM 3.1, Clipping 44%)	LTE-TDD	6.91	± 9.6 %
10653	AAD	LTE-TDD (OFDMA, 10 MHz, E-TM 3.1, Clipping 44%)	LTE-TDD	7.42	± 9.6 %
10654	AAD	LTE-TDD (OFDMA, 15 MHz, E-TM 3.1, Clipping 44%)	LTE-TDD	6.96	± 9.6 %

10655	AAE	LTE-TDD (OFDMA, 20 MHz, E-TM 3.1, Clipping 44%)	LTE-TDD	7.21	± 9.6 %
10658	AAA	Pulse Waveform (200Hz, 10%)	Test	10.00	± 9.6 %
10659	AAA	Pulse Waveform (200Hz, 20%)	Test	6.99	± 9.6 %
10660	AAA	Pulse Waveform (200Hz, 40%)	Test	3.98	± 9.6 %
10661	AAA	Pulse Waveform (200Hz, 60%)	Test	2.22	± 9.6 %
10662	AAA	Pulse Waveform (200Hz, 80%)	Test	0.97	± 9.6 %
10670	AAA	Bluetooth Low Energy	Bluetooth	2.19	± 9.6 %

^E Uncertainty is determined using the max. deviation from linear response applying rectangular distribution and is expressed for the square of the field value.



Accredited by the Swiss Accreditation Service (SAS)
The Swiss Accreditation Service is one of the signatories to the EA
Multilateral Agreement for the recognition of calibration certificates

Accreditation No.: **SCS 0108**

Client **PG Test**

Certificate No: **EX3-3914_Feb19**

CALIBRATION CERTIFICATE

Object: **EX3DV4 - SN:3914**

Calibration procedure(s): **DA CAL-01 v5, DA CAL-12 v5, DA CAL-14 v5, DA CAL-20 v5, DA CAL-25 v7**
Calibration procedure for dissymmetric E-field probes

Calibration date: **February 19, 2019** *02-26-2019*

This calibration certificate documents the traceability to national standards, which realize the physical units of measurements (SI).
The measurements and the uncertainties with confidence probability are given on the following pages and are part of the certificate.

All calibrations have been conducted in the closed laboratory facility: environment temperature (22 ± 3)°C and humidity < 70%.

Calibration Equipment used (M&TE critical for calibration)

Primary Standards	ID	Cal Date (Certificate No.)	Scheduled Calibration
Power meter NRP	SN: 104778	04-Apr-18 (No. 217-02672/02673)	Apr-19
Power sensor NRP-Z91	SN: 103244	04-Apr-18 (No. 217-02672)	Apr-19
Power sensor NRP-Z91	SN: 103245	04-Apr-18 (No. 217-02673)	Apr-19
Reference 20 dB Attenuator	SN: S5277 (20x)	04-Apr-18 (No. 217-02682)	Apr-19
DAE4	SN: 660	19-Dec-18 (No. DAE4-660_Dec18)	Dec-19
Reference Probe ES3DV2	SN: 3013	31-Dec-18 (No. ES3-3013_Dec18)	Dec-19
Secondary Standards	ID	Check Date (in house)	Scheduled Check
Power meter E4419B	SN: GB41293874	06-Apr-16 (in house check Jun-18)	In house check: Jun-20
Power sensor E4412A	SN: MY41498087	06-Apr-16 (in house check Jun-18)	In house check: Jun-20
Power sensor E4412A	SN: 000110210	06-Apr-16 (in house check Jun-18)	In house check: Jun-20
RF generator HP 8648C	SN: US3642U01700	04-Aug-99 (in house check Jun-18)	In house check: Jun-20
Network Analyzer E8358A	SN: US41080477	31-Mar-14 (in house check Oct-18)	In house check: Oct-19

	Name	Function	Signature
Calibrated by:	Jeton Kastrati	Laboratory Technician	
Approved by:	Katja Pokovic	Technical Manager	

Issued: February 20, 2019

This calibration certificate shall not be reproduced except in full without written approval of the laboratory.



Accredited by the Swiss Accreditation Service (SAS)

Accreditation No.: **SCS 0108**

The Swiss Accreditation Service is one of the signatories to the EA Multilateral Agreement for the recognition of calibration certificates

Glossary:

TSL	tissue simulating liquid
NORM _{x,y,z}	sensitivity in free space
ConvF	sensitivity in TSL / NORM _{x,y,z}
DCP	diode compression point
CF	crest factor (1/duty_cycle) of the RF signal
A, B, C, D	modulation dependent linearization parameters
Polarization φ	φ rotation around probe axis
Polarization ϑ	ϑ rotation around an axis that is in the plane normal to probe axis (at measurement center), i.e., $\vartheta = 0$ is normal to probe axis
Connector Angle	information used in DASY system to align probe sensor X to the robot coordinate system

Calibration is Performed According to the Following Standards:

- IEEE Std 1528-2013, "IEEE Recommended Practice for Determining the Peak Spatial-Averaged Specific Absorption Rate (SAR) in the Human Head from Wireless Communications Devices: Measurement Techniques", June 2013
- IEC 62209-1, "Measurement procedure for the assessment of Specific Absorption Rate (SAR) from hand-held and body-mounted devices used next to the ear (frequency range of 300 MHz to 6 GHz)", July 2016
- IEC 62209-2, "Procedure to determine the Specific Absorption Rate (SAR) for wireless communication devices used in close proximity to the human body (frequency range of 30 MHz to 6 GHz)", March 2010
- KDB 865664, "SAR Measurement Requirements for 100 MHz to 6 GHz"

Methods Applied and Interpretation of Parameters:

- NORM_{x,y,z}**: Assessed for E-field polarization $\vartheta = 0$ ($f \leq 900$ MHz in TEM-cell; $f > 1800$ MHz: R22 waveguide). NORM_{x,y,z} are only intermediate values, i.e., the uncertainties of NORM_{x,y,z} does not affect the E²-field uncertainty inside TSL (see below ConvF).
- NORM(f)_{x,y,z} = NORM_{x,y,z} * frequency_response** (see Frequency Response Chart). This linearization is implemented in DASY4 software versions later than 4.2. The uncertainty of the frequency response is included in the stated uncertainty of ConvF.
- DCP_{x,y,z}**: DCP are numerical linearization parameters assessed based on the data of power sweep with CW signal (no uncertainty required). DCP does not depend on frequency nor media.
- PAR**: PAR is the Peak to Average Ratio that is not calibrated but determined based on the signal characteristics
- A_{x,y,z}; B_{x,y,z}; C_{x,y,z}; D_{x,y,z}; VR_{x,y,z}; A, B, C, D** are numerical linearization parameters assessed based on the data of power sweep for specific modulation signal. The parameters do not depend on frequency nor media. VR is the maximum calibration range expressed in RMS voltage across the diode.
- ConvF and Boundary Effect Parameters**: Assessed in flat phantom using E-field (or Temperature Transfer Standard for $f \leq 800$ MHz) and inside waveguide using analytical field distributions based on power measurements for $f > 800$ MHz. The same setups are used for assessment of the parameters applied for boundary compensation (alpha, depth) of which typical uncertainty values are given. These parameters are used in DASY4 software to improve probe accuracy close to the boundary. The sensitivity in TSL corresponds to NORM_{x,y,z} * ConvF whereby the uncertainty corresponds to that given for ConvF. A frequency dependent ConvF is used in DASY version 4.4 and higher which allows extending the validity from ± 50 MHz to ± 100 MHz.
- Spherical isotropy (3D deviation from isotropy)**: in a field of low gradients realized using a flat phantom exposed by a patch antenna.
- Sensor Offset**: The sensor offset corresponds to the offset of virtual measurement center from the probe tip (on probe axis). No tolerance required.
- Connector Angle**: The angle is assessed using the information gained by determining the NORM_x (no uncertainty required).

DASY/EASY - Parameters of Probe: EX3DV4 - SN:3914

Basic Calibration Parameters

	Sensor X	Sensor Y	Sensor Z	Unc (k=2)
Norm ($\mu\text{V}/(\text{V}/\text{m})^2$) ^A	0.46	0.41	0.44	$\pm 10.1 \%$
DCP (mV) ^B	98.0	104.4	100.8	

Calibration Results for Modulation Response

UID	Communication System Name		A dB	B dB $\sqrt{\mu\text{V}}$	C	D dB	VR mV	Max dev.	Max Unc ^E (k=2)
0	CW	X	0.00	0.00	1.00	0.00	135.8	$\pm 3.3 \%$	$\pm 4.7 \%$
		Y	0.00	0.00	1.00		149.1		
		Z	0.00	0.00	1.00		130.4		
10352-AAA	Pulse Waveform (200Hz, 10%)	X	11.50	82.25	17.46	10.00	60.0	$\pm 2.9 \%$	$\pm 9.6 \%$
		Y	13.06	84.85	18.88		60.0		
		Z	15.00	85.74	19.04		60.0		
10353-AAA	Pulse Waveform (200Hz, 20%)	X	15.00	85.61	17.12	6.99	80.0	$\pm 1.7 \%$	$\pm 9.6 \%$
		Y	15.00	87.20	18.40		80.0		
		Z	15.00	86.88	18.11		80.0		
10354-AAA	Pulse Waveform (200Hz, 40%)	X	15.00	85.07	15.18	3.98	95.0	$\pm 1.1 \%$	$\pm 9.6 \%$
		Y	15.00	89.57	18.09		95.0		
		Z	15.00	87.22	16.52		95.0		
10355-AAA	Pulse Waveform (200Hz, 60%)	X	0.82	65.05	7.38	2.22	120.0	$\pm 1.2 \%$	$\pm 9.6 \%$
		Y	15.00	94.17	19.03		120.0		
		Z	15.00	84.14	13.59		120.0		
10387-AAA	QPSK Waveform, 1 MHz	X	0.56	60.35	7.26	0.00	150.0	$\pm 2.8 \%$	$\pm 9.6 \%$
		Y	0.80	64.04	10.54		150.0		
		Z	0.51	60.00	6.79		150.0		
10388-AAA	QPSK Waveform, 10 MHz	X	2.18	68.24	15.67	0.00	150.0	$\pm 1.2 \%$	$\pm 9.6 \%$
		Y	2.41	70.06	16.91		150.0		
		Z	2.04	67.38	15.28		150.0		
10396-AAA	64-QAM Waveform, 100 kHz	X	2.71	69.05	18.06	3.01	150.0	$\pm 0.7 \%$	$\pm 9.6 \%$
		Y	3.50	74.05	20.22		150.0		
		Z	2.76	69.32	18.16		150.0		
10399-AAA	64-QAM Waveform, 40 MHz	X	3.50	67.38	15.86	0.00	150.0	$\pm 2.2 \%$	$\pm 9.6 \%$
		Y	3.57	67.89	16.25		150.0		
		Z	3.38	66.82	15.58		150.0		
10414-AAA	WLAN CCDF, 64-QAM, 40MHz	X	4.87	65.94	15.72	0.00	150.0	$\pm 4.2 \%$	$\pm 9.6 \%$
		Y	4.84	65.99	15.74		150.0		
		Z	4.71	65.47	15.46		150.0		

Note: For details on UID parameters see Appendix

The reported uncertainty of measurement is stated as the standard uncertainty of measurement multiplied by the coverage factor $k=2$, which for a normal distribution corresponds to a coverage probability of approximately 95%.

^A The uncertainties of Norm X,Y,Z do not affect the E^2 -field uncertainty inside TSL (see Pages 5 and 6).

^B Numerical linearization parameter: uncertainty not required.

^E Uncertainty is determined using the max. deviation from linear response applying rectangular distribution and is expressed for the square of the field value.

DASY/EASY - Parameters of Probe: EX3DV4 - SN:3914

Sensor Model Parameters

	C1 fF	C2 fF	α V ⁻¹	T1 ms.V ⁻²	T2 ms.V ⁻¹	T3 ms	T4 V ⁻²	T5 V ⁻¹	T6
X	42.5	324.17	36.82	9.95	0.55	5.06	0.00	0.49	1.01
Y	42.9	310.45	33.81	12.34	0.63	5.02	2.00	0.15	1.01
Z	39.7	301.66	36.55	9.75	0.75	5.05	0.45	0.44	1.01

Other Probe Parameters

Sensor Arrangement	Triangular
Connector Angle (°)	0.5
Mechanical Surface Detection Mode	enabled
Optical Surface Detection Mode	disabled
Probe Overall Length	337 mm
Probe Body Diameter	10 mm
Tip Length	9 mm
Tip Diameter	2.5 mm
Probe Tip to Sensor X Calibration Point	1 mm
Probe Tip to Sensor Y Calibration Point	1 mm
Probe Tip to Sensor Z Calibration Point	1 mm
Recommended Measurement Distance from Surface	1.4 mm

DASY/EASY - Parameters of Probe: EX3DV4 - SN:3914

Calibration Parameter Determined in Head Tissue Simulating Media

f (MHz) ^C	Relative Permittivity ^F	Conductivity (S/m) ^F	ConvF X	ConvF Y	ConvF Z	Alpha ^G	Depth ^G (mm)	Unc (k=2)
6	55.5	0.75	21.24	21.24	21.24	0.00	1.00	± 13.3 %
13	55.5	0.75	18.06	18.06	18.06	0.00	1.00	± 13.3 %
750	41.9	0.89	10.00	10.00	10.00	0.54	0.82	± 12.0 %
835	41.5	0.90	9.50	9.50	9.50	0.50	0.86	± 12.0 %
1750	40.1	1.37	8.16	8.16	8.16	0.41	0.80	± 12.0 %
1900	40.0	1.40	7.80	7.80	7.80	0.40	0.84	± 12.0 %
2300	39.5	1.67	7.44	7.44	7.44	0.37	0.84	± 12.0 %
2450	39.2	1.80	7.13	7.13	7.13	0.39	0.86	± 12.0 %
2600	39.0	1.96	7.11	7.11	7.11	0.39	0.89	± 12.0 %
3500	37.9	2.91	6.99	6.99	6.99	0.25	1.20	± 13.1 %
3700	37.7	3.12	6.75	6.75	6.75	0.25	1.20	± 13.1 %
5250	35.9	4.71	5.19	5.19	5.19	0.40	1.80	± 13.1 %
5600	35.5	5.07	4.73	4.73	4.73	0.40	1.80	± 13.1 %
5750	35.4	5.22	4.90	4.90	4.90	0.40	1.80	± 13.1 %

^C Frequency validity above 300 MHz of ± 100 MHz only applies for DASY v4.4 and higher (see Page 2), else it is restricted to ± 50 MHz. The uncertainty is the RSS of the ConvF uncertainty at calibration frequency and the uncertainty for the indicated frequency band. Frequency validity below 300 MHz is ± 10, 25, 40, 50 and 70 MHz for ConvF assessments at 30, 64, 128, 150 and 220 MHz respectively. Validity of ConvF assessed at 6 MHz is 4-9 MHz, and ConvF assessed at 13 MHz is 9-19 MHz. Above 5 GHz frequency validity can be extended to ± 110 MHz.

^F At frequencies below 3 GHz, the validity of tissue parameters (ϵ and σ) can be relaxed to ± 10% if liquid compensation formula is applied to measured SAR values. At frequencies above 3 GHz, the validity of tissue parameters (ϵ and σ) is restricted to ± 5%. The uncertainty is the RSS of the ConvF uncertainty for indicated target tissue parameters.

^G Alpha/Depth are determined during calibration. SPEAG warrants that the remaining deviation due to the boundary effect after compensation is always less than ± 1% for frequencies below 3 GHz and below ± 2% for frequencies between 3-6 GHz at any distance larger than half the probe tip diameter from the boundary.

DASY/EASY - Parameters of Probe: EX3DV4 - SN:3914

Calibration Parameter Determined in Body Tissue Simulating Media

f (MHz) ^C	Relative Permittivity ^F	Conductivity (S/m) ^F	ConvF X	ConvF Y	ConvF Z	Alpha ^G	Depth ^G (mm)	Unc (k=2)
750	55.5	0.96	9.73	9.73	9.73	0.54	0.84	± 12.0 %
835	55.2	0.97	9.46	9.46	9.46	0.50	0.80	± 12.0 %
1750	53.4	1.49	7.89	7.89	7.89	0.38	0.84	± 12.0 %
1900	53.3	1.52	7.60	7.60	7.60	0.29	1.03	± 12.0 %
2300	52.9	1.81	7.43	7.43	7.43	0.38	0.84	± 12.0 %
2450	52.7	1.95	7.34	7.34	7.34	0.33	0.87	± 12.0 %
2600	52.5	2.16	7.15	7.15	7.15	0.26	0.97	± 12.0 %
3500	51.3	3.31	6.88	6.88	6.88	0.25	1.15	± 13.1 %
3700	51.0	3.55	6.58	6.58	6.58	0.30	1.15	± 13.1 %
5250	48.9	5.36	4.61	4.61	4.61	0.50	1.90	± 13.1 %
5600	48.5	5.77	3.92	3.92	3.92	0.50	1.90	± 13.1 %
5750	48.3	5.94	4.05	4.05	4.05	0.50	1.90	± 13.1 %

^C Frequency validity above 300 MHz of ± 100 MHz only applies for DASY v4.4 and higher (see Page 2), else it is restricted to ± 50 MHz. The uncertainty is the RSS of the ConvF uncertainty at calibration frequency and the uncertainty for the indicated frequency band. Frequency validity below 300 MHz is ± 10, 25, 40, 50 and 70 MHz for ConvF assessments at 30, 64, 128, 150 and 220 MHz respectively. Validity of ConvF assessed at 6 MHz is 4-9 MHz, and ConvF assessed at 13 MHz is 9-19 MHz. Above 5 GHz frequency validity can be extended to ± 110 MHz.

^F At frequencies below 3 GHz, the validity of tissue parameters (ϵ and σ) can be relaxed to ± 10% if liquid compensation formula is applied to measured SAR values. At frequencies above 3 GHz, the validity of tissue parameters (ϵ and σ) is restricted to ± 5%. The uncertainty is the RSS of the ConvF uncertainty for indicated target tissue parameters.

^G Alpha/Depth are determined during calibration. SPEAG warrants that the remaining deviation due to the boundary effect after compensation is always less than ± 1% for frequencies below 3 GHz and below ± 2% for frequencies between 3-6 GHz at any distance larger than half the probe tip diameter from the boundary.

Frequency Response of E-Field (TEM-Cell:ifi110 EXX, Waveguide: R22)

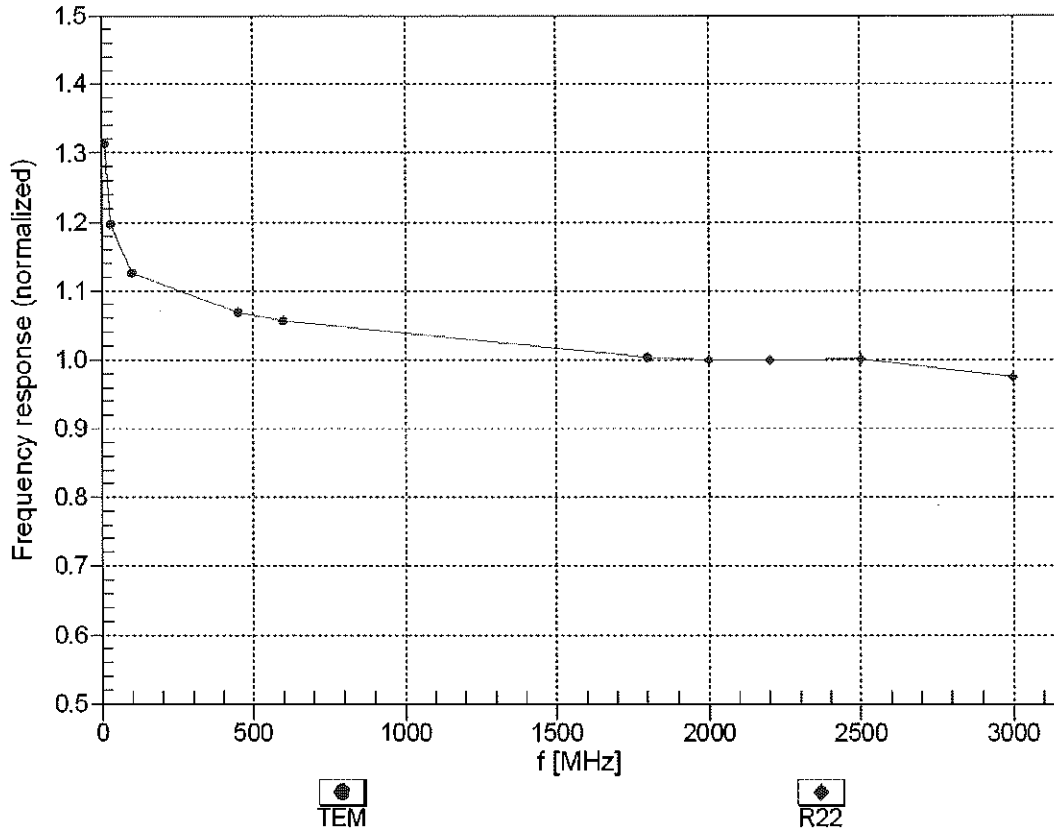

Uncertainty of Frequency Response of E-field: $\pm 6.3\%$ (k=2)

Receiving Pattern (ϕ), $\theta = 0^\circ$

f=600 MHz,TEM

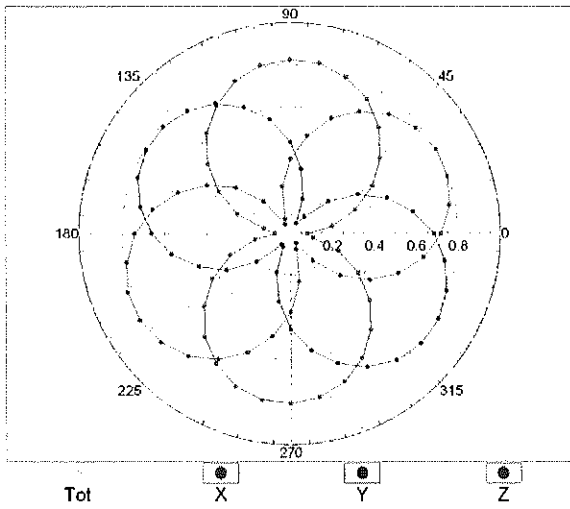

f=1800 MHz,R22

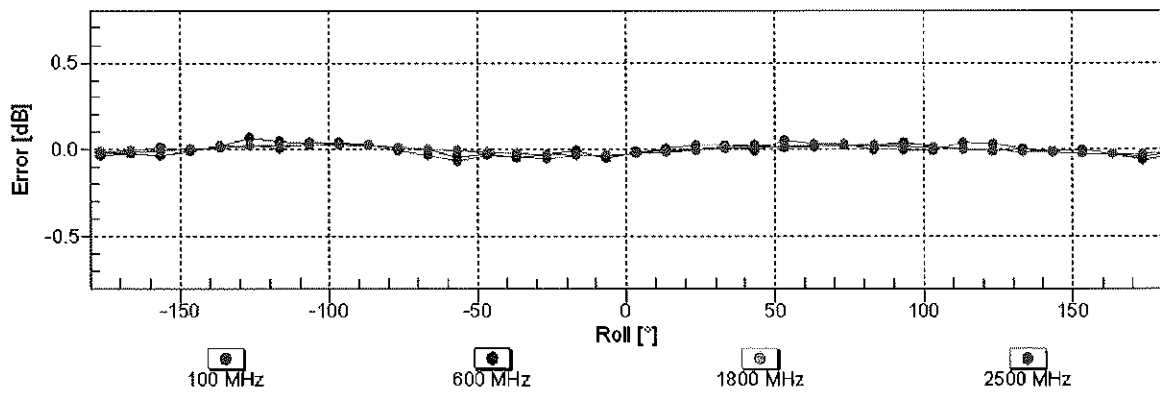
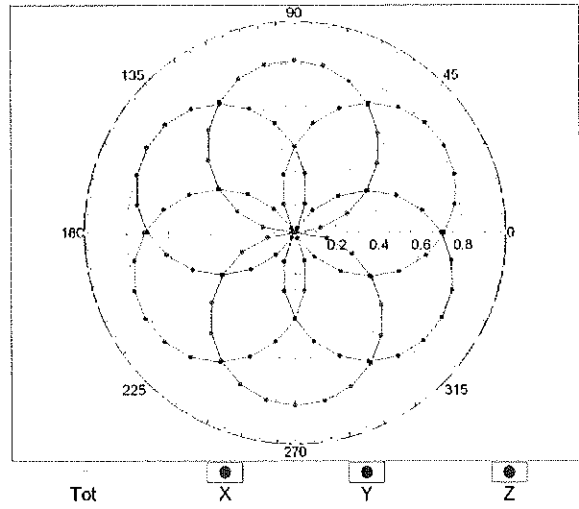

Uncertainty of Axial Isotropy Assessment: $\pm 0.5\%$ (k=2)

Dynamic Range $f(SAR_{head})$ (TEM cell , $f_{eval}= 1900$ MHz)

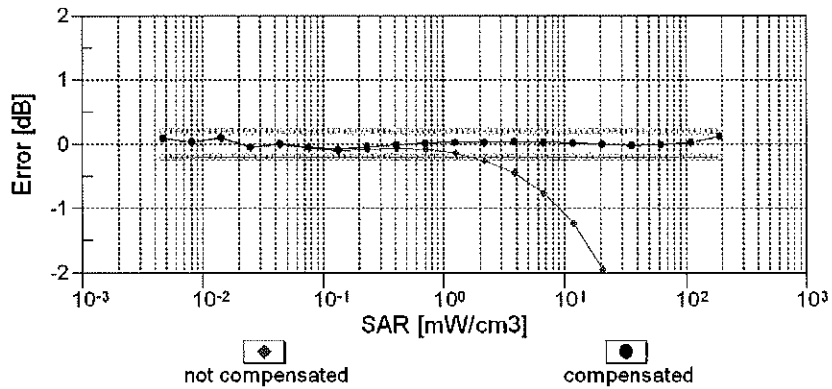
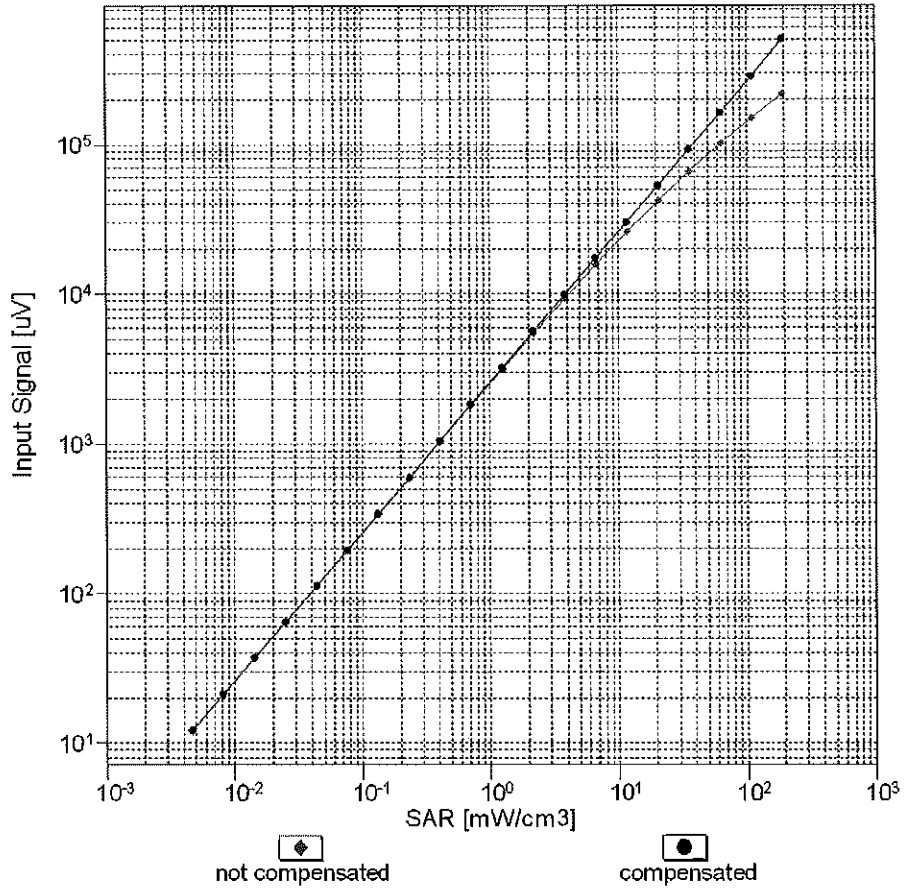

Uncertainty of Linearity Assessment: $\pm 0.6\%$ ($k=2$)

Conversion Factor Assessment

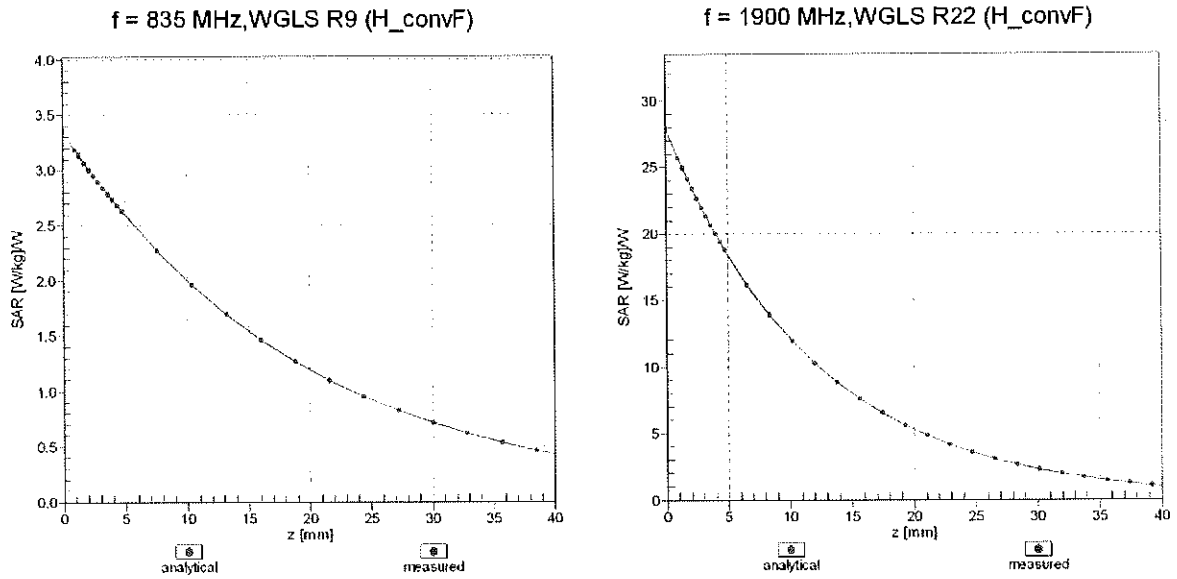

Deviation from Isotropy in Liquid

Error (ϕ, θ), f = 900 MHz

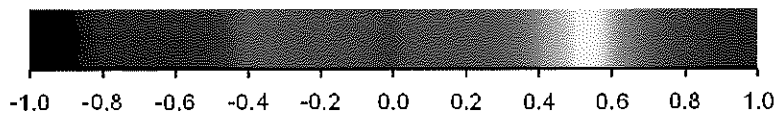
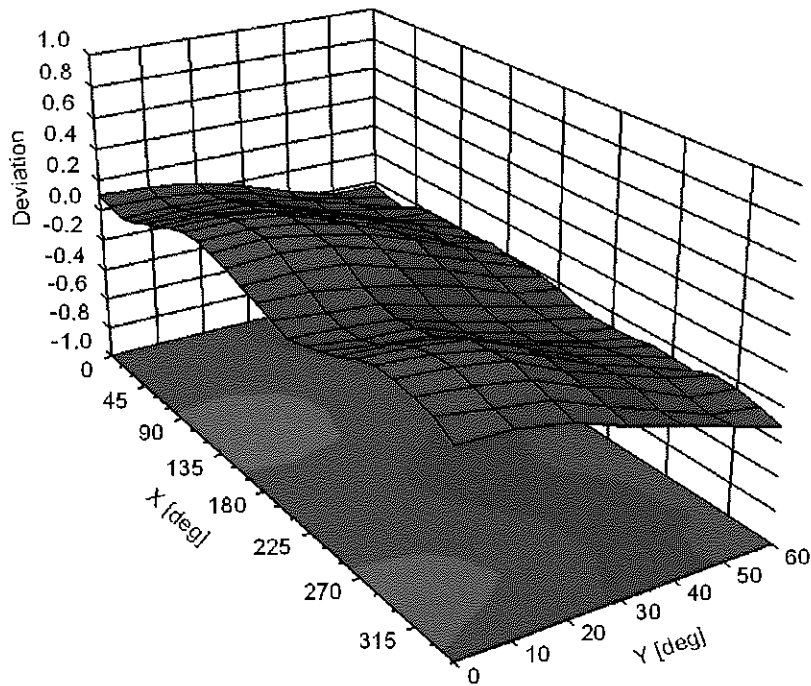

Uncertainty of Spherical Isotropy Assessment: $\pm 2.6\%$ (k=2)

Appendix: Modulation Calibration Parameters

UID	Rev	Communication System Name	Group	PAR (dB)	Unc ^E (k=2)
0		CW	CW	0.00	± 4.7 %
10010	CAA	SAR Validation (Square, 100ms, 10ms)	Test	10.00	± 9.6 %
10011	CAB	UMTS-FDD (WCDMA)	WCDMA	2.91	± 9.6 %
10012	CAB	IEEE 802.11b WiFi 2.4 GHz (DSSS, 1 Mbps)	WLAN	1.87	± 9.6 %
10013	CAB	IEEE 802.11g WiFi 2.4 GHz (DSSS-OFDM, 6 Mbps)	WLAN	9.46	± 9.6 %
10021	DAC	GSM-FDD (TDMA, GMSK)	GSM	9.39	± 9.6 %
10023	DAC	GPRS-FDD (TDMA, GMSK, TN 0)	GSM	9.57	± 9.6 %
10024	DAC	GPRS-FDD (TDMA, GMSK, TN 0-1)	GSM	6.56	± 9.6 %
10025	DAC	EDGE-FDD (TDMA, 8PSK, TN 0)	GSM	12.62	± 9.6 %
10026	DAC	EDGE-FDD (TDMA, 8PSK, TN 0-1)	GSM	9.55	± 9.6 %
10027	DAC	GPRS-FDD (TDMA, GMSK, TN 0-1-2)	GSM	4.80	± 9.6 %
10028	DAC	GPRS-FDD (TDMA, GMSK, TN 0-1-2-3)	GSM	3.55	± 9.6 %
10029	DAC	EDGE-FDD (TDMA, 8PSK, TN 0-1-2)	GSM	7.78	± 9.6 %
10030	CAA	IEEE 802.15.1 Bluetooth (GFSK, DH1)	Bluetooth	5.30	± 9.6 %
10031	CAA	IEEE 802.15.1 Bluetooth (GFSK, DH3)	Bluetooth	1.87	± 9.6 %
10032	CAA	IEEE 802.15.1 Bluetooth (GFSK, DH5)	Bluetooth	1.16	± 9.6 %
10033	CAA	IEEE 802.15.1 Bluetooth (PI/4-DQPSK, DH1)	Bluetooth	7.74	± 9.6 %
10034	CAA	IEEE 802.15.1 Bluetooth (PI/4-DQPSK, DH3)	Bluetooth	4.53	± 9.6 %
10035	CAA	IEEE 802.15.1 Bluetooth (PI/4-DQPSK, DH5)	Bluetooth	3.83	± 9.6 %
10036	CAA	IEEE 802.15.1 Bluetooth (8-DPSK, DH1)	Bluetooth	8.01	± 9.6 %
10037	CAA	IEEE 802.15.1 Bluetooth (8-DPSK, DH3)	Bluetooth	4.77	± 9.6 %
10038	CAA	IEEE 802.15.1 Bluetooth (8-DPSK, DH5)	Bluetooth	4.10	± 9.6 %
10039	CAB	CDMA2000 (1xRTT, RC1)	CDMA2000	4.57	± 9.6 %
10042	CAB	IS-54 / IS-136 FDD (TDMA/FDM, PI/4-DQPSK, Halfrate)	AMPS	7.78	± 9.6 %
10044	CAA	IS-91/EIA/TIA-553 FDD (FDMA, FM)	AMPS	0.00	± 9.6 %
10048	CAA	DECT (TDD, TDMA/FDM, GFSK, Full Slot, 24)	DECT	13.80	± 9.6 %
10049	CAA	DECT (TDD, TDMA/FDM, GFSK, Double Slot, 12)	DECT	10.79	± 9.6 %
10056	CAA	UMTS-TDD (TD-SCDMA, 1.28 Mcps)	TD-SCDMA	11.01	± 9.6 %
10058	DAC	EDGE-FDD (TDMA, 8PSK, TN 0-1-2-3)	GSM	6.52	± 9.6 %
10059	CAB	IEEE 802.11b WiFi 2.4 GHz (DSSS, 2 Mbps)	WLAN	2.12	± 9.6 %
10060	CAB	IEEE 802.11b WiFi 2.4 GHz (DSSS, 5.5 Mbps)	WLAN	2.83	± 9.6 %
10061	CAB	IEEE 802.11b WiFi 2.4 GHz (DSSS, 11 Mbps)	WLAN	3.60	± 9.6 %
10062	CAC	IEEE 802.11a/h WiFi 5 GHz (OFDM, 6 Mbps)	WLAN	8.68	± 9.6 %
10063	CAC	IEEE 802.11a/h WiFi 5 GHz (OFDM, 9 Mbps)	WLAN	8.63	± 9.6 %
10064	CAC	IEEE 802.11a/h WiFi 5 GHz (OFDM, 12 Mbps)	WLAN	9.09	± 9.6 %
10065	CAC	IEEE 802.11a/h WiFi 5 GHz (OFDM, 18 Mbps)	WLAN	9.00	± 9.6 %
10066	CAC	IEEE 802.11a/h WiFi 5 GHz (OFDM, 24 Mbps)	WLAN	9.38	± 9.6 %
10067	CAC	IEEE 802.11a/h WiFi 5 GHz (OFDM, 36 Mbps)	WLAN	10.12	± 9.6 %
10068	CAC	IEEE 802.11a/h WiFi 5 GHz (OFDM, 48 Mbps)	WLAN	10.24	± 9.6 %
10069	CAC	IEEE 802.11a/h WiFi 5 GHz (OFDM, 54 Mbps)	WLAN	10.56	± 9.6 %
10071	CAB	IEEE 802.11g WiFi 2.4 GHz (DSSS/OFDM, 9 Mbps)	WLAN	9.83	± 9.6 %
10072	CAB	IEEE 802.11g WiFi 2.4 GHz (DSSS/OFDM, 12 Mbps)	WLAN	9.62	± 9.6 %
10073	CAB	IEEE 802.11g WiFi 2.4 GHz (DSSS/OFDM, 18 Mbps)	WLAN	9.94	± 9.6 %
10074	CAB	IEEE 802.11g WiFi 2.4 GHz (DSSS/OFDM, 24 Mbps)	WLAN	10.30	± 9.6 %
10075	CAB	IEEE 802.11g WiFi 2.4 GHz (DSSS/OFDM, 36 Mbps)	WLAN	10.77	± 9.6 %
10076	CAB	IEEE 802.11g WiFi 2.4 GHz (DSSS/OFDM, 48 Mbps)	WLAN	10.94	± 9.6 %
10077	CAB	IEEE 802.11g WiFi 2.4 GHz (DSSS/OFDM, 54 Mbps)	WLAN	11.00	± 9.6 %
10081	CAB	CDMA2000 (1xRTT, RC3)	CDMA2000	3.97	± 9.6 %
10082	CAB	IS-54 / IS-136 FDD (TDMA/FDM, PI/4-DQPSK, Fullrate)	AMPS	4.77	± 9.6 %
10090	DAC	GPRS-FDD (TDMA, GMSK, TN 0-4)	GSM	6.56	± 9.6 %
10097	CAB	UMTS-FDD (HSDPA)	WCDMA	3.98	± 9.6 %
10098	CAB	UMTS-FDD (HSUPA, Subtest 2)	WCDMA	3.98	± 9.6 %
10099	DAC	EDGE-FDD (TDMA, 8PSK, TN 0-4)	GSM	9.55	± 9.6 %
10100	CAE	LTE-FDD (SC-FDMA, 100% RB, 20 MHz, QPSK)	LTE-FDD	5.67	± 9.6 %
10101	CAE	LTE-FDD (SC-FDMA, 100% RB, 20 MHz, 16-QAM)	LTE-FDD	6.42	± 9.6 %
10102	CAE	LTE-FDD (SC-FDMA, 100% RB, 20 MHz, 64-QAM)	LTE-FDD	6.60	± 9.6 %
10103	CAG	LTE-TDD (SC-FDMA, 100% RB, 20 MHz, QPSK)	LTE-TDD	9.29	± 9.6 %
10104	CAG	LTE-TDD (SC-FDMA, 100% RB, 20 MHz, 16-QAM)	LTE-TDD	9.97	± 9.6 %
10105	CAG	LTE-TDD (SC-FDMA, 100% RB, 20 MHz, 64-QAM)	LTE-TDD	10.01	± 9.6 %
10108	CAG	LTE-FDD (SC-FDMA, 100% RB, 10 MHz, QPSK)	LTE-FDD	5.80	± 9.6 %

10109	CAG	LTE-FDD (SC-FDMA, 100% RB, 10 MHz, 16-QAM)	LTE-FDD	6.43	±9.6 %
10110	CAG	LTE-FDD (SC-FDMA, 100% RB, 5 MHz, QPSK)	LTE-FDD	5.75	±9.6 %
10111	CAG	LTE-FDD (SC-FDMA, 100% RB, 5 MHz, 16-QAM)	LTE-FDD	6.44	±9.6 %
10112	CAG	LTE-FDD (SC-FDMA, 100% RB, 10 MHz, 64-QAM)	LTE-FDD	6.59	±9.6 %
10113	CAG	LTE-FDD (SC-FDMA, 100% RB, 5 MHz, 64-QAM)	LTE-FDD	6.62	±9.6 %
10114	CAC	IEEE 802.11n (HT Greenfield, 13.5 Mbps, BPSK)	WLAN	8.10	±9.6 %
10115	CAC	IEEE 802.11n (HT Greenfield, 81 Mbps, 16-QAM)	WLAN	8.46	±9.6 %
10116	CAC	IEEE 802.11n (HT Greenfield, 135 Mbps, 64-QAM)	WLAN	8.15	±9.6 %
10117	CAC	IEEE 802.11n (HT Mixed, 13.5 Mbps, BPSK)	WLAN	8.07	±9.6 %
10118	CAC	IEEE 802.11n (HT Mixed, 81 Mbps, 16-QAM)	WLAN	8.59	±9.6 %
10119	CAC	IEEE 802.11n (HT Mixed, 135 Mbps, 64-QAM)	WLAN	8.13	±9.6 %
10140	CAE	LTE-FDD (SC-FDMA, 100% RB, 15 MHz, 16-QAM)	LTE-FDD	6.49	±9.6 %
10141	CAE	LTE-FDD (SC-FDMA, 100% RB, 15 MHz, 64-QAM)	LTE-FDD	6.53	±9.6 %
10142	CAE	LTE-FDD (SC-FDMA, 100% RB, 3 MHz, QPSK)	LTE-FDD	5.73	±9.6 %
10143	CAE	LTE-FDD (SC-FDMA, 100% RB, 3 MHz, 16-QAM)	LTE-FDD	6.35	±9.6 %
10144	CAE	LTE-FDD (SC-FDMA, 100% RB, 3 MHz, 64-QAM)	LTE-FDD	6.65	±9.6 %
10145	CAF	LTE-FDD (SC-FDMA, 100% RB, 1.4 MHz, QPSK)	LTE-FDD	5.76	±9.6 %
10146	CAF	LTE-FDD (SC-FDMA, 100% RB, 1.4 MHz, 16-QAM)	LTE-FDD	6.41	±9.6 %
10147	CAF	LTE-FDD (SC-FDMA, 100% RB, 1.4 MHz, 64-QAM)	LTE-FDD	6.72	±9.6 %
10149	CAE	LTE-FDD (SC-FDMA, 50% RB, 20 MHz, 16-QAM)	LTE-FDD	6.42	±9.6 %
10150	CAE	LTE-FDD (SC-FDMA, 50% RB, 20 MHz, 64-QAM)	LTE-FDD	6.60	±9.6 %
10151	CAG	LTE-TDD (SC-FDMA, 50% RB, 20 MHz, QPSK)	LTE-TDD	9.28	±9.6 %
10152	CAG	LTE-TDD (SC-FDMA, 50% RB, 20 MHz, 16-QAM)	LTE-TDD	9.92	±9.6 %
10153	CAG	LTE-TDD (SC-FDMA, 50% RB, 20 MHz, 64-QAM)	LTE-TDD	10.05	±9.6 %
10154	CAG	LTE-FDD (SC-FDMA, 50% RB, 10 MHz, QPSK)	LTE-FDD	5.75	±9.6 %
10155	CAG	LTE-FDD (SC-FDMA, 50% RB, 10 MHz, 16-QAM)	LTE-FDD	6.43	±9.6 %
10156	CAG	LTE-FDD (SC-FDMA, 50% RB, 5 MHz, QPSK)	LTE-FDD	5.79	±9.6 %
10157	CAG	LTE-FDD (SC-FDMA, 50% RB, 5 MHz, 16-QAM)	LTE-FDD	6.49	±9.6 %
10158	CAG	LTE-FDD (SC-FDMA, 50% RB, 10 MHz, 64-QAM)	LTE-FDD	6.62	±9.6 %
10159	CAG	LTE-FDD (SC-FDMA, 50% RB, 5 MHz, 64-QAM)	LTE-FDD	6.56	±9.6 %
10160	CAE	LTE-FDD (SC-FDMA, 50% RB, 15 MHz, QPSK)	LTE-FDD	5.82	±9.6 %
10161	CAE	LTE-FDD (SC-FDMA, 50% RB, 15 MHz, 16-QAM)	LTE-FDD	6.43	±9.6 %
10162	CAE	LTE-FDD (SC-FDMA, 50% RB, 15 MHz, 64-QAM)	LTE-FDD	6.58	±9.6 %
10166	CAF	LTE-FDD (SC-FDMA, 50% RB, 1.4 MHz, QPSK)	LTE-FDD	5.46	±9.6 %
10167	CAF	LTE-FDD (SC-FDMA, 50% RB, 1.4 MHz, 16-QAM)	LTE-FDD	6.21	±9.6 %
10168	CAF	LTE-FDD (SC-FDMA, 50% RB, 1.4 MHz, 64-QAM)	LTE-FDD	6.79	±9.6 %
10169	CAE	LTE-FDD (SC-FDMA, 1 RB, 20 MHz, QPSK)	LTE-FDD	5.73	±9.6 %
10170	CAE	LTE-FDD (SC-FDMA, 1 RB, 20 MHz, 16-QAM)	LTE-FDD	6.52	±9.6 %
10171	AAE	LTE-FDD (SC-FDMA, 1 RB, 20 MHz, 64-QAM)	LTE-FDD	6.49	±9.6 %
10172	CAG	LTE-TDD (SC-FDMA, 1 RB, 20 MHz, QPSK)	LTE-TDD	9.21	±9.6 %
10173	CAG	LTE-TDD (SC-FDMA, 1 RB, 20 MHz, 16-QAM)	LTE-TDD	9.48	±9.6 %
10174	CAG	LTE-TDD (SC-FDMA, 1 RB, 20 MHz, 64-QAM)	LTE-TDD	10.25	±9.6 %
10175	CAG	LTE-FDD (SC-FDMA, 1 RB, 10 MHz, QPSK)	LTE-FDD	5.72	±9.6 %
10176	CAG	LTE-FDD (SC-FDMA, 1 RB, 10 MHz, 16-QAM)	LTE-FDD	6.52	±9.6 %
10177	CAI	LTE-FDD (SC-FDMA, 1 RB, 5 MHz, QPSK)	LTE-FDD	5.73	±9.6 %
10178	CAG	LTE-FDD (SC-FDMA, 1 RB, 5 MHz, 16-QAM)	LTE-FDD	6.52	±9.6 %
10179	CAG	LTE-FDD (SC-FDMA, 1 RB, 10 MHz, 64-QAM)	LTE-FDD	6.50	±9.6 %
10180	CAG	LTE-FDD (SC-FDMA, 1 RB, 5 MHz, 64-QAM)	LTE-FDD	6.50	±9.6 %
10181	CAE	LTE-FDD (SC-FDMA, 1 RB, 15 MHz, QPSK)	LTE-FDD	5.72	±9.6 %
10182	CAE	LTE-FDD (SC-FDMA, 1 RB, 15 MHz, 16-QAM)	LTE-FDD	6.52	±9.6 %
10183	AAD	LTE-FDD (SC-FDMA, 1 RB, 15 MHz, 64-QAM)	LTE-FDD	6.50	±9.6 %
10184	CAE	LTE-FDD (SC-FDMA, 1 RB, 3 MHz, QPSK)	LTE-FDD	5.73	±9.6 %
10185	CAE	LTE-FDD (SC-FDMA, 1 RB, 3 MHz, 16-QAM)	LTE-FDD	6.51	±9.6 %
10186	AAE	LTE-FDD (SC-FDMA, 1 RB, 3 MHz, 64-QAM)	LTE-FDD	6.50	±9.6 %
10187	CAF	LTE-FDD (SC-FDMA, 1 RB, 1.4 MHz, QPSK)	LTE-FDD	5.73	±9.6 %
10188	CAF	LTE-FDD (SC-FDMA, 1 RB, 1.4 MHz, 16-QAM)	LTE-FDD	6.52	±9.6 %
10189	AAF	LTE-FDD (SC-FDMA, 1 RB, 1.4 MHz, 64-QAM)	LTE-FDD	6.50	±9.6 %
10193	CAC	IEEE 802.11n (HT Greenfield, 6.5 Mbps, BPSK)	WLAN	8.09	±9.6 %
10194	CAC	IEEE 802.11n (HT Greenfield, 39 Mbps, 16-QAM)	WLAN	8.12	±9.6 %
10195	CAC	IEEE 802.11n (HT Greenfield, 65 Mbps, 64-QAM)	WLAN	8.21	±9.6 %
10196	CAC	IEEE 802.11n (HT Mixed, 6.5 Mbps, BPSK)	WLAN	8.10	±9.6 %
10197	CAC	IEEE 802.11n (HT Mixed, 39 Mbps, 16-QAM)	WLAN	8.13	±9.6 %
10198	CAC	IEEE 802.11n (HT Mixed, 65 Mbps, 64-QAM)	WLAN	8.27	±9.6 %
10219	CAC	IEEE 802.11n (HT Mixed, 7.2 Mbps, BPSK)	WLAN	8.03	±9.6 %

10220	CAC	IEEE 802.11n (HT Mixed, 43.3 Mbps, 16-QAM)	WLAN	8.13	± 9.6 %
10221	CAC	IEEE 802.11n (HT Mixed, 72.2 Mbps, 64-QAM)	WLAN	8.27	± 9.6 %
10222	CAC	IEEE 802.11n (HT Mixed, 15 Mbps, BPSK)	WLAN	8.06	± 9.6 %
10223	CAC	IEEE 802.11n (HT Mixed, 90 Mbps, 16-QAM)	WLAN	8.48	± 9.6 %
10224	CAC	IEEE 802.11n (HT Mixed, 150 Mbps, 64-QAM)	WLAN	8.08	± 9.6 %
10225	CAB	UMTS-FDD (HSPA+)	WCDMA	5.97	± 9.6 %
10226	CAA	LTE-TDD (SC-FDMA, 1 RB, 1.4 MHz, 16-QAM)	LTE-TDD	9.49	± 9.6 %
10227	CAA	LTE-TDD (SC-FDMA, 1 RB, 1.4 MHz, 64-QAM)	LTE-TDD	10.26	± 9.6 %
10228	CAA	LTE-TDD (SC-FDMA, 1 RB, 1.4 MHz, QPSK)	LTE-TDD	9.22	± 9.6 %
10229	CAC	LTE-TDD (SC-FDMA, 1 RB, 3 MHz, 16-QAM)	LTE-TDD	9.48	± 9.6 %
10230	CAC	LTE-TDD (SC-FDMA, 1 RB, 3 MHz, 64-QAM)	LTE-TDD	10.25	± 9.6 %
10231	CAC	LTE-TDD (SC-FDMA, 1 RB, 3 MHz, QPSK)	LTE-TDD	9.19	± 9.6 %
10232	CAF	LTE-TDD (SC-FDMA, 1 RB, 5 MHz, 16-QAM)	LTE-TDD	9.48	± 9.6 %
10233	CAF	LTE-TDD (SC-FDMA, 1 RB, 5 MHz, 64-QAM)	LTE-TDD	10.25	± 9.6 %
10234	CAF	LTE-TDD (SC-FDMA, 1 RB, 5 MHz, QPSK)	LTE-TDD	9.21	± 9.6 %
10235	CAF	LTE-TDD (SC-FDMA, 1 RB, 10 MHz, 16-QAM)	LTE-TDD	9.48	± 9.6 %
10236	CAF	LTE-TDD (SC-FDMA, 1 RB, 10 MHz, 64-QAM)	LTE-TDD	10.25	± 9.6 %
10237	CAF	LTE-TDD (SC-FDMA, 1 RB, 10 MHz, QPSK)	LTE-TDD	9.21	± 9.6 %
10238	CAF	LTE-TDD (SC-FDMA, 1 RB, 15 MHz, 16-QAM)	LTE-TDD	9.48	± 9.6 %
10239	CAF	LTE-TDD (SC-FDMA, 1 RB, 15 MHz, 64-QAM)	LTE-TDD	10.25	± 9.6 %
10240	CAF	LTE-TDD (SC-FDMA, 1 RB, 15 MHz, QPSK)	LTE-TDD	9.21	± 9.6 %
10241	CAA	LTE-TDD (SC-FDMA, 50% RB, 1.4 MHz, 16-QAM)	LTE-TDD	9.82	± 9.6 %
10242	CAA	LTE-TDD (SC-FDMA, 50% RB, 1.4 MHz, 64-QAM)	LTE-TDD	9.86	± 9.6 %
10243	CAA	LTE-TDD (SC-FDMA, 50% RB, 1.4 MHz, QPSK)	LTE-TDD	9.46	± 9.6 %
10244	CAC	LTE-TDD (SC-FDMA, 50% RB, 3 MHz, 16-QAM)	LTE-TDD	10.06	± 9.6 %
10245	CAC	LTE-TDD (SC-FDMA, 50% RB, 3 MHz, 64-QAM)	LTE-TDD	10.06	± 9.6 %
10246	CAC	LTE-TDD (SC-FDMA, 50% RB, 3 MHz, QPSK)	LTE-TDD	9.30	± 9.6 %
10247	CAF	LTE-TDD (SC-FDMA, 50% RB, 5 MHz, 16-QAM)	LTE-TDD	9.91	± 9.6 %
10248	CAF	LTE-TDD (SC-FDMA, 50% RB, 5 MHz, 64-QAM)	LTE-TDD	10.09	± 9.6 %
10249	CAF	LTE-TDD (SC-FDMA, 50% RB, 5 MHz, QPSK)	LTE-TDD	9.29	± 9.6 %
10250	CAF	LTE-TDD (SC-FDMA, 50% RB, 10 MHz, 16-QAM)	LTE-TDD	9.81	± 9.6 %
10251	CAF	LTE-TDD (SC-FDMA, 50% RB, 10 MHz, 64-QAM)	LTE-TDD	10.17	± 9.6 %
10252	CAF	LTE-TDD (SC-FDMA, 50% RB, 10 MHz, QPSK)	LTE-TDD	9.24	± 9.6 %
10253	CAF	LTE-TDD (SC-FDMA, 50% RB, 15 MHz, 16-QAM)	LTE-TDD	9.90	± 9.6 %
10254	CAF	LTE-TDD (SC-FDMA, 50% RB, 15 MHz, 64-QAM)	LTE-TDD	10.14	± 9.6 %
10255	CAF	LTE-TDD (SC-FDMA, 50% RB, 15 MHz, QPSK)	LTE-TDD	9.20	± 9.6 %
10256	CAA	LTE-TDD (SC-FDMA, 100% RB, 1.4 MHz, 16-QAM)	LTE-TDD	9.96	± 9.6 %
10257	CAA	LTE-TDD (SC-FDMA, 100% RB, 1.4 MHz, 64-QAM)	LTE-TDD	10.08	± 9.6 %
10258	CAA	LTE-TDD (SC-FDMA, 100% RB, 1.4 MHz, QPSK)	LTE-TDD	9.34	± 9.6 %
10259	CAC	LTE-TDD (SC-FDMA, 100% RB, 3 MHz, 16-QAM)	LTE-TDD	9.98	± 9.6 %
10260	CAC	LTE-TDD (SC-FDMA, 100% RB, 3 MHz, 64-QAM)	LTE-TDD	9.97	± 9.6 %
10261	CAC	LTE-TDD (SC-FDMA, 100% RB, 3 MHz, QPSK)	LTE-TDD	9.24	± 9.6 %
10262	CAF	LTE-TDD (SC-FDMA, 100% RB, 5 MHz, 16-QAM)	LTE-TDD	9.83	± 9.6 %
10263	CAF	LTE-TDD (SC-FDMA, 100% RB, 5 MHz, 64-QAM)	LTE-TDD	10.16	± 9.6 %
10264	CAF	LTE-TDD (SC-FDMA, 100% RB, 5 MHz, QPSK)	LTE-TDD	9.23	± 9.6 %
10265	CAF	LTE-TDD (SC-FDMA, 100% RB, 10 MHz, 16-QAM)	LTE-TDD	9.92	± 9.6 %
10266	CAF	LTE-TDD (SC-FDMA, 100% RB, 10 MHz, 64-QAM)	LTE-TDD	10.07	± 9.6 %
10267	CAF	LTE-TDD (SC-FDMA, 100% RB, 10 MHz, QPSK)	LTE-TDD	9.30	± 9.6 %
10268	CAF	LTE-TDD (SC-FDMA, 100% RB, 15 MHz, 16-QAM)	LTE-TDD	10.06	± 9.6 %
10269	CAF	LTE-TDD (SC-FDMA, 100% RB, 15 MHz, 64-QAM)	LTE-TDD	10.13	± 9.6 %
10270	CAF	LTE-TDD (SC-FDMA, 100% RB, 15 MHz, QPSK)	LTE-TDD	9.58	± 9.6 %
10274	CAB	UMTS-FDD (HSUPA, Subtest 5, 3GPP Rel8.10)	WCDMA	4.87	± 9.6 %
10275	CAB	UMTS-FDD (HSUPA, Subtest 5, 3GPP Rel8.4)	WCDMA	3.96	± 9.6 %
10277	CAA	PHS (QPSK)	PHS	11.81	± 9.6 %
10278	CAA	PHS (QPSK, BW 884MHz, Rolloff 0.5)	PHS	11.81	± 9.6 %
10279	CAA	PHS (QPSK, BW 884MHz, Rolloff 0.38)	PHS	12.18	± 9.6 %
10290	AAB	CDMA2000, RC1, SO55, Full Rate	CDMA2000	3.91	± 9.6 %
10291	AAB	CDMA2000, RC3, SO55, Full Rate	CDMA2000	3.46	± 9.6 %
10292	AAB	CDMA2000, RC3, SO32, Full Rate	CDMA2000	3.39	± 9.6 %
10293	AAB	CDMA2000, RC3, SO3, Full Rate	CDMA2000	3.50	± 9.6 %
10295	AAB	CDMA2000, RC1, SO3, 1/8th Rate 25 fr.	CDMA2000	12.49	± 9.6 %
10297	AAD	LTE-FDD (SC-FDMA, 50% RB, 20 MHz, QPSK)	LTE-FDD	5.81	± 9.6 %
10298	AAD	LTE-FDD (SC-FDMA, 50% RB, 3 MHz, QPSK)	LTE-FDD	5.72	± 9.6 %
10299	AAD	LTE-FDD (SC-FDMA, 50% RB, 3 MHz, 16-QAM)	LTE-FDD	6.39	± 9.6 %

10300	AAD	LTE-FDD (SC-FDMA, 50% RB, 3 MHz, 64-QAM)	LTE-FDD	6.60	± 9.6 %
10301	AAA	IEEE 802.16e WiMAX (29:18, 5ms, 10MHz, QPSK, PUSC)	WiMAX	12.03	± 9.6 %
10302	AAA	IEEE 802.16e WiMAX (29:18, 5ms, 10MHz, QPSK, PUSC, 3 CTRL symbols)	WiMAX	12.57	± 9.6 %
10303	AAA	IEEE 802.16e WiMAX (31:15, 5ms, 10MHz, 64QAM, PUSC)	WiMAX	12.52	± 9.6 %
10304	AAA	IEEE 802.16e WiMAX (29:18, 5ms, 10MHz, 64QAM, PUSC)	WiMAX	11.86	± 9.6 %
10305	AAA	IEEE 802.16e WiMAX (31:15, 10ms, 10MHz, 64QAM, PUSC, 15 symbols)	WiMAX	15.24	± 9.6 %
10306	AAA	IEEE 802.16e WiMAX (29:18, 10ms, 10MHz, 64QAM, PUSC, 18 symbols)	WiMAX	14.67	± 9.6 %
10307	AAA	IEEE 802.16e WiMAX (29:18, 10ms, 10MHz, QPSK, PUSC, 18 symbols)	WiMAX	14.49	± 9.6 %
10308	AAA	IEEE 802.16e WiMAX (29:18, 10ms, 10MHz, 16QAM, PUSC)	WiMAX	14.46	± 9.6 %
10309	AAA	IEEE 802.16e WiMAX (29:18, 10ms, 10MHz, 16QAM, AMC 2x3, 18 symbols)	WiMAX	14.58	± 9.6 %
10310	AAA	IEEE 802.16e WiMAX (29:18, 10ms, 10MHz, QPSK, AMC 2x3, 18 symbols)	WiMAX	14.57	± 9.6 %
10311	AAD	LTE-FDD (SC-FDMA, 100% RB, 15 MHz, QPSK)	LTE-FDD	6.06	± 9.6 %
10313	AAA	iDEN 1:3	iDEN	10.51	± 9.6 %
10314	AAA	iDEN 1:6	iDEN	13.48	± 9.6 %
10315	AAB	IEEE 802.11b WiFi 2.4 GHz (DSSS, 1 Mbps, 96pc duty cycle)	WLAN	1.71	± 9.6 %
10316	AAB	IEEE 802.11g WiFi 2.4 GHz (ERP-OFDM, 6 Mbps, 96pc duty cycle)	WLAN	8.36	± 9.6 %
10317	AAC	IEEE 802.11a WiFi 5 GHz (OFDM, 6 Mbps, 96pc duty cycle)	WLAN	8.36	± 9.6 %
10352	AAA	Pulse Waveform (200Hz, 10%)	Generic	10.00	± 9.6 %
10353	AAA	Pulse Waveform (200Hz, 20%)	Generic	6.99	± 9.6 %
10354	AAA	Pulse Waveform (200Hz, 40%)	Generic	3.98	± 9.6 %
10355	AAA	Pulse Waveform (200Hz, 60%)	Generic	2.22	± 9.6 %
10356	AAA	Pulse Waveform (200Hz, 80%)	Generic	0.97	± 9.6 %
10387	AAA	QPSK Waveform, 1 MHz	Generic	5.10	± 9.6 %
10388	AAA	QPSK Waveform, 10 MHz	Generic	5.22	± 9.6 %
10396	AAA	64-QAM Waveform, 100 kHz	Generic	6.27	± 9.6 %
10399	AAA	64-QAM Waveform, 40 MHz	Generic	6.27	± 9.6 %
10400	AAD	IEEE 802.11ac WiFi (20MHz, 64-QAM, 99pc duty cycle)	WLAN	8.37	± 9.6 %
10401	AAD	IEEE 802.11ac WiFi (40MHz, 64-QAM, 99pc duty cycle)	WLAN	8.60	± 9.6 %
10402	AAD	IEEE 802.11ac WiFi (80MHz, 64-QAM, 99pc duty cycle)	WLAN	8.53	± 9.6 %
10403	AAB	CDMA2000 (1xEV-DO, Rev. 0)	CDMA2000	3.76	± 9.6 %
10404	AAB	CDMA2000 (1xEV-DO, Rev. A)	CDMA2000	3.77	± 9.6 %
10406	AAB	CDMA2000, RC3, SO32, SCH0, Full Rate	CDMA2000	5.22	± 9.6 %
10410	AAF	LTE-TDD (SC-FDMA, 1 RB, 10 MHz, QPSK, UL Subframe=2,3,4,7,8,9, Subframe Conf=4)	LTE-TDD	7.82	± 9.6 %
10414	AAA	WLAN CCDF, 64-QAM, 40MHz	Generic	8.54	± 9.6 %
10415	AAA	IEEE 802.11b WiFi 2.4 GHz (DSSS, 1 Mbps, 99pc duty cycle)	WLAN	1.54	± 9.6 %
10416	AAA	IEEE 802.11g WiFi 2.4 GHz (ERP-OFDM, 6 Mbps, 99pc duty cycle)	WLAN	8.23	± 9.6 %
10417	AAB	IEEE 802.11a/h WiFi 5 GHz (OFDM, 6 Mbps, 99pc duty cycle)	WLAN	8.23	± 9.6 %
10418	AAA	IEEE 802.11g WiFi 2.4 GHz (DSSS-OFDM, 6 Mbps, 99pc duty cycle, Long preamble)	WLAN	8.14	± 9.6 %
10419	AAA	IEEE 802.11g WiFi 2.4 GHz (DSSS-OFDM, 6 Mbps, 99pc duty cycle, Short preamble)	WLAN	8.19	± 9.6 %
10422	AAB	IEEE 802.11n (HT Greenfield, 7.2 Mbps, BPSK)	WLAN	8.32	± 9.6 %
10423	AAB	IEEE 802.11n (HT Greenfield, 43.3 Mbps, 16-QAM)	WLAN	8.47	± 9.6 %
10424	AAB	IEEE 802.11n (HT Greenfield, 72.2 Mbps, 64-QAM)	WLAN	8.40	± 9.6 %
10425	AAB	IEEE 802.11n (HT Greenfield, 15 Mbps, BPSK)	WLAN	8.41	± 9.6 %
10426	AAB	IEEE 802.11n (HT Greenfield, 90 Mbps, 16-QAM)	WLAN	8.45	± 9.6 %
10427	AAB	IEEE 802.11n (HT Greenfield, 150 Mbps, 64-QAM)	WLAN	8.41	± 9.6 %
10430	AAD	LTE-FDD (OFDMA, 5 MHz, E-TM 3.1)	LTE-FDD	8.28	± 9.6 %
10431	AAD	LTE-FDD (OFDMA, 10 MHz, E-TM 3.1)	LTE-FDD	8.38	± 9.6 %
10432	AAC	LTE-FDD (OFDMA, 15 MHz, E-TM 3.1)	LTE-FDD	8.34	± 9.6 %
10433	AAC	LTE-FDD (OFDMA, 20 MHz, E-TM 3.1)	LTE-FDD	8.34	± 9.6 %
10434	AAA	W-CDMA (BS Test Model 1, 64 DPCH)	WCDMA	8.60	± 9.6 %
10435	AAF	LTE-TDD (SC-FDMA, 1 RB, 20 MHz, QPSK, UL Subframe=2,3,4,7,8,9)	LTE-TDD	7.82	± 9.6 %
10447	AAD	LTE-FDD (OFDMA, 5 MHz, E-TM 3.1, Clipping 44%)	LTE-FDD	7.56	± 9.6 %
10448	AAD	LTE-FDD (OFDMA, 10 MHz, E-TM 3.1, Clipping 44%)	LTE-FDD	7.53	± 9.6 %
10449	AAC	LTE-FDD (OFDMA, 15 MHz, E-TM 3.1, Clipping 44%)	LTE-FDD	7.51	± 9.6 %
10450	AAC	LTE-FDD (OFDMA, 20 MHz, E-TM 3.1, Clipping 44%)	LTE-FDD	7.48	± 9.6 %

10451	AAA	W-CDMA (BS Test Model 1, 64 DPCH, Clipping 44%)	WCDMA	7.59	± 9.6 %
10456	AAB	IEEE 802.11ac WIFI (160MHz, 64-QAM, 99pc duty cycle)	WLAN	8.63	± 9.6 %
10457	AAA	UMTS-FDD (DC-HSDPA)	WCDMA	6.62	± 9.6 %
10458	AAA	CDMA2000 (1xEV-DO, Rev. B, 2 carriers)	CDMA2000	6.55	± 9.6 %
10459	AAA	CDMA2000 (1xEV-DO, Rev. B, 3 carriers)	CDMA2000	8.25	± 9.6 %
10460	AAA	UMTS-FDD (WCDMA, AMR)	WCDMA	2.39	± 9.6 %
10461	AAA	LTE-TDD (SC-FDMA, 1 RB, 1.4 MHz, QPSK, UL Subframe=2,3,4,7,8,9)	LTE-TDD	7.82	± 9.6 %
10462	AAA	LTE-TDD (SC-FDMA, 1 RB, 1.4 MHz, 16-QAM, UL Subframe=2,3,4,7,8,9)	LTE-TDD	8.30	± 9.6 %
10463	AAA	LTE-TDD (SC-FDMA, 1 RB, 1.4 MHz, 64-QAM, UL Subframe=2,3,4,7,8,9)	LTE-TDD	8.56	± 9.6 %
10464	AAB	LTE-TDD (SC-FDMA, 1 RB, 3 MHz, QPSK, UL Subframe=2,3,4,7,8,9)	LTE-TDD	7.82	± 9.6 %
10465	AAB	LTE-TDD (SC-FDMA, 1 RB, 3 MHz, 16-QAM, UL Subframe=2,3,4,7,8,9)	LTE-TDD	8.32	± 9.6 %
10466	AAB	LTE-TDD (SC-FDMA, 1 RB, 3 MHz, 64-QAM, UL Subframe=2,3,4,7,8,9)	LTE-TDD	8.57	± 9.6 %
10467	AAE	LTE-TDD (SC-FDMA, 1 RB, 5 MHz, QPSK, UL Subframe=2,3,4,7,8,9)	LTE-TDD	7.82	± 9.6 %
10468	AAE	LTE-TDD (SC-FDMA, 1 RB, 5 MHz, 16-QAM, UL Subframe=2,3,4,7,8,9)	LTE-TDD	8.32	± 9.6 %
10469	AAE	LTE-TDD (SC-FDMA, 1 RB, 5 MHz, 64-QAM, UL Subframe=2,3,4,7,8,9)	LTE-TDD	8.56	± 9.6 %
10470	AAE	LTE-TDD (SC-FDMA, 1 RB, 10 MHz, QPSK, UL Subframe=2,3,4,7,8,9)	LTE-TDD	7.82	± 9.6 %
10471	AAE	LTE-TDD (SC-FDMA, 1 RB, 10 MHz, 16-QAM, UL Subframe=2,3,4,7,8,9)	LTE-TDD	8.32	± 9.6 %
10472	AAE	LTE-TDD (SC-FDMA, 1 RB, 10 MHz, 64-QAM, UL Subframe=2,3,4,7,8,9)	LTE-TDD	8.57	± 9.6 %
10473	AAE	LTE-TDD (SC-FDMA, 1 RB, 15 MHz, QPSK, UL Subframe=2,3,4,7,8,9)	LTE-TDD	7.82	± 9.6 %
10474	AAE	LTE-TDD (SC-FDMA, 1 RB, 15 MHz, 16-QAM, UL Subframe=2,3,4,7,8,9)	LTE-TDD	8.32	± 9.6 %
10475	AAE	LTE-TDD (SC-FDMA, 1 RB, 15 MHz, 64-QAM, UL Subframe=2,3,4,7,8,9)	LTE-TDD	8.57	± 9.6 %
10477	AAF	LTE-TDD (SC-FDMA, 1 RB, 20 MHz, 16-QAM, UL Subframe=2,3,4,7,8,9)	LTE-TDD	8.32	± 9.6 %
10478	AAF	LTE-TDD (SC-FDMA, 1 RB, 20 MHz, 64-QAM, UL Subframe=2,3,4,7,8,9)	LTE-TDD	8.57	± 9.6 %
10479	AAA	LTE-TDD (SC-FDMA, 50% RB, 1.4 MHz, QPSK, UL Subframe=2,3,4,7,8,9)	LTE-TDD	7.74	± 9.6 %
10480	AAA	LTE-TDD (SC-FDMA, 50% RB, 1.4 MHz, 16-QAM, UL Subframe=2,3,4,7,8,9)	LTE-TDD	8.18	± 9.6 %
10481	AAA	LTE-TDD (SC-FDMA, 50% RB, 1.4 MHz, 64-QAM, UL Subframe=2,3,4,7,8,9)	LTE-TDD	8.45	± 9.6 %
10482	AAB	LTE-TDD (SC-FDMA, 50% RB, 3 MHz, QPSK, UL Subframe=2,3,4,7,8,9)	LTE-TDD	7.71	± 9.6 %
10483	AAB	LTE-TDD (SC-FDMA, 50% RB, 3 MHz, 16-QAM, UL Subframe=2,3,4,7,8,9)	LTE-TDD	8.39	± 9.6 %
10484	AAB	LTE-TDD (SC-FDMA, 50% RB, 3 MHz, 64-QAM, UL Subframe=2,3,4,7,8,9)	LTE-TDD	8.47	± 9.6 %
10485	AAE	LTE-TDD (SC-FDMA, 50% RB, 5 MHz, QPSK, UL Subframe=2,3,4,7,8,9)	LTE-TDD	7.59	± 9.6 %
10486	AAE	LTE-TDD (SC-FDMA, 50% RB, 5 MHz, 16-QAM, UL Subframe=2,3,4,7,8,9)	LTE-TDD	8.38	± 9.6 %
10487	AAE	LTE-TDD (SC-FDMA, 50% RB, 5 MHz, 64-QAM, UL Subframe=2,3,4,7,8,9)	LTE-TDD	8.60	± 9.6 %
10488	AAE	LTE-TDD (SC-FDMA, 50% RB, 10 MHz, QPSK, UL Subframe=2,3,4,7,8,9)	LTE-TDD	7.70	± 9.6 %
10489	AAE	LTE-TDD (SC-FDMA, 50% RB, 10 MHz, 16-QAM, UL Subframe=2,3,4,7,8,9)	LTE-TDD	8.31	± 9.6 %
10490	AAE	LTE-TDD (SC-FDMA, 50% RB, 10 MHz, 64-QAM, UL Subframe=2,3,4,7,8,9)	LTE-TDD	8.54	± 9.6 %
10491	AAE	LTE-TDD (SC-FDMA, 50% RB, 15 MHz, QPSK, UL Subframe=2,3,4,7,8,9)	LTE-TDD	7.74	± 9.6 %

10492	AAE	LTE-TDD (SC-FDMA, 50% RB, 15 MHz, 16-QAM, UL Subframe=2,3,4,7,8,9)	LTE-TDD	8.41	± 9.6 %
10493	AAE	LTE-TDD (SC-FDMA, 50% RB, 15 MHz, 64-QAM, UL Subframe=2,3,4,7,8,9)	LTE-TDD	8.55	± 9.6 %
10494	AAF	LTE-TDD (SC-FDMA, 50% RB, 20 MHz, QPSK, UL Subframe=2,3,4,7,8,9)	LTE-TDD	7.74	± 9.6 %
10495	AAF	LTE-TDD (SC-FDMA, 50% RB, 20 MHz, 16-QAM, UL Subframe=2,3,4,7,8,9)	LTE-TDD	8.37	± 9.6 %
10496	AAF	LTE-TDD (SC-FDMA, 50% RB, 20 MHz, 64-QAM, UL Subframe=2,3,4,7,8,9)	LTE-TDD	8.54	± 9.6 %
10497	AAA	LTE-TDD (SC-FDMA, 100% RB, 1.4 MHz, QPSK, UL Subframe=2,3,4,7,8,9)	LTE-TDD	7.67	± 9.6 %
10498	AAA	LTE-TDD (SC-FDMA, 100% RB, 1.4 MHz, 16-QAM, UL Subframe=2,3,4,7,8,9)	LTE-TDD	8.40	± 9.6 %
10499	AAA	LTE-TDD (SC-FDMA, 100% RB, 1.4 MHz, 64-QAM, UL Subframe=2,3,4,7,8,9)	LTE-TDD	8.68	± 9.6 %
10500	AAB	LTE-TDD (SC-FDMA, 100% RB, 3 MHz, QPSK, UL Subframe=2,3,4,7,8,9)	LTE-TDD	7.67	± 9.6 %
10501	AAB	LTE-TDD (SC-FDMA, 100% RB, 3 MHz, 16-QAM, UL Subframe=2,3,4,7,8,9)	LTE-TDD	8.44	± 9.6 %
10502	AAB	LTE-TDD (SC-FDMA, 100% RB, 3 MHz, 64-QAM, UL Subframe=2,3,4,7,8,9)	LTE-TDD	8.52	± 9.6 %
10503	AAE	LTE-TDD (SC-FDMA, 100% RB, 5 MHz, QPSK, UL Subframe=2,3,4,7,8,9)	LTE-TDD	7.72	± 9.6 %
10504	AAE	LTE-TDD (SC-FDMA, 100% RB, 5 MHz, 16-QAM, UL Subframe=2,3,4,7,8,9)	LTE-TDD	8.31	± 9.6 %
10505	AAE	LTE-TDD (SC-FDMA, 100% RB, 5 MHz, 64-QAM, UL Subframe=2,3,4,7,8,9)	LTE-TDD	8.54	± 9.6 %
10506	AAE	LTE-TDD (SC-FDMA, 100% RB, 10 MHz, QPSK, UL Subframe=2,3,4,7,8,9)	LTE-TDD	7.74	± 9.6 %
10507	AAE	LTE-TDD (SC-FDMA, 100% RB, 10 MHz, 16-QAM, UL Subframe=2,3,4,7,8,9)	LTE-TDD	8.36	± 9.6 %
10508	AAE	LTE-TDD (SC-FDMA, 100% RB, 10 MHz, 64-QAM, UL Subframe=2,3,4,7,8,9)	LTE-TDD	8.55	± 9.6 %
10509	AAE	LTE-TDD (SC-FDMA, 100% RB, 15 MHz, QPSK, UL Subframe=2,3,4,7,8,9)	LTE-TDD	7.99	± 9.6 %
10510	AAE	LTE-TDD (SC-FDMA, 100% RB, 15 MHz, 16-QAM, UL Subframe=2,3,4,7,8,9)	LTE-TDD	8.49	± 9.6 %
10511	AAE	LTE-TDD (SC-FDMA, 100% RB, 15 MHz, 64-QAM, UL Subframe=2,3,4,7,8,9)	LTE-TDD	8.51	± 9.6 %
10512	AAF	LTE-TDD (SC-FDMA, 100% RB, 20 MHz, QPSK, UL Subframe=2,3,4,7,8,9)	LTE-TDD	7.74	± 9.6 %
10513	AAF	LTE-TDD (SC-FDMA, 100% RB, 20 MHz, 16-QAM, UL Subframe=2,3,4,7,8,9)	LTE-TDD	8.42	± 9.6 %
10514	AAF	LTE-TDD (SC-FDMA, 100% RB, 20 MHz, 64-QAM, UL Subframe=2,3,4,7,8,9)	LTE-TDD	8.45	± 9.6 %
10515	AAA	IEEE 802.11b WiFi 2.4 GHz (DSSS, 2 Mbps, 99pc duty cycle)	WLAN	1.58	± 9.6 %
10516	AAA	IEEE 802.11b WiFi 2.4 GHz (DSSS, 5.5 Mbps, 99pc duty cycle)	WLAN	1.57	± 9.6 %
10517	AAA	IEEE 802.11b WiFi 2.4 GHz (DSSS, 11 Mbps, 99pc duty cycle)	WLAN	1.58	± 9.6 %
10518	AAB	IEEE 802.11a/h WiFi 5 GHz (OFDM, 9 Mbps, 99pc duty cycle)	WLAN	8.23	± 9.6 %
10519	AAB	IEEE 802.11a/h WiFi 5 GHz (OFDM, 12 Mbps, 99pc duty cycle)	WLAN	8.39	± 9.6 %
10520	AAB	IEEE 802.11a/h WiFi 5 GHz (OFDM, 18 Mbps, 99pc duty cycle)	WLAN	8.12	± 9.6 %
10521	AAB	IEEE 802.11a/h WiFi 5 GHz (OFDM, 24 Mbps, 99pc duty cycle)	WLAN	7.97	± 9.6 %
10522	AAB	IEEE 802.11a/h WiFi 5 GHz (OFDM, 36 Mbps, 99pc duty cycle)	WLAN	8.45	± 9.6 %
10523	AAB	IEEE 802.11a/h WiFi 5 GHz (OFDM, 48 Mbps, 99pc duty cycle)	WLAN	8.08	± 9.6 %
10524	AAB	IEEE 802.11a/h WiFi 5 GHz (OFDM, 54 Mbps, 99pc duty cycle)	WLAN	8.27	± 9.6 %
10525	AAB	IEEE 802.11ac WiFi (20MHz, MCS0, 99pc duty cycle)	WLAN	8.36	± 9.6 %
10526	AAB	IEEE 802.11ac WiFi (20MHz, MCS1, 99pc duty cycle)	WLAN	8.42	± 9.6 %
10527	AAB	IEEE 802.11ac WiFi (20MHz, MCS2, 99pc duty cycle)	WLAN	8.21	± 9.6 %
10528	AAB	IEEE 802.11ac WiFi (20MHz, MCS3, 99pc duty cycle)	WLAN	8.36	± 9.6 %
10529	AAB	IEEE 802.11ac WiFi (20MHz, MCS4, 99pc duty cycle)	WLAN	8.36	± 9.6 %
10531	AAB	IEEE 802.11ac WiFi (20MHz, MCS6, 99pc duty cycle)	WLAN	8.43	± 9.6 %
10532	AAB	IEEE 802.11ac WiFi (20MHz, MCS7, 99pc duty cycle)	WLAN	8.29	± 9.6 %
10533	AAB	IEEE 802.11ac WiFi (20MHz, MCS8, 99pc duty cycle)	WLAN	8.38	± 9.6 %
10534	AAB	IEEE 802.11ac WiFi (40MHz, MCS0, 99pc duty cycle)	WLAN	8.45	± 9.6 %

10535	AAB	IEEE 802.11ac WiFi (40MHz, MCS1, 99pc duty cycle)	WLAN	8.45	± 9.6 %
10536	AAB	IEEE 802.11ac WiFi (40MHz, MCS2, 99pc duty cycle)	WLAN	8.32	± 9.6 %
10537	AAB	IEEE 802.11ac WiFi (40MHz, MCS3, 99pc duty cycle)	WLAN	8.44	± 9.6 %
10538	AAB	IEEE 802.11ac WiFi (40MHz, MCS4, 99pc duty cycle)	WLAN	8.54	± 9.6 %
10540	AAB	IEEE 802.11ac WiFi (40MHz, MCS6, 99pc duty cycle)	WLAN	8.39	± 9.6 %
10541	AAB	IEEE 802.11ac WiFi (40MHz, MCS7, 99pc duty cycle)	WLAN	8.46	± 9.6 %
10542	AAB	IEEE 802.11ac WiFi (40MHz, MCS8, 99pc duty cycle)	WLAN	8.65	± 9.6 %
10543	AAB	IEEE 802.11ac WiFi (40MHz, MCS9, 99pc duty cycle)	WLAN	8.65	± 9.6 %
10544	AAB	IEEE 802.11ac WiFi (80MHz, MCS0, 99pc duty cycle)	WLAN	8.47	± 9.6 %
10545	AAB	IEEE 802.11ac WiFi (80MHz, MCS1, 99pc duty cycle)	WLAN	8.55	± 9.6 %
10546	AAB	IEEE 802.11ac WiFi (80MHz, MCS2, 99pc duty cycle)	WLAN	8.35	± 9.6 %
10547	AAB	IEEE 802.11ac WiFi (80MHz, MCS3, 99pc duty cycle)	WLAN	8.49	± 9.6 %
10548	AAB	IEEE 802.11ac WiFi (80MHz, MCS4, 99pc duty cycle)	WLAN	8.37	± 9.6 %
10550	AAB	IEEE 802.11ac WiFi (80MHz, MCS6, 99pc duty cycle)	WLAN	8.38	± 9.6 %
10551	AAB	IEEE 802.11ac WiFi (80MHz, MCS7, 99pc duty cycle)	WLAN	8.50	± 9.6 %
10552	AAB	IEEE 802.11ac WiFi (80MHz, MCS8, 99pc duty cycle)	WLAN	8.42	± 9.6 %
10553	AAB	IEEE 802.11ac WiFi (80MHz, MCS9, 99pc duty cycle)	WLAN	8.45	± 9.6 %
10554	AAC	IEEE 802.11ac WiFi (160MHz, MCS0, 99pc duty cycle)	WLAN	8.48	± 9.6 %
10555	AAC	IEEE 802.11ac WiFi (160MHz, MCS1, 99pc duty cycle)	WLAN	8.47	± 9.6 %
10556	AAC	IEEE 802.11ac WiFi (160MHz, MCS2, 99pc duty cycle)	WLAN	8.50	± 9.6 %
10557	AAC	IEEE 802.11ac WiFi (160MHz, MCS3, 99pc duty cycle)	WLAN	8.52	± 9.6 %
10558	AAC	IEEE 802.11ac WiFi (160MHz, MCS4, 99pc duty cycle)	WLAN	8.61	± 9.6 %
10560	AAC	IEEE 802.11ac WiFi (160MHz, MCS6, 99pc duty cycle)	WLAN	8.73	± 9.6 %
10561	AAC	IEEE 802.11ac WiFi (160MHz, MCS7, 99pc duty cycle)	WLAN	8.56	± 9.6 %
10562	AAC	IEEE 802.11ac WiFi (160MHz, MCS8, 99pc duty cycle)	WLAN	8.69	± 9.6 %
10563	AAC	IEEE 802.11ac WiFi (160MHz, MCS9, 99pc duty cycle)	WLAN	8.77	± 9.6 %
10564	AAA	IEEE 802.11g WiFi 2.4 GHz (DSSS-OFDM, 9 Mbps, 99pc duty cycle)	WLAN	8.25	± 9.6 %
10565	AAA	IEEE 802.11g WiFi 2.4 GHz (DSSS-OFDM, 12 Mbps, 99pc duty cycle)	WLAN	8.45	± 9.6 %
10566	AAA	IEEE 802.11g WiFi 2.4 GHz (DSSS-OFDM, 18 Mbps, 99pc duty cycle)	WLAN	8.13	± 9.6 %
10567	AAA	IEEE 802.11g WiFi 2.4 GHz (DSSS-OFDM, 24 Mbps, 99pc duty cycle)	WLAN	8.00	± 9.6 %
10568	AAA	IEEE 802.11g WiFi 2.4 GHz (DSSS-OFDM, 36 Mbps, 99pc duty cycle)	WLAN	8.37	± 9.6 %
10569	AAA	IEEE 802.11g WiFi 2.4 GHz (DSSS-OFDM, 48 Mbps, 99pc duty cycle)	WLAN	8.10	± 9.6 %
10570	AAA	IEEE 802.11g WiFi 2.4 GHz (DSSS-OFDM, 54 Mbps, 99pc duty cycle)	WLAN	8.30	± 9.6 %
10571	AAA	IEEE 802.11b WiFi 2.4 GHz (DSSS, 1 Mbps, 90pc duty cycle)	WLAN	1.99	± 9.6 %
10572	AAA	IEEE 802.11b WiFi 2.4 GHz (DSSS, 2 Mbps, 90pc duty cycle)	WLAN	1.99	± 9.6 %
10573	AAA	IEEE 802.11b WiFi 2.4 GHz (DSSS, 5.5 Mbps, 90pc duty cycle)	WLAN	1.98	± 9.6 %
10574	AAA	IEEE 802.11b WiFi 2.4 GHz (DSSS, 11 Mbps, 90pc duty cycle)	WLAN	1.98	± 9.6 %
10575	AAA	IEEE 802.11g WiFi 2.4 GHz (DSSS-OFDM, 6 Mbps, 90pc duty cycle)	WLAN	8.59	± 9.6 %
10576	AAA	IEEE 802.11g WiFi 2.4 GHz (DSSS-OFDM, 9 Mbps, 90pc duty cycle)	WLAN	8.60	± 9.6 %
10577	AAA	IEEE 802.11g WiFi 2.4 GHz (DSSS-OFDM, 12 Mbps, 90pc duty cycle)	WLAN	8.70	± 9.6 %
10578	AAA	IEEE 802.11g WiFi 2.4 GHz (DSSS-OFDM, 18 Mbps, 90pc duty cycle)	WLAN	8.49	± 9.6 %
10579	AAA	IEEE 802.11g WiFi 2.4 GHz (DSSS-OFDM, 24 Mbps, 90pc duty cycle)	WLAN	8.36	± 9.6 %
10580	AAA	IEEE 802.11g WiFi 2.4 GHz (DSSS-OFDM, 36 Mbps, 90pc duty cycle)	WLAN	8.76	± 9.6 %
10581	AAA	IEEE 802.11g WiFi 2.4 GHz (DSSS-OFDM, 48 Mbps, 90pc duty cycle)	WLAN	8.35	± 9.6 %
10582	AAA	IEEE 802.11g WiFi 2.4 GHz (DSSS-OFDM, 54 Mbps, 90pc duty cycle)	WLAN	8.67	± 9.6 %
10583	AAB	IEEE 802.11a/h WiFi 5 GHz (OFDM, 6 Mbps, 90pc duty cycle)	WLAN	8.59	± 9.6 %
10584	AAB	IEEE 802.11a/h WiFi 5 GHz (OFDM, 9 Mbps, 90pc duty cycle)	WLAN	8.60	± 9.6 %
10585	AAB	IEEE 802.11a/h WiFi 5 GHz (OFDM, 12 Mbps, 90pc duty cycle)	WLAN	8.70	± 9.6 %
10586	AAB	IEEE 802.11a/h WiFi 5 GHz (OFDM, 18 Mbps, 90pc duty cycle)	WLAN	8.49	± 9.6 %
10587	AAB	IEEE 802.11a/h WiFi 5 GHz (OFDM, 24 Mbps, 90pc duty cycle)	WLAN	8.36	± 9.6 %

10588	AAB	IEEE 802.11a/h WiFi 5 GHz (OFDM, 36 Mbps, 90pc duty cycle)	WLAN	8.76	± 9.6 %
10589	AAB	IEEE 802.11a/h WiFi 5 GHz (OFDM, 48 Mbps, 90pc duty cycle)	WLAN	8.35	± 9.6 %
10590	AAB	IEEE 802.11a/h WiFi 5 GHz (OFDM, 54 Mbps, 90pc duty cycle)	WLAN	8.67	± 9.6 %
10591	AAB	IEEE 802.11n (HT Mixed, 20MHz, MCS0, 90pc duty cycle)	WLAN	8.63	± 9.6 %
10592	AAB	IEEE 802.11n (HT Mixed, 20MHz, MCS1, 90pc duty cycle)	WLAN	8.79	± 9.6 %
10593	AAB	IEEE 802.11n (HT Mixed, 20MHz, MCS2, 90pc duty cycle)	WLAN	8.64	± 9.6 %
10594	AAB	IEEE 802.11n (HT Mixed, 20MHz, MCS3, 90pc duty cycle)	WLAN	8.74	± 9.6 %
10595	AAB	IEEE 802.11n (HT Mixed, 20MHz, MCS4, 90pc duty cycle)	WLAN	8.74	± 9.6 %
10596	AAB	IEEE 802.11n (HT Mixed, 20MHz, MCS5, 90pc duty cycle)	WLAN	8.71	± 9.6 %
10597	AAB	IEEE 802.11n (HT Mixed, 20MHz, MCS6, 90pc duty cycle)	WLAN	8.72	± 9.6 %
10598	AAB	IEEE 802.11n (HT Mixed, 20MHz, MCS7, 90pc duty cycle)	WLAN	8.50	± 9.6 %
10599	AAB	IEEE 802.11n (HT Mixed, 40MHz, MCS0, 90pc duty cycle)	WLAN	8.79	± 9.6 %
10600	AAB	IEEE 802.11n (HT Mixed, 40MHz, MCS1, 90pc duty cycle)	WLAN	8.88	± 9.6 %
10601	AAB	IEEE 802.11n (HT Mixed, 40MHz, MCS2, 90pc duty cycle)	WLAN	8.82	± 9.6 %
10602	AAB	IEEE 802.11n (HT Mixed, 40MHz, MCS3, 90pc duty cycle)	WLAN	8.94	± 9.6 %
10603	AAB	IEEE 802.11n (HT Mixed, 40MHz, MCS4, 90pc duty cycle)	WLAN	9.03	± 9.6 %
10604	AAB	IEEE 802.11n (HT Mixed, 40MHz, MCS5, 90pc duty cycle)	WLAN	8.76	± 9.6 %
10605	AAB	IEEE 802.11n (HT Mixed, 40MHz, MCS6, 90pc duty cycle)	WLAN	8.97	± 9.6 %
10606	AAB	IEEE 802.11n (HT Mixed, 40MHz, MCS7, 90pc duty cycle)	WLAN	8.82	± 9.6 %
10607	AAB	IEEE 802.11ac WiFi (20MHz, MCS0, 90pc duty cycle)	WLAN	8.64	± 9.6 %
10608	AAB	IEEE 802.11ac WiFi (20MHz, MCS1, 90pc duty cycle)	WLAN	8.77	± 9.6 %
10609	AAB	IEEE 802.11ac WiFi (20MHz, MCS2, 90pc duty cycle)	WLAN	8.57	± 9.6 %
10610	AAB	IEEE 802.11ac WiFi (20MHz, MCS3, 90pc duty cycle)	WLAN	8.78	± 9.6 %
10611	AAB	IEEE 802.11ac WiFi (20MHz, MCS4, 90pc duty cycle)	WLAN	8.70	± 9.6 %
10612	AAB	IEEE 802.11ac WiFi (20MHz, MCS5, 90pc duty cycle)	WLAN	8.77	± 9.6 %
10613	AAB	IEEE 802.11ac WiFi (20MHz, MCS6, 90pc duty cycle)	WLAN	8.94	± 9.6 %
10614	AAB	IEEE 802.11ac WiFi (20MHz, MCS7, 90pc duty cycle)	WLAN	8.59	± 9.6 %
10615	AAB	IEEE 802.11ac WiFi (20MHz, MCS8, 90pc duty cycle)	WLAN	8.82	± 9.6 %
10616	AAB	IEEE 802.11ac WiFi (40MHz, MCS0, 90pc duty cycle)	WLAN	8.82	± 9.6 %
10617	AAB	IEEE 802.11ac WiFi (40MHz, MCS1, 90pc duty cycle)	WLAN	8.81	± 9.6 %
10618	AAB	IEEE 802.11ac WiFi (40MHz, MCS2, 90pc duty cycle)	WLAN	8.58	± 9.6 %
10619	AAB	IEEE 802.11ac WiFi (40MHz, MCS3, 90pc duty cycle)	WLAN	8.86	± 9.6 %
10620	AAB	IEEE 802.11ac WiFi (40MHz, MCS4, 90pc duty cycle)	WLAN	8.87	± 9.6 %
10621	AAB	IEEE 802.11ac WiFi (40MHz, MCS5, 90pc duty cycle)	WLAN	8.77	± 9.6 %
10622	AAB	IEEE 802.11ac WiFi (40MHz, MCS6, 90pc duty cycle)	WLAN	8.68	± 9.6 %
10623	AAB	IEEE 802.11ac WiFi (40MHz, MCS7, 90pc duty cycle)	WLAN	8.82	± 9.6 %
10624	AAB	IEEE 802.11ac WiFi (40MHz, MCS8, 90pc duty cycle)	WLAN	8.96	± 9.6 %
10625	AAB	IEEE 802.11ac WiFi (40MHz, MCS9, 90pc duty cycle)	WLAN	8.96	± 9.6 %
10626	AAB	IEEE 802.11ac WiFi (80MHz, MCS0, 90pc duty cycle)	WLAN	8.83	± 9.6 %
10627	AAB	IEEE 802.11ac WiFi (80MHz, MCS1, 90pc duty cycle)	WLAN	8.88	± 9.6 %
10628	AAB	IEEE 802.11ac WiFi (80MHz, MCS2, 90pc duty cycle)	WLAN	8.71	± 9.6 %
10629	AAB	IEEE 802.11ac WiFi (80MHz, MCS3, 90pc duty cycle)	WLAN	8.85	± 9.6 %
10630	AAB	IEEE 802.11ac WiFi (80MHz, MCS4, 90pc duty cycle)	WLAN	8.72	± 9.6 %
10631	AAB	IEEE 802.11ac WiFi (80MHz, MCS5, 90pc duty cycle)	WLAN	8.81	± 9.6 %
10632	AAB	IEEE 802.11ac WiFi (80MHz, MCS6, 90pc duty cycle)	WLAN	8.74	± 9.6 %
10633	AAB	IEEE 802.11ac WiFi (80MHz, MCS7, 90pc duty cycle)	WLAN	8.83	± 9.6 %
10634	AAB	IEEE 802.11ac WiFi (80MHz, MCS8, 90pc duty cycle)	WLAN	8.80	± 9.6 %
10635	AAB	IEEE 802.11ac WiFi (80MHz, MCS9, 90pc duty cycle)	WLAN	8.81	± 9.6 %
10636	AAC	IEEE 802.11ac WiFi (160MHz, MCS0, 90pc duty cycle)	WLAN	8.83	± 9.6 %
10637	AAC	IEEE 802.11ac WiFi (160MHz, MCS1, 90pc duty cycle)	WLAN	8.79	± 9.6 %
10638	AAC	IEEE 802.11ac WiFi (160MHz, MCS2, 90pc duty cycle)	WLAN	8.86	± 9.6 %
10639	AAC	IEEE 802.11ac WiFi (160MHz, MCS3, 90pc duty cycle)	WLAN	8.85	± 9.6 %
10640	AAC	IEEE 802.11ac WiFi (160MHz, MCS4, 90pc duty cycle)	WLAN	8.98	± 9.6 %
10641	AAC	IEEE 802.11ac WiFi (160MHz, MCS5, 90pc duty cycle)	WLAN	9.06	± 9.6 %
10642	AAC	IEEE 802.11ac WiFi (160MHz, MCS6, 90pc duty cycle)	WLAN	9.06	± 9.6 %
10643	AAC	IEEE 802.11ac WiFi (160MHz, MCS7, 90pc duty cycle)	WLAN	8.89	± 9.6 %
10644	AAC	IEEE 802.11ac WiFi (160MHz, MCS8, 90pc duty cycle)	WLAN	9.05	± 9.6 %
10645	AAC	IEEE 802.11ac WiFi (160MHz, MCS9, 90pc duty cycle)	WLAN	9.11	± 9.6 %
10646	AAF	LTE-TDD (SC-FDMA, 1 RB, 5 MHz, QPSK, UL Subframe=2,7)	LTE-TDD	11.96	± 9.6 %
10647	AAF	LTE-TDD (SC-FDMA, 1 RB, 20 MHz, QPSK, UL Subframe=2,7)	LTE-TDD	11.96	± 9.6 %
10648	AAA	CDMA2000 (1x Advanced)	CDMA2000	3.45	± 9.6 %
10652	AAD	LTE-TDD (OFDMA, 5 MHz, E-TM 3.1, Clipping 44%)	LTE-TDD	6.91	± 9.6 %
10653	AAD	LTE-TDD (OFDMA, 10 MHz, E-TM 3.1, Clipping 44%)	LTE-TDD	7.42	± 9.6 %
10654	AAD	LTE-TDD (OFDMA, 15 MHz, E-TM 3.1, Clipping 44%)	LTE-TDD	6.96	± 9.6 %

10655	AAE	LTE-TDD (OFDMA, 20 MHz, E-TM 3.1, Clipping 44%)	LTE-TDD	7.21	± 9.6 %
10658	AAA	Pulse Waveform (200Hz, 10%)	Test	10.00	± 9.6 %
10659	AAA	Pulse Waveform (200Hz, 20%)	Test	6.99	± 9.6 %
10660	AAA	Pulse Waveform (200Hz, 40%)	Test	3.98	± 9.6 %
10661	AAA	Pulse Waveform (200Hz, 60%)	Test	2.22	± 9.6 %
10662	AAA	Pulse Waveform (200Hz, 80%)	Test	0.97	± 9.6 %
10670	AAA	Bluetooth Low Energy	Bluetooth	2.19	± 9.6 %

^E Uncertainty is determined using the max. deviation from linear response applying rectangular distribution and is expressed for the square of the field value.



Accredited by the Swiss Accreditation Service (SAS)
The Swiss Accreditation Service is one of the signatories to the EA
Multilateral Agreement for the recognition of calibration certificates

Accreditation No.: **SCS 0108**

Client **PC-Test**

Certificate No: **EX3-7308_Aug18**

CALIBRATION CERTIFICATE

Object: **EX3DV4 - SN:7308**

Calibration procedure(s): **QA CAL-01.v9, QA CAL-14.v4, QA CAL-23.v5, QA CAL-25.v6
Calibration procedure for dosimetric E-field probes**

Calibration date: **August 23, 2018**

*BN ✓
09-06-2018*

This calibration certificate documents the traceability to national standards, which realize the physical units of measurements (SI).
The measurements and the uncertainties with confidence probability are given on the following pages and are part of the certificate.

All calibrations have been conducted in the closed laboratory facility: environment temperature (22 ± 3)°C and humidity < 70%.

Calibration Equipment used (M&TE critical for calibration)

Primary Standards	ID	Cal Date (Certificate No.)	Scheduled Calibration
Power meter NRP	SN: 104778	04-Apr-18 (No. 217-02672/02673)	Apr-19
Power sensor NRP-Z91	SN: 103244	04-Apr-18 (No. 217-02672)	Apr-19
Power sensor NRP-Z91	SN: 103245	04-Apr-18 (No. 217-02673)	Apr-19
Reference 20 dB Attenuator	SN: S5277 (20x)	04-Apr-18 (No. 217-02682)	Apr-19
Reference Probe ES3DV2	SN: 3013	30-Dec-17 (No. ES3-3013_Dec17)	Dec-18
DAE4	SN: 660	21-Dec-17 (No. DAE4-660_Dec17)	Dec-18
Secondary Standards	ID	Check Date (in house)	Scheduled Check
Power meter E4419B	SN: GB41293874	06-Apr-16 (in house check Jun-18)	In house check: Jun-20
Power sensor E4412A	SN: MY41498087	06-Apr-16 (in house check Jun-18)	In house check: Jun-20
Power sensor E4412A	SN: 000110210	06-Apr-16 (in house check Jun-18)	In house check: Jun-20
RF generator HP 8648C	SN: US3642U01700	04-Aug-99 (in house check Jun-18)	In house check: Jun-20
Network Analyzer E8358A	SN: US41080477	31-Mar-14 (in house check Oct-17)	In house check: Oct-18

Calibrated by: **Jeton Kastrati** (Name), **Laboratory Technician** (Function), [Signature]

Approved by: **Katja Pokovic** (Name), **Technical Manager** (Function), [Signature]

This calibration certificate shall not be reproduced except in full without written approval of the laboratory. Issued: August 24, 2018