



SAR EVALUATION REPORT

Applicant Name:
 LG Electronics MobileComm U.S.A., Inc.
 1000 Sylvan Avenue
 Englewood Cliffs, NJ 07632
 United States

Date of Testing:
 07/08/18 - 07/16/18
Test Site/Location:
 PCTEST Lab, Columbia, MD, USA
Document Serial No.:
 1M1806270133-01-R1.ZNF

FCC ID: ZNFX410PM

APPLICANT: LG ELECTRONICS MOBILECOMM U.S.A., INC.

DUT Type: Portable Handset
Application Type: Class II Permissive Change
FCC Rule Part(s): CFR §2.1093
Model: LM-X410PM
Additional Model(s): LMX410PM, X410PM
Permissive Change(s): See FCC Change Document

Equipment Class	Band & Mode	Tx Frequency	SAR		
			1g Head (W/kg)	1g Body-Worn (W/kg)	1g Hotspot (W/kg)
PCE	CDMA/EVDO BC10 (§90S)	817.90 - 823.10 MHz	0.48	0.71	0.75
PCE	CDMA/EVDO BC0 (§22H)	824.70 - 848.31 MHz	0.53	0.66	0.69
PCE	GSM/GPRS/EDGE 850	824.20 - 848.80 MHz	0.59	0.83	0.83
PCE	UMTS 850	826.40 - 846.60 MHz	0.51	0.65	0.65
PCE	UMTS 1750	1712.4 - 1752.6 MHz	0.46	0.89	0.89
PCE	PCS CDMA/EVDO	1851.25 - 1908.75 MHz	0.69	0.80	0.85
PCE	GSM/GPRS/EDGE 1900	1850.20 - 1909.80 MHz	0.39	0.40	0.40
PCE	UMTS 1900	1852.4 - 1907.6 MHz	0.64	0.78	0.78
PCE	LTE Band 12	699.7 - 715.3 MHz	0.38	0.52	0.56
PCE	LTE Band 13	779.5 - 784.5 MHz	0.42	0.64	0.72
PCE	LTE Band 26 (Cell)	814.7 - 848.3 MHz	0.56	0.69	0.70
PCE	LTE Band 5 (Cell)	824.7 - 848.3 MHz	N/A	N/A	N/A
PCE	LTE Band 4 (AWS)	1710.7 - 1754.3 MHz	0.64	1.14	1.14
PCE	LTE Band 25 (PCS)	1850.7 - 1914.3 MHz	0.79	1.06	1.06
PCE	LTE Band 2 (PCS)	1850.7 - 1909.3 MHz	N/A	N/A	N/A
PCE	LTE Band 41	2498.5 - 2687.5 MHz	0.71	1.11	1.11
DTS	2.4 GHz WLAN	2412 - 2462 MHz	1.08	0.28	0.28
NII	U-NII-1	5180 - 5240 MHz	N/A	N/A	0.91
NII	U-NII-2A	5260 - 5320 MHz	1.01	0.38	N/A
NII	U-NII-2C	5500 - 5720 MHz	1.11	0.34	N/A
NII	U-NII-3	5745 - 5825 MHz	1.13	0.35	0.84
DSS/DTS	Bluetooth	2402 - 2480 MHz	0.37	N/A	N/A
Simultaneous SAR per KDB 690783 D01v01r03:			1.59	1.52	1.57

Note: This revised Test Report (S/N: 1M1806270133-01-R1.ZNF) supersedes and replaces the previously issued test report on the same subject device for the same type of testing as indicated. Please discard or destroy the previously issued test report(s) and dispose of it accordingly.

This wireless portable device has been shown to be capable of compliance for localized specific absorption rate (SAR) for uncontrolled environment/general population exposure limits specified in ANSI/IEEE C95.1-1992 and has been tested in accordance with the measurement procedures specified in Section 1.7 of this report; for North American frequency bands only.

I attest to the accuracy of data. All measurements reported herein were performed by me or were made under my supervision and are correct to the best of my knowledge and belief. I assume full responsibility for the completeness of these measurements and vouch for the qualifications of all persons taking them. Test results reported herein relate only to the item(s) tested.

Randy Ortanez
 President





The SAR Tick is an initiative of the Mobile & Wireless Forum (MWF). While a product may be considered eligible, use of the SAR Tick logo requires an agreement with the MWF. Further details can be obtained by emailing: sartick@mwfai.info.

FCC ID: ZNFX410PM		SAR EVALUATION REPORT		Approved by: Quality Manager
Document S/N: 1M1806270133-01-R1.ZNF	Test Dates: 07/08/18 - 07/16/18	DUT Type: Portable Handset		Page 1 of 95

TABLE OF CONTENTS

1	DEVICE UNDER TEST	3
2	LTE INFORMATION	11
3	INTRODUCTION	12
4	DOSIMETRIC ASSESSMENT	13
5	DEFINITION OF REFERENCE POINTS.....	14
6	TEST CONFIGURATION POSITIONS.....	15
7	RF EXPOSURE LIMITS	18
8	FCC MEASUREMENT PROCEDURES.....	19
9	RF CONDUCTED POWERS	26
10	SYSTEM VERIFICATION.....	50
11	SAR DATA SUMMARY	53
12	FCC MULTI-TX AND ANTENNA SAR CONSIDERATIONS.....	72
13	SAR MEASUREMENT VARIABILITY	88
14	ADDITIONAL TESTING PER FCC GUIDANCE	89
15	EQUIPMENT LIST.....	91
16	MEASUREMENT UNCERTAINTIES.....	92
17	CONCLUSION.....	93
18	REFERENCES	94
APPENDIX A:	SAR TEST PLOTS	
APPENDIX B:	SAR DIPOLE VERIFICATION PLOTS	
APPENDIX C:	PROBE AND DIPOLE CALIBRATION CERTIFICATES	
APPENDIX D:	SAR TISSUE SPECIFICATIONS	
APPENDIX E:	SAR SYSTEM VALIDATION	
APPENDIX F:	DUT ANTENNA DIAGRAM & SAR TEST SETUP PHOTOGRAPHS	
APPENDIX G:	POWER REDUCTION VERIFICATION	

FCC ID: ZNFX410PM	 PCTEST <small>ENGINEERING LABORATORY, INC.</small>	SAR EVALUATION REPORT		Approved by: Quality Manager
Document S/N: 1M1806270133-01-R1.ZNF	Test Dates: 07/08/18 - 07/16/18	DUT Type: Portable Handset	Page 2 of 95	

1 DEVICE UNDER TEST

1.1 Device Overview



Band & Mode	Operating Modes	Tx Frequency
CDMA/EVDO BC10 (§90S)	Voice/Data	817.90 - 823.10 MHz
CDMA/EVDO BC0 (§22H)	Voice/Data	824.70 - 848.31 MHz
GSM/GPRS/EDGE 850	Voice/Data	824.20 - 848.80 MHz
UMTS 850	Voice/Data	826.40 - 846.60 MHz
UMTS 1750	Voice/Data	1712.4 - 1752.6 MHz
PCS CDMA/EVDO	Voice/Data	1851.25 - 1908.75 MHz
GSM/GPRS/EDGE 1900	Voice/Data	1850.20 - 1909.80 MHz
UMTS 1900	Voice/Data	1852.4 - 1907.6 MHz
LTE Band 12	Data	699.7 - 715.3 MHz
LTE Band 13	Data	779.5 - 784.5 MHz
LTE Band 26 (Cell)	Data	814.7 - 848.3 MHz
LTE Band 5 (Cell)	Data	824.7 - 848.3 MHz
LTE Band 4 (AWS)	Data	1710.7 - 1754.3 MHz
LTE Band 25 (PCS)	Data	1850.7 - 1914.3 MHz
LTE Band 2 (PCS)	Data	1850.7 - 1909.3 MHz
LTE Band 41	Data	2498.5 - 2687.5 MHz
2.4 GHz WLAN	Voice/Data	2412 - 2462 MHz
U-NII-1	Voice/Data	5180 - 5240 MHz
U-NII-2A	Voice/Data	5260 - 5320 MHz
U-NII-2C	Voice/Data	5500 - 5720 MHz
U-NII-3	Voice/Data	5745 - 5825 MHz
Bluetooth	Data	2402 - 2480 MHz

1.2 Power Reduction for SAR

This device uses an independent fixed level power reduction mechanism for WLAN operations during voice or VoIP held to ear scenarios. Per FCC Guidance, the held-to-ear exposure conditions were evaluated at reduced power according to the head SAR positions described in IEEE 1528-2013. Detailed descriptions of the power reduction mechanism are included in the operational description.

1.3 Nominal and Maximum Output Power Specifications

This device operates using the following maximum and nominal output power specifications. SAR values were scaled to the maximum allowed power to determine compliance per KDB Publication 447498 D01v06.



FCC ID: ZNFX410PM	 PCTEST ENGINEERING LABORATORY, INC.	SAR EVALUATION REPORT	 LG	Approved by: Quality Manager
Document S/N: 1M1806270133-01-R1.ZNF	Test Dates: 07/08/18 - 07/16/18	DUT Type: Portable Handset	Page 3 of 95	

1.3.1 Maximum PCE Power

Mode / Band		Voice (dBm)	Burst Average GMSK (dBm)		Burst Average 8-PSK (dBm)	
		1 TX Slot	1 TX Slots	2 TX Slots	1 TX Slots	2 TX Slots
GSM/GPRS/EDGE 850	Maximum	33.7	33.7	31.7	27.7	26.7
	Nominal	33.2	33.2	31.2	27.2	26.2
GSM/GPRS/EDGE 1900	Maximum	30.7	30.7	28.7	26.2	25.7
	Nominal	30.2	30.2	28.2	25.7	25.2

Mode / Band		Modulated Average (dBm)		
		3GPP WCDMA	3GPP HSDPA	3GPP HSUPA
UMTS Band 5 (850 MHz)	Maximum	24.7	24.7	24.7
	Nominal	24.2	24.2	24.2
UMTS Band 4 (1750 MHz)	Maximum	24.7	24.7	24.7
	Nominal	24.2	24.2	24.2
UMTS Band 2 (1900 MHz)	Maximum	24.7	24.7	24.7
	Nominal	24.2	24.2	24.2



Mode / Band		Modulated Average (dBm)
CDMA/EVDO BC10 (\$90S)	Maximum	25.2
	Nominal	24.7
CDMA/EVDO BC0 (\$22H)	Maximum	25.2
	Nominal	24.7
PCS CDMA/EVDO	Maximum	25.2
	Nominal	24.7

FCC ID: ZNFX410PM	 PCTEST ENGINEERING LABORATORY, INC.	SAR EVALUATION REPORT	 LG	Approved by: Quality Manager
Document S/N: 1M1806270133-01-R1.ZNF	Test Dates: 07/08/18 - 07/16/18	DUT Type: Portable Handset		Page 4 of 95

Mode / Band		Modulated Average (dBm)
LTE Band 12	Maximum	25.2
	Nominal	24.7
LTE Band 13	Maximum	25.2
	Nominal	24.7
LTE Band 26 (Cell)	Maximum	25.2
	Nominal	24.7
LTE Band 5 (Cell)	Maximum	25.2
	Nominal	24.7
LTE Band 4 (AWS)	Maximum	25.2
	Nominal	24.7
LTE Band 25 (PCS)	Maximum	25.2
	Nominal	24.7
LTE Band 2 (PCS)	Maximum	25.2
	Nominal	24.7
LTE Band 41 PC3	Maximum	25.2
	Nominal	24.7
LTE Band 41 PC2	Maximum	27.7
	Nominal	27.2

1.3.2 Maximum Bluetooth and WLAN Power

Mode / Band		Modulated Average (dBm)		
		Ch. 1	Ch. 2-10	Ch. 11
IEEE 802.11b (2.4 GHz)	Maximum	19.0		
	Nominal	18.0		
IEEE 802.11g (2.4 GHz)	Maximum	14.5	16.5	14.5
	Nominal	13.5	15.5	13.5
IEEE 802.11n (2.4 GHz)	Maximum	14.5	16.5	14.5
	Nominal	13.5	15.5	13.5

FCC ID: ZNFX410PM	 PCTEST ENGINEERING LABORATORY, INC.	SAR EVALUATION REPORT	 LG	Approved by: Quality Manager
Document S/N: 1M1806270133-01-R1.ZNF	Test Dates: 07/08/18 - 07/16/18	DUT Type: Portable Handset	Page 5 of 95	



Mode / Band		Modulated Average (dBm)
Bluetooth	Maximum	10.0
	Nominal	9.0
Bluetooth LE	Maximum	4.0
	Nominal	3.0

Mode / Band		Modulated Average (dBm)					
		20 MHz Bandwidth			40 MHz Bandwidth		80 MHz Bandwidth
		Ch. 36, 64, 100, 165	Ch. 40-60	Ch. 104-161	Ch. 38, 62, 102, 159	Ch. 46, 54, 110-151	
IEEE 802.11a (5 GHz)	Maximum	16.0	18.0	19.0			
	Nominal	15.0	17.0	18.0			
IEEE 802.11n (5 GHz)	Maximum	16.0	18.0	19.0	14.0	16.3	
	Nominal	15.0	17.0	18.0	13.0	15.3	
IEEE 802.11ac (5 GHz)	Maximum	13.5			10.3		9.3
	Nominal	12.5			9.3		8.3

1.3.3 Reduced WLAN Power

Mode / Band		Modulated Average (dBm)		
		Ch. 1	Ch. 2-10	Ch. 11
IEEE 802.11b (2.4 GHz)	Maximum	16.5		
	Nominal	15.5		
IEEE 802.11g (2.4 GHz)	Maximum	14.5	16.5	14.5
	Nominal	13.5	15.5	13.5
IEEE 802.11n (2.4 GHz)	Maximum	14.5	16.5	14.5
	Nominal	13.5	15.5	13.5

Mode / Band		Modulated Average (dBm)		
		20 MHz Bandwidth	40 MHz Bandwidth	80 MHz Bandwidth
IEEE 802.11a (5 GHz)	Maximum	11.3		
	Nominal	10.3		
IEEE 802.11n (5 GHz)	Maximum	11.3	11.3	
	Nominal	10.3	10.3	
IEEE 802.11ac (5 GHz)	Maximum	11.3	10.3	9.3
	Nominal	10.3	9.3	8.3

FCC ID: ZNFX410PM	 PCTEST ENGINEERING LABORATORY, INC.	SAR EVALUATION REPORT		Approved by: Quality Manager
Document S/N: 1M1806270133-01-R1.ZNF	Test Dates: 07/08/18 - 07/16/18	DUT Type: Portable Handset		Page 6 of 95

1.4 DUT Antenna Locations

The overall dimensions of this device are > 9 x 5 cm. The overall diagonal dimension of the device is ≤160 mm and the diagonal display is ≤150 mm. A diagram showing the location of the device antennas can be found in Appendix F.

**Table 1-1
Device Edges/Sides for SAR Testing**



Mode	Back	Front	Top	Bottom	Right	Left
EVDO BC10 (§90S)	Yes	Yes	No	Yes	Yes	Yes
EVDO BC0 (§22H)	Yes	Yes	No	Yes	Yes	Yes
GPRS 850	Yes	Yes	No	Yes	Yes	Yes
UMTS 850	Yes	Yes	No	Yes	Yes	Yes
UMTS 1750	Yes	Yes	No	Yes	No	Yes
PCS EVDO	Yes	Yes	No	Yes	No	Yes
GPRS 1900	Yes	Yes	No	Yes	No	Yes
UMTS 1900	Yes	Yes	No	Yes	No	Yes
LTE Band 12	Yes	Yes	No	Yes	Yes	Yes
LTE Band 13	Yes	Yes	No	Yes	Yes	Yes
LTE Band 26 (Cell)	Yes	Yes	No	Yes	Yes	Yes
LTE Band 4 (AWS)	Yes	Yes	No	Yes	No	Yes
LTE Band 25 (PCS)	Yes	Yes	No	Yes	No	Yes
LTE Band 41	Yes	Yes	No	Yes	No	Yes
2.4 GHz WLAN	Yes	Yes	Yes	No	No	Yes
5 GHz WLAN	Yes	Yes	Yes	No	No	Yes

Note: Particular DUT edges were not required to be evaluated for wireless router SAR if the edges were greater than 2.5 cm from the transmitting antenna according to FCC KDB Publication 941225 D06v02r01 Section III. The distances between the transmit antennas and the edges of the device are included in the filing.

1.5 Simultaneous Transmission Capabilities

According to FCC KDB Publication 447498 D01v06, transmitters are considered to be transmitting simultaneously when there is overlapping transmission, with the exception of transmissions during network hand-offs with maximum hand-off duration less than 30 seconds.

This device contains multiple transmitters that may operate simultaneously, and therefore requires a simultaneous transmission analysis according to FCC KDB Publication 447498 D01v06 4.3.2 procedures.

FCC ID: ZNFX410PM	 PCTEST ENGINEERING LABORATORY, INC.	SAR EVALUATION REPORT		Approved by: Quality Manager
Document S/N: 1M1806270133-01-R1.ZNF	Test Dates: 07/08/18 - 07/16/18	DUT Type: Portable Handset	Page 7 of 95	

**Table 1-2
Simultaneous Transmission Scenarios**



No.	Capable Transmit Configuration	Head	Body-Worn Accessory	Wireless Router	Notes
1	1x CDMA voice + 2.4 GHz WI-FI	Yes	Yes	N/A	
2	1x CDMA voice + 5 GHz WI-FI	Yes	Yes	N/A	
3	1x CDMA voice + 2.4 GHz Bluetooth	Yes^	Yes	N/A	^ Bluetooth Tethering is considered
4	GSM voice + 2.4 GHz WI-FI	Yes	Yes	N/A	
5	GSM voice + 5 GHz WI-FI	Yes	Yes	N/A	
6	GSM voice + 2.4 GHz Bluetooth	Yes^	Yes	N/A	^ Bluetooth Tethering is considered
7	UMTS + 2.4 GHz WI-FI	Yes	Yes	Yes	
8	UMTS + 5 GHz WI-FI	Yes	Yes	Yes	
9	UMTS + 2.4 GHz Bluetooth	Yes^	Yes	Yes^	^ Bluetooth Tethering is considered
10	LTE + 2.4 GHz WI-FI	Yes*	Yes*	Yes	* Pre-installed VOIP applications are considered
11	LTE + 5 GHz WI-FI	Yes*	Yes*	Yes	* Pre-installed VOIP applications are considered
12	LTE + 2.4 GHz Bluetooth	Yes*^	Yes*	Yes^	* Pre-installed VOIP applications are considered ^ Bluetooth Tethering is considered
13	CDMA/EVDO data + 2.4 GHz WI-FI	Yes*	Yes*	Yes	* Pre-installed VOIP applications are considered
14	CDMA/EVDO data + 5 GHz WI-FI	Yes*	Yes*	Yes	* Pre-installed VOIP applications are considered
15	CDMA/EVDO data + 2.4 GHz Bluetooth	Yes*^	Yes*	Yes^	* Pre-installed VOIP applications are considered ^ Bluetooth Tethering is considered
16	GPRS/EDGE + 2.4 GHz WI-FI	Yes*	Yes*	Yes	* Pre-installed VOIP applications are considered
17	GPRS/EDGE + 5 GHz WI-FI	Yes*	Yes*	Yes	* Pre-installed VOIP applications are considered
18	GPRS/EDGE + 2.4 GHz Bluetooth	Yes*^	Yes*	Yes^	* Pre-installed VOIP applications are considered ^ Bluetooth Tethering is considered

- 2.4 GHz WLAN, 5 GHz WLAN, and 2.4 GHz Bluetooth share the same antenna path and cannot transmit simultaneously.
- All licensed modes share the same antenna path and cannot transmit simultaneously.
- When the user utilizes multiple services in UMTS 3G mode it uses multi-Radio Access Bearer or multi-RAB. The power control is based on a physical control channel (Dedicated Physical Control Channel [DPCCH]) and power control will be adjusted to meet the needs of both services. Therefore, the UMTS+WLAN scenario also represents the UMTS Voice/DATA + WLAN Hotspot scenario.
- Per the manufacturer, WIFI Direct is expected to be used in conjunction with a held-to-ear or body-worn accessory voice call. Therefore, the simultaneous transmission scenarios involving WIFI are listed in the above table.
- 5 GHz Wireless Router is only supported for the U-NII-1 and U-NII-3 by S/W, therefore U-NII2A, and U-NII2C were not evaluated for wireless router conditions.
- This device supports VoWIFI.
- This device supports BT Tethering.

1.6 Miscellaneous SAR Test Considerations

(A) WIFI/BT

Since Wireless Router operations are not allowed by the chipset firmware using U-NII-2A & U-NII-2C WIFI, only 2.4 GHz, U-NII-1 and U-NII-3 WIFI Hotspot SAR tests and combinations are considered for SAR with respect to Wireless Router configurations according to FCC KDB 941225 D06v02r01.

FCC ID: ZNFX410PM		SAR EVALUATION REPORT		Approved by: Quality Manager
Document S/N: 1M1806270133-01-R1.ZNF	Test Dates: 07/08/18 - 07/16/18	DUT Type: Portable Handset		Page 8 of 95

Per FCC KDB 447498 D01v06, the 1g SAR exclusion threshold for distances <50mm is defined by the following equation:

$$\frac{\text{Max Power of Channel (mW)}}{\text{Test Separation Dist (mm)}} * \sqrt{\text{Frequency(GHz)}} \leq 3.0$$

Based on the maximum conducted power of Bluetooth (rounded to the nearest mW) and the antenna to user separation distance, body-worn and hotspot Bluetooth SAR was not required; $[(10/10) * \sqrt{2.480}] = 1.6 < 3.0$. Per KDB Publication 447498 D01v06, the maximum power of the channel was rounded to the nearest mW before calculation.

This device supports IEEE 802.11ac with the following features:

- a) Up to 80 MHz Bandwidth only
- b) No aggregate channel configurations
- c) 1 Tx antenna output
- d) 256 QAM is supported
- e) TDWR and Band gap channels are supported

(B) Licensed Transmitter(s)

GSM/GPRS/EDGE DTM is not supported for US bands. Therefore, the GSM Voice modes in this report do not transmit simultaneously with GPRS/EDGE Data.



This device is only capable of QPSK HSUPA in the uplink. Therefore, no additional SAR tests are required beyond that described for devices with HSUPA in KDB 941225 D01v03r01.

LTE SAR for the higher modulations and lower bandwidths were not tested since the maximum average output power of all required channels and configurations was not more than 0.5 dB higher than the highest bandwidth; and the reported LTE SAR for the highest bandwidth was less than 1.45 W/kg for all configurations according to FCC KDB 941225 D05v02r04.

This device supports LTE capabilities with overlapping transmission frequency ranges. When the supported frequency range of an LTE Band falls completely within an LTE band with a larger transmission frequency range, both LTE bands have the same target power (or the band with the larger transmission frequency range has a higher target power), and both LTE bands share the same transmission path and signal characteristics, SAR was only assessed for the band with the larger transmission frequency range.

This device supports both Power Class 2 (PC2) and Power Class 3 (PC3) for LTE Band 41. Per May 2017 TCB Workshop Notes, SAR tests were performed with Power Class 3 (given the specific UL/DL limitations for Power Class 2). Additionally, SAR testing for the power class condition was evaluated for the highest configuration in Power Class 3 for each test configuration to confirm the results were scalable linearly (See Section 14.1).

This device supports LTE Carrier Aggregation (CA) in the downlink only. All uplink communications are identical to Release 8 specifications. Per FCC KDB Publication 941225 D05A v01r02, SAR for downlink only LTE CA operations was not needed since the maximum average output power in downlink only LTE CA mode was not >0.25 dB higher than the maximum output power when downlink carrier aggregation was inactive. LTE Downlink Carrier Aggregation was fully addressed in the original filing. Per FCC Guidance, only combinations that were impacted with respect to this permissive change were additionally evaluated. Refer RF Exposure Technical Report S/N 1M1805310115-01-R3.ZNF for LTE downlink CA conducted power measurements which have been addressed per KDB 941225 D05A and April 2018 TCBC Workshop guidance.



FCC ID: ZNFX410PM	 PCTEST ENGINEERING LABORATORY, INC.	SAR EVALUATION REPORT	 LG	Approved by: Quality Manager
Document S/N: 1M1806270133-01-R1.ZNF	Test Dates: 07/08/18 - 07/16/18	DUT Type: Portable Handset		Page 9 of 95

1.7 Guidance Applied

- IEEE 1528-2013
- FCC KDB Publication 941225 D01v03r01, D05v02r04, D06v02r0, D05Av01r02 (2G/3G/4G and Hotspot)
- FCC KDB Publication 248227 D01v02r02 (SAR Considerations for 802.11 Devices)
- FCC KDB Publication 447498 D01v06 (General SAR Guidance)
- FCC KDB Publication 865664 D01v01r04, D02v01r02 (SAR Measurements up to 6 GHz)
- October 2013 TCB Workshop Notes (GPRS Testing Considerations)
- May 2017 TCB Workshop Notes (LTE Band 41 Power Class 2/3)
- April 2018 TCB Workshop Notes (LTE DL CA)

1.8 Device Serial Numbers



Several samples with identical hardware were used to support SAR testing. The manufacturer has confirmed that the device(s) tested have the same physical, mechanical and thermal characteristics and are within operational tolerances expected for production units. The serial numbers used for each test are indicated alongside the results in Section 11.

FCC ID: ZNFX410PM		SAR EVALUATION REPORT		Approved by: Quality Manager
Document S/N: 1M1806270133-01-R1.ZNF	Test Dates: 07/08/18 - 07/16/18	DUT Type: Portable Handset	Page 10 of 95	

2

LTE INFORMATION

LTE Information						
FCC ID	ZNFX410PM					
Form Factor	Portable Handset					
Frequency Range of each LTE transmission band	LTE Band 12 (699.7 - 715.3 MHz)					
	LTE Band 13 (779.5 - 784.5 MHz)					
	LTE Band 26 (Cell) (814.7 - 848.3 MHz)					
	LTE Band 5 (Cell) (824.7 - 848.3 MHz)					
	LTE Band 4 (AWS) (1710.7 - 1754.3 MHz)					
	LTE Band 25 (PCS) (1850.7 - 1914.3 MHz)					
	LTE Band 2 (PCS) (1850.7 - 1909.3 MHz)					
	LTE Band 41 (2498.5 - 2687.5 MHz)					
	Channel Bandwidths	LTE Band 12: 1.4 MHz, 3 MHz, 5 MHz, 10 MHz				
		LTE Band 13: 5 MHz, 10 MHz				
LTE Band 26 (Cell): 1.4 MHz, 3 MHz, 5 MHz, 10 MHz, 15 MHz						
LTE Band 5 (Cell): 1.4 MHz, 3 MHz, 5 MHz, 10 MHz						
LTE Band 4 (AWS): 1.4 MHz, 3 MHz, 5 MHz, 10 MHz, 15 MHz, 20 MHz						
LTE Band 25 (PCS): 1.4 MHz, 3 MHz, 5 MHz, 10 MHz, 15 MHz, 20 MHz						
LTE Band 2 (PCS): 1.4 MHz, 3 MHz, 5 MHz, 10 MHz, 15 MHz, 20 MHz						
LTE Band 41: 5 MHz, 10 MHz, 15 MHz, 20 MHz						
Channel Numbers and Frequencies (MHz)		Low	Low-Mid	Mid	Mid-High	High
		LTE Band 12: 1.4 MHz	699.7 (23017)	707.5 (23095)	715.3 (23173)	
	LTE Band 12: 3 MHz	700.5 (23025)	707.5 (23095)	714.5 (23165)		
	LTE Band 12: 5 MHz	701.5 (23035)	707.5 (23095)	713.5 (23155)		
	LTE Band 12: 10 MHz	704 (23060)	707.5 (23095)	711 (23130)		
	LTE Band 13: 5 MHz	779.5 (23205)	782 (23230)	784.5 (23255)		
	LTE Band 13: 10 MHz	N/A	782 (23230)	N/A		
	LTE Band 26 (Cell): 1.4 MHz	814.7 (26697)	831.5 (26865)	848.3 (27033)		
	LTE Band 26 (Cell): 3 MHz	815.5 (26705)	831.5 (26865)	847.5 (27025)		
	LTE Band 26 (Cell): 5 MHz	816.5 (26715)	831.5 (26865)	846.5 (27015)		
	LTE Band 26 (Cell): 10 MHz	819 (26740)	831.5 (26865)	844 (26990)		
	LTE Band 26 (Cell): 15 MHz	821.5 (26765)	831.5 (26865)	841.5 (26965)		
	LTE Band 5 (Cell): 1.4 MHz	824.7 (20407)	836.5 (20525)	848.3 (20643)		
	LTE Band 5 (Cell): 3 MHz	825.5 (20415)	836.5 (20525)	847.5 (20635)		
	LTE Band 5 (Cell): 5 MHz	826.5 (20425)	836.5 (20525)	846.5 (20625)		
	LTE Band 5 (Cell): 10 MHz	829 (20450)	836.5 (20525)	844 (20600)		
	LTE Band 4 (AWS): 1.4 MHz	1710.7 (19957)	1732.5 (20175)	1754.3 (20393)		
	LTE Band 4 (AWS): 3 MHz	1711.5 (19965)	1732.5 (20175)	1753.5 (20385)		
	LTE Band 4 (AWS): 5 MHz	1712.5 (19975)	1732.5 (20175)	1752.5 (20375)		
	LTE Band 4 (AWS): 10 MHz	1715 (20000)	1732.5 (20175)	1750 (20350)		
	LTE Band 4 (AWS): 15 MHz	1717.5 (20025)	1732.5 (20175)	1747.5 (20325)		
	LTE Band 4 (AWS): 20 MHz	1720 (20050)	1732.5 (20175)	1745 (20300)		
	LTE Band 25 (PCS): 1.4 MHz	1850.7 (26047)	1882.5 (26365)	1914.3 (26683)		
	LTE Band 25 (PCS): 3 MHz	1851.5 (26055)	1882.5 (26365)	1913.5 (26675)		
	LTE Band 25 (PCS): 5 MHz	1852.5 (26065)	1882.5 (26365)	1912.5 (26665)		
	LTE Band 25 (PCS): 10 MHz	1855 (26090)	1882.5 (26365)	1910 (26640)		
	LTE Band 25 (PCS): 15 MHz	1857.5 (26115)	1882.5 (26365)	1907.5 (26615)		
	LTE Band 25 (PCS): 20 MHz	1860 (26140)	1882.5 (26365)	1905 (26590)		
	LTE Band 2 (PCS): 1.4 MHz	1850.7 (18607)	1880 (18900)	1909.3 (19193)		
	LTE Band 2 (PCS): 3 MHz	1851.5 (18615)	1880 (18900)	1908.5 (19185)		
	LTE Band 2 (PCS): 5 MHz	1852.5 (18625)	1880 (18900)	1907.5 (19175)		
	LTE Band 2 (PCS): 10 MHz	1855 (18650)	1880 (18900)	1905 (19150)		
	LTE Band 2 (PCS): 15 MHz	1857.5 (18675)	1880 (18900)	1902.5 (19125)		
	LTE Band 2 (PCS): 20 MHz	1860 (18700)	1880 (18900)	1900 (19100)		
	LTE Band 41: 5 MHz	2506 (39750)	2549.5 (40185)	2593 (40620)	2636.5 (41055)	2680 (41490)
	LTE Band 41: 10 MHz	2506 (39750)	2549.5 (40185)	2593 (40620)	2636.5 (41055)	2680 (41490)
	LTE Band 41: 15 MHz	2506 (39750)	2549.5 (40185)	2593 (40620)	2636.5 (41055)	2680 (41490)
	LTE Band 41: 20 MHz	2506 (39750)	2549.5 (40185)	2593 (40620)	2636.5 (41055)	2680 (41490)
UE Category	6					
Modulations Supported in UL	QPSK, 16QAM					
LTE MPR Permanently implemented per 3GPP TS 36.101 section 6.2.3-6.2.5? (manufacturer attestation to be provided)	YES					
A-MPR (Additional MPR) disabled for SAR Testing?	YES					
LTE Carrier Aggregation Possible Combinations	The technical description includes all the possible carrier aggregation combinations					
LTE Additional Information	This device does not support full CA features on 3GPP Release 11. It supports a maximum of 2 carriers in the downlink. All uplink communications are identical to the Release 8 Specifications. Uplink communications are done on the PCC. The following LTE Release 11 Features are not supported: Relay, HetNet, Enhanced MIMO, eICIC, WiFi Offloading, MDH, eMBMS, Cross-Carrier Scheduling, Enhanced SC-FDMA.					

FCC ID: ZNFX410PM		SAR EVALUATION REPORT		Approved by: Quality Manager
Document S/N: 1M1806270133-01-R1.ZNF	Test Dates: 07/08/18 - 07/16/18	DUT Type: Portable Handset	Page 11 of 95	

The FCC and Innovation, Science, and Economic Development Canada have adopted the guidelines for evaluating the environmental effects of radio frequency (RF) radiation in ET Docket 93-62 on Aug. 6, 1996 and Health Canada Safety Code 6 to protect the public and workers from the potential hazards of RF emissions due to FCC-regulated portable devices. [1]

The safety limits used for the environmental evaluation measurements are based on the criteria published by the American National Standards Institute (ANSI) for localized specific absorption rate (SAR) in IEEE/ANSI C95.1-1992 Standard for Safety Levels with Respect to Human Exposure to Radio Frequency Electromagnetic Fields, 3 kHz to 300 GHz [3] and Health Canada RF Exposure Guidelines Safety Code 6 [22]. The measurement procedure described in IEEE/ANSI C95.3-2002 Recommended Practice for the Measurement of Potentially Hazardous Electromagnetic Fields - RF and Microwave [4] is used for guidance in measuring the Specific Absorption Rate (SAR) due to the RF radiation exposure from the Equipment Under Test (EUT). These criteria for SAR evaluation are similar to those recommended by the International Committee for Non-Ionizing Radiation Protection (ICNIRP) in Biological Effects and Exposure Criteria for Radiofrequency Electromagnetic Fields,” Report No. Vol 74. SAR is a measure of the rate of energy absorption due to exposure to an RF transmitting source. SAR values have been related to threshold levels for potential biological hazards.

3.1 SAR Definition

Specific Absorption Rate is defined as the time derivative (rate) of the incremental energy (dU) absorbed by (dissipated in) an incremental mass (dm) contained in a volume element (dV) of a given density (ρ). It is also defined as the rate of RF energy absorption per unit mass at a point in an absorbing body (see Equation 3-1).

Equation 3-1
SAR Mathematical Equation

$$SAR = \frac{d}{dt} \left(\frac{dU}{dm} \right) = \frac{d}{dt} \left(\frac{dU}{\rho dv} \right)$$



SAR is expressed in units of Watts per Kilogram (W/kg).

$$SAR = \frac{\sigma \cdot E^2}{\rho}$$

where:

- σ = conductivity of the tissue-simulating material (S/m)
- ρ = mass density of the tissue-simulating material (kg/m³)
- E = Total RMS electric field strength (V/m)

NOTE: The primary factors that control rate of energy absorption were found to be the wavelength of the incident field in relation to the dimensions and geometry of the irradiated organism, the orientation of the organism in relation to the polarity of field vectors, the presence of reflecting surfaces, and whether conductive contact is made by the organism with a ground plane.[6]

FCC ID: ZNFX410PM	 PCTEST ENGINEERING LABORATORY, INC.	SAR EVALUATION REPORT	 LG	Approved by: Quality Manager
Document S/N: 1M1806270133-01-R1.ZNF	Test Dates: 07/08/18 - 07/16/18	DUT Type: Portable Handset		Page 12 of 95

4 DOSIMETRIC ASSESSMENT

4.1 Measurement Procedure

The evaluation was performed using the following procedure compliant to FCC KDB Publication 865664 D01v01r04 and IEEE 1528-2013:

1. The SAR distribution at the exposed side of the head or body was measured at a distance no greater than 5.0 mm from the inner surface of the shell. The area covered the entire dimension of the device-head and body interface and the horizontal grid resolution was determined per FCC KDB Publication 865664 D01v01r04 (See Table 4-1) and IEEE 1528-2013.
2. The point SAR measurement was taken at the maximum SAR region determined from Step 1 to enable the monitoring of SAR fluctuations/drifts during the 1g/10g cube evaluation. SAR at this fixed point was measured and used as a reference value.
3. Based on the area scan data, the peak of the region with maximum SAR was determined by spline interpolation. Around this point, a volume was assessed according to the measurement resolution and volume size requirements of FCC KDB Publication 865664 D01v01r04 (See Table 4-1) and IEEE 1528-2013. On the basis of this data set, the spatial peak SAR value was evaluated with the following procedure (see references or the DASY manual online for more details):
 - a. SAR values at the inner surface of the phantom are extrapolated from the measured values along the line away from the surface with spacing no greater than that in Table 4-1. The extrapolation was based on a least-squares algorithm. A polynomial of the fourth order was calculated through the points in the z-axis (normal to the phantom shell).
 - b. After the maximum interpolated values were calculated between the points in the cube, the SAR was averaged over the spatial volume (1g or 10g) using a 3D-Spline interpolation algorithm. The 3D-spline is composed of three one-dimensional splines with the “Not a knot” condition (in x, y, and z directions). The volume was then integrated with the trapezoidal algorithm. One thousand points (10 x 10 x 10) were obtained through interpolation, in order to calculate the averaged SAR.
 - c. All neighboring volumes were evaluated until no neighboring volume with a higher average value was found.
4. The SAR reference value, at the same location as step 2, was re-measured after the zoom scan was complete to calculate the SAR drift. If the drift deviated by more than 5%, the SAR test and drift measurements were repeated.

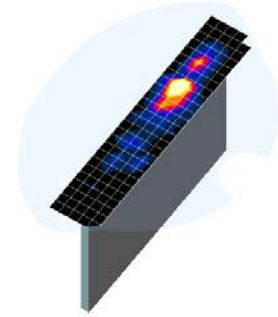



Figure 4-1
Sample SAR Area Scan

Table 4-1
Area and Zoom Scan Resolutions per FCC KDB Publication 865664 D01v01r04*

Frequency	Maximum Area Scan Resolution (mm) ($\Delta x_{area}, \Delta y_{area}$)	Maximum Zoom Scan Resolution (mm) ($\Delta x_{zoom}, \Delta y_{zoom}$)	Maximum Zoom Scan Spatial Resolution (mm)			Minimum Zoom Scan Volume (mm) (x,y,z)
			Uniform Grid	Graded Grid		
			$\Delta z_{zoom}(n)$	$\Delta z_{zoom}(1)^*$	$\Delta z_{zoom}(n>1)^*$	
≤ 2 GHz	≤ 15	≤ 8	≤ 5	≤ 4	≤ 1.5* $\Delta z_{zoom}(n-1)$	≥ 30
2-3 GHz	≤ 12	≤ 5	≤ 5	≤ 4	≤ 1.5* $\Delta z_{zoom}(n-1)$	≥ 30
3-4 GHz	≤ 12	≤ 5	≤ 4	≤ 3	≤ 1.5* $\Delta z_{zoom}(n-1)$	≥ 28
4-5 GHz	≤ 10	≤ 4	≤ 3	≤ 2.5	≤ 1.5* $\Delta z_{zoom}(n-1)$	≥ 25
5-6 GHz	≤ 10	≤ 4	≤ 2	≤ 2	≤ 1.5* $\Delta z_{zoom}(n-1)$	≥ 22

*Also compliant to IEEE 1528-2013 Table 6

FCC ID: ZNFX410PM		SAR EVALUATION REPORT		Approved by: Quality Manager
Document S/N: 1M1806270133-01-R1.ZNF	Test Dates: 07/08/18 - 07/16/18	DUT Type: Portable Handset		Page 13 of 95

5 DEFINITION OF REFERENCE POINTS

5.1 EAR REFERENCE POINT

Figure 5-2 shows the front, back and side views of the SAM Twin Phantom. The point “M” is the reference point for the center of the mouth, “LE” is the left ear reference point (ERP), and “RE” is the right ERP. The ERP is 15mm posterior to the entrance to the ear canal (EEC) along the B-M line (Back-Mouth), as shown in Figure 5-1. The plane passing through the two ear canals and M is defined as the Reference Plane. The line N-F (Neck-Front), also called the Reference Pivoting Line, is not perpendicular to the reference plane (see Figure 5-1). Line B-M is perpendicular to the N-F line. Both N-F and B-M lines are marked on the external phantom shell to facilitate handset positioning [5].

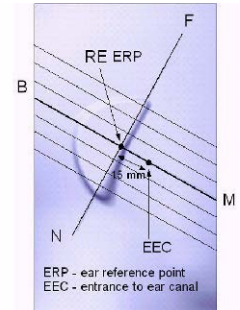

Figure 5-1
Close-Up Side view of ERP

5.2 HANDSET REFERENCE POINTS

Two imaginary lines on the handset were established: the vertical centerline and the horizontal line. The test device was placed in a normal operating position with the acoustic output located along the “vertical centerline” on the front of the device aligned to the “ear reference point” (See Figure 5-3). The acoustic output was then located at the same level as the center of the ear reference point. The test device was positioned so that the “vertical centerline” was bisecting the front surface of the handset at its top and bottom edges, positioning the “ear reference point” on the outer surface of the both the left and right head phantoms on the ear reference point.



Figure 5-2
Front, back and side view of SAM Twin Phantom

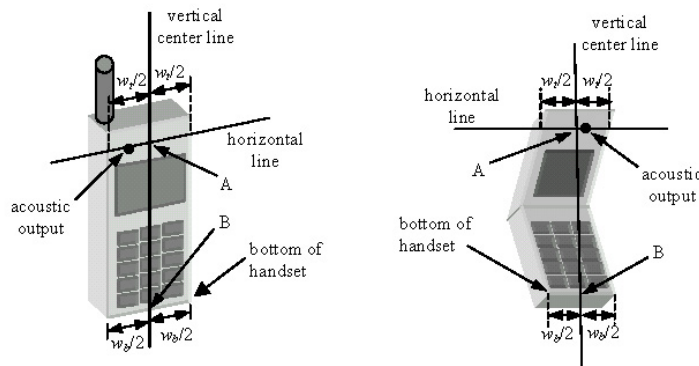



Figure 5-3
Handset Vertical Center & Horizontal Line Reference Points

FCC ID: ZNFX410PM	 PCTEST ENGINEERING LABORATORY, INC.	SAR EVALUATION REPORT	 LG	Approved by: Quality Manager
Document S/N: 1M1806270133-01-R1.ZNF	Test Dates: 07/08/18 - 07/16/18	DUT Type: Portable Handset		Page 14 of 95

6 TEST CONFIGURATION POSITIONS

6.1 Device Holder

The device holder is made out of low-loss POM material having the following dielectric parameters: relative permittivity $\epsilon = 3$ and loss tangent $\delta = 0.02$.

6.2 Positioning for Cheek

1. The test device was positioned with the device close to the surface of the phantom such that point A is on the (virtual) extension of the line passing through points RE and LE on the phantom (see Figure 6-1), such that the plane defined by the vertical center line and the horizontal line of the phone is approximately parallel to the sagittal plane of the phantom.

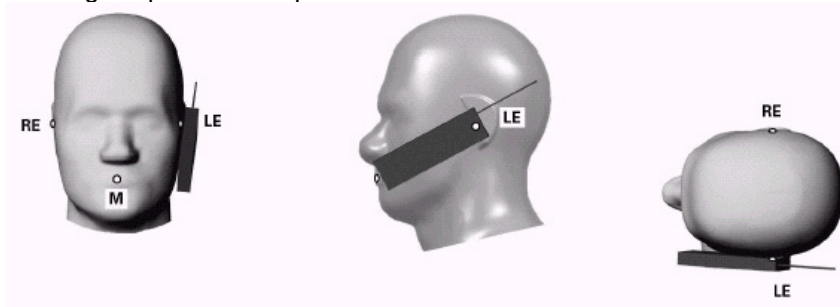



Figure 6-1 Front, Side and Top View of Cheek Position

2. The handset was translated towards the phantom along the line passing through RE & LE until the handset touches the pinna.
3. While maintaining the handset in this plane, the handset was rotated around the LE-RE line until the vertical centerline was in the reference plane.
4. The phone was then rotated around the vertical centerline until the phone (horizontal line) was symmetrical with respect to the line NF.
5. While maintaining the vertical centerline in the reference plane, keeping point A on the line passing through RE and LE, and maintaining the device contact with the ear, the device was rotated about the NF line until any point on the handset made contact with a phantom point below the ear (cheek) (See Figure 6-2).

6.3 Positioning for Ear / 15° Tilt

With the test device aligned in the “Cheek Position”:

1. While maintaining the orientation of the phone, the phone was retracted parallel to the reference plane far enough to enable a rotation of the phone by 15 degrees.
2. The phone was then rotated around the horizontal line by 15 degrees.
3. While maintaining the orientation of the phone, the phone was moved parallel to the reference plane until any part of the handset touched the head. (In this position, point A was located on the line RE-LE). The tilted position is obtained when the contact is on the pinna. If the contact was at any location other than the pinna, the angle of the phone would then be reduced. In this situation, the tilted position was obtained when any part of the phone was in contact of the ear as well as a second part of the phone was in contact with the head (see Figure 6-2).

FCC ID: ZNFX410PM	 PCTEST ENGINEERING LABORATORY, INC.	SAR EVALUATION REPORT	 LG	Approved by: Quality Manager
Document S/N: 1M1806270133-01-R1.ZNF	Test Dates: 07/08/18 - 07/16/18	DUT Type: Portable Handset		Page 15 of 95

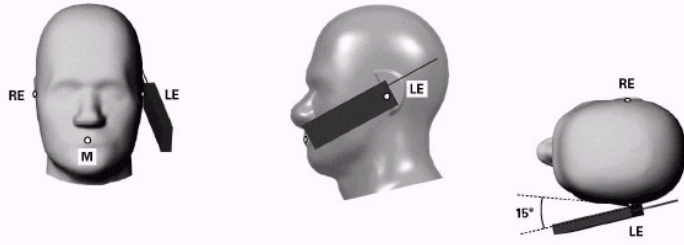

Figure 6-2 Front, Side and Top View of Ear/15° Tilt Position

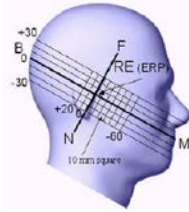

Figure 6-3 Side view w/ relevant markings

6.4 SAR Evaluations near the Mouth/Jaw Regions of the SAM Phantom

Antennas located near the bottom of a phone may require SAR measurements around the mouth and jaw regions of the SAM head phantom. This typically applies to clam-shell style phones that are generally longer in the unfolded normal use positions or to certain older style long rectangular phones. Per IEEE 1528-2013, a rotated SAM phantom is necessary to allow probe access to such regions. Both SAM heads of the TwinSAM-Chin20 are rotated 20 degrees around the NF line. Each head can be removed from the table for emptying and cleaning.

Under these circumstances, the following procedures apply, adopted from the FCC guidance on SAR handsets document FCC KDB Publication 648474 D04v01r03. The SAR required in these regions of SAM should be measured using a flat phantom. The phone should be positioned with a separation distance of 4 mm between the ear reference point (ERP) and the outer surface of the flat phantom shell. While maintaining this distance at the ERP location, the low (bottom) edge of the phone should be lowered from the phantom to establish the same separation distance between the peak SAR location identified by the truncated partial SAR distribution measured with the SAM phantom. The distance from the peak SAR location to the phone is determined by the straight line passing perpendicularly through the phantom surface. When it is not feasible to maintain 4 mm separation at the ERP while also establishing the required separation at the peak SAR location, the top edge of the phone will be allowed to touch the phantom with a separation < 4 mm at the ERP. The phone should not be tilted to the left or right while placed in this inclined position to the flat phantom.

6.5 Body-Worn Accessory Configurations

Body-worn operating configurations are tested with the belt-clips and holsters attached to the device and positioned against a flat phantom in a normal use configuration (see Figure 6-4). Per FCC KDB Publication 648474 D04v01r03, Body-worn accessory exposure is typically related to voice mode operations when handsets are carried in body-worn accessories. The body-worn accessory procedures in FCC KDB Publication 447498 D01v06 should be used to test for body-worn accessory SAR compliance, without a headset connected to it. This enables the test results for such configuration to be compatible with that required for hotspot mode when the body-worn accessory test separation distance is greater than or equal to that required for hotspot mode, when applicable. When the reported SAR for a body-worn accessory, measured without a headset connected to the handset, is > 1.2 W/kg, the highest reported SAR configuration for that wireless mode and frequency band should be repeated for that body-worn accessory with a headset attached to the handset.

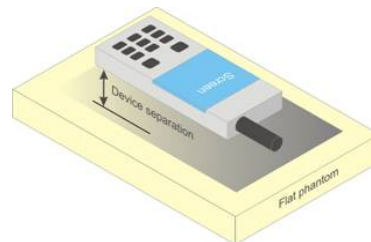



Figure 6-4 Sample Body-Worn Diagram

Accessories for Body-worn operation configurations are divided into two categories: those that do not contain metallic components and those that do contain metallic components. When multiple accessories that do not

FCC ID: ZNFX410PM	 PCTEST ENGINEERING LABORATORY, INC.	SAR EVALUATION REPORT		Approved by: Quality Manager
Document S/N: 1M1806270133-01-R1.ZNF	Test Dates: 07/08/18 - 07/16/18	DUT Type: Portable Handset		Page 16 of 95

contain metallic components are supplied with the device, the device is tested with only the accessory that dictates the closest spacing to the body. Then multiple accessories that contain metallic components are tested with the device with each accessory. If multiple accessories share an identical metallic component (i.e. the same metallic belt-clip used with different holsters with no other metallic components) only the accessory that dictates the closest spacing to the body is tested.

Body-worn accessories may not always be supplied or available as options for some devices intended to be authorized for body-worn use. In this case, a test configuration with a separation distance between the back of the device and the flat phantom is used. Test position spacing was documented. Transmitters that are designed to operate in front of a person's face, as in push-to-talk configurations, are tested for SAR compliance with the front of the device positioned to face the flat phantom in head fluid. For devices that are carried next to the body such as a shoulder, waist or chest-worn transmitters, SAR compliance is tested with the accessories, including headsets and microphones, attached to the device and positioned against a flat phantom in a normal use configuration.

6.6 Extremity Exposure Configurations



Devices that are designed or intended for use on extremities or mainly operated in extremity only exposure conditions; i.e., hands, wrists, feet and ankles, may require extremity SAR evaluation. When the device also operates in close proximity to the user's body, SAR compliance for the body is also required. The 1g body and 10g extremity SAR Exclusion Thresholds found in KDB Publication 447498 D01v06 should be applied to determine SAR test requirements.

Per KDB Publication 447498 D01v06, Cell phones (handsets) are not normally designed to be used on extremities or operated in extremity only exposure conditions. The maximum output power levels of handsets generally do not require extremity SAR testing to show compliance. Therefore, extremity SAR was not evaluated for this device.

6.7 Wireless Router Configurations

Some battery-operated handsets have the capability to transmit and receive user data through simultaneous transmission of WIFI simultaneously with a separate licensed transmitter. The FCC has provided guidance in FCC KDB Publication 941225 D06v02r01 where SAR test considerations for handsets ($L \times W \geq 9 \text{ cm} \times 5 \text{ cm}$) are based on a composite test separation distance of 10 mm from the front, back and edges of the device containing transmitting antennas within 2.5 cm of their edges, determined from general mixed use conditions for this type of devices. Since the hotspot SAR results may overlap with the body-worn accessory SAR requirements, the more conservative configurations can be considered, thus excluding some body-worn accessory SAR tests.

When the user enables the personal wireless router functions for the handset, actual operations include simultaneous transmission of both the WIFI transmitter and another licensed transmitter. Both transmitters often do not transmit at the same transmitting frequency and thus cannot be evaluated for SAR under actual use conditions due to the limitations of the SAR assessment probes. Therefore, SAR must be evaluated for each frequency transmission and mode separately and spatially summed with the WIFI transmitter according to FCC KDB Publication 447498 D01v06 procedures. The "Portable Hotspot" feature on the handset was NOT activated during SAR assessments, to ensure the SAR measurements were evaluated for a single transmission frequency RF signal at a time.

FCC ID: ZNFX410PM	 PCTEST ENGINEERING LABORATORY, INC.	SAR EVALUATION REPORT	 LG	Approved by: Quality Manager
Document S/N: 1M1806270133-01-R1.ZNF	Test Dates: 07/08/18 - 07/16/18	DUT Type: Portable Handset	Page 17 of 95	

7 RF EXPOSURE LIMITS

7.1 Uncontrolled Environment

UNCONTROLLED ENVIRONMENTS are defined as locations where there is the exposure of individuals who have no knowledge or control of their exposure. The general population/uncontrolled exposure limits are applicable to situations in which the general public may be exposed or in which persons who are exposed as a consequence of their employment may not be made fully aware of the potential for exposure or cannot exercise control over their exposure. Members of the general public would come under this category when exposure is not employment-related; for example, in the case of a wireless transmitter that exposes persons in its vicinity.



7.2 Controlled Environment

CONTROLLED ENVIRONMENTS are defined as locations where there is exposure that may be incurred by persons who are aware of the potential for exposure, (i.e. as a result of employment or occupation). In general, occupational/controlled exposure limits are applicable to situations in which persons are exposed as a consequence of their employment, who have been made fully aware of the potential for exposure and can exercise control over their exposure. This exposure category is also applicable when the exposure is of a transient nature due to incidental passage through a location where the exposure levels may be higher than the general population/uncontrolled limits, but the exposed person is fully aware of the potential for exposure and can exercise control over his or her exposure by leaving the area or by some other appropriate means.

**Table 7-1
SAR Human Exposure Specified in ANSI/IEEE C95.1-1992 and Health Canada Safety Code 6**

HUMAN EXPOSURE LIMITS		
	UNCONTROLLED ENVIRONMENT <i>General Population</i> (W/kg) or (mW/g)	CONTROLLED ENVIRONMENT <i>Occupational</i> (W/kg) or (mW/g)
Peak Spatial Average SAR Head	1.6	8.0
Whole Body SAR	0.08	0.4
Peak Spatial Average SAR Hands, Feet, Ankle, Wrists, etc.	4.0	20

1. The Spatial Peak value of the SAR averaged over any 1 gram of tissue (defined as a tissue volume in the shape of a cube) and over the appropriate averaging time.
2. The Spatial Average value of the SAR averaged over the whole body.
3. The Spatial Peak value of the SAR averaged over any 10 grams of tissue (defined as a tissue volume in the shape of a cube) and over the appropriate averaging time.

FCC ID: ZNFX410PM	 PCTEST ENGINEERING LABORATORY, INC.	SAR EVALUATION REPORT	 LG	Approved by: Quality Manager
Document S/N: 1M1806270133-01-R1.ZNF	Test Dates: 07/08/18 - 07/16/18	DUT Type: Portable Handset		Page 18 of 95

8 FCC MEASUREMENT PROCEDURES

Power measurements for licensed transmitters are performed using a base station simulator under digital average power.

8.1 Measured and Reported SAR

Per FCC KDB Publication 447498 D01v06, when SAR is not measured at the maximum power level allowed for production units, the results must be scaled to the maximum tune-up tolerance limit according to the power applied to the individual channels tested to determine compliance. For simultaneous transmission, the measured aggregate SAR must be scaled according to the sum of the differences between the maximum tune-up tolerance and actual power used to test each transmitter. When SAR is measured at or scaled to the maximum tune-up tolerance limit, the results are referred to as *reported* SAR. The highest *reported* SAR results are identified on the grant of equipment authorization according to procedures in KDB 690783 D01v01r03.

8.2 3G SAR Test Reduction Procedure

In FCC KDB Publication 941225 D01v03r01, certain transmission modes within a frequency band and wireless mode evaluated for SAR are defined as primary modes. The equivalent modes considered for SAR test reduction are denoted as secondary modes. When the maximum output power including tune-up tolerance specified for production units in a secondary mode is ≤ 0.25 dB higher than the primary mode or when the highest reported SAR of the primary mode, scaled by the ratio of specified maximum output power and tune-up tolerance of secondary to primary mode, is ≤ 1.2 W/kg, SAR measurements are not required for the secondary mode. These criteria are referred to as the 3G SAR test reduction procedure. When the 3G SAR test reduction procedure is not satisfied, SAR measurements are additionally required for the secondary mode.

8.3 Procedures Used to Establish RF Signal for SAR

The following procedures are according to FCC KDB Publication 941225 D01v03r01 “3G SAR Measurement Procedures.”



The device is placed into a simulated call using a base station simulator in a RF shielded chamber. Establishing connections in this manner ensure a consistent means for testing SAR and are recommended for evaluating SAR [4]. Devices under test are evaluated prior to testing, with a fully charged battery and were configured to operate at maximum output power. In order to verify that the device is tested throughout the SAR test at maximum output power, the SAR measurement system measures a “point SAR” at an arbitrary reference point at the start and end of the 1 gram SAR evaluation, to assess for any power drifts during the evaluation. If the power drift deviates by more than 5%, the SAR test and drift measurements are repeated.

8.4 SAR Measurement Conditions for CDMA2000

The following procedures were performed according to FCC KDB Publication 941225 D01v03r01 “3G SAR Measurement Procedures.”

8.4.1 Output Power Verification

See 3GPP2 C.S0011/TIA-98-E as recommended by FCC KDB Publication 941225 D01v03r01 “3G SAR Measurement Procedures.” Maximum output power is verified on the High, Middle and Low channels according to procedures in section 4.4.5.2 of 3GPP2 C.S0011/TIA-98-E. SO55 tests were measured with power control bits in the “All Up” condition.

FCC ID: ZNFX410PM	 PCTEST ENGINEERING LABORATORY, INC.	SAR EVALUATION REPORT	 LG	Approved by: Quality Manager
Document S/N: 1M1806270133-01-R1.ZNF	Test Dates: 07/08/18 - 07/16/18	DUT Type: Portable Handset		Page 19 of 95

1. If the mobile station (MS) supports Reverse TCH RC 1 and Forward TCH RC 1, set up a call using Fundamental Channel Test Mode 1 (RC=1/1) with 9600 bps data rate only.
2. Under RC1, C.S0011 Table 4.4.5.2-1, Table 8-1 parameters were applied.
3. If the MS supports the RC 3 Reverse FCH, RC3 Reverse SCH₀ and demodulation of RC 3,4, or 5, set up a call using Supplemental Channel Test Mode 3 (RC 3/3) with 9600 bps Fundamental Channel and 9600 bps SCH₀ data rate.
4. Under RC3, C.S0011 Table 4.4.5.2-2, Table 8-2 was applied.

Table 8-1
Parameters for Max. Power for RC1

Parameter	Units	Value
$\frac{I_{or}}{I_{or}}$	dBm/1.23 MHz	-104
$\frac{Pilot E_c}{I_{or}}$	dB	-7
$\frac{Traffic E_c}{I_{or}}$	dB	-7.4

Table 8-2
Parameters for Max. Power for RC3

Parameter	Units	Value
$\frac{I_{or}}{I_{or}}$	dBm/1.23 MHz	-86
$\frac{Pilot E_c}{I_{or}}$	dB	-7
$\frac{Traffic E_c}{I_{or}}$	dB	-7.4

5. FCHs were configured at full rate for maximum SAR with “All Up” power control bits.

8.4.2 Head SAR Measurements

SAR for next to the ear head exposure is measured in RC3 with the handset configured to transmit at full rate in SO55. The 3G SAR test reduction procedure is applied to RC1 with RC3 as the primary mode; otherwise, SAR is required for the channel with maximum measured output in RC1 using the head exposure configuration that results in the highest reported SAR in RC3.

Head SAR is additionally evaluated using EVDO Rev. A to support compliance for VoIP operations. See Section 8.4.5 for EVDO Rev. A configuration parameters.

8.4.3 Body-worn SAR Measurements



SAR for body-worn exposure configurations is measured in RC3 with the DUT configured to transmit at full rate on FCH with all other code channels disabled using TDSO / SO32. The 3G SAR test reduction procedure is applied to the multiple code channel configuration (FCH+SCH_n), with FCH only as the primary mode. Otherwise, SAR is required for multiple code channel configuration (FCH + SCH_n), with FCH at full rate and SCH₀ enabled at 9600 bps, using the highest reported SAR configuration for FCH only. When multiple code channels are enabled, the transmitter output can shift by more than 0.5 dB and may lead to higher SAR drifts and SCH dropouts.

The 3G SAR test reduction procedure is applied to body-worn accessory SAR in RC1 with RC3 as the primary mode. Otherwise, SAR is required for RC1, with SO55 and full rate, using the highest reported SAR configuration for body-worn accessory exposure in RC3.

8.4.4 Body-worn SAR Measurements for EVDO Devices

For handsets with EVDO capabilities, the 3G SAR test reduction procedure is applied to EVDO Rev. 0 with 1x RTT RC3 as the primary mode to determine body-worn accessory test requirements. Otherwise, body-worn accessory SAR is required for Rev. 0, at 153.6 kbps, using the highest reported SAR configuration for body-worn accessory exposure in RC3.

The 3G SAR test reduction procedure is applied to Rev. A, with Rev. 0 as the primary mode to determine body-worn accessory SAR test requirements. When SAR is not required for Rev. 0, the 3G SAR test reduction is applied with 1x RTT RC3 as the primary mode.

FCC ID: ZNFX410PM	 PCTEST ENGINEERING LABORATORY, INC.	SAR EVALUATION REPORT	 LG	Approved by: Quality Manager
Document S/N: 1M1806270133-01-R1.ZNF	Test Dates: 07/08/18 - 07/16/18	DUT Type: Portable Handset	Page 20 of 95	

When SAR is required for EVDO Rev. A, SAR is measured with a Reverse Data Channel payload size of 4096 bits and a Termination Target of 16 slots defined for Subtype 2 Physical Layer configurations, using the highest reported SAR configuration for body-worn accessory exposure in Rev. 0 or 1x RTT RC3, as appropriate.

8.4.5 Body SAR Measurements for EVDO Hotspot

Hotspot Body SAR is measured using Subtype 0/1 Physical Layer configurations for Rev. 0. The 3G SAR test reduction procedure is applied to Rev. A, Subtype 2 Physical layer configuration, with Rev. 0 as the primary mode; otherwise, SAR is measured for Rev. A using the highest reported SAR configuration for body-worn accessory exposure in Rev. 0. The AT is tested with a Reverse Data Channel rate of 153.6 kbps in Subtype 0/1 Physical Layer configurations; and a Reverse Data Channel payload size of 4096 bits and Termination Target of 16 slots in Subtype 2 Physical Layer configurations.

For EVDO data devices that also support 1x RTT voice and/or data operations, the 3G SAR test reduction procedure is applied to 1x RTT RC3 and RC1 with EVDO Rev. 0 and Rev. A as the respective primary modes. Otherwise, the 'Body-Worn Accessory SAR' procedures in the '3GPP2 CDMA 2000 1x Handsets' section are applied.

8.5 SAR Measurement Conditions for UMTS

8.5.1 Output Power Verification

Maximum output power is verified on the High, Middle and Low channels according to the general descriptions in section 5.2 of 3GPP TS 34.121, using the appropriate RMC with TPC (transmit power control) set to all "1s" or applying the required inner loop power control procedures to maintain maximum output power while HSUPA is active. Results for all applicable physical channel configurations (DPCCH, DPDCH_n and spreading codes, HS-DPCCH etc) are tabulated in this test report. All configurations that are not supported by the DUT or cannot be measured due to technical or equipment limitations are identified.

8.5.2 Head SAR Measurements



SAR for next to the ear head exposure is measured using a 12.2 kbps RMC with TPC bits configured to all "1s". The 3G SAR test reduction procedure is applied to AMR configurations with 12.2 kbps RMC as the primary mode. Otherwise, SAR is measured for 12.2 kbps AMR in 3.4 kbps SRB (signaling radio bearer) using the highest reported SAR configuration in 12.2 kbps RMC for head exposure.

8.5.3 Body SAR Measurements

SAR for body exposure configurations is measured using the 12.2 kbps RMC with the TPC bits all "1s". The 3G SAR test reduction procedure is applied to other spreading codes and multiple DPDCH_n configurations supported by the handset with 12.2 kbps RMC as the primary mode. Otherwise, SAR is measured using an applicable RMC configuration with the corresponding spreading code or DPDCH_n, for the highest reported SAR configuration in 12.2 kbps RMC.

8.5.4 SAR Measurements with Rel 5 HSDPA

The 3G SAR test reduction procedure is applied to HSDPA body configurations with 12.2 kbps RMC as the primary mode. Otherwise, Body SAR for HSDPA is measured using an FRC with H-Set 1 in Sub-test 1 and a 12.2 kbps RMC configured in Test Loop Mode 1, for the highest reported SAR configuration in

FCC ID: ZNFX410PM	 PCTEST ENGINEERING LABORATORY, INC.	SAR EVALUATION REPORT	 LG	Approved by: Quality Manager
Document S/N: 1M1806270133-01-R1.ZNF	Test Dates: 07/08/18 - 07/16/18	DUT Type: Portable Handset		Page 21 of 95

12.2 kbps RMC without HSDPA. Handsets with both HSDPA and HSUPA are tested according to Release 6 HSPA test procedures.

8.5.5 SAR Measurements with Rel 6 HSUPA

The 3G SAR test reduction procedure is applied to HSPA (HSUPA/HSDPA with RMC) body configurations with 12.2 kbps RMC as the primary mode. Otherwise, Body SAR for HSPA is measured with E-DCH Sub-test 5, using H-Set 1 and QPSK for FRC and a 12.2 kbps RMC configured in Test Loop Mode 1 and power control algorithm 2, according to the highest reported body SAR configuration in 12.2 kbps RMC without HSPA.

When VOIP applies to head exposure, the 3G SAR test reduction procedure is applied with 12.2 kbps RMC as the primary mode; otherwise, the same HSPA configuration used for body SAR measurements are applied to head exposure testing.

8.6 SAR Measurement Conditions for LTE

LTE modes are tested according to FCC KDB 941225 D05v02r04 publication. Establishing connections with base station simulators ensure a consistent means for testing SAR and are recommended for evaluating SAR [4]. The R&S CMW500 or Anritsu MT8820C simulators are used for LTE output power measurements and SAR testing. Closed loop power control was used so the UE transmits with maximum output power during SAR testing. SAR tests were performed with the same number of RB and RB offsets transmitting on all TTI frames (maximum TTI).

8.6.1 Spectrum Plots for RB Configurations

A properly configured base station simulator was used for SAR tests and power measurements. Therefore, spectrum plots for RB configurations were not required to be included in this report.

8.6.2 MPR

MPR is permanently implemented for this device by the manufacturer. The specific manufacturer target MPR is indicated alongside the SAR results. MPR is enabled for this device, according to 3GPP TS36.101 Section 6.2.3 – 6.2.5 under Table 6.2.3-1.



8.6.3 A-MPR

A-MPR (Additional MPR) has been disabled for all SAR tests by setting NS=01 on the base station simulator.

8.6.4 Required RB Size and RB Offsets for SAR Testing

According to FCC KDB 941225 D05v02r04:

- a. Per Section 5.2.1, SAR is required for QPSK 1 RB Allocation for the largest bandwidth
 - i. The required channel and offset combination with the highest maximum output power is required for SAR.
 - ii. When the reported SAR is ≤ 0.8 W/kg, testing of the remaining RB offset configurations and required test channels is not required. Otherwise, SAR is required for the remaining required test channels using the RB offset configuration with highest output power for that channel.
 - iii. When the reported SAR for a required test channel is > 1.45 W/kg, SAR is required for all RB offset configurations for that channel.

FCC ID: ZNFX410PM	 PCTEST ENGINEERING LABORATORY, INC.	SAR EVALUATION REPORT	 LG	Approved by: Quality Manager
Document S/N: 1M1806270133-01-R1.ZNF	Test Dates: 07/08/18 - 07/16/18	DUT Type: Portable Handset		Page 22 of 95

- b. Per Section 5.2.2, SAR is required for 50% RB allocation using the largest bandwidth following the same procedures outlined in Section 5.2.1.
- c. Per Section 5.2.3, QPSK SAR is not required for the 100% allocation when the highest maximum output power for the 100% allocation is less than the highest maximum output power of the 1 RB and 50% RB allocations and the reported SAR for the 1 RB and 50% RB allocations is < 0.8 W/kg.
- d. Per Section 5.2.4 and 5.3, SAR tests for higher order modulations and lower bandwidths configurations are not required when the conducted power of the required test configurations determined by Sections 5.2.1 through 5.2.3 is less than or equal to ½ dB higher than the equivalent configuration using QPSK modulation and when the QPSK SAR for those configurations is <1.45 W/kg.

8.6.5 TDD

LTE TDD testing is performed using the SAR test guidance provided in FCC KDB 941225 D05v02r04. TDD is tested at the highest duty factor using UL-DL configuration 0 with special subframe configuration 6 and applying the FDD LTE procedures in KDB 941225 D05v02r04. SAR testing is performed using the extended cyclic prefix listed in 3GPP TS 36.211 Section 4.

8.7 SAR Testing with 802.11 Transmitters

The normal network operating configurations of 802.11 transmitters are not suitable for SAR measurements. Unpredictable fluctuations in network traffic and antenna diversity conditions can introduce undesirable variations in SAR results. The SAR for these devices should be measured using chipset based test mode software to ensure the results are consistent and reliable. See KDB Publication 248227 D01v02r02 for more details.

8.7.1 General Device Setup

Chipset based test mode software is hardware dependent and generally varies among manufacturers. The device operating parameters established in test mode for SAR measurements must be identical to those programmed in production units, including output power levels, amplifier gain settings and other RF performance tuning parameters.



A periodic duty factor is required for current generation SAR systems to measure SAR. When 802.11 frame gaps are accounted for in the transmission, a maximum transmission duty factor of 92 - 96% is typically achievable in most test mode configurations. A minimum transmission duty factor of 85% is required to avoid certain hardware and device implementation issues related to wide range SAR scaling. The reported SAR is scaled to 100% transmission duty factor to determine compliance at the maximum tune-up tolerance limit.

8.7.2 U-NII-1 and U-NII-2A

For devices that operate in both U-NII-1 and U-NII-2A bands, when the same maximum output power is specified for both bands, SAR measurement using OFDM SAR test procedures is not required for U-NII-1 unless the highest reported SAR for U-NII-2A is > 1.2 W/kg. When different maximum output powers are specified for the bands, SAR measurement for the U-NII band with the lower maximum output power is not required unless the highest reported SAR for the U-NII band with the higher maximum output power, adjusted by the ratio of lower to higher specified maximum output power for the two bands, is > 1.2 W/kg.

8.7.3 U-NII-2C and U-NII-3

The frequency range covered by U-NII-2C and U-NII-3 is 380 MHz (5.47 – 5.85 GHz), which requires a minimum of at least two SAR probe calibration frequency points to support SAR measurements. When Terminal Doppler Weather Radar (TDWR) restriction applies, the channels at 5.60 – 5.65 GHz in U-NII-2C

FCC ID: ZNFX410PM	 PCTEST ENGINEERING LABORATORY, INC.	SAR EVALUATION REPORT		Approved by: Quality Manager
Document S/N: 1M1806270133-01-R1.ZNF	Test Dates: 07/08/18 - 07/16/18	DUT Type: Portable Handset	Page 23 of 95	

band must be disabled with acceptable mechanisms and documented in the equipment certification. Unless band gap channels are permanently disabled, SAR must be considered for these channels. Each band is tested independently according to the normally required OFDM SAR measurement and probe calibration frequency points requirements.

8.7.4 Initial Test Position Procedure

For exposure conditions with multiple test positions, such as handset operating next to the ear, devices with hotspot mode or UMPC mini-tablet, procedures for initial test position can be applied. Using the transmission mode determined by the DSSS procedure or initial test configuration, area scans are measured for all positions in an exposure condition. The test position with the highest extrapolated (peak) SAR is used as the initial test position. When reported SAR for the initial test position is ≤ 0.4 W/kg, no additional testing for the remaining test positions is required. Otherwise, SAR is evaluated at the subsequent highest peak SAR positions until the reported SAR result is ≤ 0.8 W/kg or all test positions are measured.

8.7.5 2.4 GHz SAR Test Requirements

SAR is measured for 2.4 GHz 802.11b DSSS using either the fixed test position or, when applicable, the initial test position procedure. SAR test reduction is determined according to the following:

- 1) When the reported SAR of the highest measured maximum output power channel for the exposure configuration is ≤ 0.8 W/kg, no further SAR testing is required for 802.11b DSSS in that exposure configuration.
- 2) When the reported SAR is > 0.8 W/kg, SAR is required for that position using the next highest measured output power channel. When any reported SAR is > 1.2 W/kg, SAR is required for the third channel; i.e., all channels require testing.



2.4 GHz 802.11 g/n OFDM are additionally evaluated for SAR if the highest reported SAR for 802.11b, adjusted by the ratio of the OFDM to DSSS specified maximum output power, is > 1.2 W/kg. When SAR is required for OFDM modes in 2.4 GHz band, the Initial Test Configuration Procedures should be followed.

8.7.6 OFDM Transmission Mode and SAR Test Channel Selection

When the same maximum output power was specified for multiple OFDM transmission mode configurations in a frequency band or aggregated band, SAR is measured using the configuration with the largest channel bandwidth, lowest order modulation and lowest data rate. When the maximum output power of a channel is the same for equivalent OFDM configurations; for example, 802.11a, 802.11n and 802.11ac or 802.11g and 802.11n with the same channel bandwidth, modulation and data rate etc., the lower order 802.11 mode i.e., 802.11a, then 802.11n and 802.11ac or 802.11g then 802.11n, is used for SAR measurement. When the maximum output power are the same for multiple test channels, either according to the default or additional power measurement requirements, SAR is measured using the channel closest to the middle of the frequency band or aggregated band. When there are multiple channels with the same maximum output power, SAR is measured using the higher number channel.

8.7.7 Initial Test Configuration Procedure

For OFDM, an initial test configuration is determined for each frequency band and aggregated band, according to the transmission mode with the highest maximum output power specified for SAR measurements. When the same maximum output power is specified for multiple OFDM transmission mode configurations in a frequency band or aggregated band, SAR is measured using the configuration(s) with the largest channel bandwidth, lowest order modulation, lowest data rate and lowest order IEEE 802.11 mode.



FCC ID: ZNFX410PM	 PCTEST ENGINEERING LABORATORY, INC.	SAR EVALUATION REPORT	 LG	Approved by: Quality Manager
Document S/N: 1M1806270133-01-R1.ZNF	Test Dates: 07/08/18 - 07/16/18	DUT Type: Portable Handset	Page 24 of 95	

The channel of the transmission mode with the highest average RF output conducted power will be the initial test configuration.

When the reported SAR is ≤ 0.8 W/kg, no additional measurements on other test channels are required. Otherwise, SAR is evaluated using the subsequent highest average RF output channel until the reported SAR result is ≤ 1.2 W/kg or all channels are measured. When there are multiple untested channels having the same subsequent highest average RF output power, the channel with higher frequency from the lowest 802.11 mode is considered for SAR measurements (See Section 8.7.6).

8.7.8 Subsequent Test Configuration Procedures

For OFDM configurations in each frequency band and aggregated band, SAR is evaluated for initial test configuration using the fixed test position or the initial test position procedure. When the highest reported SAR (for the initial test configuration), adjusted by the ratio of the specified maximum output power of the subsequent test configuration to initial test configuration, is ≤ 1.2 W/kg, no additional SAR tests for the subsequent test configurations are required.

FCC ID: ZNFX410PM	 SAR EVALUATION REPORT 		Approved by: Quality Manager
Document S/N: 1M1806270133-01-R1.ZNF	Test Dates: 07/08/18 - 07/16/18	DUT Type: Portable Handset	Page 25 of 95

9 RF CONDUCTED POWERS

9.1 CDMA Conducted Powers



**Table 9-1
Maximum Conducted Power**

Band	Channel	Rule Part	Frequency	SO55 [dBm]	SO55 [dBm]	TDSO SO32 [dBm]	TDSO SO32 [dBm]	1x EvDO Rev. 0 [dBm]	1x EvDO Rev. A [dBm]
	F-RC		MHz	RC1	RC3	FCH+SCH	FCH	(RTAP)	(RETAP)
Cellular	564	90S	820.1	24.85	24.97	25.14	25.19	25.13	25.19
Cellular	1013	22H	824.7	25.08	25.13	25.20	25.06	25.08	25.04
	384	22H	836.52	25.14	25.13	25.00	25.08	25.10	25.09
	777	22H	848.31	25.13	25.16	25.00	25.04	25.06	25.12
PCS	25	24E	1851.25	25.15	25.07	25.05	25.13	25.08	25.12
	600	24E	1880	25.20	25.13	25.10	25.17	25.15	25.15
	1175	24E	1908.75	25.11	25.20	25.03	25.12	25.10	25.08

Note: RC1 is only applicable for IS-95 compatibility. For FCC Rule Part 90S, Per FCC KDB Publication 447498 D01v06 4.1.g), only one channel is required since the device operates within the transmission range of 817.90 – 823.10 MHz.



**Figure 9-1
Power Measurement Setup**

FCC ID: ZNFX410PM	 PCTEST ENGINEERING LABORATORY, INC.	SAR EVALUATION REPORT	 LG	Approved by: Quality Manager
Document S/N: 1M1806270133-01-R1.ZNF	Test Dates: 07/08/18 - 07/16/18	DUT Type: Portable Handset	Page 26 of 95	



9.2 GSM Conducted Powers

Table 9-2
Maximum Conducted Power

Maximum Burst-Averaged Output Power						
Band	Channel	Voice	GPRS/EDGE Data (GMSK)		EDGE Data (8-PSK)	
		GSM [dBm] CS (1 Slot)	GPRS [dBm] 1 Tx Slot	GPRS [dBm] 2 Tx Slot	EDGE [dBm] 1 Tx Slot	EDGE [dBm] 2 Tx Slot
GSM 850	128	33.62	33.67	31.63	27.47	26.47
	190	33.61	33.69	31.54	27.52	26.59
	251	33.52	33.54	31.55	27.60	26.56
GSM 1900	512	30.56	30.48	28.53	26.00	25.64
	661	30.51	30.57	28.61	26.11	25.55
	810	30.47	30.57	28.66	26.13	25.57

Calculated Maximum Frame-Averaged Output Power						
Band	Channel	Voice	GPRS/EDGE Data (GMSK)		EDGE Data (8-PSK)	
		GSM [dBm] CS (1 Slot)	GPRS [dBm] 1 Tx Slot	GPRS [dBm] 2 Tx Slot	EDGE [dBm] 1 Tx Slot	EDGE [dBm] 2 Tx Slot
GSM 850	128	24.59	24.64	25.61	18.44	20.45
	190	24.58	24.66	25.52	18.49	20.57
	251	24.49	24.51	25.53	18.57	20.54
GSM 1900	512	21.53	21.45	22.51	16.97	19.62
	661	21.48	21.54	22.59	17.08	19.53
	810	21.44	21.54	22.64	17.10	19.55

GSM 850	Frame	24.17	24.17	25.18	18.17	20.18
GSM 1900	Avg.Targets:	21.17	21.17	22.18	16.67	19.18

FCC ID: ZNFX410PM	 PCTEST ENGINEERING LABORATORY, INC.	SAR EVALUATION REPORT		 LG	Approved by: Quality Manager
Document S/N: 1M1806270133-01-R1.ZNF	Test Dates: 07/08/18 - 07/16/18	DUT Type: Portable Handset		Page 27 of 95	

Note:

1. Both burst-averaged and calculated frame-averaged powers are included. Frame-averaged power was calculated from the measured burst-averaged power by converting the slot powers into linear units and calculating the energy over 8 timeslots.
2. GPRS/EDGE (GMSK) output powers were measured with coding scheme setting of 1 (CS1) on the base station simulator. CS1 was configured to measure GPRS output power measurements and SAR to ensure GMSK modulation in the signal. Our Investigation has shown that CS1 - CS4 settings do not have any impact on the output levels or modulation in the GPRS modes.
3. EDGE (8-PSK) output powers were measured with MCS7 on the base station simulator. MCS7 coding scheme was used to measure the output powers for EDGE since investigation has shown that choosing MCS7 coding scheme will ensure 8-PSK modulation. It has been shown that MCS levels that produce 8PSK modulation do not have an impact on output power.

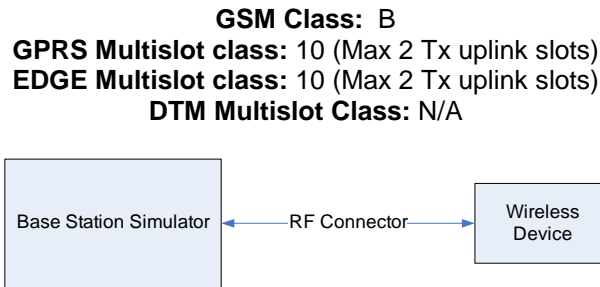



Figure 9-2
Power Measurement Setup

FCC ID: ZNFX410PM	 PCTEST ENGINEERING LABORATORY, INC.	SAR EVALUATION REPORT		Approved by: Quality Manager
Document S/N: 1M1806270133-01-R1.ZNF	Test Dates: 07/08/18 - 07/16/18	DUT Type: Portable Handset	Page 28 of 95	

9.3 UMTS Conducted Powers

**Table 9-3
Maximum Conducted Power**

3GPP Release Version	Mode	3GPP 34.121 Subtest	Cellular Band [dBm]			AWS Band [dBm]			PCS Band [dBm]			3GPP MPR [dB]
			4132	4183	4233	1312	1412	1513	9262	9400	9538	
99	WCDMA	12.2 kbps RMC	24.61	24.61	24.64	24.69	24.70	24.66	24.65	24.63	24.62	-
99		12.2 kbps AMR	24.66	24.59	24.60	24.42	24.59	24.60	24.61	24.53	24.63	-
6	HSDPA	Subtest 1	24.42	24.57	24.55	24.69	24.46	24.49	24.45	24.42	24.69	0
6		Subtest 2	24.43	24.54	24.66	24.47	24.49	24.32	24.44	24.52	24.67	0
6		Subtest 3	24.01	24.20	24.16	24.03	23.88	23.94	24.01	24.02	24.19	0.5
6		Subtest 4	24.05	24.02	24.15	24.02	24.06	23.95	24.01	23.97	24.12	0.5
6	HSUPA	Subtest 1	22.82	22.94	23.12	22.75	22.57	22.54	22.67	22.71	22.76	0
6		Subtest 2	22.47	22.37	22.46	22.72	22.60	22.74	22.62	22.51	22.67	2
6		Subtest 3	23.37	23.37	23.44	23.59	23.58	23.64	23.76	23.79	23.86	1
6		Subtest 4	21.76	21.88	21.84	22.23	22.24	22.29	22.05	22.24	22.34	2
6		Subtest 5	23.28	23.45	23.26	23.49	23.27	23.61	23.50	23.57	23.71	0

Note: It is expected by the manufacturer that MPR for some HSUPA subtests may deviate from the expected MPR targets specified by 3GPP

This device does not support DC-HSDPA.



**Figure 9-3
Power Measurement Setup**

FCC ID: ZNFX410PM	PCTEST ENGINEERING LABORATORY, INC.	SAR EVALUATION REPORT	LG	Approved by: Quality Manager
Document S/N: 1M1806270133-01-R1.ZNF	Test Dates: 07/08/18 - 07/16/18	DUT Type: Portable Handset	Page 29 of 95	

9.4 LTE Conducted Powers

9.4.1 LTE Band 12



Table 9-4
LTE Band 12 Conducted Powers - 10 MHz Bandwidth

LTE Band 12 10 MHz Bandwidth					
Modulation	RB Size	RB Offset	Mid Channel	MPR Allowed per 3GPP [dB]	MPR [dB]
			23095 (707.5 MHz)		
			Conducted Power [dBm]		
QPSK	1	0	24.97	0	0
	1	25	24.81		0
	1	49	24.87		0
	25	0	23.98	0-1	1
	25	12	23.86		1
	25	25	23.75		1
	50	0	23.75		1
16QAM	1	0	24.15	0-1	1
	1	25	24.03		1
	1	49	24.08		1
	25	0	22.92	0-2	2
	25	12	22.94		2
	25	25	22.82		2
	50	0	22.97		2

Note: LTE Band 12 at 10 MHz bandwidth does not support three non-overlapping channels. Per KDB Publication 941225 D05v02, when a device supports overlapping channel assignment in a channel bandwidth configuration, the middle channel of the group of overlapping channels should be selected for testing.

Table 9-5
LTE Band 12 Conducted Powers - 5 MHz Bandwidth

LTE Band 12 5 MHz Bandwidth							
Modulation	RB Size	RB Offset	Low Channel	Mid Channel	High Channel	MPR Allowed per 3GPP [dB]	MPR [dB]
			23035 (701.5 MHz)	23095 (707.5 MHz)	23155 (713.5 MHz)		
			Conducted Power [dBm]				
QPSK	1	0	25.00	24.93	24.69	0	0
	1	12	24.92	25.04	24.80		0
	1	24	24.79	24.85	24.95		0
	12	0	24.07	23.99	23.86	0-1	1
	12	6	23.92	23.95	23.93		1
	12	13	24.01	23.76	23.90		1
	25	0	24.13	23.95	23.82		1
16QAM	1	0	24.20	24.07	23.99	0-1	1
	1	12	24.02	24.10	24.03		1
	1	24	24.07	24.00	24.07		1
	12	0	23.06	22.95	22.90	0-2	2
	12	6	22.87	22.86	22.99		2
	12	13	23.01	22.94	22.96		2
	25	0	22.98	23.04	22.87		2



FCC ID: ZNFX410PM	 PCTEST ENGINEERING LABORATORY, INC.	SAR EVALUATION REPORT	 LG	Approved by: Quality Manager
Document S/N: 1M1806270133-01-R1.ZNF	Test Dates: 07/08/18 - 07/16/18	DUT Type: Portable Handset		Page 30 of 95

**Table 9-6
LTE Band 12 Conducted Powers - 3 MHz Bandwidth**

LTE Band 12 3 MHz Bandwidth							
Modulation	RB Size	RB Offset	Low Channel	Mid Channel	High Channel	MPR Allowed per 3GPP [dB]	MPR [dB]
			23025 (700.5 MHz)	23095 (707.5 MHz)	23165 (714.5 MHz)		
			Conducted Power [dBm]				
QPSK	1	0	24.94	24.86	24.77	0	0
	1	7	24.98	24.93	24.98		0
	1	14	24.80	24.97	24.99		0
	8	0	24.17	24.06	24.10	0-1	1
	8	4	23.96	23.89	24.14		1
	8	7	24.11	23.99	24.02		1
	15	0	24.03	23.90	24.00		1
16QAM	1	0	24.01	24.06	24.09	0-1	1
	1	7	24.17	24.05	24.00		1
	1	14	23.96	24.04	24.05		1
	8	0	23.20	23.07	22.95	0-2	2
	8	4	23.02	22.98	22.92		2
	8	7	23.07	22.99	22.95		2
	15	0	23.05	22.99	23.04		2

**Table 9-7
LTE Band 12 Conducted Powers -1.4 MHz Bandwidth**

LTE Band 12 1.4 MHz Bandwidth							
Modulation	RB Size	RB Offset	Low Channel	Mid Channel	High Channel	MPR Allowed per 3GPP [dB]	MPR [dB]
			23017 (699.7 MHz)	23095 (707.5 MHz)	23173 (715.3 MHz)		
			Conducted Power [dBm]				
QPSK	1	0	25.05	24.76	24.85	0	0
	1	2	24.76	24.59	24.71		0
	1	5	24.84	24.62	25.00		0
	3	0	25.07	24.80	24.71		0
	3	2	25.06	24.91	24.83		0
	3	3	25.03	24.85	24.82		0
	6	0	24.13	24.10	24.15	0-1	1
16QAM	1	0	24.07	24.01	24.10	0-1	1
	1	2	23.97	23.93	23.97		1
	1	5	24.00	23.87	24.03		1
	3	0	24.09	23.93	23.90		1
	3	2	24.14	23.93	23.93		1
	3	3	24.04	23.88	23.79		1
	6	0	22.92	23.04	22.99	0-2	2

FCC ID: ZNFX410PM		SAR EVALUATION REPORT		Approved by: Quality Manager
Document S/N: 1M1806270133-01-R1.ZNF	Test Dates: 07/08/18 - 07/16/18	DUT Type: Portable Handset		Page 31 of 95

9.4.2

LTE Band 13



Table 9-8
LTE Band 13 Conducted Powers - 10 MHz Bandwidth

LTE Band 13 10 MHz Bandwidth					
Modulation	RB Size	RB Offset	Mid Channel	MPR Allowed per 3GPP [dB]	MPR [dB]
			23230 (782.0 MHz)		
			Conducted Power [dBm]		
QPSK	1	0	25.06	0	0
	1	25	25.12		0
	1	49	25.20		0
	25	0	24.04	0-1	1
	25	12	23.99		1
	25	25	24.02		1
	50	0	23.90		1
16QAM	1	0	23.94	0-1	1
	1	25	23.92		1
	1	49	24.00		1
	25	0	23.06	0-2	2
	25	12	23.04		2
	25	25	23.13		2
	50	0	22.99		2

Table 9-9
LTE Band 13 Conducted Powers - 5 MHz Bandwidth

LTE Band 13 5 MHz Bandwidth					
Modulation	RB Size	RB Offset	Mid Channel	MPR Allowed per 3GPP [dB]	MPR [dB]
			23230 (782.0 MHz)		
			Conducted Power [dBm]		
QPSK	1	0	24.82	0	0
	1	12	24.97		0
	1	24	24.79		0
	12	0	24.06	0-1	1
	12	6	23.93		1
	12	13	23.97		1
	25	0	23.94		1
16QAM	1	0	23.93	0-1	1
	1	12	24.09		1
	1	24	24.05		1
	12	0	23.09	0-2	2
	12	6	23.05		2
	12	13	22.99		2

Note: LTE Band 13 at 5 MHz bandwidth does not support three non-overlapping channels. Per KDB Publication 941225 D05v02, when a device supports overlapping channel assignment in a channel bandwidth configuration, the middle channel of the group of overlapping channels should be selected for testing.

FCC ID: ZNFX410PM	 PCTEST ENGINEERING LABORATORY, INC.	SAR EVALUATION REPORT		Approved by: Quality Manager
Document S/N: 1M1806270133-01-R1.ZNF	Test Dates: 07/08/18 - 07/16/18	DUT Type: Portable Handset		Page 32 of 95

9.4.3

LTE Band 26 (Cell)

Table 9-10
LTE Band 26 (Cell) Conducted Powers - 15 MHz Bandwidth

LTE Band 26 (Cell) 15 MHz Bandwidth					
Modulation	RB Size	RB Offset	Mid Channel	MPR Allowed per 3GPP [dB]	MPR [dB]
			26865 (831.5 MHz)		
			Conducted Power [dBm]		
QPSK	1	0	24.76	0	0
	1	36	24.70		0
	1	74	24.97		0
	36	0	23.84	0-1	1
	36	18	23.76		1
	36	37	24.03		1
16QAM	75	0	23.92	0-1	1
	1	0	23.73		1
	1	36	23.77		1
	1	74	23.85	0-2	1
	36	0	22.84		2
	36	18	22.68		2
	36	37	22.97		2
75	0	22.87	2		

Note: LTE Band 26 (Cell) at 15 MHz bandwidth does not support three non-overlapping channels. Per KDB Publication 941225 D05v02, when a device supports overlapping channel assignment in a channel bandwidth configuration, the middle channel of the group of overlapping channels should be selected for testing.

Table 9-11
LTE Band 26 (Cell) Conducted Powers - 10 MHz Bandwidth

LTE Band 26 (Cell) 10 MHz Bandwidth							
Modulation	RB Size	RB Offset	Low Channel	Mid Channel	High Channel	MPR Allowed per 3GPP [dB]	MPR [dB]
			26740 (819.0 MHz)	26865 (831.5 MHz)	26990 (844.0 MHz)		
			Conducted Power [dBm]				
QPSK	1	0	25.10	24.86	25.12	0	0
	1	25	24.79	24.84	25.13		0
	1	49	24.73	25.02	25.07		0
	25	0	23.83	23.93	24.17	0-1	1
	25	12	23.78	23.97	23.94		1
	25	25	23.71	23.89	23.91		1
16QAM	50	0	23.75	23.81	24.09	0-1	1
	1	0	24.14	23.91	23.94		1
	1	25	24.03	23.90	23.94		1
	1	49	24.16	24.05	23.83	0-2	1
	25	0	22.88	22.95	23.20		2
	25	12	22.72	22.83	23.06		2
	25	25	22.58	22.91	22.86		2
50	0	22.75	22.88	22.99	2		





FCC ID: ZNFX410PM		SAR EVALUATION REPORT		Approved by: Quality Manager
Document S/N: 1M1806270133-01-R1.ZNF	Test Dates: 07/08/18 - 07/16/18	DUT Type: Portable Handset		Page 33 of 95

Table 9-12
LTE Band 26 (Cell) Conducted Powers - 5 MHz Bandwidth

LTE Band 26 (Cell) 5 MHz Bandwidth							
Modulation	RB Size	RB Offset	Low Channel	Mid Channel	High Channel	MPR Allowed per 3GPP [dB]	MPR [dB]
			26715 (816.5 MHz)	26865 (831.5 MHz)	27015 (846.5 MHz)		
			Conducted Power [dBm]				
QPSK	1	0	24.93	24.76	25.01	0	0
	1	12	24.95	24.74	24.97		0
	1	24	24.88	24.75	24.88		0
	12	0	23.89	23.85	24.00	0-1	1
	12	6	23.76	23.80	23.93		1
	12	13	23.74	23.83	23.84		1
16QAM	25	0	23.92	23.84	24.04	0-1	1
	1	0	23.92	24.14	24.08		1
	1	12	23.84	24.18	24.02		1
	1	24	23.78	24.15	23.81	0-2	1
	12	0	22.87	22.91	23.03		2
	12	6	22.84	22.80	23.00		2
	12	13	22.83	22.95	22.79	2	
	25	0	22.79	22.77	22.90	2	

Table 9-13
LTE Band 26 (Cell) Conducted Powers - 3 MHz Bandwidth

LTE Band 26 (Cell) 3 MHz Bandwidth							
Modulation	RB Size	RB Offset	Low Channel	Mid Channel	High Channel	MPR Allowed per 3GPP [dB]	MPR [dB]
			26705 (815.5 MHz)	26865 (831.5 MHz)	27025 (847.5 MHz)		
			Conducted Power [dBm]				
QPSK	1	0	24.90	24.71	24.92	0	0
	1	7	24.88	24.75	24.98		0
	1	14	24.68	24.81	24.87		0
	8	0	23.94	23.92	24.08	0-1	1
	8	4	23.92	23.78	24.10		1
	8	7	23.90	23.92	24.09		1
16QAM	15	0	23.88	23.85	23.92	0-1	1
	1	0	23.69	24.04	23.95		1
	1	7	23.64	24.12	23.87		1
	1	14	23.52	24.13	23.62	0-2	1
	8	0	23.02	22.87	23.08		2
	8	4	23.01	22.88	23.02		2
	8	7	22.98	22.91	22.95	2	
	15	0	22.82	22.95	22.93	2	

FCC ID: ZNFX410PM		SAR EVALUATION REPORT		Approved by: Quality Manager
Document S/N: 1M1806270133-01-R1.ZNF	Test Dates: 07/08/18 - 07/16/18	DUT Type: Portable Handset		Page 34 of 95

**Table 9-14
LTE Band 26 (Cell) Conducted Powers -1.4 MHz Bandwidth**

LTE Band 26 (Cell) 1.4 MHz Bandwidth							
Modulation	RB Size	RB Offset	Low Channel	Mid Channel	High Channel	MPR Allowed per 3GPP [dB]	MPR [dB]
			26697 (814.7 MHz)	26865 (831.5 MHz)	27033 (848.3 MHz)		
			Conducted Power [dBm]				
QPSK	1	0	24.88	24.63	24.88	0	0
	1	2	24.78	24.49	24.88		0
	1	5	24.79	24.80	25.01		0
	3	0	24.97	24.92	24.75		0
	3	2	24.95	24.86	24.80		0
	3	3	24.82	24.86	24.76		0
	6	0	24.01	23.78	24.02	0-1	1
16QAM	1	0	23.83	23.77	24.11	0-1	1
	1	2	23.61	23.78	23.84		1
	1	5	23.91	24.00	24.08		1
	3	0	24.10	23.95	23.90		1
	3	2	24.08	23.93	23.91		1
	3	3	24.16	23.90	23.83		1
	6	0	22.94	22.90	22.72	0-2	2

9.4.4 LTE Band 4 (AWS)

**Table 9-15
LTE Band 4 (AWS) Conducted Powers - 20 MHz Bandwidth**

LTE Band 4 (AWS) 20 MHz Bandwidth						
Modulation	RB Size	RB Offset	Mid Channel	MPR Allowed per 3GPP [dB]	MPR [dB]	
			20175 (1732.5 MHz)			
			Conducted Power [dBm]			
QPSK	1	0	25.16	0	0	
	1	50	24.92		0	
	1	99	24.91		0	
	16QAM	50	0	23.82	0-1	1
		50	25	23.74		1
		50	50	23.66		1
		100	0	23.78		1
16QAM	1	0	24.06	0-1	1	
	1	50	24.08		1	
	1	99	24.10		1	
	16QAM	50	0	22.92	0-2	2
		50	25	22.87		2
		50	50	22.90		2
		100	0	22.79		2

Note: LTE Band 4 (AWS) at 20 MHz bandwidth does not support three non-overlapping channels. Per KDB Publication 941225 D05v02, when a device supports overlapping channel assignment in a channel bandwidth configuration, the middle channel of the group of overlapping channels should be selected for testing.



FCC ID: ZNFX410PM	 PCTEST ENGINEERING LABORATORY, INC.	SAR EVALUATION REPORT		Approved by: Quality Manager
Document S/N: 1M1806270133-01-R1.ZNF	Test Dates: 07/08/18 - 07/16/18	DUT Type: Portable Handset	Page 35 of 95	

Table 9-16
LTE Band 4 (AWS) Conducted Powers - 15 MHz Bandwidth

LTE Band 4 (AWS) 15 MHz Bandwidth							
Modulation	RB Size	RB Offset	Low Channel	Mid Channel	High Channel	MPR Allowed per 3GPP [dB]	MPR [dB]
			20025 (1717.5 MHz)	20175 (1732.5 MHz)	20325 (1747.5 MHz)		
			Conducted Power [dBm]				
QPSK	1	0	25.12	25.11	25.05	0	0
	1	36	24.90	24.78	25.09		0
	1	74	25.06	24.87	25.17		0
	36	0	24.02	23.95	23.88	0-1	1
	36	18	24.04	24.01	23.86		1
	36	37	23.98	23.84	23.84		1
16QAM	75	0	23.93	24.03	23.81	0-1	1
	1	0	23.71	24.11	24.01		1
	1	36	23.65	24.07	24.05		1
	1	74	23.70	24.18	23.94	0-2	1
	36	0	22.79	22.91	22.84		2
	36	18	22.81	22.91	22.79		2
	36	37	22.78	22.79	22.77	2	
	75	0	22.94	22.96	22.92	2	

Table 9-17
LTE Band 4 (AWS) Conducted Powers - 10 MHz Bandwidth

LTE Band 4 (AWS) 10 MHz Bandwidth							
Modulation	RB Size	RB Offset	Low Channel	Mid Channel	High Channel	MPR Allowed per 3GPP [dB]	MPR [dB]
			20000 (1715.0 MHz)	20175 (1732.5 MHz)	20350 (1750.0 MHz)		
			Conducted Power [dBm]				
QPSK	1	0	25.10	25.09	25.04	0	0
	1	25	25.00	24.92	24.91		0
	1	49	25.00	24.97	25.19		0
	25	0	23.87	23.85	23.85	0-1	1
	25	12	23.79	23.73	23.83		1
	25	25	23.80	23.70	23.68		1
16QAM	50	0	23.82	23.76	23.81	0-1	1
	1	0	23.73	24.07	23.78		1
	1	25	23.60	24.04	23.71		1
	1	49	23.65	24.14	23.78	0-2	1
	25	0	22.80	22.79	23.07		2
	25	12	22.82	22.95	22.94		2
	25	25	22.79	22.74	22.82	2	
	50	0	22.81	22.94	22.76	2	



FCC ID: ZNFX410PM		SAR EVALUATION REPORT		Approved by: Quality Manager
Document S/N: 1M1806270133-01-R1.ZNF	Test Dates: 07/08/18 - 07/16/18	DUT Type: Portable Handset		Page 36 of 95

Table 9-18
LTE Band 4 (AWS) Conducted Powers - 5 MHz Bandwidth

LTE Band 4 (AWS) 5 MHz Bandwidth							
Modulation	RB Size	RB Offset	Low Channel	Mid Channel	High Channel	MPR Allowed per 3GPP [dB]	MPR [dB]
			19975 (1712.5 MHz)	20175 (1732.5 MHz)	20375 (1752.5 MHz)		
			Conducted Power [dBm]				
QPSK	1	0	25.13	24.73	24.95	0	0
	1	12	25.09	24.82	25.03		0
	1	24	25.05	24.78	24.91		0
	12	0	23.82	23.74	23.86	0-1	1
	12	6	23.85	23.72	23.87		1
	12	13	23.81	23.77	23.81		1
16QAM	25	0	23.94	23.76	23.86	0-1	1
	1	0	23.81	24.20	23.76		1
	1	12	23.82	24.14	23.76		1
	1	24	23.69	24.04	23.72	0-2	1
	12	0	22.85	22.85	22.81		2
	12	6	22.94	23.02	22.98		2
	12	13	22.89	22.80	22.74	2	
	25	0	22.87	22.71	22.73	2	

Table 9-19
LTE Band 4 (AWS) Conducted Powers - 3 MHz Bandwidth

LTE Band 4 (AWS) 3 MHz Bandwidth							
Modulation	RB Size	RB Offset	Low Channel	Mid Channel	High Channel	MPR Allowed per 3GPP [dB]	MPR [dB]
			19965 (1711.5 MHz)	20175 (1732.5 MHz)	20385 (1753.5 MHz)		
			Conducted Power [dBm]				
QPSK	1	0	25.10	24.83	24.99	0	0
	1	7	25.08	24.85	25.03		0
	1	14	24.96	24.86	25.08		0
	8	0	24.10	23.70	23.98	0-1	1
	8	4	24.13	23.82	23.88		1
	8	7	24.08	23.96	24.08		1
16QAM	15	0	24.00	23.76	23.89	0-1	1
	1	0	24.11	23.77	23.55		1
	1	7	24.11	23.71	23.57		1
	1	14	24.10	23.72	23.53	0-2	1
	8	0	22.91	22.85	22.92		2
	8	4	22.92	22.94	22.85		2
	8	7	22.99	22.91	22.99	2	
	15	0	22.92	22.77	22.96	2	



FCC ID: ZNFX410PM		SAR EVALUATION REPORT		Approved by: Quality Manager
Document S/N: 1M1806270133-01-R1.ZNF	Test Dates: 07/08/18 - 07/16/18	DUT Type: Portable Handset		Page 37 of 95

Table 9-20
LTE Band 4 (AWS) Conducted Powers -1.4 MHz Bandwidth

LTE Band 4 (AWS) 1.4 MHz Bandwidth							
Modulation	RB Size	RB Offset	Low Channel	Mid Channel	High Channel	MPR Allowed per 3GPP [dB]	MPR [dB]
			19957 (1710.7 MHz)	20175 (1732.5 MHz)	20393 (1754.3 MHz)		
			Conducted Power [dBm]				
QPSK	1	0	24.93	24.82	24.96	0	0
	1	2	24.89	24.71	24.83		0
	1	5	24.81	24.86	25.03		0
	3	0	25.03	24.89	24.67		0
	3	2	24.88	24.83	24.79		0
	3	3	24.88	24.89	24.75		0
	6	0	23.92	23.73	23.94	0-1	1
16QAM	1	0	23.81	23.88	24.15	0-1	1
	1	2	23.44	23.53	23.80		1
	1	5	23.86	23.88	24.05		1
	3	0	23.94	23.95	23.91		1
	3	2	24.15	24.00	23.89		1
	3	3	24.10	23.96	24.01		1
	6	0	22.82	22.76	22.64	0-2	2

9.4.5 LTE Band 25 (PCS)

Table 9-21
LTE Band 25 (PCS) Conducted Powers - 20 MHz Bandwidth

LTE Band 25 (PCS) 20 MHz Bandwidth								
Modulation	RB Size	RB Offset	Low Channel	Mid Channel	High Channel	MPR Allowed per 3GPP [dB]	MPR [dB]	
			26140 (1860.0 MHz)	26365 (1882.5 MHz)	26590 (1905.0 MHz)			
			Conducted Power [dBm]					
QPSK	1	0	25.12	25.07	25.05	0	0	
	1	50	24.97	24.82	24.96		0	
	1	99	25.09	24.93	25.16		0	
	QPSK	50	0	23.83	23.93	23.81	0-1	1
		50	25	23.72	23.71	23.83		1
		50	50	23.81	23.75	23.52		1
		100	0	23.85	23.82	23.65		1
16QAM	1	0	24.03	24.12	24.07	0-1	1	
	1	50	24.07	24.09	24.00		1	
	1	99	24.15	24.12	23.99		1	
	16QAM	50	0	22.97	22.92	22.91	0-2	2
		50	25	22.85	22.66	22.59		2
		50	50	22.84	22.73	22.51		2
		100	0	22.86	22.82	22.68		2



FCC ID: ZNFX410PM	 PCTEST ENGINEERING LABORATORY, INC.	SAR EVALUATION REPORT		Approved by: Quality Manager
Document S/N: 1M1806270133-01-R1.ZNF	Test Dates: 07/08/18 - 07/16/18	DUT Type: Portable Handset	Page 38 of 95	

Table 9-22
LTE Band 25 (PCS) Conducted Powers - 15 MHz Bandwidth

LTE Band 25 (PCS) 15 MHz Bandwidth							
Modulation	RB Size	RB Offset	Low Channel	Mid Channel	High Channel	MPR Allowed per 3GPP [dB]	MPR [dB]
			26115 (1857.5 MHz)	26365 (1882.5 MHz)	26615 (1907.5 MHz)		
			Conducted Power [dBm]				
QPSK	1	0	25.13	25.02	25.16	0	0
	1	36	24.81	24.82	25.04		0
	1	74	25.01	24.86	25.11		0
	36	0	23.97	23.85	23.84	0-1	1
	36	18	23.94	23.77	23.82		1
	36	37	23.91	23.88	23.80		1
	75	0	23.92	23.94	23.89		1
16QAM	1	0	23.72	24.16	24.08	0-1	1
	1	36	23.66	24.01	23.85		1
	1	74	23.72	24.10	23.87		1
	36	0	22.78	22.99	22.61	0-2	2
	36	18	22.68	22.68	22.65		2
	36	37	22.85	22.75	22.61		2
	75	0	22.81	22.74	22.84		2

Table 9-23
LTE Band 25 (PCS) Conducted Powers - 10 MHz Bandwidth

LTE Band 25 (PCS) 10 MHz Bandwidth							
Modulation	RB Size	RB Offset	Low Channel	Mid Channel	High Channel	MPR Allowed per 3GPP [dB]	MPR [dB]
			26090 (1855.0 MHz)	26365 (1882.5 MHz)	26640 (1910.0 MHz)		
			Conducted Power [dBm]				
QPSK	1	0	25.07	25.05	25.03	0	0
	1	25	24.93	24.88	25.00		0
	1	49	24.85	24.85	24.88		0
	25	0	23.71	23.77	23.65	0-1	1
	25	12	23.75	23.69	23.69		1
	25	25	23.84	23.66	23.50		1
	50	0	23.74	23.75	23.62		1
16QAM	1	0	23.54	24.11	23.85	0-1	1
	1	25	23.58	23.90	23.70		1
	1	49	23.51	23.95	23.60		1
	25	0	22.77	22.80	22.82	0-2	2
	25	12	22.76	22.80	22.84		2
	25	25	22.75	22.70	22.51		2
	50	0	22.68	22.83	22.60		2





FCC ID: ZNFX410PM	 PCTEST ENGINEERING LABORATORY, INC.	SAR EVALUATION REPORT	 LG	Approved by: Quality Manager
Document S/N: 1M1806270133-01-R1.ZNF	Test Dates: 07/08/18 - 07/16/18	DUT Type: Portable Handset	Page 39 of 95	

Table 9-24
LTE Band 25 (PCS) Conducted Powers - 5 MHz Bandwidth

LTE Band 25 (PCS) 5 MHz Bandwidth							
Modulation	RB Size	RB Offset	Low Channel	Mid Channel	High Channel	MPR Allowed per 3GPP [dB]	MPR [dB]
			26065 (1852.5 MHz)	26365 (1882.5 MHz)	26665 (1912.5 MHz)		
			Conducted Power [dBm]				
QPSK	1	0	25.00	24.80	24.79	0	0
	1	12	24.94	24.72	24.82		0
	1	24	24.90	24.76	24.78		0
	12	0	23.62	23.67	23.89	0-1	1
	12	6	23.71	23.68	23.67		1
	12	13	23.69	23.75	23.65		1
	25	0	23.73	23.73	23.63		1
16QAM	1	0	23.76	24.12	23.65	0-1	1
	1	12	23.74	24.11	23.72		1
	1	24	23.77	24.03	23.63		1
	12	0	22.64	22.93	22.67	0-2	2
	12	6	22.77	22.89	22.77		2
	12	13	22.66	22.85	22.57		2
	25	0	22.58	22.61	22.75		2

Table 9-25
LTE Band 25 (PCS) Conducted Powers - 3 MHz Bandwidth

LTE Band 25 (PCS) 3 MHz Bandwidth							
Modulation	RB Size	RB Offset	Low Channel	Mid Channel	High Channel	MPR Allowed per 3GPP [dB]	MPR [dB]
			26055 (1851.5 MHz)	26365 (1882.5 MHz)	26675 (1913.5 MHz)		
			Conducted Power [dBm]				
QPSK	1	0	24.86	24.82	24.85	0	0
	1	7	24.83	24.79	24.75		0
	1	14	24.87	24.82	24.82		0
	8	0	23.74	23.74	23.81	0-1	1
	8	4	23.71	23.74	23.90		1
	8	7	23.75	23.79	23.84		1
	15	0	23.81	23.74	23.65		1
16QAM	1	0	23.44	23.95	23.48	0-1	1
	1	7	23.45	23.92	23.62		1
	1	14	23.33	23.97	23.53		1
	8	0	22.88	22.76	22.80	0-2	2
	8	4	22.87	22.89	22.87		2
	8	7	22.90	22.85	22.80		2
	15	0	22.76	22.88	22.72		2

FCC ID: ZNFX410PM	 PCTEST <small>ENGINEERING LABORATORY, INC.</small>	SAR EVALUATION REPORT		Approved by: Quality Manager
Document S/N: 1M1806270133-01-R1.ZNF	Test Dates: 07/08/18 - 07/16/18	DUT Type: Portable Handset	Page 40 of 95	

**Table 9-26
LTE Band 25 (PCS) Conducted Powers -1.4 MHz Bandwidth**

LTE Band 25 (PCS) 1.4 MHz Bandwidth							
Modulation	RB Size	RB Offset	Low Channel	Mid Channel	High Channel	MPR Allowed per 3GPP [dB]	MPR [dB]
			26047 (1850.7 MHz)	26365 (1882.5 MHz)	26683 (1914.3 MHz)		
			Conducted Power [dBm]				
QPSK	1	0	24.75	24.68	24.83	0	0
	1	2	24.64	24.54	24.82		0
	1	5	24.71	24.69	24.88		0
	3	0	24.55	24.80	24.67		0
	3	2	24.74	24.65	24.67		0
	3	3	24.60	24.56	24.58		0
	6	0	23.90	23.65	23.86		0-1
16QAM	1	0	23.95	23.54	23.78	0-1	1
	1	2	23.83	23.43	23.52		1
	1	5	24.05	23.61	23.75		1
	3	0	23.84	23.93	23.68		1
	3	2	23.76	23.84	23.59		1
	3	3	23.85	24.02	23.44		1
	6	0	22.54	22.82	22.77		0-2

9.4.6 LTE Band 41 Power Class 3

**Table 9-27
LTE Band 41 Conducted Powers - 20 MHz Bandwidth**

LTE Band 41 20 MHz Bandwidth										
Modulation	RB Size	RB Offset	Low Channel	Low-Mid Channel	Mid Channel	Mid-High Channel	High Channel	MPR Allowed per 3GPP [dB]	MPR [dB]	
			39750 (2506.0 MHz)	40185 (2549.5 MHz)	40620 (2593.0 MHz)	41055 (2636.5 MHz)	41490 (2680.0 MHz)			
			Conducted Power [dBm]							
QPSK	1	0	24.95	24.98	25.09	25.00	25.15	0	0	
	1	50	24.87	24.70	24.87	24.82	24.80		0	
	1	99	24.82	24.96	24.87	25.04	24.95		0	
	QPSK	50	0	23.61	23.81	23.70	23.66	23.88	0-1	1
		50	25	23.69	23.62	23.73	23.63	23.72		1
		50	50	23.73	23.50	23.71	23.78	23.78		1
		100	0	23.69	23.61	23.63	23.86	23.65		1
16QAM	1	0	23.83	23.94	24.04	23.97	23.78	0-1	1	
	1	50	23.74	23.69	23.92	23.74	23.64		1	
	1	99	23.80	23.80	24.12	23.94	23.83		1	
	16QAM	50	0	22.53	22.93	22.93	22.74	22.66	0-2	2
		50	25	22.48	22.66	22.87	22.65	22.69		2
		50	50	22.58	22.53	22.78	22.68	22.79		2
		100	0	22.52	22.64	22.81	22.69	22.74		2





FCC ID: ZNFX410PM		SAR EVALUATION REPORT		Approved by: Quality Manager
Document S/N: 1M1806270133-01-R1.ZNF	Test Dates: 07/08/18 - 07/16/18	DUT Type: Portable Handset		Page 41 of 95

Table 9-28
LTE Band 41 Conducted Powers - 15 MHz Bandwidth

LTE Band 41 15 MHz Bandwidth										
Modulation	RB Size	RB Offset	Low Channel	Low-Mid Channel	Mid Channel	Mid-High Channel	High Channel	MPR Allowed per 3GPP [dB]	MPR [dB]	
			39750 (2506.0 MHz)	40185 (2549.5 MHz)	40620 (2593.0 MHz)	41055 (2636.5 MHz)	41490 (2680.0 MHz)			
Conducted Power [dBm]										
QPSK	1	0	24.78	25.12	24.97	24.95	25.13	0	0	
	1	36	24.66	24.87	24.81	24.86	24.77		0	
	1	74	24.79	24.89	24.82	24.78	25.00		0	
	QPSK	36	0	23.71	23.69	23.70	23.77	23.60	0-1	1
		36	18	23.69	23.69	23.61	23.69	23.66		1
		36	37	23.60	23.60	23.76	23.69	23.70		1
		75	0	23.63	23.64	23.74	23.64	23.70		1
16QAM	1	0	23.78	24.00	23.99	23.79	23.87	0-1	1	
	1	36	23.65	23.71	23.78	23.81	23.67		1	
	1	74	23.72	23.76	23.92	23.84	23.86		1	
	16QAM	36	0	22.65	22.62	22.69	22.56	22.59	0-2	2
		36	18	22.43	22.47	22.68	22.57	22.64		2
		36	37	22.44	22.68	22.77	22.72	22.52		2
		75	0	22.47	22.64	22.67	22.65	22.56		2



Table 9-29
LTE Band 41 Conducted Powers - 10 MHz Bandwidth

LTE Band 41 10 MHz Bandwidth										
Modulation	RB Size	RB Offset	Low Channel	Low-Mid Channel	Mid Channel	Mid-High Channel	High Channel	MPR Allowed per 3GPP [dB]	MPR [dB]	
			39750 (2506.0 MHz)	40185 (2549.5 MHz)	40620 (2593.0 MHz)	41055 (2636.5 MHz)	41490 (2680.0 MHz)			
Conducted Power [dBm]										
QPSK	1	0	24.53	24.81	24.75	24.84	24.83	0	0	
	1	25	24.70	24.85	24.74	24.82	24.93		0	
	1	49	24.74	24.83	24.89	24.76	25.01		0	
	QPSK	25	0	23.51	23.57	23.64	23.64	23.74	0-1	1
		25	12	23.45	23.63	23.65	23.71	23.61		1
		25	25	23.57	23.57	23.66	23.79	23.59		1
16QAM	50	0	23.48	23.59	23.72	23.66	23.54	0-2	1	
	1	0	23.58	23.76	23.80	23.71	23.75		1	
	1	25	23.64	23.70	23.86	23.73	23.70		1	
	1	49	23.69	23.71	23.95	23.75	23.79		1	
	25	0	22.50	22.65	22.68	22.58	22.60		2	
	25	12	22.48	22.66	22.65	22.75	22.60		2	
16QAM	25	25	22.54	22.65	22.65	22.71	22.63	0-2	2	
	50	0	22.49	22.72	22.78	22.61	22.76		2	

FCC ID: ZNFX410PM	 PCTEST ENGINEERING LABORATORY, INC.	SAR EVALUATION REPORT		Approved by: Quality Manager
Document S/N: 1M1806270133-01-R1.ZNF	Test Dates: 07/08/18 - 07/16/18	DUT Type: Portable Handset	Page 42 of 95	

**Table 9-30
LTE Band 41 Conducted Powers - 5 MHz Bandwidth**

LTE Band 41 5 MHz Bandwidth										
Modulation	RB Size	RB Offset	Low Channel	Low-Mid Channel	Mid Channel	Mid-High Channel	High Channel	MPR Allowed per 3GPP [dB]	MPR [dB]	
			39750 (2506.0 MHz)	40185 (2549.5 MHz)	40620 (2593.0 MHz)	41055 (2636.5 MHz)	41490 (2680.0 MHz)			
			Conducted Power [dBm]							
QPSK	1	0	24.61	24.65	24.71	24.67	24.80	0	0	
	1	12	24.67	24.76	24.83	24.75	24.87		0	
	1	24	24.68	24.67	24.58	24.67	24.73		0	
	QPSK	12	0	23.51	23.54	23.60	23.52	23.69	0-1	1
		12	6	23.46	23.68	23.54	23.66	23.76		1
		12	13	23.54	23.52	23.70	23.59	23.60		1
		25	0	23.55	23.66	23.55	23.71	23.57		1
1		0	23.52	23.58	23.75	23.73	23.71	1		
16QAM	1	12	23.53	23.73	23.84	23.77	23.78	0-1	1	
	1	24	23.52	23.58	23.82	23.58	23.61		1	
	12	0	22.62	22.53	22.70	22.59	22.58		2	
	16QAM	12	6	22.50	22.63	22.65	22.50	22.50	0-2	2
		12	13	22.56	22.53	22.72	22.67	22.60		2
		25	0	22.49	22.61	22.71	22.57	22.65		2

FCC ID: ZNFX410PM		SAR EVALUATION REPORT		Approved by: Quality Manager
Document S/N: 1M1806270133-01-R1.ZNF	Test Dates: 07/08/18 - 07/16/18	DUT Type: Portable Handset		Page 43 of 95

9.4.7

LTE Band 41 Power Class 2

Table 9-31
LTE Band 41 Conducted Powers - 20 MHz Bandwidth

LTE Band 41 20 MHz Bandwidth										
Modulation	RB Size	RB Offset	Low Channel	Low-Mid Channel	Mid Channel	Mid-High Channel	High Channel	MPR Allowed per 3GPP [dB]	MPR [dB]	
			39750 (2506.0 MHz)	40185 (2549.5 MHz)	40620 (2593.0 MHz)	41055 (2636.5 MHz)	41490 (2680.0 MHz)			
Conducted Power [dBm]										
QPSK	1	0	27.47	27.58	27.62	27.67	27.68	0	0	
	1	50	27.36	27.41	27.48	27.28	27.26		0	
	1	99	27.50	27.60	27.59	27.50	27.52		0	
	50	0	26.26	26.35	26.30	26.37	26.50	0-1	1	
	50	25	26.28	26.25	26.40	26.49	26.27		1	
	50	50	26.35	26.21	26.39	26.41	26.39		1	
100	0	26.33	26.25	26.24	26.39	26.40	0-1	1		
16QAM	1	0	26.61	26.60	26.63	26.53		26.67	1	
	1	50	26.45	26.54	26.59	26.55		26.51	1	
	1	99	26.61	26.56	26.66	26.62		26.64	1	
	50	0	25.16	25.41	25.51	25.29		25.29	0-2	2
	50	25	25.24	25.28	25.50	25.30		25.26		2
	50	50	25.20	25.28	25.35	25.34	25.33	2		
100	0	25.20	25.33	25.40	25.42	25.37	2			

Table 9-32
LTE Band 41 Conducted Powers - 15 MHz Bandwidth

LTE Band 41 15 MHz Bandwidth										
Modulation	RB Size	RB Offset	Low Channel	Low-Mid Channel	Mid Channel	Mid-High Channel	High Channel	MPR Allowed per 3GPP [dB]	MPR [dB]	
			39750 (2506.0 MHz)	40185 (2549.5 MHz)	40620 (2593.0 MHz)	41055 (2636.5 MHz)	41490 (2680.0 MHz)			
Conducted Power [dBm]										
QPSK	1	0	27.35	27.58	27.53	27.39	27.49	0	0	
	1	36	27.25	27.40	27.22	27.21	27.33		0	
	1	74	27.33	27.43	27.31	27.39	27.51		0	
	36	0	26.22	26.39	26.43	26.50	26.36	0-1	1	
	36	18	26.25	26.47	26.37	26.31	26.36		1	
	36	37	26.25	26.27	26.28	26.27	26.34		1	
75	0	26.26	26.37	26.34	26.44	26.46	0-1	1		
16QAM	1	0	26.58	26.54	26.67	26.63		26.64	1	
	1	36	26.40	26.58	26.63	26.54		26.61	1	
	1	74	26.53	26.63	26.65	26.67		26.65	1	
	36	0	25.09	25.36	25.35	25.37		25.39	0-2	2
	36	18	25.16	25.21	25.35	25.34		25.25		2
	36	37	25.24	25.28	25.28	25.37	25.37	2		
75	0	25.11	25.24	25.30	25.43	25.22	2			





FCC ID: ZNFX410PM		SAR EVALUATION REPORT		Approved by: Quality Manager
Document S/N: 1M1806270133-01-R1.ZNF	Test Dates: 07/08/18 - 07/16/18	DUT Type: Portable Handset		Page 44 of 95

Table 9-33
LTE Band 41 Conducted Powers - 10 MHz Bandwidth

LTE Band 41 10 MHz Bandwidth										
Modulation	RB Size	RB Offset	Low Channel	Low-Mid Channel	Mid Channel	Mid-High Channel	High Channel	MPR Allowed per 3GPP [dB]	MPR [dB]	
			39750 (2506.0 MHz)	40185 (2549.5 MHz)	40620 (2593.0 MHz)	41055 (2636.5 MHz)	41490 (2680.0 MHz)			
Conducted Power [dBm]										
QPSK	1	0	27.11	27.38	27.39	27.36	27.53	0	0	
	1	25	27.05	27.32	27.29	27.23	27.41		0	
	1	49	27.30	27.50	27.35	27.43	27.40		0	
	QPSK	25	0	26.12	26.29	26.40	26.28	26.27	0-1	1
		25	12	26.11	26.20	26.24	26.29	26.30		1
		25	25	26.14	26.32	26.27	26.31	26.42		1
		50	0	26.24	26.34	26.31	26.40	26.27		1
50		12	26.11	26.20	26.24	26.29	26.30	1		
16QAM	1	0	26.49	26.11	26.45	26.66	26.63	0-1	1	
	1	25	26.52	26.60	26.63	26.43	26.64		1	
	1	49	26.44	26.19	26.68	26.63	26.60		1	
	16QAM	25	0	25.04	25.16	25.25	25.18	25.17	0-2	2
		25	12	25.17	25.28	25.32	25.29	25.14		2
		25	25	25.16	25.18	25.36	25.21	25.42		2
		50	0	25.16	25.25	25.26	25.38	25.25		2

Table 9-34
LTE Band 41 Conducted Powers - 5 MHz Bandwidth

LTE Band 41 5 MHz Bandwidth											
Modulation	RB Size	RB Offset	Low Channel	Low-Mid Channel	Mid Channel	Mid-High Channel	High Channel	MPR Allowed per 3GPP [dB]	MPR [dB]		
			39750 (2506.0 MHz)	40185 (2549.5 MHz)	40620 (2593.0 MHz)	41055 (2636.5 MHz)	41490 (2680.0 MHz)				
Conducted Power [dBm]											
QPSK	1	0	27.20	27.21	27.30	27.25	27.33	0	0		
	1	12	27.18	27.24	27.32	27.38	27.21		0		
	1	24	27.25	27.24	27.15	27.17	27.23		0		
	QPSK	12	0	26.18	26.33	26.15	26.17	26.38	0-1	1	
		12	6	26.18	26.27	26.27	26.30	26.25		1	
		12	13	26.13	26.17	26.23	26.29	26.31		1	
16QAM	25	0	26.09	26.20	26.27	26.32	26.30	0-2	1		
	1	0	26.34	26.48	26.50	26.46	26.44		0-1	1	
	1	12	26.31	26.55	26.51	26.55	26.48			1	
	16QAM	1	24	26.41	26.45	26.64	26.42		26.48	0-2	1
		12	0	25.19	25.28	25.25	25.30		25.23		2
		12	6	25.13	25.25	25.29	25.32		25.23		2
		12	13	25.21	25.24	25.46	25.25		25.23		2
25	0	25.00	25.20	25.24	25.27	25.21	2				

FCC ID: ZNFX410PM		SAR EVALUATION REPORT		Approved by: Quality Manager
Document S/N: 1M1806270133-01-R1.ZNF	Test Dates: 07/08/18 - 07/16/18	DUT Type: Portable Handset		Page 45 of 95

9.5 WLAN Conducted Powers

Table 9-35
2.4 GHz WLAN Maximum Average RF Power

2.4GHz Conducted Power [dBm]				
Freq [MHz]	Channel	IEEE Transmission Mode		
		802.11b	802.11g	802.11n
		Average	Average	Average
2412	1	18.44	14.24	14.01
2417	2	N/A	15.95	16.20
2437	6	18.15	15.51	15.67
2457	10	N/A	15.57	15.91
2462	11	18.01	13.76	13.55

Table 9-36
5 GHz WLAN Maximum Average RF Power

5GHz (20MHz) Conducted Power [dBm]				
Freq [MHz]	Channel	IEEE Transmission Mode		
		802.11a	802.11n	802.11ac
		Average	Average	Average
5180	36	15.52	15.10	12.54
5200	40	17.63	17.80	12.61
5220	44	17.53	17.67	12.56
5240	48	17.70	17.83	12.53
5260	52	17.57	17.94	12.53
5280	56	17.78	17.89	12.75
5300	60	17.75	17.94	12.57
5320	64	15.63	15.28	12.55
5500	100	15.59	15.32	12.55
5520	104	18.15	18.21	12.39
5600	120	18.53	18.19	12.62
5620	124	18.46	18.17	12.79
5720	144	18.40	18.62	13.04
5745	149	18.76	18.43	12.73
5785	157	18.77	18.48	12.81
5805	161	18.51	18.36	12.46
5825	165	15.83	15.53	12.73



FCC ID: ZNFX410PM		SAR EVALUATION REPORT		Approved by: Quality Manager
Document S/N: 1M1806270133-01-R1.ZNF	Test Dates: 07/08/18 - 07/16/18	DUT Type: Portable Handset		Page 46 of 95

Table 9-37
2.4 GHz WLAN Reduced Average RF Power



2.4GHz Conducted Power [dBm]				
Freq [MHz]	Channel	IEEE Transmission Mode		
		802.11b	802.11g	802.11n
		Average	Average	Average
2412	1	16.26	14.24	14.01
2417	2	N/A	15.95	16.20
2437	6	16.04	15.51	15.67
2457	10	N/A	15.57	15.91
2462	11	15.92	13.76	13.55

Table 9-38
5 GHz WLAN Reduced Average RF Power

5GHz (40MHz) Conducted Power [dBm]		
Freq [MHz]	Channel	IEEE Transmission Mode
		802.11n
		Average
5190	38	11.20
5230	46	11.23
5270	54	10.85
5310	62	10.72
5510	102	11.26
5590	118	11.26
5630	126	11.20
5710	142	10.89
5755	151	11.28
5795	159	11.29

Justification for test configurations for WLAN per KDB Publication 248227 D01v02r02:

- Power measurements were performed for the transmission mode configuration with the highest maximum output power specified for production units.
- For transmission modes with the same maximum output power specification, powers were measured for the largest channel bandwidth, lowest order modulation and lowest data rate.
- For transmission modes with identical maximum specified output power, channel bandwidth, modulation and data rates, power measurements were required for all identical configurations.
- For each transmission mode configuration, powers were measured for the highest and lowest channels; and at the mid-band channel(s) when there were at least 3 channels supported. For configurations with multiple mid-band channels, due to an even number of channels, both channels were measured.
- The bolded data rate and channel above were tested for SAR.

FCC ID: ZNFX410PM	 PCTEST ENGINEERING LABORATORY, INC.	SAR EVALUATION REPORT		Approved by: Quality Manager
Document S/N: 1M1806270133-01-R1.ZNF	Test Dates: 07/08/18 - 07/16/18	DUT Type: Portable Handset	Page 47 of 95	

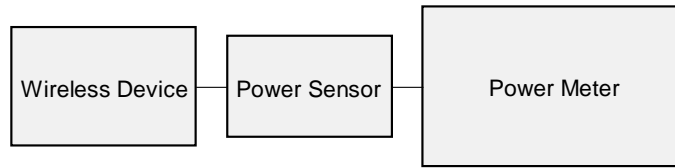



Figure 9-4
Power Measurement Setup

9.6 Bluetooth Conducted Powers

Table 9-39
Bluetooth Average RF Power

Frequency [MHz]	Data Rate [Mbps]	Channel No.	Avg Conducted Power	
			[dBm]	[mW]
2402	1.0	0	4.97	3.137
2441	1.0	39	7.33	5.402
2480	1.0	78	9.60	9.111
2402	2.0	0	2.37	1.725
2441	2.0	39	4.76	2.994
2480	2.0	78	7.08	5.099
2402	3.0	0	2.45	1.757
2441	3.0	39	4.84	3.049
2480	3.0	78	7.14	5.181

Note: The bolded data rates and channel above were tested for SAR.

FCC ID: ZNFX410PM	 PCTEST ENGINEERING LABORATORY, INC.	SAR EVALUATION REPORT		Approved by: Quality Manager
Document S/N: 1M1806270133-01-R1.ZNF	Test Dates: 07/08/18 - 07/16/18	DUT Type: Portable Handset	Page 48 of 95	

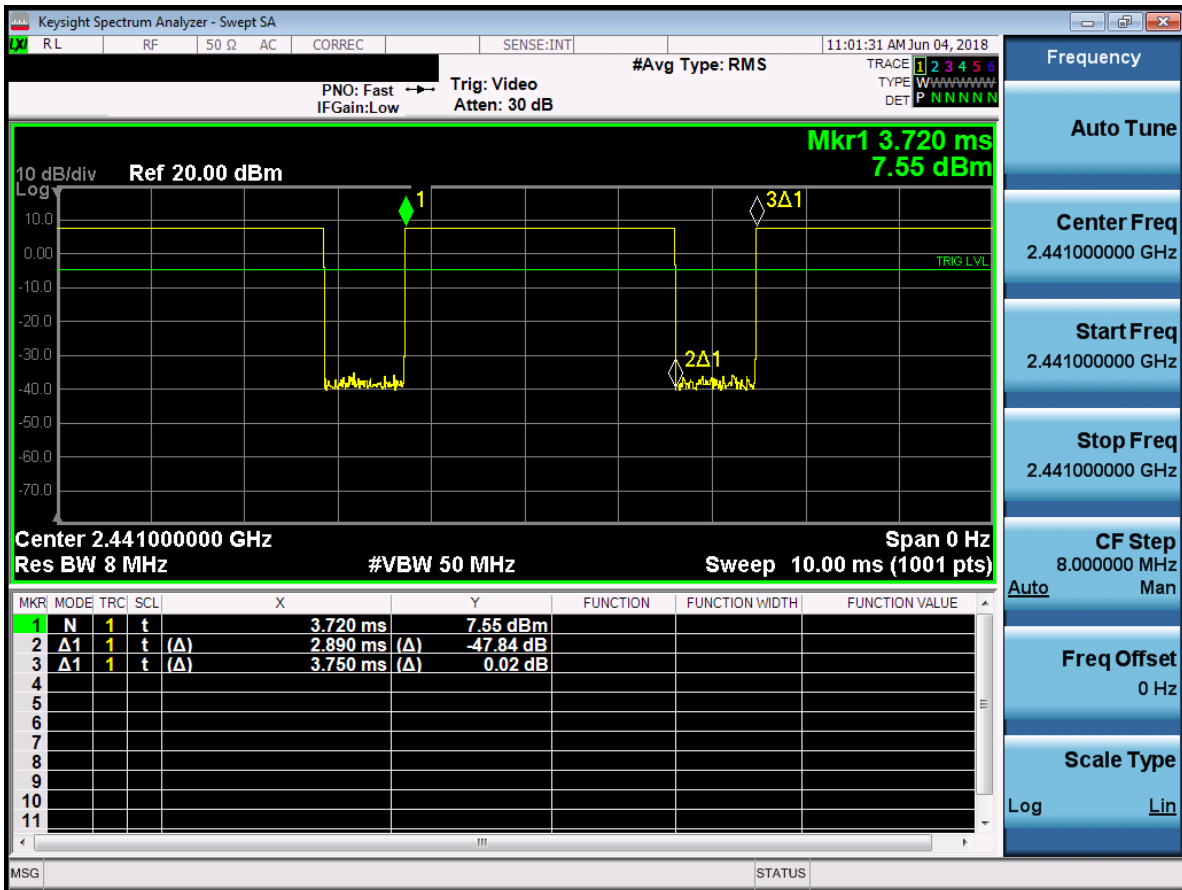

Figure 9-5
Bluetooth Transmission Plot

Equation 9-1
Bluetooth Duty Cycle Calculation

$$Duty\ Cycle = \frac{Pulse\ Width}{Period} * 100\% = \frac{2.89ms}{3.75ms} * 100\% = 77.1\%$$

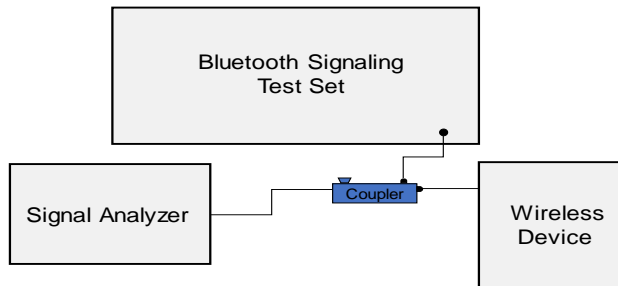

Figure 9-6
Power Measurement Setup



FCC ID: ZNFX410PM	PCTEST ENGINEERING LABORATORY, INC.	SAR EVALUATION REPORT	LG	Approved by: Quality Manager
Document S/N: 1M1806270133-01-R1.ZNF	Test Dates: 07/08/18 - 07/16/18	DUT Type: Portable Handset		Page 49 of 95

10 SYSTEM VERIFICATION

10.1 Tissue Verification

**Table 10-1
Head Measured Tissue Properties**



Calibrated for Tests Performed on:	Tissue Type	Tissue Temp During Calibration (°C)	Measured Frequency (MHz)	Measured Conductivity, σ (S/m)	Measured Dielectric Constant, ϵ	TARGET Conductivity, σ (S/m)	TARGET Dielectric Constant, ϵ	% dev σ	% dev ϵ
7/12/2018	750H	21.6	700	0.850	42.628	0.889	42.201	-4.39%	1.01%
			710	0.861	42.504	0.890	42.149	-3.26%	0.84%
			740	0.886	42.030	0.893	41.994	-0.78%	0.09%
			755	0.900	41.911	0.894	41.916	0.67%	-0.01%
			770	0.916	41.672	0.895	41.838	2.35%	-0.40%
			785	0.930	41.451	0.896	41.760	3.79%	-0.74%
7/9/2018	835H	19.9	820	0.912	42.855	0.899	41.578	1.45%	3.07%
			835	0.917	42.813	0.900	41.500	1.89%	3.16%
			850	0.923	42.773	0.916	41.500	0.76%	3.07%
7/10/2018	1750H	21.1	1710	1.330	39.904	1.348	40.142	-1.34%	-0.59%
			1750	1.353	39.840	1.371	40.079	-1.31%	-0.60%
			1790	1.374	39.772	1.394	40.016	-1.43%	-0.61%
7/12/2018	1900H	22.8	1850	1.432	40.058	1.400	40.000	2.29%	0.15%
			1880	1.446	40.050	1.400	40.000	3.29%	0.12%
			1910	1.469	40.000	1.400	40.000	4.93%	0.00%
7/11/2018	2450H	22.4	2400	1.792	38.140	1.756	39.289	2.05%	-2.92%
			2450	1.842	37.957	1.800	39.200	2.33%	-3.17%
			2500	1.903	37.745	1.855	39.136	2.59%	-3.55%
			2600	2.006	37.343	1.964	39.009	2.14%	-4.27%
			2650	2.064	37.161	2.018	38.945	2.28%	-4.58%
			2700	2.113	36.952	2.073	38.882	1.93%	-4.96%
7/9/2018	5200H-5800H	20.3	5240	4.607	35.738	4.696	35.940	-1.90%	-0.56%
			5260	4.628	35.683	4.717	35.917	-1.89%	-0.65%
			5280	4.655	35.637	4.737	35.894	-1.73%	-0.72%
			5300	4.669	35.624	4.758	35.871	-1.87%	-0.69%
			5320	4.693	35.577	4.778	35.849	-1.78%	-0.76%
			5500	4.886	35.265	4.963	35.643	-1.55%	-1.06%
			5520	4.917	35.198	4.983	35.620	-1.32%	-1.18%
			5580	4.984	35.106	5.045	35.551	-1.21%	-1.25%
			5600	5.014	35.059	5.065	35.529	-1.01%	-1.32%
			5745	5.183	34.784	5.214	35.363	-0.59%	-1.64%
			5765	5.211	34.730	5.234	35.340	-0.44%	-1.73%
			5785	5.226	34.702	5.255	35.317	-0.55%	-1.74%
			5800	5.247	34.675	5.270	35.300	-0.44%	-1.77%

FCC ID: ZNFX410PM	 PCTEST ENGINEERING LABORATORY, INC.	SAR EVALUATION REPORT	 LG	Approved by: Quality Manager
Document S/N: 1M1806270133-01-R1.ZNF	Test Dates: 07/08/18 - 07/16/18	DUT Type: Portable Handset		Page 50 of 95

**Table 10-2
Body Measured Tissue Properties**

Calibrated for Tests Performed on:	Tissue Type	Tissue Temp During Calibration (°C)	Measured Frequency (MHz)	Measured Conductivity, σ (S/m)	Measured Dielectric Constant, ϵ	TARGET Conductivity, σ (S/m)	TARGET Dielectric Constant, ϵ	% dev σ	% dev ϵ
7/11/2018	750B	21.8	700	0.947	54.202	0.959	55.726	-1.25%	-2.73%
			710	0.952	54.172	0.960	55.687	-0.83%	-2.72%
			740	0.962	54.145	0.963	55.570	-0.10%	-2.56%
			755	0.966	54.137	0.964	55.512	0.21%	-2.48%
			770	0.974	54.049	0.965	55.453	0.93%	-2.53%
			785	0.979	54.018	0.966	55.395	1.35%	-2.49%
7/13/2018	835B	20.6	820	1.008	53.472	0.969	55.258	4.02%	-3.23%
			835	1.014	53.336	0.970	55.200	4.54%	-3.38%
			850	1.015	53.370	0.988	55.154	2.73%	-3.23%
7/10/2018	1750B	21.8	1710	1.471	52.126	1.463	53.537	0.55%	-2.64%
			1750	1.493	51.998	1.488	53.432	0.34%	-2.68%
			1790	1.524	51.963	1.514	53.326	0.66%	-2.56%
7/8/2018	1900B	22.2	1850	1.506	52.525	1.520	53.300	-0.92%	-1.45%
			1880	1.541	52.499	1.520	53.300	1.38%	-1.50%
			1910	1.578	52.368	1.520	53.300	3.82%	-1.75%
7/11/2018	1900B	22.3	1850	1.511	52.497	1.520	53.300	-0.59%	-1.51%
			1880	1.544	52.399	1.520	53.300	1.58%	-1.69%
			1910	1.576	52.306	1.520	53.300	3.68%	-1.86%
7/16/2018	1900B	21.4	1850	1.509	51.758	1.520	53.300	-0.72%	-2.89%
			1880	1.541	51.653	1.520	53.300	1.38%	-3.09%
			1910	1.579	51.555	1.520	53.300	3.88%	-3.27%
7/9/2018	2450B	22.8	2400	1.934	51.497	1.902	52.767	1.68%	-2.41%
			2450	1.984	51.351	1.950	52.700	1.74%	-2.56%
			2500	2.053	51.215	2.021	52.636	1.58%	-2.70%
			2550	2.104	51.066	2.092	52.573	0.57%	-2.87%
			2600	2.167	50.890	2.163	52.509	0.18%	-3.08%
			2650	2.232	50.770	2.234	52.445	-0.09%	-3.19%
			2700	2.284	50.557	2.305	52.382	-0.91%	-3.48%
7/12/2018	2450B	21.6	2600	2.190	50.319	2.163	52.509	1.25%	-4.17%
			2650	2.253	50.162	2.234	52.445	0.85%	-4.35%
			2700	2.305	49.992	2.305	52.382	0.00%	-4.56%
7/9/2018	5200B-5800B	21.8	5200	5.396	48.353	5.299	49.014	1.83%	-1.35%
			5220	5.435	48.278	5.323	48.987	2.10%	-1.45%
			5240	5.453	48.252	5.346	48.960	2.00%	-1.45%
			5260	5.481	48.187	5.369	48.933	2.09%	-1.52%
			5280	5.504	48.182	5.393	48.906	2.06%	-1.48%
			5600	5.941	47.649	5.766	48.471	3.04%	-1.70%
			5745	6.150	47.377	5.936	48.275	3.61%	-1.86%
			5765	6.176	47.352	5.959	48.248	3.64%	-1.86%
			5785	6.204	47.321	5.982	48.220	3.71%	-1.86%

The above measured tissue parameters were used in the DASY software. The DASY software was used to perform interpolation to determine the dielectric parameters at the SAR test device frequencies (per KDB Publication 865664 D01v01r04 and IEEE 1528-2013 6.6.1.2). The tissue parameters listed in the SAR test plots may slightly differ from the table above due to significant digit rounding in the software.

FCC ID: ZNFX410PM		SAR EVALUATION REPORT		Approved by: Quality Manager
Document S/N: 1M1806270133-01-R1.ZNF	Test Dates: 07/08/18 - 07/16/18	DUT Type: Portable Handset	Page 51 of 95	

10.2 Test System Verification

Prior to SAR assessment, the system is verified to $\pm 10\%$ of the SAR measurement on the reference dipole at the time of calibration by the calibration facility. Full system validation status and result summary can be found in Appendix E.

**Table 10-3
System Verification Results**

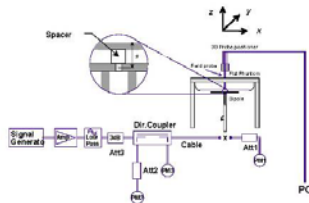

System Verification TARGET & MEASURED												
SAR System #	Tissue Frequency (MHz)	Tissue Type	Date:	Amb. Temp (°C)	Liquid Temp (°C)	Input Power (W)	Source SN	Probe SN	Measured SAR _{1g} (W/kg)	1 W Target SAR _{1g} (W/kg)	1 W Normalized SAR _{1g} (W/kg)	Deviation _{1g} (%)
G	750	HEAD	07/12/2018	23.6	21.6	0.200	1054	3332	1.560	8.370	7.800	-6.81%
E	835	HEAD	07/09/2018	20.9	19.9	0.200	4d047	3213	1.890	9.130	9.450	3.50%
E	1750	HEAD	07/10/2018	23.3	21.1	0.100	1150	3213	3.570	36.100	35.700	-1.11%
E	1900	HEAD	07/12/2018	24.0	22.8	0.100	5d148	3213	4.130	40.100	41.300	2.99%
G	2450	HEAD	07/11/2018	21.9	21.4	0.100	882	3332	5.270	52.200	52.700	0.96%
G	2600	HEAD	07/11/2018	21.9	21.4	0.100	1004	3332	5.850	55.900	58.500	4.65%
H	5250	HEAD	07/09/2018	20.3	20.3	0.050	1191	7409	3.820	78.900	76.400	-3.17%
H	5600	HEAD	07/09/2018	20.3	20.3	0.050	1191	7409	4.060	83.600	81.200	-2.87%
H	5750	HEAD	07/09/2018	20.3	20.3	0.050	1191	7409	3.810	79.100	76.200	-3.67%
H	750	BODY	07/11/2018	23.8	21.3	0.200	1161	7409	1.740	8.430	8.700	3.20%
J	835	BODY	07/13/2018	20.5	20.6	0.200	4d047	3347	1.910	9.570	9.550	-0.21%
J	1750	BODY	07/10/2018	22.0	21.8	0.100	1150	3347	3.610	36.500	36.100	-1.10%
I	1900	BODY	07/08/2018	20.3	21.1	0.100	5d080	7406	4.110	39.100	41.100	5.12%
I	1900	BODY	07/11/2018	21.3	21.8	0.100	5d149	7406	4.280	40.100	42.800	6.73%
I	1900	BODY	07/16/2018	21.3	21.3	0.100	5d080	7406	4.090	39.100	40.900	4.60%
K	2450	BODY	07/09/2018	22.2	22.0	0.100	797	3319	5.270	51.100	52.700	3.13%
K	2600	BODY	07/09/2018	22.2	22.0	0.100	1126	3319	5.610	54.300	56.100	3.31%
K	2600	BODY	07/12/2018	23.3	21.6	0.100	1004	3319	5.580	54.800	55.800	1.82%
D	5250	BODY	07/09/2018	21.5	20.8	0.050	1237	7357	3.580	76.900	71.600	-6.89%
D	5600	BODY	07/09/2018	21.5	20.8	0.050	1237	7357	3.960	78.500	79.200	0.89%
D	5750	BODY	07/09/2018	21.5	20.8	0.050	1237	7357	3.700	77.100	74.000	-4.02%



**Figure 10-1
System Verification Setup Diagram**



**Figure 10-2
System Verification Setup Photo**

FCC ID: ZNFX410PM	 PCTEST ENGINEERING LABORATORY, INC.	SAR EVALUATION REPORT	 LG	Approved by: Quality Manager
Document S/N: 1M1806270133-01-R1.ZNF	Test Dates: 07/08/18 - 07/16/18	DUT Type: Portable Handset	Page 52 of 95	

11 SAR DATA SUMMARY



11.1 Standalone Head SAR Data

**Table 11-1
CDMA BC10 (\$90S) Head SAR**

MEASUREMENT RESULTS														
FREQUENCY		Mode/Band	Service	Maximum Allowed Power [dBm]	Conducted Power [dBm]	Power Drift [dB]	Side	Test Position	Device Serial Number	Duty Cycle	SAR (1g)	Scaling Factor	Reported SAR (1g)	Plot #
MHz	Ch.										(W/kg)		(W/kg)	
820.10	564	CDMA BC10 (\$90S)	RC3 / SO55	25.2	24.97	-0.01	Right	Cheek	04397	1:1	0.459	1.054	0.484	
820.10	564	CDMA BC10 (\$90S)	RC3 / SO55	25.2	24.97	0.03	Right	Tilt	04397	1:1	0.255	1.054	0.269	
820.10	564	CDMA BC10 (\$90S)	RC3 / SO55	25.2	24.97	0.00	Left	Cheek	04397	1:1	0.421	1.054	0.444	
820.10	564	CDMA BC10 (\$90S)	RC3 / SO55	25.2	24.97	0.04	Left	Tilt	04397	1:1	0.246	1.054	0.259	
820.10	564	CDMA BC10 (\$90S)	EVDO Rev. A	25.2	25.19	0.00	Right	Cheek	04397	1:1	0.475	1.002	0.476	A1
820.10	564	CDMA BC10 (\$90S)	EVDO Rev. A	25.2	25.19	0.01	Right	Tilt	04397	1:1	0.257	1.002	0.258	
820.10	564	CDMA BC10 (\$90S)	EVDO Rev. A	25.2	25.19	-0.01	Left	Cheek	04397	1:1	0.437	1.002	0.438	
820.10	564	CDMA BC10 (\$90S)	EVDO Rev. A	25.2	25.19	-0.04	Left	Tilt	04397	1:1	0.261	1.002	0.262	
ANSI / IEEE C95.1 1992 - SAFETY LIMIT Spatial Peak Uncontrolled Exposure/General Population								Head 1.6 W/kg (mW/g) averaged over 1 gram						

**Table 11-2
CDMA BC0 (\$22H) Head SAR**

MEASUREMENT RESULTS														
FREQUENCY		Mode/Band	Service	Maximum Allowed Power [dBm]	Conducted Power [dBm]	Power Drift [dB]	Side	Test Position	Device Serial Number	Duty Cycle	SAR (1g)	Scaling Factor	Reported SAR (1g)	Plot #
MHz	Ch.										(W/kg)		(W/kg)	
836.52	384	CDMA BC0 (\$22H)	RC3 / SO55	25.2	25.13	0.01	Right	Cheek	04397	1:1	0.500	1.016	0.508	
836.52	384	CDMA BC0 (\$22H)	RC3 / SO55	25.2	25.13	0.01	Right	Tilt	04397	1:1	0.308	1.016	0.313	
836.52	384	CDMA BC0 (\$22H)	RC3 / SO55	25.2	25.13	0.03	Left	Cheek	04397	1:1	0.473	1.016	0.481	
836.52	384	CDMA BC0 (\$22H)	RC3 / SO55	25.2	25.13	0.03	Left	Tilt	04397	1:1	0.293	1.016	0.298	
836.52	384	CDMA BC0 (\$22H)	EVDO Rev. A	25.2	25.09	-0.04	Right	Cheek	04397	1:1	0.517	1.026	0.530	A2
836.52	384	CDMA BC0 (\$22H)	EVDO Rev. A	25.2	25.09	0.07	Right	Tilt	04397	1:1	0.269	1.026	0.276	
836.52	384	CDMA BC0 (\$22H)	EVDO Rev. A	25.2	25.09	0.05	Left	Cheek	04397	1:1	0.443	1.026	0.455	
836.52	384	CDMA BC0 (\$22H)	EVDO Rev. A	25.2	25.09	0.01	Left	Tilt	04397	1:1	0.260	1.026	0.267	
ANSI / IEEE C95.1 1992 - SAFETY LIMIT Spatial Peak Uncontrolled Exposure/General Population								Head 1.6 W/kg (mW/g) averaged over 1 gram						

FCC ID: ZNFX410PM		SAR EVALUATION REPORT		Approved by: Quality Manager
Document S/N: 1M1806270133-01-R1.ZNF	Test Dates: 07/08/18 - 07/16/18	DUT Type: Portable Handset	Page 53 of 95	

**Table 11-3
GSM 850 Head SAR**



MEASUREMENT RESULTS															
FREQUENCY		Mode/Band	Service	Maximum Allowed Power [dBm]	Conducted Power [dBm]	Power Drift [dB]	Side	Test Position	Device Serial Number	# of Time Slots	Duty Cycle	SAR (1g)	Scaling Factor	Reported SAR (1g)	Plot #
MHz	Ch.											(W/kg)		(W/kg)	
836.60	190	GSM 850	GSM	33.7	33.61	-0.03	Right	Cheek	04397	1	1:8.3	0.452	1.021	0.461	
836.60	190	GSM 850	GSM	33.7	33.61	-0.01	Right	Tilt	04397	1	1:8.3	0.259	1.021	0.264	
836.60	190	GSM 850	GSM	33.7	33.61	0.00	Left	Cheek	04397	1	1:8.3	0.400	1.021	0.408	
836.60	190	GSM 850	GSM	33.7	33.61	0.02	Left	Tilt	04397	1	1:8.3	0.235	1.021	0.240	
836.60	190	GSM 850	GPRS	31.7	31.54	-0.05	Right	Cheek	04397	2	1:4.15	0.568	1.038	0.590	A3
836.60	190	GSM 850	GPRS	31.7	31.54	0.02	Right	Tilt	04397	2	1:4.15	0.338	1.038	0.351	
836.60	190	GSM 850	GPRS	31.7	31.54	0.05	Left	Cheek	04397	2	1:4.15	0.496	1.038	0.515	
836.60	190	GSM 850	GPRS	31.7	31.54	0.01	Left	Tilt	04397	2	1:4.15	0.311	1.038	0.323	
ANSI / IEEE C95.1 1992 - SAFETY LIMIT Spatial Peak Uncontrolled Exposure/General Population							Head 1.6 W/kg (mW/g) averaged over 1 gram								

**Table 11-4
UMTS 850 Head SAR**

MEASUREMENT RESULTS														
FREQUENCY		Mode/Band	Service	Maximum Allowed Power [dBm]	Conducted Power [dBm]	Power Drift [dB]	Side	Test Position	Device Serial Number	Duty Cycle	SAR (1g)	Scaling Factor	Reported SAR (1g)	Plot #
MHz	Ch.										(W/kg)		(W/kg)	
836.60	4183	UMTS 850	RMC	24.7	24.61	0.02	Right	Cheek	04397	1:1	0.496	1.021	0.506	A4
836.60	4183	UMTS 850	RMC	24.7	24.61	0.02	Right	Tilt	04397	1:1	0.271	1.021	0.277	
836.60	4183	UMTS 850	RMC	24.7	24.61	-0.02	Left	Cheek	04397	1:1	0.403	1.021	0.411	
836.60	4183	UMTS 850	RMC	24.7	24.61	0.08	Left	Tilt	04397	1:1	0.251	1.021	0.256	
ANSI / IEEE C95.1 1992 - SAFETY LIMIT Spatial Peak Uncontrolled Exposure/General Population							Head 1.6 W/kg (mW/g) averaged over 1 gram							

**Table 11-5
UMTS 1750 Head SAR**

MEASUREMENT RESULTS														
FREQUENCY		Mode/Band	Service	Maximum Allowed Power [dBm]	Conducted Power [dBm]	Power Drift [dB]	Side	Test Position	Device Serial Number	Duty Cycle	SAR (1g)	Scaling Factor	Reported SAR (1g)	Plot #
MHz	Ch.										(W/kg)		(W/kg)	
1732.40	1412	UMTS 1750	RMC	24.7	24.70	-0.01	Right	Cheek	04462	1:1	0.287	1.000	0.287	
1732.40	1412	UMTS 1750	RMC	24.7	24.70	0.15	Right	Tilt	04462	1:1	0.165	1.000	0.165	
1732.40	1412	UMTS 1750	RMC	24.7	24.70	-0.02	Left	Cheek	04462	1:1	0.458	1.000	0.458	A5
1732.40	1412	UMTS 1750	RMC	24.7	24.70	0.06	Left	Tilt	04462	1:1	0.158	1.000	0.158	
ANSI / IEEE C95.1 1992 - SAFETY LIMIT Spatial Peak Uncontrolled Exposure/General Population							Head 1.6 W/kg (mW/g) averaged over 1 gram							



FCC ID: ZNFX410PM		SAR EVALUATION REPORT		Approved by: Quality Manager
Document S/N: 1M1806270133-01-R1.ZNF	Test Dates: 07/08/18 - 07/16/18	DUT Type: Portable Handset	Page 54 of 95	

**Table 11-6
PCS CDMA Head SAR**

MEASUREMENT RESULTS														
FREQUENCY		Mode/Band	Service	Maximum Allowed Power [dBm]	Conducted Power [dBm]	Power Drift [dB]	Side	Test Position	Device Serial Number	Duty Cycle	SAR (1g)	Scaling Factor	Reported SAR (1g)	Plot #
MHz	Ch.										(W/kg)		(W/kg)	
1880.00	600	PCS CDMA	RC3 / SO55	25.2	25.13	0.04	Right	Cheek	04397	1:1	0.412	1.016	0.419	
1880.00	600	PCS CDMA	RC3 / SO55	25.2	25.13	0.06	Right	Tilt	04397	1:1	0.227	1.016	0.231	
1851.25	25	PCS CDMA	RC3 / SO55	25.2	25.07	-0.01	Left	Cheek	04397	1:1	0.646	1.030	0.665	
1880.00	600	PCS CDMA	RC3 / SO55	25.2	25.13	-0.01	Left	Cheek	04397	1:1	0.678	1.016	0.689	
1908.75	1175	PCS CDMA	RC3 / SO55	25.2	25.20	0.05	Left	Cheek	04397	1:1	0.692	1.000	0.692	A6
1880.00	600	PCS CDMA	RC3 / SO55	25.2	25.13	0.09	Left	Tilt	04397	1:1	0.266	1.016	0.270	
1880.00	600	PCS CDMA	EVDO Rev. A	25.2	25.15	-0.02	Right	Cheek	04397	1:1	0.404	1.012	0.409	
1880.00	600	PCS CDMA	EVDO Rev. A	25.2	25.15	0.00	Right	Tilt	04397	1:1	0.228	1.012	0.231	
1851.25	25	PCS CDMA	EVDO Rev. A	25.2	25.12	0.01	Left	Cheek	04397	1:1	0.623	1.019	0.635	
1880.00	600	PCS CDMA	EVDO Rev. A	25.2	25.15	0.08	Left	Cheek	04397	1:1	0.682	1.012	0.690	
1908.75	1175	PCS CDMA	EVDO Rev. A	25.2	25.08	-0.15	Left	Cheek	04397	1:1	0.673	1.028	0.692	
1880.00	600	PCS CDMA	EVDO Rev. A	25.2	25.15	0.02	Left	Tilt	04397	1:1	0.243	1.012	0.246	
ANSI / IEEE C95.1 1992 - SAFETY LIMIT Spatial Peak Uncontrolled Exposure/General Population								Head 1.6 W/kg (mW/g) averaged over 1 gram						

**Table 11-7
GSM 1900 Head SAR**

MEASUREMENT RESULTS															
FREQUENCY		Mode/Band	Service	Maximum Allowed Power [dBm]	Conducted Power [dBm]	Power Drift [dB]	Side	Test Position	Device Serial Number	# of Time Slots	Duty Cycle	SAR (1g)	Scaling Factor	Reported SAR (1g)	Plot #
MHz	Ch.											(W/kg)		(W/kg)	
1880.00	661	GSM 1900	GSM	30.7	30.51	0.00	Right	Cheek	04397	1	1:8.3	0.197	1.045	0.206	
1880.00	661	GSM 1900	GSM	30.7	30.51	-0.04	Right	Tilt	04397	1	1:8.3	0.141	1.045	0.147	
1880.00	661	GSM 1900	GSM	30.7	30.51	-0.03	Left	Cheek	04397	1	1:8.3	0.326	1.045	0.341	
1880.00	661	GSM 1900	GSM	30.7	30.51	0.04	Left	Tilt	04397	1	1:8.3	0.152	1.045	0.159	
1880.00	661	GSM 1900	GPRS	28.7	28.61	-0.01	Right	Cheek	04397	2	1:4.15	0.211	1.021	0.215	
1880.00	661	GSM 1900	GPRS	28.7	28.61	0.17	Right	Tilt	04397	2	1:4.15	0.149	1.021	0.152	
1880.00	661	GSM 1900	GPRS	28.7	28.61	0.08	Left	Cheek	04397	2	1:4.15	0.386	1.021	0.394	A7
1880.00	661	GSM 1900	GPRS	28.7	28.61	-0.03	Left	Tilt	04397	2	1:4.15	0.163	1.021	0.166	
ANSI / IEEE C95.1 1992 - SAFETY LIMIT Spatial Peak Uncontrolled Exposure/General Population								Head 1.6 W/kg (mW/g) averaged over 1 gram							



FCC ID: ZNFX410PM	 PCTEST ENGINEERING LABORATORY, INC.	SAR EVALUATION REPORT		Approved by: Quality Manager
Document S/N: 1M1806270133-01-R1.ZNF	Test Dates: 07/08/18 - 07/16/18	DUT Type: Portable Handset		Page 55 of 95

**Table 11-8
UMTS 1900 Head SAR**

MEASUREMENT RESULTS														
FREQUENCY		Mode/Band	Service	Maximum Allowed Power [dBm]	Conducted Power [dBm]	Power Drift [dB]	Side	Test Position	Device Serial Number	Duty Cycle	SAR (1g)	Scaling Factor	Reported SAR (1g)	Plot #
MHz	Ch.										(W/kg)		(W/kg)	
1880.00	9400	UMTS 1900	RMC	24.7	24.63	0.15	Right	Cheek	04397	1:1	0.330	1.016	0.335	
1880.00	9400	UMTS 1900	RMC	24.7	24.63	0.03	Right	Tilt	04397	1:1	0.235	1.016	0.239	
1852.40	9262	UMTS 1900	RMC	24.7	24.65	0.00	Left	Cheek	04397	1:1	0.544	1.012	0.551	
1880.00	9400	UMTS 1900	RMC	24.7	24.63	0.00	Left	Cheek	04397	1:1	0.610	1.016	0.620	
1907.60	9538	UMTS 1900	RMC	24.7	24.62	0.02	Left	Cheek	04397	1:1	0.623	1.019	0.635	A8
1880.00	9400	UMTS 1900	RMC	24.7	24.63	0.03	Left	Tilt	04397	1:1	0.228	1.016	0.232	
ANSI / IEEE C95.1 1992 - SAFETY LIMIT Spatial Peak Uncontrolled Exposure/General Population							Head 1.6 W/kg (mW/g) averaged over 1 gram							

**Table 11-9
LTE Band 12 Head SAR**

MEASUREMENT RESULTS																			
FREQUENCY		Mode	Bandwidth [MHz]	Maximum Allowed Power [dBm]	Conducted Power [dBm]	Power Drift [dB]	MPR [dB]	Side	Test Position	Modulation	RB Size	RB Offset	Device Serial Number	Duty Cycle	SAR (1g)	Scaling Factor	Reported SAR (1g)	Plot #	
MHz	Ch.														(W/kg)		(W/kg)		
707.50	23095	Mid	LTE Band 12	10	25.2	24.97	-0.03	0	Right	Cheek	QPSK	1	0	04462	1:1	0.359	1.054	0.378	A9
707.50	23095	Mid	LTE Band 12	10	24.2	23.98	-0.03	1	Right	Cheek	QPSK	25	0	04462	1:1	0.255	1.052	0.268	
707.50	23095	Mid	LTE Band 12	10	25.2	24.97	-0.01	0	Right	Tilt	QPSK	1	0	04462	1:1	0.158	1.054	0.167	
707.50	23095	Mid	LTE Band 12	10	24.2	23.98	0.03	1	Right	Tilt	QPSK	25	0	04462	1:1	0.124	1.052	0.130	
707.50	23095	Mid	LTE Band 12	10	25.2	24.97	0.08	0	Left	Cheek	QPSK	1	0	04462	1:1	0.327	1.054	0.345	
707.50	23095	Mid	LTE Band 12	10	24.2	23.98	-0.03	1	Left	Cheek	QPSK	25	0	04462	1:1	0.252	1.052	0.265	
707.50	23095	Mid	LTE Band 12	10	25.2	24.97	0.02	0	Left	Tilt	QPSK	1	0	04462	1:1	0.167	1.054	0.176	
707.50	23095	Mid	LTE Band 12	10	24.2	23.98	0.03	1	Left	Tilt	QPSK	25	0	04462	1:1	0.135	1.052	0.142	
ANSI / IEEE C95.1 1992 - SAFETY LIMIT Spatial Peak Uncontrolled Exposure/General Population							Head 1.6 W/kg (mW/g) averaged over 1 gram												

FCC ID: ZNFX410PM		SAR EVALUATION REPORT		Approved by: Quality Manager
Document S/N: 1M1806270133-01-R1.ZNF	Test Dates: 07/08/18 - 07/16/18	DUT Type: Portable Handset	Page 56 of 95	

**Table 11-10
LTE Band 13 Head SAR**



MEASUREMENT RESULTS																			
FREQUENCY		Mode	Bandwidth [MHz]	Maximum Allowed Power [dBm]	Conducted Power [dBm]	Power Drift [dB]	MPR [dB]	Side	Test Position	Modulation	RB Size	RB Offset	Device Serial Number	Duty Cycle	SAR (1g)	Scaling Factor	Reported SAR (1g)	Plot #	
MHz	Ch.														(W/kg)		(W/kg)		
782.00	23230	Mid	LTE Band 13	10	25.2	25.20	-0.07	0	Right	Cheek	QPSK	1	49	04462	1:1	0.419	1.000	0.419	A10
782.00	23230	Mid	LTE Band 13	10	24.2	24.04	-0.02	1	Right	Cheek	QPSK	25	0	04462	1:1	0.343	1.038	0.356	
782.00	23230	Mid	LTE Band 13	10	25.2	25.20	0.00	0	Right	Tilt	QPSK	1	49	04462	1:1	0.285	1.000	0.285	
782.00	23230	Mid	LTE Band 13	10	24.2	24.04	0.02	1	Right	Tilt	QPSK	25	0	04462	1:1	0.215	1.038	0.223	
782.00	23230	Mid	LTE Band 13	10	25.2	25.20	0.08	0	Left	Cheek	QPSK	1	49	04462	1:1	0.392	1.000	0.392	
782.00	23230	Mid	LTE Band 13	10	24.2	24.04	-0.11	1	Left	Cheek	QPSK	25	0	04462	1:1	0.303	1.038	0.315	
782.00	23230	Mid	LTE Band 13	10	25.2	25.20	-0.10	0	Left	Tilt	QPSK	1	49	04462	1:1	0.269	1.000	0.269	
782.00	23230	Mid	LTE Band 13	10	24.2	24.04	-0.02	1	Left	Tilt	QPSK	25	0	04462	1:1	0.214	1.038	0.222	
ANSI / IEEE C95.1 1992 - SAFETY LIMIT Spatial Peak Uncontrolled Exposure/General Population										Head 1.6 W/kg (mW/g) averaged over 1 gram									

**Table 11-11
LTE Band 26 (Cell) Head SAR**

MEASUREMENT RESULTS																			
FREQUENCY		Mode	Bandwidth [MHz]	Maximum Allowed Power [dBm]	Conducted Power [dBm]	Power Drift [dB]	MPR [dB]	Side	Test Position	Modulation	RB Size	RB Offset	Device Serial Number	Duty Cycle	SAR (1g)	Scaling Factor	Reported SAR (1g)	Plot #	
MHz	Ch.														(W/kg)		(W/kg)		
831.50	26865	Mid	LTE Band 26 (Cell)	15	25.2	24.97	0.01	0	Right	Cheek	QPSK	1	74	04462	1:1	0.527	1.054	0.555	A11
831.50	26865	Mid	LTE Band 26 (Cell)	15	24.2	24.03	0.01	1	Right	Cheek	QPSK	36	37	04462	1:1	0.413	1.040	0.430	
831.50	26865	Mid	LTE Band 26 (Cell)	15	25.2	24.97	0.02	0	Right	Tilt	QPSK	1	74	04462	1:1	0.297	1.054	0.313	
831.50	26865	Mid	LTE Band 26 (Cell)	15	24.2	24.03	0.02	1	Right	Tilt	QPSK	36	37	04462	1:1	0.242	1.040	0.252	
831.50	26865	Mid	LTE Band 26 (Cell)	15	25.2	24.97	0.07	0	Left	Cheek	QPSK	1	74	04462	1:1	0.457	1.054	0.482	
831.50	26865	Mid	LTE Band 26 (Cell)	15	24.2	24.03	0.02	1	Left	Cheek	QPSK	36	37	04462	1:1	0.359	1.040	0.373	
831.50	26865	Mid	LTE Band 26 (Cell)	15	25.2	24.97	0.08	0	Left	Tilt	QPSK	1	74	04462	1:1	0.294	1.054	0.310	
831.50	26865	Mid	LTE Band 26 (Cell)	15	24.2	24.03	0.00	1	Left	Tilt	QPSK	36	37	04462	1:1	0.227	1.040	0.236	
ANSI / IEEE C95.1 1992 - SAFETY LIMIT Spatial Peak Uncontrolled Exposure/General Population										Head 1.6 W/kg (mW/g) averaged over 1 gram									

**Table 11-12
LTE Band 4 (AWS) Head SAR**

MEASUREMENT RESULTS																			
FREQUENCY		Mode	Bandwidth [MHz]	Maximum Allowed Power [dBm]	Conducted Power [dBm]	Power Drift [dB]	MPR [dB]	Side	Test Position	Modulation	RB Size	RB Offset	Device Serial Number	Duty Cycle	SAR (1g)	Scaling Factor	Reported SAR (1g)	Plot #	
MHz	Ch.														(W/kg)		(W/kg)		
1732.50	20175	Mid	LTE Band 4 (AWS)	20	25.2	25.16	0.02	0	Right	Cheek	QPSK	1	0	04397	1:1	0.368	1.009	0.371	
1732.50	20175	Mid	LTE Band 4 (AWS)	20	24.2	23.82	0.00	1	Right	Cheek	QPSK	50	0	04397	1:1	0.258	1.091	0.281	
1732.50	20175	Mid	LTE Band 4 (AWS)	20	25.2	25.16	0.03	0	Right	Tilt	QPSK	1	0	04397	1:1	0.296	1.009	0.299	
1732.50	20175	Mid	LTE Band 4 (AWS)	20	24.2	23.82	0.07	1	Right	Tilt	QPSK	50	0	04397	1:1	0.195	1.091	0.213	
1732.50	20175	Mid	LTE Band 4 (AWS)	20	25.2	25.16	0.06	0	Left	Cheek	QPSK	1	0	04397	1:1	0.631	1.009	0.637	A12
1732.50	20175	Mid	LTE Band 4 (AWS)	20	24.2	23.82	0.03	1	Left	Cheek	QPSK	50	0	04397	1:1	0.479	1.091	0.523	
1732.50	20175	Mid	LTE Band 4 (AWS)	20	25.2	25.16	-0.06	0	Left	Tilt	QPSK	1	0	04397	1:1	0.248	1.009	0.250	
1732.50	20175	Mid	LTE Band 4 (AWS)	20	24.2	23.82	0.03	1	Left	Tilt	QPSK	50	0	04397	1:1	0.185	1.091	0.202	
ANSI / IEEE C95.1 1992 - SAFETY LIMIT Spatial Peak Uncontrolled Exposure/General Population										Head 1.6 W/kg (mW/g) averaged over 1 gram									

FCC ID: ZNFX410PM		SAR EVALUATION REPORT		Approved by: Quality Manager
Document S/N: 1M1806270133-01-R1.ZNF	Test Dates: 07/08/18 - 07/16/18	DUT Type: Portable Handset		Page 57 of 95

**Table 11-13
LTE Band 25 (PCS) Head SAR**

MEASUREMENT RESULTS																			
FREQUENCY		Mode	Bandwidth [MHz]	Maximum Allowed Power [dBm]	Conducted Power [dBm]	Power Drift [dB]	MPR [dB]	Side	Test Position	Modulation	RB Size	RB Offset	Device Serial Number	Duty Cycle	SAR (1g)	Scaling Factor	Reported SAR (1g)	Plot #	
MHz	Ch.														(W/kg)		(W/kg)		
1905.00	26590	High	LTE Band 25 (PCS)	20	25.2	25.16	-0.08	0	Right	Cheek	QPSK	1	99	04397	1:1	0.484	1.009	0.488	
1882.50	26365	Mid	LTE Band 25 (PCS)	20	24.2	23.93	-0.15	1	Right	Cheek	QPSK	50	0	04397	1:1	0.338	1.064	0.360	
1905.00	26590	High	LTE Band 25 (PCS)	20	25.2	25.16	-0.15	0	Right	Tilt	QPSK	1	99	04397	1:1	0.252	1.009	0.254	
1882.50	26365	Mid	LTE Band 25 (PCS)	20	24.2	23.93	-0.02	1	Right	Tilt	QPSK	50	0	04397	1:1	0.181	1.064	0.193	
1860.00	26140	Low	LTE Band 25 (PCS)	20	25.2	25.12	-0.11	0	Left	Cheek	QPSK	1	0	04397	1:1	0.730	1.019	0.744	
1882.50	26365	Mid	LTE Band 25 (PCS)	20	25.2	25.07	-0.03	0	Left	Cheek	QPSK	1	0	04397	1:1	0.749	1.030	0.771	
1905.00	26590	High	LTE Band 25 (PCS)	20	25.2	25.16	-0.07	0	Left	Cheek	QPSK	1	99	04397	1:1	0.783	1.009	0.790	A13
1882.50	26365	Mid	LTE Band 25 (PCS)	20	24.2	23.93	-0.03	1	Left	Cheek	QPSK	50	0	04397	1:1	0.556	1.064	0.592	
1905.00	26590	High	LTE Band 25 (PCS)	20	25.2	25.16	0.08	0	Left	Tilt	QPSK	1	99	04397	1:1	0.305	1.009	0.308	
1882.50	26365	Mid	LTE Band 25 (PCS)	20	24.2	23.93	0.13	1	Left	Tilt	QPSK	50	0	04397	1:1	0.229	1.064	0.244	
ANSI / IEEE C95.1 1992 - SAFETY LIMIT Spatial Peak Uncontrolled Exposure/General Population										Head 1.6 W/kg (mW/g) averaged over 1 gram									



**Table 11-14
LTE Band 41 Head SAR**

MEASUREMENT RESULTS																				
Power Class	FREQUENCY		Mode	Bandwidth [MHz]	Maximum Allowed Power [dBm]	Conducted Power [dBm]	Power Drift [dB]	MPR [dB]	Side	Test Position	Modulation	RB Size	RB Offset	Device Serial Number	Duty Cycle	SAR (1g)	Scaling Factor	Reported SAR (1g)	Plot #	
	MHz	Ch.														(W/kg)		(W/kg)		
Power Class 3	2680.00	41490	High	LTE Band 41	20	25.2	25.15	0.15	0	Right	Cheek	QPSK	1	0	04421	1:1.58	0.307	1.012	0.311	
Power Class 3	2680.00	41490	High	LTE Band 41	20	24.2	23.88	0.12	1	Right	Cheek	QPSK	50	0	04421	1:1.58	0.220	1.076	0.237	
Power Class 3	2680.00	41490	High	LTE Band 41	20	25.2	25.15	0.17	0	Right	Tilt	QPSK	1	0	04421	1:1.58	0.186	1.012	0.188	
Power Class 3	2680.00	41490	High	LTE Band 41	20	24.2	23.88	0.15	1	Right	Tilt	QPSK	50	0	04421	1:1.58	0.135	1.076	0.145	
Power Class 3	2680.00	41490	High	LTE Band 41	20	25.2	25.15	-0.09	0	Left	Cheek	QPSK	1	0	04421	1:1.58	0.526	1.012	0.532	
Power Class 3	2680.00	41490	High	LTE Band 41	20	24.2	23.88	0.05	1	Left	Cheek	QPSK	50	0	04421	1:1.58	0.360	1.076	0.387	
Power Class 2	2680.00	41490	High	LTE Band 41	20	27.7	27.68	-0.08	0	Left	Cheek	QPSK	1	0	04421	1:2.31	0.708	1.005	0.712	A14
Power Class 3	2680.00	41490	High	LTE Band 41	20	25.2	25.15	0.10	0	Left	Tilt	QPSK	1	0	04421	1:1.58	0.113	1.012	0.114	
Power Class 3	2680.00	41490	High	LTE Band 41	20	24.2	23.88	0.18	1	Left	Tilt	QPSK	50	0	04221	1:1.58	0.083	1.076	0.089	
ANSI / IEEE C95.1 1992 - SAFETY LIMIT Spatial Peak Uncontrolled Exposure/General Population										Head 1.6 W/kg (mW/g) averaged over 1 gram										

**Table 11-15
DTS Head SAR**

MEASUREMENT RESULTS																		
FREQUENCY		Mode	Service	Bandwidth [MHz]	Maximum Allowed Power [dBm]	Conducted Power [dBm]	Power Drift [dB]	Side	Test Position	Device Serial Number	Data Rate (Mbps)	Duty Cycle (%)	Peak SAR of Area Scan	SAR (1g)	Scaling Factor (Power)	Scaling Factor (Duty Cycle)	Reported SAR (1g)	Plot #
MHz	Ch.												(W/kg)	(W/kg)			(W/kg)	
2412	1	802.11b	DSSS	22	16.5	16.26	0.14	Right	Cheek	04363	1	96.9	1.237	0.994	1.057	1.032	1.084	A15
2437	6	802.11b	DSSS	22	16.5	16.04	0.11	Right	Cheek	04363	1	96.9	1.136	0.901	1.112	1.032	1.034	
2462	11	802.11b	DSSS	22	16.5	15.92	-0.02	Right	Cheek	04363	1	96.9	0.914	0.787	1.143	1.032	0.928	
2412	1	802.11b	DSSS	22	16.5	16.26	-0.02	Right	Tilt	04363	1	96.9	0.959	0.780	1.057	1.032	0.851	
2437	6	802.11b	DSSS	22	16.5	16.04	0.03	Right	Tilt	04363	1	96.9	0.890	0.710	1.112	1.032	0.815	
2412	1	802.11b	DSSS	22	16.5	16.26	-0.16	Left	Cheek	04363	1	96.9	0.509	0.457	1.057	1.032	0.499	
2412	1	802.11b	DSSS	22	16.5	16.26	0.13	Left	Tilt	04363	1	96.9	0.413	-	1.057	1.032	-	
2412	1	802.11b	DSSS	22	16.5	16.26	-0.12	Right	Cheek	04363	1	96.9	1.083	0.975	1.057	1.032	1.064	
ANSI / IEEE C95.1 1992 - SAFETY LIMIT Spatial Peak Uncontrolled Exposure/General Population										Head 1.6 W/kg (mW/g) averaged over 1 gram								

Note: Blue entries represent variability measurements.

FCC ID: ZNFX410PM		SAR EVALUATION REPORT		Approved by: Quality Manager
Document S/N: 1M1806270133-01-R1.ZNF	Test Dates: 07/08/18 - 07/16/18	DUT Type: Portable Handset		Page 58 of 95



**Table 11-16
NII Head SAR**

MEASUREMENT RESULTS																		
FREQUENCY		Mode	Service	Bandwidth [MHz]	Maximum Allowed Power [dBm]	Conducted Power [dBm]	Power Drift [dB]	Side	Test Position	Device Serial Number	Data Rate (Mbps)	Duty Cycle (%)	Peak SAR of Area Scan	SAR (1g)	Scaling Factor (Power)	Scaling Factor (Duty Cycle)	Reported SAR (1g)	Plot #
MHz	Ch.												W/kg	(W/kg)			(W/kg)	
5270	54	802.11n	OFDM	40	11.3	10.85	0.12	Right	Cheek	04363	13.5	94.0	1.846	0.815	1.109	1.064	0.962	
5310	62	802.11n	OFDM	40	11.3	10.72	0.17	Right	Cheek	04363	13.5	94.0	1.882	0.812	1.143	1.064	0.988	
5270	54	802.11n	OFDM	40	11.3	10.85	0.16	Right	Tilt	04363	13.5	94.0	1.752	0.831	1.109	1.064	0.981	
5310	62	802.11n	OFDM	40	11.3	10.72	0.14	Right	Tilt	04363	13.5	94.0	1.775	0.831	1.143	1.064	1.011	
5270	54	802.11n	OFDM	40	11.3	10.85	-0.18	Left	Cheek	04363	13.5	94.0	0.899	0.438	1.109	1.064	0.517	
5270	54	802.11n	OFDM	40	11.3	10.85	0.15	Left	Tilt	04363	13.5	94.0	0.857	-	1.109	1.064	-	
5270	54	802.11n	OFDM	40	11.3	10.85	0.13	Right	Tilt	04363	13.5	94.0	1.709	0.811	1.109	1.064	0.957	
5510	102	802.11n	OFDM	40	11.3	11.26	0.13	Right	Cheek	04363	13.5	94.0	2.416	0.938	1.009	1.064	1.007	
5590	118	802.11n	OFDM	40	11.3	11.26	-0.13	Right	Cheek	04363	13.5	94.0	2.535	1.030	1.009	1.064	1.106	
5510	102	802.11n	OFDM	40	11.3	11.26	0.19	Right	Tilt	04363	13.5	94.0	2.473	1.030	1.009	1.064	1.106	
5590	118	802.11n	OFDM	40	11.3	11.26	0.17	Right	Tilt	04363	13.5	94.0	2.392	1.030	1.009	1.064	1.106	
5510	102	802.11n	OFDM	40	11.3	11.26	-0.15	Left	Cheek	04363	13.5	94.0	1.138	0.603	1.009	1.064	0.647	
5590	118	802.11n	OFDM	40	11.3	11.26	0.06	Left	Cheek	04363	13.5	94.0	1.601	0.747	1.009	1.064	0.802	
5590	118	802.11n	OFDM	40	11.3	11.26	0.18	Left	Tilt	04363	13.5	94.0	1.555	0.531	1.009	1.064	0.570	
5510	102	802.11n	OFDM	40	11.3	11.26	0.18	Right	Tilt	04363	13.5	94.0	2.191	0.974	1.009	1.064	1.046	
5755	151	802.11n	OFDM	40	11.3	11.28	0.10	Right	Cheek	04363	13.5	94.0	2.648	0.996	1.005	1.064	1.065	
5795	159	802.11n	OFDM	40	11.3	11.29	-0.05	Right	Cheek	04363	13.5	94.0	2.679	1.030	1.002	1.064	1.098	
5755	151	802.11n	OFDM	40	11.3	11.28	0.18	Right	Tilt	04363	13.5	94.0	2.739	1.060	1.005	1.064	1.133	A16
5795	159	802.11n	OFDM	40	11.3	11.29	0.19	Right	Tilt	04363	13.5	94.0	2.758	0.902	1.002	1.064	0.962	
5755	151	802.11n	OFDM	40	11.3	11.28	0.15	Left	Cheek	04363	13.5	94.0	1.790	0.821	1.005	1.064	0.878	
5795	159	802.11n	OFDM	40	11.3	11.29	0.16	Left	Cheek	04363	13.5	94.0	1.909	0.846	1.002	1.064	0.902	
5755	151	802.11n	OFDM	40	11.3	11.28	0.13	Left	Tilt	04363	13.5	94.0	1.729	0.821	1.005	1.064	0.878	
5795	159	802.11n	OFDM	40	11.3	11.29	0.16	Left	Tilt	04363	13.5	94.0	1.849	0.875	1.002	1.064	0.933	
5755	151	802.11n	OFDM	40	11.3	11.28	0.18	Right	Tilt	04363	13.5	94.0	2.324	0.979	1.005	1.064	1.047	
ANSI / IEEE C95.1 1992 - SAFETY LIMIT Spatial Peak Uncontrolled Exposure/General Population										Head 1.6 W/kg (mW/g) averaged over 1 gram								

Note: Blue entries represent variability measurements.

**Table 11-17
DSS Head SAR**

MEASUREMENT RESULTS																	
FREQUENCY		Mode	Service	Maximum Allowed Power [dBm]	Conducted Power [dBm]	Power Drift [dB]	Side	Test Position	Device Serial Number	Data Rate (Mbps)	Duty Cycle %	SAR (1g)	Scaling Factor (Cond Power)	Scaling Factor (Duty Cycle)	Reported SAR (1g)	Plot #	
MHz	Ch.											(W/kg)			(W/kg)		
2480.00	78	Bluetooth	FHSS	10.0	9.60	0.03	Right	Cheek	04363	1	77.1	0.260	1.096	1.297	0.370	A17	
2480.00	78	Bluetooth	FHSS	10.0	9.60	-0.04	Right	Tilt	04363	1	77.1	0.208	1.096	1.297	0.296		
2480.00	78	Bluetooth	FHSS	10.0	9.60	0.01	Left	Cheek	04363	1	77.1	0.103	1.096	1.297	0.146		
2480.00	78	Bluetooth	FHSS	10.0	9.60	0.11	Left	Tilt	04363	1	77.1	0.111	1.096	1.297	0.158		
ANSI / IEEE C95.1 1992 - SAFETY LIMIT Spatial Peak Uncontrolled Exposure/General Population										Head 1.6 W/kg (mW/g) averaged over 1 gram							



FCC ID: ZNFX410PM		SAR EVALUATION REPORT		Approved by: Quality Manager
Document S/N: 1M1806270133-01-R1.ZNF	Test Dates: 07/08/18 - 07/16/18	DUT Type: Portable Handset	Page 59 of 95	

11.2 Standalone Body-Worn SAR Data

**Table 11-18
GSM/UMTS/CDMA Body-Worn SAR Data**

MEASUREMENT RESULTS															
FREQUENCY		Mode	Service	Maximum Allowed Power [dBm]	Conducted Power [dBm]	Power Drift [dB]	Spacing	Device Serial Number	# of Time Slots	Duty Cycle	Side	SAR (1g)	Scaling Factor	Reported SAR (1g)	Plot #
MHz	Ch.											(W/kg)		(W/kg)	
820.10	564	CDMA BC10 (\$90S)	TDSO / SO32	25.2	25.19	-0.12	10 mm	04462	N/A	1:1	back	0.705	1.002	0.706	A18
824.70	1013	CDMA BC0 (\$22H)	TDSO / SO32	25.2	25.06	-0.02	10 mm	04462	N/A	1:1	back	0.522	1.033	0.539	
836.52	384	CDMA BC0 (\$22H)	TDSO / SO32	25.2	25.08	-0.03	10 mm	04462	N/A	1:1	back	0.603	1.028	0.620	
848.31	777	CDMA BC0 (\$22H)	TDSO / SO32	25.2	25.04	-0.02	10 mm	04462	N/A	1:1	back	0.635	1.038	0.659	A20
824.20	128	GSM 850	GSM	33.7	33.62	-0.02	10 mm	04397	1	1:8.3	back	0.521	1.019	0.531	
836.60	190	GSM 850	GSM	33.7	33.61	0.00	10 mm	04397	1	1:8.3	back	0.619	1.021	0.632	
848.80	251	GSM 850	GSM	33.7	33.52	0.09	10 mm	04397	1	1:8.3	back	0.664	1.042	0.692	
824.20	128	GSM 850	GPRS	31.7	31.63	-0.03	10 mm	04397	2	1:4.15	back	0.625	1.016	0.635	
836.60	190	GSM 850	GPRS	31.7	31.54	-0.05	10 mm	04397	2	1:4.15	back	0.757	1.038	0.786	
848.80	251	GSM 850	GPRS	31.7	31.55	0.04	10 mm	04397	2	1:4.15	back	0.800	1.035	0.828	A22
848.80	251	GSM 850	GPRS	31.7	31.55	0.08	10 mm	04397	2	1:4.15	back	0.791	1.035	0.819	
826.40	4132	UMTS 850	RMC	24.7	24.61	0.02	10 mm	04462	N/A	1:1	back	0.634	1.021	0.647	A23
836.60	4183	UMTS 850	RMC	24.7	24.61	0.05	10 mm	04462	N/A	1:1	back	0.599	1.021	0.612	
846.60	4233	UMTS 850	RMC	24.7	24.64	0.01	10 mm	04462	N/A	1:1	back	0.583	1.014	0.591	
1712.40	1312	UMTS 1750	RMC	24.7	24.69	0.01	10 mm	04462	N/A	1:1	back	0.857	1.002	0.859	
1732.40	1412	UMTS 1750	RMC	24.7	24.70	0.03	10 mm	04462	N/A	1:1	back	0.885	1.000	0.885	A25
1752.60	1513	UMTS 1750	RMC	24.7	24.66	-0.06	10 mm	04462	N/A	1:1	back	0.875	1.009	0.883	
1851.25	25	PCS CDMA	TDSO / SO32	25.2	25.13	0.00	10 mm	04421	N/A	1:1	back	0.784	1.016	0.797	A26
1880.00	600	PCS CDMA	TDSO / SO32	25.2	25.17	0.02	10 mm	04421	N/A	1:1	back	0.731	1.007	0.736	
1908.75	1175	PCS CDMA	TDSO / SO32	25.2	25.12	-0.02	10 mm	04421	N/A	1:1	back	0.733	1.019	0.747	
1880.00	661	GSM 1900	GSM	30.7	30.51	-0.02	10 mm	04421	1	1:8.3	back	0.347	1.045	0.363	
1880.00	661	GSM 1900	GPRS	28.7	28.61	-0.03	10 mm	04421	2	1:4.15	back	0.394	1.021	0.402	A28
1852.40	9262	UMTS 1900	RMC	24.7	24.65	-0.11	10 mm	04397	N/A	1:1	back	0.766	1.012	0.775	A29
1880.00	9400	UMTS 1900	RMC	24.7	24.63	-0.02	10 mm	04397	N/A	1:1	back	0.669	1.016	0.680	
1907.60	9538	UMTS 1900	RMC	24.7	24.62	-0.07	10 mm	04397	N/A	1:1	back	0.726	1.019	0.740	
ANSI / IEEE C95.1 1992 - SAFETY LIMIT Spatial Peak Uncontrolled Exposure/General Population							Body 1.6 W/kg (mW/g) averaged over 1 gram								

Note: Blue entries represent variability measurements.

FCC ID: ZNFX410PM		SAR EVALUATION REPORT		Approved by: Quality Manager
Document S/N: 1M1806270133-01-R1.ZNF	Test Dates: 07/08/18 - 07/16/18	DUT Type: Portable Handset	Page 60 of 95	

**Table 11-19
LTE Body-Worn SAR**



MEASUREMENT RESULTS																			
FREQUENCY		Mode	Bandwidth [MHz]	Maximum Allowed Power [dBm]	Conducted Power [dBm]	Power Drift [dB]	MPR [dB]	Device Serial Number	Modulation	RB Size	RB Offset	Spacing	Side	Duty Cycle	SAR (1g)	Scaling Factor	Reported SAR (1g)	Plot #	
MHz	Ch.														(W/kg)		(W/kg)		
707.50	23095	Mid	LTE Band 12	10	25.2	24.97	-0.14	0	04421	QPSK	1	0	10 mm	back	1:1	0.496	1.054	0.523	A30
707.50	23095	Mid	LTE Band 12	10	24.2	23.98	-0.04	1	04421	QPSK	25	0	10 mm	back	1:1	0.363	1.052	0.382	
782.00	23230	Mid	LTE Band 13	10	25.2	25.20	0.03	0	04421	QPSK	1	49	10 mm	back	1:1	0.644	1.000	0.644	A32
782.00	23230	Mid	LTE Band 13	10	24.2	24.04	0.03	1	04421	QPSK	25	0	10 mm	back	1:1	0.531	1.038	0.551	
831.50	26865	Mid	LTE Band 26 (Cell)	15	25.2	24.97	0.00	0	04462	QPSK	1	74	10 mm	back	1:1	0.654	1.054	0.689	A34
831.50	26865	Mid	LTE Band 26 (Cell)	15	24.2	24.03	0.00	1	04462	QPSK	36	37	10 mm	back	1:1	0.517	1.040	0.538	
1732.50	20175	Mid	LTE Band 4 (AWS)	20	25.2	25.16	-0.04	0	04462	QPSK	1	0	10 mm	back	1:1	1.090	1.009	1.100	
1732.50	20175	Mid	LTE Band 4 (AWS)	20	24.2	23.82	-0.01	1	04462	QPSK	50	0	10 mm	back	1:1	0.781	1.091	0.852	
1732.50	20175	Mid	LTE Band 4 (AWS)	20	24.2	23.78	0.00	1	04462	QPSK	100	0	10 mm	back	1:1	0.769	1.102	0.847	
1732.50	20175	Mid	LTE Band 4 (AWS)	20	25.2	25.16	0.02	0	04462	QPSK	1	0	10 mm	back	1:1	1.130	1.009	1.140	A36
1860.00	26140	Low	LTE Band 25 (PCS)	20	25.2	25.12	0.02	0	04397	QPSK	1	0	10 mm	back	1:1	1.040	1.019	1.060	A37
1882.50	26365	Mid	LTE Band 25 (PCS)	20	25.2	25.07	-0.01	0	04397	QPSK	1	0	10 mm	back	1:1	0.970	1.030	0.999	
1905.00	26590	High	LTE Band 25 (PCS)	20	25.2	25.16	0.01	0	04397	QPSK	1	99	10 mm	back	1:1	0.980	1.009	0.989	
1882.50	26365	Mid	LTE Band 25 (PCS)	20	24.2	23.93	0.04	1	04397	QPSK	50	0	10 mm	back	1:1	0.743	1.064	0.791	
1860.00	26140	Low	LTE Band 25 (PCS)	20	24.2	23.85	-0.04	1	04397	QPSK	100	0	10 mm	back	1:1	0.770	1.084	0.835	
1860.00	26140	Low	LTE Band 25 (PCS)	20	25.2	25.12	-0.16	0	04397	QPSK	1	0	10 mm	back	1:1	1.020	1.019	1.039	
ANSI / IEEE C95.1 1992 - SAFETY LIMIT Spatial Peak Uncontrolled Exposure/General Population									Body 1.6 W/kg (mW/g) averaged over 1 gram										

Note: Blue entries represent variability measurements.

**Table 11-20
LTE Band 41 Body-Worn SAR**

MEASUREMENT RESULTS																			
Power Class	FREQUENCY		Mode	Bandwidth [MHz]	Maximum Allowed Power [dBm]	Conducted Power [dBm]	Power Drift [dB]	MPR [dB]	Device Serial Number	Modulation	RB Size	RB Offset	Spacing	Side	Duty Cycle	SAR (1g)	Scaling Factor	Reported SAR (1g)	Plot #
	MHz	Ch.														(W/kg)		(W/kg)	
Power Class 3	2506.00	39750	Low	LTE Band 41	20	25.2	24.95	-0.12	0	04421	QPSK	1	0	10 mm	back	1:1.58	0.685	1.059	0.725
Power Class 3	2549.50	40185	Low-Mid	LTE Band 41	20	25.2	24.98	-0.02	0	04421	QPSK	1	0	10 mm	back	1:1.58	0.792	1.052	0.833
Power Class 3	2593.00	40620	Mid	LTE Band 41	20	25.2	25.09	-0.04	0	04421	QPSK	1	0	10 mm	back	1:1.58	0.807	1.026	0.828
Power Class 3	2636.50	41055	Mid-High	LTE Band 41	20	25.2	25.04	-0.15	0	04421	QPSK	1	99	10 mm	back	1:1.58	0.656	1.038	0.681
Power Class 3	2680.00	41490	High	LTE Band 41	20	25.2	25.15	-0.14	0	04421	QPSK	1	0	10 mm	back	1:1.58	0.619	1.012	0.626
Power Class 3	2680.00	41490	High	LTE Band 41	20	24.2	23.88	-0.01	1	04421	QPSK	50	0	10 mm	back	1:1.58	0.454	1.076	0.489
Power Class 3	2636.50	41055	Mid-High	LTE Band 41	20	24.2	23.86	-0.12	1	04421	QPSK	100	0	10 mm	back	1:1.58	0.521	1.081	0.563
Power Class 2	2549.50	40185	Low-Mid	LTE Band 41	20	27.7	27.58	-0.19	0	04421	QPSK	1	0	10 mm	back	1:2.31	1.080	1.028	1.110
Power Class 2	2549.50	40185	Low-Mid	LTE Band 41	20	27.7	27.58	-0.13	0	04421	QPSK	1	0	10 mm	back	1:2.31	1.050	1.028	1.079
ANSI / IEEE C95.1 1992 - SAFETY LIMIT Spatial Peak Uncontrolled Exposure/General Population									Body 1.6 W/kg (mW/g) averaged over 1 gram										

Note: Blue entries represent variability measurements.



FCC ID: ZNFX410PM		SAR EVALUATION REPORT		Approved by: Quality Manager
Document S/N: 1M1806270133-01-R1-ZNF	Test Dates: 07/08/18 - 07/16/18	DUT Type: Portable Handset	Page 61 of 95	

**Table 11-21
DTS Body-Worn SAR**

MEASUREMENT RESULTS																		
FREQUENCY		Mode	Service	Bandwidth [MHz]	Maximum Allowed Power [dBm]	Conducted Power [dBm]	Power Drift [dB]	Spacing	Device Serial Number	Data Rate (Mbps)	Side	Duty Cycle (%)	Peak SAR of Area Scan	SAR (1g)	Scaling Factor (Power)	Scaling Factor (Duty Cycle)	Reported SAR (1g)	Plot #
MHz	Ch.												W/kg	(W/kg)			(W/kg)	
2412	1	802.11b	DSSS	22	19.0	18.44	0.04	10 mm	04363	1	back	96.9	0.288	0.237	1.138	1.032	0.278	A39
ANSI / IEEE C95.1 1992 - SAFETY LIMIT Spatial Peak Uncontrolled Exposure/General Population										Body 1.6 W/kg (mW/g) averaged over 1 gram								

**Table 11-22
NII Body-Worn SAR**



MEASUREMENT RESULTS																		
FREQUENCY		Mode	Service	Bandwidth [MHz]	Maximum Allowed Power [dBm]	Conducted Power [dBm]	Power Drift [dB]	Spacing	Device Serial Number	Data Rate (Mbps)	Side	Duty Cycle (%)	Peak SAR of Area Scan	SAR (1g)	Scaling Factor (Power)	Scaling Factor (Duty Cycle)	Reported SAR (1g)	Plot #
MHz	Ch.												W/kg	(W/kg)			(W/kg)	
5280	56	802.11a	OFDM	20	18.0	17.78	0.21	10 mm	04348	6	back	96.9	0.657	0.345	1.052	1.032	0.375	A40
5600	120	802.11a	OFDM	20	19.0	18.53	0.13	10 mm	04348	6	back	96.9	0.698	0.296	1.114	1.032	0.340	
5785	157	802.11a	OFDM	20	19.0	18.77	-0.01	10 mm	04348	6	back	96.9	0.782	0.325	1.054	1.032	0.354	
ANSI / IEEE C95.1 1992 - SAFETY LIMIT Spatial Peak Uncontrolled Exposure/General Population										Body 1.6 W/kg (mW/g) averaged over 1 gram								

FCC ID: ZNFX410PM		SAR EVALUATION REPORT		Approved by: Quality Manager
Document S/N: 1M1806270133-01-R1.ZNF	Test Dates: 07/08/18 - 07/16/18	DUT Type: Portable Handset		Page 62 of 95

11.3 Standalone Hotspot SAR Data

**Table 11-23
CDMA Hotspot SAR Data**



MEASUREMENT RESULTS														
FREQUENCY		Mode	Service	Maximum Allowed Power [dBm]	Conducted Power [dBm]	Power Drift [dB]	Spacing	Device Serial Number	Duty Cycle	Side	SAR (1g)	Scaling Factor	Reported SAR (1g)	Plot #
MHz	Ch.										(W/kg)		(W/kg)	
820.10	564	CDMA BC10 (\$90S)	EVDO Rev. 0	25.2	25.13	-0.04	10 mm	04462	1:1	back	0.663	1.016	0.674	
820.10	564	CDMA BC10 (\$90S)	EVDO Rev. 0	25.2	25.13	0.00	10 mm	04462	1:1	front	0.511	1.016	0.519	
820.10	564	CDMA BC10 (\$90S)	EVDO Rev. 0	25.2	25.13	-0.06	10 mm	04462	1:1	bottom	0.291	1.016	0.296	
820.10	564	CDMA BC10 (\$90S)	EVDO Rev. 0	25.2	25.13	-0.01	10 mm	04462	1:1	right	0.742	1.016	0.754	A19
820.10	564	CDMA BC10 (\$90S)	EVDO Rev. 0	25.2	25.13	0.01	10 mm	04462	1:1	left	0.480	1.016	0.488	
836.52	384	CDMA BC0 (\$22H)	EVDO Rev. 0	25.2	25.10	-0.06	10 mm	04462	1:1	back	0.613	1.023	0.627	
836.52	384	CDMA BC0 (\$22H)	EVDO Rev. 0	25.2	25.10	0.01	10 mm	04462	1:1	front	0.503	1.023	0.515	
836.52	384	CDMA BC0 (\$22H)	EVDO Rev. 0	25.2	25.10	0.02	10 mm	04462	1:1	bottom	0.405	1.023	0.414	
824.70	1013	CDMA BC0 (\$22H)	EVDO Rev. 0	25.2	25.08	0.03	10 mm	04462	1:1	right	0.630	1.028	0.648	
836.52	384	CDMA BC0 (\$22H)	EVDO Rev. 0	25.2	25.10	-0.04	10 mm	04462	1:1	right	0.671	1.023	0.686	A21
848.31	777	CDMA BC0 (\$22H)	EVDO Rev. 0	25.2	25.06	0.01	10 mm	04462	1:1	right	0.623	1.033	0.644	
836.52	384	CDMA BC0 (\$22H)	EVDO Rev. 0	25.2	25.10	-0.02	10 mm	04462	1:1	left	0.354	1.023	0.362	
1851.25	25	PCS CDMA	EVDO Rev. 0	25.2	25.08	-0.06	10 mm	04421	1:1	back	0.751	1.028	0.772	
1880.00	600	PCS CDMA	EVDO Rev. 0	25.2	25.15	-0.01	10 mm	04421	1:1	back	0.719	1.012	0.728	
1908.75	1175	PCS CDMA	EVDO Rev. 0	25.2	25.10	-0.07	10 mm	04421	1:1	back	0.835	1.023	0.854	A27
1880.00	600	PCS CDMA	EVDO Rev. 0	25.2	25.15	0.01	10 mm	04421	1:1	front	0.646	1.012	0.654	
1880.00	600	PCS CDMA	EVDO Rev. 0	25.2	25.15	-0.01	10 mm	04421	1:1	bottom	0.391	1.012	0.396	
1880.00	600	PCS CDMA	EVDO Rev. 0	25.2	25.15	0.00	10 mm	04421	1:1	left	0.603	1.012	0.610	
ANSI / IEEE C95.1 1992 - SAFETY LIMIT							Body							
Spatial Peak							1.6 W/kg (mW/g)							
Uncontrolled Exposure/General Population							averaged over 1 gram							

FCC ID: ZNFX410PM		SAR EVALUATION REPORT		Approved by: Quality Manager
Document S/N: 1M1806270133-01-R1.ZNF	Test Dates: 07/08/18 - 07/16/18	DUT Type: Portable Handset	Page 63 of 95	

**Table 11-24
GSM/UMTS Hotspot SAR Data**



MEASUREMENT RESULTS															
FREQUENCY		Mode	Service	Maximum Allowed Power [dBm]	Conducted Power [dBm]	Power Drift [dB]	Spacing	Device Serial Number	# of GPRS Slots	Duty Cycle	Side	SAR (1g)	Scaling Factor	Reported SAR (1g)	Plot #
MHz	Ch.											(W/kg)		(W/kg)	
824.20	128	GSM 850	GPRS	31.7	31.63	-0.03	10 mm	04397	2	1:4.15	back	0.625	1.016	0.635	
836.60	190	GSM 850	GPRS	31.7	31.54	-0.05	10 mm	04397	2	1:4.15	back	0.757	1.038	0.786	
848.80	251	GSM 850	GPRS	31.7	31.55	0.04	10 mm	04397	2	1:4.15	back	0.800	1.035	0.828	A22
836.60	190	GSM 850	GPRS	31.7	31.54	-0.04	10 mm	04397	2	1:4.15	front	0.592	1.038	0.614	
836.60	190	GSM 850	GPRS	31.7	31.54	-0.07	10 mm	04397	2	1:4.15	bottom	0.422	1.038	0.438	
836.60	190	GSM 850	GPRS	31.7	31.54	0.06	10 mm	04397	2	1:4.15	right	0.702	1.038	0.729	
836.60	190	GSM 850	GPRS	31.7	31.54	-0.05	10 mm	04397	2	1:4.15	left	0.436	1.038	0.453	
848.80	251	GSM 850	GPRS	31.7	31.55	0.08	10 mm	04397	2	1:4.15	back	0.791	1.035	0.819	
826.40	4132	UMTS 850	RMC	24.7	24.61	0.02	10 mm	04462	N/A	1:1	back	0.634	1.021	0.647	
836.60	4183	UMTS 850	RMC	24.7	24.61	0.05	10 mm	04462	N/A	1:1	back	0.599	1.021	0.612	
846.60	4233	UMTS 850	RMC	24.7	24.64	0.01	10 mm	04462	N/A	1:1	back	0.583	1.014	0.591	
836.60	4183	UMTS 850	RMC	24.7	24.61	-0.04	10 mm	04462	N/A	1:1	front	0.486	1.021	0.496	
836.60	4183	UMTS 850	RMC	24.7	24.61	-0.06	10 mm	04462	N/A	1:1	bottom	0.392	1.021	0.400	
826.40	4132	UMTS 850	RMC	24.7	24.61	0.12	10 mm	04462	N/A	1:1	right	0.640	1.021	0.653	A24
836.60	4183	UMTS 850	RMC	24.7	24.61	-0.04	10 mm	04462	N/A	1:1	right	0.628	1.021	0.641	
846.60	4233	UMTS 850	RMC	24.7	24.64	0.03	10 mm	04462	N/A	1:1	right	0.637	1.014	0.646	
836.60	4183	UMTS 850	RMC	24.7	24.61	0.01	10 mm	04462	N/A	1:1	left	0.364	1.021	0.372	
1712.40	1312	UMTS 1750	RMC	24.7	24.69	0.01	10 mm	04462	N/A	1:1	back	0.857	1.002	0.859	
1732.40	1412	UMTS 1750	RMC	24.7	24.70	0.03	10 mm	04462	N/A	1:1	back	0.885	1.000	0.885	A25
1752.60	1513	UMTS 1750	RMC	24.7	24.66	-0.06	10 mm	04462	N/A	1:1	back	0.875	1.009	0.883	
1732.40	1412	UMTS 1750	RMC	24.7	24.70	0.06	10 mm	04462	N/A	1:1	front	0.670	1.000	0.670	
1732.40	1412	UMTS 1750	RMC	24.7	24.70	-0.01	10 mm	04462	N/A	1:1	bottom	0.266	1.000	0.266	
1732.40	1412	UMTS 1750	RMC	24.7	24.70	-0.02	10 mm	04462	N/A	1:1	left	0.489	1.000	0.489	
1880.00	661	GSM 1900	GPRS	28.7	28.61	-0.03	10 mm	04421	2	1:4.15	back	0.394	1.021	0.402	A28
1880.00	661	GSM 1900	GPRS	28.7	28.61	0.03	10 mm	04421	2	1:4.15	front	0.363	1.021	0.371	
1880.00	661	GSM 1900	GPRS	28.7	28.61	0.06	10 mm	04421	2	1:4.15	bottom	0.180	1.021	0.184	
1880.00	661	GSM 1900	GPRS	28.7	28.61	0.04	10 mm	04421	2	1:4.15	left	0.355	1.021	0.362	
1852.40	9262	UMTS 1900	RMC	24.7	24.65	-0.11	10 mm	04397	N/A	1:1	back	0.766	1.012	0.775	A29
1880.00	9400	UMTS 1900	RMC	24.7	24.63	-0.02	10 mm	04397	N/A	1:1	back	0.669	1.016	0.680	
1907.60	9538	UMTS 1900	RMC	24.7	24.62	-0.07	10 mm	04397	N/A	1:1	back	0.726	1.019	0.740	
1880.00	9400	UMTS 1900	RMC	24.7	24.63	0.02	10 mm	04397	N/A	1:1	front	0.575	1.016	0.584	
1880.00	9400	UMTS 1900	RMC	24.7	24.63	-0.04	10 mm	04397	N/A	1:1	bottom	0.349	1.016	0.355	
1880.00	9400	UMTS 1900	RMC	24.7	24.63	-0.05	10 mm	04397	N/A	1:1	left	0.545	1.016	0.554	
ANSI / IEEE C95.1 1992 - SAFETY LIMIT								Body							
Spatial Peak								1.6 W/kg (mW/g)							
Uncontrolled Exposure/General Population								averaged over 1 gram							

Note: Blue entries represent variability measurements.

FCC ID: ZNFX410PM		SAR EVALUATION REPORT		Approved by: Quality Manager
Document S/N: 1M1806270133-01-R1.ZNF	Test Dates: 07/08/18 - 07/16/18	DUT Type: Portable Handset	Page 64 of 95	

**Table 11-25
LTE Band 12 Hotspot SAR**

MEASUREMENT RESULTS																			
FREQUENCY		Mode	Bandwidth [MHz]	Maximum Allowed Power [dBm]	Conducted Power [dBm]	Power Drift [dB]	MPR [dB]	Device Serial Number	Modulation	RB Size	RB Offset	Spacing	Side	Duty Cycle	SAR (1g)	Scaling Factor	Reported SAR (1g)	Plot #	
MHz	Ch.														(W/kg)		(W/kg)		
707.50	23095	Mid	LTE Band 12	10	25.2	24.97	-0.14	0	04421	QPSK	1	0	10 mm	back	1:1	0.496	1.054	0.523	
707.50	23095	Mid	LTE Band 12	10	24.2	23.98	-0.04	1	04421	QPSK	25	0	10 mm	back	1:1	0.363	1.052	0.382	
707.50	23095	Mid	LTE Band 12	10	25.2	24.97	0.09	0	04421	QPSK	1	0	10 mm	front	1:1	0.402	1.054	0.424	
707.50	23095	Mid	LTE Band 12	10	24.2	23.98	0.01	1	04421	QPSK	25	0	10 mm	front	1:1	0.293	1.052	0.308	
707.50	23095	Mid	LTE Band 12	10	25.2	24.97	0.06	0	04421	QPSK	1	0	10 mm	bottom	1:1	0.208	1.054	0.219	
707.50	23095	Mid	LTE Band 12	10	24.2	23.98	0.02	1	04421	QPSK	25	0	10 mm	bottom	1:1	0.157	1.052	0.165	
707.50	23095	Mid	LTE Band 12	10	25.2	24.97	-0.08	0	04421	QPSK	1	0	10 mm	right	1:1	0.534	1.054	0.563	A31
707.50	23095	Mid	LTE Band 12	10	24.2	23.98	-0.13	1	04421	QPSK	25	0	10 mm	right	1:1	0.431	1.052	0.453	
707.50	23095	Mid	LTE Band 12	10	25.2	24.97	-0.05	0	04421	QPSK	1	0	10 mm	left	1:1	0.251	1.054	0.265	
707.50	23095	Mid	LTE Band 12	10	24.2	23.98	0.02	1	04421	QPSK	25	0	10 mm	left	1:1	0.185	1.052	0.195	
ANSI / IEEE C95.1 1992 - SAFETY LIMIT Spatial Peak Uncontrolled Exposure/General Population							Body 1.6 W/kg (mW/g) averaged over 1 gram												



FCC ID: ZNFX410PM		SAR EVALUATION REPORT		Approved by: Quality Manager
Document S/N: 1M1806270133-01-R1.ZNF	Test Dates: 07/08/18 - 07/16/18	DUT Type: Portable Handset		Page 65 of 95

**Table 11-26
LTE Band 13 Hotspot SAR**

MEASUREMENT RESULTS																			
FREQUENCY		Mode	Bandwidth [MHz]	Maximum Allowed Power [dBm]	Conducted Power [dBm]	Power Drift [dB]	MPR [dB]	Device Serial Number	Modulation	RB Size	RB Offset	Spacing	Side	Duty Cycle	SAR (1g)	Scaling Factor	Reported SAR (1g)	Plot #	
MHz	Ch.														(W/kg)		(W/kg)		
782.00	23230	Mid	LTE Band 13	10	25.2	25.20	0.03	0	04421	QPSK	1	49	10 mm	back	1:1	0.644	1.000	0.644	
782.00	23230	Mid	LTE Band 13	10	24.2	24.04	0.03	1	04421	QPSK	25	0	10 mm	back	1:1	0.531	1.038	0.551	
782.00	23230	Mid	LTE Band 13	10	25.2	25.20	0.01	0	04421	QPSK	1	49	10 mm	front	1:1	0.532	1.000	0.532	
782.00	23230	Mid	LTE Band 13	10	24.2	24.04	0.06	1	04421	QPSK	25	0	10 mm	front	1:1	0.441	1.038	0.458	
782.00	23230	Mid	LTE Band 13	10	25.2	25.20	0.01	0	04421	QPSK	1	49	10 mm	bottom	1:1	0.326	1.000	0.326	
782.00	23230	Mid	LTE Band 13	10	24.2	24.04	-0.02	1	04421	QPSK	25	0	10 mm	bottom	1:1	0.259	1.038	0.269	
782.00	23230	Mid	LTE Band 13	10	25.2	25.20	-0.02	0	04421	QPSK	1	49	10 mm	right	1:1	0.716	1.000	0.716	A33
782.00	23230	Mid	LTE Band 13	10	24.2	24.04	0.02	1	04421	QPSK	25	0	10 mm	right	1:1	0.554	1.038	0.575	
782.00	23230	Mid	LTE Band 13	10	25.2	25.20	-0.17	0	04421	QPSK	1	49	10 mm	left	1:1	0.283	1.000	0.283	
782.00	23230	Mid	LTE Band 13	10	24.2	24.04	-0.01	1	04421	QPSK	25	0	10 mm	left	1:1	0.179	1.038	0.186	
ANSI / IEEE C95.1 1992 - SAFETY LIMIT Spatial Peak Uncontrolled Exposure/General Population								Body 1.6 W/kg (mW/g) averaged over 1 gram											

**Table 11-27
LTE Band 26 (Cell) Hotspot SAR**

MEASUREMENT RESULTS																			
FREQUENCY		Mode	Bandwidth [MHz]	Maximum Allowed Power [dBm]	Conducted Power [dBm]	Power Drift [dB]	MPR [dB]	Device Serial Number	Modulation	RB Size	RB Offset	Spacing	Side	Duty Cycle	SAR (1g)	Scaling Factor	Reported SAR (1g)	Plot #	
MHz	Ch.														(W/kg)		(W/kg)		
831.50	26865	Mid	LTE Band 26 (Cell)	15	25.2	24.97	0.00	0	04462	QPSK	1	74	10 mm	back	1:1	0.654	1.054	0.689	
831.50	26865	Mid	LTE Band 26 (Cell)	15	24.2	24.03	0.00	1	04462	QPSK	36	37	10 mm	back	1:1	0.517	1.040	0.538	
831.50	26865	Mid	LTE Band 26 (Cell)	15	25.2	24.97	-0.05	0	04462	QPSK	1	74	10 mm	front	1:1	0.527	1.054	0.555	
831.50	26865	Mid	LTE Band 26 (Cell)	15	24.2	24.03	0.00	1	04462	QPSK	36	37	10 mm	front	1:1	0.424	1.040	0.441	
831.50	26865	Mid	LTE Band 26 (Cell)	15	25.2	24.97	0.00	0	04462	QPSK	1	74	10 mm	bottom	1:1	0.394	1.054	0.415	
831.50	26865	Mid	LTE Band 26 (Cell)	15	24.2	24.03	-0.07	1	04462	QPSK	36	37	10 mm	bottom	1:1	0.346	1.040	0.360	
831.50	26865	Mid	LTE Band 26 (Cell)	15	25.2	24.97	-0.06	0	04462	QPSK	1	74	10 mm	right	1:1	0.664	1.054	0.700	A35
831.50	26865	Mid	LTE Band 26 (Cell)	15	24.2	24.03	-0.01	1	04462	QPSK	36	37	10 mm	right	1:1	0.546	1.040	0.568	
831.50	26865	Mid	LTE Band 26 (Cell)	15	25.2	24.97	-0.16	0	04462	QPSK	1	74	10 mm	left	1:1	0.378	1.054	0.398	
831.50	26865	Mid	LTE Band 26 (Cell)	15	24.2	24.03	0.00	1	04462	QPSK	36	37	10 mm	left	1:1	0.316	1.040	0.329	
ANSI / IEEE C95.1 1992 - SAFETY LIMIT Spatial Peak Uncontrolled Exposure/General Population								Body 1.6 W/kg (mW/g) averaged over 1 gram											

FCC ID: ZNFX410PM		SAR EVALUATION REPORT		Approved by: Quality Manager
Document S/N: 1M1806270133-01-R1.ZNF	Test Dates: 07/08/18 - 07/16/18	DUT Type: Portable Handset	Page 66 of 95	

**Table 11-28
LTE Band 4 (AWS) Hotspot SAR**



MEASUREMENT RESULTS																			
FREQUENCY		Mode	Bandwidth [MHz]	Maximum Allowed Power [dBm]	Conducted Power [dBm]	Power Drift [dB]	MPR [dB]	Device Serial Number	Modulation	RB Size	RB Offset	Spacing	Side	Duty Cycle	SAR (1g)	Scaling Factor	Reported SAR (1g)	Plot #	
MHz	Ch.														(W/kg)		(W/kg)		
1732.50	20175	Mid	LTE Band 4 (AWS)	20	25.2	25.16	-0.04	0	04462	QPSK	1	0	10 mm	back	1:1	1.090	1.009	1.100	
1732.50	20175	Mid	LTE Band 4 (AWS)	20	24.2	23.82	-0.01	1	04462	QPSK	50	0	10 mm	back	1:1	0.781	1.091	0.852	
1732.50	20175	Mid	LTE Band 4 (AWS)	20	24.2	23.78	0.00	1	04462	QPSK	100	0	10 mm	back	1:1	0.769	1.102	0.847	
1732.50	20175	Mid	LTE Band 4 (AWS)	20	25.2	25.16	0.02	0	04462	QPSK	1	0	10 mm	front	1:1	0.845	1.009	0.853	
1732.50	20175	Mid	LTE Band 4 (AWS)	20	24.2	23.82	0.04	1	04462	QPSK	50	0	10 mm	front	1:1	0.611	1.091	0.667	
1732.50	20175	Mid	LTE Band 4 (AWS)	20	24.2	23.78	0.04	1	04462	QPSK	100	0	10 mm	front	1:1	0.599	1.102	0.660	
1732.50	20175	Mid	LTE Band 4 (AWS)	20	25.2	25.16	-0.04	0	04462	QPSK	1	0	10 mm	bottom	1:1	0.330	1.009	0.333	
1732.50	20175	Mid	LTE Band 4 (AWS)	20	24.2	23.82	-0.04	1	04462	QPSK	50	0	10 mm	bottom	1:1	0.236	1.091	0.257	
1732.50	20175	Mid	LTE Band 4 (AWS)	20	25.2	25.16	-0.02	0	04462	QPSK	1	0	10 mm	left	1:1	0.571	1.009	0.576	
1732.50	20175	Mid	LTE Band 4 (AWS)	20	24.2	23.82	-0.02	1	04462	QPSK	50	0	10 mm	left	1:1	0.422	1.091	0.460	
1732.50	20175	Mid	LTE Band 4 (AWS)	20	25.2	25.16	0.02	0	04462	QPSK	1	0	10 mm	back	1:1	1.130	1.009	1.140	A36
ANSI / IEEE C95.1 1992 - SAFETY LIMIT Spatial Peak Uncontrolled Exposure/General Population								Body 1.6 W/kg (mW/g) averaged over 1 gram											

Note: Blue entries represent variability measurements.

**Table 11-29
LTE Band 25 (PCS) Hotspot SAR**

MEASUREMENT RESULTS																			
FREQUENCY		Mode	Bandwidth [MHz]	Maximum Allowed Power [dBm]	Conducted Power [dBm]	Power Drift [dB]	MPR [dB]	Device Serial Number	Modulation	RB Size	RB Offset	Spacing	Side	Duty Cycle	SAR (1g)	Scaling Factor	Reported SAR (1g)	Plot #	
MHz	Ch.														(W/kg)		(W/kg)		
1860.00	26140	Low	LTE Band 25 (PCS)	20	25.2	25.12	0.02	0	04397	QPSK	1	0	10 mm	back	1:1	1.040	1.019	1.060	A37
1882.50	26365	Mid	LTE Band 25 (PCS)	20	25.2	25.07	-0.01	0	04397	QPSK	1	0	10 mm	back	1:1	0.970	1.030	0.999	
1905.00	26590	High	LTE Band 25 (PCS)	20	25.2	25.16	0.01	0	04397	QPSK	1	99	10 mm	back	1:1	0.980	1.009	0.989	
1882.50	26365	Mid	LTE Band 25 (PCS)	20	24.2	23.93	0.04	1	04397	QPSK	50	0	10 mm	back	1:1	0.743	1.064	0.791	
1860.00	26140	Low	LTE Band 25 (PCS)	20	24.2	23.85	-0.04	1	04397	QPSK	100	0	10 mm	back	1:1	0.770	1.084	0.835	
1905.00	26590	High	LTE Band 25 (PCS)	20	25.2	25.16	-0.08	0	04397	QPSK	1	99	10 mm	front	1:1	0.684	1.009	0.690	
1882.50	26365	Mid	LTE Band 25 (PCS)	20	24.2	23.93	0.01	1	04397	QPSK	50	0	10 mm	front	1:1	0.528	1.064	0.562	
1905.00	26590	High	LTE Band 25 (PCS)	20	25.2	25.16	-0.08	0	04397	QPSK	1	99	10 mm	bottom	1:1	0.483	1.009	0.487	
1882.50	26365	Mid	LTE Band 25 (PCS)	20	24.2	23.93	0.05	1	04397	QPSK	50	0	10 mm	bottom	1:1	0.347	1.064	0.369	
1905.00	26590	High	LTE Band 25 (PCS)	20	25.2	25.16	-0.03	0	04397	QPSK	1	99	10 mm	left	1:1	0.688	1.009	0.694	
1882.50	26365	Mid	LTE Band 25 (PCS)	20	24.2	23.93	-0.02	1	04397	QPSK	50	0	10 mm	left	1:1	0.537	1.064	0.571	
1860.00	26140	Low	LTE Band 25 (PCS)	20	25.2	25.12	-0.16	0	04397	QPSK	1	0	10 mm	back	1:1	1.020	1.019	1.039	
ANSI / IEEE C95.1 1992 - SAFETY LIMIT Spatial Peak Uncontrolled Exposure/General Population								Body 1.6 W/kg (mW/g) averaged over 1 gram											

Note: Blue entries represent variability measurements.

FCC ID: ZNFX410PM		SAR EVALUATION REPORT		Approved by: Quality Manager
Document S/N: 1M1806270133-01-R1.ZNF	Test Dates: 07/08/18 - 07/16/18	DUT Type: Portable Handset	Page 67 of 95	



**Table 11-30
LTE Band 41 Hotspot SAR**

MEASUREMENT RESULTS																				
Power Class	FREQUENCY		Mode	Bandwidth [MHz]	Maximum Allowed Power [dBm]	Conducted Power [dBm]	Power Drift [dB]	MPR [dB]	Device Serial Number	Modulation	RB Size	RB Offset	Spacing	Side	Duty Cycle	SAR (1g)	Scaling Factor	Reported SAR (1g)	Plot #	
	MHz	Ch.														(W/kg)		(W/kg)		
Power Class 3	2506.00	39750	Low	LTE Band 41	20	25.2	24.95	-0.12	0	04421	QPSK	1	0	10 mm	back	1:1.58	0.685	1.059	0.725	
Power Class 3	2549.50	40185	Low-Mid	LTE Band 41	20	25.2	24.98	-0.02	0	04421	QPSK	1	0	10 mm	back	1:1.58	0.792	1.052	0.833	
Power Class 3	2593.00	40620	Mid	LTE Band 41	20	25.2	25.09	-0.04	0	04421	QPSK	1	0	10 mm	back	1:1.58	0.807	1.026	0.828	
Power Class 3	2636.50	41055	Mid-High	LTE Band 41	20	25.2	25.04	-0.15	0	04421	QPSK	1	99	10 mm	back	1:1.58	0.656	1.038	0.681	
Power Class 3	2680.00	41490	High	LTE Band 41	20	25.2	25.15	-0.14	0	04421	QPSK	1	0	10 mm	back	1:1.58	0.619	1.012	0.626	
Power Class 3	2680.00	41490	High	LTE Band 41	20	24.2	23.88	-0.01	1	04421	QPSK	50	0	10 mm	back	1:1.58	0.454	1.076	0.489	
Power Class 3	2636.50	41055	Mid-High	LTE Band 41	20	24.2	23.86	-0.12	1	04421	QPSK	100	0	10 mm	back	1:1.58	0.521	1.081	0.563	
Power Class 2	2549.50	40185	Low-Mid	LTE Band 41	20	27.7	27.58	-0.19	0	04421	QPSK	1	0	10 mm	back	1:2.31	1.080	1.028	1.110	A38
Power Class 3	2680.00	41490	High	LTE Band 41	20	25.2	25.15	-0.03	0	04421	QPSK	1	0	10 mm	front	1:1.58	0.400	1.012	0.405	
Power Class 3	2680.00	41490	High	LTE Band 41	20	24.2	23.88	0.11	1	04421	QPSK	50	0	10 mm	front	1:1.58	0.305	1.076	0.328	
Power Class 3	2680.00	41490	High	LTE Band 41	20	25.2	25.15	-0.15	0	04421	QPSK	1	0	10 mm	bottom	1:1.58	0.252	1.012	0.255	
Power Class 3	2680.00	41490	High	LTE Band 41	20	24.2	23.88	0.12	1	04421	QPSK	50	0	10 mm	bottom	1:1.58	0.173	1.076	0.186	
Power Class 3	2680.00	41490	High	LTE Band 41	20	25.2	25.15	0.03	0	04421	QPSK	1	0	10 mm	left	1:1.58	0.356	1.012	0.360	
Power Class 3	2680.00	41490	High	LTE Band 41	20	24.2	23.88	0.01	1	04421	QPSK	50	0	10 mm	left	1:1.58	0.264	1.076	0.284	
Power Class 2	2549.50	40185	Low-Mid	LTE Band 41	20	27.7	27.58	-0.13	0	04421	QPSK	1	0	10 mm	back	1:2.31	1.050	1.028	1.079	
ANSI / IEEE C95.1 1992 - SAFETY LIMIT Spatial Peak Uncontrolled Exposure/General Population										Body 1.6 W/kg (mW/g) averaged over 1 gram										

Note: Blue entries represent variability measurements.

**Table 11-31
WLAN Hotspot SAR**

MEASUREMENT RESULTS																			
FREQUENCY	Mode	Service	Bandwidth [MHz]	Maximum Allowed Power [dBm]	Conducted Power [dBm]	Power Drift [dB]	Spacing	Device Serial Number	Data Rate (Mbps)	Side	Duty Cycle (%)	Peak SAR of Area Scan	SAR (1g)	Scaling Factor (Power)	Scaling Factor (Duty Cycle)	Reported SAR (1g)	Plot #		
												(W/kg)	(W/kg)			(W/kg)			
2412	1	802.11b	DSSS	22	19.0	18.44	0.04	10 mm	04363	1	back	96.9	0.288	0.237	1.138	1.032	0.278	A39	
2412	1	802.11b	DSSS	22	19.0	18.44	0.12	10 mm	04363	1	front	96.9	0.270	-	1.138	1.032	-		
2412	1	802.11b	DSSS	22	19.0	18.44	0.18	10 mm	04363	1	top	96.9	0.174	-	1.138	1.032	-		
2412	1	802.11b	DSSS	22	19.0	18.44	0.17	10 mm	04363	1	left	96.9	0.187	-	1.138	1.032	-		
5240	48	802.11a	OFDM	20	18.0	17.70	0.05	10 mm	04348	6	back	96.9	0.661	0.296	1.072	1.032	0.327		
5240	48	802.11a	OFDM	20	18.0	17.70	0.10	10 mm	04348	6	front	96.9	1.201	0.535	1.072	1.032	0.592		
5200	40	802.11a	OFDM	20	18.0	17.63	-0.01	10 mm	04348	6	top	96.9	1.704	0.756	1.089	1.032	0.850		
5220	44	802.11a	OFDM	20	18.0	17.53	0.01	10 mm	04348	6	top	96.9	1.739	0.794	1.114	1.032	0.913		
5240	48	802.11a	OFDM	20	18.0	17.70	-0.12	10 mm	04348	6	top	96.9	1.873	0.826	1.072	1.032	0.914	A41	
5240	48	802.11a	OFDM	20	18.0	17.70	0.15	10 mm	04348	6	left	96.9	0.276	0.124	1.072	1.032	0.137		
5785	157	802.11a	OFDM	20	19.0	18.77	-0.01	10 mm	04348	6	back	96.9	0.782	0.325	1.054	1.032	0.354		
5745	149	802.11a	OFDM	20	19.0	18.76	0.00	10 mm	04348	6	front	96.9	1.398	0.743	1.057	1.032	0.810		
5785	157	802.11a	OFDM	20	19.0	18.77	0.04	10 mm	04348	6	front	96.9	1.800	0.771	1.054	1.032	0.839		
5785	157	802.11a	OFDM	20	19.0	18.77	0.16	10 mm	04348	6	top	96.9	1.392	0.649	1.054	1.032	0.706		
5785	157	802.11a	OFDM	20	19.0	18.77	0.15	10 mm	04348	6	left	96.9	0.276	0.130	1.054	1.032	0.141		
ANSI / IEEE C95.1 1992 - SAFETY LIMIT Spatial Peak Uncontrolled Exposure/General Population										Body 1.6 W/kg (mW/g) averaged over 1 gram									

FCC ID: ZNFX410PM		SAR EVALUATION REPORT		Approved by: Quality Manager
Document S/N: 1M1806270133-01-R1.ZNF	Test Dates: 07/08/18 - 07/16/18	DUT Type: Portable Handset	Page 68 of 95	

11.4 SAR Test Notes

General Notes:



1. The test data reported are the worst-case SAR values according to test procedures specified in IEEE 1528-2013, and FCC KDB Publication 447498 D01v06.
2. Batteries are fully charged at the beginning of the SAR measurements.
3. Liquid tissue depth was at least 15.0 cm for all frequencies.
4. The manufacturer has confirmed that the device(s) tested have the same physical, mechanical and thermal characteristics and are within operational tolerances expected for production units.
5. SAR results were scaled to the maximum allowed power to demonstrate compliance per FCC KDB Publication 447498 D01v06.
6. Device was tested using a fixed spacing for body-worn accessory testing. A separation distance of 10 mm was considered because the manufacturer has determined that there will be body-worn accessories available in the marketplace for users to support this separation distance.
7. Per FCC KDB Publication 648474 D04v01r03, body-worn SAR was evaluated without a headset connected to the device. Since the standalone reported body-worn SAR was ≤ 1.2 W/kg, no additional body-worn SAR evaluations using a headset cable were required.
8. Per FCC KDB 865664 D01v01r04, variability SAR tests were performed when the measured SAR results for a frequency band were greater than or equal to 0.8 W/kg. Repeated SAR measurements are highlighted in the tables above for clarity. Please see Section 13 for variability analysis.
9. During SAR Testing for the Wireless Router conditions per FCC KDB Publication 941225 D06v02r01, the actual Portable Hotspot operation (with actual simultaneous transmission of a transmitter with WIFI) was not activated (See Section 6.7 for more details).

GSM Test Notes:

1. Body-Worn accessory testing is typically associated with voice operations. Therefore, GSM voice was evaluated for body-worn SAR.
2. Justification for reduced test configurations per KDB Publication 941225 D01v03r01 and October 2013 TCB Workshop Notes: The source-based frame-averaged output power was evaluated for all GPRS/EDGE slot configurations. The configuration with the highest target frame averaged output power was evaluated for hotspot SAR. When the maximum frame-averaged powers are equivalent across two or more slots (within 0.25 dB), the configuration with the most number of time slots was tested.
3. Per FCC KDB Publication 447498 D01v06, if the reported (scaled) SAR measured at the middle channel or highest output power channel for each test configuration is ≤ 0.8 W/kg for 1g evaluations then testing at the other channels is not required for such test configuration(s). When the maximum output power variation across the required test channels is $> \frac{1}{2}$ dB, instead of the middle channel, the highest output power channel was used.
4. GPRS was additionally evaluated for head and body-worn exposure conditions to address possible VoIP scenarios.

CDMA Notes:

1. Head SAR for CDMA2000 mode was tested under RC3/SO55 per FCC KDB Publication 941225 D01v03r01.
2. Body-Worn SAR was tested with 1x RTT with TDSO / SO32 FCH Only. EVDO Rev0 and RevA and TDSO / SO32 FCH+SCH SAR tests were not required per the 3G SAR Test Reduction Procedure in FCC KDB Publication 941225 D01v03r01.
3. CDMA Wireless Router SAR is measured using Subtype 0/1 Physical Layer configurations for Rev. 0 according to KDB 941225 D01v03r01 procedures for data devices. Wireless Router SAR tests for Subtype 2 of Rev.A and 1x RTT configurations were not required per the 3G SAR Test Reduction Policy in KDB Publication 941225 D01v03r01.
4. Head SAR was additionally evaluated using EVDO Rev. A to determine compliance for VoIP operations.
5. Per FCC KDB Publication 447498 D01v06, if the reported (scaled) SAR measured at the middle channel or highest output power channel for each test configuration is ≤ 0.8 W/kg for 1g evaluations then testing at the other channels is not required for such test configuration(s). When the maximum output power

FCC ID: ZNFX410PM	 PCTEST ENGINEERING LABORATORY, INC.	SAR EVALUATION REPORT	 LG	Approved by: Quality Manager
Document S/N: 1M1806270133-01-R1.ZNF	Test Dates: 07/08/18 - 07/16/18	DUT Type: Portable Handset	Page 69 of 95	

variation across the required test channels is > ½ dB, instead of the middle channel, the highest output power channel was used.

UMTS Notes:



1. UMTS mode in was tested under RMC 12.2 kbps with HSPA Inactive per KDB Publication 941225 D01v03r01. AMR and HSPA SAR was not required per the 3G Test Reduction Procedure in KDB Publication 941225 D01v03r01.
2. Per FCC KDB Publication 447498 D01v06, if the reported (scaled) SAR measured at the middle channel or highest output power channel for each test configuration is ≤ 0.8 W/kg for 1g evaluations then testing at the other channels is not required for such test configuration(s). When the maximum output power variation across the required test channels is > ½ dB, instead of the middle channel, the highest output power channel was used.

LTE Notes:

1. LTE Considerations: LTE test configurations are determined according to SAR Evaluation Considerations for LTE Devices in FCC KDB Publication 941225 D05v02r04. The general test procedures used for testing can be found in Section 8.6.4.
2. MPR is permanently implemented for this device by the manufacturer. The specific manufacturer target MPR is indicated alongside the SAR results. MPR is enabled for this device, according to 3GPP TS36.101 Section 6.2.3 – 6.2.5 under Table 6.2.3-1.
3. A-MPR was disabled for all SAR tests by setting NS=01 and MCC=001 on the base station simulator. SAR tests were performed with the same number of RB and RB offsets transmitting on all TTI frames (maximum TTI).
4. Per FCC KDB Publication 447498 D01v06, when the reported LTE Band 41 SAR measured at the highest output power channel in a given a test configuration was > 0.6 W/kg for 1g evaluations, testing at the other channels was required for such test configurations.
5. TDD LTE was tested per the guidance provided in FCC KDB Publication 941225 D05v02r04. Testing was performed using UL-DL configuration 0 with 6 UL subframes and 2 S subframes using extended cyclic prefix only and special subframe configuration 6. SAR tests were performed at maximum output power and worst-case transmission duty factor in extended cyclic prefix. Per 3GPP 36.211 Section 4, the duty factor for special subframe configuration 6 using extended cyclic prefix is 0.633.
6. This device supports Power Class 2 and Power Class 3 operations for LTE Band 41. The highest available duty cycle for Power Class 2 operations is 43.3 % using UL-DL configuration 1. Per FCC Guidance, all SAR tests were performed using Power Class 3. SAR with power class 2 at the available duty factor was additionally performed for the power class 3 configuration with the highest SAR configuration for each exposure conditions. Please see Section 14 for linearity results.

WLAN Notes:



1. For held-to-ear and hotspot operations, the initial test position procedures were applied. The test position with the highest extrapolated peak SAR will be used as the initial test position. When reported SAR for the initial test position is ≤ 0.4 W/kg for 1g evaluations, no additional testing for the remaining test positions was required. Otherwise, SAR is evaluated at the subsequent highest peak SAR positions until the reported SAR result is ≤ 0.8 W/kg or all test positions are measured.
2. Justification for test configurations for WLAN per KDB Publication 248227 D01v02r02 for 2.4 GHz WIFI operations, the highest measured maximum output power channel for DSSS was selected for SAR measurement. SAR for OFDM modes (2.4 GHz 802.11g/n) was not required due to the maximum allowed powers and the highest reported DSSS SAR. See Section 8.7.5 for more information.
3. Justification for test configurations for WLAN per KDB Publication 248227 D01v02r02 for 5 GHz WIFI operations, the initial test configuration was selected according to the transmission mode with the highest maximum allowed powers. Other transmission modes were not investigated since the highest reported SAR for initial test configuration adjusted by the ratio of maximum output powers is less than 1.2 W/kg for 1g evaluations. See Section 8.7.6 for more information.

FCC ID: ZNFX410PM	 SAR EVALUATION REPORT 		Approved by: Quality Manager
Document S/N: 1M1806270133-01-R1.ZNF	Test Dates: 07/08/18 - 07/16/18	DUT Type: Portable Handset	Page 70 of 95

4. When the maximum reported 1g averaged SAR is ≤ 0.8 W/kg, SAR testing on additional channels was not required. Otherwise, SAR for the next highest output power channel was required until the reported SAR result was ≤ 1.20 W/kg for 1g evaluations or all test channels were measured.
5. The device was configured to transmit continuously at the required data rate, channel bandwidth and signal modulation, using the highest transmission duty factor supported by the test mode tools. The reported SAR was scaled to the 100% transmission duty factor to determine compliance. Procedures used to measure the duty factor are identical to that in the associated EMC test reports.

Bluetooth Notes

1. Bluetooth SAR was measured with the device connected to a call box with hopping disabled with DH5 operation and Tx Tests test mode type. Per October 2016 TCB Workshop Notes, the reported SAR was scaled to the 100% transmission duty factor to determine compliance. See Section 9.6 for the time domain plot and calculation for the duty factor of the device.

FCC ID: ZNFX410PM	 SAR EVALUATION REPORT 		Approved by: Quality Manager
Document S/N: 1M1806270133-01-R1.ZNF	Test Dates: 07/08/18 - 07/16/18	DUT Type: Portable Handset	Page 71 of 95

12 FCC MULTI-TX AND ANTENNA SAR CONSIDERATIONS

12.1 Introduction

The following procedures adopted from FCC KDB Publication 447498 D01v06 are applicable to devices with built-in unlicensed transmitters such as 802.11 and Bluetooth devices which may simultaneously transmit with the licensed transmitter.

12.2 Simultaneous Transmission Procedures

This device contains transmitters that may operate simultaneously. Therefore simultaneous transmission analysis is required. Per FCC KDB Publication 447498 D01v06 4.3.2 and IEEE 1528-2013 Section 6.3.4.1.2, simultaneous transmission SAR test exclusion may be applied when the sum of the 1g SAR for all the simultaneous transmitting antennas in a specific a physical test configuration is ≤ 1.6 W/kg. The different test positions in an exposure condition may be considered collectively to determine SAR test exclusion according to the sum of 1g or 10g SAR.



When standalone SAR is not required to be measured, per FCC KDB 447498 D01v06 4.3.2 b), the following equation must be used to estimate the standalone 1g SAR for simultaneous transmission assessment involving that transmitter.

$$\text{Estimated SAR} = \frac{\sqrt{f(\text{GHz})}}{7.5} * \frac{(\text{Max Power of channel, mW})}{\text{Min. Separation Distance, mm}}$$

**Table 12-1
Estimated SAR**

Mode	Frequency	Maximum Allowed Power	Separation Distance (Body)	Estimated SAR (Body)
	[MHz]	[dBm]	[mm]	[W/kg]
Bluetooth	2480	10.00	10	0.210

Note: Per KDB Publication 447498 D01v06, the maximum power of the channel was rounded to the nearest mW before calculation.

FCC ID: ZNFX410PM	 PCTEST ENGINEERING LABORATORY, INC.	SAR EVALUATION REPORT	 LG	Approved by: Quality Manager
Document S/N: 1M1806270133-01-R1.ZNF	Test Dates: 07/08/18 - 07/16/18	DUT Type: Portable Handset		Page 72 of 95

12.3 Head SAR Simultaneous Transmission Analysis



(*) For test positions that were not required to be evaluated for WLAN SAR per FCC KDB publication 248227, the worst case WLAN SAR result for applicable exposure conditions was used for simultaneous transmission analysis.

Table 12-2
Simultaneous Transmission Scenario with 2.4 GHz WLAN (Held to Ear)

Exposure Condition	Mode	2G/3G/4G SAR (W/kg)	2.4 GHz WLAN SAR (W/kg)	Σ SAR (W/kg)	
		1	2	1+2	
Head SAR	CDMA/EVDO BC10 (§90S)	0.484	1.084	1.568	
	CDMA/EVDO BC0 (§22H)	0.530	1.084	See Table Below	
	GSM/GPRS 850	0.590	1.084	See Table Below	
	UMTS 850	0.506	1.084	1.590	
	UMTS 1750	0.458	1.084	1.542	
	PCS CDMA/EVDO	0.692	1.084	See Table Below	
	GSM/GPRS 1900	0.394	1.084	1.478	
	UMTS 1900	0.635	1.084	See Table Below	
	LTE Band 12	0.378	1.084	1.462	
	LTE Band 13	0.419	1.084	1.503	
	LTE Band 26 (Cell)	0.555	1.084	See Table Below	
	LTE Band 4 (AWS)	0.637	1.084	See Table Below	
	LTE Band 25 (PCS)	0.790	1.084	See Table Below	
LTE Band 41	0.712	1.084	See Table Below		

Simult Tx	Configuration	CDMA BC0 (§22H) SAR (W/kg)	2.4 GHz WLAN SAR (W/kg)	Σ SAR (W/kg)	Simult Tx	Configuration	EVDO BC0 (§22H) SAR (W/kg)	2.4 GHz WLAN SAR (W/kg)	Σ SAR (W/kg)	SPLSR
		1	2	1+2			1	2	1+2	1+2
Head SAR	Right Cheek	0.508	1.084	1.592	Head SAR	Right Cheek	0.530	1.084	See Note 1	0.03
	Right Tilt	0.313	0.851	1.164		Right Tilt	0.276	0.851	1.127	N/A
	Left Cheek	0.481	0.499	0.980		Left Cheek	0.455	0.499	0.954	N/A
	Left Tilt	0.298	1.084*	1.382		Left Tilt	0.267	1.084*	1.351	N/A

Simult Tx	Configuration	GSM 850 SAR (W/kg)	2.4 GHz WLAN SAR (W/kg)	Σ SAR (W/kg)	Simult Tx	Configuration	GPRS 850 SAR (W/kg)	2.4 GHz WLAN SAR (W/kg)	Σ SAR (W/kg)	SPLSR
		1	2	1+2			1	2	1+2	1+2
Head SAR	Right Cheek	0.461	1.084	1.545	Head SAR	Right Cheek	0.590	1.084	See Note 1	0.04
	Right Tilt	0.264	0.851	1.115		Right Tilt	0.351	0.851	1.202	N/A
	Left Cheek	0.408	0.499	0.907		Left Cheek	0.515	0.499	1.014	N/A
	Left Tilt	0.240	1.084*	1.324		Left Tilt	0.323	1.084*	1.407	N/A



FCC ID: ZNFX410PM	 PCTEST ENGINEERING LABORATORY, INC.	SAR EVALUATION REPORT		Approved by: Quality Manager
Document S/N: 1M1806270133-01-R1-ZNF	Test Dates: 07/08/18 - 07/16/18	DUT Type: Portable Handset	Page 73 of 95	

Simult Tx	Configuration	PCS CDMA SAR (W/kg)	2.4 GHz WLAN SAR (W/kg)	Σ SAR (W/kg)	Simult Tx	Configuration	PCS EVDO SAR (W/kg)	2.4 GHz WLAN SAR (W/kg)	Σ SAR (W/kg)
		1	2	1+2			1	2	1+2
Head SAR	Right Cheek	0.419	1.084	1.503	Head SAR	Right Cheek	0.409	1.084	1.493
	Right Tilt	0.231	0.851	1.082		Right Tilt	0.231	0.851	1.082
	Left Cheek	0.692	0.499	1.191		Left Cheek	0.692	0.499	1.191
	Left Tilt	0.270	1.084*	1.354		Left Tilt	0.246	1.084*	1.330

Simult Tx	Configuration	UMTS 1900 SAR (W/kg)	2.4 GHz WLAN SAR (W/kg)	Σ SAR (W/kg)	Simult Tx	Configuration	LTE Band 26 (Cell) SAR (W/kg)	2.4 GHz WLAN SAR (W/kg)	Σ SAR (W/kg)	SPLSR
		1	2	1+2			1	2	1+2	1+2
Head SAR	Right Cheek	0.335	1.084	1.419	Head SAR	Right Cheek	0.555	1.084	See Note 1	0.03
	Right Tilt	0.239	0.851	1.090		Right Tilt	0.313	0.851	1.164	N/A
	Left Cheek	0.635	0.499	1.134		Left Cheek	0.482	0.499	0.981	N/A
	Left Tilt	0.232	1.084*	1.316		Left Tilt	0.310	1.084*	1.394	N/A

Simult Tx	Configuration	LTE Band 4 (AWS) SAR (W/kg)	2.4 GHz WLAN SAR (W/kg)	Σ SAR (W/kg)	Simult Tx	Configuration	LTE Band 25 (PCS) SAR (W/kg)	2.4 GHz WLAN SAR (W/kg)	Σ SAR (W/kg)
		1	2	1+2			1	2	1+2
Head SAR	Right Cheek	0.371	1.084	1.455	Head SAR	Right Cheek	0.488	1.084	1.572
	Right Tilt	0.299	0.851	1.150		Right Tilt	0.254	0.851	1.105
	Left Cheek	0.637	0.499	1.136		Left Cheek	0.790	0.499	1.289
	Left Tilt	0.250	1.084*	1.334		Left Tilt	0.308	1.084*	1.392

Simult Tx	Configuration	LTE Band 41 SAR (W/kg)	2.4 GHz WLAN SAR (W/kg)	Σ SAR (W/kg)
		1	2	1+2
Head SAR	Right Cheek	0.311	1.084	1.395
	Right Tilt	0.188	0.851	1.039
	Left Cheek	0.712	0.499	1.211
	Left Tilt	0.114	1.084*	1.198

FCC ID: ZNFX410PM	 PCTEST ENGINEERING LABORATORY, INC.	SAR EVALUATION REPORT	 LG	Approved by: Quality Manager
Document S/N: 1M1806270133-01-R1.ZNF	Test Dates: 07/08/18 - 07/16/18	DUT Type: Portable Handset	Page 74 of 95	



**Table 12-3
Simultaneous Transmission Scenario with 5 GHz WLAN (Held to Ear)**

Exposure Condition	Mode	2G/3G/4G SAR (W/kg)	5 GHz WLAN SAR (W/kg)	Σ SAR (W/kg)
		1	2	1+2
Head SAR	CDMA/EVDO BC10 (§90S)	0.484	1.133	See Table Below
	CDMA/EVDO BC0 (§22H)	0.530	1.133	See Table Below
	GSM/GPRS 850	0.590	1.133	See Table Below
	UMTS 850	0.506	1.133	See Table Below
	UMTS 1750	0.458	1.133	1.591
	PCS CDMA/EVDO	0.692	1.133	See Table Below
	GSM/GPRS 1900	0.394	1.133	1.527
	UMTS 1900	0.635	1.133	See Table Below
	LTE Band 12	0.378	1.133	1.511
	LTE Band 13	0.419	1.133	1.552
	LTE Band 26 (Cell)	0.555	1.133	See Table Below
	LTE Band 4 (AWS)	0.637	1.133	See Table Below
	LTE Band 25 (PCS)	0.790	1.133	See Table Below
	LTE Band 41	0.712	1.133	See Table Below

Simult Tx	Configuration	CDMA BC10 (§90S) SAR (W/kg)	5 GHz WLAN SAR (W/kg)	Σ SAR (W/kg)	Simult Tx	Configuration	EVDO BC10 (§90S) SAR (W/kg)	5 GHz WLAN SAR (W/kg)	Σ SAR (W/kg)
		1	2	1+2			1	2	1+2
Head SAR	Right Cheek	0.484	1.106	1.590	Head SAR	Right Cheek	0.476	1.106	1.582
	Right Tilt	0.269	1.133	1.402		Right Tilt	0.258	1.133	1.391
	Left Cheek	0.444	0.902	1.346		Left Cheek	0.438	0.902	1.340
	Left Tilt	0.259	0.933	1.192		Left Tilt	0.262	0.933	1.195

Simult Tx	Configuration	CDMA BC0 (§22H) SAR (W/kg)	5 GHz WLAN SAR (W/kg)	Σ SAR (W/kg)	SPLSR	Simult Tx	Configuration	EVDO BC0 (§22H) SAR (W/kg)	5 GHz WLAN SAR (W/kg)	Σ SAR (W/kg)	SPLSR
		1	2	1+2	1+2			1	2	1+2	1+2
Head SAR	Right Cheek	0.508	1.106	See Note 1	0.03	Head SAR	Right Cheek	0.530	1.106	See Note 1	0.03
	Right Tilt	0.313	1.133	1.446	N/A		Right Tilt	0.276	1.133	1.409	N/A
	Left Cheek	0.481	0.902	1.383	N/A		Left Cheek	0.455	0.902	1.357	N/A
	Left Tilt	0.298	0.933	1.231	N/A		Left Tilt	0.267	0.933	1.200	N/A

Simult Tx	Configuration	GSM 850 SAR (W/kg)	5 GHz WLAN SAR (W/kg)	Σ SAR (W/kg)	Simult Tx	Configuration	GPRS 850 SAR (W/kg)	5 GHz WLAN SAR (W/kg)	Σ SAR (W/kg)	SPLSR
		1	2	1+2			1	2	1+2	1+2
Head SAR	Right Cheek	0.461	1.106	1.567	Head SAR	Right Cheek	0.590	1.106	See Note 1	0.03
	Right Tilt	0.264	1.133	1.397		Right Tilt	0.351	1.133	1.484	N/A
	Left Cheek	0.408	0.902	1.310		Left Cheek	0.515	0.902	1.417	N/A
	Left Tilt	0.240	0.933	1.173		Left Tilt	0.323	0.933	1.256	N/A



FCC ID: ZNFX410PM		SAR EVALUATION REPORT		Approved by: Quality Manager
Document S/N: 1M1806270133-01-R1.ZNF	Test Dates: 07/08/18 - 07/16/18	DUT Type: Portable Handset	Page 75 of 95	

Simult Tx	Configuration	UMTS 850 SAR (W/kg)	5 GHz WLAN SAR (W/kg)	Σ SAR (W/kg)	SPLSR	Simult Tx	Configuration	PCS CDMA SAR (W/kg)	5 GHz WLAN SAR (W/kg)	Σ SAR (W/kg)
		1	2	1+2	1+2			1	2	1+2
Head SAR	Right Cheek	0.506	1.106	See Note 1	0.03	Head SAR	Right Cheek	0.419	1.106	1.525
	Right Tilt	0.277	1.133	1.410	N/A		Right Tilt	0.231	1.133	1.364
	Left Cheek	0.411	0.902	1.313	N/A		Left Cheek	0.692	0.902	1.594
	Left Tilt	0.256	0.933	1.189	N/A		Left Tilt	0.270	0.933	1.203

Simult Tx	Configuration	PCS EVDO SAR (W/kg)	5 GHz WLAN SAR (W/kg)	Σ SAR (W/kg)	Simult Tx	Configuration	UMTS 1900 SAR (W/kg)	5 GHz WLAN SAR (W/kg)	Σ SAR (W/kg)
		1	2	1+2			1	2	1+2
Head SAR	Right Cheek	0.409	1.106	1.515	Head SAR	Right Cheek	0.335	1.106	1.441
	Right Tilt	0.231	1.133	1.364		Right Tilt	0.239	1.133	1.372
	Left Cheek	0.692	0.902	1.594		Left Cheek	0.635	0.902	1.537
	Left Tilt	0.246	0.933	1.179		Left Tilt	0.232	0.933	1.165

Simult Tx	Configuration	LTE Band 26 (Cell) SAR (W/kg)	5 GHz WLAN SAR (W/kg)	Σ SAR (W/kg)	SPLSR	Simult Tx	Configuration	LTE Band 4 (AWS) SAR (W/kg)	5 GHz WLAN SAR (W/kg)	Σ SAR (W/kg)
		1	2	1+2	1+2			1	2	1+2
Head SAR	Right Cheek	0.555	1.106	See Note 1	0.03	Head SAR	Right Cheek	0.371	1.106	1.477
	Right Tilt	0.313	1.133	1.446	N/A		Right Tilt	0.299	1.133	1.432
	Left Cheek	0.482	0.902	1.384	N/A		Left Cheek	0.637	0.902	1.539
	Left Tilt	0.310	0.933	1.243	N/A		Left Tilt	0.250	0.933	1.183



Simult Tx	Configuration	LTE Band 25 (PCS) SAR (W/kg)	5 GHz WLAN SAR (W/kg)	Σ SAR (W/kg)	SPLSR	Simult Tx	Configuration	LTE Band 41 SAR (W/kg)	5 GHz WLAN SAR (W/kg)	Σ SAR (W/kg)	SPLSR
		1	2	1+2	1+2			1	2	1+2	1+2
Head SAR	Right Cheek	0.488	1.106	1.594	N/A	Head SAR	Right Cheek	0.311	1.106	1.417	N/A
	Right Tilt	0.254	1.133	1.387	N/A		Right Tilt	0.188	1.133	1.321	N/A
	Left Cheek	0.790	0.902	See Note 1	0.03		Left Cheek	0.712	0.902	See Note 1	0.02
	Left Tilt	0.308	0.933	1.241	N/A		Left Tilt	0.114	0.933	1.047	N/A

FCC ID: ZNFX410PM	 PCTEST ENGINEERING LABORATORY, INC.	SAR EVALUATION REPORT		Approved by: Quality Manager
Document S/N: 1M1806270133-01-R1-ZNF	Test Dates: 07/08/18 - 07/16/18	DUT Type: Portable Handset	Page 76 of 95	

**Table 12-4
Simultaneous Transmission Scenario with Bluetooth (Held to Ear)**

Exposure Condition	Mode	2G/3G/4G SAR (W/kg)	Bluetooth SAR (W/kg)	Σ SAR (W/kg)
		1	2	1+2
Head SAR	CDMA/EVDO BC10 (§90S)	0.484	0.370	0.854
	CDMA/EVDO BC0 (§22H)	0.530	0.370	0.900
	GSM/GPRS 850	0.590	0.370	0.960
	UMTS 850	0.506	0.370	0.876
	UMTS 1750	0.458	0.370	0.828
	PCS CDMA/EVDO	0.692	0.370	1.062
	GSM/GPRS 1900	0.394	0.370	0.764
	UMTS 1900	0.635	0.370	1.005
	LTE Band 12	0.378	0.370	0.748
	LTE Band 13	0.419	0.370	0.789
	LTE Band 26 (Cell)	0.555	0.370	0.925
	LTE Band 4 (AWS)	0.637	0.370	1.007
	LTE Band 25 (PCS)	0.790	0.370	1.160
	LTE Band 41	0.712	0.370	1.082

Note 1: No evaluation was performed to determine the aggregate 1g SAR for these configurations as the SPLS ratio between the antenna pairs was not greater than 0.04 per FCC KDB 447498 D01v06. See Section 12.6 for detailed SPLS ratio analysis

FCC ID: ZNFX410PM		SAR EVALUATION REPORT		Approved by: Quality Manager
Document S/N: 1M1806270133-01-R1.ZNF	Test Dates: 07/08/18 - 07/16/18	DUT Type: Portable Handset	Page 77 of 95	

12.4 Body-Worn Simultaneous Transmission Analysis

Table 12-5
Simultaneous Transmission Scenario with 2.4 GHz WLAN (Body-Worn at 1.0 cm)

Exposure Condition	Mode	2G/3G/4G SAR (W/kg)	2.4 GHz WLAN SAR (W/kg)	Σ SAR (W/kg)
		1	2	1+2
Body-Worn	CDMA BC10 (§90S)	0.706	0.278	0.984
	CDMA BC0 (§22H)	0.659	0.278	0.937
	GSM/GPRS 850	0.828	0.278	1.106
	UMTS 850	0.647	0.278	0.925
	UMTS 1750	0.885	0.278	1.163
	PCS CDMA	0.797	0.278	1.075
	GSM/GPRS 1900	0.402	0.278	0.680
	UMTS 1900	0.775	0.278	1.053
	LTE Band 12	0.523	0.278	0.801
	LTE Band 13	0.644	0.278	0.922
	LTE Band 26 (Cell)	0.689	0.278	0.967
	LTE Band 4 (AWS)	1.140	0.278	1.418
	LTE Band 25 (PCS)	1.060	0.278	1.338
LTE Band 41	1.110	0.278	1.388	

Table 12-6
Simultaneous Transmission Scenario with 5 GHz WLAN (Body-Worn at 1.0 cm)

Exposure Condition	Mode	2G/3G/4G SAR (W/kg)	5 GHz WLAN SAR (W/kg)	Σ SAR (W/kg)
		1	2	1+2
Body-Worn	CDMA BC10 (§90S)	0.706	0.375	1.081
	CDMA BC0 (§22H)	0.659	0.375	1.034
	GSM/GPRS 850	0.828	0.375	1.203
	UMTS 850	0.647	0.375	1.022
	UMTS 1750	0.885	0.375	1.260
	PCS CDMA	0.797	0.375	1.172
	GSM/GPRS 1900	0.402	0.375	0.777
	UMTS 1900	0.775	0.375	1.150
	LTE Band 12	0.523	0.375	0.898
	LTE Band 13	0.644	0.375	1.019
	LTE Band 26 (Cell)	0.689	0.375	1.064
	LTE Band 4 (AWS)	1.140	0.375	1.515
	LTE Band 25 (PCS)	1.060	0.375	1.435
LTE Band 41	1.110	0.375	1.485	





FCC ID: ZNFX410PM	 PCTEST ENGINEERING LABORATORY, INC.	SAR EVALUATION REPORT		Approved by: Quality Manager
Document S/N: 1M1806270133-01-R1.ZNF	Test Dates: 07/08/18 - 07/16/18	DUT Type: Portable Handset	Page 78 of 95	

Table 12-7
Simultaneous Transmission Scenario with Bluetooth (Body-Worn at 1.0 cm)

Exposure Condition	Mode	2G/3G/4G SAR (W/kg)	Bluetooth SAR (W/kg)	Σ SAR (W/kg)
		1	2	1+2
Body-Worn	CDMA BC10 (§90S)	0.706	0.210	0.916
	CDMA BC0 (§22H)	0.659	0.210	0.869
	GSM/GPRS 850	0.828	0.210	1.038
	UMTS 850	0.647	0.210	0.857
	UMTS 1750	0.885	0.210	1.095
	PCS CDMA	0.797	0.210	1.007
	GSM/GPRS 1900	0.402	0.210	0.612
	UMTS 1900	0.775	0.210	0.985
	LTE Band 12	0.523	0.210	0.733
	LTE Band 13	0.644	0.210	0.854
	LTE Band 26 (Cell)	0.689	0.210	0.899
	LTE Band 4 (AWS)	1.140	0.210	1.350
	LTE Band 25 (PCS)	1.060	0.210	1.270
	LTE Band 41	1.110	0.210	1.320

Note: Bluetooth SAR was not required to be measured per FCC KDB Publication 447498 D01v06. Estimated SAR results were used in the above table to determine simultaneous transmission SAR test exclusion.

FCC ID: ZNFX410PM		SAR EVALUATION REPORT		Approved by: Quality Manager
Document S/N: 1M1806270133-01-R1.ZNF	Test Dates: 07/08/18 - 07/16/18	DUT Type: Portable Handset		Page 79 of 95

12.5 Hotspot SAR Simultaneous Transmission Analysis

Per FCC KDB Publication 941225 D06v02r01, the devices edges with antennas more than 2.5 cm from edge are not required to be evaluated for SAR (“-“).

(*) For test positions that were not required to be evaluated for WLAN SAR per FCC KDB publication 248227, the worst case WLAN SAR result for applicable exposure conditions was used for simultaneous transmission analysis.

Table 12-8
Simultaneous Transmission Scenario with 2.4 GHz WLAN (Hotspot at 1.0 cm)

Exposure Condition	Mode	2G/3G/4G SAR (W/kg)	2.4 GHz WLAN SAR (W/kg)	Σ SAR (W/kg)
		1	2	1+2
Hotspot SAR	EVDO BC10 (§90S)	0.754	0.278	1.032
	EVDO BC0 (§22H)	0.686	0.278	0.964
	GPRS 850	0.828	0.278	1.106
	UMTS 850	0.653	0.278	0.931
	UMTS 1750	0.885	0.278	1.163
	PCS EVDO	0.854	0.278	1.132
	GPRS 1900	0.402	0.278	0.680
	UMTS 1900	0.775	0.278	1.053
	LTE Band 12	0.563	0.278	0.841
	LTE Band 13	0.716	0.278	0.994
	LTE Band 26 (Cell)	0.700	0.278	0.978
	LTE Band 4 (AWS)	1.140	0.278	1.418
	LTE Band 25 (PCS)	1.060	0.278	1.338
	LTE Band 41	1.110	0.278	1.388





FCC ID: ZNFX410PM	 PCTEST ENGINEERING LABORATORY, INC.	SAR EVALUATION REPORT		Approved by: Quality Manager
Document S/N: 1M1806270133-01-R1.ZNF	Test Dates: 07/08/18 - 07/16/18	DUT Type: Portable Handset	Page 80 of 95	

Table 12-9
Simultaneous Transmission Scenario with 5 GHz WLAN (Hotspot at 1.0 cm)

Exposure Condition	Mode	2G/3G/4G SAR (W/kg)	5 GHz WLAN SAR (W/kg)	Σ SAR (W/kg)
		1	2	1+2
Hotspot SAR	EVDO BC10 (§90S)	0.754	0.914	See Table Below
	EVDO BC0 (§22H)	0.686	0.914	See Table Below
	GPRS 850	0.828	0.914	See Table Below
	UMTS 850	0.653	0.914	1.567
	UMTS 1750	0.885	0.914	See Table Below
	PCS EVDO	0.854	0.914	See Table Below
	GPRS 1900	0.402	0.914	1.316
	UMTS 1900	0.775	0.914	See Table Below
	LTE Band 12	0.563	0.914	1.477
	LTE Band 13	0.716	0.914	See Table Below
	LTE Band 26 (Cell)	0.700	0.914	See Table Below
	LTE Band 4 (AWS)	1.140	0.914	See Table Below
	LTE Band 25 (PCS)	1.060	0.914	See Table Below
	LTE Band 41	1.110	0.914	See Table Below

Simult Tx	Configuration	EVDO BC10 (§90S) SAR (W/kg)	5 GHz WLAN SAR (W/kg)	Σ SAR (W/kg)	Simult Tx	Configuration	EVDO BC0 (§22H) SAR (W/kg)	5 GHz WLAN SAR (W/kg)	Σ SAR (W/kg)
		1	2	1+2			1	2	1+2
Hotspot SAR	Back	0.674	0.354	1.028	Hotspot SAR	Back	0.627	0.354	0.981
	Front	0.519	0.839	1.358		Front	0.515	0.839	1.354
	Top	-	0.914	0.914		Top	-	0.914	0.914
	Bottom	0.296	-	0.296		Bottom	0.414	-	0.414
	Right	0.754	-	0.754		Right	0.686	-	0.686
	Left	0.488	0.141	0.629		Left	0.362	0.141	0.503



Simult Tx	Configuration	GPRS 850 SAR (W/kg)	5 GHz WLAN SAR (W/kg)	Σ SAR (W/kg)	Simult Tx	Configuration	UMTS 1750 SAR (W/kg)	5 GHz WLAN SAR (W/kg)	Σ SAR (W/kg)
		1	2	1+2			1	2	1+2
Hotspot SAR	Back	0.828	0.354	1.182	Hotspot SAR	Back	0.885	0.354	1.239
	Front	0.614	0.839	1.453		Front	0.670	0.839	1.509
	Top	-	0.914	0.914		Top	-	0.914	0.914
	Bottom	0.438	-	0.438		Bottom	0.266	-	0.266
	Right	0.729	-	0.729		Right	-	-	-
	Left	0.453	0.141	0.594		Left	0.489	0.141	0.630

FCC ID: ZNFX410PM	 PCTEST ENGINEERING LABORATORY, INC.	SAR EVALUATION REPORT		Approved by: Quality Manager
Document S/N: 1M1806270133-01-R1.ZNF	Test Dates: 07/08/18 - 07/16/18	DUT Type: Portable Handset		Page 81 of 95

Simult Tx	Configuration	PCS EVDO SAR (W/kg)	5 GHz WLAN SAR (W/kg)	Σ SAR (W/kg)	Simult Tx	Configuration	UMTS 1900 SAR (W/kg)	5 GHz WLAN SAR (W/kg)	Σ SAR (W/kg)
		1	2	1+2			1	2	1+2
Hotspot SAR	Back	0.854	0.354	1.208	Hotspot SAR	Back	0.775	0.354	1.129
	Front	0.654	0.839	1.493		Front	0.584	0.839	1.423
	Top	-	0.914	0.914		Top	-	0.914	0.914
	Bottom	0.396	-	0.396		Bottom	0.355	-	0.355
	Right	-	-	-		Right	-	-	-
	Left	0.610	0.141	0.751		Left	0.554	0.141	0.695
Simult Tx	Configuration	LTE Band 13 SAR (W/kg)	5 GHz WLAN SAR (W/kg)	Σ SAR (W/kg)	Simult Tx	Configuration	LTE Band 26 (Cell) SAR (W/kg)	5 GHz WLAN SAR (W/kg)	Σ SAR (W/kg)
		1	2	1+2			1	2	1+2
Hotspot SAR	Back	0.644	0.354	0.998	Hotspot SAR	Back	0.689	0.354	1.043
	Front	0.532	0.839	1.371		Front	0.555	0.839	1.394
	Top	-	0.914	0.914		Top	-	0.914	0.914
	Bottom	0.326	-	0.326		Bottom	0.415	-	0.415
	Right	0.716	-	0.716		Right	0.700	-	0.700
	Left	0.283	0.141	0.424		Left	0.398	0.141	0.539

Simult Tx	Configuration	LTE Band 4 (AWS) SAR (W/kg)	5 GHz WLAN SAR (W/kg)	Σ SAR (W/kg)	SPLSR	Simult Tx	Configuration	LTE Band 25 (PCS) SAR (W/kg)	5 GHz WLAN SAR (W/kg)	Σ SAR (W/kg)
		1	2	1+2	1+2			1	2	1+2
Hotspot SAR	Back	1.140	0.354	1.494	N/A	Hotspot SAR	Back	1.060	0.354	1.414
	Front	0.853	0.839	See Note 1	0.02		Front	0.690	0.839	1.529
	Top	-	0.914	0.914	N/A		Top	-	0.914	0.914
	Bottom	0.333	-	0.333	N/A		Bottom	0.487	-	0.487
	Right	-	-	-	N/A		Right	-	-	-
	Left	0.576	0.141	0.717	N/A		Left	0.694	0.141	0.835

Simult Tx	Configuration	LTE Band 41 SAR (W/kg)	5 GHz WLAN SAR (W/kg)	Σ SAR (W/kg)
		1	2	1+2
Hotspot SAR	Back	1.110	0.354	1.464
	Front	0.405	0.839	1.244
	Top	-	0.914	0.914
	Bottom	0.255	-	0.255
	Right	-	-	-
	Left	0.360	0.141	0.501

FCC ID: ZNFX410PM	 PCTEST ENGINEERING LABORATORY, INC.	SAR EVALUATION REPORT		Approved by: Quality Manager
Document S/N: 1M1806270133-01-R1.ZNF	Test Dates: 07/08/18 - 07/16/18	DUT Type: Portable Handset	Page 82 of 95	



**Table 12-10
Simultaneous Transmission Scenario with Bluetooth (Hotspot at 1.0 cm)**

Exposure Condition	Mode	2G/3G/4G SAR (W/kg)	Bluetooth SAR (W/kg)	Σ SAR (W/kg)
		1	2	1+2
Hotspot SAR	EVDO BC10 (§90S)	0.754	0.210	0.964
	EVDO BC0 (§22H)	0.686	0.210	0.896
	GPRS 850	0.828	0.210	1.038
	UMTS 850	0.653	0.210	0.863
	UMTS 1750	0.885	0.210	1.095
	PCS EVDO	0.854	0.210	1.064
	GPRS 1900	0.402	0.210	0.612
	UMTS 1900	0.775	0.210	0.985
	LTE Band 12	0.563	0.210	0.773
	LTE Band 13	0.716	0.210	0.926
	LTE Band 26 (Cell)	0.700	0.210	0.910
	LTE Band 4 (AWS)	1.140	0.210	1.350
	LTE Band 25 (PCS)	1.060	0.210	1.270
	LTE Band 41	1.110	0.210	1.320

Bluetooth SAR was not required to be measured per FCC KDB Publication 447498 D01v06. Estimated SAR results were used in the above table to determine simultaneous transmission SAR test exclusion.

Notes:

- No evaluation was performed to determine the aggregate 1g SAR for these configurations as the SPLS ratio between the antenna pairs was not greater than 0.04 per FCC KDB 447498 D01v06. See Section 12.6 for detailed SPLS ratio analysis.

FCC ID: ZNFX410PM		SAR EVALUATION REPORT		Approved by: Quality Manager
Document S/N: 1M1806270133-01-R1.ZNF	Test Dates: 07/08/18 - 07/16/18	DUT Type: Portable Handset	Page 83 of 95	

12.6 SPLSR Evaluation and Analysis

Per FCC KDB Publication 447498 D01v06, when the sum of the standalone transmitters is more than 1.6 W/kg for 1g, the SAR sum to peak locations can be analyzed to determine SAR distribution overlaps. When the SAR peak to location ratio (shown below) for each pair of antennas is ≤ 0.04 for 1g, simultaneous SAR evaluation is not required. The distance between the transmitters was calculated using the following formula.

$$\text{Distance}_{\text{Tx1-Tx2}} = R_i = \sqrt{(x_1 - x_2)^2 + (y_1 - y_2)^2 + (z_1 - z_2)^2} \text{ (Head)}$$

$$\text{Distance}_{\text{Tx1-Tx2}} = R_i = \sqrt{(x_1 - x_2)^2 + (y_1 - y_2)^2} \text{ (Hotspot)}$$

$$\text{SPLS Ratio} = \frac{(SAR_1 + SAR_2)^{1.5}}{R_i}$$



12.6.1 Head SPLSR Evaluation and Analysis

Table 12-11
Peak SAR Locations for Right Cheek

Mode/Band	x (mm)	y (mm)	z (mm)
2.4 GHz WLAN	11.77	-325.98	-171.52
5 GHz WLAN	3.90	-331.90	-172.98
Cell. CDMA BC0	43.80	-269.67	-173.50
Cell. EVDO BC0	45.14	-268.94	-173.41
GPRS 850	41.19	-278.53	-173.98
UMTS 850	45.12	-268.95	-173.27
LTE Band 26 (Cell)	45.12	-268.95	-173.23



Table 12-12
Right Cheek SAR to Peak Location Separation Ratio Calculations

Antenna Pair		Standalone SAR (W/kg)		Standalone SAR Sum (W/kg)	Peak SAR Separation Distance (mm)	SPLS Ratio	Plot Number
Ant "a"	Ant "b"	a	b	a+b	D _{a-b}	(a+b) ^{1.5} /D _{a-b}	
2.4 GHz WLAN	Cell. EVDO BC0	1.084	0.53	1.614	66.11	0.03	1
2.4 GHz WLAN	GPRS 850	1.084	0.59	1.674	55.88	0.04	2
2.4 GHz WLAN	LTE Band 26 (Cell)	1.084	0.555	1.639	66.09	0.03	3
5 GHz WLAN	Cell. CDMA BC0	1.106	0.508	1.614	73.92	0.03	4
5 GHz WLAN	Cell. EVDO BC0	1.106	0.53	1.636	75.27	0.03	5
5 GHz WLAN	GPRS 850	1.106	0.59	1.696	65.11	0.03	6
5 GHz WLAN	UMTS 850	1.106	0.506	1.612	75.25	0.03	7
5 GHz WLAN	LTE Band 26 (Cell)	1.106	0.555	1.661	75.25	0.03	8

FCC ID: ZNFX410PM	 PCTEST ENGINEERING LABORATORY, INC.	SAR EVALUATION REPORT	 LG	Approved by: Quality Manager
Document S/N: 1M1806270133-01-R1.ZNF	Test Dates: 07/08/18 - 07/16/18	DUT Type: Portable Handset		Page 84 of 95

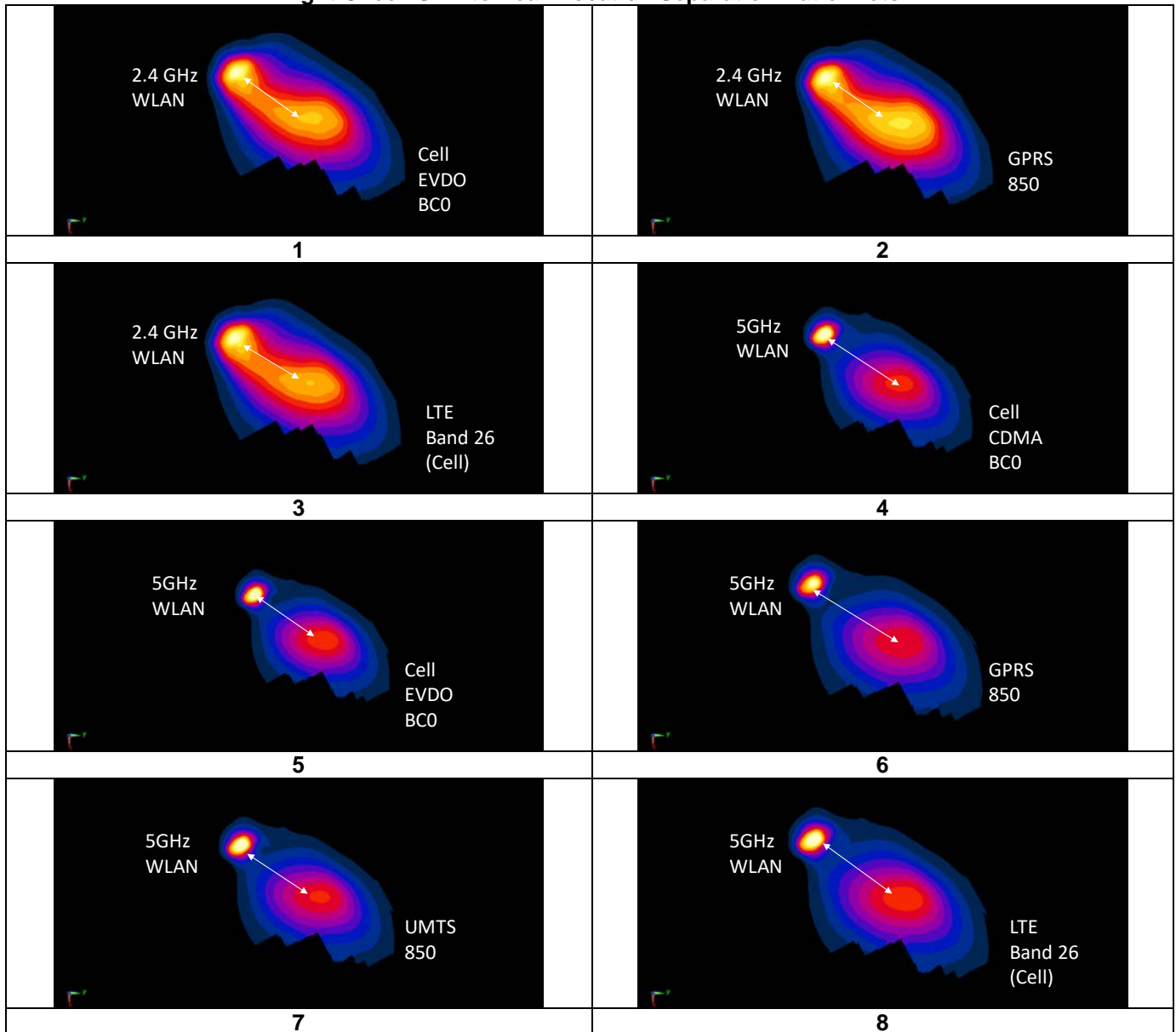
**Table 12-13
Right Cheek SAR to Peak Location Separation Ratio Plots**



FCC ID: ZNFX410PM	 SAR EVALUATION REPORT 		Approved by: Quality Manager
Document S/N: 1M1806270133-01-R1.ZNF	Test Dates: 07/08/18 - 07/16/18	DUT Type: Portable Handset	Page 85 of 95

**Table 12-14
Peak SAR Locations for Left Cheek**



Mode/Band	x (mm)	y (mm)	z (mm)
5 GHz WLAN	-21.31	292.47	-166.20
LTE Band 25 (PCS)	45.74	253.23	-172.88
LTE Band 41	46.94	244.50	-170.76

**Table 12-15
Right Cheek SAR to Peak Location Separation Ratio Calculations**

Antenna Pair		Standalone SAR (W/kg)		Standalone SAR Sum (W/kg)	Peak SAR Separation Distance (mm)	SPLS Ratio	Plot Number
Ant "a"	Ant "b"	a	b	a+b	D _{a-b}	$(a+b)^{1.5}/D_{a-b}$	
5 GHz WLAN	LTE Band 25 (PCS)	0.902	0.79	1.692	77.98	0.03	1
5 GHz WLAN	LTE Band 41	0.902	0.712	1.614	83.55	0.02	2

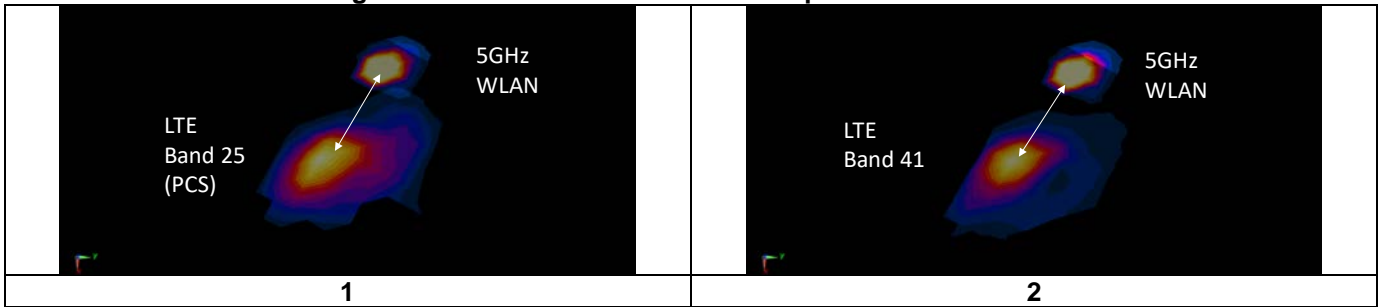
**Table 12-16
Right Cheek SAR to Peak Location Separation Ratio Plots**



FCC ID: ZNFX410PM		SAR EVALUATION REPORT		Approved by: Quality Manager
Document S/N: 1M1806270133-01-R1.ZNF	Test Dates: 07/08/18 - 07/16/18	DUT Type: Portable Handset		Page 86 of 95

12.6.2 Hotspot SPLSR Evaluation and Analysis

Table 12-17
Peak SAR Locations for Front Side

Mode/Band	x (mm)	y (mm)
5 GHz WLAN	-41.00	71.00
LTE Band 4 (AWS)	-52.00	-54.00

Table 12-18
Front Side SAR to Peak Location Separation Ratio Calculations

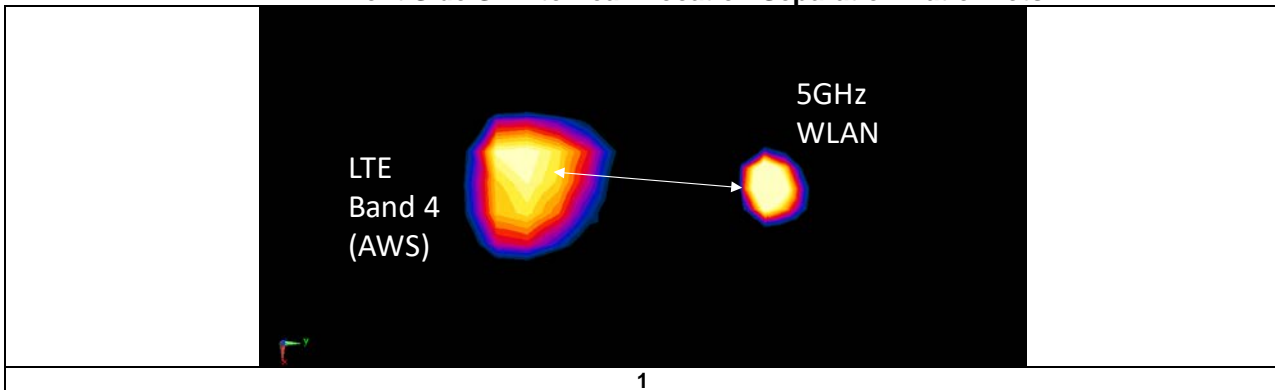

Antenna Pair		Standalone SAR (W/kg)		Standalone SAR Sum (W/kg)	Peak SAR Separation Distance (mm)	SPLSR Ratio	Plot Number
Ant "a"	Ant "b"	a	b	a+b	D_{a-b}	$(a+b)^{1.5}/D_{a-b}$	
5 GHz WLAN	LTE Band 4 (AWS)	0.839	0.853	1.692	125.48	0.02	1

Table 12-19
Front Side SAR to Peak Location Separation Ratio Plots



12.7 Simultaneous Transmission Conclusion

The above numerical summed SAR results and SPLSR analysis are sufficient to determine that simultaneous transmission cases will not exceed the SAR limit and therefore no measured volumetric simultaneous SAR summation is required per FCC KDB Publication 447498 D01v06 and IEEE 1528- 2013 Section 6.3.4.1.

FCC ID: ZNFX410PM	 PCTEST ENGINEERING LABORATORY, INC.	SAR EVALUATION REPORT	 LG	Approved by: Quality Manager
Document S/N: 1M1806270133-01-R1.ZNF	Test Dates: 07/08/18 - 07/16/18	DUT Type: Portable Handset		Page 87 of 95

13 SAR MEASUREMENT VARIABILITY

13.1 Measurement Variability

Per FCC KDB Publication 865664 D01v01r04, SAR measurement variability was assessed for each frequency band, which was determined by the SAR probe calibration point and tissue-equivalent medium used for the device measurements. When both head and body tissue-equivalent media were required for SAR measurements in a frequency band, the variability measurement procedures were applied to the tissue medium with the highest measured SAR, using the highest measured SAR configuration for that tissue-equivalent medium. These additional measurements were repeated after the completion of all measurements requiring the same head or body tissue-equivalent medium in a frequency band. The test device was returned to ambient conditions (normal room temperature) with the battery fully charged before it was re-mounted on the device holder for the repeated measurement(s) to minimize any unexpected variations in the repeated results.

SAR Measurement Variability was assessed using the following procedures for each frequency band:

- 1) When the original highest measured SAR is ≥ 0.80 W/kg, the measurement was repeated once.
- 2) A second repeated measurement was performed only if the ratio of largest to smallest SAR for the original and first repeated measurements was > 1.20 or when the original or repeated measurement was ≥ 1.45 W/kg (~ 10% from the 1g SAR limit).
- 3) A third repeated measurement was performed only if the original, first or second repeated measurement was ≥ 1.5 W/kg and the ratio of largest to smallest SAR for the original, first and second repeated measurements is > 1.20 .
- 4) Repeated measurements are not required when the original highest measured SAR is < 0.80 W/kg

**Table 13-1
Head SAR Measurement Variability Results**



HEAD VARIABILITY RESULTS														
Band	FREQUENCY		Mode/Band	Service	Side	Test Position	Data Rate (Mbps)	Measured SAR (1g)	1st Repeated SAR (1g)	Ratio	2nd Repeated SAR (1g)	Ratio	3rd Repeated SAR (1g)	Ratio
	MHz	Ch.						(W/kg)	(W/kg)		(W/kg)		(W/kg)	
2450	2412.00	1	802.11b, 22 MHz Bandwidth	DSSS	Right	Cheek	1	0.994	0.975	1.02	N/A	N/A	N/A	N/A
5250	5270.00	54	802.11n, 40 MHz Bandwidth	OFDM	Right	Tilt	13.5	0.831	0.811	1.02	N/A	N/A	N/A	N/A
5600	5510.00	102	802.11n, 40 MHz Bandwidth	OFDM	Right	Tilt	13.5	1.030	0.974	1.06	N/A	N/A	N/A	N/A
5750	5755.00	151	802.11n, 40 MHz Bandwidth	OFDM	Right	Tilt	13.5	1.060	0.979	1.08	N/A	N/A	N/A	N/A
ANSI / IEEE C95.1 1992 - SAFETY LIMIT Spatial Peak Uncontrolled Exposure/General Population							Head 1.6 W/kg (mW/g) averaged over 1 gram							

**Table 13-2
Body SAR Measurement Variability Results**

BODY VARIABILITY RESULTS															
Band	FREQUENCY		Mode	Service	# of Time Slots	Power Class	Side	Spacing	Measured SAR (1g)	1st Repeated SAR (1g)	Ratio	2nd Repeated SAR (1g)	Ratio	3rd Repeated SAR (1g)	Ratio
	MHz	Ch.							(W/kg)	(W/kg)		(W/kg)		(W/kg)	
835	848.80	251	GSM 850	GPRS	2	N/A	back	10 mm	0.800	0.791	N/A	N/A	N/A	N/A	N/A
1750	1732.50	20175	LTE Band 4 (AWS), 20 MHz Bandwidth	QPSK, 1 RB, 0 RB Offset	N/A	N/A	back	10 mm	1.090	1.130	1.04	N/A	N/A	N/A	N/A
1900	1860.00	26140	LTE Band 25 (PCS), 20 MHz Bandwidth	QPSK, 1 RB, 0 RB Offset	N/A	N/A	back	10 mm	1.040	1.020	1.02	N/A	N/A	N/A	N/A
2600	2549.50	40165	LTE Band 41, 20 MHz Bandwidth	QPSK, 1 RB, 0 RB Offset	N/A	2	back	10 mm	1.080	1.050	1.03	N/A	N/A	N/A	N/A
ANSI / IEEE C95.1 1992 - SAFETY LIMIT Spatial Peak Uncontrolled Exposure/General Population								Body 1.6 W/kg (mW/g) averaged over 1 gram							

13.2 Measurement Uncertainty

The measured SAR was < 1.5 W/kg for all frequency bands. Therefore, per KDB Publication 865664 D01v01r04, the extended measurement uncertainty analysis per IEEE 1528-2013 was not required.

FCC ID: ZNFX410PM		SAR EVALUATION REPORT		Approved by: Quality Manager
Document S/N: 1M1806270133-01-R1.ZNF	Test Dates: 07/08/18 - 07/16/18	DUT Type: Portable Handset	Page 88 of 95	

14 ADDITIONAL TESTING PER FCC GUIDANCE

14.1 LTE Band 41 Power Class 2 and Power Class 3 Linearity

This device supports Power Class 2 and Power Class 3 operations for LTE Band 41. The highest available duty cycle for Power Class 2 operations is 43.3 % using UL-DL configuration 1. Per May 2017 TCB Workshop Notes based on the device behavior, all SAR tests were performed using Power Class 3. SAR with Power Class 2 at the highest power and available duty factor was additionally performed for the Power Class 3 configuration with the highest SAR for each exposure condition. The linearity between the Power Class 2 and Power Class 3 SAR results and the respective frame averaged powers was calculated to determine that the results were linear. Per May 2017 TCB Workshop, no additional SAR measurements were required since the linearity between power classes was < 10% and all reported SAR values were < 1.4 W/kg for 1g and < 3.5 W/kg for 10g.

LTE Band 41 SAR testing with power class 2 at the highest power and available duty factor was additionally performed for the power class 3 configuration with the highest SAR for each exposure condition.

Table 14-1
LTE Band 41 Head Linearity Data

	LTE Band 41 PC3	LTE Band 41 PC2
Maximum Allowed Output Power (dBm)	25.2	27.7
Measured Output Power (dBm)	25.15	27.68
Measured SAR (W/kg)	0.526	0.708
Measured Power (mW)	327.34	586.14
Duty Cycle	63.3%	43.3%
Frame Averaged Output Power (mW)	207.21	253.80
% deviation from expected linearity		9.89%

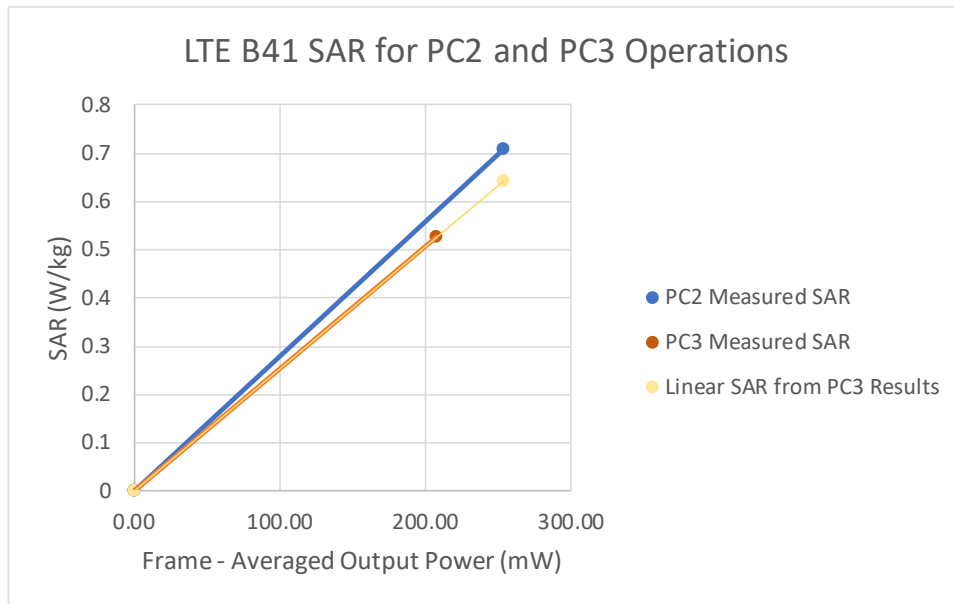

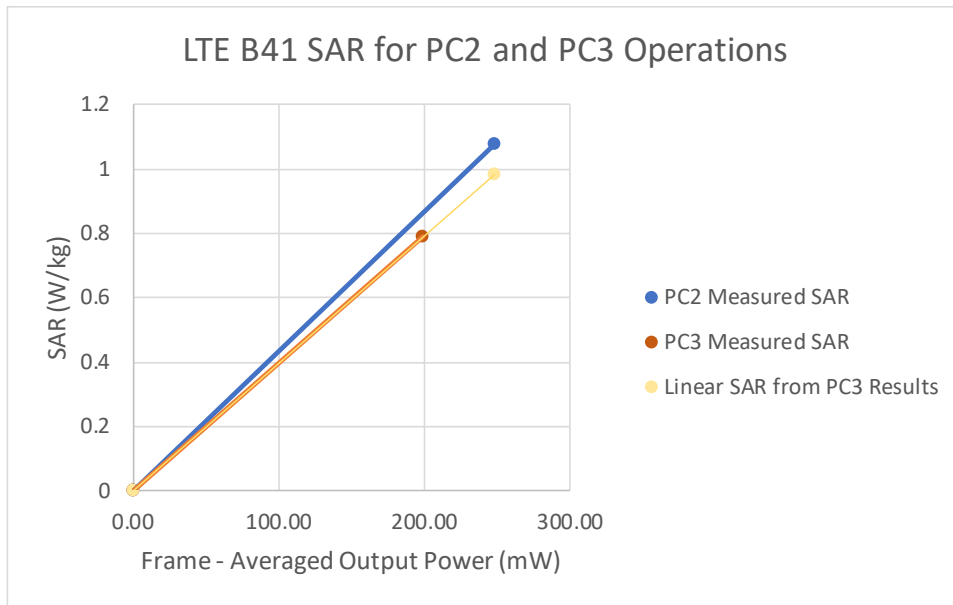

Figure 14-1
LTE Band 41 Head Linearity



FCC ID: ZNFX410PM	 PCTEST ENGINEERING LABORATORY, INC.	SAR EVALUATION REPORT	 LG	Approved by: Quality Manager
Document S/N: 1M1806270133-01-R1.ZNF	Test Dates: 07/08/18 - 07/16/18	DUT Type: Portable Handset		Page 89 of 95

**Table 14-2
LTE Band 41 Body-Worn and Hotspot Linearity Data**

	LTE Band 41 PC3	LTE Band 41 PC2
Maximum Allowed Output Power (dBm)	25.2	27.7
Measured Output Power (dBm)	24.98	27.58
Measured SAR (W/kg)	0.792	1.08
Measured Power (mW)	314.77	572.80
Duty Cycle	63.3%	43.3%
Frame Averaged Output Power (mW)	199.25	248.02
% deviation from expected linearity		9.55%





**Figure 14-2
LTE Band 41 Body-Worn and Hotspot Linearity**

FCC ID: ZNFX410PM		SAR EVALUATION REPORT		Approved by: Quality Manager
Document S/N: 1M1806270133-01-R1.ZNF	Test Dates: 07/08/18 - 07/16/18	DUT Type: Portable Handset		Page 90 of 95

15 EQUIPMENT LIST



Manufacturer	Model	Description	Cal Date	Cal Interval	Cal Due	Serial Number
Agilent	8753ES	S-Parameter Vector Network Analyzer	8/17/2017	Annual	8/17/2018	MY40003841
Agilent	8753ES	S-Parameter Network Analyzer	9/14/2017	Annual	9/14/2018	US39170118
Agilent	E4438C	ESG Vector Signal Generator	3/21/2017	Biennial	3/21/2019	MY45090700
Agilent	E5515C	8960 Series 10 Wireless Communications Test Set	11/15/2017	Annual	11/15/2018	GB42230325
Agilent	E5515C	Wireless Communications Test Set	1/24/2018	Annual	1/24/2019	GB44400860
Agilent	N4010A	Wireless Connectivity Test Set	N/A	N/A	N/A	GB46170464
Agilent	N5182A	MXG Vector Signal Generator	1/24/2018	Annual	1/24/2019	MY47420651
Agilent	N9020A	MXA Signal Analyzer	1/24/2018	Annual	1/24/2019	US46470561
Amplifier Research	150A100C	DC Amplifier	CBT	N/A	CBT	348812
Amplifier Research	15S1G6	Amplifier	CBT	N/A	CBT	433971
Anritsu	MA24106A	USB Power Sensor	3/12/2018	Annual	3/12/2019	1344555
Anritsu	MA24106A	USB Power Sensor	4/18/2018	Annual	4/18/2019	1344556
Anritsu	MA2411B	Pulse Power Sensor	3/2/2018	Annual	3/2/2019	1207364
Anritsu	MA2411B	Pulse Power Sensor	3/2/2018	Annual	3/2/2019	1339018
Anritsu	ML2495A	Power Meter	10/22/2017	Annual	10/22/2018	941001
Anritsu	MT8820C	Radio Communication Analyzer	3/20/2018	Annual	3/20/2019	6201144419
COMTECH	AR85729-5	Solid State Amplifier	CBT	N/A	CBT	M1S5A00-009
COMTECH	AR85729-5/5759B	Solid State Amplifier	CBT	N/A	CBT	M3W1A00-1002
Control Company	4040	Therm./ Clock/ Humidity Monitor	1/8/2018	Annual	1/8/2019	160473909
Control Company	4352	Ultra Long Stem Thermometer	1/8/2018	Annual	1/8/2019	160508097
Keysight	772D	Dual Directional Coupler	CBT	N/A	CBT	MY52180215
MCL	BW-N6W5+	6dB Attenuator	CBT	N/A	CBT	1139
Mini Circuits	PWR-4GHS	USB Power Sensor	1/20/2018	Annual	1/20/2019	11710030063
Mini Circuits	PWR-4GHS	USB Power Sensor	1/22/2018	Annual	1/22/2019	11710030062
MiniCircuits	SLP-2400+	Low Pass Filter	CBT	N/A	CBT	R8979500903
MiniCircuits	VLF-6000+	Low Pass Filter	CBT	N/A	CBT	N/A
Mini-Circuits	BW-N20W5	Power Attenuator	CBT	N/A	CBT	1226
Mini-Circuits	BW-N20W5+	DC to 18 GHz Precision Fixed 20 dB Attenuator	CBT	N/A	CBT	N/A
Mini-Circuits	NLP-1200+	Low Pass Filter DC to 1000 MHz	CBT	N/A	CBT	N/A
Mini-Circuits	NLP-2950+	Low Pass Filter DC to 2700 MHz	CBT	N/A	CBT	N/A
Narda	4014C-6	4 - 8 GHz SMA 6 dB Directional Coupler	CBT	N/A	CBT	N/A
Narda	4772-3	Attenuator (3dB)	CBT	N/A	CBT	9406
Pasternack	PE2208-6	Bidirectional Coupler	CBT	N/A	CBT	N/A
Pasternack	PE2209-10	Bidirectional Coupler	CBT	N/A	CBT	N/A
Pasternack	PE5011-1	Torque Wrench	7/19/2017	Biennial	7/19/2019	N/A
Rohde & Schwarz	CMU200	Base Station Simulator	5/18/2018	Annual	5/18/2019	109892
Rohde & Schwarz	CMW500	Radio Communication Tester	11/3/2017	Annual	11/3/2018	100976
Rohde & Schwarz	CMW500	Radio Communication Tester	4/3/2018	Biennial	4/3/2020	103962
Seekonk	NC-100	Torque Wrench (8" lb)	8/30/2016	Biennial	8/30/2018	N/A
Seekonk	NC-100	Torque Wrench	12/28/2017	Annual	12/28/2018	N/A
Seekonk	NC-100	Torque Wrench 5/16", 8" lbs	1/22/2018	Annual	1/22/2019	N/A
SPEAG	D750V3	750 MHz Dipole	3/7/2017	Biennial	3/7/2019	1054
SPEAG	D835V2	835 MHz SAR Dipole	7/13/2016	Triennial	7/13/2019	4d047
SPEAG	D1750V2	1750 MHz SAR Dipole	7/14/2016	Triennial	7/14/2019	1150
SPEAG	D1900V2	1900 MHz SAR Dipole	2/7/2018	Annual	2/7/2019	5d148
SPEAG	D2450V2	2450 MHz SAR Dipole	2/7/2018	Annual	2/7/2019	882
SPEAG	D2600V2	2600 MHz SAR Dipole	4/11/2018	Annual	4/11/2019	1004
SPEAG	D5GHzV2	5 GHz SAR Dipole	9/21/2016	Biennial	9/21/2018	1191
SPEAG	D750V3	750 MHz SAR Dipole	7/13/2016	Triennial	7/13/2019	1161
SPEAG	D1900V2	1900 MHz SAR Dipole	7/8/2016	Triennial	7/8/2019	5d080
SPEAG	D1900V2	1900 MHz SAR Dipole	7/11/2017	Biennial	7/11/2019	5d149
SPEAG	D2450V2	2450 MHz SAR Dipole	9/11/2017	Annual	9/11/2018	797
SPEAG	D2600V2	2600 MHz SAR Dipole	7/10/2017	Annual	7/10/2018	1126
SPEAG	D5GHzV2	5 GHz SAR Dipole	8/15/2017	Annual	8/15/2018	1237
SPEAG	ES3DV3	SAR Probe	8/14/2017	Annual	8/14/2018	3332
SPEAG	ES3DV3	SAR Probe	2/13/2018	Annual	2/13/2019	3213
SPEAG	EX3DV4	SAR Probe	6/25/2018	Annual	6/25/2019	7409
SPEAG	ES3DV3	SAR Probe	3/27/2018	Annual	3/27/2019	3347
SPEAG	EX3DV4	SAR Probe	5/22/2018	Annual	5/22/2019	7406
SPEAG	ES3DV3	SAR Probe	3/13/2018	Annual	3/13/2019	3319
SPEAG	EX3DV4	SAR Probe	4/18/2018	Annual	4/18/2019	7357
SPEAG	DAE4	Dasy Data Acquisition Electronics	8/9/2017	Annual	8/9/2018	1323
SPEAG	DAE4	Dasy Data Acquisition Electronics	2/9/2018	Annual	2/9/2019	1272
SPEAG	DAE4	Dasy Data Acquisition Electronics	6/18/2018	Annual	6/18/2019	1334
SPEAG	DAE4	Dasy Data Acquisition Electronics	11/9/2017	Annual	11/9/2018	1450
SPEAG	DAE4	Dasy Data Acquisition Electronics	5/22/2018	Annual	5/22/2019	859
SPEAG	DAE4	Dasy Data Acquisition Electronics	3/7/2018	Annual	3/7/2019	1368
SPEAG	DAE4	Dasy Data Acquisition Electronics	4/11/2018	Annual	4/11/2019	1407
SPEAG	DAK-3.5	Dielectric Assessment Kit	9/12/2017	Annual	9/12/2018	1091

Note: CBT (Calibrated Before Testing). Prior to testing, the measurement paths containing a cable, amplifier, attenuator, coupler or filter were connected to a calibrated source (i.e. a signal generator) to determine the losses of the measurement path. The power meter offset was then adjusted to compensate for the measurement system losses. This level offset is stored within the power meter before measurements are made. This calibration verification procedure applies to the system verification and output power measurements. The calibrated reading is then taken directly from the power meter after compensation of the losses for all final power measurements. Each equipment was used solely within the calibration period.

FCC ID: ZNFX410PM		SAR EVALUATION REPORT		Approved by: Quality Manager
Document S/N: 1M1806270133-01-R1.ZNF	Test Dates: 07/08/18 - 07/16/18	DUT Type: Portable Handset		Page 91 of 95

16 MEASUREMENT UNCERTAINTIES

a	c	d	e= f(d,k)	f	g	h = c x f/e	i = c x g/e	k
Uncertainty Component	Tol. (± %)	Prob. Dist.	Div.	c _i 1gm	c _i 10 gms	1gm u _i (± %)	10gms u _i (± %)	v _i
Measurement System								
Probe Calibration	6.55	N	1	1.0	1.0	6.6	6.6	∞
Axial Isotropy	0.25	N	1	0.7	0.7	0.2	0.2	∞
Hemishperical Isotropy	1.3	N	1	0.7	0.7	0.9	0.9	∞
Boundary Effect	2.0	R	1.73	1.0	1.0	1.2	1.2	∞
Linearity	0.3	N	1	1.0	1.0	0.3	0.3	∞
System Detection Limits	0.25	R	1.73	1.0	1.0	0.1	0.1	∞
Readout Electronics	0.3	N	1	1.0	1.0	0.3	0.3	∞
Response Time	0.8	R	1.73	1.0	1.0	0.5	0.5	∞
Integration Time	2.6	R	1.73	1.0	1.0	1.5	1.5	∞
RF Ambient Conditions - Noise	3.0	R	1.73	1.0	1.0	1.7	1.7	∞
RF Ambient Conditions - Reflections	3.0	R	1.73	1.0	1.0	1.7	1.7	∞
Probe Positioner Mechanical Tolerance	0.4	R	1.73	1.0	1.0	0.2	0.2	∞
Probe Positioning w/ respect to Phantom	6.7	R	1.73	1.0	1.0	3.9	3.9	∞
Extrapolation, Interpolation & Integration algorithms for Max. SAR Evaluation	4.0	R	1.73	1.0	1.0	2.3	2.3	∞
Test Sample Related								
Test Sample Positioning	2.7	N	1	1.0	1.0	2.7	2.7	35
Device Holder Uncertainty	1.67	N	1	1.0	1.0	1.7	1.7	5
Output Power Variation - SAR drift measurement	5.0	R	1.73	1.0	1.0	2.9	2.9	∞
SAR Scaling	0.0	R	1.73	1.0	1.0	0.0	0.0	∞
Phantom & Tissue Parameters								
Phantom Uncertainty (Shape & Thickness tolerances)	7.6	R	1.73	1.0	1.0	4.4	4.4	∞
Liquid Conductivity - measurement uncertainty	4.2	N	1	0.78	0.71	3.3	3.0	10
Liquid Permittivity - measurement uncertainty	4.1	N	1	0.23	0.26	1.0	1.1	10
Liquid Conductivity - Temperature Uncertainty	3.4	R	1.73	0.78	0.71	1.5	1.4	∞
Liquid Permittivity - Temperature Uncertainty	0.6	R	1.73	0.23	0.26	0.1	0.1	∞
Liquid Conductivity - deviation from target values	5.0	R	1.73	0.64	0.43	1.8	1.2	∞
Liquid Permittivity - deviation from target values	5.0	R	1.73	0.60	0.49	1.7	1.4	∞
Combined Standard Uncertainty (k=1)	RSS					11.5	11.3	60
Expanded Uncertainty (95% CONFIDENCE LEVEL)	k=2					23.0	22.6	



FCC ID: ZNFX410PM	 PCTEST ENGINEERING LABORATORY, INC.	SAR EVALUATION REPORT	 LG	Approved by: Quality Manager
Document S/N: 1M1806270133-01-R1.ZNF	Test Dates: 07/08/18 - 07/16/18	DUT Type: Portable Handset		Page 92 of 95

17 CONCLUSION

17.1 Measurement Conclusion



The SAR evaluation indicates that the EUT complies with the RF radiation exposure limits of the FCC and Innovation, Science, and Economic Development Canada, with respect to all parameters subject to this test. These measurements were taken to simulate the RF effects of RF exposure under worst-case conditions. Precise laboratory measures were taken to assure repeatability of the tests. The results and statements relate only to the item(s) tested.

Please note that the absorption and distribution of electromagnetic energy in the body are very complex phenomena that depend on the mass, shape, and size of the body, the orientation of the body with respect to the field vectors, and the electrical properties of both the body and the environment. Other variables that may play a substantial role in possible biological effects are those that characterize the environment (e.g. ambient temperature, air velocity, relative humidity, and body insulation) and those that characterize the individual (e.g. age, gender, activity level, debilitation, or disease). Because various factors may interact with one another to vary the specific biological outcome of an exposure to electromagnetic fields, any protection guide should consider maximal amplification of biological effects as a result of field-body interactions, environmental conditions, and physiological variables. [3]



FCC ID: ZNFX410PM	 PCTEST ENGINEERING LABORATORY, INC.	SAR EVALUATION REPORT	 LG	Approved by: Quality Manager
Document S/N: 1M1806270133-01-R1.ZNF	Test Dates: 07/08/18 - 07/16/18	DUT Type: Portable Handset		Page 93 of 95

18 REFERENCES

- [1] Federal Communications Commission, ET Docket 93-62, Guidelines for Evaluating the Environmental Effects of Radiofrequency Radiation, Aug. 1996.
- [2] ANSI/IEEE C95.1-2005, American National Standard safety levels with respect to human exposure to radio frequency electromagnetic fields, 3kHz to 300GHz, New York: IEEE, 2006.
- [3] ANSI/IEEE C95.1-1992, American National Standard safety levels with respect to human exposure to radio frequency electromagnetic fields, 3kHz to 300GHz, New York: IEEE, Sept. 1992.
- [4] ANSI/IEEE C95.3-2002, IEEE Recommended Practice for the Measurement of Potentially Hazardous Electromagnetic Fields - RF and Microwave, New York: IEEE, December 2002.
- [5] IEEE Standards Coordinating Committee 39 –Standards Coordinating Committee 34 – IEEE Std. 1528-2013, IEEE Recommended Practice for Determining the Peak Spatial-Average Specific Absorption Rate (SAR) in the Human Head from Wireless Communications Devices: Measurement Techniques.
- [6] NCRP, National Council on Radiation Protection and Measurements, Biological Effects and Exposure Criteria for RadioFrequency Electromagnetic Fields, NCRP Report No. 86, 1986. Reprinted Feb. 1995.
- [7] T. Schmid, O. Egger, N. Kuster, Automated E-field scanning system for dosimetric assessments, IEEE Transaction on Microwave Theory and Techniques, vol. 44, Jan. 1996, pp. 105-113.
- [8] K. Pokovic, T. Schmid, N. Kuster, Robust setup for precise calibration of E-field probes in tissue simulating liquids at mobile communications frequencies, ICECOM97, Oct. 1997, pp. 1 -124.
- [9] K. Pokovic, T. Schmid, and N. Kuster, E-field Probe with improved isotropy in brain simulating liquids, Proceedings of the ELMAR, Zadar, Croatia, June 23-25, 1996, pp. 172-175.
- [10] Schmid & Partner Engineering AG, Application Note: Data Storage and Evaluation, June 1998, p2.
- [11] V. Hombach, K. Meier, M. Burkhardt, E. Kuhn, N. Kuster, The Dependence of EM Energy Absorption upon Human Modeling at 900 MHz, IEEE Transaction on Microwave Theory and Techniques, vol. 44 no. 10, Oct. 1996, pp. 1865-1873.
- [12] N. Kuster and Q. Balzano, Energy absorption mechanism by biological bodies in the near field of dipole antennas above 300MHz, IEEE Transaction on Vehicular Technology, vol. 41, no. 1, Feb. 1992, pp. 17-23.
- [13] G. Hartsgrove, A. Kraszewski, A. Surowiec, Simulated Biological Materials for Electromagnetic Radiation Absorption Studies, University of Ottawa, Bioelectromagnetics, Canada: 1987, pp. 29-36.
- [14] Q. Balzano, O. Garay, T. Manning Jr., Electromagnetic Energy Exposure of Simulated Users of Portable Cellular Telephones, IEEE Transactions on Vehicular Technology, vol. 44, no.3, Aug. 1995.
- [15] W. Gander, Computermathematick, Birkhaeuser, Basel, 1992.
- [16] W.H. Press, S.A. Teukolsky, W.T. Vetterling, and B.P. Flannery, Numerical Recipes in C, The Art of Scientific Computing, Second edition, Cambridge University Press, 1992.
- [17] N. Kuster, R. Kastle, T. Schmid, Dosimetric evaluation of mobile communications equipment with known precision, IEEE Transaction on Communications, vol. E80-B, no. 5, May 1997, pp. 645-652.

FCC ID: ZNFX410PM	 PCTEST ENGINEERING LABORATORY, INC.	SAR EVALUATION REPORT	 LG	Approved by: Quality Manager
Document S/N: 1M1806270133-01-R1.ZNF	Test Dates: 07/08/18 - 07/16/18	DUT Type: Portable Handset		Page 94 of 95

- [18] CENELEC CLC/SC111B, European Prestandard (prENV 50166-2), Human Exposure to Electromagnetic Fields High-frequency: 10kHz-300GHz, Jan. 1995.
- [19] Prof. Dr. Niels Kuster, ETH, Eidgenössische Technische Hochschule Zürich, Dosimetric Evaluation of the Cellular Phone.
- [20] IEC 62209-1, Measurement procedure for the assessment of specific absorption rate of human exposure to radio frequency fields from hand-held and body-mounted wireless communication devices - Part 1: Devices used next to the ear (Frequency range of 300 MHz to 6 GHz), July 2016.
- [21] Innovation, Science, Economic Development Canada RSS-102 Radio Frequency Exposure Compliance of Radiocommunication Apparatus (All Frequency Bands) Issue 5, March 2015.
- [22] Health Canada Safety Code 6 Limits of Human Exposure to Radio Frequency Electromagnetic Fields in the Frequency Range from 3 kHz – 300 GHz, 2015
- [23] FCC SAR Test Procedures for 2G-3G Devices, Mobile Hotspot and UMPC Devices KDB Publications 941225, D01-D07
- [24] SAR Measurement Guidance for IEEE 802.11 Transmitters, KDB Publication 248227 D01
- [25] FCC SAR Considerations for Handsets with Multiple Transmitters and Antennas, KDB Publications 648474 D03-D04
- [26] FCC SAR Evaluation Considerations for Laptop, Notebook, Netbook and Tablet Computers, FCC KDB Publication 616217 D04
- [27] FCC SAR Measurement and Reporting Requirements for 100MHz – 6 GHz, KDB Publications 865664 D01-D02
- [28] FCC General RF Exposure Guidance and SAR Procedures for Dongles, KDB Publication 447498, D01-D02
- [29] Anexo à Resolução No. 533, de 10 de Setembro de 2009.
- [30] IEC 62209-2, Human exposure to radio frequency fields from hand-held and body-mounted wireless communication devices - Human models, instrumentation, and procedures - Part 2: Procedure to determine the specific absorption rate (SAR) for wireless communication devices used in close proximity to the human body (frequency range of 30 MHz to 6 GHz), Mar. 2010.

FCC ID: ZNFX410PM	 SAR EVALUATION REPORT 		Approved by: Quality Manager
Document S/N: 1M1806270133-01-R1.ZNF	Test Dates: 07/08/18 - 07/16/18	DUT Type: Portable Handset	Page 95 of 95

APPENDIX A: SAR TEST DATA

PCTEST ENGINEERING LABORATORY, INC.

DUT: ZNFX410PM; Type: Portable Handset; Serial: 04397

Communication System: UID 0, Cellular CDMA; Frequency: 820.1 MHz; Duty Cycle: 1:1
Medium: 835 Head Medium parameters used (interpolated):
 $f = 820.1 \text{ MHz}$; $\sigma = 0.912 \text{ S/m}$; $\epsilon_r = 42.855$; $\rho = 1000 \text{ kg/m}^3$
Phantom section: Right Section

Test Date: 07-09-2018; Ambient Temp: 20.9°C; Tissue Temp: 19.9°C

Probe: ES3DV3 - SN3213; ConvF(6.42, 6.42, 6.42); Calibrated: 2/13/2018;
Sensor-Surface: 3mm (Mechanical Surface Detection)
Electronics: DAE4 Sn1272; Calibrated: 2/9/2018
Phantom: SAM V5.0 Right; Type: QD000P40CD; Serial: 1647
Measurement SW: DASY52, Version 52.10; SEMCAD X Version 14.6.10 (7417)

Mode: Cell. EVDO Rev. A, Rule Part 90S, Right Head, Cheek, Mid.ch

Area Scan (9x15x1): Measurement grid: dx=15mm, dy=15mm

Zoom Scan (5x5x7)/Cube 0: Measurement grid: dx=8mm, dy=8mm, dz=5mm

Reference Value = 23.64 V/m; Power Drift = 0.00 dB

Peak SAR (extrapolated) = 0.603 W/kg

SAR(1 g) = 0.475 W/kg

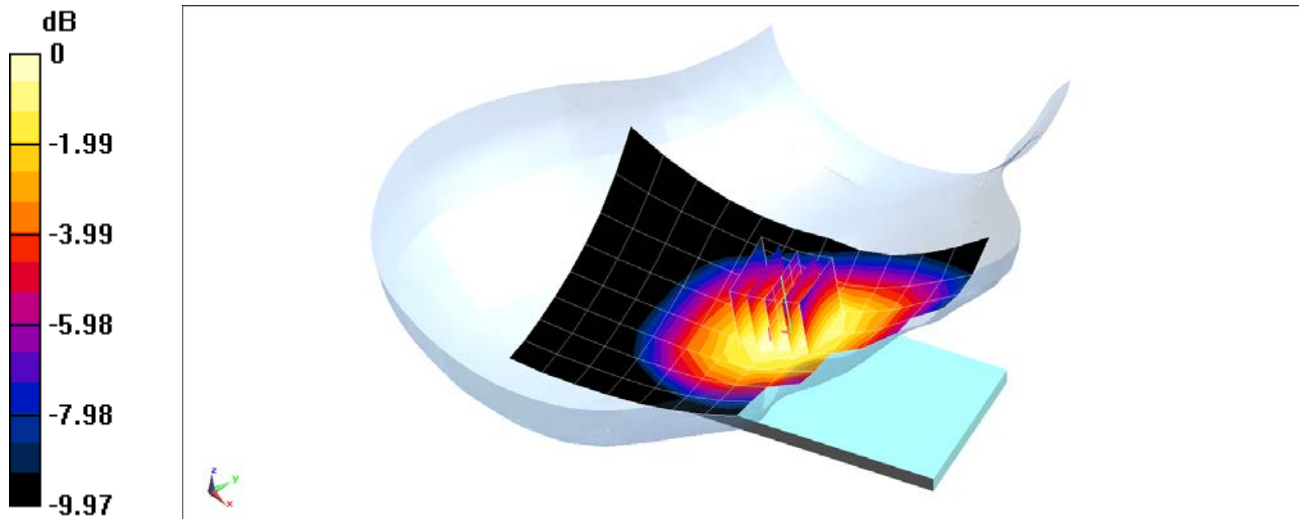

0 dB = 0.521 W/kg = -2.83 dBW/kg

PCTEST ENGINEERING LABORATORY, INC.

DUT: ZNFX410PM; Type: Portable Handset; Serial: 04397

Communication System: UID 0, CDMA; Frequency: 836.52 MHz; Duty Cycle: 1:1
Medium: 835 Head Medium parameters used (interpolated):
 $f = 836.52$ MHz; $\sigma = 0.918$ S/m; $\epsilon_r = 42.809$; $\rho = 1000$ kg/m³
Phantom section: Right Section

Test Date: 07-09-2018; Ambient Temp: 20.9°C; Tissue Temp: 19.9°C

Probe: ES3DV3 - SN3213; ConvF(6.42, 6.42, 6.42); Calibrated: 2/13/2018;
Sensor-Surface: 3mm (Mechanical Surface Detection)
Electronics: DAE4 Sn1272; Calibrated: 2/9/2018
Phantom: SAM V5.0 Right; Type: QD000P40CD; Serial: 1647
Measurement SW: DASY52, Version 52.10;SEMCAD X Version 14.6.10 (7417)

Mode: Cell. EVDO Rev. A, Rule Part 22H, Right Head, Cheek, Mid.ch

Area Scan (9x15x1): Measurement grid: dx=15mm, dy=15mm

Zoom Scan (5x5x7)/Cube 0: Measurement grid: dx=8mm, dy=8mm, dz=5mm

Reference Value = 24.69 V/m; Power Drift = -0.04 dB

Peak SAR (extrapolated) = 0.658 W/kg

SAR(1 g) = 0.517 W/kg

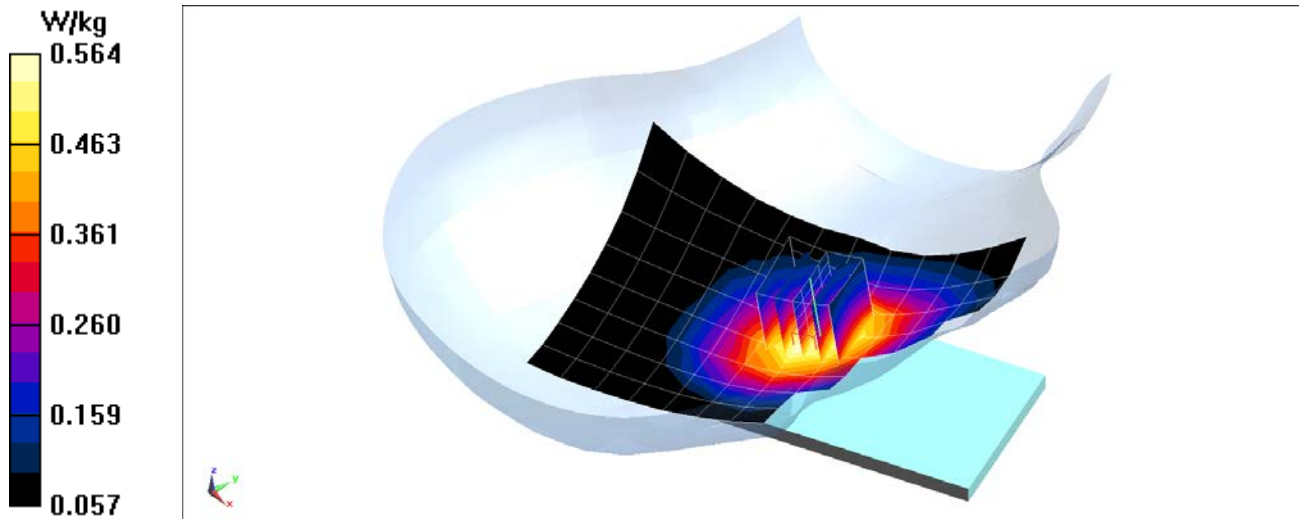

PCTEST ENGINEERING LABORATORY, INC.

DUT: ZNFX410PM; Type: Portable Handset; Serial: 04397

Communication System: UID 0, _GSM GPRS; 2 Tx slots; Frequency: 836.6 MHz; Duty Cycle: 1:4.15
Medium: 835 Head Medium parameters used (interpolated):
 $f = 836.6 \text{ MHz}$; $\sigma = 0.918 \text{ S/m}$; $\epsilon_r = 42.809$; $\rho = 1000 \text{ kg/m}^3$
Phantom section: Right Section

Test Date: 07-09-2018; Ambient Temp: 20.9°C; Tissue Temp: 19.9°C

Probe: ES3DV3 - SN3213; ConvF(6.42, 6.42, 6.42); Calibrated: 2/13/2018;
Sensor-Surface: 3mm (Mechanical Surface Detection)
Electronics: DAE4 Sn1272; Calibrated: 2/9/2018
Phantom: SAM V5.0 Right; Type: QD000P40CD; Serial: 1647
Measurement SW: DASY52, Version 52.10; SEMCAD X Version 14.6.10 (7417)

Mode: GPRS 850, Right Head, Cheek, Mid.ch, 2 Tx slots

Area Scan (9x15x1): Measurement grid: $dx=15\text{mm}$, $dy=15\text{mm}$
Zoom Scan (5x5x7)/Cube 0: Measurement grid: $dx=8\text{mm}$, $dy=8\text{mm}$, $dz=5\text{mm}$
Reference Value = 25.68 V/m; Power Drift = -0.05 dB
Peak SAR (extrapolated) = 0.712 W/kg
SAR(1 g) = 0.568 W/kg

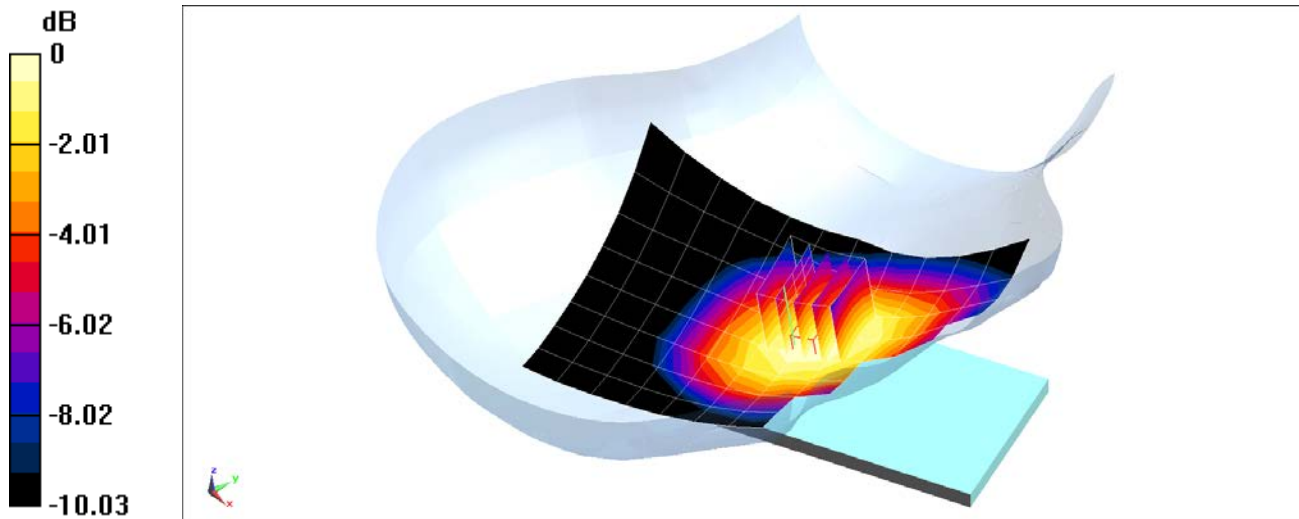

0 dB = 0.616 W/kg = -2.10 dBW/kg

PCTEST ENGINEERING LABORATORY, INC.

DUT: ZNFX410PM; Type: Portable Handset; Serial: 04397

Communication System: UID 0, UMTS; Frequency: 836.6 MHz; Duty Cycle: 1:1
Medium: 835 Head Medium parameters used (interpolated):
 $f = 836.6 \text{ MHz}$; $\sigma = 0.918 \text{ S/m}$; $\epsilon_r = 42.809$; $\rho = 1000 \text{ kg/m}^3$
Phantom section: Right Section

Test Date: 07-09-2018; Ambient Temp: 20.9°C; Tissue Temp: 19.9°C

Probe: ES3DV3 - SN3213; ConvF(6.42, 6.42, 6.42); Calibrated: 2/13/2018;
Sensor-Surface: 3mm (Mechanical Surface Detection)
Electronics: DAE4 Sn1272; Calibrated: 2/9/2018
Phantom: SAM V5.0 Right; Type: QD000P40CD; Serial: 1647
Measurement SW: DASY52, Version 52.10; SEMCAD X Version 14.6.10 (7417)

Mode: UMTS 850, Right Head, Cheek, Mid.ch

Area Scan (9x15x1): Measurement grid: dx=15mm, dy=15mm
Zoom Scan (5x5x7)/Cube 0: Measurement grid: dx=8mm, dy=8mm, dz=5mm
Reference Value = 24.05 V/m; Power Drift = 0.02 dB
Peak SAR (extrapolated) = 0.635 W/kg
SAR(1 g) = 0.496 W/kg

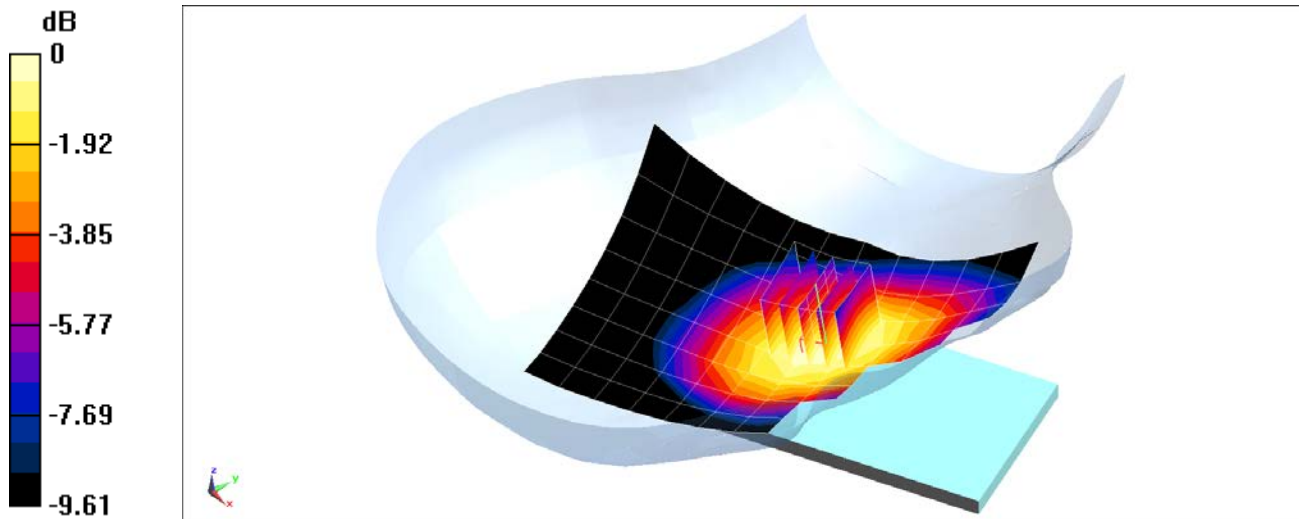

0 dB = 0.541 W/kg = -2.67 dBW/kg

PCTEST ENGINEERING LABORATORY, INC.

DUT: ZNFX410PM; Type: Portable Handset; Serial: 04462

Communication System: UID 0, UMTS; Frequency: 1732.4 MHz; Duty Cycle: 1:1
Medium: 1750 Head Medium parameters used (interpolated):
 $f = 1732.4$ MHz; $\sigma = 1.343$ S/m; $\epsilon_r = 39.868$; $\rho = 1000$ kg/m³
Phantom section: Left Section

Test Date: 07-10-2018; Ambient Temp: 23.3°C; Tissue Temp: 21.1°C

Probe: ES3DV3 - SN3213; ConvF(5.45, 5.45, 5.45); Calibrated: 2/13/2018;
Sensor-Surface: 3mm (Mechanical Surface Detection)
Electronics: DAE4 Sn1272; Calibrated: 2/9/2018
Phantom: SAM V5.0 Right; Type: QD000P40CD; Serial: 1647
Measurement SW: DASY52, Version 52.10;SEMCAD X Version 14.6.10 (7417)

Mode: UMTS 1750, Left Head, Cheek, Mid.ch

Area Scan (9x15x1): Measurement grid: dx=15mm, dy=15mm
Zoom Scan (5x5x7)/Cube 0: Measurement grid: dx=8mm, dy=8mm, dz=5mm
Reference Value = 19.53 V/m; Power Drift = -0.02 dB
Peak SAR (extrapolated) = 0.689 W/kg
SAR(1 g) = 0.458 W/kg

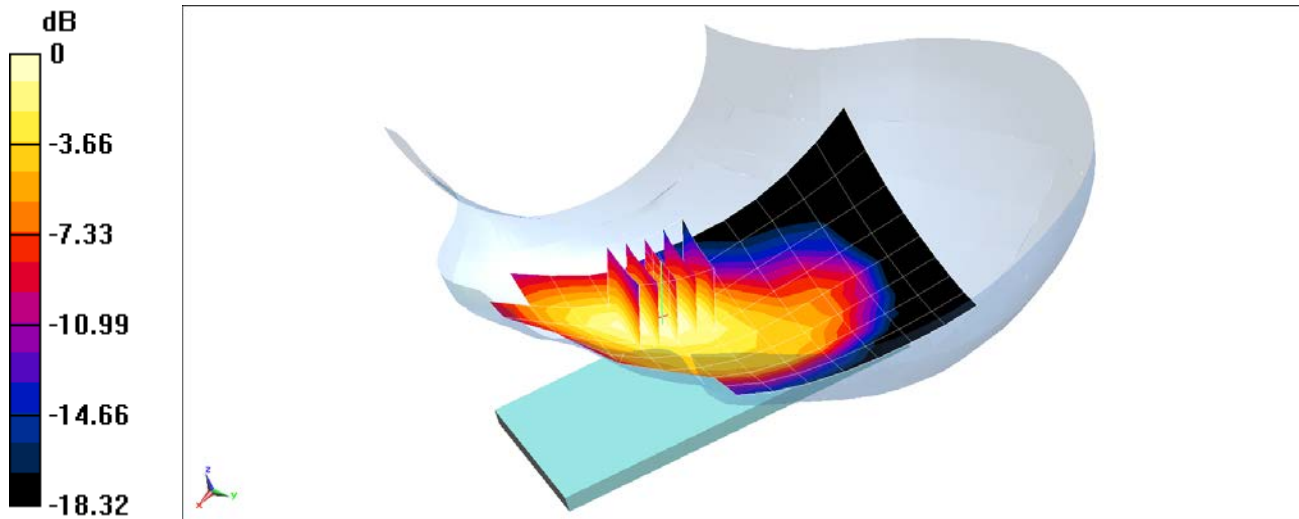

0 dB = 0.536 W/kg = -2.71 dBW/kg

PCTEST ENGINEERING LABORATORY, INC.

DUT: ZNFX410PM; Type: Portable Handset; Serial: 04397

Communication System: UID 0, CDMA; Frequency: 1908.75 MHz; Duty Cycle: 1:1
Medium: 1900 Head Medium parameters used (interpolated):
 $f = 1908.75 \text{ MHz}$; $\sigma = 1.468 \text{ S/m}$; $\epsilon_r = 40.002$; $\rho = 1000 \text{ kg/m}^3$
Phantom section: Left Section

Test Date: 07-12-2018; Ambient Temp: 24.0°C; Tissue Temp: 22.8°C

Probe: ES3DV3 - SN3213; ConvF(5.3, 5.3, 5.3); Calibrated: 2/13/2018;
Sensor-Surface: 3mm (Mechanical Surface Detection)

Electronics: DAE4 Sn1272; Calibrated: 2/9/2018

Phantom: SAM V5.0 Right; Type: QD000P40CD; Serial: 1647

Measurement SW: DASY52, Version 52.10; SEMCAD X Version 14.6.10 (7417)

Mode: PCS CDMA, Left Head, Cheek, High.ch

Area Scan (9x15x1): Measurement grid: dx=15mm, dy=15mm

Zoom Scan (5x5x7)/Cube 0: Measurement grid: dx=8mm, dy=8mm, dz=5mm

Reference Value = 22.81 V/m; Power Drift = 0.05 dB

Peak SAR (extrapolated) = 1.06 W/kg

SAR(1 g) = 0.692 W/kg

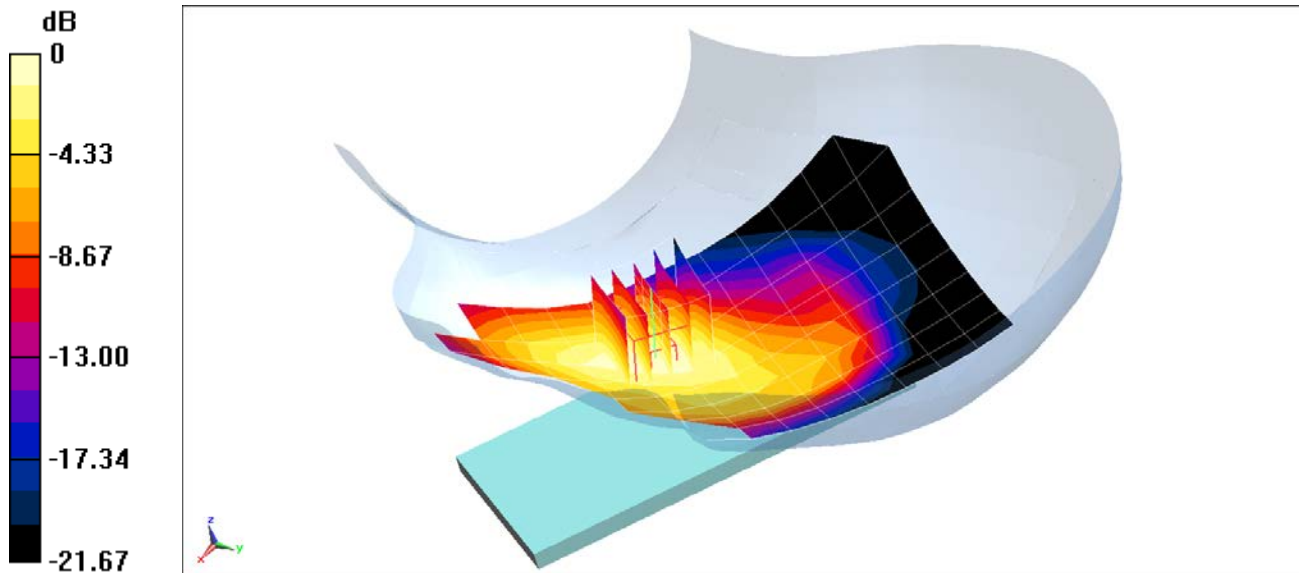

0 dB = 0.812 W/kg = -0.90 dBW/kg

PCTEST ENGINEERING LABORATORY, INC.

DUT: ZNFX410PM; Type: Portable Handset; Serial: 04397

Communication System: UID 0, _GSM GPRS; 2 Tx slots; Frequency: 1880 MHz; Duty Cycle: 1:4.15

Medium: 1900 Head Medium parameters used:

$f = 1880 \text{ MHz}$; $\sigma = 1.446 \text{ S/m}$; $\epsilon_r = 40.05$; $\rho = 1000 \text{ kg/m}^3$

Phantom section: Left Section

Test Date: 07-12-2018; Ambient Temp: 24.0°C; Tissue Temp: 22.8°C

Probe: ES3DV3 - SN3213; ConvF(5.3, 5.3, 5.3); Calibrated: 2/13/2018;

Sensor-Surface: 3mm (Mechanical Surface Detection)

Electronics: DAE4 Sn1272; Calibrated: 2/9/2018

Phantom: SAM V5.0 Right; Type: QD000P40CD; Serial: 1647

Measurement SW: DASY52, Version 52.10; SEMCAD X Version 14.6.10 (7417)

Mode: GPRS 1900, Left Head, Cheek, Mid.ch, 2 Tx slots

Area Scan (9x15x1): Measurement grid: dx=15mm, dy=15mm

Zoom Scan (5x5x7)/Cube 0: Measurement grid: dx=8mm, dy=8mm, dz=5mm

Reference Value = 17.13 V/m; Power Drift = 0.08 dB

Peak SAR (extrapolated) = 0.605 W/kg

SAR(1 g) = 0.386 W/kg

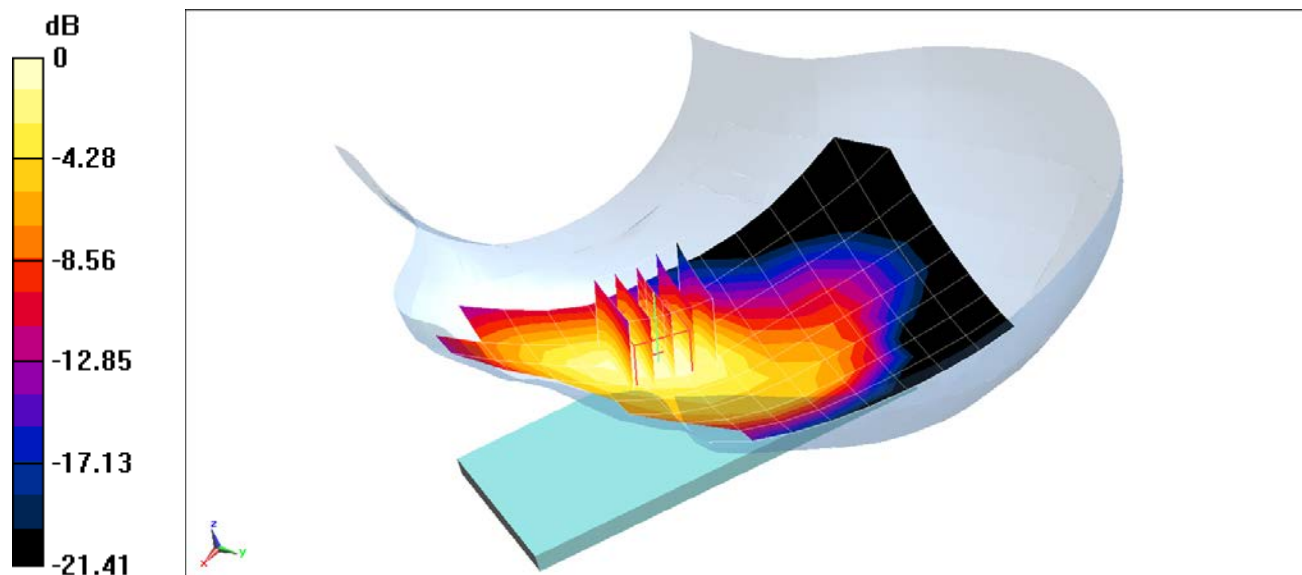

0 dB = 0.453 W/kg = -3.44 dBW/kg

PCTEST ENGINEERING LABORATORY, INC.

DUT: ZNFX410PM; Type: Portable Handset; Serial: 04397

Communication System: UID 0, UMTS; Frequency: 1907.6 MHz; Duty Cycle: 1:1
Medium: 1900 Head Medium parameters used (interpolated):
 $f = 1907.6$ MHz; $\sigma = 1.467$ S/m; $\epsilon_r = 40.004$; $\rho = 1000$ kg/m³
Phantom section: Left Section

Test Date: 07-12-2018; Ambient Temp: 24.0°C; Tissue Temp: 22.8°C

Probe: ES3DV3 - SN3213; ConvF(5.3, 5.3, 5.3); Calibrated: 2/13/2018;
Sensor-Surface: 3mm (Mechanical Surface Detection)
Electronics: DAE4 Sn1272; Calibrated: 2/9/2018

Phantom: SAM V5.0 Right; Type: QD000P40CD; Serial: 1647
Measurement SW: DASY52, Version 52.10;SEMCAD X Version 14.6.10 (7417)

Mode: UMTS 1900, Left Head, Cheek, High.ch

Area Scan (9x15x1): Measurement grid: dx=15mm, dy=15mm

Zoom Scan (5x5x7)/Cube 0: Measurement grid: dx=8mm, dy=8mm, dz=5mm

Reference Value = 21.72 V/m; Power Drift = 0.02 dB

Peak SAR (extrapolated) = 0.972 W/kg

SAR(1 g) = 0.623 W/kg

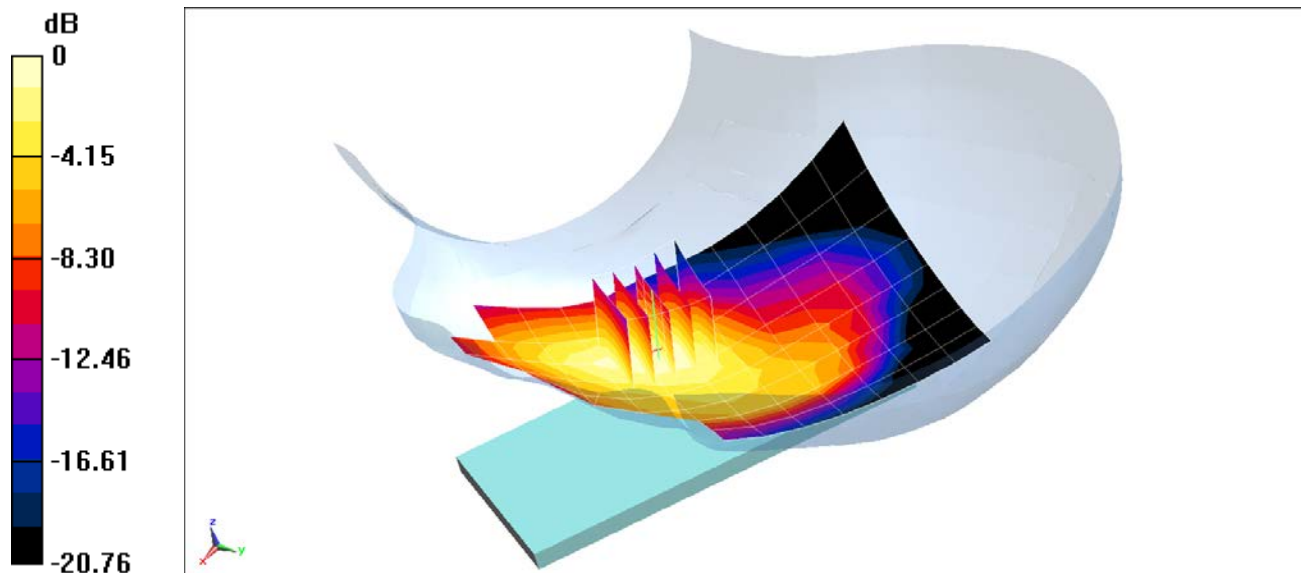

0 dB = 0.731 W/kg = -1.36 dBW/kg

PCTEST ENGINEERING LABORATORY, INC.

DUT: ZNFX410PM; Type: Portable Handset; Serial: 04462

Communication System: UID 0, LTE Band 12; Frequency: 707.5 MHz; Duty Cycle: 1:1

Medium: 750 Head Medium parameters used (interpolated):

$f = 707.5$ MHz; $\sigma = 0.858$ S/m; $\epsilon_r = 42.535$; $\rho = 1000$ kg/m³

Phantom section: Right Section

Test Date: 07-12-2018; Ambient Temp: 23.6°C; Tissue Temp: 21.6°C

Probe: ES3DV3 - SN3332; ConvF(6.81, 6.81, 6.81); Calibrated: 8/14/2017;

Sensor-Surface: 3mm (Mechanical Surface Detection)

Electronics: DAE4 Sn1323; Calibrated: 8/9/2017

Phantom: SAM Left; Type: QD000P40CA; Serial: TP:82355

Measurement SW: DASY52, Version 52.10;SEMCAD X Version 14.6.10 (7417)

**Mode: LTE Band 12, Right Head, Cheek, Mid.ch,
10 MHz Bandwidth, QPSK, 1 RB, 0 RB Offset**

Area Scan (9x14x1): Measurement grid: dx=15mm, dy=15mm

Zoom Scan (6x5x7)/Cube 0: Measurement grid: dx=8mm, dy=8mm, dz=5mm

Reference Value = 21.80 V/m; Power Drift = -0.03 dB

Peak SAR (extrapolated) = 0.445 W/kg

SAR(1 g) = 0.359 W/kg

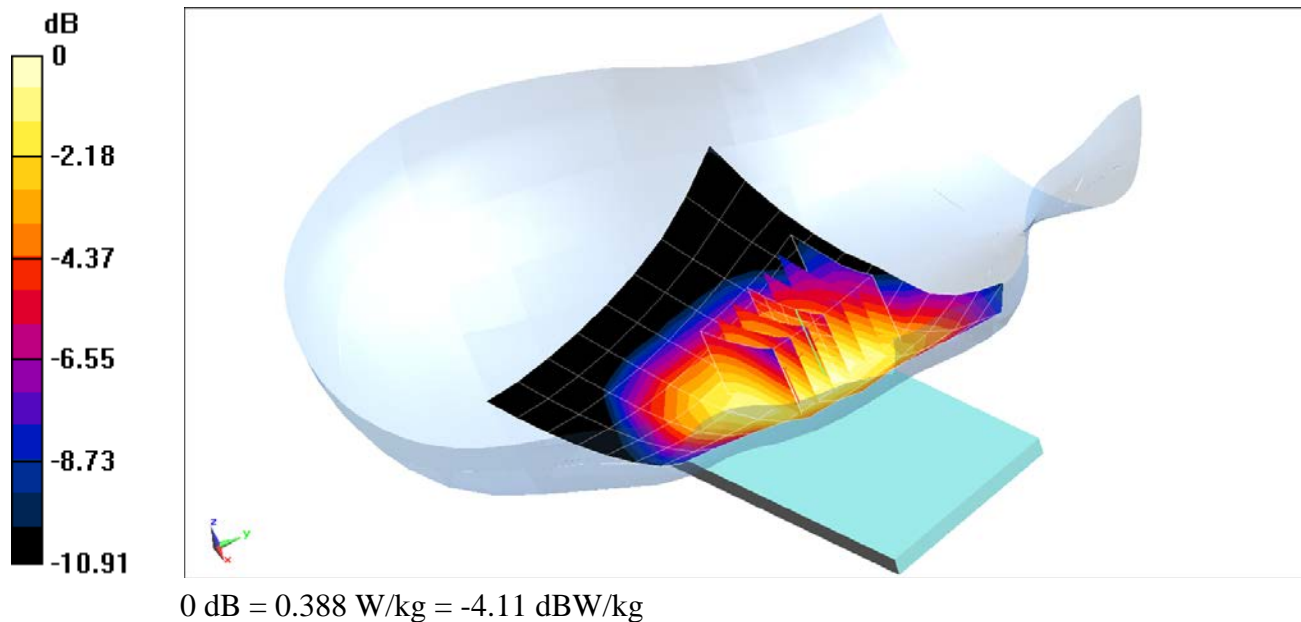

PCTEST ENGINEERING LABORATORY, INC.

DUT: ZNFX410PM; Type: Portable Handset; Serial: 04462

Communication System: UID 0, LTE Band 13; Frequency: 782 MHz; Duty Cycle: 1:1

Medium: 750 Head Medium parameters used (interpolated):

$f = 782 \text{ MHz}$; $\sigma = 0.927 \text{ S/m}$; $\epsilon_r = 41.495$; $\rho = 1000 \text{ kg/m}^3$

Phantom section: Right Section

Test Date: 07-12-2018; Ambient Temp: 23.6°C; Tissue Temp: 21.6°C

Probe: ES3DV3 - SN3332; ConvF(6.81, 6.81, 6.81); Calibrated: 8/14/2017;

Sensor-Surface: 3mm (Mechanical Surface Detection)

Electronics: DAE4 Sn1323; Calibrated: 8/9/2017

Phantom: SAM Left; Type: QD000P40CA; Serial: TP:82355

Measurement SW: DASY52, Version 52.10;SEMCAD X Version 14.6.10 (7417)

**Mode: LTE Band 13, Right Head, Cheek, Mid.ch,
10 MHz Bandwidth, QPSK, 1 RB, 49 RB Offset**

Area Scan (9x13x1): Measurement grid: dx=15mm, dy=15mm

Zoom Scan (7x6x7)/Cube 0: Measurement grid: dx=8mm, dy=8mm, dz=5mm

Reference Value = 22.44 V/m; Power Drift = -0.07 dB

Peak SAR (extrapolated) = 0.517 W/kg

SAR(1 g) = 0.419 W/kg

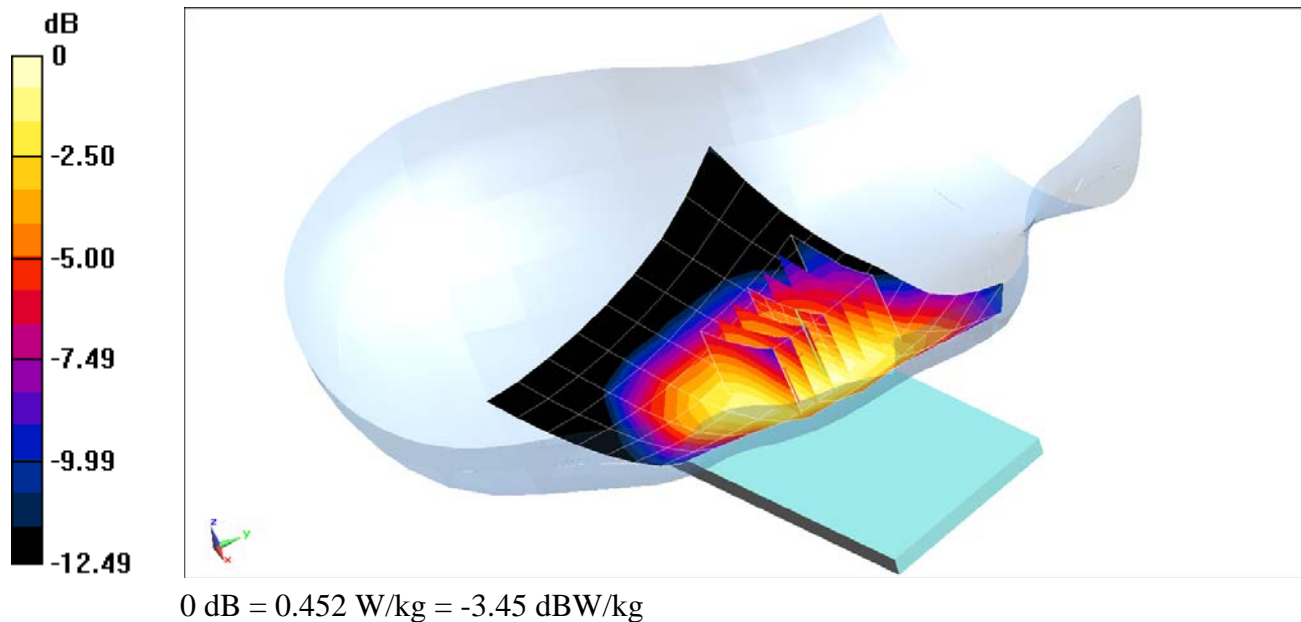

PCTEST ENGINEERING LABORATORY, INC.

DUT: ZNFX410PM; Type: Portable Handset; Serial: 04462

Communication System: UID 0, LTE Band 26; Frequency: 831.5 MHz; Duty Cycle: 1:1

Medium: 835 Head Medium parameters used (interpolated):

$f = 831.5 \text{ MHz}$; $\sigma = 0.916 \text{ S/m}$; $\epsilon_r = 42.823$; $\rho = 1000 \text{ kg/m}^3$

Phantom section: Right Section

Test Date: 07-09-2018; Ambient Temp: 20.9°C; Tissue Temp: 19.9°C

Probe: ES3DV3 - SN3213; ConvF(6.42, 6.42, 6.42); Calibrated: 2/13/2018;

Sensor-Surface: 3mm (Mechanical Surface Detection)

Electronics: DAE4 Sn1272; Calibrated: 2/9/2018

Phantom: SAM V5.0 Right; Type: QD000P40CD; Serial: 1647

Measurement SW: DASY52, Version 52.10;SEMCAD X Version 14.6.10 (7417)

**Mode: LTE Band 26 (Cell.), Right Head, Cheek, Mid.ch,
15 MHz Bandwidth, QPSK, 1 RB, 74 RB Offset**

Area Scan (9x15x1): Measurement grid: dx=15mm, dy=15mm

Zoom Scan (5x5x7)/Cube 0: Measurement grid: dx=8mm, dy=8mm, dz=5mm

Reference Value = 25.95 V/m; Power Drift = 0.01 dB

Peak SAR (extrapolated) = 0.682 W/kg

SAR(1 g) = 0.527 W/kg

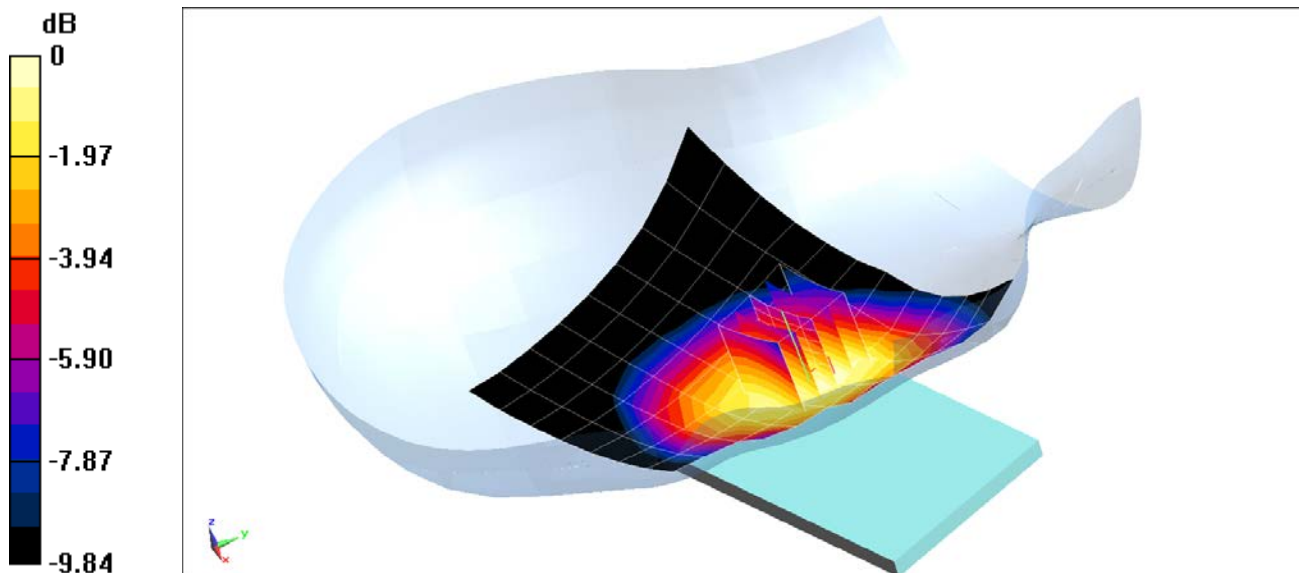

0 dB = 0.576 W/kg = -2.40 dBW/kg

PCTEST ENGINEERING LABORATORY, INC.

DUT: ZNFX410PM; Type: Portable Handset; Serial: 04397

Communication System: UID 0, LTE Band 4 (AWS); Frequency: 1732.5 MHz; Duty Cycle: 1:1
Medium: 1750 Head Medium parameters used (interpolated):
 $f = 1732.5$ MHz; $\sigma = 1.343$ S/m; $\epsilon_r = 39.868$; $\rho = 1000$ kg/m³
Phantom section: Left Section

Test Date: 07-10-2018; Ambient Temp: 23.3°C; Tissue Temp: 21.1°C

Probe: ES3DV3 - SN3213; ConvF(5.45, 5.45, 5.45); Calibrated: 2/13/2018;
Sensor-Surface: 3mm (Mechanical Surface Detection)
Electronics: DAE4 Sn1272; Calibrated: 2/9/2018
Phantom: SAM V5.0 Right; Type: QD000P40CD; Serial: 1647
Measurement SW: DASY52, Version 52.10; SEMCAD X Version 14.6.10 (7417)

**Mode: LTE Band 4 (AWS), Left Head, Cheek, Mid.ch,
20 MHz Bandwidth, QPSK, 1 RB, 0 RB Offset**

Area Scan (9x15x1): Measurement grid: dx=15mm, dy=15mm
Zoom Scan (5x5x7)/Cube 0: Measurement grid: dx=8mm, dy=8mm, dz=5mm
Reference Value = 23.90 V/m; Power Drift = 0.06 dB
Peak SAR (extrapolated) = 0.954 W/kg
SAR(1 g) = 0.631 W/kg

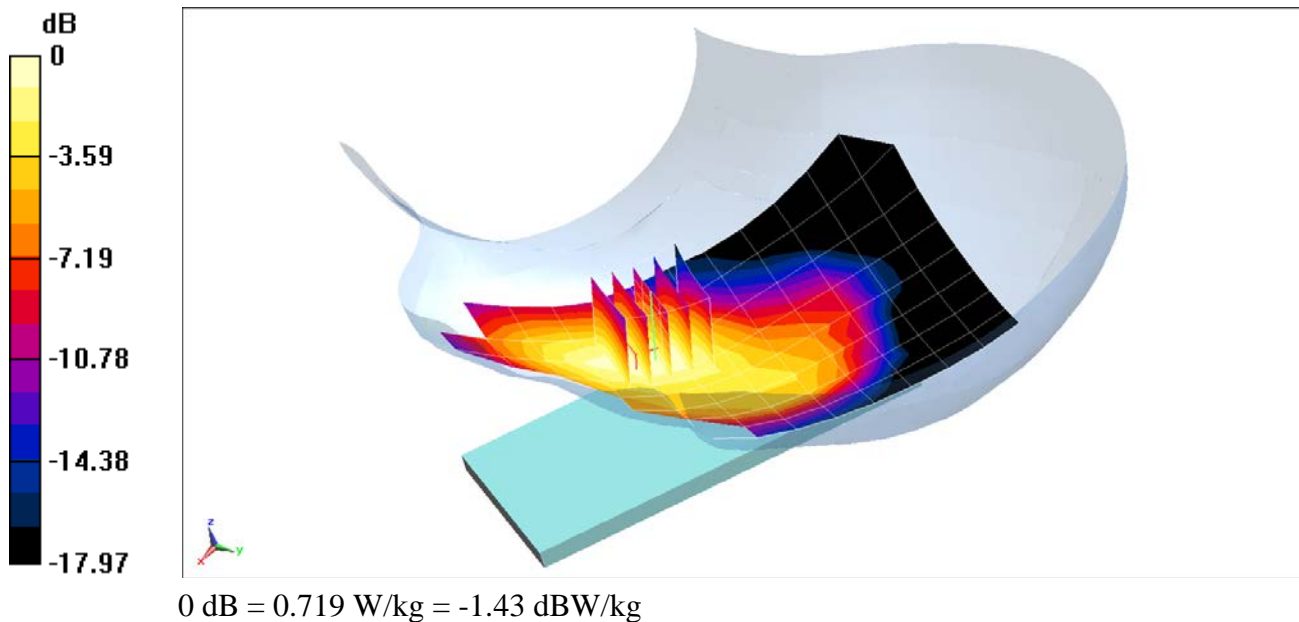

PCTEST ENGINEERING LABORATORY, INC.

DUT: ZNFX410PM; Type: Portable Handset; Serial: 04397

Communication System: UID 0, LTE Band 25 (PCS); Frequency: 1905 MHz; Duty Cycle: 1:1
Medium: 1900 Head Medium parameters used (interpolated):
 $f = 1905 \text{ MHz}$; $\sigma = 1.465 \text{ S/m}$; $\epsilon_r = 40.008$; $\rho = 1000 \text{ kg/m}^3$
Phantom section: Left Section

Test Date: 07-12-2018; Ambient Temp: 24.0°C; Tissue Temp: 22.8°C

Probe: ES3DV3 - SN3213; ConvF(5.3, 5.3, 5.3); Calibrated: 2/13/2018;
Sensor-Surface: 3mm (Mechanical Surface Detection)
Electronics: DAE4 Sn1272; Calibrated: 2/9/2018
Phantom: SAM V5.0 Right; Type: QD000P40CD; Serial: 1647
Measurement SW: DASY52, Version 52.10; SEMCAD X Version 14.6.10 (7417)

**Mode: LTE Band 25 (PCS), Left Head, Cheek, High.ch,
20 MHz Bandwidth, QPSK, 1 RB, 99 RB Offset**

Area Scan (9x14x1): Measurement grid: dx=15mm, dy=15mm
Zoom Scan (5x5x7)/Cube 0: Measurement grid: dx=8mm, dy=8mm, dz=5mm
Reference Value = 25.73 V/m; Power Drift = -0.07 dB
Peak SAR (extrapolated) = 1.22 W/kg
SAR(1 g) = 0.783 W/kg

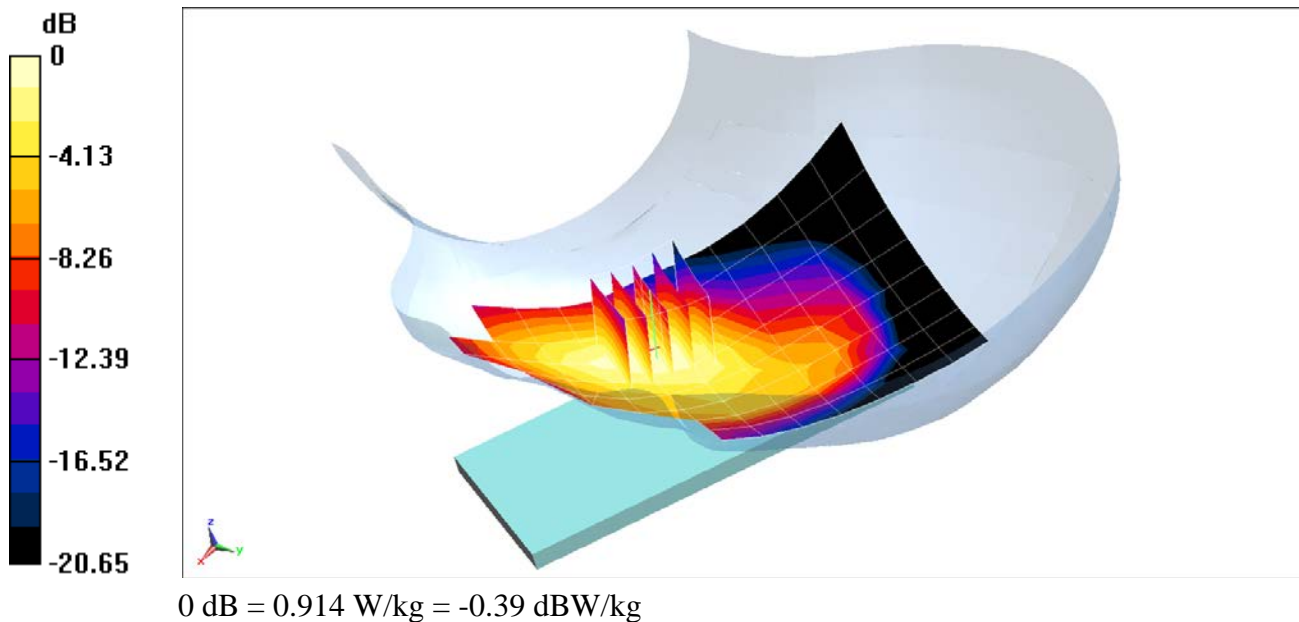

PCTEST ENGINEERING LABORATORY, INC.

DUT: ZNFX410PM; Type: Portable Handset; Serial: 04421

Communication System: UID 0, _LTE Band 41 (Class 2); Frequency: 2680 MHz; Duty Cycle: 1:2.31

Medium: 2450 Head Medium parameters used (interpolated):

$f = 2680$ MHz; $\sigma = 2.093$ S/m; $\epsilon_r = 37.036$; $\rho = 1000$ kg/m³

Phantom section: Left Section

Test Date: 07-11-2018; Ambient Temp: 21.9°C; Tissue Temp: 21.4°C

Probe: ES3DV3 - SN3332; ConvF(4.56, 4.56, 4.56); Calibrated: 8/14/2017;

Sensor-Surface: 3mm (Mechanical Surface Detection)

Electronics: DAE4 Sn1323; Calibrated: 8/9/2017

Phantom: SAM Front; Type: SAM; Serial: 1686

Measurement SW: DASY52, Version 52.10; SEMCAD X Version 14.6.10 (7417)

**Mode: LTE Band 41 PC2, Left Head, Cheek, High.ch,
20 MHz Bandwidth, QPSK, 1 RB, 0 RB Offset**

Area Scan (10x17x1): Measurement grid: dx=12mm, dy=12mm

Zoom Scan (7x7x7)/Cube 0: Measurement grid: dx=5mm, dy=5mm, dz=5mm

Reference Value = 21.36 V/m; Power Drift = -0.08 dB

Peak SAR (extrapolated) = 1.31 W/kg

SAR(1 g) = 0.708 W/kg

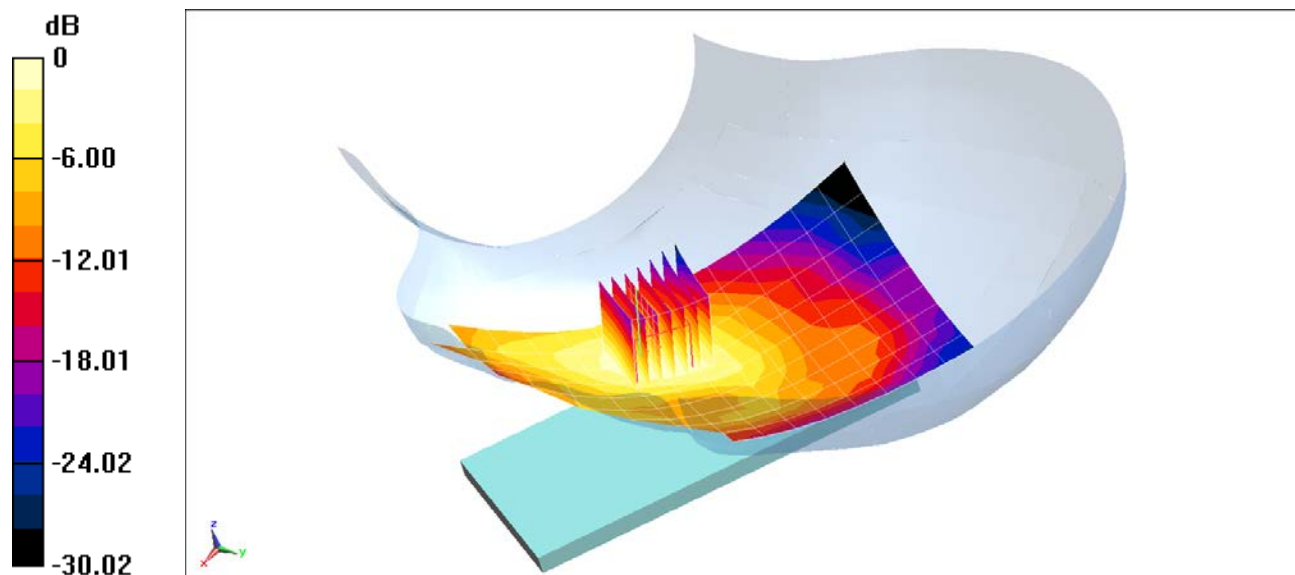

PCTEST ENGINEERING LABORATORY, INC.

DUT: ZNFX410PM; Type: Portable Handset; Serial: 04363

Communication System: UID 0, _IEEE 802.11b; Frequency: 2412 MHz; Duty Cycle: 1:1
Medium: 2450 Head Medium parameters used (interpolated):
 $f = 2412 \text{ MHz}$; $\sigma = 1.804 \text{ S/m}$; $\epsilon_r = 38.096$; $\rho = 1000 \text{ kg/m}^3$
Phantom section: Right Section

Test Date: 07-11-2018; Ambient Temp: 21.9°C; Tissue Temp: 21.4°C

Probe: ES3DV3 - SN3332; ConvF(4.68, 4.68, 4.68); Calibrated: 8/14/2017;
Sensor-Surface: 3mm (Mechanical Surface Detection)
Electronics: DAE4 Sn1323; Calibrated: 8/9/2017
Phantom: SAM Front; Type: SAM; Serial: 1686
Measurement SW: DASY52, Version 52.10; SEMCAD X Version 14.6.10 (7417)

Mode: IEEE 802.11b, 22 MHz Bandwidth, Right Head, Cheek, Ch 1, 1 Mbps

Area Scan (11x18x1): Measurement grid: $dx=12\text{mm}$, $dy=12\text{mm}$
Zoom Scan (7x7x7)/Cube 0: Measurement grid: $dx=5\text{mm}$, $dy=5\text{mm}$, $dz=5\text{mm}$
Reference Value = 13.96 V/m; Power Drift = 0.14 dB
Peak SAR (extrapolated) = 2.22 W/kg
SAR(1 g) = 0.994 W/kg

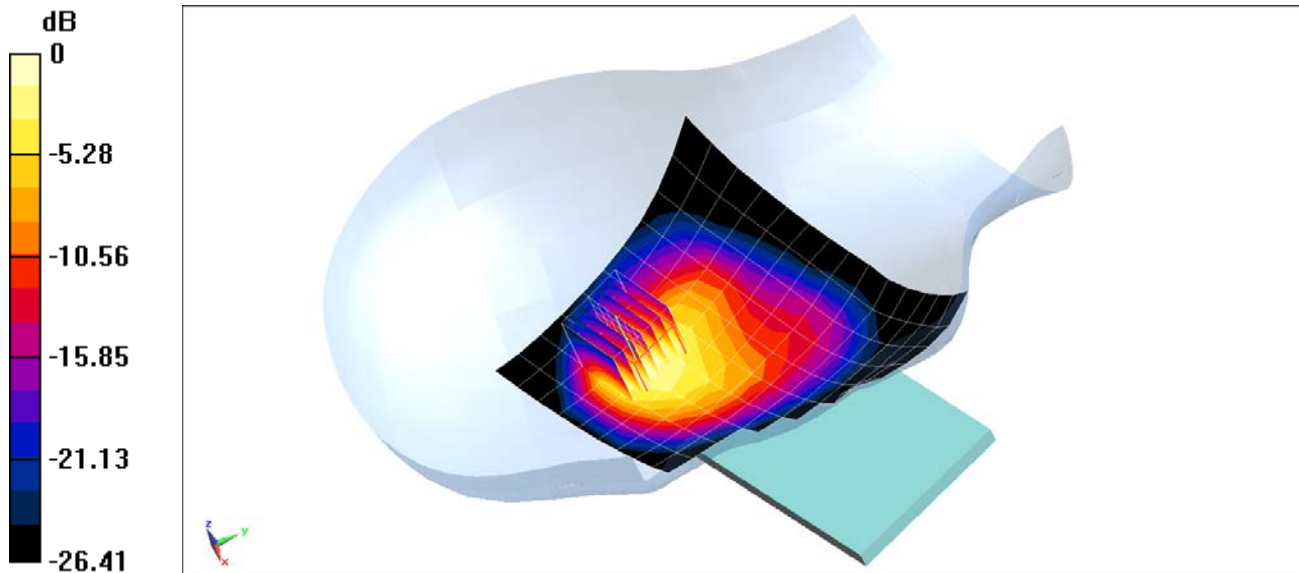

0 dB = 1.27 W/kg = 1.04 dBW/kg

PCTEST ENGINEERING LABORATORY, INC.

DUT: ZNFX410PM; Type: Portable Handset; Serial: 04363

Communication System: UID 0, 802.11n 5.2-5.8 GHz Band; Frequency: 5755 MHz; Duty Cycle: 1:1
Medium: 5GHz Head Medium parameters used (interpolated):
 $f = 5755 \text{ MHz}$; $\sigma = 5.197 \text{ S/m}$; $\epsilon_r = 34.757$; $\rho = 1000 \text{ kg/m}^3$
Phantom section: Right Section

Test Date: 07-09-2018; Ambient Temp: 20.3°C; Tissue Temp: 20.3°C

Probe: EX3DV4 - SN7409; ConvF(4.82, 4.82, 4.82); Calibrated: 6/25/2018;
Sensor-Surface: 1.4mm (Mechanical Surface Detection)
Electronics: DAE4 Sn1334; Calibrated: 6/18/2018
Phantom: SAM with CRP (Left); Type: SAM; Serial: 1715
Measurement SW: DASY52, Version 52.10; SEMCAD X Version 14.6.10 (7417)

**Mode: IEEE 802.11n, U-NII-3, 40 MHz Bandwidth,
Right Head, Tilt, Ch 151, 13.5 Mbps**

Area Scan (13x21x1): Measurement grid: dx=10mm, dy=10mm

Zoom Scan (7x7x7)/Cube 0: Measurement grid: dx=4mm, dy=4mm, dz=1.4mm; Graded Ratio: 1.4

Reference Value = 3.616 V/m; Power Drift = 0.18 dB

Peak SAR (extrapolated) = 5.07 W/kg

SAR(1 g) = 1.06 W/kg

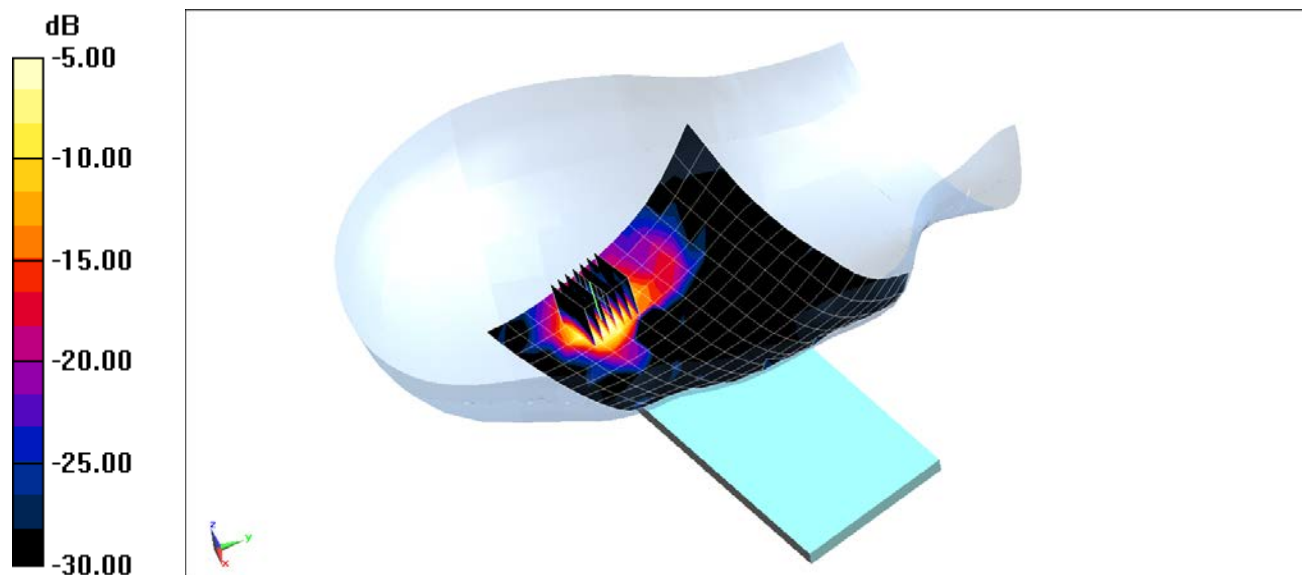

0 dB = 2.82 W/kg = 4.50 dBW/kg

PCTEST ENGINEERING LABORATORY, INC.

DUT: ZNFX410PM; Type: Portable Handset; Serial: 04363

Communication System: UID 0, Bluetooth; Frequency: 2480 MHz; Duty Cycle: 1: 1.297

Medium: 2450 Head Medium parameters used (interpolated):

$f = 2480 \text{ MHz}$; $\sigma = 1.879 \text{ S/m}$; $\epsilon_r = 37.83$; $\rho = 1000 \text{ kg/m}^3$

Phantom section: Right Section

Test Date: 07-11-2018; Ambient Temp: 21.9°C; Tissue Temp: 21.4°C

Probe: ES3DV3 - SN3332; ConvF(4.68, 4.68, 4.68); Calibrated: 8/14/2017;

Sensor-Surface: 3mm (Mechanical Surface Detection)

Electronics: DAE4 Sn1323; Calibrated: 8/9/2017

Phantom: SAM Front; Type: SAM; Serial: 1686

Measurement SW: DASY52, Version 52.10;SEMCAD X Version 14.6.10 (7417)

Mode: Bluetooth, Right Head, Cheek, Ch 78, 1 Mbps

Area Scan (11x19x1): Measurement grid: dx=12mm, dy=12mm

Zoom Scan (7x7x7)/Cube 0: Measurement grid: dx=5mm, dy=5mm, dz=5mm

Reference Value = 12.50 V/m; Power Drift = 0.03 dB

Peak SAR (extrapolated) = 0.632 W/kg

SAR(1 g) = 0.260 W/kg

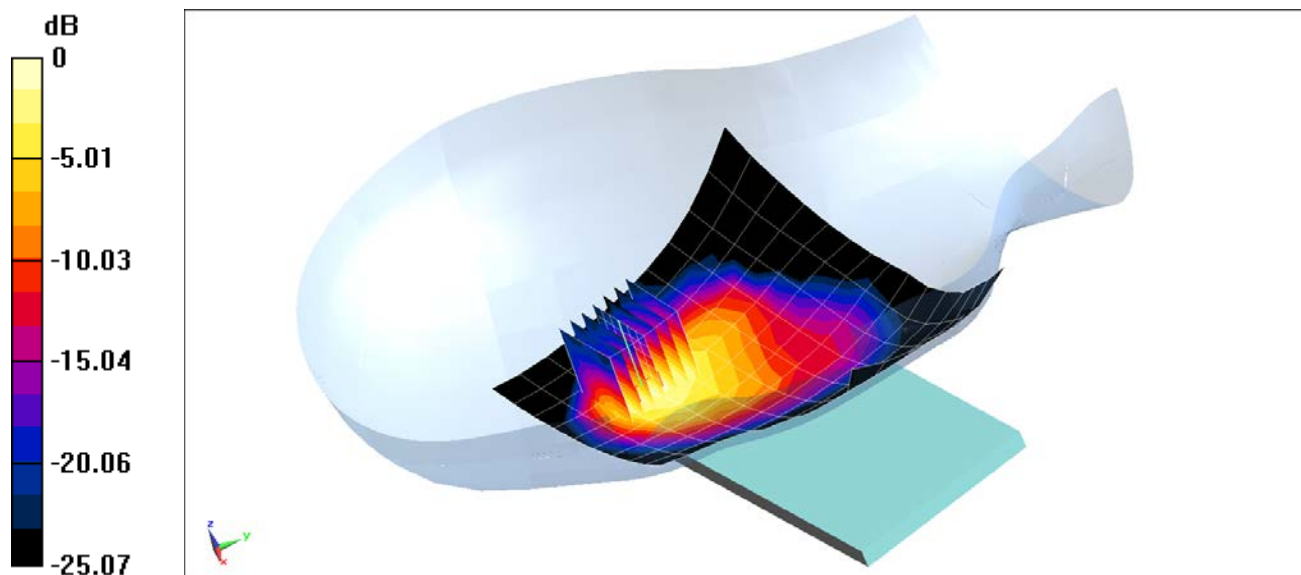

0 dB = 0.335 W/kg = -4.75 dBW/kg

PCTEST ENGINEERING LABORATORY, INC.

DUT: ZNFX410PM; Type: Portable Handset; Serial: 04462

Communication System: UID 0, CDMA; Frequency: 820.1 MHz; Duty Cycle: 1:1
Medium: 835 Body Medium parameters used (interpolated):
 $f = 820.1 \text{ MHz}$; $\sigma = 1.008 \text{ S/m}$; $\epsilon_r = 53.471$; $\rho = 1000 \text{ kg/m}^3$
Phantom section: Flat Section; Space: 1.0 cm

Test Date: 07-13-2018; Ambient Temp: 20.5°C; Tissue Temp: 20.6°C

Probe: ES3DV3 - SN3347; ConvF(6.37, 6.37, 6.37); Calibrated: 3/27/2018;
Sensor-Surface: 3mm (Mechanical Surface Detection)
Electronics: DAE4 Sn1450; Calibrated: 11/9/2017
Phantom: Twin-SAM V5.0 Right; Type: QD 000 P40 CD; Serial: 1800
Measurement SW: DASY52, Version 52.10; SEMCAD X Version 14.6.10 (7417)

Mode: Cell. CDMA BC10, Body SAR, Back side, Mid.ch

Area Scan (9x15x1): Measurement grid: dx=15mm, dy=15mm
Zoom Scan (6x5x7)/Cube 0: Measurement grid: dx=8mm, dy=8mm, dz=5mm
Reference Value = 27.59 V/m; Power Drift = -0.12 dB
Peak SAR (extrapolated) = 0.883 W/kg
SAR(1 g) = 0.705 W/kg

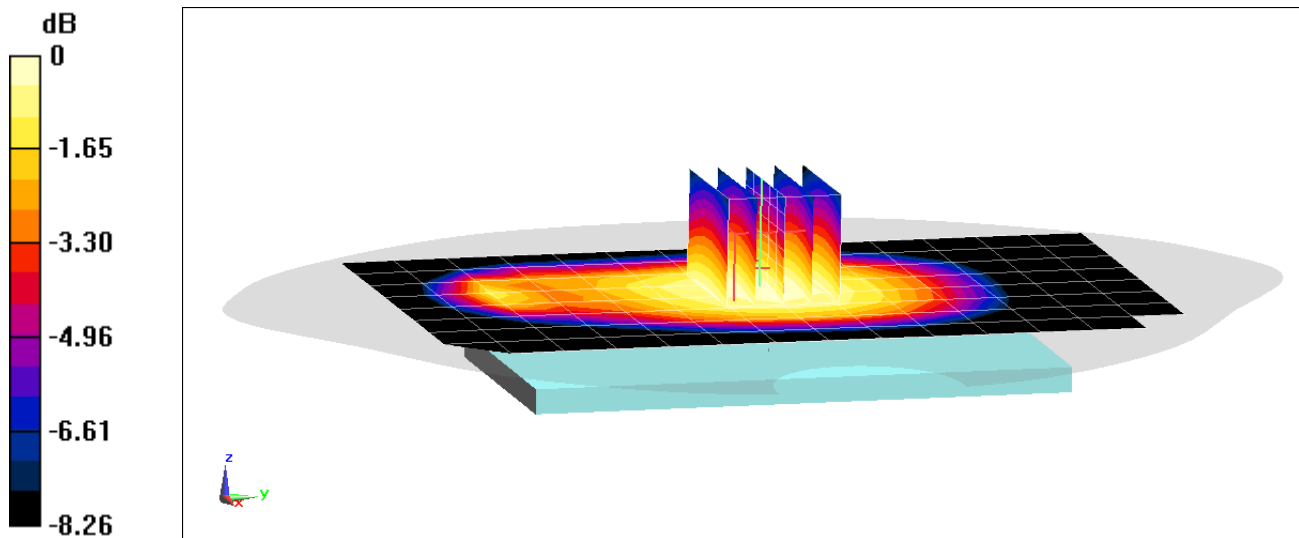

0 dB = 0.771 W/kg = -1.13 dBW/kg

PCTEST ENGINEERING LABORATORY, INC.

DUT: ZNFX410PM; Type: Portable Handset; Serial: 04462

Communication System: UID 0, CDMA; Frequency: 820.1 MHz; Duty Cycle: 1:1
Medium: 835 Body Medium parameters used (interpolated):
 $f = 820.1 \text{ MHz}$; $\sigma = 1.008 \text{ S/m}$; $\epsilon_r = 53.471$; $\rho = 1000 \text{ kg/m}^3$
Phantom section: Flat Section; Space: 1.0 cm

Test Date: 07-13-2018; Ambient Temp: 20.5°C; Tissue Temp: 20.6°C

Probe: ES3DV3 - SN3347; ConvF(6.37, 6.37, 6.37); Calibrated: 3/27/2018;
Sensor-Surface: 3mm (Mechanical Surface Detection)
Electronics: DAE4 Sn1450; Calibrated: 11/9/2017

Phantom: Twin-SAM V5.0 Right; Type: QD 000 P40 CD; Serial: 1800
Measurement SW: DASY52, Version 52.10; SEMCAD X Version 14.6.10 (7417)

Mode: Cell. EVDO Rev.0 BC10, Body SAR, Right Edge, Mid.ch

Area Scan (10x13x1): Measurement grid: dx=5mm, dy=15mm

Zoom Scan (6x6x7)/Cube 0: Measurement grid: dx=8mm, dy=8mm, dz=5mm

Reference Value = 28.25 V/m; Power Drift = -0.01 dB

Peak SAR (extrapolated) = 1.05 W/kg

SAR(1 g) = 0.742 W/kg

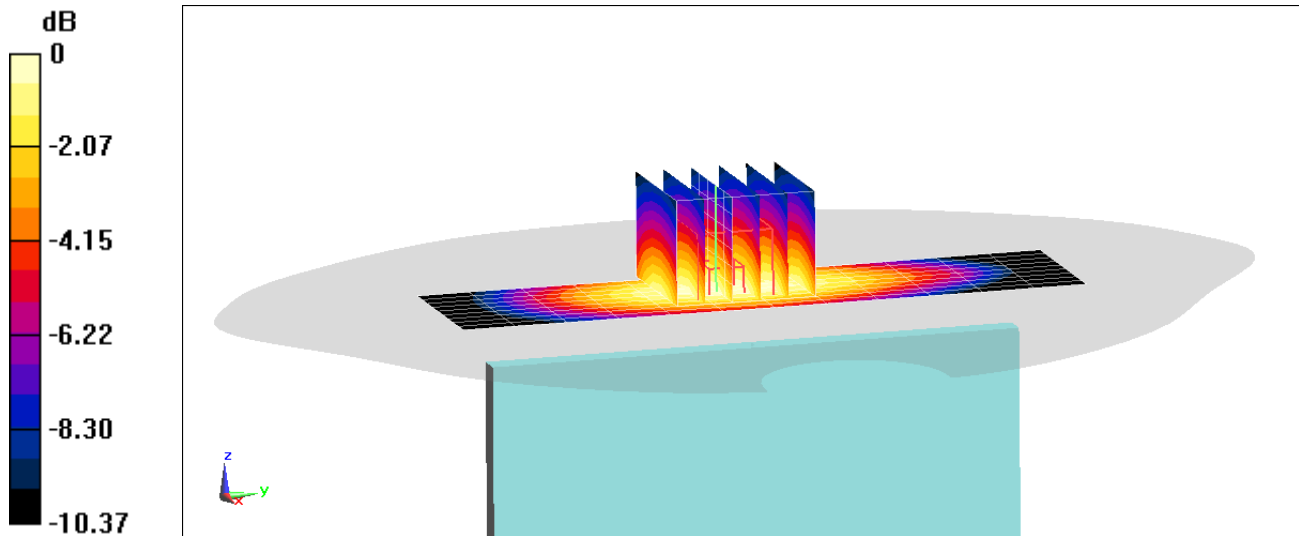

0 dB = 0.847 W/kg = -0.72 dBW/kg

PCTEST ENGINEERING LABORATORY, INC.

DUT: ZNFX410PM; Type: Portable Handset; Serial: 04462

Communication System: UID 0, CDMA; Frequency: 848.31 MHz; Duty Cycle: 1:1
Medium: 835 Body Medium parameters used (interpolated):
 $f = 848.31 \text{ MHz}$; $\sigma = 1.015 \text{ S/m}$; $\epsilon_r = 53.366$; $\rho = 1000 \text{ kg/m}^3$
Phantom section: Flat Section; Space: 1.0 cm

Test Date: 07-13-2018; Ambient Temp: 20.5°C; Tissue Temp: 20.6°C

Probe: ES3DV3 - SN3347; ConvF(6.37, 6.37, 6.37); Calibrated: 3/27/2018;
Sensor-Surface: 3mm (Mechanical Surface Detection)
Electronics: DAE4 Sn1450; Calibrated: 11/9/2017
Phantom: Twin-SAM V5.0 Right; Type: QD 000 P40 CD; Serial: 1800
Measurement SW: DASY52, Version 52.10; SEMCAD X Version 14.6.10 (7417)

Mode: Cell. CDMA BC0, Body SAR, Back side, High.ch

Area Scan (9x15x1): Measurement grid: dx=15mm, dy=15mm
Zoom Scan (5x5x7)/Cube 0: Measurement grid: dx=8mm, dy=8mm, dz=5mm
Reference Value = 26.65 V/m; Power Drift = -0.02 dB
Peak SAR (extrapolated) = 1.13 W/kg
SAR(1 g) = 0.635 W/kg

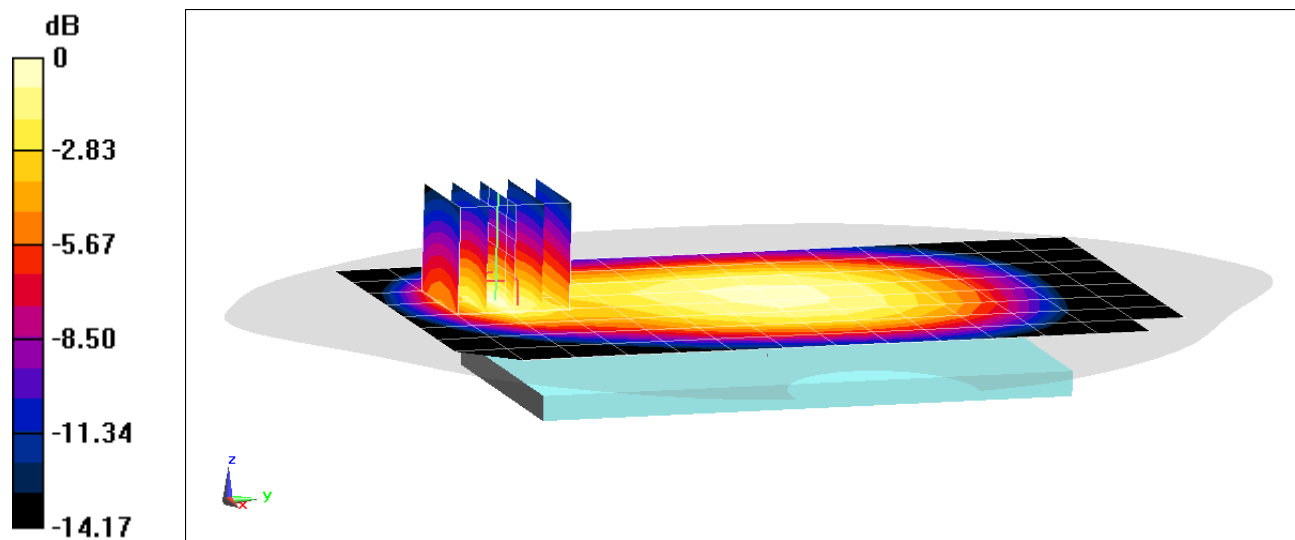

0 dB = 0.798 W/kg = -0.98 dBW/kg

PCTEST ENGINEERING LABORATORY, INC.

DUT: ZNFX410PM; Type: Portable Handset; Serial: 04462

Communication System: UID 0, CDMA; Frequency: 836.52 MHz; Duty Cycle: 1:1
Medium: 835 Body Medium parameters used (interpolated):
 $f = 836.52 \text{ MHz}$; $\sigma = 1.014 \text{ S/m}$; $\epsilon_r = 53.339$; $\rho = 1000 \text{ kg/m}^3$
Phantom section: Flat Section; Space: 1.0 cm

Test Date: 07-13-2018; Ambient Temp: 20.5°C; Tissue Temp: 20.6°C

Probe: ES3DV3 - SN3347; ConvF(6.37, 6.37, 6.37); Calibrated: 3/27/2018;
Sensor-Surface: 3mm (Mechanical Surface Detection)
Electronics: DAE4 Sn1450; Calibrated: 11/9/2017
Phantom: Twin-SAM V5.0 Right; Type: QD 000 P40 CD; Serial: 1800
Measurement SW: DASY52, Version 52.10;SEMCAD X Version 14.6.10 (7417)

Mode: Cell. EVDO Rev.0 BC0, Body SAR, Right Edge, Mid.ch

Area Scan (10x13x1): Measurement grid: dx=5mm, dy=15mm
Zoom Scan (5x5x7)/Cube 0: Measurement grid: dx=8mm, dy=8mm, dz=5mm
Reference Value = 26.93 V/m; Power Drift = -0.04 dB
Peak SAR (extrapolated) = 0.949 W/kg
SAR(1 g) = 0.671 W/kg

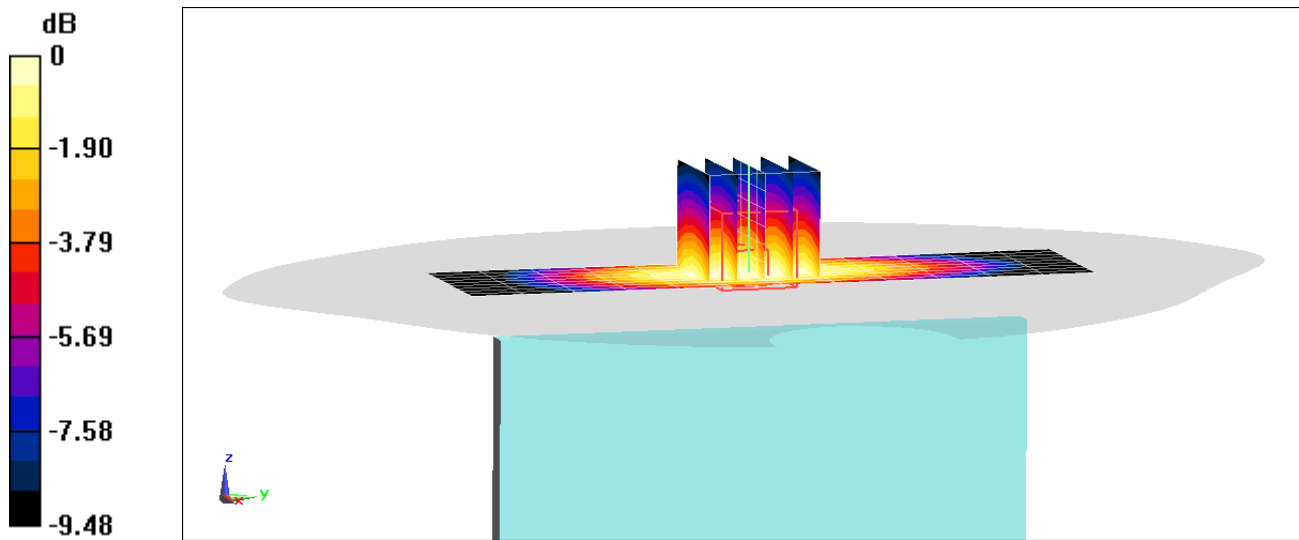

PCTEST ENGINEERING LABORATORY, INC.

DUT: ZNFX410PM; Type: Portable Handset; Serial: 04397

Communication System: UID 0, GSM GPRS; 2 Tx slots; Frequency: 848.8 MHz; Duty Cycle: 1:4.15
Medium: 835 Body Medium parameters used (interpolated):
 $f = 848.8 \text{ MHz}$; $\sigma = 1.015 \text{ S/m}$; $\epsilon_r = 53.367$; $\rho = 1000 \text{ kg/m}^3$
Phantom section: Flat Section; Space: 1.0 cm

Test Date: 07-13-2018; Ambient Temp: 20.5°C; Tissue Temp: 20.6°C

Probe: ES3DV3 - SN3347; ConvF(6.37, 6.37, 6.37); Calibrated: 3/27/2018;
Sensor-Surface: 3mm (Mechanical Surface Detection)
Electronics: DAE4 Sn1450; Calibrated: 11/9/2017
Phantom: Twin-SAM V5.0 Right; Type: QD 000 P40 CD; Serial: 1800
Measurement SW: DASY52, Version 52.10; SEMCAD X Version 14.6.10 (7417)

Mode: GPRS 850, Body SAR, Back side, High.ch, 2 Tx Slots

Area Scan (9x14x1): Measurement grid: dx=15mm, dy=15mm

Zoom Scan (5x5x7)/Cube 0: Measurement grid: dx=8mm, dy=8mm, dz=5mm

Reference Value = 28.89 V/m; Power Drift = 0.04 dB

Peak SAR (extrapolated) = 1.02 W/kg

SAR(1 g) = 0.800 W/kg

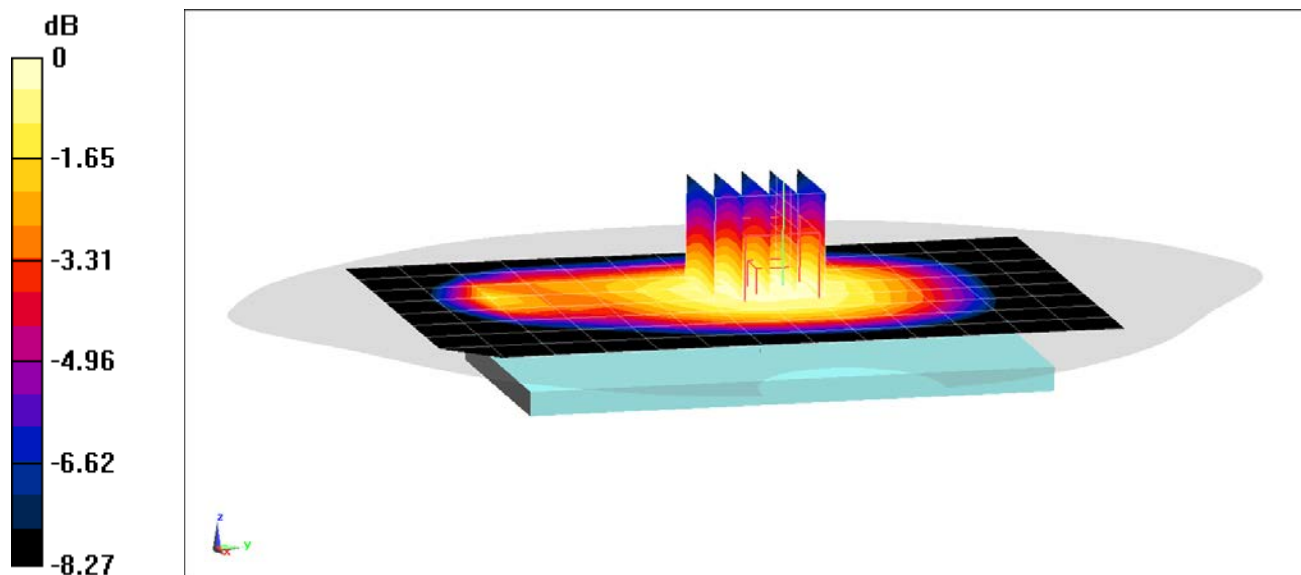

0 dB = 0.876 W/kg = -0.57 dBW/kg

PCTEST ENGINEERING LABORATORY, INC.

DUT: ZNFX410PM; Type: Portable Handset; Serial: 04462

Communication System: UID 0, UMTS; Frequency: 826.4 MHz; Duty Cycle: 1:1
Medium: 835 Body Medium parameters used (interpolated):
 $f = 826.4 \text{ MHz}$; $\sigma = 1.011 \text{ S/m}$; $\epsilon_r = 53.414$; $\rho = 1000 \text{ kg/m}^3$
Phantom section: Flat Section; Space: 1.0 cm

Test Date: 07-13-2018; Ambient Temp: 20.5°C; Tissue Temp: 20.6°C

Probe: ES3DV3 - SN3347; ConvF(6.37, 6.37, 6.37); Calibrated: 3/27/2018;
Sensor-Surface: 3mm (Mechanical Surface Detection)
Electronics: DAE4 Sn1450; Calibrated: 11/9/2017
Phantom: Twin-SAM V5.0 Right; Type: QD 000 P40 CD; Serial: 1800
Measurement SW: DASY52, Version 52.10; SEMCAD X Version 14.6.10 (7417)

Mode: UMTS 850, Body SAR, Back side, Low.ch

Area Scan (9x14x1): Measurement grid: dx=15mm, dy=15mm
Zoom Scan (5x5x7)/Cube 0: Measurement grid: dx=8mm, dy=8mm, dz=5mm
Reference Value = 25.58 V/m; Power Drift = 0.02 dB
Peak SAR (extrapolated) = 0.798 W/kg
SAR(1 g) = 0.634 W/kg

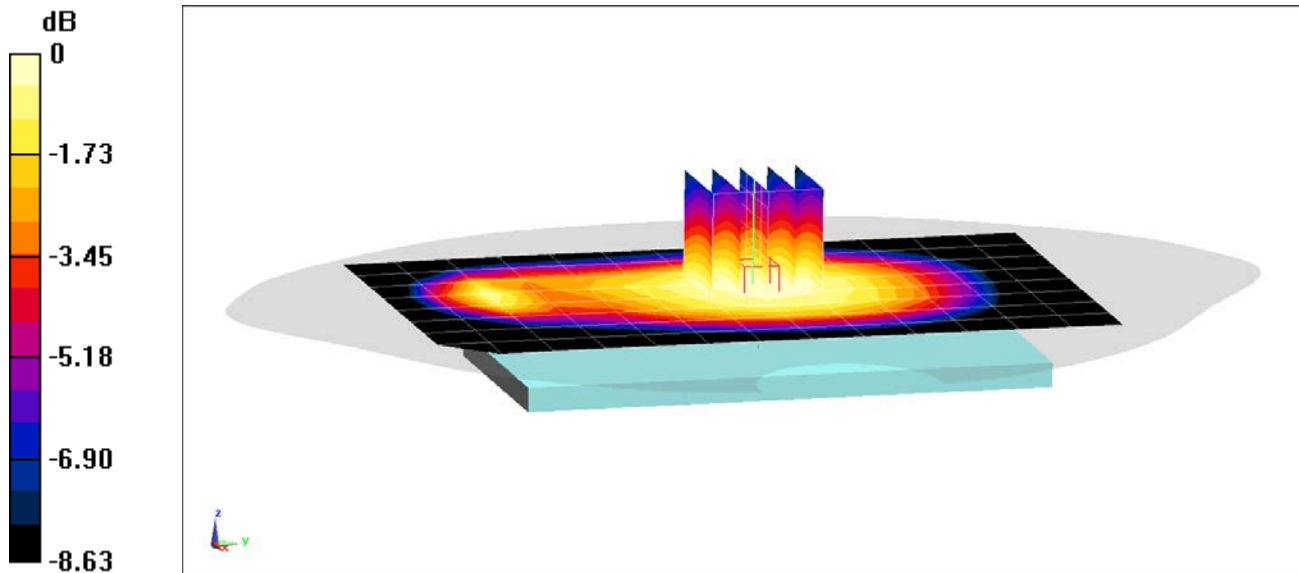

0 dB = 0.693 W/kg = -1.59 dBW/kg

PCTEST ENGINEERING LABORATORY, INC.

DUT: ZNFX410PM; Type: Portable Handset; Serial: 04462

Communication System: UID 0, UMTS, Frequency: 826.4 MHz; Duty Cycle: 1:1
Medium: 835 Body Medium parameters used (interpolated):
 $f = 826.4 \text{ MHz}$; $\sigma = 1.011 \text{ S/m}$; $\epsilon_r = 53.414$; $\rho = 1000 \text{ kg/m}^3$
Phantom section: Flat Section; Space: 1.0 cm

Test Date: 07-13-2018; Ambient Temp: 20.5°C; Tissue Temp: 20.6°C

Probe: ES3DV3 - SN3347; ConvF(6.37, 6.37, 6.37); Calibrated: 3/27/2018;
Sensor-Surface: 3mm (Mechanical Surface Detection)
Electronics: DAE4 Sn1450; Calibrated: 11/9/2017
Phantom: Twin-SAM V5.0 Right; Type: QD 000 P40 CD; Serial: 1800
Measurement SW: DASY52, Version 52.10; SEMCAD X Version 14.6.10 (7417)

Mode: UMTS 850, Body SAR, Right Edge, Low.ch

Area Scan (10x13x1): Measurement grid: dx=5mm, dy=15mm
Zoom Scan (6x6x7)/Cube 0: Measurement grid: dx=8mm, dy=8mm, dz=5mm
Reference Value = 25.77 V/m; Power Drift = 0.12 dB
Peak SAR (extrapolated) = 0.903 W/kg
SAR(1 g) = 0.640 W/kg

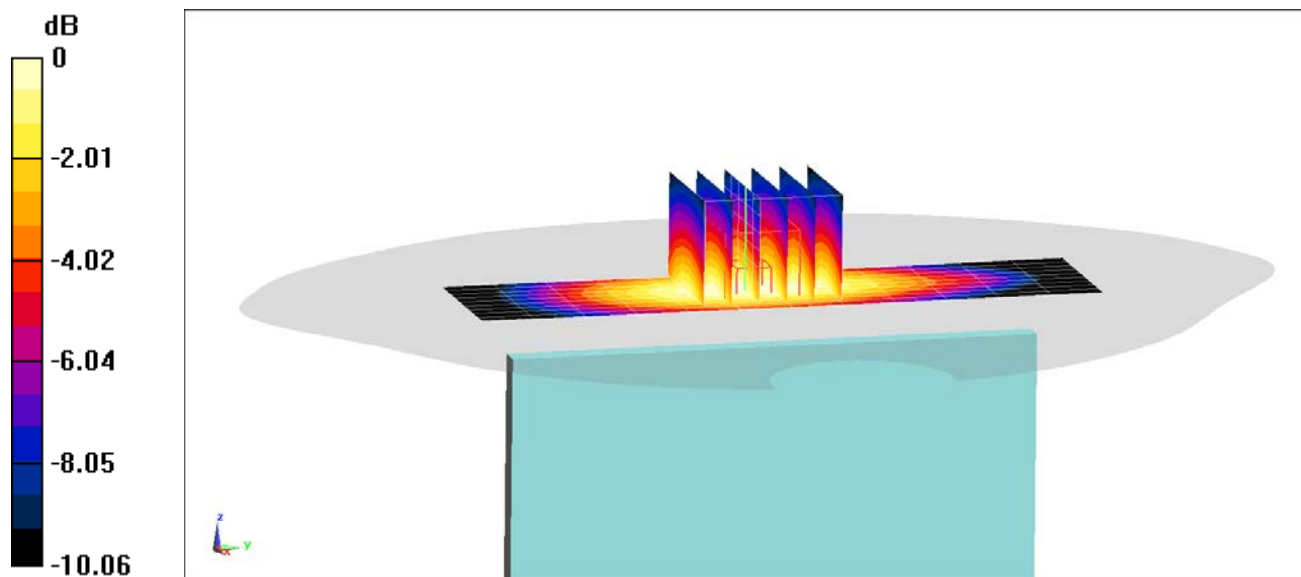

0 dB = 0.718 W/kg = -1.44 dBW/kg

PCTEST ENGINEERING LABORATORY, INC.

DUT: ZNFX410PM; Type: Portable Handset; Serial: 04462

Communication System: UID 0, UMTS; Frequency: 1732.4 MHz; Duty Cycle: 1:1
Medium: 1750 Body Medium parameters used (interpolated):
 $f = 1732.4$ MHz; $\sigma = 1.483$ S/m; $\epsilon_r = 52.054$; $\rho = 1000$ kg/m³
Phantom section: Flat Section; Space: 1.0 cm

Test Date: 07-10-2018; Ambient Temp: 22.0°C; Tissue Temp: 21.8°C

Probe: ES3DV3 - SN3347; ConvF(5.17, 5.17, 5.17); Calibrated: 3/27/2018;
Sensor-Surface: 3mm (Mechanical Surface Detection)
Electronics: DAE4 Sn1450; Calibrated: 11/9/2017
Phantom: Twin-SAM V5.0 Right; Type: QD 000 P40 CD; Serial: 1800
Measurement SW: DASY52, Version 52.10; SEMCAD X Version 14.6.10 (7417)

Mode: UMTS 1750, Body SAR, Back side, Mid.ch

Area Scan (9x15x1): Measurement grid: dx=15mm, dy=15mm
Zoom Scan (5x5x7)/Cube 0: Measurement grid: dx=8mm, dy=8mm, dz=5mm
Reference Value = 25.81 V/m; Power Drift = 0.03 dB
Peak SAR (extrapolated) = 1.48 W/kg
SAR(1 g) = 0.885 W/kg

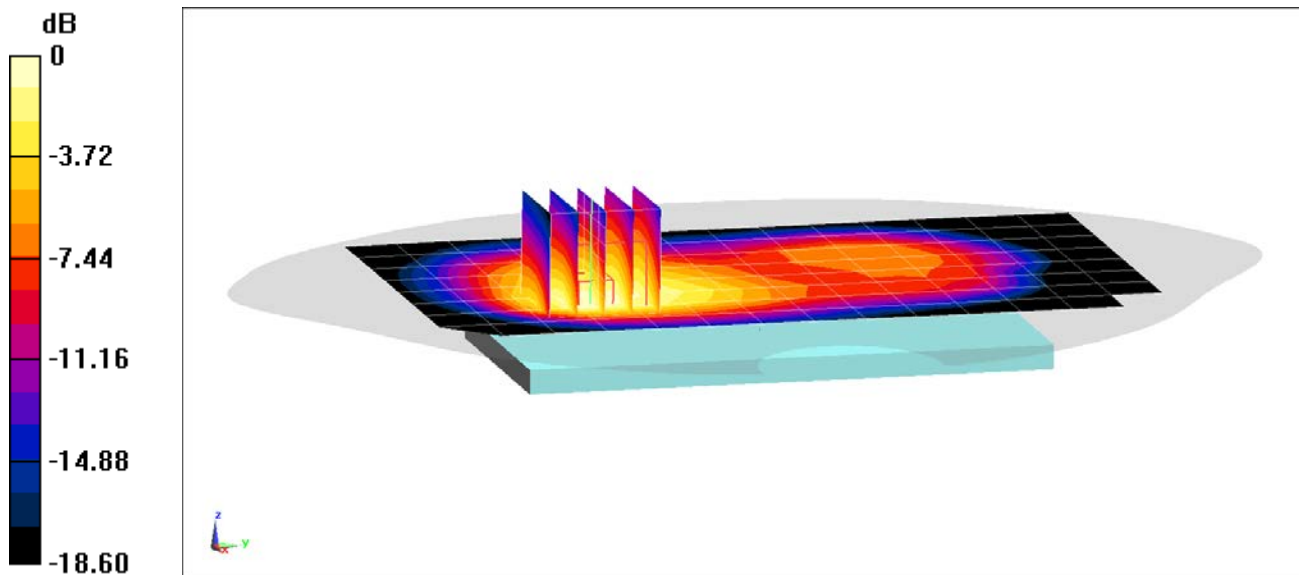

0 dB = 1.06 W/kg = 0.25 dBW/kg

PCTEST ENGINEERING LABORATORY, INC.

DUT: ZNFX410PM; Type: Portable Handset; Serial: 04421

Communication System: UID 0, CDMA; Frequency: 1851.25 MHz; Duty Cycle: 1:1
Medium: 1900 Body Medium parameters used (interpolated):
 $f = 1851.25$ MHz; $\sigma = 1.512$ S/m; $\epsilon_r = 52.493$; $\rho = 1000$ kg/m³
Phantom section: Flat Section; Space: 1.0 cm

Test Date: 07-11-2018; Ambient Temp: 21.3°C; Tissue Temp: 21.8°C

Probe: EX3DV4 - SN7406; ConvF(7.74, 7.74, 7.74); Calibrated: 5/22/2018;
Sensor-Surface: 1.4mm (Mechanical Surface Detection)
Electronics: DAE4 Sn859; Calibrated: 5/22/2018
Phantom: Twin-SAM V5.0; Type: QD 000 P40 CD; Serial: 1692
Measurement SW: DASY52, Version 52.10; SEMCAD X Version 14.6.10 (7417)

Mode: PCS CDMA, Body SAR, Back side, Low.ch

Area Scan (9x15x1): Measurement grid: dx=15mm, dy=15mm
Zoom Scan (6x6x7)/Cube 0: Measurement grid: dx=8mm, dy=8mm, dz=5mm
Reference Value = 23.79 V/m; Power Drift = 0.00 dB
Peak SAR (extrapolated) = 1.38 W/kg
SAR(1 g) = 0.784 W/kg

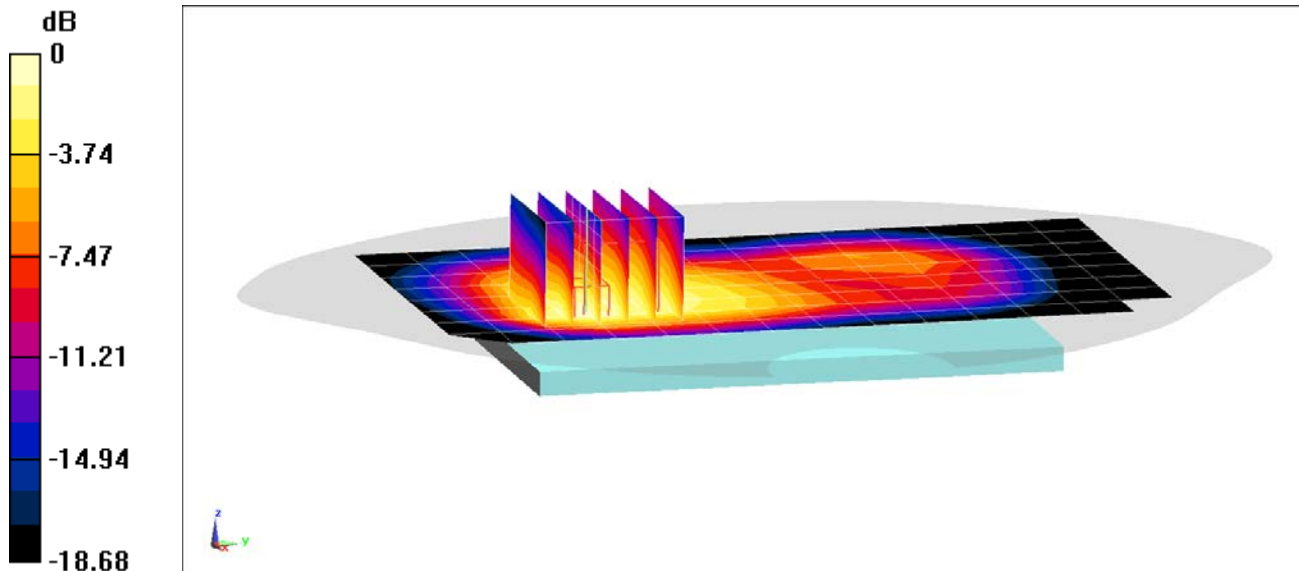

0 dB = 1.15 W/kg = 0.61 dBW/kg

PCTEST ENGINEERING LABORATORY, INC.

DUT: ZNFX410PM; Type: Portable Handset; Serial: 04421

Communication System: UID 0, CDMA; Frequency: 1908.75 MHz; Duty Cycle: 1:1
Medium: 1900 Body Medium parameters used (interpolated):
 $f = 1908.75 \text{ MHz}$; $\sigma = 1.575 \text{ S/m}$; $\epsilon_r = 52.31$; $\rho = 1000 \text{ kg/m}^3$
Phantom section: Flat Section; Space: 1.0 cm

Test Date: 07-11-2018; Ambient Temp: 21.3°C; Tissue Temp: 21.8°C

Probe: EX3DV4 - SN7406; ConvF(7.74, 7.74, 7.74); Calibrated: 5/22/2018;
Sensor-Surface: 1.4mm (Mechanical Surface Detection)
Electronics: DAE4 Sn859; Calibrated: 5/22/2018
Phantom: Twin-SAM V5.0; Type: QD 000 P40 CD; Serial: 1692
Measurement SW: DASY52, Version 52.10; SEMCAD X Version 14.6.10 (7417)

Mode: PCS EVDO Rev.0, Body SAR, Back side, High.ch

Area Scan (9x15x1): Measurement grid: dx=15mm, dy=15mm
Zoom Scan (6x5x7)/Cube 0: Measurement grid: dx=8mm, dy=8mm, dz=5mm
Reference Value = 23.56 V/m; Power Drift = -0.07 dB
Peak SAR (extrapolated) = 1.58 W/kg
SAR(1 g) = 0.835 W/kg

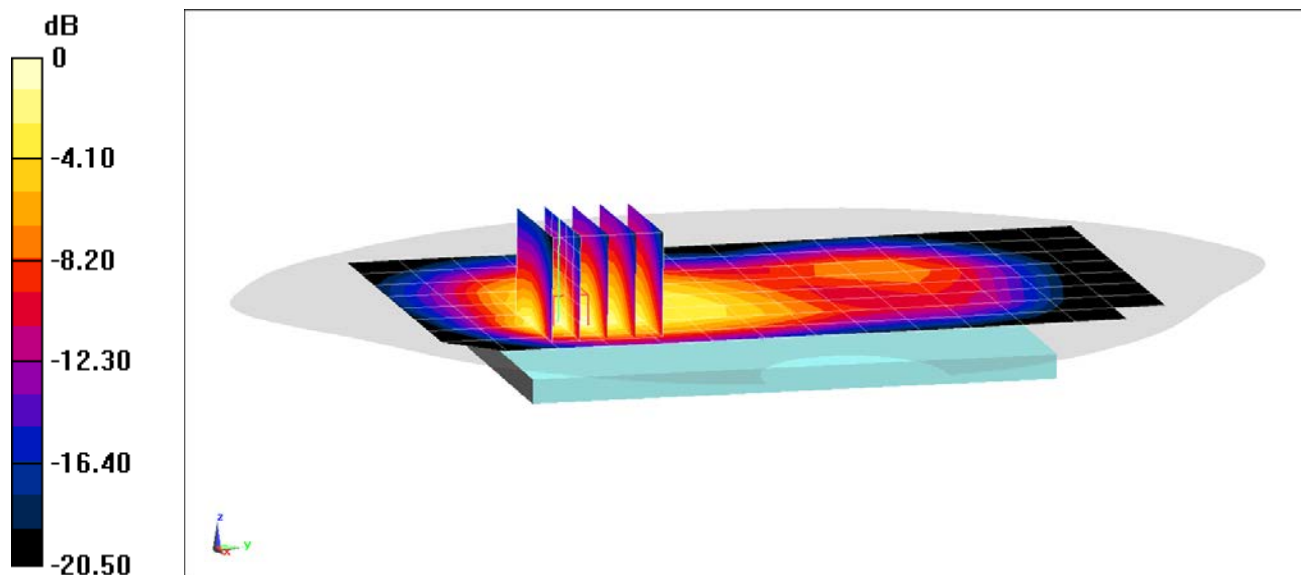

0 dB = 1.30 W/kg = 1.14 dBW/kg

PCTEST ENGINEERING LABORATORY, INC.

DUT: ZNFX410PM; Type: Portable Handset; Serial: 04421

Communication System: UID 0, GSM GPRS; 2 Tx slots; Frequency: 1880 MHz; Duty Cycle: 1:4.15

Medium: 1900 Body Medium parameters used:

$f = 1880 \text{ MHz}$; $\sigma = 1.544 \text{ S/m}$; $\epsilon_r = 52.399$; $\rho = 1000 \text{ kg/m}^3$

Phantom section: Flat Section; Space: 1.0 cm

Test Date: 07-11-2018; Ambient Temp: 21.3°C; Tissue Temp: 21.8°C

Probe: EX3DV4 - SN7406; ConvF(7.74, 7.74, 7.74); Calibrated: 5/22/2018;

Sensor-Surface: 1.4mm (Mechanical Surface Detection)

Electronics: DAE4 Sn859; Calibrated: 5/22/2018

Phantom: Twin-SAM V5.0; Type: QD 000 P40 CD; Serial: 1692

Measurement SW: DASY52, Version 52.10;SEMCAD X Version 14.6.10 (7417)

Mode: GPRS 1900, Body SAR, Back side, Mid.ch, 2 Tx Slots

Area Scan (9x15x1): Measurement grid: dx=15mm, dy=15mm

Zoom Scan (6x6x7)/Cube 0: Measurement grid: dx=8mm, dy=8mm, dz=5mm

Reference Value = 16.83 V/m; Power Drift = -0.03 dB

Peak SAR (extrapolated) = 0.718 W/kg

SAR(1 g) = 0.394 W/kg

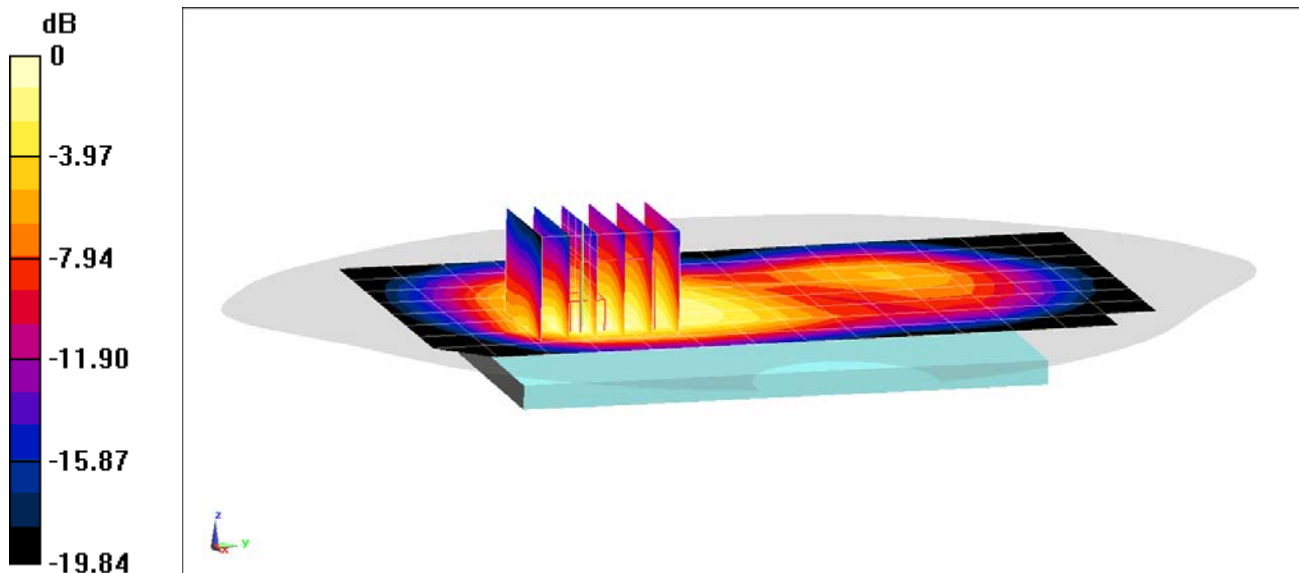

0 dB = 0.595 W/kg = -2.25 dBW/kg

PCTEST ENGINEERING LABORATORY, INC.

DUT: ZNFX410PM; Type: Portable Handset; Serial: 04397

Communication System: UID 0, UMTS; Frequency: 1852.4 MHz; Duty Cycle: 1:1
Medium: 1900 Body Medium parameters used (interpolated):
 $f = 1852.4 \text{ MHz}$; $\sigma = 1.509 \text{ S/m}$; $\epsilon_r = 52.523$; $\rho = 1000 \text{ kg/m}^3$
Phantom section: Flat Section; Space: 1.0 cm

Test Date: 07-08-2018; Ambient Temp: 20.3°C; Tissue Temp: 21.1°C

Probe: EX3DV4 - SN7406; ConvF(7.74, 7.74, 7.74); Calibrated: 5/22/2018;
Sensor-Surface: 1.4mm (Mechanical Surface Detection)
Electronics: DAE4 Sn859; Calibrated: 5/22/2018
Phantom: Twin-SAM V5.0; Type: QD 000 P40 CD; Serial: 1692
Measurement SW: DASY52, Version 52.10; SEMCAD X Version 14.6.10 (7417)

Mode: UMTS 1900, Body SAR, Back side, Low.ch

Area Scan (9x15x1): Measurement grid: dx=15mm, dy=15mm
Zoom Scan (6x7x7)/Cube 0: Measurement grid: dx=8mm, dy=8mm, dz=5mm
Reference Value = 23.05 V/m; Power Drift = -0.11 dB
Peak SAR (extrapolated) = 1.35 W/kg
SAR(1 g) = 0.766 W/kg

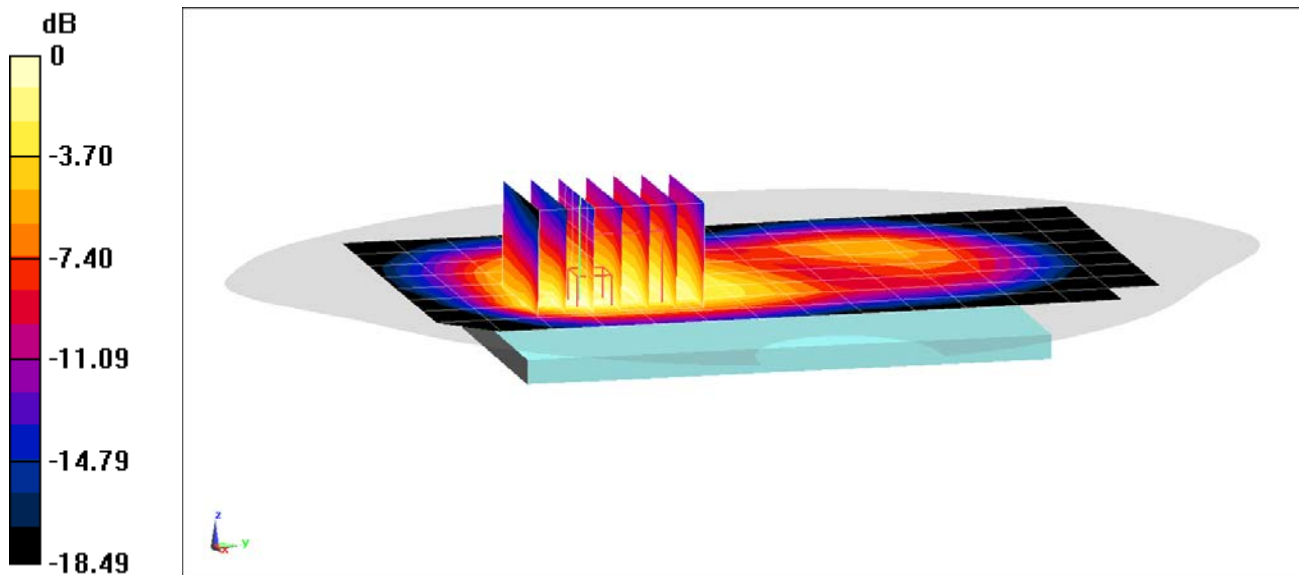

0 dB = 1.09 W/kg = 0.37 dBW/kg

PCTEST ENGINEERING LABORATORY, INC.

DUT: ZNFX410PM; Type: Portable Handset; Serial: 04421

Communication System: UID 0, LTE Band 12; Frequency: 707.5 MHz; Duty Cycle: 1:1
Medium: 750 Body Medium parameters used (interpolated):
 $f = 707.5 \text{ MHz}$; $\sigma = 0.951 \text{ S/m}$; $\epsilon_r = 54.179$; $\rho = 1000 \text{ kg/m}^3$
Phantom section: Flat Section; Space: 1.0 cm

Test Date: 07-11-2018; Ambient Temp: 23.8°C; Tissue Temp: 21.3°C

Probe: EX3DV4 - SN7409; ConvF(9.82, 9.82, 9.82); Calibrated: 6/25/2018;

Sensor-Surface: 1.4mm (Mechanical Surface Detection)

Electronics: DAE4 Sn1334; Calibrated: 6/18/2018

Phantom: SAM with CRP v5.0 (Right); Type: QD000P40CD; Serial: TP:1759

Measurement SW: DASY52, Version 52.10;SEMCAD X Version 14.6.10 (7417)

**Mode: LTE Band 12, Body SAR, Back side, Mid.ch,
10 MHz Bandwidth, QPSK, 1 RB, 0 RB Offset**

Area Scan (9x13x1): Measurement grid: dx=15mm, dy=15mm

Zoom Scan (5x5x7)/Cube 0: Measurement grid: dx=8mm, dy=8mm, dz=5mm

Reference Value = 23.36 V/m; Power Drift = -0.14 dB

Peak SAR (extrapolated) = 0.923 W/kg

SAR(1 g) = 0.496 W/kg

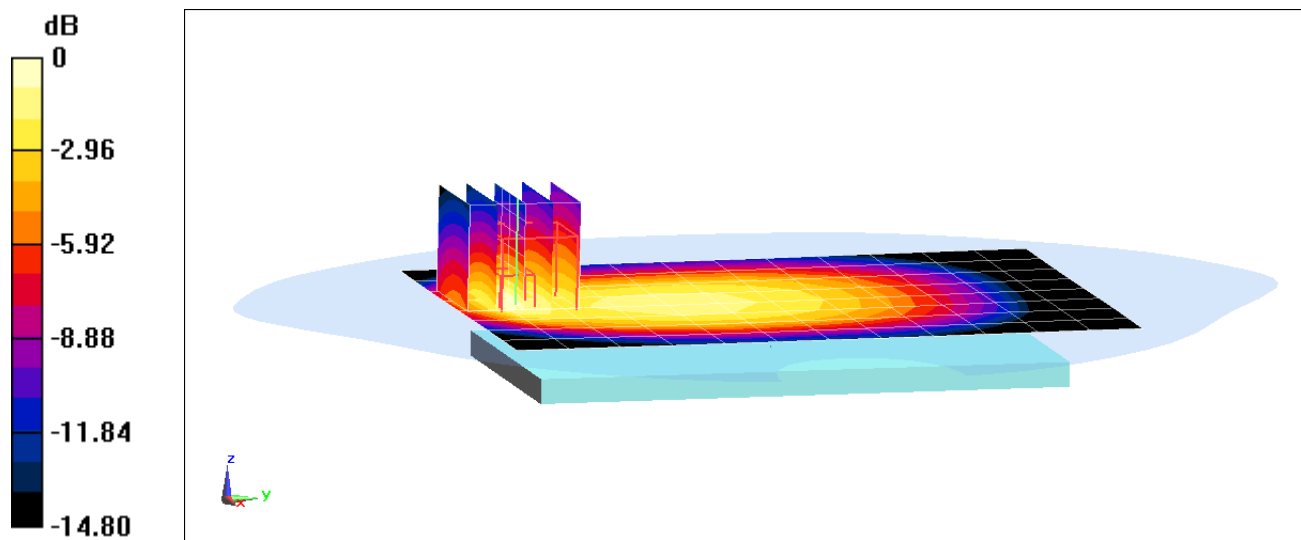

0 dB = 0.759 W/kg = -1.20 dBW/kg

PCTEST ENGINEERING LABORATORY, INC.

DUT: ZNFX410PM; Type: Portable Handset; Serial: 04421

Communication System: UID 0, LTE Band 12; Frequency: 707.5 MHz; Duty Cycle: 1:1

Medium: 750 Body Medium parameters used (interpolated):

$f = 707.5 \text{ MHz}$; $\sigma = 0.951 \text{ S/m}$; $\epsilon_r = 54.179$; $\rho = 1000 \text{ kg/m}^3$

Phantom section: Flat Section; Space: 1.0 cm

Test Date: 07-11-2018; Ambient Temp: 23.8°C; Tissue Temp: 21.3°C

Probe: EX3DV4 - SN7409; ConvF(9.82, 9.82, 9.82); Calibrated: 6/25/2018;

Sensor-Surface: 1.4mm (Mechanical Surface Detection)

Electronics: DAE4 Sn1334; Calibrated: 6/18/2018

Phantom: SAM with CRP v5.0 (Right); Type: QD000P40CD; Serial: TP:1759

Measurement SW: DASY52, Version 52.10;SEMCAD X Version 14.6.10 (7417)

**Mode: LTE Band 12, Body SAR, Right Edge, Mid.ch,
10 MHz Bandwidth, QPSK, 1 RB, 0 RB Offset**

Area Scan (13x13x1): Measurement grid: dx=5mm, dy=15mm

Zoom Scan (5x5x7)/Cube 0: Measurement grid: dx=8mm, dy=8mm, dz=5mm

Reference Value = 24.33 V/m; Power Drift = -0.08 dB

Peak SAR (extrapolated) = 0.786 W/kg

SAR(1 g) = 0.534 W/kg

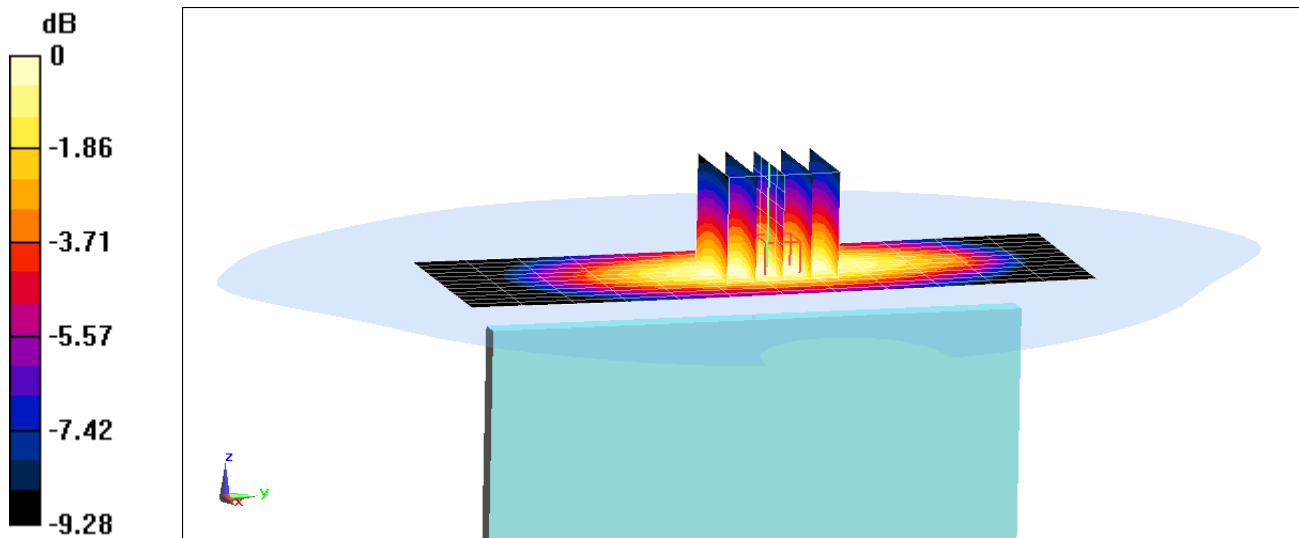

0 dB = 0.695 W/kg = -1.58 dBW/kg

PCTEST ENGINEERING LABORATORY, INC.

DUT: ZNFX410PM; Type: Portable Handset; Serial: 04421

Communication System: UID 0, LTE Band 13; Frequency: 782 MHz; Duty Cycle: 1:1

Medium: 750 Body Medium parameters used (interpolated):

$f = 782 \text{ MHz}$; $\sigma = 0.978 \text{ S/m}$; $\epsilon_r = 54.024$; $\rho = 1000 \text{ kg/m}^3$

Phantom section: Flat Section; Space: 1.0 cm

Test Date: 07-11-2018; Ambient Temp: 23.8°C; Tissue Temp: 21.3°C

Probe: EX3DV4 - SN7409; ConvF(9.82, 9.82, 9.82); Calibrated: 6/25/2018;

Sensor-Surface: 1.4mm (Mechanical Surface Detection)

Electronics: DAE4 Sn1334; Calibrated: 6/18/2018

Phantom: SAM with CRP v5.0 (Right); Type: QD000P40CD; Serial: TP:1759

Measurement SW: DASY52, Version 52.10; SEMCAD X Version 14.6.10 (7417)

**Mode: LTE Band 13, Body SAR, Back side, Mid.ch,
10 MHz Bandwidth, QPSK, 1 RB, 49 RB Offset**

Area Scan (9x13x1): Measurement grid: dx=15mm, dy=15mm

Zoom Scan (5x5x7)/Cube 0: Measurement grid: dx=8mm, dy=8mm, dz=5mm

Reference Value = 25.78 V/m; Power Drift = 0.03 dB

Peak SAR (extrapolated) = 0.850 W/kg

SAR(1 g) = 0.644 W/kg

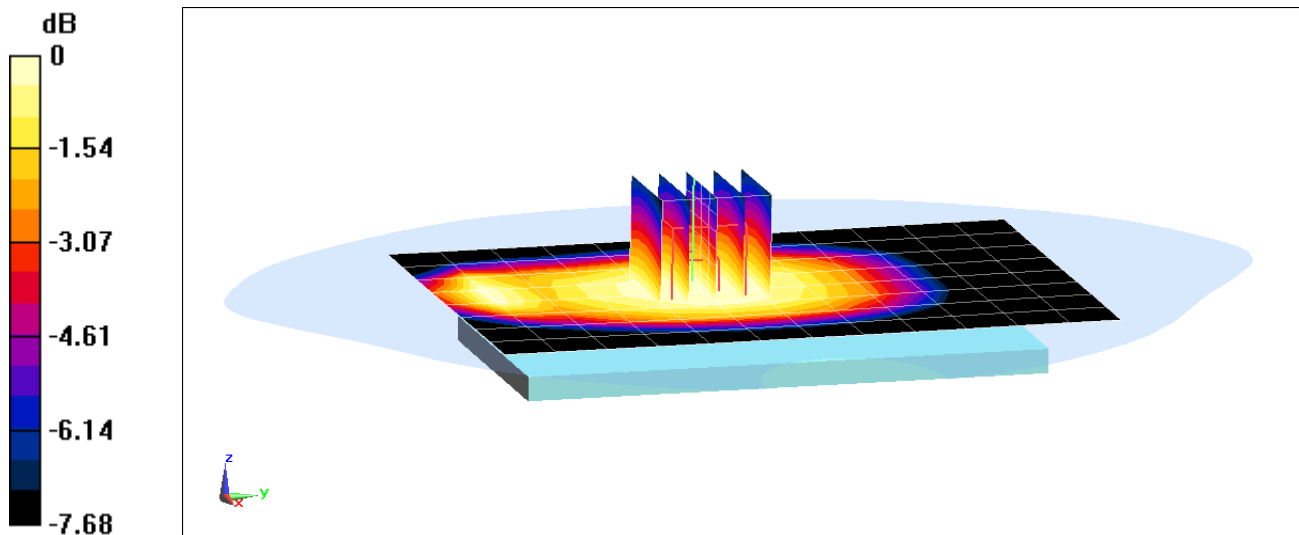

0 dB = 0.775 W/kg = -1.11 dBW/kg

PCTEST ENGINEERING LABORATORY, INC.

DUT: ZNFX410PM; Type: Portable Handset; Serial: 04421

Communication System: UID 0, LTE Band 13; Frequency: 782 MHz; Duty Cycle: 1:1

Medium: 750 Body Medium parameters used (interpolated):

$f = 782 \text{ MHz}$; $\sigma = 0.978 \text{ S/m}$; $\epsilon_r = 54.024$; $\rho = 1000 \text{ kg/m}^3$

Phantom section: Flat Section; Space: 1.0 cm

Test Date: 07-11-2018; Ambient Temp: 23.8°C; Tissue Temp: 21.3°C

Probe: EX3DV4 - SN7409; ConvF(9.82, 9.82, 9.82); Calibrated: 6/25/2018;

Sensor-Surface: 1.4mm (Mechanical Surface Detection)

Electronics: DAE4 Sn1334; Calibrated: 6/18/2018

Phantom: SAM with CRP v5.0 (Right); Type: QD000P40CD; Serial: TP:1759

Measurement SW: DASY52, Version 52.10;SEMCAD X Version 14.6.10 (7417)

**Mode: LTE Band 13, Body SAR, Right Edge, Mid.ch,
10 MHz Bandwidth, QPSK, 1 RB, 49 RB Offset**

Area Scan (13x13x1): Measurement grid: dx=5mm, dy=15mm

Zoom Scan (5x5x7)/Cube 0: Measurement grid: dx=8mm, dy=8mm, dz=5mm

Reference Value = 27.60 V/m; Power Drift = -0.02 dB

Peak SAR (extrapolated) = 1.07 W/kg

SAR(1 g) = 0.716 W/kg

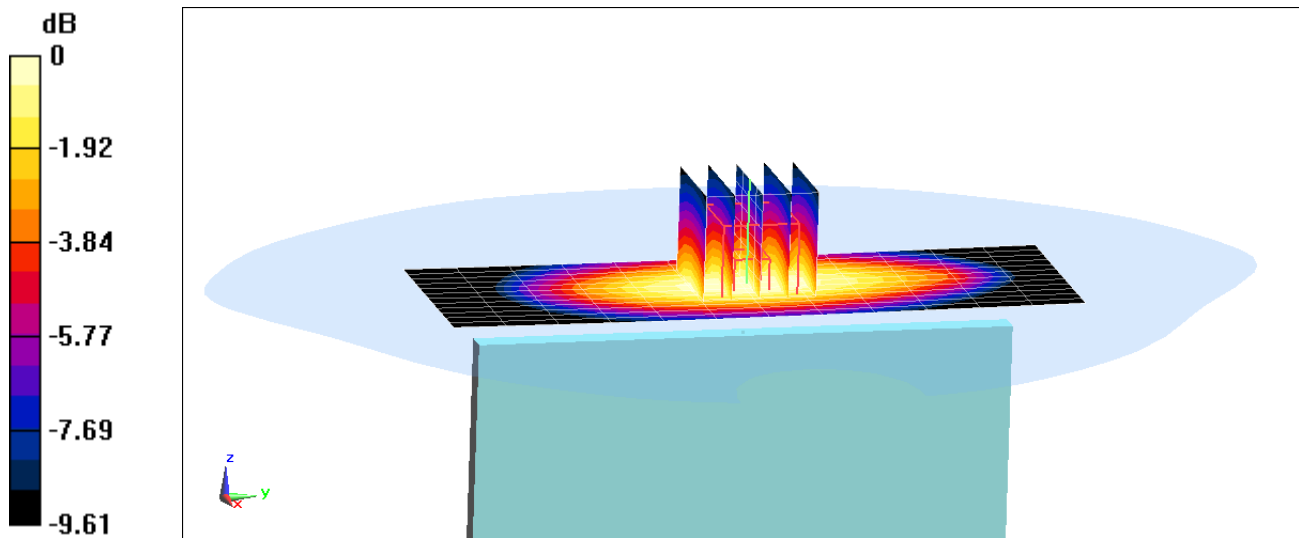

0 dB = 0.940 W/kg = -0.27 dBW/kg

PCTEST ENGINEERING LABORATORY, INC.

DUT: ZNFX410PM; Type: Portable Handset; Serial: 04462

Communication System: UID 0, LTE Band 26; Frequency: 831.5 MHz; Duty Cycle: 1:1

Medium: 835 Body Medium parameters used (interpolated):

$f = 831.5 \text{ MHz}$; $\sigma = 1.013 \text{ S/m}$; $\epsilon_r = 53.368$; $\rho = 1000 \text{ kg/m}^3$

Phantom section: Flat Section; Space: 1.0 cm

Test Date: 07-13-2018; Ambient Temp: 20.5°C; Tissue Temp: 20.6°C

Probe: ES3DV3 - SN3347; ConvF(6.37, 6.37, 6.37); Calibrated: 3/27/2018;

Sensor-Surface: 3mm (Mechanical Surface Detection)

Electronics: DAE4 Sn1450; Calibrated: 11/9/2017

Phantom: Twin-SAM V5.0 Right; Type: QD 000 P40 CD; Serial: 1800

Measurement SW: DASY52, Version 52.10; SEMCAD X Version 14.6.10 (7417)

**Mode: LTE Band 26 (Cell.), Body SAR, Back side, Mid.ch,
15 MHz Bandwidth, QPSK, 1 RB, 74 RB Offset**

Area Scan (9x15x1): Measurement grid: dx=15mm, dy=15mm

Zoom Scan (5x5x7)/Cube 0: Measurement grid: dx=8mm, dy=8mm, dz=5mm

Reference Value = 26.20 V/m; Power Drift = 0.00 dB

Peak SAR (extrapolated) = 0.814 W/kg

SAR(1 g) = 0.654 W/kg

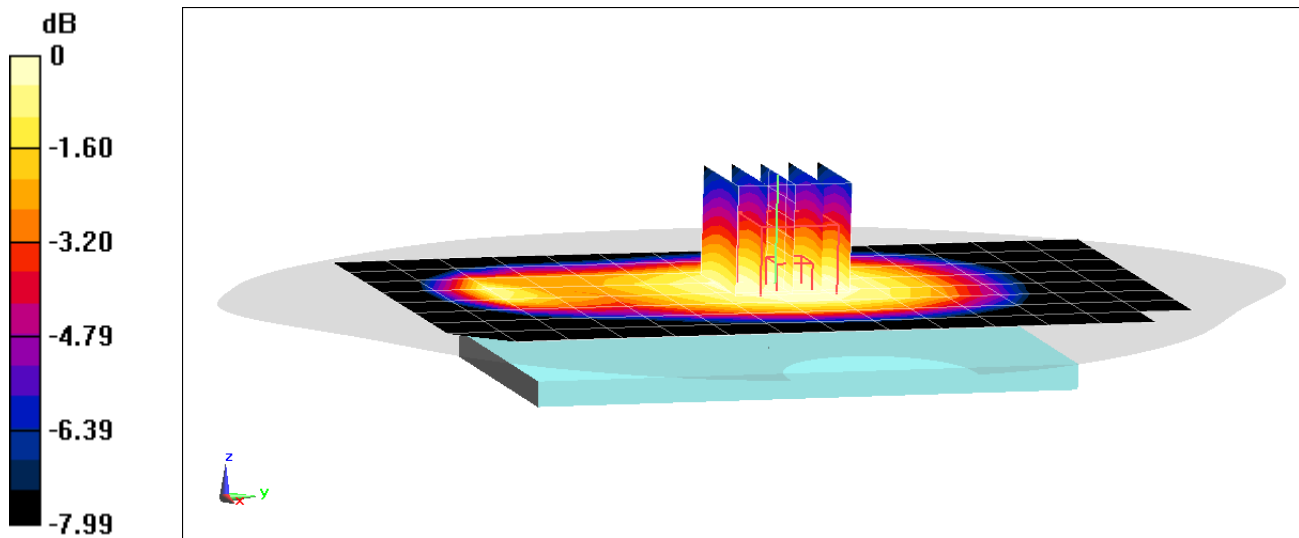

0 dB = 0.712 W/kg = -1.48 dBW/kg

PCTEST ENGINEERING LABORATORY, INC.

DUT: ZNFX410PM; Type: Portable Handset; Serial: 04462

Communication System: UID 0, LTE Band 26; Frequency: 831.5 MHz; Duty Cycle: 1:1

Medium: 835 Body Medium parameters used (interpolated):

$f = 831.5 \text{ MHz}$; $\sigma = 1.013 \text{ S/m}$; $\epsilon_r = 53.368$; $\rho = 1000 \text{ kg/m}^3$

Phantom section: Flat Section; Space: 1.0 cm

Test Date: 07-13-2018; Ambient Temp: 20.5°C; Tissue Temp: 20.6°C

Probe: ES3DV3 - SN3347; ConvF(6.37, 6.37, 6.37); Calibrated: 3/27/2018;

Sensor-Surface: 3mm (Mechanical Surface Detection)

Electronics: DAE4 Sn1450; Calibrated: 11/9/2017

Phantom: Twin-SAM V5.0 Right; Type: QD 000 P40 CD; Serial: 1800

Measurement SW: DASY52, Version 52.10; SEMCAD X Version 14.6.10 (7417)

**Mode: LTE Band 26 (Cell.), Body SAR, Right Edge, Mid.ch,
15 MHz Bandwidth, QPSK, 1 RB, 74 RB Offset**

Area Scan (11x13x1): Measurement grid: dx=5mm, dy=15mm

Zoom Scan (5x5x7)/Cube 0: Measurement grid: dx=8mm, dy=8mm, dz=5mm

Reference Value = 26.81 V/m; Power Drift = -0.06 dB

Peak SAR (extrapolated) = 0.933 W/kg

SAR(1 g) = 0.664 W/kg

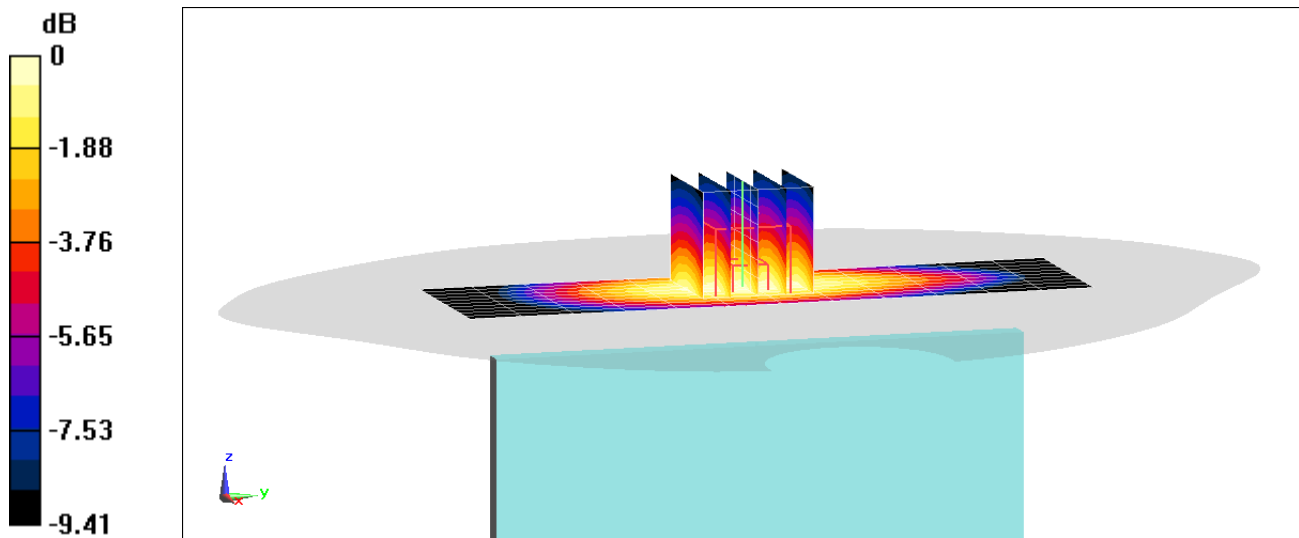

0 dB = 0.760 W/kg = -1.19 dBW/kg

PCTEST ENGINEERING LABORATORY, INC.

DUT: ZNFX410PM; Type: Portable Handset; Serial: 04462

Communication System: UID 0, LTE Band 4 (AWS); Frequency: 1732.5 MHz; Duty Cycle: 1:1
Medium: 1750 Body Medium parameters used (interpolated):
 $f = 1732.5$ MHz; $\sigma = 1.483$ S/m; $\epsilon_r = 52.054$; $\rho = 1000$ kg/m³
Phantom section: Flat Section; Space: 1.0 cm

Test Date: 07-10-2018; Ambient Temp: 22.0°C; Tissue Temp: 21.8°C

Probe: ES3DV3 - SN3347; ConvF(5.17, 5.17, 5.17); Calibrated: 3/27/2018;
Sensor-Surface: 3mm (Mechanical Surface Detection)
Electronics: DAE4 Sn1450; Calibrated: 11/9/2017
Phantom: Twin-SAM V5.0 Right; Type: QD 000 P40 CD; Serial: 1800
Measurement SW: DASY52, Version 52.10; SEMCAD X Version 14.6.10 (7417)

**Mode: LTE Band 4 (AWS), Body SAR, Back side, Mid.ch,
20 MHz Bandwidth, QPSK, 1 RB, 0 RB Offset**

Area Scan (9x14x1): Measurement grid: dx=15mm, dy=15mm
Zoom Scan (6x6x7)/Cube 0: Measurement grid: dx=8mm, dy=8mm, dz=5mm
Reference Value = 29.26 V/m; Power Drift = 0.02 dB
Peak SAR (extrapolated) = 1.84 W/kg
SAR(1 g) = 1.13 W/kg

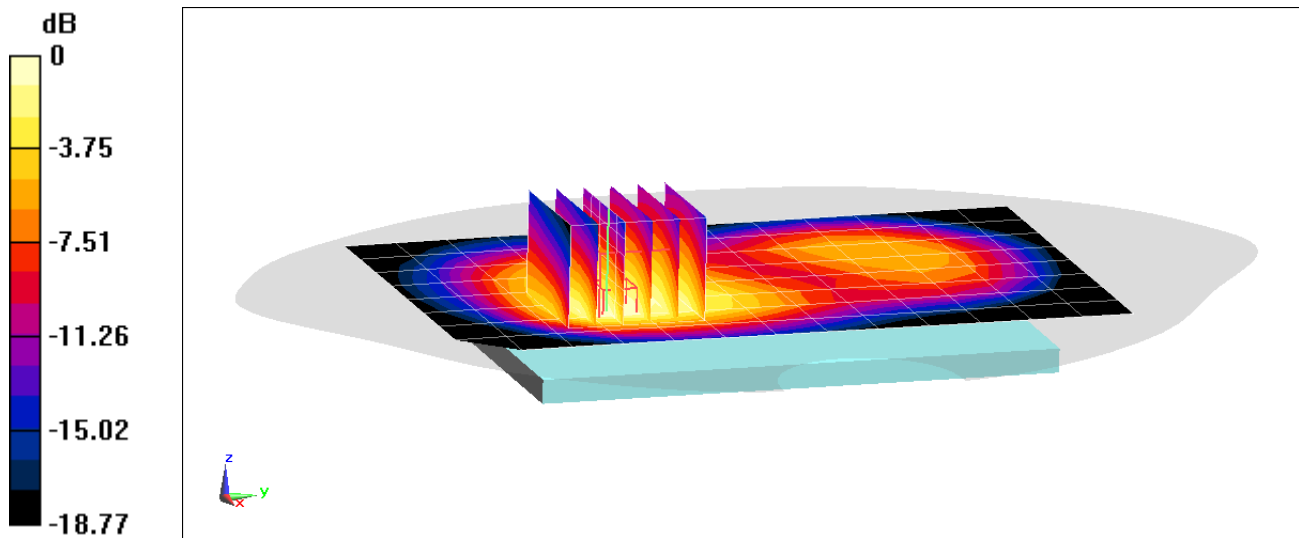

PCTEST ENGINEERING LABORATORY, INC.

DUT: ZNFX410PM; Type: Portable Handset; Serial: 04397

Communication System: UID 0, LTE Band 25 (PCS); Frequency: 1860 MHz; Duty Cycle: 1:1
Medium: 1900 Body Medium parameters used (interpolated):
 $f = 1860 \text{ MHz}$; $\sigma = 1.518 \text{ S/m}$; $\epsilon_r = 52.516$; $\rho = 1000 \text{ kg/m}^3$
Phantom section: Flat Section; Space: 1.0 cm

Test Date: 07-08-2018; Ambient Temp: 20.3°C; Tissue Temp: 21.1°C

Probe: EX3DV4 - SN7406; ConvF(7.74, 7.74, 7.74); Calibrated: 5/22/2018;
Sensor-Surface: 1.4mm (Mechanical Surface Detection)
Electronics: DAE4 Sn859; Calibrated: 5/22/2018
Phantom: Twin-SAM V5.0; Type: QD 000 P40 CD; Serial: 1692
Measurement SW: DASY52, Version 52.10; SEMCAD X Version 14.6.10 (7417)

**Mode: LTE Band 25 (PCS), Body SAR, Back side, Low.ch,
20 MHz Bandwidth, QPSK, 1 RB, 0 RB Offset**

Area Scan (9x15x1): Measurement grid: dx=15mm, dy=15mm
Zoom Scan (6x6x7)/Cube 0: Measurement grid: dx=8mm, dy=8mm, dz=5mm
Reference Value = 26.44 V/m; Power Drift = 0.02 dB
Peak SAR (extrapolated) = 1.86 W/kg
SAR(1 g) = 1.04 W/kg

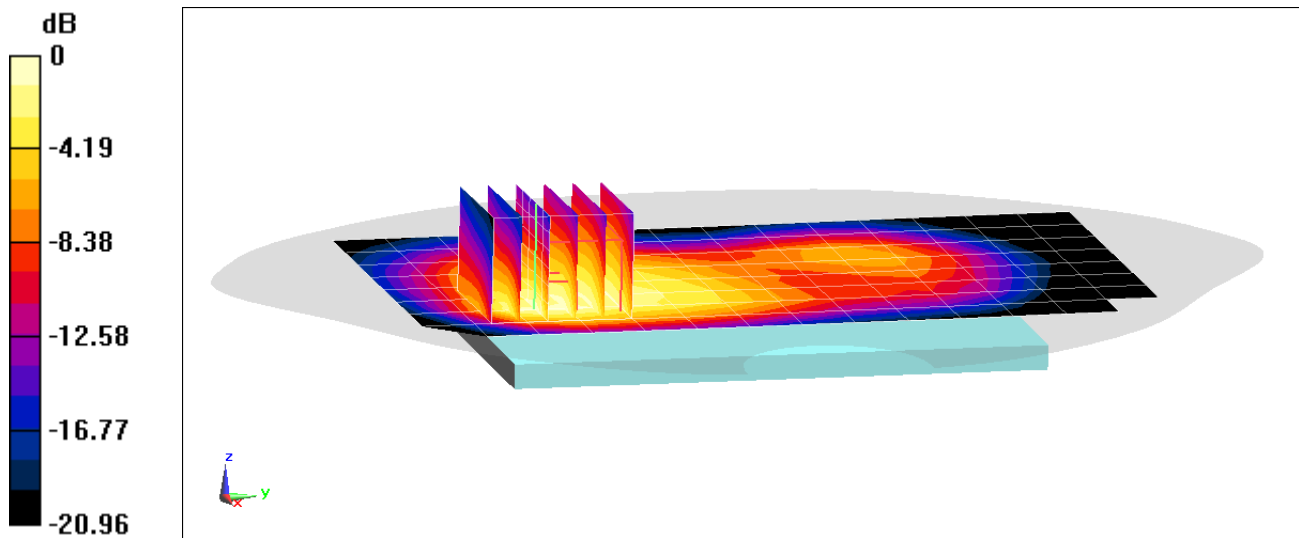

0 dB = 1.50 W/kg = 1.76 dBW/kg

PCTEST ENGINEERING LABORATORY, INC.

DUT: ZNFX410PM; Type: Portable Handset; Serial: 04421

Communication System: UID 0, _LTE Band 41 (Class 2); Frequency: 2549.5 MHz; Duty Cycle: 1:2.31

Medium: 2450 Body Medium parameters used:

$f = 2550$ MHz; $\sigma = 2.104$ S/m; $\epsilon_r = 51.066$; $\rho = 1000$ kg/m³

Phantom section: Flat Section; Space: 1.0 cm

Test Date: 07-09-2018; Ambient Temp: 22.2°C; Tissue Temp: 22.0°C

Probe: ES3DV3 - SN3319; ConvF(4.33, 4.33, 4.33); Calibrated: 3/13/2018;

Sensor-Surface: 3mm (Mechanical Surface Detection)

Electronics: DAE4 Sn1368; Calibrated: 3/7/2018

Phantom: LeftTwin-SAM V5.0; Type: QD 000 P40 CD; Serial: 1375

Measurement SW: DASY52, Version 52.10;SEMCAD X Version 14.6.10 (7417)

**Mode: LTE Band 41 PC2, Body SAR, Back side, Low-Mid.ch,
20 MHz Bandwidth, QPSK, 1 RB, 0 RB Offset**

Area Scan (10x16x1): Measurement grid: dx=12mm, dy=12mm

Zoom Scan (8x9x7)/Cube 0: Measurement grid: dx=5mm, dy=5mm, dz=5mm

Reference Value = 20.58 V/m; Power Drift = -0.19 dB

Peak SAR (extrapolated) = 2.28 W/kg

SAR(1 g) = 1.08 W/kg

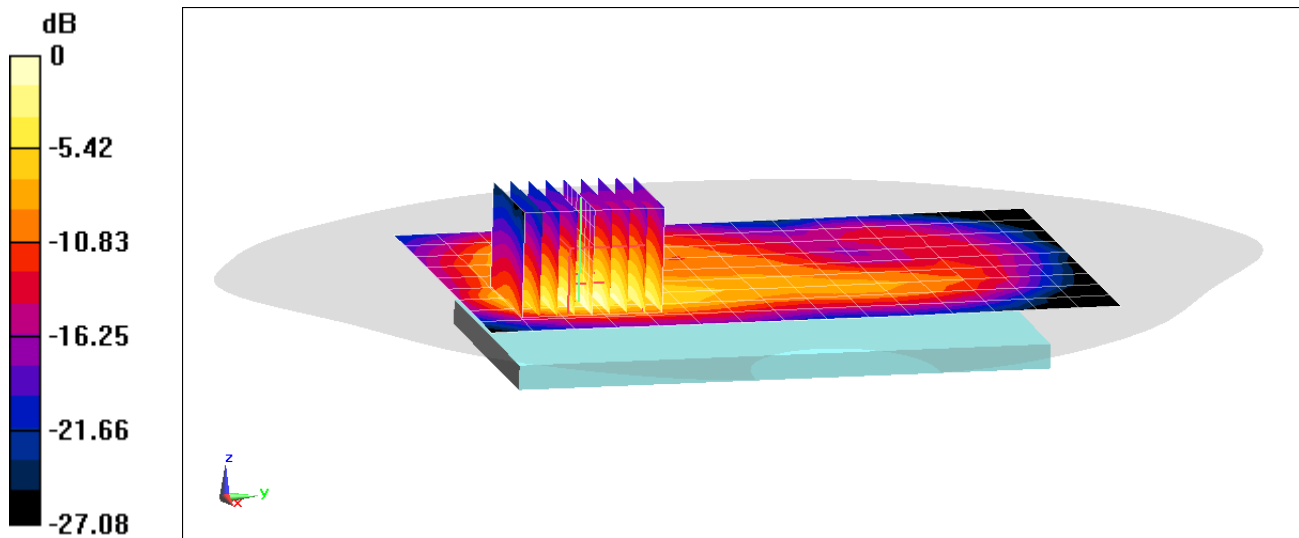

0 dB = 1.37 W/kg = 1.37 dBW/kg

PCTEST ENGINEERING LABORATORY, INC.

DUT: ZNFX410PM; Type: Portable Handset; Serial: 04363

Communication System: UID 0, _IEEE 802.11b; Frequency: 2412 MHz; Duty Cycle: 1:1
Medium: 2450 Body Medium parameters used (interpolated):
 $f = 2412 \text{ MHz}$; $\sigma = 1.946 \text{ S/m}$; $\epsilon_r = 51.462$; $\rho = 1000 \text{ kg/m}^3$
Phantom section: Flat Section; Space: 1.0 cm

Test Date: 07-09-2018; Ambient Temp: 22.2°C; Tissue Temp: 22.0°C

Probe: ES3DV3 - SN3319; ConvF(4.51, 4.51, 4.51); Calibrated: 3/13/2018;
Sensor-Surface: 3mm (Mechanical Surface Detection)
Electronics: DAE4 Sn1368; Calibrated: 3/7/2018
Phantom: LeftTwin-SAM V5.0; Type: QD 000 P40 CD; Serial: 1375
Measurement SW: DASY52, Version 52.10; SEMCAD X Version 14.6.10 (7417)

Mode: IEEE 802.11b, 22 MHz Bandwidth, Body SAR, Ch 1, 1 Mbps, Back Side

Area Scan (11x17x1): Measurement grid: dx=12mm, dy=12mm

Zoom Scan (7x7x7)/Cube 0: Measurement grid: dx=5mm, dy=5mm, dz=5mm

Reference Value = 11.76 V/m; Power Drift = 0.04 dB

Peak SAR (extrapolated) = 0.453 W/kg

SAR(1 g) = 0.237 W/kg

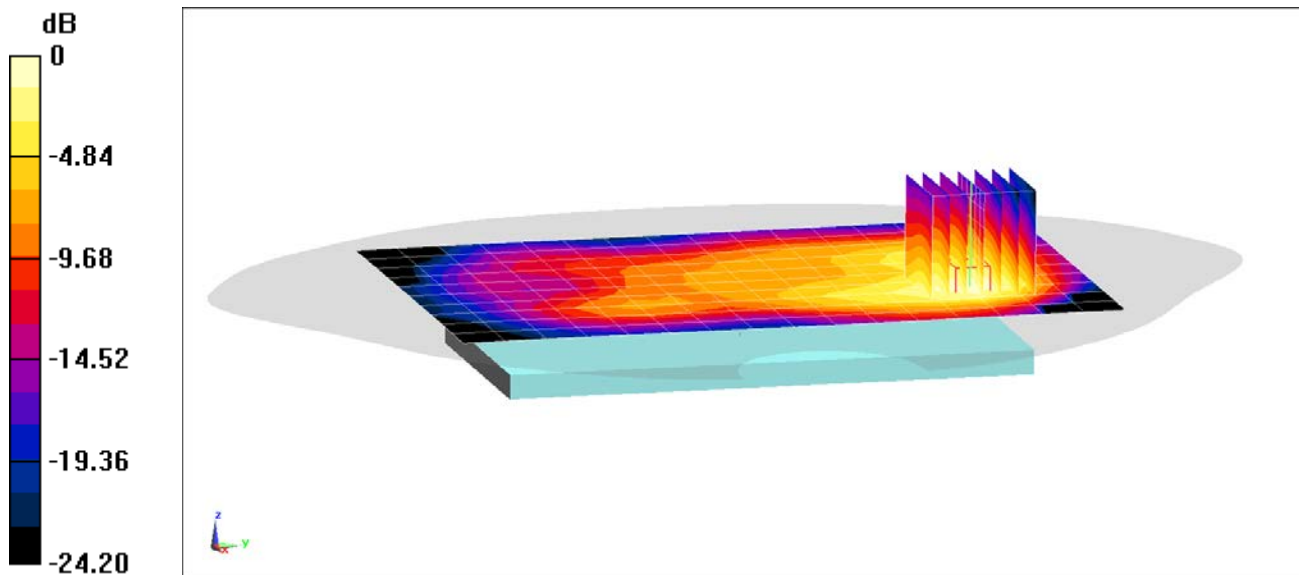

0 dB = 0.294 W/kg = -5.32 dBW/kg

PCTEST ENGINEERING LABORATORY, INC.

DUT: ZNFX410PM; Type: Portable Handset; Serial: 04348

Communication System: UID 0, 802.11a 5.2-5.8 GHz Band; Frequency: 5280 MHz; Duty Cycle: 1:1

Medium: 5 GHz Body Medium parameters used:

$f = 5280 \text{ MHz}$; $\sigma = 5.504 \text{ S/m}$; $\epsilon_r = 48.182$; $\rho = 1000 \text{ kg/m}^3$

Phantom section: Flat Section; Space: 1.0 cm

Test Date: 07-09-2018; Ambient Temp: 21.5°C; Tissue Temp: 20.8°C

Probe: EX3DV4 - SN7357; ConvF(4.78, 4.78, 4.78); Calibrated: 4/18/2018;

Sensor-Surface: 1.4mm (Mechanical Surface Detection)

Electronics: DAE4 Sn1407; Calibrated: 4/11/2018

Phantom: SAM with CRP v5.0 Left; Type: QD000P40CD; Serial: 1687

Measurement SW: DASY52, Version 52.10;SEMCAD X Version 14.6.10 (7417)

**Mode: IEEE 802.11a, UNII-2A, 20 MHz Bandwidth,
Body SAR, Ch 56, 6 Mbps, Back Side**

Area Scan (13x22x1): Measurement grid: dx=10mm, dy=10mm

Zoom Scan (7x7x7)/Cube 0: Measurement grid: dx=4mm, dy=4mm, dz=1.4mm; Graded Ratio: 1.4

Reference Value = 8.319 V/m; Power Drift = 0.21 dB

Peak SAR (extrapolated) = 1.33 W/kg

SAR(1 g) = 0.345 W/kg

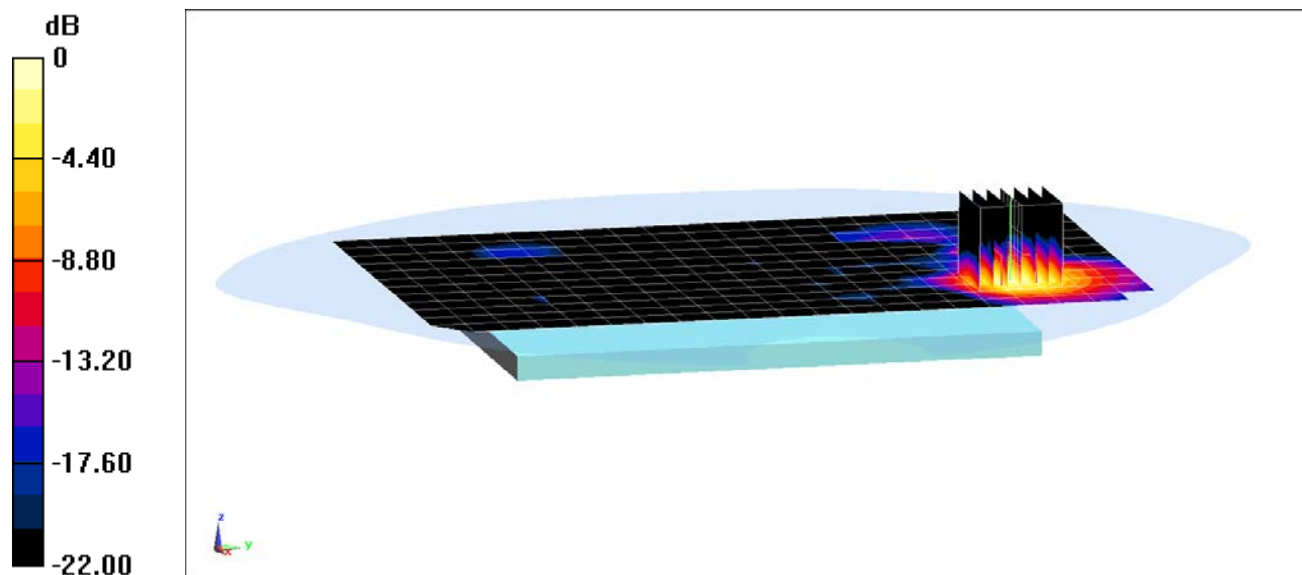

0 dB = 0.804 W/kg = -0.95 dBW/kg

PCTEST ENGINEERING LABORATORY, INC.

DUT: ZNFX410PM; Type: Portable Handset; Serial: 04348

Communication System: UID 0, 802.11a 5.2-5.8 GHz Band; Frequency: 5240 MHz; Duty Cycle: 1:1

Medium: 5 GHz Body Medium parameters used:

$f = 5240 \text{ MHz}$; $\sigma = 5.453 \text{ S/m}$; $\epsilon_r = 48.252$; $\rho = 1000 \text{ kg/m}^3$

Phantom section: Flat Section; Space: 1.0 cm

Test Date: 07-09-2018; Ambient Temp: 21.5°C; Tissue Temp: 20.8°C

Probe: EX3DV4 - SN7357; ConvF(4.78, 4.78, 4.78); Calibrated: 4/18/2018;

Sensor-Surface: 1.4mm (Mechanical Surface Detection)

Electronics: DAE4 Sn1407; Calibrated: 4/11/2018

Phantom: SAM with CRP v5.0 Left; Type: QD000P40CD; Serial: 1687

Measurement SW: DASY52, Version 52.10;SEMCAD X Version 14.6.10 (7417)

**Mode: IEEE 802.11a, U-NII-1, 20 MHz Bandwidth,
Body SAR, Ch 48, 6 Mbps, Top Edge**

Area Scan (9x13x1): Measurement grid: dx=5mm, dy=10mm

Zoom Scan (7x7x7)/Cube 0: Measurement grid: dx=4mm, dy=4mm, dz=1.4mm; Graded Ratio: 1.4

Reference Value = 3.400 V/m; Power Drift = -0.12 dB

Peak SAR (extrapolated) = 2.89 W/kg

SAR(1 g) = 0.826 W/kg

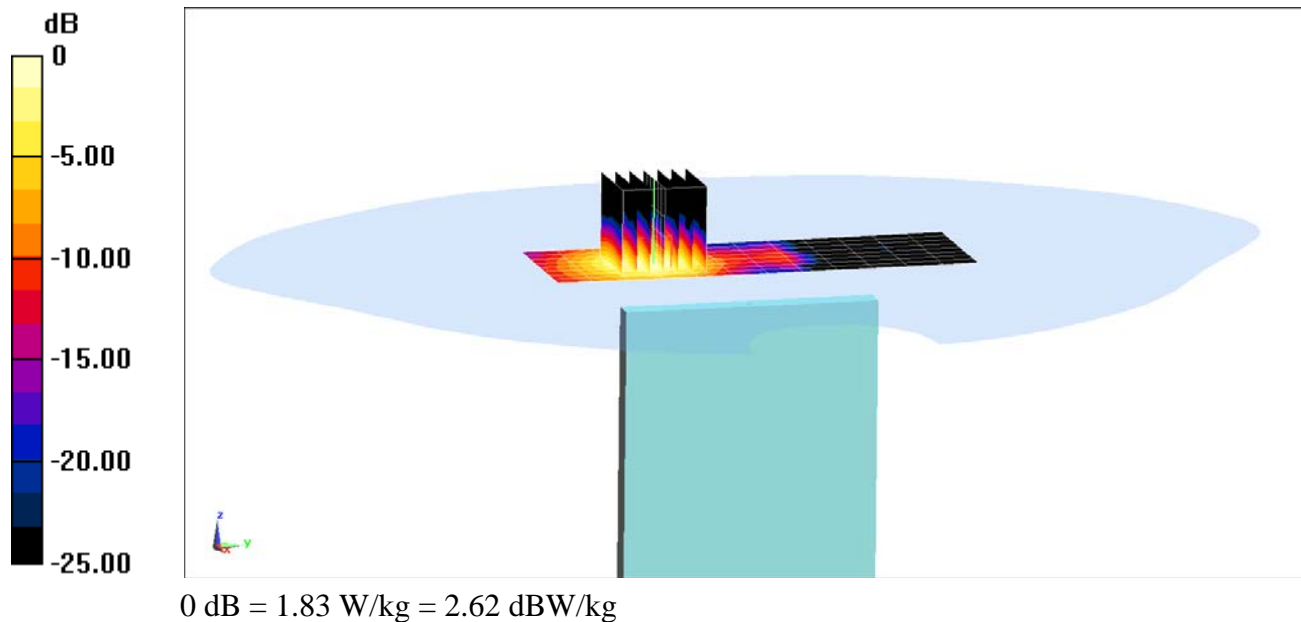

APPENDIX B: SYSTEM VERIFICATION

PCTEST ENGINEERING LABORATORY, INC.

DUT: Dipole 750 MHz; Type: D750V3; Serial: 1054

Communication System: UID 0, CW; Frequency: 750 MHz; Duty Cycle: 1:1

Medium: 750 Head Medium parameters used (interpolated):

$f = 750 \text{ MHz}$; $\sigma = 0.895 \text{ S/m}$; $\epsilon_r = 41.951$; $\rho = 1000 \text{ kg/m}^3$

Phantom section: Flat Section; Space: 1.5 cm

Test Date: 07-12-2018; Ambient Temp: 23.6°C; Tissue Temp: 21.6°C

Probe: ES3DV3 - SN3332; ConvF(6.81, 6.81, 6.81); Calibrated: 8/14/2017;

Sensor-Surface: 3mm (Mechanical Surface Detection)

Electronics: DAE4 Sn1323; Calibrated: 8/9/2017

Phantom: SAM Left; Type: QD000P40CA; Serial: TP:82355

Measurement SW: DASY52, Version 52.10;SEMCAD X Version 14.6.10 (7417)

750 MHz System Verification at 23.0 dBm (200 mW)

Area Scan (7x15x1): Measurement grid: dx=15mm, dy=15mm

Zoom Scan (5x5x7)/Cube 0: Measurement grid: dx=8mm, dy=8mm, dz=5mm

Peak SAR (extrapolated) = 2.28 W/kg

SAR(1 g) = 1.56 W/kg

Deviation(1 g) = -6.81%

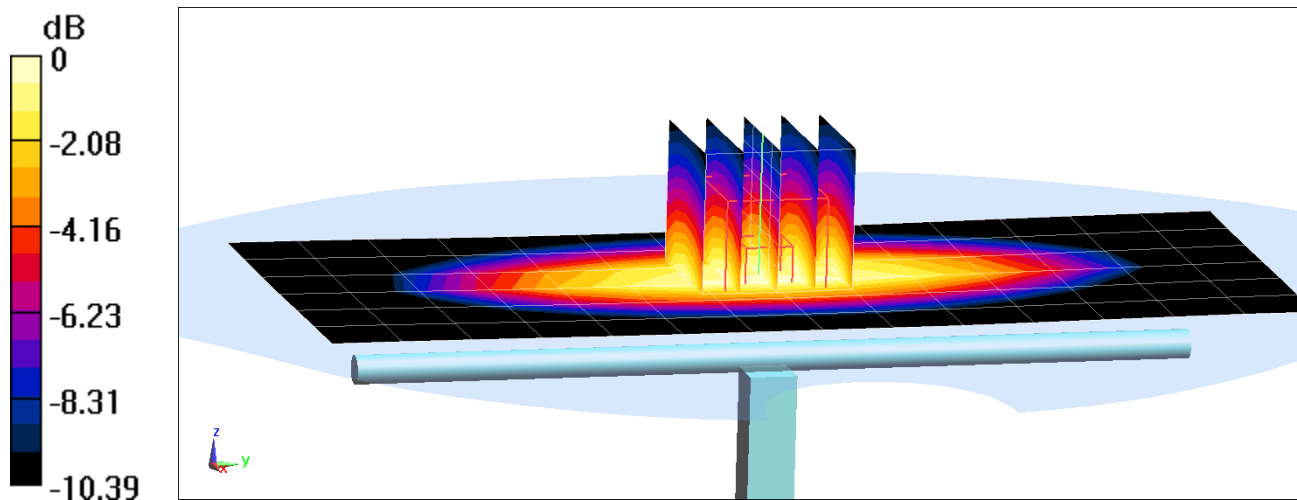

0 dB = 1.82 W/kg = 2.60 dBW/kg

PCTEST ENGINEERING LABORATORY, INC.

DUT: Dipole 835 MHz; Type: D835V2; Serial: 4d047

Communication System: UID 0, CW; Frequency: 835 MHz; Duty Cycle: 1:1
Medium: 835 Head Medium parameters used:
 $f = 835 \text{ MHz}$; $\sigma = 0.917 \text{ S/m}$; $\epsilon_r = 42.813$; $\rho = 1000 \text{ kg/m}^3$
Phantom section: Flat Section; Space: 1.5 cm

Test Date: 07-09-2018; Ambient Temp: 20.9°C; Tissue Temp: 19.9°C

Probe: ES3DV3 - SN3213; ConvF(6.42, 6.42, 6.42); Calibrated: 2/13/2018;
Sensor-Surface: 3mm (Mechanical Surface Detection)
Electronics: DAE4 Sn1272; Calibrated: 2/9/2018
Phantom: SAM V5.0 Right; Type: QD000P40CD; Serial: 1647
Measurement SW: DASY52, Version 52.10; SEMCAD X Version 14.6.10 (7417)

835 MHz System Verification at 23.0 dBm (200 mW)

Area Scan (7x14x1): Measurement grid: dx=15mm, dy=15mm
Zoom Scan (5x5x7)/Cube 0: Measurement grid: dx=8mm, dy=8mm, dz=5mm
Peak SAR (extrapolated) = 2.78 W/kg
SAR(1 g) = 1.89 W/kg
Deviation(1 g) = 3.50%

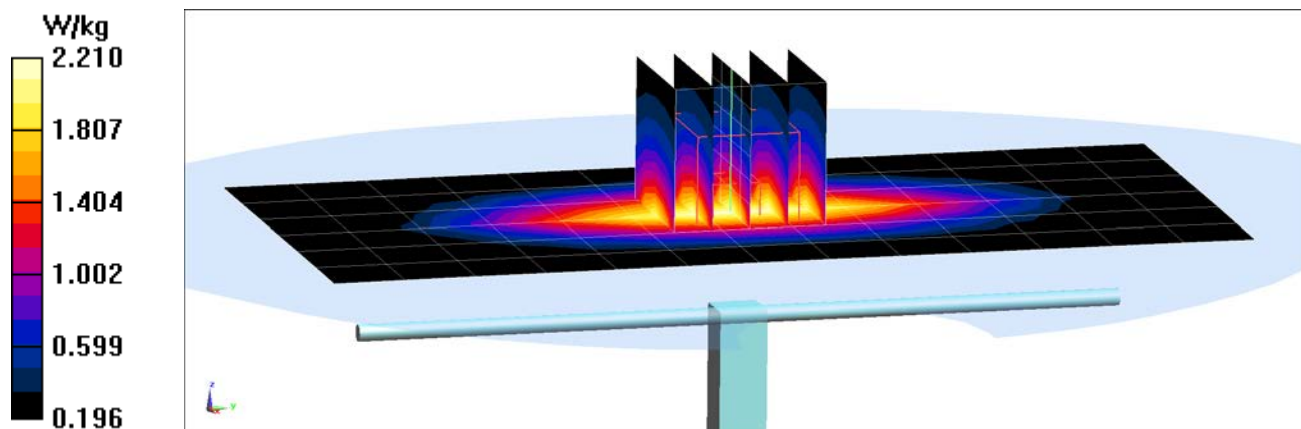

PCTEST ENGINEERING LABORATORY, INC.

DUT: Dipole 1750 MHz; Type: D1750V2; Serial: 1150

Communication System: UID 0, CW; Frequency: 1750 MHz; Duty Cycle: 1:1

Medium: 1750 Head Medium parameters used:

$f = 1750 \text{ MHz}$; $\sigma = 1.353 \text{ S/m}$; $\epsilon_r = 39.84$; $\rho = 1000 \text{ kg/m}^3$

Phantom section: Flat Section; Space: 1.0 cm

Test Date: 07-10-2018; Ambient Temp: 23.3°C; Tissue Temp: 21.1°C

Probe: ES3DV3 - SN3213; ConvF(5.45, 5.45, 5.45); Calibrated: 2/13/2018;

Sensor-Surface: 3mm (Mechanical Surface Detection)

Electronics: DAE4 Sn1272; Calibrated: 2/9/2018

Phantom: SAM V5.0 Right; Type: QD000P40CD; Serial: 1647

Measurement SW: DASY52, Version 52.10; SEMCAD X Version 14.6.10 (7417)

1750 MHz System Verification at 20.0 dBm (100 mW)

Area Scan (7x9x1): Measurement grid: dx=15mm, dy=15mm

Zoom Scan (5x6x7)/Cube 0: Measurement grid: dx=8mm, dy=8mm, dz=5mm

Peak SAR (extrapolated) = 6.35 W/kg

SAR(1 g) = 3.57 W/kg

Deviation(1 g) = -1.11%

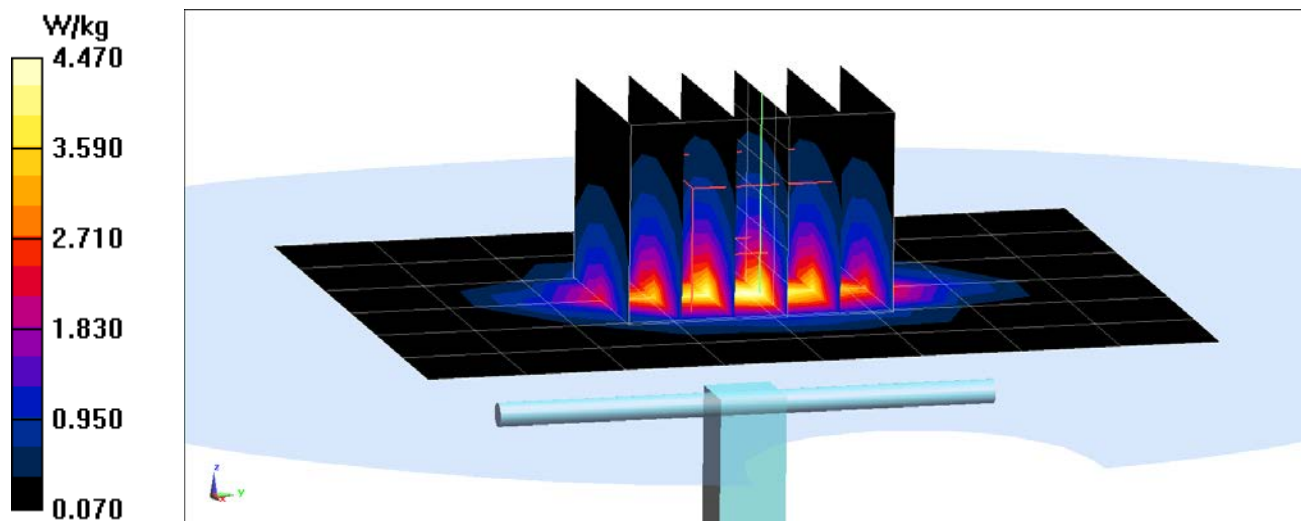

PCTEST ENGINEERING LABORATORY, INC.

DUT: Dipole 1900 MHz; Type: D1900V2; Serial: 5d148

Communication System: UID 0, CW; Frequency: 1900 MHz; Duty Cycle: 1:1

Medium: 1900 Head Medium parameters used (interpolated):

$f = 1900 \text{ MHz}$; $\sigma = 1.461 \text{ S/m}$; $\epsilon_r = 40.017$; $\rho = 1000 \text{ kg/m}^3$

Phantom section: Flat Section; Space: 1.0 cm

Test Date: 07-12-2018; Ambient Temp: 24.0°C; Tissue Temp: 22.8°C

Probe: ES3DV3 - SN3213; ConvF(5.3, 5.3, 5.3); Calibrated: 2/13/2018;

Sensor-Surface: 3mm (Mechanical Surface Detection)

Electronics: DAE4 Sn1272; Calibrated: 2/9/2018

Phantom: SAM V5.0 Right; Type: QD000P40CD; Serial: 1647

Measurement SW: DASY52, Version 52.10; SEMCAD X Version 14.6.10 (7417)

1900 MHz System Verification at 20.0 dBm (100 mW)

Area Scan (7x10x1): Measurement grid: dx=15mm, dy=15mm

Zoom Scan (5x5x7)/Cube 0: Measurement grid: dx=8mm, dy=8mm, dz=5mm

Peak SAR (extrapolated) = 7.64 W/kg

SAR(1 g) = 4.13 W/kg

Deviation(1 g) = 2.99%

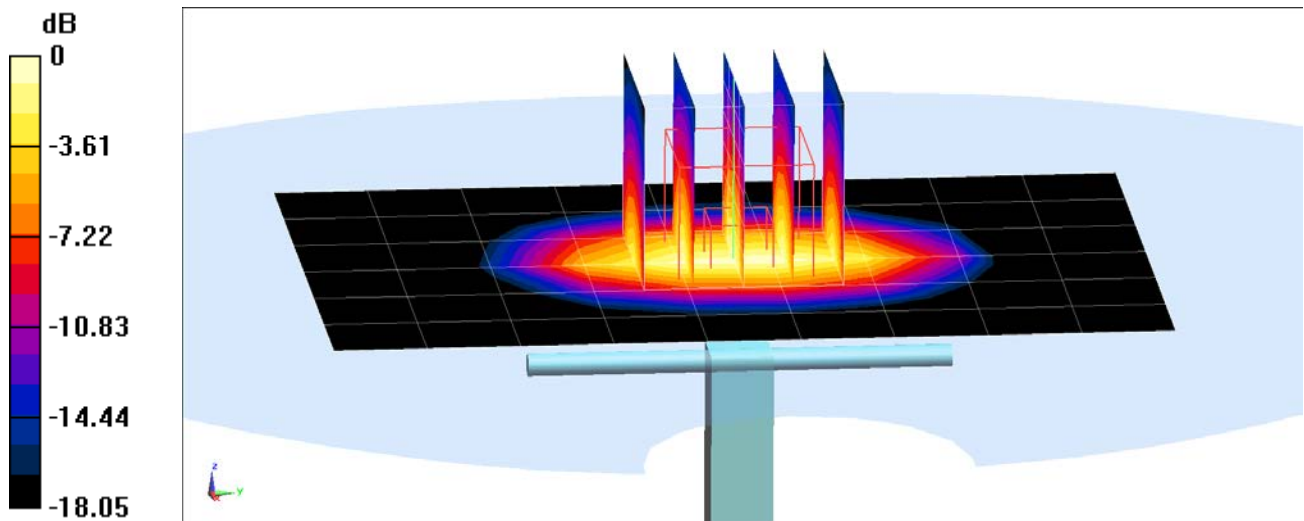

0 dB = 5.25 W/kg = 7.20 dBW/kg

PCTEST ENGINEERING LABORATORY, INC.

DUT: Dipole 2450 MHz; Type: D2450V2; Serial: 882

Communication System: UID 0, CW; Frequency: 2450 MHz; Duty Cycle: 1:1

Medium: 2450 Head Medium parameters used:

$f = 2450 \text{ MHz}$; $\sigma = 1.842 \text{ S/m}$; $\epsilon_r = 37.957$; $\rho = 1000 \text{ kg/m}^3$

Phantom section: Flat Section; Space: 1.0 cm

Test Date: 07-11-2018; Ambient Temp: 21.9°C; Tissue Temp: 21.4°C

Probe: ES3DV3 - SN3332; ConvF(4.68, 4.68, 4.68); Calibrated: 8/14/2017;

Sensor-Surface: 3mm (Mechanical Surface Detection)

Electronics: DAE4 Sn1323; Calibrated: 8/9/2017

Phantom: SAM Front; Type: SAM; Serial: 1686

Measurement SW: DASY52, Version 52.10; SEMCAD X Version 14.6.10 (7417)

2450 MHz System Verification at 20.0 dBm (100 mW)

Area Scan (8x9x1): Measurement grid: dx=12mm, dy=12mm

Zoom Scan (7x7x7)/Cube 0: Measurement grid: dx=5mm, dy=5mm, dz=5mm

Peak SAR (extrapolated) = 10.9 W/kg

SAR(1 g) = 5.27 W/kg

Deviation(1 g) = 0.96%

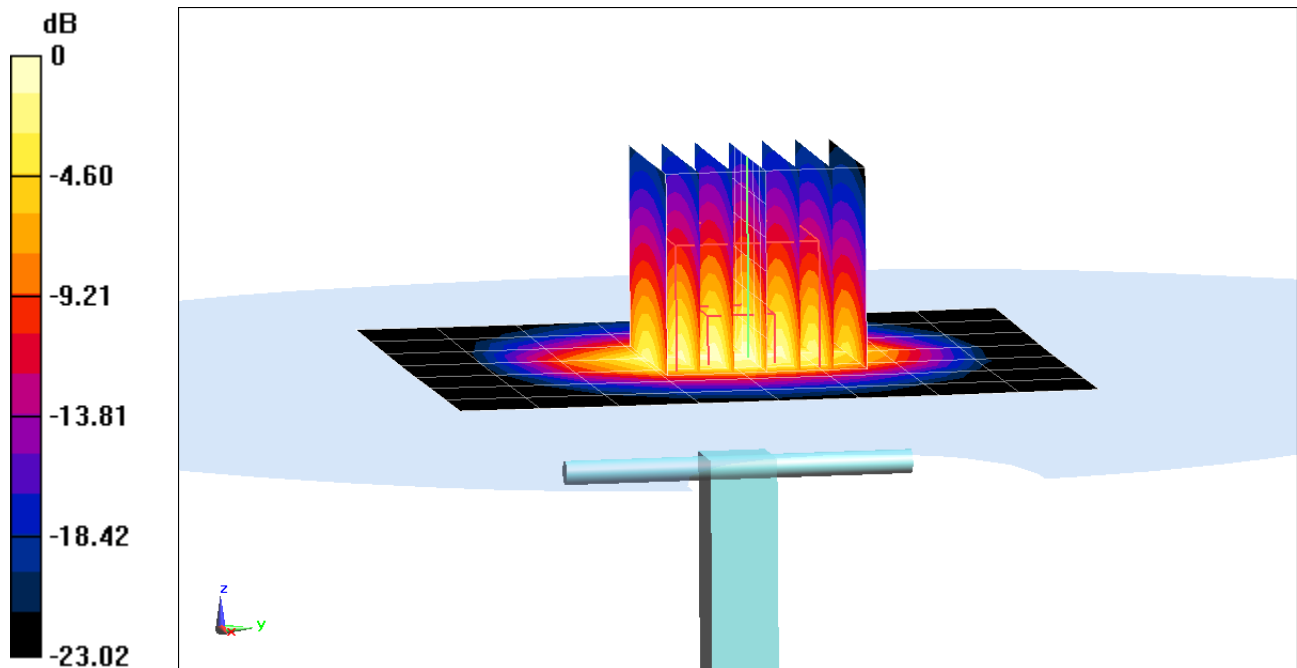

0 dB = 6.89 W/kg = 8.38 dBW/kg

PCTEST ENGINEERING LABORATORY, INC.

DUT: Dipole 2600 MHz; Type: D2600V2; Serial: 1004

Communication System: UID 0, CW; Frequency: 2600 MHz; Duty Cycle: 1:1

Medium: 2450 Head Medium parameters used:

$f = 2600$ MHz; $\sigma = 2.006$ S/m; $\epsilon_r = 37.343$; $\rho = 1000$ kg/m³

Phantom section: Flat Section; Space: 1.0 cm

Test Date: 07-11-2018; Ambient Temp: 21.9°C; Tissue Temp: 21.4°C

Probe: ES3DV3 - SN3332; ConvF(4.56, 4.56, 4.56); Calibrated: 8/14/2017;

Sensor-Surface: 3mm (Mechanical Surface Detection)

Electronics: DAE4 Sn1323; Calibrated: 8/9/2017

Phantom: SAM Front; Type: SAM; Serial: 1686

Measurement SW: DASY52, Version 52.10; SEMCAD X Version 14.6.10 (7417)

2600 MHz System Verification at 20.0 dBm (100 mW)

Area Scan (8x9x1): Measurement grid: dx=12mm, dy=12mm

Zoom Scan (7x7x7)/Cube 0: Measurement grid: dx=5mm, dy=5mm, dz=5mm

Peak SAR (extrapolated) = 13.1 W/kg

SAR(1 g) = 5.85 W/kg

Deviation(1 g) = 4.65%

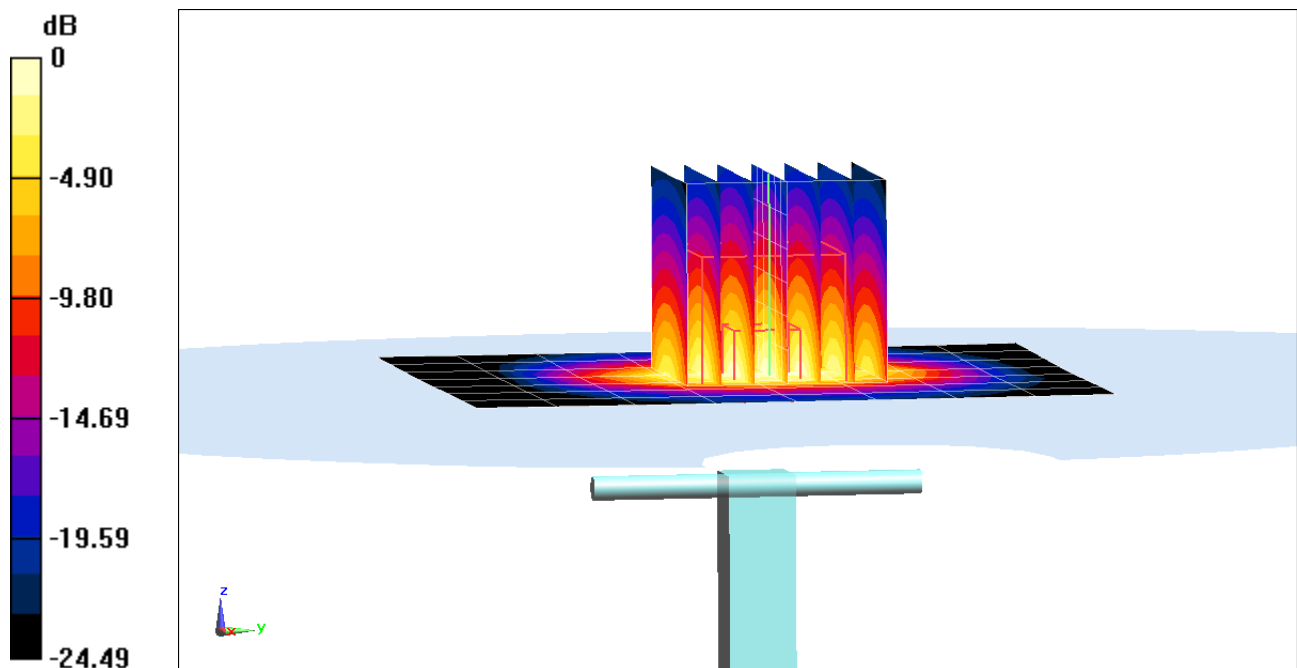

0 dB = 7.64 W/kg = 8.83 dBW/kg

PCTEST ENGINEERING LABORATORY, INC.

DUT: Dipole 5 GHz; Type: D5GHzV2; Serial: 1191

Communication System: UID 0, CW; Frequency: 5250 MHz; Duty Cycle: 1:1
Medium: 5GHz Head Medium parameters used (interpolated):
 $f = 5250 \text{ MHz}$; $\sigma = 4.617 \text{ S/m}$; $\epsilon_r = 35.711$; $\rho = 1000 \text{ kg/m}^3$
Phantom section: Flat Section; Space: 1.0 cm

Test Date: 07-09-2018; Ambient Temp: 20.3°C; Tissue Temp: 20.3°C

Probe: EX3DV4 - SN7409; ConvF(5.2, 5.2, 5.2); Calibrated: 6/25/2018;
Sensor-Surface: 1.4mm (Mechanical Surface Detection)
Electronics: DAE4 Sn1334; Calibrated: 6/18/2018
Phantom: SAM with CRP (Left); Type: SAM; Serial: 1715
Measurement SW: DASY52, Version 52.10; SEMCAD X Version 14.6.10 (7417)

5250 MHz System Verification at 17.0 dBm (50 mW)

Area Scan (7x7x1): Measurement grid: dx=10mm, dy=10mm

Zoom Scan (8x8x7)/Cube 0: Measurement grid: dx=4mm, dy=4mm, dz=1.4mm; Graded Ratio: 1.4

Peak SAR (extrapolated) = 16.2 W/kg

SAR(1 g) = 3.82 W/kg

Deviation(1 g) = -3.17%

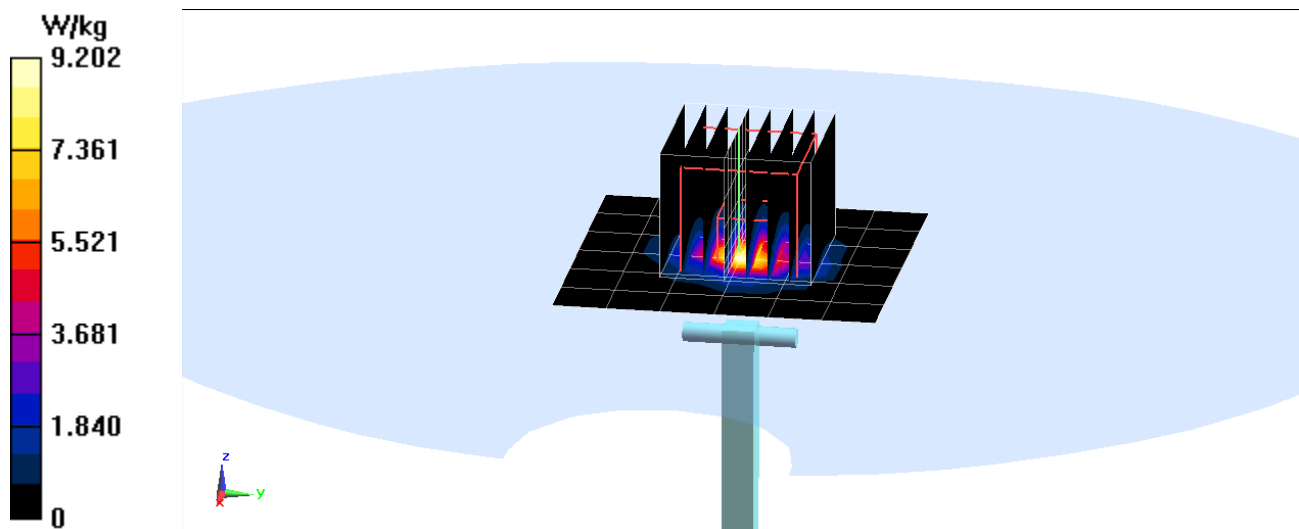

PCTEST ENGINEERING LABORATORY, INC.

DUT: Dipole 5 GHz; Type: D5GHzV2; Serial: 1191

Communication System: UID 0, CW; Frequency: 5600 MHz; Duty Cycle: 1:1
Medium: 5GHz Head Medium parameters used:
 $f = 5600 \text{ MHz}$; $\sigma = 5.014 \text{ S/m}$; $\epsilon_r = 35.059$; $\rho = 1000 \text{ kg/m}^3$
Phantom section: Flat Section; Space: 1.0 cm

Test Date: 07-09-2018; Ambient Temp: 20.3°C; Tissue Temp: 20.3°C

Probe: EX3DV4 - SN7409; ConvF(4.77, 4.77, 4.77); Calibrated: 6/25/2018;
Sensor-Surface: 1.4mm (Mechanical Surface Detection)
Electronics: DAE4 Sn1334; Calibrated: 6/18/2018
Phantom: SAM with CRP (Left); Type: SAM; Serial: 1715
Measurement SW: DASY52, Version 52.10; SEMCAD X Version 14.6.10 (7417)

5600 MHz System Verification at 17.0 dBm (50 mW)

Area Scan (7x7x1): Measurement grid: dx=10mm, dy=10mm

Zoom Scan (8x8x7)/Cube 0: Measurement grid: dx=4mm, dy=4mm, dz=1.4mm; Graded Ratio: 1.4

Peak SAR (extrapolated) = 18.4 W/kg

SAR(1 g) = 4.06 W/kg

Deviation(1 g) = -2.87%

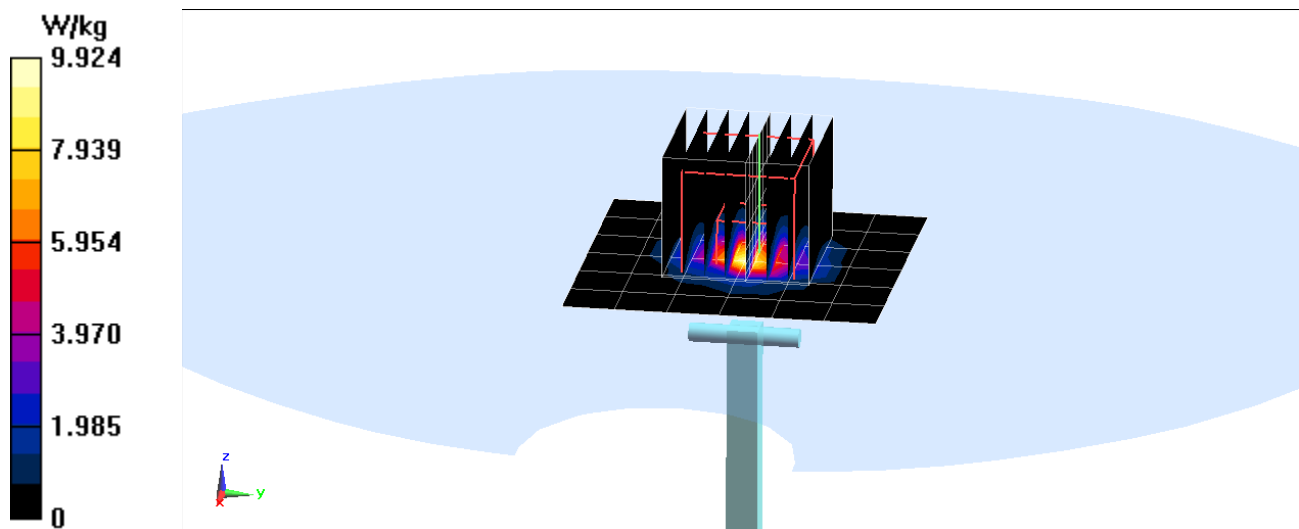

PCTEST ENGINEERING LABORATORY, INC.

DUT: Dipole 5 GHz; Type: D5GHzV2; Serial: 1191

Communication System: UID 0, CW; Frequency: 5750 MHz; Duty Cycle: 1:1

Medium: 5GHz Head Medium parameters used (interpolated):

$f = 5750 \text{ MHz}$; $\sigma = 5.19 \text{ S/m}$; $\epsilon_r = 34.77$; $\rho = 1000 \text{ kg/m}^3$

Phantom section: Flat Section; Space: 1.0 cm

Test Date: 07-09-2018; Ambient Temp: 20.3°C; Tissue Temp: 20.3°C

Probe: EX3DV4 - SN7409; ConvF(4.82, 4.82, 4.82); Calibrated: 6/25/2018;

Sensor-Surface: 1.4mm (Mechanical Surface Detection)

Electronics: DAE4 Sn1334; Calibrated: 6/18/2018

Phantom: SAM with CRP (Left); Type: SAM; Serial: 1715

Measurement SW: DASY52, Version 52.10;SEMCAD X Version 14.6.10 (7417)

5750 MHz System Verification at 17.0 dBm (50 mW)

Area Scan (7x7x1): Measurement grid: dx=10mm, dy=10mm

Zoom Scan (8x8x7)/Cube 0: Measurement grid: dx=4mm, dy=4mm, dz=1.4mm; Graded Ratio: 1.4

Peak SAR (extrapolated) = 18.1 W/kg

SAR(1 g) = 3.81 W/kg

Deviation(1 g) = -3.67%

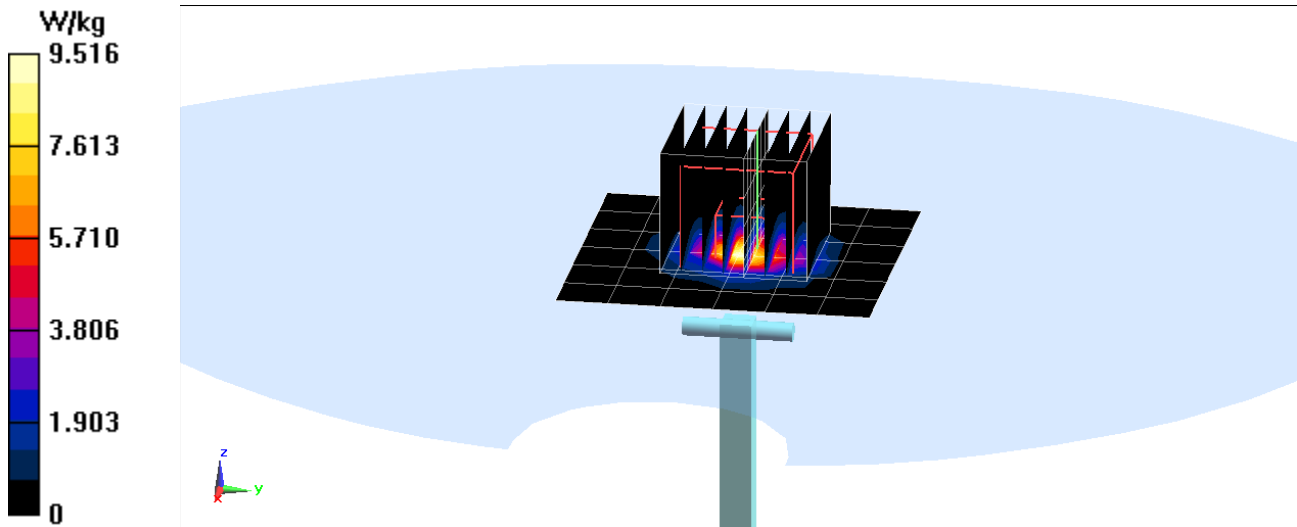

PCTEST ENGINEERING LABORATORY, INC.

DUT: Dipole 750 MHz; Type: D750V3; Serial: 1161

Communication System: UID 0, CW; Frequency: 750 MHz; Duty Cycle: 1:1
Medium: 750 Body Medium parameters used (interpolated):
 $f = 750 \text{ MHz}$; $\sigma = 0.965 \text{ S/m}$; $\epsilon_r = 54.14$; $\rho = 1000 \text{ kg/m}^3$
Phantom section: Flat Section; Space: 1.5 cm

Test Date: 07-11-2018; Ambient Temp: 23.8°C; Tissue Temp: 21.3°C

Probe: EX3DV4 - SN7409; ConvF(9.82, 9.82, 9.82); Calibrated: 6/25/2018;
Sensor-Surface: 1.4mm (Mechanical Surface Detection)
Electronics: DAE4 Sn1334; Calibrated: 6/18/2018

Phantom: SAM with CRP v5.0 (Right); Type: QD000P40CD; Serial: TP:1759
Measurement SW: DASY52, Version 52.10; SEMCAD X Version 14.6.10 (7417)

750 MHz System Verification at 23.0 dBm (200 mW)

Area Scan (7x15x1): Measurement grid: dx=15mm, dy=15mm

Zoom Scan (5x5x7)/Cube 0: Measurement grid: dx=8mm, dy=8mm, dz=5mm

Peak SAR (extrapolated) = 2.61 W/kg

SAR(1 g) = 1.74 W/kg

Deviation(1 g) = 3.20%

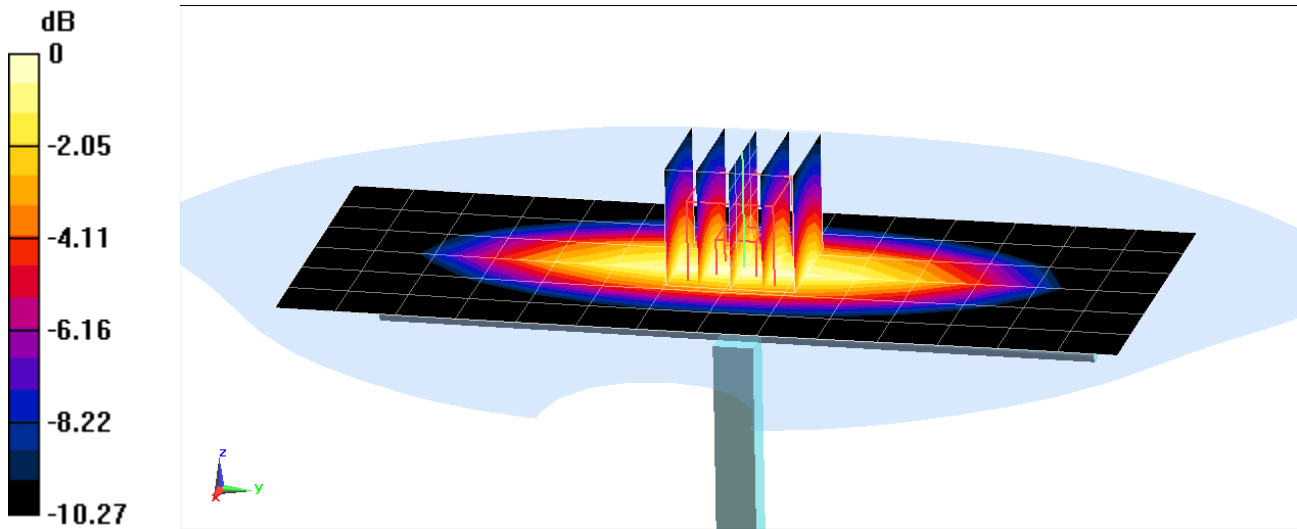

0 dB = 2.32 W/kg = 3.65 dBW/kg

PCTEST ENGINEERING LABORATORY, INC.

DUT: Dipole 835 MHz; Type: D835V2; Serial: 4d047

Communication System: UID 0, CW; Frequency: 835 MHz; Duty Cycle: 1:1

Medium: 835 Body Medium parameters used:

$f = 835 \text{ MHz}$; $\sigma = 1.014 \text{ S/m}$; $\epsilon_r = 53.336$; $\rho = 1000 \text{ kg/m}^3$

Phantom section: Flat Section; Space: 1.5 cm

Test Date: 07-13-2018; Ambient Temp: 20.5°C; Tissue Temp: 20.6°C

Probe: ES3DV3 - SN3347; ConvF(6.37, 6.37, 6.37); Calibrated: 3/27/2018;

Sensor-Surface: 3mm (Mechanical Surface Detection)

Electronics: DAE4 Sn1450; Calibrated: 11/9/2017

Phantom: Twin-SAM V5.0 Right; Type: QD 000 P40 CD; Serial: 1800

Measurement SW: DASY52, Version 52.10; SEMCAD X Version 14.6.10 (7417)

835 MHz System Verification at 23.0 dBm (200 mW)

Area Scan (7x14x1): Measurement grid: dx=15mm, dy=15mm

Zoom Scan (5x5x7)/Cube 0: Measurement grid: dx=8mm, dy=8mm, dz=5mm

Peak SAR (extrapolated) = 2.80 W/kg

SAR(1 g) = 1.91 W/kg

Deviation(1 g) = -0.21%

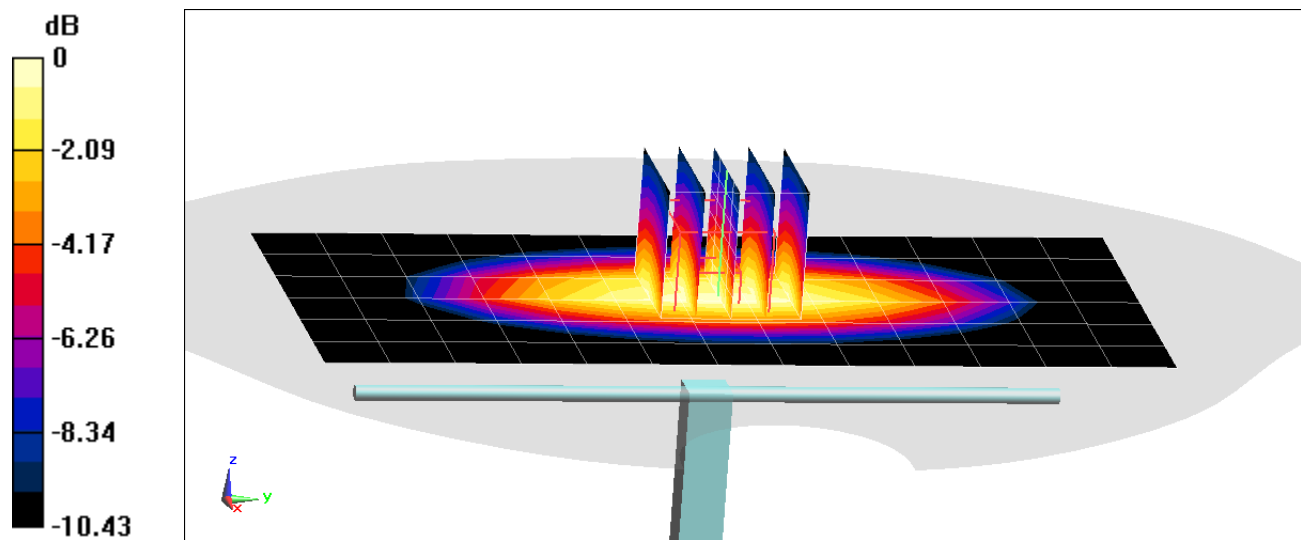

0 dB = 2.22 W/kg = 3.46 dBW/kg

PCTEST ENGINEERING LABORATORY, INC.

DUT: Dipole 1750 MHz; Type: D1750V2; Serial: 1150

Communication System: UID 0, CW; Frequency: 1750 MHz; Duty Cycle: 1:1

Medium: 1750 Body Medium parameters used:

$f = 1750 \text{ MHz}$; $\sigma = 1.493 \text{ S/m}$; $\epsilon_r = 51.998$; $\rho = 1000 \text{ kg/m}^3$

Phantom section: Flat Section; Space: 1.0 cm

Test Date: 07-10-2018; Ambient Temp: 22.0°C; Tissue Temp: 21.8°C

Probe: ES3DV3 - SN3347; ConvF(5.17, 5.17, 5.17); Calibrated: 3/27/2018;

Sensor-Surface: 3mm (Mechanical Surface Detection)

Electronics: DAE4 Sn1450; Calibrated: 11/9/2017

Phantom: Twin-SAM V5.0 Right; Type: QD 000 P40 CD; Serial: 1800

Measurement SW: DASY52, Version 52.10; SEMCAD X Version 14.6.10 (7417)

1750 MHz System Verification at 20.0 dBm (100 mW)

Area Scan (7x9x1): Measurement grid: dx=15mm, dy=15mm

Zoom Scan (5x5x7)/Cube 0: Measurement grid: dx=8mm, dy=8mm, dz=5mm

Peak SAR (extrapolated) = 6.29 W/kg

SAR(1 g) = 3.61 W/kg

Deviation(1 g) = -1.10%

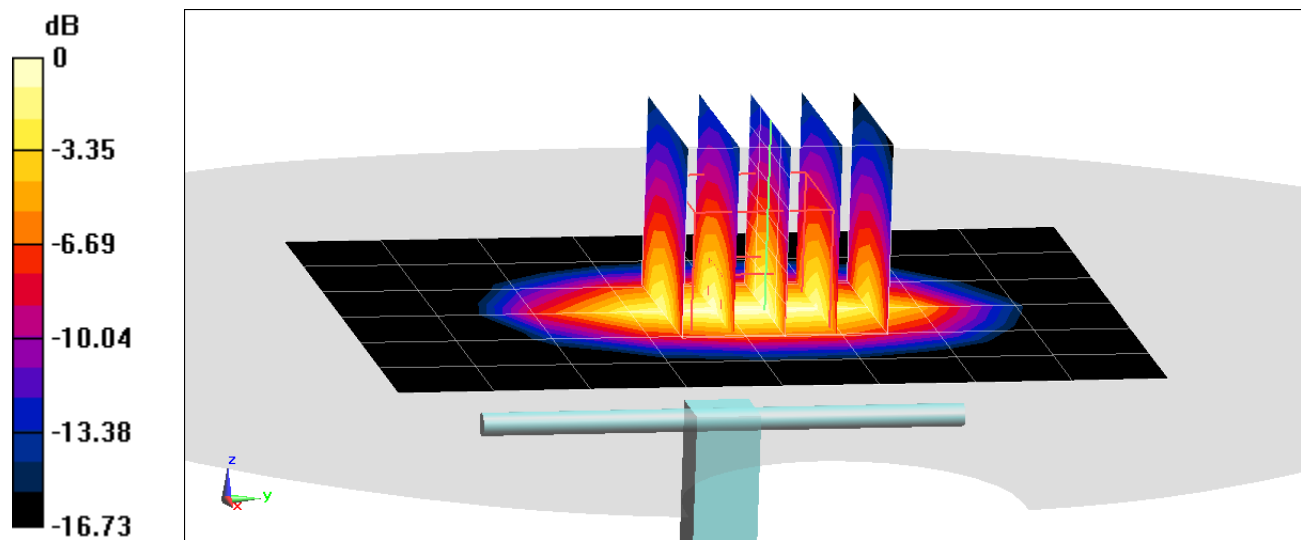

0 dB = 4.48 W/kg = 6.51 dBW/kg

PCTEST ENGINEERING LABORATORY, INC.

DUT: Dipole 1900 MHz; Type: D1900V2; Serial: 5d080

Communication System: UID 0, CW; Frequency: 1900 MHz; Duty Cycle: 1:1
Medium: 1900 Body Medium parameters used (interpolated):
 $f = 1900 \text{ MHz}$; $\sigma = 1.566 \text{ S/m}$; $\epsilon_r = 52.412$; $\rho = 1000 \text{ kg/m}^3$
Phantom section: Flat Section; Space: 1.0cm

Test Date: 07-08-2018; Ambient Temp: 20.3°C; Tissue Temp: 21.1°C

Probe: EX3DV4 - SN7406; ConvF(7.74, 7.74, 7.74); Calibrated: 5/22/2018;
Sensor-Surface: 1.4mm (Mechanical Surface Detection)
Electronics: DAE4 Sn859; Calibrated: 5/22/2018
Phantom: Twin-SAM V5.0; Type: QD 000 P40 CD; Serial: 1692
Measurement SW: DASY52, Version 52.10; SEMCAD X Version 14.6.10 (7417)

1900 MHz System Verification at 20.0 dBm (100 mW)

Area Scan (7x11x1): Measurement grid: dx=15mm, dy=15mm

Zoom Scan (5x5x7)/Cube 0: Measurement grid: dx=8mm, dy=8mm, dz=5mm

Peak SAR (extrapolated) = 7.73 W/kg

SAR(1 g) = 4.11 W/kg

Deviation(1 g) = 5.12%

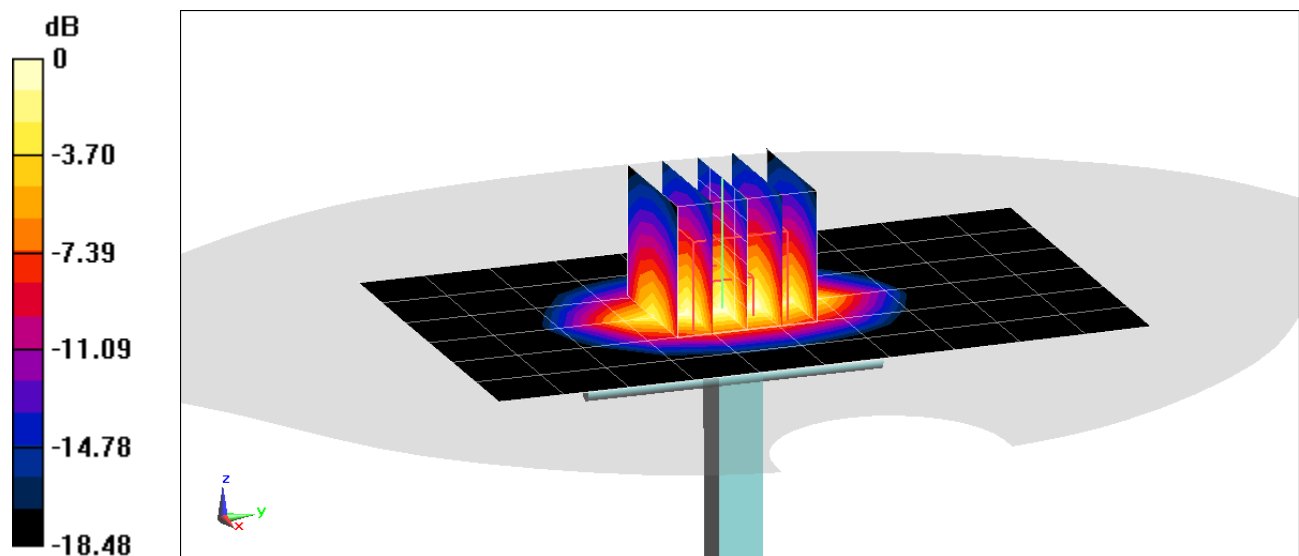

0 dB = 6.44 W/kg = 8.09 dBW/kg

PCTEST ENGINEERING LABORATORY, INC.

DUT: Dipole 1900 MHz; Type: D1900V2; Serial: 5d149

Communication System: UID 0, CW; Frequency: 1900 MHz; Duty Cycle: 1:1
Medium: 1900 Body Medium parameters used (interpolated):
 $f = 1900$ MHz; $\sigma = 1.565$ S/m; $\epsilon_r = 52.337$; $\rho = 1000$ kg/m³
Phantom section: Flat Section; Space: 1.0 cm

Test Date: 07-11-2018; Ambient Temp: 21.3°C; Tissue Temp: 21.8°C

Probe: EX3DV4 - SN7406; ConvF(7.74, 7.74, 7.74); Calibrated: 5/22/2018;
Sensor-Surface: 1.4mm (Mechanical Surface Detection)
Electronics: DAE4 Sn859; Calibrated: 5/22/2018
Phantom: Twin-SAM V5.0; Type: QD 000 P40 CD; Serial: 1692
Measurement SW: DASY52, Version 52.10;SEMCAD X Version 14.6.10 (7417)

1900 MHz System Verification at 20.0 dBm (100 mW)

Area Scan (7x11x1): Measurement grid: dx=15mm, dy=15mm
Zoom Scan (5x5x7)/Cube 0: Measurement grid: dx=8mm, dy=8mm, dz=5mm
Peak SAR (extrapolated) = 8.03 W/kg
SAR(1 g) = 4.28 W/kg
Deviation(1 g) = 6.73%

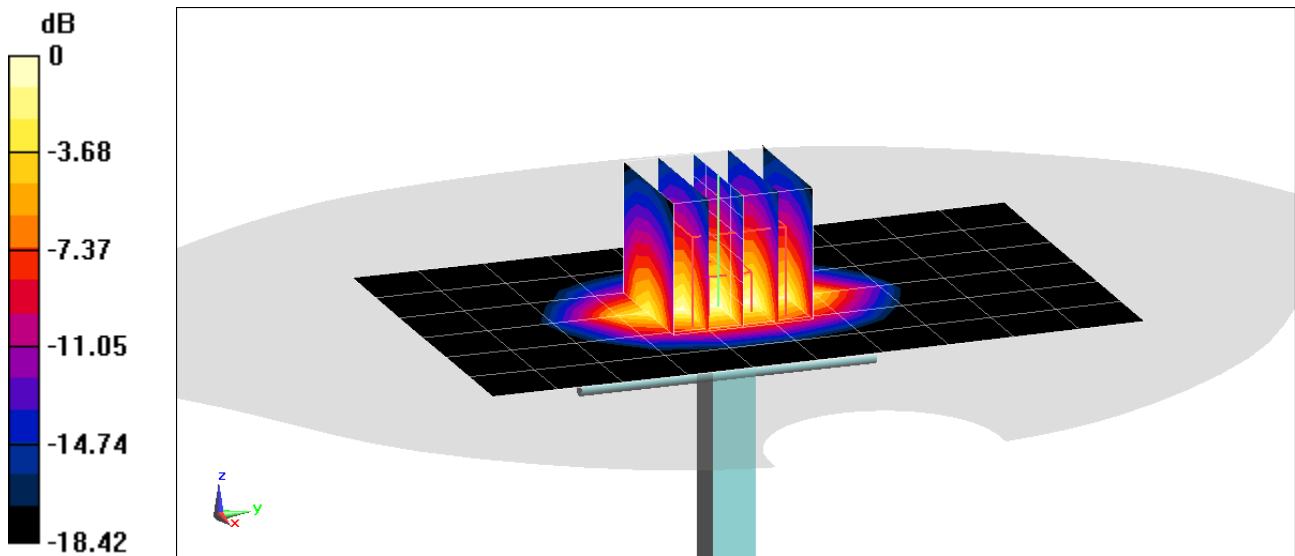

PCTEST ENGINEERING LABORATORY, INC.

DUT: Dipole 2450 MHz; Type: D2450V2; Serial: 797

Communication System: UID 0, CW; Frequency: 2450 MHz; Duty Cycle: 1:1

Medium: 2450 Body Medium parameters used:

$f = 2450$ MHz; $\sigma = 1.984$ S/m; $\epsilon_r = 51.351$; $\rho = 1000$ kg/m³

Phantom section: Flat Section; Space: 1.0 cm

Test Date: 07-09-2018; Ambient Temp: 22.2°C; Tissue Temp: 22.0°C

Probe: ES3DV3 - SN3319; ConvF(4.51, 4.51, 4.51); Calibrated: 3/13/2018;

Sensor-Surface: 3mm (Mechanical Surface Detection)

Electronics: DAE4 Sn1368; Calibrated: 3/7/2018

Phantom: LeftTwin-SAM V5.0; Type: QD 000 P40 CD; Serial: 1375

Measurement SW: DASY52, Version 52.10;SEMCAD X Version 14.6.10 (7417)

2450 MHz System Verification at 20.0 dBm (100 mW)

Area Scan (8x9x1): Measurement grid: dx=12mm, dy=12mm

Zoom Scan (7x7x7)/Cube 0: Measurement grid: dx=5mm, dy=5mm, dz=5mm

Peak SAR (extrapolated) = 10.9 W/kg

SAR(1 g) = 5.27 W/kg

Deviation(1 g) = 3.13%

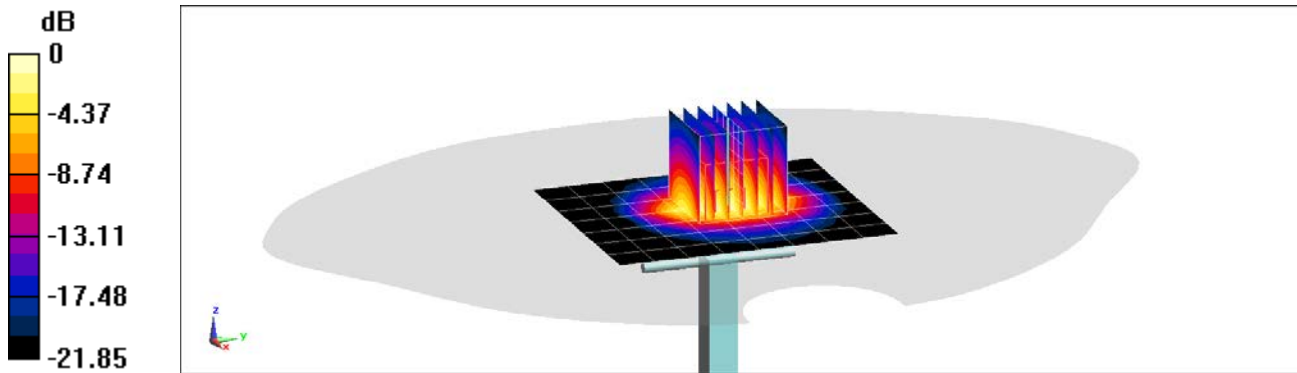

0 dB = 6.97 W/kg = 8.43 dBW/kg

PCTEST ENGINEERING LABORATORY, INC.

DUT: Dipole 2600 MHz; Type: D2600V2; Serial: 1126

Communication System: UID 0, CW; Frequency: 2600 MHz; Duty Cycle: 1:1

Medium: 2450 Body Medium parameters used:

$f = 2600 \text{ MHz}$; $\sigma = 2.167 \text{ S/m}$; $\epsilon_r = 50.89$; $\rho = 1000 \text{ kg/m}^3$

Phantom section: Flat Section; Space: 1.0 cm

Test Date: 07-09-2018; Ambient Temp: 22.2°C; Tissue Temp: 22.0°C

Probe: ES3DV3 - SN3319; ConvF(4.33, 4.33, 4.33); Calibrated: 3/13/2018;

Sensor-Surface: 3mm (Mechanical Surface Detection)

Electronics: DAE4 Sn1368; Calibrated: 3/7/2018

Phantom: LeftTwin-SAM V5.0; Type: QD 000 P40 CD; Serial: 1375

Measurement SW: DASY52, Version 52.10;SEMCAD X Version 14.6.10 (7417)

2600 MHz System Verification at 20.0 dBm (100 mW)

Area Scan (8x9x1): Measurement grid: dx=12mm, dy=12mm

Zoom Scan (7x7x7)/Cube 0: Measurement grid: dx=5mm, dy=5mm, dz=5mm

Peak SAR (extrapolated) = 12.2 W/kg

SAR(1 g) = 5.61 W/kg

Deviation(1 g) = 3.31%

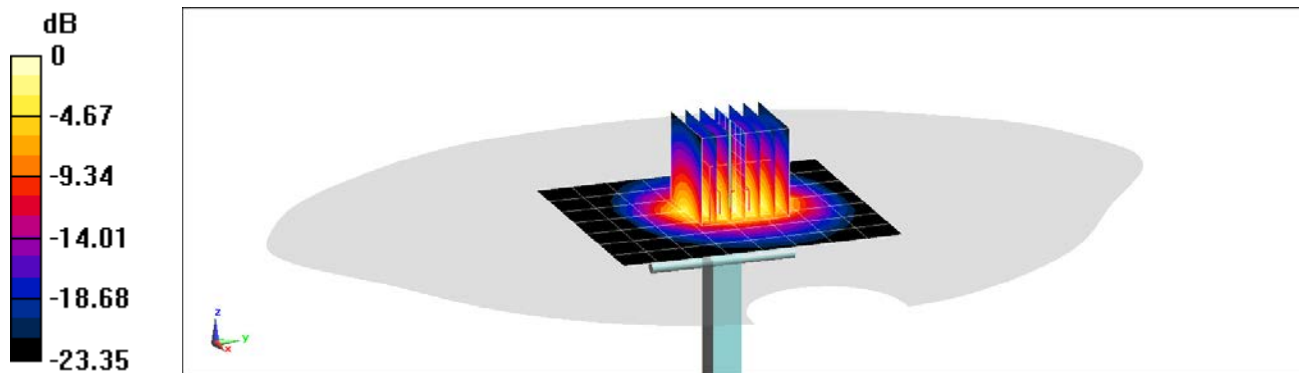

0 dB = 7.52 W/kg = 8.76 dBW/kg

PCTEST ENGINEERING LABORATORY, INC.

DUT: Dipole 2600 MHz; Type: D2600V2; Serial: 1004

Communication System: UID 0, CW; Frequency: 2600 MHz; Duty Cycle: 1:1

Medium: 2450 Body Medium parameters used:

$f = 2600 \text{ MHz}$; $\sigma = 2.19 \text{ S/m}$; $\epsilon_r = 50.319$; $\rho = 1000 \text{ kg/m}^3$

Phantom section: Flat Section; Space: 1.0 cm

Test Date: 07-12-2018; Ambient Temp: 23.3°C; Tissue Temp: 21.6°C

Probe: ES3DV3 - SN3319; ConvF(4.33, 4.33, 4.33); Calibrated: 3/13/2018;

Sensor-Surface: 3mm (Mechanical Surface Detection)

Electronics: DAE4 Sn1368; Calibrated: 3/7/2018

Phantom: LeftTwin-SAM V5.0; Type: QD 000 P40 CD; Serial: 1375

Measurement SW: DASY52, Version 52.10; SEMCAD X Version 14.6.10 (7417)

2600 MHz System Verification at 20.0 dBm (100 mW)

Area Scan (8x9x1): Measurement grid: dx=12mm, dy=12mm

Zoom Scan (7x7x7)/Cube 0: Measurement grid: dx=5mm, dy=5mm, dz=5mm

Peak SAR (extrapolated) = 12.3 W/kg

SAR(1 g) = 5.58 W/kg

Deviation(1 g) = 1.82%

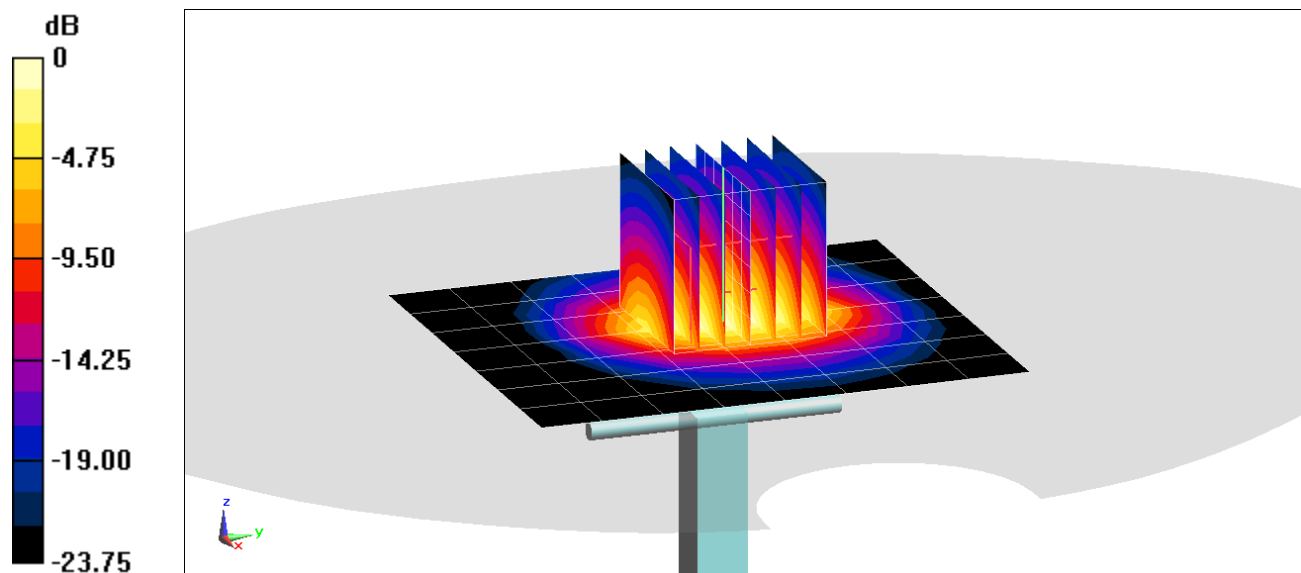

0 dB = 7.43 W/kg = 8.71 dBW/kg

PCTEST ENGINEERING LABORATORY, INC.

DUT: Dipole 5 GHz; Type: D5GHzV2; Serial: 1237

Communication System: UID 0, CW; Frequency: 5250 MHz; Duty Cycle: 1:1
Medium: 5 GHz Body Medium parameters used (interpolated):
 $f = 5250 \text{ MHz}$; $\sigma = 5.467 \text{ S/m}$; $\epsilon_r = 48.22$; $\rho = 1000 \text{ kg/m}^3$
Phantom section: Flat Section; Space: 1.0 cm

Test Date: 07-09-2018; Ambient Temp: 21.5°C; Tissue Temp: 20.8°C

Probe: EX3DV4 - SN7357; ConvF(4.78, 4.78, 4.78); Calibrated: 4/18/2018;
Sensor-Surface: 1.4mm (Mechanical Surface Detection)

Electronics: DAE4 Sn1407; Calibrated: 4/11/2018

Phantom: SAM with CRP v5.0 Left; Type: QD000P40CD; Serial: 1687

Measurement SW: DASY52, Version 52.10;SEMCAD X Version 14.6.10 (7417)

5250 MHz System Verification at 17.0 dBm (50 mW)

Area Scan (7x7x1): Measurement grid: dx=10mm, dy=10mm

Zoom Scan (8x8x7)/Cube 0: Measurement grid: dx=4mm, dy=4mm, dz=1.4mm; Graded Ratio: 1.4

Peak SAR (extrapolated) = 14.8 W/kg

SAR(1 g) = 3.58 W/kg

Deviation(1 g) = -6.89%

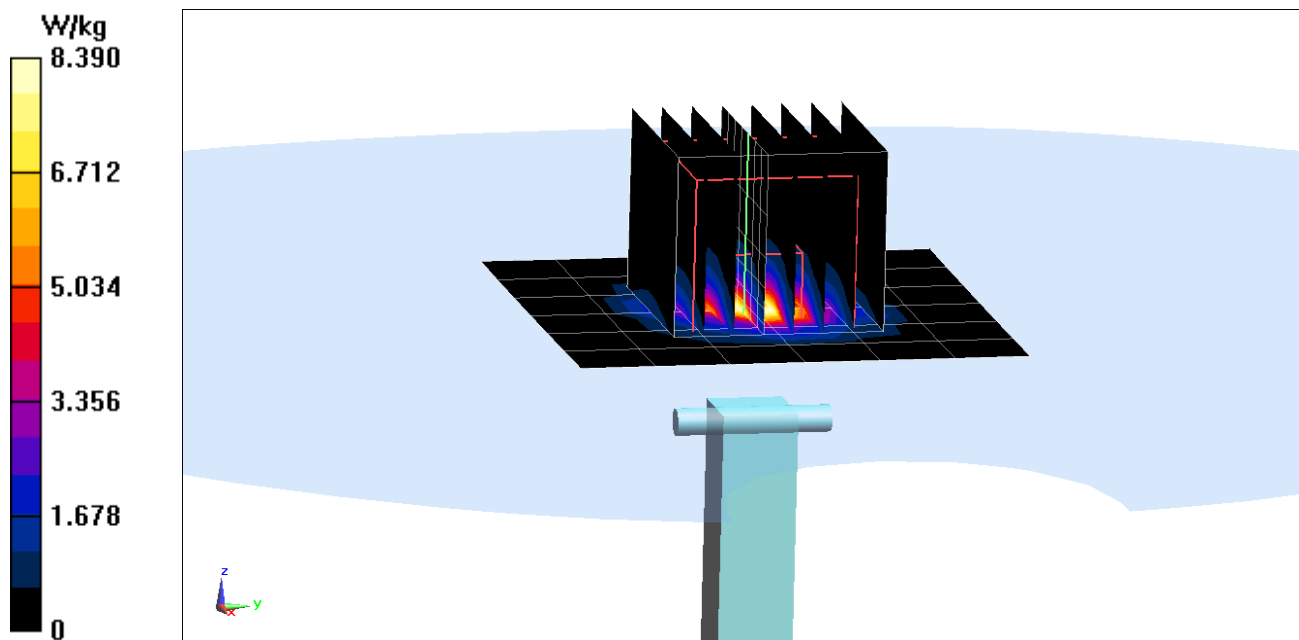

PCTEST ENGINEERING LABORATORY, INC.

DUT: Dipole 5 GHz; Type: D5GHzV2; Serial: 1237

Communication System: UID 0, CW; Frequency: 5600 MHz; Duty Cycle: 1:1

Medium: 5 GHz Body Medium parameters used:

$f = 5600 \text{ MHz}$; $\sigma = 5.941 \text{ S/m}$; $\epsilon_r = 47.649$; $\rho = 1000 \text{ kg/m}^3$

Phantom section: Flat Section; Space: 1.0 cm

Test Date: 07-09-2018; Ambient Temp: 21.5°C; Tissue Temp: 20.8°C

Probe: EX3DV4 - SN7357; ConvF(4.2, 4.2, 4.2); Calibrated: 4/18/2018;

Sensor-Surface: 1.4mm (Mechanical Surface Detection)

Electronics: DAE4 Sn1407; Calibrated: 4/11/2018

Phantom: SAM with CRP v5.0 Left; Type: QD000P40CD; Serial: 1687

Measurement SW: DASY52, Version 52.10; SEMCAD X Version 14.6.10 (7417)

5600 MHz System Verification at 17.0 dBm (50 mW)

Area Scan (7x7x1): Measurement grid: dx=10mm, dy=10mm

Zoom Scan (8x8x7)/Cube 0: Measurement grid: dx=4mm, dy=4mm, dz=1.4mm; Graded Ratio: 1.4

Peak SAR (extrapolated) = 18.0 W/kg

SAR(1 g) = 3.96 W/kg

Deviation(1 g) = 0.89%

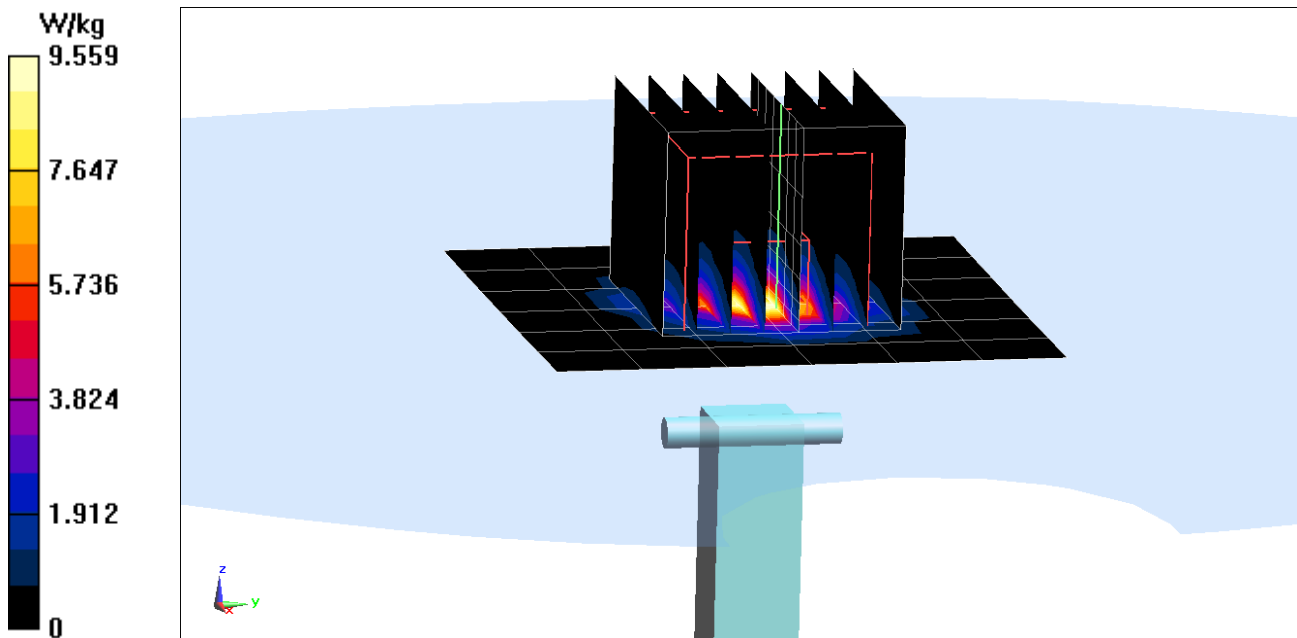

PCTEST ENGINEERING LABORATORY, INC.

DUT: Dipole 5 GHz; Type: D5GHzV2; Serial: 1237

Communication System: UID 0, CW; Frequency: 5750 MHz; Duty Cycle: 1:1
Medium: 5 GHz Body Medium parameters used (interpolated):
 $f = 5750 \text{ MHz}$; $\sigma = 6.156 \text{ S/m}$; $\epsilon_r = 47.371$; $\rho = 1000 \text{ kg/m}^3$
Phantom section: Flat Section; Space: 1.0 cm

Test Date: 07-09-2018; Ambient Temp: 21.5°C; Tissue Temp: 20.8°C

Probe: EX3DV4 - SN7357; ConvF(4.21, 4.21, 4.21); Calibrated: 4/18/2018;
Sensor-Surface: 1.4mm (Mechanical Surface Detection)

Electronics: DAE4 Sn1407; Calibrated: 4/11/2018

Phantom: SAM with CRP v5.0 Left; Type: QD000P40CD; Serial: 1687

Measurement SW: DASY52, Version 52.10;SEMCAD X Version 14.6.10 (7417)

5750 MHz System Verification at 17.0 dBm (50 mW)

Area Scan (7x7x1): Measurement grid: dx=10mm, dy=10mm

Zoom Scan (8x8x7)/Cube 0: Measurement grid: dx=4mm, dy=4mm, dz=1.4mm; Graded Ratio: 1.4

Peak SAR (extrapolated) = 17.4 W/kg

SAR(1 g) = 3.7 W/kg

Deviation(1 g) = -4.02%

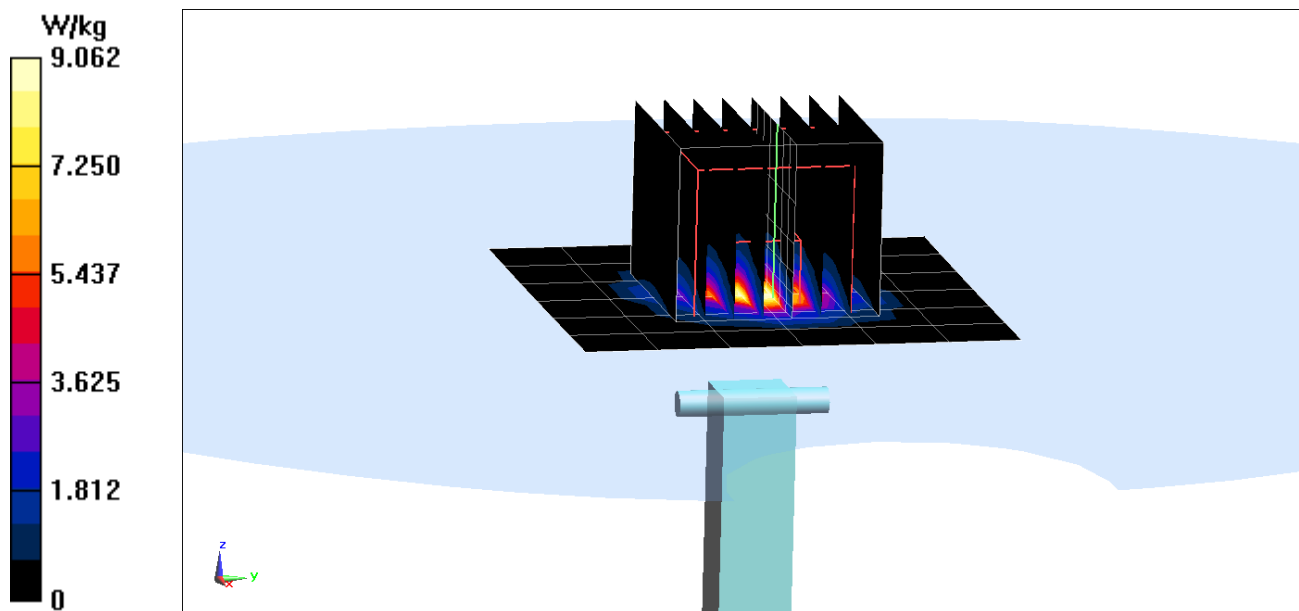

APPENDIX C: PROBE CALIBRATION



Accredited by the Swiss Accreditation Service (SAS)
The Swiss Accreditation Service is one of the signatories to the EA
Multilateral Agreement for the recognition of calibration certificates

Accreditation No.: **SCS 0108**

Client **PC Test**

Certificate No: **D750V3-1054_Mar17**

CALIBRATION CERTIFICATE

Object **D750V3 - SN:1054**

Calibration procedure(s) **QA CAL-05.v9**
Calibration procedure for dipole validation kits above 700 MHz

BNV
03-27-2017
BNV
04-04-2018

Calibration date: **March 07, 2017**

This calibration certificate documents the traceability to national standards, which realize the physical units of measurements (SI).
The measurements and the uncertainties with confidence probability are given on the following pages and are part of the certificate.

All calibrations have been conducted in the closed laboratory facility: environment temperature (22 ± 3)°C and humidity < 70%.

Calibration Equipment used (M&TE critical for calibration)

Primary Standards	ID #	Cal Date (Certificate No.)	Scheduled Calibration
Power meter NRP	SN: 104778	06-Apr-16 (No. 217-02288/02289)	Apr-17
Power sensor NRP-Z91	SN: 103244	06-Apr-16 (No. 217-02288)	Apr-17
Power sensor NRP-Z91	SN: 103245	06-Apr-16 (No. 217-02289)	Apr-17
Reference 20 dB Attenuator	SN: 5058 (20K)	05-Apr-16 (No. 217-02292)	Apr-17
Type-N mismatch combination	SN: 5047.2 / 06327	05-Apr-16 (No. 217-02295)	Apr-17
Reference Probe EX3DV4	SN: 7349	31-Dec-16 (No. EX3-7349_Dec16)	Dec-17
DAE4	SN: 601	04-Jan-17 (No. DAE4-601_Jan17)	Jan-18

Secondary Standards	ID #	Check Date (In house)	Scheduled Check
Power meter EPM-442A	SN: GB37480704	07-Oct-15 (In house check Oct-16)	In house check: Oct-18
Power sensor HP 8481A	SN: US37292783	07-Oct-15 (In house check Oct-16)	In house check: Oct-18
Power sensor HP 8481A	SN: MY41092317	07-Oct-15 (In house check Oct-16)	In house check: Oct-18
RF generator R&S SMT-06	SN: 100972	15-Jun-15 (In house check Oct-16)	In house check: Oct-18
Network Analyzer HP 8753E	SN: US37390585	18-Oct-01 (In house check Oct-18)	In house check: Oct-17

Calibrated by: **Johannes Kurikka** Name: Johannes Kurikka Function: Laboratory Technician

Signature: *Johannes Kurikka*

Approved by: **Katja Pokovic** Name: Katja Pokovic Technical Manager

Signature: *Katja Pokovic*

Issued: March 14, 2017

This calibration certificate shall not be reproduced except in full without written approval of the laboratory.



Accredited by the Swiss Accreditation Service (SAS)
The Swiss Accreditation Service is one of the signatories to the EA
Multilateral Agreement for the recognition of calibration certificates

Accreditation No.: **SCS 0108**

Glossary:

TSL tissue simulating liquid
ConvF sensitivity in TSL / NORM x,y,z
N/A not applicable or not measured

Calibration is Performed According to the Following Standards:

- a) IEEE Std 1528-2013, "IEEE Recommended Practice for Determining the Peak Spatial-Averaged Specific Absorption Rate (SAR) in the Human Head from Wireless Communications Devices: Measurement Techniques", June 2013
- b) IEC 62209-1, "Procedure to measure the Specific Absorption Rate (SAR) for hand-held devices used in close proximity to the ear (frequency range of 300 MHz to 3 GHz)", February 2005
- c) IEC 62209-2, "Procedure to determine the Specific Absorption Rate (SAR) for wireless communication devices used in close proximity to the human body (frequency range of 30 MHz to 6 GHz)", March 2010
- d) KDB 865664, "SAR Measurement Requirements for 100 MHz to 6 GHz"

Additional Documentation:

- e) DASY4/5 System Handbook

Methods Applied and Interpretation of Parameters:

- *Measurement Conditions:* Further details are available from the Validation Report at the end of the certificate. All figures stated in the certificate are valid at the frequency indicated.
- *Antenna Parameters with TSL:* The dipole is mounted with the spacer to position its feed point exactly below the center marking of the flat phantom section, with the arms oriented parallel to the body axis.
- *Feed Point Impedance and Return Loss:* These parameters are measured with the dipole positioned under the liquid filled phantom. The impedance stated is transformed from the measurement at the SMA connector to the feed point. The Return Loss ensures low reflected power. No uncertainty required.
- *Electrical Delay:* One-way delay between the SMA connector and the antenna feed point. No uncertainty required.
- *SAR measured:* SAR measured at the stated antenna input power.
- *SAR normalized:* SAR as measured, normalized to an input power of 1 W at the antenna connector.
- *SAR for nominal TSL parameters:* The measured TSL parameters are used to calculate the nominal SAR result.

The reported uncertainty of measurement is stated as the standard uncertainty of measurement multiplied by the coverage factor $k=2$, which for a normal distribution corresponds to a coverage probability of approximately 95%.

Measurement Conditions

DASY system configuration, as far as not given on page 1.

DASY Version	DASY5	V52.8.8
Extrapolation	Advanced Extrapolation	
Phantom	Modular Flat Phantom	
Distance Dipole Center - TSL	15 mm	with Spacer
Zoom Scan Resolution	dx, dy, dz = 5 mm	
Frequency	750 MHz \pm 1 MHz	

Head TSL parameters

The following parameters and calculations were applied.

	Temperature	Permittivity	Conductivity
Nominal Head TSL parameters	22.0 °C	41.9	0.89 mho/m
Measured Head TSL parameters	(22.0 \pm 0.2) °C	40.9 \pm 6 %	0.91 mho/m \pm 6 %
Head TSL temperature change during test	< 0.5 °C	----	----

SAR result with Head TSL

SAR averaged over 1 cm ³ (1 g) of Head TSL	Condition	
SAR measured	250 mW input power	2.14 W/kg
SAR for nominal Head TSL parameters	normalized to 1W	8.37 W/kg \pm 17.0 % (k=2)

SAR averaged over 10 cm ³ (10 g) of Head TSL	condition	
SAR measured	250 mW input power	1.40 W/kg
SAR for nominal Head TSL parameters	normalized to 1W	5.60 W/kg \pm 16.5 % (k=2)

Body TSL parameters

The following parameters and calculations were applied.

	Temperature	Permittivity	Conductivity
Nominal Body TSL parameters	22.0 °C	55.5	0.96 mho/m
Measured Body TSL parameters	(22.0 \pm 0.2) °C	54.6 \pm 6 %	0.99 mho/m \pm 6 %
Body TSL temperature change during test	< 0.5 °C	----	----

SAR result with Body TSL

SAR averaged over 1 cm ³ (1 g) of Body TSL	Condition	
SAR measured	250 mW input power	2.21 W/kg
SAR for nominal Body TSL parameters	normalized to 1W	8.61 W/kg \pm 17.0 % (k=2)

SAR averaged over 10 cm ³ (10 g) of Body TSL	condition	
SAR measured	250 mW input power	1.45 W/kg
SAR for nominal Body TSL parameters	normalized to 1W	5.68 W/kg \pm 16.5 % (k=2)

Appendix (Additional assessments outside the scope of SCS 0108)

Antenna Parameters with Head TSL

Impedance, transformed to feed point	54.7 Ω - 0.7 j Ω
Return Loss	- 26.8 dB

Antenna Parameters with Body TSL

Impedance, transformed to feed point	50.7 Ω - 3.6 j Ω
Return Loss	- 28.7 dB

General Antenna Parameters and Design

Electrical Delay (one direction)	1.033 ns
----------------------------------	----------

After long term use with 100W radiated power, only a slight warming of the dipole near the feedpoint can be measured.

The dipole is made of standard semirigid coaxial cable. The center conductor of the feeding line is directly connected to the second arm of the dipole. The antenna is therefore short-circuited for DC-signals. On some of the dipoles, small end caps are added to the dipole arms in order to improve matching when loaded according to the position as explained in the "Measurement Conditions" paragraph. The SAR data are not affected by this change. The overall dipole length is still according to the Standard.

No excessive force must be applied to the dipole arms, because they might bend or the soldered connections near the feedpoint may be damaged.

Additional EUT Data

Manufactured by	SPEAG
Manufactured on	November 08, 2011

DASY5 Validation Report for Head TSL

Date: 07.03.2017

Test Laboratory: SPEAG, Zurich, Switzerland

DUT: Dipole 750 MHz; Type: D750V3; Serial: D750V3 - SN:1054

Communication System: UID 0 - CW ; Frequency: 750 MHz

Medium parameters used: $f = 750 \text{ MHz}$; $\sigma = 0.91 \text{ S/m}$; $\epsilon_r = 40.9$; $\rho = 1000 \text{ kg/m}^3$

Phantom section: Flat Section

Measurement Standard: DASY5 (IEEE/IEC/ANSI C63.19-2011)

DASY52 Configuration:

- Probe: EX3DV4 - SN7349; ConvF(10.17, 10.17, 10.17); Calibrated: 31.12.2016;
- Sensor-Surface: 1.4mm (Mechanical Surface Detection)
- Electronics: DAE4 Sn601; Calibrated: 04.01.2017
- Phantom: Flat Phantom 4.9 (front); Type: QD 00L P49 AA; Serial: 1001
- DASY52 52.8.8(1222); SEMCAD X 14.6.10(7331)

Dipole Calibration for Head Tissue/Pin=250 mW, d=15mm/Zoom Scan (7x7x7)/Cube 0:

Measurement grid: $dx=5\text{mm}$, $dy=5\text{mm}$, $dz=5\text{mm}$

Reference Value = 59.71 V/m; Power Drift = 0.01 dB

Peak SAR (extrapolated) = 3.21 W/kg

SAR(1 g) = 2.14 W/kg; SAR(10 g) = 1.4 W/kg

Maximum value of SAR (measured) = 2.85 W/kg

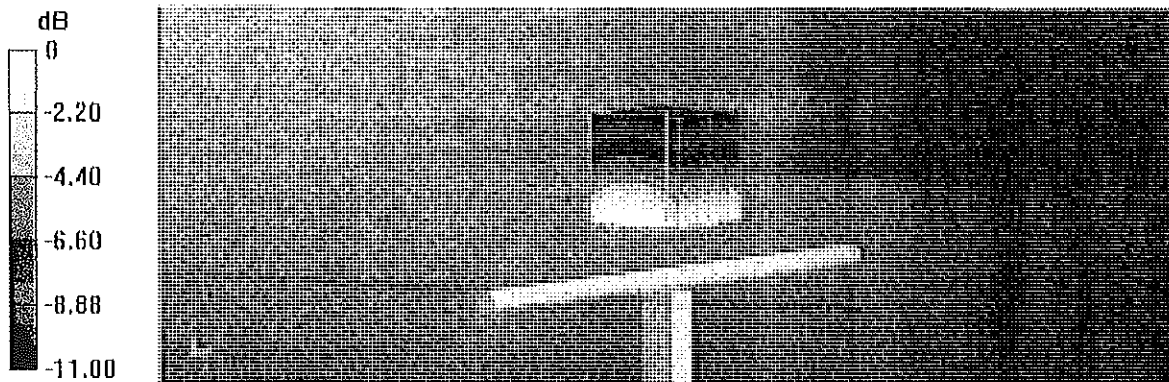

Impedance Measurement Plot for Head TSL

7 Mar 2017 12:25:14
 CH1 S11 1 U FS 1: 54.732 Ω -732.42 m Ω 289.73 pF 750.000 000 MHz

*
 Del
 CA

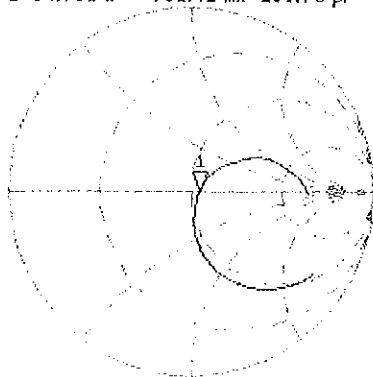

Avg
 16

H1d

CH2 S11 LOG 5 dB/REF -20 dB 1:-26.788 dB 750.000 000 MHz

CA

Avg
 16

H1d

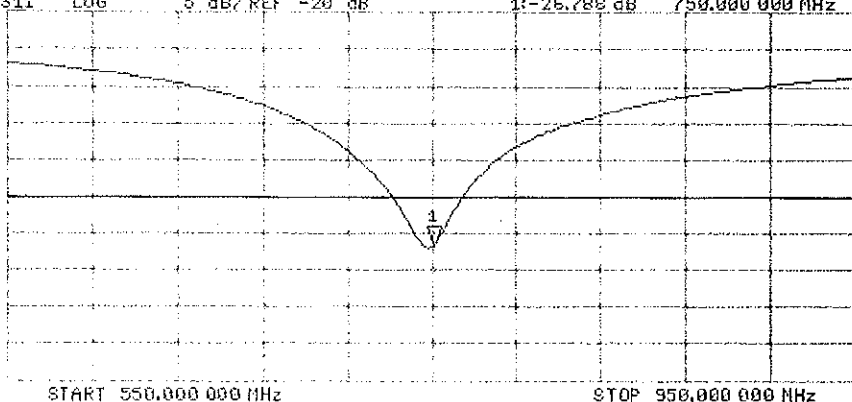

DASY5 Validation Report for Body TSL

Date: 07.03.2017

Test Laboratory: SPEAG, Zurich, Switzerland

DUT: Dipole 750 MHz; Type: D750V3; Serial: D750V3 - SN:1054

Communication System: UID 0 - CW ; Frequency: 750 MHz

Medium parameters used: $f = 750$ MHz; $\sigma = 0.99$ S/m; $\epsilon_r = 54.6$; $\rho = 1000$ kg/m³

Phantom section: Flat Section

Measurement Standard: DASY5 (IEEE/IEC/ANSI C63.19-2011)

DASY52 Configuration:

- Probe: EX3DV4 - SN7349; ConvF(9.99, 9.99, 9.99); Calibrated: 31.12.2016;
- Sensor-Surface: 1.4mm (Mechanical Surface Detection)
- Electronics: DAE4 Sn601; Calibrated: 04.01.2017
- Phantom: Flat Phantom 4.9 (Back); Type: QD 00R P49 AA; Serial: 1005
- DASY52 52.8.8(1222); SEMCAD X 14.6.10(7331)

Dipole Calibration for Body Tissue/Pin=250 mW, d=15mm/Zoom Scan (7x7x7)/Cube 0:

Measurement grid: dx=5mm, dy=5mm, dz=5mm

Reference Value = 57.88 V/m; Power Drift = -0.01 dB

Peak SAR (extrapolated) = 3.31 W/kg

SAR(1 g) = 2.21 W/kg; SAR(10 g) = 1.45 W/kg

Maximum value of SAR (measured) = 2.94 W/kg

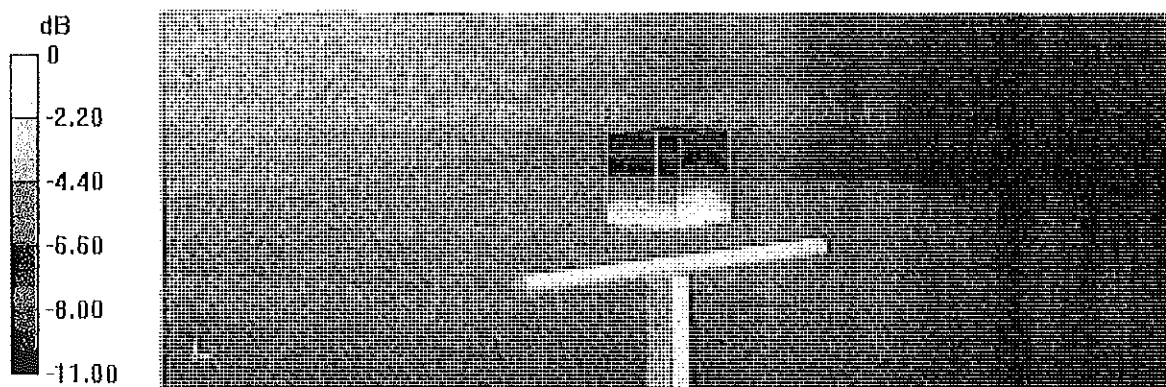

Impedance Measurement Plot for Body TSL

7 Mar 2017 11:51:37
S11 1 U FS 1150.666 Ω -3.6309 Ω 58.445 pF 750.000 000 MHz

*
De1

Ca

Avg
16

H1d

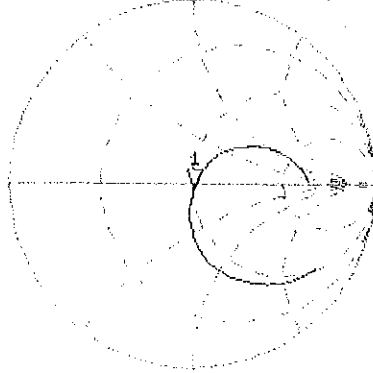

CH2 S11 LOG 5 dB/REF -20 dB 1:-28.716 dB 750.000 000 MHz

Ca

Avg
16

H1d

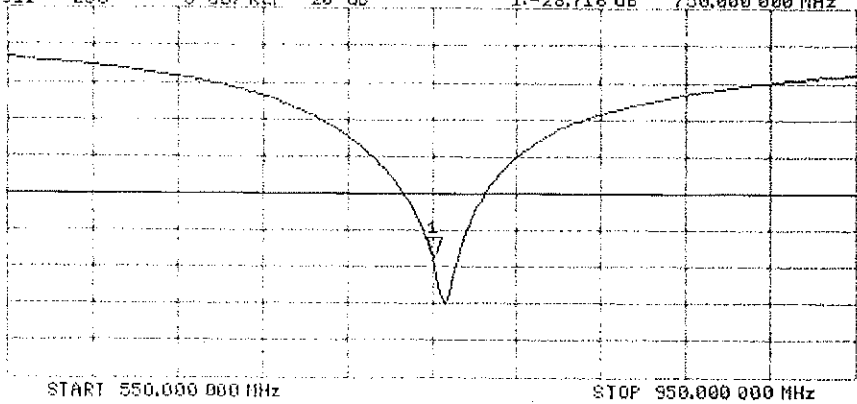

Certification of Calibration

Object: D750V3 – SN:1054

Calibration procedure(s): Procedure for Calibration Extension for SAR Dipoles.

Extended Calibration date: March 07, 2018

Description: SAR Validation Dipole at 750 MHz.

Calibration Equipment used:

Manufacturer	Model	Description	Cal Date	Cal Interval	Cal Due	Serial Number
Agilent	8753ES	S-Parameter Network Analyzer	8/3/2017	Annual	8/3/2018	MY40000670
Agilent	N5182A	MXG Vector Signal Generator	1/24/2018	Annual	1/24/2019	MY47420651
Amplifier Research	1551G6	Amplifier	CBT	N/A	CBT	433971
Anritsu	MA2411B	Pulse Power Sensor	3/2/2018	Annual	3/2/2019	1207364
Anritsu	MA2411B	Pulse Power Sensor	10/16/2017	Annual	10/16/2018	1126066
Anritsu	ML2495A	Power Meter	10/22/2017	Annual	10/22/2018	1328004
Keysight Technologies	85033E	Standard Mechanical Calibration Kit (DC to 9GHz, 3.5mm)	6/1/2017	Annual	6/1/2018	MY53401181
Mini-Circuits	BW-N20W5+	DC to 18 GHz Precision Fixed 20 dB Attenuator	CBT	N/A	CBT	N/A
Mini-Circuits	NLP-2950+	Low Pass Filter DC to 2700 MHz	CBT	N/A	CBT	N/A
Narda	4772-3	Attenuator (3dB)	CBT	N/A	CBT	9406
Pasternack	PE2208-6	Bidirectional Coupler	CBT	N/A	CBT	N/A
Seekonk	NC-100	Torque Wrench 5/16", 8" lbs	1/22/2018	Annual	1/22/2019	N/A
SPEAG	DAE4	Dasy Data Acquisition Electronics	7/13/2017	Annual	7/13/2018	1322
SPEAG	DAE4	Dasy Data Acquisition Electronics	6/21/2017	Annual	6/21/2018	1333
SPEAG	EX3DV4	SAR Probe	7/17/2017	Annual	7/17/2018	7410
SPEAG	ES3DV3	SAR Probe	9/18/2017	Annual	9/18/2018	3287

Measurement Uncertainty = $\pm 23\%$ (k=2)

	Name	Function	Signature
Calibrated By:	Brodie Halfoster	Test Engineer	<i>BRODIE HALFOSTER</i>
Approved By:	Kaitlin O'Keefe	Senior Technical Manager	<i>KOK</i>

DIPOLE CALIBRATION EXTENSION

Per KDB 865664 D01, calibration intervals of up to three years may be considered for reference dipoles when it is demonstrated that the SAR target, impedance and return loss of a dipole have remained stable according to the following requirements:

1. The measured SAR does not deviate more than 10% from the target on the calibration certificate.
2. The return-loss does not deviate more than 20% from the previous measurement and meets the required 20dB minimum return-loss requirement.
3. The measurement of real or imaginary parts of impedance does not deviate more than 5Ω from the previous measurement.

The following dipole was checked to pass the above 3 requirements to have 2-year calibration period from the calibration date:

Calibration Date	Expiration Date	Certificate Elect Cal Delay (ns)	Certificate SAR Target Head (10) W/m ² @ 210 dBm	Measured Head SAR (10) W/m ² @ 210 dBm	Deviation (g)	Certificate SAR Target Body (10) W/m ² @ 210 dBm	Measured Body SAR (10) W/m ² @ 210 dBm	Deviation (g)	Certificate Impedance Head (Ohm) Real	Measured Impedance Head (Ohm) Real	Difference (Ohm) Real	Certificate Impedance Head (Ohm) Imaginary	Measured Impedance Head (Ohm) Imaginary	Difference (Ohm) Imaginary	Certificate Return Loss Head (dB)	Measured Return Loss Head (dB)	Deviation (dB)	PASS/FAIL
3/7/2017	3/7/2018	1.033	1.67	1.70	1.80%	1.10	1.11	0.09%	54.7	53.4	-1.3	-0.7	-2.0	1.8	-20.6	-20.0	-4.00%	PASS

Calibration Date	Expiration Date	Certificate Elect Cal Delay (ns)	Certificate SAR Target Body (10) W/m ² @ 210 dBm	Measured Body SAR (10) W/m ² @ 210 dBm	Deviation (g)	Certificate SAR Target Body (10) W/m ² @ 210 dBm	Measured Body SAR (10) W/m ² @ 210 dBm	Deviation (g)	Certificate Impedance Body (Ohm) Real	Measured Impedance Body (Ohm) Real	Difference (Ohm) Real	Certificate Impedance Body (Ohm) Imaginary	Measured Impedance Body (Ohm) Imaginary	Difference (Ohm) Imaginary	Certificate Return Loss Body (dB)	Measured Return Loss Body (dB)	Deviation (dB)	PASS/FAIL
3/7/2017	3/7/2018	1.033	1.72	1.70	-1.20%	1.14	1.12	-1.41%	50.7	50.4	-0.3	-3.6	-3.0	0.3	-28.7	-28.5	0.60%	PASS

Impedance & Return-Loss Measurement Plot for Head TSL

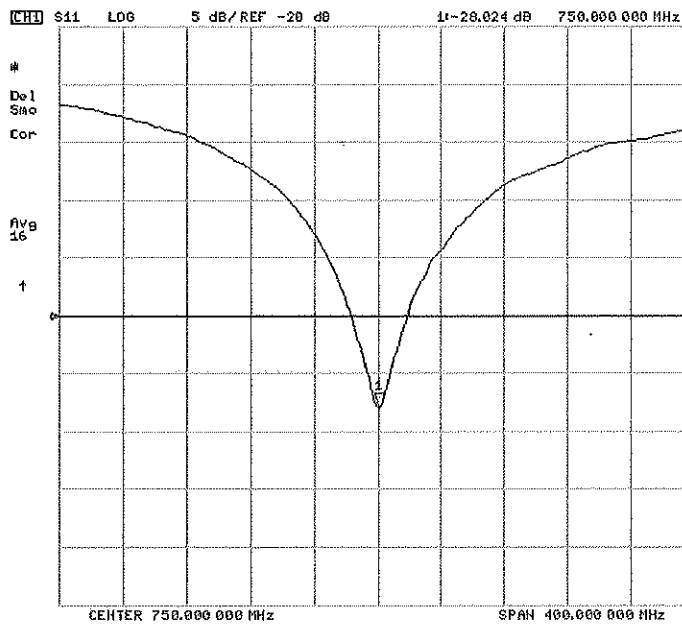
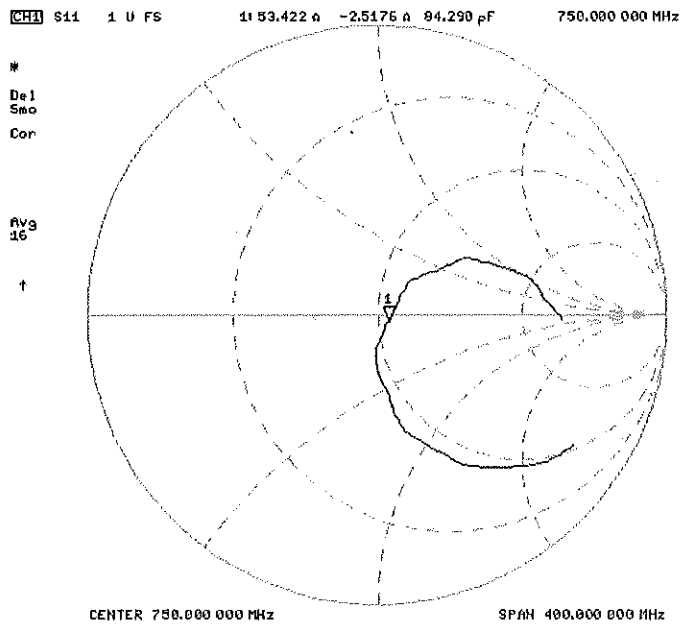

Impedance & Return-Loss Measurement Plot for Body TSL

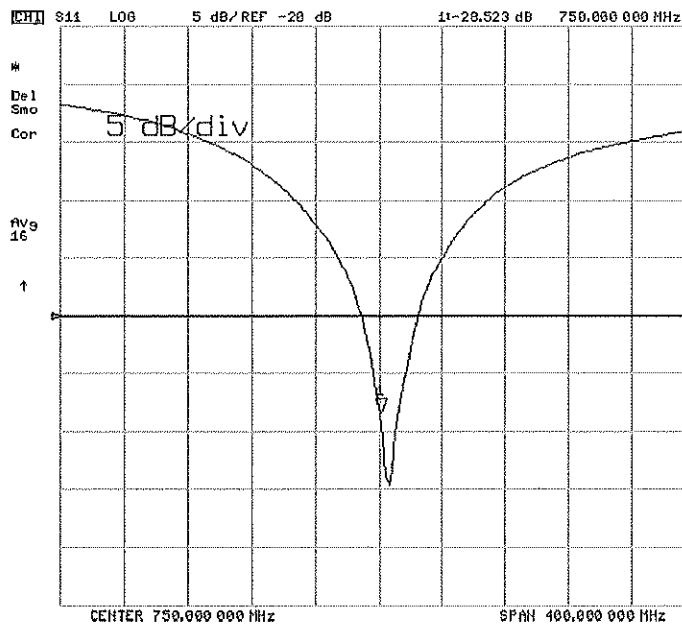
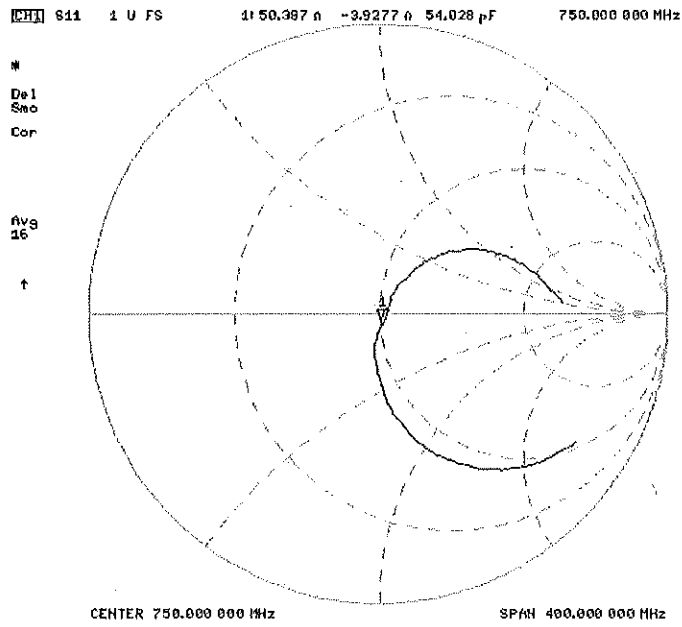



Accredited by the Swiss Accreditation Service (SAS)
The Swiss Accreditation Service is one of the signatories to the EA
Multilateral Agreement for the recognition of calibration certificates

Accreditation No.: **SCS 0108**

Client **PC Test**

Certificate No: **D835V2-4d047_Jul16**

CALIBRATION CERTIFICATE

Object **D835V2 - SN:4d047**

Calibration procedure(s) **QA CAL-05.v9
Calibration procedure for dipole validation kits above 700 MHz**

Calibration date: **July 13, 2016**

*BNV
7/16/2016
Extended
BNV
7/18/2016*

This calibration certificate documents the traceability to national standards, which realize the physical units of measurements (SI).
The measurements and the uncertainties with confidence probability are given on the following pages and are part of the certificate.

All calibrations have been conducted in the closed laboratory facility: environment temperature (22 ± 3)°C and humidity < 70%.

Calibration Equipment used (M&TE critical for calibration)

Primary Standards	ID #	Cal Date (Certificate No.)	Scheduled Calibration
Power meter NRP	SN: 104778	06-Apr-16 (No. 217-02288/02289)	Apr-17
Power sensor NRP-Z91	SN: 103244	06-Apr-16 (No. 217-02288)	Apr-17
Power sensor NRP-Z91	SN: 103245	06-Apr-16 (No. 217-02289)	Apr-17
Reference 20 dB Attenuator	SN: 5058 (20k)	05-Apr-16 (No. 217-02292)	Apr-17
Type-N mismatch combination	SN: 5047.2 / 06327	05-Apr-16 (No. 217-02295)	Apr-17
Reference Probe EX3DV4	SN: 7349	15-Jun-16 (No. EX3-7349_Jun16)	Jun-17
DAE4	SN: 601	30-Dec-15 (No. DAE4-601_Dec15)	Dec-16

Secondary Standards	ID #	Check Date (in house)	Scheduled Check
Power meter EPM-442A	SN: GB37480704	07-Oct-15 (No. 217-02222)	In house check: Oct-16
Power sensor HP 8481A	SN: US37292783	07-Oct-15 (No. 217-02222)	In house check: Oct-16
Power sensor HP 8481A	SN: MY41092317	07-Oct-15 (No. 217-02223)	In house check: Oct-16
RF generator R&S SMT-06	SN: 100972	15-Jun-15 (in house check Jun-15)	In house check: Oct-16
Network Analyzer HP 8753E	SN: US37390585	18-Oct-01 (in house check Oct-15)	In house check: Oct-16

Calibrated by: **Jeton Kastrall** Function: **Laboratory Technician**

Approved by: **Katja Pokovic** Technical Manager

Signature
[Handwritten Signature]

[Handwritten Signature]

Issued: July 13, 2016

This calibration certificate shall not be reproduced except in full without written approval of the laboratory.



Accredited by the Swiss Accreditation Service (SAS)

Accreditation No.: **SCS 0108**

The Swiss Accreditation Service is one of the signatories to the EA
Multilateral Agreement for the recognition of calibration certificates

Glossary:

TSL	tissue simulating liquid
ConvF	sensitivity in TSL / NORM x,y,z
N/A	not applicable or not measured

Calibration is Performed According to the Following Standards:

- IEEE Std 1528-2013, "IEEE Recommended Practice for Determining the Peak Spatial-Averaged Specific Absorption Rate (SAR) in the Human Head from Wireless Communications Devices: Measurement Techniques", June 2013
- IEC 62209-1, "Procedure to measure the Specific Absorption Rate (SAR) for hand-held devices used in close proximity to the ear (frequency range of 300 MHz to 3 GHz)", February 2005
- IEC 62209-2, "Procedure to determine the Specific Absorption Rate (SAR) for wireless communication devices used in close proximity to the human body (frequency range of 30 MHz to 6 GHz)", March 2010
- KDB 865664, "SAR Measurement Requirements for 100 MHz to 6 GHz"

Additional Documentation:

- DASY4/5 System Handbook

Methods Applied and Interpretation of Parameters:

- Measurement Conditions:** Further details are available from the Validation Report at the end of the certificate. All figures stated in the certificate are valid at the frequency indicated.
- Antenna Parameters with TSL:** The dipole is mounted with the spacer to position its feed point exactly below the center marking of the flat phantom section, with the arms oriented parallel to the body axis.
- Feed Point Impedance and Return Loss:** These parameters are measured with the dipole positioned under the liquid filled phantom. The impedance stated is transformed from the measurement at the SMA connector to the feed point. The Return Loss ensures low reflected power. No uncertainty required.
- Electrical Delay:** One-way delay between the SMA connector and the antenna feed point. No uncertainty required.
- SAR measured:** SAR measured at the stated antenna input power.
- SAR normalized:** SAR as measured, normalized to an input power of 1 W at the antenna connector.
- SAR for nominal TSL parameters:** The measured TSL parameters are used to calculate the nominal SAR result.

The reported uncertainty of measurement is stated as the standard uncertainty of measurement multiplied by the coverage factor $k=2$, which for a normal distribution corresponds to a coverage probability of approximately 95%.

Measurement Conditions

DASY system configuration, as far as not given on page 1.

DASY Version	DASY5	V52.8.8
Extrapolation	Advanced Extrapolation	
Phantom	Modular Flat Phantom	
Distance Dipole Center - TSL	15 mm	with Spacer
Zoom Scan Resolution	dx, dy, dz = 5 mm	
Frequency	835 MHz \pm 1 MHz	

Head TSL parameters

The following parameters and calculations were applied.

	Temperature	Permittivity	Conductivity
Nominal Head TSL parameters	22.0 °C	41.5	0.90 mho/m
Measured Head TSL parameters	(22.0 \pm 0.2) °C	40.6 \pm 6 %	0.94 mho/m \pm 6 %
Head TSL temperature change during test	< 0.5 °C	----	----

SAR result with Head TSL

SAR averaged over 1 cm ³ (1 g) of Head TSL	Condition	
SAR measured	250 mW input power	2.37 W/kg
SAR for nominal Head TSL parameters	normalized to 1W	9.13 W/kg \pm 17.0 % (k=2)

SAR averaged over 10 cm ³ (10 g) of Head TSL	condition	
SAR measured	250 mW input power	1.53 W/kg
SAR for nominal Head TSL parameters	normalized to 1W	5.95 W/kg \pm 16.5 % (k=2)

Body TSL parameters

The following parameters and calculations were applied.

	Temperature	Permittivity	Conductivity
Nominal Body TSL parameters	22.0 °C	55.2	0.97 mho/m
Measured Body TSL parameters	(22.0 \pm 0.2) °C	54.9 \pm 6 %	1.01 mho/m \pm 6 %
Body TSL temperature change during test	< 0.5 °C	----	----

SAR result with Body TSL

SAR averaged over 1 cm ³ (1 g) of Body TSL	Condition	
SAR measured	250 mW input power	2.47 W/kg
SAR for nominal Body TSL parameters	normalized to 1W	9.57 W/kg \pm 17.0 % (k=2)

SAR averaged over 10 cm ³ (10 g) of Body TSL	condition	
SAR measured	250 mW input power	1.60 W/kg
SAR for nominal Body TSL parameters	normalized to 1W	6.24 W/kg \pm 16.5 % (k=2)

Appendix (Additional assessments outside the scope of SCS 0108)

Antenna Parameters with Head TSL

Impedance, transformed to feed point	49.8 Ω - 5.9 j Ω
Return Loss	- 24.5 dB

Antenna Parameters with Body TSL

Impedance, transformed to feed point	45.8 Ω - 8.2 j Ω
Return Loss	- 20.3 dB

General Antenna Parameters and Design

Electrical Delay (one direction)	None ns
----------------------------------	---------

After long term use with 100W radiated power, only a slight warming of the dipole near the feedpoint can be measured.

The dipole is made of standard semirigid coaxial cable. The center conductor of the feeding line is directly connected to the second arm of the dipole. The antenna is therefore short-circuited for DC-signals. On some of the dipoles, small end caps are added to the dipole arms in order to improve matching when loaded according to the position as explained in the "Measurement Conditions" paragraph. The SAR data are not affected by this change. The overall dipole length is still according to the Standard.

No excessive force must be applied to the dipole arms, because they might bend or the soldered connections near the feedpoint may be damaged.

Additional EUT Data

Manufactured by	SPEAG
Manufactured on	August 16, 2006

DASY5 Validation Report for Head TSL

Date: 13.07.2016

Test Laboratory: SPEAG, Zurich, Switzerland

DUT: Dipole 835 MHz D835V2; Type: D835V2; Serial: D835V2 - SN:4d047

Communication System: UID 0 - CW; Frequency: 835 MHz

Medium parameters used: $f = 835$ MHz; $\sigma = 0.94$ S/m; $\epsilon_r = 40.6$; $\rho = 1000$ kg/m³

Phantom section: Flat Section

Measurement Standard: DASY5 (IEEE/IEC/ANSI C63.19-2011)

DASY52 Configuration:

- Probe: EX3DV4 - SN7349; ConvF(9.72, 9.72, 9.72); Calibrated: 15.06.2016;
- Sensor-Surface: 1.4mm (Mechanical Surface Detection)
- Electronics: DAE4 Sn601; Calibrated: 30.12.2015
- Phantom: Flat Phantom 4.9L; Type: QD000P49AA; Serial: 1001
- DASY52 52.8.8(1258); SEMCAD X 14.6.10(7372)

Dipole Calibration for Head Tissue/Pin=250 mW, d=15mm/Zoom Scan (7x7x7)/Cube 0:

Measurement grid: dx=5mm, dy=5mm, dz=5mm

Reference Value = 60.98 V/m; Power Drift = 0.01 dB

Peak SAR (extrapolated) = 3.56 W/kg

SAR(1 g) = 2.37 W/kg; SAR(10 g) = 1.53 W/kg

Maximum value of SAR (measured) = 3.17 W/kg

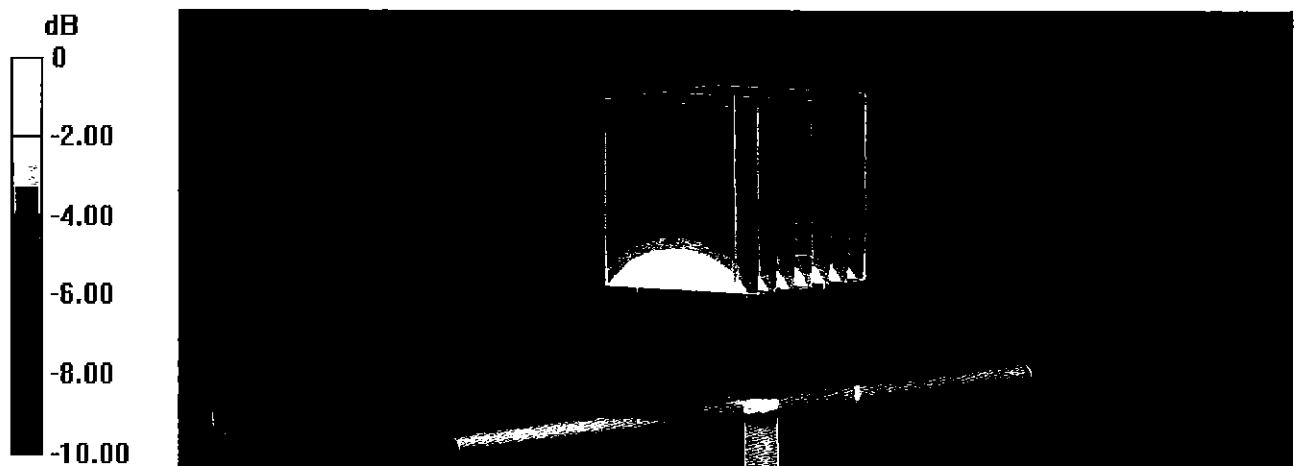

0 dB = 3.17 W/kg = 5.01 dBW/kg

Impedance Measurement Plot for Head TSL

13 Jul 2016 12:00:27

CH1 S11 1 U FS

1: 49.820 Ω -5.9316 Ω 32.134 pF

835.000 000 MHz

*
De1
CA

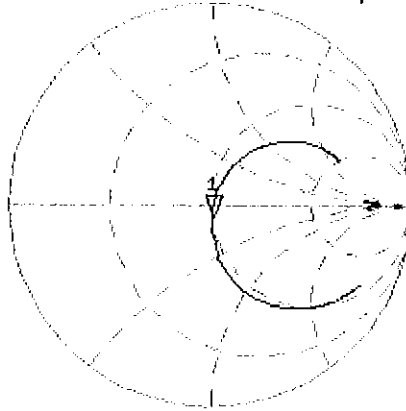

Avg
16

H1d

CH2 S11 LOG

5 dB/REF -20 dB

1:-24.525 dB

835.000 000 MHz

CA

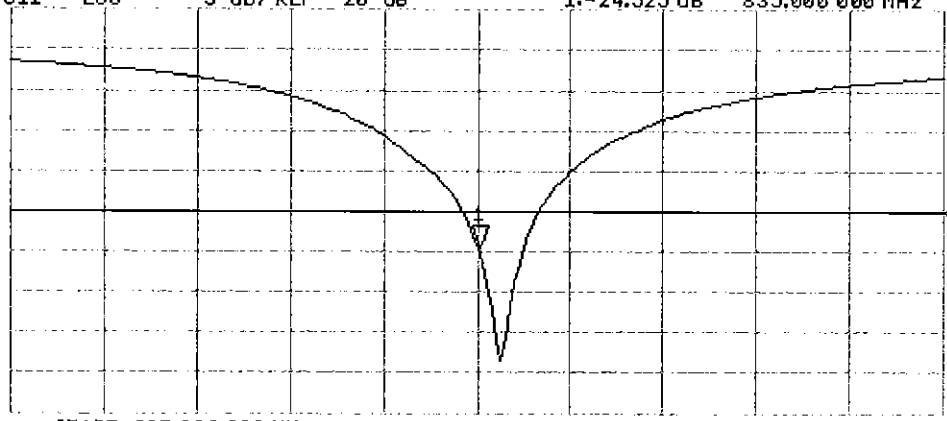

Avg
16

H1d

START 635.000 000 MHz

STOP 1 035.000 000 MHz

DASY5 Validation Report for Body TSL

Date: 13.07.2016

Test Laboratory: SPEAG, Zurich, Switzerland

DUT: Dipole 835 MHz D835V2; Type: D835V2; Serial: D835V2 - SN:4d047

Communication System: UID 0 - CW; Frequency: 835 MHz

Medium parameters used: $f = 835$ MHz; $\sigma = 1.01$ S/m; $\epsilon_r = 54.9$; $\rho = 1000$ kg/m³

Phantom section: Flat Section

Measurement Standard: DASY5 (IEEE/IEC/ANSI C63.19-2011)

DASY52 Configuration:

- Probe: EX3DV4 - SN7349; ConvF(9.73, 9.73, 9.73); Calibrated: 15.06.2016;
- Sensor-Surface: 1.4mm (Mechanical Surface Detection)
- Electronics: DAE4 Sn601; Calibrated: 30.12.2015
- Phantom: Flat Phantom 4.9L; Type: QD000P49AA; Serial: 1001
- DASY52 52.8.8(1258); SEMCAD X 14.6.10(7372)

Dipole Calibration for Body Tissue/Pin=250 mW, d=15mm/Zoom Scan (7x7x7)/Cube 0:

Measurement grid: dx=5mm, dy=5mm, dz=5mm

Reference Value = 59.88 V/m; Power Drift = -0.01 dB

Peak SAR (extrapolated) = 3.67 W/kg

SAR(1 g) = 2.47 W/kg; SAR(10 g) = 1.6 W/kg

Maximum value of SAR (measured) = 3.27 W/kg



0 dB = 3.27 W/kg = 5.15 dBW/kg

Impedance Measurement Plot for Body TSL

13 Jul 2016 13:35:41
CH1 S11 1 U FS 1: 45.793 Ω -8.1777 Ω 23.308 pF 835.000 000 MHz

*
Del

CA

Avg
16

H1 d

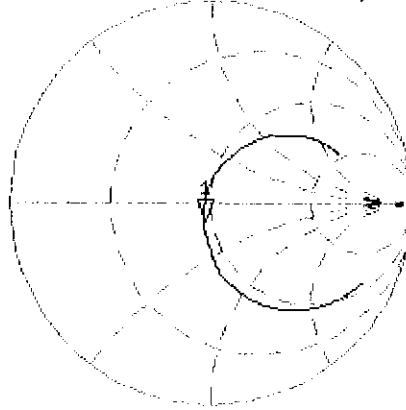

CH2 S11 LOG 5 dB/ REF -20 dB 1: -20.332 dB 835.000 000 MHz

CA

H1 d

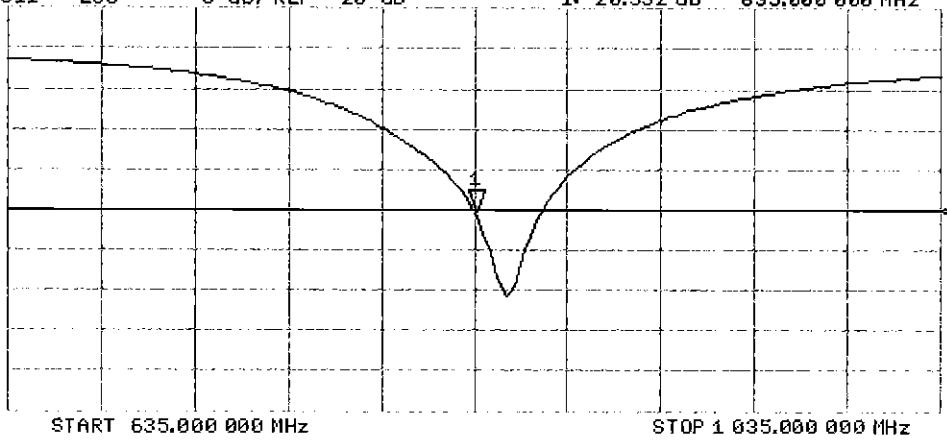

Certification of Calibration

Object D835V2 – SN: 4d047

Calibration procedure(s) Procedure for Calibration Extension for SAR Dipoles.

Calibration date: July 13, 2017

Description: SAR Validation Dipole at 835 MHz.

Calibration Equipment used:

Manufacturer	Model	Description	Cal Date	Cal Interval	Cal Due	Serial Number
Control Company	4040	Therm./Clock/Humidity Monitor	3/31/2017	Biennial	3/31/2019	170232394
Control Company	4352	Ultra Long Stem Thermometer	5/2/2017	Biennial	5/2/2019	170330156
Amplifier Research	1551G6	Amplifier	CBT	N/A	CBT	433971
Narda	4772-3	Attenuator (3dB)	CBT	N/A	CBT	9406
Keysight Technologies	85033E	Standard Mechanical Calibration Kit (DC to 9GHz, 3.5mm)	6/1/2017	Annual	6/1/2018	MY53401181
Agilent	8753ES	S-Parameter Network Analyzer	10/26/2016	Annual	10/26/2017	US39170118
Mini-Circuits	BW-N20W5+	DC to 18 GHz Precision Fixed 20 dB Attenuator	CBT	N/A	CBT	N/A
SPEAG	DAE4	Dasy Data Acquisition Electronics	3/8/2017	Annual	3/8/2018	1368
SPEAG	DAE4	Dasy Data Acquisition Electronics	3/13/2017	Annual	3/13/2018	1415
SPEAG	DAK-3.5	Dielectric Assessment Kit	5/10/2017	Annual	5/10/2018	1070
SPEAG	ES3DV3	SAR Probe	3/14/2017	Annual	3/14/2018	3209
SPEAG	ES3DV3	SAR Probe	3/14/2017	Annual	3/14/2018	3319
Anritsu	MA2411B	Pulse Power Sensor	2/10/2017	Annual	2/10/2018	1207364
Anritsu	MA2411B	Pulse Power Sensor	2/10/2017	Annual	2/10/2018	1339018
Anritsu	ML2495A	Power Meter	10/16/2015	Biennial	10/16/2017	941001
Agilent	N5182A	MXG Vector Signal Generator	2/28/2017	Annual	2/28/2018	MY47420800
Seekonk	NC-100	Torque Wrench	11/6/2015	Biennial	11/6/2017	N/A
Mini-Circuits	NLP-2950+	Low Pass Filter DC to 2700 MHz	CBT	N/A	CBT	N/A
Pasternack	PE2208-6	Bidirectional Coupler	CBT	N/A	CBT	N/A

Measurement Uncertainty = $\pm 23\%$ (k=2)

	Name	Function	Signature
Calibrated By:	Brodie Halfoster	Test Engineer	<i>BRODIE HALBFOSTER</i>
Approved By:	Kaitlin O'Keefe	Senior Technical Manager	<i>KOK</i>

DIPOLE CALIBRATION EXTENSION

Per KDB 865664 D01, calibration intervals of up to three years may be considered for reference dipoles when it is demonstrated that the SAR target, impedance and return loss of a dipole have remained stable according to the following requirements:

1. The measured SAR does not deviate more than 10% from the target on the calibration certificate.
2. The return-loss does not deviate more than 20% from the previous measurement and meets the required 20dB minimum return-loss requirement.
3. The measurement of real or imaginary parts of impedance does not deviate more than 5Ω from the previous measurement.

The following dipole was checked to pass the above 3 requirements to have 2-year calibration period from the calibration date:

Calibration Date	Extension Date	Certificate Electrical Delay (ns)	Certificate SAR Target Head (1g) W/kg @ 23.0 dBm	Measured Head SAR (1g) W/kg @ 23.0 dBm	Deviation 1g (%)	Certificate SAR Target Head (10g) W/kg @ 23.0 dBm	Measured Head SAR (10g) W/kg @ 23.0 dBm	Deviation 10g (%)	Certificate Impedance Head (Ohm) Real	Measured Impedance Head (Ohm) Real	Difference (Ohm) Real	Certificate Impedance Head (Ohm) Imaginary	Measured Impedance Head (Ohm) Imaginary	Difference (Ohm) Imaginary	Certificate Return Loss Head (dB)	Measured Return Loss Head (dB)	Deviation (%)	PASS/FAIL
7/13/2016	7/13/2017	0	1.83	1.95	6.79%	1.19	1.28	7.56%	49.8	50.8	1	-5.0	-2.3	3.6	-24.5	-25.2	-15.10%	PASS
Calibration Date	Extension Date	Certificate Electrical Delay (ns)	Certificate SAR Target Body (1g) W/kg @ 23.0 dBm	Measured Body SAR (1g) W/kg @ 23.0 dBm	Deviation 1g (%)	Certificate SAR Target Body (10g) W/kg @ 23.0 dBm	Measured Body SAR (10g) W/kg @ 23.0 dBm	Deviation 10g (%)	Certificate Impedance Body (Ohm) Real	Measured Impedance Body (Ohm) Real	Difference (Ohm) Real	Certificate Impedance Body (Ohm) Imaginary	Measured Impedance Body (Ohm) Imaginary	Difference (Ohm) Imaginary	Certificate Return Loss Body (dB)	Measured Return Loss Body (dB)	Deviation (%)	PASS/FAIL
7/13/2016	7/13/2017	0	1.91	1.99	3.97%	1.25	1.31	4.97%	45.8	46.3	0.5	-8.2	-6.7	1.5	-20.3	-22.5	-10.80%	PASS

Impedance & Return-Loss Measurement Plot for Head TSL

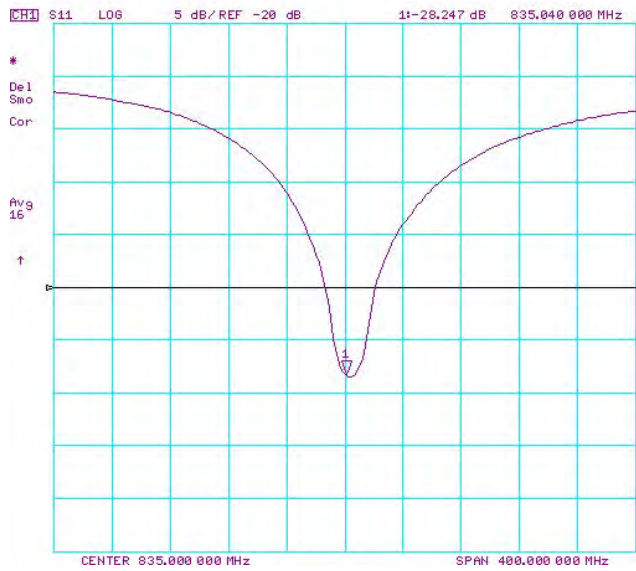
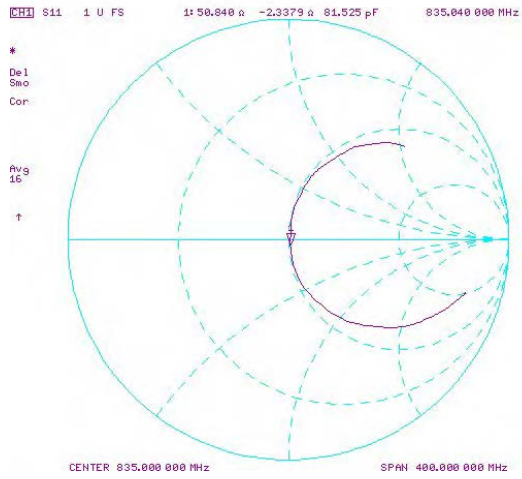

Impedance & Return-Loss Measurement Plot for Body TSL

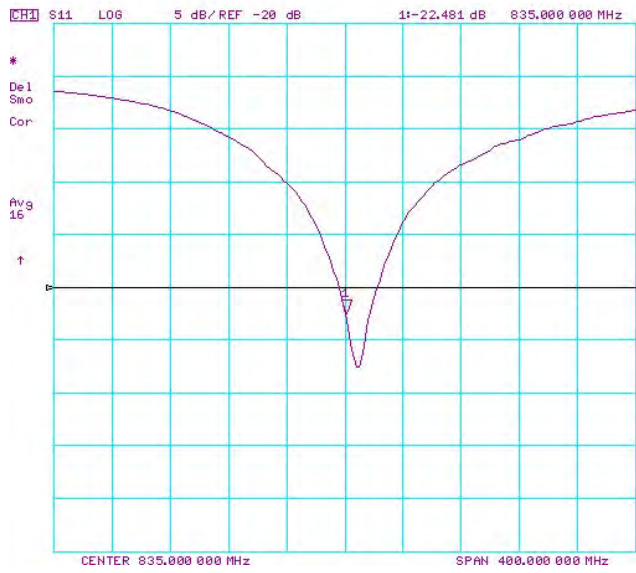
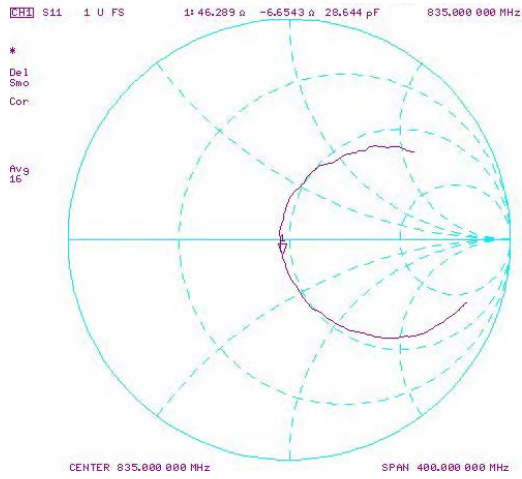

Certification of Calibration

Object D835V2 – SN: 4d047

Calibration procedure(s) Procedure for Calibration Extension for SAR Dipoles.

Extended Calibration date: 07/12/2018

Description: SAR Validation Dipole at 835 MHz.

Calibration Equipment used:

Manufacturer	Model	Description	Cal Date	Cal Interval	Cal Due	Serial Number
Agilent	E4438C	ESG Vector Signal Generator	3/24/2017	Biennial	3/24/2019	MY42082385
Agilent	8753ES	S-Parameter Network Analyzer	9/14/2017	Annual	9/14/2018	US39170118
Amplifier Research	15S1G6	Amplifier	CBT	N/A	CBT	433971
Anritsu	ML2495A	Power Meter	11/28/2017	Annual	11/28/2018	1039008
Anritsu	MA2411B	Pulse Power Sensor	3/2/2018	Annual	3/2/2019	1207364
Anritsu	MA2411B	Pulse Power Sensor	11/15/2017	Annual	11/15/2018	1339007
Control Company	4040	Therm./Clock/Humidity Monitor	3/31/2017	Biennial	3/31/2019	170232394
Control Company	4352	Ultra Long Stem Thermometer	5/2/2017	Biennial	5/2/2019	170330156
Keysight	772D	Dual Directional Coupler	CBT	N/A	CBT	MY52180215
Keysight Technologies	85033E	Standard Mechanical Calibration Kit (DC to 9GHz, 3.5mm)	6/4/2018	Annual	6/4/2019	MY53401181
Mini-Circuits	BW-N20W5+	DC to 18 GHz Precision Fixed 20 dB Attenuator	CBT	N/A	CBT	N/A
Mini-Circuits	NLP-2950+	Low Pass Filter DC to 2700 MHz	CBT	N/A	CBT	N/A
Narda	4772-3	Attenuator (3dB)	CBT	N/A	CBT	9406
Pasternack	PE2208-6	Bidirectional Coupler	CBT	N/A	CBT	N/A
Pasternack	PE5011-1	Torque Wrench	7/19/2017	Biennial	7/19/2019	N/A
SPEAG	DAE4	Dasy Data Acquisition Electronics	2/9/2018	Annual	2/9/2019	1272
SPEAG	DAE4	Dasy Data Acquisition Electronics	11/9/2017	Annual	11/9/2018	1450
SPEAG	DAK-3.5	Dielectric Assessment Kit	9/12/2017	Annual	9/12/2018	1091
SPEAG	ES3DV3	SAR Probe	2/13/2018	Annual	2/13/2019	3213
SPEAG	ES3DV3	SAR Probe	3/27/2018	Annual	3/27/2019	3347

Measurement Uncertainty = $\pm 23\%$ (k=2)

	Name	Function	Signature
Calibrated By:	Brodie Halfoster	Test Engineer	<i>BRODIE HALFOSTER</i>
Approved By:	Kaitlin O'Keefe	Senior Technical Manager	<i>KOK</i>

DIPOLE CALIBRATION EXTENSION

Per KDB 865664 D01, calibration intervals of up to three years may be considered for reference dipoles when it is demonstrated that the SAR target, impedance and return loss of a dipole have remained stable according to the following requirements:

1. The measured SAR does not deviate more than 10% from the target on the calibration certificate.
2. The return-loss does not deviate more than 20% from the previous measurement and meets the required 20dB minimum return-loss requirement.
3. The measurement of real or imaginary parts of impedance does not deviate more than 5Ω from the previous measurement.

The following dipole was checked to pass the above 3 requirements to have 3-year calibration period from the calibration date:

Calibration Date	Extension Date	Certificate Electrical Delay (ns)	Certificate SAR Target Head (1g) W/kg @ 23.0 dBm	Measured Head SAR (1g) W/kg @ 23.0 dBm	Deviation 1g (%)	Certificate SAR Target Head (10g) W/kg @ 23.0 dBm	Measured Head SAR (10g) W/kg @ 23.0 dBm	Deviation 10g (%)	Certificate Impedance Head (Ohm) Real	Measured Impedance Head (Ohm) Real	Difference (Ohm) Real	Certificate Impedance Head (Ohm) Imaginary	Measured Impedance Head (Ohm) Imaginary	Difference (Ohm) Imaginary	Certificate Return Loss Head (dB)	Measured Return Loss Head (dB)	Deviation (%)	PASS/FAIL
7/13/2016	7/12/2018	0	1.825	1.850	3.50%	1.150	1.240	4.20%	49.8	47.6	2.2	-5.9	-3.6	2.3	-24.5	-27.1	-10.60%	PASS
Calibration Date	Extension Date	Certificate Electrical Delay (ns)	Certificate SAR Target Body (1g) W/kg @ 23.0 dBm	Measured Body SAR (1g) W/kg @ 23.0 dBm	Deviation 1g (%)	Certificate SAR Target Body (10g) W/kg @ 23.0 dBm	Measured Body SAR (10g) W/kg @ 23.0 dBm	Deviation 10g (%)	Certificate Impedance Body (Ohm) Real	Measured Impedance Body (Ohm) Real	Difference (Ohm) Real	Certificate Impedance Body (Ohm) Imaginary	Measured Impedance Body (Ohm) Imaginary	Difference (Ohm) Imaginary	Certificate Return Loss Body (dB)	Measured Return Loss Body (dB)	Deviation (%)	PASS/FAIL
7/13/2016	7/12/2018	0	1.914	1.910	-0.21%	1.248	1.260	0.96%	45.8	45.6	0.2	-8.2	-5.6	2.6	-20.3	-22.6	-11.30%	PASS

Impedance & Return-Loss Measurement Plot for Head TSL

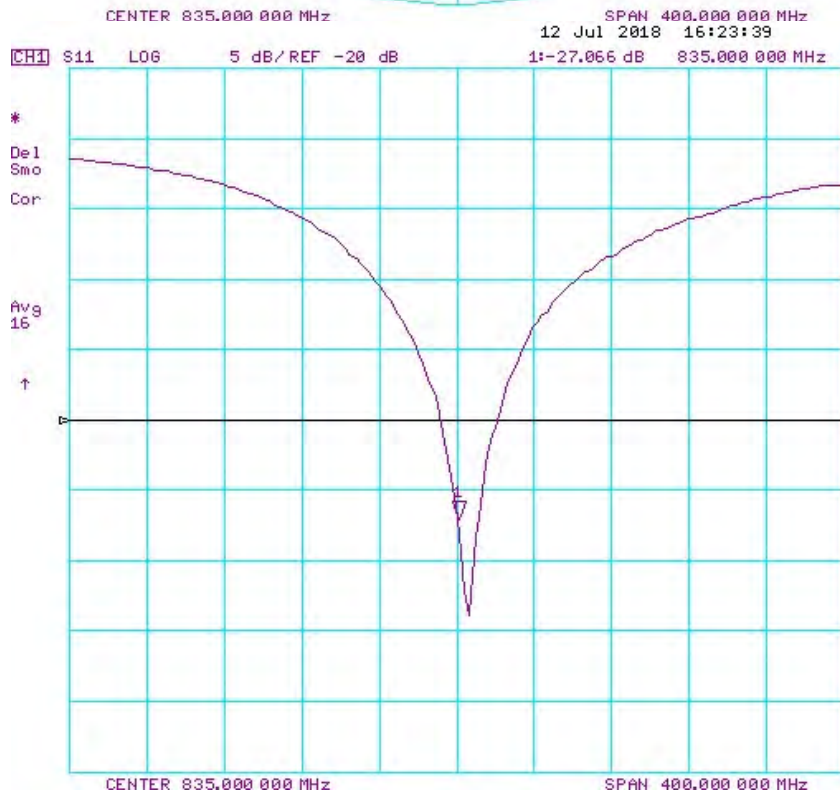
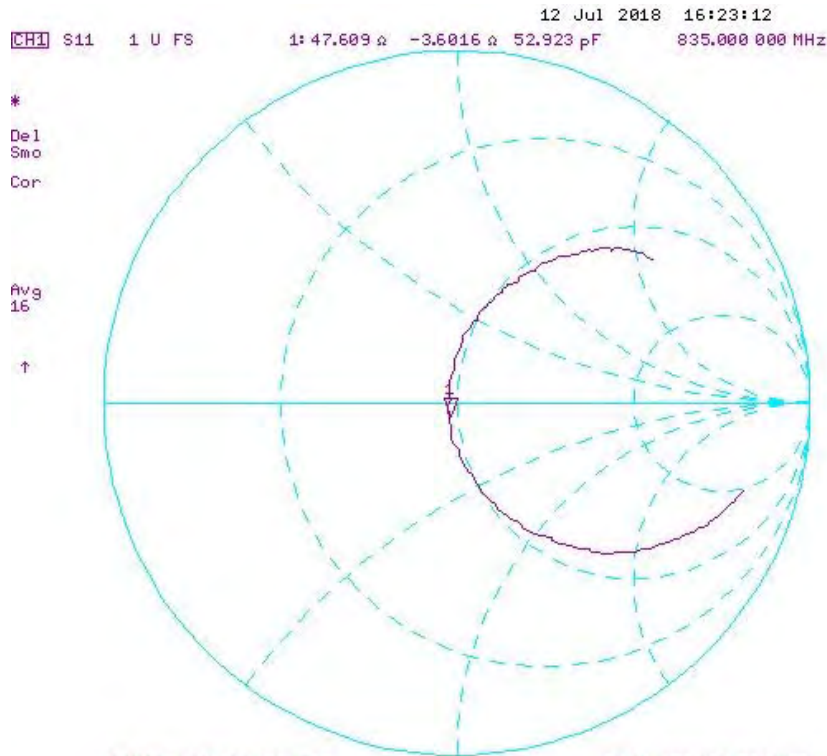

Impedance & Return-Loss Measurement Plot for Body TSL

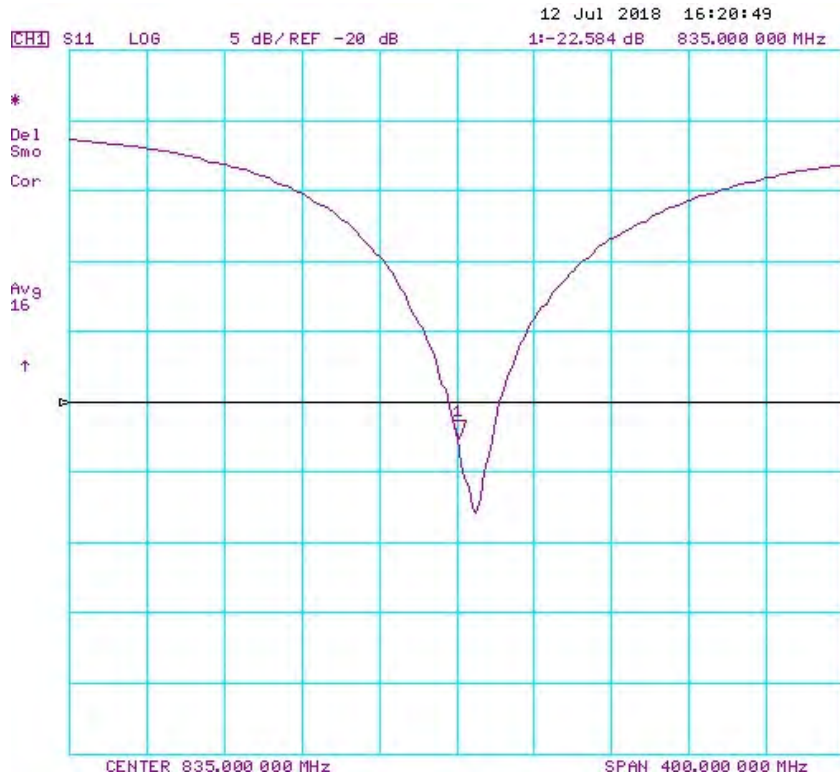
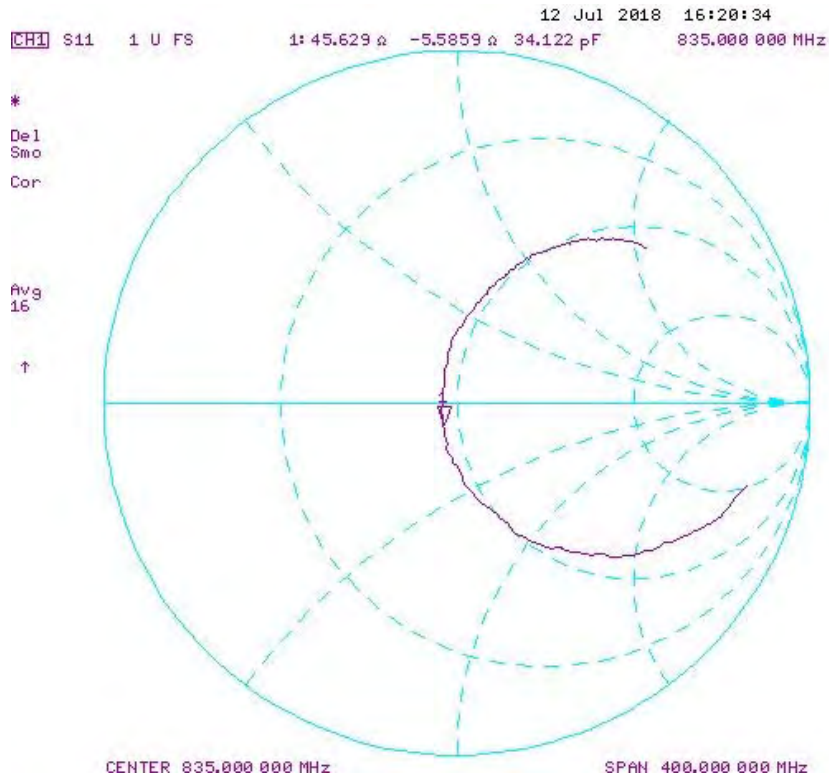

**Calibration Laboratory of
Schmid & Partner
Engineering AG**
Zeughausstrasse 43, 8004 Zurich, Switzerland



S Schweizerischer Kalibrierdienst
C Service suisse d'étalonnage
S Servizio svizzero di taratura
S Swiss Calibration Service

Accredited by the Swiss Accreditation Service (SAS)
The Swiss Accreditation Service is one of the signatories to the EA
Multilateral Agreement for the recognition of calibration certificates

Accreditation No.: **SCS 0108**

Client **PC Test**

Certificate No: **D1750V2-1150_Jul16**

CALIBRATION CERTIFICATE

Object **D1750V2 - SN:1150**

Calibration procedure(s) **QA CAL-05.v9**
Calibration procedure for dipole validation kits above 700 MHz

Calibration date: **July 14, 2016**

✓PN
8/9/16
Extended
BN
7/18/2018

This calibration certificate documents the traceability to national standards, which realize the physical units of measurements (SI).
The measurements and the uncertainties with confidence probability are given on the following pages and are part of the certificate.

All calibrations have been conducted in the closed laboratory facility: environment temperature (22 ± 3)°C and humidity < 70%.

Calibration Equipment used (M&TE critical for calibration)

Primary Standards	ID #	Cal Date (Certificate No.)	Scheduled Calibration
Power meter NRP	SN: 104778	06-Apr-16 (No. 217-02288/02289)	Apr-17
Power sensor NRP-Z91	SN: 103244	06-Apr-16 (No. 217-02288)	Apr-17
Power sensor NRP-Z91	SN: 103245	06-Apr-16 (No. 217-02289)	Apr-17
Reference 20 dB Attenuator	SN: 5058 (20k)	05-Apr-16 (No. 217-02292)	Apr-17
Type-N mismatch combination	SN: 5047.2 / 06327	05-Apr-16 (No. 217-02295)	Apr-17
Reference Probe EX3DV4	SN: 7349	15-Jun-16 (No. EX3-7349_Jun16)	Jun-17
DAE4	SN: 601	30-Dec-15 (No. DAE4-601_Dec15)	Dec-16

Secondary Standards	ID #	Check Date (in house)	Scheduled Check
Power meter EPM-442A	SN: GB37480704	07-Oct-15 (No. 217-02222)	In house check: Oct-16
Power sensor HP 8481A	SN: US37292783	07-Oct-15 (No. 217-02222)	In house check: Oct-16
Power sensor HP 8481A	SN: MY41092317	07-Oct-15 (No. 217-02223)	In house check: Oct-16
RF generator R&S SMT-06	SN: 100972	15-Jun-15 (in house check Jun-15)	In house check: Oct-16
Network Analyzer HP 8753E	SN: US37390585	18-Oct-01 (in house check Oct-15)	In house check: Oct-16

Calibrated by: **Jeton Kastrati** Name: **Jeton Kastrati** Function: **Laboratory Technician**

Approved by: **Katja Pokovic** Name: **Katja Pokovic** Function: **Technical Manager**

Signature
[Handwritten Signature]

Issued: July 14, 2016

This calibration certificate shall not be reproduced except in full without written approval of the laboratory.



Accredited by the Swiss Accreditation Service (SAS)
The Swiss Accreditation Service is one of the signatories to the EA
Multilateral Agreement for the recognition of calibration certificates

Accreditation No.: **SCS 0108**

Glossary:

TSL	tissue simulating liquid
ConvF	sensitivity in TSL / NORM x,y,z
N/A	not applicable or not measured

Calibration is Performed According to the Following Standards:

- IEEE Std 1528-2013, "IEEE Recommended Practice for Determining the Peak Spatial-Averaged Specific Absorption Rate (SAR) in the Human Head from Wireless Communications Devices: Measurement Techniques", June 2013
- IEC 62209-1, "Procedure to measure the Specific Absorption Rate (SAR) for hand-held devices used in close proximity to the ear (frequency range of 300 MHz to 3 GHz)", February 2005
- IEC 62209-2, "Procedure to determine the Specific Absorption Rate (SAR) for wireless communication devices used in close proximity to the human body (frequency range of 30 MHz to 6 GHz)", March 2010
- KDB 865664, "SAR Measurement Requirements for 100 MHz to 6 GHz"

Additional Documentation:

- DASY4/5 System Handbook

Methods Applied and Interpretation of Parameters:

- Measurement Conditions:** Further details are available from the Validation Report at the end of the certificate. All figures stated in the certificate are valid at the frequency indicated.
- Antenna Parameters with TSL:** The dipole is mounted with the spacer to position its feed point exactly below the center marking of the flat phantom section, with the arms oriented parallel to the body axis.
- Feed Point Impedance and Return Loss:** These parameters are measured with the dipole positioned under the liquid filled phantom. The impedance stated is transformed from the measurement at the SMA connector to the feed point. The Return Loss ensures low reflected power. No uncertainty required.
- Electrical Delay:** One-way delay between the SMA connector and the antenna feed point. No uncertainty required.
- SAR measured:** SAR measured at the stated antenna input power.
- SAR normalized:** SAR as measured, normalized to an input power of 1 W at the antenna connector.
- SAR for nominal TSL parameters:** The measured TSL parameters are used to calculate the nominal SAR result.

The reported uncertainty of measurement is stated as the standard uncertainty of measurement multiplied by the coverage factor $k=2$, which for a normal distribution corresponds to a coverage probability of approximately 95%.

Measurement Conditions

DASY system configuration, as far as not given on page 1.

DASY Version	DASY5	V52.8.8
Extrapolation	Advanced Extrapolation	
Phantom	Modular Flat Phantom	
Distance Dipole Center - TSL	10 mm	with Spacer
Zoom Scan Resolution	dx, dy, dz = 5 mm	
Frequency	1750 MHz \pm 1 MHz	

Head TSL parameters

The following parameters and calculations were applied.

	Temperature	Permittivity	Conductivity
Nominal Head TSL parameters	22.0 °C	40.1	1.37 mho/m
Measured Head TSL parameters	(22.0 \pm 0.2) °C	38.8 \pm 6 %	1.36 mho/m \pm 6 %
Head TSL temperature change during test	< 0.5 °C	----	----

SAR result with Head TSL

SAR averaged over 1 cm ³ (1 g) of Head TSL	Condition	
SAR measured	250 mW input power	9.06 W/kg
SAR for nominal Head TSL parameters	normalized to 1W	36.1 W/kg \pm 17.0 % (k=2)

SAR averaged over 10 cm ³ (10 g) of Head TSL	condition	
SAR measured	250 mW input power	4.80 W/kg
SAR for nominal Head TSL parameters	normalized to 1W	19.2 W/kg \pm 16.5 % (k=2)

Body TSL parameters

The following parameters and calculations were applied.

	Temperature	Permittivity	Conductivity
Nominal Body TSL parameters	22.0 °C	53.4	1.49 mho/m
Measured Body TSL parameters	(22.0 \pm 0.2) °C	53.4 \pm 6 %	1.48 mho/m \pm 6 %
Body TSL temperature change during test	< 0.5 °C	----	----

SAR result with Body TSL

SAR averaged over 1 cm ³ (1 g) of Body TSL	Condition	
SAR measured	250 mW input power	9.09 W/kg
SAR for nominal Body TSL parameters	normalized to 1W	36.5 W/kg \pm 17.0 % (k=2)

SAR averaged over 10 cm ³ (10 g) of Body TSL	condition	
SAR measured	250 mW input power	4.85 W/kg
SAR for nominal Body TSL parameters	normalized to 1W	19.5 W/kg \pm 16.5 % (k=2)

Appendix (Additional assessments outside the scope of SCS 0108)

Antenna Parameters with Head TSL

Impedance, transformed to feed point	50.9 Ω + 0.4 j Ω
Return Loss	- 40.2 dB

Antenna Parameters with Body TSL

Impedance, transformed to feed point	46.4 Ω - 0.5 j Ω
Return Loss	- 28.5 dB

General Antenna Parameters and Design

Electrical Delay (one direction)	1.218 ns
----------------------------------	----------

After long term use with 100W radiated power, only a slight warming of the dipole near the feedpoint can be measured.

The dipole is made of standard semirigid coaxial cable. The center conductor of the feeding line is directly connected to the second arm of the dipole. The antenna is therefore short-circuited for DC-signals. On some of the dipoles, small end caps are added to the dipole arms in order to improve matching when loaded according to the position as explained in the "Measurement Conditions" paragraph. The SAR data are not affected by this change. The overall dipole length is still according to the Standard.

No excessive force must be applied to the dipole arms, because they might bend or the soldered connections near the feedpoint may be damaged.

Additional EUT Data

Manufactured by	SPEAG
Manufactured on	April 10, 2015

DASY5 Validation Report for Head TSL

Date: 14.07.2016

Test Laboratory: SPEAG, Zurich, Switzerland

DUT: Dipole 1750 MHz D1750V2; Type: D1750V2; Serial: D1750V2 - SN:1150

Communication System: UID 0 - CW; Frequency: 1750 MHz

Medium parameters used: $f = 1750$ MHz; $\sigma = 1.36$ S/m; $\epsilon_r = 38.8$; $\rho = 1000$ kg/m³

Phantom section: Flat Section

Measurement Standard: DASY5 (IEEE/IEC/ANSI C63.19-2011)

DASY52 Configuration:

- Probe: EX3DV4 - SN7349; ConvF(8.46, 8.46, 8.46); Calibrated: 15.06.2016;
- Sensor-Surface: 1.4mm (Mechanical Surface Detection)
- Electronics: DAE4 Sn601; Calibrated: 30.12.2015
- Phantom: Flat Phantom 5.0 (front); Type: QD000P50AA; Serial: 1001
- DASY52 52.8.8(1258); SEMCAD X 14.6.10(7372)

Dipole Calibration for Head Tissue/Pin=250 mW, d=10mm/Zoom Scan (7x7x7)/Cube 0:

Measurement grid: dx=5mm, dy=5mm, dz=5mm

Reference Value = 104.4 V/m; Power Drift = -0.03 dB

Peak SAR (extrapolated) = 16.6 W/kg

SAR(1 g) = 9.06 W/kg; SAR(10 g) = 4.8 W/kg

Maximum value of SAR (measured) = 13.9 W/kg



0 dB = 13.9 W/kg = 11.43 dBW/kg

Impedance Measurement Plot for Head TSL

14 Jul 2016 13:09:21

CH1 S11 1 U FS 2: 50.889 Ω 0.4121 Ω 37.479 μH 1 750.000 000 MHz

*
De1
CA
Avg
16
H1d

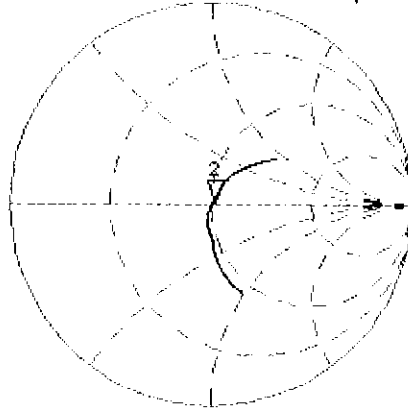

CH2 S11 LOG 5 dB/REF -20 dB 2:-40.230 dB 1 750.000 000 MHz

CA
Avg
16
H1d

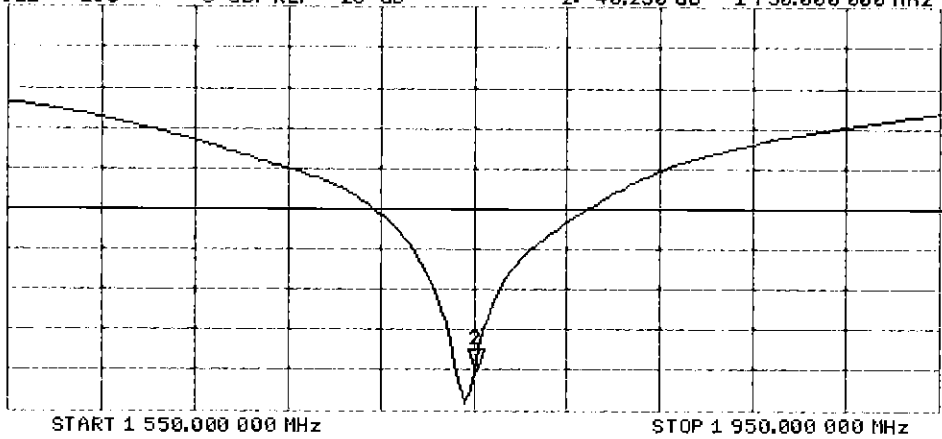

DASY5 Validation Report for Body TSL

Date: 14.07.2016

Test Laboratory: SPEAG, Zurich, Switzerland

DUT: Dipole 1750 MHz D1750V2; Type: D1750V2; Serial: D1750V2 - SN:1150

Communication System: UID 0 - CW; Frequency: 1750 MHz

Medium parameters used: $f = 1750$ MHz; $\sigma = 1.48$ S/m; $\epsilon_r = 53.4$; $\rho = 1000$ kg/m³

Phantom section: Flat Section

Measurement Standard: DASY5 (IEEE/IEC/ANSI C63.19-2011)

DASY52 Configuration:

- Probe: EX3DV4 - SN7349; ConvF(8.25, 8.25, 8.25); Calibrated: 15.06.2016;
- Sensor-Surface: 1.4mm (Mechanical Surface Detection)
- Electronics: DAE4 Sn601; Calibrated: 30.12.2015
- Phantom: Flat Phantom 5.0 (back); Type: QD000P50AA; Serial: 1002
- DASY52 52.8.8(1258); SEMCAD X 14.6.10(7372)

Dipole Calibration for Body Tissue/Pin=250 mW, d=10mm/Zoom Scan (7x7x7)/Cube 0:

Measurement grid: dx=5mm, dy=5mm, dz=5mm

Reference Value = 100.4 V/m; Power Drift = -0.01 dB

Peak SAR (extrapolated) = 16.0 W/kg

SAR(1 g) = 9.09 W/kg; SAR(10 g) = 4.85 W/kg

Maximum value of SAR (measured) = 13.7 W/kg

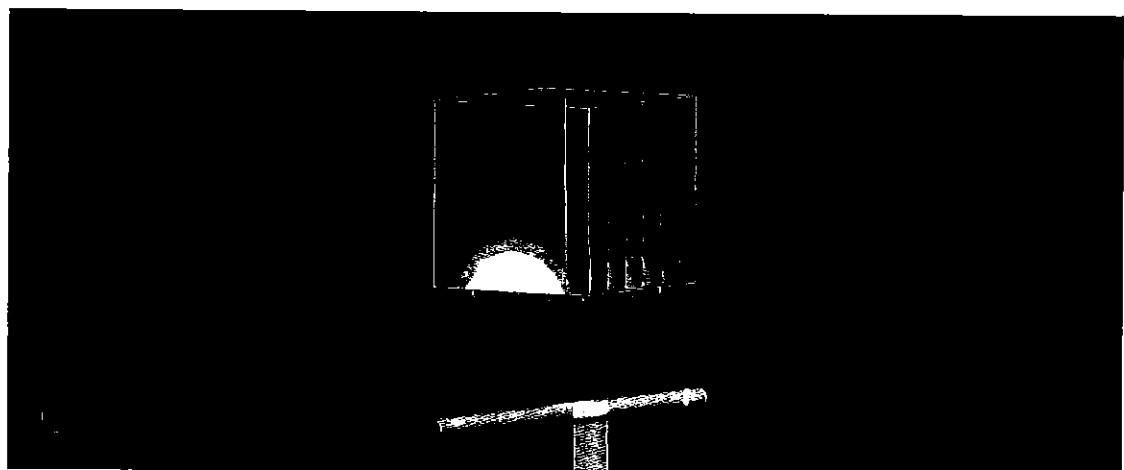
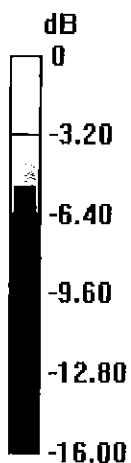

0 dB = 13.7 W/kg = 11.37 dBW/kg

Impedance Measurement Plot for Body TSL

14 Jul 2016 13:08:43

CH1 S11 1 U FS

2: 46.404 Ω -456.80 m Ω 194.83 pF

1 750.000 000 MHz

*
De1

CA

Avg
16

H1d

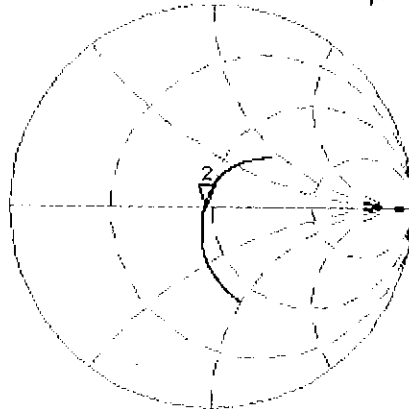

CH2 S11 LOG

5 dB/REF -20 dB

2: -28.487 dB 1 750.000 000 MHz

CA

Avg
16

H1d

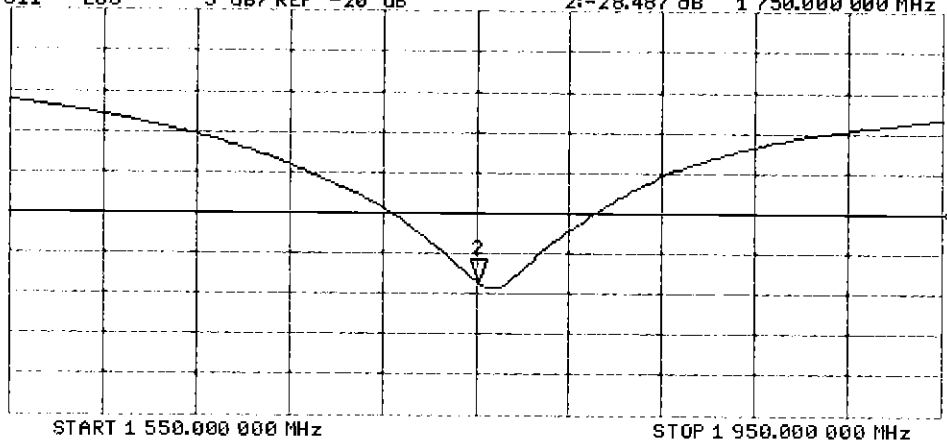

Certification of Calibration

Object D1750V2 – SN: 1150

Calibration procedure(s) Procedure for Calibration Extension for SAR Dipoles.

Calibration date: July 07, 2017

Description: SAR Validation Dipole at 1750 MHz.

Calibration Equipment used:

Manufacturer	Model	Description	Cal Date	Cal Interval	Cal Due	Serial Number
Control Company	4040	Therm./Clock/Humidity Monitor	3/31/2017	Biennial	3/31/2019	170232394
Control Company	4352	Ultra Long Stem Thermometer	5/2/2017	Biennial	5/2/2019	170330156
Amplifier Research	1551G6	Amplifier	CBT	N/A	CBT	433971
Narda	4772-3	Attenuator (3dB)	CBT	N/A	CBT	9406
Keysight Technologies	85033E	Standard Mechanical Calibration Kit (DC to 9GHz, 3.5mm)	6/1/2017	Annual	6/1/2018	MY53401181
Agilent	8753ES	S-Parameter Network Analyzer	10/26/2016	Annual	10/26/2017	US39170118
Mini-Circuits	BW-N20W5+	DC to 18 GHz Precision Fixed 20 dB Attenuator	CBT	N/A	CBT	N/A
SPEAG	DAE4	Dasy Data Acquisition Electronics	3/8/2017	Annual	3/8/2018	1368
SPEAG	DAE4	Dasy Data Acquisition Electronics	3/13/2017	Annual	3/13/2018	1415
SPEAG	DAK-3.5	Dielectric Assessment Kit	5/10/2017	Annual	5/10/2018	1070
SPEAG	ES3DV3	SAR Probe	3/14/2017	Annual	3/14/2018	3209
SPEAG	ES3DV3	SAR Probe	3/14/2017	Annual	3/14/2018	3319
Anritsu	MA2411B	Pulse Power Sensor	2/10/2017	Annual	2/10/2018	1207364
Anritsu	MA2411B	Pulse Power Sensor	2/10/2017	Annual	2/10/2018	1339018
Anritsu	ML2495A	Power Meter	10/16/2015	Biennial	10/16/2017	941001
Agilent	N5182A	MXG Vector Signal Generator	2/28/2017	Annual	2/28/2018	MY47420800
Seekonk	NC-100	Torque Wrench	11/6/2015	Biennial	11/6/2017	N/A
Mini-Circuits	NLP-2950+	Low Pass Filter DC to 2700 MHz	CBT	N/A	CBT	N/A
Pasternack	PE2209-10	Bidirectional Coupler	CBT	N/A	CBT	N/A

Measurement Uncertainty = $\pm 23\%$ (k=2)

	Name	Function	Signature
Calibrated By:	Brodie Halfoster	Test Engineer	<i>BRODIE HALBFOSTER</i>
Approved By:	Kaitlin O'Keefe	Senior Technical Manager	<i>KOK</i>

DIPOLE CALIBRATION EXTENSION

Per KDB 865664 D01, calibration intervals of up to three years may be considered for reference dipoles when it is demonstrated that the SAR target, impedance and return loss of a dipole have remained stable according to the following requirements:

1. The measured SAR does not deviate more than 10% from the target on the calibration certificate.
2. The return-loss does not deviate more than 20% from the previous measurement and meets the required 20dB minimum return-loss requirement.
3. The measurement of real or imaginary parts of impedance does not deviate more than 5Ω from the previous measurement.

The following dipole was checked to pass the above 3 requirements to have 2-year calibration period from the calibration date:

Calibration Date	Extension Date	Certificate Electrical Delay (ns)	Certificate SAR Target Head (1g) W/kg @ 20.0 dBm	Measured Head SAR (1g) W/kg @ 20.0 dBm	Deviation 1g (%)	Certificate SAR Target Head (10g) W/kg @ 20.0 dBm	Measured Head SAR (10g) W/kg @ 20.0 dBm	Deviation 10g (%)	Certificate Impedance Head (Ohm) Real	Measured Impedance Head (Ohm) Real	Difference (Ohm) Real	Certificate Impedance Head (Ohm) Imaginary	Measured Impedance Head (Ohm) Imaginary	Difference (Ohm) Imaginary	Certificate Return Loss Head (dB)	Measured Return Loss Head (dB)	Deviation (%)	PASS/FAIL
7/14/2016	7/7/2017	1.218	3.67	3.57	-1.11%	1.92	1.88	-2.08%	50.9	49.9	1	0.4	-1.8	2.1	-40.2	-33.4	16.90%	PASS
Calibration Date	Extension Date	Certificate Electrical Delay (ns)	Certificate SAR Target Body (1g) W/kg @ 20.0 dBm	Measured Body SAR (1g) W/kg @ 20.0 dBm	Deviation 1g (%)	Certificate SAR Target Body (10g) W/kg @ 20.0 dBm	Measured Body SAR (10g) W/kg @ 20.0 dBm	Deviation 10g (%)	Certificate Impedance Body (Ohm) Real	Measured Impedance Body (Ohm) Real	Difference (Ohm) Real	Certificate Impedance Body (Ohm) Imaginary	Measured Impedance Body (Ohm) Imaginary	Difference (Ohm) Imaginary	Certificate Return Loss Body (dB)	Measured Return Loss Body (dB)	Deviation (%)	PASS/FAIL
7/14/2016	7/7/2017	1.218	3.65	3.68	0.82%	1.95	1.97	1.03%	46.4	45.5	0.9	-0.5	0.7	1.2	-28.5	-23.6	17.20%	PASS

Impedance & Return-Loss Measurement Plot for Head TSL

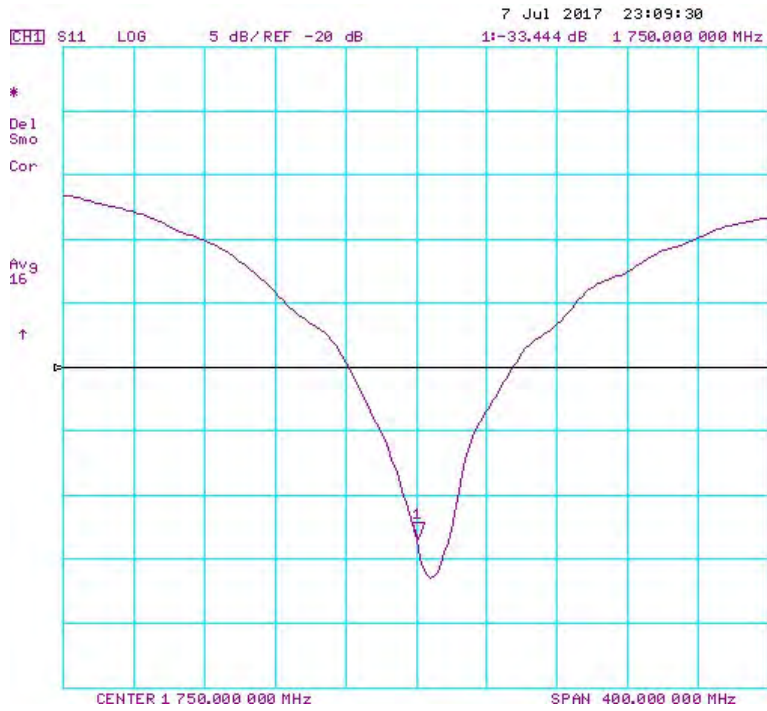
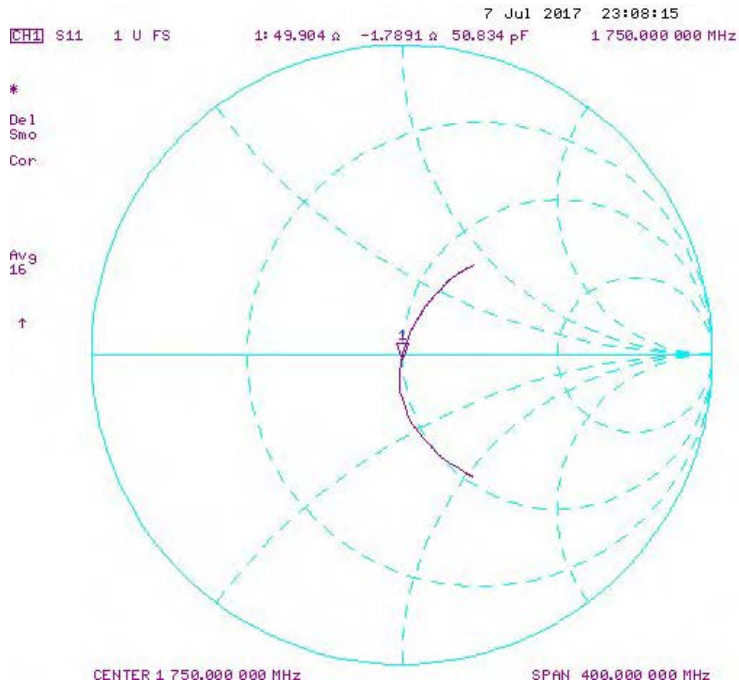

Impedance & Return-Loss Measurement Plot for Body TSL

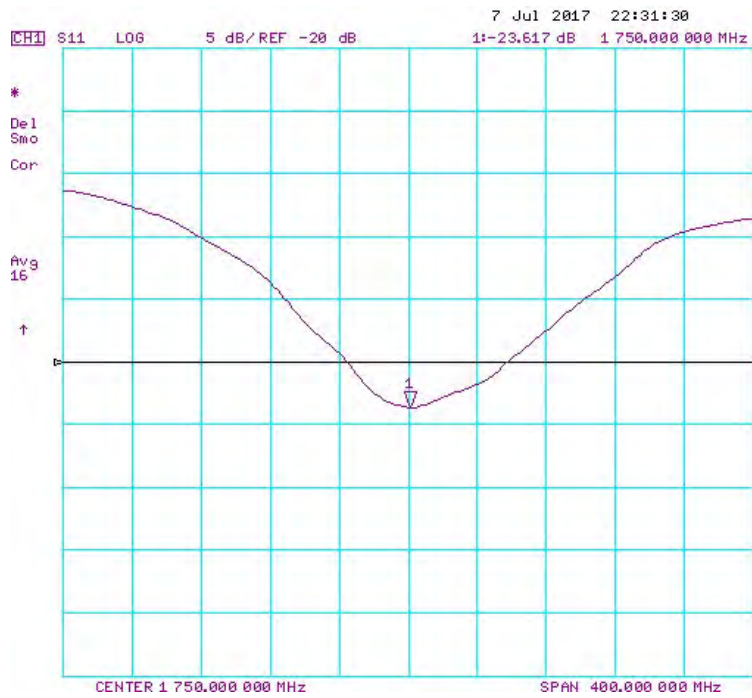
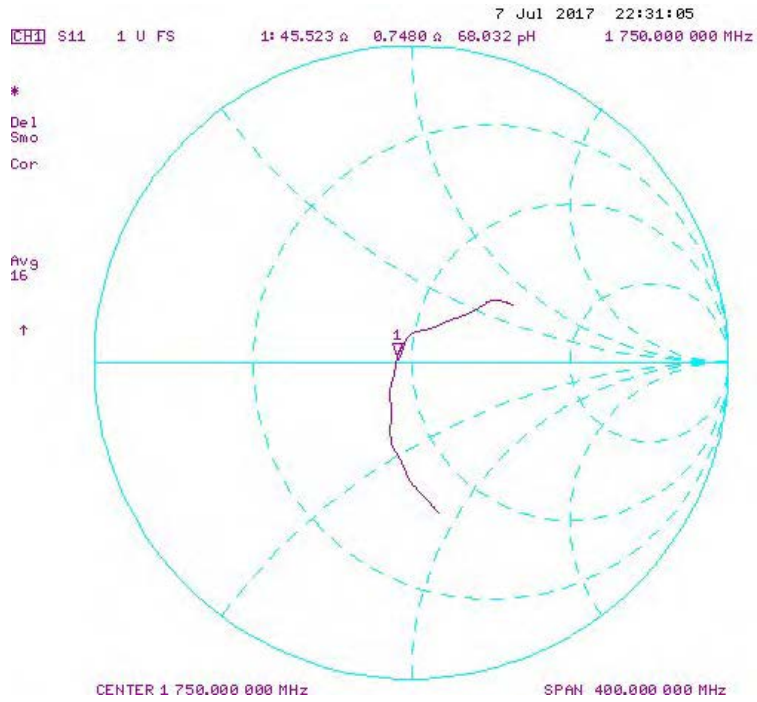

Certification of Calibration

Object: D1750V2 – SN: 1150

Calibration procedure(s): Procedure for Calibration Extension for SAR Dipoles.

Extended Calibration date: 07/12/2018

Description: SAR Validation Dipole at 1750 MHz.

Calibration Equipment used:

Manufacturer	Model	Description	Cal Date	Cal Interval	Cal Due	Serial Number
Agilent	E4438C	ESG Vector Signal Generator	3/24/2017	Biennial	3/24/2019	MY42082385
Agilent	8753ES	S-Parameter Network Analyzer	9/14/2017	Annual	9/14/2018	US39170118
Amplifier Research	15S1G6	Amplifier	CBT	N/A	CBT	433971
Anritsu	ML2495A	Power Meter	11/28/2017	Annual	11/28/2018	1039008
Anritsu	MA2411B	Pulse Power Sensor	3/2/2018	Annual	3/2/2019	1207364
Anritsu	MA2411B	Pulse Power Sensor	11/15/2017	Annual	11/15/2018	1339007
Control Company	4040	Therm./Clock/Humidity Monitor	3/31/2017	Biennial	3/31/2019	170232394
Control Company	4352	Ultra Long Stem Thermometer	5/2/2017	Biennial	5/2/2019	170330156
Keysight	772D	Dual Directional Coupler	CBT	N/A	CBT	MY52180215
Keysight Technologies	85033E	Standard Mechanical Calibration Kit (DC to 9GHz, 3.5mm)	6/4/2018	Annual	6/4/2019	MY53401181
Mini-Circuits	BW-N20W5+	DC to 18 GHz Precision Fixed 20 dB Attenuator	CBT	N/A	CBT	N/A
Mini-Circuits	NLP-2950+	Low Pass Filter DC to 2700 MHz	CBT	N/A	CBT	N/A
Narda	4772-3	Attenuator (3dB)	CBT	N/A	CBT	9406
Pasternack	PE2208-6	Bidirectional Coupler	CBT	N/A	CBT	N/A
Pasternack	PE5011-1	Torque Wrench	7/19/2017	Biennial	7/19/2019	N/A
SPEAG	DAE4	Dasy Data Acquisition Electronics	2/9/2018	Annual	2/9/2019	1272
SPEAG	DAE4	Dasy Data Acquisition Electronics	11/9/2017	Annual	11/9/2018	1450
SPEAG	DAK-3.5	Dielectric Assessment Kit	9/12/2017	Annual	9/12/2018	1091
SPEAG	ES3DV3	SAR Probe	2/13/2018	Annual	2/13/2019	3213
SPEAG	ES3DV3	SAR Probe	3/27/2018	Annual	3/27/2019	3347

Measurement Uncertainty = $\pm 23\%$ (k=2)

	Name	Function	Signature
Calibrated By:	Brodie Halfoster	Test Engineer	<i>BRODIE HALFOSTER</i>
Approved By:	Kaitlin O'Keefe	Senior Technical Manager	<i>KOK</i>

DIPOLE CALIBRATION EXTENSION

Per KDB 865664 D01, calibration intervals of up to three years may be considered for reference dipoles when it is demonstrated that the SAR target, impedance and return loss of a dipole have remained stable according to the following requirements:

1. The measured SAR does not deviate more than 10% from the target on the calibration certificate.
2. The return-loss does not deviate more than 20% from the previous measurement and meets the required 20dB minimum return-loss requirement.
3. The measurement of real or imaginary parts of impedance does not deviate more than 5Ω from the previous measurement.

The following dipole was checked to pass the above 3 requirements to have 3-year calibration period from the calibration date:

Calibration Date	Extension Date	Certificate Electrical Delay (ns)	Certificate SAR Target Head (1g) W/kg @ 20.0 dBm	Measured Head SAR (1g) W/kg @ 20.0 dBm	Deviation 1g (%)	Certificate SAR Target Head (10g) W/kg @ 20.0 dBm	Measured Head SAR (10g) W/kg @ 20.0 dBm	Deviation 10g (%)	Certificate Impedance Head (Ohm) Real	Measured Impedance Head (Ohm) Real	Difference (Ohm) Real	Certificate Impedance Head (Ohm) Imaginary	Measured Impedance Head (Ohm) Imaginary	Difference (Ohm) Imaginary	Certificate Return Loss Head (dB)	Measured Return Loss Head (dB)	Deviation (%)	PASS/FAIL
7/14/2016	7/12/2018	1.218	3.61	3.57	-1.11%	1.92	1.90	-1.04%	50.9	48.2	2.7	0.4	0.0	0.4	-40.2	-35.1	12.70%	PASS
Calibration Date	Extension Date	Certificate Electrical Delay (ns)	Certificate SAR Target Body (1g) W/kg @ 20.0 dBm	Measured Body SAR (1g) W/kg @ 20.0 dBm	Deviation 1g (%)	Certificate SAR Target Body (10g) W/kg @ 20.0 dBm	Measured Body SAR (10g) W/kg @ 20.0 dBm	Deviation 10g (%)	Certificate Impedance Body (Ohm) Real	Measured Impedance Body (Ohm) Real	Difference (Ohm) Real	Certificate Impedance Body (Ohm) Imaginary	Measured Impedance Body (Ohm) Imaginary	Difference (Ohm) Imaginary	Certificate Return Loss Body (dB)	Measured Return Loss Body (dB)	Deviation (%)	PASS/FAIL
7/14/2016	7/12/2018	1.218	3.65	3.61	-1.10%	1.95	1.93	-1.03%	46.4	44.8	1.6	-0.5	-0.2	0.3	-28.5	-24.6	13.70%	PASS

Impedance & Return-Loss Measurement Plot for Head TSL

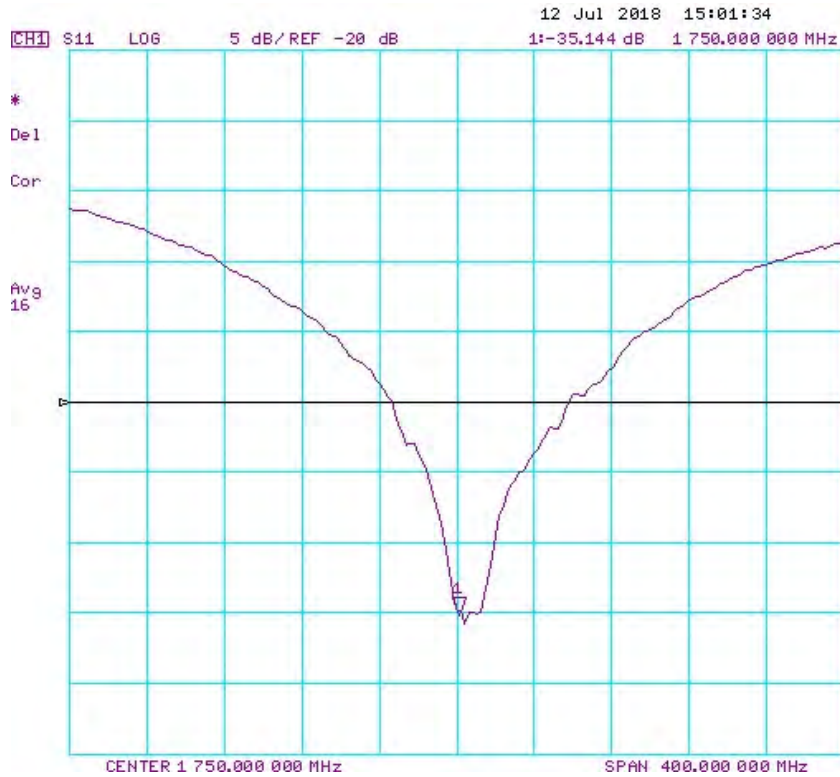
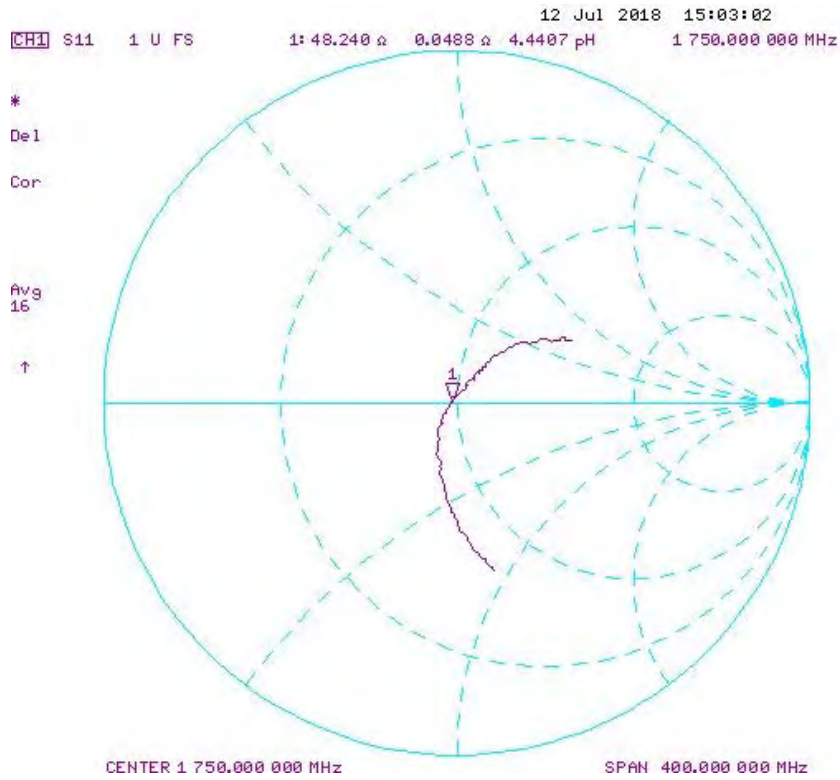

Impedance & Return-Loss Measurement Plot for Body TSL

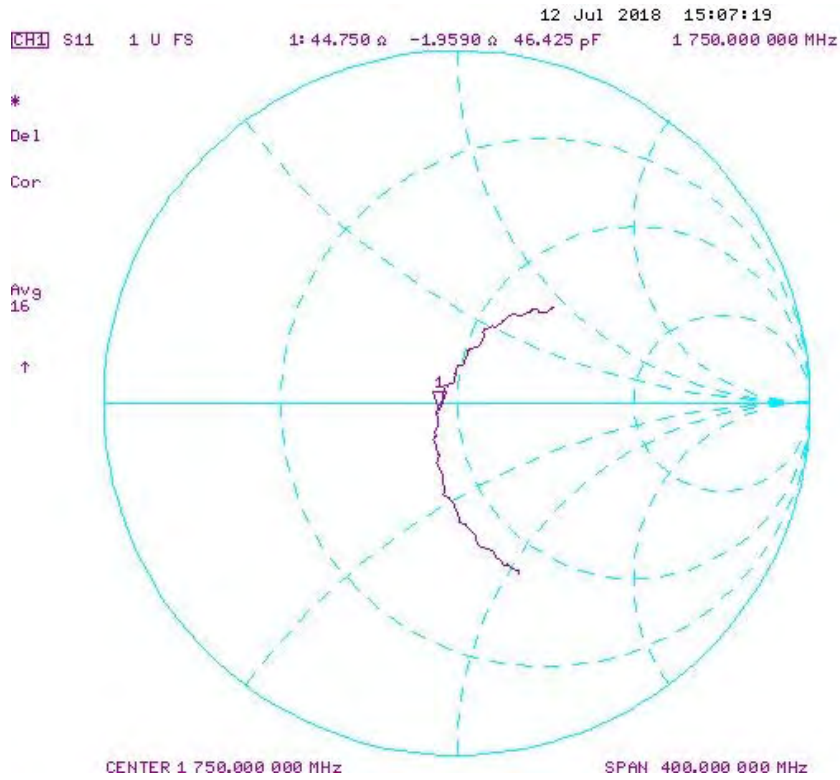



Accredited by the Swiss Accreditation Service (SAS)
The Swiss Accreditation Service is one of the signatories to the EA
Multilateral Agreement for the recognition of calibration certificates

Accreditation No.: **SCS 0108**

Client **PC Test**

Certificate No: **D1900V2-5d148_Feb18**

CALIBRATION CERTIFICATE

Object **D1900V2 - SN:5d148**

Calibration procedure(s) **QA CAL-05.v9
Calibration procedure for dipole validation kits above 700 MHz**

*BNV
03-02-2018*

Calibration date: **February 07, 2018**

This calibration certificate documents the traceability to national standards, which realize the physical units of measurements (SI).
The measurements and the uncertainties with confidence probability are given on the following pages and are part of the certificate.

All calibrations have been conducted in the closed laboratory facility: environment temperature (22 ± 3)°C and humidity < 70%.

Calibration Equipment used (M&TE critical for calibration)

Primary Standards	ID #	Cal Date (Certificate No.)	Scheduled Calibration
Power meter NRP	SN: 104778	04-Apr-17 (No. 217-02521/02522)	Apr-18
Power sensor NRP-Z91	SN: 103244	04-Apr-17 (No. 217-02521)	Apr-18
Power sensor NRP-Z91	SN: 103245	04-Apr-17 (No. 217-02522)	Apr-18
Reference 20 dB Attenuator	SN: 5058 (20k)	07-Apr-17 (No. 217-02528)	Apr-18
Type-N mismatch combination	SN: 5047.2 / 06327	07-Apr-17 (No. 217-02529)	Apr-18
Reference Probe EX3DV4	SN: 7349	30-Dec-17 (No. EX3-7349_Dec17)	Dec-18
DAE4	SN: 601	26-Oct-17 (No. DAE4-601_Oct17)	Oct-18

Secondary Standards	ID #	Check Date (in house)	Scheduled Check
Power meter EPM-442A	SN: GB37480704	07-Oct-15 (in house check Oct-16)	In house check: Oct-18
Power sensor HP 8481A	SN: US37292783	07-Oct-15 (in house check Oct-16)	In house check: Oct-18
Power sensor HP 8481A	SN: MY41092317	07-Oct-15 (in house check Oct-16)	In house check: Oct-18
RF generator R&S SMT-06	SN: 100972	15-Jun-15 (in house check Oct-16)	In house check: Oct-18
Network Analyzer HP 8753E	SN: US37390585	18-Oct-01 (in house check Oct-17)	In house check: Oct-18

Calibrated by: **Claudio Leubler** Name: Claudio Leubler Function: Laboratory Technician

Signature

Approved by: **Katja Pokovic** Name: Katja Pokovic Function: Technical Manager

Issued: February 7, 2018

This calibration certificate shall not be reproduced except in full without written approval of the laboratory.



Accredited by the Swiss Accreditation Service (SAS)

The Swiss Accreditation Service is one of the signatories to the EA
Multilateral Agreement for the recognition of calibration certificates

Accreditation No.: **SCS 0108**

Glossary:

TSL	tissue simulating liquid
ConvF	sensitivity in TSL / NORM x,y,z
N/A	not applicable or not measured

Calibration is Performed According to the Following Standards:

- IEEE Std 1528-2013, "IEEE Recommended Practice for Determining the Peak Spatial-Averaged Specific Absorption Rate (SAR) in the Human Head from Wireless Communications Devices: Measurement Techniques", June 2013
- IEC 62209-1, "Measurement procedure for the assessment of Specific Absorption Rate (SAR) from hand-held and body-mounted devices used next to the ear (frequency range of 300 MHz to 6 GHz)", July 2016
- IEC 62209-2, "Procedure to determine the Specific Absorption Rate (SAR) for wireless communication devices used in close proximity to the human body (frequency range of 30 MHz to 6 GHz)", March 2010
- KDB 865664, "SAR Measurement Requirements for 100 MHz to 6 GHz"

Additional Documentation:

- DASY4/5 System Handbook

Methods Applied and Interpretation of Parameters:

- Measurement Conditions:** Further details are available from the Validation Report at the end of the certificate. All figures stated in the certificate are valid at the frequency indicated.
- Antenna Parameters with TSL:** The dipole is mounted with the spacer to position its feed point exactly below the center marking of the flat phantom section, with the arms oriented parallel to the body axis.
- Feed Point Impedance and Return Loss:** These parameters are measured with the dipole positioned under the liquid filled phantom. The impedance stated is transformed from the measurement at the SMA connector to the feed point. The Return Loss ensures low reflected power. No uncertainty required.
- Electrical Delay:** One-way delay between the SMA connector and the antenna feed point. No uncertainty required.
- SAR measured:** SAR measured at the stated antenna input power.
- SAR normalized:** SAR as measured, normalized to an input power of 1 W at the antenna connector.
- SAR for nominal TSL parameters:** The measured TSL parameters are used to calculate the nominal SAR result.

The reported uncertainty of measurement is stated as the standard uncertainty of measurement multiplied by the coverage factor $k=2$, which for a normal distribution corresponds to a coverage probability of approximately 95%.

Measurement Conditions

DASY system configuration, as far as not given on page 1.

DASY Version	DASY5	V52.10.0
Extrapolation	Advanced Extrapolation	
Phantom	Modular Flat Phantom	
Distance Dipole Center - TSL	10 mm	with Spacer
Zoom Scan Resolution	dx, dy, dz = 5 mm	
Frequency	1900 MHz \pm 1 MHz	

Head TSL parameters

The following parameters and calculations were applied.

	Temperature	Permittivity	Conductivity
Nominal Head TSL parameters	22.0 °C	40.0	1.40 mho/m
Measured Head TSL parameters	(22.0 \pm 0.2) °C	40.7 \pm 6 %	1.39 mho/m \pm 6 %
Head TSL temperature change during test	< 0.5 °C	----	----

SAR result with Head TSL

SAR averaged over 1 cm³ (1 g) of Head TSL	Condition	
SAR measured	250 mW input power	9.95 W/kg
SAR for nominal Head TSL parameters	normalized to 1W	40.1 W/kg \pm 17.0 % (k=2)

SAR averaged over 10 cm³ (10 g) of Head TSL	condition	
SAR measured	250 mW input power	5.22 W/kg
SAR for nominal Head TSL parameters	normalized to 1W	21.0 W/kg \pm 16.5 % (k=2)

Body TSL parameters

The following parameters and calculations were applied.

	Temperature	Permittivity	Conductivity
Nominal Body TSL parameters	22.0 °C	53.3	1.52 mho/m
Measured Body TSL parameters	(22.0 \pm 0.2) °C	55.2 \pm 6 %	1.48 mho/m \pm 6 %
Body TSL temperature change during test	< 0.5 °C	----	----

SAR result with Body TSL

SAR averaged over 1 cm³ (1 g) of Body TSL	Condition	
SAR measured	250 mW input power	9.68 W/kg
SAR for nominal Body TSL parameters	normalized to 1W	39.6 W/kg \pm 17.0 % (k=2)

SAR averaged over 10 cm³ (10 g) of Body TSL	condition	
SAR measured	250 mW input power	5.14 W/kg
SAR for nominal Body TSL parameters	normalized to 1W	20.9 W/kg \pm 16.5 % (k=2)

Appendix (Additional assessments outside the scope of SCS 0108)

Antenna Parameters with Head TSL

Impedance, transformed to feed point	52.1 Ω + 5.8 j Ω
Return Loss	- 24.3 dB

Antenna Parameters with Body TSL

Impedance, transformed to feed point	47.8 Ω + 6.5 j Ω
Return Loss	- 23.1 dB

General Antenna Parameters and Design

Electrical Delay (one direction)	1.199 ns
----------------------------------	----------

After long term use with 100W radiated power, only a slight warming of the dipole near the feedpoint can be measured.

The dipole is made of standard semirigid coaxial cable. The center conductor of the feeding line is directly connected to the second arm of the dipole. The antenna is therefore short-circuited for DC-signals. On some of the dipoles, small end caps are added to the dipole arms in order to improve matching when loaded according to the position as explained in the "Measurement Conditions" paragraph. The SAR data are not affected by this change. The overall dipole length is still according to the Standard.

No excessive force must be applied to the dipole arms, because they might bend or the soldered connections near the feedpoint may be damaged.

Additional EUT Data

Manufactured by	SPEAG
Manufactured on	March 11, 2011

DASY5 Validation Report for Head TSL

Date: 07.02.2018

Test Laboratory: SPEAG, Zurich, Switzerland

DUT: Dipole 1900 MHz; Type: D1900V2; Serial: D1900V2 - SN:5d148

Communication System: UID 0 - CW; Frequency: 1900 MHz

Medium parameters used: $f = 1900$ MHz; $\sigma = 1.39$ S/m; $\epsilon_r = 40.7$; $\rho = 1000$ kg/m³

Phantom section: Flat Section

Measurement Standard: DASY5 (IEEE/IEC/ANSI C63.19-2011)

DASY52 Configuration:

- Probe: EX3DV4 - SN7349; ConvF(8.18, 8.18, 8.18); Calibrated: 30.12.2017;
- Sensor-Surface: 1.4mm (Mechanical Surface Detection)
- Electronics: DAE4 Sn601; Calibrated: 26.10.2017
- Phantom: Flat Phantom 5.0 (front); Type: QD 000 P50 AA; Serial: 1001
- DASY52 52.10.0(1446); SEMCAD X 14.6.10(7417)

Dipole Calibration for Head Tissue/Pin=250 mW, d=10mm/Zoom Scan (7x7x7)/Cube 0:

Measurement grid: dx=5mm, dy=5mm, dz=5mm

Reference Value = 109.6 V/m; Power Drift = -0.07 dB

Peak SAR (extrapolated) = 18.5 W/kg

SAR(1 g) = 9.95 W/kg; SAR(10 g) = 5.22 W/kg

Maximum value of SAR (measured) = 15.3 W/kg

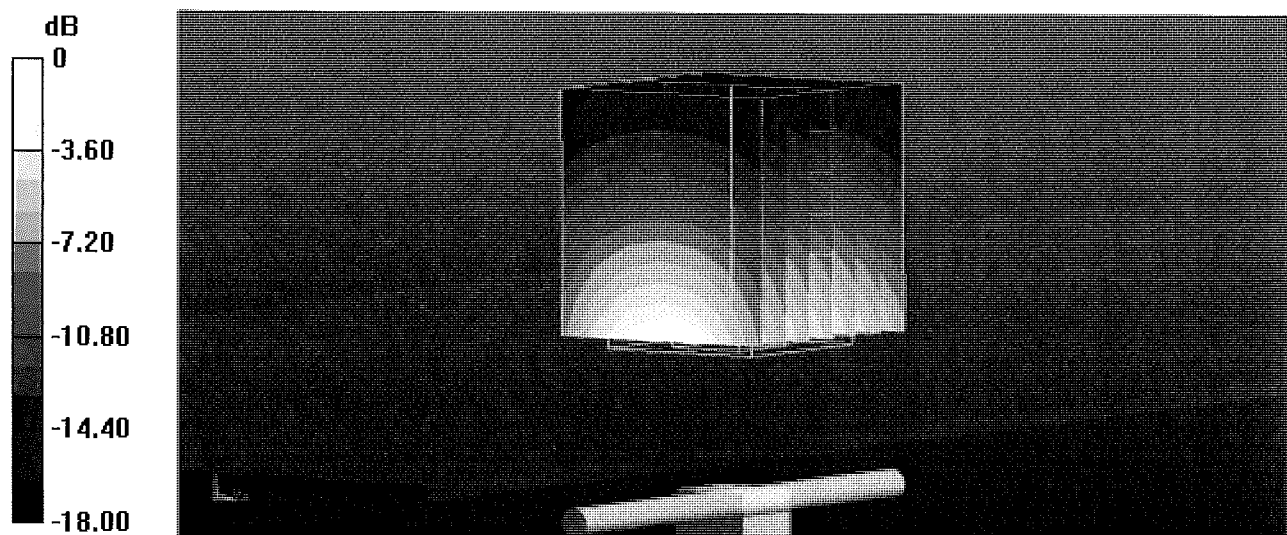

0 dB = 15.3 W/kg = 11.85 dBW/kg

Impedance Measurement Plot for Head TSL

7 Feb 2018 15:15:06

CH1 S11 1 U FS 1: 52.148 Ω 5.8281 Ω 488.20 μ H 1 900.000 000 MHz

*
Del
CA

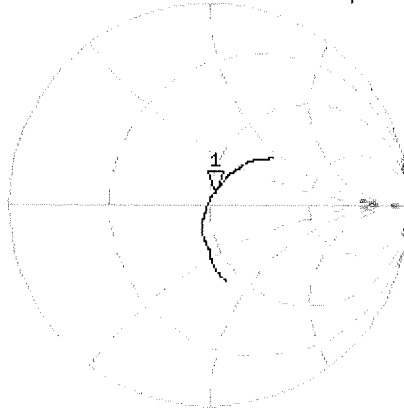

Avg
16

H1d

CH2 S11 LOG 5 dB/REF -20 dB 1:-24.331 dB 1 900.000 000 MHz

CA

Avg
16

H1d

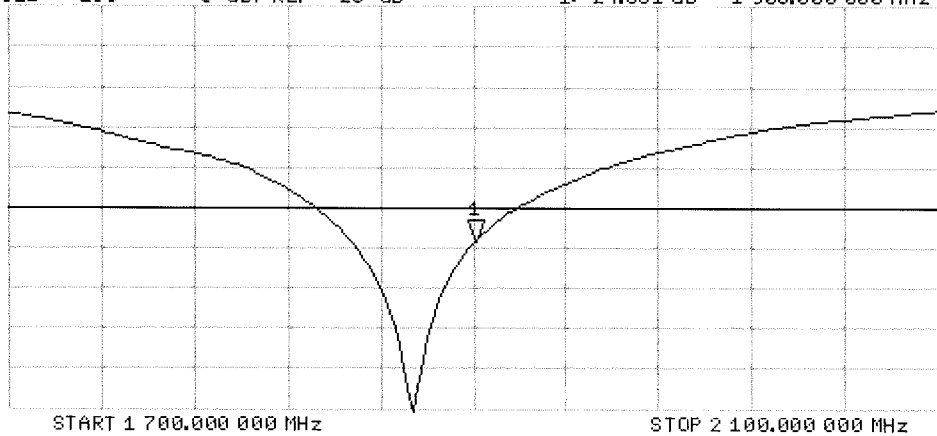

DASY5 Validation Report for Body TSL

Date: 07.02.2018

Test Laboratory: SPEAG, Zurich, Switzerland

DUT: Dipole 1900 MHz; Type: D1900V2; Serial: D1900V2 - SN:5d148

Communication System: UID 0 - CW; Frequency: 1900 MHz

Medium parameters used: $f = 1900$ MHz; $\sigma = 1.48$ S/m; $\epsilon_r = 55.2$; $\rho = 1000$ kg/m³

Phantom section: Flat Section

Measurement Standard: DASY5 (IEEE/IEC/ANSI C63.19-2011)

DASY52 Configuration:

- Probe: EX3DV4 - SN7349; ConvF(8.15, 8.15, 8.15); Calibrated: 30.12.2017;
- Sensor-Surface: 1.4mm (Mechanical Surface Detection)
- Electronics: DAE4 Sn601; Calibrated: 26.10.2017
- Phantom: Flat Phantom 5.0 (back); Type: QD 000 P50 AA; Serial: 1002
- DASY52 52.10.0(1446); SEMCAD X 14.6.10(7417)

Dipole Calibration for Body Tissue/Pin=250 mW, d=10mm/Zoom Scan (7x7x7)/Cube 0:

Measurement grid: dx=5mm, dy=5mm, dz=5mm

Reference Value = 103.0 V/m; Power Drift = -0.09 dB

Peak SAR (extrapolated) = 17.2 W/kg

SAR(1 g) = 9.68 W/kg; SAR(10 g) = 5.14 W/kg

Maximum value of SAR (measured) = 14.4 W/kg

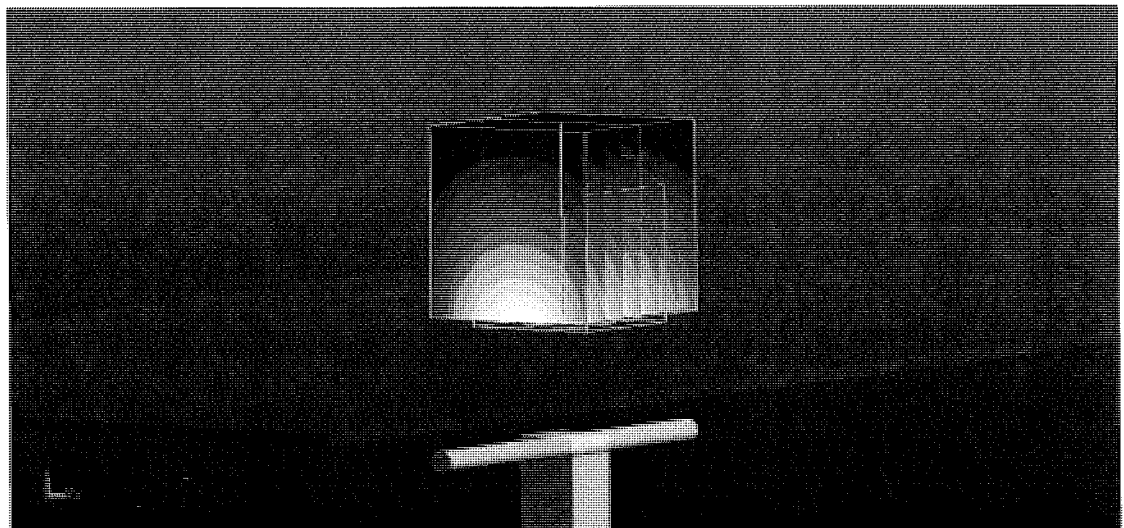
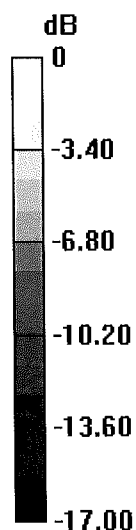

0 dB = 14.4 W/kg = 11.58 dBW/kg

Impedance Measurement Plot for Body TSL

7 Feb 2018 15:14:31

CH1 S11 1 U FS 1: 47.787 Ω 6.4551 Ω 540.71 μH 1 900.000 000 MHz

*
Del
CA
Avg
16
H1d

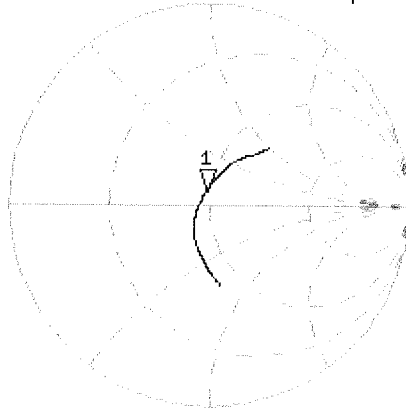

CH2 S11 LOG 5 dB/REF -20 dB 1:-23.146 dB 1 900.000 000 MHz

CA
Avg
16
H1d

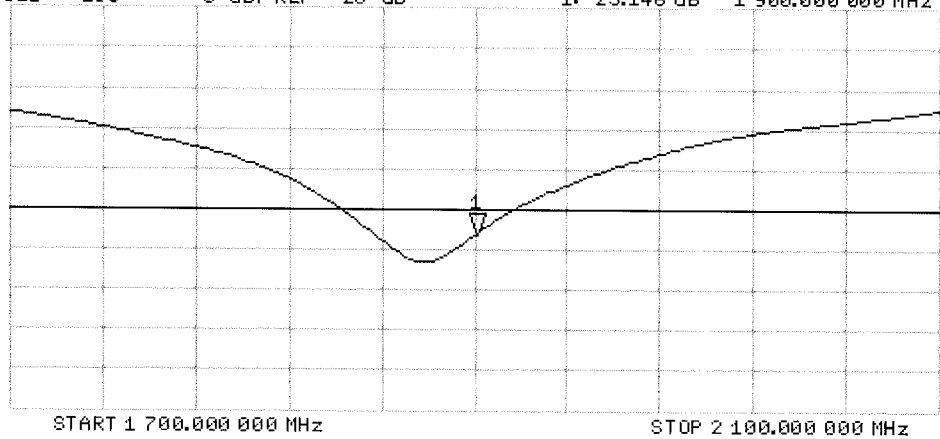



Accredited by the Swiss Accreditation Service (SAS)
The Swiss Accreditation Service is one of the signatories to the EA
Multilateral Agreement for the recognition of calibration certificates

Accreditation No.: **SCS 0108**

Client **PC Test**

Certificate No: **D2450V2-882_Feb18**

CALIBRATION CERTIFICATE

Object **D2450V2 - SN:882**

Calibration procedure(s) **QA CAL-05.v9
Calibration procedure for dipole validation kits above 700 MHz**

*BN ✓
03-02-2018*

Calibration date: **February 07, 2018**

This calibration certificate documents the traceability to national standards, which realize the physical units of measurements (SI).
The measurements and the uncertainties with confidence probability are given on the following pages and are part of the certificate.

All calibrations have been conducted in the closed laboratory facility: environment temperature (22 ± 3)°C and humidity < 70%.

Calibration Equipment used (M&TE critical for calibration)

Primary Standards	ID #	Cal Date (Certificate No.)	Scheduled Calibration
Power meter NRP	SN: 104778	04-Apr-17 (No. 217-02521/02522)	Apr-18
Power sensor NRP-Z91	SN: 103244	04-Apr-17 (No. 217-02521)	Apr-18
Power sensor NRP-Z91	SN: 103245	04-Apr-17 (No. 217-02522)	Apr-18
Reference 20 dB Attenuator	SN: 5058 (20k)	07-Apr-17 (No. 217-02528)	Apr-18
Type-N mismatch combination	SN: 5047.2 / 06327	07-Apr-17 (No. 217-02529)	Apr-18
Reference Probe EX3DV4	SN: 7349	30-Dec-17 (No. EX3-7349_Dec17)	Dec-18
DAE4	SN: 601	26-Oct-17 (No. DAE4-601_Oct17)	Oct-18

Secondary Standards	ID #	Check Date (in house)	Scheduled Check
Power meter EPM-442A	SN: GB37480704	07-Oct-15 (in house check Oct-16)	In house check: Oct-18
Power sensor HP 8481A	SN: US37292783	07-Oct-15 (in house check Oct-16)	In house check: Oct-18
Power sensor HP 8481A	SN: MY41092317	07-Oct-15 (in house check Oct-16)	In house check: Oct-18
RF generator R&S SMT-06	SN: 100972	15-Jun-15 (in house check Oct-16)	In house check: Oct-18
Network Analyzer HP 8753E	SN: US37390585	18-Oct-01 (in house check Oct-17)	In house check: Oct-18

Calibrated by: **Claudio Leubler** Name: Claudio Leubler Function: Laboratory Technician

Signature *[Handwritten Signature]*

Approved by: **Katja Pokovic** Name: Katja Pokovic Function: Technical Manager

Signature *[Handwritten Signature]*

Issued: February 7, 2018

This calibration certificate shall not be reproduced except in full without written approval of the laboratory.



Accredited by the Swiss Accreditation Service (SAS)

The Swiss Accreditation Service is one of the signatories to the EA
Multilateral Agreement for the recognition of calibration certificates

Accreditation No.: **SCS 0108**

Glossary:

TSL	tissue simulating liquid
ConvF	sensitivity in TSL / NORM x,y,z
N/A	not applicable or not measured

Calibration is Performed According to the Following Standards:

- IEEE Std 1528-2013, "IEEE Recommended Practice for Determining the Peak Spatial-Averaged Specific Absorption Rate (SAR) in the Human Head from Wireless Communications Devices: Measurement Techniques", June 2013
- IEC 62209-1, "Measurement procedure for the assessment of Specific Absorption Rate (SAR) from hand-held and body-mounted devices used next to the ear (frequency range of 300 MHz to 6 GHz)", July 2016
- IEC 62209-2, "Procedure to determine the Specific Absorption Rate (SAR) for wireless communication devices used in close proximity to the human body (frequency range of 30 MHz to 6 GHz)", March 2010
- KDB 865664, "SAR Measurement Requirements for 100 MHz to 6 GHz"

Additional Documentation:

- DASY4/5 System Handbook

Methods Applied and Interpretation of Parameters:

- Measurement Conditions:** Further details are available from the Validation Report at the end of the certificate. All figures stated in the certificate are valid at the frequency indicated.
- Antenna Parameters with TSL:** The dipole is mounted with the spacer to position its feed point exactly below the center marking of the flat phantom section, with the arms oriented parallel to the body axis.
- Feed Point Impedance and Return Loss:** These parameters are measured with the dipole positioned under the liquid filled phantom. The impedance stated is transformed from the measurement at the SMA connector to the feed point. The Return Loss ensures low reflected power. No uncertainty required.
- Electrical Delay:** One-way delay between the SMA connector and the antenna feed point. No uncertainty required.
- SAR measured:** SAR measured at the stated antenna input power.
- SAR normalized:** SAR as measured, normalized to an input power of 1 W at the antenna connector.
- SAR for nominal TSL parameters:** The measured TSL parameters are used to calculate the nominal SAR result.

The reported uncertainty of measurement is stated as the standard uncertainty of measurement multiplied by the coverage factor $k=2$, which for a normal distribution corresponds to a coverage probability of approximately 95%.

Measurement Conditions

DASY system configuration, as far as not given on page 1.

DASY Version	DASY5	V52.10.0
Extrapolation	Advanced Extrapolation	
Phantom	Modular Flat Phantom	
Distance Dipole Center - TSL	10 mm	with Spacer
Zoom Scan Resolution	dx, dy, dz = 5 mm	
Frequency	2450 MHz \pm 1 MHz	

Head TSL parameters

The following parameters and calculations were applied.

	Temperature	Permittivity	Conductivity
Nominal Head TSL parameters	22.0 °C	39.2	1.80 mho/m
Measured Head TSL parameters	(22.0 \pm 0.2) °C	37.9 \pm 6 %	1.87 mho/m \pm 6 %
Head TSL temperature change during test	< 0.5 °C	----	----

SAR result with Head TSL

SAR averaged over 1 cm³ (1 g) of Head TSL	Condition	
SAR measured	250 mW input power	13.4 W/kg
SAR for nominal Head TSL parameters	normalized to 1W	52.2 W/kg \pm 17.0 % (k=2)

SAR averaged over 10 cm³ (10 g) of Head TSL	condition	
SAR measured	250 mW input power	6.22 W/kg
SAR for nominal Head TSL parameters	normalized to 1W	24.5 W/kg \pm 16.5 % (k=2)

Body TSL parameters

The following parameters and calculations were applied.

	Temperature	Permittivity	Conductivity
Nominal Body TSL parameters	22.0 °C	52.7	1.95 mho/m
Measured Body TSL parameters	(22.0 \pm 0.2) °C	51.4 \pm 6 %	2.04 mho/m \pm 6 %
Body TSL temperature change during test	< 0.5 °C	----	----

SAR result with Body TSL

SAR averaged over 1 cm³ (1 g) of Body TSL	Condition	
SAR measured	250 mW input power	12.9 W/kg
SAR for nominal Body TSL parameters	normalized to 1W	50.2 W/kg \pm 17.0 % (k=2)

SAR averaged over 10 cm³ (10 g) of Body TSL	condition	
SAR measured	250 mW input power	5.98 W/kg
SAR for nominal Body TSL parameters	normalized to 1W	23.6 W/kg \pm 16.5 % (k=2)

Appendix (Additional assessments outside the scope of SCS 0108)

Antenna Parameters with Head TSL

Impedance, transformed to feed point	52.0 Ω + 1.3 j Ω
Return Loss	- 32.6 dB

Antenna Parameters with Body TSL

Impedance, transformed to feed point	48.8 Ω + 3.7 j Ω
Return Loss	- 28.1 dB

General Antenna Parameters and Design

Electrical Delay (one direction)	1.156 ns
----------------------------------	----------

After long term use with 100W radiated power, only a slight warming of the dipole near the feedpoint can be measured.

The dipole is made of standard semirigid coaxial cable. The center conductor of the feeding line is directly connected to the second arm of the dipole. The antenna is therefore short-circuited for DC-signals. On some of the dipoles, small end caps are added to the dipole arms in order to improve matching when loaded according to the position as explained in the "Measurement Conditions" paragraph. The SAR data are not affected by this change. The overall dipole length is still according to the Standard.

No excessive force must be applied to the dipole arms, because they might bend or the soldered connections near the feedpoint may be damaged.

Additional EUT Data

Manufactured by	SPEAG
Manufactured on	October 06, 2011

DASY5 Validation Report for Head TSL

Date: 07.02.2018

Test Laboratory: SPEAG, Zurich, Switzerland

DUT: Dipole 2450 MHz; Type: D2450V2; Serial: D2450V2 - SN:882

Communication System: UID 0 - CW; Frequency: 2450 MHz

Medium parameters used: $f = 2450$ MHz; $\sigma = 1.87$ S/m; $\epsilon_r = 37.9$; $\rho = 1000$ kg/m³

Phantom section: Flat Section

Measurement Standard: DASY5 (IEEE/IEC/ANSI C63.19-2011)

DASY52 Configuration:

- Probe: EX3DV4 - SN7349; ConvF(7.88, 7.88, 7.88); Calibrated: 30.12.2017;
- Sensor-Surface: 1.4mm (Mechanical Surface Detection)
- Electronics: DAE4 Sn601; Calibrated: 26.10.2017
- Phantom: Flat Phantom 5.0 (front); Type: QD 000 P50 AA; Serial: 1001
- DASY52 52.10.0(1446); SEMCAD X 14.6.10(7417)

Dipole Calibration for Head Tissue/Pin=250 mW, d=10mm/Zoom Scan (7x7x7)/Cube 0:

Measurement grid: dx=5mm, dy=5mm, dz=5mm

Reference Value = 112.2 V/m; Power Drift = -0.03 dB

Peak SAR (extrapolated) = 27.1 W/kg

SAR(1 g) = 13.4 W/kg; SAR(10 g) = 6.22 W/kg

Maximum value of SAR (measured) = 21.6 W/kg

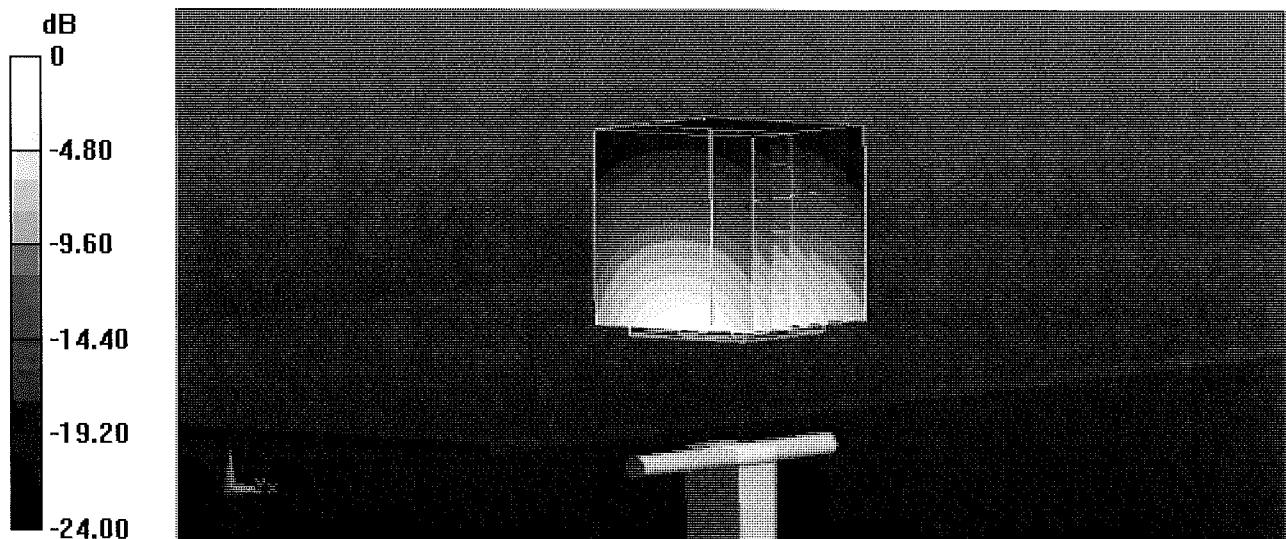

0 dB = 21.6 W/kg = 13.34 dBW/kg

Impedance Measurement Plot for Head TSL

7 Feb 2018 15:38:37

[CH1] S11 1 U FS 1: 52.023 Ω 1.2734 Ω 82.724 pF 2 450.000 000 MHz

*
Del
CA

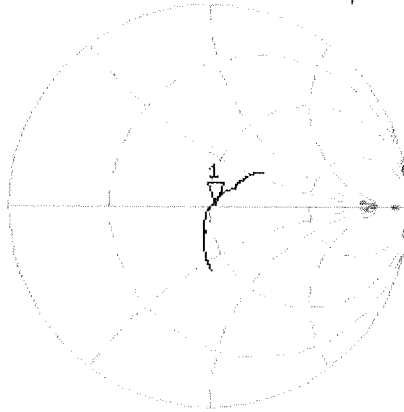

Avg
16

H1d

CH2 S11 LOG 5 dB/ REF -20 dB 1: -32.606 dB 2 450.000 000 MHz

CA

Avg
16

H1d

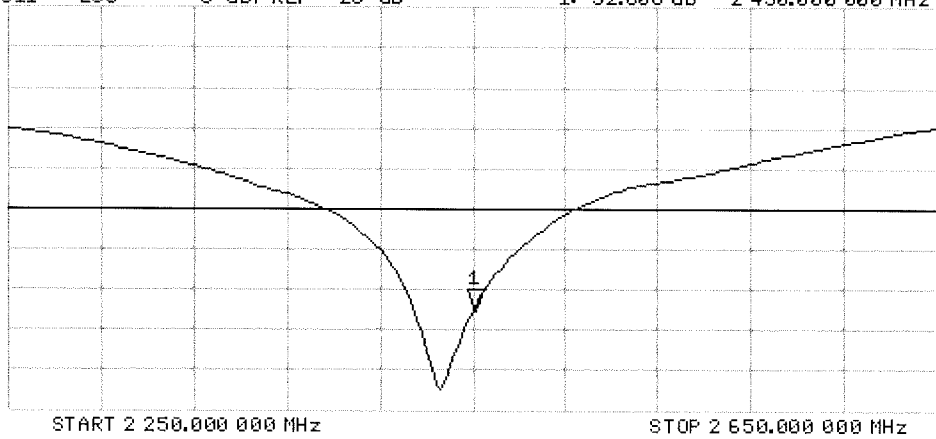

DASY5 Validation Report for Body TSL

Date: 07.02.2018

Test Laboratory: SPEAG, Zurich, Switzerland

DUT: Dipole 2450 MHz; Type: D2450V2; Serial: D2450V2 - SN:882

Communication System: UID 0 - CW; Frequency: 2450 MHz

Medium parameters used: $f = 2450$ MHz; $\sigma = 2.04$ S/m; $\epsilon_r = 51.4$; $\rho = 1000$ kg/m³

Phantom section: Flat Section

Measurement Standard: DASY5 (IEEE/IEC/ANSI C63.19-2011)

DASY52 Configuration:

- Probe: EX3DV4 - SN7349; ConvF(8.01, 8.01, 8.01); Calibrated: 30.12.2017;
- Sensor-Surface: 1.4mm (Mechanical Surface Detection)
- Electronics: DAE4 Sn601; Calibrated: 26.10.2017
- Phantom: Flat Phantom 5.0 (back); Type: QD 000 P50 AA; Serial: 1002
- DASY52 52.10.0(1446); SEMCAD X 14.6.10(7417)

Dipole Calibration for Body Tissue/Pin=250 mW, d=10mm/Zoom Scan (7x7x7)/Cube 0:

Measurement grid: dx=5mm, dy=5mm, dz=5mm

Reference Value = 107.8 V/m; Power Drift = -0.01 dB

Peak SAR (extrapolated) = 25.9 W/kg

SAR(1 g) = 12.9 W/kg; SAR(10 g) = 5.98 W/kg

Maximum value of SAR (measured) = 21.2 W/kg

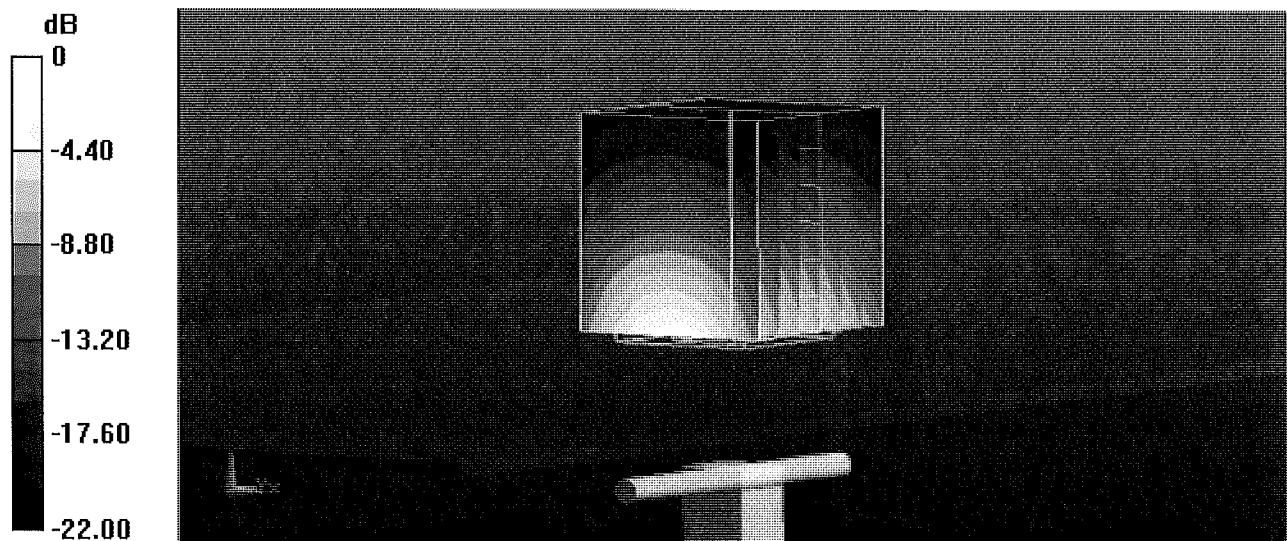

0 dB = 21.2 W/kg = 13.26 dBW/kg

Impedance Measurement Plot for Body TSL

7 Feb 2018 15:38:06

CH1 S11 1 U FS 1: 48.838 Ω 3.7051 Ω 240.69 μ H 2 450.000 000 MHz

*
De1
CA

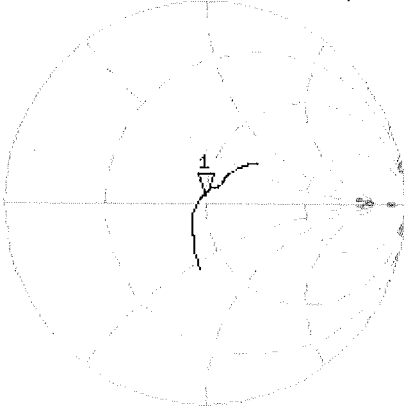

Avg
16
H1d

CH2 S11 LOG 5 dB/REF -20 dB 1:-28.126 dB 2 450.000 000 MHz

CA
Avg
16
H1d

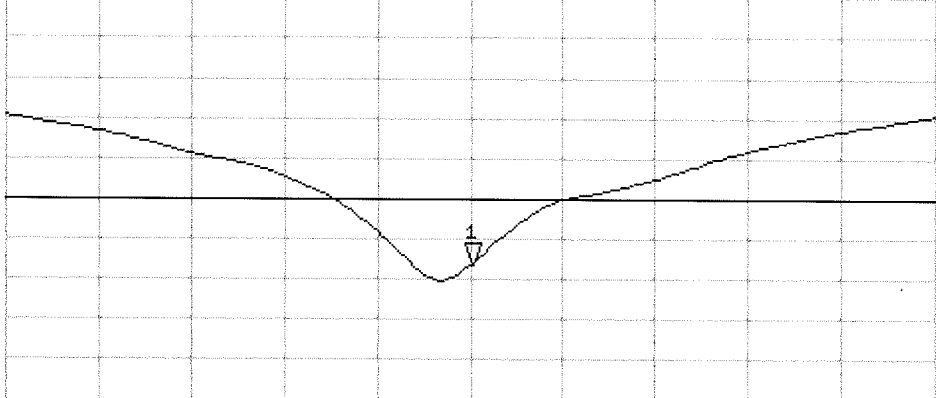

START 2 250.000 000 MHz STOP 2 650.000 000 MHz



Accredited by the Swiss Accreditation Service (SAS)
The Swiss Accreditation Service is one of the signatories to the EA
Multilateral Agreement for the recognition of calibration certificates

Accreditation No.: **SCS 0108**

Client **PC Test**

Certificate No: **D2600V2-1004_Apr18**

CALIBRATION CERTIFICATE

Object **D2600V2 - SN:1004**

Calibration procedure(s) **QA CAL-05.v10
Calibration procedure for dipole validation kits above 700 MHz**

*BN ✓
05-01-2018*

Calibration date: **April 11, 2018**

This calibration certificate documents the traceability to national standards, which realize the physical units of measurements (SI).
The measurements and the uncertainties with confidence probability are given on the following pages and are part of the certificate.

All calibrations have been conducted in the closed laboratory facility: environment temperature (22 ± 3)°C and humidity < 70%.

Calibration Equipment used (M&TE critical for calibration)

Primary Standards	ID #	Cal Date (Certificate No.)	Scheduled Calibration
Power meter NRP	SN: 104778	04-Apr-18 (No. 217-02672/02673)	Apr-19
Power sensor NRP-Z91	SN: 103244	04-Apr-18 (No. 217-02672)	Apr-19
Power sensor NRP-Z91	SN: 103245	04-Apr-18 (No. 217-02673)	Apr-19
Reference 20 dB Attenuator	SN: 5058 (20k)	04-Apr-18 (No. 217-02682)	Apr-19
Type-N mismatch combination	SN: 5047.2 / 06327	04-Apr-18 (No. 217-02683)	Apr-19
Reference Probe EX3DV4	SN: 7349	30-Dec-17 (No. EX3-7349_Dec17)	Dec-18
DAE4	SN: 601	26-Oct-17 (No. DAE4-601_Oct17)	Oct-18

Secondary Standards	ID #	Check Date (in house)	Scheduled Check
Power meter EPM-442A	SN: GB37480704	07-Oct-15 (in house check Oct-16)	In house check: Oct-18
Power sensor HP 8481A	SN: US37292783	07-Oct-15 (in house check Oct-16)	In house check: Oct-18
Power sensor HP 8481A	SN: MY41092317	07-Oct-15 (in house check Oct-16)	In house check: Oct-18
RF generator R&S SMT-06	SN: 100972	15-Jun-15 (in house check Oct-16)	In house check: Oct-18
Network Analyzer HP 8753E	SN: US37390585	18-Oct-01 (in house check Oct-17)	In house check: Oct-18

Calibrated by: **Michael Weber** Name: Michael Weber Function: Laboratory Technician

M. Weber

Approved by: **Katja Pokovic** Name: Katja Pokovic Function: Technical Manager

Katja Pokovic

Issued: April 12, 2018

This calibration certificate shall not be reproduced except in full without written approval of the laboratory.



Accredited by the Swiss Accreditation Service (SAS)

Accreditation No.: **SCS 0108**

The Swiss Accreditation Service is one of the signatories to the EA Multilateral Agreement for the recognition of calibration certificates

Glossary:

TSL	tissue simulating liquid
ConvF	sensitivity in TSL / NORM x,y,z
N/A	not applicable or not measured

Calibration is Performed According to the Following Standards:

- IEEE Std 1528-2013, "IEEE Recommended Practice for Determining the Peak Spatial-Averaged Specific Absorption Rate (SAR) in the Human Head from Wireless Communications Devices: Measurement Techniques", June 2013
- IEC 62209-1, "Measurement procedure for the assessment of Specific Absorption Rate (SAR) from hand-held and body-mounted devices used next to the ear (frequency range of 300 MHz to 6 GHz)", July 2016
- IEC 62209-2, "Procedure to determine the Specific Absorption Rate (SAR) for wireless communication devices used in close proximity to the human body (frequency range of 30 MHz to 6 GHz)", March 2010
- KDB 865664, "SAR Measurement Requirements for 100 MHz to 6 GHz"

Additional Documentation:

- DASY4/5 System Handbook

Methods Applied and Interpretation of Parameters:

- Measurement Conditions:** Further details are available from the Validation Report at the end of the certificate. All figures stated in the certificate are valid at the frequency indicated.
- Antenna Parameters with TSL:** The dipole is mounted with the spacer to position its feed point exactly below the center marking of the flat phantom section, with the arms oriented parallel to the body axis.
- Feed Point Impedance and Return Loss:** These parameters are measured with the dipole positioned under the liquid filled phantom. The impedance stated is transformed from the measurement at the SMA connector to the feed point. The Return Loss ensures low reflected power. No uncertainty required.
- Electrical Delay:** One-way delay between the SMA connector and the antenna feed point. No uncertainty required.
- SAR measured:** SAR measured at the stated antenna input power.
- SAR normalized:** SAR as measured, normalized to an input power of 1 W at the antenna connector.
- SAR for nominal TSL parameters:** The measured TSL parameters are used to calculate the nominal SAR result.

The reported uncertainty of measurement is stated as the standard uncertainty of measurement multiplied by the coverage factor $k=2$, which for a normal distribution corresponds to a coverage probability of approximately 95%.

Measurement Conditions

DASY system configuration, as far as not given on page 1.

DASY Version	DASY5	V52.10.0
Extrapolation	Advanced Extrapolation	
Phantom	Modular Flat Phantom	
Distance Dipole Center - TSL	10 mm	with Spacer
Zoom Scan Resolution	dx, dy, dz = 5 mm	
Frequency	2600 MHz \pm 1 MHz	

Head TSL parameters

The following parameters and calculations were applied.

	Temperature	Permittivity	Conductivity
Nominal Head TSL parameters	22.0 °C	39.0	1.96 mho/m
Measured Head TSL parameters	(22.0 \pm 0.2) °C	37.8 \pm 6 %	2.03 mho/m \pm 6 %
Head TSL temperature change during test	< 0.5 °C	----	----

SAR result with Head TSL

SAR averaged over 1 cm³ (1 g) of Head TSL	Condition	
SAR measured	250 mW input power	14.3 W/kg
SAR for nominal Head TSL parameters	normalized to 1W	55.9 W/kg \pm 17.0 % (k=2)

SAR averaged over 10 cm³ (10 g) of Head TSL	condition	
SAR measured	250 mW input power	6.35 W/kg
SAR for nominal Head TSL parameters	normalized to 1W	25.1 W/kg \pm 16.5 % (k=2)

Body TSL parameters

The following parameters and calculations were applied.

	Temperature	Permittivity	Conductivity
Nominal Body TSL parameters	22.0 °C	52.5	2.16 mho/m
Measured Body TSL parameters	(22.0 \pm 0.2) °C	52.1 \pm 6 %	2.19 mho/m \pm 6 %
Body TSL temperature change during test	< 0.5 °C	----	----

SAR result with Body TSL

SAR averaged over 1 cm³ (1 g) of Body TSL	Condition	
SAR measured	250 mW input power	13.8 W/kg
SAR for nominal Body TSL parameters	normalized to 1W	54.8 W/kg \pm 17.0 % (k=2)

SAR averaged over 10 cm³ (10 g) of Body TSL	condition	
SAR measured	250 mW input power	6.20 W/kg
SAR for nominal Body TSL parameters	normalized to 1W	24.7 W/kg \pm 16.5 % (k=2)

Appendix (Additional assessments outside the scope of SCS 0108)

Antenna Parameters with Head TSL

Impedance, transformed to feed point	47.7 Ω - 5.7 j Ω
Return Loss	- 24.1 dB

Antenna Parameters with Body TSL

Impedance, transformed to feed point	46.0 Ω - 3.8 j Ω
Return Loss	- 24.9 dB

General Antenna Parameters and Design

Electrical Delay (one direction)	1.149 ns
----------------------------------	----------

After long term use with 100W radiated power, only a slight warming of the dipole near the feedpoint can be measured.

The dipole is made of standard semirigid coaxial cable. The center conductor of the feeding line is directly connected to the second arm of the dipole. The antenna is therefore short-circuited for DC-signals. On some of the dipoles, small end caps are added to the dipole arms in order to improve matching when loaded according to the position as explained in the "Measurement Conditions" paragraph. The SAR data are not affected by this change. The overall dipole length is still according to the Standard.

No excessive force must be applied to the dipole arms, because they might bend or the soldered connections near the feedpoint may be damaged.

Additional EUT Data

Manufactured by	SPEAG
Manufactured on	December 23, 2006

DASY5 Validation Report for Head TSL

Date: 11.04.2018

Test Laboratory: SPEAG, Zurich, Switzerland

DUT: Dipole 2600 MHz; Type: D2600V2; Serial: D2600V2 - SN: 1004

Communication System: UID 0 - CW; Frequency: 2600 MHz

Medium parameters used: $f = 2600$ MHz; $\sigma = 2.03$ S/m; $\epsilon_r = 37.8$; $\rho = 1000$ kg/m³

Phantom section: Flat Section

Measurement Standard: DASY5 (IEEE/IEC/ANSI C63.19-2011)

DASY52 Configuration:

- Probe: EX3DV4 - SN7349; ConvF(7.7, 7.7, 7.7); Calibrated: 30.12.2017;
- Sensor-Surface: 1.4mm (Mechanical Surface Detection)
- Electronics: DAE4 Sn601; Calibrated: 26.10.2017
- Phantom: Flat Phantom 5.0 (front); Type: QD 000 P50 AA; Serial: 1001
- DASY52 52.10.0(1446); SEMCAD X 14.6.10(7417)

Dipole Calibration for Head Tissue/Pin=250 mW, d=10mm/Zoom Scan (7x7x7)/Cube 0:

Measurement grid: dx=5mm, dy=5mm, dz=5mm

Reference Value = 118.5 V/m; Power Drift = -0.04 dB

Peak SAR (extrapolated) = 28.6 W/kg

SAR(1 g) = 14.3 W/kg; SAR(10 g) = 6.35 W/kg

Maximum value of SAR (measured) = 23.9 W/kg

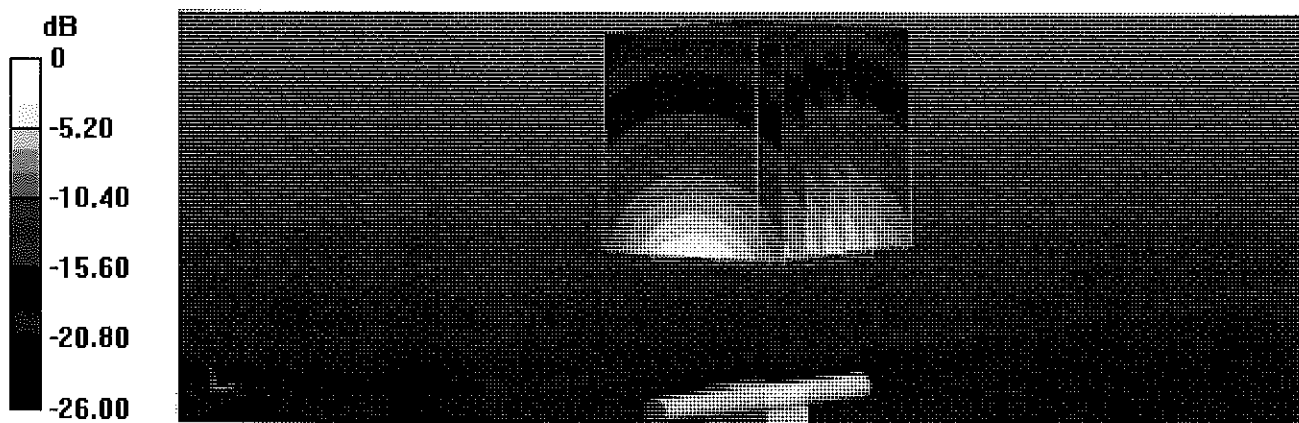

0 dB = 23.9 W/kg = 13.78 dBW/kg

Impedance Measurement Plot for Head TSL

11 Apr 2018 11:25:16

[CH1] S11 1 U FS 1: 47.721 Ω -5.6836 Ω 10.770 pF 2 500.000 000 MHz

*
De1

CA

Avg
16

H1 d

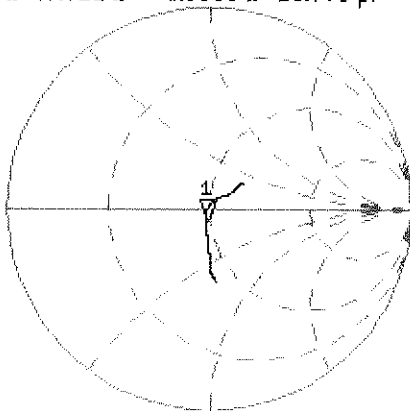

CH2 S11 LOG 5 dB/REF -20 dB 1: -24.073 dB 2 500.000 000 MHz

CA

Avg
16

H1 d

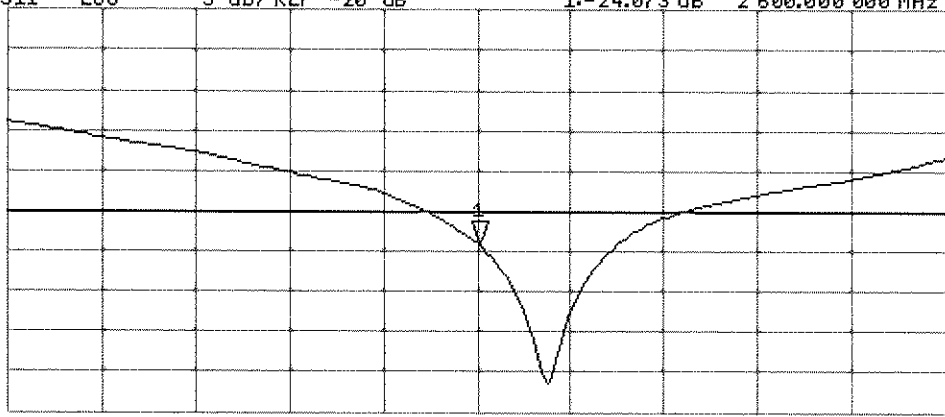

START 2 400.000 000 MHz

STOP 2 800.000 000 MHz

DASY5 Validation Report for Body TSL

Date: 11.04.2018

Test Laboratory: SPEAG, Zurich, Switzerland

DUT: Dipole 2600 MHz; Type: D2600V2; Serial: D2600V2 - SN: 1004

Communication System: UID 0 - CW; Frequency: 2600 MHz

Medium parameters used: $f = 2600$ MHz; $\sigma = 2.19$ S/m; $\epsilon_r = 52.1$; $\rho = 1000$ kg/m³

Phantom section: Flat Section

Measurement Standard: DASY5 (IEEE/IEC/ANSI C63.19-2011)

DASY52 Configuration:

- Probe: EX3DV4 - SN7349; ConvF(7.81, 7.81, 7.81); Calibrated: 30.12.2017;
- Sensor-Surface: 1.4mm (Mechanical Surface Detection)
- Electronics: DAE4 Sn601; Calibrated: 26.10.2017
- Phantom: Flat Phantom 5.0 (back); Type: QD 000 P50 AA; Serial: 1002
- DASY52 52.10.0(1446); SEMCAD X 14.6.10(7417)

Dipole Calibration for Body Tissue/ $P_{in}=250$ mW, $d=10$ mm/Zoom Scan (7x7x7)/Cube 0:

Measurement grid: $dx=5$ mm, $dy=5$ mm, $dz=5$ mm

Reference Value = 108.5 V/m; Power Drift = -0.09 dB

Peak SAR (extrapolated) = 28.3 W/kg

SAR(1 g) = 13.8 W/kg; SAR(10 g) = 6.2 W/kg

Maximum value of SAR (measured) = 22.9 W/kg

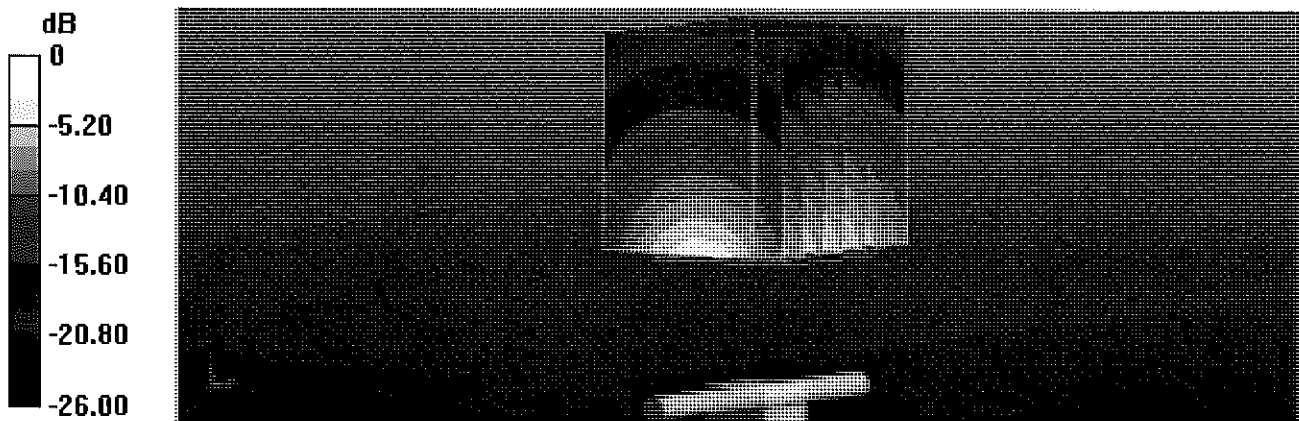

0 dB = 22.9 W/kg = 13.60 dBW/kg

Impedance Measurement Plot for Body TSL

11 Apr 2018 11:24:36

CH1 S11 1 U FS 1: 46.039 Ω -3.7520 Ω 16.315 pF 2 600.000 000 MHz

*
De1

CA

Avg
16

H1 d

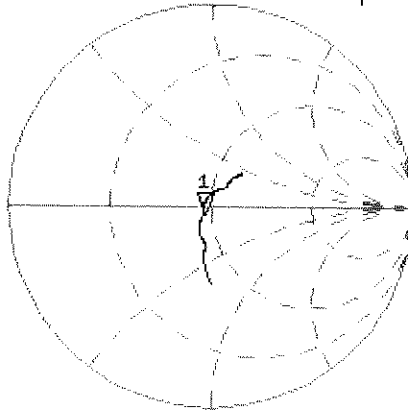

CH2 S11 LOG 5 dB/REF -20 dB 1:-24.921 dB 2 600.000 000 MHz

CA

Avg
16

H1 d

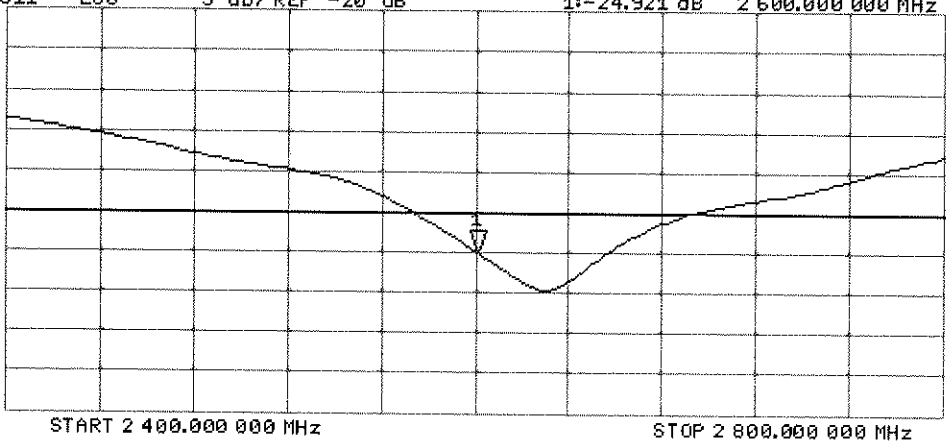



Accredited by the Swiss Accreditation Service (SAS)
The Swiss Accreditation Service is one of the signatories to the EA
Multilateral Agreement for the recognition of calibration certificates

Accreditation No.: **SCS 0108**

Client **PC Test**

Certificate No: **D5GHzV2-1191_Sep16**

CALIBRATION CERTIFICATE

Object **D5GHzV2 - SN:1191**

Calibration procedure(s) **QA CAL-22.v2**
Calibration procedure for dipole validation kits between 3-6 GHz

Calibration date: **September 21, 2016**

BNV
09-28-2016
Extended
09/2017
SC

This calibration certificate documents the traceability to national standards, which realize the physical units of measurements (SI).
The measurements and the uncertainties with confidence probability are given on the following pages and are part of the certificate.

All calibrations have been conducted in the closed laboratory facility: environment temperature (22 ± 3)°C and humidity < 70%.

Calibration Equipment used (M&TE critical for calibration)

Primary Standards	ID #	Cal Date (Certificate No.)	Scheduled Calibration
Power meter NRP	SN: 104778	06-Apr-16 (No. 217-02288/02289)	Apr-17
Power sensor NRP-Z91	SN: 103244	06-Apr-16 (No. 217-02288)	Apr-17
Power sensor NRP-Z91	SN: 103245	06-Apr-16 (No. 217-02289)	Apr-17
Reference 20 dB Attenuator	SN: 5058 (20k)	05-Apr-16 (No. 217-02292)	Apr-17
Type-N mismatch combination	SN: 5047.2 / 06327	05-Apr-16 (No. 217-02295)	Apr-17
Reference Probe EX3DV4	SN: 3503	30-Jun-16 (No. EX3-3503_Jun16)	Jun-17
DAE4	SN: 601	30-Dec-15 (No. DAE4-601_Dec15)	Dec-16
Secondary Standards	ID #	Check Date (in house)	Scheduled Check
Power meter EPM-442A	SN: GB37480704	07-Oct-15 (No. 217-02222)	In house check: Oct-16
Power sensor HP 8481A	SN: US37292783	07-Oct-15 (No. 217-02222)	In house check: Oct-16
Power sensor HP 8481A	SN: MY41092317	07-Oct-15 (No. 217-02223)	In house check: Oct-16
RF generator R&S SMT-06	SN: 100972	15-Jun-15 (in house check Jun-15)	In house check: Oct-16
Network Analyzer HP 8753E	SN: US37390585	18-Oct-01 (in house check Oct-15)	In house check: Oct-16

Calibrated by: **Leif Klysner** Laboratory Technician *Leif Klysner*

Approved by: **Katja Pokovic** Technical Manager *Katja Pokovic*

Issued: September 22, 2016

This calibration certificate shall not be reproduced except in full without written approval of the laboratory.



Accredited by the Swiss Accreditation Service (SAS)

The Swiss Accreditation Service is one of the signatories to the EA Multilateral Agreement for the recognition of calibration certificates

Accreditation No.: **SCS 0108**

Glossary:

TSL	tissue simulating liquid
ConvF	sensitivity in TSL / NORM x,y,z
N/A	not applicable or not measured

Calibration is Performed According to the Following Standards:

- IEEE Std 1528-2013, "IEEE Recommended Practice for Determining the Peak Spatial-Averaged Specific Absorption Rate (SAR) in the Human Head from Wireless Communications Devices: Measurement Techniques", June 2013
- IEC 62209-2, "Procedure to determine the Specific Absorption Rate (SAR) for wireless communication devices used in close proximity to the human body (frequency range of 30 MHz to 6 GHz)", March 2010
- KDB 865664, "SAR Measurement Requirements for 100 MHz to 6 GHz"

Additional Documentation:

- DASY4/5 System Handbook

Methods Applied and Interpretation of Parameters:

- Measurement Conditions:* Further details are available from the Validation Report at the end of the certificate. All figures stated in the certificate are valid at the frequency indicated.
- Antenna Parameters with TSL:* The dipole is mounted with the spacer to position its feed point exactly below the center marking of the flat phantom section, with the arms oriented parallel to the body axis.
- Feed Point Impedance and Return Loss:* These parameters are measured with the dipole positioned under the liquid filled phantom. The impedance stated is transformed from the measurement at the SMA connector to the feed point. The Return Loss ensures low reflected power. No uncertainty required.
- Electrical Delay:* One-way delay between the SMA connector and the antenna feed point. No uncertainty required.
- SAR measured:* SAR measured at the stated antenna input power.
- SAR normalized:* SAR as measured, normalized to an input power of 1 W at the antenna connector.
- SAR for nominal TSL parameters:* The measured TSL parameters are used to calculate the nominal SAR result.

The reported uncertainty of measurement is stated as the standard uncertainty of measurement multiplied by the coverage factor $k=2$, which for a normal distribution corresponds to a coverage probability of approximately 95%.

Measurement Conditions

DASY system configuration, as far as not given on page 1.

DASY Version	DASY5	V52.8.8
Extrapolation	Advanced Extrapolation	
Phantom	Modular Flat Phantom V5.0	
Distance Dipole Center - TSL	10 mm	with Spacer
Zoom Scan Resolution	dx, dy = 4.0 mm, dz = 1.4 mm	Graded Ratio = 1.4 (Z direction)
Frequency	5250 MHz ± 1 MHz 5600 MHz ± 1 MHz 5750 MHz ± 1 MHz	

Head TSL parameters at 5250 MHz

The following parameters and calculations were applied.

	Temperature	Permittivity	Conductivity
Nominal Head TSL parameters	22.0 °C	35.9	4.71 mho/m
Measured Head TSL parameters	(22.0 ± 0.2) °C	34.5 ± 6 %	4.59 mho/m ± 6 %
Head TSL temperature change during test	< 0.5 °C	----	----

SAR result with Head TSL at 5250 MHz

SAR averaged over 1 cm³ (1 g) of Head TSL	Condition	
SAR measured	100 mW input power	7.96 W/kg
SAR for nominal Head TSL parameters	normalized to 1W	78.9 W/kg ± 19.9 % (k=2)

SAR averaged over 10 cm³ (10 g) of Head TSL	condition	
SAR measured	100 mW input power	2.29 W/kg
SAR for nominal Head TSL parameters	normalized to 1W	22.6 W/kg ± 19.5 % (k=2)

Head TSL parameters at 5600 MHz

The following parameters and calculations were applied.

	Temperature	Permittivity	Conductivity
Nominal Head TSL parameters	22.0 °C	35.5	5.07 mho/m
Measured Head TSL parameters	(22.0 ± 0.2) °C	34.0 ± 6 %	4.93 mho/m ± 6 %
Head TSL temperature change during test	< 0.5 °C	----	----

SAR result with Head TSL at 5600 MHz

SAR averaged over 1 cm ³ (1 g) of Head TSL	Condition	
SAR measured	100 mW input power	8.45 W/kg
SAR for nominal Head TSL parameters	normalized to 1W	83.6 W / kg ± 19.9 % (k=2)

SAR averaged over 10 cm ³ (10 g) of Head TSL	condition	
SAR measured	100 mW input power	2.41 W/kg
SAR for nominal Head TSL parameters	normalized to 1W	23.8 W/kg ± 19.5 % (k=2)

Head TSL parameters at 5750 MHz

The following parameters and calculations were applied.

	Temperature	Permittivity	Conductivity
Nominal Head TSL parameters	22.0 °C	35.4	5.22 mho/m
Measured Head TSL parameters	(22.0 ± 0.2) °C	33.8 ± 6 %	5.08 mho/m ± 6 %
Head TSL temperature change during test	< 0.5 °C	----	----

SAR result with Head TSL at 5750 MHz

SAR averaged over 1 cm ³ (1 g) of Head TSL	Condition	
SAR measured	100 mW input power	7.99 W/kg
SAR for nominal Head TSL parameters	normalized to 1W	79.1 W/kg ± 19.9 % (k=2)

SAR averaged over 10 cm ³ (10 g) of Head TSL	condition	
SAR measured	100 mW input power	2.27 W/kg
SAR for nominal Head TSL parameters	normalized to 1W	22.4 W/kg ± 19.5 % (k=2)

Body TSL parameters at 5250 MHz

The following parameters and calculations were applied.

	Temperature	Permittivity	Conductivity
Nominal Body TSL parameters	22.0 °C	48.9	5.36 mho/m
Measured Body TSL parameters	(22.0 ± 0.2) °C	47.4 ± 6 %	5.52 mho/m ± 6 %
Body TSL temperature change during test	< 0.5 °C	----	----

SAR result with Body TSL at 5250 MHz

SAR averaged over 1 cm ³ (1 g) of Body TSL	Condition	
SAR measured	100 mW input power	7.74 W/kg
SAR for nominal Body TSL parameters	normalized to 1W	77.0 W/kg ± 19.9 % (k=2)

SAR averaged over 10 cm ³ (10 g) of Body TSL	condition	
SAR measured	100 mW input power	2.17 W/kg
SAR for nominal Body TSL parameters	normalized to 1W	21.6 W/kg ± 19.5 % (k=2)

Body TSL parameters at 5600 MHz

The following parameters and calculations were applied.

	Temperature	Permittivity	Conductivity
Nominal Body TSL parameters	22.0 °C	48.5	5.77 mho/m
Measured Body TSL parameters	(22.0 ± 0.2) °C	46.8 ± 6 %	6.00 mho/m ± 6 %
Body TSL temperature change during test	< 0.5 °C	----	----

SAR result with Body TSL at 5600 MHz

SAR averaged over 1 cm ³ (1 g) of Body TSL	Condition	
SAR measured	100 mW input power	7.96 W/kg
SAR for nominal Body TSL parameters	normalized to 1W	79.2 W/kg ± 19.9 % (k=2)

SAR averaged over 10 cm ³ (10 g) of Body TSL	condition	
SAR measured	100 mW input power	2.24 W/kg
SAR for nominal Body TSL parameters	normalized to 1W	22.2 W/kg ± 19.5 % (k=2)

Body TSL parameters at 5750 MHz

The following parameters and calculations were applied.

	Temperature	Permittivity	Conductivity
Nominal Body TSL parameters	22.0 °C	48.3	5.94 mho/m
Measured Body TSL parameters	(22.0 ± 0.2) °C	46.5 ± 6 %	6.21 mho/m ± 6 %
Body TSL temperature change during test	< 0.5 °C	----	----

SAR result with Body TSL at 5750 MHz

SAR averaged over 1 cm ³ (1 g) of Body TSL	Condition	
SAR measured	100 mW input power	7.65 W/kg
SAR for nominal Body TSL parameters	normalized to 1W	76.1 W/kg ± 19.9 % (k=2)

SAR averaged over 10 cm ³ (10 g) of Body TSL	condition	
SAR measured	100 mW input power	2.14 W/kg
SAR for nominal Body TSL parameters	normalized to 1W	21.2 W/kg ± 19.5 % (k=2)

Appendix (Additional assessments outside the scope of SCS 0108)

Antenna Parameters with Head TSL at 5250 MHz

Impedance, transformed to feed point	55.7 Ω - 4.3 j Ω
Return Loss	- 23.4 dB

Antenna Parameters with Head TSL at 5600 MHz

Impedance, transformed to feed point	58.3 Ω - 3.2 j Ω
Return Loss	- 21.8 dB

Antenna Parameters with Head TSL at 5750 MHz

Impedance, transformed to feed point	58.1 Ω + 4.8 j Ω
Return Loss	- 21.2 dB

Antenna Parameters with Body TSL at 5250 MHz

Impedance, transformed to feed point	56.1 Ω - 3.7 j Ω
Return Loss	- 23.4 dB

Antenna Parameters with Body TSL at 5600 MHz

Impedance, transformed to feed point	58.9 Ω - 1.7 j Ω
Return Loss	- 21.7 dB

Antenna Parameters with Body TSL at 5750 MHz

Impedance, transformed to feed point	59.5 Ω + 6.9 j Ω
Return Loss	- 19.4 dB

General Antenna Parameters and Design

Electrical Delay (one direction)	1.204 ns
----------------------------------	----------

After long term use with 100W radiated power, only a slight warming of the dipole near the feedpoint can be measured.

The dipole is made of standard semirigid coaxial cable. The center conductor of the feeding line is directly connected to the second arm of the dipole. The antenna is therefore short-circuited for DC-signals. On some of the dipoles, small end caps are added to the dipole arms in order to improve matching when loaded according to the position as explained in the "Measurement Conditions" paragraph. The SAR data are not affected by this change. The overall dipole length is still according to the Standard.

No excessive force must be applied to the dipole arms, because they might bend or the soldered connections near the feedpoint may be damaged.

Additional EUT Data

Manufactured by	SPEAG
Manufactured on	August 28, 2003

DASY5 Validation Report for Head TSL

Date: 21.09.2016

Test Laboratory: SPEAG, Zurich, Switzerland

DUT: Dipole D5GHzV2; Type: D5GHzV2; Serial: D5GHzV2 - SN:1191

Communication System: UID 0 - CW; Frequency: 5250 MHz, Frequency: 5600 MHz, Frequency: 5750 MHz
Medium parameters used: $f = 5250$ MHz; $\sigma = 4.59$ S/m; $\epsilon_r = 34.5$; $\rho = 1000$ kg/m³, Medium parameters used: $f = 5600$ MHz; $\sigma = 4.93$ S/m; $\epsilon_r = 34$; $\rho = 1000$ kg/m³, Medium parameters used: $f = 5750$ MHz; $\sigma = 5.08$ S/m; $\epsilon_r = 33.8$; $\rho = 1000$ kg/m³

Phantom section: Flat Section

Measurement Standard: DASY5 (IEEE/IEC/ANSI C63.19-2011)

DASY52 Configuration:

- Probe: EX3DV4 - SN3503; ConvF(5.42, 5.42, 5.42); Calibrated: 30.06.2016, ConvF(4.89, 4.89, 4.89); Calibrated: 30.06.2016, ConvF(4.85, 4.85, 4.85); Calibrated: 30.06.2016;
- Sensor-Surface: 1.4mm (Mechanical Surface Detection)
- Electronics: DAE4 Sn601; Calibrated: 30.12.2015
- Phantom: Flat Phantom 5.0 (front); Type: QD000P50AA; Serial: 1001
- DASY52 52.8.8(1258); SEMCAD X 14.6.10(7372)

Dipole Calibration for Head Tissue/Pin=100mW, dist=10mm, f=5250 MHz/Zoom Scan, dist=1.4mm (8x8x7)/Cube 0: Measurement grid: dx=4mm, dy=4mm, dz=1.4mm

Reference Value = 68.49 V/m; Power Drift = 0.01 dB

Peak SAR (extrapolated) = 28.6 W/kg

SAR(1 g) = 7.96 W/kg; SAR(10 g) = 2.29 W/kg

Maximum value of SAR (measured) = 18.2 W/kg

Dipole Calibration for Head Tissue/Pin=100mW, dist=10mm, f=5600 MHz/Zoom Scan, dist=1.4mm (8x8x7)/Cube 0: Measurement grid: dx=4mm, dy=4mm, dz=1.4mm

Reference Value = 69.34 V/m; Power Drift = -0.00 dB

Peak SAR (extrapolated) = 32.9 W/kg

SAR(1 g) = 8.45 W/kg; SAR(10 g) = 2.41 W/kg

Maximum value of SAR (measured) = 20.0 W/kg

Dipole Calibration for Head Tissue/Pin=100mW, dist=10mm, f=5750 MHz/Zoom Scan, dist=1.4mm (8x8x7)/Cube 0: Measurement grid: dx=4mm, dy=4mm, dz=1.4mm

Reference Value = 67.15 V/m; Power Drift = 0.02 dB

Peak SAR (extrapolated) = 32.3 W/kg

SAR(1 g) = 7.99 W/kg; SAR(10 g) = 2.27 W/kg

Maximum value of SAR (measured) = 19.3 W/kg

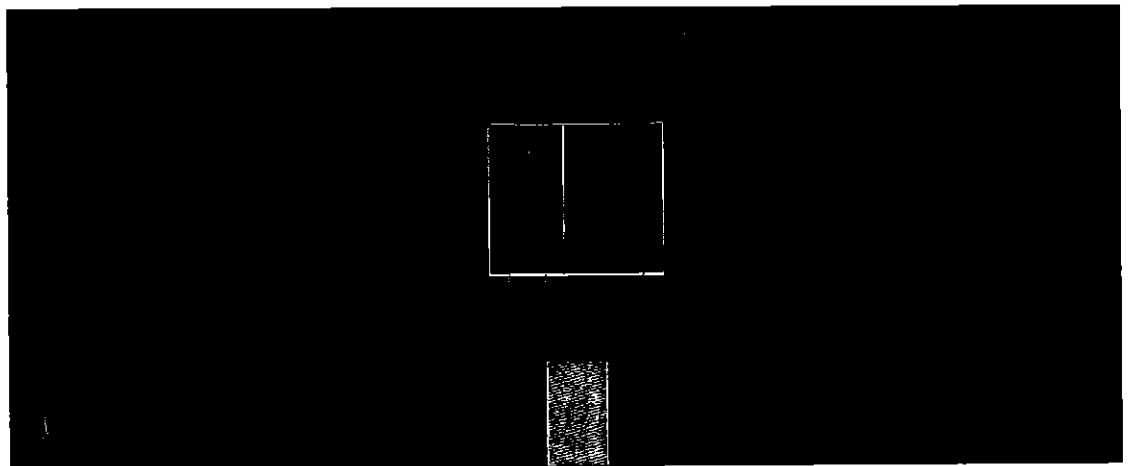
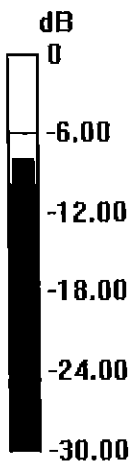

0 dB = 18.2 W/kg = 12.60 dBW/kg

Impedance Measurement Plot for Head TSL

20 Sep 2016 13:20:17

CH1 S11 1 U FS 1: 55.695 Ω -4.2793 Ω 7.0842 pF 5 250.000 000 MHz

*
De1
Cor
Avg
16
H1d

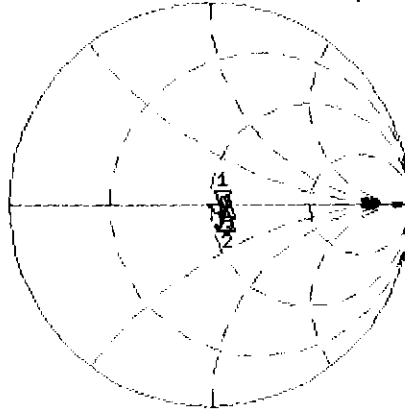

CH1 Markers
2: 58.262 Ω
-3.1738 Ω
5.60000 GHz
3: 58.078 Ω
4.7969 Ω
5.75000 GHz

CH2 S11 LOG 5 dB/REF -20 dB 1: -23.432 dB 5 250.000 000 MHz

Cor
Avg
16
H1d

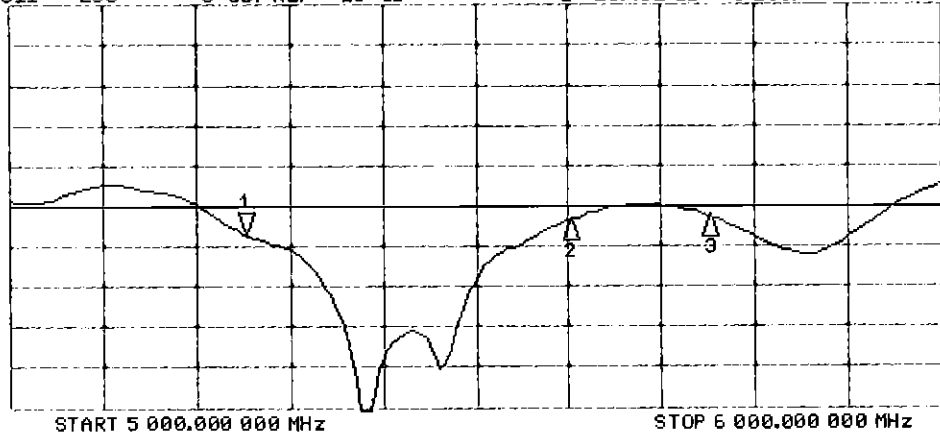

CH2 Markers
2: -21.752 dB
5.60000 GHz
3: -21.228 dB
5.75000 GHz

DASY5 Validation Report for Body TSL

Date: 20.09.2016

Test Laboratory: SPEAG, Zurich, Switzerland

DUT: Dipole D5GHzV2; Type: D5GHzV2; Serial: D5GHzV2 - SN:1191

Communication System: UID 0 - CW; Frequency: 5250 MHz, Frequency: 5600 MHz, Frequency: 5750 MHz
Medium parameters used: $f = 5250$ MHz; $\sigma = 5.52$ S/m; $\epsilon_r = 47.4$; $\rho = 1000$ kg/m³, Medium parameters used: $f = 5600$ MHz; $\sigma = 6$ S/m; $\epsilon_r = 46.8$; $\rho = 1000$ kg/m³, Medium parameters used: $f = 5750$ MHz; $\sigma = 6.21$ S/m; $\epsilon_r = 46.5$; $\rho = 1000$ kg/m³

Phantom section: Flat Section

Measurement Standard: DASY5 (IEEE/IEC/ANSI C63.19-2011)

DASY52 Configuration:

- Probe: EX3DV4 - SN3503; ConvF(4.85, 4.85, 4.85); Calibrated: 30.06.2016, ConvF(4.35, 4.35, 4.35); Calibrated: 30.06.2016, ConvF(4.3, 4.3, 4.3); Calibrated: 30.06.2016;
- Sensor-Surface: 1.4mm (Mechanical Surface Detection)
- Electronics: DAE4 Sn601; Calibrated: 30.12.2015
- Phantom: Flat Phantom 5.0 (back); Type: QD000P50AA; Serial: 1002
- DASY52 52.8.8(1258); SEMCAD X 14.6.10(7372)

Dipole Calibration for Body Tissue/Pin=100mW, dist=10mm, f=5250MHz/Zoom Scan,

dist=1.4mm (8x8x7)/Cube 0: Measurement grid: dx=4mm, dy=4mm, dz=1.4mm

Reference Value = 66.49 V/m; Power Drift = -0.07 dB

Peak SAR (extrapolated) = 29.1 W/kg

SAR(1 g) = 7.74 W/kg; SAR(10 g) = 2.17 W/kg

Maximum value of SAR (measured) = 17.7 W/kg

Dipole Calibration for Body Tissue/Pin=100mW, dist=10mm, f=5600 MHz/Zoom Scan,

dist=1.4mm (8x8x7)/Cube 0: Measurement grid: dx=4mm, dy=4mm, dz=1.4mm

Reference Value = 65.85 V/m; Power Drift = -0.09 dB

Peak SAR (extrapolated) = 32.5 W/kg

SAR(1 g) = 7.96 W/kg; SAR(10 g) = 2.24 W/kg

Maximum value of SAR (measured) = 18.8 W/kg

Dipole Calibration for Body Tissue/Pin=100mW, dist=10mm, f=5750 MHz/Zoom Scan,

dist=1.4mm (8x8x7)/Cube 0: Measurement grid: dx=4mm, dy=4mm, dz=1.4mm

Reference Value = 64.21 V/m; Power Drift = -0.09 dB

Peak SAR (extrapolated) = 32.7 W/kg

SAR(1 g) = 7.65 W/kg; SAR(10 g) = 2.14 W/kg

Maximum value of SAR (measured) = 18.5 W/kg

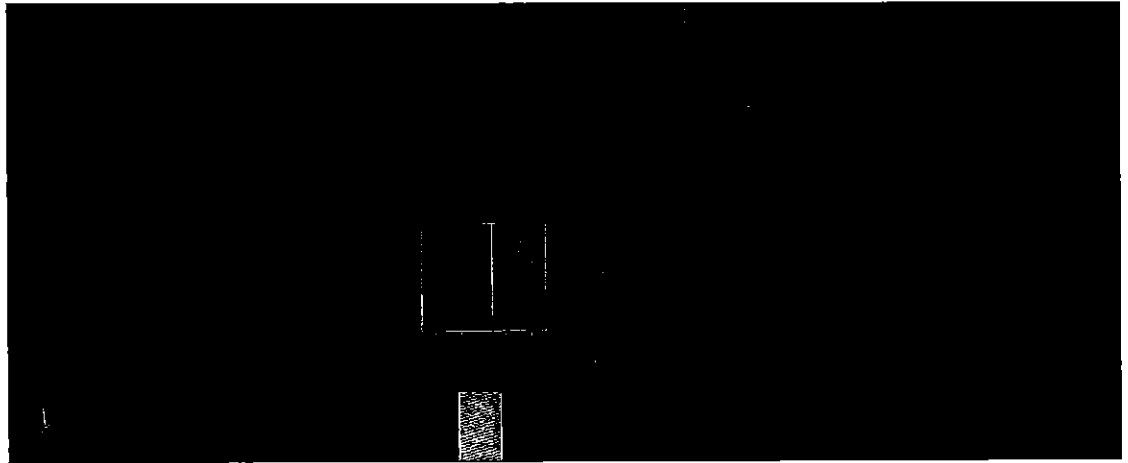
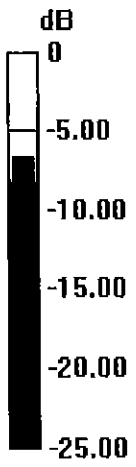

0 dB = 17.7 W/kg = 12.48 dBW/kg

Impedance Measurement Plot for Body TSL

20 Sep 2016 13:19:13

CH1 S11 1 U FS 1: 56.143 Ω -3.6992 Ω 8.1950 pF 5 250.000 000 MHz

*
De1
Cor
Avg
16
H1d

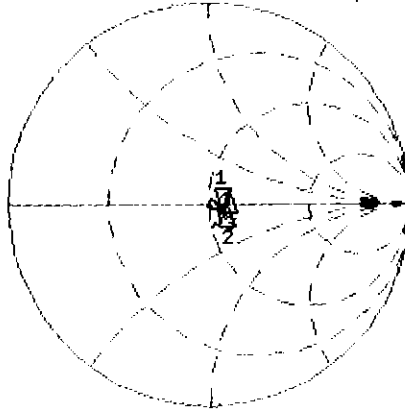

CH1 Markers
2: 58.887 Ω
-1.6504 Ω
5.60000 GHz
3: 59.510 Ω
6.9121 Ω
5.75000 GHz

CH2 S11 LOG 5 dB/REF -20 dB 1: -23.406 dB 5 250.000 000 MHz

Cor
Avg
16
H1d

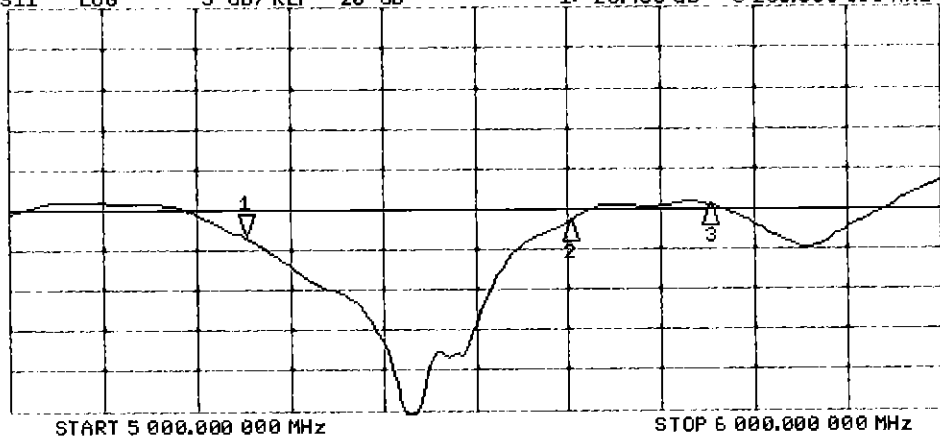

CH2 Markers
2: -21.616 dB
5.60000 GHz
3: -19.400 dB
5.75000 GHz

Certification of Calibration

Object: D5GHzV2 – SN: 1191

Calibration procedure(s): Procedure for Calibration Extension for SAR Dipoles.

Extension Calibration date: 9/19/2017

Description: SAR Validation Dipole at 5250, 5600, and 5750 MHz.

Calibration Equipment used:

Manufacturer	Model	Description	Cal Date	Cal Interval	Cal Due	Serial Number
Control Company	4040	Therm./Clock/Humidity Monitor	3/31/2017	Biennial	3/31/2019	170232394
Control Company	4352	Ultra Long Stem Thermometer	5/2/2017	Biennial	5/2/2019	170330156
Amplifier Research	1551G6	Amplifier	CBT	N/A	CBT	433971
Narda	4772-3	Attenuator (3dB)	CBT	N/A	CBT	9406
Keysight	772D	Dual Directional Coupler	CBT	N/A	CBT	MY52180215
Keysight Technologies	85033E	Standard Mechanical Calibration Kit (DC to 9GHz, 3.5mm)	6/1/2017	Annual	6/1/2018	MY53401181
Agilent	8753ES	S-Parameter Network Analyzer	10/26/2016	Annual	10/26/2017	US39170118
Mini-Circuits	BW-N20W5+	DC to 18 GHz Precision Fixed 20 dB Attenuator	CBT	N/A	CBT	N/A
SPEAG	DAK-3.5	Dielectric Assessment Kit	5/10/2017	Annual	5/10/2018	1070
SPEAG	EX3DV4	SAR Probe	1/13/2017	Annual	1/13/2018	3589
SPEAG	EX3DV4	SAR Probe	2/13/2017	Annual	2/13/2018	3914
SPEAG	DAE4	Dasy Data Acquisition Electronics	1/16/2017	Annual	1/16/2018	1466
SPEAG	DAE4	Dasy Data Acquisition Electronics	2/9/2017	Annual	2/9/2018	665
Anritsu	MA2411B	Pulse Power Sensor	2/10/2017	Annual	2/10/2018	1207364
Anritsu	MA2411B	Pulse Power Sensor	2/10/2017	Annual	2/10/2018	1339018
Anritsu	ML2495A	Power Meter	10/16/2015	Biennial	10/16/2017	941001
Agilent	N5182A	MXG Vector Signal Generator	2/28/2017	Annual	2/28/2018	MY47420800
Seekonk	NC-100	Torque Wrench	11/6/2015	Biennial	11/6/2017	N/A
MiniCircuits	VLF-6000+	Low Pass Filter	CBT	N/A	CBT	N/A
Narda	4014C-6	4 - 8 GHz SMA 6 dB Directional Coupler	CBT	N/A	CBT	N/A

Measurement Uncertainty = $\pm 23\%$ (k=2)

	Name	Function	Signature
Calibrated By:	Brodie Halfoster	Test Engineer	<i>BRODIE HALBFOSTER</i>
Approved By:	Kaitlin O'Keefe	Senior Technical Manager	<i>KOK</i>

DIPOLE CALIBRATION EXTENSION

Per KDB 865664 D01, calibration intervals of up to three years may be considered for reference dipoles when it is demonstrated that the SAR target, impedance and return loss of a dipole have remained stable according to the following requirements:

1. The measured SAR does not deviate more than 10% from the target on the calibration certificate.
2. The return-loss does not deviate more than 20% from the previous measurement and meets the required 20dB minimum return-loss requirement.
3. The measurement of real or imaginary parts of impedance does not deviate more than 5Ω from the previous measurement.

The following dipole was checked to pass the above 3 requirements to have 2-year calibration period from the calibration date:

Frequency (MHz)	Calibration Date	Extension Date	Certificate Electrical Delay (ns)	Certificate SAR Target Head (1g W/kg @ 17.0 dBm)	Measured Head SAR (1g) W/kg @ 17.0 dBm	Deviation 1g (%)	Certificate SAR Target Head (10g W/kg @ 17.0 dBm)	Measured Head SAR (10g) W/kg @ 17.0 dBm	Deviation 10g (%)	Certificate Impedance Head (Ohm) Real	Measured Impedance Head (Ohm) Real	Difference (Ohm) Real	Certificate Impedance Head (Ohm) Imaginary	Measured Impedance Head (Ohm) Imaginary	Difference (Ohm) Imaginary	Certificate Return Loss Head (dB)	Measured Return Loss Head (dB)	Deviation (%)	PASS/FAIL
5250	9/21/2016	9/19/2017	1.204	3.95	3.70	-6.21%	1.13	1.05	-7.08%	55.7	53.4	2.3	-4.3	-6.4	2.1	-23.4	-26.9	-15.00%	PASS
5600	9/21/2016	9/19/2017	1.204	4.18	4.03	-3.59%	1.19	1.13	-5.04%	58.3	55.8	2.7	-3.2	-1.2	2.0	-21.8	-26.1	-19.80%	PASS
5750	9/21/2016	9/19/2017	1.204	3.96	3.84	-3.03%	1.12	1.10	-1.79%	58.1	57.4	0.7	4.8	3.2	1.6	-21.2	-21.0	0.90%	PASS

Frequency (MHz)	Calibration Date	Extension Date	Certificate Electrical Delay (ns)	Certificate SAR Target Body (1g W/kg @ 17.0 dBm)	Measured Body SAR (1g) W/kg @ 17.0 dBm	Deviation 1g (%)	Certificate SAR Target Body (10g W/kg @ 17.0 dBm)	Measured Body SAR (10g) W/kg @ 17.0 dBm	Deviation 10g (%)	Certificate Impedance Body (Ohm) Real	Measured Impedance Body (Ohm) Real	Difference (Ohm) Real	Certificate Impedance Body (Ohm) Imaginary	Measured Impedance Body (Ohm) Imaginary	Difference (Ohm) Imaginary	Certificate Return Loss Body (dB)	Measured Return Loss Body (dB)	Deviation (%)	PASS/FAIL
5250	9/21/2016	9/19/2017	1.204	3.85	3.80	-1.30%	1.08	1.06	-1.85%	56.1	54.0	2.1	-3.7	-3.3	0.4	-23.4	-26.0	-11.10%	PASS
5600	9/21/2016	9/19/2017	1.204	3.96	4.06	2.53%	1.11	1.13	1.80%	58.9	56.5	2.4	-1.7	0.5	2.2	-21.7	-24.5	-12.80%	PASS
5750	9/21/2016	9/19/2017	1.204	3.81	3.66	-3.81%	1.06	1.02	-3.77%	59.5	58.0	1.5	6.9	5.2	1.7	-19.4	-21.1	-8.70%	PASS

Impedance & Return-Loss Measurement Plot for Head TSL

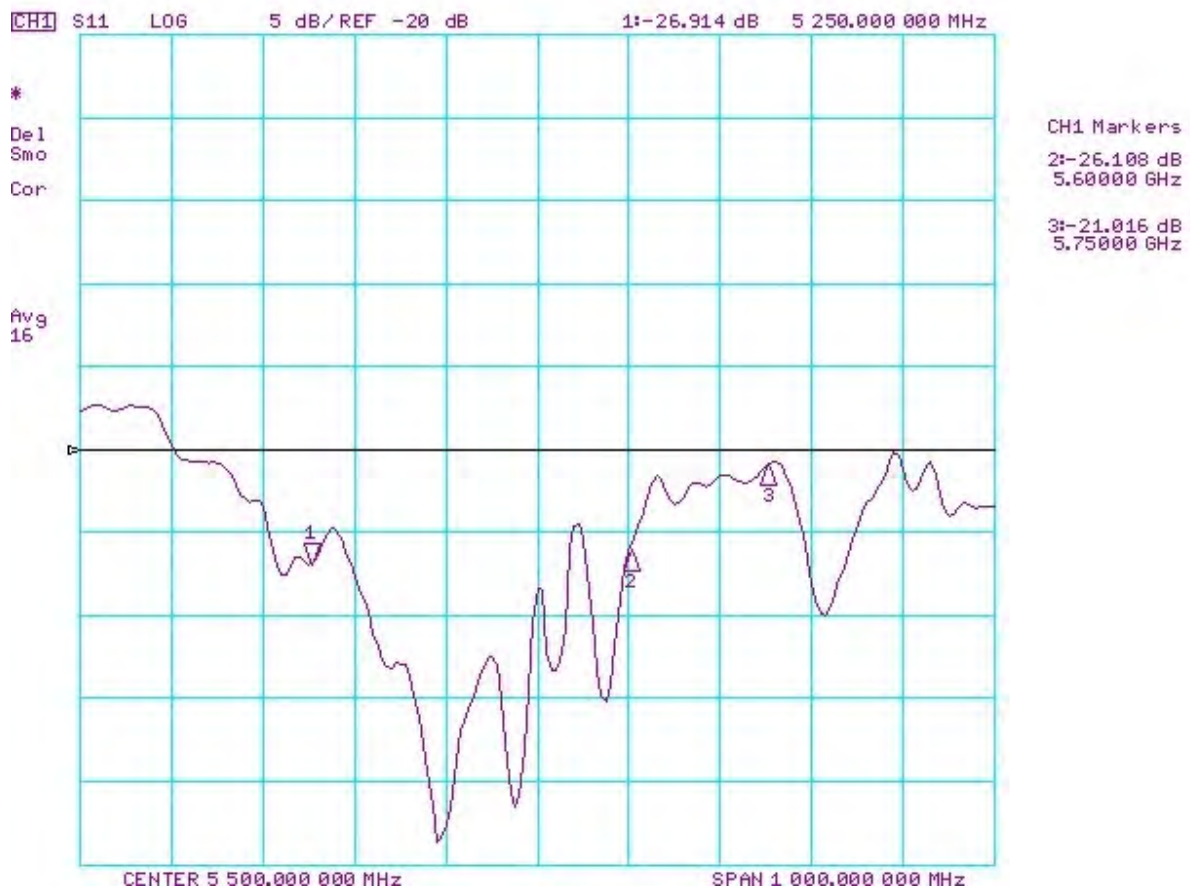
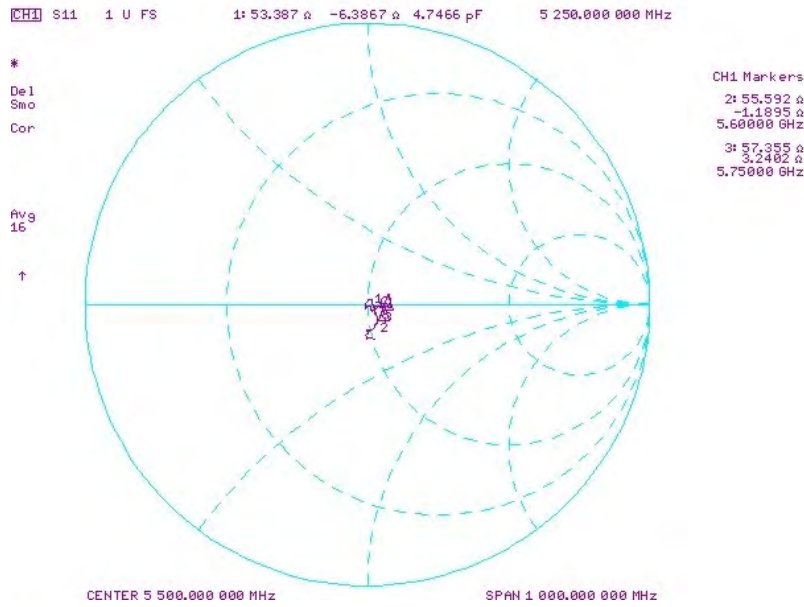

Impedance & Return-Loss Measurement Plot for Body TSL

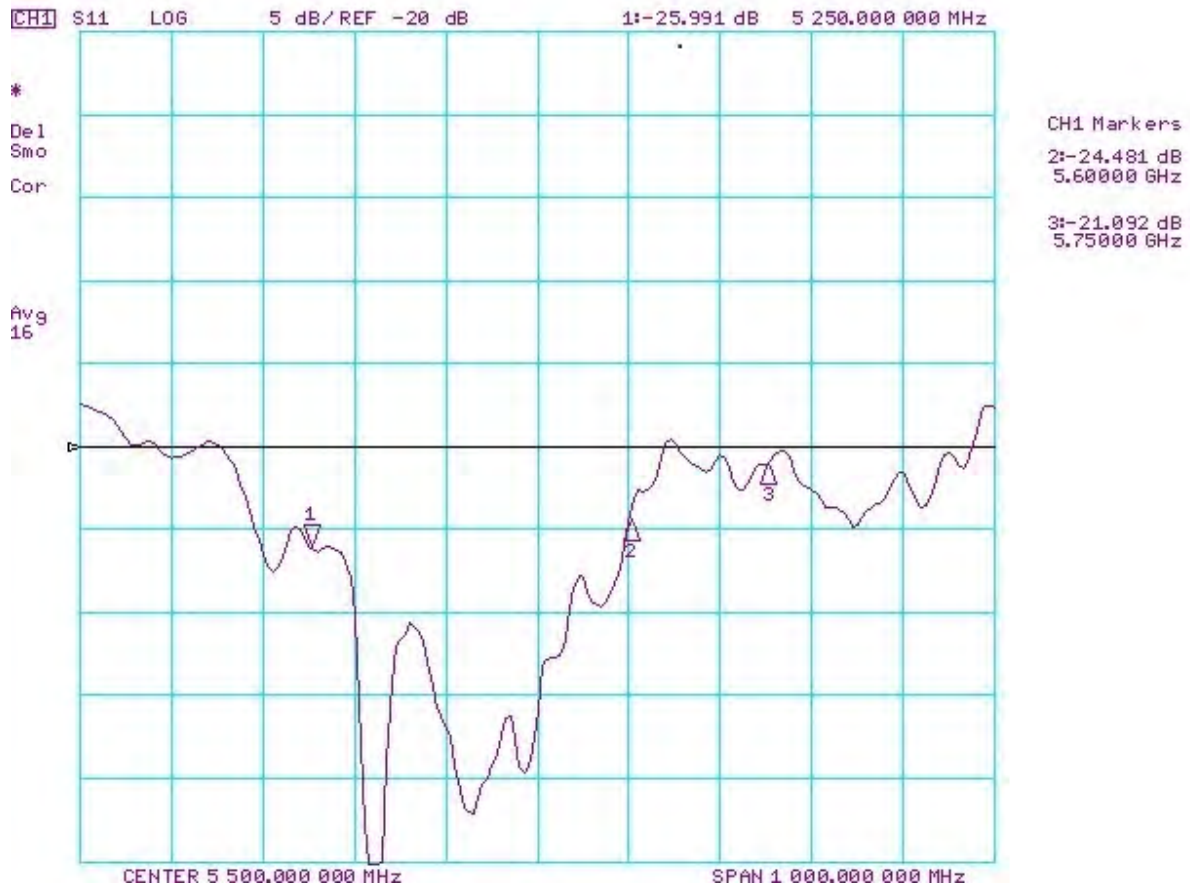
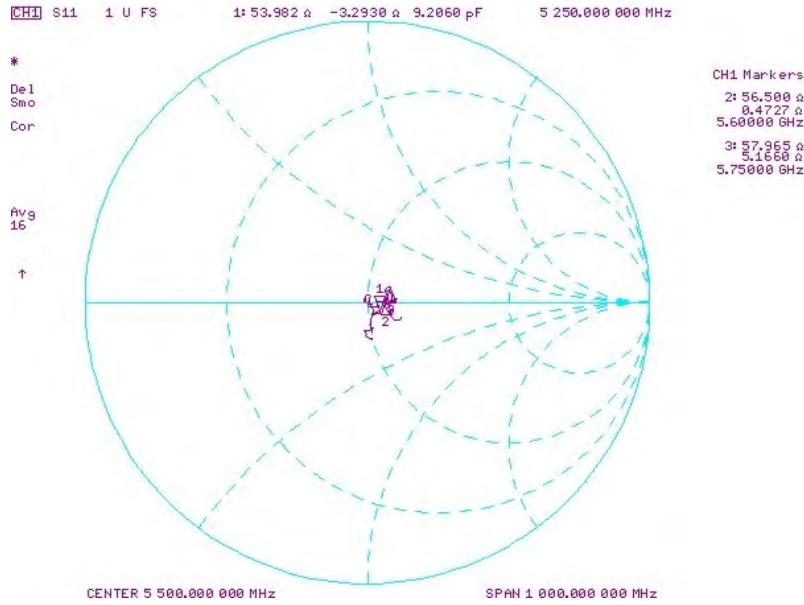



Accredited by the Swiss Accreditation Service (SAS)
The Swiss Accreditation Service is one of the signatories to the EA
Multilateral Agreement for the recognition of calibration certificates

Accreditation No.: **SCS 0108**

Client **PC Test**

Certificate No: **D750V3-1161_Jul16**

CALIBRATION CERTIFICATE

Object **D750V3 - SN:1161**

Calibration procedure(s) **QA CAL-05.v9**
Calibration procedure for dipole validation kits above 700 MHz

Calibration date: **July 13, 2016**

✓PN
8/9/16
Extended
BN
7/18/2018

This calibration certificate documents the traceability to national standards, which realize the physical units of measurements (SI).
The measurements and the uncertainties with confidence probability are given on the following pages and are part of the certificate.

All calibrations have been conducted in the closed laboratory facility: environment temperature $(22 \pm 3)^\circ\text{C}$ and humidity $< 70\%$.

Calibration Equipment used (M&TE critical for calibration)

Primary Standards	ID #	Cal Date (Certificate No.)	Scheduled Calibration
Power meter NRP	SN: 104778	06-Apr-16 (No. 217-02288/02289)	Apr-17
Power sensor NRP-Z91	SN: 103244	06-Apr-16 (No. 217-02288)	Apr-17
Power sensor NRP-Z91	SN: 103245	06-Apr-16 (No. 217-02289)	Apr-17
Reference 20 dB Attenuator	SN: 5058 (20k)	05-Apr-16 (No. 217-02292)	Apr-17
Type-N mismatch combination	SN: 5047.2 / 06327	05-Apr-16 (No. 217-02295)	Apr-17
Reference Probe EX3DV4	SN: 7349	15-Jun-16 (No. EX3-7349_Jun16)	Jun-17
DAE4	SN: 601	30-Dec-15 (No. DAE4-601_Dec15)	Dec-16

Secondary Standards	ID #	Check Date (in house)	Scheduled Check
Power meter EPM-442A	SN: GB37480704	07-Oct-15 (No. 217-02222)	In house check: Oct-16
Power sensor HP 8481A	SN: US37292783	07-Oct-15 (No. 217-02222)	In house check: Oct-16
Power sensor HP 8481A	SN: MY41092317	07-Oct-15 (No. 217-02223)	In house check: Oct-16
RF generator R&S SMT-06	SN: 100972	15-Jun-15 (in house check Jun-15)	In house check: Oct-16
Network Analyzer HP 8753E	SN: US37390585	18-Oct-01 (in house check Oct-15)	In house check: Oct-16

Calibrated by: **Claudio Leubler** Name: **Claudio Leubler** Function: **Laboratory Technician**

Approved by: **Katja Pokovic** Name: **Katja Pokovic** Function: **Technical Manager**

Signature

Issued: July 13, 2016

This calibration certificate shall not be reproduced except in full without written approval of the laboratory.



Accredited by the Swiss Accreditation Service (SAS)
The Swiss Accreditation Service is one of the signatories to the EA
Multilateral Agreement for the recognition of calibration certificates

Accreditation No.: **SCS 0108**

Glossary:

TSL	tissue simulating liquid
ConvF	sensitivity in TSL / NORM x,y,z
N/A	not applicable or not measured

Calibration is Performed According to the Following Standards:

- a) IEEE Std 1528-2013, "IEEE Recommended Practice for Determining the Peak Spatial-Averaged Specific Absorption Rate (SAR) in the Human Head from Wireless Communications Devices: Measurement Techniques", June 2013
- b) IEC 62209-1, "Procedure to measure the Specific Absorption Rate (SAR) for hand-held devices used in close proximity to the ear (frequency range of 300 MHz to 3 GHz)", February 2005
- c) IEC 62209-2, "Procedure to determine the Specific Absorption Rate (SAR) for wireless communication devices used in close proximity to the human body (frequency range of 30 MHz to 6 GHz)", March 2010
- d) KDB 865664, "SAR Measurement Requirements for 100 MHz to 6 GHz"

Additional Documentation:

- e) DASY4/5 System Handbook

Methods Applied and Interpretation of Parameters:

- *Measurement Conditions:* Further details are available from the Validation Report at the end of the certificate. All figures stated in the certificate are valid at the frequency indicated.
- *Antenna Parameters with TSL:* The dipole is mounted with the spacer to position its feed point exactly below the center marking of the flat phantom section, with the arms oriented parallel to the body axis.
- *Feed Point Impedance and Return Loss:* These parameters are measured with the dipole positioned under the liquid filled phantom. The impedance stated is transformed from the measurement at the SMA connector to the feed point. The Return Loss ensures low reflected power. No uncertainty required.
- *Electrical Delay:* One-way delay between the SMA connector and the antenna feed point. No uncertainty required.
- *SAR measured:* SAR measured at the stated antenna input power.
- *SAR normalized:* SAR as measured, normalized to an input power of 1 W at the antenna connector.
- *SAR for nominal TSL parameters:* The measured TSL parameters are used to calculate the nominal SAR result.

The reported uncertainty of measurement is stated as the standard uncertainty of measurement multiplied by the coverage factor $k=2$, which for a normal distribution corresponds to a coverage probability of approximately 95%.

Measurement Conditions

DASY system configuration, as far as not given on page 1.

DASY Version	DASY5	V52.8.8
Extrapolation	Advanced Extrapolation	
Phantom	Modular Flat Phantom	
Distance Dipole Center - TSL	15 mm	with Spacer
Zoom Scan Resolution	dx, dy, dz = 5 mm	
Frequency	750 MHz \pm 1 MHz	

Head TSL parameters

The following parameters and calculations were applied.

	Temperature	Permittivity	Conductivity
Nominal Head TSL parameters	22.0 °C	41.9	0.89 mho/m
Measured Head TSL parameters	(22.0 \pm 0.2) °C	40.9 \pm 6 %	0.91 mho/m \pm 6 %
Head TSL temperature change during test	< 0.5 °C	----	----

SAR result with Head TSL

SAR averaged over 1 cm ³ (1 g) of Head TSL	Condition	
SAR measured	250 mW input power	2.09 W/kg
SAR for nominal Head TSL parameters	normalized to 1W	8.17 W/kg \pm 17.0 % (k=2)

SAR averaged over 10 cm ³ (10 g) of Head TSL	condition	
SAR measured	250 mW input power	1.37 W/kg
SAR for nominal Head TSL parameters	normalized to 1W	5.39 W/kg \pm 16.5 % (k=2)

Body TSL parameters

The following parameters and calculations were applied.

	Temperature	Permittivity	Conductivity
Nominal Body TSL parameters	22.0 °C	55.5	0.96 mho/m
Measured Body TSL parameters	(22.0 \pm 0.2) °C	55.1 \pm 6 %	0.99 mho/m \pm 6 %
Body TSL temperature change during test	< 0.5 °C	----	----

SAR result with Body TSL

SAR averaged over 1 cm ³ (1 g) of Body TSL	Condition	
SAR measured	250 mW input power	2.16 W/kg
SAR for nominal Body TSL parameters	normalized to 1W	8.43 W/kg \pm 17.0 % (k=2)

SAR averaged over 10 cm ³ (10 g) of Body TSL	condition	
SAR measured	250 mW input power	1.41 W/kg
SAR for nominal Body TSL parameters	normalized to 1W	5.53 W/kg \pm 16.5 % (k=2)

Appendix (Additional assessments outside the scope of SCS 0108)

Antenna Parameters with Head TSL

Impedance, transformed to feed point	55.6 Ω - 0.9 $j\Omega$
Return Loss	- 25.4 dB

Antenna Parameters with Body TSL

Impedance, transformed to feed point	50.2 Ω - 4.0 $j\Omega$
Return Loss	- 28.0 dB

General Antenna Parameters and Design

Electrical Delay (one direction)	1.033 ns
----------------------------------	----------

After long term use with 100W radiated power, only a slight warming of the dipole near the feedpoint can be measured.

The dipole is made of standard semirigid coaxial cable. The center conductor of the feeding line is directly connected to the second arm of the dipole. The antenna is therefore short-circuited for DC-signals. On some of the dipoles, small end caps are added to the dipole arms in order to improve matching when loaded according to the position as explained in the "Measurement Conditions" paragraph. The SAR data are not affected by this change. The overall dipole length is still according to the Standard.

No excessive force must be applied to the dipole arms, because they might bend or the soldered connections near the feedpoint may be damaged.

Additional EUT Data

Manufactured by	SPEAG
Manufactured on	November 19, 2015

DASY5 Validation Report for Head TSL

Date: 13.07.2016

Test Laboratory: SPEAG, Zurich, Switzerland

DUT: Dipole 750 MHz; Type: D750V3; Serial: D750V3 - SN:1161

Communication System: UID 0 - CW; Frequency: 750 MHz

Medium parameters used: $f = 750$ MHz; $\sigma = 0.91$ S/m; $\epsilon_r = 40.9$; $\rho = 1000$ kg/m³

Phantom section: Flat Section

Measurement Standard: DASY5 (IEEE/IEC/ANSI C63.19-2011)

DASY52 Configuration:

- Probe: EX3DV4 - SN7349; ConvF(10.07, 10.07, 10.07); Calibrated: 15.06.2016;
- Sensor-Surface: 1.4mm (Mechanical Surface Detection)
- Electronics: DAE4 Sn601; Calibrated: 30.12.2015
- Phantom: Flat Phantom 4.9L; Type: QD000P49AA; Serial: 1001
- DASY52 52.8.8(1258); SEMCAD X 14.6.10(7372)

Dipole Calibration for Head Tissue/Pin=250 mW, d=15mm/Zoom Scan (7x7x7)/Cube 0:

Measurement grid: dx=5mm, dy=5mm, dz=5mm

Reference Value = 58.07 V/m; Power Drift = -0.00 dB

Peak SAR (extrapolated) = 3.13 W/kg

SAR(1 g) = 2.09 W/kg; SAR(10 g) = 1.37 W/kg

Maximum value of SAR (measured) = 2.80 W/kg

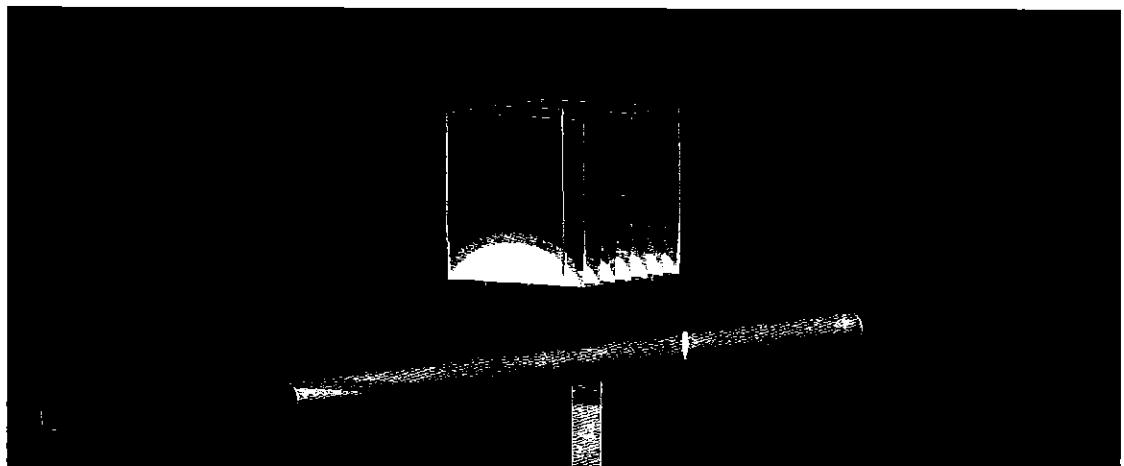

0 dB = 2.80 W/kg = 4.47 dBW/kg

Impedance Measurement Plot for Head TSL

13 Jul 2016 09:55:53
 [CH1] S11 1 U FS 1: 55.615 Ω -949.22 m Ω 223.56 pF 750.000 000 MHz

*
 De1

CA

Avg
 16

H1d

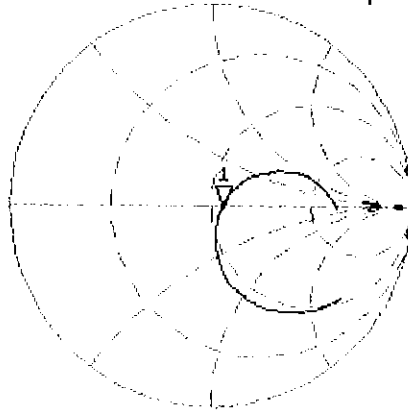

CH2 S11 LOG 5 dB/REF -20 dB 1:-25.361 dB 750.000 000 MHz

CA

Avg
 16

H1d

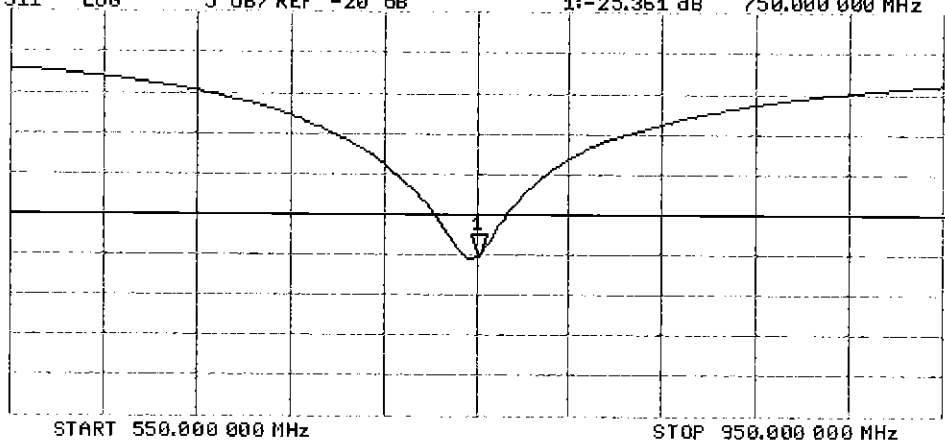

DASY5 Validation Report for Body TSL

Date: 13.07.2016

Test Laboratory: SPEAG, Zurich, Switzerland

DUT: Dipole 750 MHz; Type: D750V3; Serial: D750V3 - SN:1161

Communication System: UID 0 - CW; Frequency: 750 MHz

Medium parameters used: $f = 750$ MHz; $\sigma = 0.99$ S/m; $\epsilon_r = 55.1$; $\rho = 1000$ kg/m³

Phantom section: Flat Section

Measurement Standard: DASY5 (IEEE/IEC/ANSI C63.19-2011)

DASY52 Configuration:

- Probe: EX3DV4 - SN7349; ConvF(9.99, 9.99, 9.99); Calibrated: 15.06.2016;
- Sensor-Surface: 1.4mm (Mechanical Surface Detection)
- Electronics: DAE4 Sn601; Calibrated: 30.12.2015
- Phantom: Flat Phantom 4.9L; Type: QD000P49AA; Serial: 1001
- DASY52 52.8.8(1258); SEMCAD X 14.6.10(7372)

Dipole Calibration for Body Tissue/Pin=250 mW, d=15mm/Zoom Scan (7x7x7)/Cube 0:

Measurement grid: dx=5mm, dy=5mm, dz=5mm

Reference Value = 56.33 V/m; Power Drift = -0.00 dB

Peak SAR (extrapolated) = 3.22 W/kg

SAR(1 g) = 2.16 W/kg; SAR(10 g) = 1.41 W/kg

Maximum value of SAR (measured) = 2.87 W/kg



0 dB = 2.87 W/kg = 4.58 dBW/kg

Impedance Measurement Plot for Body TSL

13 Jul 2016 13:16:34
[CH1] S11 1 U FS 1: 50.244 Ω -3.9707 Ω 53.443 pF 750.000 000 MHz

*
Del
CA

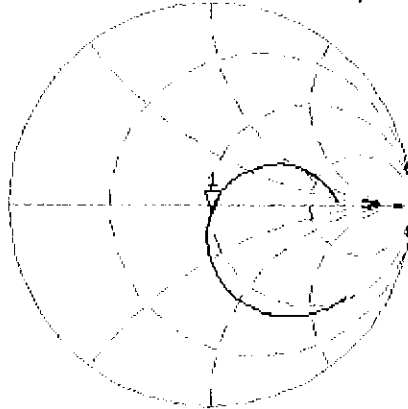

Avg
16
H1d

CH2 S11 LOG 5 dB/REF -20 dB 1:-27.995 dB 750.000 000 MHz

CA
H1d

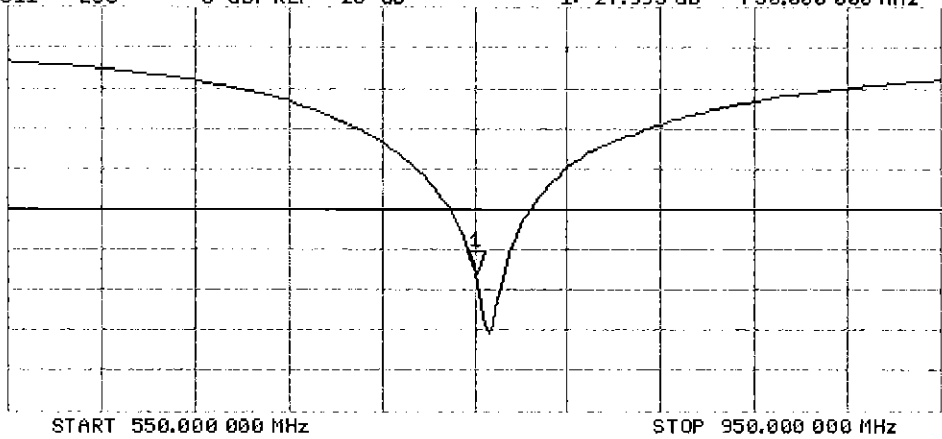

Certification of Calibration

Object: D750V3 – SN: 1161

Calibration procedure(s): Procedure for Calibration Extension for SAR Dipoles.

Calibration date: July 12, 2017

Description: SAR Validation Dipole at 750 MHz.

Calibration Equipment used:

Manufacturer	Model	Description	Cal Date	Cal Interval	Cal Due	Serial Number
Control Company	4040	Therm./Clock/Humidity Monitor	3/31/2017	Biennial	3/31/2019	170232394
Control Company	4352	Ultra Long Stem Thermometer	5/2/2017	Biennial	5/2/2019	170330156
Amplifier Research	1551G6	Amplifier	CBT	N/A	CBT	433971
Narda	4772-3	Attenuator (3dB)	CBT	N/A	CBT	9406
Keysight Technologies	85033E	Standard Mechanical Calibration Kit (DC to 9GHz, 3.5mm)	6/1/2017	Annual	6/1/2018	MY53401181
Agilent	8753ES	S-Parameter Network Analyzer	10/26/2016	Annual	10/26/2017	US39170118
Mini-Circuits	BW-N20W5+	DC to 18 GHz Precision Fixed 20 dB Attenuator	CBT	N/A	CBT	N/A
SPEAG	DAE4	Dasy Data Acquisition Electronics	3/8/2017	Annual	3/8/2018	1368
SPEAG	DAE4	Dasy Data Acquisition Electronics	6/14/2017	Annual	6/14/2018	1334
SPEAG	DAK-3.5	Dielectric Assessment Kit	5/10/2017	Annual	5/10/2018	1070
SPEAG	ES3DV3	SAR Probe	11/15/2016	Annual	11/15/2017	3334
SPEAG	ES3DV3	SAR Probe	3/14/2017	Annual	3/14/2018	3319
Anritsu	MA2411B	Pulse Power Sensor	2/10/2017	Annual	2/10/2018	1207364
Anritsu	MA2411B	Pulse Power Sensor	2/10/2017	Annual	2/10/2018	1339018
Anritsu	ML2495A	Power Meter	10/16/2015	Biennial	10/16/2017	941001
Agilent	N5182A	MXG Vector Signal Generator	2/28/2017	Annual	2/28/2018	MY47420800
Seekonk	NC-100	Torque Wrench	11/6/2015	Biennial	11/6/2017	N/A
Mini-Circuits	NLP-2950+	Low Pass Filter DC to 2700 MHz	CBT	N/A	CBT	N/A
Pasternack	PE2208-6	Bidirectional Coupler	CBT	N/A	CBT	N/A

Measurement Uncertainty = $\pm 23\%$ (k=2)

	Name	Function	Signature
Calibrated By:	Brodie Halfoster	Test Engineer	<i>BRODIE HALBFOSTER</i>
Approved By:	Kaitlin O'Keefe	Senior Technical Manager	<i>KOK</i>

DIPOLE CALIBRATION EXTENSION

Per KDB 865664 D01, calibration intervals of up to three years may be considered for reference dipoles when it is demonstrated that the SAR target, impedance and return loss of a dipole have remained stable according to the following requirements:

1. The measured SAR does not deviate more than 10% from the target on the calibration certificate.
2. The return-loss does not deviate more than 20% from the previous measurement and meets the required 20dB minimum return-loss requirement.
3. The measurement of real or imaginary parts of impedance does not deviate more than 5Ω from the previous measurement.

The following dipole was checked to pass the above 3 requirements to have 2-year calibration period from the calibration date:

Calibration Date	Extension Date	Certificate Electrical Delay (ns)	Certificate SAR Target Head (1g) W/kg @ 23.0 dBm	Measured Head SAR (1g) W/kg @ 23.0 dBm	Deviation 1g (%)	Certificate SAR Target Head (10g) W/kg @ 23.0 dBm	Measured Head SAR (10g) W/kg @ 23.0 dBm	Deviation 10g (%)	Certificate Impedance Head (Ohm) Real	Measured Impedance Head (Ohm) Real	Difference (Ohm) Real	Certificate Impedance Head (Ohm) Imaginary	Measured Impedance Head (Ohm) Imaginary	Difference (Ohm) Imaginary	Certificate Return Loss Head (dB)	Measured Return Loss Head (dB)	Deviation (%)	PASS/FAIL
7/13/2016	7/12/2017	1.033	1.63	1.65	0.98%	1.08	1.09	1.11%	55.6	54.5	1.1	-0.9	-4.0	3.1	-25.4	-24.8	2.40%	PASS
Calibration Date	Extension Date	Certificate Electrical Delay (ns)	Certificate SAR Target Body (1g) W/kg @ 23.0 dBm	Measured Body SAR (1g) W/kg @ 23.0 dBm	Deviation 1g (%)	Certificate SAR Target Body (10g) W/kg @ 23.0 dBm	Measured Body SAR (10g) W/kg @ 23.0 dBm	Deviation 10g (%)	Certificate Impedance Body (Ohm) Real	Measured Impedance Body (Ohm) Real	Difference (Ohm) Real	Certificate Impedance Body (Ohm) Imaginary	Measured Impedance Body (Ohm) Imaginary	Difference (Ohm) Imaginary	Certificate Return Loss Body (dB)	Measured Return Loss Body (dB)	Deviation (%)	PASS/FAIL
7/13/2016	7/12/2017	1.033	1.69	1.75	3.80%	1.11	1.17	5.79%	50.2	48.0	2.2	-4.0	-6.9	2.9	-28.0	-23.9	14.60%	PASS

Impedance & Return-Loss Measurement Plot for Head TSL

12 Jul 2017 23:41:56
 S11 1 U FS 1: 54.459 Ω -4.0215 Ω 52.768 pF 750.000 000 MHz

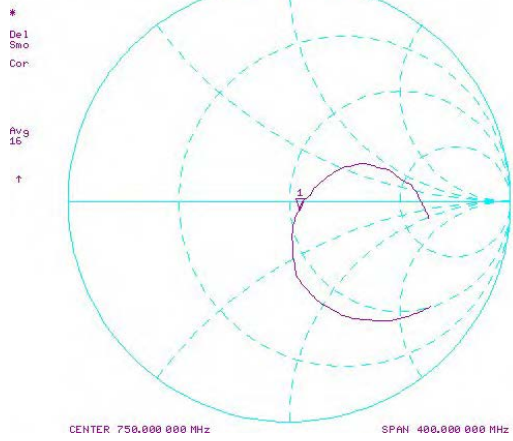

12 Jul 2017 23:35:17
 S11 LOG 5 dB/REF -20 dB 1:-24.763 dB 750.000 000 MHz

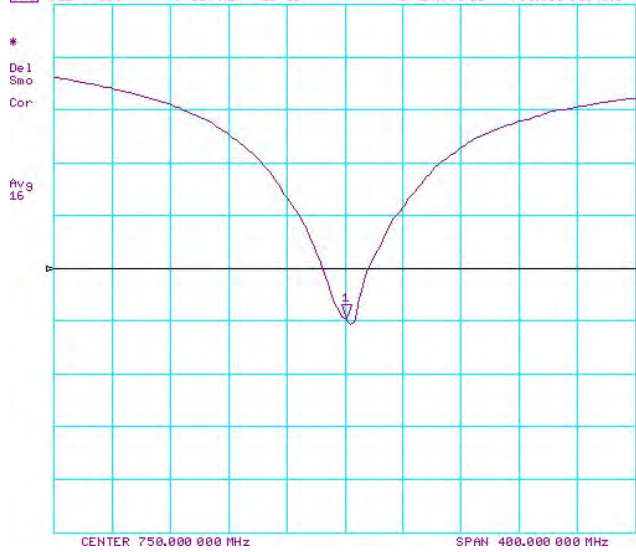

Impedance & Return-Loss Measurement Plot for Body TSL

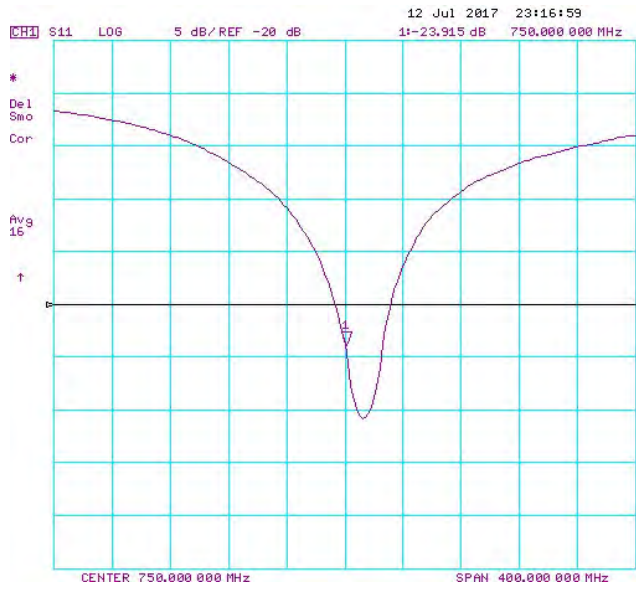
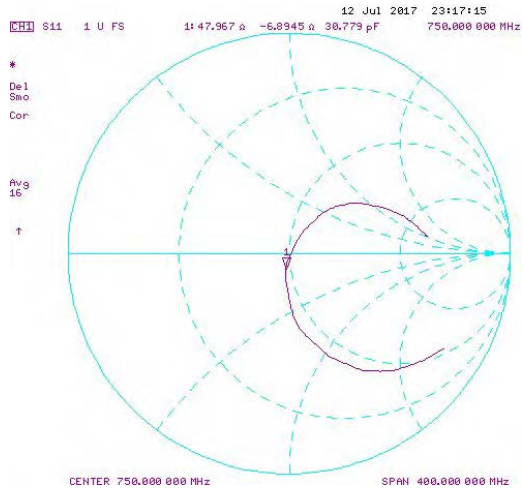

Certification of Calibration

Object: D750V3 – SN: 1161

Calibration procedure(s): Procedure for Calibration Extension for SAR Dipoles.

Extended Calibration date: 07/12/2018

Description: SAR Validation Dipole at 750 MHz.

Calibration Equipment used:

Manufacturer	Model	Description	Cal Date	Cal Interval	Cal Due	Serial Number
Agilent	E4438C	ESG Vector Signal Generator	3/24/2017	Biennial	3/24/2019	MY42082385
Agilent	8753ES	S-Parameter Network Analyzer	9/14/2017	Annual	9/14/2018	US39170118
Amplifier Research	15S1G6	Amplifier	CBT	N/A	CBT	433971
Anritsu	ML2495A	Power Meter	11/28/2017	Annual	11/28/2018	1039008
Anritsu	MA2411B	Pulse Power Sensor	3/2/2018	Annual	3/2/2019	1207364
Anritsu	MA2411B	Pulse Power Sensor	11/15/2017	Annual	11/15/2018	1339007
Control Company	4040	Therm./Clock/Humidity Monitor	3/31/2017	Biennial	3/31/2019	170232394
Control Company	4352	Ultra Long Stem Thermometer	5/2/2017	Biennial	5/2/2019	170330156
Keysight	772D	Dual Directional Coupler	CBT	N/A	CBT	MY52180215
Keysight Technologies	85033E	Standard Mechanical Calibration Kit (DC to 9GHz, 3.5mm)	6/4/2018	Annual	6/4/2019	MY53401181
Mini-Circuits	BW-N20W5+	DC to 18 GHz Precision Fixed 20 dB Attenuator	CBT	N/A	CBT	N/A
Mini-Circuits	NLP-2950+	Low Pass Filter DC to 2700 MHz	CBT	N/A	CBT	N/A
Narda	4772-3	Attenuator (3dB)	CBT	N/A	CBT	9406
Pasternack	PE2208-6	Bidirectional Coupler	CBT	N/A	CBT	N/A
Pasternack	PE5011-1	Torque Wrench	7/19/2017	Biennial	7/19/2019	N/A
SPEAG	DAE4	Dasy Data Acquisition Electronics	2/9/2018	Annual	2/9/2019	1272
SPEAG	DAE4	Dasy Data Acquisition Electronics	6/18/2018	Annual	6/18/2019	1334
SPEAG	DAK-3.5	Dielectric Assessment Kit	9/12/2017	Annual	9/12/2018	1091
SPEAG	ES3DV3	SAR Probe	2/13/2018	Annual	2/13/2019	3213
SPEAG	ES3DV3	SAR Probe	6/25/2018	Annual	6/25/2019	7409

Measurement Uncertainty = $\pm 23\%$ (k=2)

	Name	Function	Signature
Calibrated By:	Brodie Halfoster	Test Engineer	<i>BRODIE HALFOSTER</i>
Approved By:	Kaitlin O'Keefe	Senior Technical Manager	<i>KOK</i>

DIPOLE CALIBRATION EXTENSION

Per KDB 865664 D01, calibration intervals of up to three years may be considered for reference dipoles when it is demonstrated that the SAR target, impedance and return loss of a dipole have remained stable according to the following requirements:

1. The measured SAR does not deviate more than 10% from the target on the calibration certificate.
2. The return-loss does not deviate more than 20% from the previous measurement and meets the required 20dB minimum return-loss requirement.
3. The measurement of real or imaginary parts of impedance does not deviate more than 5Ω from the previous measurement.

The following dipole was checked to pass the above 3 requirements to have 3-year calibration period from the calibration date:

Calibration Date	Extension Date	Certificate Electrical Delay (ns)	Certificate SAR Target Head (1g) W/kg @ 23.0 dBm	Measured Head SAR (1g) W/kg @ 23.0 dBm	Deviation 1g (%)	Certificate SAR Target Head (10g) W/kg @ 23.0 dBm	Measured Head SAR (10g) W/kg @ 23.0 dBm	Deviation 10g (%)	Certificate Impedance Head (Ohm) Real	Measured Impedance Head (Ohm) Real	Difference (Ohm) Real	Certificate Impedance Head (Ohm) Imaginary	Measured Impedance Head (Ohm) Imaginary	Difference (Ohm) Imaginary	Certificate Return Loss Head (dB)	Measured Return Loss Head (dB)	Deviation (%)	PASS/FAIL
7/13/2016	7/12/2018	1.033	1.63	1.58	-3.30%	1.08	1.03	-4.45%	55.6	53.2	2.4	-0.9	-4.3	3.4	-25.4	-25.9	-2.00%	PASS
Calibration Date	Extension Date	Certificate Electrical Delay (ns)	Certificate SAR Target Body (1g) W/kg @ 23.0 dBm	Measured Body SAR (1g) W/kg @ 23.0 dBm	Deviation 1g (%)	Certificate SAR Target Body (10g) W/kg @ 23.0 dBm	Measured Body SAR (10g) W/kg @ 23.0 dBm	Deviation 10g (%)	Certificate Impedance Body (Ohm) Real	Measured Impedance Body (Ohm) Real	Difference (Ohm) Real	Certificate Impedance Body (Ohm) Imaginary	Measured Impedance Body (Ohm) Imaginary	Difference (Ohm) Imaginary	Certificate Return Loss Body (dB)	Measured Return Loss Body (dB)	Deviation (%)	PASS/FAIL
7/13/2016	7/12/2018	1.033	1.69	1.74	3.20%	1.11	1.15	3.98%	50.2	49.0	1.2	-4.0	-5.9	1.9	-28.0	-24.4	12.90%	PASS

Impedance & Return-Loss Measurement Plot for Head TSL

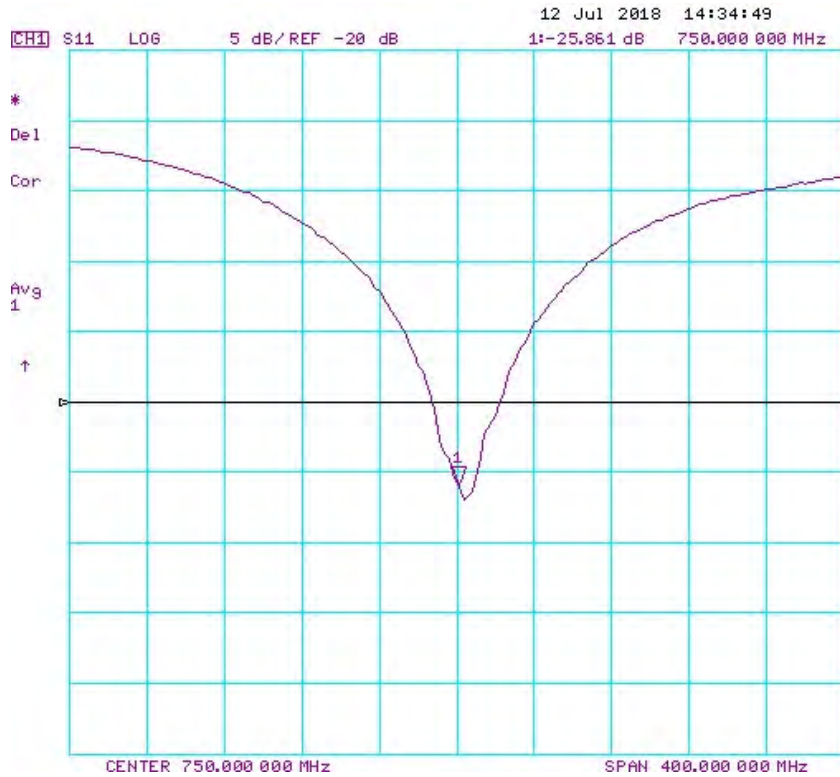
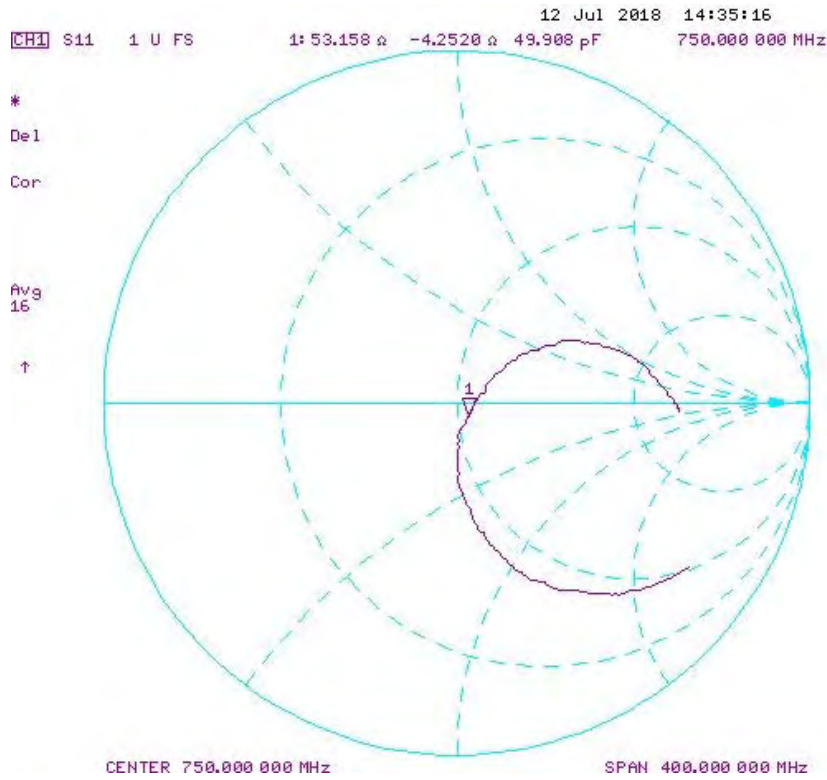

Impedance & Return-Loss Measurement Plot for Body TSL

