



SAR EVALUATION REPORT

Applicant Name:
 LG Electronics MobileComm U.S.A., Inc.
 1000 Sylvan Avenue
 Englewood Cliffs, NJ 07632
 United States

Date of Testing:
 03/28/18 - 04/11/18
Test Site/Location:
 PCTEST Lab, Columbia, MD, USA
Document Serial No.:
 1M1803140041-01-R1.ZNF

FCC ID: ZNFX410AS
APPLICANT: LG ELECTRONICS MOBILECOMM U.S.A., INC.

DUT Type: Portable Handset
Application Type: Certification
FCC Rule Part(s): CFR §2.1093
Model: LM-X410AS
Additional Model(s): LMX410AS, X410AS, LM-X410ASR, LMX410ASR, X410ASR

Equipment Class	Band & Mode	Tx Frequency	SAR		
			1g Head (W/kg)	1g Body-Worn (W/kg)	1g Hotspot (W/kg)
PCE	GSM/GPRS/EDGE 850	824.20 - 848.80 MHz	0.50	0.75	0.75
PCE	GSM/GPRS/EDGE 1900	1850.20 - 1909.80 MHz	0.30	0.46	0.46
PCE	UMTS 850	826.40 - 846.60 MHz	0.49	0.72	0.72
PCE	UMTS 1750	1712.4 - 1752.6 MHz	0.48	0.79	0.79
PCE	UMTS 1900	1852.4 - 1907.6 MHz	0.71	1.00	1.00
PCE	LTE Band 12	699.7 - 715.3 MHz	0.39	0.52	0.52
PCE	LTE Band 14	790.5 - 795.5 MHz	0.47	0.84	0.84
PCE	LTE Band 5 (Cell)	824.7 - 848.3 MHz	0.39	0.54	0.54
PCE	LTE Band 4 (AWS)	1710.7 - 1754.3 MHz	0.53	0.88	0.88
PCE	LTE Band 2 (PCS)	1850.7 - 1909.3 MHz	0.72	1.03	1.04
DTS	2.4 GHz WLAN	2412 - 2462 MHz	0.99	0.18	0.18
NII	U-NII-1	5180 - 5240 MHz	N/A	N/A	0.16
NII	U-NII-2A	5260 - 5320 MHz	0.70	0.12	N/A
NII	U-NII-2C	5500 - 5700 MHz	0.81	< 0.1	N/A
NII	U-NII-3	5745 - 5825 MHz	0.50	< 0.1	< 0.1
DSS/DTS	Bluetooth	2402 - 2480 MHz	< 0.1	N/A	N/A
Simultaneous SAR per KDB 690783 D01v01r03:			1.53	1.26	1.27

This revised Test Report (S/N: 1M1803140041-01-R1.ZNF) supersedes and replaces the previously issued test report on the same subject device for the same type of testing as indicated. Please discard or destroy the previously issued test report(s) and dispose of it accordingly.

This wireless portable device has been shown to be capable of compliance for localized specific absorption rate (SAR) for uncontrolled environment/general population exposure limits specified in ANSI/IEEE C95.1-1992 and has been tested in accordance with the measurement procedures specified in Section 1.8 of this report; for North American frequency bands only.

I attest to the accuracy of data. All measurements reported herein were performed by me or were made under my supervision and are correct to the best of my knowledge and belief. I assume full responsibility for the completeness of these measurements and vouch for the qualifications of all persons taking them. Test results reported herein relate only to the item(s) tested.

Randy Ortanez
 President





The SAR Tick is an initiative of the Mobile & Wireless Forum (MWF). While a product may be considered eligible, use of the SAR Tick logo requires an agreement with the MWF. Further details can be obtained by emailing: sartick@mwfai.info.

FCC ID: ZNFX410AS		SAR EVALUATION REPORT		Approved by: Quality Manager
Document S/N: 1M1803140041-01-R1.ZNF	Test Dates: 03/28/18 - 04/11/18	DUT Type: Portable Handset		Page 1 of 69

TABLE OF CONTENTS

1	DEVICE UNDER TEST	3
2	LTE INFORMATION	9
3	INTRODUCTION	10
4	DOSIMETRIC ASSESSMENT	11
5	DEFINITION OF REFERENCE POINTS	12
6	TEST CONFIGURATION POSITIONS	13
7	RF EXPOSURE LIMITS	16
8	FCC MEASUREMENT PROCEDURES.....	17
9	RF CONDUCTED POWERS	22
10	SYSTEM VERIFICATION.....	41
11	SAR DATA SUMMARY	44
12	FCC MULTI-TX AND ANTENNA SAR CONSIDERATIONS.....	57
13	SAR MEASUREMENT VARIABILITY	64
14	EQUIPMENT LIST.....	65
15	MEASUREMENT UNCERTAINTIES.....	66
16	CONCLUSION.....	67
17	REFERENCES	68
APPENDIX A:	SAR TEST PLOTS	
APPENDIX B:	SAR DIPOLE VERIFICATION PLOTS	
APPENDIX C:	PROBE AND DIPOLE CALIBRATION CERTIFICATES	
APPENDIX D:	SAR TISSUE SPECIFICATIONS	
APPENDIX E:	SAR SYSTEM VALIDATION	
APPENDIX F:	DUT ANTENNA DIAGRAM & SAR TEST SETUP PHOTOGRAPHS	

FCC ID: ZNFX410AS		SAR EVALUATION REPORT		Approved by: Quality Manager
Document S/N: 1M1803140041-01-R1.ZNF	Test Dates: 03/28/18 - 04/11/18	DUT Type: Portable Handset	Page 2 of 69	



1 DEVICE UNDER TEST

1.1 Device Overview

Band & Mode	Operating Modes	Tx Frequency
GSM/GPRS/EDGE 850	Voice/Data	824.20 - 848.80 MHz
GSM/GPRS/EDGE 1900	Voice/Data	1850.20 - 1909.80 MHz
UMTS 850	Voice/Data	826.40 - 846.60 MHz
UMTS 1750	Voice/Data	1712.4 - 1752.6 MHz
UMTS 1900	Voice/Data	1852.4 - 1907.6 MHz
LTE Band 12	Voice/Data	699.7 - 715.3 MHz
LTE Band 14	Voice/Data	790.5 - 795.5 MHz
LTE Band 5 (Cell)	Voice/Data	824.7 - 848.3 MHz
LTE Band 4 (AWS)	Voice/Data	1710.7 - 1754.3 MHz
LTE Band 2 (PCS)	Voice/Data	1850.7 - 1909.3 MHz
2.4 GHz WLAN	Voice/Data	2412 - 2462 MHz
U-NII-1	Voice/Data	5180 - 5240 MHz
U-NII-2A	Voice/Data	5260 - 5320 MHz
U-NII-2C	Voice/Data	5500 - 5700 MHz
U-NII-3	Voice/Data	5745 - 5825 MHz
Bluetooth	Data	2402 - 2480 MHz
NFC	Data	13.56 MHz

1.2 Power Reduction for SAR

There is no power reduction used for any band/mode implemented in this device for SAR purposes.

FCC ID: ZNFX410AS	 PCTEST ENGINEERING LABORATORY, INC.	SAR EVALUATION REPORT	 LG	Approved by: Quality Manager
Document S/N: 1M1803140041-01-R1.ZNF	Test Dates: 03/28/18 - 04/11/18	DUT Type: Portable Handset	Page 3 of 69	



1.3 Nominal and Maximum Output Power Specifications

This device operates using the following maximum and nominal output power specifications. SAR values were scaled to the maximum allowed power to determine compliance per KDB Publication 447498 D01v06.

1.3.1 Maximum Output Power

Mode / Band		Voice (dBm)	Burst Average GMSK (dBm)		Burst Average 8-PSK (dBm)	
		1 TX Slot	1 TX Slots	2 TX Slots	1 TX Slots	2 TX Slots
GSM/GPRS/EDGE 850	Maximum	33.7	33.7	31.7	27.7	26.7
	Nominal	33.2	33.2	31.2	27.2	26.2
GSM/GPRS/EDGE 1900	Maximum	30.7	30.7	28.7	26.2	25.7
	Nominal	30.2	30.2	28.2	25.7	25.2



Mode / Band		Modulated Average (dBm)		
		3GPP WCDMA	3GPP HSDPA	3GPP HSUPA
UMTS Band 5 (850 MHz)	Maximum	25.2	25.2	25.2
	Nominal	24.7	24.7	24.7
UMTS Band 4 (1750 MHz)	Maximum	24.7	24.7	24.7
	Nominal	24.2	24.2	24.2
UMTS Band 2 (1900 MHz)	Maximum	24.7	24.7	24.7
	Nominal	24.2	24.2	24.2

FCC ID: ZNFX410AS	 PCTEST ENGINEERING LABORATORY, INC.	SAR EVALUATION REPORT	 LG	Approved by: Quality Manager
Document S/N: 1M1803140041-01-R1.ZNF	Test Dates: 03/28/18 - 04/11/18	DUT Type: Portable Handset		Page 4 of 69

Mode / Band		Modulated Average (dBm)
LTE Band 12	Maximum	25.2
	Nominal	24.7
LTE Band 14	Maximum	25.2
	Nominal	24.7
LTE Band 5 (Cell)	Maximum	25.2
	Nominal	24.7
LTE Band 4 (AWS)	Maximum	25.2
	Nominal	24.7
LTE Band 2 (PCS)	Maximum	25.2
	Nominal	24.7

Mode / Band		Modulated Average (dBm)		
		Ch. 1	Ch. 2-10	Ch. 11
IEEE 802.11b (2.4 GHz)	Maximum	15.5		
	Nominal	14.5		
IEEE 802.11g (2.4 GHz)	Maximum	13.5	14.5	13.5
	Nominal	12.5	13.5	12.5
IEEE 802.11n (2.4 GHz)	Maximum	13.5	14.5	13.5
	Nominal	12.5	13.5	12.5

Mode / Band		Modulated Average (dBm)					
		20 MHz Bandwidth		40 MHz Bandwidth		80 MHz Bandwidth	
		Ch. 36-100	Ch.104-165	Ch. 38-102	Ch. 110-159	Ch. 42-106	Ch. 122-155
IEEE 802.11a (5 GHz)	Maximum	10.5	9.5				
	Nominal	9.5	8.5				
IEEE 802.11n (5 GHz)	Maximum	10.5	9.5	10.0	9.5		
	Nominal	9.5	8.5	9.0	8.5		
IEEE 802.11ac (5 GHz)	Maximum	10.5	9.5	9.5	9.0	9.5	9.0
	Nominal	9.5	8.5	8.5	8.0	8.5	8.0

FCC ID: ZNFX410AS	 PCTEST ENGINEERING LABORATORY, INC.	SAR EVALUATION REPORT	 LG	Approved by: Quality Manager
Document S/N: 1M1803140041-01-R1.ZNF	Test Dates: 03/28/18 - 04/11/18	DUT Type: Portable Handset		Page 5 of 69

Mode / Band		Modulated Average (dBm)
Bluetooth	Maximum	10.5
	Nominal	9.5
Bluetooth LE	Maximum	1.5
	Nominal	0.5

1.4 DUT Antenna Locations

The overall dimensions of this device are > 9 x 5 cm. The overall diagonal dimension of the device is ≤160 mm and the diagonal display is ≤150 mm. A diagram showing the location of the device antennas can be found in Appendix F.



**Table 1-1
Device Edges/Sides for SAR Testing**

Mode	Back	Front	Top	Bottom	Right	Left
GPRS 850	Yes	Yes	No	Yes	Yes	Yes
GPRS 1900	Yes	Yes	No	Yes	No	Yes
UMTS 850	Yes	Yes	No	Yes	Yes	Yes
UMTS 1750	Yes	Yes	No	Yes	No	Yes
UMTS 1900	Yes	Yes	No	Yes	No	Yes
LTE Band 12	Yes	Yes	No	Yes	Yes	Yes
LTE Band 14	Yes	Yes	No	Yes	Yes	Yes
LTE Band 5 (Cell)	Yes	Yes	No	Yes	Yes	Yes
LTE Band 4 (AWS)	Yes	Yes	No	Yes	No	Yes
LTE Band 2 (PCS)	Yes	Yes	No	Yes	No	Yes
2.4 GHz WLAN	Yes	Yes	Yes	No	No	Yes
5 GHz WLAN	Yes	Yes	Yes	No	No	Yes

Note: Particular DUT edges were not required to be evaluated for wireless router SAR if the edges were greater than 2.5 cm from the transmitting antenna according to FCC KDB Publication 941225 D06v02r01 Section III. The distances between the transmit antennas and the edges of the device are included in the filing. When wireless router mode is enabled, U-NII-2A and U-NII-2C operations are disabled. Therefore, U-NII-2A and U-NII-2C operations are not considered in this section.

1.5 Near Field Communications (NFC) Antenna

This DUT has NFC operations. The NFC antenna is integrated into the device for this model. Therefore, all SAR tests were performed with the device which already incorporates the NFC antenna. A diagram showing the location of the NFC antenna can be found in Appendix F.

FCC ID: ZNFX410AS	 PCTEST ENGINEERING LABORATORY, INC.	SAR EVALUATION REPORT	 LG	Approved by: Quality Manager
Document S/N: 1M1803140041-01-R1.ZNF	Test Dates: 03/28/18 - 04/11/18	DUT Type: Portable Handset		Page 6 of 69

1.6 Simultaneous Transmission Capabilities

According to FCC KDB Publication 447498 D01v06, transmitters are considered to be transmitting simultaneously when there is overlapping transmission, with the exception of transmissions during network hand-offs with maximum hand-off duration less than 30 seconds.

This device contains multiple transmitters that may operate simultaneously, and therefore requires a simultaneous transmission analysis according to FCC KDB Publication 447498 D01v06 4.3.2 procedures.

**Table 1-2
Simultaneous Transmission Scenarios**

No.	Capable Transmit Configuration	Head	Body-Worn Accessory	Wireless Router	Notes
1	GSM voice + 2.4 GHz WI-FI	Yes	Yes	N/A	
2	GSM voice + 5 GHz WI-FI	Yes	Yes	N/A	
3	GSM voice + 2.4 GHz Bluetooth	Yes [^]	Yes	N/A	[^] Bluetooth Tethering is considered
4	UMTS + 2.4 GHz WI-FI	Yes	Yes	Yes	
5	UMTS + 5 GHz WI-FI	Yes	Yes	Yes	
6	UMTS + 2.4 GHz Bluetooth	Yes [^]	Yes	Yes [^]	[^] Bluetooth Tethering is considered
7	LTE + 2.4 GHz WI-FI	Yes	Yes	Yes	
8	LTE + 5 GHz WI-FI	Yes	Yes	Yes	
9	LTE + 2.4 GHz Bluetooth	Yes [^]	Yes	Yes [^]	[^] Bluetooth Tethering is considered
10	GPRS/EDGE + 2.4 GHz WI-FI	Yes [*]	Yes [*]	Yes	[*] Pre-installed VOIP applications are considered
11	GPRS/EDGE + 5 GHz WI-FI	Yes [*]	Yes [*]	Yes	[*] Pre-installed VOIP applications are considered
12	GPRS/EDGE + 2.4 GHz Bluetooth	Yes ^{*^}	Yes [*]	Yes [^]	[*] Pre-installed VOIP applications are considered [^] Bluetooth Tethering is considered



- 2.4 GHz WLAN, 5 GHz WLAN, and 2.4 GHz Bluetooth share the same antenna path and cannot transmit simultaneously.
- All licensed modes share the same antenna path and cannot transmit simultaneously.
- When the user utilizes multiple services in UMTS 3G mode it uses multi-Radio Access Bearer or multi-RAB. The power control is based on a physical control channel (Dedicated Physical Control Channel [DPCCH]) and power control will be adjusted to meet the needs of both services. Therefore, the UMTS+WLAN scenario also represents the UMTS Voice/DATA + WLAN Hotspot scenario.
- Per the manufacturer, WIFI Direct is expected to be used in conjunction with a held-to-ear or body-worn accessory voice call. Therefore, there are no simultaneous transmission scenarios involving WIFI direct beyond that listed in the above table.
- 5 GHz Wireless Router is only supported for U-NII-1 and U-NII-3 by S/W, therefore U-NII2A and U-NII2C were not evaluated for wireless router conditions.
- This device supports VOLTE.
- This device supports VoWIFI.
- This device supports Bluetooth Tethering.

1.7 Miscellaneous SAR Test Considerations

(A) WIFI/BT

Since U-NII-1 and U-NII-2A bands have the same maximum output power and the highest reported SAR for U-NII-2A is less than 1.2 W/kg, SAR is not required for U-NII-1 band according to FCC KDB Publication 248227 D01v02r02.

Since Wireless Router operations are not allowed by the chipset firmware using U-NII-2A & U-NII-2C WIFI, only 2.4 GHz, U-NII-1, and U-NII-3 WIFI Hotspot SAR tests and combinations are considered for SAR with respect to Wireless Router configurations according to FCC KDB 941225 D06v02r01.

FCC ID: ZNFX410AS	 PCTEST ENGINEERING LABORATORY, INC.	SAR EVALUATION REPORT	 LG	Approved by: Quality Manager
Document S/N: 1M1803140041-01-R1-ZNF	Test Dates: 03/28/18 - 04/11/18	DUT Type: Portable Handset		Page 7 of 69

Per FCC KDB 447498 D01v06, the 1g SAR exclusion threshold for distances <50mm is defined by the following equation:

$$\frac{\text{Max Power of Channel (mW)}}{\text{Test Separation Dist (mm)}} * \sqrt{\text{Frequency(GHz)}} \leq 3.0$$

Based on the maximum conducted power of Bluetooth (rounded to the nearest mW) and the antenna to user separation distance, body-worn and hotspot Bluetooth SAR was not required; $[(11/10) * \sqrt{2.480}] = 1.73 < 3.0$. Per KDB Publication 447498 D01v06, the maximum power of the channel was rounded to the nearest mW before calculation.

This device supports IEEE 802.11ac with the following features:

- a) Up to 80 MHz Bandwidth only
- b) No aggregate channel configurations
- c) 1 Tx antenna output
- d) 256 QAM is supported
- e) TDWR channels are supported

(B) Licensed Transmitter(s)

GSM/GPRS/EDGE DTM is not supported for US bands. Therefore, the GSM Voice modes in this report do not transmit simultaneously with GPRS/EDGE Data.

This device is only capable of QPSK HSUPA in the uplink. Therefore, no additional SAR tests are required beyond that described for devices with HSUPA in KDB 941225 D01v03r01.

LTE SAR for the higher modulations and lower bandwidths were not tested since the maximum average output power of all required channels and configurations was not more than 0.5 dB higher than the highest bandwidth; and the reported LTE SAR for the highest bandwidth was less than 1.45 W/kg for all configurations according to FCC KDB 941225 D05v02r04.



This device supports LTE Carrier Aggregation (CA) in the downlink only. All uplink communications are identical to Release 8 specifications. Per FCC KDB Publication 941225 D05A v01r02, SAR for LTE CA operations was not needed since the maximum average output power in LTE CA mode was not >0.25 dB higher than the maximum output power when downlink carrier aggregation was inactive.

1.8 Guidance Applied

- IEEE 1528-2013
- FCC KDB Publication 941225 D01v03r01, D05v02r04, D05Av01r02, D06v02r01 (2G/3G/4G and Hotspot)
- FCC KDB Publication 248227 D01v02r02 (SAR Considerations for 802.11 Devices)
- FCC KDB Publication 447498 D01v06 (General SAR Guidance)
- FCC KDB Publication 865664 D01v01r04, D02v01r02 (SAR Measurements up to 6 GHz)
- October 2013 TCB Workshop Notes (GPRS Testing Considerations)
- Fall 2017 TCB Workshop Notes (LTE Carrier Aggregation)

1.9 Device Serial Numbers



Several samples with identical hardware were used to support SAR testing. The manufacturer has confirmed that the device(s) tested have the same physical, mechanical and thermal characteristics and are within operational tolerances expected for production units. The serial numbers used for each test are indicated alongside the results in Section 11.

FCC ID: ZNFX410AS	 PCTEST PROFESSIONAL LABORATORY, INC.	SAR EVALUATION REPORT	 LG	Approved by: Quality Manager
Document S/N: 1M1803140041-01-R1-ZNF	Test Dates: 03/28/18 - 04/11/18	DUT Type: Portable Handset		Page 8 of 69

2

LTE INFORMATION

LTE Information			
FCC ID	ZNFX410AS		
Form Factor	Portable Handset		
Frequency Range of each LTE transmission band	LTE Band 12 (699.7 - 715.3 MHz)		
	LTE Band 14 (790.5 - 795.5 MHz)		
	LTE Band 5 (Cell) (824.7 - 848.3 MHz)		
	LTE Band 4 (AWS) (1710.7 - 1754.3 MHz)		
	LTE Band 2 (PCS) (1850.7 - 1909.3 MHz)		
Channel Bandwidths	LTE Band 12: 1.4 MHz, 3 MHz, 5 MHz, 10 MHz		
	LTE Band 14: 5 MHz, 10 MHz		
	LTE Band 5 (Cell): 1.4 MHz, 3 MHz, 5 MHz, 10 MHz		
	LTE Band 4 (AWS): 1.4 MHz, 3 MHz, 5 MHz, 10 MHz, 15 MHz, 20 MHz		
LTE Band 2 (PCS): 1.4 MHz, 3 MHz, 5 MHz, 10 MHz, 15 MHz, 20 MHz			
Channel Numbers and Frequencies (MHz)	Low	Mid	High
LTE Band 12: 1.4 MHz	699.7 (23017)	707.5 (23095)	715.3 (23173)
LTE Band 12: 3 MHz	700.5 (23025)	707.5 (23095)	714.5 (23165)
LTE Band 12: 5 MHz	701.5 (23035)	707.5 (23095)	713.5 (23155)
LTE Band 12: 10 MHz	704 (23060)	707.5 (23095)	711 (23130)
LTE Band 14: 5 MHz	790.5 (23305)	793 (23330)	795.5 (23355)
LTE Band 14: 10 MHz	N/A	793 (23330)	N/A
LTE Band 5 (Cell): 1.4 MHz	824.7 (20407)	836.5 (20525)	848.3 (20643)
LTE Band 5 (Cell): 3 MHz	825.5 (20415)	836.5 (20525)	847.5 (20635)
LTE Band 5 (Cell): 5 MHz	826.5 (20425)	836.5 (20525)	846.5 (20625)
LTE Band 5 (Cell): 10 MHz	829 (20450)	836.5 (20525)	844 (20600)
LTE Band 4 (AWS): 1.4 MHz	1710.7 (19957)	1732.5 (20175)	1754.3 (20393)
LTE Band 4 (AWS): 3 MHz	1711.5 (19965)	1732.5 (20175)	1753.5 (20385)
LTE Band 4 (AWS): 5 MHz	1712.5 (19975)	1732.5 (20175)	1752.5 (20375)
LTE Band 4 (AWS): 10 MHz	1715 (20000)	1732.5 (20175)	1750 (20350)
LTE Band 4 (AWS): 15 MHz	1717.5 (20025)	1732.5 (20175)	1747.5 (20325)
LTE Band 4 (AWS): 20 MHz	1720 (20050)	1732.5 (20175)	1745 (20300)
LTE Band 2 (PCS): 1.4 MHz	1850.7 (18607)	1880 (18900)	1909.3 (19193)
LTE Band 2 (PCS): 3 MHz	1851.5 (18615)	1880 (18900)	1908.5 (19185)
LTE Band 2 (PCS): 5 MHz	1852.5 (18625)	1880 (18900)	1907.5 (19175)
LTE Band 2 (PCS): 10 MHz	1855 (18650)	1880 (18900)	1905 (19150)
LTE Band 2 (PCS): 15 MHz	1857.5 (18675)	1880 (18900)	1902.5 (19125)
LTE Band 2 (PCS): 20 MHz	1860 (18700)	1880 (18900)	1900 (19100)
UE Category	4		
Modulations Supported in UL	QPSK, 16QAM		
LTE MPR Permanently implemented per 3GPP TS 36.101 section 6.2.3~6.2.5? (manufacturer attestation to be provided)	YES		
A-MPR (Additional MPR) disabled for SAR Testing?	YES		
LTE Carrier Aggregation Possible Combinations	The technical description includes all the possible carrier aggregation combinations		
LTE Additional Information	This device does not support full CA features on 3GPP Release 10. It supports a maximum of 2 carriers in the downlink. All uplink communications are identical to the Release 8 Specifications. Uplink communications are done on the PCC. The following LTE Release 10 Features are not supported: Relay, HetNet, Enhanced MIMO, eICIC, WIFI Offloading, MDH, eMBMS, Cross-Carrier Scheduling, Enhanced SC-FDMA.		

FCC ID: ZNFX410AS		SAR EVALUATION REPORT		Approved by: Quality Manager
Document S/N: 1M1803140041-01-R1.ZNF	Test Dates: 03/28/18 - 04/11/18	DUT Type: Portable Handset	Page 9 of 69	

The FCC and Innovation, Science, and Economic Development Canada have adopted the guidelines for evaluating the environmental effects of radio frequency (RF) radiation in ET Docket 93-62 on Aug. 6, 1996 and Health Canada Safety Code 6 to protect the public and workers from the potential hazards of RF emissions due to FCC-regulated portable devices. [1]

The safety limits used for the environmental evaluation measurements are based on the criteria published by the American National Standards Institute (ANSI) for localized specific absorption rate (SAR) in IEEE/ANSI C95.1-1992 Standard for Safety Levels with Respect to Human Exposure to Radio Frequency Electromagnetic Fields, 3 kHz to 300 GHz [3] and Health Canada RF Exposure Guidelines Safety Code 6 [22]. The measurement procedure described in IEEE/ANSI C95.3-2002 Recommended Practice for the Measurement of Potentially Hazardous Electromagnetic Fields - RF and Microwave [4] is used for guidance in measuring the Specific Absorption Rate (SAR) due to the RF radiation exposure from the Equipment Under Test (EUT). These criteria for SAR evaluation are similar to those recommended by the International Committee for Non-Ionizing Radiation Protection (ICNIRP) in Biological Effects and Exposure Criteria for Radiofrequency Electromagnetic Fields,” Report No. Vol 74. SAR is a measure of the rate of energy absorption due to exposure to an RF transmitting source. SAR values have been related to threshold levels for potential biological hazards.

3.1 SAR Definition

Specific Absorption Rate is defined as the time derivative (rate) of the incremental energy (dU) absorbed by (dissipated in) an incremental mass (dm) contained in a volume element (dV) of a given density (ρ). It is also defined as the rate of RF energy absorption per unit mass at a point in an absorbing body (see Equation 3-1).

Equation 3-1
SAR Mathematical Equation

$$SAR = \frac{d}{dt} \left(\frac{dU}{dm} \right) = \frac{d}{dt} \left(\frac{dU}{\rho dv} \right)$$



SAR is expressed in units of Watts per Kilogram (W/kg).

$$SAR = \frac{\sigma \cdot E^2}{\rho}$$

where:

- σ = conductivity of the tissue-simulating material (S/m)
- ρ = mass density of the tissue-simulating material (kg/m³)
- E = Total RMS electric field strength (V/m)

NOTE: The primary factors that control rate of energy absorption were found to be the wavelength of the incident field in relation to the dimensions and geometry of the irradiated organism, the orientation of the organism in relation to the polarity of field vectors, the presence of reflecting surfaces, and whether conductive contact is made by the organism with a ground plane.[6]

FCC ID: ZNFX410AS	 PCTEST ENGINEERING LABORATORY, INC.	SAR EVALUATION REPORT	 LG	Approved by: Quality Manager
Document S/N: 1M1803140041-01-R1.ZNF	Test Dates: 03/28/18 - 04/11/18	DUT Type: Portable Handset		Page 10 of 69

4 DOSIMETRIC ASSESSMENT

4.1 Measurement Procedure

The evaluation was performed using the following procedure compliant to FCC KDB Publication 865664 D01v01r04 and IEEE 1528-2013:

1. The SAR distribution at the exposed side of the head or body was measured at a distance no greater than 5.0 mm from the inner surface of the shell. The area covered the entire dimension of the device-head and body interface and the horizontal grid resolution was determined per FCC KDB Publication 865664 D01v01r04 (See Table 4-1) and IEEE 1528-2013.
2. The point SAR measurement was taken at the maximum SAR region determined from Step 1 to enable the monitoring of SAR fluctuations/drifts during the 1g/10g cube evaluation. SAR at this fixed point was measured and used as a reference value.
3. Based on the area scan data, the peak of the region with maximum SAR was determined by spline interpolation. Around this point, a volume was assessed according to the measurement resolution and volume size requirements of FCC KDB Publication 865664 D01v01r04 (See Table 4-1) and IEEE 1528-2013. On the basis of this data set, the spatial peak SAR value was evaluated with the following procedure (see references or the DASY manual online for more details):
 - a. SAR values at the inner surface of the phantom are extrapolated from the measured values along the line away from the surface with spacing no greater than that in Table 4-1. The extrapolation was based on a least-squares algorithm. A polynomial of the fourth order was calculated through the points in the z-axis (normal to the phantom shell).
 - b. After the maximum interpolated values were calculated between the points in the cube, the SAR was averaged over the spatial volume (1g or 10g) using a 3D-Spline interpolation algorithm. The 3D-spline is composed of three one-dimensional splines with the “Not a knot” condition (in x, y, and z directions). The volume was then integrated with the trapezoidal algorithm. One thousand points (10 x 10 x 10) were obtained through interpolation, in order to calculate the averaged SAR.
 - c. All neighboring volumes were evaluated until no neighboring volume with a higher average value was found.
4. The SAR reference value, at the same location as step 2, was re-measured after the zoom scan was complete to calculate the SAR drift. If the drift deviated by more than 5%, the SAR test and drift measurements were repeated.

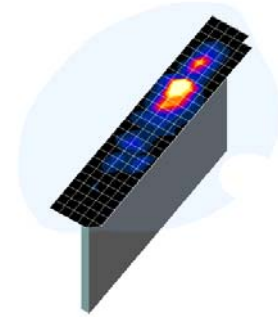



**Figure 4-1
Sample SAR Area
Scan**

**Table 4-1
Area and Zoom Scan Resolutions per FCC KDB Publication 865664 D01v01r04***

Frequency	Maximum Area Scan Resolution (mm) ($\Delta x_{area}, \Delta y_{area}$)	Maximum Zoom Scan Resolution (mm) ($\Delta x_{zoom}, \Delta y_{zoom}$)	Maximum Zoom Scan Spatial Resolution (mm)			Minimum Zoom Scan Volume (mm) (x,y,z)
			Uniform Grid	Graded Grid		
			$\Delta z_{zoom}(n)$	$\Delta z_{zoom}(1)^*$	$\Delta z_{zoom}(n>1)^*$	
≤ 2 GHz	≤ 15	≤ 8	≤ 5	≤ 4	≤ 1.5* $\Delta z_{zoom}(n-1)$	≥ 30
2-3 GHz	≤ 12	≤ 5	≤ 5	≤ 4	≤ 1.5* $\Delta z_{zoom}(n-1)$	≥ 30
3-4 GHz	≤ 12	≤ 5	≤ 4	≤ 3	≤ 1.5* $\Delta z_{zoom}(n-1)$	≥ 28
4-5 GHz	≤ 10	≤ 4	≤ 3	≤ 2.5	≤ 1.5* $\Delta z_{zoom}(n-1)$	≥ 25
5-6 GHz	≤ 10	≤ 4	≤ 2	≤ 2	≤ 1.5* $\Delta z_{zoom}(n-1)$	≥ 22

*Also compliant to IEEE 1528-2013 Table 6

FCC ID: ZNFX410AS	 SAR EVALUATION REPORT 		Approved by: Quality Manager
Document S/N: 1M1803140041-01-R1.ZNF	Test Dates: 03/28/18 - 04/11/18	DUT Type: Portable Handset	Page 11 of 69

5 DEFINITION OF REFERENCE POINTS

5.1 EAR REFERENCE POINT

Figure 5-2 shows the front, back and side views of the SAM Twin Phantom. The point “M” is the reference point for the center of the mouth, “LE” is the left ear reference point (ERP), and “RE” is the right ERP. The ERP is 15mm posterior to the entrance to the ear canal (EEC) along the B-M line (Back-Mouth), as shown in Figure 5-1. The plane passing through the two ear canals and M is defined as the Reference Plane. The line N-F (Neck-Front), also called the Reference Pivoting Line, is not perpendicular to the reference plane (see Figure 5-1). Line B-M is perpendicular to the N-F line. Both N-F and B-M lines are marked on the external phantom shell to facilitate handset positioning [5].

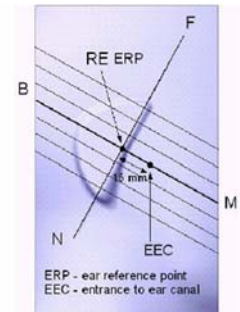

Figure 5-1
Close-Up Side view of ERP

5.2 HANDSET REFERENCE POINTS

Two imaginary lines on the handset were established: the vertical centerline and the horizontal line. The test device was placed in a normal operating position with the acoustic output located along the “vertical centerline” on the front of the device aligned to the “ear reference point” (See Figure 5-3). The acoustic output was then located at the same level as the center of the ear reference point. The test device was positioned so that the “vertical centerline” was bisecting the front surface of the handset at its top and bottom edges, positioning the “ear reference point” on the outer surface of the both the left and right head phantoms on the ear reference point.



Figure 5-2
Front, back and side view of SAM Twin Phantom

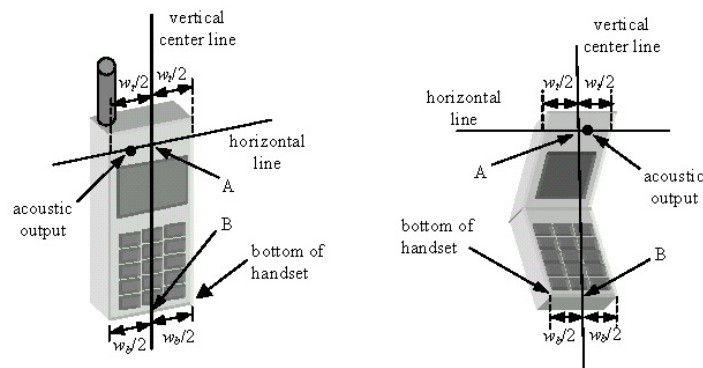



Figure 5-3
Handset Vertical Center & Horizontal Line Reference Points

FCC ID: ZNFX410AS	 PCTEST ENGINEERING LABORATORY, INC.	SAR EVALUATION REPORT	 LG	Approved by: Quality Manager
Document S/N: 1M1803140041-01-R1.ZNF	Test Dates: 03/28/18 - 04/11/18	DUT Type: Portable Handset		Page 12 of 69

6 TEST CONFIGURATION POSITIONS

6.1 Device Holder

The device holder is made out of low-loss POM material having the following dielectric parameters: relative permittivity $\epsilon = 3$ and loss tangent $\delta = 0.02$.

6.2 Positioning for Cheek

1. The test device was positioned with the device close to the surface of the phantom such that point A is on the (virtual) extension of the line passing through points RE and LE on the phantom (see Figure 6-1), such that the plane defined by the vertical center line and the horizontal line of the phone is approximately parallel to the sagittal plane of the phantom.

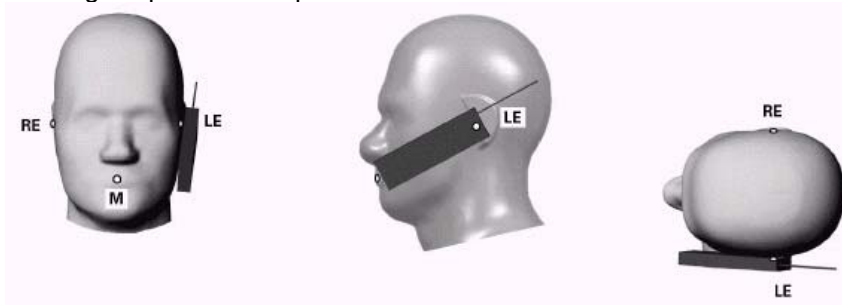



Figure 6-1 Front, Side and Top View of Cheek Position

2. The handset was translated towards the phantom along the line passing through RE & LE until the handset touches the pinna.
3. While maintaining the handset in this plane, the handset was rotated around the LE-RE line until the vertical centerline was in the reference plane.
4. The phone was then rotated around the vertical centerline until the phone (horizontal line) was symmetrical with respect to the line NF.
5. While maintaining the vertical centerline in the reference plane, keeping point A on the line passing through RE and LE, and maintaining the device contact with the ear, the device was rotated about the NF line until any point on the handset made contact with a phantom point below the ear (cheek) (See Figure 6-2).

6.3 Positioning for Ear / 15° Tilt

With the test device aligned in the “Cheek Position”:

1. While maintaining the orientation of the phone, the phone was retracted parallel to the reference plane far enough to enable a rotation of the phone by 15 degrees.
2. The phone was then rotated around the horizontal line by 15 degrees.
3. While maintaining the orientation of the phone, the phone was moved parallel to the reference plane until any part of the handset touched the head. (In this position, point A was located on the line RE-LE). The tilted position is obtained when the contact is on the pinna. If the contact was at any location other than the pinna, the angle of the phone would then be reduced. In this situation, the tilted position was obtained when any part of the phone was in contact of the ear as well as a second part of the phone was in contact with the head (see Figure 6-2).

FCC ID: ZNFX410AS	 PCTEST PROFESSIONAL LABORATORY, INC.	SAR EVALUATION REPORT	 LG	Approved by: Quality Manager
Document S/N: 1M1803140041-01-R1.ZNF	Test Dates: 03/28/18 - 04/11/18	DUT Type: Portable Handset		Page 13 of 69

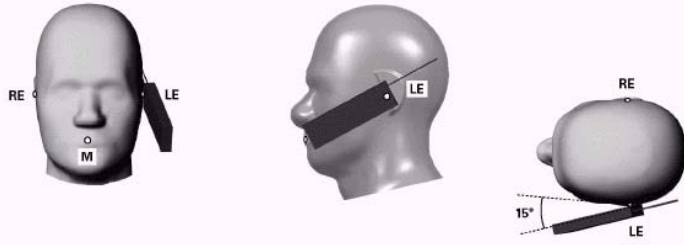

Figure 6-2 Front, Side and Top View of Ear/15° Tilt Position

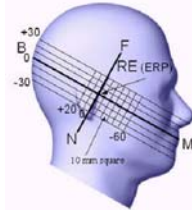

Figure 6-3 Side view w/ relevant markings

6.4 SAR Evaluations near the Mouth/Jaw Regions of the SAM Phantom

Antennas located near the bottom of a phone may require SAR measurements around the mouth and jaw regions of the SAM head phantom. This typically applies to clam-shell style phones that are generally longer in the unfolded normal use positions or to certain older style long rectangular phones. Per IEEE 1528-2013, a rotated SAM phantom is necessary to allow probe access to such regions. Both SAM heads of the TwinSAM-Chin20 are rotated 20 degrees around the NF line. Each head can be removed from the table for emptying and cleaning.

Under these circumstances, the following procedures apply, adopted from the FCC guidance on SAR handsets document FCC KDB Publication 648474 D04v01r03. The SAR required in these regions of SAM should be measured using a flat phantom. The phone should be positioned with a separation distance of 4 mm between the ear reference point (ERP) and the outer surface of the flat phantom shell. While maintaining this distance at the ERP location, the low (bottom) edge of the phone should be lowered from the phantom to establish the same separation distance between the peak SAR location identified by the truncated partial SAR distribution measured with the SAM phantom. The distance from the peak SAR location to the phone is determined by the straight line passing perpendicularly through the phantom surface. When it is not feasible to maintain 4 mm separation at the ERP while also establishing the required separation at the peak SAR location, the top edge of the phone will be allowed to touch the phantom with a separation < 4 mm at the ERP. The phone should not be tilted to the left or right while placed in this inclined position to the flat phantom.

6.5 Body-Worn Accessory Configurations

Body-worn operating configurations are tested with the belt-clips and holsters attached to the device and positioned against a flat phantom in a normal use configuration (see Figure 6-4). Per FCC KDB Publication 648474 D04v01r03, Body-worn accessory exposure is typically related to voice mode operations when handsets are carried in body-worn accessories. The body-worn accessory procedures in FCC KDB Publication 447498 D01v06 should be used to test for body-worn accessory SAR compliance, without a headset connected to it. This enables the test results for such configuration to be compatible with that required for hotspot mode when the body-worn accessory test separation distance is greater than or equal to that required for hotspot mode, when applicable. When the reported SAR for a body-worn accessory, measured without a headset connected to the handset, is > 1.2 W/kg, the highest reported SAR configuration for that wireless mode and frequency band should be repeated for that body-worn accessory with a headset attached to the handset.

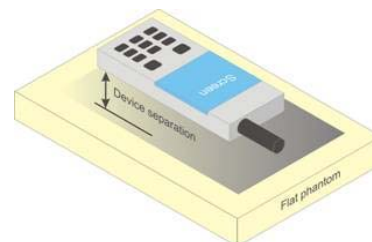



Figure 6-4 Sample Body-Worn Diagram

Accessories for Body-worn operation configurations are divided into two categories: those that do not contain metallic components and those that do contain metallic components. When multiple accessories that do not

FCC ID: ZNFX410AS	 PCTEST PROFESSIONAL LABORATORY, INC.	SAR EVALUATION REPORT	 LG	Approved by: Quality Manager
Document S/N: 1M1803140041-01-R1.ZNF	Test Dates: 03/28/18 - 04/11/18	DUT Type: Portable Handset		Page 14 of 69

contain metallic components are supplied with the device, the device is tested with only the accessory that dictates the closest spacing to the body. Then multiple accessories that contain metallic components are tested with the device with each accessory. If multiple accessories share an identical metallic component (i.e. the same metallic belt-clip used with different holsters with no other metallic components) only the accessory that dictates the closest spacing to the body is tested.

Body-worn accessories may not always be supplied or available as options for some devices intended to be authorized for body-worn use. In this case, a test configuration with a separation distance between the back of the device and the flat phantom is used. Test position spacing was documented. Transmitters that are designed to operate in front of a person's face, as in push-to-talk configurations, are tested for SAR compliance with the front of the device positioned to face the flat phantom in head fluid. For devices that are carried next to the body such as a shoulder, waist or chest-worn transmitters, SAR compliance is tested with the accessories, including headsets and microphones, attached to the device and positioned against a flat phantom in a normal use configuration.

6.6 Extremity Exposure Configurations



Devices that are designed or intended for use on extremities or mainly operated in extremity only exposure conditions; i.e., hands, wrists, feet and ankles, may require extremity SAR evaluation. When the device also operates in close proximity to the user's body, SAR compliance for the body is also required. The 1g body and 10g extremity SAR Exclusion Thresholds found in KDB Publication 447498 D01v06 should be applied to determine SAR test requirements.

Per KDB Publication 447498 D01v06, Cell phones (handsets) are not normally designed to be used on extremities or operated in extremity only exposure conditions. The maximum output power levels of handsets generally do not require extremity SAR testing to show compliance. Therefore, extremity SAR was not evaluated for this device.

6.7 Wireless Router Configurations

Some battery-operated handsets have the capability to transmit and receive user data through simultaneous transmission of WIFI simultaneously with a separate licensed transmitter. The FCC has provided guidance in FCC KDB Publication 941225 D06v02r01 where SAR test considerations for handsets ($L \times W \geq 9 \text{ cm} \times 5 \text{ cm}$) are based on a composite test separation distance of 10 mm from the front, back and edges of the device containing transmitting antennas within 2.5 cm of their edges, determined from general mixed use conditions for this type of devices. Since the hotspot SAR results may overlap with the body-worn accessory SAR requirements, the more conservative configurations can be considered, thus excluding some body-worn accessory SAR tests.

When the user enables the personal wireless router functions for the handset, actual operations include simultaneous transmission of both the WIFI transmitter and another licensed transmitter. Both transmitters often do not transmit at the same transmitting frequency and thus cannot be evaluated for SAR under actual use conditions due to the limitations of the SAR assessment probes. Therefore, SAR must be evaluated for each frequency transmission and mode separately and spatially summed with the WIFI transmitter according to FCC KDB Publication 447498 D01v06 procedures. The "Portable Hotspot" feature on the handset was NOT activated during SAR assessments, to ensure the SAR measurements were evaluated for a single transmission frequency RF signal at a time.

FCC ID: ZNFX410AS		SAR EVALUATION REPORT		Approved by: Quality Manager
Document S/N: 1M1803140041-01-R1.ZNF	Test Dates: 03/28/18 - 04/11/18	DUT Type: Portable Handset	Page 15 of 69	

7 RF EXPOSURE LIMITS

7.1 Uncontrolled Environment

UNCONTROLLED ENVIRONMENTS are defined as locations where there is the exposure of individuals who have no knowledge or control of their exposure. The general population/uncontrolled exposure limits are applicable to situations in which the general public may be exposed or in which persons who are exposed as a consequence of their employment may not be made fully aware of the potential for exposure or cannot exercise control over their exposure. Members of the general public would come under this category when exposure is not employment-related; for example, in the case of a wireless transmitter that exposes persons in its vicinity.



7.2 Controlled Environment

CONTROLLED ENVIRONMENTS are defined as locations where there is exposure that may be incurred by persons who are aware of the potential for exposure, (i.e. as a result of employment or occupation). In general, occupational/controlled exposure limits are applicable to situations in which persons are exposed as a consequence of their employment, who have been made fully aware of the potential for exposure and can exercise control over their exposure. This exposure category is also applicable when the exposure is of a transient nature due to incidental passage through a location where the exposure levels may be higher than the general population/uncontrolled limits, but the exposed person is fully aware of the potential for exposure and can exercise control over his or her exposure by leaving the area or by some other appropriate means.

**Table 7-1
SAR Human Exposure Specified in ANSI/IEEE C95.1-1992 and Health Canada Safety Code 6**

HUMAN EXPOSURE LIMITS		
	UNCONTROLLED ENVIRONMENT <i>General Population</i> (W/kg) or (mW/g)	CONTROLLED ENVIRONMENT <i>Occupational</i> (W/kg) or (mW/g)
Peak Spatial Average SAR Head	1.6	8.0
Whole Body SAR	0.08	0.4
Peak Spatial Average SAR Hands, Feet, Ankle, Wrists, etc.	4.0	20

1. The Spatial Peak value of the SAR averaged over any 1 gram of tissue (defined as a tissue volume in the shape of a cube) and over the appropriate averaging time.
2. The Spatial Average value of the SAR averaged over the whole body.
3. The Spatial Peak value of the SAR averaged over any 10 grams of tissue (defined as a tissue volume in the shape of a cube) and over the appropriate averaging time.

FCC ID: ZNFX410AS	 PCTEST ENGINEERING LABORATORY, INC.	SAR EVALUATION REPORT	 LG	Approved by: Quality Manager
Document S/N: 1M1803140041-01-R1.ZNF	Test Dates: 03/28/18 - 04/11/18	DUT Type: Portable Handset		Page 16 of 69

8 FCC MEASUREMENT PROCEDURES

Power measurements for licensed transmitters are performed using a base station simulator under digital average power.

8.1 Measured and Reported SAR

Per FCC KDB Publication 447498 D01v06, when SAR is not measured at the maximum power level allowed for production units, the results must be scaled to the maximum tune-up tolerance limit according to the power applied to the individual channels tested to determine compliance. For simultaneous transmission, the measured aggregate SAR must be scaled according to the sum of the differences between the maximum tune-up tolerance and actual power used to test each transmitter. When SAR is measured at or scaled to the maximum tune-up tolerance limit, the results are referred to as *reported* SAR. The highest *reported* SAR results are identified on the grant of equipment authorization according to procedures in KDB 690783 D01v01r03.

8.2 3G SAR Test Reduction Procedure

In FCC KDB Publication 941225 D01v03r01, certain transmission modes within a frequency band and wireless mode evaluated for SAR are defined as primary modes. The equivalent modes considered for SAR test reduction are denoted as secondary modes. When the maximum output power including tune-up tolerance specified for production units in a secondary mode is ≤ 0.25 dB higher than the primary mode or when the highest reported SAR of the primary mode, scaled by the ratio of specified maximum output power and tune-up tolerance of secondary to primary mode, is ≤ 1.2 W/kg, SAR measurements are not required for the secondary mode. These criteria are referred to as the 3G SAR test reduction procedure. When the 3G SAR test reduction procedure is not satisfied, SAR measurements are additionally required for the secondary mode.

8.3 Procedures Used to Establish RF Signal for SAR



The following procedures are according to FCC KDB Publication 941225 D01v03r01 “3G SAR Measurement Procedures.”

The device is placed into a simulated call using a base station simulator in a RF shielded chamber. Establishing connections in this manner ensure a consistent means for testing SAR and are recommended for evaluating SAR [4]. Devices under test are evaluated prior to testing, with a fully charged battery and were configured to operate at maximum output power. In order to verify that the device is tested throughout the SAR test at maximum output power, the SAR measurement system measures a “point SAR” at an arbitrary reference point at the start and end of the 1 gram SAR evaluation, to assess for any power drifts during the evaluation. If the power drift deviates by more than 5%, the SAR test and drift measurements are repeated.

8.4 SAR Measurement Conditions for UMTS

8.4.1 Output Power Verification

Maximum output power is verified on the High, Middle and Low channels according to the general descriptions in section 5.2 of 3GPP TS 34.121, using the appropriate RMC with TPC (transmit power control) set to all “1s” or applying the required inner loop power control procedures to maintain maximum output power while HSUPA is active. Results for all applicable physical channel configurations (DPCCH, DPDCHn and spreading codes, HS-DPCCH etc) are tabulated in this test report. All configurations that are not supported by the DUT or cannot be measured due to technical or equipment limitations are identified.

FCC ID: ZNFX410AS		SAR EVALUATION REPORT		Approved by: Quality Manager
Document S/N: 1M1803140041-01-R1.ZNF	Test Dates: 03/28/18 - 04/11/18	DUT Type: Portable Handset		Page 17 of 69

8.4.2 Head SAR Measurements

SAR for next to the ear head exposure is measured using a 12.2 kbps RMC with TPC bits configured to all “1’s”. The 3G SAR test reduction procedure is applied to AMR configurations with 12.2 kbps RMC as the primary mode. Otherwise, SAR is measured for 12.2 kbps AMR in 3.4 kbps SRB (signaling radio bearer) using the highest reported SAR configuration in 12.2 kbps RMC for head exposure.

8.4.3 Body SAR Measurements

SAR for body exposure configurations is measured using the 12.2 kbps RMC with the TPC bits all “1s”. The 3G SAR test reduction procedure is applied to other spreading codes and multiple DPDCH_n configurations supported by the handset with 12.2 kbps RMC as the primary mode. Otherwise, SAR is measured using an applicable RMC configuration with the corresponding spreading code or DPDCH_n, for the highest reported SAR configuration in 12.2 kbps RMC.

8.4.4 SAR Measurements with Rel 5 HSDPA

The 3G SAR test reduction procedure is applied to HSDPA body configurations with 12.2 kbps RMC as the primary mode. Otherwise, Body SAR for HSDPA is measured using an FRC with H-Set 1 in Sub-test 1 and a 12.2 kbps RMC configured in Test Loop Mode 1, for the highest reported SAR configuration in 12.2 kbps RMC without HSDPA. Handsets with both HSDPA and HSUPA are tested according to Release 6 HSPA test procedures.

8.4.5 SAR Measurements with Rel 6 HSUPA

The 3G SAR test reduction procedure is applied to HSPA (HSUPA/HSDPA with RMC) body configurations with 12.2 kbps RMC as the primary mode. Otherwise, Body SAR for HSPA is measured with E-DCH Sub-test 5, using H-Set 1 and QPSK for FRC and a 12.2 kbps RMC configured in Test Loop Mode 1 and power control algorithm 2, according to the highest reported body SAR configuration in 12.2 kbps RMC without HSPA.



When VOIP applies to head exposure, the 3G SAR test reduction procedure is applied with 12.2 kbps RMC as the primary mode; otherwise, the same HSPA configuration used for body SAR measurements are applied to head exposure testing.

8.5 SAR Measurement Conditions for LTE

LTE modes are tested according to FCC KDB 941225 D05v02r04 publication. Establishing connections with base station simulators ensure a consistent means for testing SAR and are recommended for evaluating SAR [4]. The R&S CMW500 or Anritsu MT8820C simulators are used for LTE output power measurements and SAR testing. Closed loop power control was used so the UE transmits with maximum output power during SAR testing. SAR tests were performed with the same number of RB and RB offsets transmitting on all TTI frames (maximum TTI).

8.5.1 Spectrum Plots for RB Configurations

A properly configured base station simulator was used for SAR tests and power measurements. Therefore, spectrum plots for RB configurations were not required to be included in this report.

FCC ID: ZNFX410AS		SAR EVALUATION REPORT		Approved by: Quality Manager
Document S/N: 1M1803140041-01-R1.ZNF	Test Dates: 03/28/18 - 04/11/18	DUT Type: Portable Handset	Page 18 of 69	

8.5.2 MPR

MPR is permanently implemented for this device by the manufacturer. The specific manufacturer target MPR is indicated alongside the SAR results. MPR is enabled for this device, according to 3GPP TS36.101 Section 6.2.3 – 6.2.5 under Table 6.2.3-1.

8.5.3 A-MPR

A-MPR (Additional MPR) has been disabled for all SAR tests by setting NS=01 on the base station simulator.



8.5.4 Required RB Size and RB Offsets for SAR Testing

According to FCC KDB 941225 D05v02r04:

- a. Per Section 5.2.1, SAR is required for QPSK 1 RB Allocation for the largest bandwidth
 - i. The required channel and offset combination with the highest maximum output power is required for SAR.
 - ii. When the reported SAR is ≤ 0.8 W/kg, testing of the remaining RB offset configurations and required test channels is not required. Otherwise, SAR is required for the remaining required test channels using the RB offset configuration with highest output power for that channel.
 - iii. When the reported SAR for a required test channel is > 1.45 W/kg, SAR is required for all RB offset configurations for that channel.
- b. Per Section 5.2.2, SAR is required for 50% RB allocation using the largest bandwidth following the same procedures outlined in Section 5.2.1.
- c. Per Section 5.2.3, QPSK SAR is not required for the 100% allocation when the highest maximum output power for the 100% allocation is less than the highest maximum output power of the 1 RB and 50% RB allocations and the reported SAR for the 1 RB and 50% RB allocations is < 0.8 W/kg.
- d. Per Section 5.2.4 and 5.3, SAR tests for higher order modulations and lower bandwidths configurations are not required when the conducted power of the required test configurations determined by Sections 5.2.1 through 5.2.3 is less than or equal to $\frac{1}{2}$ dB higher than the equivalent configuration using QPSK modulation and when the QPSK SAR for those configurations is < 1.45 W/kg.

8.5.5 Downlink Only Carrier Aggregation

Conducted power measurements with LTE Carrier Aggregation (CA) (downlink only) active are made in accordance to KDB Publication 941225 D05Av01r02. The RRC connection is only handled by one cell, the primary component carrier (PCC) for downlink and uplink communications. After making a data connection to the PCC, the UE device adds secondary component carrier(s) (SCC) on the downlink only. All uplink communications and acknowledgements remain identical to specifications when downlink carrier aggregation is inactive on the PCC. For every supported combination of downlink only carrier aggregation, additional conducted output powers are measured with the downlink carrier aggregation active for the configuration with highest measured maximum conducted power with downlink carrier aggregation inactive measured among the channel bandwidth, modulation, and RB combinations in each frequency band. Per FCC KDB Publication 941225 D05Av01r02, no SAR measurements are required for carrier aggregation configurations when the average output power with downlink only carrier aggregation active is not more than 0.25 dB higher than the average output power with downlink only carrier aggregation inactive.

FCC ID: ZNFX410AS		SAR EVALUATION REPORT		Approved by: Quality Manager
Document S/N: 1M1803140041-01-R1.ZNF	Test Dates: 03/28/18 - 04/11/18	DUT Type: Portable Handset		Page 19 of 69

8.6 SAR Testing with 802.11 Transmitters

The normal network operating configurations of 802.11 transmitters are not suitable for SAR measurements. Unpredictable fluctuations in network traffic and antenna diversity conditions can introduce undesirable variations in SAR results. The SAR for these devices should be measured using chipset based test mode software to ensure the results are consistent and reliable. See KDB Publication 248227 D01v02r02 for more details.

8.6.1 General Device Setup

Chipset based test mode software is hardware dependent and generally varies among manufacturers. The device operating parameters established in test mode for SAR measurements must be identical to those programmed in production units, including output power levels, amplifier gain settings and other RF performance tuning parameters.

A periodic duty factor is required for current generation SAR systems to measure SAR. When 802.11 frame gaps are accounted for in the transmission, a maximum transmission duty factor of 92 - 96% is typically achievable in most test mode configurations. A minimum transmission duty factor of 85% is required to avoid certain hardware and device implementation issues related to wide range SAR scaling. The reported SAR is scaled to 100% transmission duty factor to determine compliance at the maximum tune-up tolerance limit.

8.6.2 U-NII-1 and U-NII-2A

For devices that operate in both U-NII-1 and U-NII-2A bands, when the same maximum output power is specified for both bands, SAR measurement using OFDM SAR test procedures is not required for U-NII-1 unless the highest reported SAR for U-NII-2A is > 1.2 W/kg. When different maximum output powers are specified for the bands, SAR measurement for the U-NII band with the lower maximum output power is not required unless the highest reported SAR for the U-NII band with the higher maximum output power, adjusted by the ratio of lower to higher specified maximum output power for the two bands, is > 1.2 W/kg.

8.6.3 U-NII-2C and U-NII-3



The frequency range covered by U-NII-2C and U-NII-3 is 380 MHz (5.47 – 5.85 GHz), which requires a minimum of at least two SAR probe calibration frequency points to support SAR measurements. When Terminal Doppler Weather Radar (TDWR) restriction applies, the channels at 5.60 – 5.65 GHz in U-NII-2C band must be disabled with acceptable mechanisms and documented in the equipment certification. Unless band gap channels are permanently disabled, SAR must be considered for these channels. Each band is tested independently according to the normally required OFDM SAR measurement and probe calibration frequency points requirements.

8.6.4 Initial Test Position Procedure

For exposure conditions with multiple test positions, such as handset operating next to the ear, devices with hotspot mode or UMPC mini-tablet, procedures for initial test position can be applied. Using the transmission mode determined by the DSSS procedure or initial test configuration, area scans are measured for all positions in an exposure condition. The test position with the highest extrapolated (peak) SAR is used as the initial test position. When reported SAR for the initial test position is ≤ 0.4 W/kg, no additional testing for the remaining test positions is required. Otherwise, SAR is evaluated at the subsequent highest peak SAR positions until the reported SAR result is ≤ 0.8 W/kg or all test positions are measured.

8.6.5 2.4 GHz SAR Test Requirements

SAR is measured for 2.4 GHz 802.11b DSSS using either the fixed test position or, when applicable, the initial test position procedure. SAR test reduction is determined according to the following:

FCC ID: ZNFX410AS	 PCTEST PROFESSIONAL LABORATORY, INC.	SAR EVALUATION REPORT	 LG	Approved by: Quality Manager
Document S/N: 1M1803140041-01-R1.ZNF	Test Dates: 03/28/18 - 04/11/18	DUT Type: Portable Handset	Page 20 of 69	

- 1) When the reported SAR of the highest measured maximum output power channel for the exposure configuration is ≤ 0.8 W/kg, no further SAR testing is required for 802.11b DSSS in that exposure configuration.
- 2) When the reported SAR is > 0.8 W/kg, SAR is required for that position using the next highest measured output power channel. When any reported SAR is > 1.2 W/kg, SAR is required for the third channel; i.e., all channels require testing.

2.4 GHz 802.11 g/n OFDM are additionally evaluated for SAR if the highest reported SAR for 802.11b, adjusted by the ratio of the OFDM to DSSS specified maximum output power, is > 1.2 W/kg. When SAR is required for OFDM modes in 2.4 GHz band, the Initial Test Configuration Procedures should be followed.

8.6.6 OFDM Transmission Mode and SAR Test Channel Selection

When the same maximum output power was specified for multiple OFDM transmission mode configurations in a frequency band or aggregated band, SAR is measured using the configuration with the largest channel bandwidth, lowest order modulation and lowest data rate. When the maximum output power of a channel is the same for equivalent OFDM configurations; for example, 802.11a, 802.11n and 802.11ac or 802.11g and 802.11n with the same channel bandwidth, modulation and data rate etc., the lower order 802.11 mode i.e., 802.11a, then 802.11n and 802.11ac or 802.11g then 802.11n, is used for SAR measurement. When the maximum output power are the same for multiple test channels, either according to the default or additional power measurement requirements, SAR is measured using the channel closest to the middle of the frequency band or aggregated band. When there are multiple channels with the same maximum output power, SAR is measured using the higher number channel.



8.6.7 Initial Test Configuration Procedure

For OFDM, an initial test configuration is determined for each frequency band and aggregated band, according to the transmission mode with the highest maximum output power specified for SAR measurements. When the same maximum output power is specified for multiple OFDM transmission mode configurations in a frequency band or aggregated band, SAR is measured using the configuration(s) with the largest channel bandwidth, lowest order modulation, lowest data rate and lowest order IEEE 802.11 mode. The channel of the transmission mode with the highest average RF output conducted power will be the initial test configuration.

When the reported SAR is ≤ 0.8 W/kg, no additional measurements on other test channels are required. Otherwise, SAR is evaluated using the subsequent highest average RF output channel until the reported SAR result is ≤ 1.2 W/kg or all channels are measured. When there are multiple untested channels having the same subsequent highest average RF output power, the channel with higher frequency from the lowest 802.11 mode is considered for SAR measurements (See Section 8.6.6).

8.6.8 Subsequent Test Configuration Procedures

For OFDM configurations in each frequency band and aggregated band, SAR is evaluated for initial test configuration using the fixed test position or the initial test position procedure. When the highest reported SAR (for the initial test configuration), adjusted by the ratio of the specified maximum output power of the subsequent test configuration to initial test configuration, is ≤ 1.2 W/kg, no additional SAR tests for the subsequent test configurations are required.

FCC ID: ZNFX410AS		SAR EVALUATION REPORT		Approved by: Quality Manager
Document S/N: 1M1803140041-01-R1.ZNF	Test Dates: 03/28/18 - 04/11/18	DUT Type: Portable Handset		Page 21 of 69

9 RF CONDUCTED POWERS



9.1 GSM Conducted Powers

**Table 9-1
Maximum Conducted Power**

Maximum Burst-Averaged Output Power						
Band	Channel	Voice	GPRS/EDGE Data (GMSK)		EDGE Data (8-PSK)	
		GSM [dBm] CS (1 Slot)	GPRS [dBm] 1 Tx Slot	GPRS [dBm] 2 Tx Slot	EDGE [dBm] 1 Tx Slot	EDGE [dBm] 2 Tx Slot
GSM 850	128	33.59	33.55	31.45	27.65	26.45
	190	33.30	33.35	31.35	27.70	26.42
	251	33.41	33.45	31.35	27.60	26.44
GSM 1900	512	30.62	30.65	28.70	26.05	25.70
	661	30.64	30.70	28.55	26.10	25.61
	810	30.41	30.35	28.60	26.00	25.63

Calculated Maximum Frame-Averaged Output Power						
Band	Channel	Voice	GPRS/EDGE Data (GMSK)		EDGE Data (8-PSK)	
		GSM [dBm] CS (1 Slot)	GPRS [dBm] 1 Tx Slot	GPRS [dBm] 2 Tx Slot	EDGE [dBm] 1 Tx Slot	EDGE [dBm] 2 Tx Slot
GSM 850	128	24.56	24.52	25.43	18.62	20.43
	190	24.27	24.32	25.33	18.67	20.40
	251	24.38	24.42	25.33	18.57	20.42
GSM 1900	512	21.59	21.62	22.68	17.02	19.68
	661	21.61	21.67	22.53	17.07	19.59
	810	21.38	21.32	22.58	16.97	19.61

GSM 850	Frame	24.17	24.17	25.18	18.17	20.18
GSM 1900	Avg. Targets:	21.17	21.17	22.18	16.67	19.18

FCC ID: ZNFX410AS	 PCTEST ENGINEERING LABORATORY, INC.	SAR EVALUATION REPORT	 LG	Approved by: Quality Manager
Document S/N: 1M1803140041-01-R1.ZNF	Test Dates: 03/28/18 - 04/11/18	DUT Type: Portable Handset		Page 22 of 69

Note:

1. Both burst-averaged and calculated frame-averaged powers are included. Frame-averaged power was calculated from the measured burst-averaged power by converting the slot powers into linear units and calculating the energy over 8 timeslots.
2. GPRS/EDGE (GMSK) output powers were measured with coding scheme setting of 1 (CS1) on the base station simulator. CS1 was configured to measure GPRS output power measurements and SAR to ensure GMSK modulation in the signal. Our Investigation has shown that CS1 - CS4 settings do not have any impact on the output levels or modulation in the GPRS modes.
3. EDGE (8-PSK) output powers were measured with MCS7 on the base station simulator. MCS7 coding scheme was used to measure the output powers for EDGE since investigation has shown that choosing MCS7 coding scheme will ensure 8-PSK modulation. It has been shown that MCS levels that produce 8PSK modulation do not have an impact on output power.

GSM Class: B
GPRS Multislot class: 10 (Max 2 Tx uplink slots)
EDGE Multislot class: 10 (Max 2 Tx uplink slots)
DTM Multislot Class: N/A

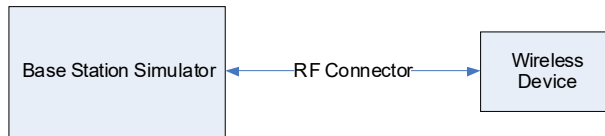



Figure 9-1
Power Measurement Setup

FCC ID: ZNFX410AS	 SAR EVALUATION REPORT 		Approved by: Quality Manager
Document S/N: 1M1803140041-01-R1.ZNF	Test Dates: 03/28/18 - 04/11/18	DUT Type: Portable Handset	Page 23 of 69

9.2 UMTS Conducted Powers

**Table 9-2
Maximum Conducted Power**



3GPP Release Version	Mode	3GPP 34.121 Subtest	Cellular Band [dBm]			AWS Band [dBm]			PCS Band [dBm]			3GPP MPR [dB]
			4132	4183	4233	1312	1412	1513	9262	9400	9538	
99	WCDMA	12.2 kbps RMC	25.00	25.10	25.15	24.55	24.65	24.60	24.55	24.55	24.65	-
99		12.2 kbps AMR	25.00	25.10	25.15	24.55	24.65	24.60	24.55	24.55	24.65	-
6	HSDPA	Subtest 1	25.10	25.05	25.20	24.65	24.60	24.65	24.60	24.70	24.65	0
6		Subtest 2	25.00	25.00	25.10	24.70	24.65	24.65	24.50	24.60	24.70	0
6		Subtest 3	24.55	24.50	24.65	24.15	24.20	24.20	24.10	24.20	24.20	0.5
6		Subtest 4	24.55	24.50	24.65	24.20	24.20	24.20	24.05	24.15	24.15	0.5
6	HSUPA	Subtest 1	25.11	25.15	25.09	24.64	24.69	24.64	24.68	24.69	24.70	0
6		Subtest 2	23.19	23.19	23.18	22.88	22.82	22.83	22.84	22.87	22.83	2
6		Subtest 3	24.16	24.18	24.15	23.69	23.69	23.69	23.71	23.76	23.70	1
6		Subtest 4	23.29	23.31	23.40	22.82	22.81	22.82	22.81	22.82	22.82	2
6		Subtest 5	25.20	25.17	25.12	24.70	24.68	24.63	24.70	24.65	24.66	0

This device does not support DC-HSDPA.

It is expected by the manufacturer that MPR for some HSUPA subtests may deviate by +/- 1 dB from the expected MPR targets specified by 3GPP.



**Figure 9-2
Power Measurement Setup**

FCC ID: ZNFX410AS		SAR EVALUATION REPORT		Approved by: Quality Manager
Document S/N: 1M1803140041-01-R1.ZNF	Test Dates: 03/28/18 - 04/11/18	DUT Type: Portable Handset		Page 24 of 69

9.3 LTE Conducted Powers

9.3.1 LTE Band 12



Table 9-3
LTE Band 12 Conducted Powers - 10 MHz Bandwidth

LTE Band 12 10 MHz Bandwidth					
Modulation	RB Size	RB Offset	Mid Channel	MPR Allowed per 3GPP [dB]	MPR [dB]
			23095 (707.5 MHz)		
			Conducted Power [dBm]		
QPSK	1	0	25.07	0	0
	1	25	24.98		0
	1	49	24.93		0
	25	0	23.91	0-1	1
	25	12	24.00		1
	25	25	23.91		1
16QAM	50	0	23.95	0-1	1
	1	0	23.97		1
	1	25	24.10		1
	1	49	24.03	0-2	1
	25	0	22.72		2
	25	12	22.80		2
	25	25	22.73	2	
	50	0	22.73	2	

Note: LTE Band 12 at 10 MHz bandwidth does not support three non-overlapping channels. Per KDB Publication 941225 D05v02, when a device supports overlapping channel assignment in a channel bandwidth configuration, the middle channel of the group of overlapping channels should be selected for testing.

Table 9-4
LTE Band 12 Conducted Powers - 5 MHz Bandwidth

LTE Band 12 5 MHz Bandwidth								
Modulation	RB Size	RB Offset	Low Channel	Mid Channel	High Channel	MPR Allowed per 3GPP [dB]	MPR [dB]	
			23035 (701.5 MHz)	23095 (707.5 MHz)	23155 (713.5 MHz)			
			Conducted Power [dBm]					
QPSK	1	0	24.78	24.69	24.83	0	0	
	1	12	24.87	25.19	25.03		0	
	1	24	25.00	24.85	24.81		0	
	12	0	23.96	23.91	24.01	0-1	1	
	12	6	23.97	24.17	24.06		1	
	12	13	23.88	24.02	24.02		1	
16QAM	25	0	24.01	23.98	24.08	0-1	1	
	1	0	23.75	23.77	24.19		0-1	1
	1	12	23.91	24.20	23.96			1
	1	24	23.47	23.79	23.45	0-2		1
	12	0	22.85	22.65	22.66		2	
	12	6	22.87	22.91	22.84		2	
	12	13	22.74	22.81	22.82	2		
	25	0	22.87	22.79	22.90	2		



FCC ID: ZNFX410AS		SAR EVALUATION REPORT		Approved by: Quality Manager
Document S/N: 1M1803140041-01-R1.ZNF	Test Dates: 03/28/18 - 04/11/18	DUT Type: Portable Handset		Page 25 of 69

**Table 9-5
LTE Band 12 Conducted Powers - 3 MHz Bandwidth**

LTE Band 12 3 MHz Bandwidth							
Modulation	RB Size	RB Offset	Low Channel	Mid Channel	High Channel	MPR Allowed per 3GPP [dB]	MPR [dB]
			23025 (700.5 MHz)	23095 (707.5 MHz)	23165 (714.5 MHz)		
			Conducted Power [dBm]				
QPSK	1	0	24.82	24.86	25.11	0	0
	1	7	24.90	25.19	25.20		0
	1	14	24.93	24.99	25.19		0
	8	0	24.03	23.94	24.01	0-1	1
	8	4	24.01	24.01	24.08		1
	8	7	24.19	24.05	24.04		1
16QAM	15	0	23.99	24.01	24.05	0-1	1
	1	0	23.75	23.61	23.95		1
	1	7	23.80	23.57	23.93		1
	1	14	23.71	23.63	23.89	0-2	1
	8	0	22.80	22.67	22.67		2
	8	4	22.80	22.99	22.87		2
	8	7	22.81	23.01	22.81	2	
	15	0	22.74	22.88	22.80	2	

**Table 9-6
LTE Band 12 Conducted Powers -1.4 MHz Bandwidth**

LTE Band 12 1.4 MHz Bandwidth							
Modulation	RB Size	RB Offset	Low Channel	Mid Channel	High Channel	MPR Allowed per 3GPP [dB]	MPR [dB]
			23017 (699.7 MHz)	23095 (707.5 MHz)	23173 (715.3 MHz)		
			Conducted Power [dBm]				
QPSK	1	0	24.81	24.93	25.10	0	0
	1	2	25.18	24.92	25.13		0
	1	5	24.88	25.05	24.77		0
	3	0	24.84	24.78	24.91		0
	3	2	24.88	25.00	24.94		0
	3	3	24.87	25.01	24.88	0	
16QAM	6	0	23.83	23.94	23.96	0-1	1
	1	0	23.80	23.94	23.70	0-1	1
	1	2	23.88	24.10	24.14		1
	1	5	23.87	24.17	23.95		1
	3	0	24.11	23.92	23.92		1
	3	2	24.11	23.75	24.02		1
	3	3	23.96	23.77	23.94	1	
	6	0	22.73	22.85	22.53	0-2	2

FCC ID: ZNFX410AS	 PCTEST ENGINEERING LABORATORY, INC.	SAR EVALUATION REPORT	 LG	Approved by: Quality Manager
Document S/N: 1M1803140041-01-R1.ZNF	Test Dates: 03/28/18 - 04/11/18	DUT Type: Portable Handset		Page 26 of 69

9.3.2



LTE Band 14

Table 9-7
LTE Band 14 Conducted Powers - 10 MHz Bandwidth

LTE Band 14 10 MHz Bandwidth					
Modulation	RB Size	RB Offset	Mid Channel	MPR Allowed per 3GPP [dB]	MPR [dB]
			23330 (793.0 MHz)		
			Conducted Power [dBm]		
QPSK	1	0	25.12	0	0
	1	25	25.17		0
	1	49	25.15		0
	25	0	24.04	0-1	1
	25	12	24.10		1
	25	25	24.06		1
	50	0	24.05		1
16QAM	1	0	24.14	0-1	1
	1	25	24.19		1
	1	49	23.94		1
	25	0	22.96	0-2	2
	25	12	22.96		2
	25	25	22.92		2
	50	0	22.98		2

Table 9-8
LTE Band 14 Conducted Powers - 5 MHz Bandwidth

LTE Band 14 5 MHz Bandwidth					
Modulation	RB Size	RB Offset	Mid Channel	MPR Allowed per 3GPP [dB]	MPR [dB]
			23330 (793.0 MHz)		
			Conducted Power [dBm]		
QPSK	1	0	24.98	0	0
	1	12	25.15		0
	1	24	24.85		0
	12	0	24.06	0-1	1
	12	6	24.09		1
	12	13	24.12		1
	25	0	24.11		1
16QAM	1	0	23.82	0-1	1
	1	12	23.90		1
	1	24	23.61		1
	12	0	22.87	0-2	2
	12	6	22.82		2
	12	13	22.83		2
	25	0	22.95		2

FCC ID: ZNFX410AS	 PCTEST ENGINEERING LABORATORY, INC.	SAR EVALUATION REPORT	 LG	Approved by: Quality Manager
Document S/N: 1M1803140041-01-R1.ZNF	Test Dates: 03/28/18 - 04/11/18	DUT Type: Portable Handset		Page 27 of 69

9.3.3

LTE Band 5 (Cell)

Table 9-9
LTE Band 5 (Cell) Conducted Powers - 10 MHz Bandwidth

LTE Band 5 (Cell) 10 MHz Bandwidth					
Modulation	RB Size	RB Offset	Mid Channel	MPR Allowed per 3GPP [dB]	MPR [dB]
			20525 (836.5 MHz)		
			Conducted Power [dBm]		
QPSK	1	0	25.00	0	0
	1	25	24.82		0
	1	49	24.84		0
	25	0	24.00	0-1	1
	25	12	24.00		1
	25	25	24.01		1
	50	0	24.00		1
16QAM	1	0	23.74	0-1	1
	1	25	24.20		1
	1	49	23.89		1
	25	0	22.66	0-2	2
	25	12	22.66		2
	25	25	22.73		2
	50	0	22.67		2

Note: LTE Band 5 (Cell) at 10 MHz bandwidth does not support three non-overlapping channels. Per KDB Publication 941225 D05v02, when a device supports overlapping channel assignment in a channel bandwidth configuration, the middle channel of the group of overlapping channels should be selected for testing.

Table 9-10
LTE Band 5 (Cell) Conducted Powers - 5 MHz Bandwidth

LTE Band 5 (Cell) 5 MHz Bandwidth							
Modulation	RB Size	RB Offset	Low Channel	Mid Channel	High Channel	MPR Allowed per 3GPP [dB]	MPR [dB]
			20425 (826.5 MHz)	20525 (836.5 MHz)	20625 (846.5 MHz)		
			Conducted Power [dBm]				
QPSK	1	0	24.92	24.60	24.75	0	0
	1	12	25.13	24.68	24.95		0
	1	24	25.17	24.75	24.76		0
	12	0	23.90	23.90	24.02	0-1	1
	12	6	24.06	24.01	23.91		1
	12	13	24.04	23.96	23.83		1
	25	0	23.96	23.90	24.04		1
16QAM	1	0	23.84	23.68	23.96	0-1	1
	1	12	23.83	23.60	23.75		1
	1	24	23.80	23.78	23.70		1
	12	0	22.48	22.41	22.50	0-2	2
	12	6	22.55	22.53	22.55		2
	12	13	22.54	22.46	22.48		2
	25	0	22.76	22.59	22.52		2





FCC ID: ZNFX410AS	 PCTEST ENGINEERING LABORATORY, INC.	SAR EVALUATION REPORT	 LG	Approved by: Quality Manager
Document S/N: 1M1803140041-01-R1.ZNF	Test Dates: 03/28/18 - 04/11/18	DUT Type: Portable Handset		Page 28 of 69

Table 9-11
LTE Band 5 (Cell) Conducted Powers - 3 MHz Bandwidth

LTE Band 5 (Cell) 3 MHz Bandwidth							
Modulation	RB Size	RB Offset	Low Channel	Mid Channel	High Channel	MPR Allowed per 3GPP [dB]	MPR [dB]
			20415 (825.5 MHz)	20525 (836.5 MHz)	20635 (847.5 MHz)		
			Conducted Power [dBm]				
QPSK	1	0	25.05	24.97	24.88	0	0
	1	7	25.10	25.17	24.93		0
	1	14	25.13	25.14	24.84		0
	8	0	23.96	23.97	24.05	0-1	1
	8	4	23.90	23.92	23.87		1
	8	7	23.89	23.93	24.03		1
	15	0	23.85	23.88	23.85		1
16QAM	1	0	23.73	23.78	23.68	0-1	1
	1	7	23.74	23.74	23.84		1
	1	14	23.76	24.04	23.73		1
	8	0	22.73	22.50	22.60	0-2	2
	8	4	22.77	22.92	22.64		2
	8	7	22.69	22.91	22.59		2
	15	0	22.57	22.66	22.38		2

Table 9-12
LTE Band 5 (Cell) Conducted Powers -1.4 MHz Bandwidth

LTE Band 5 (Cell) 1.4 MHz Bandwidth							
Modulation	RB Size	RB Offset	Low Channel	Mid Channel	High Channel	MPR Allowed per 3GPP [dB]	MPR [dB]
			20407 (824.7 MHz)	20525 (836.5 MHz)	20643 (848.3 MHz)		
			Conducted Power [dBm]				
QPSK	1	0	24.78	25.01	25.00	0	0
	1	2	24.88	25.08	25.01		0
	1	5	24.78	24.87	24.93		0
	3	0	24.81	24.91	25.01		0
	3	2	25.00	25.04	25.05		0
	3	3	24.89	24.90	25.02		0
	6	0	23.90	23.92	23.97	0-1	1
16QAM	1	0	23.81	23.71	23.85	0-1	1
	1	2	24.04	23.82	23.95		1
	1	5	23.91	23.81	23.73		1
	3	0	24.00	23.99	23.74		1
	3	2	23.90	24.03	23.59		1
	3	3	23.87	24.00	23.48		1
	6	0	22.44	22.94	22.62	0-2	2

FCC ID: ZNFX410AS		SAR EVALUATION REPORT		Approved by: Quality Manager
Document S/N: 1M1803140041-01-R1.ZNF	Test Dates: 03/28/18 - 04/11/18	DUT Type: Portable Handset		Page 29 of 69

9.3.4

LTE Band 4 (AWS)

Table 9-13
LTE Band 4 (AWS) Conducted Powers - 20 MHz Bandwidth

LTE Band 4 (AWS) 20 MHz Bandwidth					
Modulation	RB Size	RB Offset	Mid Channel	MPR Allowed per 3GPP [dB]	MPR [dB]
			20175 (1732.5 MHz)		
			Conducted Power [dBm]		
QPSK	1	0	24.96	0	0
	1	50	25.17		0
	1	99	24.81		0
	50	0	24.08	0-1	1
	50	25	24.15		1
	50	50	24.10		1
	100	0	24.06		1
16QAM	1	0	23.84	0-1	1
	1	50	23.88		1
	1	99	23.81		1
	50	0	23.02	0-2	2
	50	25	23.15		2
	50	50	22.94		2
	100	0	23.00		2

Note: LTE Band 4 (AWS) at 20 MHz bandwidth does not support three non-overlapping channels. Per KDB Publication 941225 D05v02, when a device supports overlapping channel assignment in a channel bandwidth configuration, the middle channel of the group of overlapping channels should be selected for testing.

Table 9-14
LTE Band 4 (AWS) Conducted Powers - 15 MHz Bandwidth

LTE Band 4 (AWS) 15 MHz Bandwidth							
Modulation	RB Size	RB Offset	Low Channel	Mid Channel	High Channel	MPR Allowed per 3GPP [dB]	MPR [dB]
			20025 (1717.5 MHz)	20175 (1732.5 MHz)	20325 (1747.5 MHz)		
			Conducted Power [dBm]				
QPSK	1	0	25.06	24.78	25.00	0	0
	1	36	24.96	25.13	25.15		0
	1	74	25.18	25.08	25.02		0
	36	0	23.98	24.08	24.14	0-1	1
	36	18	23.98	24.08	24.14		1
	36	37	23.99	23.98	24.11		1
	75	0	24.02	23.98	24.10		1
16QAM	1	0	23.97	23.54	24.13	0-1	1
	1	36	24.20	24.07	24.00		1
	1	74	23.91	24.19	24.18		1
	36	0	22.82	23.01	23.18	0-2	2
	36	18	22.94	22.93	23.18		2
	36	37	22.76	22.88	22.96		2
	75	0	22.91	23.01	23.12		2



FCC ID: ZNFX410AS	 PCTEST ENGINEERING LABORATORY, INC.	SAR EVALUATION REPORT	 LG	Approved by: Quality Manager
Document S/N: 1M1803140041-01-R1.ZNF	Test Dates: 03/28/18 - 04/11/18	DUT Type: Portable Handset		Page 30 of 69

Table 9-15
LTE Band 4 (AWS) Conducted Powers - 10 MHz Bandwidth

LTE Band 4 (AWS) 10 MHz Bandwidth							
Modulation	RB Size	RB Offset	Low Channel	Mid Channel	High Channel	MPR Allowed per 3GPP [dB]	MPR [dB]
			20000 (1715.0 MHz)	20175 (1732.5 MHz)	20350 (1750.0 MHz)		
			Conducted Power [dBm]				
QPSK	1	0	24.94	24.74	25.09	0	0
	1	25	24.99	25.14	25.19		0
	1	49	24.84	24.88	25.09		0
	25	0	23.99	24.09	24.17	0-1	1
	25	12	23.99	24.09	24.16		1
	25	25	23.93	23.99	24.14		1
16QAM	50	0	23.97	23.96	24.20	0-1	1
	1	0	23.86	24.00	23.84		1
	1	25	24.05	23.63	23.94		1
	1	49	23.81	23.62	23.95	0-2	1
	25	0	22.94	23.06	23.02		2
	25	12	22.96	23.04	23.16		2
	25	25	22.80	22.97	23.13	2	
	50	0	22.83	23.05	23.06	2	

Table 9-16
LTE Band 4 (AWS) Conducted Powers - 5 MHz Bandwidth

LTE Band 4 (AWS) 5 MHz Bandwidth							
Modulation	RB Size	RB Offset	Low Channel	Mid Channel	High Channel	MPR Allowed per 3GPP [dB]	MPR [dB]
			19975 (1712.5 MHz)	20175 (1732.5 MHz)	20375 (1752.5 MHz)		
			Conducted Power [dBm]				
QPSK	1	0	24.79	24.83	25.04	0	0
	1	12	25.18	25.12	25.02		0
	1	24	25.05	24.92	25.00		0
	12	0	23.98	24.06	24.19	0-1	1
	12	6	24.01	24.08	24.18		1
	12	13	23.98	24.05	24.20		1
16QAM	25	0	23.96	24.02	24.20	0-1	1
	1	0	23.60	23.78	23.89		1
	1	12	23.66	23.77	23.87		1
	1	24	23.68	23.89	23.86	0-2	1
	12	0	23.04	22.75	23.07		2
	12	6	22.91	22.79	23.13		2
	12	13	22.85	22.79	23.16	2	
	25	0	23.05	22.96	22.97	2	





FCC ID: ZNFX410AS	 PCTEST <small>ENGINEERING LABORATORY, INC.</small>	SAR EVALUATION REPORT	 LG	Approved by: Quality Manager
Document S/N: 1M1803140041-01-R1.ZNF	Test Dates: 03/28/18 - 04/11/18	DUT Type: Portable Handset	Page 31 of 69	

Table 9-17
LTE Band 4 (AWS) Conducted Powers - 3 MHz Bandwidth

LTE Band 4 (AWS) 3 MHz Bandwidth							
Modulation	RB Size	RB Offset	Low Channel	Mid Channel	High Channel	MPR Allowed per 3GPP [dB]	MPR [dB]
			19965 (1711.5 MHz)	20175 (1732.5 MHz)	20385 (1753.5 MHz)		
			Conducted Power [dBm]				
QPSK	1	0	25.12	25.03	24.82	0	0
	1	7	25.19	25.10	25.02		0
	1	14	25.15	25.07	24.85		0
	8	0	23.75	23.87	23.98	0-1	1
	8	4	23.77	23.96	24.05		1
	8	7	23.74	23.95	23.96		1
	15	0	23.72	23.83	23.92		1
16QAM	1	0	23.52	23.79	23.86	0-1	1
	1	7	23.75	23.68	23.95		1
	1	14	23.59	23.80	23.77		1
	8	0	22.65	22.83	22.82	0-2	2
	8	4	22.71	22.85	22.91		2
	8	7	22.65	22.82	22.92		2
	15	0	22.63	22.85	22.77		2

Table 9-18
LTE Band 4 (AWS) Conducted Powers - 1.4 MHz Bandwidth

LTE Band 4 (AWS) 1.4 MHz Bandwidth							
Modulation	RB Size	RB Offset	Low Channel	Mid Channel	High Channel	MPR Allowed per 3GPP [dB]	MPR [dB]
			19957 (1710.7 MHz)	20175 (1732.5 MHz)	20393 (1754.3 MHz)		
			Conducted Power [dBm]				
QPSK	1	0	24.86	25.03	25.03	0	0
	1	2	24.94	25.09	25.00		0
	1	5	24.82	25.03	24.98		0
	3	0	24.86	25.02	24.97		0
	3	2	24.95	25.08	24.98		0
	3	3	24.91	25.01	24.93		0
	6	0	23.90	24.11	24.02	0-1	1
16QAM	1	0	23.93	23.68	23.74	0-1	1
	1	2	23.44	23.78	23.87		1
	1	5	23.37	23.89	23.96		1
	3	0	23.89	24.08	23.79		1
	3	2	23.55	24.13	23.81		1
	3	3	23.68	24.10	23.85		1
	6	0	22.76	23.17	23.20	0-2	2

FCC ID: ZNFX410AS		SAR EVALUATION REPORT		Approved by: Quality Manager
Document S/N: 1M1803140041-01-R1.ZNF	Test Dates: 03/28/18 - 04/11/18	DUT Type: Portable Handset		Page 32 of 69

9.3.5

LTE Band 2 (PCS)

Table 9-19
LTE Band 2 (PCS) Conducted Powers - 20 MHz Bandwidth

LTE Band 2 (PCS) 20 MHz Bandwidth							
Modulation	RB Size	RB Offset	Low Channel	Mid Channel	High Channel	MPR Allowed per 3GPP [dB]	MPR [dB]
			18700 (1860.0 MHz)	18900 (1880.0 MHz)	19100 (1900.0 MHz)		
			Conducted Power [dBm]				
QPSK	1	0	24.95	25.04	25.00	0	0
	1	50	25.20	25.18	24.99		0
	1	99	25.10	24.89	25.16		0
	50	0	23.98	23.99	24.08	0-1	1
	50	25	24.11	23.95	24.04		1
	50	50	23.93	23.91	24.01		1
16QAM	100	0	23.96	23.95	24.05	0-1	1
	1	0	23.92	23.65	23.98		1
	1	50	23.84	23.96	23.73		1
	1	99	23.68	23.66	23.80	0-2	1
	50	0	22.70	22.83	22.80		2
	50	25	22.84	22.86	22.86		2
	50	50	22.66	22.74	22.69	2	
	100	0	22.81	22.79	22.81	2	

Table 9-20
LTE Band 2 (PCS) Conducted Powers - 15 MHz Bandwidth

LTE Band 2 (PCS) 15 MHz Bandwidth							
Modulation	RB Size	RB Offset	Low Channel	Mid Channel	High Channel	MPR Allowed per 3GPP [dB]	MPR [dB]
			18675 (1857.5 MHz)	18900 (1880.0 MHz)	19125 (1902.5 MHz)		
			Conducted Power [dBm]				
QPSK	1	0	25.19	24.92	24.80	0	0
	1	36	25.16	25.04	25.12		0
	1	74	25.19	25.14	24.99		0
	36	0	24.02	24.03	24.03	0-1	1
	36	18	24.02	24.06	24.12		1
	36	37	23.96	23.98	24.04		1
	75	0	23.95	23.99	24.04		1
16QAM	1	0	23.98	23.62	24.18	0-1	1
	1	36	24.11	23.61	24.13		1
	1	74	24.08	23.41	24.06		1
	36	0	22.90	22.91	22.91	0-2	2
	36	18	22.91	22.91	23.01		2
	36	37	22.67	22.82	22.90		2
	75	0	22.77	22.84	22.88	2	



FCC ID: ZNFX410AS		SAR EVALUATION REPORT		Approved by: Quality Manager
Document S/N: 1M1803140041-01-R1.ZNF	Test Dates: 03/28/18 - 04/11/18	DUT Type: Portable Handset		Page 33 of 69

Table 9-21
LTE Band 2 (PCS) Conducted Powers - 10 MHz Bandwidth

LTE Band 2 (PCS) 10 MHz Bandwidth							
Modulation	RB Size	RB Offset	Low Channel	Mid Channel	High Channel	MPR Allowed per 3GPP [dB]	MPR [dB]
			18650 (1855.0 MHz)	18900 (1880.0 MHz)	19150 (1905.0 MHz)		
			Conducted Power [dBm]				
QPSK	1	0	25.13	25.08	25.16	0	0
	1	25	25.12	25.16	25.10		0
	1	49	25.18	25.08	25.14		0
	25	0	23.99	24.09	24.00	0-1	1
	25	12	24.05	24.14	24.14		1
	25	25	23.87	23.93	24.08		1
16QAM	50	0	23.95	23.92	24.05	0-1	1
	1	0	23.91	24.18	23.88		1
	1	25	24.19	24.19	23.87		1
	1	49	23.75	24.00	24.02	0-2	1
	25	0	22.89	22.93	22.99		2
	25	12	22.81	22.92	23.03		2
	25	25	22.68	22.96	23.10	2	
	50	0	22.74	22.84	22.87	2	

Table 9-22
LTE Band 2 (PCS) Conducted Powers - 5 MHz Bandwidth

LTE Band 2 (PCS) 5 MHz Bandwidth							
Modulation	RB Size	RB Offset	Low Channel	Mid Channel	High Channel	MPR Allowed per 3GPP [dB]	MPR [dB]
			18625 (1852.5 MHz)	18900 (1880.0 MHz)	19175 (1907.5 MHz)		
			Conducted Power [dBm]				
QPSK	1	0	25.09	24.84	25.00	0	0
	1	12	25.18	25.19	25.19		0
	1	24	25.05	24.85	25.01		0
	12	0	24.00	23.97	24.04	0-1	1
	12	6	24.00	24.02	24.09		1
	12	13	23.98	23.97	23.99		1
16QAM	25	0	24.06	24.09	24.02	0-1	1
	1	0	23.83	23.43	23.86		1
	1	12	23.88	23.60	23.99		1
	1	24	23.64	23.50	23.96	0-2	1
	12	0	22.78	22.84	22.76		2
	12	6	22.78	22.90	22.81		2
	12	13	22.77	22.86	22.74	2	
	25	0	22.89	22.79	22.86	2	





FCC ID: ZNFX410AS	 PCTEST ENGINEERING LABORATORY, INC.	SAR EVALUATION REPORT	 LG	Approved by: Quality Manager
Document S/N: 1M1803140041-01-R1.ZNF	Test Dates: 03/28/18 - 04/11/18	DUT Type: Portable Handset	Page 34 of 69	

Table 9-23
LTE Band 2 (PCS) Conducted Powers - 3 MHz Bandwidth

LTE Band 2 (PCS) 3 MHz Bandwidth							
Modulation	RB Size	RB Offset	Low Channel	Mid Channel	High Channel	MPR Allowed per 3GPP [dB]	MPR [dB]
			18615 (1851.5 MHz)	18900 (1880.0 MHz)	19185 (1908.5 MHz)		
			Conducted Power [dBm]				
QPSK	1	0	25.07	25.14	25.17	0	0
	1	7	25.17	25.18	25.14		0
	1	14	25.19	25.10	25.16		0
	8	0	23.99	24.08	24.15	0-1	1
	8	4	23.95	24.11	24.09		1
	8	7	23.93	24.08	24.02		1
	15	0	24.02	24.07	24.06		1
16QAM	1	0	23.92	23.55	24.01	0-1	1
	1	7	23.95	23.58	24.04		1
	1	14	23.90	23.37	24.00		1
	8	0	23.08	22.87	22.91	0-2	2
	8	4	22.89	22.91	22.93		2
	8	7	22.87	22.93	22.88		2
	15	0	22.94	22.93	22.72		2

Table 9-24
LTE Band 2 (PCS) Conducted Powers -1.4 MHz Bandwidth

LTE Band 2 (PCS) 1.4 MHz Bandwidth							
Modulation	RB Size	RB Offset	Low Channel	Mid Channel	High Channel	MPR Allowed per 3GPP [dB]	MPR [dB]
			18607 (1850.7 MHz)	18900 (1880.0 MHz)	19193 (1909.3 MHz)		
			Conducted Power [dBm]				
QPSK	1	0	24.87	25.18	25.07	0	0
	1	2	25.01	25.11	25.11		0
	1	5	25.08	25.02	25.18		0
	3	0	24.93	25.16	25.01		0
	3	2	25.00	25.20	25.01		0
	3	3	24.96	25.17	25.14		0
	6	0	23.92	24.04	24.06	0-1	1
16QAM	1	0	23.47	23.98	24.13	0-1	1
	1	2	23.43	23.95	24.20		1
	1	5	23.52	23.81	23.77		1
	3	0	23.87	23.93	23.88		1
	3	2	23.86	23.98	23.96		1
	3	3	23.76	24.12	23.93		1
	6	0	22.58	22.84	22.97	0-2	2

FCC ID: ZNFX410AS	 PCTEST ENGINEERING LABORATORY, INC.	SAR EVALUATION REPORT	 LG	Approved by: Quality Manager
Document S/N: 1M1803140041-01-R1.ZNF	Test Dates: 03/28/18 - 04/11/18	DUT Type: Portable Handset	Page 35 of 69	

9.3.6 LTE Carrier Aggregation Conducted Powers

Table 9-25
LTE Carrier Aggregation Conducted Powers

Combination	PCC										SCC				Power	
	PCC Band	PCC BW [MHz]	PCC (UL) Channel	PCC (UL) Freq. [MHz]	Modulation	PCC UL# RB	PCC UL RB Offset	PCC (DL) Ch.	PCC (DL) Freq. [MHz]	SCC Band	SCC BW [MHz]	SCC (DL) Ch.	SCC (DL) Freq. [MHz]	LTE Tx Power with DL CA Enabled (dBm)	LTE Single Carrier Tx Power (dBm)	
CA_2A-5A (1)	LTE B2	5	19175	1907.5	QPSK	1	12	1175	1987.5	LTE B5	10	2525	881.5	25.03	25.19	
CA_2A-5A (1)	LTE B5	5	20425	826.5	QPSK	1	24	2425	871.5	LTE B2	10	900	1960	25.07	25.17	
CA_2A-12A (2)	LTE B2	5	19175	1907.5	QPSK	1	12	1175	1987.5	LTE B12	10	5095	737.5	25.01	25.19	
CA_2A-12A (2)	LTE B12	5	23095	707.5	QPSK	1	12	5095	737.5	LTE B2	10	900	1960	25.06	25.19	
CA_4A-5A	LTE B4	10	20350	1750	QPSK	1	25	2350	2150	LTE B5	10	2525	881.5	25.08	25.19	
CA_4A-5A	LTE B5	5	20425	826.5	QPSK	1	24	2425	871.5	LTE B4	10	2175	2132.5	25.17	25.17	
CA_4A-12A	LTE B4	3	19965	1711.5	QPSK	1	7	1965	2111.5	LTE B12	10	5095	737.5	25.09	25.19	
CA_4A-12A	LTE B12	5	23095	707.5	QPSK	1	12	5095	737.5	LTE B4	10	2175	2132.5	25.11	25.19	
CA_4A-12A (3)	LTE B4	10	20350	1750	QPSK	1	25	2350	2150	LTE B12	10	5095	737.5	25.06	25.19	
CA_4A-12A (3)	LTE B12	5	23095	707.5	QPSK	1	12	5095	737.5	LTE B4	10	2175	2132.5	25.11	25.19	

Notes:

- For every supported combination of downlink carrier aggregation, power measurements were performed with the downlink carrier aggregation active for the configuration with highest measured maximum conducted power with downlink carrier aggregation inactive measured among the channel bandwidth, modulation, and RB combinations in each frequency band.
- All control and acknowledge data is sent on uplink channels that operate identical to specifications when downlink carrier aggregation is inactive.
- For downlink carrier aggregation combinations, PCC uplink channel was selected based on section C)3)b)ii) of KBD 941225 D05 V01r02. The downlink PCC channel was paired with the selected PCC uplink channel according to normal configurations without carrier aggregation. For inter-band CA, the SCC downlink channels were selected near the middle of their transmission bands. All selected downlink channels remained fully within the downlink transmission band of the respective component carrier.

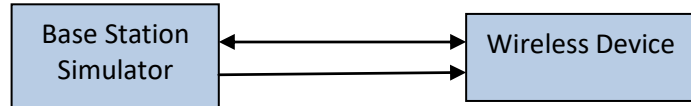



Figure 9-3
Power Measurement Setup

FCC ID: ZNFX410AS		SAR EVALUATION REPORT		Approved by: Quality Manager
Document S/N: 1M1803140041-01-R1.ZNF	Test Dates: 03/28/18 - 04/11/18	DUT Type: Portable Handset	Page 36 of 69	

9.4 WLAN Conducted Powers



Table 9-26
2.4 GHz WLAN Average RF Power

2.4GHz Conducted Power [dBm]				
Freq [MHz]	Channel	IEEE Transmission Mode		
		802.11b	802.11g	802.11n
2412	1	14.77	13.39	13.38
2417	2	N/A	14.34	14.38
2437	6	14.86	14.34	14.27
2457	10	N/A	14.25	14.21
2462	11	14.92	13.37	13.35

Table 9-27
5 GHz WLAN Average RF Power

5GHz (20MHz) Conducted Power [dBm]				
Freq [MHz]	Channel	IEEE Transmission Mode		
		802.11a	802.11n	802.11ac
5180	36	10.06	9.99	9.97
5200	40	9.90	9.90	9.82
5220	44	9.92	9.86	9.86
5240	48	9.95	9.87	9.86
5260	52	9.83	9.82	9.86
5280	56	9.82	9.76	9.80
5300	60	9.79	9.68	9.73
5320	64	9.67	9.67	9.66
5500	100	9.62	9.52	9.54
5600	120	9.46	9.36	9.41
5700	140	9.49	9.37	9.47
5745	149	9.30	9.26	9.25
5785	157	9.17	9.10	9.10
5825	165	8.88	8.90	8.90

5GHz (40MHz) Conducted Power [dBm]			
Freq [MHz]	Channel	IEEE Transmission Mode	
		802.11n	802.11ac
5190	38	9.54	9.35
5230	46	9.48	9.22
5270	54	9.45	9.11
5310	62	9.36	9.10
5510	102	9.16	8.82
5590	118	8.99	8.68
5670	134	8.98	8.61
5755	151	8.80	8.49
5795	159	8.68	8.44

FCC ID: ZNFX410AS	 SAR EVALUATION REPORT 		Approved by: Quality Manager
Document S/N: 1M1803140041-01-R1.ZNF	Test Dates: 03/28/18 - 04/11/18	DUT Type: Portable Handset	Page 37 of 69

Justification for test configurations for WLAN per KDB Publication 248227 D01v02r02:

- Power measurements were performed for the transmission mode configuration with the highest maximum output power specified for production units.
- For transmission modes with the same maximum output power specification, powers were measured for the largest channel bandwidth, lowest order modulation and lowest data rate.
- For transmission modes with identical maximum specified output power, channel bandwidth, modulation and data rates, power measurements were required for all identical configurations.
- For each transmission mode configuration, powers were measured for the highest and lowest channels; and at the mid-band channel(s) when there were at least 3 channels supported. For configurations with multiple mid-band channels, due to an even number of channels, both channels were measured.
- The bolded data rate and channel above were tested for SAR.

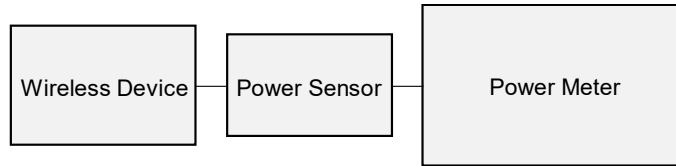



Figure 9-4
Power Measurement Setup



FCC ID: ZNFX410AS	 SAR EVALUATION REPORT 		Approved by: Quality Manager
Document S/N: 1M1803140041-01-R1.ZNF	Test Dates: 03/28/18 - 04/11/18	DUT Type: Portable Handset	Page 38 of 69

9.5 Bluetooth Conducted Powers

Table 9-28
Bluetooth Average RF Power

Frequency [MHz]	Data Rate [Mbps]	Channel No.	Avg Conducted Power	
			[dBm]	[mW]
2402	1.0	0	9.31	8.539
2441	1.0	39	10.29	10.680
2480	1.0	78	8.70	7.410
2402	2.0	0	8.66	7.349
2441	2.0	39	9.65	9.221
2480	2.0	78	8.03	6.350
2402	3.0	0	8.67	7.363
2441	3.0	39	9.65	9.221
2480	3.0	78	8.11	6.470

Note: The bolded data rates and channel above were tested for SAR.

FCC ID: ZNFX410AS	 PCTEST ENGINEERING LABORATORY, INC.	SAR EVALUATION REPORT	 LG	Approved by: Quality Manager
Document S/N: 1M1803140041-01-R1.ZNF	Test Dates: 03/28/18 - 04/11/18	DUT Type: Portable Handset		Page 39 of 69

**Figure 9-5
Bluetooth Transmission Plot**

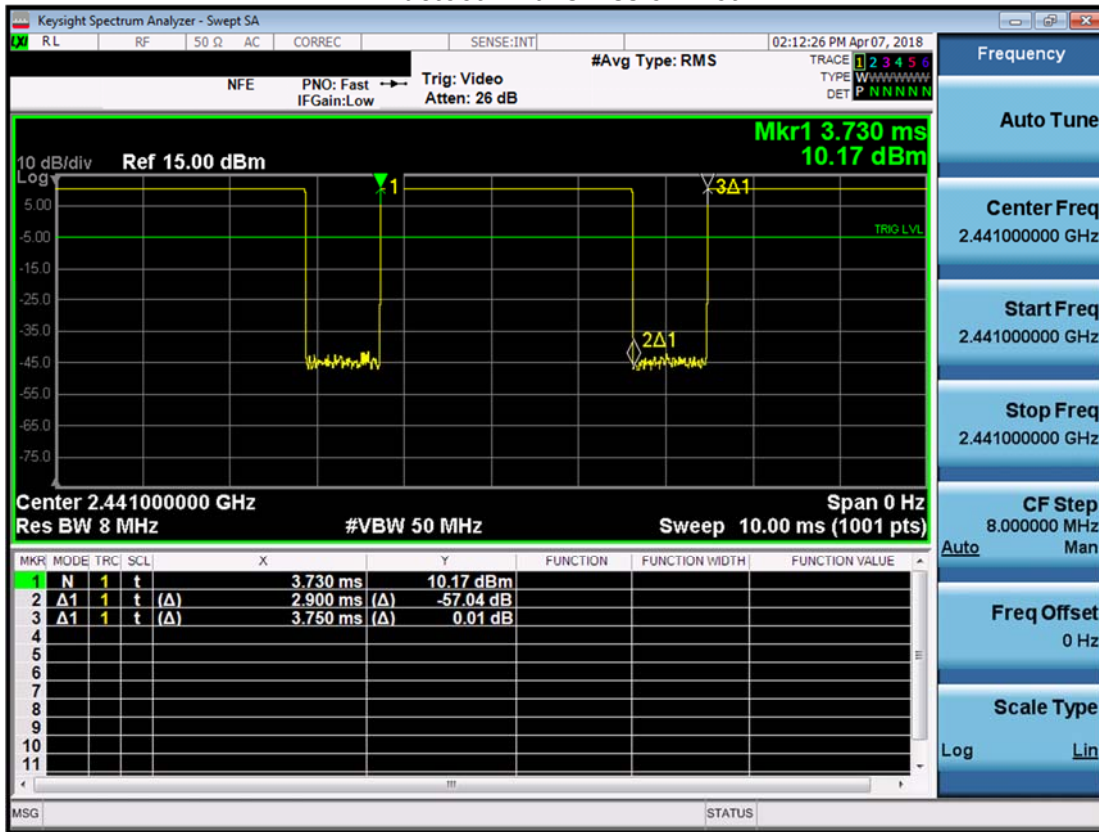

**Equation 9-1
Bluetooth Duty Cycle Calculation**

$$Duty\ Cycle = \frac{Pulse\ Width}{Period} * 100\% = \frac{2.90\ ms}{3.75\ ms} * 100\% = 77.3\%$$

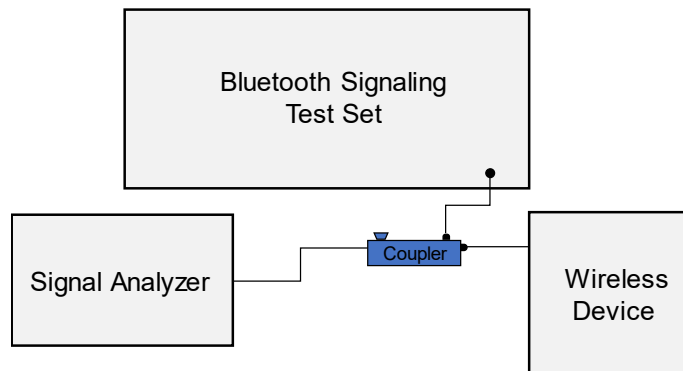

**Figure 9-6
Power Measurement Setup**



FCC ID: ZNFX410AS		SAR EVALUATION REPORT		Approved by: Quality Manager
Document S/N: 1M1803140041-01-R1.ZNF	Test Dates: 03/28/18 - 04/11/18	DUT Type: Portable Handset		Page 40 of 69

10 SYSTEM VERIFICATION

10.1 Tissue Verification

**Table 10-1
Measured Head Tissue Properties**



Calibrated for Tests Performed on:	Tissue Type	Tissue Temp During Calibration (°C)	Measured Frequency (MHz)	Measured Conductivity, σ (S/m)	Measured Dielectric Constant, ϵ	TARGET Conductivity, σ (S/m)	TARGET Dielectric Constant, ϵ	% dev σ	% dev ϵ
4/6/2018	750H	22.0	700	0.889	41.513	0.889	42.201	0.00%	-1.63%
			710	0.892	41.490	0.890	42.149	0.22%	-1.56%
			740	0.902	41.409	0.893	41.994	1.01%	-1.39%
			755	0.908	41.364	0.894	41.916	1.57%	-1.32%
			785	0.919	41.287	0.896	41.760	2.57%	-1.13%
			800	0.923	41.257	0.897	41.682	2.90%	-1.02%
4/2/2018	835H	19.7	820	0.905	42.630	0.899	41.578	0.67%	2.53%
			835	0.920	42.445	0.900	41.500	2.22%	2.28%
			850	0.935	42.263	0.916	41.500	2.07%	1.84%
4/2/2018	1750H	21.4	1710	1.348	39.541	1.348	40.142	0.00%	-1.50%
			1750	1.388	39.359	1.371	40.079	1.24%	-1.80%
			1790	1.430	39.200	1.394	40.016	2.58%	-2.04%
4/5/2018	1900H	22.3	1850	1.376	40.133	1.400	40.000	-1.71%	0.33%
			1880	1.407	40.025	1.400	40.000	0.50%	0.06%
			1910	1.440	39.896	1.400	40.000	2.86%	-0.26%
3/28/2018	2450H	23.2	2400	1.753	40.274	1.756	39.289	-0.17%	2.51%
			2450	1.808	40.109	1.800	39.200	0.44%	2.32%
			2500	1.866	39.918	1.855	39.136	0.59%	2.00%
4/11/2018	2450H	22.7	2400	1.787	39.586	1.756	39.289	1.77%	0.76%
			2450	1.847	39.419	1.800	39.200	2.61%	0.56%
			2500	1.902	39.216	1.855	39.136	2.53%	0.20%
04/05/2018	5200H-5800H	21.1	5220	4.488	34.972	4.676	35.963	-4.02%	-2.76%
			5240	4.506	34.947	4.696	35.940	-4.05%	-2.76%
			5260	4.519	34.923	4.717	35.917	-4.20%	-2.77%
			5500	4.752	34.587	4.963	35.643	-4.25%	-2.96%
			5580	4.835	34.481	5.045	35.551	-4.16%	-3.01%
			5600	4.855	34.446	5.065	35.529	-4.15%	-3.05%
			5700	4.951	34.345	5.168	35.414	-4.20%	-3.02%
			5745	5.000	34.249	5.214	35.363	-4.10%	-3.15%
5765	5.018	34.219	5.234	35.340	-4.13%	-3.17%			

FCC ID: ZNFX410AS	 PCTEST ENGINEERING LABORATORY, INC.	SAR EVALUATION REPORT	 LG	Approved by: Quality Manager
Document S/N: 1M1803140041-01-R1.ZNF	Test Dates: 03/28/18 - 04/11/18	DUT Type: Portable Handset		Page 41 of 69

**Table 10-2
Measured Body Tissue Properties**

Calibrated for Tests Performed on:	Tissue Type	Tissue Temp During Calibration (°C)	Measured Frequency (MHz)	Measured Conductivity, σ (S/m)	Measured Dielectric Constant, ϵ	TARGET Conductivity, σ (S/m)	TARGET Dielectric Constant, ϵ	% dev σ	% dev ϵ
4/3/2018	750B	21.7	700	0.970	53.149	0.959	55.726	1.15%	-4.62%
			710	0.974	53.123	0.960	55.687	1.46%	-4.60%
			740	0.984	53.066	0.963	55.570	2.18%	-4.51%
			755	0.990	53.033	0.964	55.512	2.70%	-4.47%
			785	1.003	52.946	0.966	55.395	3.83%	-4.42%
			800	1.008	52.900	0.967	55.336	4.24%	-4.40%
4/9/2018	750B	21.5	700	0.932	54.200	0.959	55.726	-2.82%	-2.74%
			710	0.936	54.171	0.960	55.687	-2.50%	-2.72%
			740	0.947	54.101	0.963	55.570	-1.66%	-2.64%
			755	0.954	54.062	0.964	55.512	-1.04%	-2.61%
			785	0.965	53.991	0.966	55.395	-0.10%	-2.53%
			800	0.970	53.953	0.967	55.336	0.31%	-2.50%
4/3/2018	835B	21.3	820	0.960	53.680	0.969	55.258	-0.93%	-2.86%
			835	0.974	53.530	0.970	55.200	0.41%	-3.03%
			850	0.989	53.387	0.988	55.154	0.10%	-3.20%
4/6/2018	835B	22.0	820	0.960	54.422	0.969	55.258	-0.93%	-1.51%
			835	0.975	54.294	0.970	55.200	0.52%	-1.64%
			850	0.989	54.174	0.988	55.154	0.10%	-1.78%
4/3/2018	1750B	22.1	1710	1.437	51.957	1.463	53.537	-1.78%	-2.95%
			1750	1.480	51.845	1.488	53.432	-0.54%	-2.97%
			1790	1.525	51.702	1.514	53.326	0.73%	-3.05%
4/5/2018	1750B	21.5	1710	1.454	52.032	1.463	53.537	-0.62%	-2.81%
			1750	1.499	51.867	1.488	53.432	0.74%	-2.93%
			1790	1.543	51.715	1.514	53.326	1.92%	-3.02%
4/2/2018	1900B	22.1	1850	1.522	54.195	1.520	53.300	0.13%	1.68%
			1880	1.555	54.092	1.520	53.300	2.30%	1.49%
			1910	1.590	53.987	1.520	53.300	4.61%	1.29%
4/5/2018	1900B	21.7	1850	1.520	53.877	1.520	53.300	0.00%	1.08%
			1880	1.553	53.793	1.520	53.300	2.17%	0.92%
			1910	1.587	53.695	1.520	53.300	4.41%	0.74%
4/3/2018	2450B	21.6	2400	1.988	51.278	1.902	52.767	4.52%	-2.82%
			2450	2.043	51.130	1.950	52.700	4.77%	-2.98%
			2500	2.106	50.978	2.021	52.636	4.21%	-3.15%
04/02/2018	5200B-5800B	21.8	5240	5.478	47.205	5.346	48.960	2.47%	-3.58%
			5260	5.499	47.203	5.369	48.933	2.42%	-3.54%
			5500	5.822	46.770	5.650	48.607	3.04%	-3.78%
			5580	5.937	46.620	5.743	48.499	3.38%	-3.87%
			5600	5.955	46.600	5.766	48.471	3.28%	-3.86%
			5700	6.072	46.412	5.883	48.336	3.21%	-3.98%
			5745	6.153	46.367	5.936	48.275	3.66%	-3.95%
			5765	6.182	46.318	5.959	48.248	3.74%	-4.00%
04/09/2018	5250B	21.9	5180	5.396	47.784	5.276	49.041	2.27%	-2.56%
			5240	5.481	47.664	5.346	48.960	2.53%	-2.65%
			5260	5.506	47.622	5.369	48.933	2.55%	-2.68%

The above measured tissue parameters were used in the DASY software. The DASY software was used to perform interpolation to determine the dielectric parameters at the SAR test device frequencies (per KDB Publication 865664 D01v01r04 and IEEE 1528-2013 6.6.1.2). The tissue parameters listed in the SAR test plots may slightly differ from the table above due to significant digit rounding in the software.

FCC ID: ZNFX410AS		SAR EVALUATION REPORT		Approved by: Quality Manager
Document S/N: 1M1803140041-01-R1.ZNF	Test Dates: 03/28/18 - 04/11/18	DUT Type: Portable Handset	Page 42 of 69	

10.2 Test System Verification

Prior to SAR assessment, the system is verified to $\pm 10\%$ of the SAR measurement on the reference dipole at the time of calibration by the calibration facility. Full system validation status and result summary can be found in Appendix E.

**Table 10-3
System Verification Results – 1g**

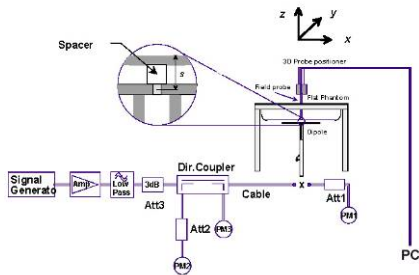

System Verification TARGET & MEASURED												
SAR System #	Tissue Frequency (MHz)	Tissue Type	Date:	Amb. Temp (°C)	Liquid Temp (°C)	Input Power (W)	Source SN	Probe SN	Measured SAR _{1g} (W/kg)	1 W Target SAR _{1g} (W/kg)	1 W Normalized SAR _{1g} (W/kg)	Deviation _{1g} (%)
H	750	HEAD	04/06/2018	22.5	22.0	0.200	1046	7410	1.550	8.260	7.750	-6.17%
E	835	HEAD	04/02/2018	19.8	19.7	0.200	4d132	3213	1.900	9.360	9.500	1.50%
H	1750	HEAD	04/02/2018	22.0	21.4	0.100	1148	7410	3.500	36.400	35.000	-3.85%
G	1900	HEAD	04/05/2018	22.2	21.2	0.100	5d080	3332	3.860	39.300	38.600	-1.78%
G	2450	HEAD	03/28/2018	22.3	21.5	0.100	797	3332	4.920	52.700	49.200	-6.64%
G	2450	HEAD	04/11/2018	22.1	21.9	0.100	797	3332	5.130	52.700	51.300	-2.66%
H	5250	HEAD	04/05/2018	22.5	21.1	0.050	1191	3589	3.750	78.900	75.000	-4.94%
H	5600	HEAD	04/05/2018	22.5	21.1	0.050	1191	3589	4.210	83.600	84.200	0.72%
H	5750	HEAD	04/05/2018	22.5	21.1	0.050	1191	3589	3.700	79.100	74.000	-6.45%
I	750	BODY	04/03/2018	22.0	20.9	0.200	1054	3287	1.750	8.610	8.750	1.63%
I	750	BODY	04/09/2018	22.6	21.5	0.200	1003	3287	1.760	8.580	8.800	2.56%
E	835	BODY	04/03/2018	22.0	21.3	0.200	4d132	3213	2.070	9.710	10.350	6.59%
E	835	BODY	04/06/2018	24.2	22.0	0.200	4d132	3213	1.960	9.710	9.800	0.93%
H	1750	BODY	04/03/2018	22.5	22.1	0.100	1148	7410	3.490	37.000	34.900	-5.68%
I	1750	BODY	04/05/2018	22.6	21.2	0.100	1148	3287	3.930	37.000	39.300	6.22%
J	1900	BODY	04/02/2018	21.0	21.0	0.100	5d148	3914	4.260	39.600	42.600	7.58%
J	1900	BODY	04/05/2018	21.9	21.7	0.100	5d148	3914	4.180	39.600	41.800	5.56%
K	2450	BODY	04/03/2018	22.4	21.6	0.100	797	3319	5.050	51.100	50.500	-1.17%
D	5250	BODY	04/02/2018	22.5	20.6	0.050	1237	7308	3.600	76.900	72.000	-6.37%
D	5250	BODY	04/09/2018	22.1	21.9	0.050	1237	7308	3.650	76.900	73.000	-5.07%
D	5600	BODY	04/02/2018	22.5	20.6	0.050	1237	7308	3.800	78.500	76.000	-3.18%
D	5750	BODY	04/02/2018	22.5	20.6	0.050	1237	7308	3.600	77.100	72.000	-6.61%



**Figure 10-1
System Verification Setup Diagram**



**Figure 10-2
System Verification Setup Photo**

FCC ID: ZNFX410AS		SAR EVALUATION REPORT		Approved by: Quality Manager
Document S/N: 1M1803140041-01-R1.ZNF	Test Dates: 03/28/18 - 04/11/18	DUT Type: Portable Handset		Page 43 of 69

11 SAR DATA SUMMARY



11.1 Standalone Head SAR Data

**Table 11-1
GSM 850 Head SAR**

MEASUREMENT RESULTS															
FREQUENCY		Mode/Band	Service	Maximum Allowed Power [dBm]	Conducted Power [dBm]	Power Drift [dB]	Side	Test Position	Device Serial Number	# of Time Slots	Duty Cycle	SAR (1g)	Scaling Factor	Reported SAR (1g)	Plot #
MHz	Ch.											(W/kg)		(W/kg)	
836.60	190	GSM 850	GSM	33.7	33.30	0.05	Right	Cheek	01207	1	1:8.3	0.373	1.096	0.409	
836.60	190	GSM 850	GSM	33.7	33.30	0.09	Right	Tilt	01207	1	1:8.3	0.220	1.096	0.241	
836.60	190	GSM 850	GSM	33.7	33.30	0.18	Left	Cheek	01207	1	1:8.3	0.373	1.096	0.409	
836.60	190	GSM 850	GSM	33.7	33.30	-0.09	Left	Tilt	01207	1	1:8.3	0.221	1.096	0.242	
836.60	190	GSM 850	GPRS	31.7	31.35	0.03	Right	Cheek	01207	2	1:4.15	0.464	1.084	0.503	A1
836.60	190	GSM 850	GPRS	31.7	31.35	0.04	Right	Tilt	01207	2	1:4.15	0.275	1.084	0.298	
836.60	190	GSM 850	GPRS	31.7	31.35	-0.12	Left	Cheek	01207	2	1:4.15	0.429	1.084	0.465	
836.60	190	GSM 850	GPRS	31.7	31.35	0.06	Left	Tilt	01207	2	1:4.15	0.276	1.084	0.299	
ANSI / IEEE C95.1 1992 - SAFETY LIMIT Spatial Peak Uncontrolled Exposure/General Population							Head 1.6 W/kg (mW/g) averaged over 1 gram								

**Table 11-2
GSM 1900 Head SAR**

MEASUREMENT RESULTS															
FREQUENCY		Mode/Band	Service	Maximum Allowed Power [dBm]	Conducted Power [dBm]	Power Drift [dB]	Side	Test Position	Device Serial Number	# of Time Slots	Duty Cycle	SAR (1g)	Scaling Factor	Reported SAR (1g)	Plot #
MHz	Ch.											(W/kg)		(W/kg)	
1880.00	661	GSM 1900	GSM	30.7	30.64	0.03	Right	Cheek	01207	1	1:8.3	0.219	1.014	0.222	
1880.00	661	GSM 1900	GSM	30.7	30.64	0.03	Right	Tilt	01207	1	1:8.3	0.158	1.014	0.160	
1880.00	661	GSM 1900	GSM	30.7	30.64	0.02	Left	Cheek	01207	1	1:8.3	0.267	1.014	0.271	
1880.00	661	GSM 1900	GSM	30.7	30.64	0.11	Left	Tilt	01207	1	1:8.3	0.145	1.014	0.147	
1880.00	661	GSM 1900	GPRS	28.7	28.55	-0.16	Right	Cheek	01207	2	1:4.15	0.262	1.035	0.271	
1880.00	661	GSM 1900	GPRS	28.7	28.55	0.19	Right	Tilt	01207	2	1:4.15	0.188	1.035	0.195	
1880.00	661	GSM 1900	GPRS	28.7	28.55	0.02	Left	Cheek	01207	2	1:4.15	0.291	1.035	0.301	A2
1880.00	661	GSM 1900	GPRS	28.7	28.55	-0.12	Left	Tilt	01207	2	1:4.15	0.172	1.035	0.178	
ANSI / IEEE C95.1 1992 - SAFETY LIMIT Spatial Peak Uncontrolled Exposure/General Population							Head 1.6 W/kg (mW/g) averaged over 1 gram								

FCC ID: ZNFX410AS		SAR EVALUATION REPORT		Approved by: Quality Manager
Document S/N: 1M1803140041-01-R1.ZNF	Test Dates: 03/28/18 - 04/11/18	DUT Type: Portable Handset		Page 44 of 69

**Table 11-3
UMTS 850 Head SAR**



MEASUREMENT RESULTS														
FREQUENCY		Mode/Band	Service	Maximum Allowed Power [dBm]	Conducted Power [dBm]	Power Drift [dB]	Side	Test Position	Device Serial Number	Duty Cycle	SAR (1g)	Scaling Factor	Reported SAR (1g)	Plot #
MHz	Ch.										(W/kg)		(W/kg)	
836.60	4183	UMTS 850	RMC	25.2	25.10	0.01	Right	Cheek	01207	1:1	0.482	1.023	0.493	A3
836.60	4183	UMTS 850	RMC	25.2	25.10	0.09	Right	Tilt	01207	1:1	0.277	1.023	0.283	
836.60	4183	UMTS 850	RMC	25.2	25.10	0.04	Left	Cheek	01207	1:1	0.439	1.023	0.449	
836.60	4183	UMTS 850	RMC	25.2	25.10	-0.04	Left	Tilt	01207	1:1	0.263	1.023	0.269	
ANSI / IEEE C95.1 1992 - SAFETY LIMIT Spatial Peak Uncontrolled Exposure/General Population							Head 1.6 W/kg (W/kg) averaged over 1 gram							

**Table 11-4
UMTS 1750 Head SAR**

MEASUREMENT RESULTS														
FREQUENCY		Mode/Band	Service	Maximum Allowed Power [dBm]	Conducted Power [dBm]	Power Drift [dB]	Side	Test Position	Device Serial Number	Duty Cycle	SAR (1g)	Scaling Factor	Reported SAR (1g)	Plot #
MHz	Ch.										(W/kg)		(W/kg)	
1732.40	1412	UMTS 1750	RMC	24.7	24.65	0.02	Right	Cheek	01199	1:1	0.331	1.012	0.335	
1732.40	1412	UMTS 1750	RMC	24.7	24.65	-0.05	Right	Tilt	01199	1:1	0.206	1.012	0.208	
1732.40	1412	UMTS 1750	RMC	24.7	24.65	0.06	Left	Cheek	01199	1:1	0.478	1.012	0.484	A4
1732.40	1412	UMTS 1750	RMC	24.7	24.65	0.02	Left	Tilt	01199	1:1	0.203	1.012	0.205	
ANSI / IEEE C95.1 1992 - SAFETY LIMIT Spatial Peak Uncontrolled Exposure/General Population							Head 1.6 W/kg (mW/g) averaged over 1 gram							

**Table 11-5
UMTS 1900 Head SAR**

MEASUREMENT RESULTS														
FREQUENCY		Mode/Band	Service	Maximum Allowed Power [dBm]	Conducted Power [dBm]	Power Drift [dB]	Side	Test Position	Device Serial Number	Duty Cycle	SAR (1g)	Scaling Factor	Reported SAR (1g)	Plot #
MHz	Ch.										(W/kg)		(W/kg)	
1880.00	9400	UMTS 1900	RMC	24.7	24.55	-0.03	Right	Cheek	01199	1:1	0.503	1.035	0.521	
1880.00	9400	UMTS 1900	RMC	24.7	24.55	-0.03	Right	Tilt	01199	1:1	0.347	1.035	0.359	
1852.40	9262	UMTS 1900	RMC	24.7	24.55	-0.03	Left	Cheek	01199	1:1	0.577	1.035	0.597	
1880.00	9400	UMTS 1900	RMC	24.7	24.55	0.05	Left	Cheek	01199	1:1	0.672	1.035	0.696	
1907.60	9538	UMTS 1900	RMC	24.7	24.65	0.06	Left	Cheek	01199	1:1	0.705	1.012	0.713	A5
1880.00	9400	UMTS 1900	RMC	24.7	24.55	0.03	Left	Tilt	01199	1:1	0.314	1.035	0.325	
ANSI / IEEE C95.1 1992 - SAFETY LIMIT Spatial Peak Uncontrolled Exposure/General Population							Head 1.6 W/kg (mW/g) averaged over 1 gram							

FCC ID: ZNFX410AS		SAR EVALUATION REPORT		Approved by: Quality Manager
Document S/N: 1M1803140041-01-R1.ZNF	Test Dates: 03/28/18 - 04/11/18	DUT Type: Portable Handset	Page 45 of 69	

**Table 11-6
LTE Band 12 Head SAR**



MEASUREMENT RESULTS																			
FREQUENCY		Mode	Bandwidth [MHz]	Maximum Allowed Power [dBm]	Conducted Power [dBm]	Power Drift [dB]	MPR [dB]	Side	Test Position	Modulation	RB Size	RB Offset	Device Serial Number	Duty Cycle	SAR (1g)	Scaling Factor	Reported SAR (1g)	Plot #	
MHz	Ch.														(W/kg)		(W/kg)		
707.50	23095	Mid	LTE Band 12	10	25.2	25.07	-0.14	0	Right	Cheek	QPSK	1	0	01199	1:1	0.375	1.030	0.386	A6
707.50	23095	Mid	LTE Band 12	10	24.2	24.00	-0.11	1	Right	Cheek	QPSK	25	12	01199	1:1	0.307	1.047	0.321	
707.50	23095	Mid	LTE Band 12	10	25.2	25.07	0.20	0	Right	Tilt	QPSK	1	0	01199	1:1	0.152	1.030	0.157	
707.50	23095	Mid	LTE Band 12	10	24.2	24.00	0.16	1	Right	Tilt	QPSK	25	12	01199	1:1	0.141	1.047	0.148	
707.50	23095	Mid	LTE Band 12	10	25.2	25.07	-0.11	0	Left	Cheek	QPSK	1	0	01199	1:1	0.296	1.030	0.305	
707.50	23095	Mid	LTE Band 12	10	24.2	24.00	-0.07	1	Left	Cheek	QPSK	25	12	01199	1:1	0.249	1.047	0.261	
707.50	23095	Mid	LTE Band 12	10	25.2	25.07	0.08	0	Left	Tilt	QPSK	1	0	01199	1:1	0.136	1.030	0.140	
707.50	23095	Mid	LTE Band 12	10	24.2	24.00	-0.04	1	Left	Tilt	QPSK	25	12	01199	1:1	0.121	1.047	0.127	
ANSI / IEEE C95.1 1992 - SAFETY LIMIT Spatial Peak Uncontrolled Exposure/General Population										Head 1.6 W/kg (mW/g) averaged over 1 gram									

**Table 11-7
LTE Band 14 Head SAR**

MEASUREMENT RESULTS																			
FREQUENCY		Mode	Bandwidth [MHz]	Maximum Allowed Power [dBm]	Conducted Power [dBm]	Power Drift [dB]	MPR [dB]	Side	Test Position	Modulation	RB Size	RB Offset	Device Serial Number	Duty Cycle	SAR (1g)	Scaling Factor	Reported SAR (1g)	Plot #	
MHz	Ch.														(W/kg)		(W/kg)		
793.00	23330	Mid	LTE Band 14	10	25.2	25.17	0.05	0	Right	Cheek	QPSK	1	25	01199	1:1	0.462	1.007	0.465	A7
793.00	23330	Mid	LTE Band 14	10	24.2	24.10	0.06	1	Right	Cheek	QPSK	25	12	01199	1:1	0.384	1.023	0.393	
793.00	23330	Mid	LTE Band 14	10	25.2	25.17	-0.03	0	Right	Tilt	QPSK	1	25	01199	1:1	0.273	1.007	0.275	
793.00	23330	Mid	LTE Band 14	10	24.2	24.10	0.14	1	Right	Tilt	QPSK	25	12	01199	1:1	0.228	1.023	0.233	
793.00	23330	Mid	LTE Band 14	10	25.2	25.17	-0.01	0	Left	Cheek	QPSK	1	25	01199	1:1	0.379	1.007	0.382	
793.00	23330	Mid	LTE Band 14	10	24.2	24.10	0.04	1	Left	Cheek	QPSK	25	12	01199	1:1	0.298	1.023	0.305	
793.00	23330	Mid	LTE Band 14	10	25.2	25.17	0.01	0	Left	Tilt	QPSK	1	25	01199	1:1	0.228	1.007	0.230	
793.00	23330	Mid	LTE Band 14	10	24.2	24.10	0.03	1	Left	Tilt	QPSK	25	12	01199	1:1	0.190	1.023	0.194	
ANSI / IEEE C95.1 1992 - SAFETY LIMIT Spatial Peak Uncontrolled Exposure/General Population										Head 1.6 W/kg (mW/g) averaged over 1 gram									

**Table 11-8
LTE Band 5 (Cell) Head SAR**

MEASUREMENT RESULTS																			
FREQUENCY		Mode	Bandwidth [MHz]	Maximum Allowed Power [dBm]	Conducted Power [dBm]	Power Drift [dB]	MPR [dB]	Side	Test Position	Modulation	RB Size	RB Offset	Device Serial Number	Duty Cycle	SAR (1g)	Scaling Factor	Reported SAR (1g)	Plot #	
MHz	Ch.														(W/kg)		(W/kg)		
836.50	20525	Mid	LTE Band 5 (Cell)	10	25.2	25.00	0.15	0	Right	Cheek	QPSK	1	0	01199	1:1	0.374	1.047	0.392	A8
836.50	20525	Mid	LTE Band 5 (Cell)	10	24.2	24.01	-0.04	1	Right	Cheek	QPSK	25	25	01199	1:1	0.321	1.045	0.335	
836.50	20525	Mid	LTE Band 5 (Cell)	10	25.2	25.00	0.15	0	Right	Tilt	QPSK	1	0	01199	1:1	0.193	1.047	0.202	
836.50	20525	Mid	LTE Band 5 (Cell)	10	24.2	24.01	0.01	1	Right	Tilt	QPSK	25	25	01199	1:1	0.169	1.045	0.177	
836.50	20525	Mid	LTE Band 5 (Cell)	10	25.2	25.00	0.21	0	Left	Cheek	QPSK	1	0	01199	1:1	0.301	1.047	0.315	
836.50	20525	Mid	LTE Band 5 (Cell)	10	24.2	24.01	0.11	1	Left	Cheek	QPSK	25	25	01199	1:1	0.278	1.045	0.291	
836.50	20525	Mid	LTE Band 5 (Cell)	10	25.2	25.00	-0.01	0	Left	Tilt	QPSK	1	0	01199	1:1	0.189	1.047	0.198	
836.50	20525	Mid	LTE Band 5 (Cell)	10	24.2	24.01	-0.04	1	Left	Tilt	QPSK	25	25	01199	1:1	0.158	1.045	0.165	
ANSI / IEEE C95.1 1992 - SAFETY LIMIT Spatial Peak Uncontrolled Exposure/General Population										Head 1.6 W/kg (mW/g) averaged over 1 gram									

FCC ID: ZNFX410AS		SAR EVALUATION REPORT		Approved by: Quality Manager
Document S/N: 1M1803140041-01-R1.ZNF	Test Dates: 03/28/18 - 04/11/18	DUT Type: Portable Handset	Page 46 of 69	

**Table 11-9
LTE Band 4 (AWS) Head SAR**

MEASUREMENT RESULTS																			
FREQUENCY		Mode	Bandwidth [MHz]	Maximum Allowed Power [dBm]	Conducted Power [dBm]	Power Drift [dB]	MPR [dB]	Side	Test Position	Modulation	RB Size	RB Offset	Device Serial Number	Duty Cycle	SAR (1g)	Scaling Factor	Reported SAR (1g)	Plot #	
MHz	Ch.														(W/kg)		(W/kg)		
1732.50	20175	Mid	LTE Band 4 (AWS)	20	25.2	25.17	0.17	0	Right	Cheek	QPSK	1	50	01207	1:1	0.358	1.007	0.361	
1732.50	20175	Mid	LTE Band 4 (AWS)	20	24.2	24.15	-0.09	1	Right	Cheek	QPSK	50	25	01207	1:1	0.267	1.012	0.270	
1732.50	20175	Mid	LTE Band 4 (AWS)	20	25.2	25.17	0.16	0	Right	Tilt	QPSK	1	50	01207	1:1	0.306	1.007	0.308	
1732.50	20175	Mid	LTE Band 4 (AWS)	20	24.2	24.15	0.04	1	Right	Tilt	QPSK	50	25	01207	1:1	0.242	1.012	0.245	
1732.50	20175	Mid	LTE Band 4 (AWS)	20	25.2	25.17	0.00	0	Left	Cheek	QPSK	1	50	01207	1:1	0.530	1.007	0.534	A9
1732.50	20175	Mid	LTE Band 4 (AWS)	20	24.2	24.15	-0.08	1	Left	Cheek	QPSK	50	25	01207	1:1	0.420	1.012	0.425	
1732.50	20175	Mid	LTE Band 4 (AWS)	20	25.2	25.17	0.10	0	Left	Tilt	QPSK	1	50	01207	1:1	0.277	1.007	0.279	
1732.50	20175	Mid	LTE Band 4 (AWS)	20	24.2	24.15	0.06	1	Left	Tilt	QPSK	50	25	01207	1:1	0.215	1.012	0.218	
ANSI / IEEE C95.1 1992 - SAFETY LIMIT Spatial Peak Uncontrolled Exposure/General Population										Head 1.6 W/kg (mW/g) averaged over 1 gram									



**Table 11-10
LTE Band 2 (PCS) Head SAR**

MEASUREMENT RESULTS																			
FREQUENCY		Mode	Bandwidth [MHz]	Maximum Allowed Power [dBm]	Conducted Power [dBm]	Power Drift [dB]	MPR [dB]	Side	Test Position	Modulation	RB Size	RB Offset	Device Serial Number	Duty Cycle	SAR (1g)	Scaling Factor	Reported SAR (1g)	Plot #	
MHz	Ch.														(W/kg)		(W/kg)		
1860.00	18700	Low	LTE Band 2 (PCS)	20	25.2	25.20	0.02	0	Right	Cheek	QPSK	1	50	01199	1:1	0.612	1.000	0.612	
1860.00	18700	Low	LTE Band 2 (PCS)	20	24.2	24.11	0.00	1	Right	Cheek	QPSK	50	25	01199	1:1	0.457	1.021	0.467	
1860.00	18700	Low	LTE Band 2 (PCS)	20	25.2	25.20	0.00	0	Right	Tilt	QPSK	1	50	01199	1:1	0.397	1.000	0.397	
1860.00	18700	Low	LTE Band 2 (PCS)	20	24.2	24.11	0.07	1	Right	Tilt	QPSK	50	25	01199	1:1	0.301	1.021	0.307	
1860.00	18700	Low	LTE Band 2 (PCS)	20	25.2	25.20	0.02	0	Left	Cheek	QPSK	1	50	01199	1:1	0.691	1.000	0.691	
1880.00	18900	Mid	LTE Band 2 (PCS)	20	25.2	25.18	0.03	0	Left	Cheek	QPSK	1	50	01199	1:1	0.717	1.005	0.721	A10
1900.00	19100	High	LTE Band 2 (PCS)	20	25.2	25.16	-0.09	0	Left	Cheek	QPSK	1	99	01199	1:1	0.711	1.009	0.717	
1860.00	18700	Low	LTE Band 2 (PCS)	20	24.2	24.11	0.06	1	Left	Cheek	QPSK	50	25	01199	1:1	0.495	1.021	0.505	
1860.00	18700	Low	LTE Band 2 (PCS)	20	25.2	25.20	-0.21	0	Left	Tilt	QPSK	1	50	01199	1:1	0.396	1.000	0.396	
1860.00	18700	Low	LTE Band 2 (PCS)	20	24.2	24.11	0.06	1	Left	Tilt	QPSK	50	25	01199	1:1	0.312	1.021	0.319	
ANSI / IEEE C95.1 1992 - SAFETY LIMIT Spatial Peak Uncontrolled Exposure/General Population										Head 1.6 W/kg (mW/g) averaged over 1 gram									

**Table 11-11
DTS Head SAR**

MEASUREMENT RESULTS																		
FREQUENCY		Mode	Service	Bandwidth [MHz]	Maximum Allowed Power [dBm]	Conducted Power [dBm]	Power Drift [dB]	Side	Test Position	Device Serial Number	Data Rate (Mbps)	Duty Cycle (%)	Peak SAR of Area Scan	SAR (1g)	Scaling Factor (Power)	Scaling Factor (Duty Cycle)	Reported SAR (1g)	Plot #
MHz	Ch.												(W/kg)	(W/kg)			(W/kg)	
2412	1	802.11b	DSSS	22	15.5	14.77	0.15	Right	Cheek	01355	1	99.8	1.049	0.830	1.183	1.002	0.984	
2437	6	802.11b	DSSS	22	15.5	14.86	0.16	Right	Cheek	01355	1	99.8	0.979	0.856	1.159	1.002	0.994	A11
2462	11	802.11b	DSSS	22	15.5	14.92	0.10	Right	Cheek	01355	1	99.8	1.050	0.830	1.143	1.002	0.951	
2462	11	802.11b	DSSS	22	15.5	14.92	0.10	Right	Tilt	01355	1	99.8	0.797	0.656	1.143	1.002	0.751	
2462	11	802.11b	DSSS	22	15.5	14.92	-0.13	Left	Cheek	01355	1	99.8	0.410	0.336	1.143	1.002	0.385	
2462	11	802.11b	DSSS	22	15.5	14.92	-0.03	Left	Tilt	01355	1	99.8	0.413	0.365	1.143	1.002	0.418	
2437	6	802.11b	DSSS	22	15.5	14.86	-0.03	Right	Cheek	01355	1	99.8	1.008	0.822	1.159	1.002	0.955	
ANSI / IEEE C95.1 1992 - SAFETY LIMIT Spatial Peak Uncontrolled Exposure/General Population										Head 1.6 W/kg (mW/g) averaged over 1 gram								

Note: Blue entry represents variability measurement.



FCC ID: ZNFX410AS		SAR EVALUATION REPORT		Approved by: Quality Manager
Document S/N: 1M1803140041-01-R1.ZNF	Test Dates: 03/28/18 - 04/11/18	DUT Type: Portable Handset		Page 47 of 69

**Table 11-12
NII Head SAR**

MEASUREMENT RESULTS																		
FREQUENCY		Mode	Service	Bandwidth [MHz]	Maximum Allowed Power [dBm]	Conducted Power [dBm]	Power Drift [dB]	Side	Test Position	Device Serial Number	Data Rate (Mbps)	Duty Cycle (%)	Peak SAR of Area Scan	SAR (1g)	Scaling Factor (Power)	Scaling Factor (Duty Cycle)	Reported SAR (1g)	Plot #
MHz	Ch.												W/kg	(W/kg)			(W/kg)	
5260	52	802.11a	OFDM	20	10.5	9.83	-0.17	Right	Cheek	01363	6	99.1	1.123	0.538	1.167	1.009	0.633	
5260	52	802.11a	OFDM	20	10.5	9.83	0.15	Right	Tilt	01363	6	99.1	1.074	0.593	1.167	1.009	0.698	
5260	52	802.11a	OFDM	20	10.5	9.83	0.21	Left	Cheek	01363	6	99.1	0.545	-	1.167	1.009	-	
5260	52	802.11a	OFDM	20	10.5	9.83	0.20	Left	Tilt	01363	6	99.1	0.505	-	1.167	1.009	-	
5500	100	802.11a	OFDM	20	10.5	9.62	0.19	Right	Cheek	01363	6	99.1	1.306	0.597	1.225	1.009	0.738	
5500	100	802.11a	OFDM	20	10.5	9.62	0.14	Right	Tilt	01363	6	99.1	1.302	0.654	1.225	1.009	0.808	A12
5600	120	802.11a	OFDM	20	9.5	9.46	0.16	Right	Tilt	01363	6	99.1	1.259	0.558	1.009	1.009	0.568	
5700	140	802.11a	OFDM	20	9.5	9.49	0.19	Right	Tilt	01363	6	99.1	1.181	0.500	1.002	1.009	0.506	
5500	100	802.11a	OFDM	20	10.5	9.62	0.09	Left	Cheek	01363	6	99.1	0.678	0.345	1.225	1.009	0.426	
5500	100	802.11a	OFDM	20	10.5	9.62	0.18	Left	Tilt	01363	6	99.1	0.614	-	1.225	1.009	-	
5755	151	802.11n	OFDM	40	9.5	8.80	0.19	Right	Cheek	01363	13.5	99.6	1.103	0.420	1.175	1.004	0.495	
5755	151	802.11n	OFDM	40	9.5	8.80	0.07	Right	Tilt	01363	13.5	99.6	0.961	0.416	1.175	1.004	0.491	
5755	151	802.11n	OFDM	40	9.5	8.80	0.11	Left	Cheek	01363	13.5	99.6	0.738	-	1.175	1.004	-	
5755	151	802.11n	OFDM	40	9.5	8.80	-0.20	Left	Tilt	01363	13.5	99.6	0.548	-	1.175	1.004	-	
ANSI / IEEE C95.1 1992 - SAFETY LIMIT Spatial Peak Uncontrolled Exposure/General Population									Head 1.6 W/kg (mW/g) averaged over 1 gram									

**Table 11-13
DSS Head SAR**



MEASUREMENT RESULTS																	
FREQUENCY		Mode	Service	Maximum Allowed Power [dBm]	Conducted Power [dBm]	Power Drift [dB]	Side	Test Position	Device Serial Number	Data Rate (Mbps)	Duty Cycle %	SAR (1g)	Scaling Factor (Cond Power)	Scaling Factor (Duty Cycle)	Reported SAR (1g)	Plot #	
MHz	Ch.											(W/kg)			(W/kg)		
2441.00	39	Bluetooth	FHSS	10.5	10.29	0.14	Right	Cheek	01355	1	77.3	0.068	1.050	1.294	0.092	A13	
2441.00	39	Bluetooth	FHSS	10.5	10.29	0.15	Right	Tilt	01355	1	77.3	0.050	1.050	1.294	0.068		
2441.00	39	Bluetooth	FHSS	10.5	10.29	0.11	Left	Cheek	01355	1	77.3	0.024	1.050	1.294	0.033		
2441.00	39	Bluetooth	FHSS	10.5	10.29	0.14	Left	Tilt	01355	1	77.3	0.025	1.050	1.294	0.034		
ANSI / IEEE C95.1 1992 - SAFETY LIMIT Spatial Peak Uncontrolled Exposure/General Population									Head 1.6 W/kg (mW/g) averaged over 1 gram								

FCC ID: ZNFX410AS		SAR EVALUATION REPORT		Approved by: Quality Manager
Document S/N: 1M1803140041-01-R1.ZNF	Test Dates: 03/28/18 - 04/11/18	DUT Type: Portable Handset	Page 48 of 69	

11.2 Standalone Body-Worn SAR Data

**Table 11-14
GSM/UMTS Body-Worn SAR Data**

MEASUREMENT RESULTS															
FREQUENCY		Mode	Service	Maximum Allowed Power [dBm]	Conducted Power [dBm]	Power Drift [dB]	Spacing	Device Serial Number	# of Time Slots	Duty Cycle	Side	SAR (1g)	Scaling Factor	Reported SAR (1g)	Plot #
MHz	Ch.											(W/kg)		(W/kg)	
836.60	190	GSM 850	GSM	33.7	33.30	0.00	10 mm	01215	1	1:8.3	back	0.593	1.096	0.650	
824.20	128	GSM 850	GPRS	31.7	31.45	-0.01	10 mm	01215	2	1:4.15	back	0.618	1.059	0.654	
836.60	190	GSM 850	GPRS	31.7	31.35	-0.06	10 mm	01215	2	1:4.15	back	0.696	1.084	0.754	A14
848.80	251	GSM 850	GPRS	31.7	31.35	-0.01	10 mm	01215	2	1:4.15	back	0.643	1.084	0.697	
1880.00	661	GSM 1900	GSM	30.7	30.64	0.06	10 mm	01207	1	1:8.3	back	0.386	1.014	0.391	
1880.00	661	GSM 1900	GPRS	28.7	28.55	0.14	10 mm	01207	2	1:4.15	back	0.441	1.035	0.456	A15
826.40	4132	UMTS 850	RMC	25.2	25.00	0.00	10 mm	01215	N/A	1:1	back	0.598	1.047	0.626	
836.60	4183	UMTS 850	RMC	25.2	25.10	-0.03	10 mm	01215	N/A	1:1	back	0.665	1.023	0.680	
846.60	4233	UMTS 850	RMC	25.2	25.15	0.03	10 mm	01215	N/A	1:1	back	0.715	1.012	0.724	A16
1712.40	1312	UMTS 1750	RMC	24.7	24.55	0.04	10 mm	01207	N/A	1:1	back	0.764	1.035	0.791	A17
1732.40	1412	UMTS 1750	RMC	24.7	24.65	0.02	10 mm	01207	N/A	1:1	back	0.710	1.012	0.719	
1752.60	1513	UMTS 1750	RMC	24.7	24.60	0.08	10 mm	01207	N/A	1:1	back	0.714	1.023	0.730	
1852.40	9262	UMTS 1900	RMC	24.7	24.55	0.00	10 mm	01207	N/A	1:1	back	0.899	1.035	0.930	
1880.00	9400	UMTS 1900	RMC	24.7	24.55	0.00	10 mm	01207	N/A	1:1	back	0.968	1.035	1.002	
1907.60	9538	UMTS 1900	RMC	24.7	24.65	0.05	10 mm	01207	N/A	1:1	back	0.978	1.012	0.990	A18
ANSI / IEEE C95.1 1992 - SAFETY LIMIT Spatial Peak Uncontrolled Exposure/General Population							Body 1.6 W/kg (mW/g) averaged over 1 gram								

FCC ID: ZNFX410AS		SAR EVALUATION REPORT		Approved by: Quality Manager
Document S/N: 1M1803140041-01-R1.ZNF	Test Dates: 03/28/18 - 04/11/18	DUT Type: Portable Handset	Page 49 of 69	

**Table 11-15
LTE Body-Worn SAR**

MEASUREMENT RESULTS																			
FREQUENCY		Mode	Bandwidth [MHz]	Maximum Allowed Power [dBm]	Conducted Power [dBm]	Power Drift [dB]	MPR [dB]	Device Serial Number	Modulation	RB Size	RB Offset	Spacing	Side	Duty Cycle	SAR (1g) (W/kg)	Scaling Factor	Reported SAR (1g) (W/kg)	Plot #	
MHz	Ch.																		
707.50	23095	Mid	LTE Band 12	10	25.2	25.07	0.08	0	01207	QPSK	1	0	10 mm	back	1:1	0.509	1.030	0.524	A19
707.50	23095	Mid	LTE Band 12	10	24.2	24.00	-0.01	1	01207	QPSK	25	12	10 mm	back	1:1	0.407	1.047	0.426	
793.00	23330	Mid	LTE Band 14	10	25.2	25.17	0.20	0	01199	QPSK	1	25	10 mm	back	1:1	0.831	1.007	0.837	A20
793.00	23330	Mid	LTE Band 14	10	24.2	24.10	-0.02	1	01199	QPSK	25	12	10 mm	back	1:1	0.633	1.023	0.648	
793.00	23330	Mid	LTE Band 14	10	24.2	24.05	-0.05	1	01199	QPSK	50	0	10 mm	back	1:1	0.629	1.035	0.651	
793.00	23330	Mid	LTE Band 14	10	25.2	25.17	-0.05	0	01199	QPSK	1	25	10 mm	back	1:1	0.766	1.007	0.771	
836.50	20525	Mid	LTE Band 5 (Cell)	10	25.2	25.00	0.10	0	01215	QPSK	1	0	10 mm	back	1:1	0.512	1.047	0.536	A21
836.50	20525	Mid	LTE Band 5 (Cell)	10	24.2	24.01	0.00	1	01215	QPSK	25	25	10 mm	back	1:1	0.428	1.045	0.447	
1732.50	20175	Mid	LTE Band 4 (AWS)	20	25.2	25.17	-0.05	0	01215	QPSK	1	50	10 mm	back	1:1	0.805	1.007	0.811	
1732.50	20175	Mid	LTE Band 4 (AWS)	20	24.2	24.15	0.00	1	01215	QPSK	50	25	10 mm	back	1:1	0.578	1.012	0.585	
1732.50	20175	Mid	LTE Band 4 (AWS)	20	24.2	24.06	-0.08	1	01215	QPSK	100	0	10 mm	back	1:1	0.585	1.033	0.604	
1732.50	20175	Mid	LTE Band 4 (AWS)	20	25.2	25.17	-0.08	0	01215	QPSK	1	50	10 mm	back	1:1	0.878	1.007	0.884	A22
1860.00	18700	Low	LTE Band 2 (PCS)	20	25.2	25.20	-0.11	0	01207	QPSK	1	50	10 mm	back	1:1	1.030	1.000	1.030	A23
1880.00	18900	Mid	LTE Band 2 (PCS)	20	25.2	25.18	-0.10	0	01207	QPSK	1	50	10 mm	back	1:1	0.988	1.005	0.993	
1900.00	19100	High	LTE Band 2 (PCS)	20	25.2	25.16	0.06	0	01207	QPSK	1	99	10 mm	back	1:1	0.969	1.009	0.978	
1860.00	18700	Low	LTE Band 2 (PCS)	20	24.2	24.11	-0.02	1	01207	QPSK	50	25	10 mm	back	1:1	0.734	1.021	0.749	
1900.00	19100	High	LTE Band 2 (PCS)	20	24.2	24.05	0.00	1	01207	QPSK	100	0	10 mm	back	1:1	0.752	1.035	0.778	
ANSI / IEEE C95.1 1992 - SAFETY LIMIT Spatial Peak Uncontrolled Exposure/General Population									Body 1.6 W/kg (mW/g) averaged over 1 gram										



Note: Blue entry represents variability measurement.

**Table 11-16
DTS Body-Worn SAR**

MEASUREMENT RESULTS																		
FREQUENCY		Mode	Service	Bandwidth [MHz]	Maximum Allowed Power [dBm]	Conducted Power [dBm]	Power Drift [dB]	Spacing	Device Serial Number	Data Rate (Mbps)	Side	Duty Cycle (%)	Peak SAR of Area Scan (W/kg)	SAR (1g) (W/kg)	Scaling Factor (Power)	Scaling Factor (Duty Cycle)	Reported SAR (1g) (W/kg)	Plot #
MHz	Ch.																	
2462	11	802.11b	DSSS	22	15.5	14.92	-0.02	10 mm	01355	1	back	99.8	0.183	0.153	1.143	1.002	0.175	A25
ANSI / IEEE C95.1 1992 - SAFETY LIMIT Spatial Peak Uncontrolled Exposure/General Population									Body 1.6 W/kg (mW/g) averaged over 1 gram									

**Table 11-17
NII Body-Worn SAR**



MEASUREMENT RESULTS																		
FREQUENCY		Mode	Service	Bandwidth [MHz]	Maximum Allowed Power [dBm]	Conducted Power [dBm]	Power Drift [dB]	Spacing	Device Serial Number	Data Rate (Mbps)	Side	Duty Cycle (%)	Peak SAR of Area Scan (W/kg)	SAR (1g) (W/kg)	Scaling Factor (Power)	Scaling Factor (Duty Cycle)	Reported SAR (1g) (W/kg)	Plot #
MHz	Ch.																	
5260	52	802.11a	OFDM	20	10.5	9.83	0.14	10 mm	01363	6	back	99.1	0.210	0.102	1.167	1.009	0.120	A27
5500	100	802.11a	OFDM	20	10.5	9.62	-0.03	10 mm	01363	6	back	99.1	0.126	0.071	1.225	1.009	0.088	
5755	151	802.11n	OFDM	40	9.5	8.80	0.10	10 mm	01363	13.5	back	99.6	0.147	0.068	1.175	1.004	0.080	
ANSI / IEEE C95.1 1992 - SAFETY LIMIT Spatial Peak Uncontrolled Exposure/General Population									Body 1.6 W/kg (mW/g) averaged over 1 gram									

FCC ID: ZNFX410AS		SAR EVALUATION REPORT		Approved by: Quality Manager
Document S/N: 1M1803140041-01-R1.ZNF	Test Dates: 03/28/18 - 04/11/18	DUT Type: Portable Handset	Page 50 of 69	

11.3 Standalone Hotspot SAR Data

**Table 11-18
GPRS/UMTS Hotspot SAR Data**

MEASUREMENT RESULTS															
FREQUENCY		Mode	Service	Maximum Allowed Power [dBm]	Conducted Power [dBm]	Power Drift [dB]	Spacing	Device Serial Number	# of GPRS Slots	Duty Cycle	Side	SAR (1g)	Scaling Factor	Reported SAR (1g)	Plot #
MHz	Ch.											(W/kg)		(W/kg)	
824.20	128	GSM 850	GPRS	31.7	31.45	-0.01	10 mm	01215	2	1:4.15	back	0.618	1.059	0.654	
836.60	190	GSM 850	GPRS	31.7	31.35	-0.06	10 mm	01215	2	1:4.15	back	0.696	1.084	0.754	A14
848.80	251	GSM 850	GPRS	31.7	31.35	-0.01	10 mm	01215	2	1:4.15	back	0.643	1.084	0.697	
836.60	190	GSM 850	GPRS	31.7	31.35	0.02	10 mm	01215	2	1:4.15	front	0.537	1.084	0.582	
836.60	190	GSM 850	GPRS	31.7	31.35	-0.01	10 mm	01215	2	1:4.15	bottom	0.308	1.084	0.334	
836.60	190	GSM 850	GPRS	31.7	31.35	0.05	10 mm	01215	2	1:4.15	right	0.525	1.084	0.569	
836.60	190	GSM 850	GPRS	31.7	31.35	0.14	10 mm	01215	2	1:4.15	left	0.346	1.084	0.375	
1880.00	661	GSM 1900	GPRS	28.7	28.55	0.14	10 mm	01207	2	1:4.15	back	0.441	1.035	0.456	A15
1880.00	661	GSM 1900	GPRS	28.7	28.55	0.11	10 mm	01207	2	1:4.15	front	0.418	1.035	0.433	
1880.00	661	GSM 1900	GPRS	28.7	28.55	-0.17	10 mm	01207	2	1:4.15	bottom	0.168	1.035	0.174	
1880.00	661	GSM 1900	GPRS	28.7	28.55	0.01	10 mm	01207	2	1:4.15	left	0.274	1.035	0.284	
826.40	4132	UMTS 850	RMC	25.2	25.00	0.00	10 mm	01215	N/A	1:1	back	0.598	1.047	0.626	
836.60	4183	UMTS 850	RMC	25.2	25.10	-0.03	10 mm	01215	N/A	1:1	back	0.665	1.023	0.680	
846.60	4233	UMTS 850	RMC	25.2	25.15	0.03	10 mm	01215	N/A	1:1	back	0.715	1.012	0.724	A16
836.60	4183	UMTS 850	RMC	25.2	25.10	0.02	10 mm	01215	N/A	1:1	front	0.523	1.023	0.535	
836.60	4183	UMTS 850	RMC	25.2	25.10	0.02	10 mm	01215	N/A	1:1	bottom	0.260	1.023	0.266	
836.60	4183	UMTS 850	RMC	25.2	25.10	0.01	10 mm	01215	N/A	1:1	right	0.505	1.023	0.517	
836.60	4183	UMTS 850	RMC	25.2	25.10	0.01	10 mm	01215	N/A	1:1	left	0.361	1.023	0.369	
1712.40	1312	UMTS 1750	RMC	24.7	24.55	0.04	10 mm	01207	N/A	1:1	back	0.764	1.035	0.791	A17
1732.40	1412	UMTS 1750	RMC	24.7	24.65	0.02	10 mm	01207	N/A	1:1	back	0.710	1.012	0.719	
1752.60	1513	UMTS 1750	RMC	24.7	24.60	0.08	10 mm	01207	N/A	1:1	back	0.714	1.023	0.730	
1732.40	1412	UMTS 1750	RMC	24.7	24.65	0.17	10 mm	01207	N/A	1:1	front	0.700	1.012	0.708	
1732.40	1412	UMTS 1750	RMC	24.7	24.65	0.04	10 mm	01207	N/A	1:1	bottom	0.241	1.012	0.244	
1732.40	1412	UMTS 1750	RMC	24.7	24.65	0.06	10 mm	01207	N/A	1:1	left	0.421	1.012	0.426	
1852.40	9262	UMTS 1900	RMC	24.7	24.55	0.00	10 mm	01207	N/A	1:1	back	0.899	1.035	0.930	
1880.00	9400	UMTS 1900	RMC	24.7	24.55	0.00	10 mm	01207	N/A	1:1	back	0.968	1.035	1.002	
1907.60	9538	UMTS 1900	RMC	24.7	24.65	0.05	10 mm	01207	N/A	1:1	back	0.978	1.012	0.990	A18
1852.40	9262	UMTS 1900	RMC	24.7	24.55	-0.03	10 mm	01207	N/A	1:1	front	0.811	1.035	0.839	
1880.00	9400	UMTS 1900	RMC	24.7	24.55	-0.04	10 mm	01207	N/A	1:1	front	0.886	1.035	0.917	
1907.60	9538	UMTS 1900	RMC	24.7	24.65	0.00	10 mm	01207	N/A	1:1	front	0.925	1.012	0.936	
1880.00	9400	UMTS 1900	RMC	24.7	24.55	-0.05	10 mm	01207	N/A	1:1	bottom	0.332	1.035	0.344	
1880.00	9400	UMTS 1900	RMC	24.7	24.55	0.12	10 mm	01207	N/A	1:1	left	0.606	1.035	0.627	
ANSI / IEEE C95.1 1992 - SAFETY LIMIT Spatial Peak							Body 1.6 W/kg (mW/g) averaged over 1 gram								
Uncontrolled Exposure/General Population															

FCC ID: ZNFX410AS		SAR EVALUATION REPORT		Approved by: Quality Manager
Document S/N: 1M1803140041-01-R1.ZNF	Test Dates: 03/28/18 - 04/11/18	DUT Type: Portable Handset	Page 51 of 69	



**Table 11-19
LTE Band 12 Hotspot SAR**

MEASUREMENT RESULTS																			
FREQUENCY		Mode	Bandwidth [MHz]	Maximum Allowed Power [dBm]	Conducted Power [dBm]	Power Drift [dB]	MPR [dB]	Device Serial Number	Modulation	RB Size	RB Offset	Spacing	Side	Duty Cycle	SAR (1g)	Scaling Factor	Reported SAR (1g)	Plot #	
MHz	Ch.														(W/kg)		(W/kg)		
707.50	23095	Mid	LTE Band 12	10	25.2	25.07	0.08	0	01207	QPSK	1	0	10 mm	back	1:1	0.509	1.030	0.524	A19
707.50	23095	Mid	LTE Band 12	10	24.2	24.00	-0.01	1	01207	QPSK	25	12	10 mm	back	1:1	0.407	1.047	0.426	
707.50	23095	Mid	LTE Band 12	10	25.2	25.07	0.03	0	01207	QPSK	1	0	10 mm	front	1:1	0.397	1.030	0.409	
707.50	23095	Mid	LTE Band 12	10	24.2	24.00	-0.04	1	01207	QPSK	25	12	10 mm	front	1:1	0.326	1.047	0.341	
707.50	23095	Mid	LTE Band 12	10	25.2	25.07	-0.02	0	01207	QPSK	1	0	10 mm	bottom	1:1	0.202	1.030	0.208	
707.50	23095	Mid	LTE Band 12	10	24.2	24.00	0.04	1	01207	QPSK	25	12	10 mm	bottom	1:1	0.152	1.047	0.159	
707.50	23095	Mid	LTE Band 12	10	25.2	25.07	-0.02	0	01207	QPSK	1	0	10 mm	right	1:1	0.508	1.030	0.523	
707.50	23095	Mid	LTE Band 12	10	24.2	24.00	0.02	1	01207	QPSK	25	12	10 mm	right	1:1	0.429	1.047	0.449	
707.50	23095	Mid	LTE Band 12	10	25.2	25.07	0.05	0	01207	QPSK	1	0	10 mm	left	1:1	0.285	1.030	0.294	
707.50	23095	Mid	LTE Band 12	10	24.2	24.00	-0.11	1	01207	QPSK	25	12	10 mm	left	1:1	0.245	1.047	0.257	
ANSI / IEEE C95.1 1992 - SAFETY LIMIT Spatial Peak Uncontrolled Exposure/General Population								Body 1.6 W/kg (mW/g) averaged over 1 gram											

**Table 11-20
LTE Band 14 Hotspot SAR**

MEASUREMENT RESULTS																			
FREQUENCY		Mode	Bandwidth [MHz]	Maximum Allowed Power [dBm]	Conducted Power [dBm]	Power Drift [dB]	MPR [dB]	Device Serial Number	Modulation	RB Size	RB Offset	Spacing	Side	Duty Cycle	SAR (1g)	Scaling Factor	Reported SAR (1g)	Plot #	
MHz	Ch.														(W/kg)		(W/kg)		
793.00	23330	Mid	LTE Band 14	10	25.2	25.17	0.20	0	01199	QPSK	1	25	10 mm	back	1:1	0.831	1.007	0.837	A20
793.00	23330	Mid	LTE Band 14	10	24.2	24.10	-0.02	1	01199	QPSK	25	12	10 mm	back	1:1	0.633	1.023	0.648	
793.00	23330	Mid	LTE Band 14	10	24.2	24.05	-0.05	1	01199	QPSK	50	0	10 mm	back	1:1	0.629	1.035	0.651	
793.00	23330	Mid	LTE Band 14	10	25.2	25.17	0.03	0	01199	QPSK	1	25	10 mm	front	1:1	0.582	1.007	0.586	
793.00	23330	Mid	LTE Band 14	10	24.2	24.10	0.03	1	01199	QPSK	25	12	10 mm	front	1:1	0.432	1.023	0.442	
793.00	23330	Mid	LTE Band 14	10	25.2	25.17	-0.01	0	01199	QPSK	1	25	10 mm	bottom	1:1	0.281	1.007	0.283	
793.00	23330	Mid	LTE Band 14	10	24.2	24.10	0.02	1	01199	QPSK	25	12	10 mm	bottom	1:1	0.227	1.023	0.232	
793.00	23330	Mid	LTE Band 14	10	25.2	25.17	0.00	0	01199	QPSK	1	25	10 mm	right	1:1	0.749	1.007	0.754	
793.00	23330	Mid	LTE Band 14	10	24.2	24.10	-0.09	1	01199	QPSK	25	12	10 mm	right	1:1	0.610	1.023	0.624	
793.00	23330	Mid	LTE Band 14	10	25.2	25.17	-0.01	0	01199	QPSK	1	25	10 mm	left	1:1	0.460	1.007	0.463	
793.00	23330	Mid	LTE Band 14	10	24.2	24.10	0.02	1	01199	QPSK	25	12	10 mm	left	1:1	0.368	1.023	0.376	
793.00	23330	Mid	LTE Band 14	10	25.2	25.17	-0.05	0	01199	QPSK	1	25	10 mm	back	1:1	0.766	1.007	0.771	
ANSI / IEEE C95.1 1992 - SAFETY LIMIT Spatial Peak Uncontrolled Exposure/General Population								Body 1.6 W/kg (mW/g) averaged over 1 gram											

Note: Blue entry represents variability measurement.

FCC ID: ZNFX410AS		SAR EVALUATION REPORT		Approved by: Quality Manager
Document S/N: 1M1803140041-01-R1.ZNF	Test Dates: 03/28/18 - 04/11/18	DUT Type: Portable Handset		Page 52 of 69



**Table 11-21
LTE Band 5 (Cell) Hotspot SAR**

MEASUREMENT RESULTS																			
FREQUENCY		Mode	Bandwidth [MHz]	Maximum Allowed Power [dBm]	Conducted Power [dBm]	Power Drift [dB]	MPR [dB]	Device Serial Number	Modulation	RB Size	RB Offset	Spacing	Side	Duty Cycle	SAR (1g)	Scaling Factor	Reported SAR (1g)	Plot #	
MHz	Ch.														(W/kg)		(W/kg)		
836.50	20525	Mid	LTE Band 5 (Cell)	10	25.2	25.00	0.10	0	01215	QPSK	1	0	10 mm	back	1:1	0.512	1.047	0.536	A21
836.50	20525	Mid	LTE Band 5 (Cell)	10	24.2	24.01	0.00	1	01215	QPSK	25	25	10 mm	back	1:1	0.428	1.045	0.447	
836.50	20525	Mid	LTE Band 5 (Cell)	10	25.2	25.00	-0.16	0	01215	QPSK	1	0	10 mm	front	1:1	0.423	1.047	0.443	
836.50	20525	Mid	LTE Band 5 (Cell)	10	24.2	24.01	-0.03	1	01215	QPSK	25	25	10 mm	front	1:1	0.370	1.045	0.387	
836.50	20525	Mid	LTE Band 5 (Cell)	10	25.2	25.00	0.00	0	01215	QPSK	1	0	10 mm	bottom	1:1	0.246	1.047	0.258	
836.50	20525	Mid	LTE Band 5 (Cell)	10	24.2	24.01	-0.08	1	01215	QPSK	25	25	10 mm	bottom	1:1	0.228	1.045	0.238	
836.50	20525	Mid	LTE Band 5 (Cell)	10	25.2	25.00	0.01	0	01215	QPSK	1	0	10 mm	right	1:1	0.375	1.047	0.393	
836.50	20525	Mid	LTE Band 5 (Cell)	10	24.2	24.01	-0.03	1	01215	QPSK	25	25	10 mm	right	1:1	0.366	1.045	0.382	
836.50	20525	Mid	LTE Band 5 (Cell)	10	25.2	25.00	-0.16	0	01215	QPSK	1	0	10 mm	left	1:1	0.259	1.047	0.271	
836.50	20525	Mid	LTE Band 5 (Cell)	10	24.2	24.01	0.01	1	01215	QPSK	25	25	10 mm	left	1:1	0.250	1.045	0.261	
ANSI / IEEE C95.1 1992 - SAFETY LIMIT Spatial Peak Uncontrolled Exposure/General Population								Body 1.6 W/kg (mW/g) averaged over 1 gram											

**Table 11-22
LTE Band 4 (AWS) Hotspot SAR**

MEASUREMENT RESULTS																			
FREQUENCY		Mode	Bandwidth [MHz]	Maximum Allowed Power [dBm]	Conducted Power [dBm]	Power Drift [dB]	MPR [dB]	Device Serial Number	Modulation	RB Size	RB Offset	Spacing	Side	Duty Cycle	SAR (1g)	Scaling Factor	Reported SAR (1g)	Plot #	
MHz	Ch.														(W/kg)		(W/kg)		
1732.50	20175	Mid	LTE Band 4 (AWS)	20	25.2	25.17	-0.05	0	01215	QPSK	1	50	10 mm	back	1:1	0.805	1.007	0.811	
1732.50	20175	Mid	LTE Band 4 (AWS)	20	24.2	24.15	0.00	1	01215	QPSK	50	25	10 mm	back	1:1	0.578	1.012	0.585	
1732.50	20175	Mid	LTE Band 4 (AWS)	20	24.2	24.06	-0.08	1	01215	QPSK	100	0	10 mm	back	1:1	0.585	1.033	0.604	
1732.50	20175	Mid	LTE Band 4 (AWS)	20	25.2	25.17	-0.02	0	01215	QPSK	1	50	10 mm	front	1:1	0.740	1.007	0.745	
1732.50	20175	Mid	LTE Band 4 (AWS)	20	24.2	24.15	0.04	1	01215	QPSK	50	25	10 mm	front	1:1	0.645	1.012	0.653	
1732.50	20175	Mid	LTE Band 4 (AWS)	20	25.2	25.17	0.00	0	01215	QPSK	1	50	10 mm	bottom	1:1	0.279	1.007	0.281	
1732.50	20175	Mid	LTE Band 4 (AWS)	20	24.2	24.15	0.04	1	01215	QPSK	50	25	10 mm	bottom	1:1	0.220	1.012	0.223	
1732.50	20175	Mid	LTE Band 4 (AWS)	20	25.2	25.17	-0.01	0	01215	QPSK	1	50	10 mm	left	1:1	0.455	1.007	0.458	
1732.50	20175	Mid	LTE Band 4 (AWS)	20	24.2	24.15	0.03	1	01215	QPSK	50	25	10 mm	left	1:1	0.365	1.012	0.369	
1732.50	20175	Mid	LTE Band 4 (AWS)	20	25.2	25.17	-0.08	0	01215	QPSK	1	50	10 mm	back	1:1	0.878	1.007	0.884	A22
ANSI / IEEE C95.1 1992 - SAFETY LIMIT Spatial Peak Uncontrolled Exposure/General Population								Body 1.6 W/kg (mW/g) averaged over 1 gram											

Note: Blue entry represents variability measurement.

FCC ID: ZNFX410AS		SAR EVALUATION REPORT		Approved by: Quality Manager
Document S/N: 1M1803140041-01-R1-ZNF	Test Dates: 03/28/18 - 04/11/18	DUT Type: Portable Handset	Page 53 of 69	



**Table 11-23
LTE Band 2 (PCS) Hotspot SAR**

MEASUREMENT RESULTS																			
FREQUENCY		Mode	Bandwidth [MHz]	Maximum Allowed Power [dBm]	Conducted Power [dBm]	Power Drift [dB]	MPR [dB]	Device Serial Number	Modulation	RB Size	RB Offset	Spacing	Side	Duty Cycle	SAR (1g) (W/kg)	Scaling Factor	Reported SAR (1g) (W/kg)	Plot #	
MHz	Ch.																		
1860.00	18700	Low	LTE Band 2 (PCS)	20	25.2	25.20	-0.11	0	01207	QPSK	1	50	10 mm	back	1:1	1.030	1.000	1.030	
1880.00	18900	Mid	LTE Band 2 (PCS)	20	25.2	25.18	-0.10	0	01207	QPSK	1	50	10 mm	back	1:1	0.988	1.005	0.993	
1900.00	19100	High	LTE Band 2 (PCS)	20	25.2	25.16	0.06	0	01207	QPSK	1	99	10 mm	back	1:1	0.969	1.009	0.978	
1860.00	18700	Low	LTE Band 2 (PCS)	20	24.2	24.11	-0.02	1	01207	QPSK	50	25	10 mm	back	1:1	0.734	1.021	0.749	
1900.00	19100	High	LTE Band 2 (PCS)	20	24.2	24.05	0.00	1	01207	QPSK	100	0	10 mm	back	1:1	0.752	1.035	0.778	
1860.00	18700	Low	LTE Band 2 (PCS)	20	25.2	25.20	0.18	0	01207	QPSK	1	50	10 mm	front	1:1	0.924	1.000	0.924	
1880.00	18900	Mid	LTE Band 2 (PCS)	20	25.2	25.18	-0.15	0	01207	QPSK	1	50	10 mm	front	1:1	1.030	1.005	1.035	A24
1900.00	19100	High	LTE Band 2 (PCS)	20	25.2	25.16	-0.15	0	01207	QPSK	1	99	10 mm	front	1:1	0.873	1.009	0.881	
1860.00	18700	Low	LTE Band 2 (PCS)	20	24.2	24.11	-0.07	1	01207	QPSK	50	25	10 mm	front	1:1	0.776	1.021	0.792	
1900.00	19100	High	LTE Band 2 (PCS)	20	24.2	24.05	-0.19	1	01207	QPSK	100	0	10 mm	front	1:1	0.660	1.035	0.683	
1860.00	18700	Low	LTE Band 2 (PCS)	20	25.2	25.20	0.05	0	01207	QPSK	1	50	10 mm	bottom	1:1	0.284	1.000	0.284	
1860.00	18700	Low	LTE Band 2 (PCS)	20	24.2	24.11	-0.11	1	01207	QPSK	50	25	10 mm	bottom	1:1	0.255	1.021	0.260	
1860.00	18700	Low	LTE Band 2 (PCS)	20	25.2	25.20	0.17	0	01207	QPSK	1	50	10 mm	left	1:1	0.775	1.000	0.775	
1860.00	18700	Low	LTE Band 2 (PCS)	20	24.2	24.11	0.03	1	01207	QPSK	50	25	10 mm	left	1:1	0.589	1.021	0.581	
1880.00	18900	Mid	LTE Band 2 (PCS)	20	25.2	25.18	0.01	0	01207	QPSK	1	50	10 mm	front	1:1	1.000	1.005	1.005	
ANSI / IEEE C95.1 1992 - SAFETY LIMIT Spatial Peak Uncontrolled Exposure/General Population								Body 1.6 W/kg (mW/g) averaged over 1 gram											

Note: Blue entry represents variability measurement.

**Table 11-24
WLAN Hotspot SAR**

MEASUREMENT RESULTS																		
FREQUENCY		Mode	Service	Bandwidth [MHz]	Maximum Allowed Power [dBm]	Conducted Power [dBm]	Power Drift [dB]	Spacing	Device Serial Number	Data Rate (Mbps)	Side	Duty Cycle (%)	Peak SAR of Area Scan W/kg	SAR (1g) (W/kg)	Scaling Factor (Power)	Scaling Factor (Duty Cycle)	Reported SAR (1g) (W/kg)	Plot #
MHz	Ch.																	
2462	11	802.11b	DSSS	22	15.5	14.92	-0.02	10 mm	01355	1	back	99.8	0.183	0.153	1.143	1.002	0.175	
2462	11	802.11b	DSSS	22	15.5	14.92	0.08	10 mm	01355	1	front	99.8	0.191	0.156	1.143	1.002	0.179	A26
2462	11	802.11b	DSSS	22	15.5	14.92	0.12	10 mm	01355	1	top	99.8	0.121	-	1.143	1.002	-	
2462	11	802.11b	DSSS	22	15.5	14.92	0.21	10 mm	01355	1	left	99.8	0.128	-	1.143	1.002	-	
5180	36	802.11a	OFDM	20	10.5	10.06	-0.07	10 mm	01363	6	back	99.1	0.275	-	1.107	1.009	-	
5180	36	802.11a	OFDM	20	10.5	10.06	0.11	10 mm	01363	6	front	99.1	0.196	-	1.107	1.009	-	
5180	36	802.11a	OFDM	20	10.5	10.06	-0.12	10 mm	01363	6	top	99.1	0.326	0.141	1.107	1.009	0.157	A28
5180	36	802.11a	OFDM	20	10.5	10.06	0.16	10 mm	01363	6	left	99.1	0.105	-	1.107	1.009	-	
5755	151	802.11n	OFDM	40	9.5	8.80	0.10	10 mm	01363	13.5	back	99.6	0.147	0.068	1.175	1.004	0.080	
5755	151	802.11n	OFDM	40	9.5	8.80	0.00	10 mm	01363	13.5	front	99.6	0.246	0.076	1.175	1.004	0.090	
5755	151	802.11n	OFDM	40	9.5	8.80	-0.15	10 mm	01363	13.5	top	99.6	0.211	-	1.175	1.004	-	
5755	151	802.11n	OFDM	40	9.5	8.80	0.00	10 mm	01363	13.5	left	99.6	0.067	-	1.175	1.004	-	
ANSI / IEEE C95.1 1992 - SAFETY LIMIT Spatial Peak Uncontrolled Exposure/General Population								Body 1.6 W/kg (mW/g) averaged over 1 gram										

FCC ID: ZNFX410AS		SAR EVALUATION REPORT		Approved by: Quality Manager
Document S/N: 1M1803140041-01-R1-ZNF	Test Dates: 03/28/18 - 04/11/18	DUT Type: Portable Handset		Page 54 of 69

11.4 SAR Test Notes

General Notes:



1. The test data reported are the worst-case SAR values according to test procedures specified in IEEE 1528-2013, and FCC KDB Publication 447498 D01v06.
2. Batteries are fully charged at the beginning of the SAR measurements.
3. Liquid tissue depth was at least 15.0 cm for all frequencies.
4. The manufacturer has confirmed that the device(s) tested have the same physical, mechanical and thermal characteristics and are within operational tolerances expected for production units.
5. SAR results were scaled to the maximum allowed power to demonstrate compliance per FCC KDB Publication 447498 D01v06.
6. Device was tested using a fixed spacing for body-worn accessory testing. A separation distance of 10 mm was considered because the manufacturer has determined that there will be body-worn accessories available in the marketplace for users to support this separation distance.
7. Per FCC KDB Publication 648474 D04v01r03, body-worn SAR was evaluated without a headset connected to the device. Since the standalone reported body-worn SAR was ≤ 1.2 W/kg, no additional body-worn SAR evaluations using a headset cable were required.
8. Per FCC KDB 865664 D01v01r04, variability SAR tests were performed when the measured SAR results for a frequency band were greater than or equal to 0.8 W/kg. Repeated SAR measurements are highlighted in the tables above for clarity. Please see Section 13 for variability analysis.
9. During SAR Testing for the Wireless Router conditions per FCC KDB Publication 941225 D06v02r01, the actual Portable Hotspot operation (with actual simultaneous transmission of a transmitter with WIFI) was not activated (See Section 6.7 for more details).

GSM Test Notes:

1. Body-Worn accessory testing is typically associated with voice operations. Therefore, GSM voice was evaluated for body-worn SAR.
2. Justification for reduced test configurations per KDB Publication 941225 D01v03r01 and October 2013 TCB Workshop Notes: The source-based frame-averaged output power was evaluated for all GPRS/EDGE slot configurations. The configuration with the highest target frame averaged output power was evaluated for hotspot SAR. When the maximum frame-averaged powers are equivalent across two or more slots (within 0.25 dB), the configuration with the most number of time slots was tested.
3. Per FCC KDB Publication 447498 D01v06, if the reported (scaled) SAR measured at the middle channel or highest output power channel for each test configuration is ≤ 0.8 W/kg for 1g evaluations then testing at the other channels is not required for such test configuration(s). When the maximum output power variation across the required test channels is $> \frac{1}{2}$ dB, instead of the middle channel, the highest output power channel was used.
4. GPRS was additionally evaluated for head and body-worn exposure conditions to address possible VoIP scenarios.

UMTS Notes:

1. UMTS mode in was tested under RMC 12.2 kbps with HSPA Inactive per KDB Publication 941225 D01v03r01. AMR and HSPA SAR was not required per the 3G Test Reduction Procedure in KDB Publication 941225 D01v03r01.
2. Per FCC KDB Publication 447498 D01v06, if the reported (scaled) SAR measured at the middle channel or highest output power channel for each test configuration is ≤ 0.8 W/kg for 1g evaluations then testing at the other channels is not required for such test configuration(s). When the maximum output power variation across the required test channels is $> \frac{1}{2}$ dB, instead of the middle channel, the highest output power channel was used.

FCC ID: ZNFX410AS	 PCTEST ENGINEERING LABORATORY, INC.	SAR EVALUATION REPORT	 LG	Approved by: Quality Manager
Document S/N: 1M1803140041-01-R1-ZNF	Test Dates: 03/28/18 - 04/11/18	DUT Type: Portable Handset	Page 55 of 69	

LTE Notes:



1. LTE Considerations: LTE test configurations are determined according to SAR Evaluation Considerations for LTE Devices in FCC KDB Publication 941225 D05v02r04. The general test procedures used for testing can be found in Section 8.5.4.
2. MPR is permanently implemented for this device by the manufacturer. The specific manufacturer target MPR is indicated alongside the SAR results. MPR is enabled for this device, according to 3GPP TS36.101 Section 6.2.3 – 6.2.5 under Table 6.2.3-1.
3. A-MPR was disabled for all SAR tests by setting NS=01 on the base station simulator. SAR tests were performed with the same number of RB and RB offsets transmitting on all TTI frames (maximum TTI).
4. Per KDB Publication 941225 D05Av01r02, SAR for downlink only LTE CA operations was not needed since the maximum average output power in LTE CA mode was not >0.25 dB higher than the maximum output power when downlink carrier aggregation was inactive.

WLAN Notes:

1. For held-to-ear and hotspot operations, the initial test position procedures were applied. The test position with the highest extrapolated peak SAR will be used as the initial test position. When reported SAR for the initial test position is ≤ 0.4 W/kg for 1g evaluations, no additional testing for the remaining test positions was required. Otherwise, SAR is evaluated at the subsequent highest peak SAR positions until the reported SAR result is ≤ 0.8 W/kg or all test positions are measured.
2. Justification for test configurations for WLAN per KDB Publication 248227 D01v02r02 for 2.4 GHz WIFI operations, the highest measured maximum output power channel for DSSS was selected for SAR measurement. SAR for OFDM modes (2.4 GHz 802.11g/n) was not required due to the maximum allowed powers and the highest reported DSSS SAR. See Section 8.6.5 for more information.
3. Justification for test configurations for WLAN per KDB Publication 248227 D01v02r02 for 5 GHz WIFI operations, the initial test configuration was selected according to the transmission mode with the highest maximum allowed powers. Other transmission modes were not investigated since the highest reported SAR for initial test configuration adjusted by the ratio of maximum output powers is less than 1.2 W/kg for 1g evaluations. See Section 8.6.6 for more information.
4. When the maximum reported 1g averaged SAR is ≤ 0.8 W/kg, SAR testing on additional channels was not required. Otherwise, SAR for the next highest output power channel was required until the reported SAR result was ≤ 1.20 W/kg for 1g evaluations or all test channels were measured.
5. The device was configured to transmit continuously at the required data rate, channel bandwidth and signal modulation, using the highest transmission duty factor supported by the test mode tools. The reported SAR was scaled to the 100% transmission duty factor to determine compliance. Procedures used to measure the duty factor are identical to that in the associated EMC test reports.

Bluetooth Notes

1. Bluetooth SAR was measured with the device connected to a call box with hopping disabled with DH5 operation and Tx Tests test mode type. Per October 2016 TCB Workshop Notes, the reported SAR was scaled to the 100% transmission duty factor to determine compliance. See Section 9.5 for the time domain plot and calculation for the duty factor of the device.

FCC ID: ZNFX410AS	 SAR EVALUATION REPORT 		Approved by: Quality Manager
Document S/N: 1M1803140041-01-R1.ZNF	Test Dates: 03/28/18 - 04/11/18	DUT Type: Portable Handset	Page 56 of 69

12 FCC MULTI-TX AND ANTENNA SAR CONSIDERATIONS

12.1 Introduction

The following procedures adopted from FCC KDB Publication 447498 D01v06 are applicable to devices with built-in unlicensed transmitters such as 802.11 and Bluetooth devices which may simultaneously transmit with the licensed transmitter.

12.2 Simultaneous Transmission Procedures

This device contains transmitters that may operate simultaneously. Therefore, simultaneous transmission analysis is required. Per FCC KDB Publication 447498 D01v06 4.3.2 and IEEE 1528-2013 Section 6.3.4.1.2, simultaneous transmission SAR test exclusion may be applied when the sum of the 1g SAR for all the simultaneous transmitting antennas in a specific a physical test configuration is ≤ 1.6 W/kg. The different test positions in an exposure condition may be considered collectively to determine SAR test exclusion according to the sum of 1g or 10g SAR.



When standalone SAR is not required to be measured, per FCC KDB 447498 D01v06 4.3.2 b), the following equation must be used to estimate the standalone 1g SAR for simultaneous transmission assessment involving that transmitter.

$$\text{Estimated SAR} = \frac{\sqrt{f(\text{GHz})}}{7.5} * \frac{(\text{Max Power of channel, mW})}{\text{Min. Separation Distance, mm}}$$

**Table 12-1
Estimated SAR**

Mode	Frequency	Maximum Allowed Power	Separation Distance (Body)	Estimated SAR (Body)
	[MHz]	[dBm]	[mm]	[W/kg]
Bluetooth	2480	10.50	10	0.231

Note: Per KDB Publication 447498 D01v06, the maximum power of the channel was rounded to the nearest mW before calculation.



FCC ID: ZNFX410AS	 PCTEST ENGINEERING LABORATORY, INC.	SAR EVALUATION REPORT	 LG	Approved by: Quality Manager
Document S/N: 1M1803140041-01-R1.ZNF	Test Dates: 03/28/18 - 04/11/18	DUT Type: Portable Handset		Page 57 of 69

12.3 Head SAR Simultaneous Transmission Analysis

Table 12-2
Simultaneous Transmission Scenario with 2.4 GHz WLAN (Held to Ear)

Exposure Condition	Mode	2G/3G/4G SAR (W/kg)	2.4 GHz WLAN SAR (W/kg)	Σ SAR (W/kg)
		1	2	1+2
Head SAR	GSM/GPRS 850	0.503	0.994	1.497
	GSM/GPRS 1900	0.301	0.994	1.295
	UMTS 850	0.493	0.994	1.487
	UMTS 1750	0.484	0.994	1.478
	UMTS 1900	0.713	0.994	See Table Below
	LTE Band 12	0.386	0.994	1.380
	LTE Band 14	0.465	0.994	1.459
	LTE Band 5 (Cell)	0.392	0.994	1.386
	LTE Band 4 (AWS)	0.534	0.994	1.528
	LTE Band 2 (PCS)	0.721	0.994	See Table Below

Simult Tx	Configuration	UMTS 1900 SAR (W/kg)	2.4 GHz WLAN SAR (W/kg)	Σ SAR (W/kg)	Simult Tx	Configuration	LTE Band 2 (PCS) SAR (W/kg)	2.4 GHz WLAN SAR (W/kg)	Σ SAR (W/kg)	SPLSR
		1	2	1+2			1	2	1+2	1+2
Head SAR	Right Cheek	0.521	0.994	1.515	Head SAR	Right Cheek	0.612	0.994	See Note 1	0.03
	Right Tilt	0.359	0.751	1.110		Right Tilt	0.397	0.751	1.148	N/A
	Left Cheek	0.713	0.385	1.098		Left Cheek	0.721	0.385	1.106	N/A
	Left Tilt	0.325	0.418	0.743		Left Tilt	0.396	0.418	0.814	N/A

FCC ID: ZNFX410AS	 PCTEST ENGINEERING LABORATORY, INC.	SAR EVALUATION REPORT		Approved by: Quality Manager
Document S/N: 1M1803140041-01-R1.ZNF	Test Dates: 03/28/18 - 04/11/18	DUT Type: Portable Handset	Page 58 of 69	

**Table 12-3
Simultaneous Transmission Scenario with 5 GHz WLAN (Held to Ear)**



Exposure Condition	Mode	2G/3G/4G SAR (W/kg)	5 GHz WLAN SAR (W/kg)	Σ SAR (W/kg)
		1	2	1+2
Head SAR	GSM/GPRS 850	0.503	0.808	1.311
	GSM/GPRS 1900	0.301	0.808	1.109
	UMTS 850	0.493	0.808	1.301
	UMTS 1750	0.484	0.808	1.292
	UMTS 1900	0.713	0.808	1.521
	LTE Band 12	0.386	0.808	1.194
	LTE Band 14	0.465	0.808	1.273
	LTE Band 5 (Cell)	0.392	0.808	1.200
	LTE Band 4 (AWS)	0.534	0.808	1.342
	LTE Band 2 (PCS)	0.721	0.808	1.529

**Table 12-4
Simultaneous Transmission Scenario with Bluetooth (Held to Ear)**

Exposure Condition	Mode	2G/3G/4G SAR (W/kg)	Bluetooth SAR (W/kg)	Σ SAR (W/kg)
		1	2	1+2
Head SAR	GSM/GPRS 850	0.503	0.092	0.595
	GSM/GPRS 1900	0.301	0.092	0.393
	UMTS 850	0.493	0.092	0.585
	UMTS 1750	0.484	0.092	0.576
	UMTS 1900	0.713	0.092	0.805
	LTE Band 12	0.386	0.092	0.478
	LTE Band 14	0.465	0.092	0.557
	LTE Band 5 (Cell)	0.392	0.092	0.484
	LTE Band 4 (AWS)	0.534	0.092	0.626
	LTE Band 2 (PCS)	0.721	0.092	0.813

Note:

- No evaluation was performed to determine the aggregate 1g SAR for these configurations as the SPLS ratio between the antenna pairs was not greater than 0.04 per FCC KDB 447498 D01v06. See Section 12.6 for detailed SPLS ratio analysis.

FCC ID: ZNFX410AS		SAR EVALUATION REPORT		Approved by: Quality Manager
Document S/N: 1M1803140041-01-R1.ZNF	Test Dates: 03/28/18 - 04/11/18	DUT Type: Portable Handset		Page 59 of 69

12.4 Body-Worn Simultaneous Transmission Analysis

Table 12-5
Simultaneous Transmission Scenario with 2.4 GHz WLAN (Body-Worn at 1.0 cm)

Exposure Condition	Mode	2G/3G/4G SAR (W/kg)	2.4 GHz WLAN SAR (W/kg)	Σ SAR (W/kg)
		1	2	1+2
Body-Worn	GSM/GPRS 850	0.754	0.175	0.929
	GSM/GPRS 1900	0.456	0.175	0.631
	UMTS 850	0.724	0.175	0.899
	UMTS 1750	0.791	0.175	0.966
	UMTS 1900	1.002	0.175	1.177
	LTE Band 12	0.524	0.175	0.699
	LTE Band 14	0.837	0.175	1.012
	LTE Band 5 (Cell)	0.536	0.175	0.711
	LTE Band 4 (AWS)	0.884	0.175	1.059
	LTE Band 2 (PCS)	1.030	0.175	1.205

Table 12-6
Simultaneous Transmission Scenario with 5 GHz WLAN (Body-Worn at 1.0 cm)

Exposure Condition	Mode	2G/3G/4G SAR (W/kg)	5 GHz WLAN SAR (W/kg)	Σ SAR (W/kg)
		1	2	1+2
Body-Worn	GSM/GPRS 850	0.754	0.120	0.874
	GSM/GPRS 1900	0.456	0.120	0.576
	UMTS 850	0.724	0.120	0.844
	UMTS 1750	0.791	0.120	0.911
	UMTS 1900	1.002	0.120	1.122
	LTE Band 12	0.524	0.120	0.644
	LTE Band 14	0.837	0.120	0.957
	LTE Band 5 (Cell)	0.536	0.120	0.656
	LTE Band 4 (AWS)	0.884	0.120	1.004
	LTE Band 2 (PCS)	1.030	0.120	1.150



FCC ID: ZNFX410AS		SAR EVALUATION REPORT		Approved by: Quality Manager
Document S/N: 1M1803140041-01-R1.ZNF	Test Dates: 03/28/18 - 04/11/18	DUT Type: Portable Handset		Page 60 of 69

Table 12-7
Simultaneous Transmission Scenario with Bluetooth (Body-Worn at 1.0 cm)

Exposure Condition	Mode	2G/3G/4G SAR (W/kg)	Bluetooth SAR (W/kg)	Σ SAR (W/kg)
		1	2	1+2
Body-Worn	GSM/GPRS 850	0.754	0.231	0.985
	GSM/GPRS 1900	0.456	0.231	0.687
	UMTS 850	0.724	0.231	0.955
	UMTS 1750	0.791	0.231	1.022
	UMTS 1900	1.002	0.231	1.233
	LTE Band 12	0.524	0.231	0.755
	LTE Band 14	0.837	0.231	1.068
	LTE Band 5 (Cell)	0.536	0.231	0.767
	LTE Band 4 (AWS)	0.884	0.231	1.115
	LTE Band 2 (PCS)	1.030	0.231	1.261

12.5 Hotspot SAR Simultaneous Transmission Analysis

Table 12-8
Simultaneous Transmission Scenario with 2.4 GHz WLAN (Hotspot at 1.0 cm)

Exposure Condition	Mode	2G/3G/4G SAR (W/kg)	2.4 GHz WLAN SAR (W/kg)	Σ SAR (W/kg)
		1	2	1+2
Hotspot SAR	GPRS 850	0.754	0.179	0.933
	GPRS 1900	0.456	0.179	0.635
	UMTS 850	0.724	0.179	0.903
	UMTS 1750	0.791	0.179	0.970
	UMTS 1900	1.002	0.179	1.181
	LTE Band 12	0.524	0.179	0.703
	LTE Band 14	0.837	0.179	1.016
	LTE Band 5 (Cell)	0.536	0.179	0.715
	LTE Band 4 (AWS)	0.884	0.179	1.063
	LTE Band 2 (PCS)	1.035	0.179	1.214





FCC ID: ZNFX410AS		SAR EVALUATION REPORT		Approved by: Quality Manager
Document S/N: 1M1803140041-01-R1.ZNF	Test Dates: 03/28/18 - 04/11/18	DUT Type: Portable Handset		Page 61 of 69

Table 12-9
Simultaneous Transmission Scenario with 5 GHz WLAN (Hotspot at 1.0 cm)

Exposure Condition	Mode	2G/3G/4G SAR (W/kg)	5 GHz WLAN SAR (W/kg)	Σ SAR (W/kg)
		1	2	
Hotspot SAR	GPRS 850	0.754	0.157	0.911
	GPRS 1900	0.456	0.157	0.613
	UMTS 850	0.724	0.157	0.881
	UMTS 1750	0.791	0.157	0.948
	UMTS 1900	1.002	0.157	1.159
	LTE Band 12	0.524	0.157	0.681
	LTE Band 14	0.837	0.157	0.994
	LTE Band 5 (Cell)	0.536	0.157	0.693
	LTE Band 4 (AWS)	0.884	0.157	1.041
	LTE Band 2 (PCS)	1.035	0.157	1.192

Table 12-10
Simultaneous Transmission Scenario with Bluetooth (Hotspot at 1.0 cm)

Exposure Condition	Mode	2G/3G/4G SAR (W/kg)	Bluetooth SAR (W/kg)	Σ SAR (W/kg)
		1	2	
Hotspot SAR	GPRS 850	0.754	0.231	0.985
	GPRS 1900	0.456	0.231	0.687
	UMTS 850	0.724	0.231	0.955
	UMTS 1750	0.791	0.231	1.022
	UMTS 1900	1.002	0.231	1.233
	LTE Band 12	0.524	0.231	0.755
	LTE Band 14	0.837	0.231	1.068
	LTE Band 5 (Cell)	0.536	0.231	0.767
	LTE Band 4 (AWS)	0.884	0.231	1.115
	LTE Band 2 (PCS)	1.035	0.231	1.266

FCC ID: ZNFX410AS		SAR EVALUATION REPORT		Approved by: Quality Manager
Document S/N: 1M1803140041-01-R1.ZNF	Test Dates: 03/28/18 - 04/11/18	DUT Type: Portable Handset		Page 62 of 69

12.6 SPLSR Evaluation and Analysis

Per FCC KDB Publication 447498 D01v06, when the sum of the standalone transmitters is more than 1.6 W/kg for 1g, the SAR sum to peak locations can be analyzed to determine SAR distribution overlaps. When the SAR peak to location ratio (shown below) for each pair of antennas is ≤ 0.04 for 1g, simultaneous SAR evaluation is not required. The distance between the transmitters was calculated using the following formula.

$$\text{Distance}_{\text{Tx1} - \text{Tx2}} = R_i = \sqrt{(x_1 - x_2)^2 + (y_1 - y_2)^2 + (z_1 - z_2)^2}$$

$$\text{SPLS Ratio} = \frac{(SAR_1 + SAR_2)^{1.5}}{R_i}$$

12.6.1 Right Cheek SPLSR Evaluation and Analysis

Table 12-11
Peak SAR Locations for Head Right Cheek

Mode/Band	x (mm)	y (mm)	z (mm)	Reported SAR (W/kg)
2.4 GHz WLAN	12.91	-330.30	-170.42	0.994
LTE Band 2 (PCS)	43.21	-256.32	-172.71	0.612

Table 12-12
Right Cheek SAR to Peak Location Separation Ratio Calculation

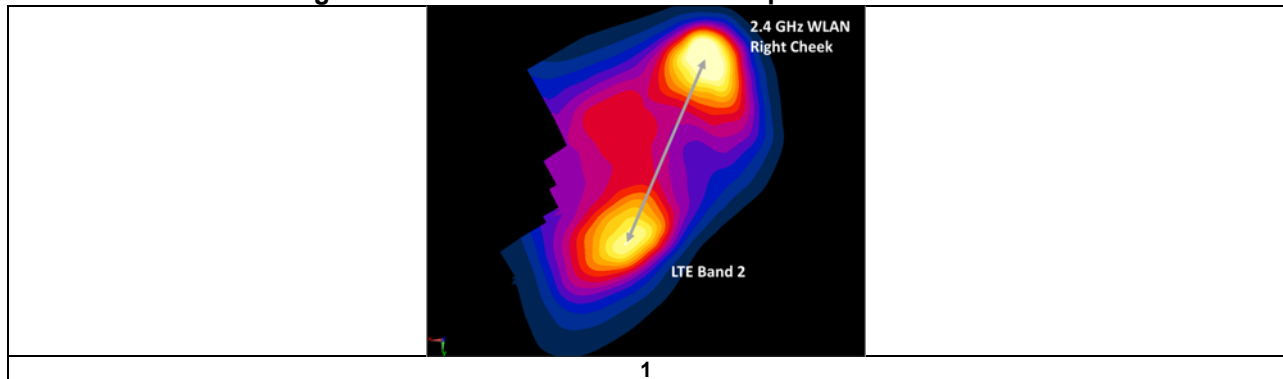

Antenna Pair		Standalone SAR (W/kg)		Standalone SAR Sum (W/kg)	Peak SAR Separation Distance (mm)	SPLS Ratio	Plot Number
Ant "a"	Ant "b"	a	b	a+b	D _{a-b}	$(a+b)^{1.5}/D_{a-b}$	
2.4 GHz WLAN	LTE Band 2 (PCS)	0.994	0.612	1.606	79.98	0.03	1

Table 12-13
Right Cheek SAR to Peak Location Separation Ratio Plot



12.7 Simultaneous Transmission Conclusion

The above numerical summed SAR results and SPLSR analysis are sufficient to determine that simultaneous transmission cases will not exceed the SAR limit and therefore no measured volumetric simultaneous SAR summation is required per FCC KDB Publication 447498 D01v06 and IEEE 1528- 2013 Section 6.3.4.1.

FCC ID: ZNFX410AS	 PCTEST ENGINEERING LABORATORY, INC.	SAR EVALUATION REPORT	 LG	Approved by: Quality Manager
Document S/N: 1M1803140041-01-R1.ZNF	Test Dates: 03/28/18 - 04/11/18	DUT Type: Portable Handset		Page 63 of 69

13 SAR MEASUREMENT VARIABILITY

13.1 Measurement Variability

Per FCC KDB Publication 865664 D01v01r04, SAR measurement variability was assessed for each frequency band, which was determined by the SAR probe calibration point and tissue-equivalent medium used for the device measurements. When both head and body tissue-equivalent media were required for SAR measurements in a frequency band, the variability measurement procedures were applied to the tissue medium with the highest measured SAR, using the highest measured SAR configuration for that tissue-equivalent medium. These additional measurements were repeated after the completion of all measurements requiring the same head or body tissue-equivalent medium in a frequency band. The test device was returned to ambient conditions (normal room temperature) with the battery fully charged before it was re-mounted on the device holder for the repeated measurement(s) to minimize any unexpected variations in the repeated results.

SAR Measurement Variability was assessed using the following procedures for each frequency band:

- 1) When the original highest measured SAR is ≥ 0.80 W/kg, the measurement was repeated once.
- 2) A second repeated measurement was performed only if the ratio of largest to smallest SAR for the original and first repeated measurements was > 1.20 or when the original or repeated measurement was ≥ 1.45 W/kg (~ 10% from the 1g SAR limit).
- 3) A third repeated measurement was performed only if the original, first or second repeated measurement was ≥ 1.5 W/kg and the ratio of largest to smallest SAR for the original, first and second repeated measurements is > 1.20 .
- 4) Repeated measurements are not required when the original highest measured SAR is < 0.80 W/kg

**Table 13-1
Head SAR Measurement Variability Results**



HEAD VARIABILITY RESULTS														
Band	FREQUENCY		Mode/Band	Service	Side	Test Position	Data Rate (Mbps)	Measured SAR (1g)	1st Repeated SAR (1g)	Ratio	2nd Repeated SAR (1g)	Ratio	3rd Repeated SAR (1g)	Ratio
	MHz	Ch.						(W/kg)	(W/kg)		(W/kg)		(W/kg)	
2450	2437.00	6	802.11b, 22 MHz Bandwidth	DSSS	Right	Cheek	1	0.856	0.822	1.04	N/A	N/A	N/A	N/A
ANSI / IEEE C95.1 1992 - SAFETY LIMIT Spatial Peak Uncontrolled Exposure/General Population							Head 1.6 W/kg (mW/g) averaged over 1 gram							

**Table 13-2
Body SAR Measurement Variability Results**

BODY VARIABILITY RESULTS													
Band	FREQUENCY		Mode	Service	Side	Spacing	Measured SAR (1g)	1st Repeated SAR (1g)	Ratio	2nd Repeated SAR (1g)	Ratio	3rd Repeated SAR (1g)	Ratio
	MHz	Ch.					(W/kg)	(W/kg)		(W/kg)		(W/kg)	
750	793.00	23330	LTE Band 14, 10 MHz Bandwidth	QPSK, 1 RB, 25 RB Offset	back	10 mm	0.831	0.766	1.08	N/A	N/A	N/A	N/A
1750	1732.50	20175	LTE Band 4 (AWS), 20 MHz Bandwidth	QPSK, 1 RB, 50 RB Offset	back	10 mm	0.805	0.878	1.09	N/A	N/A	N/A	N/A
1900	1880.00	18900	LTE Band 2 (PCS), 20 MHz Bandwidth	QPSK, 1 RB, 50 RB Offset	front	10 mm	1.030	1.000	1.03	N/A	N/A	N/A	N/A
ANSI / IEEE C95.1 1992 - SAFETY LIMIT Spatial Peak Uncontrolled Exposure/General Population							Body 1.6 W/kg (mW/g) averaged over 1 gram						

13.2 Measurement Uncertainty

The measured SAR was < 1.5 W/kg for all frequency bands. Therefore, per KDB Publication 865664 D01v01r04, the extended measurement uncertainty analysis per IEEE 1528-2013 was not required.



FCC ID: ZNFX410AS	 PCTEST ENGINEERING LABORATORY, INC.	SAR EVALUATION REPORT	 LG	Approved by: Quality Manager
Document S/N: 1M1803140041-01-R1-ZNF	Test Dates: 03/28/18 - 04/11/18	DUT Type: Portable Handset	Page 64 of 69	

14

EQUIPMENT LIST



Manufacturer	Model	Description	Cal Date	Cal Interval	Cal Due	Serial Number
Agilent	8594A	(9kHz-2.9GHz) Spectrum Analyzer	N/A	N/A	N/A	3051A00187
Narda	4014C-6	4 - 8 GHz SMA 6 dB Directional Coupler	CBT	N/A	CBT	N/A
MCL	BW-N6W5+	6dB Attenuator	CBT	N/A	CBT	1139
Amplifier Research	1551G6	Amplifier	CBT	N/A	CBT	433971
Narda	4772-3	Attenuator (3dB)	CBT	N/A	CBT	9406
Rohde & Schwarz	CMU200	Base Station Simulator	5/22/2017	Annual	5/22/2018	109892
Pasternack	PE2209-10	Bidirectional Coupler	CBT	N/A	CBT	N/A
Mini-Circuits	BW-N20W5+	DC to 18 GHz Precision Fixed 20 dB Attenuator	CBT	N/A	CBT	N/A
SPEAG	DAK-3.5	Dielectric Assessment Kit	9/12/2017	Annual	9/12/2018	1091
SPEAG	DAK-12	Dielectric Assessment Kit (10MHz - 3GHz)	3/13/2018	Annual	3/13/2019	1102
Keysight	772D	Dual Directional Coupler	CBT	N/A	CBT	MY52180215
Agilent	E4438C	ESG Vector Signal Generator	3/24/2017	Biennial	3/24/2019	MY42082385
MiniCircuits	SLP-2400+	Low Pass Filter	CBT	N/A	CBT	R8979500903
MiniCircuits	VLF-6000+	Low Pass Filter	CBT	N/A	CBT	N/A
Mini-Circuits	NLP-1200+	Low Pass Filter DC to 1000 MHz	CBT	N/A	CBT	N/A
Mini-Circuits	NLP-2950+	Low Pass Filter DC to 2700 MHz	CBT	N/A	CBT	N/A
Agilent	N9020A	MXA Signal Analyzer	1/24/2018	Annual	1/24/2019	US46470561
Agilent	N5182A	MXG Vector Signal Generator	1/24/2018	Annual	1/24/2019	MY47420651
SPEAG	DAKS-3.5	Portable Dielectric Assessment Kit	7/11/2017	Annual	7/11/2018	1039
SPEAG	DAKS-3.5	Portable Dielectric Assessment Kit	8/8/2017	Annual	8/8/2018	1041
Mini-Circuits	BW-N20W5	Power Attenuator	CBT	N/A	CBT	1226
Anritsu	ML2495A	Power Meter	10/22/2017	Annual	10/22/2018	941001
Anritsu	MA2411B	Pulse Power Sensor	3/2/2018	Annual	3/2/2019	1207364
Anritsu	MT8820C	Radio Communication Analyzer	5/23/2017	Annual	5/23/2018	6201240328
Anritsu	MT8820C	Radio Communication Analyzer	1/30/2018	Annual	1/30/2019	6201300731
Rohde & Schwarz	CMW500	Radio Communication Tester	11/3/2017	Annual	11/3/2018	100976
COMTECH	AR85729-5/5759B	Solid State Amplifier	CBT	N/A	CBT	M3W1A00-1002
Agilent	8753ES	S-Parameter Network Analyzer	2/8/2018	Annual	2/8/2019	US39170122
Agilent	8753ES	S-Parameter Vector Network Analyzer	8/17/2017	Annual	8/17/2018	MY40003841
Keysight Technologies	85033E	Standard Mechanical Calibration Kit (DC to 9GHz, 3.5mm)	6/1/2017	Annual	6/1/2018	MY53401181
Control Company	4040	Therm./ Clock/ Humidity Monitor	1/8/2018	Annual	1/8/2019	160574418
Control Company	4040	Therm./ Clock/ Humidity Monitor	3/1/2017	Biennial	3/1/2019	170152009
Pasternack	PE5011-1	Torque Wrench	7/19/2017	Biennial	7/19/2019	N/A
Pasternack	PE2208-6	Bidirectional Coupler	CBT	N/A	CBT	N/A
Pasternack	PE5011-1	Torque Wrench	7/19/2017	Biennial	7/19/2019	N/A
Seekonk	NC-100	Torque Wrench (8" lb)	8/30/2016	Biennial	8/30/2018	N/A
Seekonk	NC-100	Torque Wrench 5/16", 8" lbs	1/22/2018	Annual	1/22/2019	N/A
Control Company	4352	Ultra Long Stem Thermometer	5/2/2017	Biennial	5/2/2019	170330144
Control Company	4352	Ultra Long Stem Thermometer	5/2/2017	Biennial	5/2/2019	170330174
Anritsu	MA24106A	USB Power Sensor	6/7/2017	Annual	6/7/2018	1231538
Anritsu	MA24106A	USB Power Sensor	6/7/2017	Annual	6/7/2018	1231535
Rohde & Schwarz	CMW500	Wideband Radio Communication Tester	1/19/2018	Annual	1/19/2019	164948
Agilent	E5515C	Wireless Communications Test Set	1/24/2018	Annual	1/24/2019	GB44400860
Agilent	N4010A	Wireless Connectivity Test Set	N/A	N/A	N/A	GB44450273
SPEAG	DAKS-3.5	Portable DAK	9/5/2017	Annual	9/5/2018	1045
SPEAG	D1750V2	1750 MHz SAR Dipole	5/9/2017	Annual	5/9/2018	1148
SPEAG	D1900V2	1900 MHz SAR Dipole	7/8/2016	Biennial	7/8/2018	50800
SPEAG	D1900V2	1900 MHz SAR Dipole	2/7/2018	Annual	2/7/2019	50148
SPEAG	D2450V2	2450 MHz SAR Dipole	9/11/2017	Annual	9/11/2018	797
SPEAG	D5GHzV2	5 GHz SAR Dipole	9/21/2016	Biennial	9/21/2018	1191
SPEAG	D5GHzV2	5 GHz SAR Dipole	8/15/2017	Annual	8/15/2018	1237
SPEAG	D750V3	750 MHz Dipole	3/7/2017	Biennial	3/7/2019	1054
SPEAG	D750V3	750 MHz SAR Dipole	2/7/2018	Annual	2/7/2019	1046
SPEAG	D835V2	835 MHz SAR Dipole	1/15/2018	Annual	1/15/2019	40132
SPEAG	D750V3	750 MHz SAR Dipole	1/15/2018	Annual	1/15/2019	1003
SPEAG	DAE4	Dasy Data Acquisition Electronics	2/15/2018	Annual	2/15/2019	665
SPEAG	DAE4	Dasy Data Acquisition Electronics	2/9/2018	Annual	2/9/2019	1272
SPEAG	DAE4	Dasy Data Acquisition Electronics	8/9/2017	Annual	8/9/2018	1323
SPEAG	DAE4	Dasy Data Acquisition Electronics	6/21/2017	Annual	6/21/2018	1333
SPEAG	DAE4	Dasy Data Acquisition Electronics	7/13/2017	Annual	7/13/2018	1322
SPEAG	DAE4	Dasy Data Acquisition Electronics	6/14/2017	Annual	6/14/2018	1334
SPEAG	DAE4	Dasy Data Acquisition Electronics	3/7/2018	Annual	3/7/2019	1368
SPEAG	EX3DV4	SAR Probe	1/16/2018	Annual	1/16/2019	3589
SPEAG	ES3DV3	SAR Probe	2/13/2018	Annual	2/13/2019	3213
SPEAG	ES3DV3	SAR Probe	9/18/2017	Annual	9/18/2018	3287
SPEAG	EX3DV4	SAR Probe	2/14/2018	Annual	2/14/2019	3914
SPEAG	ES3DV3	SAR Probe	3/13/2018	Annual	3/13/2019	3319
SPEAG	ES3DV3	SAR Probe	8/14/2017	Annual	8/14/2018	3332
SPEAG	EX3DV4	SAR Probe	8/16/2017	Annual	8/16/2018	7308
SPEAG	EX3DV4	SAR Probe	7/17/2017	Annual	7/17/2018	7410

Note: CBT (Calibrated Before Testing). Prior to testing, the measurement paths containing a cable, amplifier, attenuator, coupler or filter were connected to a calibrated source (i.e. a signal generator) to determine the losses of the measurement path. The power meter offset was then adjusted to compensate for the measurement system losses. This level offset is stored within the power meter before measurements are made. This calibration verification procedure applies to the system verification and output power measurements. The calibrated reading is then taken directly from the power meter after compensation of the losses for all final power measurements.

FCC ID: ZNFX410AS		SAR EVALUATION REPORT		Approved by: Quality Manager
Document S/N: 1M1803140041-01-R1.ZNF	Test Dates: 03/28/18 - 04/11/18	DUT Type: Portable Handset		Page 65 of 69

15 MEASUREMENT UNCERTAINTIES

a	c	d	e= f(d,k)	f	g	h = c x f/e	i = c x g/e	k
Uncertainty Component	Tol. (± %)	Prob. Dist.	Div.	c _i 1gm	c _i 10 gms	1gm u _i (± %)	10gms u _i (± %)	v _i
Measurement System								
Probe Calibration	6.55	N	1	1.0	1.0	6.6	6.6	∞
Axial Isotropy	0.25	N	1	0.7	0.7	0.2	0.2	∞
Hemishperical Isotropy	1.3	N	1	0.7	0.7	0.9	0.9	∞
Boundary Effect	2.0	R	1.73	1.0	1.0	1.2	1.2	∞
Linearity	0.3	N	1	1.0	1.0	0.3	0.3	∞
System Detection Limits	0.25	R	1.73	1.0	1.0	0.1	0.1	∞
Readout Electronics	0.3	N	1	1.0	1.0	0.3	0.3	∞
Response Time	0.8	R	1.73	1.0	1.0	0.5	0.5	∞
Integration Time	2.6	R	1.73	1.0	1.0	1.5	1.5	∞
RF Ambient Conditions - Noise	3.0	R	1.73	1.0	1.0	1.7	1.7	∞
RF Ambient Conditions - Reflections	3.0	R	1.73	1.0	1.0	1.7	1.7	∞
Probe Positioner Mechanical Tolerance	0.4	R	1.73	1.0	1.0	0.2	0.2	∞
Probe Positioning w/ respect to Phantom	6.7	R	1.73	1.0	1.0	3.9	3.9	∞
Extrapolation, Interpolation & Integration algorithms for Max. SAR Evaluation	4.0	R	1.73	1.0	1.0	2.3	2.3	∞
Test Sample Related								
Test Sample Positioning	2.7	N	1	1.0	1.0	2.7	2.7	35
Device Holder Uncertainty	1.67	N	1	1.0	1.0	1.7	1.7	5
Output Power Variation - SAR drift measurement	5.0	R	1.73	1.0	1.0	2.9	2.9	∞
SAR Scaling	0.0	R	1.73	1.0	1.0	0.0	0.0	∞
Phantom & Tissue Parameters								
Phantom Uncertainty (Shape & Thickness tolerances)	7.6	R	1.73	1.0	1.0	4.4	4.4	∞
Liquid Conductivity - measurement uncertainty	4.2	N	1	0.78	0.71	3.3	3.0	10
Liquid Permittivity - measurement uncertainty	4.1	N	1	0.23	0.26	1.0	1.1	10
Liquid Conductivity - Temperature Uncertainty	3.4	R	1.73	0.78	0.71	1.5	1.4	∞
Liquid Permittivity - Temperature Uncertainty	0.6	R	1.73	0.23	0.26	0.1	0.1	∞
Liquid Conductivity - deviation from target values	5.0	R	1.73	0.64	0.43	1.8	1.2	∞
Liquid Permittivity - deviation from target values	5.0	R	1.73	0.60	0.49	1.7	1.4	∞
Combined Standard Uncertainty (k=1)	RSS					11.5	11.3	60
Expanded Uncertainty (95% CONFIDENCELEVEL)	k=2					23.0	22.6	



FCC ID: ZNFX410AS	 PCTEST ENGINEERING LABORATORY, INC.	SAR EVALUATION REPORT	 LG	Approved by: Quality Manager
Document S/N: 1M1803140041-01-R1.ZNF	Test Dates: 03/28/18 - 04/11/18	DUT Type: Portable Handset		Page 66 of 69

16 CONCLUSION

16.1 Measurement Conclusion



The SAR evaluation indicates that the EUT complies with the RF radiation exposure limits of the FCC and Innovation, Science, and Economic Development Canada, with respect to all parameters subject to this test. These measurements were taken to simulate the RF effects of RF exposure under worst-case conditions. Precise laboratory measures were taken to assure repeatability of the tests. The results and statements relate only to the item(s) tested.

Please note that the absorption and distribution of electromagnetic energy in the body are very complex phenomena that depend on the mass, shape, and size of the body, the orientation of the body with respect to the field vectors, and the electrical properties of both the body and the environment. Other variables that may play a substantial role in possible biological effects are those that characterize the environment (e.g. ambient temperature, air velocity, relative humidity, and body insulation) and those that characterize the individual (e.g. age, gender, activity level, debilitation, or disease). Because various factors may interact with one another to vary the specific biological outcome of an exposure to electromagnetic fields, any protection guide should consider maximal amplification of biological effects as a result of field-body interactions, environmental conditions, and physiological variables. [3]



FCC ID: ZNFX410AS	 PCTEST ENGINEERING LABORATORY, INC.	SAR EVALUATION REPORT	 LG	Approved by: Quality Manager
Document S/N: 1M1803140041-01-R1.ZNF	Test Dates: 03/28/18 - 04/11/18	DUT Type: Portable Handset		Page 67 of 69

17 REFERENCES

- [1] Federal Communications Commission, ET Docket 93-62, Guidelines for Evaluating the Environmental Effects of Radiofrequency Radiation, Aug. 1996.
- [2] ANSI/IEEE C95.1-2005, American National Standard safety levels with respect to human exposure to radio frequency electromagnetic fields, 3kHz to 300GHz, New York: IEEE, 2006.
- [3] ANSI/IEEE C95.1-1992, American National Standard safety levels with respect to human exposure to radio frequency electromagnetic fields, 3kHz to 300GHz, New York: IEEE, Sept. 1992.
- [4] ANSI/IEEE C95.3-2002, IEEE Recommended Practice for the Measurement of Potentially Hazardous Electromagnetic Fields - RF and Microwave, New York: IEEE, December 2002.
- [5] IEEE Standards Coordinating Committee 39 –Standards Coordinating Committee 34 – IEEE Std. 1528-2013, IEEE Recommended Practice for Determining the Peak Spatial-Average Specific Absorption Rate (SAR) in the Human Head from Wireless Communications Devices: Measurement Techniques.
- [6] NCRP, National Council on Radiation Protection and Measurements, Biological Effects and Exposure Criteria for RadioFrequency Electromagnetic Fields, NCRP Report No. 86, 1986. Reprinted Feb. 1995.
- [7] T. Schmid, O. Egger, N. Kuster, Automated E-field scanning system for dosimetric assessments, IEEE Transaction on Microwave Theory and Techniques, vol. 44, Jan. 1996, pp. 105-113.
- [8] K. Pokovic, T. Schmid, N. Kuster, Robust setup for precise calibration of E-field probes in tissue simulating liquids at mobile communications frequencies, ICECOM97, Oct. 1997, pp. 1 -124.
- [9] K. Pokovic, T. Schmid, and N. Kuster, E-field Probe with improved isotropy in brain simulating liquids, Proceedings of the ELMAR, Zadar, Croatia, June 23-25, 1996, pp. 172-175.
- [10] Schmid & Partner Engineering AG, Application Note: Data Storage and Evaluation, June 1998, p2.
- [11] V. Hombach, K. Meier, M. Burkhardt, E. Kuhn, N. Kuster, The Dependence of EM Energy Absorption upon Human Modeling at 900 MHz, IEEE Transaction on Microwave Theory and Techniques, vol. 44 no. 10, Oct. 1996, pp. 1865-1873.
- [12] N. Kuster and Q. Balzano, Energy absorption mechanism by biological bodies in the near field of dipole antennas above 300MHz, IEEE Transaction on Vehicular Technology, vol. 41, no. 1, Feb. 1992, pp. 17-23.
- [13] G. Hartsgrove, A. Kraszewski, A. Surowiec, Simulated Biological Materials for Electromagnetic Radiation Absorption Studies, University of Ottawa, Bioelectromagnetics, Canada: 1987, pp. 29-36.
- [14] Q. Balzano, O. Garay, T. Manning Jr., Electromagnetic Energy Exposure of Simulated Users of Portable Cellular Telephones, IEEE Transactions on Vehicular Technology, vol. 44, no.3, Aug. 1995.
- [15] W. Gander, Computermathematick, Birkhaeuser, Basel, 1992.
- [16] W.H. Press, S.A. Teukolsky, W.T. Vetterling, and B.P. Flannery, Numerical Recipes in C, The Art of Scientific Computing, Second edition, Cambridge University Press, 1992.
- [17] N. Kuster, R. Kastle, T. Schmid, Dosimetric evaluation of mobile communications equipment with known precision, IEEE Transaction on Communications, vol. E80-B, no. 5, May 1997, pp. 645-652.

FCC ID: ZNFX410AS	 PCTEST ENGINEERING LABORATORY, INC.	SAR EVALUATION REPORT	 LG	Approved by: Quality Manager
Document S/N: 1M1803140041-01-R1.ZNF	Test Dates: 03/28/18 - 04/11/18	DUT Type: Portable Handset	Page 68 of 69	

- [18] CENELEC CLC/SC111B, European Prestandard (prENV 50166-2), Human Exposure to Electromagnetic Fields High-frequency: 10kHz-300GHz, Jan. 1995.
- [19] Prof. Dr. Niels Kuster, ETH, Eidgenössische Technische Hochschule Zürich, Dosimetric Evaluation of the Cellular Phone.
- [20] IEC 62209-1, Measurement procedure for the assessment of specific absorption rate of human exposure to radio frequency fields from hand-held and body-mounted wireless communication devices - Part 1: Devices used next to the ear (Frequency range of 300 MHz to 6 GHz), July 2016.
- [21] Innovation, Science, Economic Development Canada RSS-102 Radio Frequency Exposure Compliance of Radiocommunication Apparatus (All Frequency Bands) Issue 5, March 2015.
- [22] Health Canada Safety Code 6 Limits of Human Exposure to Radio Frequency Electromagnetic Fields in the Frequency Range from 3 kHz – 300 GHz, 2015
- [23] FCC SAR Test Procedures for 2G-3G Devices, Mobile Hotspot and UMPC Devices KDB Publications 941225, D01-D07
- [24] SAR Measurement Guidance for IEEE 802.11 Transmitters, KDB Publication 248227 D01
- [25] FCC SAR Considerations for Handsets with Multiple Transmitters and Antennas, KDB Publications 648474 D03-D04
- [26] FCC SAR Evaluation Considerations for Laptop, Notebook, Netbook and Tablet Computers, FCC KDB Publication 616217 D04
- [27] FCC SAR Measurement and Reporting Requirements for 100MHz – 6 GHz, KDB Publications 865664 D01-D02
- [28] FCC General RF Exposure Guidance and SAR Procedures for Dongles, KDB Publication 447498, D01-D02
- [29] Anexo à Resolução No. 533, de 10 de Setembro de 2009.
- [30] IEC 62209-2, Human exposure to radio frequency fields from hand-held and body-mounted wireless communication devices - Human models, instrumentation, and procedures - Part 2: Procedure to determine the specific absorption rate (SAR) for wireless communication devices used in close proximity to the human body (frequency range of 30 MHz to 6 GHz), Mar. 2010.

FCC ID: ZNFX410AS	 SAR EVALUATION REPORT 		Approved by: Quality Manager
Document S/N: 1M1803140041-01-R1.ZNF	Test Dates: 03/28/18 - 04/11/18	DUT Type: Portable Handset	Page 69 of 69

APPENDIX A: SAR TEST DATA

PCTEST ENGINEERING LABORATORY, INC.

DUT: ZNFX410AS; Type: Portable Handset; Serial: 01207

Communication System: UID 0, _GSM GPRS; 2 Tx slots; Frequency: 836.6 MHz; Duty Cycle: 1:4.15
Medium: 835 Head Medium parameters used (interpolated):
 $f = 836.6 \text{ MHz}$; $\sigma = 0.922 \text{ S/m}$; $\epsilon_r = 42.426$; $\rho = 1000 \text{ kg/m}^3$
Phantom section: Right Section

Test Date: 04-02-2018; Ambient Temp: 19.8°C; Tissue Temp: 19.7°C

Probe: ES3DV3 - SN3213; ConvF(6.42, 6.42, 6.42); Calibrated: 2/13/2018;
Sensor-Surface: 3mm (Mechanical Surface Detection)
Electronics: DAE4 Sn1272; Calibrated: 2/9/2018
Phantom: SAM 5.0 front; Type: QD000P40CD; Serial: 1648
Measurement SW: DASY52, Version 52.10; SEMCAD X Version 14.6.10 (7417)

Mode: GPRS 850, Right Head, Cheek, Mid.ch, 2 Tx slots

Area Scan (9x15x1): Measurement grid: dx=15mm, dy=15mm
Zoom Scan (5x5x7)/Cube 0: Measurement grid: dx=8mm, dy=8mm, dz=5mm
Reference Value = 23.37 V/m; Power Drift = 0.03 dB
Peak SAR (extrapolated) = 0.582 W/kg
SAR(1 g) = 0.464 W/kg

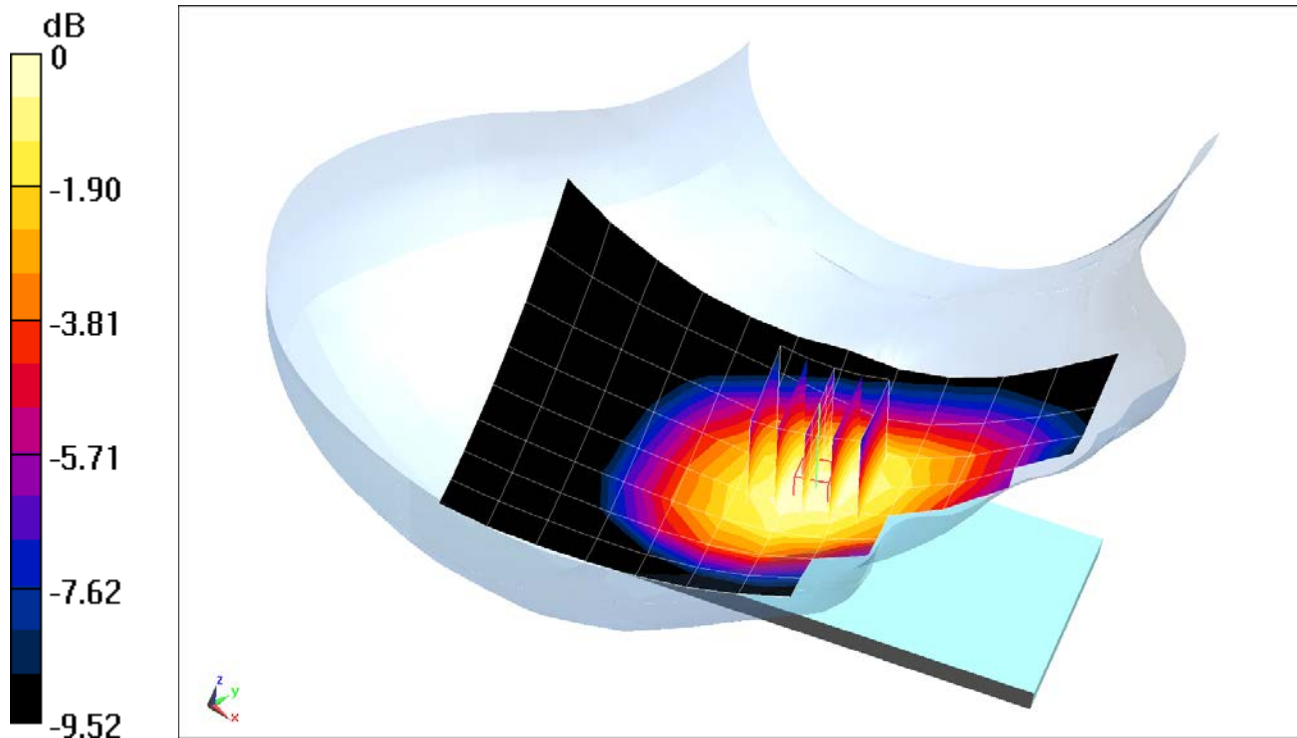

0 dB = 0.509 W/kg = -2.93 dBW/kg

PCTEST ENGINEERING LABORATORY, INC.

DUT: ZNFX410AS; Type: Portable Handset; Serial: 01207

Communication System: UID 0, _GSM GPRS; 2 Tx slots; Frequency: 1880 MHz; Duty Cycle: 1:4.15

Medium: 1900 Head Medium parameters used:

$f = 1880 \text{ MHz}$; $\sigma = 1.407 \text{ S/m}$; $\epsilon_r = 40.025$; $\rho = 1000 \text{ kg/m}^3$

Phantom section: Left Section

Test Date: 04-05-2018; Ambient Temp: 22.2°C; Tissue Temp: 21.2°C

Probe: ES3DV3 - SN3332; ConvF(5.33, 5.33, 5.33); Calibrated: 8/14/2017;

Sensor-Surface: 3mm (Mechanical Surface Detection)

Electronics: DAE4 Sn1323; Calibrated: 8/9/2017

Phantom: SAM Left; Type: QD000P40CA; Serial: TP:82355

Measurement SW: DASY52, Version 52.10; SEMCAD X Version 14.6.10 (7417)

Mode: GPRS 1900, Left Head, Cheek, Mid.ch, 2 Tx slots

Area Scan (9x15x1): Measurement grid: dx=15mm, dy=15mm

Zoom Scan (5x5x7)/Cube 0: Measurement grid: dx=8mm, dy=8mm, dz=5mm

Reference Value = 15.30 V/m; Power Drift = 0.02 dB

Peak SAR (extrapolated) = 0.441 W/kg

SAR(1 g) = 0.291 W/kg

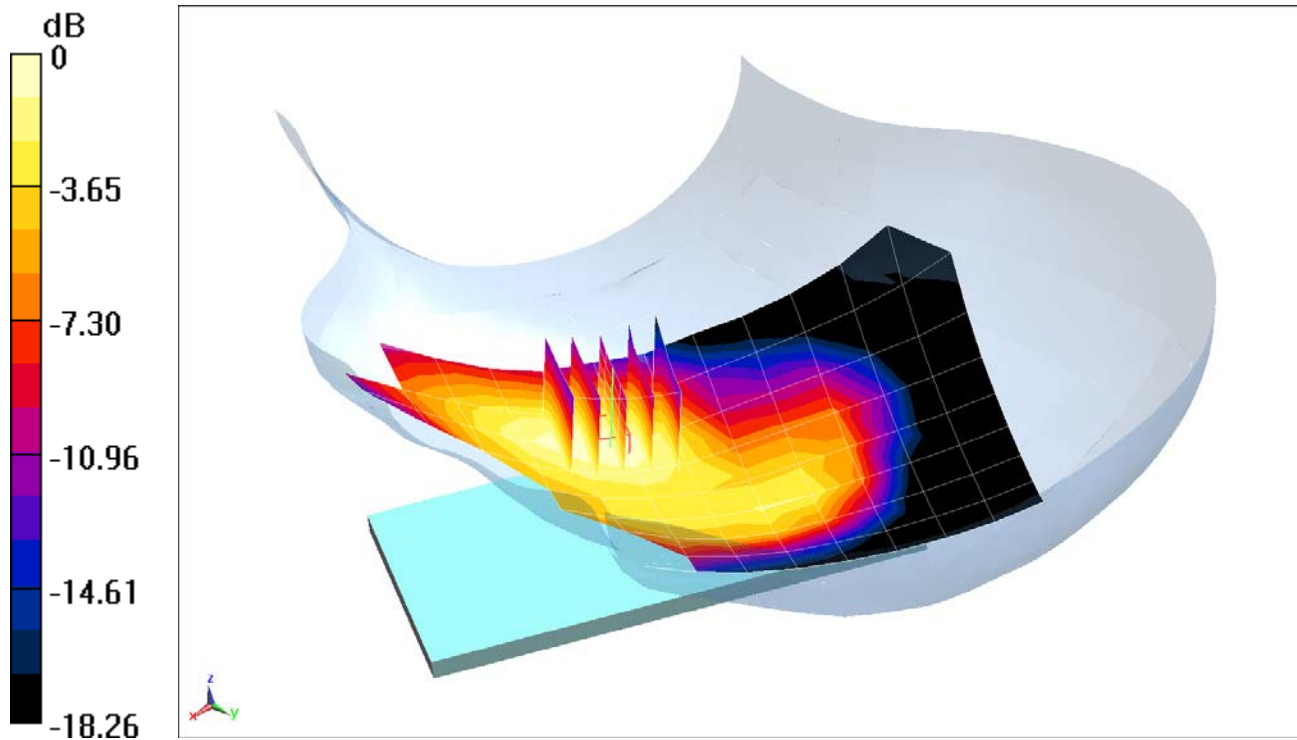

0 dB = 0.336 W/kg = -4.74 dBW/kg

PCTEST ENGINEERING LABORATORY, INC.

DUT: ZNFX410AS; Type: Portable Handset; Serial: 01207

Communication System: UID 0, UMTS; Frequency: 836.6 MHz; Duty Cycle: 1:1
Medium: 835 Head Medium parameters used (interpolated):
 $f = 836.6 \text{ MHz}$; $\sigma = 0.922 \text{ S/m}$; $\epsilon_r = 42.426$; $\rho = 1000 \text{ kg/m}^3$
Phantom section: Right Section

Test Date: 04-02-2018; Ambient Temp: 19.8°C; Tissue Temp: 19.7°C

Probe: ES3DV3 - SN3213; ConvF(6.42, 6.42, 6.42); Calibrated: 2/13/2018;
Sensor-Surface: 3mm (Mechanical Surface Detection)
Electronics: DAE4 Sn1272; Calibrated: 2/9/2018
Phantom: SAM 5.0 front; Type: QD000P40CD; Serial: 1648
Measurement SW: DASY52, Version 52.10; SEMCAD X Version 14.6.10 (7417)

Mode: UMTS 850, Right Head, Cheek, Mid.ch

Area Scan (9x15x1): Measurement grid: dx=15mm, dy=15mm

Zoom Scan (5x5x7)/Cube 0: Measurement grid: dx=8mm, dy=8mm, dz=5mm

Reference Value = 23.72 V/m; Power Drift = 0.01 dB

Peak SAR (extrapolated) = 0.612 W/kg

SAR(1 g) = 0.482 W/kg

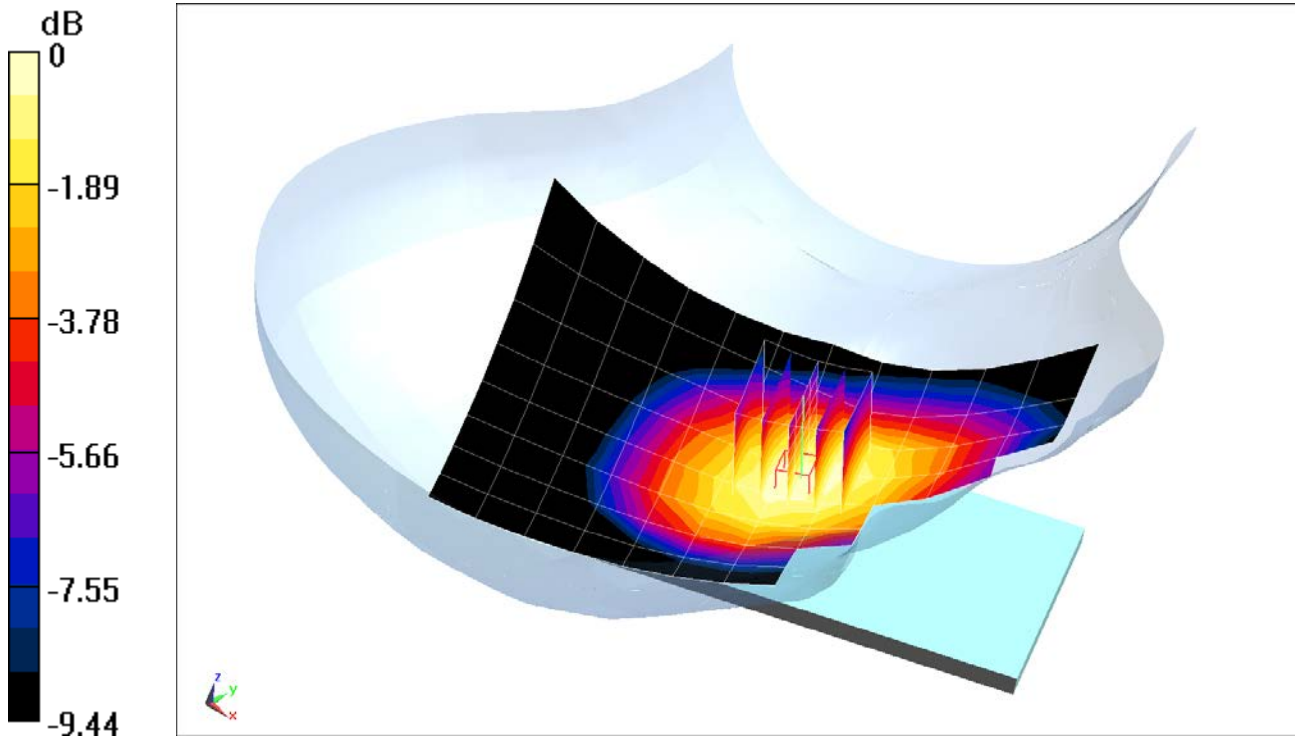

0 dB = 0.528 W/kg = -2.77 dBW/kg

PCTEST ENGINEERING LABORATORY, INC.

DUT: ZNFX410AS; Type: Portable Handset; Serial: 01199

Communication System: UID 0, UMTS; Frequency: 1732.4 MHz; Duty Cycle: 1:1
Medium: 1750 Head Medium parameters used (interpolated):
 $f = 1732.4$ MHz; $\sigma = 1.37$ S/m; $\epsilon_r = 39.439$; $\rho = 1000$ kg/m³
Phantom section: Left Section

Test Date: 04-02-2018; Ambient Temp: 22.0°C; Tissue Temp: 21.4°C

Probe: EX3DV4 - SN7410; ConvF(8.66, 8.66, 8.66); Calibrated: 7/17/2017;
Sensor-Surface: 1.4mm (Mechanical Surface Detection)

Electronics: DAE4 Sn1322; Calibrated: 7/13/2017

Phantom: SAM with CRP v5.0 (Right); Type: QD000P40CD; Serial: TP:1759
Measurement SW: DASY52, Version 52.10; SEMCAD X Version 14.6.10 (7417)

Mode: UMTS 1750, Left Head, Cheek, Mid.ch

Area Scan (9x15x1): Measurement grid: dx=15mm, dy=15mm

Zoom Scan (5x5x7)/Cube 0: Measurement grid: dx=8mm, dy=8mm, dz=5mm

Reference Value = 19.44 V/m; Power Drift = 0.06 dB

Peak SAR (extrapolated) = 0.717 W/kg

SAR(1 g) = 0.478 W/kg

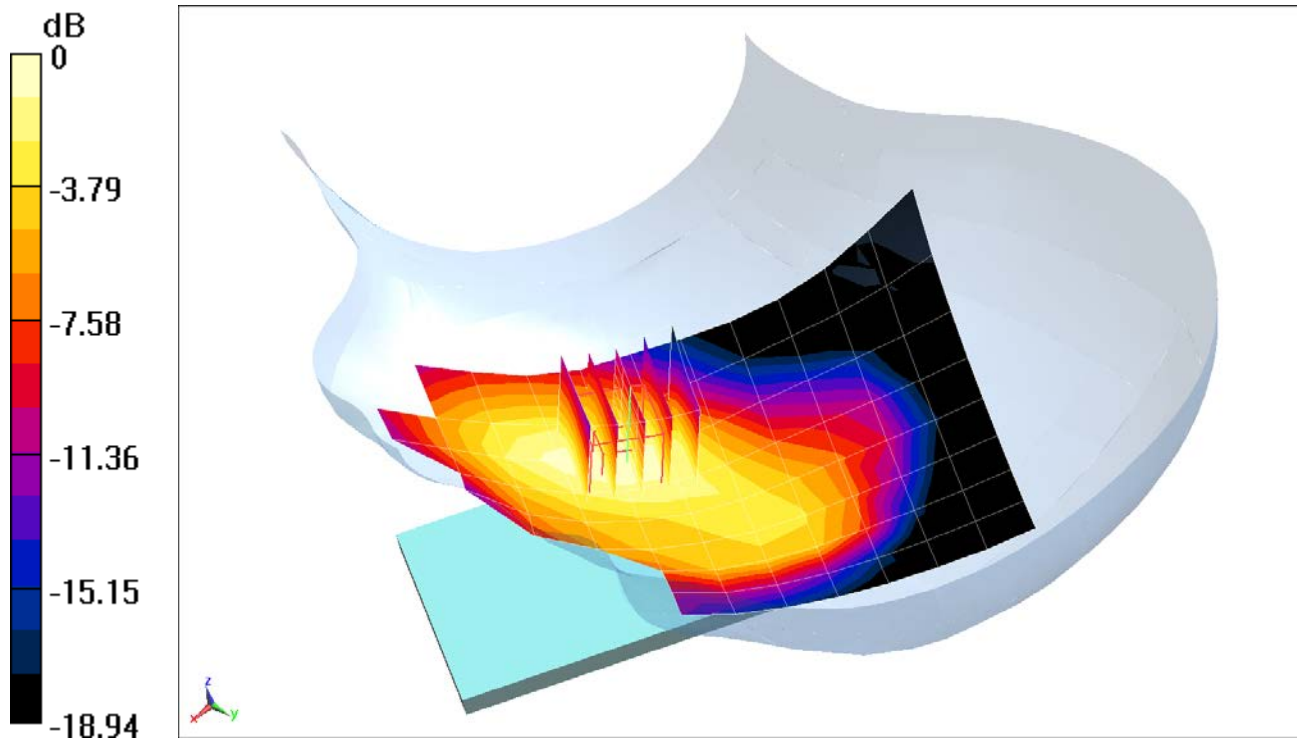

0 dB = 0.627 W/kg = -2.03 dBW/kg

PCTEST ENGINEERING LABORATORY, INC.

DUT: ZNFX410AS; Type: Portable Handset; Serial: 01199

Communication System: UID 0, UMTS; Frequency: 1907.6 MHz; Duty Cycle: 1:1
Medium: 1900 Head Medium parameters used:
 $f = 1907.6 \text{ MHz}$; $\sigma = 1.437 \text{ S/m}$; $\epsilon_r = 39.906$; $\rho = 1000 \text{ kg/m}^3$
Phantom section: Left Section

Test Date: 04-05-2018; Ambient Temp: 22.2°C; Tissue Temp: 21.2°C

Probe: ES3DV3 - SN3332; ConvF(5.33, 5.33, 5.33); Calibrated: 8/14/2017;
Sensor-Surface: 3mm (Mechanical Surface Detection)
Electronics: DAE4 Sn1323; Calibrated: 8/9/2017
Phantom: SAM Left; Type: QD000P40CA; Serial: TP:82355
Measurement SW: DASY52, Version 52.10; SEMCAD X Version 14.6.10 (7417)

Mode: UMTS 1900, Left Head, Cheek, High.ch

Area Scan (9x15x1): Measurement grid: dx=15mm, dy=15mm

Zoom Scan (5x5x7)/Cube 0: Measurement grid: dx=8mm, dy=8mm, dz=5mm

Reference Value = 23.16 V/m; Power Drift = 0.06 dB

Peak SAR (extrapolated) = 1.12 W/kg

SAR(1 g) = 0.705 W/kg

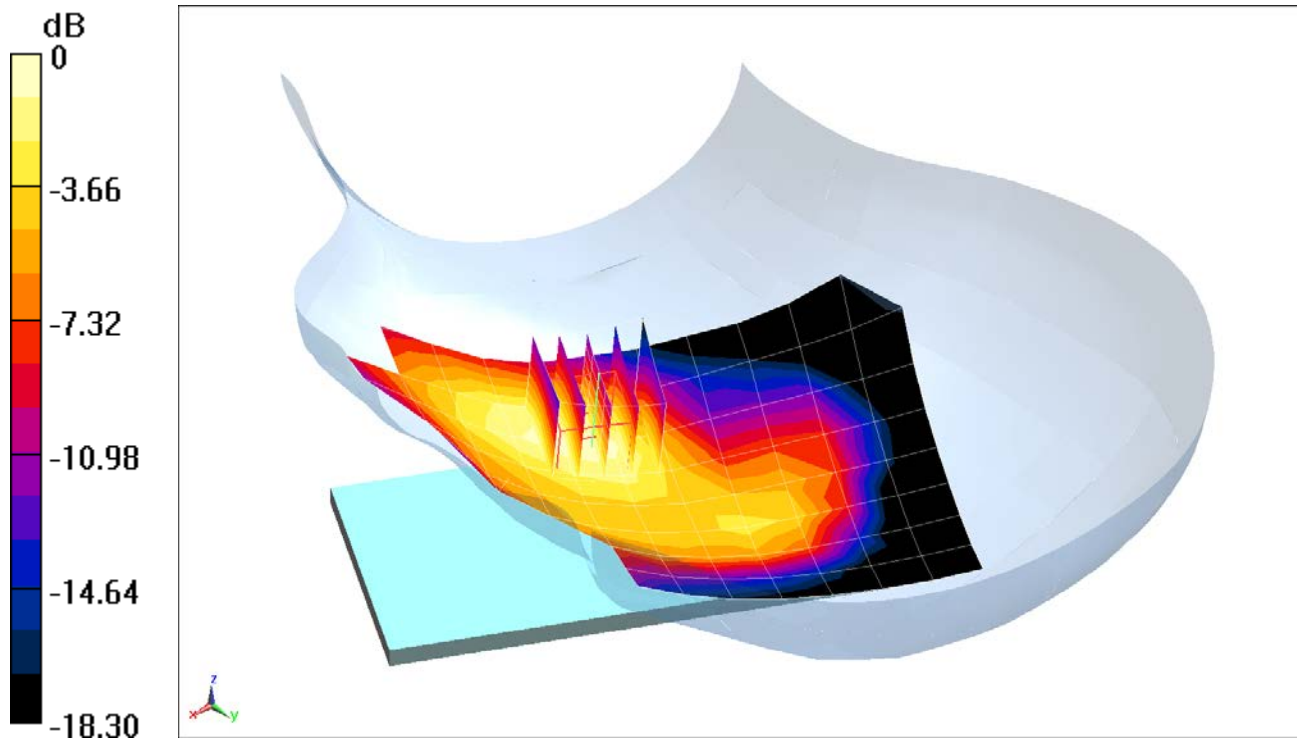

0 dB = 0.813 W/kg = -0.90 dBW/kg

PCTEST ENGINEERING LABORATORY, INC.

DUT: ZNFX410AS; Type: Portable Handset; Serial: 01199

Communication System: UID 0, LTE Band 12; Frequency: 707.5 MHz; Duty Cycle: 1:1

Medium: 750MHz Head Medium parameters used (interpolated):

$f = 707.5 \text{ MHz}$; $\sigma = 0.891 \text{ S/m}$; $\epsilon_r = 41.496$; $\rho = 1000 \text{ kg/m}^3$

Phantom section: Right Section

Test Date: 04-06-2018; Ambient Temp: 22.5°C; Tissue Temp: 22.0°C

Probe: EX3DV4 - SN7410; ConvF(10.6, 10.6, 10.6); Calibrated: 7/17/2017;

Sensor-Surface: 1.4mm (Mechanical Surface Detection)

Electronics: DAE4 Sn1322; Calibrated: 7/13/2017

Phantom: SAM with CRP v5.0 (Right); Type: QD000P40CD; Serial: TP:1759

Measurement SW: DASY52, Version 52.10;SEMCAD X Version 14.6.10 (7417)

**Mode: LTE Band 12, Right Head, Cheek, Mid.ch, 10 MHz Bandwidth,
QPSK, 1 RB, 0 RB Offset**

Area Scan (9x13x1): Measurement grid: dx=15mm, dy=15mm

Zoom Scan (6x5x7)/Cube 0: Measurement grid: dx=8mm, dy=8mm, dz=5mm

Reference Value = 20.72 V/m; Power Drift = -0.14 dB

Peak SAR (extrapolated) = 0.460 W/kg

SAR(1 g) = 0.375 W/kg

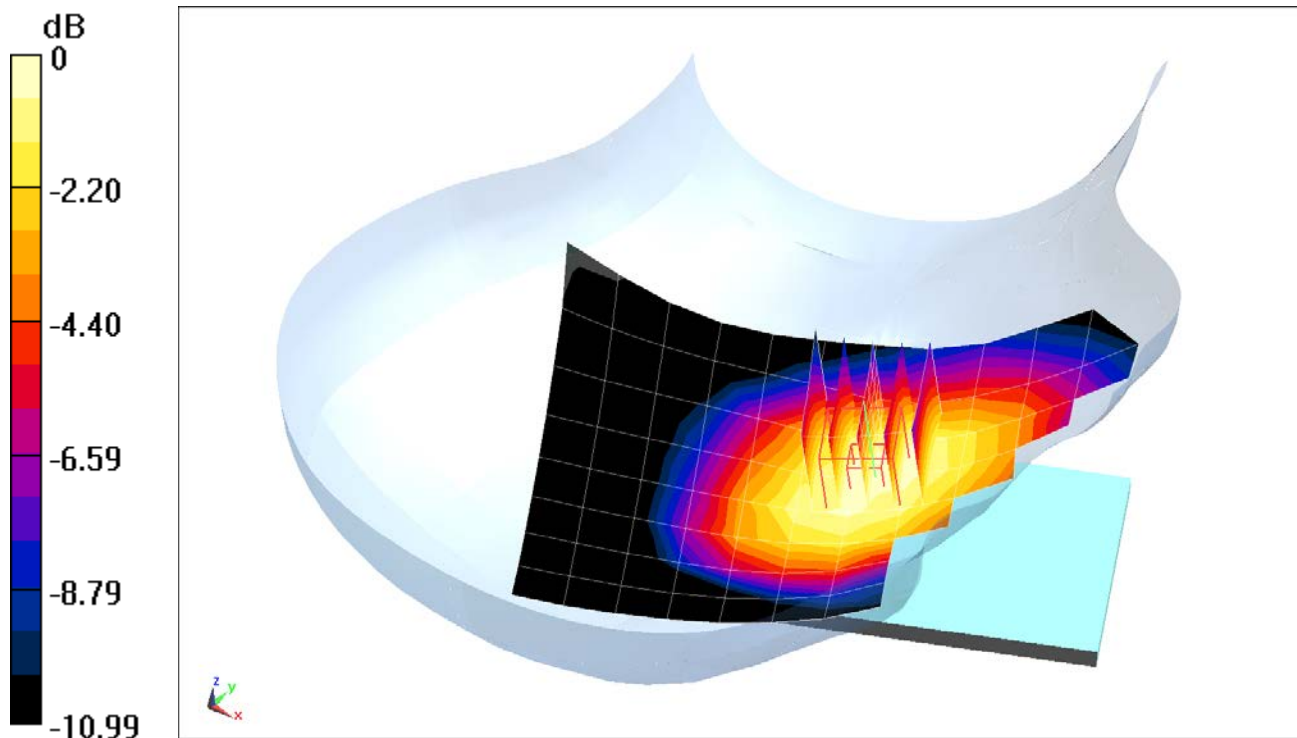

0 dB = 0.434 W/kg = -3.63 dBW/kg

PCTEST ENGINEERING LABORATORY, INC.

DUT: ZNFX410AS; Type: Portable Handset; Serial: 01199

Communication System: UID 0, LTE Band 14; Frequency: 793 MHz; Duty Cycle: 1:1
Medium: 750MHz Head Medium parameters used (interpolated):
 $f = 793 \text{ MHz}$; $\sigma = 0.921 \text{ S/m}$; $\epsilon_r = 41.271$; $\rho = 1000 \text{ kg/m}^3$
Phantom section: Right Section

Test Date: 04-06-2018; Ambient Temp: 22.5°C; Tissue Temp: 22.0°C

Probe: EX3DV4 - SN7410; ConvF(10.6, 10.6, 10.6); Calibrated: 7/17/2017;

Sensor-Surface: 1.4mm (Mechanical Surface Detection)

Electronics: DAE4 Sn1322; Calibrated: 7/13/2017

Phantom: SAM with CRP v5.0 (Right); Type: QD000P40CD; Serial: TP:1759

Measurement SW: DASY52, Version 52.10;SEMCAD X Version 14.6.10 (7417)

**Mode: LTE Band 14, Right Head, Cheek, Mid.ch, 10 MHz Bandwidth,
QPSK, 1 RB, 25 RB Offset**

Area Scan (9x13x1): Measurement grid: dx=15mm, dy=15mm

Zoom Scan (5x5x7)/Cube 0: Measurement grid: dx=8mm, dy=8mm, dz=5mm

Reference Value = 23.28 V/m; Power Drift = 0.05 dB

Peak SAR (extrapolated) = 0.575 W/kg

SAR(1 g) = 0.462 W/kg

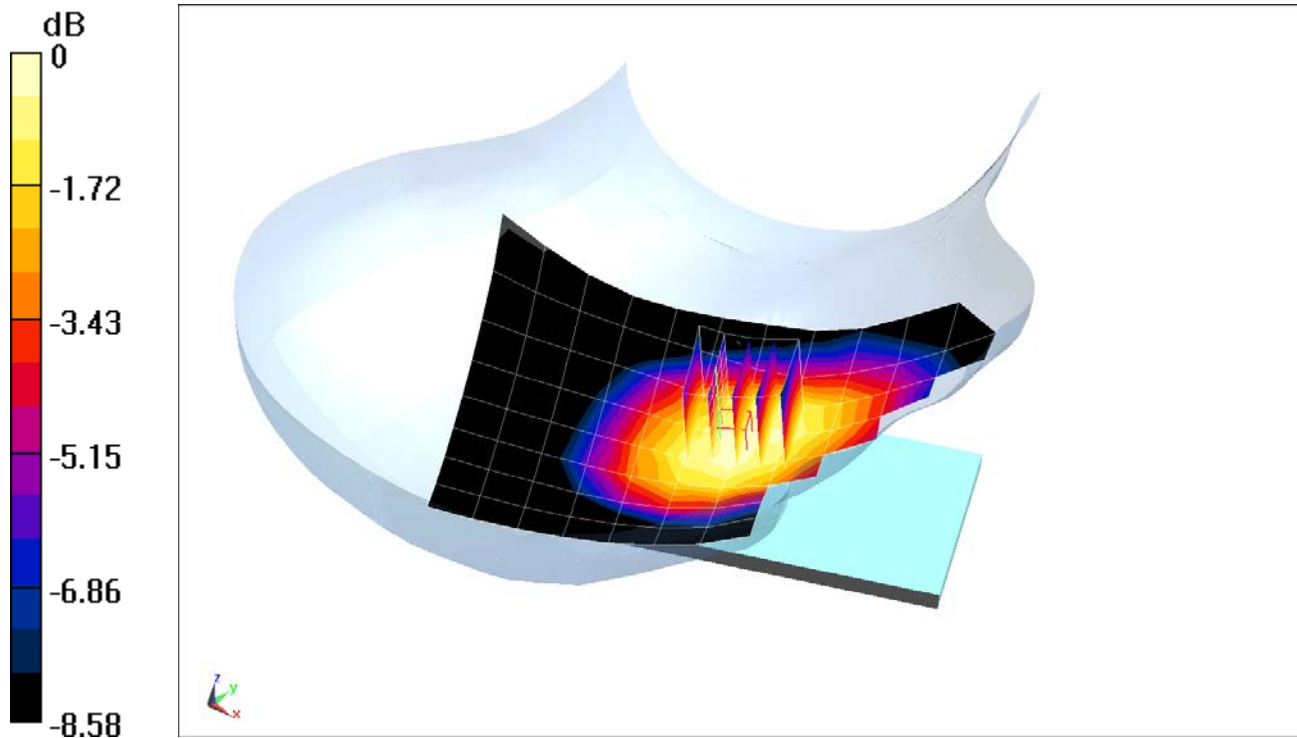

0 dB = 0.536 W/kg = -2.71 dBW/kg

PCTEST ENGINEERING LABORATORY, INC.

DUT: ZNFX410AS; Type: Portable Handset; Serial: 01199

Communication System: UID 0, LTE Band 5 (Cell.); Frequency: 836.5 MHz; Duty Cycle: 1:1
Medium: 835 Head Medium parameters used (interpolated):
 $f = 836.5 \text{ MHz}$; $\sigma = 0.921 \text{ S/m}$; $\epsilon_r = 42.427$; $\rho = 1000 \text{ kg/m}^3$
Phantom section: Right Section

Test Date: 04-02-2018; Ambient Temp: 19.8°C; Tissue Temp: 19.7°C

Probe: ES3DV3 - SN3213; ConvF(6.42, 6.42, 6.42); Calibrated: 2/13/2018;
Sensor-Surface: 3mm (Mechanical Surface Detection)
Electronics: DAE4 Sn1272; Calibrated: 2/9/2018
Phantom: SAM 5.0 front; Type: QD000P40CD; Serial: 1648
Measurement SW: DASY52, Version 52.10;SEMCAD X Version 14.6.10 (7417)

**Mode: LTE Band 5 (Cell.), Right Head, Cheek, Mid.ch, 10 MHz Bandwidth,
QPSK, 1 RB, 0 RB Offset**

Area Scan (9x15x1): Measurement grid: dx=15mm, dy=15mm
Zoom Scan (5x5x7)/Cube 0: Measurement grid: dx=8mm, dy=8mm, dz=5mm
Reference Value = 21.52 V/m; Power Drift = 0.15 dB
Peak SAR (extrapolated) = 0.484 W/kg
SAR(1 g) = 0.374 W/kg

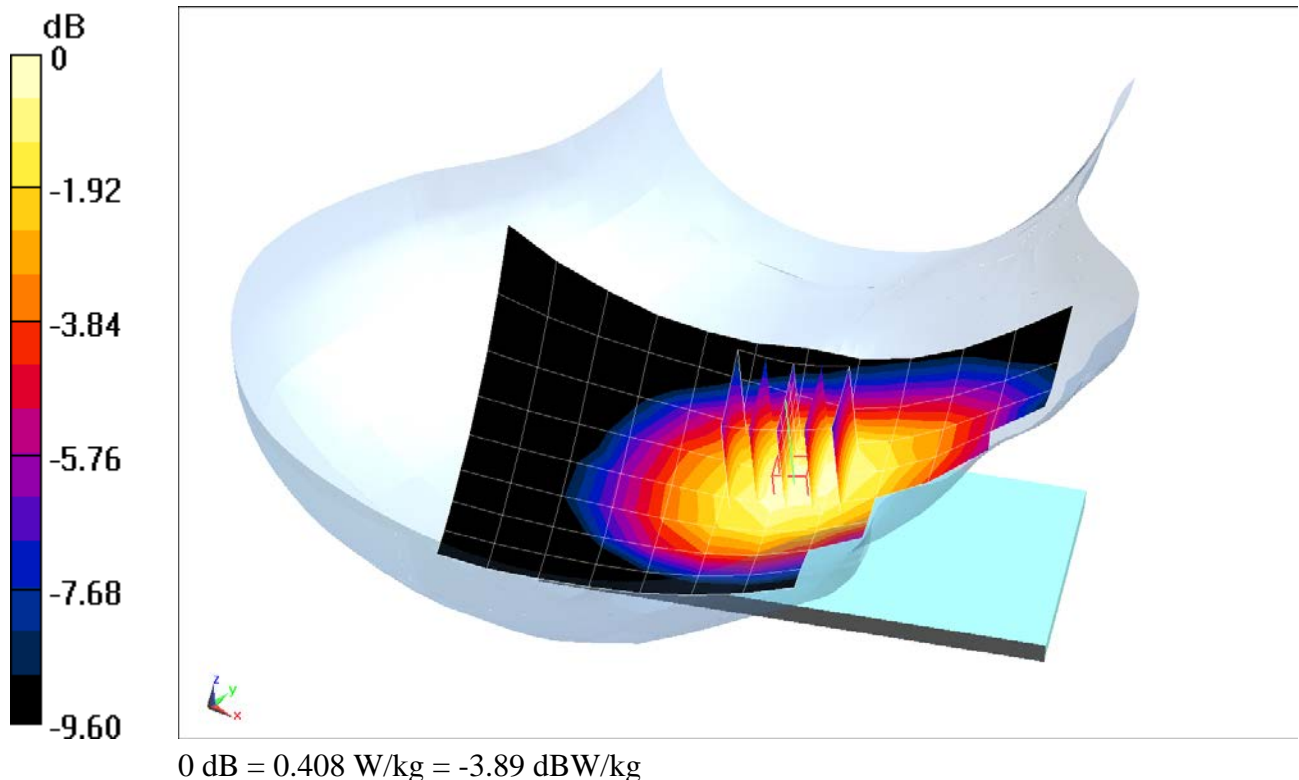

PCTEST ENGINEERING LABORATORY, INC.

DUT: ZNFX410AS; Type: Portable Handset; Serial: 01207

Communication System: UID 0, LTE Band 4 (AWS); Frequency: 1732.5 MHz; Duty Cycle: 1:1
Medium: 1750 Head Medium parameters used (interpolated):
 $f = 1732.5$ MHz; $\sigma = 1.37$ S/m; $\epsilon_r = 39.439$; $\rho = 1000$ kg/m³
Phantom section: Left Section

Test Date: 04-02-2018; Ambient Temp: 22.0°C; Tissue Temp: 21.4°C

Probe: EX3DV4 - SN7410; ConvF(8.66, 8.66, 8.66); Calibrated: 7/17/2017;

Sensor-Surface: 1.4mm (Mechanical Surface Detection)

Electronics: DAE4 Sn1322; Calibrated: 7/13/2017

Phantom: SAM with CRP v5.0 (Right); Type: QD000P40CD; Serial: TP:1759

Measurement SW: DASY52, Version 52.10; SEMCAD X Version 14.6.10 (7417)

**Mode: LTE Band 4 (AWS), Left Head, Cheek, Mid.ch, 20 MHz Bandwidth,
QPSK, 1 RB, 50 RB Offset**

Area Scan (9x15x1): Measurement grid: dx=15mm, dy=15mm

Zoom Scan (5x5x7)/Cube 0: Measurement grid: dx=8mm, dy=8mm, dz=5mm

Reference Value = 21.16 V/m; Power Drift = 0.00 dB

Peak SAR (extrapolated) = 0.799 W/kg

SAR(1 g) = 0.530 W/kg

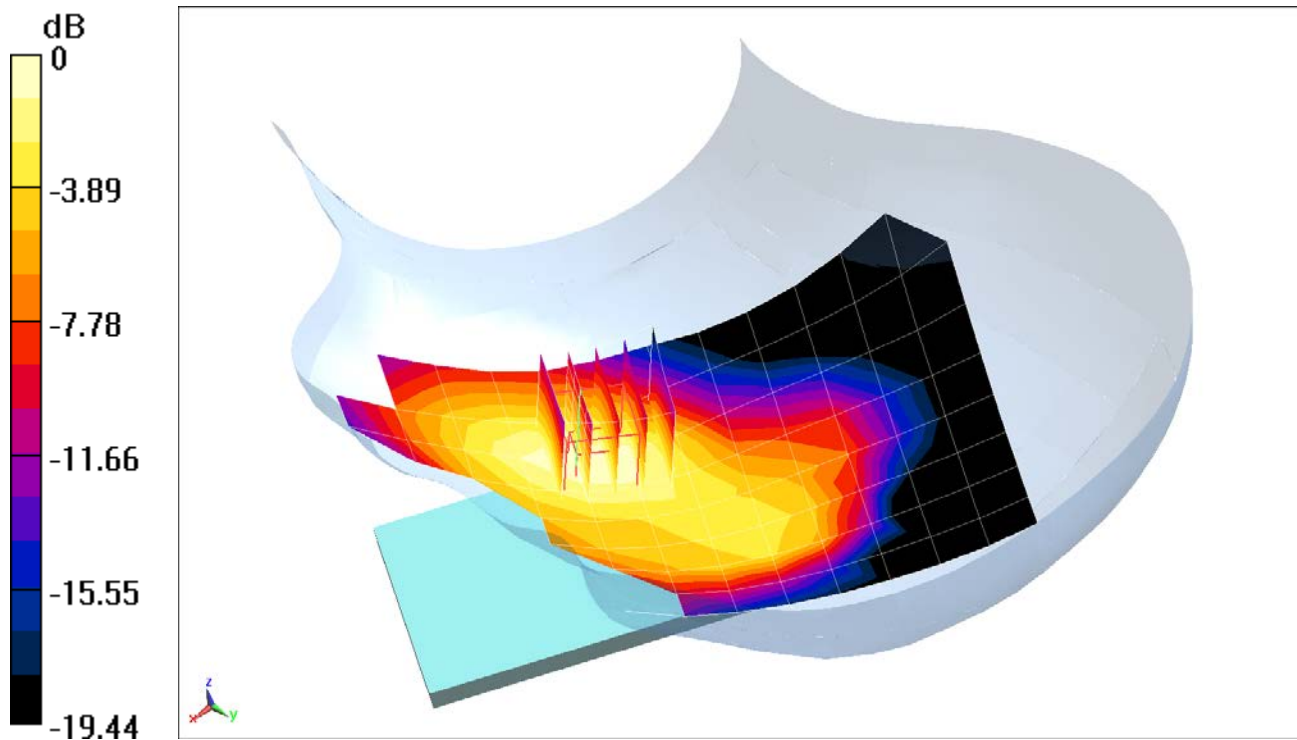

0 dB = 0.701 W/kg = -1.54 dBW/kg

PCTEST ENGINEERING LABORATORY, INC.

DUT: ZNFX410AS; Type: Portable Handset; Serial: 01199

Communication System: UID 0, LTE Band 2 (PCS); Frequency: 1880 MHz; Duty Cycle: 1:1

Medium: 1900 Head Medium parameters used:

$f = 1880 \text{ MHz}$; $\sigma = 1.407 \text{ S/m}$; $\epsilon_r = 40.025$; $\rho = 1000 \text{ kg/m}^3$

Phantom section: Left Section

Test Date: 04-05-2018; Ambient Temp: 22.2°C; Tissue Temp: 21.2°C

Probe: ES3DV3 - SN3332; ConvF(5.33, 5.33, 5.33); Calibrated: 8/14/2017;

Sensor-Surface: 3mm (Mechanical Surface Detection)

Electronics: DAE4 Sn1323; Calibrated: 8/9/2017

Phantom: SAM Left; Type: QD000P40CA; Serial: TP:82355

Measurement SW: DASY52, Version 52.10;SEMCAD X Version 14.6.10 (7417)

**Mode: LTE Band 2 (PCS), Left Head, Cheek, Mid.ch, 20 MHz Bandwidth,
QPSK, 1 RB, 50 RB Offset**

Area Scan (9x15x1): Measurement grid: dx=15mm, dy=15mm

Zoom Scan (5x5x7)/Cube 0: Measurement grid: dx=8mm, dy=8mm, dz=5mm

Reference Value = 24.89 V/m; Power Drift = 0.03 dB

Peak SAR (extrapolated) = 1.09 W/kg

SAR(1 g) = 0.717 W/kg

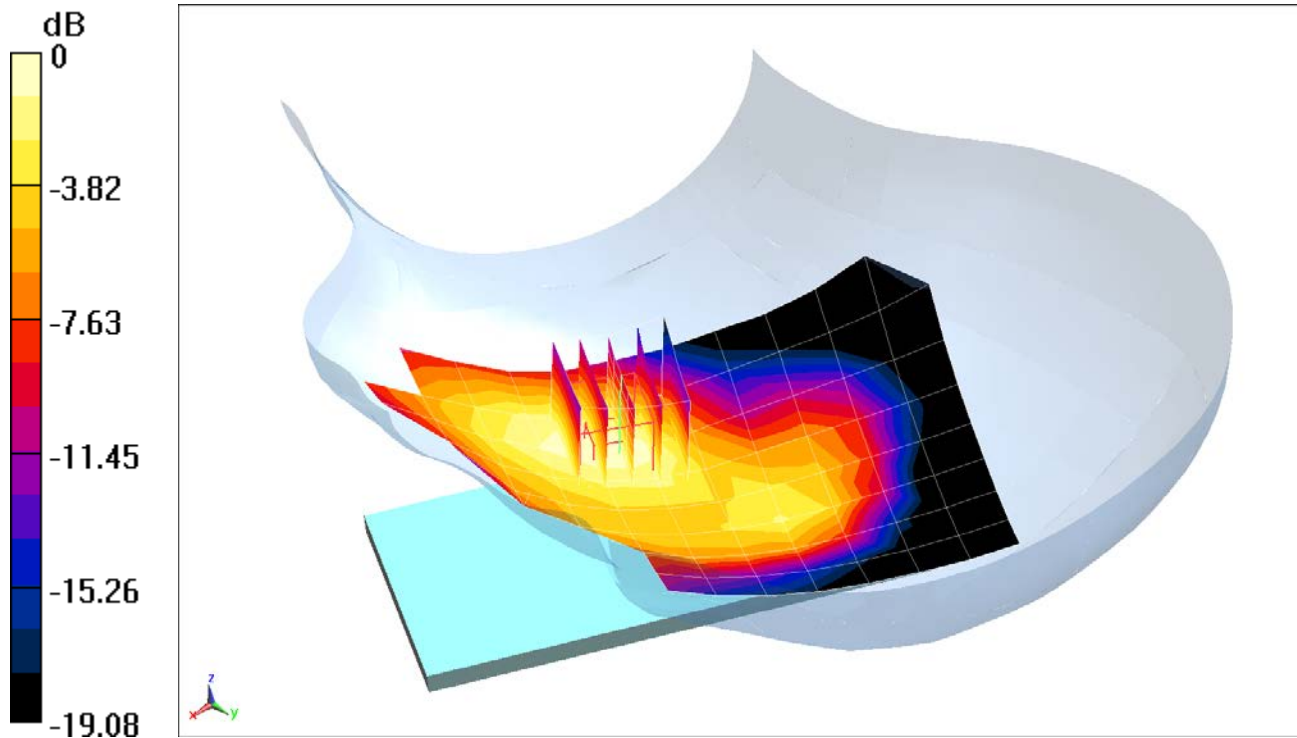

0 dB = 0.816 W/kg = -0.88 dBW/kg

PCTEST ENGINEERING LABORATORY, INC.

DUT: ZNFX410AS; Type: Portable Handset; Serial: 01355

Communication System: UID 0, _IEEE 802.11b; Frequency: 2437 MHz; Duty Cycle: 1:1
Medium: 2450 Head Medium parameters used (interpolated):
 $f = 2437 \text{ MHz}$; $\sigma = 1.794 \text{ S/m}$; $\epsilon_r = 40.152$; $\rho = 1000 \text{ kg/m}^3$
Phantom section: Right Section

Test Date: 03-28-2018; Ambient Temp: 22.3°C; Tissue Temp: 21.5°C

Probe: ES3DV3 - SN3332; ConvF(4.68, 4.68, 4.68); Calibrated: 8/14/2017;
Sensor-Surface: 3mm (Mechanical Surface Detection)
Electronics: DAE4 Sn1323; Calibrated: 8/9/2017
Phantom: SAM Front; Type: SAM; Serial: 1686
Measurement SW: DASY52, Version 52.10; SEMCAD X Version 14.6.10 (7417)

Mode: IEEE 802.11b, 22 MHz Bandwidth, Right Head, Cheek, Ch 6, 1 Mbps

Area Scan (11x18x1): Measurement grid: $dx=12\text{mm}$, $dy=12\text{mm}$

Zoom Scan (8x7x7)/Cube 0: Measurement grid: $dx=5\text{mm}$, $dy=5\text{mm}$, $dz=5\text{mm}$

Reference Value = 12.31 V/m; Power Drift = 0.16

Peak SAR (extrapolated) = 1.90 W/kg

SAR(1 g) = 0.856 W/kg

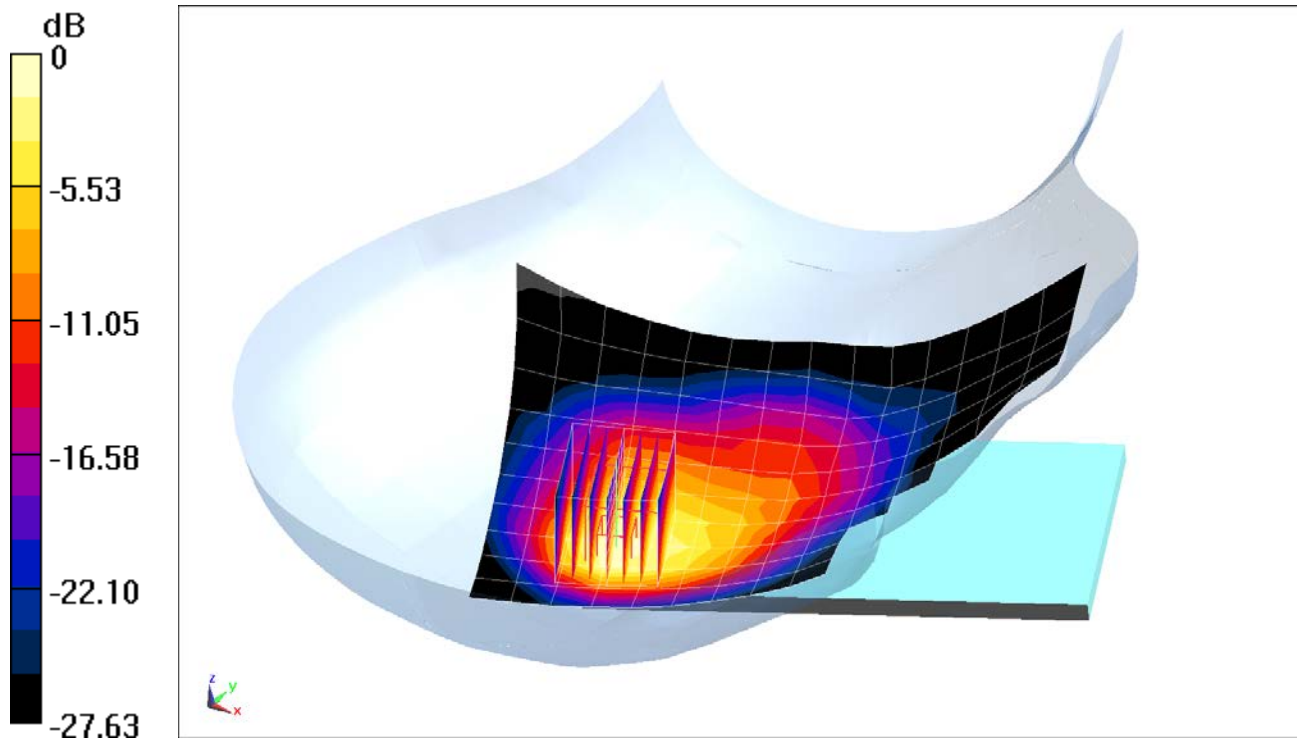

0 dB = 1.12 W/kg = 0.49 dBW/kg

PCTEST ENGINEERING LABORATORY, INC.

DUT: ZNFX410AS; Type: Portable Handset; Serial: 01363

Communication System: UID 0, 802.11a 5.2-5.8 GHz Band; Frequency: 5500 MHz; Duty Cycle: 1:1

Medium: 5GHz Head Medium parameters used:

$f = 5500 \text{ MHz}$; $\sigma = 4.752 \text{ S/m}$; $\epsilon_r = 34.587$; $\rho = 1000 \text{ kg/m}^3$

Phantom section: Right Section

Test Date: 04-05-2018; Ambient Temp: 22.5°C; Tissue Temp: 21.1°C

Probe: EX3DV4 - SN3589; ConvF(4.17, 4.17, 4.17); Calibrated: 1/16/2018;

Sensor-Surface: 1.4mm (Mechanical Surface Detection)

Electronics: DAE4 Sn1322; Calibrated: 7/13/2017

Phantom: SAM with CRP (Left); Type: SAM; Serial: 1715

Measurement SW: DASY52, Version 52.10; SEMCAD X Version 14.6.10 (7417)

**Mode: IEEE 802.11a, U-NII-2C, 20 MHz Bandwidth, Right Head, Tilt,
Ch 100, 6 Mbps**

Area Scan (13x20x1): Measurement grid: dx=10mm, dy=10mm

Zoom Scan (8x8x7)/Cube 0: Measurement grid: dx=4mm, dy=4mm, dz=1.4mm; Graded Ratio: 1.4

Reference Value = 0.8780 V/m; Power Drift = 0.14 dB

Peak SAR (extrapolated) = 2.75 W/kg

SAR(1 g) = 0.654 W/kg

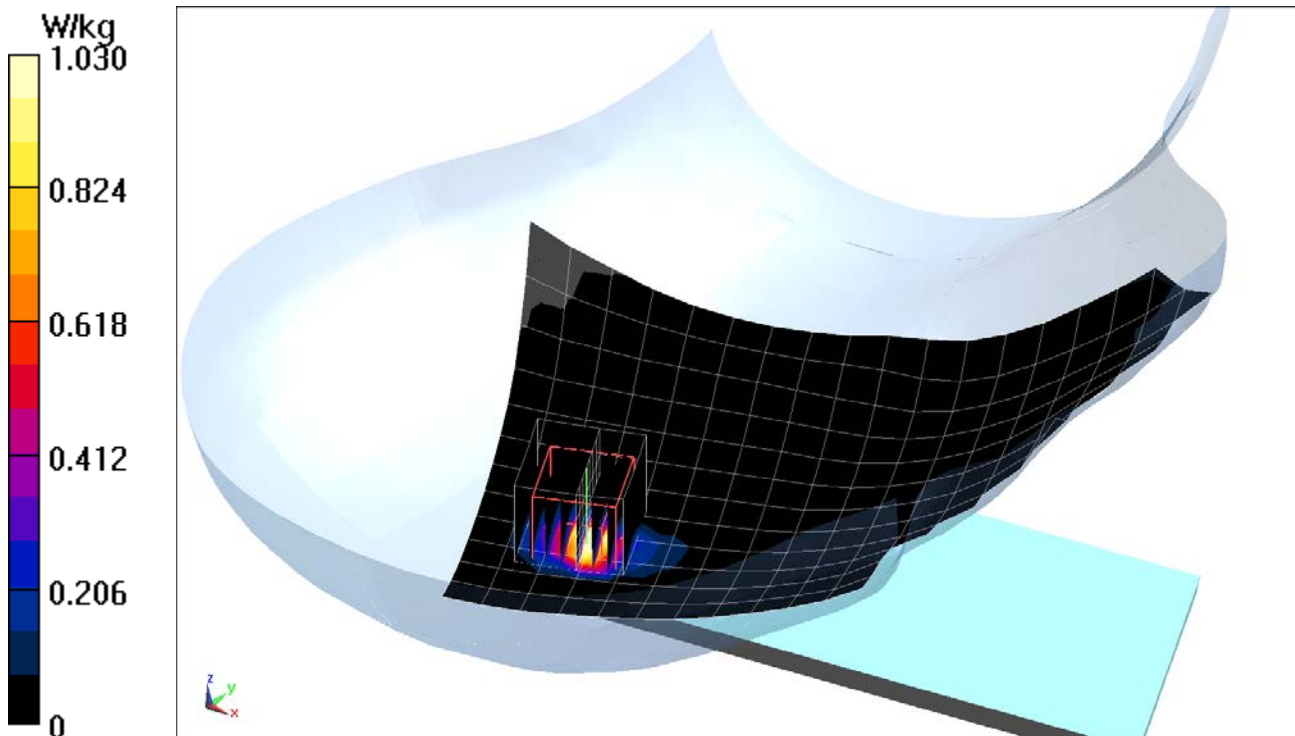

PCTEST ENGINEERING LABORATORY, INC.

DUT: ZNFX410AS; Type: Portable Handset; Serial: 01355

Communication System: UID 0, Bluetooth; Frequency: 2441 MHz; Duty Cycle: 1:1.294

Medium: 2450 Head Medium parameters used (interpolated):

$f = 2441$ MHz; $\sigma = 1.836$ S/m; $\epsilon_r = 39.449$; $\rho = 1000$ kg/m³

Phantom section: Right Section

Test Date: 04-11-2018; Ambient Temp: 22.1°C; Tissue Temp: 21.9°C

Probe: ES3DV3 - SN3332; ConvF(4.68, 4.68, 4.68); Calibrated: 8/14/2017;

Sensor-Surface: 3mm (Mechanical Surface Detection)

Electronics: DAE4 Sn1323; Calibrated: 8/9/2017

Phantom: SAM Front; Type: SAM; Serial: 1686

Measurement SW: DASY52, Version 52.10;SEMCAD X Version 14.6.10 (7417)

Mode: Bluetooth, Right Head, Cheek, Ch 39, 1Mbps

Area Scan (11x19x1): Measurement grid: dx=12mm, dy=12mm

Zoom Scan (7x7x7)/Cube 0: Measurement grid: dx=5mm, dy=5mm, dz=5mm

Reference Value = 6.696 V/m; Power Drift = 0.14 dB

Peak SAR (extrapolated) = 0.158 W/kg

SAR(1 g) = 0.068 W/kg

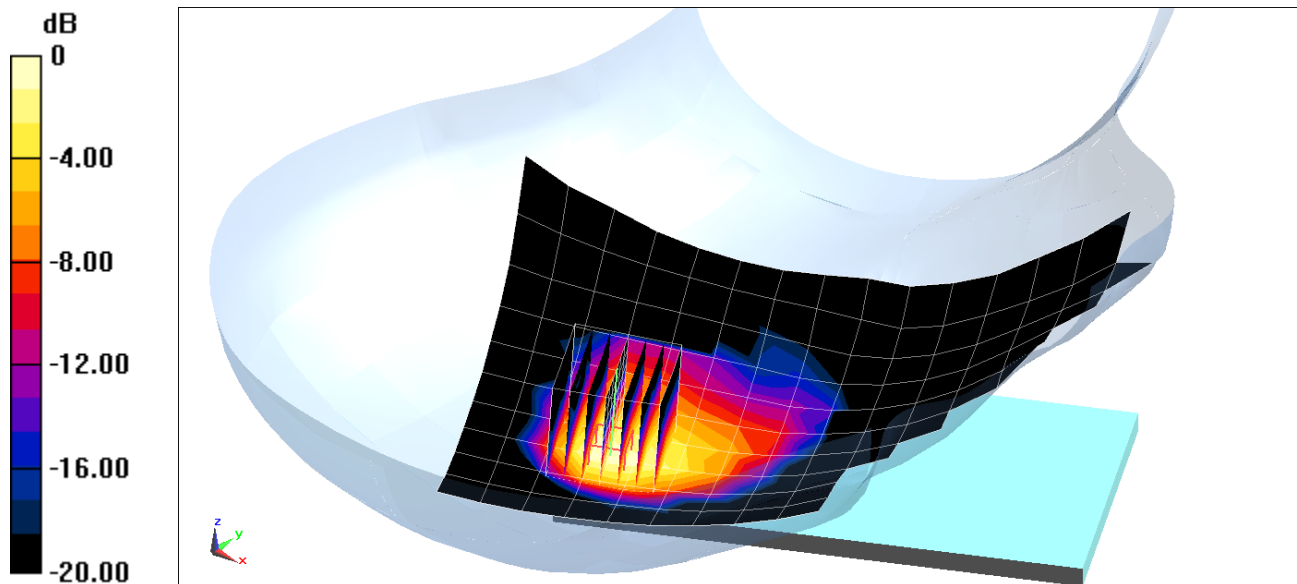

0 dB = 0.0896 W/kg = -10.48 dBW/kg

PCTEST ENGINEERING LABORATORY, INC.

DUT: ZNFX410AS; Type: Portable Handset; Serial: 01215

Communication System: UID 0, GSM GPRS; 2 Tx slots; Frequency: 836.6 MHz; Duty Cycle: 1:4.15
Medium: 835 Body Medium parameters used (interpolated):
 $f = 836.6 \text{ MHz}$; $\sigma = 0.976 \text{ S/m}$; $\epsilon_r = 54.281$; $\rho = 1000 \text{ kg/m}^3$
Phantom section: Flat Section; Space: 1.0 cm

Test Date: 04-06-2018; Ambient Temp: 24.2°C; Tissue Temp: 22.0°C

Probe: ES3DV3 - SN3213; ConvF(6.2, 6.2, 6.2); Calibrated: 2/13/2018;
Sensor-Surface: 3mm (Mechanical Surface Detection)
Electronics: DAE4 Sn1272; Calibrated: 2/9/2018

Phantom: SAM V5.0 Right; Type: QD000P40CD; Serial: 1647
Measurement SW: DASY52, Version 52.10; SEMCAD X Version 14.6.10 (7417)

Mode: GPRS 850, Body SAR, Back side, Mid.ch, 2 Tx Slots

Area Scan (9x15x1): Measurement grid: dx=15mm, dy=15mm

Zoom Scan (5x5x7)/Cube 0: Measurement grid: dx=8mm, dy=8mm, dz=5mm

Reference Value = 27.64 V/m; Power Drift = -0.06 dB

Peak SAR (extrapolated) = 0.873 W/kg

SAR(1 g) = 0.696 W/kg

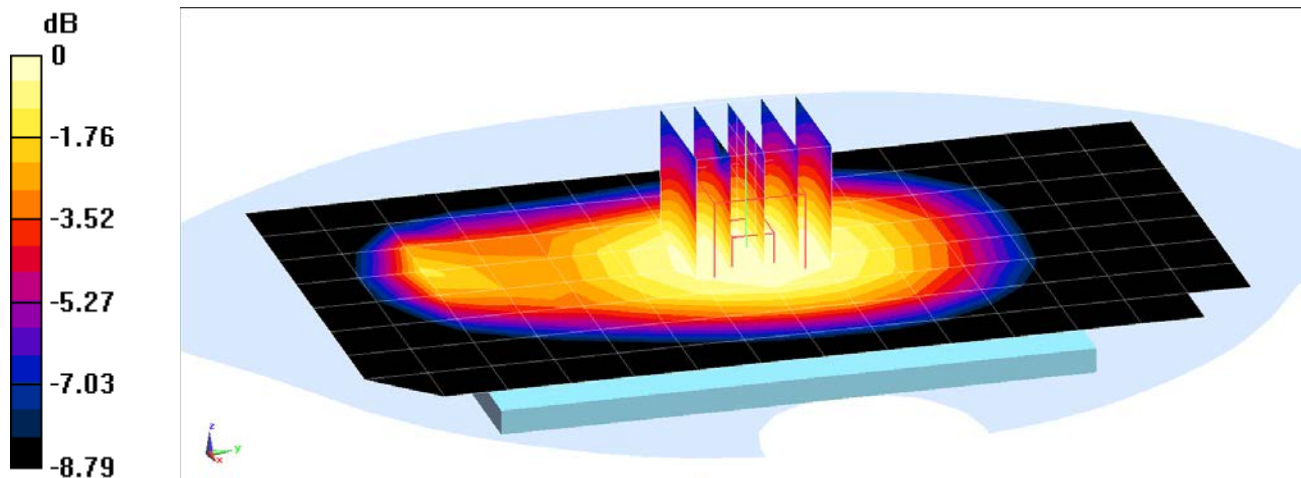

0 dB = 0.760 W/kg = -1.19 dBW/kg

PCTEST ENGINEERING LABORATORY, INC.

DUT: ZNFX410AS; Type: Portable Handset; Serial: 01207

Communication System: UID 0, GSM GPRS; 2 Tx slots; Frequency: 1880 MHz; Duty Cycle: 1:4.15

Medium: 1900 Body Medium parameters used:

$f = 1880 \text{ MHz}$; $\sigma = 1.553 \text{ S/m}$; $\epsilon_r = 53.793$; $\rho = 1000 \text{ kg/m}^3$

Phantom section: Flat Section; Space: 1.0 cm

Test Date: 04-05-2018; Ambient Temp: 21.9°C; Tissue Temp: 21.7°C

Probe: EX3DV4 - SN3914; ConvF(7.62, 7.62, 7.62); Calibrated: 2/14/2018;

Sensor-Surface: 1.4mm (Mechanical Surface Detection)

Electronics: DAE4 Sn665; Calibrated: 2/15/2018

Phantom: Twin-SAM V5.0 Right; Type: QD 000 P40 CD; Serial: 1800

Measurement SW: DASY52, Version 52.10;SEMCAD X Version 14.6.10 (7417)

Mode: GPRS 1900, Body SAR, Back side, Mid.ch, 2 Tx Slots

Area Scan (9x14x1): Measurement grid: dx=15mm, dy=15mm

Zoom Scan (5x5x7)/Cube 0: Measurement grid: dx=8mm, dy=8mm, dz=5mm

Reference Value = 17.20 V/m; Power Drift = 0.14 dB

Peak SAR (extrapolated) = 0.697 W/kg

SAR(1 g) = 0.441 W/kg

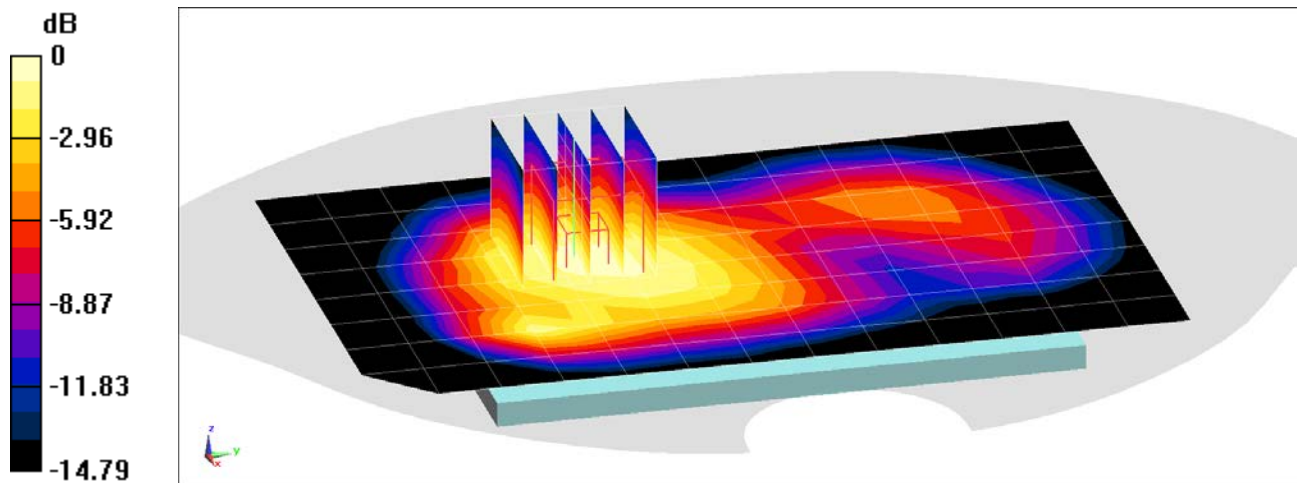

0 dB = 0.605 W/kg = -2.18 dBW/kg

PCTEST ENGINEERING LABORATORY, INC.

DUT: ZNFX410AS; Type: Portable Handset; Serial: 01215

Communication System: UID 0, UMTS; Frequency: 846.6 MHz; Duty Cycle: 1:1
Medium: 835 Body Medium parameters used (interpolated):
 $f = 846.6 \text{ MHz}$; $\sigma = 0.986 \text{ S/m}$; $\epsilon_r = 53.419$; $\rho = 1000 \text{ kg/m}^3$
Phantom section: Flat Section; Space: 1.0 cm

Test Date: 04-03-2018; Ambient Temp: 22.0°C; Tissue Temp: 21.3°C

Probe: ES3DV3 - SN3213; ConvF(6.2, 6.2, 6.2); Calibrated: 2/13/2018;
Sensor-Surface: 3mm (Mechanical Surface Detection)
Electronics: DAE4 Sn1272; Calibrated: 2/9/2018

Phantom: SAM V5.0 Right; Type: QD000P40CD; Serial: 1647
Measurement SW: DASY52, Version 52.10; SEMCAD X Version 14.6.10 (7417)

Mode: UMTS 850, Body SAR, Back side, High.ch

Area Scan (9x15x1): Measurement grid: dx=15mm, dy=15mm

Zoom Scan (5x5x7)/Cube 0: Measurement grid: dx=8mm, dy=8mm, dz=5mm

Reference Value = 27.92 V/m; Power Drift = 0.03 dB

Peak SAR (extrapolated) = 0.920 W/kg

SAR(1 g) = 0.715 W/kg

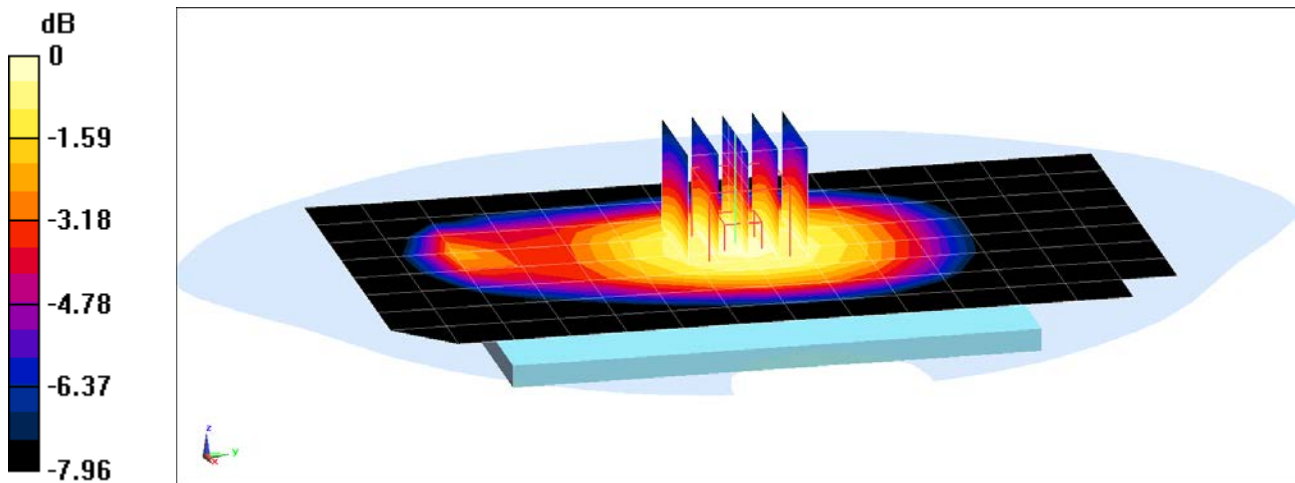

PCTEST ENGINEERING LABORATORY, INC.

DUT: ZNFX410AS; Type: Portable Handset; Serial: 01207

Communication System: UID 0, UMTS; Frequency: 1712.4 MHz; Duty Cycle: 1:1
Medium: 1750 Body Medium parameters used (interpolated):
 $f = 1712.4 \text{ MHz}$; $\sigma = 1.44 \text{ S/m}$; $\epsilon_r = 51.95$; $\rho = 1000 \text{ kg/m}^3$
Phantom section: Flat Section; Space: 1.0 cm

Test Date: 04-03-2018; Ambient Temp: 22.5°C; Tissue Temp: 22.1°C

Probe: EX3DV4 - SN7410; ConvF(8.32, 8.32, 8.32); Calibrated: 7/17/2017;
Sensor-Surface: 1.4mm (Mechanical Surface Detection)

Electronics: DAE4 Sn1322; Calibrated: 7/13/2017

Phantom: SAM with CRP v5.0 (Right); Type: QD000P40CD; Serial: TP:1759
Measurement SW: DASY52, Version 52.10; SEMCAD X Version 14.6.10 (7417)

Mode: UMTS 1750, Body SAR, Back side, Low.ch

Area Scan (9x15x1): Measurement grid: dx=15mm, dy=15mm

Zoom Scan (6x6x7)/Cube 0: Measurement grid: dx=8mm, dy=8mm, dz=5mm

Reference Value = 23.66 V/m; Power Drift = 0.04 dB

Peak SAR (extrapolated) = 1.22 W/kg

SAR(1 g) = 0.764 W/kg

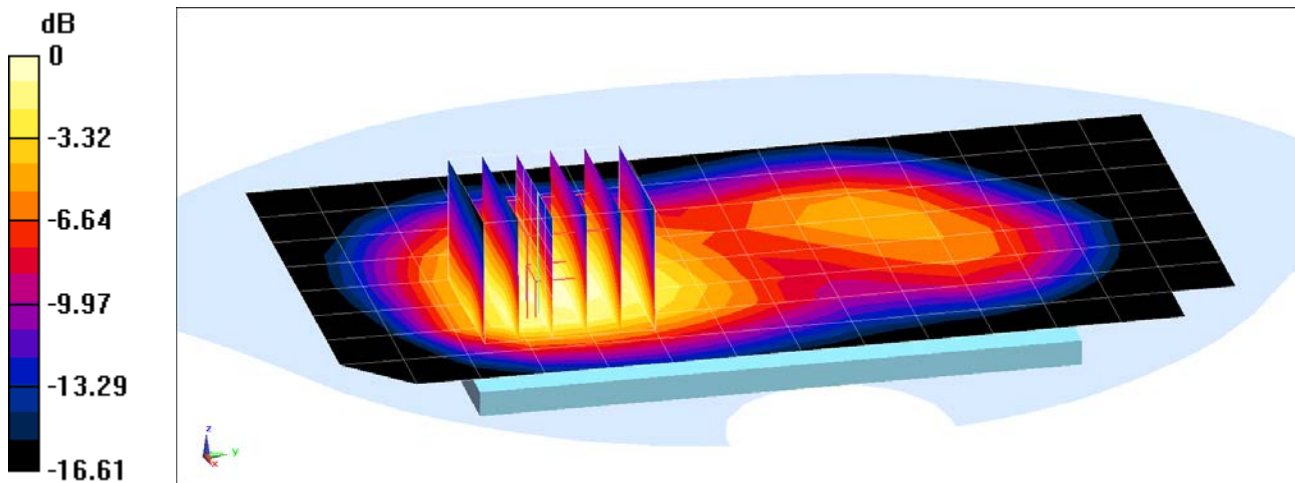

0 dB = 1.05 W/kg = 0.21 dBW/kg

PCTEST ENGINEERING LABORATORY, INC.

DUT: ZNFX410AS; Type: Portable Handset; Serial: 01207

Communication System: UID 0, UMTS; Frequency: 1907.6 MHz; Duty Cycle: 1:1
Medium: 1900 Body Medium parameters used (interpolated):
 $f = 1907.6$ MHz; $\sigma = 1.587$ S/m; $\epsilon_r = 53.995$; $\rho = 1000$ kg/m³
Phantom section: Flat Section; Space: 1.0 cm

Test Date: 04-02-2018; Ambient Temp: 21.0°C; Tissue Temp: 21.0°C

Probe: EX3DV4 - SN3914; ConvF(7.62, 7.62, 7.62); Calibrated: 2/14/2018;
Sensor-Surface: 1.4mm (Mechanical Surface Detection)

Electronics: DAE4 Sn665; Calibrated: 2/15/2018

Phantom: Twin-SAM V5.0 Right; Type: QD 000 P40 CD; Serial: 1800

Measurement SW: DASY52, Version 52.10;SEMCAD X Version 14.6.10 (7417)

Mode: UMTS 1900, Body SAR, Back side, High.ch

Area Scan (9x15x1): Measurement grid: dx=15mm, dy=15mm

Zoom Scan (5x5x7)/Cube 0: Measurement grid: dx=8mm, dy=8mm, dz=5mm

Reference Value = 25.47 V/m; Power Drift = 0.05 dB

Peak SAR (extrapolated) = 1.57 W/kg

SAR(1 g) = 0.978 W/kg

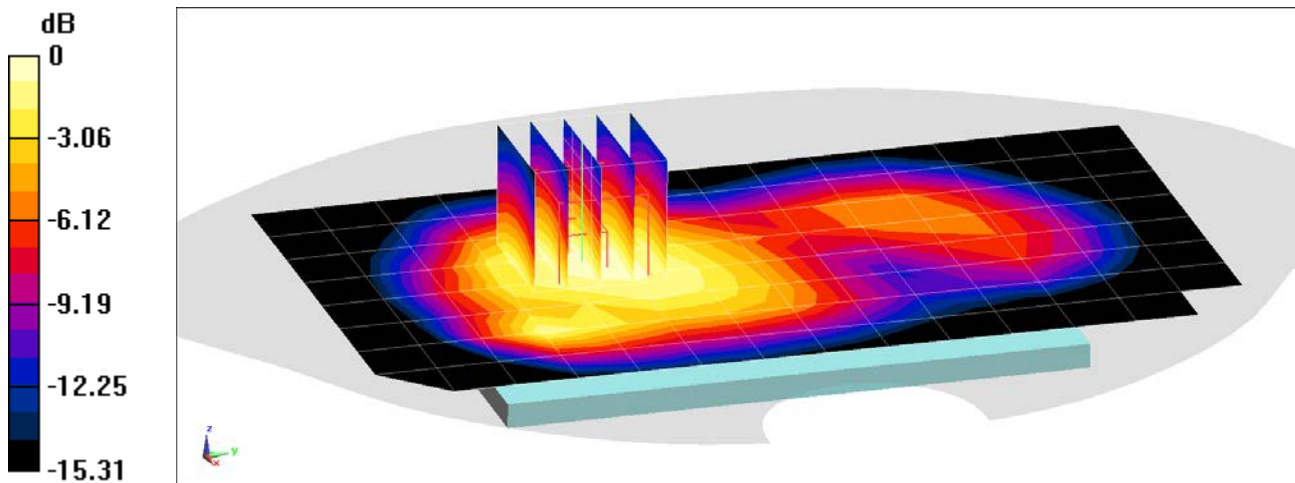

0 dB = 1.36 W/kg = 1.34 dBW/kg

PCTEST ENGINEERING LABORATORY, INC.

DUT: ZNFX410AS; Type: Portable Handset; Serial: 01207

Communication System: UID 0, LTE Band 12; Frequency: 707.5 MHz; Duty Cycle: 1:1
Medium: 750 Body Medium parameters used (interpolated):
 $f = 707.5 \text{ MHz}$; $\sigma = 0.973 \text{ S/m}$; $\epsilon_r = 53.129$; $\rho = 1000 \text{ kg/m}^3$
Phantom section: Flat Section; Space: 1.0 cm

Test Date: 04-03-2018; Ambient Temp: 22.0°C; Tissue Temp: 20.9°C

Probe: ES3DV3 - SN3287; ConvF(6.71, 6.71, 6.71); Calibrated: 9/18/2017;
Sensor-Surface: 3mm (Mechanical Surface Detection)
Electronics: DAE4 Sn1333; Calibrated: 6/21/2017
Phantom: Twin-SAM V5.0; Type: QD 000 P40 CD; Serial: 1692
Measurement SW: DASY52, Version 52.10; SEMCAD X Version 14.6.10 (7417)

**Mode: LTE Band 12, Body SAR, Back side, Mid.ch,
10 MHz Bandwidth, QPSK, 1 RB, 0 RB Offset**

Area Scan (9x13x1): Measurement grid: dx=15mm, dy=15mm
Zoom Scan (5x6x7)/Cube 0: Measurement grid: dx=8mm, dy=8mm, dz=5mm
Reference Value = 23.89 V/m; Power Drift = 0.08 dB
Peak SAR (extrapolated) = 0.838 W/kg
SAR(1 g) = 0.509 W/kg

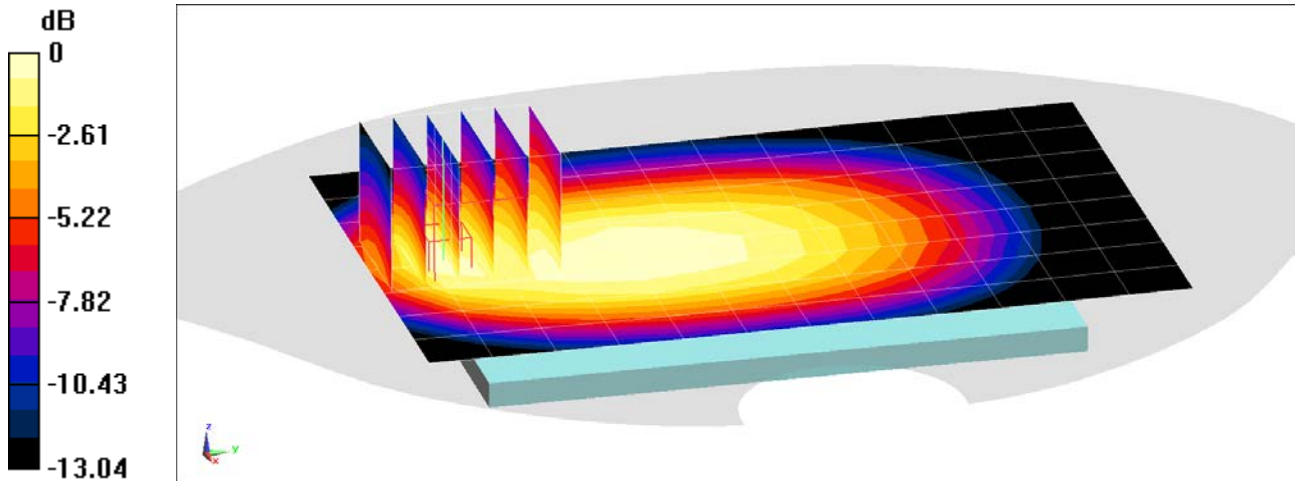

0 dB = 0.617 W/kg = -2.10 dBW/kg

PCTEST ENGINEERING LABORATORY, INC.

DUT: ZNFX410AS; Type: Portable Handset; Serial: 01199

Communication System: UID 0, LTE Band 14; Frequency: 793 MHz; Duty Cycle: 1:1
Medium: 750 Body Medium parameters used (interpolated):
 $f = 793 \text{ MHz}$; $\sigma = 1.006 \text{ S/m}$; $\epsilon_r = 52.921$; $\rho = 1000 \text{ kg/m}^3$
Phantom section: Flat Section; Space: 1.0 cm

Test Date: 04-03-2018; Ambient Temp: 22.0°C; Tissue Temp: 20.9°C

Probe: ES3DV3 - SN3287; ConvF(6.71, 6.71, 6.71); Calibrated: 9/18/2017;
Sensor-Surface: 3mm (Mechanical Surface Detection)
Electronics: DAE4 Sn1333; Calibrated: 6/21/2017
Phantom: Twin-SAM V5.0; Type: QD 000 P40 CD; Serial: 1692
Measurement SW: DASY52, Version 52.10; SEMCAD X Version 14.6.10 (7417)

**Mode: LTE Band 14, Body SAR, Back side, Mid.ch,
10 MHz Bandwidth, QPSK, 1 RB, 25 RB Offset**

Area Scan (9x13x1): Measurement grid: dx=15mm, dy=15mm

Zoom Scan (5x5x7)/Cube 0: Measurement grid: dx=8mm, dy=8mm, dz=5mm

Reference Value = 28.97 V/m; Power Drift = 0.20 dB

Peak SAR (extrapolated) = 1.10 W/kg

SAR(1 g) = 0.831 W/kg

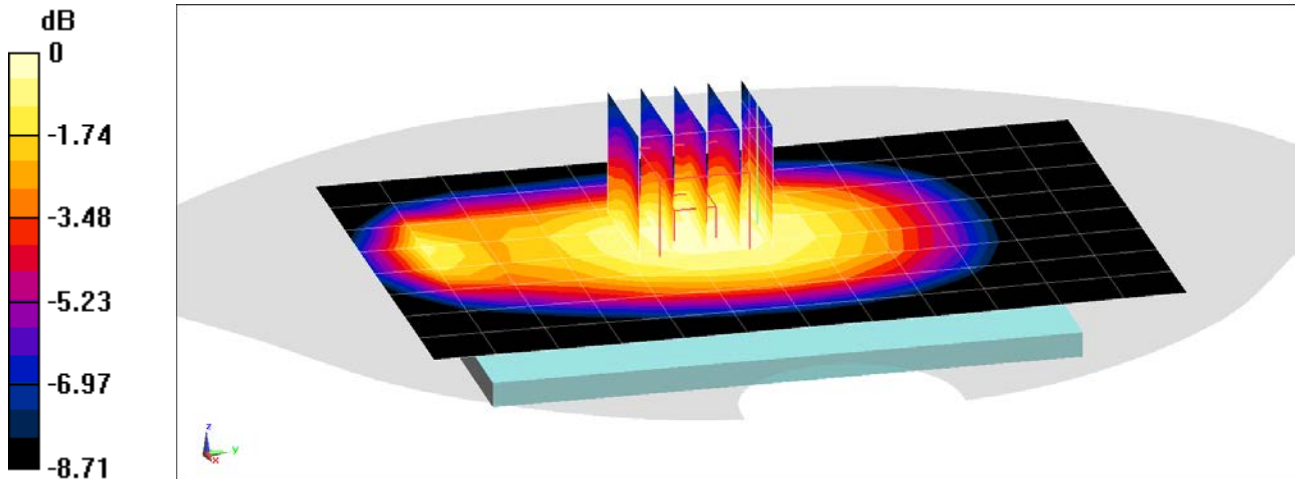

0 dB = 0.912 W/kg = -0.40 dBW/kg

PCTEST ENGINEERING LABORATORY, INC.

DUT: ZNFX410AS; Type: Portable Handset; Serial: 01215

Communication System: UID 0, LTE Band 5; Frequency: 836.5 MHz; Duty Cycle: 1:1
Medium: 835 Body Medium parameters used (interpolated):
 $f = 836.5 \text{ MHz}$; $\sigma = 0.976 \text{ S/m}$; $\epsilon_r = 54.282$; $\rho = 1000 \text{ kg/m}^3$
Phantom section: Flat Section; Space: 1.0 cm

Test Date: 04-06-2018; Ambient Temp: 24.2°C; Tissue Temp: 22.0°C

Probe: ES3DV3 - SN3213; ConvF(6.2, 6.2, 6.2); Calibrated: 2/13/2018;
Sensor-Surface: 3mm (Mechanical Surface Detection)
Electronics: DAE4 Sn1272; Calibrated: 2/9/2018

Phantom: SAM V5.0 Right; Type: QD000P40CD; Serial: 1647
Measurement SW: DASY52, Version 52.10; SEMCAD X Version 14.6.10 (7417)

**Mode: LTE Band 5 (Cell.), Body SAR, Back side, Mid.ch,
10 MHz Bandwidth, QPSK, 1 RB, 0 RB Offset**

Area Scan (9x15x1): Measurement grid: $dx=15\text{mm}$, $dy=15\text{mm}$

Zoom Scan (5x5x7)/Cube 0: Measurement grid: $dx=8\text{mm}$, $dy=8\text{mm}$, $dz=5\text{mm}$

Reference Value = 23.58 V/m; Power Drift = 0.10 dB

Peak SAR (extrapolated) = 0.634 W/kg

SAR(1 g) = 0.512 W/kg

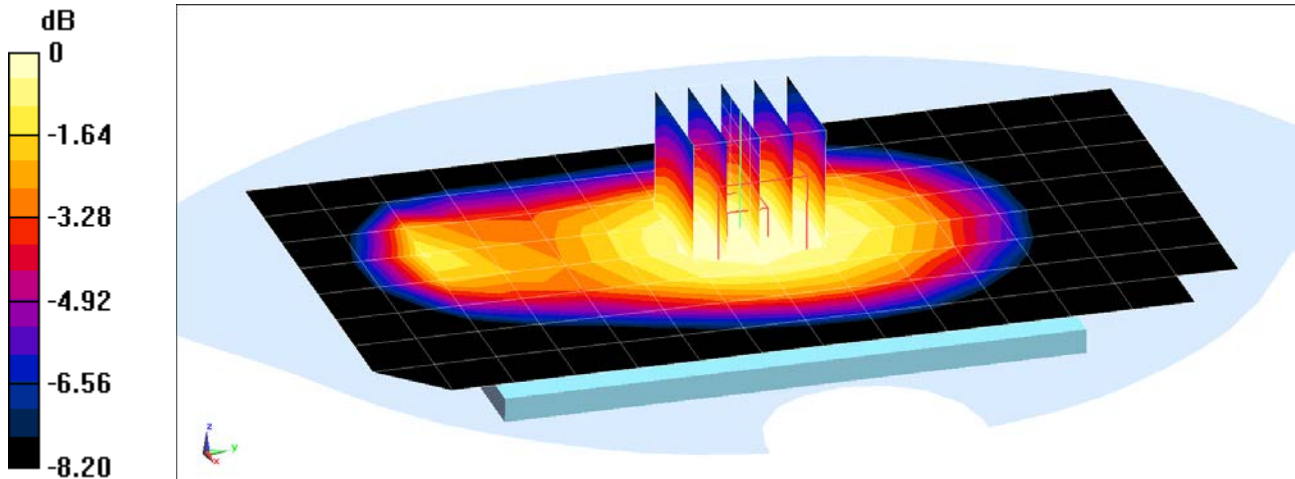

0 dB = 0.562 W/kg = -2.50 dBW/kg

PCTEST ENGINEERING LABORATORY, INC.

DUT: ZNFX410AS; Type: Portable Handset; Serial: 01215

Communication System: UID 0, LTE Band 4 (AWS); Frequency: 1732.5 MHz; Duty Cycle: 1:1
Medium: 1750 Body Medium parameters used (interpolated):
 $f = 1732.5$ MHz; $\sigma = 1.479$ S/m; $\epsilon_r = 51.939$; $\rho = 1000$ kg/m³
Phantom section: Flat Section; Space: 1.0 cm

Test Date: 04-05-2018; Ambient Temp: 22.6°C; Tissue Temp: 21.2°C

Probe: ES3DV3 - SN3287; ConvF(5.19, 5.19, 5.19); Calibrated: 9/18/2017;
Sensor-Surface: 3mm (Mechanical Surface Detection)
Electronics: DAE4 Sn1333; Calibrated: 6/21/2017
Phantom: Twin-SAM V4.0; Type: QD 000 P40 CC; Serial: 1692
Measurement SW: DASY52, Version 52.10; SEMCAD X Version 14.6.10 (7417)

**Mode: LTE Band 4 (AWS), Body SAR, Back side, Mid.ch,
20 MHz Bandwidth, QPSK, 1 RB, 50 RB Offset**

Area Scan (9x15x1): Measurement grid: dx=15mm, dy=15mm
Zoom Scan (7x6x7)/Cube 0: Measurement grid: dx=8mm, dy=8mm, dz=5mm
Reference Value = 25.22 V/m; Power Drift = -0.08 dB
Peak SAR (extrapolated) = 1.37 W/kg
SAR(1 g) = 0.878 W/kg

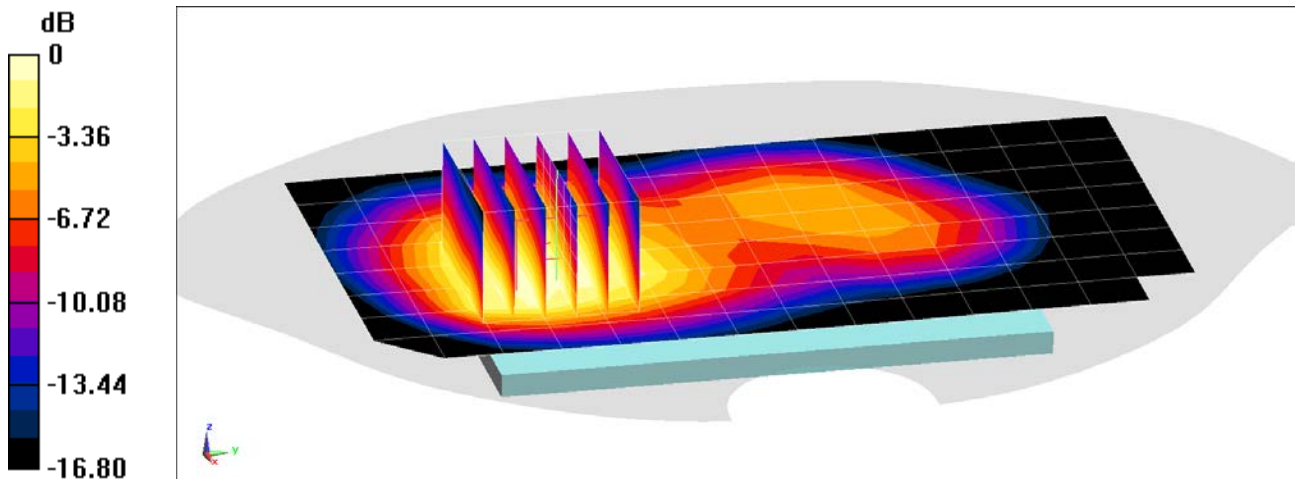

0 dB = 1.02 W/kg = 0.09 dBW/kg

PCTEST ENGINEERING LABORATORY, INC.

DUT: ZNFX410AS; Type: Portable Handset; Serial: 01207

Communication System: UID 0, LTE Band 2 (PCS); Frequency: 1860 MHz; Duty Cycle: 1:1
Medium: 1900 Body Medium parameters used (interpolated):
 $f = 1860 \text{ MHz}$; $\sigma = 1.533 \text{ S/m}$; $\epsilon_r = 54.161$; $\rho = 1000 \text{ kg/m}^3$
Phantom section: Flat Section; Space: 1.0 cm

Test Date: 04-02-2018; Ambient Temp: 21.0°C; Tissue Temp: 21.0°C

Probe: EX3DV4 - SN3914; ConvF(7.62, 7.62, 7.62); Calibrated: 2/14/2018;
Sensor-Surface: 1.4mm (Mechanical Surface Detection)

Electronics: DAE4 Sn665; Calibrated: 2/15/2018

Phantom: Twin-SAM V5.0 Right; Type: QD 000 P40 CD; Serial: 1800

Measurement SW: DASY52, Version 52.10; SEMCAD X Version 14.6.10 (7417)

**Mode: LTE Band 2 (PCS), Body SAR, Back side, Low.ch,
20 MHz Bandwidth, QPSK, 1 RB, 50 RB Offset**

Area Scan (9x15x1): Measurement grid: dx=15mm, dy=15mm

Zoom Scan (5x5x7)/Cube 0: Measurement grid: dx=8mm, dy=8mm, dz=5mm

Reference Value = 26.76 V/m; Power Drift = -0.11 dB

Peak SAR (extrapolated) = 1.61 W/kg

SAR(1 g) = 1.03 W/kg

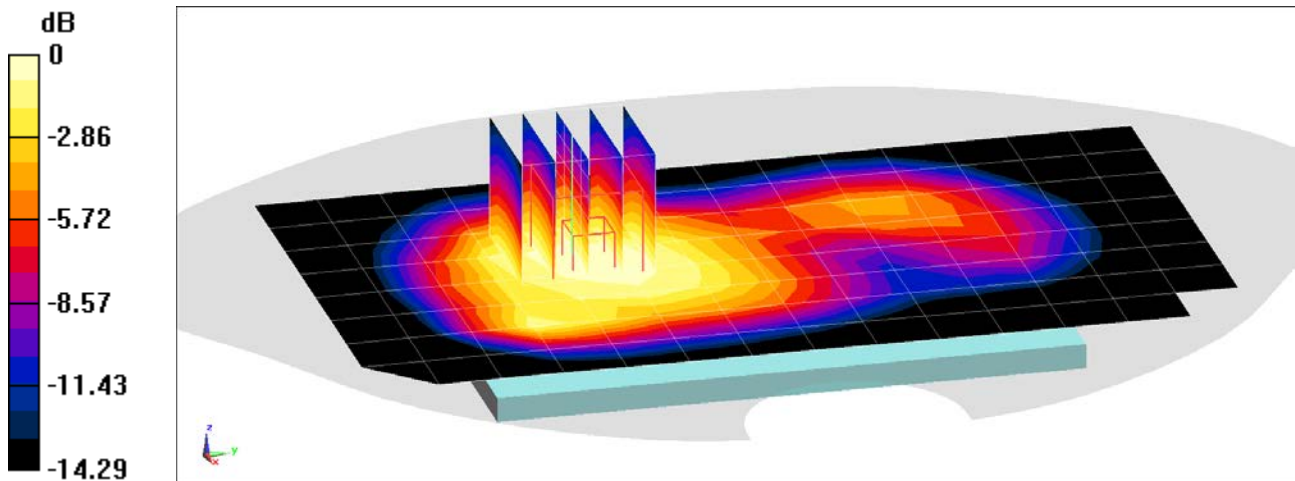

0 dB = 1.38 W/kg = 1.40 dBW/kg

PCTEST ENGINEERING LABORATORY, INC.

DUT: ZNFX410AS; Type: Portable Handset; Serial: 01207

Communication System: UID 0, LTE Band 2 (PCS); Frequency: 1880 MHz; Duty Cycle: 1:1

Medium: 1900 Body Medium parameters used:

$f = 1880 \text{ MHz}$; $\sigma = 1.555 \text{ S/m}$; $\epsilon_r = 54.092$; $\rho = 1000 \text{ kg/m}^3$

Phantom section: Flat Section; Space: 1.0 cm

Test Date: 04-02-2018; Ambient Temp: 21.0°C; Tissue Temp: 21.0°C

Probe: EX3DV4 - SN3914; ConvF(7.62, 7.62, 7.62); Calibrated: 2/14/2018;

Sensor-Surface: 1.4mm (Mechanical Surface Detection)

Electronics: DAE4 Sn665; Calibrated: 2/15/2018

Phantom: Twin-SAM V5.0 Right; Type: QD 000 P40 CD; Serial: 1800

Measurement SW: DASY52, Version 52.10; SEMCAD X Version 14.6.10 (7417)

**Mode: LTE Band 2 (PCS), Body SAR, Front side, Mid.ch,
20 MHz Bandwidth, QPSK, 1 RB, 50 RB Offset**

Area Scan (9x15x1): Measurement grid: dx=15mm, dy=15mm

Zoom Scan (6x6x7)/Cube 0: Measurement grid: dx=8mm, dy=8mm, dz=5mm

Reference Value = 25.86 V/m; Power Drift = -0.15 dB

Peak SAR (extrapolated) = 1.63 W/kg

SAR(1 g) = 1.03 W/kg

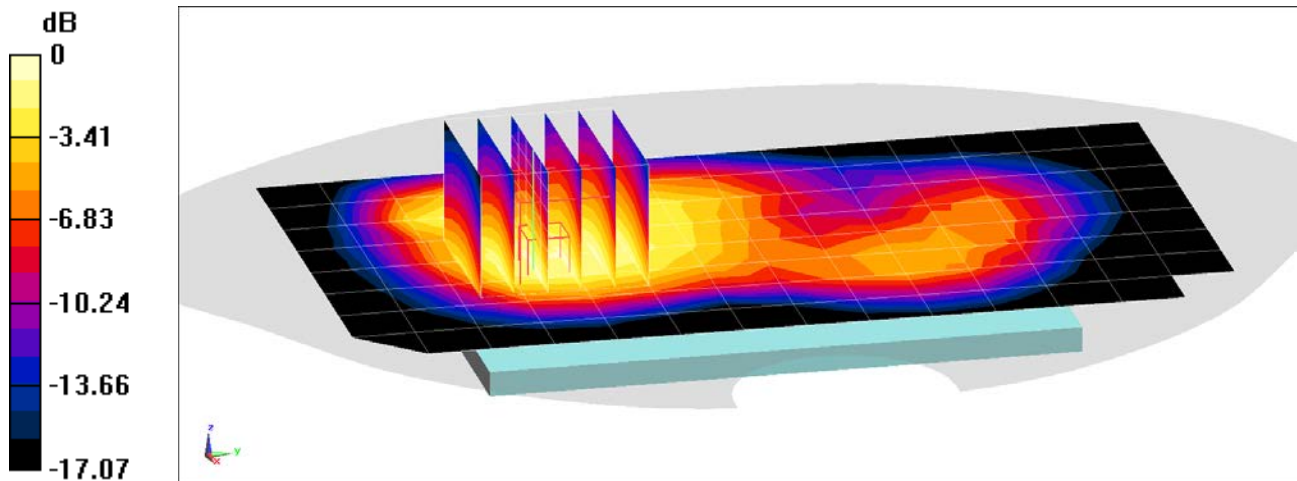

0 dB = 1.40 W/kg = 1.46 dBW/kg

PCTEST ENGINEERING LABORATORY, INC.

DUT: ZNFX410AS; Type: Portable Handset; Serial: 01355

Communication System: UID 0, 802.11b; Frequency: 2462 MHz; Duty Cycle: 1:1
Medium: 2450 Body Medium parameters used (interpolated):
 $f = 2462 \text{ MHz}$; $\sigma = 2.058 \text{ S/m}$; $\epsilon_r = 51.094$; $\rho = 1000 \text{ kg/m}^3$
Phantom section: Flat Section; Space: 1.0 cm

Test Date: 04-03-2018; Ambient Temp: 22.4°C; Tissue Temp: 21.6°C

Probe: ES3DV3 - SN3319; ConvF(4.51, 4.51, 4.51); Calibrated: 3/13/2018;
Sensor-Surface: 3mm (Mechanical Surface Detection)
Electronics: DAE4 Sn1368; Calibrated: 3/7/2018
Phantom: Right Twin-SAM V5.0; Type: QD 000 P40 CD; Serial: 1797
Measurement SW: DASY52, Version 52.10; SEMCAD X Version 14.6.10 (7417)

Mode: IEEE 802.11b, 22 MHz Bandwidth, Body SAR, Ch 11, 1 Mbps, Back Side

Area Scan (11x17x1): Measurement grid: dx=12mm, dy=12mm
Zoom Scan (7x7x7)/Cube 0: Measurement grid: dx=5mm, dy=5mm, dz=5mm
Reference Value = 9.060 V/m; Power Drift = -0.02 dB
Peak SAR (extrapolated) = 0.302 W/kg
SAR(1 g) = 0.153 W/kg

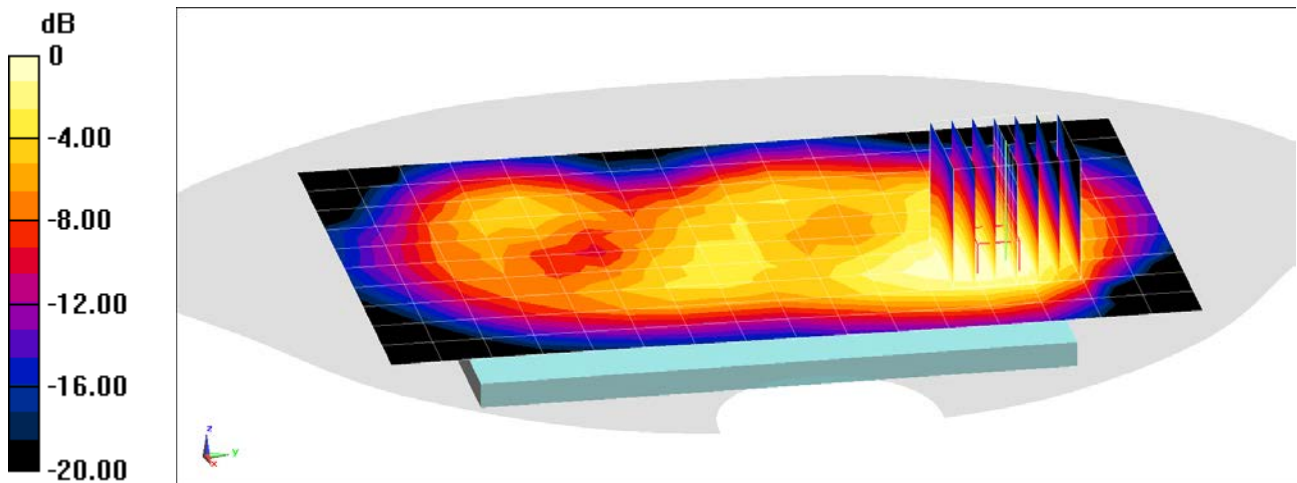

0 dB = 0.187 W/kg = -7.28 dBW/kg

PCTEST ENGINEERING LABORATORY, INC.

DUT: ZNFX410AS; Type: Portable Handset; Serial: 01355

Communication System: UID 0, 802.11b; Frequency: 2462 MHz; Duty Cycle: 1:1
Medium: 2450 Body Medium parameters used (interpolated):
 $f = 2462 \text{ MHz}$; $\sigma = 2.058 \text{ S/m}$; $\epsilon_r = 51.094$; $\rho = 1000 \text{ kg/m}^3$
Phantom section: Flat Section; Space: 1.0 cm

Test Date: 04-03-2018; Ambient Temp: 22.4°C; Tissue Temp: 21.6°C

Probe: ES3DV3 - SN3319; ConvF(4.51, 4.51, 4.51); Calibrated: 3/13/2018;
Sensor-Surface: 3mm (Mechanical Surface Detection)
Electronics: DAE4 Sn1368; Calibrated: 3/7/2018
Phantom: Right Twin-SAM V5.0; Type: QD 000 P40 CD; Serial: 1797
Measurement SW: DASY52, Version 52.10; SEMCAD X Version 14.6.10 (7417)

Mode: IEEE 802.11b, 22 MHz Bandwidth, Body SAR, Ch 11, 1 Mbps, Front Side

Area Scan (11x17x1): Measurement grid: dx=12mm, dy=12mm

Zoom Scan (7x7x7)/Cube 0: Measurement grid: dx=5mm, dy=5mm, dz=5mm

Reference Value = 5.577 V/m; Power Drift = 0.08 dB

Peak SAR (extrapolated) = 0.300 W/kg

SAR(1 g) = 0.156 W/kg

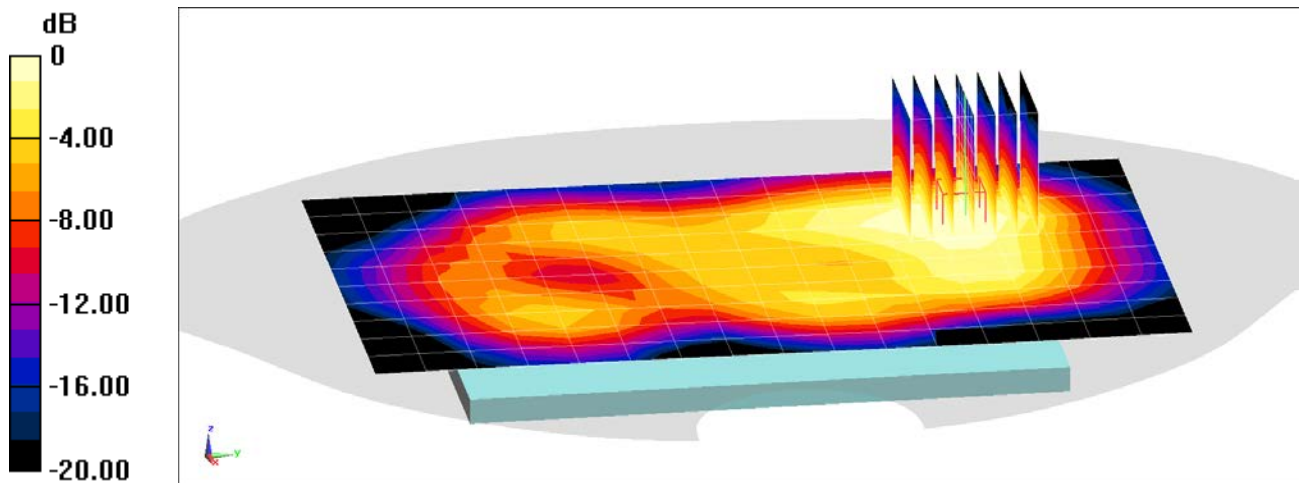

0 dB = 0.193 W/kg = -7.14 dBW/kg

PCTEST ENGINEERING LABORATORY, INC.

DUT: ZNFX410AS; Type: Portable Handset; Serial: 01363

Communication System: UID 0, 802.11a 5.2-5.8 GHz Band; Frequency: 5260 MHz; Duty Cycle: 1:1

Medium: 5 GHz Body Medium parameters used:

$f = 5260 \text{ MHz}$; $\sigma = 5.499 \text{ S/m}$; $\epsilon_r = 47.203$; $\rho = 1000 \text{ kg/m}^3$

Phantom section: Flat Section; Space: 1.0 cm

Test Date: 04-02-2018; Ambient Temp: 22.5°C; Tissue Temp: 20.6°C

Probe: EX3DV4 - SN7308; ConvF(4.84, 4.84, 4.84); Calibrated: 8/16/2017;

Sensor-Surface: 1.4mm (Mechanical Surface Detection)

Electronics: DAE4 Sn1334; Calibrated: 6/14/2017

Phantom: SAM with CRP v5.0 Front; Type: QD000P40CD; Serial: 1646

Measurement SW: DASY52, Version 52.10;SEMCAD X Version 14.6.10 (7417)

Mode: IEEE 802.11a, UNII-2A, 20 MHz Bandwidth, Body SAR, Ch 52, 6 Mbps, Back Side

Area Scan (13x22x1): Measurement grid: dx=10mm, dy=10mm

Zoom Scan (7x7x7)/Cube 0: Measurement grid: dx=4mm, dy=4mm, dz=1.4mm; Graded Ratio: 1.4

Reference Value = 4.025 V/m; Power Drift = 0.14 dB

Peak SAR (extrapolated) = 0.492 W/kg

SAR(1 g) = 0.102 W/kg

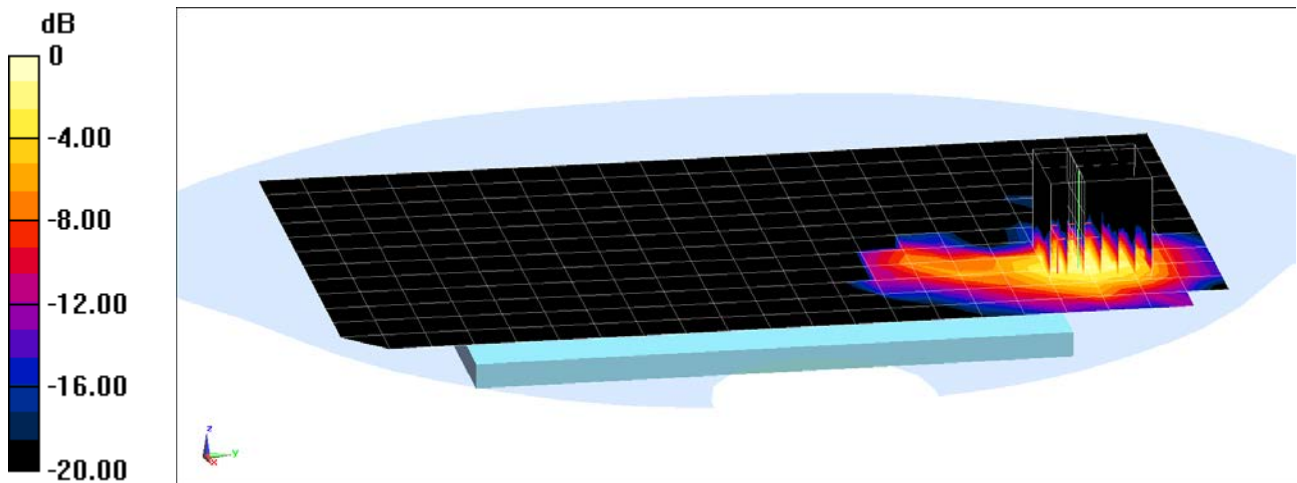

0 dB = 0.272 W/kg = -5.65 dBW/kg

PCTEST ENGINEERING LABORATORY, INC.

DUT: ZNFX410AS; Type: Portable Handset; Serial: 01363

Communication System: UID 0, 802.11a 5.2-5.8 GHz Band; Frequency: 5180 MHz; Duty Cycle: 1:1

Medium: 5 GHz Body Medium parameters used:

$f = 5180 \text{ MHz}$; $\sigma = 5.396 \text{ S/m}$; $\epsilon_r = 47.784$; $\rho = 1000 \text{ kg/m}^3$

Phantom section: Flat Section; Space: 1.0 cm

Test Date: 04-09-2018; Ambient Temp: 22.1°C; Tissue Temp: 21.9°C

Probe: EX3DV4 - SN7308; ConvF(4.84, 4.84, 4.84); Calibrated: 8/16/2017;

Sensor-Surface: 1.4mm (Mechanical Surface Detection)

Electronics: DAE4 Sn1334; Calibrated: 6/14/2017

Phantom: SAM with CRP v5.0 Front; Type: QD000P40CD; Serial: 1646

Measurement SW: DASY52, Version 52.10;SEMCAD X Version 14.6.10 (7417)

Mode: IEEE 802.11a, U-NII-1, 20 MHz Bandwidth, Body SAR, Ch 36, 6 Mbps, Top Edge

Area Scan (9x17x1): Measurement grid: dx=5mm, dy=10mm

Zoom Scan (7x7x7)/Cube 0: Measurement grid: dx=4mm, dy=4mm, dz=1.4mm; Graded Ratio: 1.4

Reference Value = 5.238 V/m; Power Drift = -0.12 dB

Peak SAR (extrapolated) = 0.544 W/kg

SAR(1 g) = 0.141 W/kg

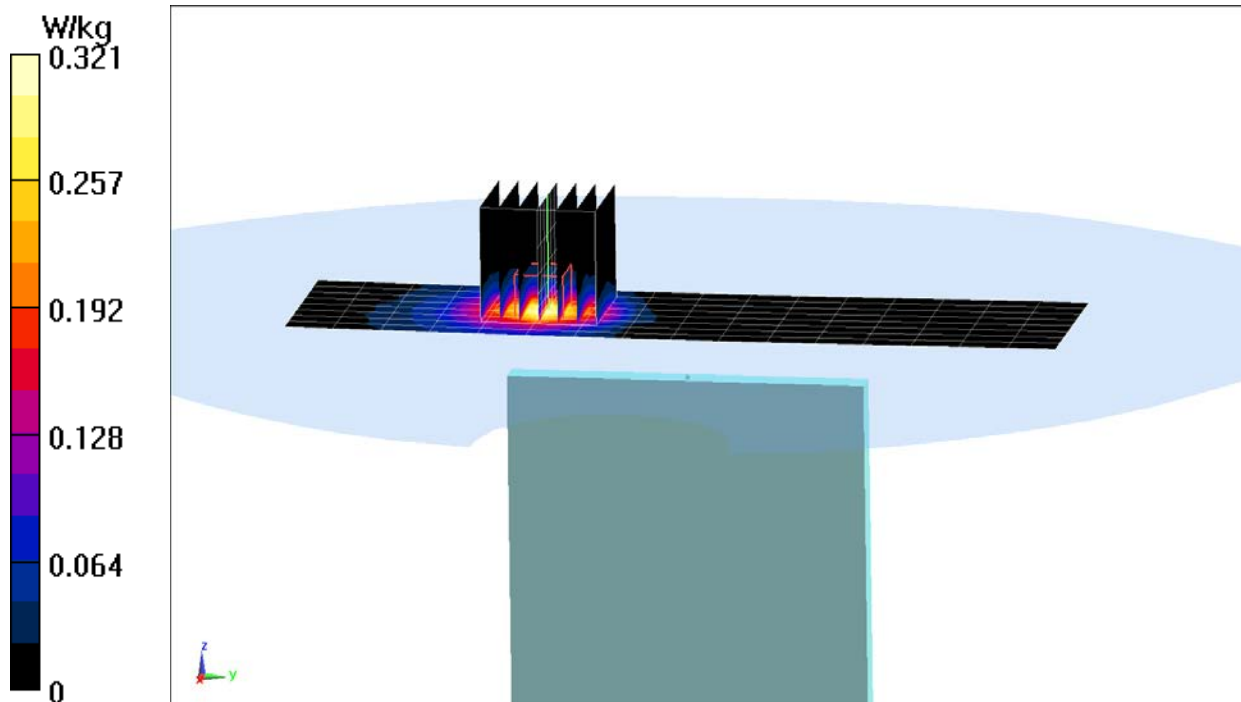

APPENDIX B: SYSTEM VERIFICATION

PCTEST ENGINEERING LABORATORY, INC.

DUT: Dipole 750 MHz; Type: D750V3; Serial: 1046

Communication System: UID 0, CW; Frequency: 750 MHz; Duty Cycle: 1:1

Medium: 750MHz Head Medium parameters used (interpolated):

$f = 750 \text{ MHz}$; $\sigma = 0.906 \text{ S/m}$; $\epsilon_r = 41.379$; $\rho = 1000 \text{ kg/m}^3$

Phantom section: Flat Section; Space: 1.5 cm

Test Date: 04-06-2018; Ambient Temp: 22.5°C; Tissue Temp: 22.0°C

Probe: EX3DV4 - SN7410; ConvF(10.6, 10.6, 10.6); Calibrated: 7/17/2017;

Sensor-Surface: 1.4mm (Mechanical Surface Detection)

Electronics: DAE4 Sn1322; Calibrated: 7/13/2017

Phantom: SAM with CRP v5.0 (Right); Type: QD000P40CD; Serial: TP:1759

Measurement SW: DASY52, Version 52.10;SEMCAD X Version 14.6.10 (7417)

750 MHz System Verification at 23.0 dBm (200 mW)

Area Scan (7x15x1): Measurement grid: dx=15mm, dy=15mm

Zoom Scan (5x5x7)/Cube 0: Measurement grid: dx=8mm, dy=8mm, dz=5mm

Peak SAR (extrapolated) = 2.33 W/kg

SAR(1 g) = 1.55 W/kg

Deviation(1 g) = -6.17%

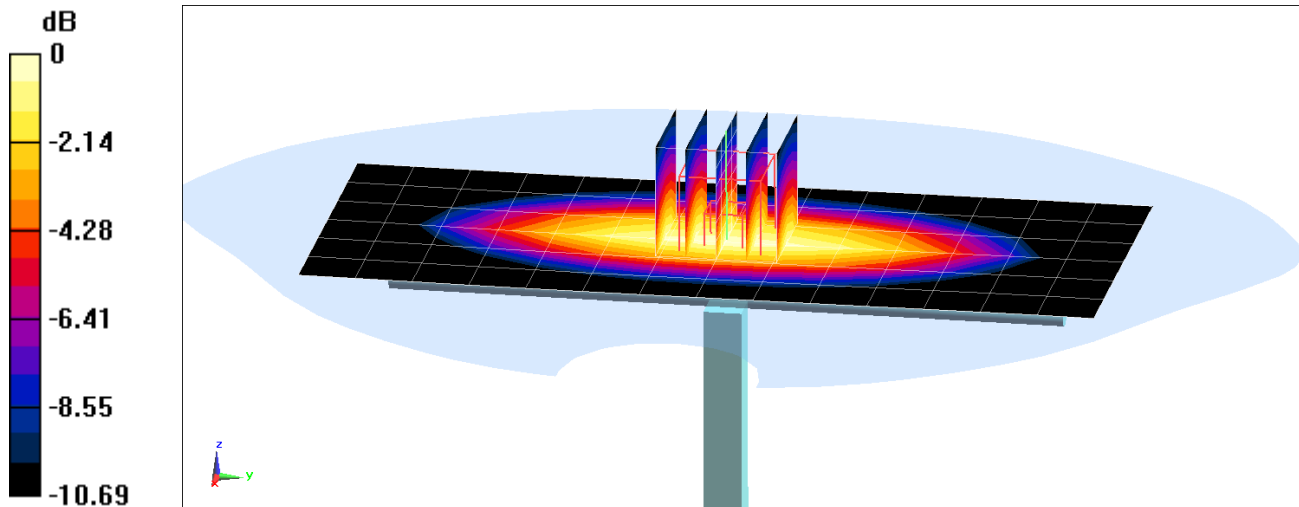

0 dB = 2.08 W/kg = 3.18 dBW/kg

PCTEST ENGINEERING LABORATORY, INC.

DUT: Dipole 835 MHz; Type: D835V2; Serial: 4d132

Communication System: UID 0, CW; Frequency: 835 MHz; Duty Cycle: 1:1

Medium: 835 Head Medium parameters used:

$f = 835 \text{ MHz}$; $\sigma = 0.92 \text{ S/m}$; $\epsilon_r = 42.445$; $\rho = 1000 \text{ kg/m}^3$

Phantom section: Flat Section; Space: 1.5 cm

Test Date: 04-02-2018; Ambient Temp: 19.8°C; Tissue Temp: 19.7°C

Probe: ES3DV3 - SN3213; ConvF(6.42, 6.42, 6.42); Calibrated: 2/13/2018;

Sensor-Surface: 3mm (Mechanical Surface Detection)

Electronics: DAE4 Sn1272; Calibrated: 2/9/2018

Phantom: SAM 5.0 front; Type: QD000P40CD; Serial: 1648

Measurement SW: DASY52, Version 52.10; SEMCAD X Version 14.6.10 (7417)

835 MHz System Verification at 23.0 dBm (200 mW)

Area Scan (7x14x1): Measurement grid: dx=15mm, dy=15mm

Zoom Scan (5x5x7)/Cube 0: Measurement grid: dx=8mm, dy=8mm, dz=5mm

Peak SAR (extrapolated) = 2.79 W/kg

SAR(1 g) = 1.9 W/kg

Deviation(1 g) = 1.50%

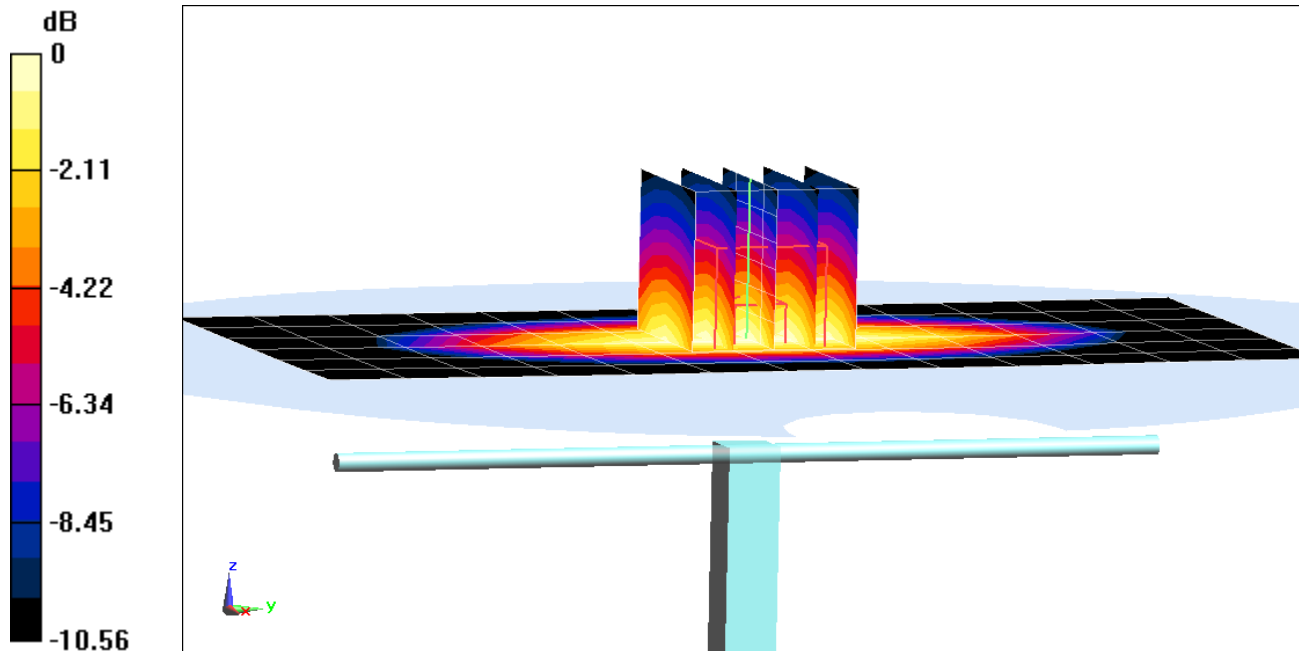

PCTEST ENGINEERING LABORATORY, INC.

DUT: Dipole 1750 MHz; Type: D1750V2; Serial: 1148

Communication System: UID 0, CW; Frequency: 1750 MHz; Duty Cycle: 1:1

Medium: 1750 Head Medium parameters used:

$f = 1750 \text{ MHz}$; $\sigma = 1.388 \text{ S/m}$; $\epsilon_r = 39.359$; $\rho = 1000 \text{ kg/m}^3$

Phantom section: Flat Section; Space: 1.0 cm

Test Date: 04-02-2018; Ambient Temp: 22.0°C; Tissue Temp: 21.4°C

Probe: EX3DV4 - SN7410; ConvF(8.66, 8.66, 8.66); Calibrated: 7/17/2017;

Sensor-Surface: 1.4mm (Mechanical Surface Detection)

Electronics: DAE4 Sn1322; Calibrated: 7/13/2017

Phantom: SAM with CRP v5.0 (Right); Type: QD000P40CD; Serial: TP:1759

Measurement SW: DASY52, Version 52.10; SEMCAD X Version 14.6.10 (7417)

1750 MHz System Verification at 20.0 dBm (100 mW)

Area Scan (7x9x1): Measurement grid: dx=15mm, dy=15mm

Zoom Scan (5x5x7)/Cube 0: Measurement grid: dx=8mm, dy=8mm, dz=5mm

Peak SAR (extrapolated) = 6.41 W/kg

SAR(1 g) = 3.5 W/kg

Deviation(1 g) = -3.85%

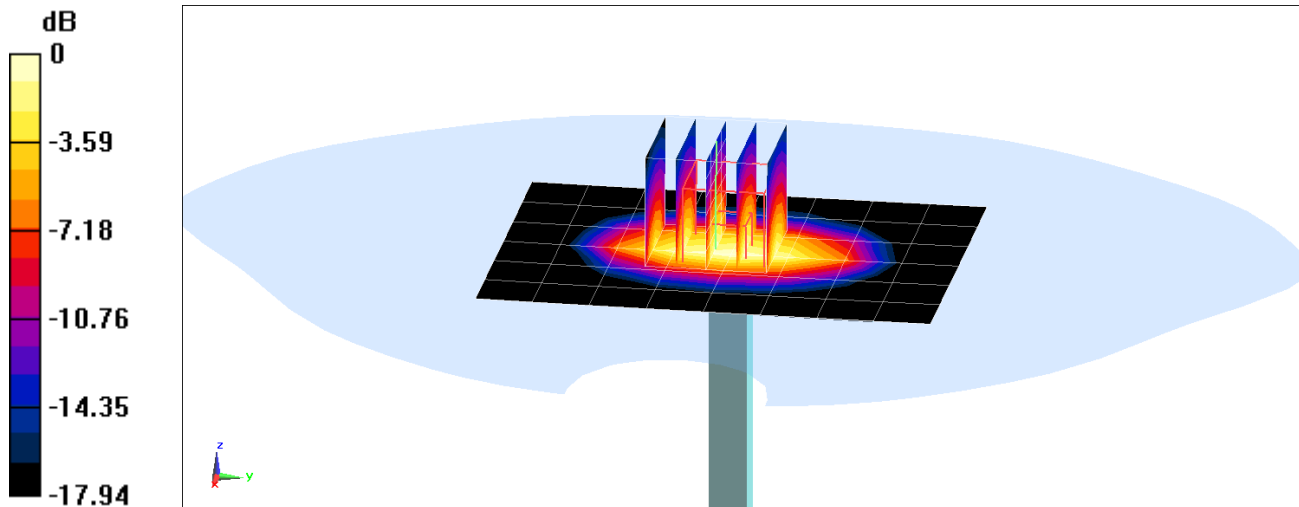

0 dB = 5.31 W/kg = 7.25 dBW/kg

PCTEST ENGINEERING LABORATORY, INC.

DUT: Dipole 1900 MHz; Type: D1900V2; Serial: 5d080

Communication System: UID 0, CW; Frequency: 1900 MHz; Duty Cycle: 1:1
Medium: 1900 Head Medium parameters used (interpolated):
 $f = 1900 \text{ MHz}$; $\sigma = 1.429 \text{ S/m}$; $\epsilon_r = 39.939$; $\rho = 1000 \text{ kg/m}^3$
Phantom section: Flat Section; Space: 1.0 cm

Test Date: 04-05-2018; Ambient Temp: 22.2°C; Tissue Temp: 21.2°C

Probe: ES3DV3 - SN3332; ConvF(5.33, 5.33, 5.33); Calibrated: 8/14/2017;
Sensor-Surface: 3mm (Mechanical Surface Detection)
Electronics: DAE4 Sn1323; Calibrated: 8/9/2017
Phantom: SAM Left; Type: QD000P40CA; Serial: TP:82355
Measurement SW: DASY52, Version 52.10; SEMCAD X Version 14.6.10 (7417)

1900 MHz System Verification at 20.0 dBm (100 mW)

Area Scan (7x10x1): Measurement grid: dx=15mm, dy=15mm
\Zoom Scan (5x5x7)/Cube 0: Measurement grid: dx=8mm, dy=8mm, dz=5mm
Peak SAR (extrapolated) = 7.02 W/kg
SAR(1 g) = 3.86 W/kg
Deviation(1 g) = -1.78%

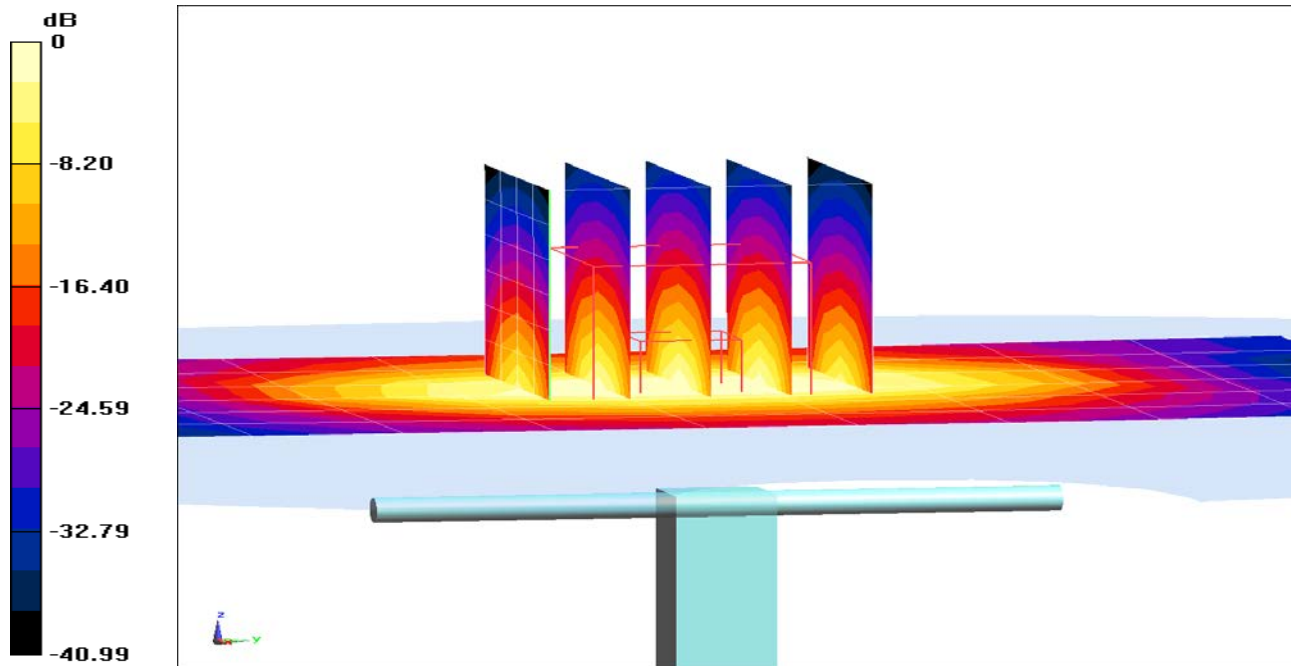

PCTEST ENGINEERING LABORATORY, INC.

DUT: Dipole 2450 MHz; Type: D2450V2; Serial: 797

Communication System: UID 0, CW; Frequency: 2450 MHz; Duty Cycle: 1:1

Medium: 2450 Head Medium parameters used:

$f = 2450 \text{ MHz}$; $\sigma = 1.808 \text{ S/m}$; $\epsilon_r = 40.109$; $\rho = 1000 \text{ kg/m}^3$

Phantom section: Flat Section; Space: 1.0 cm

Test Date: 03-28-2018; Ambient Temp: 22.3°C; Tissue Temp: 21.5°C

Probe: ES3DV3 - SN3332; ConvF(4.68, 4.68, 4.68); Calibrated: 8/14/2017;

Sensor-Surface: 3mm (Mechanical Surface Detection)

Electronics: DAE4 Sn1323; Calibrated: 8/9/2017

Phantom: SAM Front; Type: SAM; Serial: 1686

Measurement SW: DASY52, Version 52.10;SEMCAD X Version 14.6.10 (7417)

2450 MHz System Verification at 20.0 dBm (100 mW)

Area Scan (8x9x1): Measurement grid: dx=12mm, dy=12mm

Zoom Scan (7x7x7)/Cube 0: Measurement grid: dx=5mm, dy=5mm, dz=5mm

Peak SAR (extrapolated) = 10.1 W/kg

SAR(1 g) = 4.92 W/kg

Deviation(1 g) = -6.64%

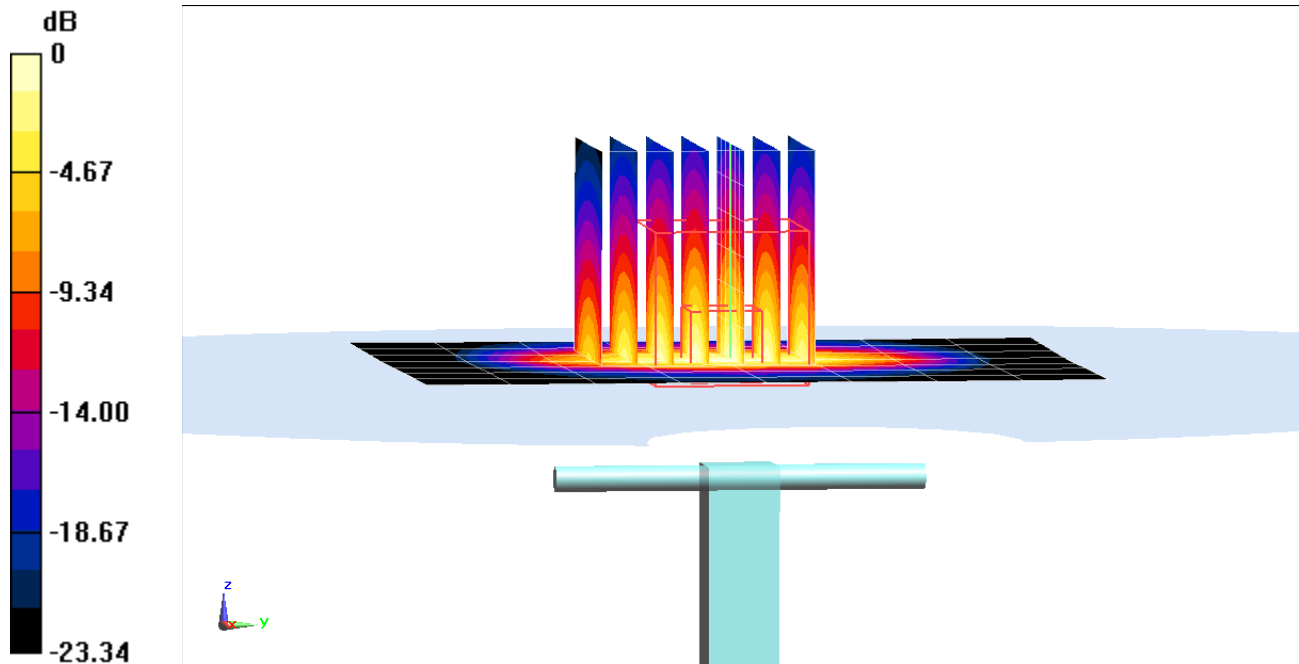

0 dB = 6.49 W/kg = 8.12 dBW/kg

PCTEST ENGINEERING LABORATORY, INC.

DUT: Dipole 5 GHz; Type: D5GHzV2; Serial: 1191

Communication System: UID 0, CW; Frequency: 5250 MHz; Duty Cycle: 1:1
Medium: 5GHz Head Medium parameters used (interpolated):
 $f = 5250 \text{ MHz}$; $\sigma = 4.513 \text{ S/m}$; $\epsilon_r = 34.935$; $\rho = 1000 \text{ kg/m}^3$
Phantom section: Flat Section; Space: 1.0 cm

Test Date: 04-05-2018; Ambient Temp: 22.5°C; Tissue Temp: 21.1°C

Probe: EX3DV4 - SN3589; ConvF(4.69, 4.69, 4.69); Calibrated: 1/16/2018;
Sensor-Surface: 1.4mm (Mechanical Surface Detection)
Electronics: DAE4 Sn1322; Calibrated: 7/13/2017
Phantom: SAM with CRP (Left); Type: SAM; Serial: 1715
Measurement SW: DASY52, Version 52.10;SEMCAD X Version 14.6.10 (7417)

5250 MHz System Verification at 17.0 dBm (50 mW)

Area Scan (7x7x1): Measurement grid: dx=10mm, dy=10mm

Zoom Scan (8x8x7)/Cube 0: Measurement grid: dx=4mm, dy=4mm, dz=1.4mm; Graded Ratio: 1.4

Peak SAR (extrapolated) = 15.4 W/kg

SAR(1 g) = 3.75 W/kg

Deviation(1 g) = -4.94%

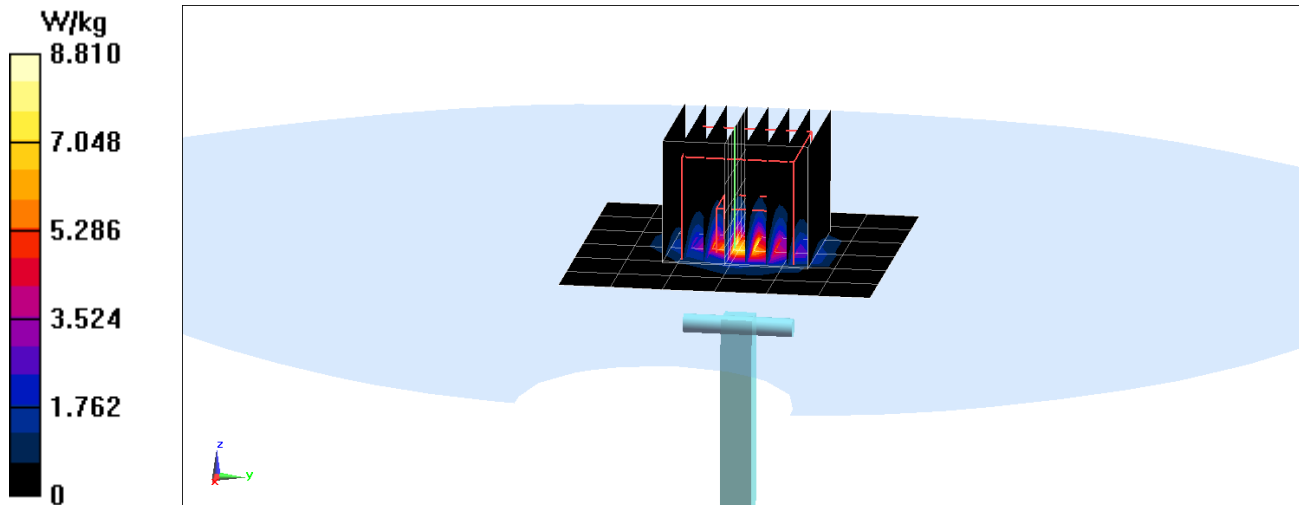

PCTEST ENGINEERING LABORATORY, INC.

DUT: Dipole 5 GHz; Type: D5GHzV2; Serial: 1191

Communication System: UID 0, CW; Frequency: 5600 MHz; Duty Cycle: 1:1

Medium: 5GHz Head Medium parameters used:

$f = 5600 \text{ MHz}$; $\sigma = 4.855 \text{ S/m}$; $\epsilon_r = 34.446$; $\rho = 1000 \text{ kg/m}^3$

Phantom section: Flat Section; Space: 1.0 cm

Test Date: 04-05-2018; Ambient Temp: 22.5°C; Tissue Temp: 21.1°C

Probe: EX3DV4 - SN3589; ConvF(4.17, 4.17, 4.17); Calibrated: 1/16/2018;

Sensor-Surface: 1.4mm (Mechanical Surface Detection)

Electronics: DAE4 Sn1322; Calibrated: 7/13/2017

Phantom: SAM with CRP (Left); Type: SAM; Serial: 1715

Measurement SW: DASY52, Version 52.10;SEMCAD X Version 14.6.10 (7417)

5600 MHz System Verification at 17.0 dBm (50 mW)

Area Scan (7x7x1): Measurement grid: dx=10mm, dy=10mm

Zoom Scan (8x8x7)/Cube 0: Measurement grid: dx=4mm, dy=4mm, dz=1.4mm; Graded Ratio: 1.4

Peak SAR (extrapolated) = 18.0 W/kg

SAR(1 g) = 4.21 W/kg

Deviation(1 g) = 0.72%

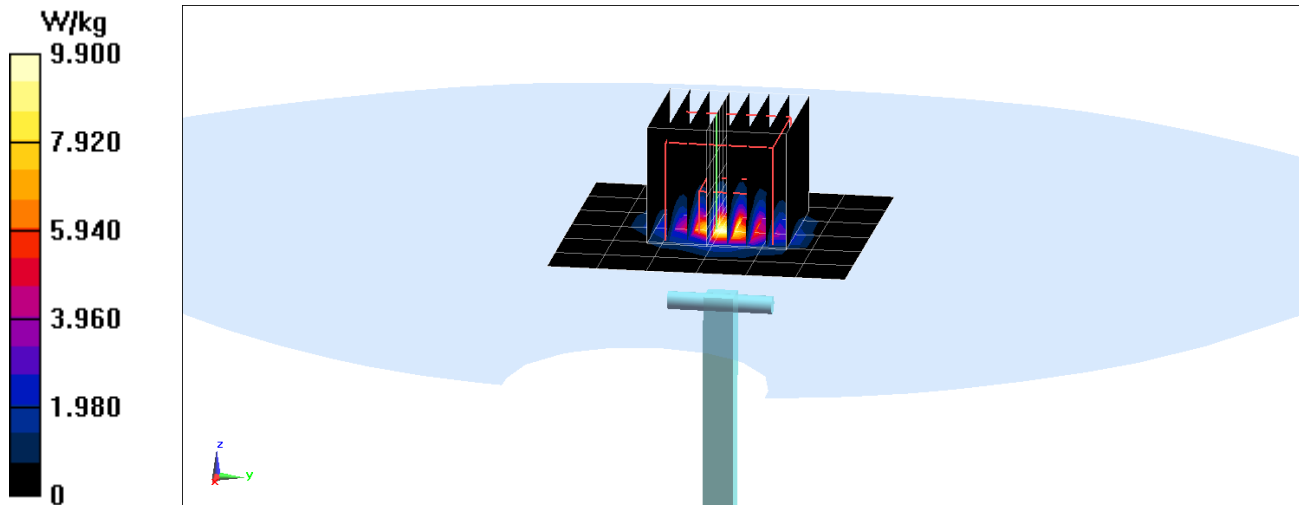

PCTEST ENGINEERING LABORATORY, INC.

DUT: Dipole 5 GHz; Type: D5GHzV2; Serial: 1191

Communication System: UID 0, CW; Frequency: 5750 MHz; Duty Cycle: 1:1
Medium: 5GHz Head Medium parameters used (interpolated):
 $f = 5750 \text{ MHz}$; $\sigma = 5.004 \text{ S/m}$; $\epsilon_r = 34.242$; $\rho = 1000 \text{ kg/m}^3$
Phantom section: Flat Section; Space: 1.0 cm

Test Date: 04-05-2018; Ambient Temp: 22.5°C; Tissue Temp: 21.1°C

Probe: EX3DV4 - SN3589; ConvF(4.42, 4.42, 4.42); Calibrated: 1/16/2018;
Sensor-Surface: 1.4mm (Mechanical Surface Detection)
Electronics: DAE4 Sn1322; Calibrated: 7/13/2017
Phantom: SAM with CRP (Left); Type: SAM; Serial: 1715
Measurement SW: DASY52, Version 52.10; SEMCAD X Version 14.6.10 (7417)

5750 MHz System Verification at 17.0 dBm (50 mW)

Area Scan (7x7x1): Measurement grid: dx=10mm, dy=10mm

Zoom Scan (8x8x7)/Cube 0: Measurement grid: dx=4mm, dy=4mm, dz=1.4mm; Graded Ratio: 1.4

Peak SAR (extrapolated) = 16.6 W/kg

SAR(1 g) = 3.7 W/kg

Deviation(1 g) = -6.45%

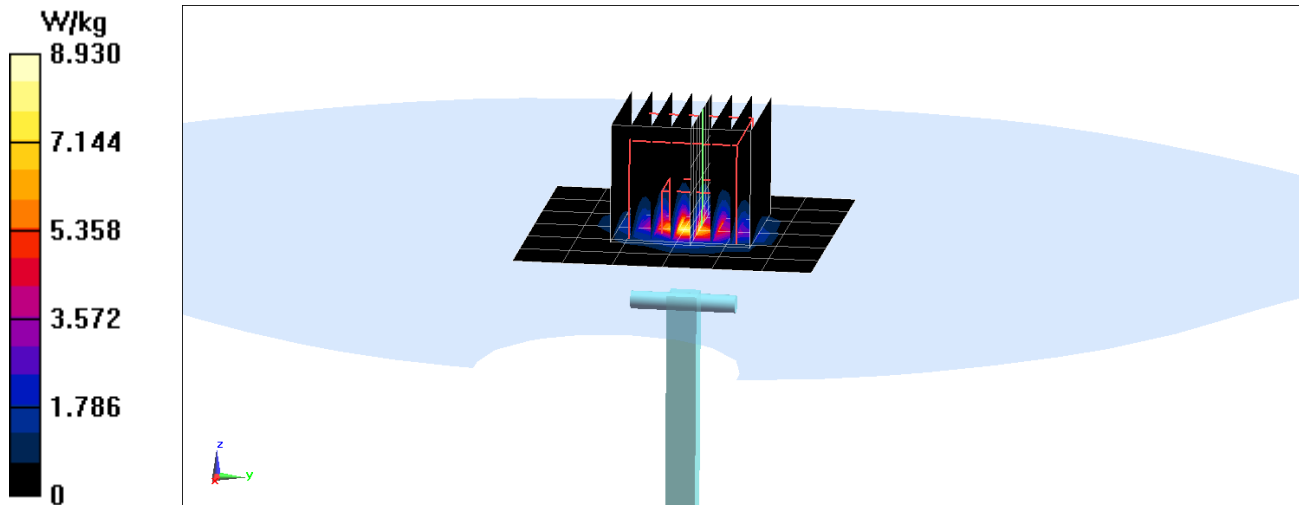

PCTEST ENGINEERING LABORATORY, INC.

DUT: Dipole 750 MHz; Type: D750V3; Serial: 1054

Communication System: UID 0, CW; Frequency: 750 MHz; Duty Cycle: 1:1

750 Body Medium parameters used (interpolated):

$f = 750 \text{ MHz}$; $\sigma = 0.988 \text{ S/m}$; $\epsilon_r = 53.044$; $\rho = 1000 \text{ kg/m}^3$

Phantom section: Flat Section; Space: 1.5 cm

Test Date: 04-03-2018; Ambient Temp: 22.0°C; Tissue Temp: 20.9°C

Probe: ES3DV3 - SN3287; ConvF(6.71, 6.71, 6.71); Calibrated: 9/18/2017;

Sensor-Surface: 3mm (Mechanical Surface Detection)

Electronics: DAE4 Sn1333; Calibrated: 6/21/2017

Phantom: Twin-SAM V5.0; Type: QD 000 P40 CD; Serial: 1692

Measurement SW: DASY52, Version 52.10; SEMCAD X Version 14.6.10 (7417)

750 MHz System Verification at 23.0 dBm (200 mW)

Area Scan (7x15x1): Measurement grid: dx=15mm, dy=15mm

Zoom Scan (5x5x7)/Cube 0: Measurement grid: dx=8mm, dy=8mm, dz=5mm

Peak SAR (extrapolated) = 2.59 W/kg

SAR(1 g) = 1.75 W/kg

Deviation(1 g) = 1.63%

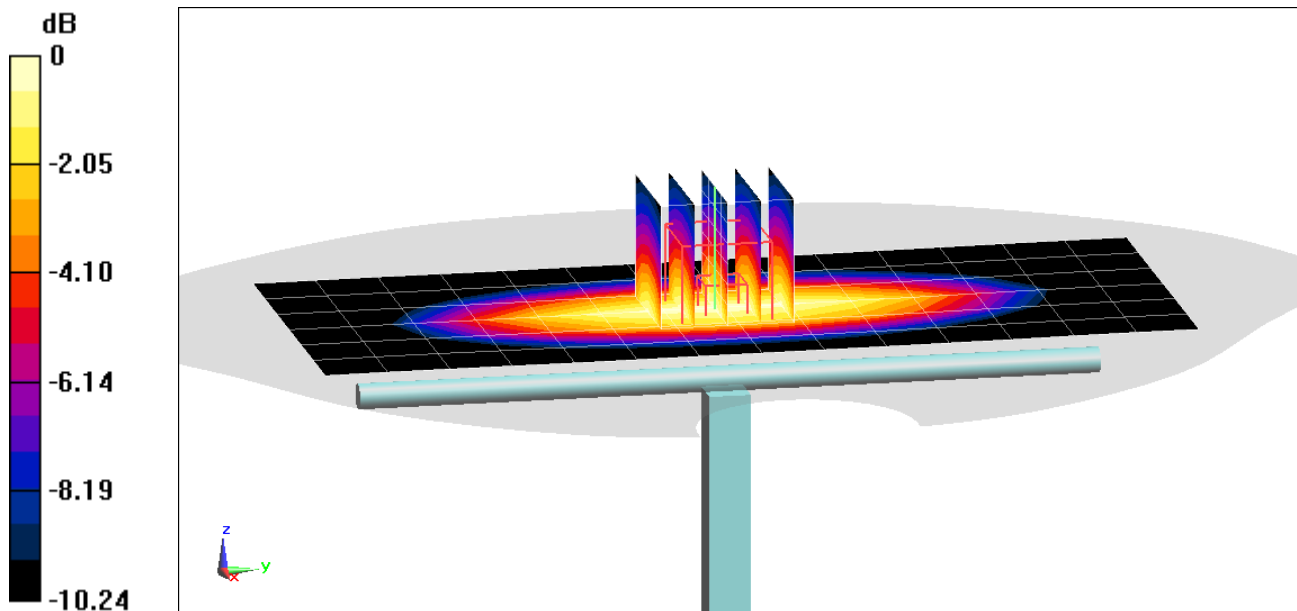

0 dB = 2.00 W/kg = 3.01 dBW/kg

PCTEST ENGINEERING LABORATORY, INC.

DUT: Dipole 750 MHz; Type: D750V3; Serial: 1003

Communication System: UID 0, CW; Frequency: 750 MHz; Duty Cycle: 1:1

Medium: 750 Body Medium parameters used (interpolated):

$f = 750 \text{ MHz}$; $\sigma = 0.952 \text{ S/m}$; $\epsilon_r = 54.075$; $\rho = 1000 \text{ kg/m}^3$

Phantom section: Flat Section; Space: 1.5 cm

Test Date: 04-09-2018; Ambient Temp: 22.6°C; Tissue Temp: 21.5°C

Probe: ES3DV3 - SN3287; ConvF(6.71, 6.71, 6.71); Calibrated: 9/18/2017;

Sensor-Surface: 3mm (Mechanical Surface Detection)

Electronics: DAE4 Sn1333; Calibrated: 6/21/2017

Phantom: Twin-SAM V5.0; Type: QD 000 P40 CD; Serial: 1692

Measurement SW: DASY52, Version 52.10; SEMCAD X Version 14.6.10 (7417)

750 MHz System Verification at 23.0 dBm (200 mW)

Area Scan (7x15x1): Measurement grid: dx=15mm, dy=15mm

Zoom Scan (5x5x7)/Cube 0: Measurement grid: dx=8mm, dy=8mm, dz=5mm

Peak SAR (extrapolated) = 2.60 W/kg

SAR(1 g) = 1.76 W/kg

Deviation(1 g) = 2.56%

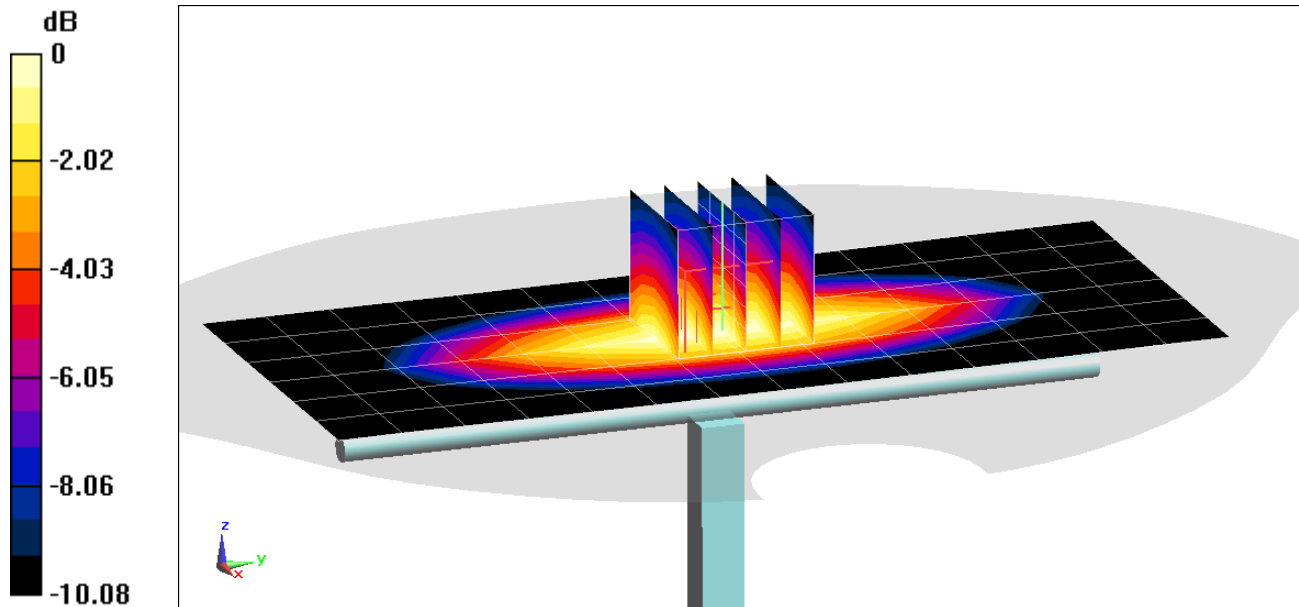

0 dB = 2.05 W/kg = 3.12 dBW/kg

PCTEST ENGINEERING LABORATORY, INC.

DUT: Dipole 835 MHz; Type: D835V2; Serial: 4d132

Communication System: UID 0, CW; Frequency: 835 MHz; Duty Cycle: 1:1

Medium: 835 Body Medium parameters used:

$f = 835 \text{ MHz}$; $\sigma = 0.974 \text{ S/m}$; $\epsilon_r = 53.53$; $\rho = 1000 \text{ kg/m}^3$

Phantom section: Flat Section; Space: 1.5 cm

Test Date: 04-03-2018; Ambient Temp: 22.0°C; Tissue Temp: 21.3°C

Probe: ES3DV3 - SN3213; ConvF(6.2, 6.2, 6.2); Calibrated: 2/13/2018;

Sensor-Surface: 3mm (Mechanical Surface Detection)

Electronics: DAE4 Sn1272; Calibrated: 2/9/2018

Phantom: SAM V5.0 Right; Type: QD000P40CD; Serial: 1647

Measurement SW: DASY52, Version 52.10; SEMCAD X Version 14.6.10 (7417)

835 MHz System Verification at 23.0 dBm (200 mW)

Area Scan (7x14x1): Measurement grid: dx=15mm, dy=15mm

Zoom Scan (5x5x7)/Cube 0: Measurement grid: dx=8mm, dy=8mm, dz=5mm

Peak SAR (extrapolated) = 3.04 W/kg

SAR(1 g) = 2.07 W/kg

Deviation(1 g) = 6.59%

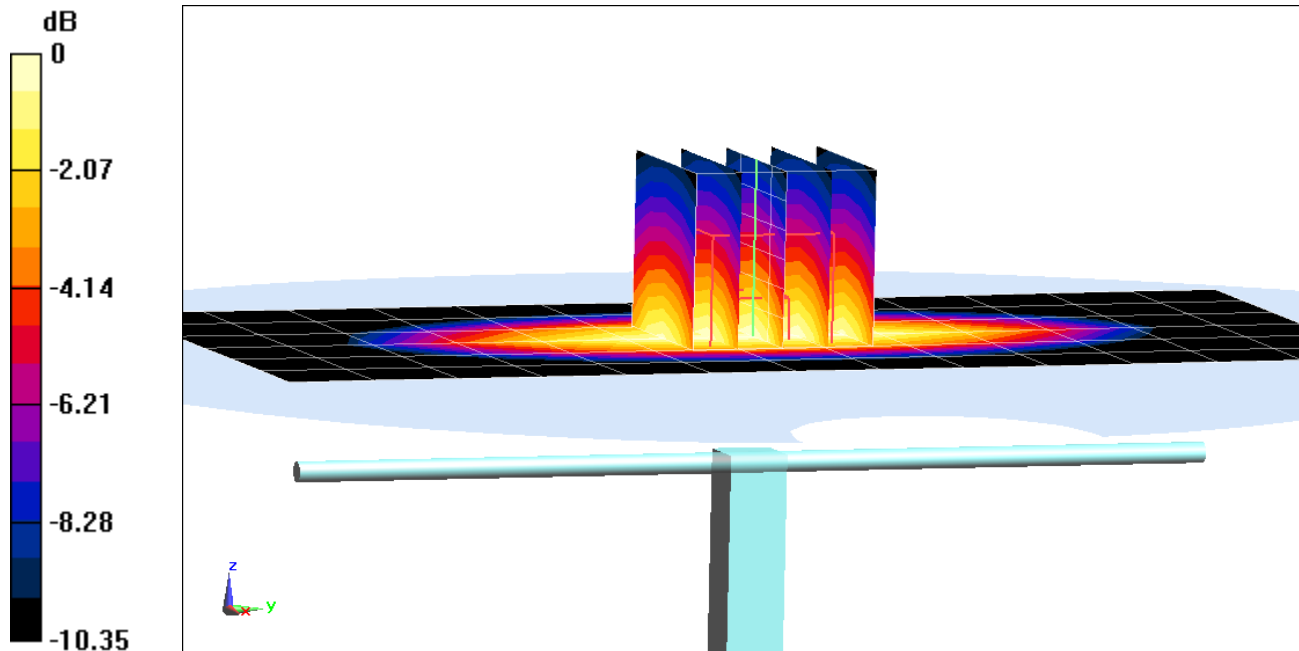

0 dB = 2.41 W/kg = 3.82 dBW/kg

PCTEST ENGINEERING LABORATORY, INC.

DUT: Dipole 1750 MHz; Type: D1750V2; Serial: 1148

Communication System: UID 0, CW; Frequency: 1750 MHz; Duty Cycle: 1:1

Medium: 1750 Body Medium parameters used:

$f = 1750 \text{ MHz}$; $\sigma = 1.48 \text{ S/m}$; $\epsilon_r = 51.845$; $\rho = 1000 \text{ kg/m}^3$

Phantom section: Flat Section; Space: 1.0 cm

Test Date: 04-03-2018; Ambient Temp: 22.5°C; Tissue Temp: 22.1°C

Probe: EX3DV4 - SN7410; ConvF(8.32, 8.32, 8.32); Calibrated: 7/17/2017;

Sensor-Surface: 1.4mm (Mechanical Surface Detection)

Electronics: DAE4 Sn1322; Calibrated: 7/13/2017

Phantom: SAM with CRP v5.0 (Right); Type: QD000P40CD; Serial: TP:1759

Measurement SW: DASY52, Version 52.10; SEMCAD X Version 14.6.10 (7417)

1750 MHz System Verification at 20.0 dBm (100 mW)

Area Scan (7x9x1): Measurement grid: dx=15mm, dy=15mm

Zoom Scan (5x5x7)/Cube 0: Measurement grid: dx=8mm, dy=8mm, dz=5mm

Peak SAR (extrapolated) = 6.23 W/kg

SAR(1 g) = 3.49 W/kg

Deviation(1 g) = -5.68%

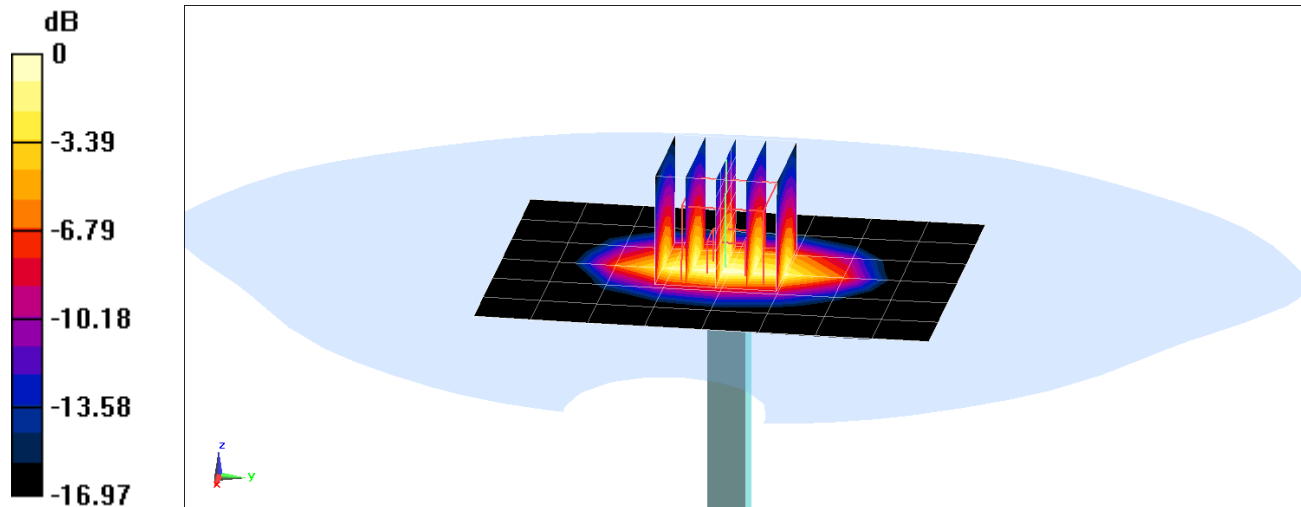

0 dB = 5.32 W/kg = 7.26 dBW/kg

PCTEST ENGINEERING LABORATORY, INC.

DUT: Dipole 1750 MHz; Type: D1750V2; Serial: 1148

Communication System: UID 0, CW; Frequency: 1750 MHz; Duty Cycle: 1:1

Medium: 1750 Body Medium parameters used:

$f = 1750 \text{ MHz}$; $\sigma = 1.499 \text{ S/m}$; $\epsilon_r = 51.867$; $\rho = 1000 \text{ kg/m}^3$

Phantom section: Flat Section; Space: 1.0 cm

Test Date: 04-05-2018; Ambient Temp: 22.6°C; Tissue Temp: 21.2°C

Probe: ES3DV3 - SN3287; ConvF(5.19, 5.19, 5.19); Calibrated: 9/18/2017;

Sensor-Surface: 3mm (Mechanical Surface Detection)

Electronics: DAE4 Sn1333; Calibrated: 6/21/2017

Phantom: Twin-SAM V4.0; Type: QD 000 P40 CC; Serial: 1692

Measurement SW: DASY52, Version 52.10; SEMCAD X Version 14.6.10 (7417)

1750 MHz System Verification at 20.0 dBm (100 mW)

Area Scan (7x9x1): Measurement grid: dx=15mm, dy=15mm

Zoom Scan (6x6x7)/Cube 0: Measurement grid: dx=8mm, dy=8mm, dz=5mm

Peak SAR (extrapolated) = 6.93 W/kg

SAR(1 g) = 3.93 W/kg

Deviation(1 g) = 6.22%

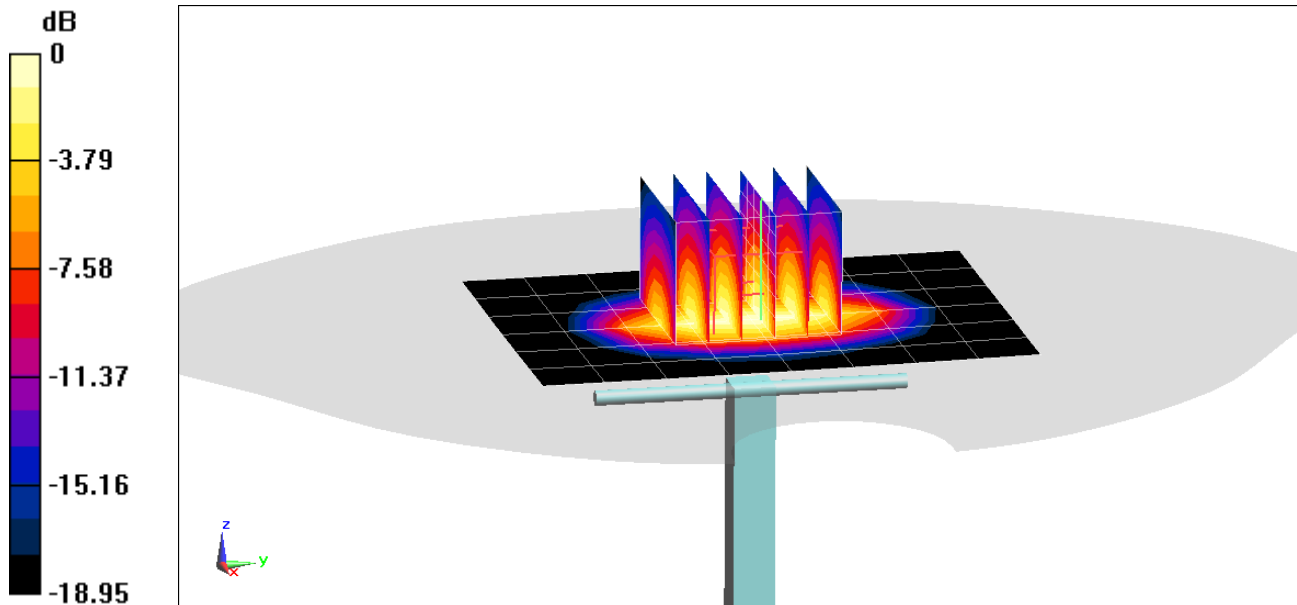

0 dB = 4.67 W/kg = 6.69 dBW/kg

PCTEST ENGINEERING LABORATORY, INC.

DUT: Dipole 1900 MHz; Type: D1900V2; Serial: 5d148

Communication System: UID 0, CW; Frequency: 1900 MHz; Duty Cycle: 1:1
Medium: 1900 Body Medium parameters used (interpolated):
 $f = 1900 \text{ MHz}$; $\sigma = 1.578 \text{ S/m}$; $\epsilon_r = 54.022$; $\rho = 1000 \text{ kg/m}^3$
Phantom section: Flat Section; Space: 1.0 cm

Test Date: 04-02-2018; Ambient Temp: 21.0°C; Tissue Temp: 21.0°C

Probe: EX3DV4 - SN3914; ConvF(7.62, 7.62, 7.62); Calibrated: 2/14/2018;
Sensor-Surface: 1.4mm (Mechanical Surface Detection)
Electronics: DAE4 Sn665; Calibrated: 2/15/2018

Phantom: Twin-SAM V5.0 Right; Type: QD 000 P40 CD; Serial: 1800
Measurement SW: DASY52, Version 52.10; SEMCAD X Version 14.6.10 (7417)

1900 MHz System Verification at 20.0 dBm (100 mW)

Area Scan (7x11x1): Measurement grid: dx=15mm, dy=15mm

Zoom Scan (5x5x7)/Cube 0: Measurement grid: dx=8mm, dy=8mm, dz=5mm

Peak SAR (extrapolated) = 7.84 W/kg

SAR(1 g) = 4.26 W/kg

Deviation(1 g) = 7.58%

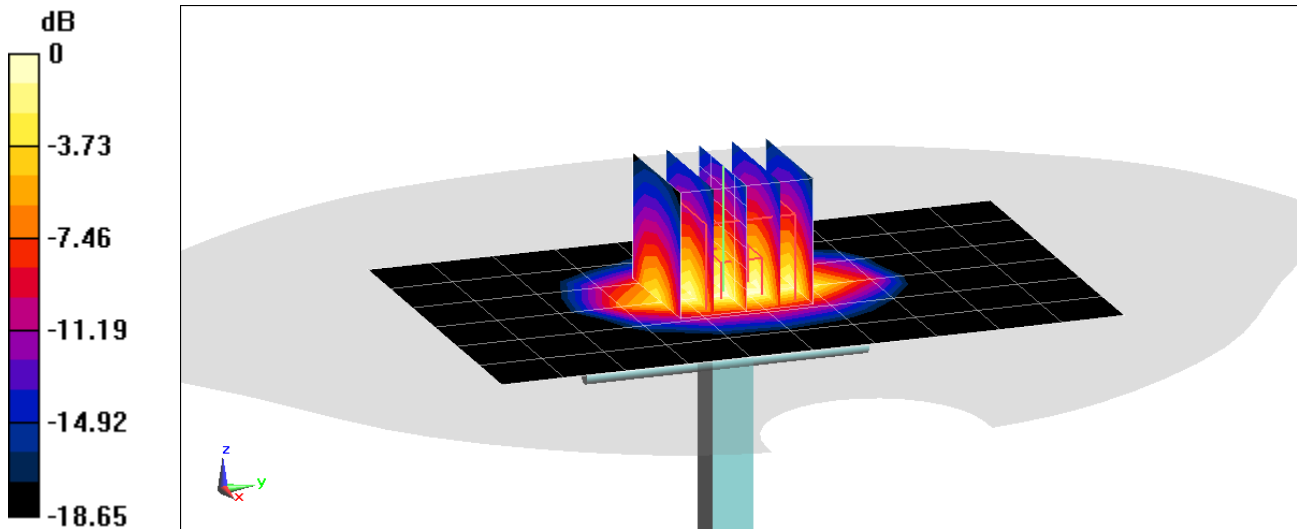

0 dB = 6.57 W/kg = 8.18 dBW/kg

PCTEST ENGINEERING LABORATORY, INC.

DUT: Dipole 2450 MHz; Type: D2450V2; Serial: 797

Communication System: UID 0, CW; Frequency: 2450 MHz; Duty Cycle: 1:1

Medium: 2450 Body Medium parameters used:

$f = 2450 \text{ MHz}$; $\sigma = 2.043 \text{ S/m}$; $\epsilon_r = 51.13$; $\rho = 1000 \text{ kg/m}^3$

Phantom section: Flat Section; Space: 1.0 cm

Test Date: 04-03-2018; Ambient Temp: 22.4°C; Tissue Temp: 21.6°C

Probe: ES3DV3 - SN3319; ConvF(4.51, 4.51, 4.51); Calibrated: 3/13/2018;

Sensor-Surface: 3mm (Mechanical Surface Detection)

Electronics: DAE4 Sn1368; Calibrated: 3/7/2018

Phantom: Right Twin-SAM V5.0; Type: QD 000 P40 CD; Serial: 1797

Measurement SW: DASY52, Version 52.10; SEMCAD X Version 14.6.10 (7417)

2450 MHz System Verification at 20.0 dBm (100 mW)

Area Scan (8x9x1): Measurement grid: dx=12mm, dy=12mm

Zoom Scan (7x7x7)/Cube 0: Measurement grid: dx=5mm, dy=5mm, dz=5mm

Peak SAR (extrapolated) = 10.5 W/kg

SAR(1 g) = 5.05 W/kg

Deviation(1 g) = -1.17%

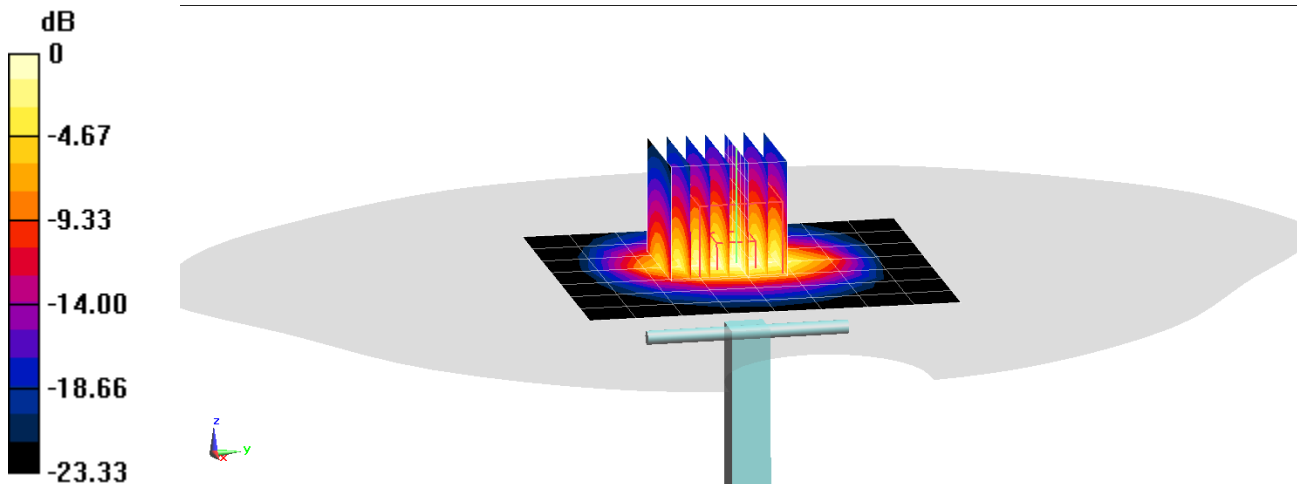

0 dB = 6.67 W/kg = 8.24 dBW/kg

PCTEST ENGINEERING LABORATORY, INC.

DUT: Dipole 5 GHz; Type: D5GHzV2; Serial: 1237

Communication System: UID 0, CW; Frequency: 5250 MHz; Duty Cycle: 1:1
Medium: 5 GHz Body Medium parameters used (interpolated):
 $f = 5250 \text{ MHz}$; $\sigma = 5.488 \text{ S/m}$; $\epsilon_r = 47.204$; $\rho = 1000 \text{ kg/m}^3$
Phantom section: Flat Section; Space: 1.0 cm

Test Date: 04-02-2018; Ambient Temp: 22.5°C; Tissue Temp: 20.6°C

Probe: EX3DV4 - SN7308; ConvF(4.84, 4.84, 4.84); Calibrated: 8/16/2017;
Sensor-Surface: 1.4mm (Mechanical Surface Detection)
Electronics: DAE4 Sn1334; Calibrated: 6/14/2017

Phantom: SAM with CRP v5.0 Front; Type: QD000P40CD; Serial: 1646
Measurement SW: DASY52, Version 52.10; SEMCAD X Version 14.6.10 (7417)

5250 MHz System Verification at 17.0 dBm (50 mW)

Area Scan (7x7x1): Measurement grid: dx=10mm, dy=10mm

Zoom Scan (8x8x7)/Cube 0: Measurement grid: dx=4mm, dy=4mm, dz=1.4mm; Graded Ratio: 1.4

Peak SAR (extrapolated) = 16.6 W/kg

SAR(1 g) = 3.6 W/kg

Deviation(1 g) = -6.37%

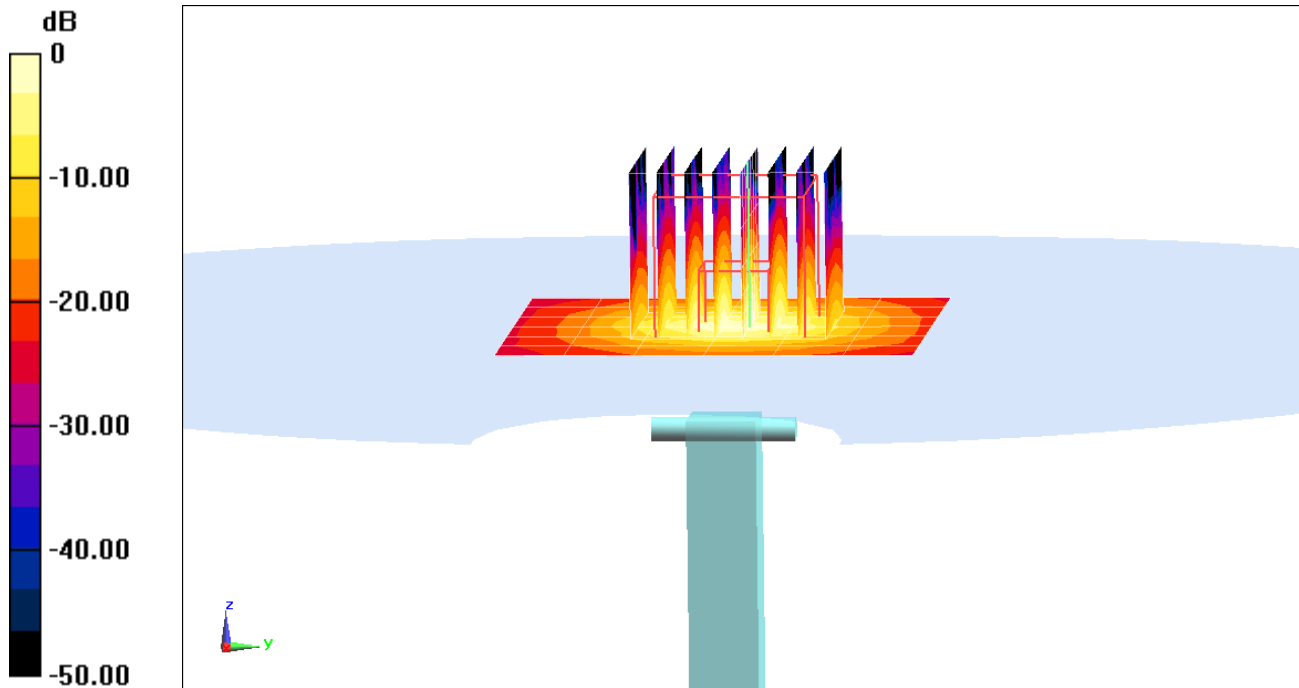

0 dB = 8.82 W/kg = 9.45 dBW/kg

PCTEST ENGINEERING LABORATORY, INC.

DUT: Dipole 5 GHz; Type: D5GHzV2; Serial: 1237

Communication System: UID 0, CW; Frequency: 5600 MHz; Duty Cycle: 1:1

Medium: 5 GHz Body Medium parameters used:

$f = 5600 \text{ MHz}$; $\sigma = 5.955 \text{ S/m}$; $\epsilon_r = 46.6$; $\rho = 1000 \text{ kg/m}^3$

Phantom section: Flat Section; Space: 1.0 cm

Test Date: 04-02-2018; Ambient Temp: 22.5°C; Tissue Temp: 20.6°C

Probe: EX3DV4 - SN7308; ConvF(4.23, 4.23, 4.23); Calibrated: 8/16/2017;

Sensor-Surface: 1.4mm (Mechanical Surface Detection)

Electronics: DAE4 Sn1334; Calibrated: 6/14/2017

Phantom: SAM with CRP v5.0 Front; Type: QD000P40CD; Serial: 1646

Measurement SW: DASY52, Version 52.10;SEMCAD X Version 14.6.10 (7417)

5600 MHz System Verification at 17.0 dBm (50 mW)

Area Scan (7x7x1): Measurement grid: dx=10mm, dy=10mm

Zoom Scan (8x8x7)/Cube 0: Measurement grid: dx=4mm, dy=4mm, dz=1.4mm; Graded Ratio: 1.4

Peak SAR (extrapolated) = 18.5 W/kg

SAR(1 g) = 3.8 W/kg

Deviation(1 g) = -3.18%

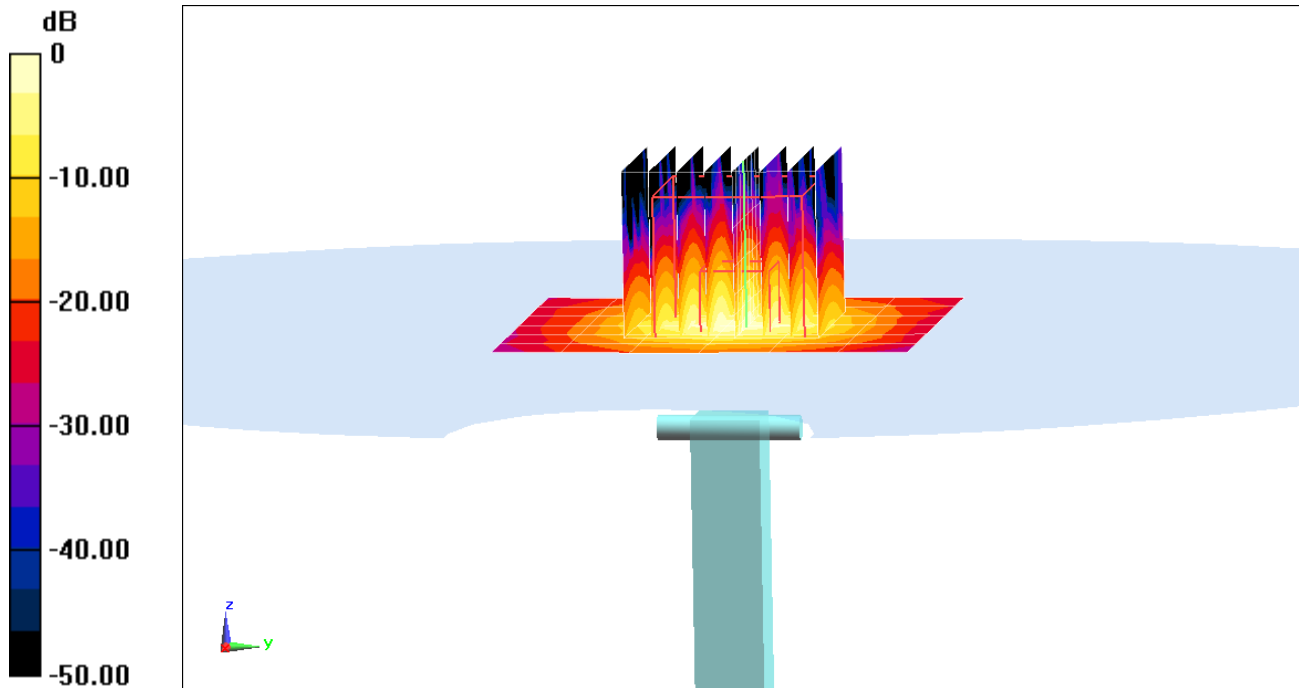

0 dB = 9.85 W/kg = 9.93 dBW/kg

PCTEST ENGINEERING LABORATORY, INC.

DUT: Dipole 5 GHz; Type: D5GHzV2; Serial: 1237

Communication System: UID 0, CW; Frequency: 5750 MHz; Duty Cycle: 1:1

Medium: 5 GHz Body Medium parameters used (interpolated):

$f = 5750 \text{ MHz}$; $\sigma = 6.16 \text{ S/m}$; $\epsilon_r = 46.355$; $\rho = 1000 \text{ kg/m}^3$

Phantom section: Flat Section; Space: 1.0 cm

Test Date: 04-02-2018; Ambient Temp: 22.5°C; Tissue Temp: 20.6°C

Probe: EX3DV4 - SN7308; ConvF(4.5, 4.5, 4.5); Calibrated: 8/16/2017;

Sensor-Surface: 1.4mm (Mechanical Surface Detection)

Electronics: DAE4 Sn1334; Calibrated: 6/14/2017

Phantom: SAM with CRP v5.0 Front; Type: QD000P40CD; Serial: 1646

Measurement SW: DASY52, Version 52.10; SEMCAD X Version 14.6.10 (7417)

5750 MHz System Verification at 17.0 dBm (50 mW)

Area Scan (7x7x1): Measurement grid: dx=10mm, dy=10mm

Zoom Scan (8x8x7)/Cube 0: Measurement grid: dx=4mm, dy=4mm, dz=1.4mm; Graded Ratio: 1.4

Peak SAR (extrapolated) = 18.3 W/kg

SAR(1 g) = 3.6 W/kg

Deviation(1 g) = -6.61%

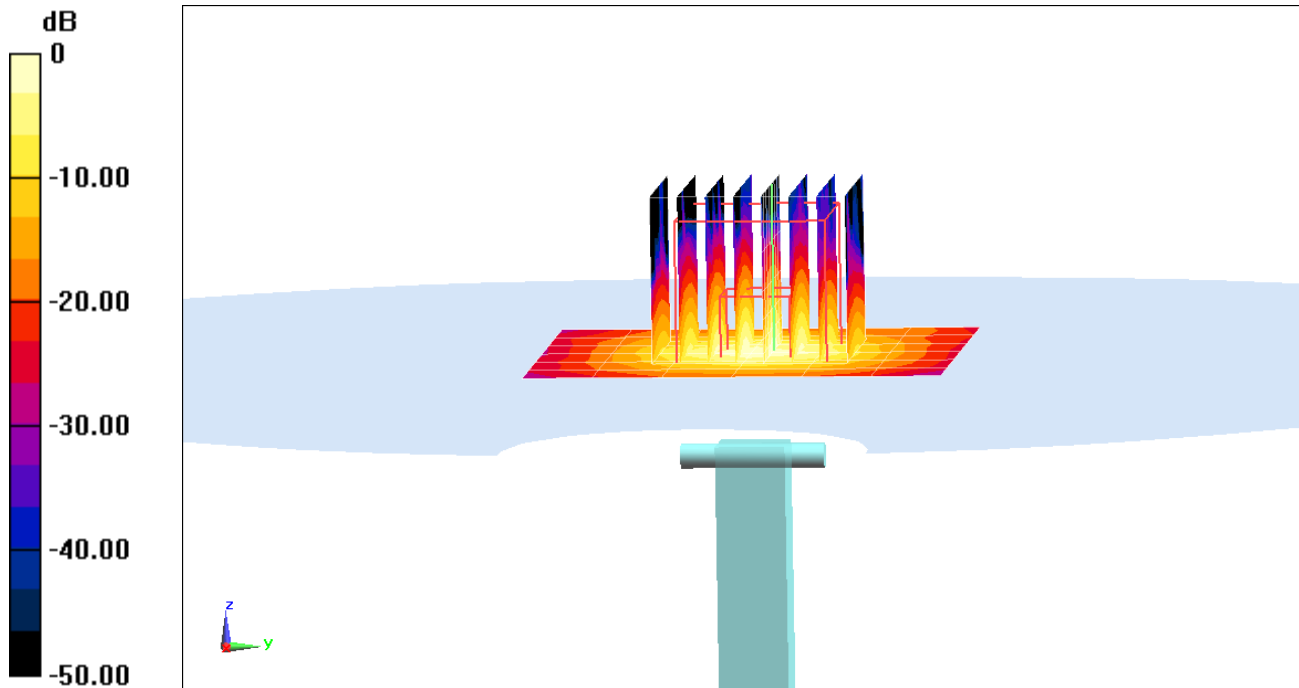

APPENDIX C: PROBE CALIBRATION



Accredited by the Swiss Accreditation Service (SAS)
The Swiss Accreditation Service is one of the signatories to the EA
Multilateral Agreement for the recognition of calibration certificates

Accreditation No.: **SCS 0108**

Client **PC Test**

Certificate No: **D750V3-1046_Feb18**

CALIBRATION CERTIFICATE

Object **D750V3 - SN:1046**

Calibration procedure(s) **QA CAL-05.v9
Calibration procedure for dipole validation kits above 700 MHz**

*BNV
03-02-2018*

Calibration date: **February 07, 2018**

This calibration certificate documents the traceability to national standards, which realize the physical units of measurements (SI).
The measurements and the uncertainties with confidence probability are given on the following pages and are part of the certificate.

All calibrations have been conducted in the closed laboratory facility: environment temperature (22 ± 3)°C and humidity < 70%.

Calibration Equipment used (M&TE critical for calibration)

Primary Standards	ID #	Cal Date (Certificate No.)	Scheduled Calibration
Power meter NRP	SN: 104778	04-Apr-17 (No. 217-02521/02522)	Apr-18
Power sensor NRP-Z91	SN: 103244	04-Apr-17 (No. 217-02521)	Apr-18
Power sensor NRP-Z91	SN: 103245	04-Apr-17 (No. 217-02522)	Apr-18
Reference 20 dB Attenuator	SN: 5058 (20k)	07-Apr-17 (No. 217-02528)	Apr-18
Type-N mismatch combination	SN: 5047.2 / 06327	07-Apr-17 (No. 217-02529)	Apr-18
Reference Probe EX3DV4	SN: 7349	30-Dec-17 (No. EX3-7349_Dec17)	Dec-18
DAE4	SN: 601	26-Oct-17 (No. DAE4-601_Oct17)	Oct-18

Secondary Standards	ID #	Check Date (in house)	Scheduled Check
Power meter EPM-442A	SN: GB37480704	07-Oct-15 (in house check Oct-16)	In house check: Oct-18
Power sensor HP 8481A	SN: US37292783	07-Oct-15 (in house check Oct-16)	In house check: Oct-18
Power sensor HP 8481A	SN: MY41092317	07-Oct-15 (in house check Oct-16)	In house check: Oct-18
RF generator R&S SMT-06	SN: 100972	15-Jun-15 (in house check Oct-16)	In house check: Oct-18
Network Analyzer HP 8753E	SN: US37390585	18-Oct-01 (in house check Oct-17)	In house check: Oct-18

Calibrated by: **Claudio Leubler** **Laboratory Technician**

Signature

Approved by: **Katja Pokovic** **Technical Manager**

Issued: February 7, 2018

This calibration certificate shall not be reproduced except in full without written approval of the laboratory.



Accredited by the Swiss Accreditation Service (SAS)

The Swiss Accreditation Service is one of the signatories to the EA
Multilateral Agreement for the recognition of calibration certificates

Accreditation No.: **SCS 0108**

Glossary:

TSL	tissue simulating liquid
ConvF	sensitivity in TSL / NORM x,y,z
N/A	not applicable or not measured

Calibration is Performed According to the Following Standards:

- IEEE Std 1528-2013, "IEEE Recommended Practice for Determining the Peak Spatial-Averaged Specific Absorption Rate (SAR) in the Human Head from Wireless Communications Devices: Measurement Techniques", June 2013
- IEC 62209-1, "Measurement procedure for the assessment of Specific Absorption Rate (SAR) from hand-held and body-mounted devices used next to the ear (frequency range of 300 MHz to 6 GHz)", July 2016
- IEC 62209-2, "Procedure to determine the Specific Absorption Rate (SAR) for wireless communication devices used in close proximity to the human body (frequency range of 30 MHz to 6 GHz)", March 2010
- KDB 865664, "SAR Measurement Requirements for 100 MHz to 6 GHz"

Additional Documentation:

- DASY4/5 System Handbook

Methods Applied and Interpretation of Parameters:

- Measurement Conditions:** Further details are available from the Validation Report at the end of the certificate. All figures stated in the certificate are valid at the frequency indicated.
- Antenna Parameters with TSL:** The dipole is mounted with the spacer to position its feed point exactly below the center marking of the flat phantom section, with the arms oriented parallel to the body axis.
- Feed Point Impedance and Return Loss:** These parameters are measured with the dipole positioned under the liquid filled phantom. The impedance stated is transformed from the measurement at the SMA connector to the feed point. The Return Loss ensures low reflected power. No uncertainty required.
- Electrical Delay:** One-way delay between the SMA connector and the antenna feed point. No uncertainty required.
- SAR measured:** SAR measured at the stated antenna input power.
- SAR normalized:** SAR as measured, normalized to an input power of 1 W at the antenna connector.
- SAR for nominal TSL parameters:** The measured TSL parameters are used to calculate the nominal SAR result.

The reported uncertainty of measurement is stated as the standard uncertainty of measurement multiplied by the coverage factor $k=2$, which for a normal distribution corresponds to a coverage probability of approximately 95%.

Measurement Conditions

DASY system configuration, as far as not given on page 1.

DASY Version	DASY5	V52.10.0
Extrapolation	Advanced Extrapolation	
Phantom	Modular Flat Phantom	
Distance Dipole Center - TSL	15 mm	with Spacer
Zoom Scan Resolution	dx, dy, dz = 5 mm	
Frequency	750 MHz \pm 1 MHz	

Head TSL parameters

The following parameters and calculations were applied.

	Temperature	Permittivity	Conductivity
Nominal Head TSL parameters	22.0 °C	41.9	0.89 mho/m
Measured Head TSL parameters	(22.0 \pm 0.2) °C	41.4 \pm 6 %	0.89 mho/m \pm 6 %
Head TSL temperature change during test	< 0.5 °C	----	----

SAR result with Head TSL

SAR averaged over 1 cm³ (1 g) of Head TSL	Condition	
SAR measured	250 mW input power	2.07 W/kg
SAR for nominal Head TSL parameters	normalized to 1W	8.26 W/kg \pm 17.0 % (k=2)

SAR averaged over 10 cm³ (10 g) of Head TSL	condition	
SAR measured	250 mW input power	1.35 W/kg
SAR for nominal Head TSL parameters	normalized to 1W	5.39 W/kg \pm 16.5 % (k=2)

Body TSL parameters

The following parameters and calculations were applied.

	Temperature	Permittivity	Conductivity
Nominal Body TSL parameters	22.0 °C	55.5	0.96 mho/m
Measured Body TSL parameters	(22.0 \pm 0.2) °C	55.2 \pm 6 %	0.96 mho/m \pm 6 %
Body TSL temperature change during test	< 0.5 °C	----	----

SAR result with Body TSL

SAR averaged over 1 cm³ (1 g) of Body TSL	Condition	
SAR measured	250 mW input power	2.15 W/kg
SAR for nominal Body TSL parameters	normalized to 1W	8.59 W/kg \pm 17.0 % (k=2)

SAR averaged over 10 cm³ (10 g) of Body TSL	condition	
SAR measured	250 mW input power	1.43 W/kg
SAR for nominal Body TSL parameters	normalized to 1W	5.72 W/kg \pm 16.5 % (k=2)

Appendix (Additional assessments outside the scope of SCS 0108)

Antenna Parameters with Head TSL

Impedance, transformed to feed point	57.0 Ω + 2.2 j Ω
Return Loss	- 23.3 dB

Antenna Parameters with Body TSL

Impedance, transformed to feed point	52.3 Ω - 2.5 j Ω
Return Loss	- 29.6 dB

General Antenna Parameters and Design

Electrical Delay (one direction)	1.040 ns
----------------------------------	----------

After long term use with 100W radiated power, only a slight warming of the dipole near the feedpoint can be measured.

The dipole is made of standard semirigid coaxial cable. The center conductor of the feeding line is directly connected to the second arm of the dipole. The antenna is therefore short-circuited for DC-signals. On some of the dipoles, small end caps are added to the dipole arms in order to improve matching when loaded according to the position as explained in the "Measurement Conditions" paragraph. The SAR data are not affected by this change. The overall dipole length is still according to the Standard.

No excessive force must be applied to the dipole arms, because they might bend or the soldered connections near the feedpoint may be damaged.

Additional EUT Data

Manufactured by	SPEAG
Manufactured on	September 02, 2011

DASY5 Validation Report for Head TSL

Date: 07.02.2018

Test Laboratory: SPEAG, Zurich, Switzerland

DUT: Dipole 750 MHz; Type: D750V3; Serial: D750V3 - SN:1046

Communication System: UID 0 - CW; Frequency: 750 MHz

Medium parameters used: $f = 750$ MHz; $\sigma = 0.89$ S/m; $\epsilon_r = 41.4$; $\rho = 1000$ kg/m³

Phantom section: Flat Section

Measurement Standard: DASY5 (IEEE/IEC/ANSI C63.19-2011)

DASY52 Configuration:

- Probe: EX3DV4 - SN7349; ConvF(10.22, 10.22, 10.22); Calibrated: 30.12.2017;
- Sensor-Surface: 1.4mm (Mechanical Surface Detection)
- Electronics: DAE4 Sn601; Calibrated: 26.10.2017
- Phantom: Flat Phantom 4.9 (front); Type: QD 00L P49 AA; Serial: 1001
- DASY52 52.10.0(1446); SEMCAD X 14.6.10(7417)

Dipole Calibration for Head Tissue/Pin=250 mW, d=15mm/Zoom Scan (7x7x7)/Cube 0:

Measurement grid: dx=5mm, dy=5mm, dz=5mm

Reference Value = 59.39 V/m; Power Drift = -0.03 dB

Peak SAR (extrapolated) = 3.11 W/kg

SAR(1 g) = 2.07 W/kg; SAR(10 g) = 1.35 W/kg

Maximum value of SAR (measured) = 2.76 W/kg

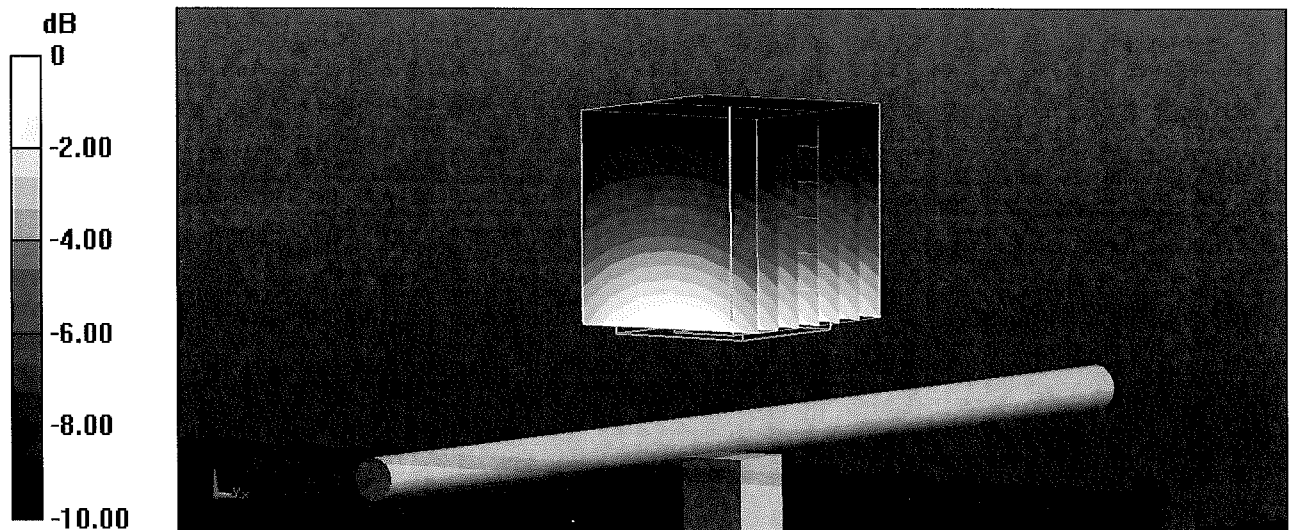

0 dB = 2.76 W/kg = 4.41 dBW/kg

Impedance Measurement Plot for Head TSL

7 Feb 2018 11:46:33

CH1 S11 1 U FS 1: 56.977 Ω 2.2461 Ω 476.64 pF 750.000 000 MHz

*
De1

CΔ

AVG
16

H1d

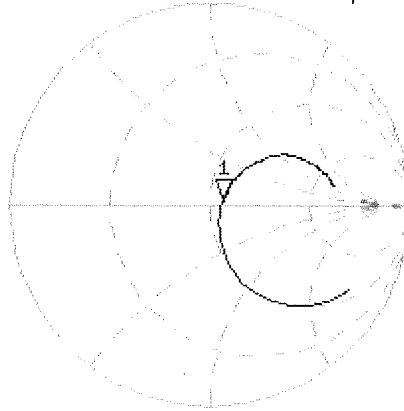

CH2 S11 LOG 5 dB/REF -20 dB 1: -23.287 dB 750.000 000 MHz

CΔ

AVG
16

H1d

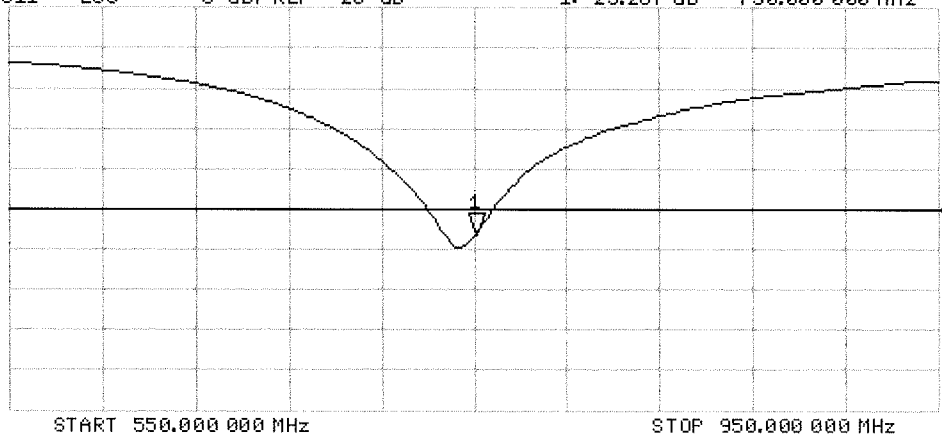

DASY5 Validation Report for Body TSL

Date: 07.02.2018

Test Laboratory: SPEAG, Zurich, Switzerland

DUT: Dipole 750 MHz; Type: D750V3; Serial: D750V3 - SN:1046

Communication System: UID 0 - CW; Frequency: 750 MHz

Medium parameters used: $f = 750 \text{ MHz}$; $\sigma = 0.96 \text{ S/m}$; $\epsilon_r = 55.2$; $\rho = 1000 \text{ kg/m}^3$

Phantom section: Flat Section

Measurement Standard: DASY5 (IEEE/IEC/ANSI C63.19-2011)

DASY52 Configuration:

- Probe: EX3DV4 - SN7349; ConvF(10.19, 10.19, 10.19); Calibrated: 30.12.2017;
- Sensor-Surface: 1.4mm (Mechanical Surface Detection)
- Electronics: DAE4 Sn601; Calibrated: 26.10.2017
- Phantom: Flat Phantom 4.9 (Back); Type: QD 00R P49 AA; Serial: 1005
- DASY52 52.10.0(1446); SEMCAD X 14.6.10(7417)

Dipole Calibration for Body Tissue/Pin=250 mW, $d=15\text{mm}$ /Zoom Scan (7x7x7)/Cube 0:

Measurement grid: $dx=5\text{mm}$, $dy=5\text{mm}$, $dz=5\text{mm}$

Reference Value = 57.54 V/m; Power Drift = -0.04 dB

Peak SAR (extrapolated) = 3.19 W/kg

SAR(1 g) = 2.15 W/kg; SAR(10 g) = 1.43 W/kg

Maximum value of SAR (measured) = 2.82 W/kg

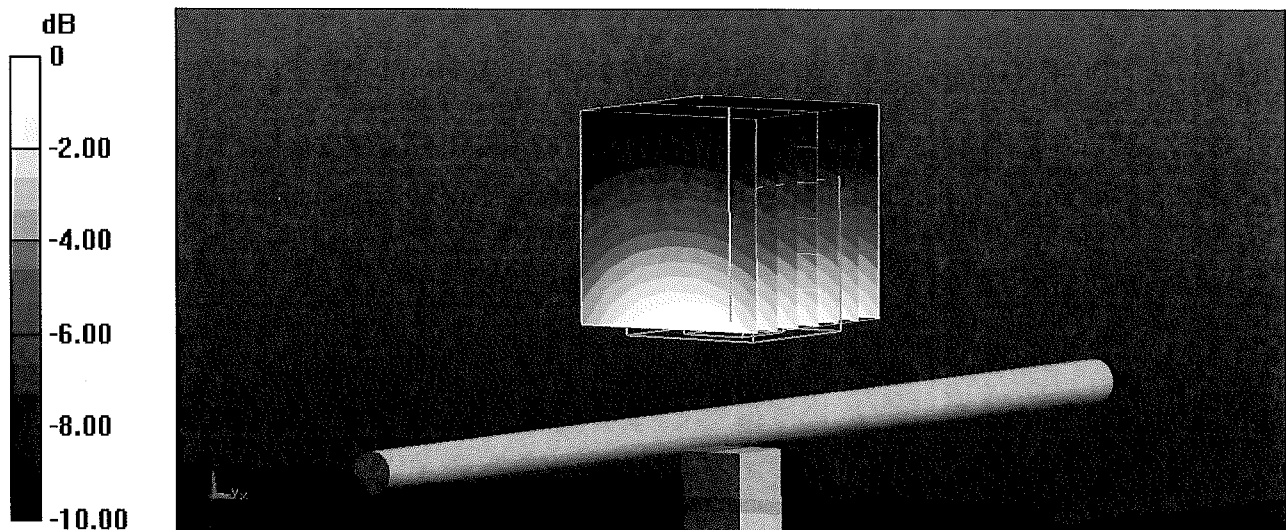

0 dB = 2.82 W/kg = 4.50 dBW/kg

Impedance Measurement Plot for Body TSL

7 Feb 2018 11:45:45

CH1 S11 1 U FS 1: 52.295 Ω -2.5059 Ω 84.684 pF 750.000 000 MHz

*
De1
Ca
Avg
16
H1d

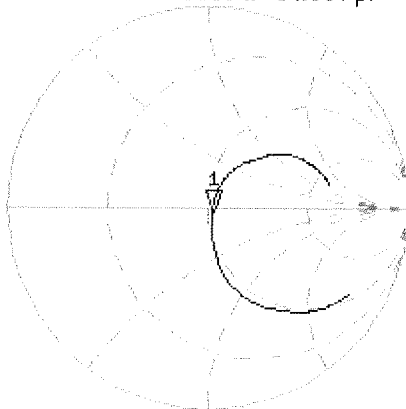

CH2 S11 LOG 5 dB/REF -20 dB 1:-29.578 dB 750.000 000 MHz

Ca
Avg
16
H1d

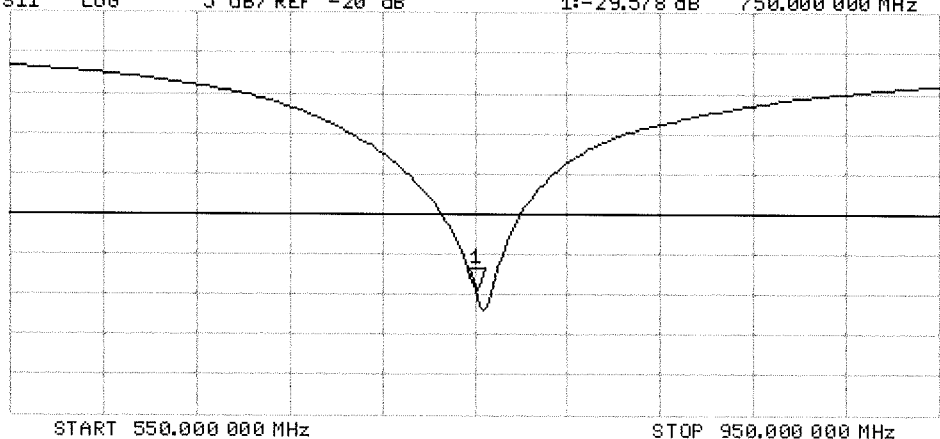



Accredited by the Swiss Accreditation Service (SAS)
The Swiss Accreditation Service is one of the signatories to the EA
Multilateral Agreement for the recognition of calibration certificates

Accreditation No.: **SCS 0108**

Client **PC Test**

Certificate No: **D835V2-4d132_Jan18**

CALIBRATION CERTIFICATE

Object **D835V2 - SN:4d132**

Calibration procedure(s) **QA CAL-05.v9**
Calibration procedure for dipole validation kits above 700 MHz

Calibration date: **January 15, 2018**

BNV
01-25-2018

This calibration certificate documents the traceability to national standards, which realize the physical units of measurements (SI).
The measurements and the uncertainties with confidence probability are given on the following pages and are part of the certificate.

All calibrations have been conducted in the closed laboratory facility: environment temperature (22 ± 3)°C and humidity < 70%.

Calibration Equipment used (M&TE critical for calibration)

Primary Standards	ID #	Cal Date (Certificate No.)	Scheduled Calibration
Power meter NRP	SN: 104778	04-Apr-17 (No. 217-02521/02522)	Apr-18
Power sensor NRP-Z91	SN: 103244	04-Apr-17 (No. 217-02521)	Apr-18
Power sensor NRP-Z91	SN: 103245	04-Apr-17 (No. 217-02522)	Apr-18
Reference 20 dB Attenuator	SN: 5058 (20k)	07-Apr-17 (No. 217-02528)	Apr-18
Type-N mismatch combination	SN: 5047.2 / 06327	07-Apr-17 (No. 217-02529)	Apr-18
Reference Probe EX3DV4	SN: 7349	30-Dec-17 (No. EX3-7349_Dec17)	Dec-18
DAE4	SN: 601	26-Oct-17 (No. DAE4-601_Oct17)	Oct-18
Secondary Standards	ID #	Check Date (in house)	Scheduled Check
Power meter EPM-442A	SN: GB37480704	07-Oct-15 (in house check Oct-16)	In house check: Oct-18
Power sensor HP 8481A	SN: US37292783	07-Oct-15 (in house check Oct-16)	In house check: Oct-18
Power sensor HP 8481A	SN: MY41092317	07-Oct-15 (in house check Oct-16)	In house check: Oct-18
RF generator R&S SMT-06	SN: 100972	15-Jun-15 (in house check Oct-16)	In house check: Oct-18
Network Analyzer HP 8753E	SN: US37390585	18-Oct-01 (in house check Oct-17)	In house check: Oct-18

Calibrated by: **Leif Klysner** Name: **Leif Klysner** Function: **Laboratory Technician**

Signature: *Leif Klysner*

Approved by: **Katja Pokovic** Name: **Katja Pokovic** Function: **Technical Manager**

Signature: *Katja Pokovic*

Issued: January 15, 2018

This calibration certificate shall not be reproduced except in full without written approval of the laboratory.



Accredited by the Swiss Accreditation Service (SAS)
The Swiss Accreditation Service is one of the signatories to the EA
Multilateral Agreement for the recognition of calibration certificates

Accreditation No.: **SCS 0108**

Glossary:

TSL	tissue simulating liquid
ConvF	sensitivity in TSL / NORM x,y,z
N/A	not applicable or not measured

Calibration is Performed According to the Following Standards:

- IEEE Std 1528-2013, "IEEE Recommended Practice for Determining the Peak Spatial-Averaged Specific Absorption Rate (SAR) in the Human Head from Wireless Communications Devices: Measurement Techniques", June 2013
- IEC 62209-1, "Measurement procedure for the assessment of Specific Absorption Rate (SAR) from hand-held and body-mounted devices used next to the ear (frequency range of 300 MHz to 6 GHz)", July 2016
- IEC 62209-2, "Procedure to determine the Specific Absorption Rate (SAR) for wireless communication devices used in close proximity to the human body (frequency range of 30 MHz to 6 GHz)", March 2010
- KDB 865664, "SAR Measurement Requirements for 100 MHz to 6 GHz"

Additional Documentation:

- DASY4/5 System Handbook

Methods Applied and Interpretation of Parameters:

- Measurement Conditions:** Further details are available from the Validation Report at the end of the certificate. All figures stated in the certificate are valid at the frequency indicated.
- Antenna Parameters with TSL:** The dipole is mounted with the spacer to position its feed point exactly below the center marking of the flat phantom section, with the arms oriented parallel to the body axis.
- Feed Point Impedance and Return Loss:** These parameters are measured with the dipole positioned under the liquid filled phantom. The impedance stated is transformed from the measurement at the SMA connector to the feed point. The Return Loss ensures low reflected power. No uncertainty required.
- Electrical Delay:** One-way delay between the SMA connector and the antenna feed point. No uncertainty required.
- SAR measured:** SAR measured at the stated antenna input power.
- SAR normalized:** SAR as measured, normalized to an input power of 1 W at the antenna connector.
- SAR for nominal TSL parameters:** The measured TSL parameters are used to calculate the nominal SAR result.

The reported uncertainty of measurement is stated as the standard uncertainty of measurement multiplied by the coverage factor $k=2$, which for a normal distribution corresponds to a coverage probability of approximately 95%.

Measurement Conditions

DASY system configuration, as far as not given on page 1.

DASY Version	DASY5	V52.10.0
Extrapolation	Advanced Extrapolation	
Phantom	Modular Flat Phantom	
Distance Dipole Center - TSL	10 mm	with Spacer
Zoom Scan Resolution	dx, dy, dz = 5.0 mm	
Frequency	835 MHz \pm 1 MHz	

Head TSL parameters

The following parameters and calculations were applied.

	Temperature	Permittivity	Conductivity
Nominal Head TSL parameters	22.0 °C	41.5	0.90 mho/m
Measured Head TSL parameters	(22.0 \pm 0.2) °C	40.7 \pm 6 %	0.92 mho/m \pm 6 %
Head TSL temperature change during test	< 0.5 °C	----	----

SAR result with Head TSL

SAR averaged over 1 cm ³ (1 g) of Head TSL	Condition	
SAR measured	250 mW input power	2.39 W/kg
SAR for nominal Head TSL parameters	normalized to 1W	9.36 W/kg \pm 17.0 % (k=2)

SAR averaged over 10 cm ³ (10 g) of Head TSL	condition	
SAR measured	250 mW input power	1.55 W/kg
SAR for nominal Head TSL parameters	normalized to 1W	6.10 W/kg \pm 16.5 % (k=2)

Body TSL parameters

The following parameters and calculations were applied.

	Temperature	Permittivity	Conductivity
Nominal Body TSL parameters	22.0 °C	55.2	0.97 mho/m
Measured Body TSL parameters	(22.0 \pm 0.2) °C	54.8 \pm 6 %	0.99 mho/m \pm 6 %
Body TSL temperature change during test	< 0.5 °C	----	----

SAR result with Body TSL

SAR averaged over 1 cm ³ (1 g) of Body TSL	Condition	
SAR measured	250 mW input power	2.47 W/kg
SAR for nominal Body TSL parameters	normalized to 1W	9.71 W/kg \pm 17.0 % (k=2)

SAR averaged over 10 cm ³ (10 g) of Body TSL	condition	
SAR measured	250 mW input power	1.62 W/kg
SAR for nominal Body TSL parameters	normalized to 1W	6.39 W/kg \pm 16.5 % (k=2)

Appendix (Additional assessments outside the scope of SCS 0108)

Antenna Parameters with Head TSL

Impedance, transformed to feed point	51.8 Ω - 2.9 j Ω
Return Loss	- 29.5 dB

Antenna Parameters with Body TSL

Impedance, transformed to feed point	47.4 Ω - 5.7 j Ω
Return Loss	- 23.9 dB

General Antenna Parameters and Design

Electrical Delay (one direction)	1.386 ns
----------------------------------	----------

After long term use with 100W radiated power, only a slight warming of the dipole near the feedpoint can be measured.

The dipole is made of standard semirigid coaxial cable. The center conductor of the feeding line is directly connected to the second arm of the dipole. The antenna is therefore short-circuited for DC-signals. On some of the dipoles, small end caps are added to the dipole arms in order to improve matching when loaded according to the position as explained in the "Measurement Conditions" paragraph. The SAR data are not affected by this change. The overall dipole length is still according to the Standard.

No excessive force must be applied to the dipole arms, because they might bend or the soldered connections near the feedpoint may be damaged.

Additional EUT Data

Manufactured by	SPEAG
Manufactured on	July 22, 2011

Appendix (Additional assessments outside the scope of SCS 0108)

Measurement Conditions

DASY system configuration, as far as not given on page 1 and 3.

Phantom	SAM Head Phantom	For usage with cSAR3DV2-R/L
---------	------------------	-----------------------------

SAR result with SAM Head (Top)

SAR averaged over 1 cm ³ (1 g) of Head TSL	Condition	
SAR measured	250 mW input power	2.40 W/kg
SAR for nominal Head TSL parameters	normalized to 1W	9.41 W/kg ± 17.5 % (k=2)

SAR averaged over 10 cm ³ (10 g) of Head TSL	condition	
SAR measured	250 mW input power	1.58 W/kg
SAR for nominal Head TSL parameters	normalized to 1W	6.21 W/kg ± 16.9 % (k=2)

SAR result with SAM Head (Mouth)

SAR averaged over 1 cm ³ (1 g) of Head TSL	Condition	
SAR measured	250 mW input power	2.47 W/kg
SAR for nominal Head TSL parameters	normalized to 1W	9.69 W/kg ± 17.5 % (k=2)

SAR averaged over 10 cm ³ (10 g) of Head TSL	condition	
SAR measured	250 mW input power	1.64 W/kg
SAR for nominal Head TSL parameters	normalized to 1W	6.45 W/kg ± 16.9 % (k=2)

SAR result with SAM Head (Neck)

SAR averaged over 1 cm ³ (1 g) of Head TSL	Condition	
SAR measured	250 mW input power	2.35 W/kg
SAR for nominal Head TSL parameters	normalized to 1W	9.22 W/kg ± 17.5 % (k=2)

SAR averaged over 10 cm ³ (10 g) of Head TSL	condition	
SAR measured	250 mW input power	1.59 W/kg
SAR for nominal Head TSL parameters	normalized to 1W	6.25 W/kg ± 16.9 % (k=2)

SAR result with SAM Head (Ear)

SAR averaged over 1 cm ³ (1 g) of Head TSL	Condition	
SAR measured	250 mW input power	2.03 W/kg
SAR for nominal Head TSL parameters	normalized to 1W	7.96 W/kg ± 17.5 % (k=2)

SAR averaged over 10 cm ³ (10 g) of Head TSL	condition	
SAR measured	250 mW input power	1.37 W/kg
SAR for nominal Head TSL parameters	normalized to 1W	5.39 W/kg ± 16.9 % (k=2)

DASY5 Validation Report for Head TSL

Date: 08.01.2018

Test Laboratory: SPEAG, Zurich, Switzerland

DUT: Dipole 835 MHz; Type: D835V2; Serial: D835V2 - SN:4d132

Communication System: UID 0 - CW; Frequency: 835 MHz

Medium parameters used: $f = 835 \text{ MHz}$; $\sigma = 0.92 \text{ S/m}$; $\epsilon_r = 40.7$; $\rho = 1000 \text{ kg/m}^3$

Phantom section: Flat Section

Measurement Standard: DASY5 (IEEE/IEC/ANSI C63.19-2011)

DASY52 Configuration:

- Probe: EX3DV4 - SN7349; ConvF(9.9, 9.9, 9.9); Calibrated: 30.12.2017;
- Sensor-Surface: 1.4mm (Mechanical Surface Detection)
- Electronics: DAE4 Sn601; Calibrated: 26.10.2017
- Phantom: Flat Phantom 4.9 (front); Type: QD 00L P49 AA; Serial: 1001
- DASY52 52.10.0(1446); SEMCAD X 14.6.10(7417)

Dipole Calibration for Head Tissue/ $P_{in}=250 \text{ mW}$, $d=10\text{mm}$ /Zoom Scan (7x7x7)/Cube 0:

Measurement grid: $dx=5\text{mm}$, $dy=5\text{mm}$, $dz=5\text{mm}$

Reference Value = 63.23 V/m ; Power Drift = -0.04 dB

Peak SAR (extrapolated) = 3.64 W/kg

SAR(1 g) = 2.39 W/kg ; SAR(10 g) = 1.55 W/kg

Maximum value of SAR (measured) = 3.22 W/kg



0 dB = $3.22 \text{ W/kg} = 5.08 \text{ dBW/kg}$

Impedance Measurement Plot for Head TSL

8 Jan 2018 16:29:07

CH1 S11 1 U FS

1: 51.768 Ω -2.8984 Ω 65.761 pF

835.000 000 MHz

*
De1
Cor

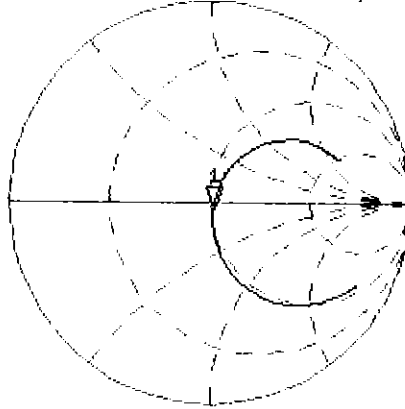

Avg
16

H1d

CH2 S11 LOG

5 dB/REF -20 dB

1:-29.535 dB

835.000 000 MHz

Cor

Avg
16

H1d

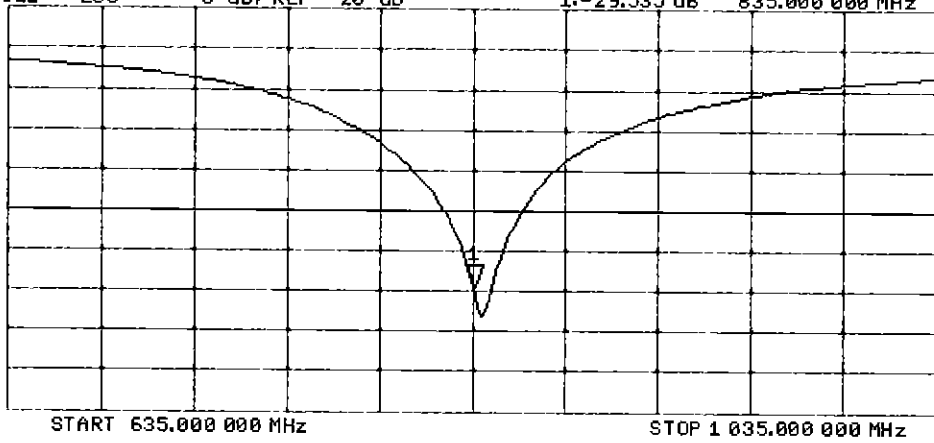

DASY5 Validation Report for Body TSL

Date: 08.01.2018

Test Laboratory: SPEAG, Zurich, Switzerland

DUT: Dipole 835 MHz; Type: D835V2; Serial: D835V2 - SN:4d132

Communication System: UID 0 - CW; Frequency: 835 MHz

Medium parameters used: $f = 835 \text{ MHz}$; $\sigma = 0.99 \text{ S/m}$; $\epsilon_r = 54.8$; $\rho = 1000 \text{ kg/m}^3$

Phantom section: Flat Section

Measurement Standard: DASY5 (IEEE/IEC/ANSI C63.19-2011)

DASY52 Configuration:

- Probe: EX3DV4 - SN7349; ConvF(10.05, 10.05, 10.05); Calibrated: 30.12.2017;
- Sensor-Surface: 1.4mm (Mechanical Surface Detection)
- Electronics: DAE4 Sn601; Calibrated: 26.10.2017
- Phantom: Flat Phantom 4.9 (Back); Type: QD 00R P49 AA; Serial: 1005
- DASY52 52.10.0(1446); SEMCAD X 14.6.10(7417)

Dipole Calibration for Body Tissue/Pin=250 mW, d=10mm/Zoom Scan (7x7x7)/Cube 0:

Measurement grid: $dx=5\text{mm}$, $dy=5\text{mm}$, $dz=5\text{mm}$

Reference Value = 60.55 V/m; Power Drift = -0.06 dB

Peak SAR (extrapolated) = 3.66 W/kg

SAR(1 g) = 2.47 W/kg; SAR(10 g) = 1.62 W/kg

Maximum value of SAR (measured) = 3.24 W/kg

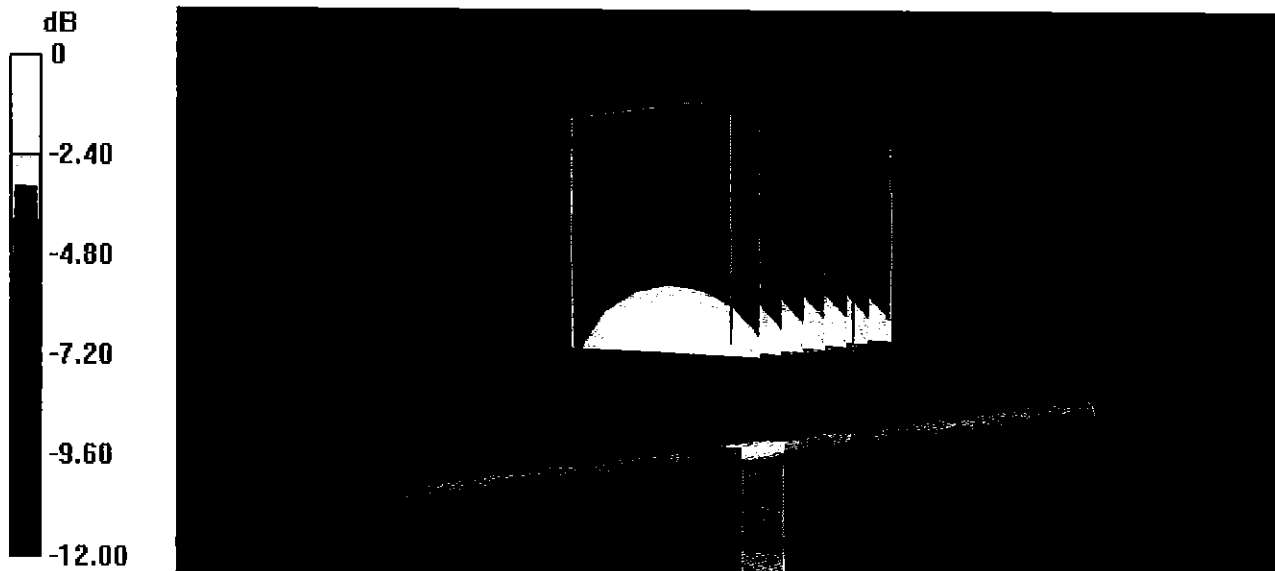

0 dB = 3.24 W/kg = 5.11 dBW/kg

Impedance Measurement Plot for Body TSL

8 Jan 2018 16:27:09

CH1 S11 1 U FS

1: 47.447 Ω -5.6680 Ω 33.628 pF

835.000 000 MHz

*
De1
Cor

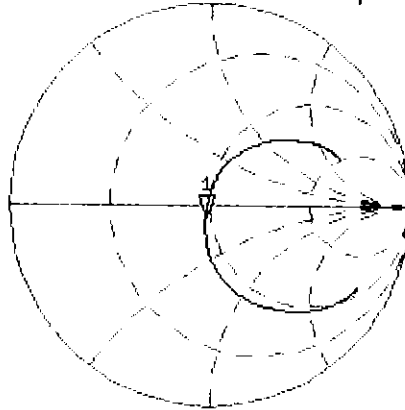

Avg
16

H1d

CH2 S11 LOG

5 dB/REF -20 dB

1:-23.922 dB

835.000 000 MHz

Cor

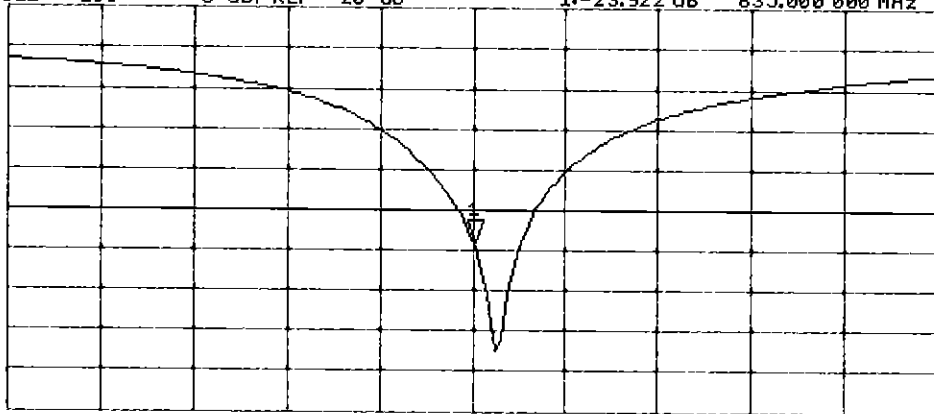

Avg
16

H1d

START 635.000 000 MHz

STOP 1 035.000 000 MHz

DASY5 Validation Report for SAM Head

Date: 15.01.2018

Test Laboratory: SPEAG, Zurich, Switzerland

DUT: Dipole 835 MHz; Type: D835V2; Serial: D835V2 - SN:4d132

Communication System: UID 0 - CW; Frequency: 835 MHz

Medium parameters used: $f = 835$ MHz; $\sigma = 0.94$ S/m; $\epsilon_r = 44.1$; $\rho = 1000$ kg/m³

Measurement Standard: DASY5 (IEEE/IEC/ANSI C63.19-2011)

DASY52 Configuration:

- Probe: EX3DV4 - SN7349; ConvF(9.9, 9.9, 9.9); Calibrated: 30.12.2017;
- Sensor-Surface: 1.4mm (Mechanical Surface Detection)
- Electronics: DAE4 Sn601; Calibrated: 26.10.2017
- Phantom: SAM Head
- DASY52 52.10.0(1446); SEMCAD X 14.6.10(7417)

SAM Head/Top/Zoom Scan (7x7x7)/Cube 0: Measurement grid: dx=5mm, dy=5mm, dz=5mm

Reference Value = 61.00 V/m; Power Drift = 0.01 dB

Peak SAR (extrapolated) = 3.56 W/kg

SAR(1 g) = 2.4 W/kg; SAR(10 g) = 1.58 W/kg

Maximum value of SAR (measured) = 3.16 W/kg

SAM Head/Mouth/Zoom Scan (7x7x7)/Cube 0: Measurement grid: dx=5mm, dy=5mm, dz=5mm

Reference Value = 60.99 V/m; Power Drift = -0.04 dB

Peak SAR (extrapolated) = 3.65 W/kg

SAR(1 g) = 2.47 W/kg; SAR(10 g) = 1.64 W/kg

Maximum value of SAR (measured) = 3.19 W/kg

SAM Head/Neck/Zoom Scan (7x7x7)/Cube 0: Measurement grid: dx=5mm, dy=5mm, dz=5mm

Reference Value = 59.20 V/m; Power Drift = 0.05 dB

Peak SAR (extrapolated) = 3.33 W/kg

SAR(1 g) = 2.35 W/kg; SAR(10 g) = 1.59 W/kg

Maximum value of SAR (measured) = 3.04 W/kg

SAM Head/Ear/Zoom Scan (7x7x7)/Cube 0: Measurement grid: dx=5mm, dy=5mm, dz=5mm

Reference Value = 55.03 V/m; Power Drift = 0.01 dB

Peak SAR (extrapolated) = 2.90 W/kg

SAR(1 g) = 2.03 W/kg; SAR(10 g) = 1.37 W/kg

Maximum value of SAR (measured) = 2.61 W/kg

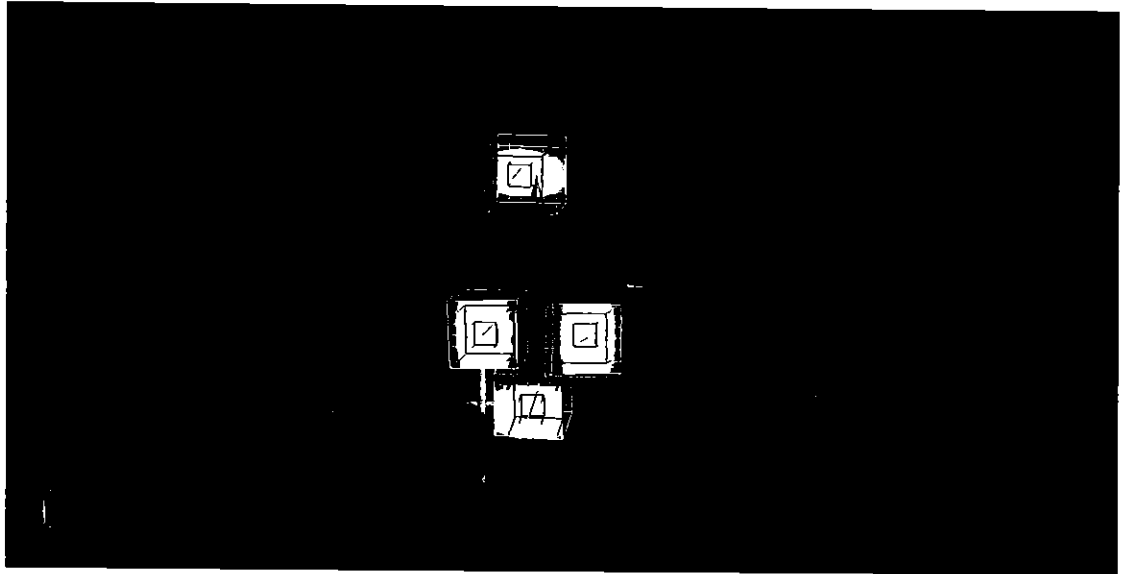
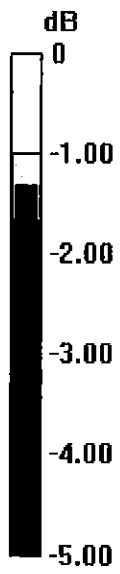

0 dB = 2.61 W/kg = 4.17 dBW/kg



Accredited by the Swiss Accreditation Service (SAS)
The Swiss Accreditation Service is one of the signatories to the EA
Multilateral Agreement for the recognition of calibration certificates

Accreditation No.: **SCS 0108**

Client **PC Test**

Certificate No: **D1750V2-1148_May17**

CALIBRATION CERTIFICATE

Object **D1750V2 - SN:1148**

Calibration procedure(s) **QA CAL-05.v9
Calibration procedure for dipole validation kits above 700 MHz**

Calibration date: **May 09, 2017**

*BN ✓
05-23-2017*

This calibration certificate documents the traceability to national standards, which realize the physical units of measurements (SI).
The measurements and the uncertainties with confidence probability are given on the following pages and are part of the certificate.

All calibrations have been conducted in the closed laboratory facility: environment temperature (22 ± 3)°C and humidity < 70%.

Calibration Equipment used (M&TE critical for calibration)

Primary Standards	ID #	Cal Date (Certificate No.)	Scheduled Calibration
Power meter NRP	SN: 104778	04-Apr-17 (No. 217-02521/02522)	Apr-18
Power sensor NRP-Z91	SN: 103244	04-Apr-17 (No. 217-02521)	Apr-18
Power sensor NRP-Z91	SN: 103245	04-Apr-17 (No. 217-02522)	Apr-18
Reference 20 dB Attenuator	SN: 5058 (20k)	07-Apr-17 (No. 217-02528)	Apr-18
Type-N mismatch combination	SN: 5047.2 / 06327	07-Apr-17 (No. 217-02529)	Apr-18
Reference Probe EX3DV4	SN: 7349	31-Dec-16 (No. EX3-7349_Dec16)	Dec-17
DAE4	SN: 601	28-Mar-17 (No. DAE4-601_Mar17)	Mar-18
Secondary Standards	ID #	Check Date (in house)	Scheduled Check
Power meter EPM-442A	SN: GB37480704	07-Oct-15 (in house check Oct-16)	In house check: Oct-18
Power sensor HP 8481A	SN: US37292783	07-Oct-15 (in house check Oct-16)	In house check: Oct-18
Power sensor HP 8481A	SN: MY41092317	07-Oct-15 (in house check Oct-16)	In house check: Oct-18
RF generator R&S SMT-06	SN: 100972	15-Jun-15 (in house check Oct-16)	In house check: Oct-18
Network Analyzer HP 8753E	SN: US37390585	18-Oct-01 (in house check Oct-16)	In house check: Oct-17

Calibrated by: **Claudio Leubler** Name: **Claudio Leubler** Function: **Laboratory Technician**

Signature

Approved by: **Katja Pokovic** Name: **Katja Pokovic** Function: **Technical Manager**

Issued: May 11, 2017

This calibration certificate shall not be reproduced except in full without written approval of the laboratory.



Accredited by the Swiss Accreditation Service (SAS)

Accreditation No.: **SCS 0108**

The Swiss Accreditation Service is one of the signatories to the EA
Multilateral Agreement for the recognition of calibration certificates

Glossary:

TSL	tissue simulating liquid
ConvF	sensitivity in TSL / NORM x,y,z
N/A	not applicable or not measured

Calibration is Performed According to the Following Standards:

- IEEE Std 1528-2013, "IEEE Recommended Practice for Determining the Peak Spatial-Averaged Specific Absorption Rate (SAR) in the Human Head from Wireless Communications Devices: Measurement Techniques", June 2013
- IEC 62209-1, "Procedure to measure the Specific Absorption Rate (SAR) for hand-held devices used in close proximity to the ear (frequency range of 300 MHz to 3 GHz)", February 2005
- IEC 62209-2, "Procedure to determine the Specific Absorption Rate (SAR) for wireless communication devices used in close proximity to the human body (frequency range of 30 MHz to 6 GHz)", March 2010
- KDB 865664, "SAR Measurement Requirements for 100 MHz to 6 GHz"

Additional Documentation:

- DASY4/5 System Handbook

Methods Applied and Interpretation of Parameters:

- Measurement Conditions:** Further details are available from the Validation Report at the end of the certificate. All figures stated in the certificate are valid at the frequency indicated.
- Antenna Parameters with TSL:** The dipole is mounted with the spacer to position its feed point exactly below the center marking of the flat phantom section, with the arms oriented parallel to the body axis.
- Feed Point Impedance and Return Loss:** These parameters are measured with the dipole positioned under the liquid filled phantom. The impedance stated is transformed from the measurement at the SMA connector to the feed point. The Return Loss ensures low reflected power. No uncertainty required.
- Electrical Delay:** One-way delay between the SMA connector and the antenna feed point. No uncertainty required.
- SAR measured:** SAR measured at the stated antenna input power.
- SAR normalized:** SAR as measured, normalized to an input power of 1 W at the antenna connector.
- SAR for nominal TSL parameters:** The measured TSL parameters are used to calculate the nominal SAR result.

The reported uncertainty of measurement is stated as the standard uncertainty of measurement multiplied by the coverage factor $k=2$, which for a normal distribution corresponds to a coverage probability of approximately 95%.

Measurement Conditions

DASY system configuration, as far as not given on page 1.

DASY Version	DASY5	V52.10.0
Extrapolation	Advanced Extrapolation	
Phantom	Modular Flat Phantom	
Distance Dipole Center - TSL	10 mm	with Spacer
Zoom Scan Resolution	dx, dy, dz = 5 mm	
Frequency	1750 MHz ± 1 MHz	

Head TSL parameters

The following parameters and calculations were applied.

	Temperature	Permittivity	Conductivity
Nominal Head TSL parameters	22.0 °C	40.1	1.37 mho/m
Measured Head TSL parameters	(22.0 ± 0.2) °C	39.0 ± 6 %	1.36 mho/m ± 6 %
Head TSL temperature change during test	< 0.5 °C	----	----

SAR result with Head TSL

SAR averaged over 1 cm ³ (1 g) of Head TSL	Condition	
SAR measured	250 mW input power	9.11 W/kg
SAR for nominal Head TSL parameters	normalized to 1W	36.4 W/kg ± 17.0 % (k=2)

SAR averaged over 10 cm ³ (10 g) of Head TSL	condition	
SAR measured	250 mW input power	4.83 W/kg
SAR for nominal Head TSL parameters	normalized to 1W	19.3 W/kg ± 16.5 % (k=2)

Body TSL parameters

The following parameters and calculations were applied.

	Temperature	Permittivity	Conductivity
Nominal Body TSL parameters	22.0 °C	53.4	1.49 mho/m
Measured Body TSL parameters	(22.0 ± 0.2) °C	53.7 ± 6 %	1.47 mho/m ± 6 %
Body TSL temperature change during test	< 0.5 °C	----	----

SAR result with Body TSL

SAR averaged over 1 cm ³ (1 g) of Body TSL	Condition	
SAR measured	250 mW input power	9.17 W/kg
SAR for nominal Body TSL parameters	normalized to 1W	37.0 W/kg ± 17.0 % (k=2)

SAR averaged over 10 cm ³ (10 g) of Body TSL	condition	
SAR measured	250 mW input power	4.93 W/kg
SAR for nominal Body TSL parameters	normalized to 1W	19.8 W/kg ± 16.5 % (k=2)

Appendix (Additional assessments outside the scope of SCS 0108)

Antenna Parameters with Head TSL

Impedance, transformed to feed point	49.8 Ω - 0.7 j Ω
Return Loss	- 42.9 dB

Antenna Parameters with Body TSL

Impedance, transformed to feed point	45.7 Ω - 0.5 j Ω
Return Loss	- 26.9 dB

General Antenna Parameters and Design

Electrical Delay (one direction)	1.223 ns
----------------------------------	----------

After long term use with 100W radiated power, only a slight warming of the dipole near the feedpoint can be measured.

The dipole is made of standard semirigid coaxial cable. The center conductor of the feeding line is directly connected to the second arm of the dipole. The antenna is therefore short-circuited for DC-signals. On some of the dipoles, small end caps are added to the dipole arms in order to improve matching when loaded according to the position as explained in the "Measurement Conditions" paragraph. The SAR data are not affected by this change. The overall dipole length is still according to the Standard.

No excessive force must be applied to the dipole arms, because they might bend or the soldered connections near the feedpoint may be damaged.

Additional EUT Data

Manufactured by	SPEAG
Manufactured on	September 30, 2014

DASY5 Validation Report for Head TSL

Date: 09.05.2017

Test Laboratory: SPEAG, Zurich, Switzerland

DUT: Dipole 1750 MHz; Type: D1750V2; Serial: D1750V2 - SN:1148

Communication System: UID 0 - CW; Frequency: 1750 MHz

Medium parameters used: $f = 1750$ MHz; $\sigma = 1.36$ S/m; $\epsilon_r = 39$; $\rho = 1000$ kg/m³

Phantom section: Flat Section

Measurement Standard: DASY5 (IEEE/IEC/ANSI C63.19-2011)

DASY52 Configuration:

- Probe: EX3DV4 - SN7349; ConvF(8.46, 8.46, 8.46); Calibrated: 31.12.2016;
- Sensor-Surface: 1.4mm (Mechanical Surface Detection)
- Electronics: DAE4 Sn601; Calibrated: 28.03.2017
- Phantom: Flat Phantom 5.0 (front); Type: QD000P50AA; Serial: 1001
- DASY52 52.10.0(1442); SEMCAD X 14.6.10(7413)

Dipole Calibration for Head Tissue/Pin=250 mW, d=10mm/Zoom Scan (7x7x7)/Cube 0:

Measurement grid: dx=5mm, dy=5mm, dz=5mm

Reference Value = 105.4 V/m; Power Drift = -0.01 dB

Peak SAR (extrapolated) = 16.5 W/kg

SAR(1 g) = 9.11 W/kg; SAR(10 g) = 4.83 W/kg

Maximum value of SAR (measured) = 13.9 W/kg

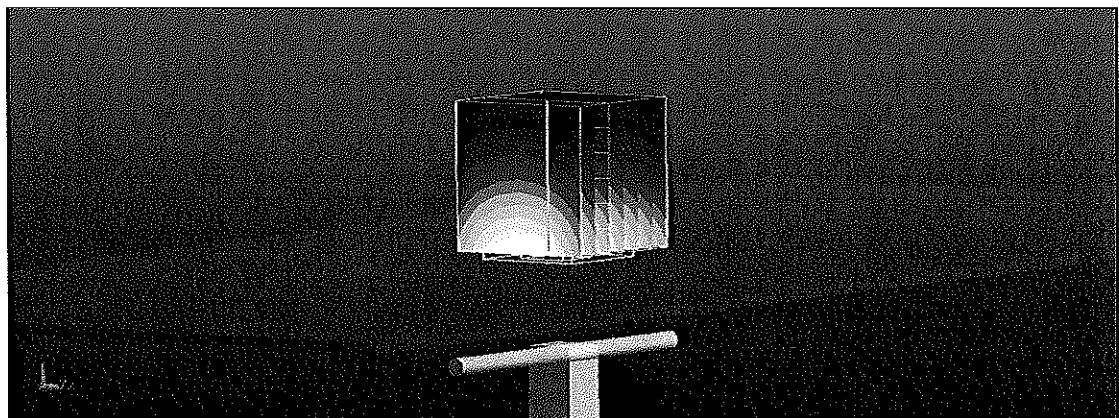
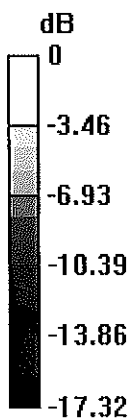

0 dB = 13.9 W/kg = 11.43 dBW/kg

Impedance Measurement Plot for Head TSL

9 May 2017 14:43:11

[CH1] S11 1 U FS 1: 49.777 Ω -683.59 m Ω 133.04 pF 1 750.000 000 MHz

*
De1
CA
Avg
16
H1d

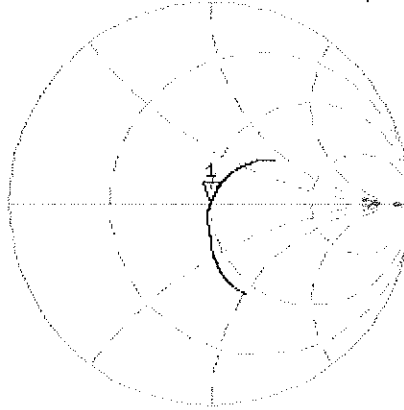

CH2 S11 LOG 5 dB/REF -20 dB 1: -42.893 dB 1 750.000 000 MHz

CA
Avg
16
H1d

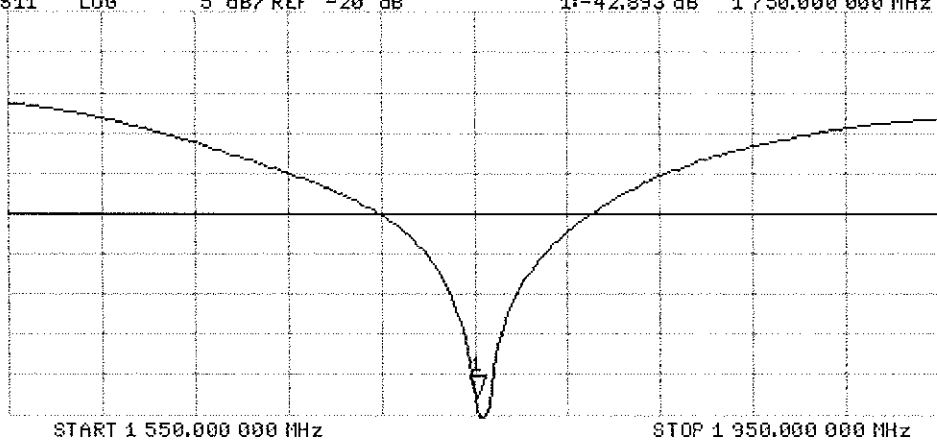

DASY5 Validation Report for Body TSL

Date: 09.05.2017

Test Laboratory: SPEAG, Zurich, Switzerland

DUT: Dipole 1750 MHz; Type: D1750V2; Serial: D1750V2 - SN:1148

Communication System: UID 0 - CW; Frequency: 1750 MHz

Medium parameters used: $f = 1750$ MHz; $\sigma = 1.47$ S/m; $\epsilon_r = 53.7$; $\rho = 1000$ kg/m³

Phantom section: Flat Section

Measurement Standard: DASY5 (IEEE/IEC/ANSI C63.19-2011)

DASY52 Configuration:

- Probe: EX3DV4 - SN7349; ConvF(8.25, 8.25, 8.25); Calibrated: 31.12.2016;
- Sensor-Surface: 1.4mm (Mechanical Surface Detection)
- Electronics: DAE4 Sn601; Calibrated: 28.03.2017
- Phantom: Flat Phantom 5.0 (back); Type: QD 000 P50 AA; Serial: 1002
- DASY52 52.10.0(1442); SEMCAD X 14.6.10(7413)

Dipole Calibration for Body Tissue/Pin=250 mW, d=10mm/Zoom Scan (7x7x7)/Cube 0:

Measurement grid: dx=5mm, dy=5mm, dz=5mm

Reference Value = 99.49 V/m; Power Drift = -0.04 dB

Peak SAR (extrapolated) = 15.9 W/kg

SAR(1 g) = 9.17 W/kg; SAR(10 g) = 4.93 W/kg

Maximum value of SAR (measured) = 13.1 W/kg

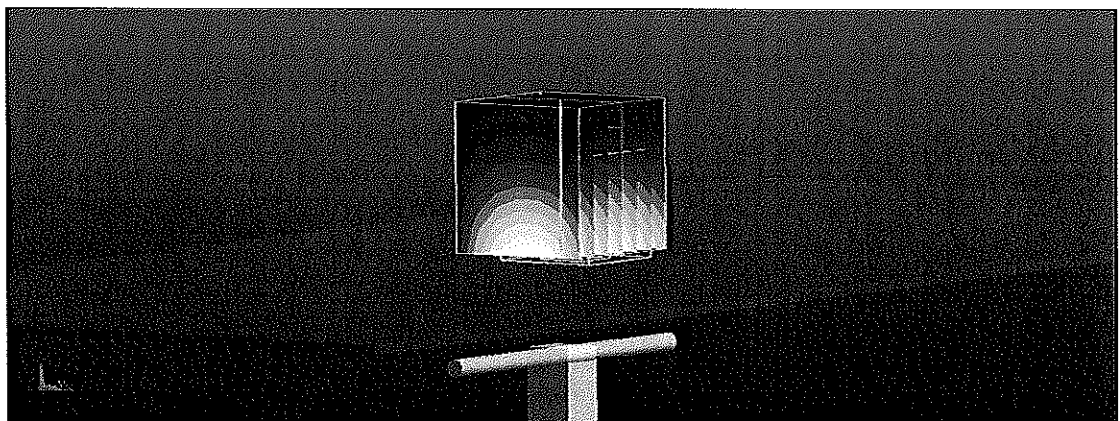
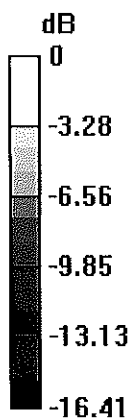

0 dB = 13.1 W/kg = 11.17 dBW/kg

Impedance Measurement Plot for Body TSL

9 May 2017 14:42:25

[CH1] S11 1 U FS 1: 45.707 Ω -513.67 $m\Omega$ 177.05 pF 1 750.000 000 MHz

*
De1
CA
Avg
16
H1d

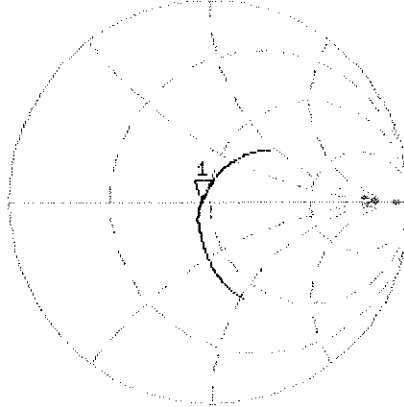

CH2 S11 LOG 5 dB/REF -20 dB 1:-26.901 dB 1 750.000 000 MHz

CA
Avg
16
H1d

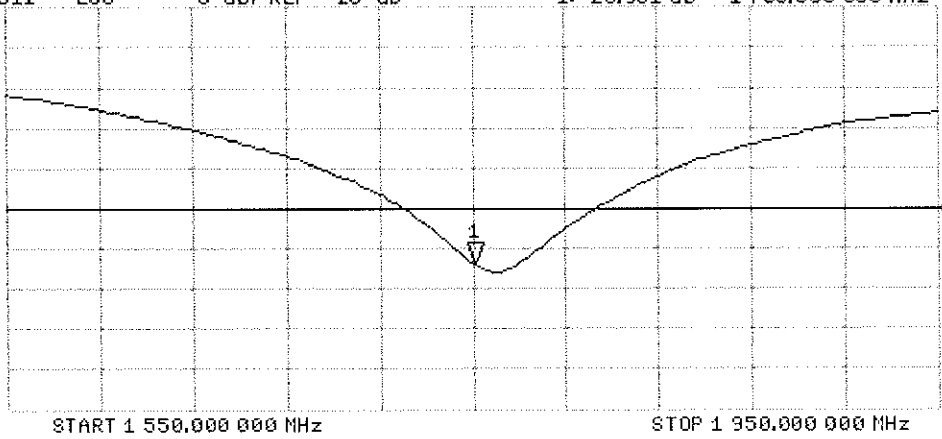



Accredited by the Swiss Accreditation Service (SAS)
The Swiss Accreditation Service is one of the signatories to the EA
Multilateral Agreement for the recognition of calibration certificates

Accreditation No.: **SCS 0108**

Client **PC Test**

Certificate No: **D1900V2-5d080_Jul16**

CALIBRATION CERTIFICATE

Object **D1900V2 - SN:5d080**

Calibration procedure(s) **QA CAL-05.v9
Calibration procedure for dipole validation kits above 700 MHz**

Calibration date: **July 08, 2016**

*BNV
7/16/2016
Extended
7/20/17
SCV*

This calibration certificate documents the traceability to national standards, which realize the physical units of measurements (SI).
The measurements and the uncertainties with confidence probability are given on the following pages and are part of the certificate.

All calibrations have been conducted in the closed laboratory facility: environment temperature (22 ± 3)°C and humidity < 70%.

Calibration Equipment used (M&TE critical for calibration)

Primary Standards	ID #	Cal Date (Certificate No.)	Scheduled Calibration
Power meter NRP	SN: 104778	06-Apr-16 (No. 217-02288/02289)	Apr-17
Power sensor NRP-Z91	SN: 103244	06-Apr-16 (No. 217-02288)	Apr-17
Power sensor NRP-Z91	SN: 103245	06-Apr-16 (No. 217-02289)	Apr-17
Reference 20 dB Attenuator	SN: 5058 (20k)	05-Apr-16 (No. 217-02292)	Apr-17
Type-N mismatch combination	SN: 5047.2 / 06327	05-Apr-16 (No. 217-02295)	Apr-17
Reference Probe EX3DV4	SN: 7349	15-Jun-16 (No. EX3-7349_Jun16)	Jun-17
DAE4	SN: 601	30-Dec-15 (No. DAE4-601_Dec15)	Dec-16

Secondary Standards	ID #	Check Date (in house)	Scheduled Check
Power meter EPM-442A	SN: GB37480704	07-Oct-15 (No. 217-02222)	In house check: Oct-16
Power sensor HP 8481A	SN: US37292783	07-Oct-15 (No. 217-02222)	In house check: Oct-16
Power sensor HP 8481A	SN: MY41092317	07-Oct-15 (No. 217-02223)	In house check: Oct-16
RF generator R&S SMT-06	SN: 100972	15-Jun-15 (in house check Jun-15)	In house check: Oct-16
Network Analyzer HP 8753E	SN: US37390585	18-Oct-01 (in house check Oct-15)	In house check: Oct-16

Calibrated by:	Name Jeton Kastrati	Function Laboratory Technician	Signature
Approved by:	Name Katja Pokovic	Function Technical Manager	Signature

Issued: July 13, 2016

This calibration certificate shall not be reproduced except in full without written approval of the laboratory.



Accredited by the Swiss Accreditation Service (SAS)
The Swiss Accreditation Service is one of the signatories to the EA
Multilateral Agreement for the recognition of calibration certificates

Accreditation No.: **SCS 0108**

Glossary:

TSL	tissue simulating liquid
ConvF	sensitivity in TSL / NORM x,y,z
N/A	not applicable or not measured

Calibration is Performed According to the Following Standards:

- a) IEEE Std 1528-2013, "IEEE Recommended Practice for Determining the Peak Spatial-Averaged Specific Absorption Rate (SAR) in the Human Head from Wireless Communications Devices: Measurement Techniques", June 2013
- b) IEC 62209-1, "Procedure to measure the Specific Absorption Rate (SAR) for hand-held devices used in close proximity to the ear (frequency range of 300 MHz to 3 GHz)", February 2005
- c) IEC 62209-2, "Procedure to determine the Specific Absorption Rate (SAR) for wireless communication devices used in close proximity to the human body (frequency range of 30 MHz to 6 GHz)", March 2010
- d) KDB 865664, "SAR Measurement Requirements for 100 MHz to 6 GHz"

Additional Documentation:

- e) DASY4/5 System Handbook

Methods Applied and Interpretation of Parameters:

- *Measurement Conditions:* Further details are available from the Validation Report at the end of the certificate. All figures stated in the certificate are valid at the frequency indicated.
- *Antenna Parameters with TSL:* The dipole is mounted with the spacer to position its feed point exactly below the center marking of the flat phantom section, with the arms oriented parallel to the body axis.
- *Feed Point Impedance and Return Loss:* These parameters are measured with the dipole positioned under the liquid filled phantom. The impedance stated is transformed from the measurement at the SMA connector to the feed point. The Return Loss ensures low reflected power. No uncertainty required.
- *Electrical Delay:* One-way delay between the SMA connector and the antenna feed point. No uncertainty required.
- *SAR measured:* SAR measured at the stated antenna input power.
- *SAR normalized:* SAR as measured, normalized to an input power of 1 W at the antenna connector.
- *SAR for nominal TSL parameters:* The measured TSL parameters are used to calculate the nominal SAR result.

The reported uncertainty of measurement is stated as the standard uncertainty of measurement multiplied by the coverage factor $k=2$, which for a normal distribution corresponds to a coverage probability of approximately 95%.

Measurement Conditions

DASY system configuration, as far as not given on page 1.

DASY Version	DASY5	V52.8.8
Extrapolation	Advanced Extrapolation	
Phantom	Modular Flat Phantom	
Distance Dipole Center - TSL	10 mm	with Spacer
Zoom Scan Resolution	dx, dy, dz = 5 mm	
Frequency	1900 MHz \pm 1 MHz	

Head TSL parameters

The following parameters and calculations were applied.

	Temperature	Permittivity	Conductivity
Nominal Head TSL parameters	22.0 °C	40.0	1.40 mho/m
Measured Head TSL parameters	(22.0 \pm 0.2) °C	39.8 \pm 6 %	1.38 mho/m \pm 6 %
Head TSL temperature change during test	< 0.5 °C	----	----

SAR result with Head TSL

SAR averaged over 1 cm ³ (1 g) of Head TSL	Condition	
SAR measured	250 mW input power	9.76 W/kg
SAR for nominal Head TSL parameters	normalized to 1W	39.3 W/kg \pm 17.0 % (k=2)

SAR averaged over 10 cm ³ (10 g) of Head TSL	condition	
SAR measured	250 mW input power	5.10 W/kg
SAR for nominal Head TSL parameters	normalized to 1W	20.5 W/kg \pm 16.5 % (k=2)

Body TSL parameters

The following parameters and calculations were applied.

	Temperature	Permittivity	Conductivity
Nominal Body TSL parameters	22.0 °C	53.3	1.52 mho/m
Measured Body TSL parameters	(22.0 \pm 0.2) °C	52.7 \pm 6 %	1.51 mho/m \pm 6 %
Body TSL temperature change during test	< 0.5 °C	----	----

SAR result with Body TSL

SAR averaged over 1 cm ³ (1 g) of Body TSL	Condition	
SAR measured	250 mW input power	9.75 W/kg
SAR for nominal Body TSL parameters	normalized to 1W	39.1 W/kg \pm 17.0 % (k=2)

SAR averaged over 10 cm ³ (10 g) of Body TSL	condition	
SAR measured	250 mW input power	5.17 W/kg
SAR for nominal Body TSL parameters	normalized to 1W	20.7 W/kg \pm 16.5 % (k=2)

Appendix (Additional assessments outside the scope of SCS 0108)

Antenna Parameters with Head TSL

Impedance, transformed to feed point	52.1 Ω + 5.3 j Ω
Return Loss	- 25.1 dB

Antenna Parameters with Body TSL

Impedance, transformed to feed point	47.4 Ω + 6.8 j Ω
Return Loss	- 22.6 dB

General Antenna Parameters and Design

Electrical Delay (one direction)	1.192 ns
----------------------------------	----------

After long term use with 100W radiated power, only a slight warming of the dipole near the feedpoint can be measured.

The dipole is made of standard semirigid coaxial cable. The center conductor of the feeding line is directly connected to the second arm of the dipole. The antenna is therefore short-circuited for DC-signals. On some of the dipoles, small end caps are added to the dipole arms in order to improve matching when loaded according to the position as explained in the "Measurement Conditions" paragraph. The SAR data are not affected by this change. The overall dipole length is still according to the Standard.

No excessive force must be applied to the dipole arms, because they might bend or the soldered connections near the feedpoint may be damaged.

Additional EUT Data

Manufactured by	SPEAG
Manufactured on	June 28, 2006

DASY5 Validation Report for Head TSL

Date: 08.07.2016

Test Laboratory: SPEAG, Zurich, Switzerland

DUT: Dipole 1900 MHz; Type: D1900V2; Serial: D1900V2 - SN:5d080

Communication System: UID 0 - CW; Frequency: 1900 MHz

Medium parameters used: $f = 1900$ MHz; $\sigma = 1.38$ S/m; $\epsilon_r = 39.8$; $\rho = 1000$ kg/m³

Phantom section: Flat Section

Measurement Standard: DASY5 (IEEE/IEC/ANSI C63.19-2011)

DASY52 Configuration:

- Probe: EX3DV4 - SN7349; ConvF(7.99, 7.99, 7.99); Calibrated: 15.06.2016;
- Sensor-Surface: 1.4mm (Mechanical Surface Detection)
- Electronics: DAE4 Sn601; Calibrated: 30.12.2015
- Phantom: Flat Phantom 5.0 (front); Type: QD000P50AA; Serial: 1001
- DASY52 52.8.8(1258); SEMCAD X 14.6.10(7372)

Dipole Calibration for Head Tissue/Pin=250 mW, d=10mm/Zoom Scan (7x7x7)/Cube 0:

Measurement grid: dx=5mm, dy=5mm, dz=5mm

Reference Value = 106.6 V/m; Power Drift = -0.04 dB

Peak SAR (extrapolated) = 18.4 W/kg

SAR(1 g) = 9.76 W/kg; SAR(10 g) = 5.1 W/kg

Maximum value of SAR (measured) = 15.0 W/kg

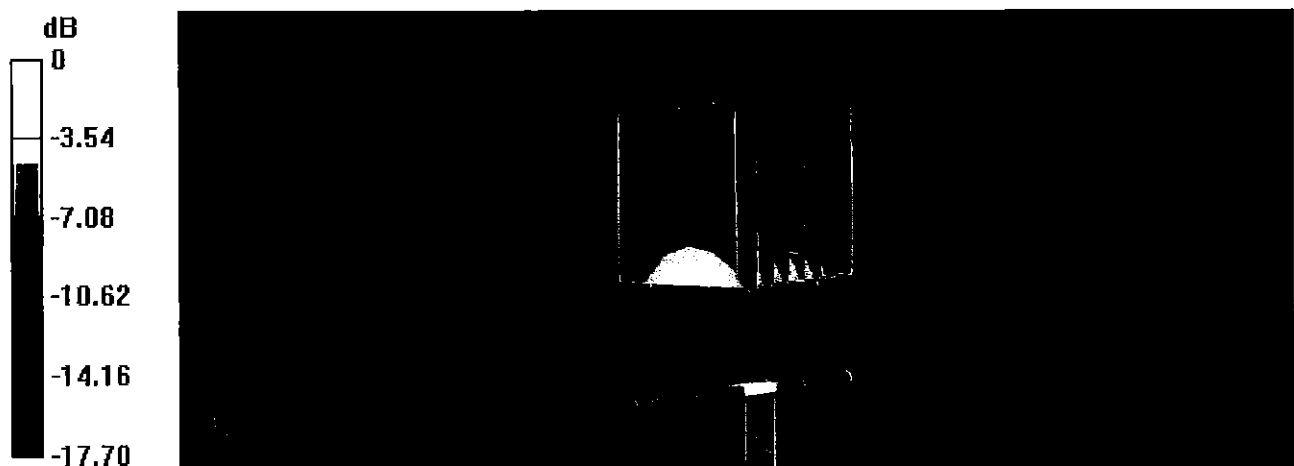

0 dB = 15.0 W/kg = 11.76 dBW/kg

Impedance Measurement Plot for Head TSL

8 Jul 2016 16:18:04

CH1 S11 1 U FS

1: 52.143 Ω 5.2500 Ω 439.78 pF

1 900.000 000 MHz

*
Del
Cor

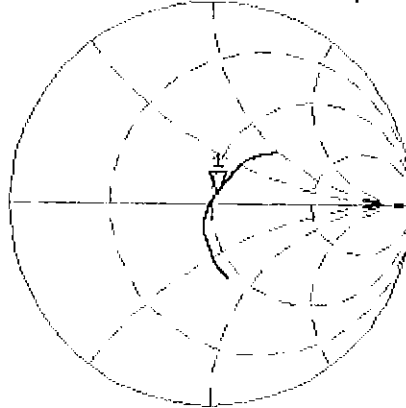

Avg
16

H1d

CH2 S11 LOG 5 dB/REF -20 dB 1:-25.118 dB 1 900.000 000 MHz

Cor

Avg
16

H1d

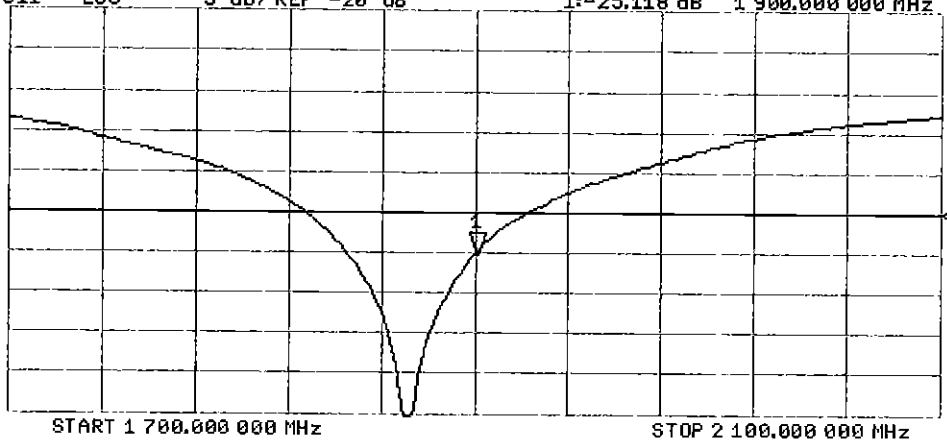

DASY5 Validation Report for Body TSL

Date: 08.07.2016

Test Laboratory: SPEAG, Zurich, Switzerland

DUT: Dipole 1900 MHz; Type: D1900V2; Serial: D1900V2 - SN:5d080

Communication System: UID 0 - CW; Frequency: 1900 MHz

Medium parameters used: $f = 1900$ MHz; $\sigma = 1.51$ S/m; $\epsilon_r = 52.7$; $\rho = 1000$ kg/m³

Phantom section: Flat Section

Measurement Standard: DASY5 (IEEE/IEC/ANSI C63.19-2011)

DASY52 Configuration:

- Probe: EX3DV4 - SN7349; ConvF(8.03, 8.03, 8.03); Calibrated: 15.06.2016;
- Sensor-Surface: 1.4mm (Mechanical Surface Detection)
- Electronics: DAE4 Sn601; Calibrated: 30.12.2015
- Phantom: Flat Phantom 5.0 (back); Type: QD000P50AA; Serial: 1002
- DASY52 52.8.8(1258); SEMCAD X 14.6.10(7372)

Dipole Calibration for Body Tissue/Pin=250 mW, d=10mm/Zoom Scan (7x7x7)/Cube 0:

Measurement grid: dx=5mm, dy=5mm, dz=5mm

Reference Value = 103.1 V/m; Power Drift = -0.02 dB

Peak SAR (extrapolated) = 17.1 W/kg

SAR(1 g) = 9.75 W/kg; SAR(10 g) = 5.17 W/kg

Maximum value of SAR (measured) = 14.7 W/kg

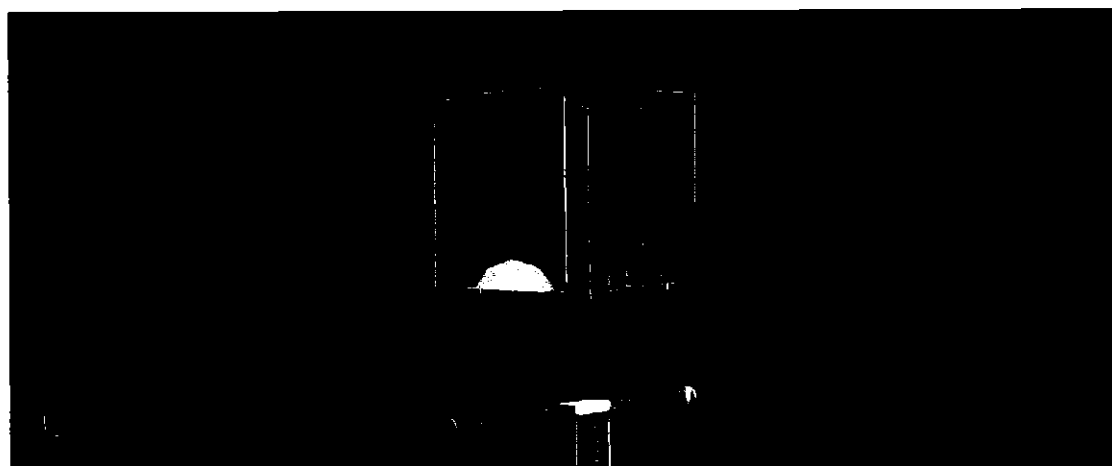
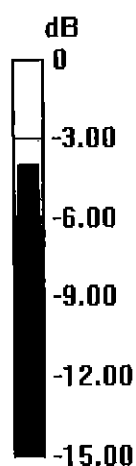

0 dB = 14.7 W/kg = 11.67 dBW/kg

Impedance Measurement Plot for Body TSL

8 Jul 2016 16:16:56

CH1 S11 1 U FS

1: 47.412 Ω 6.7422 Ω 564.78 μH

1 900.000 000 MHz

*
De1
Cor

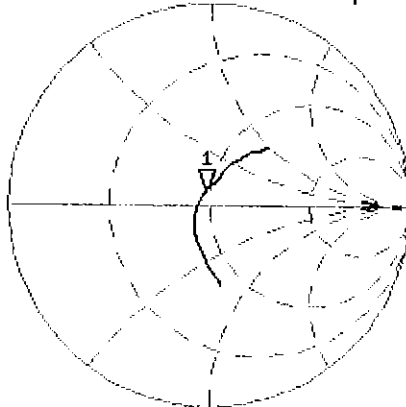

Avg
16

H1d

CH2 S11 LOG

5 dB/REF -20 dB

1:-22.620 dB

1 900.000 000 MHz

Cor

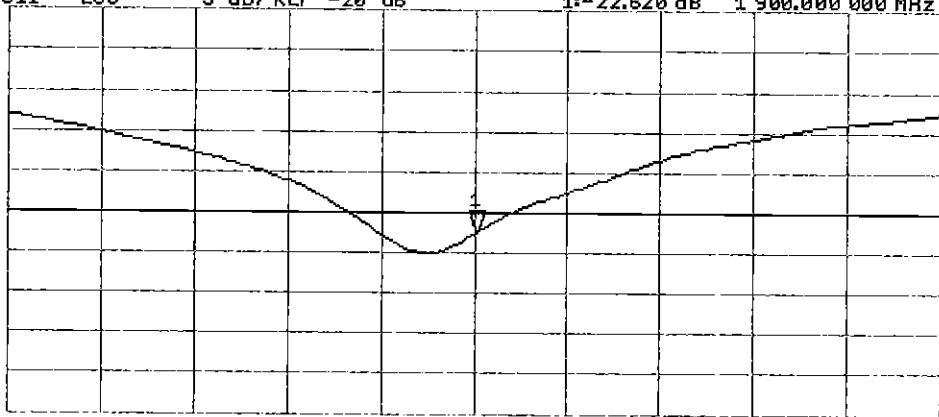

Avg
16

H1d

START 1 700.000 000 MHz

STOP 2 100.000 000 MHz

Certification of Calibration

Object: D1900V2 – SN: 5d080

Calibration procedure(s): Procedure for Calibration Extension for SAR Dipoles.

Calibration date: July 06, 2017

Description: SAR Validation Dipole at 1900 MHz.

Calibration Equipment used:

Manufacturer	Model	Description	Cal Date	Cal Interval	Cal Due	Serial Number
Control Company	4040	Therm./Clock/Humidity Monitor	3/31/2017	Biennial	3/31/2019	170232394
Control Company	4352	Ultra Long Stem Thermometer	5/2/2017	Biennial	5/2/2019	170330156
Amplifier Research	1551G6	Amplifier	CBT	N/A	CBT	433971
Narda	4772-3	Attenuator (3dB)	CBT	N/A	CBT	9406
Keysight Technologies	85033E	Standard Mechanical Calibration Kit (DC to 9GHz, 3.5mm)	6/1/2017	Annual	6/1/2018	MY53401181
Agilent	8753ES	S-Parameter Network Analyzer	10/26/2016	Annual	10/26/2017	US39170118
Mini-Circuits	BW-N20W5+	DC to 18 GHz Precision Fixed 20 dB Attenuator	CBT	N/A	CBT	N/A
SPEAG	DAE4	Dasy Data Acquisition Electronics	3/13/2017	Annual	3/13/2018	1415
SPEAG	DAK-3.5	Dielectric Assessment Kit	5/10/2017	Annual	5/10/2018	1070
SPEAG	ES3DV3	SAR Probe	3/14/2017	Annual	3/14/2018	3209
Anritsu	MA2411B	Pulse Power Sensor	2/10/2017	Annual	2/10/2018	1207364
Anritsu	MA2411B	Pulse Power Sensor	2/10/2017	Annual	2/10/2018	1339018
Anritsu	ML2495A	Power Meter	10/16/2015	Biennial	10/16/2017	941001
Agilent	N5182A	MXG Vector Signal Generator	2/28/2017	Annual	2/28/2018	MY47420800
Seekonk	NC-100	Torque Wrench	11/6/2015	Biennial	11/6/2017	N/A
Mini-Circuits	NLP-2950+	Low Pass Filter DC to 2700 MHz	CBT	N/A	CBT	N/A
Pasternack	PE2209-10	Bidirectional Coupler	CBT	N/A	CBT	N/A

Measurement Uncertainty = $\pm 23\%$ (k=2)

	Name	Function	Signature
Calibrated By:	Brodie Halfoster	Test Engineer	<i>BRODIE HALBFOSTER</i>
Approved By:	Kaitlin O'Keefe	Senior Technical Manager	<i>KOK</i>

DIPOLE CALIBRATION EXTENSION

Per KDB 865664 D01, calibration intervals of up to three years may be considered for reference dipoles when it is demonstrated that the SAR target, impedance and return loss of a dipole have remained stable according to the following requirements:

1. The measured SAR does not deviate more than 10% from the target on the calibration certificate.
2. The return-loss does not deviate more than 20% from the previous measurement and meets the required 20dB minimum return-loss requirement.
3. The measurement of real or imaginary parts of impedance does not deviate more than 5Ω from the previous measurement.

The following dipole was checked to pass the above 3 requirements to have 2-year calibration period from the calibration date:

Calibration Date	Extension Date	Certificate Electrical Delay (ns)	Certificate SAR Target Head (1g) W/kg @ 20.0 dBm	Measured Head SAR (1g) W/kg @ 20.0 dBm	Deviation 1g (%)	Certificate SAR Target Head (10g) W/kg @ 20.0 dBm	Measured Head SAR (10g) W/kg @ 20.0 dBm	Deviation 10g (%)	Certificate Impedance Head (Ohm) Real	Measured Impedance Head (Ohm) Real	Difference (Ohm) Real	Certificate Impedance Head (Ohm) Imaginary	Measured Impedance Head (Ohm) Imaginary	Difference (Ohm) Imaginary	Certificate Return Loss Head (dB)	Measured Return Loss Head (dB)	Deviation (%)	PASS/FAIL
7/8/2016	7/6/2017	1.192	3.93	3.86	-1.78%	2.05	2	-2.44%	52.1	52.9	0.8	5.3	4.7	0.6	-25.1	-25.6	-2.00%	PASS
Calibration Date	Extension Date	Certificate Electrical Delay (ns)	Certificate SAR Target Body (1g) W/kg @ 20.0 dBm	Measured Body SAR (1g) W/kg @ 20.0 dBm	Deviation 1g (%)	Certificate SAR Target Body (10g) W/kg @ 20.0 dBm	Measured Body SAR (10g) W/kg @ 20.0 dBm	Deviation 10g (%)	Certificate Impedance Body (Ohm) Real	Measured Impedance Body (Ohm) Real	Difference (Ohm) Real	Certificate Impedance Body (Ohm) Imaginary	Measured Impedance Body (Ohm) Imaginary	Difference (Ohm) Imaginary	Certificate Return Loss Body (dB)	Measured Return Loss Body (dB)	Deviation (%)	PASS/FAIL
7/8/2016	7/6/2017	1.192	3.91	4.05	3.58%	2.07	2.11	1.93%	47.4	48.5	1.1	6.8	5.1	1.7	-22.6	-25.5	-12.80%	PASS

Impedance & Return-Loss Measurement Plot for Head TSL

6 Jul 2017 22:52:01
 [CH1] S11 1 U FS 1: 52.850 Ω 4.6816 Ω 392.16 pF 1 900.000 000 MHz

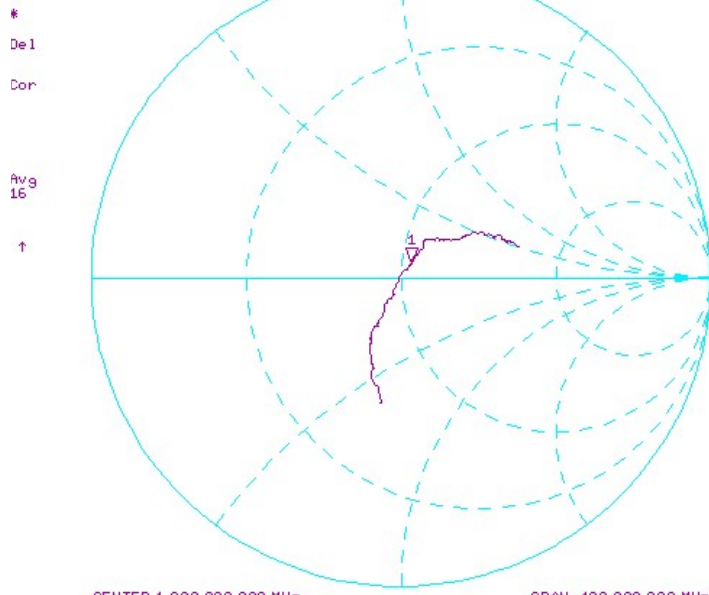

CENTER 1 900.000 000 MHz SPAN 400.000 000 MHz

6 Jul 2017 22:51:01

[CH1] S11 LOG 5 dB/REF -20 dB 1:-25.595 dB 1 900.000 000 MHz

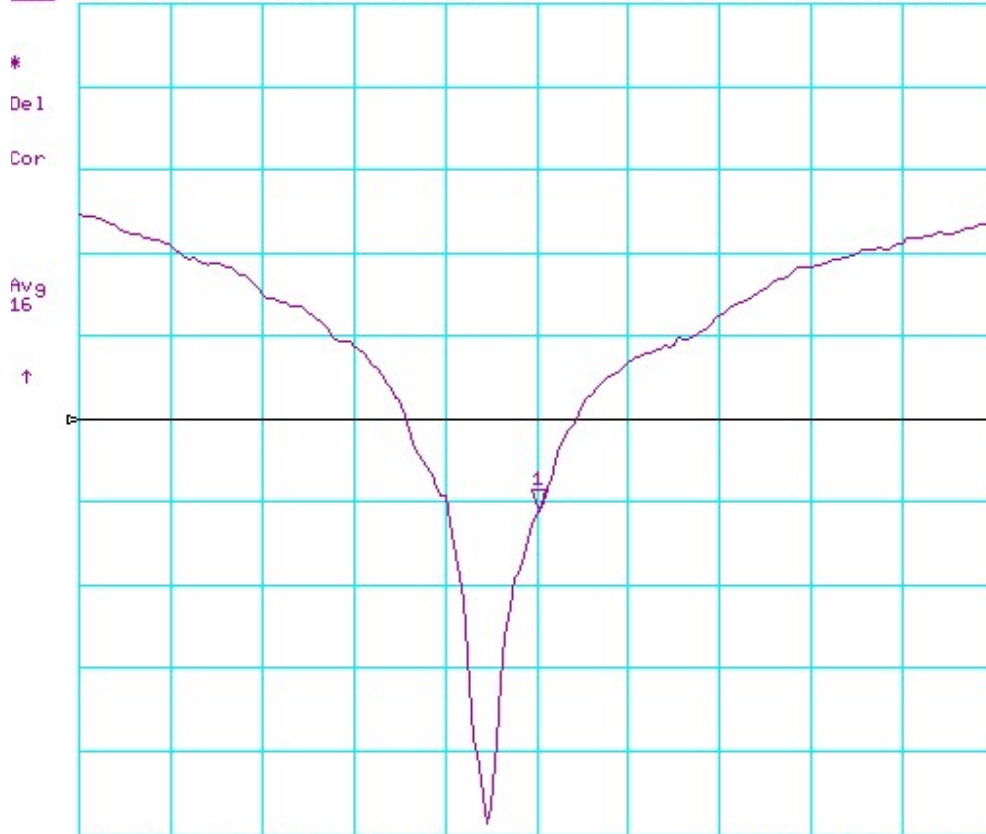

CENTER 1 900.000 000 MHz

SPAN 400.000 000 MHz

Impedance & Return-Loss Measurement Plot for Body TSL

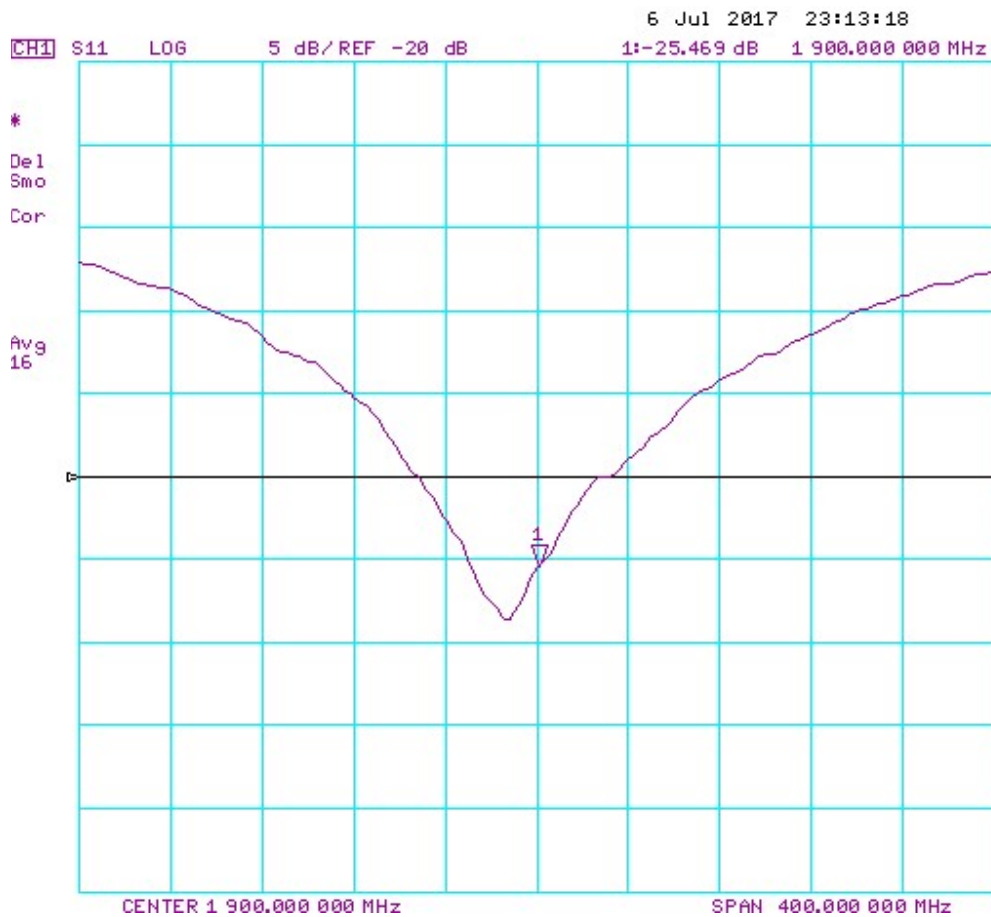
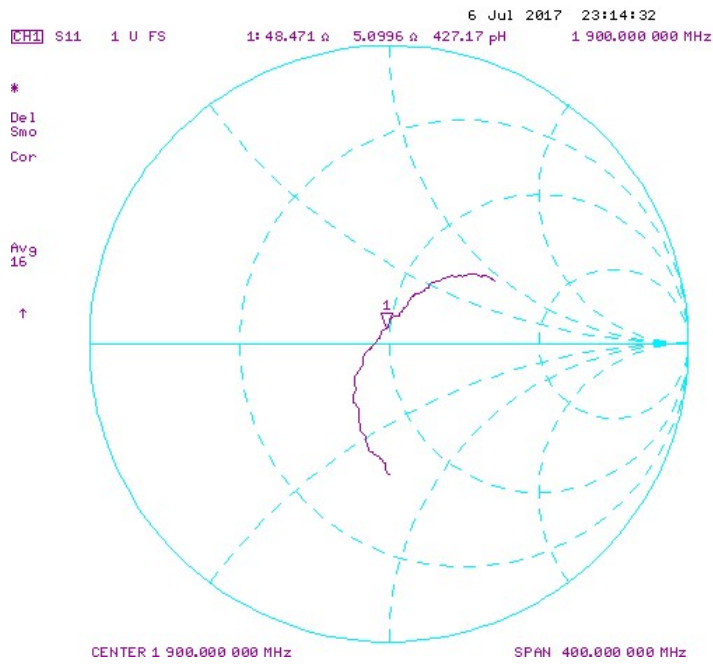



Accredited by the Swiss Accreditation Service (SAS)
The Swiss Accreditation Service is one of the signatories to the EA
Multilateral Agreement for the recognition of calibration certificates

Accreditation No.: **SCS 0108**

Client **PC Test**

Certificate No: **D2450V2-797_Sep17**

CALIBRATION CERTIFICATE

Object **D2450V2 - SN:797**

Calibration procedure(s) **QA CAL-05.v9**
Calibration procedure for dipole validation kits above 700 MHz

SCS
10/03/2017

Calibration date: **September 11, 2017**

This calibration certificate documents the traceability to national standards, which realize the physical units of measurements (SI).
The measurements and the uncertainties with confidence probability are given on the following pages and are part of the certificate.

All calibrations have been conducted in the closed laboratory facility: environment temperature $(22 \pm 3)^\circ\text{C}$ and humidity $< 70\%$.

Calibration Equipment used (M&TE critical for calibration)

Primary Standards	ID #	Cal Date (Certificate No.)	Scheduled Calibration
Power meter NRP	SN: 104778	04-Apr-17 (No. 217-02521/02522)	Apr-18
Power sensor NRP-Z91	SN: 103244	04-Apr-17 (No. 217-02521)	Apr-18
Power sensor NRP-Z91	SN: 103245	04-Apr-17 (No. 217-02522)	Apr-18
Reference 20 dB Attenuator	SN: 5058 (20k)	07-Apr-17 (No. 217-02528)	Apr-18
Type-N mismatch combination	SN: 5047.2 / 06327	07-Apr-17 (No. 217-02529)	Apr-18
Reference Probe EX3DV4	SN: 7349	31-May-17 (No. EX3-7349_May17)	May-18
DAE4	SN: 601	28-Mar-17 (No. DAE4-601_Mar17)	Mar-18
Secondary Standards	ID #	Check Date (in house)	Scheduled Check
Power meter EPM-442A	SN: GB37480704	07-Oct-15 (in house check Oct-16)	In house check: Oct-18
Power sensor HP 8481A	SN: US37292783	07-Oct-15 (in house check Oct-16)	In house check: Oct-18
Power sensor HP 8481A	SN: MY41092317	07-Oct-15 (in house check Oct-16)	In house check: Oct-18
RF generator R&S SMT-06	SN: 100972	15-Jun-15 (in house check Oct-16)	In house check: Oct-18
Network Analyzer HP 8753E	SN: US37390585	18-Oct-01 (in house check Oct-16)	In house check: Oct-17

Calibrated by: **Michael Weber** Name: Michael Weber Function: Laboratory Technician

Approved by: **Katja Pokovic** Name: Katja Pokovic Function: Technical Manager

Signature
M. Weber
K. Pokovic

Issued: September 11, 2017

This calibration certificate shall not be reproduced except in full without written approval of the laboratory.



Accredited by the Swiss Accreditation Service (SAS)

The Swiss Accreditation Service is one of the signatories to the EA
Multilateral Agreement for the recognition of calibration certificates

Accreditation No.: **SCS 0108**

Glossary:

TSL	tissue simulating liquid
ConvF	sensitivity in TSL / NORM x,y,z
N/A	not applicable or not measured

Calibration is Performed According to the Following Standards:

- IEEE Std 1528-2013, "IEEE Recommended Practice for Determining the Peak Spatial-Averaged Specific Absorption Rate (SAR) in the Human Head from Wireless Communications Devices: Measurement Techniques", June 2013
- IEC 62209-1, "Measurement procedure for the assessment of Specific Absorption Rate (SAR) from hand-held and body-mounted devices used next to the ear (frequency range of 300 MHz to 6 GHz)", July 2016
- IEC 62209-2, "Procedure to determine the Specific Absorption Rate (SAR) for wireless communication devices used in close proximity to the human body (frequency range of 30 MHz to 6 GHz)", March 2010
- KDB 865664, "SAR Measurement Requirements for 100 MHz to 6 GHz"

Additional Documentation:

- DASY4/5 System Handbook

Methods Applied and Interpretation of Parameters:

- Measurement Conditions:** Further details are available from the Validation Report at the end of the certificate. All figures stated in the certificate are valid at the frequency indicated.
- Antenna Parameters with TSL:** The dipole is mounted with the spacer to position its feed point exactly below the center marking of the flat phantom section, with the arms oriented parallel to the body axis.
- Feed Point Impedance and Return Loss:** These parameters are measured with the dipole positioned under the liquid filled phantom. The impedance stated is transformed from the measurement at the SMA connector to the feed point. The Return Loss ensures low reflected power. No uncertainty required.
- Electrical Delay:** One-way delay between the SMA connector and the antenna feed point. No uncertainty required.
- SAR measured:** SAR measured at the stated antenna input power.
- SAR normalized:** SAR as measured, normalized to an input power of 1 W at the antenna connector.
- SAR for nominal TSL parameters:** The measured TSL parameters are used to calculate the nominal SAR result.

The reported uncertainty of measurement is stated as the standard uncertainty of measurement multiplied by the coverage factor $k=2$, which for a normal distribution corresponds to a coverage probability of approximately 95%.

Measurement Conditions

DASY system configuration, as far as not given on page 1.

DASY Version	DASY5	V52.10.0
Extrapolation	Advanced Extrapolation	
Phantom	Modular Flat Phantom	
Distance Dipole Center - TSL	10 mm	with Spacer
Zoom Scan Resolution	dx, dy, dz = 5 mm	
Frequency	2450 MHz \pm 1 MHz	

Head TSL parameters

The following parameters and calculations were applied.

	Temperature	Permittivity	Conductivity
Nominal Head TSL parameters	22.0 °C	39.2	1.80 mho/m
Measured Head TSL parameters	(22.0 \pm 0.2) °C	37.8 \pm 6 %	1.86 mho/m \pm 6 %
Head TSL temperature change during test	< 0.5 °C	---	---

SAR result with Head TSL

SAR averaged over 1 cm³ (1 g) of Head TSL	Condition	
SAR measured	250 mW input power	13.5 W/kg
SAR for nominal Head TSL parameters	normalized to 1W	52.7 W/kg \pm 17.0 % (k=2)

SAR averaged over 10 cm³ (10 g) of Head TSL	condition	
SAR measured	250 mW input power	6.28 W/kg
SAR for nominal Head TSL parameters	normalized to 1W	24.8 W/kg \pm 16.5 % (k=2)

Body TSL parameters

The following parameters and calculations were applied.

	Temperature	Permittivity	Conductivity
Nominal Body TSL parameters	22.0 °C	52.7	1.95 mho/m
Measured Body TSL parameters	(22.0 \pm 0.2) °C	51.9 \pm 6 %	2.04 mho/m \pm 6 %
Body TSL temperature change during test	< 0.5 °C	---	---

SAR result with Body TSL

SAR averaged over 1 cm³ (1 g) of Body TSL	Condition	
SAR measured	250 mW input power	13.1 W/kg
SAR for nominal Body TSL parameters	normalized to 1W	51.1 W/kg \pm 17.0 % (k=2)

SAR averaged over 10 cm³ (10 g) of Body TSL	condition	
SAR measured	250 mW input power	6.14 W/kg
SAR for nominal Body TSL parameters	normalized to 1W	24.2 W/kg \pm 16.5 % (k=2)

Appendix (Additional assessments outside the scope of SCS 0108)

Antenna Parameters with Head TSL

Impedance, transformed to feed point	$53.8 \Omega + 7.4 j\Omega$
Return Loss	- 21.9 dB

Antenna Parameters with Body TSL

Impedance, transformed to feed point	$49.7 \Omega + 9.1 j\Omega$
Return Loss	- 20.9 dB

General Antenna Parameters and Design

Electrical Delay (one direction)	1.152 ns
----------------------------------	----------

After long term use with 100W radiated power, only a slight warming of the dipole near the feedpoint can be measured.

The dipole is made of standard semirigid coaxial cable. The center conductor of the feeding line is directly connected to the second arm of the dipole. The antenna is therefore short-circuited for DC-signals. On some of the dipoles, small end caps are added to the dipole arms in order to improve matching when loaded according to the position as explained in the "Measurement Conditions" paragraph. The SAR data are not affected by this change. The overall dipole length is still according to the Standard.

No excessive force must be applied to the dipole arms, because they might bend or the soldered connections near the feedpoint may be damaged.

Additional EUT Data

Manufactured by	SPEAG
Manufactured on	January 24, 2006

DASY5 Validation Report for Head TSL

Date: 11.09.2017

Test Laboratory: SPEAG, Zurich, Switzerland

DUT: Dipole 2450 MHz; Type: D2450V2; Serial: D2450V2 - SN: 797

Communication System: UID 0 - CW; Frequency: 2450 MHz

Medium parameters used: $f = 2450$ MHz; $\sigma = 1.86$ S/m; $\epsilon_r = 37.8$; $\rho = 1000$ kg/m³

Phantom section: Flat Section

Measurement Standard: DASY5 (IEEE/IEC/ANSI C63.19-2011)

DASY52 Configuration:

- Probe: EX3DV4 - SN7349; ConvF(8.12, 8.12, 8.12); Calibrated: 31.05.2017;
- Sensor-Surface: 1.4mm (Mechanical Surface Detection)
- Electronics: DAE4 Sn601; Calibrated: 28.03.2017
- Phantom: Flat Phantom 5.0 (front); Type: QD 000 P50 AA; Serial: 1001
- DASY52 52.10.0(1446); SEMCAD X 14.6.10(7417)

Dipole Calibration for Head Tissue/Pin=250 mW, d=10mm/Zoom Scan (7x7x7)/Cube 0:

Measurement grid: dx=5mm, dy=5mm, dz=5mm

Reference Value = 113.5 V/m; Power Drift = -0.08 dB

Peak SAR (extrapolated) = 26.9 W/kg

SAR(1 g) = 13.5 W/kg; SAR(10 g) = 6.28 W/kg

Maximum value of SAR (measured) = 21.6 W/kg

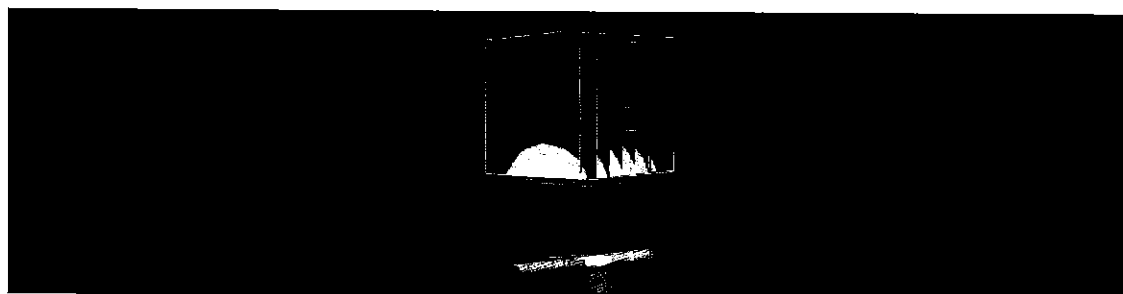
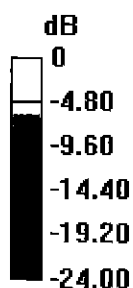

0 dB = 21.6 W/kg = 13.34 dBW/kg

Impedance Measurement Plot for Head TSL

11 Sep 2017 11:52:57

CH1 S11 1 U FS 1: 53.777 Ω 7.4395 Ω 483.28 μH 2 450.000 000 MHz

*
De1
CA
Avg
16
H1d

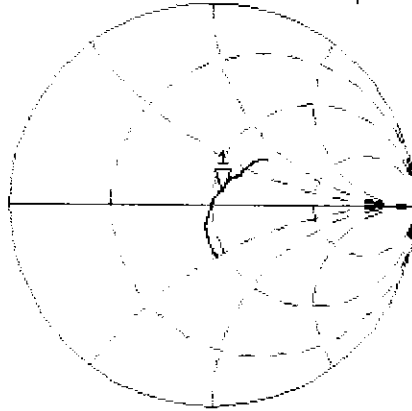

CH2 S11 LOG 5 dB/REF -20 dB 1: -21.911 dB 2 450.000 000 MHz

CA
Avg
16
H1d

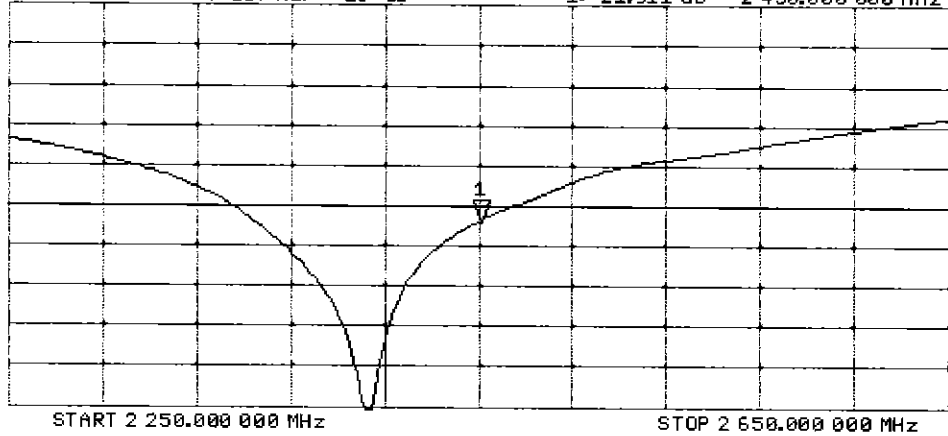

DASY5 Validation Report for Body TSL

Date: 11.09.2017

Test Laboratory: SPEAG, Zurich, Switzerland

DUT: Dipole 2450 MHz; Type: D2450V2; Serial: D2450V2 - SN: 797

Communication System: UID 0 - CW; Frequency: 2450 MHz

Medium parameters used: $f = 2450$ MHz; $\sigma = 2.04$ S/m; $\epsilon_r = 51.9$; $\rho = 1000$ kg/m³

Phantom section: Flat Section

Measurement Standard: DASY5 (IEEE/IEC/ANSI C63.19-2011)

DASY52 Configuration:

- Probe: EX3DV4 - SN7349; ConvF(8.1, 8.1, 8.1); Calibrated: 31.05.2017;
- Sensor-Surface: 1.4mm (Mechanical Surface Detection)
- Electronics: DAE4 Sn601; Calibrated: 28.03.2017
- Phantom: Flat Phantom 5.0 (back); Type: QD 000 P50 AA; Serial: 1002
- DASY52 52.10.0(1446); SEMCAD X 14.6.10(7417)

Dipole Calibration for Body Tissue/Pin=250 mW, d=10mm/Zoom Scan (7x7x7)/Cube 0:

Measurement grid: dx=5mm, dy=5mm, dz=5mm

Reference Value = 105.4 V/m; Power Drift = -0.08 dB

Peak SAR (extrapolated) = 25.6 W/kg

SAR(1 g) = 13.1 W/kg; SAR(10 g) = 6.14 W/kg

Maximum value of SAR (measured) = 20.3 W/kg

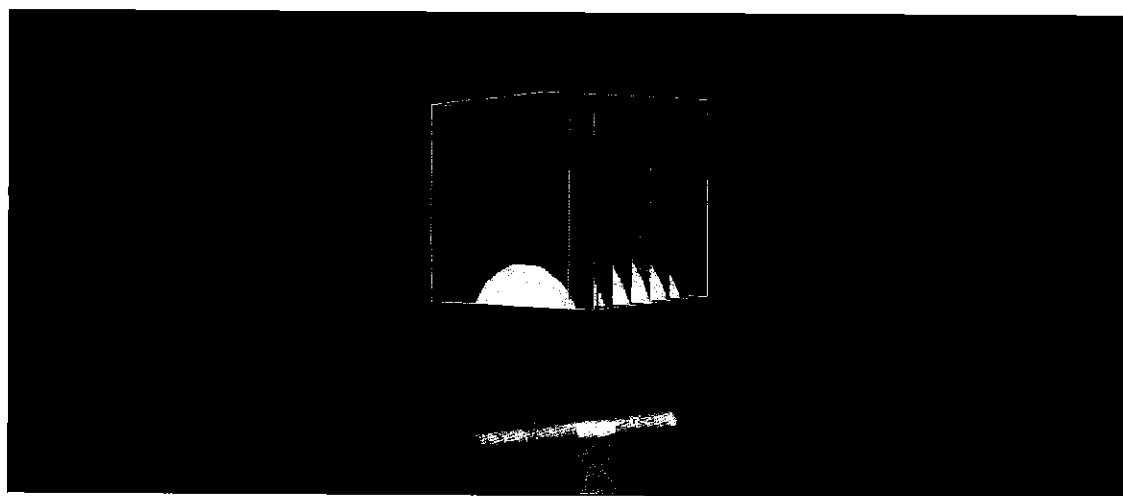
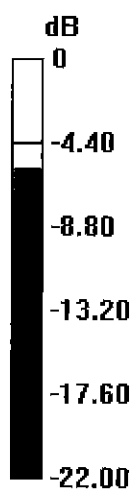

0 dB = 20.3 W/kg = 13.07 dBW/kg

Impedance Measurement Plot for Body TSL

11 Sep 2017 11:52:10

CH1 S11 1 U FS 1: 49.725 Ω 9.0703 Ω 589.22 pF 2 450.000 000 MHz

*
Del

CA

Avg
16

H1d

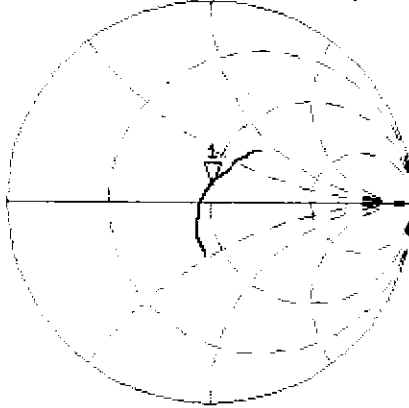

CH2 S11 LOG 5 dB/REF -20 dB 1:-20.854 dB 2 450.000 000 MHz

CA

Avg
16

H1d

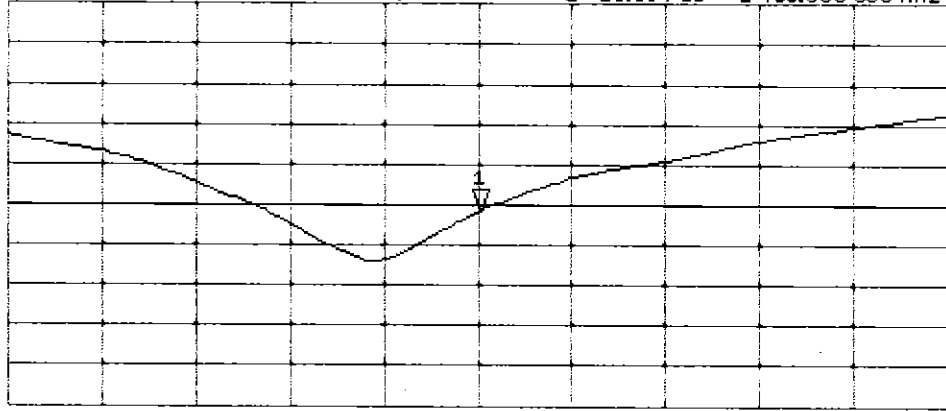

START 2 250.000 000 MHz

STOP 2 650.000 000 MHz



Accredited by the Swiss Accreditation Service (SAS)
The Swiss Accreditation Service is one of the signatories to the EA
Multilateral Agreement for the recognition of calibration certificates

Accreditation No.: **SCS 0108**

Client **PC Test**

Certificate No: **D5GHzV2-1191_Sep16**

CALIBRATION CERTIFICATE

Object **D5GHzV2 - SN:1191**

Calibration procedure(s) **QA CAL-22.v2**
Calibration procedure for dipole validation kits between 3-6 GHz

Calibration date: **September 21, 2016**

BNV
09-28-2016
Extended
09/2017
SC

This calibration certificate documents the traceability to national standards, which realize the physical units of measurements (SI).
The measurements and the uncertainties with confidence probability are given on the following pages and are part of the certificate.

All calibrations have been conducted in the closed laboratory facility: environment temperature (22 ± 3)°C and humidity < 70%.

Calibration Equipment used (M&TE critical for calibration)

Primary Standards	ID #	Cal Date (Certificate No.)	Scheduled Calibration
Power meter NRP	SN: 104778	06-Apr-16 (No. 217-02288/02289)	Apr-17
Power sensor NRP-Z91	SN: 103244	06-Apr-16 (No. 217-02288)	Apr-17
Power sensor NRP-Z91	SN: 103245	06-Apr-16 (No. 217-02289)	Apr-17
Reference 20 dB Attenuator	SN: 5058 (20k)	05-Apr-16 (No. 217-02292)	Apr-17
Type-N mismatch combination	SN: 5047.2 / 06327	05-Apr-16 (No. 217-02295)	Apr-17
Reference Probe EX3DV4	SN: 3503	30-Jun-16 (No. EX3-3503_Jun16)	Jun-17
DAE4	SN: 601	30-Dec-15 (No. DAE4-601_Dec15)	Dec-16
Secondary Standards	ID #	Check Date (in house)	Scheduled Check
Power meter EPM-442A	SN: GB37480704	07-Oct-15 (No. 217-02222)	In house check: Oct-16
Power sensor HP 8481A	SN: US37292783	07-Oct-15 (No. 217-02222)	In house check: Oct-16
Power sensor HP 8481A	SN: MY41092317	07-Oct-15 (No. 217-02223)	In house check: Oct-16
RF generator R&S SMT-06	SN: 100972	15-Jun-15 (in house check Jun-15)	In house check: Oct-16
Network Analyzer HP 8753E	SN: US37390585	18-Oct-01 (in house check Oct-15)	In house check: Oct-16

Calibrated by: **Leif Klysner** Laboratory Technician *Leif Klysner*

Approved by: **Katja Pokovic** Technical Manager *Katja Pokovic*

Issued: September 22, 2016

This calibration certificate shall not be reproduced except in full without written approval of the laboratory.



Accredited by the Swiss Accreditation Service (SAS)

Accreditation No.: **SCS 0108**

The Swiss Accreditation Service is one of the signatories to the EA Multilateral Agreement for the recognition of calibration certificates

Glossary:

TSL	tissue simulating liquid
ConvF	sensitivity in TSL / NORM x,y,z
N/A	not applicable or not measured

Calibration is Performed According to the Following Standards:

- IEEE Std 1528-2013, "IEEE Recommended Practice for Determining the Peak Spatial-Averaged Specific Absorption Rate (SAR) in the Human Head from Wireless Communications Devices: Measurement Techniques", June 2013
- IEC 62209-2, "Procedure to determine the Specific Absorption Rate (SAR) for wireless communication devices used in close proximity to the human body (frequency range of 30 MHz to 6 GHz)", March 2010
- KDB 865664, "SAR Measurement Requirements for 100 MHz to 6 GHz"

Additional Documentation:

- DASY4/5 System Handbook

Methods Applied and Interpretation of Parameters:

- Measurement Conditions:* Further details are available from the Validation Report at the end of the certificate. All figures stated in the certificate are valid at the frequency indicated.
- Antenna Parameters with TSL:* The dipole is mounted with the spacer to position its feed point exactly below the center marking of the flat phantom section, with the arms oriented parallel to the body axis.
- Feed Point Impedance and Return Loss:* These parameters are measured with the dipole positioned under the liquid filled phantom. The impedance stated is transformed from the measurement at the SMA connector to the feed point. The Return Loss ensures low reflected power. No uncertainty required.
- Electrical Delay:* One-way delay between the SMA connector and the antenna feed point. No uncertainty required.
- SAR measured:* SAR measured at the stated antenna input power.
- SAR normalized:* SAR as measured, normalized to an input power of 1 W at the antenna connector.
- SAR for nominal TSL parameters:* The measured TSL parameters are used to calculate the nominal SAR result.

The reported uncertainty of measurement is stated as the standard uncertainty of measurement multiplied by the coverage factor $k=2$, which for a normal distribution corresponds to a coverage probability of approximately 95%.

Measurement Conditions

DASY system configuration, as far as not given on page 1.

DASY Version	DASY5	V52.8.8
Extrapolation	Advanced Extrapolation	
Phantom	Modular Flat Phantom V5.0	
Distance Dipole Center - TSL	10 mm	with Spacer
Zoom Scan Resolution	dx, dy = 4.0 mm, dz = 1.4 mm	Graded Ratio = 1.4 (Z direction)
Frequency	5250 MHz ± 1 MHz 5600 MHz ± 1 MHz 5750 MHz ± 1 MHz	

Head TSL parameters at 5250 MHz

The following parameters and calculations were applied.

	Temperature	Permittivity	Conductivity
Nominal Head TSL parameters	22.0 °C	35.9	4.71 mho/m
Measured Head TSL parameters	(22.0 ± 0.2) °C	34.5 ± 6 %	4.59 mho/m ± 6 %
Head TSL temperature change during test	< 0.5 °C	----	----

SAR result with Head TSL at 5250 MHz

SAR averaged over 1 cm³ (1 g) of Head TSL	Condition	
SAR measured	100 mW input power	7.96 W/kg
SAR for nominal Head TSL parameters	normalized to 1W	78.9 W/kg ± 19.9 % (k=2)

SAR averaged over 10 cm³ (10 g) of Head TSL	condition	
SAR measured	100 mW input power	2.29 W/kg
SAR for nominal Head TSL parameters	normalized to 1W	22.6 W/kg ± 19.5 % (k=2)

Head TSL parameters at 5600 MHz

The following parameters and calculations were applied.

	Temperature	Permittivity	Conductivity
Nominal Head TSL parameters	22.0 °C	35.5	5.07 mho/m
Measured Head TSL parameters	(22.0 ± 0.2) °C	34.0 ± 6 %	4.93 mho/m ± 6 %
Head TSL temperature change during test	< 0.5 °C	----	----

SAR result with Head TSL at 5600 MHz

SAR averaged over 1 cm ³ (1 g) of Head TSL	Condition	
SAR measured	100 mW input power	8.45 W/kg
SAR for nominal Head TSL parameters	normalized to 1W	83.6 W / kg ± 19.9 % (k=2)

SAR averaged over 10 cm ³ (10 g) of Head TSL	condition	
SAR measured	100 mW input power	2.41 W/kg
SAR for nominal Head TSL parameters	normalized to 1W	23.8 W/kg ± 19.5 % (k=2)

Head TSL parameters at 5750 MHz

The following parameters and calculations were applied.

	Temperature	Permittivity	Conductivity
Nominal Head TSL parameters	22.0 °C	35.4	5.22 mho/m
Measured Head TSL parameters	(22.0 ± 0.2) °C	33.8 ± 6 %	5.08 mho/m ± 6 %
Head TSL temperature change during test	< 0.5 °C	----	----

SAR result with Head TSL at 5750 MHz

SAR averaged over 1 cm ³ (1 g) of Head TSL	Condition	
SAR measured	100 mW input power	7.99 W/kg
SAR for nominal Head TSL parameters	normalized to 1W	79.1 W/kg ± 19.9 % (k=2)

SAR averaged over 10 cm ³ (10 g) of Head TSL	condition	
SAR measured	100 mW input power	2.27 W/kg
SAR for nominal Head TSL parameters	normalized to 1W	22.4 W/kg ± 19.5 % (k=2)

Body TSL parameters at 5250 MHz

The following parameters and calculations were applied.

	Temperature	Permittivity	Conductivity
Nominal Body TSL parameters	22.0 °C	48.9	5.36 mho/m
Measured Body TSL parameters	(22.0 ± 0.2) °C	47.4 ± 6 %	5.52 mho/m ± 6 %
Body TSL temperature change during test	< 0.5 °C	----	----

SAR result with Body TSL at 5250 MHz

SAR averaged over 1 cm ³ (1 g) of Body TSL	Condition	
SAR measured	100 mW input power	7.74 W/kg
SAR for nominal Body TSL parameters	normalized to 1W	77.0 W/kg ± 19.9 % (k=2)

SAR averaged over 10 cm ³ (10 g) of Body TSL	condition	
SAR measured	100 mW input power	2.17 W/kg
SAR for nominal Body TSL parameters	normalized to 1W	21.6 W/kg ± 19.5 % (k=2)

Body TSL parameters at 5600 MHz

The following parameters and calculations were applied.

	Temperature	Permittivity	Conductivity
Nominal Body TSL parameters	22.0 °C	48.5	5.77 mho/m
Measured Body TSL parameters	(22.0 ± 0.2) °C	46.8 ± 6 %	6.00 mho/m ± 6 %
Body TSL temperature change during test	< 0.5 °C	----	----

SAR result with Body TSL at 5600 MHz

SAR averaged over 1 cm ³ (1 g) of Body TSL	Condition	
SAR measured	100 mW input power	7.96 W/kg
SAR for nominal Body TSL parameters	normalized to 1W	79.2 W/kg ± 19.9 % (k=2)

SAR averaged over 10 cm ³ (10 g) of Body TSL	condition	
SAR measured	100 mW input power	2.24 W/kg
SAR for nominal Body TSL parameters	normalized to 1W	22.2 W/kg ± 19.5 % (k=2)

Body TSL parameters at 5750 MHz

The following parameters and calculations were applied.

	Temperature	Permittivity	Conductivity
Nominal Body TSL parameters	22.0 °C	48.3	5.94 mho/m
Measured Body TSL parameters	(22.0 ± 0.2) °C	46.5 ± 6 %	6.21 mho/m ± 6 %
Body TSL temperature change during test	< 0.5 °C	----	----

SAR result with Body TSL at 5750 MHz

SAR averaged over 1 cm ³ (1 g) of Body TSL	Condition	
SAR measured	100 mW input power	7.65 W/kg
SAR for nominal Body TSL parameters	normalized to 1W	76.1 W/kg ± 19.9 % (k=2)

SAR averaged over 10 cm ³ (10 g) of Body TSL	condition	
SAR measured	100 mW input power	2.14 W/kg
SAR for nominal Body TSL parameters	normalized to 1W	21.2 W/kg ± 19.5 % (k=2)

Appendix (Additional assessments outside the scope of SCS 0108)

Antenna Parameters with Head TSL at 5250 MHz

Impedance, transformed to feed point	55.7 Ω - 4.3 j Ω
Return Loss	- 23.4 dB

Antenna Parameters with Head TSL at 5600 MHz

Impedance, transformed to feed point	58.3 Ω - 3.2 j Ω
Return Loss	- 21.8 dB

Antenna Parameters with Head TSL at 5750 MHz

Impedance, transformed to feed point	58.1 Ω + 4.8 j Ω
Return Loss	- 21.2 dB

Antenna Parameters with Body TSL at 5250 MHz

Impedance, transformed to feed point	56.1 Ω - 3.7 j Ω
Return Loss	- 23.4 dB

Antenna Parameters with Body TSL at 5600 MHz

Impedance, transformed to feed point	58.9 Ω - 1.7 j Ω
Return Loss	- 21.7 dB

Antenna Parameters with Body TSL at 5750 MHz

Impedance, transformed to feed point	59.5 Ω + 6.9 j Ω
Return Loss	- 19.4 dB

General Antenna Parameters and Design

Electrical Delay (one direction)	1.204 ns
----------------------------------	----------

After long term use with 100W radiated power, only a slight warming of the dipole near the feedpoint can be measured.

The dipole is made of standard semirigid coaxial cable. The center conductor of the feeding line is directly connected to the second arm of the dipole. The antenna is therefore short-circuited for DC-signals. On some of the dipoles, small end caps are added to the dipole arms in order to improve matching when loaded according to the position as explained in the "Measurement Conditions" paragraph. The SAR data are not affected by this change. The overall dipole length is still according to the Standard.

No excessive force must be applied to the dipole arms, because they might bend or the soldered connections near the feedpoint may be damaged.

Additional EUT Data

Manufactured by	SPEAG
Manufactured on	August 28, 2003

DASY5 Validation Report for Head TSL

Date: 21.09.2016

Test Laboratory: SPEAG, Zurich, Switzerland

DUT: Dipole D5GHzV2; Type: D5GHzV2; Serial: D5GHzV2 - SN:1191

Communication System: UID 0 - CW; Frequency: 5250 MHz, Frequency: 5600 MHz, Frequency: 5750 MHz
Medium parameters used: $f = 5250$ MHz; $\sigma = 4.59$ S/m; $\epsilon_r = 34.5$; $\rho = 1000$ kg/m³, Medium parameters used: $f = 5600$ MHz; $\sigma = 4.93$ S/m; $\epsilon_r = 34$; $\rho = 1000$ kg/m³, Medium parameters used: $f = 5750$ MHz; $\sigma = 5.08$ S/m; $\epsilon_r = 33.8$; $\rho = 1000$ kg/m³

Phantom section: Flat Section

Measurement Standard: DASY5 (IEEE/IEC/ANSI C63.19-2011)

DASY52 Configuration:

- Probe: EX3DV4 - SN3503; ConvF(5.42, 5.42, 5.42); Calibrated: 30.06.2016, ConvF(4.89, 4.89, 4.89); Calibrated: 30.06.2016, ConvF(4.85, 4.85, 4.85); Calibrated: 30.06.2016;
- Sensor-Surface: 1.4mm (Mechanical Surface Detection)
- Electronics: DAE4 Sn601; Calibrated: 30.12.2015
- Phantom: Flat Phantom 5.0 (front); Type: QD000P50AA; Serial: 1001
- DASY52 52.8.8(1258); SEMCAD X 14.6.10(7372)

Dipole Calibration for Head Tissue/Pin=100mW, dist=10mm, f=5250 MHz/Zoom Scan, dist=1.4mm (8x8x7)/Cube 0: Measurement grid: dx=4mm, dy=4mm, dz=1.4mm

Reference Value = 68.49 V/m; Power Drift = 0.01 dB

Peak SAR (extrapolated) = 28.6 W/kg

SAR(1 g) = 7.96 W/kg; SAR(10 g) = 2.29 W/kg

Maximum value of SAR (measured) = 18.2 W/kg

Dipole Calibration for Head Tissue/Pin=100mW, dist=10mm, f=5600 MHz/Zoom Scan, dist=1.4mm (8x8x7)/Cube 0: Measurement grid: dx=4mm, dy=4mm, dz=1.4mm

Reference Value = 69.34 V/m; Power Drift = -0.00 dB

Peak SAR (extrapolated) = 32.9 W/kg

SAR(1 g) = 8.45 W/kg; SAR(10 g) = 2.41 W/kg

Maximum value of SAR (measured) = 20.0 W/kg

Dipole Calibration for Head Tissue/Pin=100mW, dist=10mm, f=5750 MHz/Zoom Scan, dist=1.4mm (8x8x7)/Cube 0: Measurement grid: dx=4mm, dy=4mm, dz=1.4mm

Reference Value = 67.15 V/m; Power Drift = 0.02 dB

Peak SAR (extrapolated) = 32.3 W/kg

SAR(1 g) = 7.99 W/kg; SAR(10 g) = 2.27 W/kg

Maximum value of SAR (measured) = 19.3 W/kg

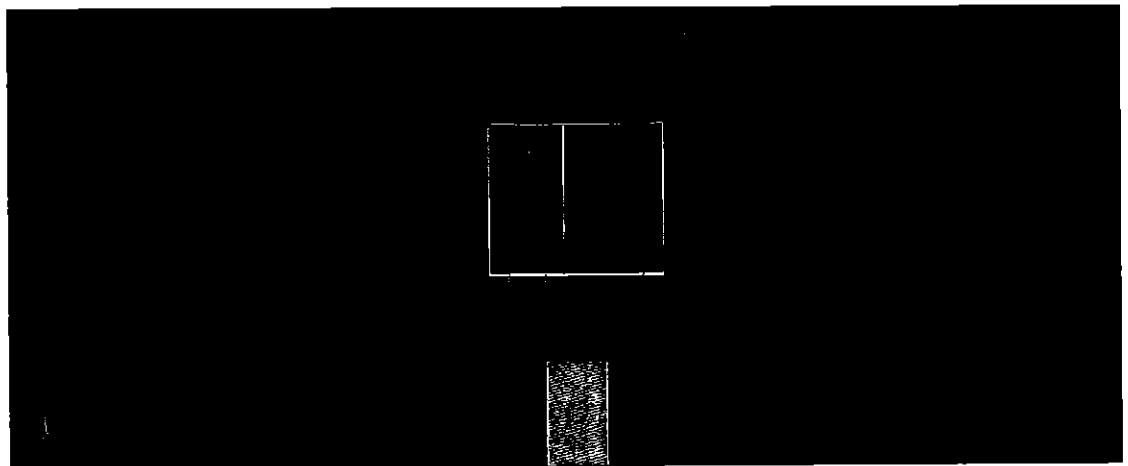
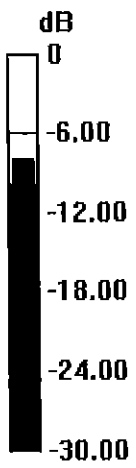

0 dB = 18.2 W/kg = 12.60 dBW/kg

Impedance Measurement Plot for Head TSL

20 Sep 2016 13:20:17

CH1 S11 1 U FS 1: 55.695 Ω -4.2793 Ω 7.0842 pF 5 250.000 000 MHz

*
Del
Cor
Avg
16
H1d

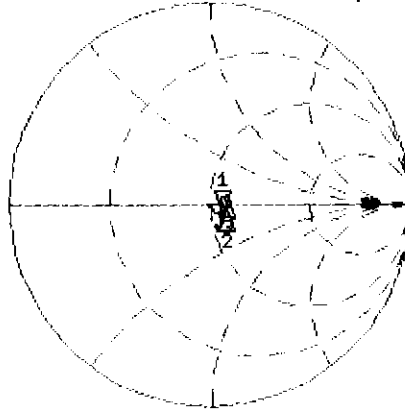

CH1 Markers
2: 58.262 Ω
-3.1738 Ω
5.60000 GHz
3: 58.078 Ω
4.7969 Ω
5.75000 GHz

CH2 S11 LOG 5 dB/REF -20 dB 1: -23.432 dB 5 250.000 000 MHz

Cor
Avg
16
H1d

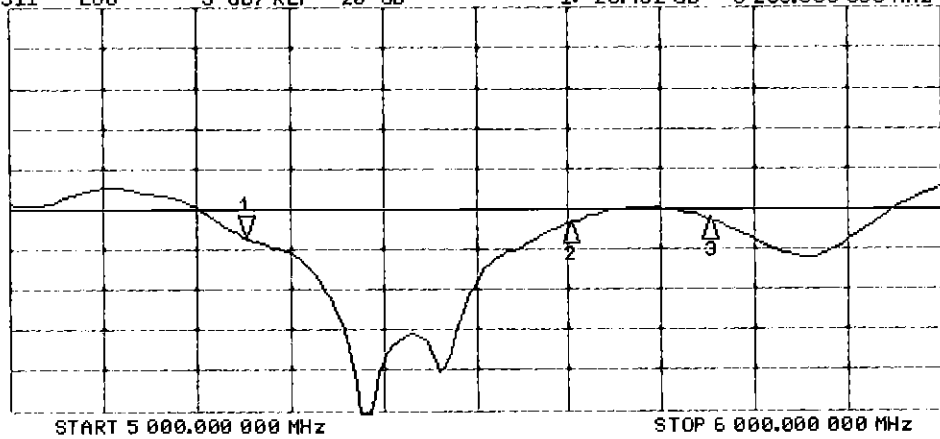

CH2 Markers
2: -21.752 dB
5.60000 GHz
3: -21.228 dB
5.75000 GHz

DASY5 Validation Report for Body TSL

Date: 20.09.2016

Test Laboratory: SPEAG, Zurich, Switzerland

DUT: Dipole D5GHzV2; Type: D5GHzV2; Serial: D5GHzV2 - SN:1191

Communication System: UID 0 - CW; Frequency: 5250 MHz, Frequency: 5600 MHz, Frequency: 5750 MHz
Medium parameters used: $f = 5250$ MHz; $\sigma = 5.52$ S/m; $\epsilon_r = 47.4$; $\rho = 1000$ kg/m³, Medium parameters used: $f = 5600$ MHz; $\sigma = 6$ S/m; $\epsilon_r = 46.8$; $\rho = 1000$ kg/m³, Medium parameters used: $f = 5750$ MHz; $\sigma = 6.21$ S/m; $\epsilon_r = 46.5$; $\rho = 1000$ kg/m³

Phantom section: Flat Section

Measurement Standard: DASY5 (IEEE/IEC/ANSI C63.19-2011)

DASY52 Configuration:

- Probe: EX3DV4 - SN3503; ConvF(4.85, 4.85, 4.85); Calibrated: 30.06.2016, ConvF(4.35, 4.35, 4.35); Calibrated: 30.06.2016, ConvF(4.3, 4.3, 4.3); Calibrated: 30.06.2016;
- Sensor-Surface: 1.4mm (Mechanical Surface Detection)
- Electronics: DAE4 Sn601; Calibrated: 30.12.2015
- Phantom: Flat Phantom 5.0 (back); Type: QD000P50AA; Serial: 1002
- DASY52 52.8.8(1258); SEMCAD X 14.6.10(7372)

Dipole Calibration for Body Tissue/Pin=100mW, dist=10mm, f=5250MHz/Zoom Scan,

dist=1.4mm (8x8x7)/Cube 0: Measurement grid: dx=4mm, dy=4mm, dz=1.4mm

Reference Value = 66.49 V/m; Power Drift = -0.07 dB

Peak SAR (extrapolated) = 29.1 W/kg

SAR(1 g) = 7.74 W/kg; SAR(10 g) = 2.17 W/kg

Maximum value of SAR (measured) = 17.7 W/kg

Dipole Calibration for Body Tissue/Pin=100mW, dist=10mm, f=5600 MHz/Zoom Scan,

dist=1.4mm (8x8x7)/Cube 0: Measurement grid: dx=4mm, dy=4mm, dz=1.4mm

Reference Value = 65.85 V/m; Power Drift = -0.09 dB

Peak SAR (extrapolated) = 32.5 W/kg

SAR(1 g) = 7.96 W/kg; SAR(10 g) = 2.24 W/kg

Maximum value of SAR (measured) = 18.8 W/kg

Dipole Calibration for Body Tissue/Pin=100mW, dist=10mm, f=5750 MHz/Zoom Scan,

dist=1.4mm (8x8x7)/Cube 0: Measurement grid: dx=4mm, dy=4mm, dz=1.4mm

Reference Value = 64.21 V/m; Power Drift = -0.09 dB

Peak SAR (extrapolated) = 32.7 W/kg

SAR(1 g) = 7.65 W/kg; SAR(10 g) = 2.14 W/kg

Maximum value of SAR (measured) = 18.5 W/kg

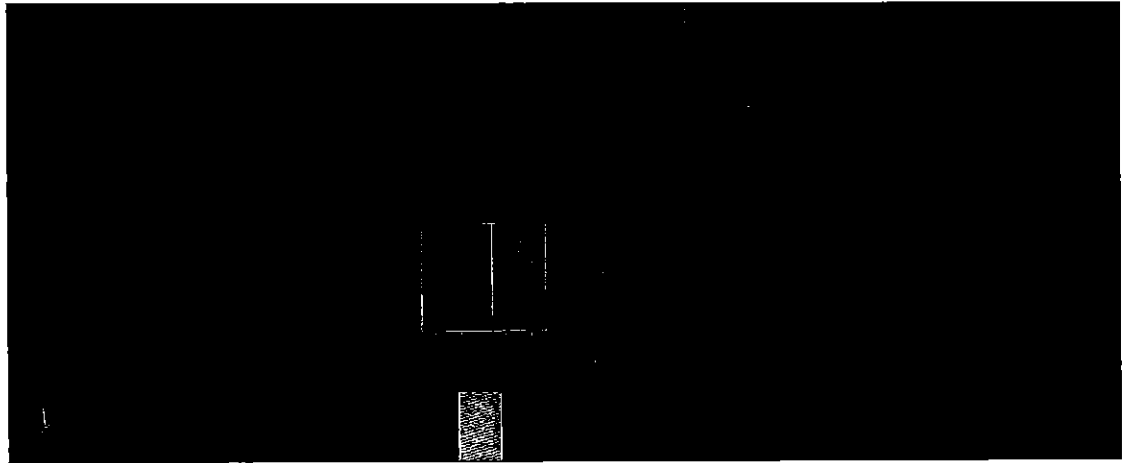
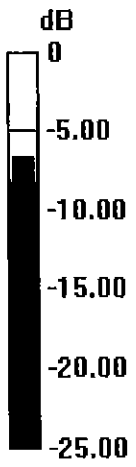

0 dB = 17.7 W/kg = 12.48 dBW/kg

Impedance Measurement Plot for Body TSL

20 Sep 2016 13:19:13

CH1 S11 1 U FS 1: 56.143 Ω -3.6992 Ω 8.1950 pF 5 250.000 000 MHz

*
De1
Cor
Avg
16
H1d

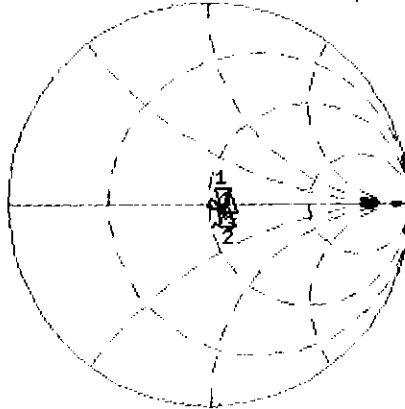

CH1 Markers
2: 58.887 Ω
-1.6504 Ω
5.60000 GHz
3: 59.510 Ω
6.9121 Ω
5.75000 GHz

CH2 S11 LOG 5 dB/REF -20 dB 1: -23.406 dB 5 250.000 000 MHz

Cor
Avg
16
H1d

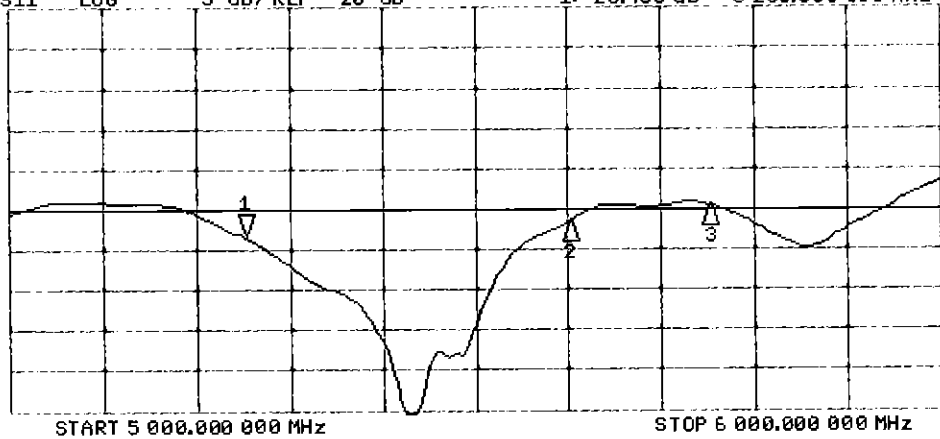

CH2 Markers
2: -21.616 dB
5.60000 GHz
3: -19.400 dB
5.75000 GHz

Certification of Calibration

Object: D5GHzV2 – SN: 1191

Calibration procedure(s): Procedure for Calibration Extension for SAR Dipoles.

Extension Calibration date: 9/19/2017

Description: SAR Validation Dipole at 5250, 5600, and 5750 MHz.

Calibration Equipment used:

Manufacturer	Model	Description	Cal Date	Cal Interval	Cal Due	Serial Number
Control Company	4040	Therm./Clock/Humidity Monitor	3/31/2017	Biennial	3/31/2019	170232394
Control Company	4352	Ultra Long Stem Thermometer	5/2/2017	Biennial	5/2/2019	170330156
Amplifier Research	1551G6	Amplifier	CBT	N/A	CBT	433971
Narda	4772-3	Attenuator (3dB)	CBT	N/A	CBT	9406
Keysight	772D	Dual Directional Coupler	CBT	N/A	CBT	MY52180215
Keysight Technologies	85033E	Standard Mechanical Calibration Kit (DC to 9GHz, 3.5mm)	6/1/2017	Annual	6/1/2018	MY53401181
Agilent	8753ES	S-Parameter Network Analyzer	10/26/2016	Annual	10/26/2017	US39170118
Mini-Circuits	BW-N20W5+	DC to 18 GHz Precision Fixed 20 dB Attenuator	CBT	N/A	CBT	N/A
SPEAG	DAK-3.5	Dielectric Assessment Kit	5/10/2017	Annual	5/10/2018	1070
SPEAG	EX3DV4	SAR Probe	1/13/2017	Annual	1/13/2018	3589
SPEAG	EX3DV4	SAR Probe	2/13/2017	Annual	2/13/2018	3914
SPEAG	DAE4	Dasy Data Acquisition Electronics	1/16/2017	Annual	1/16/2018	1466
SPEAG	DAE4	Dasy Data Acquisition Electronics	2/9/2017	Annual	2/9/2018	665
Anritsu	MA2411B	Pulse Power Sensor	2/10/2017	Annual	2/10/2018	1207364
Anritsu	MA2411B	Pulse Power Sensor	2/10/2017	Annual	2/10/2018	1339018
Anritsu	ML2495A	Power Meter	10/16/2015	Biennial	10/16/2017	941001
Agilent	N5182A	MXG Vector Signal Generator	2/28/2017	Annual	2/28/2018	MY47420800
Seekonk	NC-100	Torque Wrench	11/6/2015	Biennial	11/6/2017	N/A
MiniCircuits	VLF-6000+	Low Pass Filter	CBT	N/A	CBT	N/A
Narda	4014C-6	4 - 8 GHz SMA 6 dB Directional Coupler	CBT	N/A	CBT	N/A

Measurement Uncertainty = $\pm 23\%$ (k=2)

	Name	Function	Signature
Calibrated By:	Brodie Halfoster	Test Engineer	<i>BRODIE HALBFOSTER</i>
Approved By:	Kaitlin O'Keefe	Senior Technical Manager	<i>KOK</i>

DIPOLE CALIBRATION EXTENSION

Per KDB 865664 D01, calibration intervals of up to three years may be considered for reference dipoles when it is demonstrated that the SAR target, impedance and return loss of a dipole have remained stable according to the following requirements:

1. The measured SAR does not deviate more than 10% from the target on the calibration certificate.
2. The return-loss does not deviate more than 20% from the previous measurement and meets the required 20dB minimum return-loss requirement.
3. The measurement of real or imaginary parts of impedance does not deviate more than 5Ω from the previous measurement.

The following dipole was checked to pass the above 3 requirements to have 2-year calibration period from the calibration date:

Frequency (MHz)	Calibration Date	Extension Date	Certificate Electrical Delay (ns)	Certificate SAR Target Head (1g W/kg @ 17.0 dBm)	Measured Head SAR (1g) W/kg @ 17.0 dBm	Deviation 1g (%)	Certificate SAR Target Head (10g W/kg @ 17.0 dBm)	Measured Head SAR (10g) W/kg @ 17.0 dBm	Deviation 10g (%)	Certificate Impedance Head (Ohm) Real	Measured Impedance Head (Ohm) Real	Difference (Ohm) Real	Certificate Impedance Head (Ohm) Imaginary	Measured Impedance Head (Ohm) Imaginary	Difference (Ohm) Imaginary	Certificate Return Loss Head (dB)	Measured Return Loss Head (dB)	Deviation (%)	PASS/FAIL
5250	9/21/2016	9/19/2017	1.204	3.95	3.70	-6.21%	1.13	1.05	-7.08%	55.7	53.4	2.3	-4.3	-6.4	2.1	-23.4	-26.9	-15.00%	PASS
5600	9/21/2016	9/19/2017	1.204	4.18	4.03	-3.59%	1.19	1.13	-5.04%	58.3	55.8	2.7	-3.2	-1.2	2.0	-21.8	-26.1	-19.80%	PASS
5750	9/21/2016	9/19/2017	1.204	3.96	3.84	-3.08%	1.12	1.10	-1.79%	58.1	57.4	0.7	4.8	3.2	1.6	-21.2	-21.0	0.90%	PASS

Frequency (MHz)	Calibration Date	Extension Date	Certificate Electrical Delay (ns)	Certificate SAR Target Body (1g W/kg @ 17.0 dBm)	Measured Body SAR (1g) W/kg @ 17.0 dBm	Deviation 1g (%)	Certificate SAR Target Body (10g W/kg @ 17.0 dBm)	Measured Body SAR (10g) W/kg @ 17.0 dBm	Deviation 10g (%)	Certificate Impedance Body (Ohm) Real	Measured Impedance Body (Ohm) Real	Difference (Ohm) Real	Certificate Impedance Body (Ohm) Imaginary	Measured Impedance Body (Ohm) Imaginary	Difference (Ohm) Imaginary	Certificate Return Loss Body (dB)	Measured Return Loss Body (dB)	Deviation (%)	PASS/FAIL
5250	9/21/2016	9/19/2017	1.204	3.85	3.80	-1.30%	1.08	1.06	-1.85%	56.1	54.0	2.1	-3.7	-3.3	0.4	-23.4	-26.0	-11.10%	PASS
5600	9/21/2016	9/19/2017	1.204	3.96	4.06	2.53%	1.11	1.13	1.80%	58.9	56.5	2.4	-1.7	0.5	2.2	-21.7	-24.5	-12.80%	PASS
5750	9/21/2016	9/19/2017	1.204	3.81	3.66	-3.81%	1.06	1.02	-3.77%	59.5	58.0	1.5	6.9	5.2	1.7	-19.4	-21.1	-8.70%	PASS

Impedance & Return-Loss Measurement Plot for Head TSL

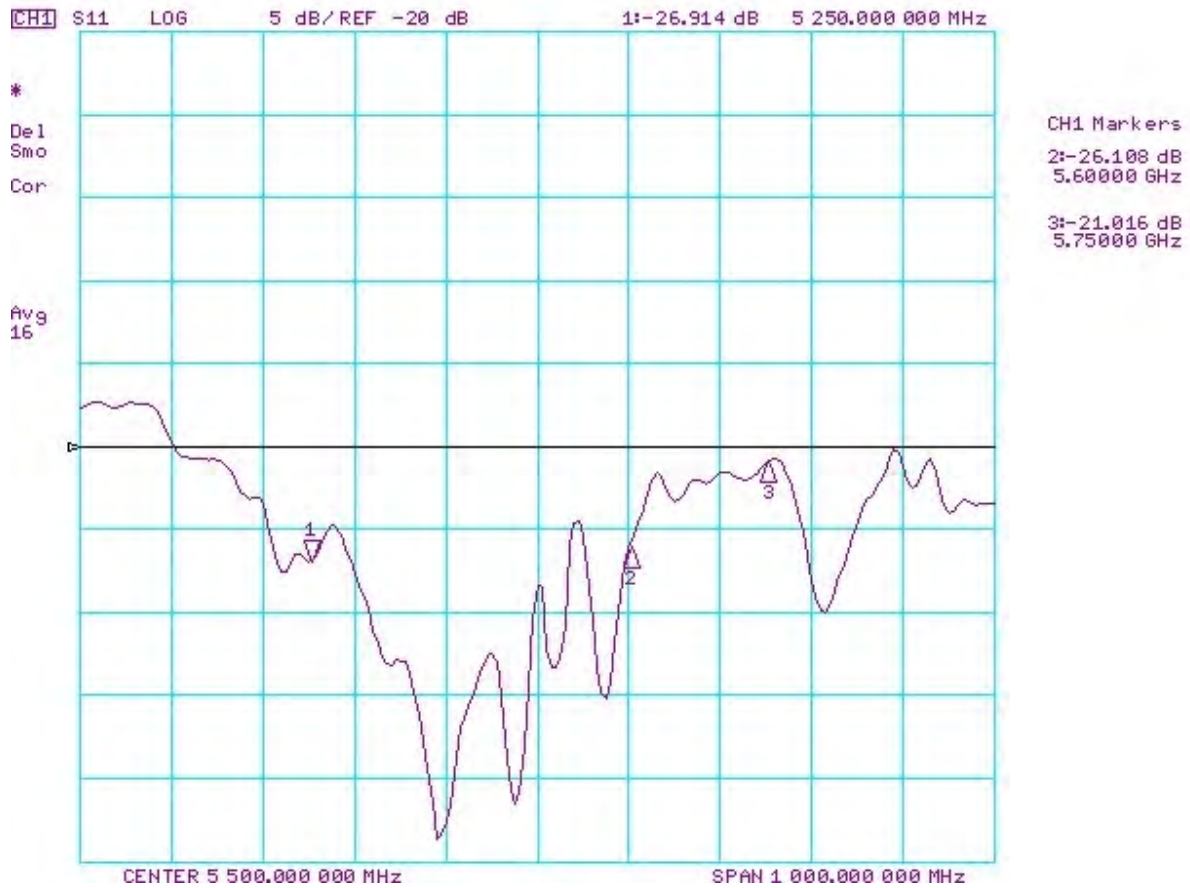
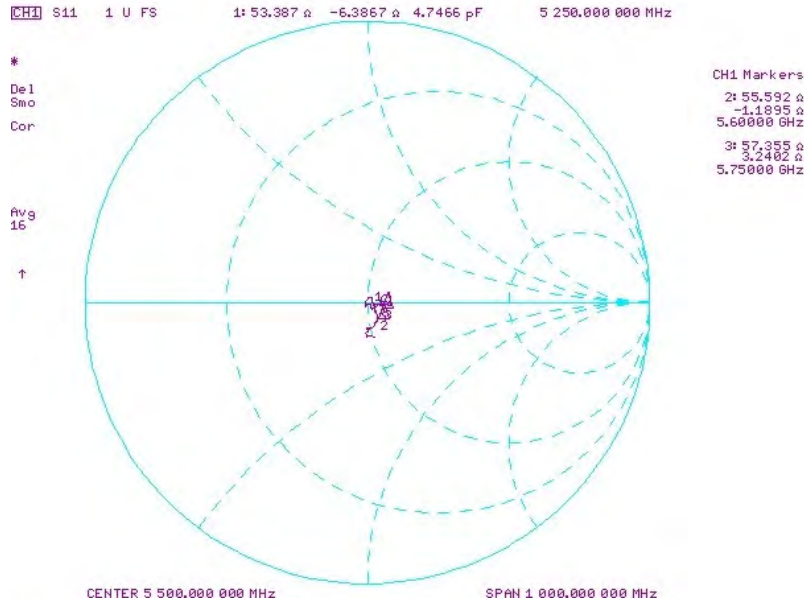

Impedance & Return-Loss Measurement Plot for Body TSL

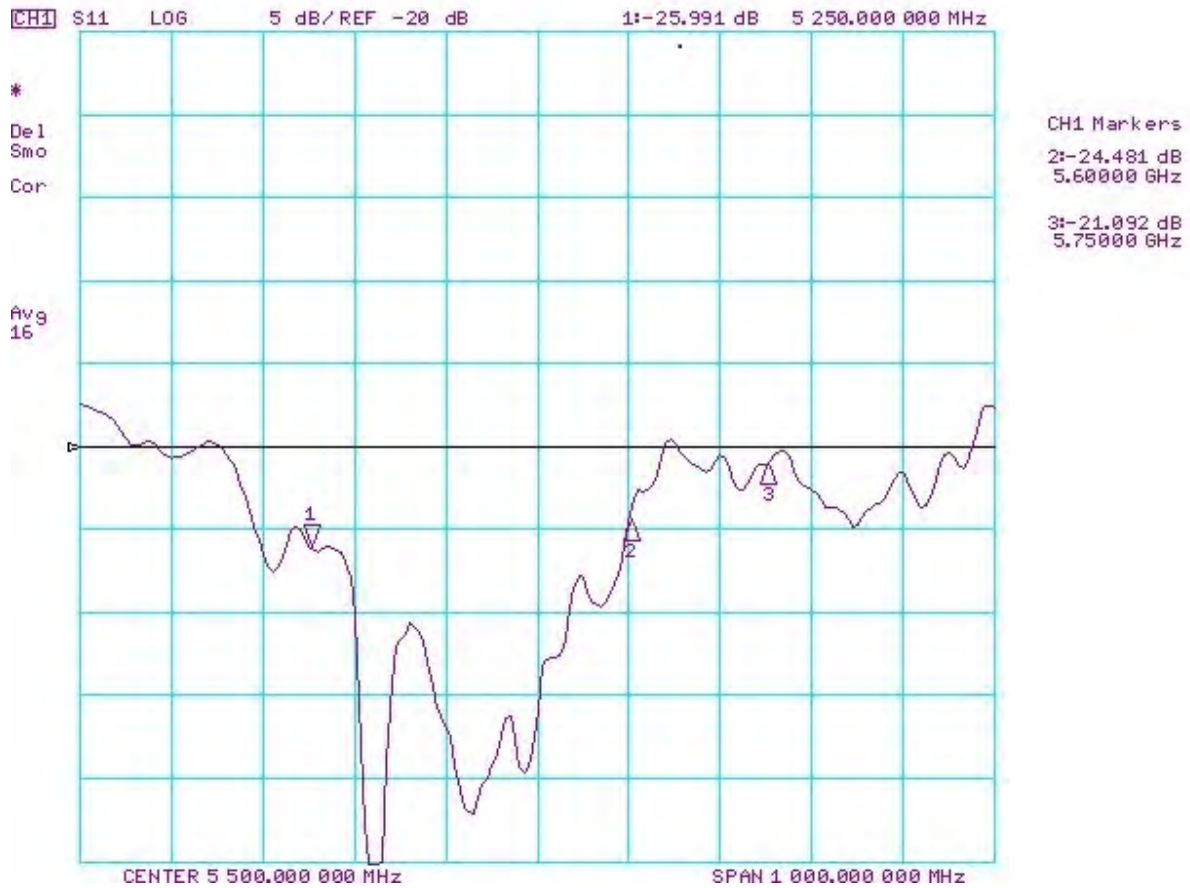
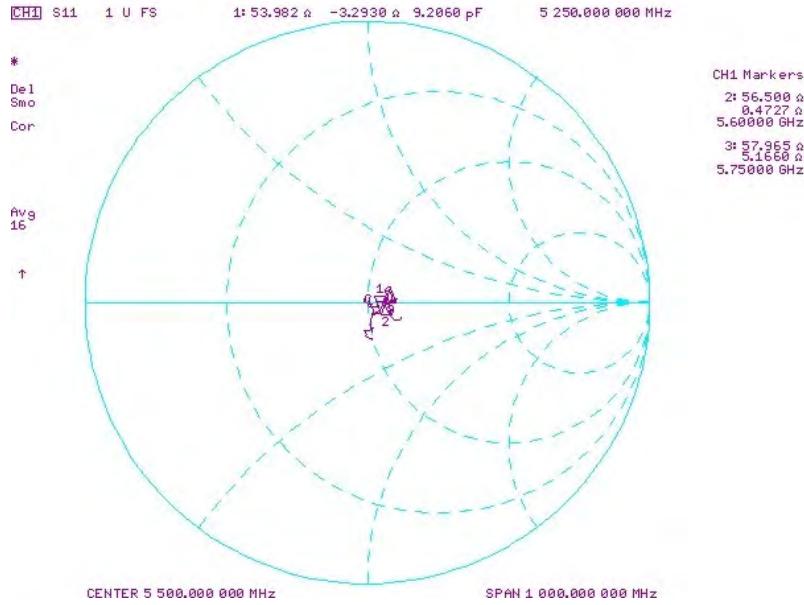



Accredited by the Swiss Accreditation Service (SAS)
The Swiss Accreditation Service is one of the signatories to the EA
Multilateral Agreement for the recognition of calibration certificates

Accreditation No.: **SCS 0108**

Client **PC Test**

Certificate No: **D750V3-1054_Mar17**

CALIBRATION CERTIFICATE

Object **D750V3 - SN:1054**

Calibration procedure(s) **QA CAL-05.v9
Calibration procedure for dipole validation kits above 700 MHz**

BNV
03-27-2017

Calibration date: **March 07, 2017**

BNV
04-04-2018

This calibration certificate documents the traceability to national standards, which realize the physical units of measurements (SI).
The measurements and the uncertainties with confidence probability are given on the following pages and are part of the certificate.

All calibrations have been conducted in the closed laboratory facility; environment temperature (22 ± 3)°C and humidity < 70%.

Calibration Equipment used (M&TE critical for calibration)

Primary Standards	ID #	Cal Date (Certificate No.)	Scheduled Calibration
Power meter NRP	SN: 104778	06-Apr-16 (No. 217-02288/02289)	Apr-17
Power sensor NRP-Z91	SN: 103244	06-Apr-16 (No. 217-02288)	Apr-17
Power sensor NRP-Z91	SN: 103245	06-Apr-16 (No. 217-02289)	Apr-17
Reference 20 dB Attenuator	SN: 5058 (20K)	05-Apr-16 (No. 217-02292)	Apr-17
Type-N mismatch combination	SN: 5047.2 / 06327	05-Apr-16 (No. 217-02295)	Apr-17
Reference Probe EX3DV4	SN: 7349	31-Dec-16 (No. EX3-7349_Dec16)	Dec-17
DAE4	SN: 601	04-Jan-17 (No. DAE4-601_Jan17)	Jan-18
Secondary Standards	ID #	Check Date (In house)	Scheduled Check
Power meter EPM-442A	SN: GB37480704	07-Oct-15 (In house check Oct-16)	In house check: Oct-18
Power sensor HP 8481A	SN: US37292783	07-Oct-15 (In house check Oct-16)	In house check: Oct-18
Power sensor HP 8481A	SN: MY41092317	07-Oct-15 (In house check Oct-16)	In house check: Oct-18
RF generator R&S SMT-06	SN: 100972	15-Jun-15 (In house check Oct-16)	In house check: Oct-18
Network Analyzer HP 8753E	SN: US37390585	18-Oct-01 (In house check Oct-18)	In house check: Oct-17

Calibrated by: **Johannes Kurikka** Name: Johannes Kurikka Function: Laboratory Technician

Approved by: **Katja Pokovic** Name: Katja Pokovic Technical Manager

Signature
Johannes Kurikka
Katja Pokovic

Issued: March 14, 2017

This calibration certificate shall not be reproduced except in full without written approval of the laboratory.



Accredited by the Swiss Accreditation Service (SAS)
The Swiss Accreditation Service is one of the signatories to the EA
Multilateral Agreement for the recognition of calibration certificates

Accreditation No.: **SCS 0108**

Glossary:

TSL tissue simulating liquid
ConvF sensitivity in TSL / NORM x,y,z
N/A not applicable or not measured

Calibration is Performed According to the Following Standards:

- a) IEEE Std 1528-2013, "IEEE Recommended Practice for Determining the Peak Spatial-Averaged Specific Absorption Rate (SAR) in the Human Head from Wireless Communications Devices: Measurement Techniques", June 2013
- b) IEC 62209-1, "Procedure to measure the Specific Absorption Rate (SAR) for hand-held devices used in close proximity to the ear (frequency range of 300 MHz to 3 GHz)", February 2005
- c) IEC 62209-2, "Procedure to determine the Specific Absorption Rate (SAR) for wireless communication devices used in close proximity to the human body (frequency range of 30 MHz to 6 GHz)", March 2010
- d) KDB 865664, "SAR Measurement Requirements for 100 MHz to 6 GHz"

Additional Documentation:

- e) DASY4/5 System Handbook

Methods Applied and Interpretation of Parameters:

- *Measurement Conditions:* Further details are available from the Validation Report at the end of the certificate. All figures stated in the certificate are valid at the frequency indicated.
- *Antenna Parameters with TSL:* The dipole is mounted with the spacer to position its feed point exactly below the center marking of the flat phantom section, with the arms oriented parallel to the body axis.
- *Feed Point Impedance and Return Loss:* These parameters are measured with the dipole positioned under the liquid filled phantom. The impedance stated is transformed from the measurement at the SMA connector to the feed point. The Return Loss ensures low reflected power. No uncertainty required.
- *Electrical Delay:* One-way delay between the SMA connector and the antenna feed point. No uncertainty required.
- *SAR measured:* SAR measured at the stated antenna input power.
- *SAR normalized:* SAR as measured, normalized to an input power of 1 W at the antenna connector.
- *SAR for nominal TSL parameters:* The measured TSL parameters are used to calculate the nominal SAR result.

The reported uncertainty of measurement is stated as the standard uncertainty of measurement multiplied by the coverage factor $k=2$, which for a normal distribution corresponds to a coverage probability of approximately 95%.

Measurement Conditions

DASY system configuration, as far as not given on page 1.

DASY Version	DASY5	V52.8.8
Extrapolation	Advanced Extrapolation	
Phantom	Modular Flat Phantom	
Distance Dipole Center - TSL	15 mm	with Spacer
Zoom Scan Resolution	dx, dy, dz = 5 mm	
Frequency	750 MHz \pm 1 MHz	

Head TSL parameters

The following parameters and calculations were applied.

	Temperature	Permittivity	Conductivity
Nominal Head TSL parameters	22.0 °C	41.9	0.89 mho/m
Measured Head TSL parameters	(22.0 \pm 0.2) °C	40.9 \pm 6 %	0.91 mho/m \pm 6 %
Head TSL temperature change during test	< 0.5 °C	----	----

SAR result with Head TSL

SAR averaged over 1 cm ³ (1 g) of Head TSL	Condition	
SAR measured	250 mW input power	2.14 W/kg
SAR for nominal Head TSL parameters	normalized to 1W	8.37 W/kg \pm 17.0 % (k=2)

SAR averaged over 10 cm ³ (10 g) of Head TSL	condition	
SAR measured	250 mW input power	1.40 W/kg
SAR for nominal Head TSL parameters	normalized to 1W	5.60 W/kg \pm 16.5 % (k=2)

Body TSL parameters

The following parameters and calculations were applied.

	Temperature	Permittivity	Conductivity
Nominal Body TSL parameters	22.0 °C	55.5	0.96 mho/m
Measured Body TSL parameters	(22.0 \pm 0.2) °C	54.6 \pm 6 %	0.99 mho/m \pm 6 %
Body TSL temperature change during test	< 0.5 °C	----	----

SAR result with Body TSL

SAR averaged over 1 cm ³ (1 g) of Body TSL	Condition	
SAR measured	250 mW input power	2.21 W/kg
SAR for nominal Body TSL parameters	normalized to 1W	8.61 W/kg \pm 17.0 % (k=2)

SAR averaged over 10 cm ³ (10 g) of Body TSL	condition	
SAR measured	250 mW input power	1.45 W/kg
SAR for nominal Body TSL parameters	normalized to 1W	5.68 W/kg \pm 16.5 % (k=2)

Appendix (Additional assessments outside the scope of SCS 0108)

Antenna Parameters with Head TSL

Impedance, transformed to feed point	54.7 Ω - 0.7 j Ω
Return Loss	- 26.8 dB

Antenna Parameters with Body TSL

Impedance, transformed to feed point	50.7 Ω - 3.6 j Ω
Return Loss	- 28.7 dB

General Antenna Parameters and Design

Electrical Delay (one direction)	1.033 ns
----------------------------------	----------

After long term use with 100W radiated power, only a slight warming of the dipole near the feedpoint can be measured.

The dipole is made of standard semirigid coaxial cable. The center conductor of the feeding line is directly connected to the second arm of the dipole. The antenna is therefore short-circuited for DC-signals. On some of the dipoles, small end caps are added to the dipole arms in order to improve matching when loaded according to the position as explained in the "Measurement Conditions" paragraph. The SAR data are not affected by this change. The overall dipole length is still according to the Standard.

No excessive force must be applied to the dipole arms, because they might bend or the soldered connections near the feedpoint may be damaged.

Additional EUT Data

Manufactured by	SPEAG
Manufactured on	November 08, 2011

DASY5 Validation Report for Head TSL

Date: 07.03.2017

Test Laboratory: SPEAG, Zurich, Switzerland

DUT: Dipole 750 MHz; Type: D750V3; Serial: D750V3 - SN:1054

Communication System: UID 0 - CW ; Frequency: 750 MHz

Medium parameters used: $f = 750 \text{ MHz}$; $\sigma = 0.91 \text{ S/m}$; $\epsilon_r = 40.9$; $\rho = 1000 \text{ kg/m}^3$

Phantom section: Flat Section

Measurement Standard: DASY5 (IEEE/IEC/ANSI C63.19-2011)

DASY52 Configuration:

- Probe: EX3DV4 - SN7349; ConvF(10.17, 10.17, 10.17); Calibrated: 31.12.2016;
- Sensor-Surface: 1.4mm (Mechanical Surface Detection)
- Electronics: DAE4 Sn601; Calibrated: 04.01.2017
- Phantom: Flat Phantom 4.9 (front); Type: QD 00L P49 AA; Serial: 1001
- DASY52 52.8.8(1222); SEMCAD X 14.6.10(7331)

Dipole Calibration for Head Tissue/Pin=250 mW, d=15mm/Zoom Scan (7x7x7)/Cube 0:

Measurement grid: $dx=5\text{mm}$, $dy=5\text{mm}$, $dz=5\text{mm}$

Reference Value = 59.71 V/m; Power Drift = 0.01 dB

Peak SAR (extrapolated) = 3.21 W/kg

SAR(1 g) = 2.14 W/kg; SAR(10 g) = 1.4 W/kg

Maximum value of SAR (measured) = 2.85 W/kg

