



## SAR EVALUATION REPORT

**Applicant Name:**  
 LG Electronics U.S.A., Inc.  
 1000 Sylvan Avenue  
 Englewood Cliffs, NJ 07632  
 United States

**Date of Testing:**  
 07/22/19 - 08/12/19  
**Test Site/Location:**  
 PCTEST Lab, Columbia, MD, USA  
**Document Serial No.:**  
 1M1907220127-01.ZNF

**FCC ID:** ZNFX320PM

**APPLICANT:** LG ELECTRONICS U.S.A., INC.

**DUT Type:** Portable Handset  
**Application Type:** Class II Permissive Change  
**FCC Rule Part(s):** CFR §2.1093  
**Model:** LM-X320PM  
**Additional Model(s):** LMX320PM, X320PM  
**Permissive Change(s):** See FCC Change Document  
**Date of Original Certification:** 08/09/2019

Equipment Class	Band & Mode	Tx Frequency	SAR		
			1g Head (W/kg)	1g Body-Worn (W/kg)	1g Hotspot (W/kg)
PCE	GSM/GPRS/EDGE 850	824.20 - 848.80 MHz	0.32	0.48	0.48
PCE	GSM/GPRS/EDGE 1900	1850.20 - 1909.80 MHz	0.34	0.35	0.35
PCE	UMTS 850	826.40 - 846.60 MHz	0.33	0.50	0.50
PCE	UMTS 1750	1712.4 - 1752.6 MHz	0.52	0.96	0.96
PCE	UMTS 1900	1852.4 - 1907.6 MHz	0.63	0.67	0.77
PCE	CDMA/EVDO BC10 (S90S)	817.90 - 823.10 MHz	0.42	0.66	0.69
PCE	CDMA/EVDO BC10 (S22H)	824.70 - 848.31 MHz	0.34	0.49	0.52
PCE	PCS CDMA/EVDO	1851.25 - 1908.75 MHz	0.72	0.60	0.83
PCE	LTE Band 71	665.5 - 695.5 MHz	0.20	0.39	0.39
PCE	LTE Band 12	699.7 - 715.3 MHz	0.27	0.38	0.38
PCE	LTE Band 13	779.5 - 784.5 MHz	0.32	0.51	0.51
PCE	LTE Band 26 (Cell)	814.7 - 848.3 MHz	0.45	0.58	0.58
PCE	LTE Band 5 (Cell)	824.7 - 848.3 MHz	N/A	N/A	N/A
PCE	LTE Band 66 (AWS)	1710.7 - 1779.3 MHz	0.57	0.83	0.83
PCE	LTE Band 4 (AWS)	1710.7 - 1754.3 MHz	N/A	N/A	N/A
PCE	LTE Band 25 (PCS)	1850.7 - 1914.3 MHz	0.78	0.67	0.88
PCE	LTE Band 2 (PCS)	1850.7 - 1909.3 MHz	N/A	N/A	N/A
PCE	LTE Band 41	2498.5 - 2687.5 MHz	0.32	0.78	1.30
DTS	2.4 GHz WLAN	2412 - 2462 MHz	0.91	0.13	0.13
DSS/DTSS	Bluetooth	2402 - 2480 MHz	0.21	N/A	N/A
Simultaneous SAR per KDB 690783 D01v01r03:			1.53	1.19	1.53

This wireless portable device has been shown to be capable of compliance for localized specific absorption rate (SAR) for uncontrolled environment/general population exposure limits specified in ANSI/IEEE C95.1-1992 and has been tested in accordance with the measurement procedures specified in Section 1.7 of this report; for North American frequency bands only.

I attest to the accuracy of data. All measurements reported herein were performed by me or were made under my supervision and are correct to the best of my knowledge and belief. I assume full responsibility for the completeness of these measurements and vouch for the qualifications of all persons taking them. Test results reported herein relate only to the item(s) tested.

Randy Ortanez  
 President





The SAR Tick is an initiative of the Mobile & Wireless Forum (MWF). While a product may be considered eligible, use of the SAR Tick logo requires an agreement with the MWF. Further details can be obtained by emailing: sartick@mwfai.info.

FCC ID: ZNFX320PM		SAR EVALUATION REPORT		Approved by: Quality Manager
Document S/N: 1M1907220127-01.ZNF	Test Dates: 07/22/19 - 08/12/19	DUT Type: Portable Handset		Page 1 of 91

# TABLE OF CONTENTS

1	DEVICE UNDER TEST .....	3
2	LTE INFORMATION.....	11
3	INTRODUCTION.....	12
4	DOSIMETRIC ASSESSMENT .....	13
5	DEFINITION OF REFERENCE POINTS.....	14
6	TEST CONFIGURATION POSITIONS .....	15
7	RF EXPOSURE LIMITS .....	18
8	FCC MEASUREMENT PROCEDURES.....	19
9	RF CONDUCTED POWERS .....	26
10	SYSTEM VERIFICATION.....	54
11	SAR DATA SUMMARY .....	56
12	FCC MULTI-TX AND ANTENNA SAR CONSIDERATIONS .....	73
13	SAR MEASUREMENT VARIABILITY .....	82
14	ADDITIONAL TESTING PER FCC GUIDANCE .....	84
15	EQUIPMENT LIST .....	87
16	MEASUREMENT UNCERTAINTIES .....	88
17	CONCLUSION .....	89
18	REFERENCES.....	90
APPENDIX A: SAR TEST PLOTS		
APPENDIX B: SAR DIPOLE VERIFICATION PLOTS		
APPENDIX C: PROBE AND DIPOLE CALIBRATION CERTIFICATES		
APPENDIX D: SAR TISSUE SPECIFICATIONS		
APPENDIX E: SAR SYSTEM VALIDATION		
APPENDIX F: DUT ANTENNA DIAGRAM & SAR TEST SETUP PHOTOGRAPHS		

FCC ID: ZNFX320PM		SAR EVALUATION REPORT		Approved by: Quality Manager
Document S/N: 1M1907220127-01.ZNF	Test Dates: 07/22/19 - 08/12/19	DUT Type: Portable Handset	Page 2 of 91	



# 1 DEVICE UNDER TEST

## 1.1 Device Overview

Band & Mode	Operating Modes	Tx Frequency
GSM/GPRS/EDGE 850	Voice/Data	824.20 - 848.80 MHz
GSM/GPRS/EDGE 1900	Voice/Data	1850.20 - 1909.80 MHz
UMTS 850	Voice/Data	826.40 - 846.60 MHz
UMTS 1750	Voice/Data	1712.4 - 1752.6 MHz
UMTS 1900	Voice/Data	1852.4 - 1907.6 MHz
CDMA/EVDO BC10 (§90S)	Voice/Data	817.90 - 823.10 MHz
CDMA/EVDO BC0 (§22H)	Voice/Data	824.70 - 848.31 MHz
PCS CDMA/EVDO	Voice/Data	1851.25 - 1908.75 MHz
LTE Band 71	Voice/Data	665.5 - 695.5 MHz
LTE Band 12	Voice/Data	699.7 - 715.3 MHz
LTE Band 13	Voice/Data	779.5 - 784.5 MHz
LTE Band 26 (Cell)	Voice/Data	814.7 - 848.3 MHz
LTE Band 5 (Cell)	Voice/Data	824.7 - 848.3 MHz
LTE Band 66 (AWS)	Voice/Data	1710.7 - 1779.3 MHz
LTE Band 4 (AWS)	Voice/Data	1710.7 - 1754.3 MHz
LTE Band 25 (PCS)	Voice/Data	1850.7 - 1914.3 MHz
LTE Band 2 (PCS)	Voice/Data	1850.7 - 1909.3 MHz
LTE Band 41	Voice/Data	2498.5 - 2687.5 MHz
2.4 GHz WLAN	Voice/Data	2412 - 2462 MHz
Bluetooth	Data	2402 - 2480 MHz

## 1.2 Power Reduction for SAR

There is no power reduction used for any band/mode implemented in this device for SAR purposes.

FCC ID: ZNFX320PM	 PCTEST ENGINEERING LABORATORY, INC.	SAR EVALUATION REPORT	 LG	Approved by: Quality Manager
Document S/N: 1M1907220127-01.ZNF	Test Dates: 07/22/19 - 08/12/19	DUT Type: Portable Handset	Page 3 of 91	

### 1.3 Nominal and Maximum Output Power Specifications



This device operates using the following maximum and nominal output power specifications. SAR values were scaled to the maximum allowed power to determine compliance per KDB Publication 447498 D01v06.

#### 1.3.1 Maximum Output Power



Mode / Band		Voice (dBm)	Burst Average GMSK (dBm)		Burst Average 8-PSK (dBm)	
		1 TX Slot	1 TX Slots	2 TX Slots	1 TX Slots	2 TX Slots
GSM/GPRS/EDGE 850	Maximum	<b>33.6</b>	<b>33.6</b>	<b>31.0</b>	<b>26.5</b>	<b>26.5</b>
	Nominal	<b>33.1</b>	<b>33.1</b>	<b>30.5</b>	<b>26.0</b>	<b>26.0</b>
GSM/GPRS/EDGE 1900	Maximum	<b>30.8</b>	<b>30.8</b>	<b>28.0</b>	<b>25.5</b>	<b>25.5</b>
	Nominal	<b>30.3</b>	<b>30.3</b>	<b>27.5</b>	<b>25.0</b>	<b>25.0</b>

Mode / Band		Modulated Average (dBm)		
		3GPP WCDMA	3GPP HSDPA	3GPP HSUPA
UMTS Band 5 (850 MHz)	Maximum	<b>25.3</b>	<b>25.3</b>	<b>24.3</b>
	Nominal	<b>24.8</b>	<b>24.8</b>	<b>23.8</b>
UMTS Band 4 (1750 MHz)	Maximum	<b>24.8</b>	<b>24.8</b>	<b>23.8</b>
	Nominal	<b>24.3</b>	<b>24.3</b>	<b>23.3</b>
UMTS Band 2 (1900 MHz)	Maximum	<b>24.8</b>	<b>24.8</b>	<b>23.8</b>
	Nominal	<b>24.3</b>	<b>24.3</b>	<b>23.3</b>

Mode / Band		Modulated Average (dBm)
CDMA/EVDO BC10 (§90S)	Maximum	<b>25.3</b>
	Nominal	<b>24.8</b>
CDMA/EVDO BC0 (§22H)	Maximum	<b>25.3</b>
	Nominal	<b>24.8</b>
PCS CDMA/EVDO	Maximum	<b>24.8</b>
	Nominal	<b>24.3</b>



FCC ID: ZNFX320PM	 <b>PCTEST</b> ENGINEERING LABORATORY, INC.	SAR EVALUATION REPORT	 <b>LG</b>	Approved by: Quality Manager
Document S/N: 1M1907220127-01.ZNF	Test Dates: 07/22/19 - 08/12/19	DUT Type: Portable Handset	Page 4 of 91	

Mode / Band		Modulated Average (dBm)
LTE Band 71	Maximum	25.3
	Nominal	24.8
LTE Band 12	Maximum	25.3
	Nominal	24.8
LTE Band 13	Maximum	25.3
	Nominal	24.8
LTE Band 26 (Cell)	Maximum	25.3
	Nominal	24.8
LTE Band 5 (Cell)	Maximum	25.3
	Nominal	24.8
LTE Band 66 (AWS)	Maximum	24.8
	Nominal	24.3
LTE Band 4 (AWS)	Maximum	24.8
	Nominal	24.3
LTE Band 25 (PCS)	Maximum	24.8
	Nominal	24.3
LTE Band 2 (PCS)	Maximum	24.8
	Nominal	24.3
LTE Band 41 (PC3)	Maximum	24.8
	Nominal	24.3
LTE Band 41 (PC2)	Maximum	27.8
	Nominal	27.3

FCC ID: ZNFX320PM	 <b>PCTEST</b> ENGINEERING LABORATORY, INC.	<b>SAR EVALUATION REPORT</b>	 <b>LG</b>	<b>Approved by:</b> Quality Manager
<b>Document S/N:</b> 1M1907220127-01.ZNF	<b>Test Dates:</b> 07/22/19 - 08/12/19	<b>DUT Type:</b> Portable Handset	Page 5 of 91	

Mode / Band		Modulated Average (dBm)				
		1	2	3 - 9	10	11
IEEE 802.11b (2.4 GHz)	Maximum	<b>16.0</b>				
	Nominal	<b>15.0</b>				
IEEE 802.11g (2.4 GHz)	Maximum	<b>15.0</b>	<b>15.5</b>	<b>15.5</b>	<b>15.5</b>	<b>15.5</b>
	Nominal	<b>14.0</b>	<b>14.5</b>	<b>14.5</b>	<b>14.5</b>	<b>14.5</b>
IEEE 802.11n (2.4 GHz)	Maximum	<b>15.0</b>	<b>15.5</b>	<b>15.5</b>	<b>15.5</b>	<b>15.5</b>
	Nominal	<b>14.0</b>	<b>14.5</b>	<b>14.5</b>	<b>14.5</b>	<b>14.5</b>

Mode / Band		Modulated Average (dBm)
Bluetooth	Maximum	<b>10.5</b>
	Nominal	<b>9.5</b>
Bluetooth LE	Maximum	<b>5.5</b>
	Nominal	<b>4.5</b>

FCC ID: ZNFX320PM	 <b>PCTEST</b> ENGINEERING LABORATORY, INC.	<b>SAR EVALUATION REPORT</b>	 <b>LG</b>	<b>Approved by:</b> Quality Manager
<b>Document S/N:</b> 1M1907220127-01.ZNF	<b>Test Dates:</b> 07/22/19 - 08/12/19	<b>DUT Type:</b> Portable Handset	Page 6 of 91	

## 1.4 DUT Antenna Locations

The overall dimensions of this device are > 9 x 5 cm. The overall diagonal dimension of the device is ≤160 mm and the diagonal display is ≤150 mm. A diagram showing the location of the device antennas can be found in Appendix F.

**Table 1-1  
Device Edges/Sides for SAR Testing**



Mode	Back	Front	Top	Bottom	Right	Left
GPRS 850	Yes	Yes	No	Yes	Yes	Yes
GPRS 1900	Yes	Yes	No	Yes	No	Yes
UMTS 850	Yes	Yes	No	Yes	Yes	Yes
UMTS 1750	Yes	Yes	No	Yes	No	Yes
UMTS 1900	Yes	Yes	No	Yes	No	Yes
EVDO BC10 (§90S)	Yes	Yes	No	Yes	Yes	Yes
EVDO BC0 (§22H)	Yes	Yes	No	Yes	Yes	Yes
PCS EVDO	Yes	Yes	No	Yes	No	Yes
LTE Band 71	Yes	Yes	No	Yes	Yes	Yes
LTE Band 12	Yes	Yes	No	Yes	Yes	Yes
LTE Band 13	Yes	Yes	No	Yes	Yes	Yes
LTE Band 26 (Cell)	Yes	Yes	No	Yes	Yes	Yes
LTE Band 66 (AWS)	Yes	Yes	No	Yes	No	Yes
LTE Band 25 (PCS)	Yes	Yes	No	Yes	No	Yes
LTE Band 41	Yes	Yes	No	Yes	Yes	Yes
2.4 GHz WLAN	Yes	Yes	Yes	No	Yes	No

Note: Particular DUT edges were not required to be evaluated for wireless router SAR if the edges were greater than 2.5 cm from the transmitting antenna according to FCC KDB Publication 941225 D06v02r01 Section III. The distances between the transmit antennas and the edges of the device are included in the filing.

## 1.5 Simultaneous Transmission Capabilities

According to FCC KDB Publication 447498 D01v06, transmitters are considered to be operating simultaneously when there is overlapping transmission, with the exception of transmissions during network hand-offs with maximum hand-off duration less than 30 seconds.

This device contains multiple transmitters that may operate simultaneously, and therefore requires a simultaneous transmission analysis according to FCC KDB Publication 447498 D01v06 4.3.2 procedures.

FCC ID: ZNFX320PM	 <b>PCTEST</b> ENGINEERING LABORATORY, INC.	<b>SAR EVALUATION REPORT</b>		<b>Approved by:</b> Quality Manager
<b>Document S/N:</b> 1M1907220127-01.ZNF	<b>Test Dates:</b> 07/22/19 - 08/12/19	<b>DUT Type:</b> Portable Handset	Page 7 of 91	

**Table 1-2  
Simultaneous Transmission Scenarios**

No.	Capable Transmit Configuration	Head	Body-Worn Accessory	Wireless Router	Notes
1	1x CDMA voice + 2.4 GHz WI-FI	Yes	Yes	N/A	
2	1x CDMA voice + 2.4 GHz Bluetooth	Yes^	Yes	N/A	^ Bluetooth Tethering is considered
3	GSM voice + 2.4 GHz WI-FI	Yes	Yes	N/A	
4	GSM voice + 2.4 GHz Bluetooth	Yes^	Yes	N/A	^ Bluetooth Tethering is considered
5	UMTS + 2.4 GHz WI-FI	Yes	Yes	Yes	
6	UMTS + 2.4 GHz Bluetooth	Yes^	Yes	Yes^	^ Bluetooth Tethering is considered
7	LTE + 2.4 GHz WI-FI	Yes	Yes	Yes	
8	LTE + 2.4 GHz Bluetooth	Yes^	Yes	Yes^	^ Bluetooth Tethering is considered
9	CDMA/EVDO data + 2.4 GHz WI-FI	Yes*	Yes*	Yes	* Pre-installed VOIP applications are considered
10	CDMA/EVDO data + 2.4 GHz Bluetooth	Yes*^	Yes*	Yes^	* Pre-installed VOIP applications are considered ^ Bluetooth Tethering is considered
11	GPRS/EDGE + 2.4 GHz WI-FI	Yes*	Yes*	Yes	* Pre-installed VOIP applications are considered
12	GPRS/EDGE + 2.4 GHz Bluetooth	Yes*^	Yes*	Yes^	* Pre-installed VOIP applications are considered ^ Bluetooth Tethering is considered

- 2.4 GHz WLAN, and 2.4 GHz Bluetooth share the same antenna path and cannot transmit simultaneously.
- All licensed modes share the same antenna path and cannot transmit simultaneously.
- When the user utilizes multiple services in UMTS 3G mode it uses multi-Radio Access Bearer or multi-RAB. The power control is based on a physical control channel (Dedicated Physical Control Channel [DPCCH]) and power control will be adjusted to meet the needs of both services. Therefore, the UMTS+WLAN scenario also represents the UMTS Voice/DATA + WLAN Hotspot scenario.
- Per the manufacturer, WIFI Direct is expected to be used in conjunction with a held-to-ear or body-worn accessory voice call. Therefore, there are no simultaneous transmission scenarios involving WIFI direct beyond that listed in the above table.
- This device supports VOLTE.
- This device supports VoWIFI.
- This device supports Bluetooth Tethering.



## 1.6 Miscellaneous SAR Test Considerations

### (A) WIFI/BT

Per FCC KDB 447498 D01v06, the 1g SAR exclusion threshold for distances <50mm is defined by the following equation:

$$\frac{\text{Max Power of Channel (mW)}}{\text{Test Separation Dist (mm)}} * \sqrt{\text{Frequency(GHz)}} \leq 3.0$$

Based on the maximum conducted power of Bluetooth (rounded to the nearest mW) and the antenna to user separation distance, body-worn and hotspot Bluetooth SAR was not required;  $[(11/10) * \sqrt{2.480}] = 1.7 < 3.0$ . Per KDB Publication 447498 D01v06, the maximum power of the channel was rounded to the nearest mW before calculation.

FCC ID: ZNFX320PM		SAR EVALUATION REPORT		Approved by: Quality Manager
Document S/N: 1M1907220127-01.ZNF	Test Dates: 07/22/19 - 08/12/19	DUT Type: Portable Handset		Page 8 of 91



## (B) Licensed Transmitter(s)

GSM/GPRS/EDGE DTM is not supported for US bands. Therefore, the GSM Voice modes in this report do not transmit simultaneously with GPRS/EDGE Data.

This device is only capable of QPSK HSUPA in the uplink. Therefore, no additional SAR tests are required beyond that described for devices with HSUPA in KDB 941225 D01v03r01.

LTE SAR for the higher modulations and lower bandwidths were not tested since the maximum average output power of all required channels and configurations was not more than 0.5 dB higher than the highest bandwidth; and the reported LTE SAR for the highest bandwidth was less than 1.45 W/kg for all configurations according to FCC KDB 941225 D05v02r04.



This device supports LTE capabilities with overlapping transmission frequency ranges. When the supported frequency range of an LTE Band falls completely within an LTE band with a larger transmission frequency range, both LTE bands have the same target power (or the band with the larger transmission frequency range has a higher target power), and both LTE bands share the same transmission path and signal characteristics, SAR was only assessed for the band with the larger transmission frequency range.

This device supports LTE Carrier Aggregation (CA) in the downlink. All uplink communications are identical to Release 8 specifications. Per FCC KDB Publication 941225 D05A v01r02, SAR for LTE CA operations was not needed since the maximum average output power in LTE CA mode was not >0.25 dB higher than the maximum output power when downlink carrier aggregation was inactive.

This device supports both Power Class 2 (PC2) and Power Class 3 (PC3) for LTE Band 41. Per May 2017 TCB Workshop Notes, SAR tests were performed with Power Class 3 (given the specific UL/DL limitations for Power Class 2). Additionally, SAR testing for the power class condition was evaluated for the highest configuration in Power Class 3 for each test configuration to confirm the results were scalable linearly (See Section 14.1).



## 1.7 Guidance Applied

- IEEE 1528-2013
- FCC KDB Publication 941225 D01v03r01, D05v02r04, D05Av01r02, D06v02r01 (2G/3G/4G and Hotspot)
- FCC KDB Publication 248227 D01v02r02 (SAR Considerations for 802.11 Devices)
- FCC KDB Publication 447498 D01v06 (General SAR Guidance)
- FCC KDB Publication 865664 D01v01r04, D02v01r02 (SAR Measurements up to 6 GHz)
- October 2013 TCB Workshop Notes (GPRS Testing Considerations)
- May 2017 TCB Workshop Notes (LTE Band 41 Power Class 2/3)
- April 2018 TCB Workshop Notes (LTE Carrier Aggregation)



FCC ID: ZNFX320PM	 PCTEST ENGINEERING LABORATORY, INC.	SAR EVALUATION REPORT	 LG	Approved by: Quality Manager
Document S/N: 1M1907220127-01.ZNF	Test Dates: 07/22/19 - 08/12/19	DUT Type: Portable Handset		Page 9 of 91

## 1.8 Device Serial Numbers

Several samples with identical hardware were used to support SAR testing. The manufacturer has confirmed that the device(s) tested have the same physical, mechanical and thermal characteristics and are within operational tolerances expected for production units. The serial numbers used for each test are indicated alongside the results in Section 11.

FCC ID: ZNFX320PM	 <b>SAR EVALUATION REPORT</b> 		<b>Approved by:</b> Quality Manager
<b>Document S/N:</b> 1M1907220127-01.ZNF	<b>Test Dates:</b> 07/22/19 - 08/12/19	<b>DUT Type:</b> Portable Handset	Page 10 of 91

LTE Information					
Form Factor	Portable Handset				
Frequency Range of each LTE transmission band	LTE Band 71 (665.5 - 695.5 MHz)				
	LTE Band 12 (699.7 - 715.3 MHz)				
	LTE Band 13 (779.5 - 784.5 MHz)				
	LTE Band 26 (Cell) (814.7 - 848.3 MHz)				
	LTE Band 5 (Cell) (824.7 - 848.3 MHz)				
	LTE Band 66 (AWS) (1710.7 - 1779.3 MHz)				
	LTE Band 4 (AWS) (1710.7 - 1754.3 MHz)				
	LTE Band 25 (PCS) (1850.7 - 1914.3 MHz)				
	LTE Band 2 (PCS) (1850.7 - 1909.3 MHz)				
	LTE Band 41 (2498.5 - 2687.5 MHz)				
	Channel Bandwidths	LTE Band 71: 5 MHz, 10 MHz, 15 MHz, 20 MHz			
LTE Band 12: 1.4 MHz, 3 MHz, 5 MHz, 10 MHz					
LTE Band 13: 5 MHz, 10 MHz					
LTE Band 26 (Cell): 1.4 MHz, 3 MHz, 5 MHz, 10 MHz, 15 MHz					
LTE Band 5 (Cell): 1.4 MHz, 3 MHz, 5 MHz, 10 MHz					
LTE Band 66 (AWS): 1.4 MHz, 3 MHz, 5 MHz, 10 MHz, 15 MHz, 20 MHz					
LTE Band 4 (AWS): 1.4 MHz, 3 MHz, 5 MHz, 10 MHz, 15 MHz, 20 MHz					
LTE Band 25 (PCS): 1.4 MHz, 3 MHz, 5 MHz, 10 MHz, 15 MHz, 20 MHz					
LTE Band 2 (PCS): 1.4 MHz, 3 MHz, 5 MHz, 10 MHz, 15 MHz, 20 MHz					
LTE Band 41: 5 MHz, 10 MHz, 15 MHz, 20 MHz					
Channel Numbers and Frequencies (MHz)		Low	Low-Mid	Mid	Mid-High
	LTE Band 71: 5 MHz	665.5 (133147)	680.5 (133297)	695.5 (133447)	
LTE Band 71: 10 MHz	668 (133172)	680.5 (133297)	693 (133422)		
LTE Band 71: 15 MHz	670.5 (133197)	680.5 (133297)	690.5 (133397)		
LTE Band 71: 20 MHz	673 (133222)	680.5 (133297)	688 (133372)		
LTE Band 12: 1.4 MHz	699.7 (23017)	707.5 (23095)	715.3 (23173)		
LTE Band 12: 3 MHz	700.5 (23025)	707.5 (23095)	714.5 (23165)		
LTE Band 12: 5 MHz	701.5 (23035)	707.5 (23095)	713.5 (23155)		
LTE Band 12: 10 MHz	704 (23060)	707.5 (23095)	711 (23130)		
LTE Band 13: 5 MHz	779.5 (23205)	782 (23230)	784.5 (23255)		
LTE Band 13: 10 MHz	N/A	782 (23230)	N/A		
LTE Band 26 (Cell): 1.4 MHz	814.7 (26697)	831.5 (26865)	848.3 (27033)		
LTE Band 26 (Cell): 3 MHz	815.5 (26705)	831.5 (26865)	847.5 (27025)		
LTE Band 26 (Cell): 5 MHz	816.5 (26715)	831.5 (26865)	846.5 (27015)		
LTE Band 26 (Cell): 10 MHz	819 (26740)	831.5 (26865)	844 (26990)		
LTE Band 26 (Cell): 15 MHz	821.5 (26765)	831.5 (26865)	841.5 (26965)		
LTE Band 5 (Cell): 1.4 MHz	824.7 (20407)	836.5 (20525)	848.3 (20643)		
LTE Band 5 (Cell): 3 MHz	825.5 (20415)	836.5 (20525)	847.5 (20635)		
LTE Band 5 (Cell): 5 MHz	826.5 (20425)	836.5 (20525)	846.5 (20625)		
LTE Band 5 (Cell): 10 MHz	829 (20450)	836.5 (20525)	844 (20600)		
LTE Band 66 (AWS): 1.4 MHz	1710.7 (131979)	1745 (132322)	1779.3 (132665)		
LTE Band 66 (AWS): 3 MHz	1711.5 (131987)	1745 (132322)	1778.5 (132657)		
LTE Band 66 (AWS): 5 MHz	1712.5 (131997)	1745 (132322)	1777.5 (132647)		
LTE Band 66 (AWS): 10 MHz	1715 (132022)	1745 (132322)	1775 (132622)		
LTE Band 66 (AWS): 15 MHz	1717.5 (132047)	1745 (132322)	1772.5 (132597)		
LTE Band 66 (AWS): 20 MHz	1720 (132072)	1745 (132322)	1770 (132572)		
LTE Band 4 (AWS): 1.4 MHz	1710.7 (19957)	1732.5 (20175)	1754.3 (20393)		
LTE Band 4 (AWS): 3 MHz	1711.5 (19965)	1732.5 (20175)	1753.5 (20385)		
LTE Band 4 (AWS): 5 MHz	1712.5 (19975)	1732.5 (20175)	1752.5 (20375)		
LTE Band 4 (AWS): 10 MHz	1715 (20000)	1732.5 (20175)	1750 (20350)		
LTE Band 4 (AWS): 15 MHz	1717.5 (20025)	1732.5 (20175)	1747.5 (20325)		
LTE Band 4 (AWS): 20 MHz	1720 (20050)	1732.5 (20175)	1745 (20300)		
LTE Band 25 (PCS): 1.4 MHz	1850.7 (26047)	1882.5 (26365)	1914.3 (26683)		
LTE Band 25 (PCS): 3 MHz	1851.5 (26055)	1882.5 (26365)	1913.5 (26675)		
LTE Band 25 (PCS): 5 MHz	1852.5 (26065)	1882.5 (26365)	1912.5 (26665)		
LTE Band 25 (PCS): 10 MHz	1855 (26090)	1882.5 (26365)	1910 (26640)		
LTE Band 25 (PCS): 15 MHz	1857.5 (26115)	1882.5 (26365)	1907.5 (26615)		
LTE Band 25 (PCS): 20 MHz	1860 (26140)	1882.5 (26365)	1905 (26590)		
LTE Band 2 (PCS): 1.4 MHz	1850.7 (18607)	1880 (18900)	1909.3 (19193)		
LTE Band 2 (PCS): 3 MHz	1851.5 (18615)	1880 (18900)	1908.5 (19185)		
LTE Band 2 (PCS): 5 MHz	1852.5 (18625)	1880 (18900)	1907.5 (19175)		
LTE Band 2 (PCS): 10 MHz	1855 (18650)	1880 (18900)	1905 (19150)		
LTE Band 2 (PCS): 15 MHz	1857.5 (18675)	1880 (18900)	1902.5 (19125)		
LTE Band 2 (PCS): 20 MHz	1860 (18700)	1880 (18900)	1900 (19100)		
LTE Band 41: 5 MHz	2506 (39750)	2549.5 (40185)	2593 (40620)	2636.5 (41055)	2680 (41490)
LTE Band 41: 10 MHz	2506 (39750)	2549.5 (40185)	2593 (40620)	2636.5 (41055)	2680 (41490)
LTE Band 41: 15 MHz	2506 (39750)	2549.5 (40185)	2593 (40620)	2636.5 (41055)	2680 (41490)
LTE Band 41: 20 MHz	2506 (39750)	2549.5 (40185)	2593 (40620)	2636.5 (41055)	2680 (41490)
UE Category	DL UE Cat 6, UL UE Cat 5				
Modulations Supported in UL	QPSK, 16QAM, 64QAM				
LTE MPR Permanently implemented per 3GPP TS 36.101 section 6.2.3-6.2.5? (manufacturer attestation to be provided)	YES				
A-MPR (Additional MPR) disabled for SAR Testing?	YES				
LTE Carrier Aggregation Possible Combinations	The technical description includes all the possible carrier aggregation combinations				
LTE Additional Information	This device does not support full CA features on 3GPP Release 11. All other uplink communications are identical to the Release 8 Specifications. Uplink communications are done on the PCC. The following LTE Release 11 Features are not supported: Relay, HetNet, Enhanced MIMO, eCIC, WIFI Offloading, eMBMS, Cross-Carrier Scheduling, Enhanced SC-FDMA.				

FCC ID: ZNFX320PM		SAR EVALUATION REPORT		Approved by: Quality Manager
Document S/N: 1M1907220127-01.ZNF	Test Dates: 07/22/19 - 08/12/19	DUT Type: Portable Handset		Page 11 of 91

The FCC and Innovation, Science, and Economic Development Canada have adopted the guidelines for evaluating the environmental effects of radio frequency (RF) radiation in ET Docket 93-62 on Aug. 6, 1996 and Health Canada Safety Code 6 to protect the public and workers from the potential hazards of RF emissions due to FCC-regulated portable devices. [1]

The safety limits used for the environmental evaluation measurements are based on the criteria published by the American National Standards Institute (ANSI) for localized specific absorption rate (SAR) in IEEE/ANSI C95.1-1992 Standard for Safety Levels with Respect to Human Exposure to Radio Frequency Electromagnetic Fields, 3 kHz to 300 GHz [3] and Health Canada RF Exposure Guidelines Safety Code 6 [22]. The measurement procedure described in IEEE/ANSI C95.3-2002 Recommended Practice for the Measurement of Potentially Hazardous Electromagnetic Fields - RF and Microwave [4] is used for guidance in measuring the Specific Absorption Rate (SAR) due to the RF radiation exposure from the Equipment Under Test (EUT). These criteria for SAR evaluation are similar to those recommended by the International Committee for Non-Ionizing Radiation Protection (ICNIRP) in Biological Effects and Exposure Criteria for Radiofrequency Electromagnetic Fields,” Report No. Vol 74. SAR is a measure of the rate of energy absorption due to exposure to an RF transmitting source. SAR values have been related to threshold levels for potential biological hazards.

### 3.1 SAR Definition

Specific Absorption Rate is defined as the time derivative (rate) of the incremental energy (dU) absorbed by (dissipated in) an incremental mass (dm) contained in a volume element (dV) of a given density ( $\rho$ ). It is also defined as the rate of RF energy absorption per unit mass at a point in an absorbing body (see Equation 3-1).

**Equation 3-1**  
**SAR Mathematical Equation**

$$SAR = \frac{d}{dt} \left( \frac{dU}{dm} \right) = \frac{d}{dt} \left( \frac{dU}{\rho dv} \right)$$



SAR is expressed in units of Watts per Kilogram (W/kg).

$$SAR = \frac{\sigma \cdot E^2}{\rho}$$

where:

- $\sigma$  = conductivity of the tissue-simulating material (S/m)
- $\rho$  = mass density of the tissue-simulating material (kg/m<sup>3</sup>)
- E = Total RMS electric field strength (V/m)

NOTE: The primary factors that control rate of energy absorption were found to be the wavelength of the incident field in relation to the dimensions and geometry of the irradiated organism, the orientation of the organism in relation to the polarity of field vectors, the presence of reflecting surfaces, and whether conductive contact is made by the organism with a ground plane.[6]

FCC ID: ZNFX320PM	 PCTEST ENGINEERING LABORATORY, INC.	SAR EVALUATION REPORT	 LG	Approved by: Quality Manager
Document S/N: 1M1907220127-01.ZNF	Test Dates: 07/22/19 - 08/12/19	DUT Type: Portable Handset		Page 12 of 91

# 4

## DOSIMETRIC ASSESSMENT

### 4.1 Measurement Procedure

The evaluation was performed using the following procedure compliant to FCC KDB Publication 865664 D01v01r04 and IEEE 1528-2013:

1. The SAR distribution at the exposed side of the head or body was measured at a distance no greater than 5.0 mm from the inner surface of the shell. The area covered the entire dimension of the device-head and body interface and the horizontal grid resolution was determined per FCC KDB Publication 865664 D01v01r04 (See Table 4-1) and IEEE 1528-2013.
2. The point SAR measurement was taken at the maximum SAR region determined from Step 1 to enable the monitoring of SAR fluctuations/drifts during the 1g/10g cube evaluation. SAR at this fixed point was measured and used as a reference value.
3. Based on the area scan data, the peak of the region with maximum SAR was determined by spline interpolation. Around this point, a volume was assessed according to the measurement resolution and volume size requirements of FCC KDB Publication 865664 D01v01r04 (See Table 4-1) and IEEE 1528-2013. On the basis of this data set, the spatial peak SAR value was evaluated with the following procedure (see references or the DASY manual online for more details):
  - a. SAR values at the inner surface of the phantom are extrapolated from the measured values along the line away from the surface with spacing no greater than that in Table 4-1. The extrapolation was based on a least-squares algorithm. A polynomial of the fourth order was calculated through the points in the z-axis (normal to the phantom shell).
  - b. After the maximum interpolated values were calculated between the points in the cube, the SAR was averaged over the spatial volume (1g or 10g) using a 3D-Spline interpolation algorithm. The 3D-spline is composed of three one-dimensional splines with the “Not a knot” condition (in x, y, and z directions). The volume was then integrated with the trapezoidal algorithm. One thousand points (10 x 10 x 10) were obtained through interpolation, in order to calculate the averaged SAR.
  - c. All neighboring volumes were evaluated until no neighboring volume with a higher average value was found.
4. The SAR reference value, at the same location as step 2, was re-measured after the zoom scan was complete to calculate the SAR drift. If the drift deviated by more than 5%, the SAR test and drift measurements were repeated.

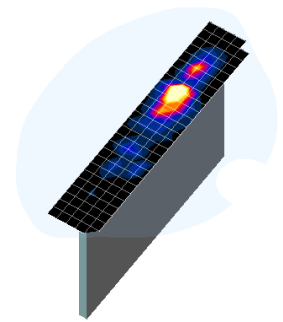



**Figure 4-1**  
Sample SAR Area Scan

**Table 4-1**  
Area and Zoom Scan Resolutions per FCC KDB Publication 865664 D01v01r04\*

Frequency	Maximum Area Scan Resolution (mm) ( $\Delta x_{\text{area}}, \Delta y_{\text{area}}$ )	Maximum Zoom Scan Resolution (mm) ( $\Delta x_{\text{zoom}}, \Delta y_{\text{zoom}}$ )	Maximum Zoom Scan Spatial Resolution (mm)			Minimum Zoom Scan Volume (mm) (x, y, z)
			Uniform Grid	Graded Grid		
				$\Delta z_{\text{zoom}}(n)$	$\Delta z_{\text{zoom}}(1)^*$	
≤ 2 GHz	≤ 15	≤ 8	≤ 5	≤ 4	≤ 1.5* $\Delta z_{\text{zoom}}(n-1)$	≥ 30
2-3 GHz	≤ 12	≤ 5	≤ 5	≤ 4	≤ 1.5* $\Delta z_{\text{zoom}}(n-1)$	≥ 30
3-4 GHz	≤ 12	≤ 5	≤ 4	≤ 3	≤ 1.5* $\Delta z_{\text{zoom}}(n-1)$	≥ 28
4-5 GHz	≤ 10	≤ 4	≤ 3	≤ 2.5	≤ 1.5* $\Delta z_{\text{zoom}}(n-1)$	≥ 25
5-6 GHz	≤ 10	≤ 4	≤ 2	≤ 2	≤ 1.5* $\Delta z_{\text{zoom}}(n-1)$	≥ 22

\*Also compliant to IEEE 1528-2013 Table 6

FCC ID: ZNFX320PM	 <b>SAR EVALUATION REPORT</b> 		Approved by: Quality Manager
Document S/N: 1M1907220127-01.ZNF	Test Dates: 07/22/19 - 08/12/19	DUT Type: Portable Handset	Page 13 of 91

## 5 DEFINITION OF REFERENCE POINTS

### 5.1 EAR REFERENCE POINT

Figure 5-2 shows the front, back and side views of the SAM Twin Phantom. The point “M” is the reference point for the center of the mouth, “LE” is the left ear reference point (ERP), and “RE” is the right ERP. The ERP is 15mm posterior to the entrance to the ear canal (EEC) along the B-M line (Back-Mouth), as shown in Figure 5-1. The plane passing through the two ear canals and M is defined as the Reference Plane. The line N-F (Neck-Front), also called the Reference Pivoting Line, is not perpendicular to the reference plane (see Figure 5-1). Line B-M is perpendicular to the N-F line. Both N-F and B-M lines are marked on the external phantom shell to facilitate handset positioning [5].

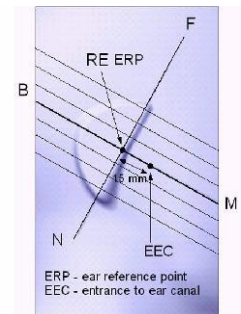

**Figure 5-1**  
Close-Up Side view  
of ERP

### 5.2 HANDSET REFERENCE POINTS



Two imaginary lines on the handset were established: the vertical centerline and the horizontal line. The test device was placed in a normal operating position with the acoustic output located along the “vertical centerline” on the front of the device aligned to the “ear reference point” (See Figure 5-3). The acoustic output was then located at the same level as the center of the ear reference point. The test device was positioned so that the “vertical centerline” was bisecting the front surface of the handset at its top and bottom edges, positioning the “ear reference point” on the outer surface of the both the left and right head phantoms on the ear reference point.

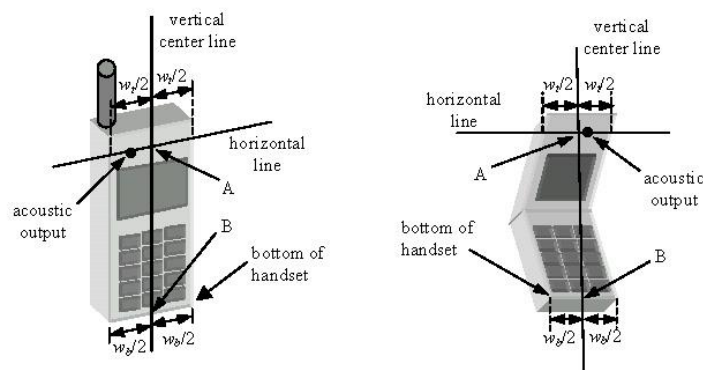

**Figure 5-2**  
Front, back and side view of SAM Twin Phantom



**Figure 5-3**  
Handset Vertical Center & Horizontal Line Reference Points

FCC ID: ZNFX320PM		SAR EVALUATION REPORT		Approved by: Quality Manager
Document S/N: 1M1907220127-01.ZNF	Test Dates: 07/22/19 - 08/12/19	DUT Type: Portable Handset		Page 14 of 91

## 6 TEST CONFIGURATION POSITIONS

### 6.1 Device Holder

The device holder is made out of low-loss POM material having the following dielectric parameters: relative permittivity  $\epsilon = 3$  and loss tangent  $\delta = 0.02$ .

### 6.2 Positioning for Cheek

1. The test device was positioned with the device close to the surface of the phantom such that point A is on the (virtual) extension of the line passing through points RE and LE on the phantom (see Figure 6-1), such that the plane defined by the vertical center line and the horizontal line of the phone is approximately parallel to the sagittal plane of the phantom.

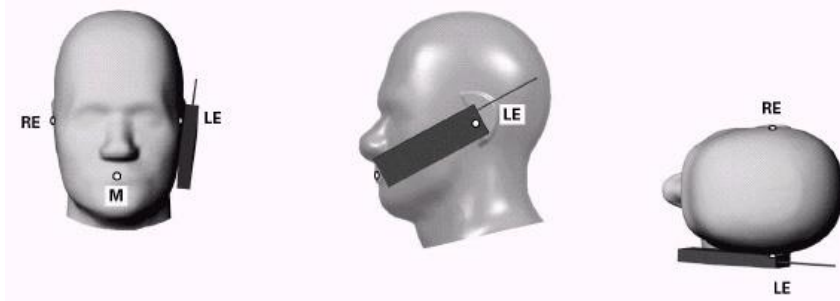



Figure 6-1 Front, Side and Top View of Cheek Position

2. The handset was translated towards the phantom along the line passing through RE & LE until the handset touches the pinna.
3. While maintaining the handset in this plane, the handset was rotated around the LE-RE line until the vertical centerline was in the reference plane.
4. The phone was then rotated around the vertical centerline until the phone (horizontal line) was symmetrical with respect to the line NF.
5. While maintaining the vertical centerline in the reference plane, keeping point A on the line passing through RE and LE, and maintaining the device contact with the ear, the device was rotated about the NF line until any point on the handset made contact with a phantom point below the ear (cheek) (See Figure 6-2).

### 6.3 Positioning for Ear / 15° Tilt

With the test device aligned in the “Cheek Position”:

1. While maintaining the orientation of the phone, the phone was retracted parallel to the reference plane far enough to enable a rotation of the phone by 15 degrees.
2. The phone was then rotated around the horizontal line by 15 degrees.
3. While maintaining the orientation of the phone, the phone was moved parallel to the reference plane until any part of the handset touched the head. (In this position, point A was located on the line RE-LE). The tilted position is obtained when the contact is on the pinna. If the contact was at any location other than the pinna, the angle of the phone would then be reduced. In this situation, the tilted position was obtained when any part of the phone was in contact of the ear as well as a second part of the phone was in contact with the head (see Figure 6-2).

FCC ID: ZNFX320PM	 <b>SAR EVALUATION REPORT</b> 		Approved by: Quality Manager
Document S/N: 1M1907220127-01.ZNF	Test Dates: 07/22/19 - 08/12/19	DUT Type: Portable Handset	Page 15 of 91



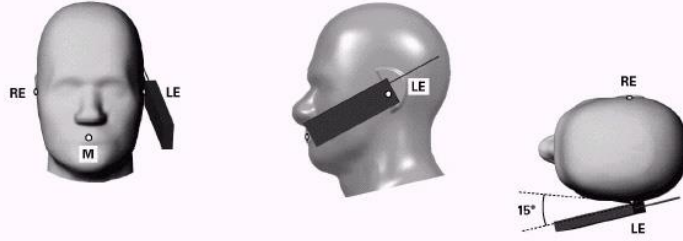

**Figure 6-2 Front, Side and Top View of Ear/15° Tilt Position**

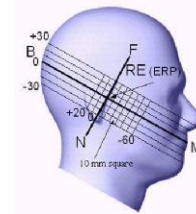

**Figure 6-3 Side view w/ relevant markings**

## 6.4 SAR Evaluations near the Mouth/Jaw Regions of the SAM Phantom

Antennas located near the bottom of a phone may require SAR measurements around the mouth and jaw regions of the SAM head phantom. This typically applies to clam-shell style phones that are generally longer in the unfolded normal use positions or to certain older style long rectangular phones. Per IEEE 1528-2013, a rotated SAM phantom is necessary to allow probe access to such regions. Both SAM heads of the TwinSAM-Chin20 are rotated 20 degrees around the NF line. Each head can be removed from the table for emptying and cleaning.

Under these circumstances, the following procedures apply, adopted from the FCC guidance on SAR handsets document FCC KDB Publication 648474 D04v01r03. The SAR required in these regions of SAM should be measured using a flat phantom. The phone should be positioned with a separation distance of 4 mm between the ear reference point (ERP) and the outer surface of the flat phantom shell. While maintaining this distance at the ERP location, the low (bottom) edge of the phone should be lowered from the phantom to establish the same separation distance between the peak SAR location identified by the truncated partial SAR distribution measured with the SAM phantom. The distance from the peak SAR location to the phone is determined by the straight line passing perpendicularly through the phantom surface. When it is not feasible to maintain 4 mm separation at the ERP while also establishing the required separation at the peak SAR location, the top edge of the phone will be allowed to touch the phantom with a separation < 4 mm at the ERP. The phone should not be tilted to the left or right while placed in this inclined position to the flat phantom.

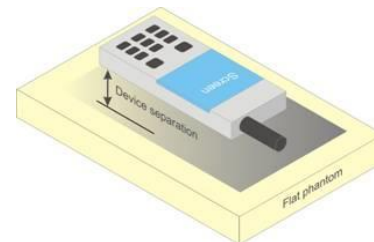

## 6.5 Body-Worn Accessory Configurations

Body-worn operating configurations are tested with the belt-clips and holsters attached to the device and positioned against a flat phantom in a normal use configuration (see Figure 6-4). Per FCC KDB Publication 648474 D04v01r03, Body-worn accessory exposure is typically related to voice mode operations when handsets are carried in body-worn accessories. The body-worn accessory procedures in FCC KDB Publication 447498 D01v06 should be used to test for body-worn accessory SAR compliance, without a headset connected to it. This enables the test results for such configuration to be compatible with that required for hotspot mode when the body-worn accessory test separation distance is greater than or equal to that required for hotspot mode, when applicable. When the reported SAR for a body-worn accessory, measured without a headset connected to the handset, is > 1.2 W/kg, the highest reported SAR configuration for that wireless mode and frequency band should be repeated for that body-worn accessory with a headset attached to the handset.



**Figure 6-4 Sample Body-Worn Diagram**

Accessories for Body-worn operation configurations are divided into two categories: those that do not contain metallic components and those that do contain metallic components. When multiple accessories that do not

FCC ID: ZNFX320PM	 PCTEST ENGINEERING LABORATORY, INC.	SAR EVALUATION REPORT	 LG	Approved by: Quality Manager
Document S/N: 1M1907220127-01.ZNF	Test Dates: 07/22/19 - 08/12/19	DUT Type: Portable Handset		Page 16 of 91



contain metallic components are supplied with the device, the device is tested with only the accessory that dictates the closest spacing to the body. Then multiple accessories that contain metallic components are tested with the device with each accessory. If multiple accessories share an identical metallic component (i.e. the same metallic belt-clip used with different holsters with no other metallic components) only the accessory that dictates the closest spacing to the body is tested.

Body-worn accessories may not always be supplied or available as options for some devices intended to be authorized for body-worn use. In this case, a test configuration with a separation distance between the back of the device and the flat phantom is used. Test position spacing was documented. Transmitters that are designed to operate in front of a person's face, as in push-to-talk configurations, are tested for SAR compliance with the front of the device positioned to face the flat phantom in head fluid. For devices that are carried next to the body such as a shoulder, waist or chest-worn transmitters, SAR compliance is tested with the accessories, including headsets and microphones, attached to the device and positioned against a flat phantom in a normal use configuration.

## 6.6 Extremity Exposure Configurations



Devices that are designed or intended for use on extremities or mainly operated in extremity only exposure conditions; i.e., hands, wrists, feet and ankles, may require extremity SAR evaluation. When the device also operates in close proximity to the user's body, SAR compliance for the body is also required. The 1g body and 10g extremity SAR Exclusion Thresholds found in KDB Publication 447498 D01v06 should be applied to determine SAR test requirements.

Per KDB Publication 447498 D01v06, Cell phones (handsets) are not normally designed to be used on extremities or operated in extremity only exposure conditions. The maximum output power levels of handsets generally do not require extremity SAR testing to show compliance. Therefore, extremity SAR was not evaluated for this device.

## 6.7 Wireless Router Configurations

Some battery-operated handsets have the capability to transmit and receive user data through simultaneous transmission of WIFI simultaneously with a separate licensed transmitter. The FCC has provided guidance in FCC KDB Publication 941225 D06v02r01 where SAR test considerations for handsets ( $L \times W \geq 9 \text{ cm} \times 5 \text{ cm}$ ) are based on a composite test separation distance of 10 mm from the front, back and edges of the device containing transmitting antennas within 2.5 cm of their edges, determined from general mixed use conditions for this type of devices. Since the hotspot SAR results may overlap with the body-worn accessory SAR requirements, the more conservative configurations can be considered, thus excluding some body-worn accessory SAR tests.

When the user enables the personal wireless router functions for the handset, actual operations include simultaneous transmission of both the WIFI transmitter and another licensed transmitter. Both transmitters often do not transmit at the same transmitting frequency and thus cannot be evaluated for SAR under actual use conditions due to the limitations of the SAR assessment probes. Therefore, SAR must be evaluated for each frequency transmission and mode separately and spatially summed with the WIFI transmitter according to FCC KDB Publication 447498 D01v06 procedures. The "Portable Hotspot" feature on the handset was NOT activated during SAR assessments, to ensure the SAR measurements were evaluated for a single transmission frequency RF signal at a time.

FCC ID: ZNFX320PM	 <b>SAR EVALUATION REPORT</b> 		<b>Approved by:</b> Quality Manager
<b>Document S/N:</b> 1M1907220127-01.ZNF	<b>Test Dates:</b> 07/22/19 - 08/12/19	<b>DUT Type:</b> Portable Handset	Page 17 of 91

# 7 RF EXPOSURE LIMITS

## 7.1 Uncontrolled Environment

UNCONTROLLED ENVIRONMENTS are defined as locations where there is the exposure of individuals who have no knowledge or control of their exposure. The general population/uncontrolled exposure limits are applicable to situations in which the general public may be exposed or in which persons who are exposed as a consequence of their employment may not be made fully aware of the potential for exposure or cannot exercise control over their exposure. Members of the general public would come under this category when exposure is not employment-related; for example, in the case of a wireless transmitter that exposes persons in its vicinity.



## 7.2 Controlled Environment

CONTROLLED ENVIRONMENTS are defined as locations where there is exposure that may be incurred by persons who are aware of the potential for exposure, (i.e. as a result of employment or occupation). In general, occupational/controlled exposure limits are applicable to situations in which persons are exposed as a consequence of their employment, who have been made fully aware of the potential for exposure and can exercise control over their exposure. This exposure category is also applicable when the exposure is of a transient nature due to incidental passage through a location where the exposure levels may be higher than the general population/uncontrolled limits, but the exposed person is fully aware of the potential for exposure and can exercise control over his or her exposure by leaving the area or by some other appropriate means.

**Table 7-1  
SAR Human Exposure Specified in ANSI/IEEE C95.1-1992 and Health Canada Safety Code 6**

HUMAN EXPOSURE LIMITS		
	UNCONTROLLED ENVIRONMENT <i>General Population (W/kg) or (mW/g)</i>	CONTROLLED ENVIRONMENT <i>Occupational (W/kg) or (mW/g)</i>
<b>Peak Spatial Average SAR</b> Head	1.6	8.0
<b>Whole Body SAR</b>	0.08	0.4
<b>Peak Spatial Average SAR</b> Hands, Feet, Ankle, Wrists, etc.	4.0	20

1. The Spatial Peak value of the SAR averaged over any 1 gram of tissue (defined as a tissue volume in the shape of a cube) and over the appropriate averaging time.
2. The Spatial Average value of the SAR averaged over the whole body.
3. The Spatial Peak value of the SAR averaged over any 10 grams of tissue (defined as a tissue volume in the shape of a cube) and over the appropriate averaging time.

FCC ID: ZNFX320PM	 PCTEST ENGINEERING LABORATORY, INC.	SAR EVALUATION REPORT	 LG	Approved by: Quality Manager
Document S/N: 1M1907220127-01.ZNF	Test Dates: 07/22/19 - 08/12/19	DUT Type: Portable Handset		Page 18 of 91

Power measurements for licensed transmitters are performed using a base station simulator under digital average power.

### 8.1 Measured and Reported SAR

Per FCC KDB Publication 447498 D01v06, when SAR is not measured at the maximum power level allowed for production units, the results must be scaled to the maximum tune-up tolerance limit according to the power applied to the individual channels tested to determine compliance. For simultaneous transmission, the measured aggregate SAR must be scaled according to the sum of the differences between the maximum tune-up tolerance and actual power used to test each transmitter. When SAR is measured at or scaled to the maximum tune-up tolerance limit, the results are referred to as *reported* SAR. The highest *reported* SAR results are identified on the grant of equipment authorization according to procedures in KDB 690783 D01v01r03.

### 8.2 3G SAR Test Reduction Procedure

In FCC KDB Publication 941225 D01v03r01, certain transmission modes within a frequency band and wireless mode evaluated for SAR are defined as primary modes. The equivalent modes considered for SAR test reduction are denoted as secondary modes. When the maximum output power including tune-up tolerance specified for production units in a secondary mode is  $\leq 0.25$  dB higher than the primary mode or when the highest reported SAR of the primary mode, scaled by the ratio of specified maximum output power and tune-up tolerance of secondary to primary mode, is  $\leq 1.2$  W/kg, SAR measurements are not required for the secondary mode. These criteria are referred to as the 3G SAR test reduction procedure. When the 3G SAR test reduction procedure is not satisfied, SAR measurements are additionally required for the secondary mode.

### 8.3 Procedures Used to Establish RF Signal for SAR

The following procedures are according to FCC KDB Publication 941225 D01v03r01 “3G SAR Measurement Procedures.”



The device is placed into a simulated call using a base station simulator in a RF shielded chamber. Establishing connections in this manner ensure a consistent means for testing SAR and are recommended for evaluating SAR [4]. Devices under test are evaluated prior to testing, with a fully charged battery and were configured to operate at maximum output power. In order to verify that the device is tested throughout the SAR test at maximum output power, the SAR measurement system measures a “point SAR” at an arbitrary reference point at the start and end of the 1 gram SAR evaluation, to assess for any power drifts during the evaluation. If the power drift deviates by more than 5%, the SAR test and drift measurements are repeated.

### 8.4 SAR Measurement Conditions for CDMA2000

The following procedures were performed according to FCC KDB Publication 941225 D01v03r01 “3G SAR Measurement Procedures.”

#### 8.4.1 Output Power Verification

See 3GPP2 C.S0011/TIA-98-E as recommended by FCC KDB Publication 941225 D01v03r01 “3G SAR Measurement Procedures.” Maximum output power is verified on the High, Middle and Low channels according to procedures in section 4.4.5.2 of 3GPP2 C.S0011/TIA-98-E. SO55 tests were measured with power control bits in the “All Up” condition.

FCC ID: ZNFX320PM			SAR EVALUATION REPORT		Approved by: Quality Manager
Document S/N: 1M1907220127-01.ZNF	Test Dates: 07/22/19 - 08/12/19	DUT Type: Portable Handset	Page 19 of 91		

1. If the mobile station (MS) supports Reverse TCH RC 1 and Forward TCH RC 1, set up a call using Fundamental Channel Test Mode 1 (RC=1/1) with 9600 bps data rate only.
2. Under RC1, C.S0011 Table 4.4.5.2-1, Table 8-1 parameters were applied.
3. If the MS supports the RC 3 Reverse FCH, RC3 Reverse SCH<sub>0</sub> and demodulation of RC 3,4, or 5, set up a call using Supplemental Channel Test Mode 3 (RC 3/3) with 9600 bps Fundamental Channel and 9600 bps SCH<sub>0</sub> data rate.
4. Under RC3, C.S0011 Table 4.4.5.2-2, Table 8-2 was applied.

**Table 8-1**  
**Parameters for Max. Power for RC1**

Parameter	Units	Value
$I_{or}$	dBm/1.23 MHz	-104
$\frac{Pilot E_c}{I_{or}}$	dB	-7
$\frac{Traffic E_c}{I_{or}}$	dB	-7.4

**Table 8-2**  
**Parameters for Max. Power for RC3**

Parameter	Units	Value
$I_{or}$	dBm/1.23 MHz	-86
$\frac{Pilot E_c}{I_{or}}$	dB	-7
$\frac{Traffic E_c}{I_{or}}$	dB	-7.4

5. FCHs were configured at full rate for maximum SAR with “All Up” power control bits.

## 8.4.2 Head SAR Measurements

SAR for next to the ear head exposure is measured in RC3 with the handset configured to transmit at fullrate in SO55. The 3G SAR test reduction procedure is applied to RC1 with RC3 as the primary mode; otherwise, SAR is required for the channel with maximum measured output in RC1 using the head exposure configuration that results in the highest reported SAR in RC3.

Head SAR is additionally evaluated using EVDO Rev. A to support compliance for VoIP operations. See Section 8.4.5 for EVDO Rev. A configuration parameters.

## 8.4.3 Body-worn SAR Measurements



SAR for body-worn exposure configurations is measured in RC3 with the DUT configured to transmit at full rate on FCH with all other code channels disabled using TDSO / SO32. The 3G SAR test reduction procedure is applied to the multiple code channel configuration (FCH+SCH<sub>n</sub>), with FCH only as the primary mode. Otherwise, SAR is required for multiple code channel configuration (FCH + SCH<sub>n</sub>), with FCH at full rate and SCH<sub>0</sub> enabled at 9600 bps, using the highest reported SAR configuration for FCH only. When multiple code channels are enabled, the transmitter output can shift by more than 0.5 dB and may lead to higher SAR drifts and SCH dropouts.

The 3G SAR test reduction procedure is applied to body-worn accessory SAR in RC1 with RC3 as the primary mode. Otherwise, SAR is required for RC1, with SO55 and full rate, using the highest reported SAR configuration for body-worn accessory exposure in RC3.

## 8.4.4 Body-worn SAR Measurements for EVDO Devices

For handsets with EVDO capabilities, the 3G SAR test reduction procedure is applied to EVDO Rev. 0 with 1x RTT RC3 as the primary mode to determine body-worn accessory test requirements. Otherwise, body-worn accessory SAR is required for Rev. 0, at 153.6 kbps, using the highest reported SAR configuration for body-worn accessory exposure in RC3.

The 3G SAR test reduction procedure is applied to Rev. A, with Rev. 0 as the primary mode to determine body-worn accessory SAR test requirements. When SAR is not required for Rev. 0, the 3G SAR test reduction is applied with 1x RTT RC3 as the primary mode.

FCC ID: ZNFX320PM	 PCTEST ENGINEERING LABORATORY, INC.	SAR EVALUATION REPORT	 LG	Approved by: Quality Manager
Document S/N: 1M1907220127-01.ZNF	Test Dates: 07/22/19 - 08/12/19	DUT Type: Portable Handset		Page 20 of 91

When SAR is required for EVDO Rev. A, SAR is measured with a Reverse Data Channel payload size of 4096 bits and a Termination Target of 16 slots defined for Subtype 2 Physical Layer configurations, using the highest reported SAR configuration for body-worn accessory exposure in Rev. 0 or 1x RTT RC3, as appropriate.

### 8.4.5 Body SAR Measurements for EVDO Hotspot

Hotspot Body SAR is measured using Subtype 0/1 Physical Layer configurations for Rev. 0. The 3G SAR test reduction procedure is applied to Rev. A, Subtype 2 Physical layer configuration, with Rev. 0 as the primary mode; otherwise, SAR is measured for Rev. A using the highest reported SAR configuration for body-worn accessory exposure in Rev. 0. The AT is tested with a Reverse Data Channel rate of 153.6 kbps in Subtype 0/1 Physical Layer configurations; and a Reverse Data Channel payload size of 4096 bits and Termination Target of 16 slots in Subtype 2 Physical Layer configurations.

For EVDO data devices that also support 1x RTT voice and/or data operations, the 3G SAR test reduction procedure is applied to 1x RTT RC3 and RC1 with EVDO Rev. 0 and Rev. A as the respective primary modes. Otherwise, the 'Body-Worn Accessory SAR' procedures in the '3GPP2 CDMA 2000 1x Handsets' section are applied.

## 8.5 SAR Measurement Conditions for UMTS

### 8.5.1 Output Power Verification



Maximum output power is verified on the High, Middle and Low channels according to the general descriptions in section 5.2 of 3GPP TS 34.121, using the appropriate RMC with TPC (transmit power control) set to all "1s" or applying the required inner loop power control procedures to maintain maximum output power while HSUPA is active. Results for all applicable physical channel configurations (DPCCH, DPDCH<sub>n</sub> and spreading codes, HS-DPCCH etc) are tabulated in this test report. All configurations that are not supported by the DUT or cannot be measured due to technical or equipment limitations are identified.

### 8.5.2 Head SAR Measurements

SAR for next to the ear head exposure is measured using a 12.2 kbps RMC with TPC bits configured to all "1s". The 3G SAR test reduction procedure is applied to AMR configurations with 12.2 kbps RMC as the primary mode. Otherwise, SAR is measured for 12.2 kbps AMR in 3.4 kbps SRB (signaling radio bearer) using the highest reported SAR configuration in 12.2 kbps RMC for head exposure.

### 8.5.3 Body SAR Measurements

SAR for body exposure configurations is measured using the 12.2 kbps RMC with the TPC bits all "1s". The 3G SAR test reduction procedure is applied to other spreading codes and multiple DPDCH<sub>n</sub> configurations supported by the handset with 12.2 kbps RMC as the primary mode. Otherwise, SAR is measured using an applicable RMC configuration with the corresponding spreading code or DPDCH<sub>n</sub>, for the highest reported SAR configuration in 12.2 kbps RMC.

FCC ID: ZNFX320PM	 <b>SAR EVALUATION REPORT</b> 		<b>Approved by:</b> Quality Manager
<b>Document S/N:</b> 1M1907220127-01.ZNF	<b>Test Dates:</b> 07/22/19 - 08/12/19	<b>DUT Type:</b> Portable Handset	Page 21 of 91



### 8.5.4 SAR Measurements with Rel 5 HSDPA

The 3G SAR test reduction procedure is applied to HSDPA body configurations with 12.2 kbps RMC as the primary mode. Otherwise, Body SAR for HSDPA is measured using an FRC with H-Set 1 in Sub-test 1 and a 12.2 kbps RMC configured in Test Loop Mode 1, for the highest reported SAR configuration in 12.2 kbps RMC without HSDPA. Handsets with both HSDPA and HSUPA are tested according to Release 6 HSPA test procedures.

### 8.5.5 SAR Measurements with Rel 6 HSUPA

The 3G SAR test reduction procedure is applied to HSPA (HSUPA/HSDPA with RMC) body configurations with 12.2 kbps RMC as the primary mode. Otherwise, Body SAR for HSPA is measured with E-DCH Sub-test 5, using H-Set 1 and QPSK for FRC and a 12.2 kbps RMC configured in Test Loop Mode 1 and power control algorithm 2, according to the highest reported body SAR configuration in 12.2 kbps RMC without HSPA.

When VOIP applies to head exposure, the 3G SAR test reduction procedure is applied with 12.2 kbps RMC as the primary mode; otherwise, the same HSPA configuration used for body SAR measurements are applied to head exposure testing.

## 8.6 SAR Measurement Conditions for LTE

LTE modes are tested according to FCC KDB 941225 D05v02r04 publication. Establishing connections with base station simulators ensure a consistent means for testing SAR and are recommended for evaluating SAR [4]. The R&S CMW500 or Anritsu MT8820C simulators are used for LTE output power measurements and SAR testing. Closed loop power control was used so the UE transmits with maximum output power during SAR testing. SAR tests were performed with the same number of RB and RB offsets transmitting on all TTI frames (maximum TTI).

### 8.6.1 Spectrum Plots for RB Configurations

A properly configured base station simulator was used for SAR tests and power measurements. Therefore, spectrum plots for RB configurations were not required to be included in this report.

### 8.6.2 MPR

MPR is permanently implemented for this device by the manufacturer. The specific manufacturer target MPR is indicated alongside the SAR results. MPR is enabled for this device, according to 3GPP TS36.101 Section 6.2.3 – 6.2.5 under Table 6.2.3-1.



### 8.6.3 A-MPR

A-MPR (Additional MPR) has been disabled for all SAR tests by setting NS=01 on the base station simulator.

### 8.6.4 Required RB Size and RB Offsets for SAR Testing

According to FCC KDB 941225 D05v02r04:

- a. Per Section 5.2.1, SAR is required for QPSK 1 RB Allocation for the largest bandwidth
  - i. The required channel and offset combination with the highest maximum output power is required for SAR.

FCC ID: ZNFX320PM	 PCTEST ENGINEERING LABORATORY, INC.	SAR EVALUATION REPORT	 LG	Approved by: Quality Manager
Document S/N: 1M1907220127-01.ZNF	Test Dates: 07/22/19 - 08/12/19	DUT Type: Portable Handset		Page 22 of 91

- ii. When the reported SAR is  $\leq 0.8$  W/kg, testing of the remaining RB offset configurations and required test channels is not required. Otherwise, SAR is required for the remaining required test channels using the RB offset configuration with highest output power for that channel.
- iii. When the reported SAR for a required test channel is  $> 1.45$  W/kg, SAR is required for all RB offset configurations for that channel.
- b. Per Section 5.2.2, SAR is required for 50% RB allocation using the largest bandwidth following the same procedures outlined in Section 5.2.1.
- c. Per Section 5.2.3, QPSK SAR is not required for the 100% allocation when the highest maximum output power for the 100% allocation is less than the highest maximum output power of the 1 RB and 50% RB allocations and the reported SAR for the 1 RB and 50% RB allocations is  $< 0.8$  W/kg.
- d. Per Section 5.2.4 and 5.3, SAR tests for higher order modulations and lower bandwidths configurations are not required when the conducted power of the required test configurations determined by Sections 5.2.1 through 5.2.3 is less than or equal to  $\frac{1}{2}$  dB higher than the equivalent configuration using QPSK modulation and when the QPSK SAR for those configurations is  $< 1.45$  W/kg.

### 8.6.5 TDD

LTE TDD testing is performed using the SAR test guidance provided in FCC KDB 941225 D05v02r04. TDD is tested at the highest duty factor using UL-DL configuration 0 with special subframe configuration 6 and applying the FDD LTE procedures in KDB 941225 D05v02r04. SAR testing is performed using the extended cyclic prefix listed in 3GPP TS 36.211 Section 4.

### 8.6.6 Downlink Only Carrier Aggregation



Conducted power measurements with LTE Carrier Aggregation (CA) (downlink only) active are made in accordance to KDB Publication 941225 D05Av01r02. The RRC connection is only handled by one cell, the primary component carrier (PCC) for downlink and uplink communications. After making a data connection to the PCC, the UE device adds secondary component carrier(s) (SCC) on the downlink only. All uplink communications and acknowledgements remain identical to specifications when downlink carrier aggregation is inactive on the PCC. Additional conducted output powers are measured with the downlink carrier aggregation active for the configuration with highest measured maximum conducted power with downlink carrier aggregation inactive measured among the channel bandwidth, modulation, and RB combinations in each frequency band. Per FCC KDB Publication 941225 D05Av01r02, no SAR measurements are required for downlink only carrier aggregation configurations when the average output power with downlink only carrier aggregation active is not more than 0.25 dB higher than the average output power with downlink only carrier aggregation inactive.

## 8.7 SAR Testing with 802.11 Transmitters

The normal network operating configurations of 802.11 transmitters are not suitable for SAR measurements. Unpredictable fluctuations in network traffic and antenna diversity conditions can introduce undesirable variations in SAR results. The SAR for these devices should be measured using chipset based test mode software to ensure the results are consistent and reliable. See KDB Publication 248227 D01v02r02 for more details.

### 8.7.1 General Device Setup

Chipset based test mode software is hardware dependent and generally varies among manufacturers. The device operating parameters established in test mode for SAR measurements must be identical to those programmed in production units, including output power levels, amplifier gain settings and other RF performance tuning parameters.

FCC ID: ZNFX320PM		SAR EVALUATION REPORT		Approved by: Quality Manager
Document S/N: 1M1907220127-01.ZNF	Test Dates: 07/22/19 - 08/12/19	DUT Type: Portable Handset	Page 23 of 91	

A periodic duty factor is required for current generation SAR systems to measure SAR. When 802.11 frame gaps are accounted for in the transmission, a maximum transmission duty factor of 92 - 96% is typically achievable in most test mode configurations. A minimum transmission duty factor of 85% is required to avoid certain hardware and device implementation issues related to wide range SAR scaling. The reported SAR is scaled to 100% transmission duty factor to determine compliance at the maximum tune-up tolerance limit.

### 8.7.2 Initial Test Position Procedure

For exposure conditions with multiple test positions, such as handset operating next to the ear, devices with hotspot mode or UMPC mini-tablet, procedures for initial test position can be applied. Using the transmission mode determined by the DSSS procedure or initial test configuration, area scans are measured for all positions in an exposure condition. The test position with the highest extrapolated (peak) SAR is used as the initial test position. When reported SAR for the initial test position is  $\leq 0.4$  W/kg, no additional testing for the remaining test positions is required. Otherwise, SAR is evaluated at the subsequent highest peak SAR positions until the reported SAR result is  $\leq 0.8$  W/kg or all test positions are measured.

### 8.7.3 2.4 GHz SAR Test Requirements

SAR is measured for 2.4 GHz 802.11b DSSS using either the fixed test position or, when applicable, the initial test position procedure. SAR test reduction is determined according to the following:

- 1) When the reported SAR of the highest measured maximum output power channel for the exposure configuration is  $\leq 0.8$  W/kg, no further SAR testing is required for 802.11b DSSS in that exposure configuration.
- 2) When the reported SAR is  $> 0.8$  W/kg, SAR is required for that position using the next highest measured output power channel. When any reported SAR is  $> 1.2$  W/kg, SAR is required for the third channel; i.e., all channels require testing.



2.4 GHz 802.11 g/n OFDM are additionally evaluated for SAR if the highest reported SAR for 802.11b, adjusted by the ratio of the OFDM to DSSS specified maximum output power, is  $> 1.2$  W/kg. When SAR is required for OFDM modes in 2.4 GHz band, the Initial Test Configuration Procedures should be followed.

### 8.7.4 OFDM Transmission Mode and SAR Test Channel Selection

When the same maximum output power was specified for multiple OFDM transmission mode configurations in a frequency band or aggregated band, SAR is measured using the configuration with the largest channel bandwidth, lowest order modulation and lowest data rate. When the maximum output power of a channel is the same for equivalent OFDM configurations; for example, 802.11g and 802.11n with the same channel bandwidth, modulation and data rate etc., the lower order 802.11 mode i.e., 802.11g then 802.11n, is used for SAR measurement. When the maximum output power are the same for multiple test channels, either according to the default or additional power measurement requirements, SAR is measured using the channel closest to the middle of the frequency band or aggregated band. When there are multiple channels with the same maximum output power, SAR is measured using the higher number channel.

### 8.7.5 Initial Test Configuration Procedure

For OFDM, an initial test configuration is determined for each frequency band and aggregated band, according to the transmission mode with the highest maximum output power specified for SAR measurements. When the same maximum output power is specified for multiple OFDM transmission mode configurations in a frequency band or aggregated band, SAR is measured using the configuration(s) with the largest channel bandwidth, lowest order modulation, lowest data rate and lowest order IEEE 802.11 mode.

FCC ID: ZNFX320PM	 PCTEST ENGINEERING LABORATORY, INC.	SAR EVALUATION REPORT	 LG	Approved by: Quality Manager
Document S/N: 1M1907220127-01.ZNF	Test Dates: 07/22/19 - 08/12/19	DUT Type: Portable Handset	Page 24 of 91	





The channel of the transmission mode with the highest average RF output conducted power will be the initial test configuration.

When the reported SAR is  $\leq 0.8$  W/kg, no additional measurements on other test channels are required. Otherwise, SAR is evaluated using the subsequent highest average RF output channel until the reported SAR result is  $\leq 1.2$  W/kg or all channels are measured. When there are multiple untested channels having the same subsequent highest average RF output power, the channel with higher frequency from the lowest 802.11 mode is considered for SAR measurements (See Section 8.7.4).

### 8.7.6 Subsequent Test Configuration Procedures

For OFDM configurations in each frequency band and aggregated band, SAR is evaluated for initial test configuration using the fixed test position or the initial test position procedure. When the highest reported SAR (for the initial test configuration), adjusted by the ratio of the specified maximum output power of the subsequent test configuration to initial test configuration, is  $\leq 1.2$  W/kg, no additional SAR tests for the subsequent test configurations are required.

FCC ID: ZNFX320PM	 <b>SAR EVALUATION REPORT</b>		 <b>Approved by:</b> Quality Manager
Document S/N: 1M1907220127-01.ZNF	Test Dates: 07/22/19 - 08/12/19	DUT Type: Portable Handset	Page 25 of 91

# 9 RF CONDUCTED POWERS

## 9.1 CDMA Conducted Powers



**Table 9-1  
Maximum Conducted Power**

Band	Channel	Rule Part	Frequency	Loopback		Data			
				SO55 [dBm]	SO55 [dBm]	TDSO SO32 [dBm]	TDSO SO32 [dBm]	1x EvDO Rev. 0 [dBm]	1x EvDO Rev. A [dBm]
	F-RC		MHz	RC1	RC3	FCH+SCH	FCH	(RTAP)	(RETAP)
Cellular	564	90S	820.1	25.05	25.12	24.11	25.12	25.01	24.98
Cellular	1013	22H	824.7	25.10	25.14	24.13	25.15	25.05	25.02
	384	22H	836.52	25.08	25.13	24.13	25.15	25.05	25.02
	777	22H	848.31	25.07	25.10	24.09	25.12	25.02	24.99
PCS	25	24E	1851.25	24.45	24.52	23.52	24.51	24.57	24.52
	600	24E	1880	24.50	24.57	23.57	24.57	24.54	24.49
	1175	24E	1908.75	24.53	24.60	23.61	24.59	24.56	24.52

Note: RC1 is only applicable for IS-95 compatibility. For FCC Rule Part 90S, Per FCC KDB Publication 447498 D01v06 4.1.g), only one channel is required since the device operates within the transmission range of 817.90 – 823.10 MHz.



**Figure 9-1  
Power Measurement Setup**

FCC ID: ZNFX320PM		SAR EVALUATION REPORT		Approved by: Quality Manager
Document S/N: 1M1907220127-01.ZNF	Test Dates: 07/22/19 - 08/12/19	DUT Type: Portable Handset	Page 26 of 91	



## 9.2 GSM Conducted Powers

**Table 9-2  
Maximum Conducted Power**

Maximum Burst-Averaged Output Power						
Band	Channel	Voice	GPRS/EDGE Data (GMSK)		EDGE Data (8-PSK)	
		GSM [dBm] CS (1 Slot)	GPRS [dBm] 1 Tx Slot	GPRS [dBm] 2 Tx Slot	EDGE [dBm] 1 Tx Slot	EDGE [dBm] 2 Tx Slot
GSM 850	128	33.46	33.47	<b>30.78</b>	26.50	26.41
	190	33.48	33.49	<b>30.85</b>	26.48	26.50
	251	33.47	33.48	<b>30.88</b>	26.50	26.44
GSM 1900	512	30.51	30.50	<b>27.59</b>	25.30	25.15
	661	30.37	30.35	<b>27.62</b>	25.29	25.14
	810	30.10	30.08	<b>27.61</b>	25.38	25.22

Calculated Maximum Frame-Averaged Output Power						
Band	Channel	Voice	GPRS/EDGE Data (GMSK)		EDGE Data (8-PSK)	
		GSM [dBm] CS (1 Slot)	GPRS [dBm] 1 Tx Slot	GPRS [dBm] 2 Tx Slot	EDGE [dBm] 1 Tx Slot	EDGE [dBm] 2 Tx Slot
GSM 850	128	24.43	24.44	<b>24.76</b>	17.47	20.39
	190	24.45	24.46	<b>24.83</b>	17.45	20.48
	251	24.44	24.45	<b>24.86</b>	17.47	20.42
GSM 1900	512	21.48	21.47	<b>21.57</b>	16.27	19.13
	661	21.34	21.32	<b>21.60</b>	16.26	19.12
	810	21.07	21.05	<b>21.59</b>	16.35	19.20

<b>GSM 850</b>	<b>Frame Avg. Targets:</b>	24.07	24.07	<b>24.48</b>	16.97	19.98
<b>GSM 1900</b>		21.27	21.27	<b>21.48</b>	15.97	18.98

FCC ID: ZNFX320PM		SAR EVALUATION REPORT		Approved by: Quality Manager
Document S/N: 1M1907220127-01.ZNF	Test Dates: 07/22/19 - 08/12/19	DUT Type: Portable Handset		Page 27 of 91



Note:

1. Both burst-averaged and calculated frame-averaged powers are included. Frame-averaged power was calculated from the measured burst-averaged power by converting the slot powers into linear units and calculating the energy over 8 timeslots.
2. GPRS/EDGE (GMSK) output powers were measured with coding scheme setting of 1 (CS1) on the base station simulator. CS1 was configured to measure GPRS output power measurements and SAR to ensure GMSK modulation in the signal. Our Investigation has shown that CS1 - CS4 settings do not have any impact on the output levels or modulation in the GPRS modes.
3. EDGE (8-PSK) output powers were measured with MCS7 on the base station simulator. MCS7 coding scheme was used to measure the output powers for EDGE since investigation has shown that choosing MCS7 coding scheme will ensure 8-PSK modulation. It has been shown that MCS levels that produce 8PSK modulation do not have an impact on output power.

**GSM Class: B**  
**GPRS Multislot class: 10 (Max 2 Tx uplink slots)**  
**EDGE Multislot class: 10 (Max 2 Tx uplink slots)**  
**DTM Multislot Class: N/A**



**Figure 9-2**  
**Power Measurement Setup**

FCC ID: ZNFX320PM	 <b>SAR EVALUATION REPORT</b> 		<b>Approved by:</b> Quality Manager
Document S/N: 1M1907220127-01.ZNF	Test Dates: 07/22/19 - 08/12/19	DUT Type: Portable Handset	Page 28 of 91

### 9.3 UMTS Conducted Powers



**Table 9-3  
Maximum Conducted Power**

3GPP Release Version	Mode	3GPP 34.121 Subtest	Cellular Band [dBm]			AWS Band [dBm]			PCS Band [dBm]			3GPP MPR [dB]
			4132	4183	4233	1312	1412	1513	9262	9400	9538	
99	WCDMA	12.2 kbps RMC	25.21	25.21	25.15	24.78	24.73	24.72	24.76	24.76	24.80	-
99		12.2 kbps AMR	25.20	25.15	25.16	24.80	24.75	24.73	24.80	24.80	24.75	-
6	HSDPA	Subtest 1	25.10	25.15	25.12	24.77	24.73	24.66	24.75	24.80	24.69	0
6		Subtest 2	25.13	25.10	25.12	24.72	24.69	24.66	24.68	24.72	24.74	0
6		Subtest 3	24.80	24.78	24.69	24.22	24.20	24.20	24.30	24.30	24.22	0.5
6		Subtest 4	24.78	24.67	24.68	24.20	24.13	24.08	24.28	24.24	24.20	0.5
6	HSUPA	Subtest 1	22.26	22.20	22.17	21.76	21.70	21.68	21.80	21.79	21.77	2
6		Subtest 2	22.23	22.19	22.19	21.77	21.72	21.67	21.79	21.77	21.74	2
6		Subtest 3	23.26	23.20	23.18	22.80	22.74	22.65	22.80	22.78	22.67	1
6		Subtest 4	21.80	21.75	21.73	21.29	21.22	21.20	21.29	21.30	21.20	2.5
6		Subtest 5	23.23	23.15	23.14	22.79	22.72	22.66	22.78	22.75	22.70	1

This device does not support DC-HSDPA.



**Figure 9-3  
Power Measurement Setup**

FCC ID: ZNFX320PM	 <b>SAR EVALUATION REPORT</b> 		Approved by: Quality Manager
Document S/N: 1M1907220127-01.ZNF	Test Dates: 07/22/19 - 08/12/19	DUT Type: Portable Handset	Page 29 of 91

## 9.4 LTE Conducted Powers



### 9.4.1

### LTE Band 71

Table 9-4  
LTE Band 71 Conducted Powers - 20 MHz Bandwidth

LTE Band 71 20 MHz Bandwidth					
Modulation	RB Size	RB Offset	Mid Channel	MPR Allowed per 3GPP [dB]	MPR [dB]
			133297 (680.5 MHz)		
			Conducted Power [dBm]		
QPSK	1	0	24.84	0	0
	1	50	<b>24.95</b>		0
	1	99	24.65		0
	50	0	23.92	0-1	1
	50	25	<b>24.04</b>		1
	50	50	23.91		1
	100	0	23.91		1
16QAM	1	0	23.94	0-1	1
	1	50	24.13		1
	1	99	23.87		1
	50	0	22.88	0-2	2
	50	25	23.00		2
	50	50	22.86		2
	100	0	22.88		2
64QAM	1	0	23.04	0-2	2
	1	50	23.24		2
	1	99	22.92		2
	50	0	21.93	0-3	3
	50	25	22.06		3
	50	50	21.94		3
	100	0	21.93		3



Note: LTE Band 71 at 20 MHz bandwidth does not support three non-overlapping channels. Per KDB Publication 941225 D05v02, when a device supports overlapping channel assignment in a channel bandwidth configuration, the middle channel of the group of overlapping channels should be selected for testing.

FCC ID: ZNFX320PM	 <b>PCTEST</b> ENGINEERING LABORATORY, INC.	SAR EVALUATION REPORT	 <b>LG</b>	Approved by: Quality Manager
Document S/N: 1M1907220127-01.ZNF	Test Dates: 07/22/19 - 08/12/19	DUT Type: Portable Handset		Page 30 of 91

**Table 9-5  
LTE Band 71 Conducted Powers - 15 MHz Bandwidth**

LTE Band 71 15 MHz Bandwidth					
Modulation	RB Size	RB Offset	Mid Channel	MPR Allowed per 3GPP [dB]	MPR [dB]
			133297 (680.5 MHz)		
			Conducted Power [dBm]		
QPSK	1	0	24.91	0	0
	1	36	24.87		0
	1	74	24.73		0
	36	0	24.00	0-1	1
	36	18	24.01		1
	36	37	23.95		1
	75	0	23.97		1
16QAM	1	0	24.10	0-1	1
	1	36	24.10		1
	1	74	23.90		1
	36	0	23.01	0-2	2
	36	18	23.03		2
	36	37	22.95		2
	75	0	23.00		2
64QAM	1	0	23.18	0-2	2
	1	36	23.13		2
	1	74	22.96		2
	36	0	22.04	0-3	3
	36	18	22.05		3
	36	37	21.97		3
	75	0	22.00		3

Note: LTE Band 71 at 15 MHz bandwidth does not support three non-overlapping channels. Per KDB Publication 941225 D05v02, when a device supports overlapping channel assignment in a channel bandwidth configuration, the middle channel of the group of overlapping channels should be selected for testing.



FCC ID: ZNFX320PM		SAR EVALUATION REPORT		Approved by: Quality Manager
Document S/N: 1M1907220127-01.ZNF	Test Dates: 07/22/19 - 08/12/19	DUT Type: Portable Handset		Page 31 of 91

**Table 9-6**  
**LTE Band 71 Conducted Powers - 10 MHz Bandwidth**

LTE Band 71 10 MHz Bandwidth							
Modulation	RB Size	RB Offset	Low Channel	Mid Channel	High Channel	MPR Allowed per 3GPP [dB]	MPR [dB]
			133172 (668.0 MHz)	133297 (680.5 MHz)	133422 (693.0 MHz)		
			Conducted Power [dBm]				
QPSK	1	0	25.12	24.93	24.78	0	0
	1	25	25.11	24.91	24.93		0
	1	49	24.87	24.77	24.82		0
	25	0	24.03	23.96	23.93	0-1	1
	25	12	24.19	24.01	23.94		1
	25	25	24.15	23.90	23.91		1
16QAM	50	0	24.14	23.95	23.92	0-1	1
	1	0	24.07	24.18	23.99		1
	1	25	24.19	24.08	24.05		1
	1	49	24.02	23.97	24.02	0-2	1
	25	0	23.00	22.97	22.98		2
	25	12	23.18	23.00	22.97		2
64QAM	25	25	23.15	22.96	22.95	0-2	2
	50	0	23.12	22.98	22.96		2
	1	0	23.16	23.13	23.00		0-2
	1	25	23.23	23.14	23.15	2	
	1	49	23.09	23.00	23.00	0-3	
	25	0	22.00	22.00	22.00		3
25	12	22.20	22.04	21.99	3		
64QAM	25	25	22.18	21.96	21.95	0-3	3
	50	0	22.14	22.00	21.96		3

**Table 9-7**  
**LTE Band 71 Conducted Powers - 5 MHz Bandwidth**

LTE Band 71 5 MHz Bandwidth								
Modulation	RB Size	RB Offset	Low Channel	Mid Channel	High Channel	MPR Allowed per 3GPP [dB]	MPR [dB]	
			133147 (665.5 MHz)	133297 (680.5 MHz)	133447 (695.5 MHz)			
			Conducted Power [dBm]					
QPSK	1	0	25.00	24.76	24.71	0	0	
	1	12	25.18	24.95	24.90		0	
	1	24	24.85	24.68	24.72		0	
	12	0	24.00	23.87	23.87	0-1	1	
	12	6	24.10	23.95	23.89		1	
	12	13	24.08	23.83	23.87		1	
16QAM	25	0	24.04	23.84	23.89	0-1	1	
	1	0	23.95	23.94	23.87		0-1	1
	1	12	24.12	24.14	24.02			1
	1	24	23.90	23.86	23.85	0-2		1
	12	0	22.96	22.94	22.93		2	
	12	6	23.10	22.93	22.93		2	
64QAM	12	13	23.09	22.90	22.90	0-2	2	
	25	0	23.02	22.90	22.92		2	
	1	0	23.06	23.00	22.94		0-2	2
	1	12	23.23	23.19	23.10	2		
	1	24	22.94	22.88	22.93	0-3		2
	12	0	21.98	21.93	21.92		3	
12	6	22.15	22.00	21.97	3			
64QAM	12	13	22.15	21.91	21.95	0-3	3	
	25	0	22.07	21.90	21.94		3	

FCC ID: ZNFX320PM	 PCTEST ENGINEERING LABORATORY, INC.	SAR EVALUATION REPORT	 LG	Approved by: Quality Manager
Document S/N: 1M1907220127-01.ZNF	Test Dates: 07/22/19 - 08/12/19	DUT Type: Portable Handset		Page 32 of 91





9.4.2

LTE Band 12

Table 9-8  
LTE Band 12 Conducted Powers - 10 MHz Bandwidth

LTE Band 12 10 MHz Bandwidth					
Modulation	RB Size	RB Offset	Mid Channel	MPR Allowed per 3GPP [dB]	MPR [dB]
			23095 (707.5 MHz)		
			Conducted Power [dBm]		
QPSK	1	0	24.85	0	0
	1	25	<b>24.98</b>		0
	1	49	24.79		0
	25	0	<b>24.08</b>	0-1	1
	25	12	24.04		1
	25	25	23.95		1
	50	0	24.03		1
16QAM	1	0	24.03	0-1	1
	1	25	24.09		1
	1	49	23.98		1
	25	0	23.04	0-2	2
	25	12	23.01		2
	25	25	22.96		2
	50	0	22.99		2
64QAM	1	0	23.13	0-2	2
	1	25	23.21		2
	1	49	23.00		2
	25	0	22.12	0-3	3
	25	12	22.07		3
	25	25	22.04		3
	50	0	22.08		3

Note: LTE Band 12 at 10 MHz bandwidth does not support three non-overlapping channels. Per KDB Publication 941225 D05v02, when a device supports overlapping channel assignment in a channel bandwidth configuration, the middle channel of the group of overlapping channels should be selected for testing.



FCC ID: ZNFX320PM	 PCTEST ENGINEERING LABORATORY, INC.	SAR EVALUATION REPORT	 LG	Approved by: Quality Manager
Document S/N: 1M1907220127-01.ZNF	Test Dates: 07/22/19 - 08/12/19	DUT Type: Portable Handset		Page 33 of 91

**Table 9-9**  
**LTE Band 12 Conducted Powers - 5 MHz Bandwidth**

LTE Band 12 5 MHz Bandwidth							
Modulation	RB Size	RB Offset	Low Channel	Mid Channel	High Channel	MPR Allowed per 3GPP [dB]	MPR [dB]
			23035 (701.5 MHz)	23095 (707.5 MHz)	23155 (713.5 MHz)		
			Conducted Power [dBm]				
QPSK	1	0	24.77	24.79	24.80	0	0
	1	12	24.99	25.07	25.15		0
	1	24	24.74	24.83	24.74		0
	12	0	23.91	23.98	24.09	0-1	1
	12	6	24.00	24.05	24.09		1
	12	13	23.90	24.01	24.01		1
	25	0	23.91	24.00	24.08		1
16QAM	1	0	23.94	23.92	23.93	0-1	1
	1	12	24.24	24.19	24.25		1
	1	24	23.92	24.00	23.93		1
	12	0	22.95	23.02	23.09	0-2	2
	12	6	23.05	23.07	23.12		2
	12	13	22.91	23.02	23.01		2
	25	0	22.94	23.00	23.07		2
64QAM	1	0	22.91	23.00	22.97	0-2	2
	1	12	23.26	23.23	23.27		2
	1	24	23.00	22.96	23.00		2
	12	0	21.97	22.01	22.15	0-3	3
	12	6	22.05	22.07	22.15		3
	12	13	21.94	22.05	22.05		3
	25	0	21.95	22.03	22.10		3



**Table 9-10**  
**LTE Band 12 Conducted Powers - 3 MHz Bandwidth**

LTE Band 12 3 MHz Bandwidth							
Modulation	RB Size	RB Offset	Low Channel	Mid Channel	High Channel	MPR Allowed per 3GPP [dB]	MPR [dB]
			23025 (700.5 MHz)	23095 (707.5 MHz)	23165 (714.5 MHz)		
			Conducted Power [dBm]				
QPSK	1	0	24.79	24.83	24.91	0	0
	1	7	24.99	24.99	25.06		0
	1	14	24.81	24.86	24.84		0
	8	0	23.87	23.89	23.98	0-1	1
	8	4	23.94	23.95	24.00		1
	8	7	23.91	23.94	23.97		1
	15	0	23.92	23.95	24.00		1
16QAM	1	0	23.93	24.00	24.03	0-1	1
	1	7	24.15	24.13	24.18		1
	1	14	24.00	24.06	23.92		1
	8	0	22.96	22.97	23.04	0-2	2
	8	4	23.02	23.03	23.06		2
	8	7	22.98	22.97	23.03		2
	15	0	22.93	22.95	23.00		2
64QAM	1	0	23.04	23.08	23.09	0-2	2
	1	7	23.20	23.21	23.21		2
	1	14	23.03	23.10	23.02		2
	8	0	21.97	22.00	22.06	0-3	3
	8	4	22.03	22.04	22.06		3
	8	7	22.00	22.00	22.04		3
	15	0	21.95	21.97	22.02		3

FCC ID: ZNFX320PM	 <b>PCTEST</b> ENGINEERING LABORATORY, INC.	<b>SAR EVALUATION REPORT</b>	 <b>LG</b>	<b>Approved by:</b> Quality Manager
<b>Document S/N:</b> 1M1907220127-01.ZNF	<b>Test Dates:</b> 07/22/19 - 08/12/19	<b>DUT Type:</b> Portable Handset	Page 34 of 91	

**Table 9-11**  
**LTE Band 12 Conducted Powers -1.4 MHz Bandwidth**

LTE Band 12 1.4 MHz Bandwidth							
Modulation	RB Size	RB Offset	Low Channel	Mid Channel	High Channel	MPR Allowed per 3GPP [dB]	MPR [dB]
			23017 (699.7 MHz)	23095 (707.5 MHz)	23173 (715.3 MHz)		
			Conducted Power [dBm]				
QPSK	1	0	24.72	24.83	24.83	0	0
	1	2	24.88	25.00	25.00		0
	1	5	24.78	24.74	24.78		0
	3	0	24.83	24.90	24.95		0
	3	2	24.90	24.80	24.96		0
	3	3	24.85	24.87	25.00		0
16QAM	6	0	23.90	23.94	23.91	0-1	1
	1	0	23.92	24.21	24.00	0-1	1
	1	2	24.10	24.09	23.99		1
	1	5	23.93	24.00	24.12		1
	3	0	23.88	23.93	23.85		1
	3	2	23.91	23.93	23.90		1
3	3	23.87	23.90	24.00	1		
64QAM	6	0	23.00	23.00	22.90	0-2	2
	1	0	22.94	23.00	23.06	0-2	2
	1	2	23.07	23.10	23.04		2
	1	5	23.02	23.01	23.15		2
	3	0	22.98	23.00	23.00		2
	3	2	23.00	22.99	23.03		2
3	3	23.00	23.03	23.09	2		
64QAM	6	0	21.95	21.98	22.00	0-3	3



FCC ID: ZNFX320PM		SAR EVALUATION REPORT		Approved by: Quality Manager
Document S/N: 1M1907220127-01.ZNF	Test Dates: 07/22/19 - 08/12/19	DUT Type: Portable Handset		Page 35 of 91

9.4.3

LTE Band 13

Table 9-12  
 LTE Band 13 Conducted Powers - 10 MHz Bandwidth



LTE Band 13 10 MHz Bandwidth					
Modulation	RB Size	RB Offset	Mid Channel	MPR Allowed per 3GPP [dB]	MPR [dB]
			23230 (782.0 MHz)		
			Conducted Power [dBm]		
QPSK	1	0	25.11	0	0
	1	25	<b>25.18</b>		0
	1	49	24.98		0
	25	0	24.25	0-1	1
	25	12	<b>24.26</b>		1
	25	25	24.13		1
	50	0	24.24		1
16QAM	1	0	24.21	0-1	1
	1	25	24.24		1
	1	49	24.22		1
	25	0	23.26	0-2	2
	25	12	23.22		2
	25	25	23.30		2
	50	0	23.20		2
64QAM	1	0	23.21	0-2	2
	1	25	23.19		2
	1	49	23.15		2
	25	0	22.27	0-3	3
	25	12	22.24		3
	25	25	22.16		3
	50	0	22.24		3

FCC ID: ZNFX320PM	 PCTEST ENGINEERING LABORATORY, INC.	SAR EVALUATION REPORT	 LG	Approved by: Quality Manager
Document S/N: 1M1907220127-01.ZNF	Test Dates: 07/22/19 - 08/12/19	DUT Type: Portable Handset		Page 36 of 91

**Table 9-13  
LTE Band 13 Conducted Powers - 5 MHz Bandwidth**

LTE Band 13 5 MHz Bandwidth					
Modulation	RB Size	RB Offset	Mid Channel	MPR Allowed per 3GPP [dB]	MPR [dB]
			23230 (782.0 MHz)		
			Conducted Power [dBm]		
QPSK	1	0	25.10	0	0
	1	12	25.29		0
	1	24	25.05		0
	12	0	24.28	0-1	1
	12	6	24.29		1
	12	13	24.21		1
	25	0	24.26		1
16QAM	1	0	24.24	0-1	1
	1	12	24.27		1
	1	24	24.26		1
	12	0	23.30	0-2	2
	12	6	23.28		2
	12	13	23.22		2
	25	0	23.25		2
64QAM	1	0	23.30	0-2	2
	1	12	23.20		2
	1	24	23.25		2
	12	0	22.30	0-3	3
	12	6	22.30		3
	12	13	22.28		3
	25	0	22.28		3

Note: LTE Band 13 at 5 MHz bandwidth does not support three non-overlapping channels. Per KDB Publication 941225 D05v02, when a device supports overlapping channel assignment in a channel bandwidth configuration, the middle channel of the group of overlapping channels should be selected for testing.

FCC ID: ZNFX320PM		SAR EVALUATION REPORT		Approved by: Quality Manager
Document S/N: 1M1907220127-01.ZNF	Test Dates: 07/22/19 - 08/12/19	DUT Type: Portable Handset		Page 37 of 91



9.4.4

LTE Band 26 (Cell)

Table 9-14  
 LTE Band 26 (Cell) Conducted Powers - 15 MHz Bandwidth

LTE Band 26 (Cell) 15 MHz Bandwidth						
Modulation	RB Size	RB Offset	Mid Channel	MPR Allowed per 3GPP [dB]	MPR [dB]	
			26865 (831.5 MHz)			
			Conducted Power [dBm]			
QPSK	1	0	25.10	0	0	
	1	36	<b>25.14</b>		0	
	1	74	24.99		0	
	16QAM	36	0	24.27	0-1	1
		36	18	<b>24.29</b>		1
		36	37	24.27		1
		75	0	24.26		1
64QAM	1	0	24.30	0-1	1	
	1	36	24.29		1	
	1	74	24.23		1	
	16QAM	36	0	23.24	0-2	2
		36	18	23.24		2
		36	37	23.21		2
		75	0	23.21		2
64QAM	1	0	23.24	0-2	2	
	1	36	23.25		2	
	1	74	23.26		2	
	16QAM	36	0	22.25	0-3	3
		36	18	22.22		3
		36	37	22.19		3
		75	0	22.29		3

Note: LTE Band 26 (Cell) at 15 MHz bandwidth does not support three non-overlapping channels. Per KDB Publication 941225 D05v02, when a device supports overlapping channel assignment in a channel bandwidth configuration, the middle channel of the group of overlapping channels should be selected for testing.



FCC ID: ZNFX320PM	 PCTEST ENGINEERING LABORATORY, INC.	SAR EVALUATION REPORT	 LG	Approved by: Quality Manager
Document S/N: 1M1907220127-01.ZNF	Test Dates: 07/22/19 - 08/12/19	DUT Type: Portable Handset		Page 38 of 91

**Table 9-15**  
**LTE Band 26 (Cell) Conducted Powers - 10 MHz Bandwidth**

LTE Band 26 (Cell) 10 MHz Bandwidth							
Modulation	RB Size	RB Offset	Low Channel	Mid Channel	High Channel	MPR Allowed per 3GPP [dB]	MPR [dB]
			26740 (819.0 MHz)	26865 (831.5 MHz)	26990 (844.0 MHz)		
			Conducted Power [dBm]				
QPSK	1	0	24.89	25.09	25.07	0	0
	1	25	25.12	25.17	25.22		0
	1	49	25.03	25.10	25.00		0
	25	0	24.12	24.27	24.28	0-1	1
	25	12	24.14	24.30	24.28		1
	25	25	24.17	24.24	24.17		1
16QAM	50	0	24.16	24.30	24.27	0-1	1
	1	0	24.09	24.27	24.22		1
	1	25	24.29	24.29	24.30		1
	1	49	24.27	24.22	24.12	0-2	1
	25	0	23.12	23.29	23.27		2
	25	12	23.14	23.25	23.27		2
64QAM	25	25	23.17	23.21	23.14	0-2	2
	50	0	23.12	23.28	23.26		2
	1	0	23.10	23.29	23.23		0-2
	1	25	23.30	23.29	23.30	2	
	1	49	23.25	23.28	23.16	0-3	
	25	0	22.12	22.29	22.27		3
25	12	22.17	22.29	22.30	3		
64QAM	25	25	22.17	22.24	22.18	0-3	3
	50	0	22.14	22.30	22.28		3

**Table 9-16**  
**LTE Band 26 (Cell) Conducted Powers - 5 MHz Bandwidth**

LTE Band 26 (Cell) 5 MHz Bandwidth							
Modulation	RB Size	RB Offset	Low Channel	Mid Channel	High Channel	MPR Allowed per 3GPP [dB]	MPR [dB]
			26715 (816.5 MHz)	26865 (831.5 MHz)	27015 (846.5 MHz)		
			Conducted Power [dBm]				
QPSK	1	0	24.81	25.03	25.02	0	0
	1	12	25.08	25.28	25.23		0
	1	24	24.87	25.01	24.87		0
	12	0	24.00	24.23	24.25	0-1	1
	12	6	24.07	24.26	24.25		1
	12	13	24.05	24.20	24.06		1
16QAM	25	0	24.06	24.26	24.16	0-1	1
	1	0	24.02	24.02	24.13		1
	1	12	24.28	24.25	24.27		1
	1	24	24.06	24.03	23.85	0-2	1
	12	0	23.02	23.22	23.23		2
	12	6	23.08	23.25	23.23		2
64QAM	12	13	23.06	23.21	23.13	0-2	2
	25	0	23.05	23.22	23.19		2
	1	0	23.09	23.19	23.30		0-2
	1	12	23.28	23.30	23.30	2	
	1	24	23.10	23.17	23.12	0-3	
	12	0	22.03	22.23	22.26		3
12	6	22.11	22.27	22.26	3		
64QAM	12	13	22.09	22.21	22.12	0-3	3
	25	0	22.07	22.24	22.18		3



FCC ID: ZNFX320PM	 <b>PCTEST</b> ENGINEERING LABORATORY, INC.	<b>SAR EVALUATION REPORT</b>	 <b>LG</b>	<b>Approved by:</b> Quality Manager
<b>Document S/N:</b> 1M1907220127-01.ZNF	<b>Test Dates:</b> 07/22/19 - 08/12/19	<b>DUT Type:</b> Portable Handset	Page 39 of 91	

**Table 9-17**  
**LTE Band 26 (Cell) Conducted Powers - 3 MHz Bandwidth**

LTE Band 26 (Cell) 3 MHz Bandwidth								
Modulation	RB Size	RB Offset	Low Channel	Mid Channel	High Channel	MPR Allowed per 3GPP [dB]	MPR [dB]	
			26705 (815.5 MHz)	26865 (831.5 MHz)	27025 (847.5 MHz)			
			Conducted Power [dBm]					
QPSK	1	0	24.91	25.12	25.11	0	0	
	1	7	25.06	25.30	25.16		0	
	1	14	24.90	25.12	25.00		0	
	8	0	23.99	24.20	24.21	0-1	1	
	8	4	24.02	24.26	24.18		1	
	8	7	23.98	24.21	24.12		1	
16QAM	15	0	24.00	24.26	24.18	0-1	1	
	1	0	24.15	24.27	24.30		0-1	1
	1	7	24.22	24.30	24.27			1
	1	14	24.19	24.30	24.09	0-2		1
	8	0	22.99	23.25	23.24		2	
	8	4	23.09	23.25	23.19		2	
64QAM	8	7	23.03	23.24	23.15	0-2	2	
	15	0	22.97	23.23	23.13		2	
	1	0	23.15	23.29	23.26		0-2	2
	1	7	23.30	23.30	23.30	0-3		2
	1	14	23.16	23.25	23.20			2
	8	0	22.00	22.26	22.28		0-3	3
	8	4	22.00	22.28	22.24	3		
	8	7	22.04	22.26	22.19	3		
15	0	22.01	22.23	22.17		3		

**Table 9-18**  
**LTE Band 26 (Cell) Conducted Powers -1.4 MHz Bandwidth**

LTE Band 26 (Cell) 1.4 MHz Bandwidth								
Modulation	RB Size	RB Offset	Low Channel	Mid Channel	High Channel	MPR Allowed per 3GPP [dB]	MPR [dB]	
			26697 (814.7 MHz)	26865 (831.5 MHz)	27033 (848.3 MHz)			
			Conducted Power [dBm]					
QPSK	1	0	24.83	25.05	24.99	0	0	
	1	2	24.88	25.19	25.11		0	
	1	5	24.84	25.03	24.93		0	
	3	0	24.94	25.16	25.10		0	
	3	2	24.95	25.19	25.13		0	
	3	3	24.95	25.17	25.06		0	
16QAM	6	0	24.00	24.23	24.17	0-1	1	
	1	0	24.12	24.24	24.15		0-1	1
	1	2	24.19	24.30	24.24			1
	1	5	24.10	24.25	24.09	1		
	3	0	24.03	24.22	24.11	1		
	3	2	24.04	24.25	24.13	1		
64QAM	3	3	24.00	24.22	24.07	0-2		1
	6	0	23.06	23.29	23.20		2	
	1	0	23.11	23.30	23.17		0-2	2
	1	2	23.18	23.30	23.30	2		
	1	5	23.15	23.25	23.11	2		
	3	0	23.10	23.29	23.19	2		
3	2	23.10	23.30	23.23	2			
3	3	23.10	23.27	23.15	2			
6	0	22.00	22.22	22.17	0-3	3		

FCC ID: ZNFX320PM	 PCTEST ENGINEERING LABORATORY, INC.	<b>SAR EVALUATION REPORT</b>	 LG	Approved by: Quality Manager
Document S/N: 1M1907220127-01.ZNF	Test Dates: 07/22/19 - 08/12/19	DUT Type: Portable Handset		Page 40 of 91



9.4.5



LTE Band 66 (AWS)

**Table 9-19**  
**LTE Band 66 (AWS) Conducted Powers - 20 MHz Bandwidth**

LTE Band 66 (AWS) 20 MHz Bandwidth							
Modulation	RB Size	RB Offset	Low Channel	Mid Channel	High Channel	MPR Allowed per 3GPP [dB]	MPR [dB]
			132072 (1720.0 MHz)	132322 (1745.0 MHz)	132572 (1770.0 MHz)		
			Conducted Power [dBm]				
QPSK	1	0	24.71	24.74	24.21	0	0
	1	50	24.76	24.78	24.50		0
	1	99	24.43	24.26	24.27		0
	50	0	23.70	23.68	23.30	0-1	1
	50	25	23.67	23.74	23.44		1
	50	50	23.53	23.55	23.50		1
16QAM	100	0	23.65	23.64	23.40	0-1	1
	1	0	23.80	23.78	23.59		1
	1	50	23.80	23.80	23.80		1
	1	99	23.50	23.55	23.75	0-2	1
	50	0	22.70	22.78	22.36		2
	50	25	22.68	22.80	22.45		2
64QAM	50	50	22.57	22.65	22.53	0-2	2
	100	0	22.64	22.75	22.45		2
	1	0	22.55	22.65	22.40		0-3
	1	50	22.57	22.79	22.75	2	
	1	99	22.21	22.40	22.46	2	
	50	0	21.80	21.73	21.42	0-3	3
50	25	21.79	21.76	21.53	3		
50	50	21.63	21.72	21.57	3		
100	0	21.78	21.78	21.52		3	

**Table 9-20**  
**LTE Band 66 (AWS) Conducted Powers - 15 MHz Bandwidth**

LTE Band 66 (AWS) 15 MHz Bandwidth								
Modulation	RB Size	RB Offset	Low Channel	Mid Channel	High Channel	MPR Allowed per 3GPP [dB]	MPR [dB]	
			132047 (1717.5 MHz)	132322 (1745.0 MHz)	132597 (1772.5 MHz)			
			Conducted Power [dBm]					
QPSK	1	0	24.70	24.53	24.64	0	0	
	1	36	24.74	24.63	24.73		0	
	1	74	24.62	24.62	24.58		0	
	36	0	23.48	23.73	23.79	0-1	1	
	36	18	23.51	23.73	23.79		1	
	36	37	23.45	23.73	23.80		1	
16QAM	75	0	23.53	23.74	23.78	0-1	1	
	1	0	23.49	23.80	23.75		0-1	1
	1	36	23.45	23.80	23.71			1
	1	74	23.40	23.80	23.78	0-2		1
	36	0	22.41	22.71	22.80		2	
	36	18	22.47	22.71	22.80		2	
64QAM	36	37	22.40	22.72	22.78	0-2	2	
	75	0	22.50	22.72	22.79		2	
	1	0	22.56	22.80	22.80		0-2	2
	1	36	22.64	22.80	22.72	0-3		2
	1	74	22.45	22.80	22.75			2
	36	0	21.67	21.77	21.76		0-3	3
36	18	21.59	21.78	21.76	3			
36	37	21.62	21.76	21.77	3			
75	0	21.53	21.77	21.74		3		



FCC ID: ZNFX320PM		SAR EVALUATION REPORT		Approved by: Quality Manager
Document S/N: 1M1907220127-01.ZNF	Test Dates: 07/22/19 - 08/12/19	DUT Type: Portable Handset		Page 41 of 91

**Table 9-21**  
**LTE Band 66 (AWS) Conducted Powers - 10 MHz Bandwidth**

LTE Band 66 (AWS) 10 MHz Bandwidth							
Modulation	RB Size	RB Offset	Low Channel	Mid Channel	High Channel	MPR Allowed per 3GPP [dB]	MPR [dB]
			132022 (1715.0 MHz)	132322 (1745.0 MHz)	132622 (1775.0 MHz)		
			Conducted Power [dBm]				
QPSK	1	0	24.26	24.35	24.34	0	0
	1	25	24.48	24.31	24.44		0
	1	49	24.25	24.26	24.22		0
	25	0	23.49	23.28	23.27	0-1	1
	25	12	23.45	23.26	23.34		1
	25	25	23.43	23.32	23.43		1
16QAM	50	0	23.41	23.35	23.33	0-1	1
	1	0	23.55	23.50	23.55		1
	1	25	23.68	23.53	23.57		1
	1	49	23.66	23.56	23.37	0-2	1
	25	0	22.59	22.34	22.32		2
	25	12	22.56	22.18	22.33		2
64QAM	25	25	22.48	22.28	22.49	0-2	2
	50	0	22.44	22.42	22.39		2
	1	0	22.57	22.45	22.53		0-2
	1	25	22.73	22.50	22.57	2	
	1	49	22.61	22.44	22.52	0-3	
	25	0	21.47	21.39	21.37		3
25	12	21.52	21.36	21.46	3		
64QAM	25	25	21.53	21.44	21.44	0-3	3
	50	0	21.53	21.34	21.51		3

**Table 9-22**  
**LTE Band 66 (AWS) Conducted Powers - 5 MHz Bandwidth**

LTE Band 66 (AWS) 5 MHz Bandwidth								
Modulation	RB Size	RB Offset	Low Channel	Mid Channel	High Channel	MPR Allowed per 3GPP [dB]	MPR [dB]	
			131997 (1712.5 MHz)	132322 (1745.0 MHz)	132647 (1777.5 MHz)			
			Conducted Power [dBm]					
QPSK	1	0	24.29	24.37	24.26	0	0	
	1	12	24.57	24.38	24.39		0	
	1	24	24.24	24.06	24.21		0	
	12	0	23.45	23.32	23.26	0-1	1	
	12	6	23.49	23.25	23.41		1	
	12	13	23.32	23.28	23.37		1	
16QAM	25	0	23.49	23.32	23.37	0-1	1	
	1	0	23.61	23.41	23.47		0-1	1
	1	12	23.77	23.54	23.71			1
	1	24	23.51	23.42	23.29	0-2		1
	12	0	22.48	22.30	22.36		2	
	12	6	22.55	22.45	22.32		2	
64QAM	12	13	22.37	22.33	22.26	0-2	2	
	25	0	22.43	22.35	22.25		2	
	1	0	22.51	22.60	22.50		0-2	2
	1	12	22.75	22.63	22.66	2		
	1	24	22.46	22.47	22.38	0-3		2
	12	0	21.49	21.33	21.48		3	
12	6	21.59	21.46	21.38	3			
64QAM	12	13	21.42	21.42	21.35	0-3	3	
	25	0	21.41	21.25	21.31		3	



FCC ID: ZNFX320PM	 <b>PCTEST</b> ENGINEERING LABORATORY, INC.	<b>SAR EVALUATION REPORT</b>	 <b>LG</b>	<b>Approved by:</b> Quality Manager
<b>Document S/N:</b> 1M1907220127-01.ZNF	<b>Test Dates:</b> 07/22/19 - 08/12/19	<b>DUT Type:</b> Portable Handset	Page 42 of 91	

**Table 9-23**  
**LTE Band 66 (AWS) Conducted Powers - 3 MHz Bandwidth**

LTE Band 66 (AWS) 3 MHz Bandwidth							
Modulation	RB Size	RB Offset	Low Channel	Mid Channel	High Channel	MPR Allowed per 3GPP [dB]	MPR [dB]
			131987 (1711.5 MHz)	132322 (1745.0 MHz)	132657 (1778.5 MHz)		
			Conducted Power [dBm]				
QPSK	1	0	24.44	24.42	24.26	0	0
	1	7	24.45	24.40	24.36		0
	1	14	24.36	24.13	24.31		0
	8	0	23.49	23.19	23.28	0-1	1
	8	4	23.44	23.36	23.30		1
	8	7	23.41	23.19	23.27		1
16QAM	15	0	23.39	23.35	23.38	0-1	1
	1	0	23.65	23.37	23.46		1
	1	7	23.76	23.55	23.76		1
	1	14	23.59	23.49	23.57	0-2	1
	8	0	22.49	22.41	22.38		2
	8	4	22.62	22.44	22.37		2
64QAM	8	7	22.55	22.36	22.42	0-2	2
	15	0	22.52	22.33	22.29		2
	1	0	22.68	22.41	22.46		0-2
	1	7	22.80	22.60	22.56	2	
	1	14	22.53	22.51	22.56	0-3	
	8	0	21.52	21.37	21.50		3
	8	4	21.66	21.37	21.45		3
	8	7	21.67	21.36	21.38	3	
15	0	21.57	21.41	21.31	3		

**Table 9-24**  
**LTE Band 66 (AWS) Conducted Powers -1.4 MHz Bandwidth**

LTE Band 66 (AWS) 1.4 MHz Bandwidth								
Modulation	RB Size	RB Offset	Low Channel	Mid Channel	High Channel	MPR Allowed per 3GPP [dB]	MPR [dB]	
			131979 (1710.7 MHz)	132322 (1745.0 MHz)	132665 (1779.3 MHz)			
			Conducted Power [dBm]					
QPSK	1	0	24.31	24.49	24.11	0	0	
	1	2	24.38	24.34	24.35		0	
	1	5	24.40	24.20	24.26		0	
	3	0	24.34	24.26	24.38	0-1	0	
	3	2	24.52	24.39	24.34		0	
	3	3	24.45	24.33	24.29		0	
16QAM	6	0	23.37	23.29	23.44	0-1	1	
	1	0	23.58	23.48	23.39		0-1	1
	1	2	23.68	23.54	23.57			1
	1	5	23.55	23.35	23.42	0-2		1
	3	0	23.57	23.26	23.36		1	
	3	2	23.65	23.44	23.51		1	
64QAM	3	3	23.58	23.30	23.30	0-2	1	
	6	0	22.60	22.38	22.34		2	
	1	0	22.60	22.37	22.42		0-2	2
	1	2	22.76	22.60	22.69	0-2		2
	1	5	22.54	22.34	22.45			2
	3	0	22.67	22.36	22.49		0-3	2
	3	2	22.64	22.36	22.49	2		
	3	3	22.60	22.43	22.47	2		
6	0	21.60	21.73	21.77	3			

FCC ID: ZNFX320PM	 <b>PCTEST</b> ENGINEERING LABORATORY, INC.	<b>SAR EVALUATION REPORT</b>	 <b>LG</b>	<b>Approved by:</b> Quality Manager
<b>Document S/N:</b> 1M1907220127-01.ZNF	<b>Test Dates:</b> 07/22/19 - 08/12/19	<b>DUT Type:</b> Portable Handset	Page 43 of 91	

9.4.6



LTE Band 25 (PCS)

Table 9-25  
LTE Band 25 (PCS) Conducted Powers - 20 MHz Bandwidth

LTE Band 25 (PCS) 20 MHz Bandwidth							
Modulation	RB Size	RB Offset	Low Channel	Mid Channel	High Channel	MPR Allowed per 3GPP [dB]	MPR [dB]
			26140 (1860.0 MHz)	26365 (1882.5 MHz)	26590 (1905.0 MHz)		
			Conducted Power [dBm]				
QPSK	1	0	24.43	24.55	24.54	0	0
	1	50	24.64	24.74	24.73		0
	1	99	24.45	24.54	24.45		0
	50	0	23.71	23.78	23.80	0-1	1
	50	25	23.68	23.79	23.79		1
	50	50	23.64	23.70	23.58		1
16QAM	100	0	23.65	23.73	23.72	0-1	1
	1	0	23.58	23.70	23.70		1
	1	50	23.80	23.80	23.79		1
	1	99	23.68	23.75	23.57	0-2	1
	50	0	22.67	22.77	22.80		2
	50	25	22.66	22.78	22.78		2
64QAM	50	50	22.64	22.70	22.57	0-2	2
	100	0	22.64	22.74	22.70		2
	1	0	22.71	22.79	22.79		0-2
	1	50	22.80	22.78	22.70	2	
	1	99	22.76	22.72	22.64	2	
	64QAM	50	0	21.68	21.80	21.79	0-3
50		25	21.73	21.79	21.80	3	
50		50	21.73	21.74	21.58	3	
100		0	21.71	21.78	21.75	3	

Table 9-26  
LTE Band 25 (PCS) Conducted Powers - 15 MHz Bandwidth

LTE Band 25 (PCS) 15 MHz Bandwidth							
Modulation	RB Size	RB Offset	Low Channel	Mid Channel	High Channel	MPR Allowed per 3GPP [dB]	MPR [dB]
			26115 (1857.5 MHz)	26365 (1882.5 MHz)	26615 (1907.5 MHz)		
			Conducted Power [dBm]				
QPSK	1	0	24.58	24.64	24.48	0	0
	1	36	24.72	24.80	24.62		0
	1	74	24.49	24.68	24.39		0
	36	0	23.78	23.80	23.80	0-1	1
	36	18	23.80	23.78	23.79		1
	36	37	23.80	23.80	23.66		1
16QAM	75	0	23.75	23.79	23.70	0-1	1
	1	0	23.68	23.70	23.80		1
	1	36	23.74	23.75	23.80		1
	1	74	23.65	23.78	23.80	0-2	1
	36	0	22.78	22.77	22.77		2
	36	18	22.80	22.79	22.77		2
64QAM	36	37	22.80	22.76	22.68	0-2	2
	75	0	22.68	22.76	22.69		2
	1	0	22.76	22.76	22.80		0-2
	1	36	22.77	22.78	22.80	2	
	1	74	22.70	22.76	22.75	0-3	
	36	0	21.78	21.78	21.68		3
36	18	21.77	21.63	21.80	3		
64QAM	36	37	21.77	21.57	21.75	0-3	3
	75	0	21.75	21.55	21.72		3



FCC ID: ZNFX320PM		SAR EVALUATION REPORT		Approved by: Quality Manager
Document S/N: 1M1907220127-01.ZNF	Test Dates: 07/22/19 - 08/12/19	DUT Type: Portable Handset		Page 44 of 91

**Table 9-27**  
**LTE Band 25 (PCS) Conducted Powers - 10 MHz Bandwidth**

LTE Band 25 (PCS) 10 MHz Bandwidth							
Modulation	RB Size	RB Offset	Low Channel	Mid Channel	High Channel	MPR Allowed per 3GPP [dB]	MPR [dB]
			26090 (1855.0 MHz)	26365 (1882.5 MHz)	26640 (1910.0 MHz)		
			Conducted Power [dBm]				
QPSK	1	0	24.60	24.72	24.56	0	0
	1	25	24.62	24.64	24.68		0
	1	49	24.53	24.75	24.48		0
	25	0	23.76	23.80	23.73	0-1	1
	25	12	23.78	23.77	23.65		1
	25	25	23.73	23.77	23.52		1
16QAM	50	0	23.73	23.76	23.69	0-1	1
	1	0	23.77	23.71	23.80		1
	1	25	23.80	23.74	23.75		1
	1	49	23.79	23.69	23.78	0-2	1
	25	0	22.75	22.79	22.73		2
	25	12	22.76	22.79	22.71		2
64QAM	25	25	22.75	22.76	22.59	0-2	2
	50	0	22.77	22.78	22.69		2
	1	0	22.80	22.76	22.65		2
	1	25	22.74	22.71	22.71	0-2	2
	1	49	22.73	22.75	22.74		2
	25	0	21.80	21.68	21.69		0-3
25	12	21.78	21.70	21.77	3		
25	25	21.80	21.62	21.66	3		
	50	0	21.79	21.65	21.64		3

**Table 9-28**  
**LTE Band 25 (PCS) Conducted Powers - 5 MHz Bandwidth**

LTE Band 25 (PCS) 5 MHz Bandwidth							
Modulation	RB Size	RB Offset	Low Channel	Mid Channel	High Channel	MPR Allowed per 3GPP [dB]	MPR [dB]
			26065 (1852.5 MHz)	26365 (1882.5 MHz)	26665 (1912.5 MHz)		
			Conducted Power [dBm]				
QPSK	1	0	24.78	24.54	24.56	0	0
	1	12	24.80	24.64	24.80		0
	1	24	24.67	24.55	24.62		0
	12	0	23.67	23.69	23.61	0-1	1
	12	6	23.76	23.76	23.66		1
	12	13	23.67	23.64	23.49		1
16QAM	25	0	23.70	23.67	23.60	0-1	1
	1	0	23.62	23.53	23.80		1
	1	12	23.68	23.66	23.80		1
	1	24	23.61	23.69	23.62	0-2	1
	12	0	22.59	22.72	22.63		2
	12	6	22.66	22.79	22.68		2
64QAM	12	13	22.55	22.69	22.57	0-2	2
	25	0	22.80	22.66	22.64		2
	1	0	22.77	22.69	22.59		0-2
	1	12	22.74	22.66	22.80	2	
	1	24	22.80	22.65	22.71	2	
	64QAM	12	0	21.76	21.73	21.72	0-3
12		6	21.70	21.79	21.72	3	
12		13	21.75	21.80	21.58	3	
25		0	21.80	21.72	21.56	3	



FCC ID: ZNFX320PM	 PCTEST ENGINEERING LABORATORY, INC.	<b>SAR EVALUATION REPORT</b>	 LG	Approved by: Quality Manager
Document S/N: 1M1907220127-01.ZNF	Test Dates: 07/22/19 - 08/12/19	DUT Type: Portable Handset		Page 45 of 91

**Table 9-29  
LTE Band 25 (PCS) Conducted Powers - 3 MHz Bandwidth**

LTE Band 25 (PCS) 3 MHz Bandwidth							
Modulation	RB Size	RB Offset	Low Channel	Mid Channel	High Channel	MPR Allowed per 3GPP [dB]	MPR [dB]
			26055 (1851.5 MHz)	26365 (1882.5 MHz)	26675 (1913.5 MHz)		
			Conducted Power [dBm]				
QPSK	1	0	24.61	24.63	24.77	0	0
	1	7	24.80	24.76	24.75		0
	1	14	24.74	24.64	24.62		0
	8	0	23.78	23.71	23.66	0-1	1
	8	4	23.76	23.62	23.71		1
	8	7	23.70	23.73	23.62		1
16QAM	15	0	23.73	23.71	23.62	0-1	1
	1	0	23.58	23.65	23.64		1
	1	7	23.72	23.72	23.61		1
	1	14	23.65	23.62	23.71	0-2	1
	8	0	22.68	22.75	22.77		2
	8	4	22.68	22.80	22.58		2
64QAM	8	7	22.62	22.73	22.51	0-2	2
	15	0	22.69	22.54	22.62		2
	1	0	22.74	22.76	22.67		2
	1	7	22.79	22.66	22.79	0-2	2
	1	14	22.76	22.65	22.67		2
	8	0	21.67	21.62	21.73		0-3
	8	4	21.73	21.68	21.75	3	
8	7	21.63	21.71	21.71	3		
	15	0	21.66	21.75	21.63		3

**Table 9-30  
LTE Band 25 (PCS) Conducted Powers -1.4 MHz Bandwidth**

LTE Band 25 (PCS) 1.4 MHz Bandwidth							
Modulation	RB Size	RB Offset	Low Channel	Mid Channel	High Channel	MPR Allowed per 3GPP [dB]	MPR [dB]
			26047 (1850.7 MHz)	26365 (1882.5 MHz)	26683 (1914.3 MHz)		
			Conducted Power [dBm]				
QPSK	1	0	24.77	24.77	24.66	0	0
	1	2	24.73	24.77	24.63		0
	1	5	24.75	24.77	24.67		0
	3	0	24.65	24.71	24.75	0-1	0
	3	2	24.63	24.72	24.65		0
	3	3	24.56	24.77	24.77		0
16QAM	6	0	23.78	23.77	23.69	0-1	1
	1	0	23.62	23.80	23.54		1
	1	2	23.65	23.71	23.67		1
	1	5	23.64	23.77	23.64	0-1	1
	3	0	23.52	23.80	23.59		1
	3	2	23.50	23.78	23.65		1
64QAM	3	3	23.80	23.70	23.76	0-2	1
	6	0	22.64	22.80	22.80		2
	1	0	22.69	22.77	22.67		0-2
	1	2	22.80	22.67	22.66	2	
	1	5	22.75	22.70	22.70	2	
	3	0	22.66	22.80	22.77	0-2	2
	3	2	22.68	22.80	22.77		2
3	3	22.65	22.79	22.66	2		
	6	0	21.71	21.65	21.80	0-3	3

FCC ID: ZNFX320PM	 PCTEST ENGINEERING LABORATORY, INC.	<b>SAR EVALUATION REPORT</b>	 LG	<b>Approved by:</b> Quality Manager
<b>Document S/N:</b> 1M1907220127-01.ZNF	<b>Test Dates:</b> 07/22/19 - 08/12/19	<b>DUT Type:</b> Portable Handset	Page 46 of 91	

9.4.7



LTE Band 41

**Table 9-31**  
**LTE Band 41 Conducted Powers - 20 MHz Bandwidth**

LTE Band 41 20 MHz Bandwidth									
Modulation	RB Size	RB Offset	Low Channel	Low-Mid Channel	Mid Channel	Mid-High Channel	High Channel	MPR Allowed per 3GPP [dB]	MPR [dB]
			39750 (2506.0 MHz)	40185 (2549.5 MHz)	40620 (2593.0 MHz)	41055 (2636.5 MHz)	41490 (2680.0 MHz)		
			Conducted Power [dBm]						
QPSK	1	0	24.50	24.50	24.54	24.52	24.59	0	0
	1	50	24.70	24.64	24.79	24.62	24.69		0
	1	99	24.44	24.39	24.42	24.31	24.37		0
	50	0	23.64	23.59	23.61	23.52	23.70	0-1	1
	50	25	23.64	23.57	23.74	23.55	23.73		1
	50	50	23.60	23.55	23.58	23.55	23.51		1
16QAM	100	0	23.60	23.64	23.65	23.54	23.64	0-1	1
	1	0	23.56	23.54	23.65	23.61	23.65		1
	1	50	23.45	23.76	23.77	23.64	23.65		1
	1	99	23.47	23.49	23.50	23.45	23.65	0-2	1
	50	0	22.69	22.67	22.72	22.60	22.80		2
	50	25	22.70	22.65	22.69	22.60	22.73		2
64QAM	50	50	22.67	22.64	22.59	22.47	22.61	0-2	2
	100	0	22.69	22.69	22.72	22.64	22.73		2
	1	0	22.71	22.70	22.73	22.60	22.80		0-3
	1	50	22.77	22.75	22.75	22.49	22.79	2	
	1	99	22.67	22.59	22.76	22.40	22.63	2	
	50	0	21.72	21.67	21.78	21.70	21.80	3	
50	25	21.76	21.70	21.76	21.67	21.76	3		
50	50	21.69	21.69	21.72	21.57	21.59	3		
100	0	21.71	21.68	21.74	21.62	21.67	3		

**Table 9-32**  
**LTE Band 41 Conducted Powers - 15 MHz Bandwidth**

LTE Band 41 15 MHz Bandwidth										
Modulation	RB Size	RB Offset	Low Channel	Low-Mid Channel	Mid Channel	Mid-High Channel	High Channel	MPR Allowed per 3GPP [dB]	MPR [dB]	
			39750 (2506.0 MHz)	40185 (2549.5 MHz)	40620 (2593.0 MHz)	41055 (2636.5 MHz)	41490 (2680.0 MHz)			
			Conducted Power [dBm]							
QPSK	1	0	24.31	24.00	24.22	23.98	24.04	0	0	
	1	36	24.46	24.13	24.52	24.24	24.33		0	
	1	74	24.22	23.97	24.26	24.04	24.17		0	
	36	0	23.48	23.10	23.45	23.16	23.25	0-1	1	
	36	18	23.50	23.18	23.50	23.17	23.32		1	
	36	37	23.42	23.17	23.48	23.09	23.27		1	
16QAM	75	0	23.48	23.11	23.43	23.10	23.27	0-1	1	
	1	0	23.17	23.19	23.11	23.04	22.90		0-2	1
	1	36	23.32	23.35	23.29	23.34	23.17			1
	1	74	23.12	23.26	23.10	23.05	23.01	0-2		1
	36	0	22.52	22.05	22.47	22.03	22.29		2	
	36	18	22.50	22.14	22.48	22.06	22.37		2	
64QAM	36	37	22.51	22.11	22.54	21.98	22.39	0-2	2	
	75	0	22.43	22.09	22.41	22.03	22.31		2	
	1	0	22.76	22.80	22.75	22.68	22.50		0-3	2
	1	36	22.72	22.76	22.69	22.79	22.69	2		
	1	74	22.71	22.72	22.74	22.63	22.61	2		
	36	0	21.70	21.77	21.79	21.75	21.78	3		
36	18	21.69	21.63	21.69	21.77	21.67	3			
36	37	21.62	21.71	21.61	21.66	21.67	3			
75	0	21.63	21.78	21.63	21.66	21.69	3			



FCC ID: ZNFX320PM		SAR EVALUATION REPORT		Approved by: Quality Manager
Document S/N: 1M1907220127-01.ZNF	Test Dates: 07/22/19 - 08/12/19	DUT Type: Portable Handset	Page 47 of 91	

**Table 9-33  
LTE Band 41 Conducted Powers - 10 MHz Bandwidth**

LTE Band 41 10 MHz Bandwidth									
Modulation	RB Size	RB Offset	Low Channel	Low-Mid Channel	Mid Channel	Mid-High Channel	High Channel	MPR Allowed per 3GPP [dB]	MPR [dB]
			39750 (2506.0 MHz)	40185 (2549.5 MHz)	40620 (2593.0 MHz)	41055 (2636.5 MHz)	41490 (2680.0 MHz)		
			Conducted Power [dBm]						
QPSK	1	0	24.46	24.09	24.41	24.16	24.25	0	0
	1	25	24.47	24.21	24.40	24.21	24.38		0
	1	49	24.39	24.10	24.38	24.11	24.34		0
	25	0	23.49	23.12	23.40	23.16	23.33	0-1	1
	25	12	23.46	23.05	23.42	23.07	23.29		1
	25	25	23.44	23.15	23.40	23.09	23.34		1
16QAM	50	0	23.42	23.14	23.35	23.07	23.27	0-1	1
	1	0	23.13	23.28	23.01	23.15	22.94		1
	1	25	23.30	23.20	23.15	23.38	23.19		1
	1	49	23.06	23.33	23.04	23.22	23.04	0-2	1
	25	0	22.56	22.10	22.50	22.03	22.46		2
	25	12	22.47	22.18	22.53	22.04	22.38		2
64QAM	25	25	22.49	22.16	22.47	22.06	22.44	0-2	2
	50	0	22.47	22.07	22.39	22.03	22.33		2
	1	0	22.55	22.69	22.59	22.65	22.55		0-2
	1	25	22.58	22.50	22.56	22.35	22.69	2	
	1	49	22.55	22.63	22.46	22.45	22.63	2	
	64QAM	25	0	21.55	21.67	21.68	21.64	21.66	0-3
25		12	21.49	21.55	21.57	21.60	21.68	3	
25		25	21.46	21.54	21.50	21.56	21.50	3	
50		0	21.44	21.53	21.39	21.50	21.33	3	

**Table 9-34  
LTE Band 41 Conducted Powers - 5 MHz Bandwidth**

LTE Band 41 5 MHz Bandwidth										
Modulation	RB Size	RB Offset	Low Channel	Low-Mid Channel	Mid Channel	Mid-High Channel	High Channel	MPR Allowed per 3GPP [dB]	MPR [dB]	
			39750 (2506.0 MHz)	40185 (2549.5 MHz)	40620 (2593.0 MHz)	41055 (2636.5 MHz)	41490 (2680.0 MHz)			
			Conducted Power [dBm]							
QPSK	1	0	24.48	24.25	24.42	23.89	24.24	0	0	
	1	12	24.72	24.26	24.73	24.23	24.61		0	
	1	24	24.44	24.25	24.44	23.89	24.30		0	
	12	0	23.44	23.34	23.42	23.03	23.29	0-1	1	
	12	6	23.52	23.37	23.44	23.13	23.32		1	
	12	13	23.41	23.06	23.41	23.07	23.29		1	
16QAM	25	0	23.40	23.13	23.35	23.03	23.35	0-1	1	
	1	0	23.38	22.99	23.34	22.93	23.20		0-1	1
	1	12	23.80	23.55	23.77	23.21	23.72			1
	1	24	23.34	22.96	23.40	22.91	23.24	0-2		1
	12	0	22.56	22.13	22.50	22.08	22.43		2	
	12	6	22.51	22.16	22.56	22.20	22.44		2	
64QAM	12	13	22.54	22.12	22.52	22.08	22.44	0-2	2	
	25	0	22.38	22.07	22.35	22.04	22.32		2	
	1	0	22.38	22.74	22.35	22.50	22.58		0-2	2
	1	12	22.80	22.56	22.65	22.22	22.60	2		
	1	24	22.74	22.70	22.39	22.62	22.66	2		
	64QAM	12	0	21.53	21.68	21.48	21.63	21.43	0-3	3
12		6	21.53	21.77	21.57	21.62	21.42	3		
12		13	21.53	21.67	21.50	21.69	21.44	3		
25		0	21.39	21.60	21.35	21.80	21.32	3		

FCC ID: ZNFX320PM	 PCTEST ENGINEERING LABORATORY, INC.	<b>SAR EVALUATION REPORT</b>	 LG	<b>Approved by:</b> Quality Manager
<b>Document S/N:</b> 1M1907220127-01.ZNF	<b>Test Dates:</b> 07/22/19 - 08/12/19	<b>DUT Type:</b> Portable Handset	Page 48 of 91	





**Table 9-35**  
**LTE Band 41 PC2 Conducted Powers - 20 MHz Bandwidth**

LTE Band 41 20 MHz Bandwidth										
Modulation	RB Size	RB Offset	Low Channel	Low-Mid Channel	Mid Channel	Mid-High Channel	High Channel	MPR Allowed per 3GPP [dB]	MPR [dB]	
			39750 (2506.0 MHz)	40185 (2549.5 MHz)	40620 (2593.0 MHz)	41055 (2636.5 MHz)	41490 (2680.0 MHz)			
			Conducted Power [dBm]							
QPSK	1	0	27.36	27.31	27.44	27.36	27.43	0	0	
	1	50	27.34	27.49	27.57	27.48	27.44		0	
	1	99	27.31	27.24	27.28	27.17	27.16		0	
	50	0	26.48	26.41	26.50	26.49	26.39	0-1	1	
	50	25	26.48	26.45	26.48	26.47	26.40		1	
	50	50	26.41	26.30	26.47	26.44	26.37		1	
100	0	26.49	26.45	26.41	26.40	26.28	0-1	1		
16QAM	1	0	26.50	26.40	26.45	26.50		26.50	0-1	1
	1	50	26.49	26.50	26.50	26.48		26.45		1
	1	99	26.40	26.36	26.30	26.33	26.43	1		
	50	0	25.42	25.41	25.50	25.47	25.50	0-2	2	
	50	25	25.42	25.42	25.49	25.49	25.48		2	
	50	50	25.38	25.37	25.42	25.34	25.45		2	
100	0	25.45	25.47	25.37	25.44	25.40	0-2	2		
64QAM	1	0	25.50	25.50	25.30	25.40		25.38	0-2	2
	1	50	25.43	25.00	25.29	25.38		25.30		2
	1	99	25.40	24.94	25.12	25.31	25.10	2		
	50	0	24.50	24.35	24.38	24.27	24.44	0-3	3	
	50	25	24.49	24.31	24.37	24.28	24.43		3	
	50	50	24.45	24.28	24.31	24.21	24.32		3	
100	0	24.47	24.29	24.33	24.27	24.37	0-3	3		

**Table 9-36**  
**LTE Band 41 PC2 Conducted Powers - 15 MHz Bandwidth**

LTE Band 41 15 MHz Bandwidth										
Modulation	RB Size	RB Offset	Low Channel	Low-Mid Channel	Mid Channel	Mid-High Channel	High Channel	MPR Allowed per 3GPP [dB]	MPR [dB]	
			39750 (2506.0 MHz)	40185 (2549.5 MHz)	40620 (2593.0 MHz)	41055 (2636.5 MHz)	41490 (2680.0 MHz)			
			Conducted Power [dBm]							
QPSK	1	0	27.48	27.15	27.38	27.05	27.25	0	0	
	1	36	27.62	27.32	27.55	27.25	27.52		0	
	1	74	27.39	27.18	27.38	27.07	27.37		0	
	36	0	26.60	26.25	26.62	26.22	26.38	0-1	1	
	36	18	26.60	26.32	26.67	26.27	26.45		1	
	36	37	26.54	26.29	26.60	26.20	26.45		1	
75	0	26.54	26.27	26.60	26.18	26.39	0-1	1		
16QAM	1	0	26.79	26.25	26.37	26.34		26.59	0-1	1
	1	36	26.61	26.43	26.33	26.52		26.55		1
	1	74	26.70	26.30	26.66	26.36	26.66	1		
	36	0	25.53	25.23	25.36	25.13	25.29	0-2	2	
	36	18	25.53	25.31	25.59	25.15	25.37		2	
	36	37	25.47	25.27	25.58	25.08	25.35		2	
75	0	25.52	25.21	25.56	25.14	25.34	0-2	2		
64QAM	1	0	25.30	25.24	25.66	25.31		25.58	0-2	2
	1	36	25.33	25.41	25.20	25.52		25.80		2
	1	74	25.31	25.28	25.55	25.33	25.65	2		
	36	0	24.34	24.23	24.55	24.13	24.29	0-3	3	
	36	18	24.24	24.30	24.58	24.15	24.36		3	
	36	37	24.49	24.30	24.58	24.07	24.34		3	
75	0	24.54	24.22	24.55	24.11	24.35	0-3	3		



FCC ID: ZNFX320PM		SAR EVALUATION REPORT		Approved by: Quality Manager
Document S/N: 1M1907220127-01.ZNF	Test Dates: 07/22/19 - 08/12/19	DUT Type: Portable Handset		Page 49 of 91

**Table 9-37**  
**LTE Band 41 PC2 Conducted Powers - 10 MHz Bandwidth**

LTE Band 41 10 MHz Bandwidth									
Modulation	RB Size	RB Offset	Low Channel	Low-Mid Channel	Mid Channel	Mid-High Channel	High Channel	MPR Allowed per 3GPP [dB]	MPR [dB]
			39750 (2506.0 MHz)	40185 (2549.5 MHz)	40620 (2593.0 MHz)	41055 (2636.5 MHz)	41490 (2680.0 MHz)		
			Conducted Power [dBm]						
QPSK	1	0	27.53	27.60	27.59	27.46	27.80	0	0
	1	25	27.58	27.70	27.67	27.54	27.65		0
	1	49	27.55	27.74	27.69	27.43	27.70		0
	25	0	26.47	26.75	26.60	26.47	26.62	0-1	1
	25	12	26.50	26.75	26.64	26.40	26.63		1
	25	25	26.52	26.77	26.68	26.43	26.47		1
16QAM	50	0	26.48	26.74	26.58	26.42	26.42	0-1	1
	1	0	26.75	26.19	26.53	26.70	26.36		1
	1	25	26.60	26.29	26.42	26.70	26.40		1
	25	0	25.55	25.73	25.58	25.41	25.73	0-2	2
	25	12	25.55	25.71	25.62	25.41	25.37		2
	25	25	25.62	25.73	25.67	25.39	25.55		2
64QAM	50	0	25.57	25.73	25.61	25.39	25.46	0-2	2
	1	0	25.77	25.20	25.80	25.66	25.16		2
	1	25	25.69	25.28	25.52	25.72	25.66		2
	1	49	25.65	25.35	25.48	25.66	25.39	0-3	2
	25	0	24.55	24.77	24.58	24.40	24.75		3
	25	12	24.54	24.73	24.64	24.41	24.74		3
25	25	24.50	24.75	24.67	24.37	24.50	3		
50	0	24.54	24.75	24.59	24.37	24.66	3		

**Table 9-38**  
**LTE Band 41 PC2 Conducted Powers - 5 MHz Bandwidth**

LTE Band 41 5 MHz Bandwidth									
Modulation	RB Size	RB Offset	Low Channel	Low-Mid Channel	Mid Channel	Mid-High Channel	High Channel	MPR Allowed per 3GPP [dB]	MPR [dB]
			39750 (2506.0 MHz)	40185 (2549.5 MHz)	40620 (2593.0 MHz)	41055 (2636.5 MHz)	41490 (2680.0 MHz)		
			Conducted Power [dBm]						
QPSK	1	0	27.54	27.65	27.22	27.26	27.50	0	0
	1	12	27.57	27.55	27.52	27.34	27.45		0
	1	24	27.45	27.57	27.59	27.77	27.35		0
	12	0	26.38	26.53	26.49	26.14	26.32	0-1	1
	12	6	26.20	26.45	26.50	26.34	26.34		1
	12	13	26.15	26.37	26.62	26.65	26.48		1
16QAM	25	0	26.28	26.66	26.23	26.22	26.11	0-1	1
	1	0	26.55	26.19	26.35	26.50	26.15		1
	1	12	26.40	26.29	26.35	26.66	26.45		1
	12	0	25.35	25.54	25.42	25.61	25.35	0-2	2
	12	6	25.40	25.22	25.38	25.44	25.40		2
	12	13	25.65	25.53	25.31	25.20	25.55		2
64QAM	25	0	25.47	25.58	25.28	25.24	25.46	0-2	2
	1	0	25.20	25.18	25.66	25.46	25.16		2
	1	12	25.44	25.22	25.44	25.66	25.66		2
	12	0	24.25	24.74	24.57	24.30	24.22	0-3	3
	12	6	24.39	24.60	24.80	24.31	24.35		3
	12	13	24.51	24.55	24.35	24.27	24.41		3
25	0	24.60	24.66	24.38	24.47	24.38	3		

FCC ID: ZNFX320PM		SAR EVALUATION REPORT		Approved by: Quality Manager
Document S/N: 1M1907220127-01.ZNF	Test Dates: 07/22/19 - 08/12/19	DUT Type: Portable Handset		Page 50 of 91

## 9.5 WLAN Conducted Powers

**Table 9-39**  
**2.4 GHz WLAN Maximum Average RF Power**

2.4GHz Conducted Power [dBm]				
Freq [MHz]	Channel	IEEE Transmission Mode		
		802.11b	802.11g	802.11n
		Average	Average	Average
2412	1	<b>15.91</b>	14.27	14.66
2417	2		14.87	14.68
2437	6	15.59	14.83	14.68
2462	11	15.89	15.32	15.22



Note: The bolded data rates and channel above were tested for SAR.

Justification for test configurations for WLAN per KDB Publication 248227 D01v02r02:

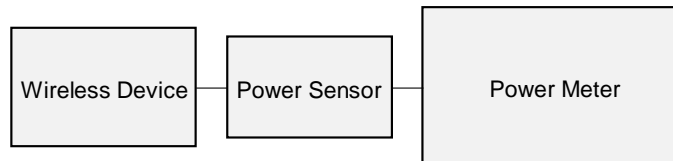
- Power measurements were performed for the transmission mode configuration with the highest maximum output power specified for production units.
- For transmission modes with the same maximum output power specification, powers were measured for the largest channel bandwidth, lowest order modulation and lowest data rate.
- For transmission modes with identical maximum specified output power, channel bandwidth, modulation and data rates, power measurements were required for all identical configurations.
- For each transmission mode configuration, powers were measured for the highest and lowest channels; and at the mid-band channel(s) when there were at least 3 channels supported. For configurations with multiple mid-band channels, due to an even number of channels, both channels were measured.
- The bolded data rate and channel above were tested for SAR.



**Figure 9-4**  
**Power Measurement Setup**



FCC ID: ZNFX320PM	 PCTEST ENGINEERING LABORATORY, INC.	SAR EVALUATION REPORT	 LG	Approved by: Quality Manager
Document S/N: 1M1907220127-01.ZNF	Test Dates: 07/22/19 - 08/12/19	DUT Type: Portable Handset	Page 51 of 91	

## 9.6 Bluetooth Conducted Powers

Table 9-40  
Bluetooth Average RF Power

Frequency [MHz]	Data Rate [Mbps]	Channel No.	Avg Conducted Power	
			[dBm]	[mW]
2402	1.0	0	10.23	10.532
2441	1.0	39	<b>10.34</b>	10.824
2480	1.0	78	9.76	9.472
2402	2.0	0	7.28	5.341
2441	2.0	39	7.00	5.016
2480	2.0	78	6.63	4.602
2402	3.0	0	7.36	5.447
2441	3.0	39	7.08	5.111
2480	3.0	78	6.71	4.687

Note: The bolded data rates and channel above were tested for SAR.

FCC ID: ZNFX320PM	 PCTEST ENGINEERING LABORATORY, INC.	SAR EVALUATION REPORT	 LG	Approved by: Quality Manager
Document S/N: 1M1907220127-01.ZNF	Test Dates: 07/22/19 - 08/12/19	DUT Type: Portable Handset		Page 52 of 91

**Figure 9-5  
Bluetooth Transmission Plot**

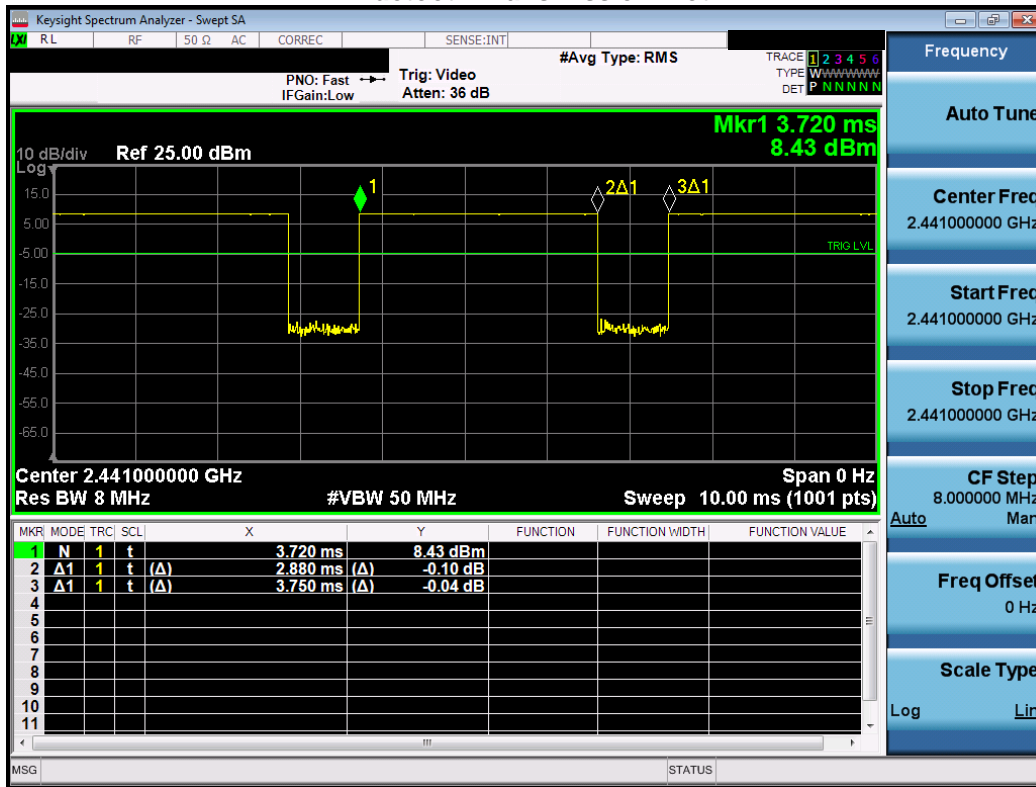

**Equation 9-1  
Bluetooth Duty Cycle Calculation**

$$Duty\ Cycle = \frac{Pulse\ Width}{Period} * 100\% = \frac{2.880ms}{3.750ms} * 100\% = 76.80\%$$

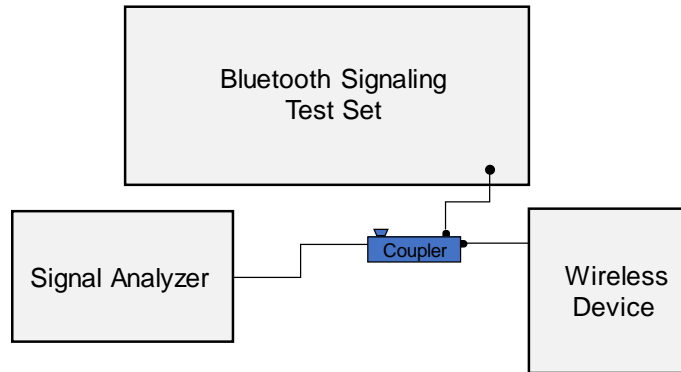

**Figure 9-6  
Power Measurement Setup**

FCC ID: ZNFX320PM		SAR EVALUATION REPORT		Approved by: Quality Manager
Document S/N: 1M1907220127-01.ZNF	Test Dates: 07/22/19 - 08/12/19	DUT Type: Portable Handset		Page 53 of 91



# 10 SYSTEM VERIFICATION

## 10.1 Tissue Verification

**Table 10-1  
Measured Tissue Properties**

Calibrated for Tests Performed on:	Tissue Type	Tissue Temp During Calibration (°C)	Measured Frequency (MHz)	Measured Conductivity, σ (S/m)	Measured Dielectric Constant, ε	TARGET Conductivity, σ (S/m)	TARGET Dielectric Constant, ε	% dev σ	% dev ε
7/29/2019	750H	20.4	680	0.845	42.717	0.888	42.305	-4.84%	0.97%
			695	0.851	42.669	0.889	42.227	-4.27%	1.05%
			700	0.852	42.656	0.889	42.201	-4.16%	1.06%
			710	0.856	42.628	0.890	42.149	-3.82%	1.14%
			720	0.859	42.603	0.891	42.097	-3.59%	1.20%
			725	0.861	42.588	0.891	42.071	-3.37%	1.22%
			740	0.867	42.540	0.893	41.994	-2.91%	1.30%
			755	0.872	42.488	0.894	41.916	-2.46%	1.36%
			770	0.878	42.437	0.895	41.838	-1.90%	1.43%
			785	0.884	42.390	0.896	41.760	-1.34%	1.51%
7/30/2019	835H	20.4	820	0.896	42.295	0.899	41.578	-0.33%	1.72%
			835	0.901	42.255	0.900	41.500	0.11%	1.82%
			850	0.907	42.214	0.916	41.500	-0.96%	1.72%
8/7/2019	835H	21.4	820	0.920	42.338	0.899	41.578	2.34%	1.83%
			835	0.926	42.299	0.900	41.500	2.89%	1.93%
			850	0.932	42.260	0.916	41.500	1.75%	1.83%
8/7/2019	1750H	21.4	1710	1.346	40.502	1.348	40.142	-0.15%	0.90%
			1750	1.370	40.408	1.371	40.079	-0.07%	0.87%
7/22/2019	1900H	21.3	1790	1.391	40.357	1.394	40.016	-0.22%	0.85%
			1850	1.414	39.864	1.400	40.000	1.00%	-0.34%
			1880	1.431	39.822	1.400	40.000	2.21%	-0.44%
7/25/2019	1900H	20.1	1910	1.451	39.791	1.400	40.000	3.64%	-0.52%
			1850	1.395	39.540	1.400	40.000	-0.36%	-1.15%
			1880	1.413	39.502	1.400	40.000	0.83%	-1.24%
8/6/2019	1900H	23.0	1910	1.430	39.474	1.400	40.000	2.14%	-1.32%
			1850	1.380	41.630	1.400	40.000	-1.43%	4.08%
			1880	1.412	41.503	1.400	40.000	0.86%	3.76%
7/23/2019	2450H	22.0	1910	1.444	41.381	1.400	40.000	3.14%	3.45%
			2400	1.788	37.713	1.756	39.289	1.82%	-4.01%
			2450	1.825	37.642	1.800	39.200	1.39%	-3.97%
			2500	1.861	37.560	1.855	39.136	0.32%	-4.00%
			2550	1.903	37.471	1.909	39.073	-0.31%	-4.10%
			2600	1.941	37.380	1.964	39.009	-1.17%	-4.16%
			2650	1.982	37.296	2.018	38.945	-1.78%	-4.23%
			2700	2.019	37.218	2.073	38.882	-2.60%	-4.28%
			2400	1.752	37.998	1.756	39.289	-0.23%	-3.29%
			2450	1.787	37.912	1.800	39.200	-0.72%	-3.25%
7/26/2019	2450H	22.8	2500	1.825	37.840	1.855	39.136	-1.62%	-3.31%
			2550	1.861	37.750	1.909	39.073	-2.51%	-3.39%
			2600	1.900	37.681	1.964	39.009	-3.26%	-3.40%
			2650	1.937	37.600	2.018	38.945	-4.01%	-3.49%
8/7/2019	2450H	21.7	2700	1.976	37.516	2.073	38.882	-4.68%	-3.51%
			2400	1.762	38.029	1.756	39.289	0.34%	-3.21%
			2450	1.802	37.944	1.800	39.200	0.11%	-3.20%
			2500	1.842	37.863	1.855	39.136	-0.70%	-3.16%
7/23/2019	750B	22.7	680	0.916	56.234	0.958	55.804	-4.38%	0.77%
			695	0.921	56.192	0.959	55.745	-3.96%	0.80%
			700	0.923	56.176	0.959	55.726	-3.73%	0.81%
			710	0.926	56.151	0.960	55.687	-3.54%	0.83%
			720	0.930	56.134	0.961	55.648	-3.23%	0.87%
			725	0.932	56.123	0.961	55.629	-3.02%	0.89%
			740	0.937	56.095	0.963	55.570	-2.70%	0.94%
			755	0.943	56.063	0.964	55.512	-2.18%	0.99%
			770	0.948	56.036	0.965	55.453	-1.76%	1.03%
			785	0.954	55.981	0.966	55.395	-1.24%	1.06%
7/25/2019	835B	20.6	820	0.953	54.329	0.969	55.258	-1.65%	-1.68%
			835	0.959	54.297	0.970	55.200	-1.13%	-1.64%
			850	0.965	54.256	0.988	55.154	-2.33%	-1.63%
7/29/2019	835B	21.6	820	0.995	53.754	0.969	55.258	2.68%	-2.72%
			835	1.001	53.721	0.970	55.200	3.20%	-2.68%
			850	1.006	53.677	0.988	55.154	1.82%	-2.68%
7/31/2019	835B	20.8	820	1.003	54.511	0.969	55.258	3.51%	-1.35%
			835	1.009	54.471	0.970	55.200	4.02%	-1.32%
			850	1.014	54.421	0.988	55.154	2.63%	-1.33%
7/24/2019	1750B	21.3	1710	1.466	51.748	1.463	53.537	0.21%	-3.34%
			1750	1.509	51.575	1.468	53.432	1.41%	-3.46%
			1790	1.551	51.409	1.514	53.326	2.44%	-3.55%
			1710	1.457	53.108	1.463	53.537	-0.41%	-0.80%
8/7/2019	1750B	21.1	1750	1.486	53.046	1.488	53.432	-0.13%	-0.72%
			1790	1.515	52.973	1.514	53.326	0.07%	-0.66%
			1850	1.484	52.299	1.520	53.300	-1.71%	-1.88%
7/29/2019	1900B	23.5	1880	1.530	52.300	1.520	53.300	0.66%	-2.68%
			1910	1.563	52.136	1.520	53.300	2.83%	-2.18%
			1850	1.504	53.836	1.520	53.300	-1.05%	1.01%
7/31/2019	1900B	23.9	1880	1.537	53.726	1.520	53.300	1.12%	0.80%
			1910	1.569	53.643	1.520	53.300	3.22%	0.64%
			1850	1.519	52.283	1.520	53.300	-0.07%	-1.91%
8/12/2019	1900B	23.2	1880	1.564	52.179	1.520	53.300	2.24%	-2.10%
			1910	1.587	52.080	1.520	53.300	4.41%	-2.29%
			2400	1.980	51.827	1.902	52.767	4.10%	-1.78%
			2450	2.047	51.621	1.950	52.700	4.97%	-2.05%
8/5/2019	2450B	21.8	2500	2.118	51.416	2.021	52.636	4.80%	-2.32%
			2550	2.186	51.219	2.092	52.573	4.49%	-2.58%
			2600	2.256	51.030	2.163	52.509	4.30%	-2.84%
			2650	2.324	50.826	2.234	52.445	4.03%	-3.05%
			2700	2.396	50.614	2.305	52.382	3.95%	-3.38%
8/7/2019	2450B	23.9	2400	1.874	52.648	1.902	52.767	-1.47%	-0.23%
			2450	1.940	52.495	1.950	52.700	-0.51%	-0.39%
			2500	2.009	52.340	2.021	52.636	-0.59%	-0.56%

The above measured tissue parameters were used in the DASY software. The DASY software was used to perform interpolation to determine the dielectric parameters at the SAR test device frequencies (per KDB Publication 865664 D01v01r04 and IEEE 1528-2013 6.6.1.2). The tissue parameters listed in the SAR test plots may slightly differ from the table above due to significant digit rounding in the software.

FCC ID: ZNFX320PM		SAR EVALUATION REPORT		Approved by: Quality Manager
Document S/N: 1M1907220127-01.ZNF	Test Dates: 07/22/19 - 08/12/19	DUT Type: Portable Handset		Page 54 of 91

## 10.2 Test System Verification

Prior to SAR assessment, the system is verified to  $\pm 10\%$  of the SAR measurement on the reference dipole at the time of calibration by the calibration facility. Full system validation status and result summary can be found in Appendix E.

**Table 10-2  
System Verification Results**

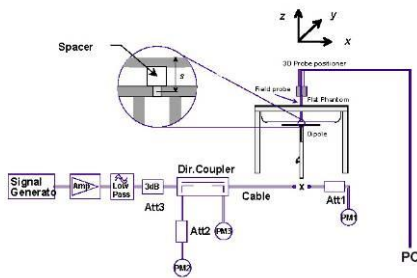

SAR System #	Tissue Frequency (MHz)	Tissue Type	Date	Amb. Temp (°C)	Liquid Temp (°C)	Input Power (W)	Source SN	Probe SN	Measured SAR <sub>1g</sub> (W/kg)	1 W Target SAR <sub>1g</sub> (W/kg)	1 W Normalized SAR <sub>1g</sub> (W/kg)	Deviation <sub>1g</sub> (%)
E	750	HEAD	07/29/2019	21.2	20.4	0.200	1003	3589	1.540	8.280	7.700	-7.00%
E	835	HEAD	07/30/2019	22.9	20.4	0.200	4d132	3589	1.960	9.590	9.800	2.19%
O	835	HEAD	08/07/2019	20.5	20.7	0.200	4d047	7538	1.980	9.420	9.900	5.10%
O	1750	HEAD	08/07/2019	20.5	20.7	0.100	1148	7538	3.700	37.000	37.000	0.00%
G	1900	HEAD	07/22/2019	21.6	21.3	0.100	5d148	7409	4.130	39.100	41.300	5.63%
H	1900	HEAD	07/25/2019	21.2	20.1	0.100	5d080	7406	4.270	39.800	42.700	7.29%
D	1900	HEAD	08/06/2019	23.2	22.6	0.100	5d080	3914	4.210	39.800	42.100	5.78%
E	2450	HEAD	07/26/2019	21.6	21.3	0.100	797	3589	5.300	52.700	53.000	0.57%
E	2450	HEAD	08/07/2019	23.8	21.7	0.100	797	7547	5.620	52.700	56.200	6.64%
E	2600	HEAD	07/23/2019	22.1	21.0	0.100	1126	3589	5.690	54.500	56.900	4.40%
G	750	BODY	07/23/2019	23.2	22.7	0.200	1003	7409	1.700	8.580	8.500	-0.93%
O	835	BODY	07/25/2019	20.5	20.6	0.200	4d047	7538	2.020	9.470	10.100	6.65%
O	835	BODY	07/29/2019	20.5	20.6	0.200	4d047	7538	2.060	9.470	10.300	8.76%
O	835	BODY	07/31/2019	20.5	20.8	0.200	4d047	7538	2.020	9.470	10.100	6.65%
I	1750	BODY	07/24/2019	23.0	21.3	0.100	1150	7357	3.550	36.600	35.500	-3.01%
G	1750	BODY	08/07/2019	22.0	21.1	0.100	1148	7409	3.990	37.700	39.900	5.84%
J	1900	BODY	07/29/2019	20.7	23.5	0.100	5d080	7488	4.100	39.200	41.000	4.59%
J	1900	BODY	07/31/2019	20.5	23.9	0.100	5d080	7488	4.140	39.200	41.400	5.61%
J	1900	BODY	08/12/2019	20.0	21.3	0.100	5d080	7488	4.160	39.200	41.600	6.12%
I	2450	BODY	08/05/2019	20.6	21.0	0.100	797	7357	5.120	51.100	51.200	0.20%
I	2450	BODY	08/07/2019	24.9	23.8	0.100	719	7357	5.400	50.100	54.000	7.78%
I	2600	BODY	08/05/2019	20.6	21.0	0.100	1004	7357	5.550	54.800	55.500	1.28%



**Figure 10-1  
System Verification Setup Diagram**



**Figure 10-2  
System Verification Setup Photo**

FCC ID: ZNFX320PM		SAR EVALUATION REPORT		Approved by: Quality Manager
Document S/N: 1M1907220127-01.ZNF	Test Dates: 07/22/19 - 08/12/19	DUT Type: Portable Handset		Page 55 of 91

# 11 SAR DATA SUMMARY



## 11.1 Standalone Head SAR Data

**Table 11-1  
GSM 850 Head SAR**

MEASUREMENT RESULTS															
FREQUENCY		Mode	Service	Maximum Allowed Power [dBm]	Conducted Power [dBm]	Power Drift [dB]	Side	Test Position	Device Serial Number	# of Time Slots	Duty Cycle	SAR (1g)	Scaling Factor	Reported SAR (1g)	Plot #
MHz	Ch.											(W/kg)		(W/kg)	
836.60	190	GSM 850	GSM	33.6	33.48	-0.01	Right	Cheek	04963	1	1:8.3	0.226	1.028	0.232	
836.60	190	GSM 850	GSM	33.6	33.48	-0.01	Right	Tilt	04963	1	1:8.3	0.123	1.028	0.126	
836.60	190	GSM 850	GSM	33.6	33.48	-0.01	Left	Cheek	04963	1	1:8.3	0.196	1.028	0.201	
836.60	190	GSM 850	GSM	33.6	33.48	0.05	Left	Tilt	04963	1	1:8.3	0.123	1.028	0.126	
836.60	190	GSM 850	GPRS	31.0	30.85	-0.02	Right	Cheek	04963	2	1:4.15	0.309	1.035	0.320	A1
836.60	190	GSM 850	GPRS	31.0	30.85	0.04	Right	Tilt	04963	2	1:4.15	0.193	1.035	0.200	
836.60	190	GSM 850	GPRS	31.0	30.85	0.04	Left	Cheek	04963	2	1:4.15	0.283	1.035	0.293	
836.60	190	GSM 850	GPRS	31.0	30.85	0.05	Left	Tilt	04963	2	1:4.15	0.183	1.035	0.189	
ANSI / IEEE C95.1 1992 - SAFETY LIMIT Spatial Peak Uncontrolled Exposure/General Population							Head 1.6 W/kg (mW/g) averaged over 1 gram								

**Table 11-2  
GSM 1900 Head SAR**

MEASUREMENT RESULTS															
FREQUENCY		Mode	Service	Maximum Allowed Power [dBm]	Conducted Power [dBm]	Power Drift [dB]	Side	Test Position	Device Serial Number	# of Time Slots	Duty Cycle	SAR (1g)	Scaling Factor	Reported SAR (1g)	Plot #
MHz	Ch.											(W/kg)		(W/kg)	
1880.00	661	GSM 1900	GSM	30.8	30.37	0.03	Right	Cheek	04963	1	1:8.3	0.143	1.104	0.158	
1880.00	661	GSM 1900	GSM	30.8	30.37	0.00	Right	Tilt	04963	1	1:8.3	0.119	1.104	0.131	
1880.00	661	GSM 1900	GSM	30.8	30.37	0.04	Left	Cheek	04963	1	1:8.3	0.273	1.104	0.301	
1880.00	661	GSM 1900	GSM	30.8	30.37	0.07	Left	Tilt	04963	1	1:8.3	0.120	1.104	0.132	
1880.00	661	GSM 1900	GPRS	28.0	27.62	-0.06	Right	Cheek	04963	2	1:4.15	0.162	1.091	0.177	
1880.00	661	GSM 1900	GPRS	28.0	27.62	0.05	Right	Tilt	04963	2	1:4.15	0.136	1.091	0.148	
1880.00	661	GSM 1900	GPRS	28.0	27.62	0.01	Left	Cheek	04963	2	1:4.15	0.312	1.091	0.340	A2
1880.00	661	GSM 1900	GPRS	28.0	27.62	-0.01	Left	Tilt	04963	2	1:4.15	0.126	1.091	0.137	
ANSI / IEEE C95.1 1992 - SAFETY LIMIT Spatial Peak Uncontrolled Exposure/General Population							Head 1.6 W/kg (mW/g) averaged over 1 gram								

FCC ID: ZNFX320PM		SAR EVALUATION REPORT		Approved by: Quality Manager
Document S/N: 1M1907220127-01.ZNF	Test Dates: 07/22/19 - 08/12/19	DUT Type: Portable Handset	Page 56 of 91	



**Table 11-3  
UMTS 850 Head SAR**



MEASUREMENT RESULTS														
FREQUENCY		Mode	Service	Maximum Allowed Power [dBm]	Conducted Power [dBm]	Power Drift [dB]	Side	Test Position	Device Serial Number	Duty Cycle	SAR (1g)	Scaling Factor	Reported SAR (1g)	Plot #
MHz	Ch.										(W/kg)		(W/kg)	
836.60	4183	UMTS 850	RMC	25.3	25.21	0.00	Right	Cheek	04963	1:1	0.326	1.021	0.333	A3
836.60	4183	UMTS 850	RMC	25.3	25.21	0.01	Right	Tilt	04963	1:1	0.179	1.021	0.183	
836.60	4183	UMTS 850	RMC	25.3	25.21	0.02	Left	Cheek	04963	1:1	0.295	1.021	0.301	
836.60	4183	UMTS 850	RMC	25.3	25.21	0.05	Left	Tilt	04963	1:1	0.184	1.021	0.188	
ANSI / IEEE C95.1 1992 - SAFETY LIMIT Spatial Peak Uncontrolled Exposure/General Population							Head 1.6 W/kg (W/kg) averaged over 1 gram							

**Table 11-4  
UMTS 1750 Head SAR**

MEASUREMENT RESULTS														
FREQUENCY		Mode	Service	Maximum Allowed Power [dBm]	Conducted Power [dBm]	Power Drift [dB]	Side	Test Position	Device Serial Number	Duty Cycle	SAR (1g)	Scaling Factor	Reported SAR (1g)	Plot #
MHz	Ch.										(W/kg)		(W/kg)	
1732.40	1412	UMTS 1750	RMC	24.8	24.73	0.11	Right	Cheek	04964	1:1	0.227	1.016	0.231	
1732.40	1412	UMTS 1750	RMC	24.8	24.73	0.06	Right	Tilt	04964	1:1	0.222	1.016	0.226	
1732.40	1412	UMTS 1750	RMC	24.8	24.73	0.08	Left	Cheek	04964	1:1	0.515	1.016	0.523	A4
1732.40	1412	UMTS 1750	RMC	24.8	24.73	0.17	Left	Tilt	04964	1:1	0.212	1.016	0.215	
ANSI / IEEE C95.1 1992 - SAFETY LIMIT Spatial Peak Uncontrolled Exposure/General Population							Head 1.6 W/kg (mW/g) averaged over 1 gram							

**Table 11-5  
UMTS 1900 Head SAR**

MEASUREMENT RESULTS														
FREQUENCY		Mode	Service	Maximum Allowed Power [dBm]	Conducted Power [dBm]	Power Drift [dB]	Side	Test Position	Device Serial Number	Duty Cycle	SAR (1g)	Scaling Factor	Reported SAR (1g)	Plot #
MHz	Ch.										(W/kg)		(W/kg)	
1880.00	9400	UMTS 1900	RMC	24.8	24.76	0.01	Right	Cheek	04963	1:1	0.295	1.009	0.298	
1880.00	9400	UMTS 1900	RMC	24.8	24.76	0.00	Right	Tilt	04963	1:1	0.249	1.009	0.251	
1852.40	9262	UMTS 1900	RMC	24.8	24.76	-0.03	Left	Cheek	04963	1:1	0.619	1.009	0.625	A5
1880.00	9400	UMTS 1900	RMC	24.8	24.76	-0.01	Left	Cheek	04963	1:1	0.605	1.009	0.610	
1907.60	9538	UMTS 1900	RMC	24.8	24.80	-0.04	Left	Cheek	04963	1:1	0.566	1.000	0.566	
1880.00	9400	UMTS 1900	RMC	24.8	24.76	0.01	Left	Tilt	04963	1:1	0.249	1.009	0.251	
ANSI / IEEE C95.1 1992 - SAFETY LIMIT Spatial Peak Uncontrolled Exposure/General Population							Head 1.6 W/kg (mW/g) averaged over 1 gram							



FCC ID: ZNFX320PM		SAR EVALUATION REPORT		Approved by: Quality Manager
Document S/N: 1M1907220127-01.ZNF	Test Dates: 07/22/19 - 08/12/19	DUT Type: Portable Handset	Page 57 of 91	

**Table 11-6  
CDMA BC10 (§90S) Head SAR**

MEASUREMENT RESULTS														
FREQUENCY		Mode	Service	Maximum Allowed Power [dBm]	Conducted Power [dBm]	Power Drift [dB]	Side	Test Position	Device Serial Number	Duty Cycle	SAR (1g)	Scaling Factor	Reported SAR (1g)	Plot #
MHz	Ch.										(W/kg)		(W/kg)	
820.10	564	CDMA BC10 (§90S)	RC3 / SO55	25.3	25.12	-0.01	Right	Cheek	04963	1:1	0.399	1.042	0.416	A6
820.10	564	CDMA BC10 (§90S)	RC3 / SO55	25.3	25.12	0.04	Right	Tilt	04963	1:1	0.234	1.042	0.244	
820.10	564	CDMA BC10 (§90S)	RC3 / SO55	25.3	25.12	0.01	Left	Cheek	04963	1:1	0.371	1.042	0.387	
820.10	564	CDMA BC10 (§90S)	RC3 / SO55	25.3	25.12	0.01	Left	Tilt	04963	1:1	0.248	1.042	0.258	
820.10	564	CDMA BC10 (§90S)	EVDO Rev. A	25.3	24.98	-0.03	Right	Cheek	04963	1:1	0.380	1.076	0.409	
820.10	564	CDMA BC10 (§90S)	EVDO Rev. A	25.3	24.98	-0.02	Right	Tilt	04963	1:1	0.254	1.076	0.273	
820.10	564	CDMA BC10 (§90S)	EVDO Rev. A	25.3	24.98	-0.08	Left	Cheek	04963	1:1	0.360	1.076	0.387	
820.10	564	CDMA BC10 (§90S)	EVDO Rev. A	25.3	24.98	0.10	Left	Tilt	04963	1:1	0.221	1.076	0.238	
ANSI / IEEE C95.1 1992 - SAFETY LIMIT Spatial Peak Uncontrolled Exposure/General Population								Head 1.6 W/kg (mW/g) averaged over 1 gram						

**Table 11-7  
CDMA BC0 (§22H) Head SAR**

MEASUREMENT RESULTS														
FREQUENCY		Mode	Service	Maximum Allowed Power [dBm]	Conducted Power [dBm]	Power Drift [dB]	Side	Test Position	Device Serial Number	Duty Cycle	SAR (1g)	Scaling Factor	Reported SAR (1g)	Plot #
MHz	Ch.										(W/kg)		(W/kg)	
836.52	384	CDMA BC0 (§22H)	RC3 / SO55	25.3	25.13	0.05	Right	Cheek	04963	1:1	0.323	1.040	0.336	A7
836.52	384	CDMA BC0 (§22H)	RC3 / SO55	25.3	25.13	0.08	Right	Tilt	04963	1:1	0.172	1.040	0.179	
836.52	384	CDMA BC0 (§22H)	RC3 / SO55	25.3	25.13	-0.03	Left	Cheek	04963	1:1	0.297	1.040	0.309	
836.52	384	CDMA BC0 (§22H)	RC3 / SO55	25.3	25.13	-0.02	Left	Tilt	04963	1:1	0.187	1.040	0.194	
836.52	384	CDMA BC0 (§22H)	EVDO Rev. A	25.3	25.02	0.15	Right	Cheek	04963	1:1	0.311	1.067	0.332	
836.52	384	CDMA BC0 (§22H)	EVDO Rev. A	25.3	25.02	-0.03	Right	Tilt	04963	1:1	0.177	1.067	0.189	
836.52	384	CDMA BC0 (§22H)	EVDO Rev. A	25.3	25.02	-0.05	Left	Cheek	04963	1:1	0.289	1.067	0.308	
836.52	384	CDMA BC0 (§22H)	EVDO Rev. A	25.3	25.02	0.06	Left	Tilt	04963	1:1	0.173	1.067	0.185	
ANSI / IEEE C95.1 1992 - SAFETY LIMIT Spatial Peak Uncontrolled Exposure/General Population								Head 1.6 W/kg (mW/g) averaged over 1 gram						



FCC ID: ZNFX320PM		SAR EVALUATION REPORT		Approved by: Quality Manager
Document S/N: 1M1907220127-01.ZNF	Test Dates: 07/22/19 - 08/12/19	DUT Type: Portable Handset	Page 58 of 91	

**Table 11-8  
PCS CDMA Head SAR**

MEASUREMENT RESULTS														
FREQUENCY		Mode	Service	Maximum Allowed Power [dBm]	Conducted Power [dBm]	Power Drift [dB]	Side	Test Position	Device Serial Number	Duty Cycle	SAR (1g)	Scaling Factor	Reported SAR (1g)	Plot #
MHz	Ch.										(W/kg)		(W/kg)	
1880.00	600	PCS CDMA	RC3 / SO55	24.8	24.57	0.00	Right	Cheek	04963	1:1	0.321	1.054	0.338	
1880.00	600	PCS CDMA	RC3 / SO55	24.8	24.57	-0.01	Right	Tilt	04963	1:1	0.251	1.054	0.265	
1851.25	25	PCS CDMA	RC3 / SO55	24.8	24.52	0.07	Left	Cheek	04963	1:1	0.664	1.067	0.708	
1880.00	600	PCS CDMA	RC3 / SO55	24.8	24.57	0.14	Left	Cheek	04963	1:1	0.657	1.054	0.692	
1908.75	1175	PCS CDMA	RC3 / SO55	24.8	24.60	0.08	Left	Cheek	04963	1:1	0.600	1.047	0.628	
1880.00	600	PCS CDMA	RC3 / SO55	24.8	24.57	0.14	Left	Tilt	04963	1:1	0.273	1.054	0.288	
1880.00	600	PCS CDMA	EVDO Rev. A	24.8	24.49	0.06	Right	Cheek	04963	1:1	0.296	1.074	0.318	
1880.00	600	PCS CDMA	EVDO Rev. A	24.8	24.49	-0.10	Right	Tilt	04963	1:1	0.250	1.074	0.269	
1851.25	25	PCS CDMA	EVDO Rev. A	24.8	24.52	0.01	Left	Cheek	04963	1:1	0.671	1.067	0.716	A8
1880.00	600	PCS CDMA	EVDO Rev. A	24.8	24.49	0.04	Left	Cheek	04963	1:1	0.647	1.074	0.695	
1908.75	1175	PCS CDMA	EVDO Rev. A	24.8	24.52	0.04	Left	Cheek	04963	1:1	0.606	1.067	0.647	
1880.00	600	PCS CDMA	EVDO Rev. A	24.8	24.49	0.02	Left	Tilt	04963	1:1	0.272	1.074	0.292	
ANSI / IEEE C95.1 1992 - SAFETY LIMIT Spatial Peak Uncontrolled Exposure/General Population								Head 1.6 W/kg (mW/g) averaged over 1 gram						

**Table 11-9  
LTE Band 71 Head SAR**

MEASUREMENT RESULTS																			
FREQUENCY		Mode	Bandwidth [MHz]	Maximum Allowed Power [dBm]	Conducted Power [dBm]	Power Drift [dB]	MPR [dB]	Side	Test Position	Modulation	RB Size	RB Offset	Device Serial Number	Duty Cycle	SAR (1g)	Scaling Factor	Reported SAR (1g)	Plot #	
MHz	Ch.														(W/kg)		(W/kg)		
680.50	133297	Mid	LTE Band 71	20	25.3	24.95	0.07	0	Right	Cheek	QPSK	1	50	04966	1:1	0.185	1.084	0.201	A9
680.50	133297	Mid	LTE Band 71	20	24.3	24.04	0.07	1	Right	Cheek	QPSK	50	25	04966	1:1	0.150	1.062	0.159	
680.50	133297	Mid	LTE Band 71	20	25.3	24.95	0.05	0	Right	Tilt	QPSK	1	50	04966	1:1	0.089	1.084	0.096	
680.50	133297	Mid	LTE Band 71	20	24.3	24.04	0.05	1	Right	Tilt	QPSK	50	25	04966	1:1	0.076	1.062	0.081	
680.50	133297	Mid	LTE Band 71	20	25.3	24.95	0.00	0	Left	Cheek	QPSK	1	50	04966	1:1	0.155	1.084	0.168	
680.50	133297	Mid	LTE Band 71	20	24.3	24.04	0.09	1	Left	Cheek	QPSK	50	25	04966	1:1	0.123	1.062	0.131	
680.50	133297	Mid	LTE Band 71	20	25.3	24.95	0.11	0	Left	Tilt	QPSK	1	50	04966	1:1	0.079	1.084	0.086	
680.50	133297	Mid	LTE Band 71	20	24.3	24.04	0.15	1	Left	Tilt	QPSK	50	25	04966	1:1	0.064	1.062	0.068	
ANSI / IEEE C95.1 1992 - SAFETY LIMIT Spatial Peak Uncontrolled Exposure/General Population										Head 1.6 W/kg (mW/g) averaged over 1 gram									

FCC ID: ZNFX320PM		<b>SAR EVALUATION REPORT</b>		Approved by: Quality Manager
Document S/N: 1M1907220127-01.ZNF	Test Dates: 07/22/19 - 08/12/19	DUT Type: Portable Handset	Page 59 of 91	

**Table 11-10  
LTE Band 12 Head SAR**



MEASUREMENT RESULTS																			
FREQUENCY		Mode	Bandwidth [MHz]	Maximum Allowed Power [dBm]	Conducted Power [dBm]	Power Drift [dB]	MPR [dB]	Side	Test Position	Modulation	RB Size	RB Offset	Device Serial Number	Duty Cycle	SAR (1g)	Scaling Factor	Reported SAR (1g)	Plot #	
MHz	Ch.														(W/kg)		(W/kg)		
707.50	23095	Mid	LTE Band 12	10	25.3	24.98	0.05	0	Right	Cheek	QPSK	1	25	04966	1:1	0.248	1.076	0.267	A10
707.50	23095	Mid	LTE Band 12	10	24.3	24.08	0.05	1	Right	Cheek	QPSK	25	0	04966	1:1	0.203	1.052	0.214	
707.50	23095	Mid	LTE Band 12	10	25.3	24.98	0.03	0	Right	Tilt	QPSK	1	25	04966	1:1	0.134	1.076	0.144	
707.50	23095	Mid	LTE Band 12	10	24.3	24.08	-0.20	1	Right	Tilt	QPSK	25	0	04966	1:1	0.113	1.052	0.119	
707.50	23095	Mid	LTE Band 12	10	25.3	24.98	0.05	0	Left	Cheek	QPSK	1	25	04966	1:1	0.247	1.076	0.266	
707.50	23095	Mid	LTE Band 12	10	24.3	24.08	0.08	1	Left	Cheek	QPSK	25	0	04966	1:1	0.186	1.052	0.196	
707.50	23095	Mid	LTE Band 12	10	25.3	24.98	-0.04	0	Left	Tilt	QPSK	1	25	04966	1:1	0.153	1.076	0.165	
707.50	23095	Mid	LTE Band 12	10	24.3	24.08	0.06	1	Left	Tilt	QPSK	25	0	04966	1:1	0.110	1.052	0.116	
ANSI / IEEE C95.1 1992 - SAFETY LIMIT Spatial Peak Uncontrolled Exposure/General Population										Head 1.6 W/kg (mW/g) averaged over 1 gram									

**Table 11-11  
LTE Band 13 Head SAR**

MEASUREMENT RESULTS																			
FREQUENCY		Mode	Bandwidth [MHz]	Maximum Allowed Power [dBm]	Conducted Power [dBm]	Power Drift [dB]	MPR [dB]	Side	Test Position	Modulation	RB Size	RB Offset	Device Serial Number	Duty Cycle	SAR (1g)	Scaling Factor	Reported SAR (1g)	Plot #	
MHz	Ch.														(W/kg)		(W/kg)		
782.00	23230	Mid	LTE Band 13	10	25.3	25.18	-0.02	0	Right	Cheek	QPSK	1	25	04966	1:1	0.308	1.028	0.317	A11
782.00	23230	Mid	LTE Band 13	10	24.3	24.26	0.13	1	Right	Cheek	QPSK	25	12	04966	1:1	0.267	1.009	0.269	
782.00	23230	Mid	LTE Band 13	10	25.3	25.18	-0.01	0	Right	Tilt	QPSK	1	25	04966	1:1	0.173	1.028	0.178	
782.00	23230	Mid	LTE Band 13	10	24.3	24.26	0.06	1	Right	Tilt	QPSK	25	12	04966	1:1	0.140	1.009	0.141	
782.00	23230	Mid	LTE Band 13	10	25.3	25.18	0.06	0	Left	Cheek	QPSK	1	25	04966	1:1	0.255	1.028	0.262	
782.00	23230	Mid	LTE Band 13	10	24.3	24.26	0.13	1	Left	Cheek	QPSK	25	12	04966	1:1	0.220	1.009	0.222	
782.00	23230	Mid	LTE Band 13	10	25.3	25.18	0.08	0	Left	Tilt	QPSK	1	25	04966	1:1	0.160	1.028	0.164	
782.00	23230	Mid	LTE Band 13	10	24.3	24.26	0.12	1	Left	Tilt	QPSK	25	12	04966	1:1	0.132	1.009	0.133	
ANSI / IEEE C95.1 1992 - SAFETY LIMIT Spatial Peak Uncontrolled Exposure/General Population										Head 1.6 W/kg (mW/g) averaged over 1 gram									

**Table 11-12  
LTE Band 26 (Cell) Head SAR**

MEASUREMENT RESULTS																			
FREQUENCY		Mode	Bandwidth [MHz]	Maximum Allowed Power [dBm]	Conducted Power [dBm]	Power Drift [dB]	MPR [dB]	Side	Test Position	Modulation	RB Size	RB Offset	Device Serial Number	Duty Cycle	SAR (1g)	Scaling Factor	Reported SAR (1g)	Plot #	
MHz	Ch.														(W/kg)		(W/kg)		
831.50	26865	Mid	LTE Band 26 (Cell)	15	25.3	25.14	0.00	0	Right	Cheek	QPSK	1	36	04966	1:1	0.433	1.038	0.449	A12
831.50	26865	Mid	LTE Band 26 (Cell)	15	24.3	24.29	0.04	1	Right	Cheek	QPSK	36	18	04966	1:1	0.353	1.002	0.354	
831.50	26865	Mid	LTE Band 26 (Cell)	15	25.3	25.14	-0.05	0	Right	Tilt	QPSK	1	36	04966	1:1	0.260	1.038	0.270	
831.50	26865	Mid	LTE Band 26 (Cell)	15	24.3	24.29	-0.16	1	Right	Tilt	QPSK	36	18	04966	1:1	0.201	1.002	0.201	
831.50	26865	Mid	LTE Band 26 (Cell)	15	25.3	25.14	0.03	0	Left	Cheek	QPSK	1	36	04966	1:1	0.381	1.038	0.395	
831.50	26865	Mid	LTE Band 26 (Cell)	15	24.3	24.29	0.05	1	Left	Cheek	QPSK	36	18	04966	1:1	0.297	1.002	0.298	
831.50	26865	Mid	LTE Band 26 (Cell)	15	25.3	25.14	0.03	0	Left	Tilt	QPSK	1	36	04966	1:1	0.275	1.038	0.285	
831.50	26865	Mid	LTE Band 26 (Cell)	15	24.3	24.29	0.02	1	Left	Tilt	QPSK	36	18	04966	1:1	0.208	1.002	0.208	
ANSI / IEEE C95.1 1992 - SAFETY LIMIT Spatial Peak Uncontrolled Exposure/General Population										Head 1.6 W/kg (mW/g) averaged over 1 gram									



FCC ID: ZNFX320PM		SAR EVALUATION REPORT		Approved by: Quality Manager
Document S/N: 1M1907220127-01.ZNF	Test Dates: 07/22/19 - 08/12/19	DUT Type: Portable Handset	Page 60 of 91	

**Table 11-13  
LTE Band 66 (AWS) Head SAR**

MEASUREMENT RESULTS																			
FREQUENCY		Mode	Bandwidth [MHz]	Maximum Allowed Power [dBm]	Conducted Power [dBm]	Power Drift [dB]	MPR [dB]	Side	Test Position	Modulation	RB Size	RB Offset	Device Serial Number	Duty Cycle	SAR (1g)	Scaling Factor	Reported SAR (1g)	Plot #	
MHz	Ch.														(W/kg)		(W/kg)		
1745.00	132322	Mid	LTE Band 66 (AWS)	20	24.8	24.78	0.03	0	Right	Cheek	QPSK	1	50	04967	1:1	0.265	1.005	0.266	
1745.00	132322	Mid	LTE Band 66 (AWS)	20	23.8	23.74	0.03	1	Right	Cheek	QPSK	50	25	04967	1:1	0.205	1.014	0.208	
1745.00	132322	Mid	LTE Band 66 (AWS)	20	24.8	24.78	0.03	0	Right	Tilt	QPSK	1	50	04967	1:1	0.264	1.005	0.265	
1745.00	132322	Mid	LTE Band 66 (AWS)	20	23.8	23.74	0.05	1	Right	Tilt	QPSK	50	25	04967	1:1	0.207	1.014	0.210	
1745.00	132322	Mid	LTE Band 66 (AWS)	20	24.8	24.78	0.17	0	Left	Cheek	QPSK	1	50	04967	1:1	0.563	1.005	0.566	A13
1745.00	132322	Mid	LTE Band 66 (AWS)	20	23.8	23.74	0.09	1	Left	Cheek	QPSK	50	25	04967	1:1	0.450	1.014	0.456	
1745.00	132322	Mid	LTE Band 66 (AWS)	20	24.8	24.78	0.04	0	Left	Tilt	QPSK	1	50	04967	1:1	0.246	1.005	0.247	
1745.00	132322	Mid	LTE Band 66 (AWS)	20	23.8	23.74	0.08	1	Left	Tilt	QPSK	50	25	04967	1:1	0.192	1.014	0.195	
ANSI / IEEE C95.1 1992 - SAFETY LIMIT Spatial Peak Uncontrolled Exposure/General Population									Head 1.6 W/kg (mW/g) averaged over 1 gram										

**Table 11-14  
LTE Band 25 (PCS) Head SAR**

MEASUREMENT RESULTS																			
FREQUENCY		Mode	Bandwidth [MHz]	Maximum Allowed Power [dBm]	Conducted Power [dBm]	Power Drift [dB]	MPR [dB]	Side	Test Position	Modulation	RB Size	RB Offset	Device Serial Number	Duty Cycle	SAR (1g)	Scaling Factor	Reported SAR (1g)	Plot #	
MHz	Ch.														(W/kg)		(W/kg)		
1882.50	26365	Mid	LTE Band 25 (PCS)	20	24.8	24.74	0.13	0	Right	Cheek	QPSK	1	50	04966	1:1	0.365	1.014	0.370	
1905.00	26590	High	LTE Band 25 (PCS)	20	23.8	23.80	0.03	1	Right	Cheek	QPSK	50	0	04966	1:1	0.293	1.000	0.293	
1882.50	26365	Mid	LTE Band 25 (PCS)	20	24.8	24.74	0.00	0	Right	Tilt	QPSK	1	50	04966	1:1	0.247	1.014	0.250	
1905.00	26590	High	LTE Band 25 (PCS)	20	23.8	23.80	0.09	1	Right	Tilt	QPSK	50	0	04966	1:1	0.218	1.000	0.218	
1860.00	26140	Low	LTE Band 25 (PCS)	20	24.8	24.64	0.12	0	Left	Cheek	QPSK	1	50	04966	1:1	0.733	1.038	0.761	
1882.50	26365	Mid	LTE Band 25 (PCS)	20	24.8	24.74	-0.08	0	Left	Cheek	QPSK	1	50	04966	1:1	0.769	1.014	0.780	A14
1905.00	26590	High	LTE Band 25 (PCS)	20	24.8	24.73	-0.03	0	Left	Cheek	QPSK	1	50	04966	1:1	0.701	1.016	0.712	
1905.00	26590	High	LTE Band 25 (PCS)	20	23.8	23.80	0.17	1	Left	Cheek	QPSK	50	0	04966	1:1	0.546	1.000	0.546	
1882.50	26365	Mid	LTE Band 25 (PCS)	20	24.8	24.74	0.00	0	Left	Tilt	QPSK	1	50	04966	1:1	0.267	1.014	0.271	
1905.00	26590	High	LTE Band 25 (PCS)	20	23.8	23.80	0.06	1	Left	Tilt	QPSK	50	0	04966	1:1	0.196	1.000	0.196	
ANSI / IEEE C95.1 1992 - SAFETY LIMIT Spatial Peak Uncontrolled Exposure/General Population									Head 1.6 W/kg (mW/g) averaged over 1 gram										

FCC ID: ZNFX320PM		<b>SAR EVALUATION REPORT</b>		<b>Approved by:</b> Quality Manager
<b>Document S/N:</b> 1M1907220127-01.ZNF	<b>Test Dates:</b> 07/22/19 - 08/12/19	<b>DUT Type:</b> Portable Handset	Page 61 of 91	

**Table 11-15  
LTE Band 41 Head SAR**

MEASUREMENT RESULTS																				
Power Class	FREQUENCY		Mode	Bandwidth [MHz]	Maximum Allowed Power [dBm]	Conducted Power [dBm]	Power Drift [dB]	MPR [dB]	Side	Test Position	Modulation	RB Size	RB Offset	Device Serial Number	Duty Cycle	SAR (1g)	Scaling Factor	Reported SAR (1g)	Plot #	
	MHz	Ch.														(W/kg)		(W/kg)		
Power Class 3	2593.00	40620	Mod	LTE Band 41	20	24.8	24.79	-0.08	0	Right	Cheek	QPSK	1	50	04967	1:1.58	0.112	1.002	0.112	
Power Class 3	2593.00	40620	Mod	LTE Band 41	20	23.8	23.74	0.08	1	Right	Cheek	QPSK	50	25	04967	1:1.58	0.090	1.014	0.091	
Power Class 3	2593.00	40620	Mod	LTE Band 41	20	24.8	24.79	0.11	0	Right	Tilt	QPSK	1	50	04967	1:1.58	0.102	1.002	0.102	
Power Class 3	2593.00	40620	Mod	LTE Band 41	20	23.8	23.74	0.14	1	Right	Tilt	QPSK	50	25	04967	1:1.58	0.079	1.014	0.080	
Power Class 3	2593.00	40620	Mod	LTE Band 41	20	24.8	24.79	0.09	0	Left	Cheek	QPSK	1	50	04967	1:1.58	0.230	1.002	0.230	
Power Class 3	2593.00	40620	Mod	LTE Band 41	20	23.8	23.74	0.12	1	Left	Cheek	QPSK	50	25	04967	1:1.58	0.168	1.014	0.170	
Power Class 2	2593.00	40620	Mod	LTE Band 41	20	27.8	27.57	0.15	0	Left	Cheek	QPSK	1	50	04967	1:2.31	0.306	1.054	0.323	A15
Power Class 3	2593.00	40620	Mod	LTE Band 41	20	24.8	24.79	-0.01	0	Left	Tilt	QPSK	1	50	04967	1:1.58	0.131	1.002	0.131	
Power Class 3	2593.00	40620	Mod	LTE Band 41	20	23.8	23.74	0.12	1	Left	Tilt	QPSK	50	25	04967	1:1.58	0.098	1.014	0.099	
ANSI / IEEE C95.1 1992 - SAFETY LIMIT Spatial Peak Uncontrolled Exposure/General Population											Head 1.6 W/kg (mW/g) averaged over 1 gram									



**Table 11-16  
DTS Head SAR**

MEASUREMENT RESULTS																		
FREQUENCY		Mode	Service	Bandwidth [MHz]	Maximum Allowed Power [dBm]	Conducted Power [dBm]	Power Drift [dB]	Side	Test Position	Device Serial Number	Data Rate (Mbps)	Duty Cycle (%)	Peak SAR of Area Scan W/kg	SAR (1g)	Scaling Factor (Power)	Scaling Factor (Duty Cycle)	Reported SAR (1g)	Plot #
MHz	Ch.													(W/kg)			(W/kg)	
2412	1	802.11b	DSSS	22	16.0	15.91	0.08	Right	Cheek	22710	1	99.0	0.618	-	1.021	1.010	-	
2412	1	802.11b	DSSS	22	16.0	15.91	-0.05	Right	Tilt	22710	1	99.0	0.564	-	1.021	1.010	-	
2412	1	802.11b	DSSS	22	16.0	15.91	0.12	Left	Cheek	22710	1	99.0	1.299	0.744	1.021	1.010	0.767	
2437	6	802.11b	DSSS	22	16.0	15.59	0.09	Left	Cheek	22710	1	99.0	1.252	0.817	1.099	1.010	0.907	A16
2462	11	802.11b	DSSS	22	16.0	15.89	0.05	Left	Cheek	22710	1	99.0	1.154	0.761	1.026	1.010	0.789	
2412	1	802.11b	DSSS	22	16.0	15.91	-0.06	Left	Tilt	22710	1	99.0	0.915	0.586	1.021	1.010	0.604	
2437	6	802.11b	DSSS	22	16.0	15.59	0.02	Left	Cheek	22710	1	99.0	1.232	0.815	1.099	1.010	0.905	
ANSI / IEEE C95.1 1992 - SAFETY LIMIT Spatial Peak Uncontrolled Exposure/General Population											Head 1.6 W/kg (mW/g) averaged over 1 gram							

Note: Blue entry indicates variability measurement.

**Table 11-17  
DSS Head SAR**

MEASUREMENT RESULTS																		
FREQUENCY		Mode	Service	Maximum Allowed Power [dBm]	Conducted Power [dBm]	Power Drift [dB]	Side	Test Position	Device Serial Number	Data Rate (Mbps)	Duty Cycle (%)	SAR (1g)	Scaling Factor (Cond Power)	Scaling Factor (Duty Cycle)	Reported SAR (1g)	Plot #		
MHz	Ch.											(W/kg)			(W/kg)			
2441.00	39	Bluetooth	FHSS	10.5	10.34	0.19	Right	Cheek	22710	1	76.8	0.083	1.038	1.302	0.112			
2441.00	39	Bluetooth	FHSS	10.5	10.34	0.09	Right	Tilt	22710	1	76.8	0.074	1.038	1.302	0.100			
2441.00	39	Bluetooth	FHSS	10.5	10.34	0.03	Left	Cheek	22710	1	76.8	0.157	1.038	1.302	0.212	A17		
2441.00	39	Bluetooth	FHSS	10.5	10.34	-0.02	Left	Tilt	22710	1	76.8	0.129	1.038	1.302	0.174			
ANSI / IEEE C95.1 1992 - SAFETY LIMIT Spatial Peak Uncontrolled Exposure/General Population											Head 1.6 W/kg (mW/g) averaged over 1 gram							



FCC ID: ZNFX320PM		<b>SAR EVALUATION REPORT</b>		Approved by: Quality Manager
Document S/N: 1M1907220127-01.ZNF	Test Dates: 07/22/19 - 08/12/19	DUT Type: Portable Handset	Page 62 of 91	

## 11.2 Standalone Body-Worn SAR Data

**Table 11-18  
GSM/UMTS/CDMA Body-Worn SAR Data**

MEASUREMENT RESULTS															
FREQUENCY		Mode	Service	Maximum Allowed Power [dBm]	Conducted Power [dBm]	Power Drift [dB]	Spacing	Device Serial Number	# of Time Slots	Duty Cycle	Side	SAR (1g)	Scaling Factor	Reported SAR (1g)	Plot #
MHz	Ch.											(W/kg)		(W/kg)	
836.60	190	GSM 850	GSM	33.6	33.48	-0.01	10 mm	04964	1	1:8.3	back	0.336	1.028	0.345	
836.60	190	GSM 850	GPRS	31.0	30.85	-0.06	10 mm	04964	2	1:4.15	back	0.461	1.035	0.477	A18
1880.00	661	GSM 1900	GSM	30.8	30.37	0.09	10 mm	04964	1	1:8.3	back	0.289	1.104	0.319	
1880.00	661	GSM 1900	GPRS	28.0	27.62	0.01	10 mm	04964	2	1:4.15	back	0.317	1.091	0.346	A19
836.60	4183	UMTS 850	RMC	25.3	25.21	-0.01	10 mm	04964	N/A	1:1	back	0.491	1.021	0.501	A21
1712.40	1312	UMTS 1750	RMC	24.8	24.78	0.01	10 mm	04963	N/A	1:1	back	0.890	1.005	0.894	
1732.40	1412	UMTS 1750	RMC	24.8	24.73	-0.03	10 mm	04963	N/A	1:1	back	0.905	1.016	0.919	
1752.60	1513	UMTS 1750	RMC	24.8	24.72	0.00	10 mm	04963	N/A	1:1	back	0.874	1.019	0.891	
1732.40	1412	UMTS 1750	RMC	24.8	24.73	-0.02	10 mm	04963	N/A	1:1	back	0.940	1.016	0.955	A22
1852.40	9262	UMTS 1900	RMC	24.8	24.76	0.05	10 mm	04964	N/A	1:1	back	0.612	1.009	0.618	
1880.00	9400	UMTS 1900	RMC	24.8	24.76	0.02	10 mm	04964	N/A	1:1	back	0.641	1.009	0.647	
1907.60	9538	UMTS 1900	RMC	24.8	24.80	0.07	10 mm	04964	N/A	1:1	back	0.668	1.000	0.668	A23
820.10	564	CDMA BC10 (§90S)	TDSO / SO32	25.3	25.12	-0.01	10 mm	04963	N/A	1:1	back	0.635	1.042	0.662	A25
836.52	384	CDMA BC0 (§22H)	TDSO / SO32	25.3	25.15	-0.05	10 mm	04964	N/A	1:1	back	0.476	1.035	0.493	A27
1880.00	600	PCS CDMA	TDSO / SO32	24.8	24.57	-0.02	10 mm	04964	N/A	1:1	back	0.565	1.054	0.596	A29
ANSI / IEEE C95.1 1992 - SAFETY LIMIT Spatial Peak Uncontrolled Exposure/General Population							Body 1.6 W/kg (mW/g) averaged over 1 gram								

Note: Blue entry indicates variability measurement.

FCC ID: ZNFX320PM		SAR EVALUATION REPORT		Approved by: Quality Manager
Document S/N: 1M1907220127-01.ZNF	Test Dates: 07/22/19 - 08/12/19	DUT Type: Portable Handset	Page 63 of 91	

**Table 11-19  
LTE Body-Worn SAR**



MEASUREMENT RESULTS																			
FREQUENCY		Mode	Bandwidth [MHz]	Maximum Allowed Power [dBm]	Conducted Power [dBm]	Power Drift [dB]	MPR [dB]	Device Serial Number	Modulation	RB Size	RB Offset	Spacing	Side	Duty Cycle	SAR (1g)	Scaling Factor	Reported SAR (1g)	Plot #	
MHz	Ch.														(W/kg)		(W/kg)		
680.50	133297	Mid	LTE Band 71	20	25.3	24.95	0.04	0	04966	QPSK	1	50	10 mm	back	1:1	0.357	1.084	0.387	A31
680.50	133297	Mid	LTE Band 71	20	24.3	24.04	0.02	1	04966	QPSK	50	25	10 mm	back	1:1	0.284	1.062	0.302	
707.50	23095	Mid	LTE Band 12	10	25.3	24.98	0.10	0	04966	QPSK	1	25	10 mm	back	1:1	0.351	1.076	0.378	A32
707.50	23095	Mid	LTE Band 12	10	24.3	24.08	0.03	1	04966	QPSK	25	0	10 mm	back	1:1	0.290	1.052	0.305	
782.00	23230	Mid	LTE Band 13	10	25.3	25.18	-0.05	0	04966	QPSK	1	25	10 mm	back	1:1	0.497	1.028	0.511	A33
782.00	23230	Mid	LTE Band 13	10	24.3	24.26	0.01	1	04966	QPSK	25	12	10 mm	back	1:1	0.398	1.009	0.402	
831.50	26865	Mid	LTE Band 26 (Cell)	15	25.3	25.14	-0.03	0	04965	QPSK	1	36	10 mm	back	1:1	0.556	1.038	0.577	A34
831.50	26865	Mid	LTE Band 26 (Cell)	15	24.3	24.29	0.00	1	04965	QPSK	36	18	10 mm	back	1:1	0.451	1.002	0.452	
1720.00	132072	Low	LTE Band 66 (AWS)	20	24.8	24.76	-0.02	0	04965	QPSK	1	50	10 mm	back	1:1	0.777	1.009	0.784	
1745.00	132322	Mid	LTE Band 66 (AWS)	20	24.8	24.78	0.00	0	04965	QPSK	1	50	10 mm	back	1:1	0.830	1.005	0.834	A35
1770.00	132572	High	LTE Band 66 (AWS)	20	24.8	24.50	0.00	0	04965	QPSK	1	50	10 mm	back	1:1	0.766	1.072	0.821	
1745.00	132322	Mid	LTE Band 66 (AWS)	20	23.8	23.74	0.01	1	04965	QPSK	50	25	10 mm	back	1:1	0.658	1.014	0.667	
1720.00	132072	Low	LTE Band 66 (AWS)	20	23.8	23.65	0.02	1	04965	QPSK	100	0	10 mm	back	1:1	0.607	1.035	0.628	
1860.00	26140	Low	LTE Band 25 (PCS)	20	24.8	24.64	-0.04	0	04965	QPSK	1	50	10 mm	back	1:1	0.644	1.038	0.668	
1882.50	26365	Mid	LTE Band 25 (PCS)	20	24.8	24.74	0.06	0	04965	QPSK	1	50	10 mm	back	1:1	0.665	1.014	0.674	A36
1905.00	26590	High	LTE Band 25 (PCS)	20	24.8	24.73	0.12	0	04965	QPSK	1	50	10 mm	back	1:1	0.583	1.016	0.592	
1905.00	26590	High	LTE Band 25 (PCS)	20	23.8	23.80	-0.01	1	04965	QPSK	50	0	10 mm	back	1:1	0.555	1.000	0.555	
ANSI / IEEE C95.1 1992 - SAFETY LIMIT Spatial Peak Uncontrolled Exposure/General Population									Body 1.6 W/kg (mW/g) averaged over 1 gram										

**Table 11-20  
LTE Band 41 Body-Worn SAR**

MEASUREMENT RESULTS																				
Power Class	FREQUENCY		Mode	Bandwidth [MHz]	Maximum Allowed Power [dBm]	Conducted Power [dBm]	Power Drift [dB]	MPR [dB]	Device Serial Number	Modulation	RB Size	RB Offset	Spacing	Side	Duty Cycle	SAR (1g)	Scaling Factor	Reported SAR (1g)	Plot #	
	MHz	Ch.														(W/kg)		(W/kg)		
Power Class 3	2593.00	40620	Mid	LTE Band 41	20	24.8	24.79	0.07	0	04966	QPSK	1	50	10 mm	back	1:1.58	0.553	1.002	0.554	
Power Class 3	2593.00	40620	Mid	LTE Band 41	20	23.8	23.74	0.04	1	04966	QPSK	50	25	10 mm	back	1:1.58	0.426	1.014	0.432	
Power Class 2	2593.00	40620	Mid	LTE Band 41	20	27.8	27.57	0.05	0	04966	QPSK	1	50	10 mm	back	1:2.31	0.738	1.054	0.778	A38
ANSI / IEEE C95.1 1992 - SAFETY LIMIT Spatial Peak Uncontrolled Exposure/General Population									Body 1.6 W/kg (mW/g) averaged over 1 gram											

**Table 11-21  
DTS Body-Worn SAR**

MEASUREMENT RESULTS																		
FREQUENCY		Mode	Service	Bandwidth [MHz]	Maximum Allowed Power [dBm]	Conducted Power [dBm]	Power Drift [dB]	Spacing	Device Serial Number	Data Rate (Mbps)	Side	Duty Cycle (%)	Peak SAR of Area Scan	SAR (1g)	Scaling Factor (Power)	Scaling Factor (Duty Cycle)	Reported SAR (1g)	Plot #
MHz	Ch.												(W/kg)	(W/kg)			(W/kg)	
2412	1	802.11b	DSSS	22	16.0	15.91	-0.10	10 mm	22710	1	back	99.0	0.197	0.126	1.021	1.010	0.130	A40
ANSI / IEEE C95.1 1992 - SAFETY LIMIT Spatial Peak Uncontrolled Exposure/General Population									Body 1.6 W/kg (mW/g) averaged over 1 gram									

FCC ID: ZNFX320PM		<b>SAR EVALUATION REPORT</b>		Approved by: Quality Manager
Document S/N: 1M1907220127-01.ZNF	Test Dates: 07/22/19 - 08/12/19	DUT Type: Portable Handset	Page 64 of 91	





# 11.3 Standalone Hotspot SAR Data

**Table 11-22  
GPRS/UMTS/CDMA Hotspot SAR Data**

MEASUREMENT RESULTS															
FREQUENCY		Mode	Service	Maximum Allowed Power (dBm)	Conducted Power (dBm)	Power Drift (dB)	Spacing	Device Serial Number	# of Time Slots	Duty Cycle	Side	SAR (1g) (W/kg)	Scaling Factor	Reported SAR (1g) (W/kg)	Plot #
MHz	Ch.														
836.60	190	GSM 850	GPRS	31.0	30.85	-0.06	10 mm	04964	2	1:4.15	back	0.461	1.035	0.477	A18
836.60	190	GSM 850	GPRS	31.0	30.85	0.00	10 mm	04964	2	1:4.15	front	0.397	1.035	0.411	
836.60	190	GSM 850	GPRS	31.0	30.85	0.01	10 mm	04964	2	1:4.15	bottom	0.157	1.035	0.162	
836.60	190	GSM 850	GPRS	31.0	30.85	0.12	10 mm	04964	2	1:4.15	right	0.454	1.035	0.470	
836.60	190	GSM 850	GPRS	31.0	30.85	0.03	10 mm	04964	2	1:4.15	left	0.314	1.035	0.325	
1880.00	661	GSM 1900	GPRS	28.0	27.62	0.01	10 mm	04964	2	1:4.15	back	0.317	1.091	0.346	
1880.00	661	GSM 1900	GPRS	28.0	27.62	-0.08	10 mm	04964	2	1:4.15	front	0.234	1.091	0.255	
1880.00	661	GSM 1900	GPRS	28.0	27.62	-0.06	10 mm	04964	2	1:4.15	bottom	0.212	1.091	0.231	
1880.00	661	GSM 1900	GPRS	28.0	27.62	-0.13	10 mm	04964	2	1:4.15	left	0.320	1.091	0.349	A20
836.60	4183	UMTS 850	RMC	25.3	25.21	-0.01	10 mm	04964	N/A	1:1	back	0.491	1.021	0.501	A21
836.60	4183	UMTS 850	RMC	25.3	25.21	-0.01	10 mm	04964	N/A	1:1	front	0.416	1.021	0.425	
836.60	4183	UMTS 850	RMC	25.3	25.21	0.03	10 mm	04964	N/A	1:1	bottom	0.155	1.021	0.158	
836.60	4183	UMTS 850	RMC	25.3	25.21	0.01	10 mm	04964	N/A	1:1	right	0.456	1.021	0.466	
836.60	4183	UMTS 850	RMC	25.3	25.21	0.13	10 mm	04964	N/A	1:1	left	0.291	1.021	0.297	
1712.40	1312	UMTS 1750	RMC	24.8	24.78	0.01	10 mm	04963	N/A	1:1	back	0.890	1.005	0.894	
1732.40	1412	UMTS 1750	RMC	24.8	24.73	-0.03	10 mm	04963	N/A	1:1	back	0.905	1.016	0.919	
1752.60	1513	UMTS 1750	RMC	24.8	24.72	0.00	10 mm	04963	N/A	1:1	back	0.874	1.019	0.891	
1732.40	1412	UMTS 1750	RMC	24.8	24.73	0.02	10 mm	04963	N/A	1:1	front	0.711	1.016	0.722	
1732.40	1412	UMTS 1750	RMC	24.8	24.73	-0.01	10 mm	04963	N/A	1:1	bottom	0.508	1.016	0.516	
1732.40	1412	UMTS 1750	RMC	24.8	24.73	0.02	10 mm	04963	N/A	1:1	left	0.633	1.016	0.643	
1732.40	1412	UMTS 1750	RMC	24.8	24.73	-0.02	10 mm	04963	N/A	1:1	back	0.940	1.016	0.955	A22
1852.40	9262	UMTS 1900	RMC	24.8	24.76	0.05	10 mm	04964	N/A	1:1	back	0.612	1.009	0.618	
1880.00	9400	UMTS 1900	RMC	24.8	24.76	0.02	10 mm	04964	N/A	1:1	back	0.641	1.009	0.647	
1907.60	9538	UMTS 1900	RMC	24.8	24.80	0.07	10 mm	04964	N/A	1:1	back	0.668	1.000	0.668	
1880.00	9400	UMTS 1900	RMC	24.8	24.76	0.08	10 mm	04964	N/A	1:1	front	0.441	1.009	0.445	
1880.00	9400	UMTS 1900	RMC	24.8	24.76	-0.11	10 mm	04964	N/A	1:1	bottom	0.429	1.009	0.433	
1852.40	9262	UMTS 1900	RMC	24.8	24.76	0.00	10 mm	04964	N/A	1:1	left	0.663	1.009	0.669	
1880.00	9400	UMTS 1900	RMC	24.8	24.76	-0.05	10 mm	04964	N/A	1:1	left	0.656	1.009	0.662	
1907.60	9538	UMTS 1900	RMC	24.8	24.80	0.03	10 mm	04964	N/A	1:1	left	0.771	1.000	0.771	A24
820.10	564	CDMA BC10 (S90S)	EVDO Rev. 0	25.3	25.01	0.17	10 mm	04963	N/A	1:1	back	0.546	1.069	0.584	
820.10	564	CDMA BC10 (S90S)	EVDO Rev. 0	25.3	25.01	-0.13	10 mm	04963	N/A	1:1	front	0.505	1.069	0.540	
820.10	564	CDMA BC10 (S90S)	EVDO Rev. 0	25.3	25.01	0.15	10 mm	04963	N/A	1:1	bottom	0.221	1.069	0.236	
820.10	564	CDMA BC10 (S90S)	EVDO Rev. 0	25.3	25.01	-0.04	10 mm	04963	N/A	1:1	right	0.643	1.069	0.687	A26
820.10	564	CDMA BC10 (S90S)	EVDO Rev. 0	25.3	25.01	0.04	10 mm	04963	N/A	1:1	left	0.412	1.069	0.440	
836.52	384	CDMA BC0 (S22H)	EVDO Rev. 0	25.3	25.05	-0.07	10 mm	04964	N/A	1:1	back	0.490	1.059	0.519	A28
836.52	384	CDMA BC0 (S22H)	EVDO Rev. 0	25.3	25.05	0.04	10 mm	04964	N/A	1:1	front	0.446	1.059	0.472	
836.52	384	CDMA BC0 (S22H)	EVDO Rev. 0	25.3	25.05	-0.13	10 mm	04964	N/A	1:1	bottom	0.166	1.059	0.176	
836.52	384	CDMA BC0 (S22H)	EVDO Rev. 0	25.3	25.05	0.03	10 mm	04964	N/A	1:1	right	0.480	1.059	0.508	
836.52	384	CDMA BC0 (S22H)	EVDO Rev. 0	25.3	25.05	0.06	10 mm	04964	N/A	1:1	left	0.309	1.059	0.327	
1880.00	600	PCS CDMA	EVDO Rev. 0	24.8	24.54	-0.01	10 mm	04964	N/A	1:1	back	0.655	1.062	0.696	
1880.00	600	PCS CDMA	EVDO Rev. 0	24.8	24.54	0.03	10 mm	04964	N/A	1:1	front	0.541	1.062	0.575	
1880.00	600	PCS CDMA	EVDO Rev. 0	24.8	24.54	0.02	10 mm	04964	N/A	1:1	bottom	0.517	1.062	0.549	
1851.25	25	PCS CDMA	EVDO Rev. 0	24.8	24.57	-0.04	10 mm	04964	N/A	1:1	left	0.681	1.054	0.718	
1880.00	600	PCS CDMA	EVDO Rev. 0	24.8	24.54	-0.03	10 mm	04964	N/A	1:1	left	0.727	1.062	0.772	
1908.75	1175	PCS CDMA	EVDO Rev. 0	24.8	24.56	0.02	10 mm	04964	N/A	1:1	left	0.783	1.057	0.828	A30
ANSI / IEEE C95.1 1992 - SAFETY LIMIT Spatial Peak Uncontrolled Exposure/General Population								Body 1.6 W/kg (mW/g) averaged over 1 gram							

Note: Blue entry indicates variability measurement.



FCC ID: ZNFX320PM		SAR EVALUATION REPORT		Approved by: Quality Manager
Document S/N: 1M1907220127-01.ZNF	Test Dates: 07/22/19 - 08/12/19	DUT Type: Portable Handset	Page 65 of 91	

**Table 11-23  
LTE Band 71 Hotspot SAR**

MEASUREMENT RESULTS																			
FREQUENCY		Mode	Bandwidth [MHz]	Maximum Allowed Power [dBm]	Conducted Power [dBm]	Power Drift [dB]	MPR [dB]	Device Serial Number	Modulation	RB Size	RB Offset	Spacing	Side	Duty Cycle	SAR (1g)	Scaling Factor	Reported SAR (1g)	Plot #	
MHz	Ch.														(W/kg)		(W/kg)		
680.50	133297	Mid	LTE Band 71	20	25.3	24.95	0.04	0	04966	QPSK	1	50	10 mm	back	1:1	0.357	1.084	0.387	A31
680.50	133297	Mid	LTE Band 71	20	24.3	24.04	0.02	1	04966	QPSK	50	25	10 mm	back	1:1	0.284	1.062	0.302	
680.50	133297	Mid	LTE Band 71	20	25.3	24.95	0.04	0	04966	QPSK	1	50	10 mm	front	1:1	0.332	1.084	0.360	
680.50	133297	Mid	LTE Band 71	20	24.3	24.04	0.04	1	04966	QPSK	50	25	10 mm	front	1:1	0.266	1.062	0.282	
680.50	133297	Mid	LTE Band 71	20	25.3	24.95	-0.16	0	04966	QPSK	1	50	10 mm	bottom	1:1	0.141	1.084	0.153	
680.50	133297	Mid	LTE Band 71	20	24.3	24.04	-0.02	1	04966	QPSK	50	25	10 mm	bottom	1:1	0.108	1.062	0.115	
680.50	133297	Mid	LTE Band 71	20	25.3	24.95	0.02	0	04966	QPSK	1	50	10 mm	right	1:1	0.290	1.084	0.314	
680.50	133297	Mid	LTE Band 71	20	24.3	24.04	0.03	1	04966	QPSK	50	25	10 mm	right	1:1	0.228	1.062	0.242	
680.50	133297	Mid	LTE Band 71	20	25.3	24.95	-0.04	0	04966	QPSK	1	50	10 mm	left	1:1	0.204	1.084	0.221	
680.50	133297	Mid	LTE Band 71	20	24.3	24.04	-0.11	1	04966	QPSK	50	25	10 mm	left	1:1	0.166	1.062	0.176	
ANSI / IEEE C95.1 1992 - SAFETY LIMIT Spatial Peak Uncontrolled Exposure/General Population								Body 1.6 W/kg (mW/g) averaged over 1 gram											

**Table 11-24  
LTE Band 12 Hotspot SAR**

MEASUREMENT RESULTS																			
FREQUENCY		Mode	Bandwidth [MHz]	Maximum Allowed Power [dBm]	Conducted Power [dBm]	Power Drift [dB]	MPR [dB]	Device Serial Number	Modulation	RB Size	RB Offset	Spacing	Side	Duty Cycle	SAR (1g)	Scaling Factor	Reported SAR (1g)	Plot #	
MHz	Ch.														(W/kg)		(W/kg)		
707.50	23095	Mid	LTE Band 12	10	25.3	24.98	0.10	0	04966	QPSK	1	25	10 mm	back	1:1	0.351	1.076	0.378	A32
707.50	23095	Mid	LTE Band 12	10	24.3	24.08	0.03	1	04966	QPSK	25	0	10 mm	back	1:1	0.290	1.052	0.305	
707.50	23095	Mid	LTE Band 12	10	25.3	24.98	0.16	0	04966	QPSK	1	25	10 mm	front	1:1	0.350	1.076	0.377	
707.50	23095	Mid	LTE Band 12	10	24.3	24.08	0.09	1	04966	QPSK	25	0	10 mm	front	1:1	0.291	1.052	0.306	
707.50	23095	Mid	LTE Band 12	10	25.3	24.98	0.01	0	04966	QPSK	1	25	10 mm	bottom	1:1	0.151	1.076	0.162	
707.50	23095	Mid	LTE Band 12	10	24.3	24.08	-0.05	1	04966	QPSK	25	0	10 mm	bottom	1:1	0.109	1.052	0.115	
707.50	23095	Mid	LTE Band 12	10	25.3	24.98	0.04	0	04966	QPSK	1	25	10 mm	right	1:1	0.337	1.076	0.363	
707.50	23095	Mid	LTE Band 12	10	24.3	24.08	-0.02	1	04966	QPSK	25	0	10 mm	right	1:1	0.297	1.052	0.312	
707.50	23095	Mid	LTE Band 12	10	25.3	24.98	-0.09	0	04966	QPSK	1	25	10 mm	left	1:1	0.207	1.076	0.223	
707.50	23095	Mid	LTE Band 12	10	24.3	24.08	-0.01	1	04966	QPSK	25	0	10 mm	left	1:1	0.179	1.052	0.188	
ANSI / IEEE C95.1 1992 - SAFETY LIMIT Spatial Peak Uncontrolled Exposure/General Population								Body 1.6 W/kg (mW/g) averaged over 1 gram											



FCC ID: ZNFX320PM		<b>SAR EVALUATION REPORT</b>		Approved by: Quality Manager
Document S/N: 1M1907220127-01.ZNF	Test Dates: 07/22/19 - 08/12/19	DUT Type: Portable Handset	Page 66 of 91	

**Table 11-25  
LTE Band 13 Hotspot SAR**

MEASUREMENT RESULTS																			
FREQUENCY		Mode	Bandwidth [MHz]	Maximum Allowed Power [dBm]	Conducted Power [dBm]	Power Drift [dB]	MPR [dB]	Device Serial Number	Modulation	RB Size	RB Offset	Spacing	Side	Duty Cycle	SAR (1g)	Scaling Factor	Reported SAR (1g)	Plot #	
MHz	Ch.														(W/kg)		(W/kg)		
782.00	23230	Mid	LTE Band 13	10	25.3	25.18	-0.05	0	04966	QPSK	1	25	10 mm	back	1:1	0.497	1.028	0.511	A33
782.00	23230	Mid	LTE Band 13	10	24.3	24.26	0.01	1	04966	QPSK	25	12	10 mm	back	1:1	0.398	1.009	0.402	
782.00	23230	Mid	LTE Band 13	10	25.3	25.18	0.03	0	04966	QPSK	1	25	10 mm	front	1:1	0.451	1.028	0.464	
782.00	23230	Mid	LTE Band 13	10	24.3	24.26	-0.01	1	04966	QPSK	25	12	10 mm	front	1:1	0.361	1.009	0.364	
782.00	23230	Mid	LTE Band 13	10	25.3	25.18	0.09	0	04966	QPSK	1	25	10 mm	bottom	1:1	0.156	1.028	0.160	
782.00	23230	Mid	LTE Band 13	10	24.3	24.26	0.02	1	04966	QPSK	25	12	10 mm	bottom	1:1	0.127	1.009	0.128	
782.00	23230	Mid	LTE Band 13	10	25.3	25.18	-0.17	0	04966	QPSK	1	25	10 mm	right	1:1	0.430	1.028	0.442	
782.00	23230	Mid	LTE Band 13	10	24.3	24.26	0.01	1	04966	QPSK	25	12	10 mm	right	1:1	0.346	1.009	0.349	
782.00	23230	Mid	LTE Band 13	10	25.3	25.18	-0.03	0	04966	QPSK	1	25	10 mm	left	1:1	0.292	1.028	0.300	
782.00	23230	Mid	LTE Band 13	10	24.3	24.26	0.00	1	04966	QPSK	25	12	10 mm	left	1:1	0.247	1.009	0.249	
ANSI / IEEE C95.1 1992 - SAFETY LIMIT Spatial Peak Uncontrolled Exposure/General Population								Body 1.6 W/kg (mW/g) averaged over 1 gram											

**Table 11-26  
LTE Band 26 (Cell) Hotspot SAR**

MEASUREMENT RESULTS																			
FREQUENCY		Mode	Bandwidth [MHz]	Maximum Allowed Power [dBm]	Conducted Power [dBm]	Power Drift [dB]	MPR [dB]	Device Serial Number	Modulation	RB Size	RB Offset	Spacing	Side	Duty Cycle	SAR (1g)	Scaling Factor	Reported SAR (1g)	Plot #	
MHz	Ch.														(W/kg)		(W/kg)		
831.50	26865	Mid	LTE Band 26 (Cell)	15	25.3	25.14	-0.03	0	04965	QPSK	1	36	10 mm	back	1:1	0.556	1.038	0.577	A34
831.50	26865	Mid	LTE Band 26 (Cell)	15	24.3	24.29	0.00	1	04965	QPSK	36	18	10 mm	back	1:1	0.451	1.002	0.452	
831.50	26865	Mid	LTE Band 26 (Cell)	15	25.3	25.14	-0.01	0	04965	QPSK	1	36	10 mm	front	1:1	0.490	1.038	0.509	
831.50	26865	Mid	LTE Band 26 (Cell)	15	24.3	24.29	0.01	1	04965	QPSK	36	18	10 mm	front	1:1	0.401	1.002	0.402	
831.50	26865	Mid	LTE Band 26 (Cell)	15	25.3	25.14	-0.04	0	04965	QPSK	1	36	10 mm	bottom	1:1	0.241	1.038	0.250	
831.50	26865	Mid	LTE Band 26 (Cell)	15	24.3	24.29	0.02	1	04965	QPSK	36	18	10 mm	bottom	1:1	0.195	1.002	0.195	
831.50	26865	Mid	LTE Band 26 (Cell)	15	25.3	25.14	0.00	0	04965	QPSK	1	36	10 mm	right	1:1	0.529	1.038	0.549	
831.50	26865	Mid	LTE Band 26 (Cell)	15	24.3	24.29	-0.02	1	04965	QPSK	36	18	10 mm	right	1:1	0.451	1.002	0.452	
831.50	26865	Mid	LTE Band 26 (Cell)	15	25.3	25.14	-0.02	0	04965	QPSK	1	36	10 mm	left	1:1	0.313	1.038	0.325	
831.50	26865	Mid	LTE Band 26 (Cell)	15	24.3	24.29	0.05	1	04965	QPSK	36	18	10 mm	left	1:1	0.269	1.002	0.270	
ANSI / IEEE C95.1 1992 - SAFETY LIMIT Spatial Peak Uncontrolled Exposure/General Population								Body 1.6 W/kg (mW/g) averaged over 1 gram											

FCC ID: ZNFX320PM		<b>SAR EVALUATION REPORT</b>		Approved by: Quality Manager
Document S/N: 1M1907220127-01.ZNF	Test Dates: 07/22/19 - 08/12/19	DUT Type: Portable Handset	Page 67 of 91	



**Table 11-27**  
**LTE Band 66 (AWS) Hotspot SAR**

MEASUREMENT RESULTS																			
FREQUENCY		Mode	Bandwidth [MHz]	Maximum Allowed Power [dBm]	Conducted Power [dBm]	Power Drift [dB]	MPR [dB]	Device Serial Number	Modulation	RB Size	RB Offset	Spacing	Side	Duty Cycle	SAR (1g)	Scaling Factor	Reported SAR (1g)	Plot #	
MHz	Ch.														(W/kg)		(W/kg)		
1720.00	132072	Low	LTE Band 66 (AWS)	20	24.8	24.76	-0.02	0	04965	QPSK	1	50	10 mm	back	1:1	0.777	1.009	0.784	
1745.00	132322	Mid	LTE Band 66 (AWS)	20	24.8	24.78	0.00	0	04965	QPSK	1	50	10 mm	back	1:1	0.830	1.005	0.834	A35
1770.00	132572	High	LTE Band 66 (AWS)	20	24.8	24.50	0.00	0	04965	QPSK	1	50	10 mm	back	1:1	0.766	1.072	0.821	
1745.00	132322	Mid	LTE Band 66 (AWS)	20	23.8	23.74	0.01	1	04965	QPSK	50	25	10 mm	back	1:1	0.658	1.014	0.667	
1720.00	132072	Low	LTE Band 66 (AWS)	20	23.8	23.65	0.02	1	04965	QPSK	100	0	10 mm	back	1:1	0.607	1.035	0.628	
1745.00	132322	Mid	LTE Band 66 (AWS)	20	24.8	24.78	0.09	0	04965	QPSK	1	50	10 mm	front	1:1	0.633	1.005	0.636	
1745.00	132322	Mid	LTE Band 66 (AWS)	20	23.8	23.74	0.05	1	04965	QPSK	50	25	10 mm	front	1:1	0.511	1.014	0.518	
1745.00	132322	Mid	LTE Band 66 (AWS)	20	24.8	24.78	-0.10	0	04965	QPSK	1	50	10 mm	bottom	1:1	0.481	1.005	0.483	
1745.00	132322	Mid	LTE Band 66 (AWS)	20	23.8	23.74	0.01	1	04965	QPSK	50	25	10 mm	bottom	1:1	0.373	1.014	0.378	
1745.00	132322	Mid	LTE Band 66 (AWS)	20	24.8	24.78	0.00	0	04965	QPSK	1	50	10 mm	left	1:1	0.617	1.005	0.620	
1745.00	132322	Mid	LTE Band 66 (AWS)	20	23.8	23.74	-0.01	1	04965	QPSK	50	25	10 mm	left	1:1	0.505	1.014	0.512	
ANSI / IEEE C95.1 1992 - SAFETY LIMIT										Body									
Spatial Peak										1.6 W/kg (mW/g)									
Uncontrolled Exposure/General Population										averaged over 1 gram									

**Table 11-28**  
**LTE Band 25 (PCS) Hotspot SAR**

MEASUREMENT RESULTS																			
FREQUENCY		Mode	Bandwidth [MHz]	Maximum Allowed Power [dBm]	Conducted Power [dBm]	Power Drift [dB]	MPR [dB]	Device Serial Number	Modulation	RB Size	RB Offset	Spacing	Side	Duty Cycle	SAR (1g)	Scaling Factor	Reported SAR (1g)	Plot #	
MHz	Ch.														(W/kg)		(W/kg)		
1860.00	26140	Low	LTE Band 25 (PCS)	20	24.8	24.64	-0.04	0	04965	QPSK	1	50	10 mm	back	1:1	0.644	1.038	0.668	
1882.50	26365	Mid	LTE Band 25 (PCS)	20	24.8	24.74	0.06	0	04965	QPSK	1	50	10 mm	back	1:1	0.665	1.014	0.674	
1905.00	26590	High	LTE Band 25 (PCS)	20	24.8	24.73	0.12	0	04965	QPSK	1	50	10 mm	back	1:1	0.583	1.016	0.592	
1905.00	26590	High	LTE Band 25 (PCS)	20	23.8	23.80	-0.01	1	04965	QPSK	50	0	10 mm	back	1:1	0.555	1.000	0.555	
1882.50	26365	Mid	LTE Band 25 (PCS)	20	24.8	24.74	0.06	0	04965	QPSK	1	50	10 mm	front	1:1	0.590	1.014	0.598	
1905.00	26590	High	LTE Band 25 (PCS)	20	23.8	23.80	0.00	1	04965	QPSK	50	0	10 mm	front	1:1	0.485	1.000	0.485	
1882.50	26365	Mid	LTE Band 25 (PCS)	20	24.8	24.74	-0.11	0	04965	QPSK	1	50	10 mm	bottom	1:1	0.520	1.014	0.527	
1905.00	26590	High	LTE Band 25 (PCS)	20	23.8	23.80	-0.06	1	04965	QPSK	50	0	10 mm	bottom	1:1	0.406	1.000	0.406	
1860.00	26140	Low	LTE Band 25 (PCS)	20	24.8	24.64	0.01	0	04965	QPSK	1	50	10 mm	left	1:1	0.674	1.038	0.700	
1882.50	26365	Mid	LTE Band 25 (PCS)	20	24.8	24.74	-0.03	0	04965	QPSK	1	50	10 mm	left	1:1	0.794	1.014	0.805	
1905.00	26590	High	LTE Band 25 (PCS)	20	24.8	24.73	0.04	0	04965	QPSK	1	50	10 mm	left	1:1	0.861	1.016	0.875	A37
1905.00	26590	High	LTE Band 25 (PCS)	20	23.8	23.80	-0.04	1	04965	QPSK	50	0	10 mm	left	1:1	0.655	1.000	0.655	
1882.50	26365	Mid	LTE Band 25 (PCS)	20	23.8	23.73	0.00	1	04965	QPSK	100	0	10 mm	left	1:1	0.606	1.016	0.616	
1905.00	26590	High	LTE Band 25 (PCS)	20	24.8	24.73	-0.05	0	04965	QPSK	1	50	10 mm	left	1:1	0.830	1.016	0.843	
ANSI / IEEE C95.1 1992 - SAFETY LIMIT										Body									
Spatial Peak										1.6 W/kg (mW/g)									
Uncontrolled Exposure/General Population										averaged over 1 gram									

Note: Blue entry indicates variability measurement.

FCC ID: ZNFX320PM		SAR EVALUATION REPORT		Approved by: Quality Manager
Document S/N: 1M1907220127-01.ZNF	Test Dates: 07/22/19 - 08/12/19	DUT Type: Portable Handset	Page 68 of 91	



**Table 11-29  
LTE Band 41 Hotspot SAR**

MEASUREMENT RESULTS																				
Power Class	FREQUENCY		Mode	Bandwidth [MHz]	Maximum Allowed Power [dBm]	Conducted Power [dBm]	Power Drift [dB]	MPR [dB]	Device Serial Number	Modulation	RB Size	RB Offset	Spacing	Side	Duty Cycle	SAR (1g)	Scaling Factor	Reported SAR (1g)	Plot #	
	MHz	Ch.														(W/kg)		(W/kg)		
Power Class 3	2593.00	40620	Mid	LTE Band 41	20	24.8	24.79	0.07	0	04966	QPSK	1	50	10 mm	back	1:1.58	0.553	1.002	0.554	
Power Class 3	2593.00	40620	Mid	LTE Band 41	20	23.8	23.74	0.04	1	04966	QPSK	50	25	10 mm	back	1:1.58	0.426	1.014	0.432	
Power Class 3	2593.00	40620	Mid	LTE Band 41	20	24.8	24.79	0.02	0	04966	QPSK	1	50	10 mm	front	1:1.58	0.507	1.002	0.508	
Power Class 3	2593.00	40620	Mid	LTE Band 41	20	23.8	23.74	0.02	1	04966	QPSK	50	25	10 mm	front	1:1.58	0.396	1.014	0.402	
Power Class 3	2506.00	39750	Low	LTE Band 41	20	24.8	24.70	0.06	0	04966	QPSK	1	50	10 mm	bottom	1:1.58	0.725	1.023	0.742	
Power Class 3	2549.50	40185	Low-Mid	LTE Band 41	20	24.8	24.64	0.06	0	04966	QPSK	1	50	10 mm	bottom	1:1.58	0.825	1.038	0.856	
Power Class 3	2593.00	40620	Mid	LTE Band 41	20	24.8	24.79	0.04	0	04966	QPSK	1	50	10 mm	bottom	1:1.58	0.915	1.002	0.917	
Power Class 3	2636.50	41055	Mid-High	LTE Band 41	20	24.8	24.62	0.03	0	04966	QPSK	1	50	10 mm	bottom	1:1.58	0.856	1.042	0.892	
Power Class 3	2680.00	41490	High	LTE Band 41	20	24.8	24.69	0.05	0	04966	QPSK	1	50	10 mm	bottom	1:1.58	0.799	1.026	0.820	
Power Class 3	2506.00	39750	Low	LTE Band 41	20	23.8	23.64	0.02	1	04966	QPSK	50	0	10 mm	bottom	1:1.58	0.607	1.038	0.630	
Power Class 3	2549.50	40185	Low-Mid	LTE Band 41	20	23.8	23.59	0.05	1	04966	QPSK	50	0	10 mm	bottom	1:1.58	0.641	1.050	0.673	
Power Class 3	2593.00	40620	Mid	LTE Band 41	20	23.8	23.74	0.01	1	04966	QPSK	50	25	10 mm	bottom	1:1.58	0.730	1.014	0.740	
Power Class 3	2636.50	41055	Mid-High	LTE Band 41	20	23.8	23.55	0.01	1	04966	QPSK	50	25	10 mm	bottom	1:1.58	0.681	1.059	0.721	
Power Class 3	2680.00	41490	High	LTE Band 41	20	23.8	23.73	0.03	1	04966	QPSK	50	25	10 mm	bottom	1:1.58	0.631	1.016	0.641	
Power Class 3	2593.00	40620	Mid	LTE Band 41	20	23.8	23.65	0.03	1	04966	QPSK	100	0	10 mm	bottom	1:1.58	0.652	1.035	0.675	
Power Class 2	2593.00	40620	Mid	LTE Band 41	20	27.8	27.57	0.08	0	04966	QPSK	1	50	10 mm	bottom	1:2.31	1.230	1.054	1.296	A39
Power Class 3	2593.00	40620	Mid	LTE Band 41	20	24.8	24.79	0.14	0	04966	QPSK	1	50	10 mm	right	1:1.58	0.179	1.002	0.179	
Power Class 3	2593.00	40620	Mid	LTE Band 41	20	23.8	23.74	0.04	1	04966	QPSK	50	25	10 mm	right	1:1.58	0.138	1.014	0.140	
Power Class 3	2593.00	40620	Mid	LTE Band 41	20	24.8	24.79	0.11	0	04966	QPSK	1	50	10 mm	left	1:1.58	0.155	1.002	0.155	
Power Class 3	2593.00	40620	Mid	LTE Band 41	20	23.8	23.74	0.20	1	04966	QPSK	50	25	10 mm	left	1:1.58	0.122	1.014	0.124	
Power Class 2	2593.00	40620	Mid	LTE Band 41	20	27.8	27.57	0.08	0	04966	QPSK	1	50	10 mm	bottom	1:2.31	1.210	1.054	1.275	
ANSI / IEEE C95.1 1992 - SAFETY LIMIT										Body										
Spatial Peak										1.6 W/kg (mW/g)										
Uncontrolled Exposure/General Population										averaged over 1 gram										

Note: Blue entry indicates variability measurement.

**Table 11-30  
WLAN Hotspot SAR**

MEASUREMENT RESULTS																		
FREQUENCY	Mode	Service	Bandwidth [MHz]	Maximum Allowed Power [dBm]	Conducted Power [dBm]	Power Drift [dB]	Spacing	Device Serial Number	Data Rate (Mbps)	Side	Duty Cycle (%)	Peak SAR of Area Scan	SAR (1g)	Scaling Factor (Power)	Scaling Factor (Duty Cycle)	Reported SAR (1g)	Plot #	
												W/kg	(W/kg)			(W/kg)		
2412	1	802.11b	DSSS	22	16.0	15.91	-0.10	10 mm	22710	1	back	99.0	0.197	0.126	1.021	1.010	0.130	A40
2412	1	802.11b	DSSS	22	16.0	15.91	0.15	10 mm	22710	1	front	99.0	0.121	-	1.021	1.010	-	
2412	1	802.11b	DSSS	22	16.0	15.91	0.15	10 mm	22710	1	top	99.0	0.124	-	1.021	1.010	-	
2412	1	802.11b	DSSS	22	16.0	15.91	0.12	10 mm	22710	1	right	99.0	0.080	-	1.021	1.010	-	
ANSI / IEEE C95.1 1992 - SAFETY LIMIT										Body								
Spatial Peak										1.6 W/kg (mW/g)								
Uncontrolled Exposure/General Population										averaged over 1 gram								

FCC ID: ZNFX320PM		<b>SAR EVALUATION REPORT</b>		Approved by: Quality Manager
Document S/N: 1M1907220127-01.ZNF	Test Dates: 07/22/19 - 08/12/19	DUT Type: Portable Handset	Page 69 of 91	

## 11.4 SAR Test Notes

### General Notes:



1. The test data reported are the worst-case SAR values according to test procedures specified in IEEE 1528-2013, and FCC KDB Publication 447498 D01v06.
2. Batteries are fully charged at the beginning of the SAR measurements.
3. Liquid tissue depth was at least 15.0 cm for all frequencies.
4. The manufacturer has confirmed that the device(s) tested have the same physical, mechanical and thermal characteristics and are within operational tolerances expected for production units.
5. SAR results were scaled to the maximum allowed power to demonstrate compliance per FCC KDB Publication 447498 D01v06.
6. Device was tested using a fixed spacing for body-worn accessory testing. A separation distance of 10 mm was considered because the manufacturer has determined that there will be body-worn accessories available in the marketplace for users to support this separation distance.
7. Per FCC KDB Publication 648474 D04v01r03, body-worn SAR was evaluated without a headset connected to the device. Since the standalone reported body-worn SAR was  $\leq 1.2$  W/kg, no additional body-worn SAR evaluations using a headset cable were required.
8. Per FCC KDB 865664 D01v01r04, variability SAR tests were performed when the measured SAR results for a frequency band were greater than or equal to 0.8 W/kg. Repeated SAR measurements are highlighted in the tables above for clarity. Please see Section 13 for variability analysis.
9. During SAR Testing for the Wireless Router conditions per FCC KDB Publication 941225 D06v02r01, the actual Portable Hotspot operation (with actual simultaneous transmission of a transmitter with WIFI) was not activated (See Section 6.7 for more details).

### GSM Test Notes:

1. Body-Worn accessory testing is typically associated with voice operations. Therefore, GSM voice was evaluated for body-worn SAR.
2. Justification for reduced test configurations per KDB Publication 941225 D01v03r01 and October 2013 TCB Workshop Notes: The source-based frame-averaged output power was evaluated for all GPRS/EDGE slot configurations. The configuration with the highest target frame averaged output power was evaluated for hotspot SAR. When the maximum frame-averaged powers are equivalent across two or more slots (within 0.25 dB), the configuration with the most number of time slots was tested.
3. Per FCC KDB Publication 447498 D01v06, if the reported (scaled) SAR measured at the middle channel or highest output power channel for each test configuration is  $\leq 0.8$  W/kg for 1g evaluations then testing at the other channels is not required for such test configuration(s). When the maximum output power variation across the required test channels is  $> \frac{1}{2}$  dB, instead of the middle channel, the highest output power channel was used.
4. GPRS was additionally evaluated for head and body-worn exposure conditions to address possible VoIP scenarios.

### CDMA Notes:

1. Head SAR for CDMA2000 mode was tested under RC3/SO55 per FCC KDB Publication 941225 D01v03r01.
2. Body-Worn SAR was tested with 1x RTT with TDSO / SO32 FCH Only. EVDO Rev0 and RevA and TDSO / SO32 FCH+SCH SAR tests were not required per the 3G SAR Test Reduction Procedure in FCC KDB Publication 941225 D01v03r01.
3. CDMA Wireless Router SAR is measured using Subtype 0/1 Physical Layer configurations for Rev. 0 according to KDB 941225 D01v03r01 procedures for data devices. Wireless Router SAR tests for Subtype 2 of Rev.A and 1x RTT configurations were not required per the 3G SAR Test Reduction Policy in KDB Publication 941225 D01v03r01.
4. Head SAR was additionally evaluated using EVDO Rev. A to determine compliance for VoIP operations.

FCC ID: ZNFX320PM	 PCTEST ENGINEERING LABORATORY, INC.	SAR EVALUATION REPORT	 LG	Approved by: Quality Manager
Document S/N: 1M1907220127-01.ZNF	Test Dates: 07/22/19 - 08/12/19	DUT Type: Portable Handset	Page 70 of 91	



5. Per FCC KDB Publication 447498 D01v06, if the reported (scaled) SAR measured at the middle channel or highest output power channel for each test configuration is  $\leq 0.8$  W/kg for 1g evaluations then testing at the other channels is not required for such test configuration(s). When the maximum output power variation across the required test channels is  $> \frac{1}{2}$  dB, instead of the middle channel, the highest output power channel was used.
6. CDMA 1X Advanced technology was not required for SAR since the maximum allowed output powers for 1X Advanced was not more than 0.25 dB higher than the maximum powers for 1X.

**UMTS Notes:**

1. UMTS mode in was tested under RMC 12.2 kbps with HSPA Inactive per KDB Publication 941225 D01v03r01. AMR and HSPA SAR was not required per the 3G Test Reduction Procedure in KDB Publication 941225 D01v03r01.
2. Per FCC KDB Publication 447498 D01v06, if the reported (scaled) SAR measured at the middle channel or highest output power channel for each test configuration is  $\leq 0.8$  W/kg for 1g evaluations then testing at the other channels is not required for such test configuration(s). When the maximum output power variation across the required test channels is  $> \frac{1}{2}$  dB, instead of the middle channel, the highest output power channel was used.

**LTE Notes:**

1. LTE Considerations: LTE test configurations are determined according to SAR Evaluation Considerations for LTE Devices in FCC KDB Publication 941225 D05v02r04. The general test procedures used for testing can be found in Section 8.6.4.
2. MPR is permanently implemented for this device by the manufacturer. The specific manufacturer target MPR is indicated alongside the SAR results. MPR is enabled for this device, according to 3GPP TS36.101 Section 6.2.3 – 6.2.5 under Table 6.2.3-1.
3. A-MPR was disabled for all SAR tests by setting NS=01 and MCC=001 on the base station simulator. SAR tests were performed with the same number of RB and RB offsets transmitting on all TTI frames (maximum TTI).
4. Per FCC KDB Publication 447498 D01v06, when the reported LTE Band 41 SAR measured at the highest output power channel in a given a test configuration was  $> 0.6$  W/kg for 1g evaluations, testing at the other channels was required for such test configurations.
5. TDD LTE was tested per the guidance provided in FCC KDB Publication 941225 D05v02r04. Testing was performed using UL-DL configuration 0 with 6 UL subframes and 2 S subframes using extended cyclic prefix only and special subframe configuration 6. SAR tests were performed at maximum output power and worst-case transmission duty factor in extended cyclic prefix. Per 3GPP 36.211 Section 4, the duty factor for special subframe configuration 6 using extended cyclic prefix is 0.633.
6. This device supports Power Class 2 and Power Class 3 operations for LTE Band 41. The highest available duty cycle for Power Class 2 operations is 43.3 % using UL-DL configuration 1. Per FCC Guidance, all SAR tests were performed using Power Class 3. SAR with power class 2 at the available duty factor was additionally performed for the power class 3 configuration with the highest SAR configuration for each exposure conditions. Please see Section 14 for linearity results.

FCC ID: ZNFX320PM	 <b>SAR EVALUATION REPORT</b> 		<b>Approved by:</b> Quality Manager
<b>Document S/N:</b> 1M1907220127-01.ZNF	<b>Test Dates:</b> 07/22/19 - 08/12/19	<b>DUT Type:</b> Portable Handset	Page 71 of 91





WLAN Notes:

1. For held-to-ear and hotspot operations, the initial test position procedures were applied. The test position with the highest extrapolated peak SAR will be used as the initial test position. When reported SAR for the initial test position is  $\leq 0.4$  W/kg for 1g evaluations, no additional testing for the remaining test positions was required. Otherwise, SAR is evaluated at the subsequent highest peak SAR positions until the reported SAR result is  $\leq 0.8$  W/kg or all test positions are measured.
2. Justification for test configurations for WLAN per KDB Publication 248227 D01v02r02 for 2.4 GHz WIFI operations, the highest measured maximum output power channel for DSSS was selected for SAR measurement. SAR for OFDM modes (2.4 GHz 802.11g/n) was not required due to the maximum allowed powers and the highest reported DSSS SAR. See Section 8.7.3 for more information.
3. When the maximum reported 1g averaged SAR is  $\leq 0.8$  W/kg, SAR testing on additional channels was not required. Otherwise, SAR for the next highest output power channel was required until the reported SAR result was  $\leq 1.20$  W/kg for 1g evaluations or all test channels were measured.
4. The device was configured to transmit continuously at the required data rate, channel bandwidth and signal modulation, using the highest transmission duty factor supported by the test mode tools. The reported SAR was scaled to the 100% transmission duty factor to determine compliance. Procedures used to measure the duty factor are identical to that in the associated EMC test reports.

Bluetooth Notes

1. Bluetooth SAR was measured with the device connected to a call box with hopping disabled with DH5 operation and Tx Tests test mode type. Per October 2016 TCB Workshop Notes, the reported SAR was scaled to the 100% transmission duty factor to determine compliance. See Section 9.6 for the time domain plot and calculation for the duty factor of the device.

FCC ID: ZNFX320PM	 <b>SAR EVALUATION REPORT</b> 		<b>Approved by:</b> Quality Manager
<b>Document S/N:</b> 1M1907220127-01.ZNF	<b>Test Dates:</b> 07/22/19 - 08/12/19	<b>DUT Type:</b> Portable Handset	Page 72 of 91



# 12 FCC MULTI-TX AND ANTENNA SAR CONSIDERATIONS

## 12.1 Introduction

The following procedures adopted from FCC KDB Publication 447498 D01v06 are applicable to devices with built-in unlicensed transmitters such as 802.11 and Bluetooth devices which may simultaneously transmit with the licensed transmitter.

## 12.2 Simultaneous Transmission Procedures

This device contains transmitters that may operate simultaneously. Therefore, simultaneous transmission analysis is required. Per FCC KDB Publication 447498 D01v06 4.3.2 and IEEE 1528-2013 Section 6.3.4.1.2, simultaneous transmission SAR test exclusion may be applied when the sum of the 1g SAR for all the simultaneous transmitting antennas in a specific a physical test configuration is  $\leq 1.6$  W/kg. The different test positions in an exposure condition may be considered collectively to determine SAR test exclusion according to the sum of 1g or 10g SAR.



When standalone SAR is not required to be measured, per FCC KDB 447498 D01v06 4.3.2 b), the following equation must be used to estimate the standalone 1g SAR for simultaneous transmission assessment involving that transmitter.

$$\text{Estimated SAR} = \frac{\sqrt{f(\text{GHz})}}{7.5} * \frac{(\text{Max Power of channel, mW})}{\text{Min. Separation Distance, mm}}$$

**Table 12-1  
Estimated SAR**

Mode	Frequency	Maximum Allowed Power	Separation Distance (Body)	Estimated SAR (Body)
	[MHz]	[dBm]	[mm]	[W/kg]
Bluetooth	2480	10.50	10	0.231

Note: Per KDB Publication 447498 D01v06, the maximum power of the channel was rounded to the nearest mW before calculation.

FCC ID: ZNFX320PM	 <b>SAR EVALUATION REPORT</b> 		<b>Approved by:</b> Quality Manager
<b>Document S/N:</b> 1M1907220127-01.ZNF	<b>Test Dates:</b> 07/22/19 - 08/12/19	<b>DUT Type:</b> Portable Handset	Page 73 of 91



## 12.3 Head SAR Simultaneous Transmission Analysis

**Table 12-2**  
Simultaneous Transmission Scenario with 2.4 GHz WLAN (Held to Ear)

Exposure Condition	Mode	2G/3G/4G SAR (W/kg)	2.4 GHz WLAN SAR (W/kg)	Σ SAR (W/kg)
		1	2	1+2
Head SAR	GSM/GPRS 850	0.320	0.907	1.227
	GSM/GPRS 1900	0.340	0.907	1.247
	UMTS 850	0.333	0.907	1.240
	UMTS 1750	0.523	0.907	1.430
	UMTS 1900	0.625	0.907	<b>1.532</b>
	CDMA/EVDO BC10 (§90S)	0.416	0.907	1.323
	CDMA/EVDO BC0 (§22H)	0.336	0.907	1.243
	PCS CDMA/EVDO	0.716	0.907	See Table Below
	LTE Band 71	0.201	0.907	1.108
	LTE Band 12	0.267	0.907	1.174
	LTE Band 13	0.317	0.907	1.224
	LTE Band 26 (Cell)	0.449	0.907	1.356
	LTE Band 66 (AWS)	0.566	0.907	1.473
	LTE Band 25 (PCS)	0.780	0.907	See Table Below
LTE Band 41	0.323	0.907	1.230	

Simult Tx	Configuration	LTE Band 25 (PCS) SAR (W/kg)	2.4 GHz WLAN SAR (W/kg)	Σ SAR (W/kg)	SPLSR	Simult Tx	Configuration	PCS EVDO SAR (W/kg)	2.4 GHz WLAN SAR (W/kg)	Σ SAR (W/kg)	SPLSR
		1	2	1+2	1+2			1	2	1+2	1+2
Head SAR	Right Cheek	0.370	0.907*	<b>1.277</b>	N/A	Head SAR	Right Cheek	0.318	0.907*	<b>1.225</b>	N/A
	Right Tilt	0.250	0.907*	1.157	N/A		Right Tilt	0.269	0.907*	1.176	N/A
	Left Cheek	0.780	0.907	See Note 1	0.03		Left Cheek	0.716	0.907	See Note 1	0.03
	Left Tilt	0.271	0.604	0.875	N/A		Left Tilt	0.292	0.604	0.896	N/A

Simult Tx	Configuration	PCS CDMA SAR (W/kg)	2.4 GHz WLAN SAR (W/kg)	Σ SAR (W/kg)	SPLSR
		1	2	1+2	1+2
Head SAR	Right Cheek	0.338	0.907*	<b>1.245</b>	N/A
	Right Tilt	0.265	0.907*	1.172	N/A
	Left Cheek	0.708	0.907	See Note 1	0.03
	Left Tilt	0.288	0.604	0.892	N/A



FCC ID: ZNFX320PM	 <b>PCTEST</b> ENGINEERING LABORATORY, INC.	<b>SAR EVALUATION REPORT</b>		<b>Approved by:</b> Quality Manager
<b>Document S/N:</b> 1M1907220127-01.ZNF	<b>Test Dates:</b> 07/22/19 - 08/12/19	<b>DUT Type:</b> Portable Handset	Page 74 of 91	

**Table 12-3  
Simultaneous Transmission Scenario with Bluetooth (Held to Ear)**

Exposure Condition	Mode	2G/3G/4G SAR (W/kg)	Bluetooth SAR (W/kg)	Σ SAR (W/kg)
		1	2	1+2
Head SAR	GSM/GPRS 850	0.320	0.212	0.532
	GSM/GPRS 1900	0.340	0.212	0.552
	UMTS 850	0.333	0.212	0.545
	UMTS 1750	0.523	0.212	0.735
	UMTS 1900	0.625	0.212	0.837
	CDMA/EVDO BC10 (§90S)	0.416	0.212	0.628
	CDMA/EVDO BC0 (§22H)	0.336	0.212	0.548
	PCS CDMA/EVDO	0.716	0.212	0.928
	LTE Band 71	0.201	0.212	0.413
	LTE Band 12	0.267	0.212	0.479
	LTE Band 13	0.317	0.212	0.529
	LTE Band 26 (Cell)	0.449	0.212	0.661
	LTE Band 66 (AWS)	0.566	0.212	0.778
	LTE Band 25 (PCS)	0.780	0.212	<b>0.992</b>
LTE Band 41	0.323	0.212	0.535	

Notes:



- No evaluation was performed to determine the aggregate 1g SAR for these configurations as the SPLS ratio between the antenna pairs was not greater than 0.04 per FCC KDB 447498 D01v06. See Section 12.6 for detailed SPLS ratio analysis.

FCC ID: ZNFX320PM		SAR EVALUATION REPORT		Approved by: Quality Manager
Document S/N: 1M1907220127-01.ZNF	Test Dates: 07/22/19 - 08/12/19	DUT Type: Portable Handset		Page 75 of 91

## 12.4 Body-Worn Simultaneous Transmission Analysis

**Table 12-4**  
**Simultaneous Transmission Scenario with 2.4 GHz WLAN (Body-Worn at 1.0 cm)**



Exposure Condition	Mode	2G/3G/4G SAR (W/kg)	2.4 GHz WLAN SAR (W/kg)	Σ SAR (W/kg)
		1	2	1+2
Body-Worn	GSM/GPRS 850	0.477	0.130	0.607
	GSM/GPRS 1900	0.346	0.130	0.476
	UMTS 850	0.501	0.130	0.631
	UMTS 1750	0.955	0.130	<b>1.085</b>
	UMTS 1900	0.668	0.130	0.798
	CDMA BC10 (§90S)	0.662	0.130	0.792
	CDMA BC0 (§22H)	0.493	0.130	0.623
	PCS CDMA	0.596	0.130	0.726
	LTE Band 71	0.387	0.130	0.517
	LTE Band 12	0.378	0.130	0.508
	LTE Band 13	0.511	0.130	0.641
	LTE Band 26 (Cell)	0.577	0.130	0.707
	LTE Band 66 (AWS)	0.834	0.130	0.964
	LTE Band 25 (PCS)	0.674	0.130	0.804
LTE Band 41	0.778	0.130	0.908	

FCC ID: ZNFX320PM		SAR EVALUATION REPORT		Approved by: Quality Manager
Document S/N: 1M1907220127-01.ZNF	Test Dates: 07/22/19 - 08/12/19	DUT Type: Portable Handset		Page 76 of 91

**Table 12-5  
Simultaneous Transmission Scenario with Bluetooth (Body-Worn at 1.0 cm)**

Exposure Condition	Mode	2G/3G/4G SAR (W/kg)	Bluetooth SAR (W/kg)	Σ SAR (W/kg)
		1	2	1+2
Body-Worn	GSM/GPRS 850	0.477	0.231	0.708
	GSM/GPRS 1900	0.346	0.231	0.577
	UMTS 850	0.501	0.231	0.732
	UMTS 1750	0.955	0.231	<b>1.186</b>
	UMTS 1900	0.668	0.231	0.899
	CDMA BC10 (§90S)	0.662	0.231	0.893
	CDMA BC0 (§22H)	0.493	0.231	0.724
	PCS CDMA	0.596	0.231	0.827
	LTE Band 71	0.387	0.231	0.618
	LTE Band 12	0.378	0.231	0.609
	LTE Band 13	0.511	0.231	0.742
	LTE Band 26 (Cell)	0.577	0.231	0.808
	LTE Band 66 (AWS)	0.834	0.231	1.065
	LTE Band 25 (PCS)	0.674	0.231	0.905
LTE Band 41	0.778	0.231	1.009	



Note: Bluetooth SAR was not required to be measured per FCC KDB Publication 447498 D01v06. Estimated SAR results were used in the above table to determine simultaneous transmission SAR test exclusion.

FCC ID: ZNFX320PM		SAR EVALUATION REPORT		Approved by: Quality Manager
Document S/N: 1M1907220127-01.ZNF	Test Dates: 07/22/19 - 08/12/19	DUT Type: Portable Handset		Page 77 of 91

## 12.5 Hotspot SAR Simultaneous Transmission Analysis

**Table 12-6**  
**Simultaneous Transmission Scenario with 2.4 GHz WLAN (Hotspot at 1.0 cm)**



Exposure Condition	Mode	2G/3G/4G SAR (W/kg)	2.4 GHz WLAN SAR (W/kg)	$\Sigma$ SAR (W/kg)
		1	2	1+2
Hotspot SAR	GPRS 850	0.477	0.130	0.607
	GPRS 1900	0.349	0.130	0.479
	UMTS 850	0.501	0.130	0.631
	UMTS 1750	0.955	0.130	1.085
	UMTS 1900	0.771	0.130	0.901
	EVDO BC10 (§90S)	0.687	0.130	0.817
	EVDO BC0 (§22H)	0.519	0.130	0.649
	PCS EVDO	0.828	0.130	0.958
	LTE Band 71	0.387	0.130	0.517
	LTE Band 12	0.378	0.130	0.508
	LTE Band 13	0.511	0.130	0.641
	LTE Band 26 (Cell)	0.577	0.130	0.707
	LTE Band 66 (AWS)	0.834	0.130	0.964
	LTE Band 25 (PCS)	0.875	0.130	1.005
LTE Band 41	1.296	0.130	<b>1.426</b>	

FCC ID: ZNFX320PM	 <b>PCTEST</b> ENGINEERING LABORATORY, INC.	<b>SAR EVALUATION REPORT</b>	 <b>LG</b>	<b>Approved by:</b> Quality Manager
<b>Document S/N:</b> 1M1907220127-01.ZNF	<b>Test Dates:</b> 07/22/19 - 08/12/19	<b>DUT Type:</b> Portable Handset	Page 78 of 91	

**Table 12-7  
Simultaneous Transmission Scenario with Bluetooth (Hotspot at 1.0 cm)**

Exposure Condition	Mode	2G/3G/4G SAR (W/kg)	Bluetooth SAR (W/kg)	Σ SAR (W/kg)
		1	2	1+2
Hotspot SAR	GPRS 850	0.477	0.231	0.708
	GPRS 1900	0.349	0.231	0.580
	UMTS 850	0.501	0.231	0.732
	UMTS 1750	0.955	0.231	1.186
	UMTS 1900	0.771	0.231	1.002
	EVDO BC10 (§90S)	0.687	0.231	0.918
	EVDO BC0 (§22H)	0.519	0.231	0.750
	PCS EVDO	0.828	0.231	1.059
	LTE Band 71	0.387	0.231	0.618
	LTE Band 12	0.378	0.231	0.609
	LTE Band 13	0.511	0.231	0.742
	LTE Band 26 (Cell)	0.577	0.231	0.808
	LTE Band 66 (AWS)	0.834	0.231	1.065
	LTE Band 25 (PCS)	0.875	0.231	1.106
LTE Band 41	1.296	0.231	<b>1.527</b>	

Note: Bluetooth SAR was not required to be measured per FCC KDB Publication 447498 D01v06. Estimated SAR results were used in the above table to determine simultaneous transmission SAR test exclusion.

FCC ID: ZNFX320PM		SAR EVALUATION REPORT		Approved by: Quality Manager
Document S/N: 1M1907220127-01.ZNF	Test Dates: 07/22/19 - 08/12/19	DUT Type: Portable Handset		Page 79 of 91

## 12.6 SPLSR Evaluation and Analysis

Per FCC KDB Publication 447498 D01v06, when the sum of the standalone transmitters is more than 1.6 W/kg for 1g, the SAR sum to peak locations can be analyzed to determine SAR distribution overlaps. When the SAR peak to location ratio (shown below) for each pair of antennas is  $\leq 0.04$  for 1g, simultaneous SAR evaluation is not required. The distance between the transmitters was calculated using the following formula.

$$\text{Distance}_{\text{Tx1} - \text{Tx2}} = R_i = \sqrt{(x_1 - x_2)^2 + (y_1 - y_2)^2 + (z_1 - z_2)^2} \text{ (Head)}$$

$$\text{SPLS Ratio} = \frac{(SAR_1 + SAR_2)^{1.5}}{R_i}$$



### 12.6.1 Head SAR SPLSR Evaluation and Analysis

**Table 12-8**  
**Peak SAR Locations for Head SAR – Left Cheek**

Mode/Band	x (mm)	y (mm)	z (mm)
2.4 GHz WLAN	20.38	326.98	-174.15
LTE Band 25	50.56	249.76	-175.83
PCS EVDO	55.20	254.19	-174.53
PCS CDMA	56.06	258.86	-174.89

**Table 12-9**  
**Head SAR – Left Cheek to Peak Location Separation Ratio Calculations**

Antenna Pair		Standalone SAR (W/kg)		Standalone SAR Sum (W/kg)	Peak SAR Separation Distance (mm)	SPLS Ratio	Plot Number
Ant "a"	Ant "b"	a	b	a+b	D <sub>a-b</sub>	$(a+b)^{1.5}/D_{a-b}$	
2.4 GHz WLAN	LTE Band 25	0.907	0.780	1.687	82.93	0.03	1
2.4 GHz WLAN	PCS EVDO	0.907	0.716	1.623	80.69	0.03	2
2.4 GHz WLAN	PCS CDMA	0.907	0.708	1.615	76.90	0.03	3

FCC ID: ZNFX320PM			SAR EVALUATION REPORT		Approved by: Quality Manager
Document S/N: 1M1907220127-01.ZNF	Test Dates: 07/22/19 - 08/12/19	DUT Type: Portable Handset		Page 80 of 91	



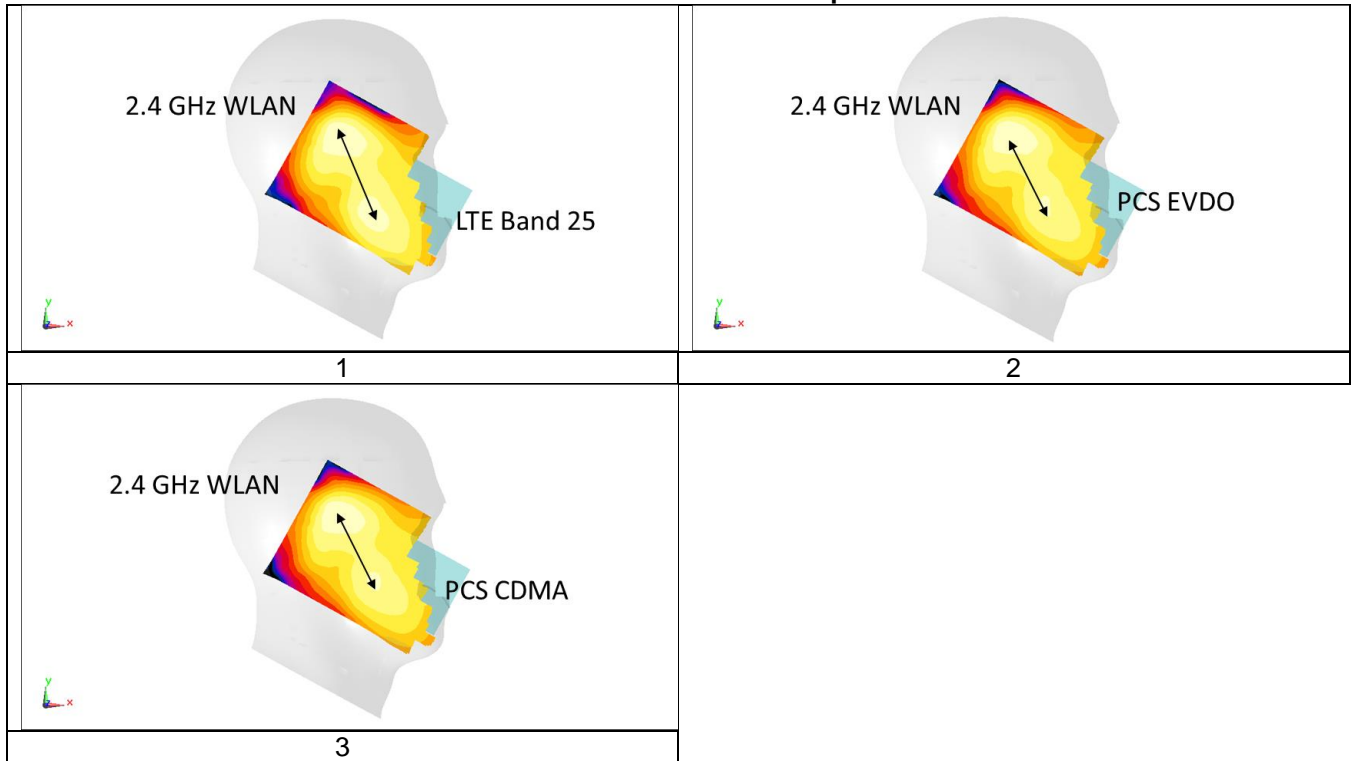

**Table 12-10  
Head SAR – Left Cheek to Peak Location Separation Ratio Plots**



### 12.7 Simultaneous Transmission Conclusion

The above numerical summed SAR results and SPLSR analysis are sufficient to determine that simultaneous transmission cases will not exceed the SAR limit and therefore no measured volumetric simultaneous SAR summation is required per FCC KDB Publication 447498 D01v06 and IEEE 1528- 2013 Section 6.3.4.1.

FCC ID: ZNFX320PM	 <b>SAR EVALUATION REPORT</b>		 <b>Approved by:</b> Quality Manager
Document S/N: 1M1907220127-01.ZNF	Test Dates: 07/22/19 - 08/12/19	DUT Type: Portable Handset	Page 81 of 91

# 13 SAR MEASUREMENT VARIABILITY

## 13.1 Measurement Variability

Per FCC KDB Publication 865664 D01v01r04, SAR measurement variability was assessed for each frequency band, which was determined by the SAR probe calibration point and tissue-equivalent medium used for the device measurements. When both head and body tissue-equivalent media were required for SAR measurements in a frequency band, the variability measurement procedures were applied to the tissue medium with the highest measured SAR, using the highest measured SAR configuration for that tissue-equivalent medium. These additional measurements were repeated after the completion of all measurements requiring the same head or body tissue-equivalent medium in a frequency band. The test device was returned to ambient conditions (normal room temperature) with the battery fully charged before it was re-mounted on the device holder for the repeated measurement(s) to minimize any unexpected variations in the repeated results.

SAR Measurement Variability was assessed using the following procedures for each frequency band:



- 1) When the original highest measured SAR is  $\geq 0.80$  W/kg, the measurement was repeated once.
- 2) A second repeated measurement was performed only if the ratio of largest to smallest SAR for the original and first repeated measurements was  $> 1.20$  or when the original or repeated measurement was  $\geq 1.45$  W/kg (~ 10% from the 1g SAR limit).
- 3) A third repeated measurement was performed only if the original, first or second repeated measurement was  $\geq 1.5$  W/kg and the ratio of largest to smallest SAR for the original, first and second repeated measurements is  $> 1.20$ .
- 4) Repeated measurements are not required when the original highest measured SAR is  $< 0.80$  W/kg

**Table 13-1  
Head SAR Measurement Variability Results**

HEAD VARIABILITY RESULTS														
Band	FREQUENCY		Mode	Service	Side	Test Position	Data Rate (Mbps)	Measured SAR (1g)	1st Repeated SAR (1g)	Ratio	2nd Repeated SAR (1g)	Ratio	3rd Repeated SAR (1g)	Ratio
	MHz	Ch.						(W/kg)	(W/kg)		(W/kg)		(W/kg)	
2450	2437.00	6	802.11b, 22 MHz Bandwidth	DSSS	Left	Cheek	1	0.817	0.815	1.00	N/A	N/A	N/A	N/A
ANSI / IEEE C95.1 1992 - SAFETY LIMIT Spatial Peak Uncontrolled Exposure/General Population						Head 1.6 W/kg (mW/g) averaged over 1 gram								



**Table 13-2  
Body SAR Measurement Variability Results**

BODY VARIABILITY RESULTS													
Band	FREQUENCY		Mode	Service	Side	Spacing	Measured SAR (1g)	1st Repeated SAR (1g)	Ratio	2nd Repeated SAR (1g)	Ratio	3rd Repeated SAR (1g)	Ratio
	MHz	Ch.					(W/kg)	(W/kg)		(W/kg)		(W/kg)	
1750	1732.40	1412	UMTS 1750	RMC	back	10 mm	0.905	0.940	1.04	N/A	N/A	N/A	N/A
1900	1905.00	26590	LTE Band 25 (PCS), 20 MHz Bandwidth	QPSK, 1 RB, 50 RB Offset	left	10 mm	0.861	0.830	1.04	N/A	N/A	N/A	N/A
2600	2593.00	40620	LTE Band 41 PC2, 20 MHz Bandwidth	QPSK, 1 RB, 50 RB Offset	bottom	10 mm	1.230	1.210	1.02	N/A	N/A	N/A	N/A
ANSI / IEEE C95.1 1992 - SAFETY LIMIT Spatial Peak Uncontrolled Exposure/General Population						Body 1.6 W/kg (mW/g) averaged over 1 gram							

FCC ID: ZNFX320PM		SAR EVALUATION REPORT		Approved by: Quality Manager
Document S/N: 1M1907220127-01.ZNF	Test Dates: 07/22/19 - 08/12/19	DUT Type: Portable Handset	Page 82 of 91	

## 13.2 Measurement Uncertainty

The measured SAR was <1.5 W/kg for all frequency bands. Therefore, per KDB Publication 865664 D01v01r04, the extended measurement uncertainty analysis per IEEE 1528-2013 was not required.

FCC ID: ZNFX320PM	 <b>SAR EVALUATION REPORT</b> 		<b>Approved by:</b> Quality Manager
<b>Document S/N:</b> 1M1907220127-01.ZNF	<b>Test Dates:</b> 07/22/19 - 08/12/19	<b>DUT Type:</b> Portable Handset	Page 83 of 91

# 14 ADDITIONAL TESTING PER FCC GUIDANCE

## 14.1 LTE Band 41 Power Class 2 and Power Class 3 Linearity

This device supports Power Class 2 and Power Class 3 operations for LTE Band 41. The highest available duty cycle for Power Class 2 operations is 43.3 % using UL-DL configuration 1. Per May 2017 TCB Workshop Notes based on the device behavior, all SAR tests were performed using Power Class 3. SAR with Power Class 2 at the highest power and available duty factor was additionally performed for the Power Class 3 configuration with the highest SAR for each exposure condition. The linearity between the Power Class 2 and Power Class 3 SAR results and the respective frame averaged powers was calculated to determine that the results were linear. Per May 2017 TCB Workshop, no additional SAR measurements were required since the linearity between power classes was < 10% and all reported SAR values were < 1.4 W/kg for 1g and < 3.5 W/kg for 10g.



LTE Band 41 SAR testing with power class 2 at the highest power and available duty factor was additionally performed for the power class 3 configuration with the highest SAR for each exposure condition.

**Table 14-1  
LTE Band 41 Head Linearity Data**

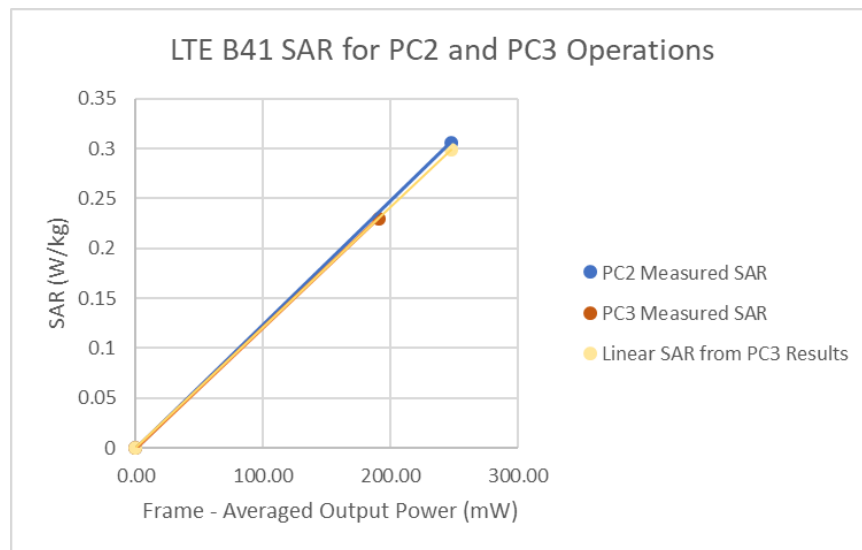
	LTE Band 41 PC3	LTE Band 41 PC2
Maximum Allowed Output Power (dBm)	24.8	27.8
Measured Output Power (dBm)	24.79	27.57
Measured SAR (W/kg)	0.23	0.306
Measured Power (mW)	301.30	571.48
Duty Cycle	63.3%	43.3%
Frame Averaged Output Power (mW)	190.72	247.45
% deviation from expected linearity		2.54%

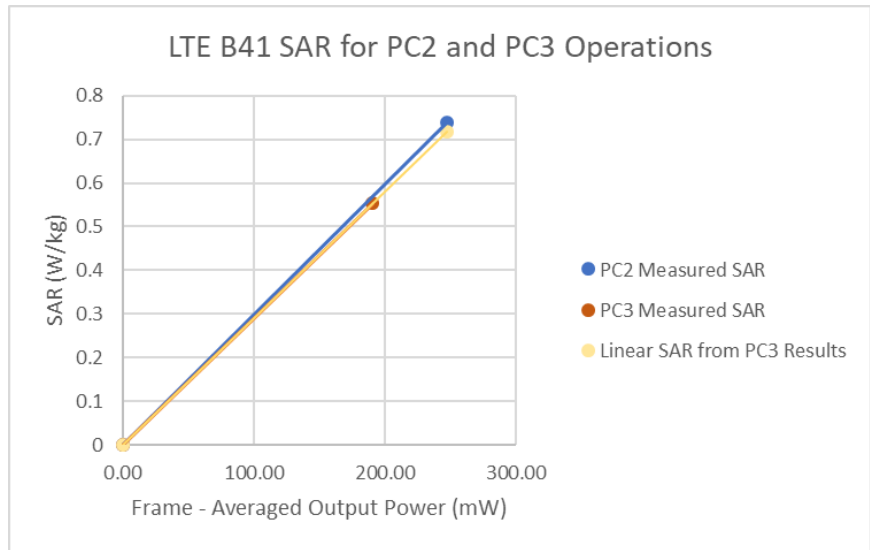

**Figure 14-1  
LTE Band 41 Head Linearity**



FCC ID: ZNFX320PM	 PCTEST ENGINEERING LABORATORY, INC.	SAR EVALUATION REPORT	 LG	Approved by: Quality Manager
Document S/N: 1M1907220127-01.ZNF	Test Dates: 07/22/19 - 08/12/19	DUT Type: Portable Handset		Page 84 of 91

**Table 14-2  
LTE Band 41 Body-Worn Linearity Data**

	LTE Band 41 PC3	LTE Band 41 PC2
Maximum Allowed Output Power (dBm)	24.8	27.8
Measured Output Power (dBm)	24.79	27.57
Measured SAR (W/kg)	0.553	0.738
Measured Power (mW)	301.30	571.48
Duty Cycle	63.3%	43.3%
Frame Averaged Output Power (mW)	190.72	247.45
% deviation from expected linearity		2.86%

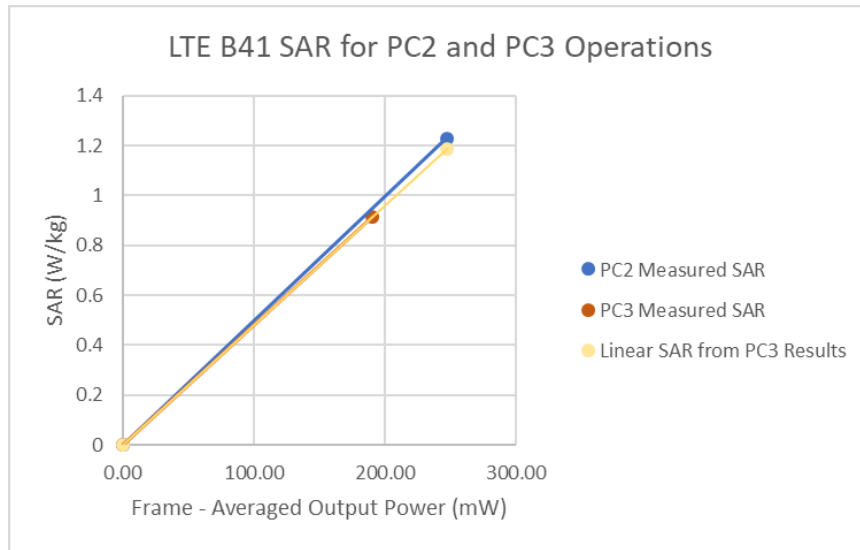

**Figure 14-2  
LTE Band 41 Body-Worn Linearity**



FCC ID: ZNFX320PM		SAR EVALUATION REPORT		Approved by: Quality Manager
Document S/N: 1M1907220127-01.ZNF	Test Dates: 07/22/19 - 08/12/19	DUT Type: Portable Handset		Page 85 of 91

**Table 14-3  
LTE Band 41 Hotspot Linearity Data**

	LTE Band 41 PC3	LTE Band 41 PC2
Maximum Allowed Output Power (dBm)	24.8	27.8
Measured Output Power (dBm)	24.79	27.57
Measured SAR (W/kg)	0.915	1.23
Measured Power (mW)	301.30	571.48
Duty Cycle	63.3%	43.3%
Frame Averaged Output Power (mW)	190.72	247.45
% deviation from expected linearity		3.61%





**Figure 14-3  
LTE Band 41 Hotspot Linearity**

FCC ID: ZNFX320PM		SAR EVALUATION REPORT		Approved by: Quality Manager
Document S/N: 1M1907220127-01.ZNF	Test Dates: 07/22/19 - 08/12/19	DUT Type: Portable Handset		Page 86 of 91



Manufacturer	Model	Description	Cal Date	Cal Interval	Cal Due	Serial Number
Agilent	8753ES	S-Parameter Vector Network Analyzer	8/30/2018	Annual	8/30/2019	MY40003841
Agilent	8753ES	Network Analyzer	3/19/2019	Annual	3/19/2020	MY40001472
Agilent	E4438C	ESG Vector Signal Generator	5/22/2019	Annual	5/22/2020	MY45091346
Agilent	E5515C	8960 Series 10 Wireless Communications Test Set	12/18/2018	Annual	12/18/2019	GB42230325
Agilent	E5515C	Wireless Communications Test Set	2/28/2018	Biennial	2/28/2020	GB41450275
Agilent	N4010A	Wireless Connectivity Test Set	N/A	N/A	N/A	GB46170464
Agilent	N5182A	MXG Vector Signal Generator	11/28/2018	Annual	11/28/2019	MY47420603
Agilent	N9020A	MXA Signal Analyzer	4/20/2019	Annual	4/20/2020	US46470561
Amplifier Research	150A100C	Amplifier	CBT	N/A	CBT	350132
Amplifier Research	150A100C	DC Amplifier	CBT	N/A	CBT	348812
Anritsu	MA2411B	Pulse Power Sensor	10/30/2018	Annual	10/30/2019	1126066
Anritsu	MA2411B	Pulse Power Sensor	10/30/2018	Annual	10/30/2019	1207470
Anritsu	ML2495A	Power Meter	10/21/2018	Annual	10/21/2019	941001
Anritsu	ML2495A	Power Meter	11/20/2018	Annual	11/20/2019	1039008
Anritsu	MT8000A	Radio Communication Test Station	11/14/2018	Annual	11/14/2019	6261914237
Anritsu	MT8820C	Radio Communication Analyzer	3/29/2019	Annual	3/29/2020	6201300731
COMTECH	AR85729-5	Solid State Amplifier	CBT	N/A	CBT	M155A00-009
COMTECH	AR85729-5/5759B	Solid State Amplifier	CBT	N/A	CBT	M3W1A00-1002
Control Company	4040	Therm./ Clock/ Humidity Monitor	1/8/2019	Annual	1/8/2020	160473909
Control Company	4352	Ultra Long Stem Thermometer	2/28/2018	Biennial	2/28/2020	170380160
Keysight Technologies	85033E	Standard Mechanical Calibration Kit (DC to 9GHz, 3.5mm)	7/2/2019	Annual	7/2/2020	MYS3401181
Keysight Technologies	AT/N6705B	DC Power Supply	CBT	N/A	CBT	MYS3001315
MCL	BW-N6W5+	6dB Attenuator	CBT	N/A	CBT	1139
Mini Circuits	PWR-5EN-4GHS	USB Power Sensor	4/19/2019	Annual	4/19/2020	11401010036
MiniCircuits	SLP-2400+	Low Pass Filter	CBT	N/A	CBT	R8979500903
Mini-Circuits	BW-N20W5+	DC to 18 GHz Precision Fixed 20 dB Attenuator	CBT	N/A	CBT	N/A
Mini-Circuits	NLP-1200+	Low Pass Filter DC to 1000 MHz	CBT	N/A	CBT	N/A
Mini-Circuits	NLP-2950+	Low Pass Filter DC to 2700 MHz	CBT	N/A	CBT	N/A
Mitutoyo	CD-6°CSX	Digital Caliper	4/18/2018	Biennial	4/18/2020	13264165
Narda	4014C-6	4 - 8 GHz SMA 6 dB Directional Coupler	CBT	N/A	CBT	N/A
Narda	4772-3	Attenuator (3dB)	CBT	N/A	CBT	9406
Pasternack	NC-100	Torque Wrench	11/1/2017	Biennial	11/1/2019	N/A
Pasternack	PE2208-6	Bidirectional Coupler	CBT	N/A	CBT	N/A
Pasternack	PE2209-10	Bidirectional Coupler	CBT	N/A	CBT	N/A
Rohde & Schwarz	CMU200	Base Station Simulator	6/3/2019	Annual	6/3/2020	109892
Rohde & Schwarz	CMW500	Wideband Radio Communication Tester	10/30/2018	Annual	10/30/2019	164948
Seekonk	NC-100	Torque Wrench	11/1/2017	Biennial	11/1/2019	N/A
Seekonk	NC-100	Torque Wrench (8" lb)	5/10/2018	Biennial	5/10/2020	21053
SPEAG	DAK-3.5	Dielectric Assessment Kit	9/11/2018	Annual	9/11/2019	1091
SPEAG	D750V3	750 MHz SAR Dipole	1/15/2018	Biennial	1/15/2020	1003
SPEAG	D835V2	835 MHz SAR Dipole	1/22/2019	Annual	1/22/2020	4d132
SPEAG	D1750V2	1750 MHz SAR Dipole	5/15/2019	Annual	5/15/2020	1148
SPEAG	D1900V2	1900 MHz SAR Dipole	2/21/2019	Annual	2/21/2020	5d148
SPEAG	D2450V2	2450 MHz SAR Dipole	9/11/2017	Biennial	9/11/2019	797
SPEAG	D2600V2	2600 MHz SAR Dipole	8/13/2018	Annual	8/13/2019	1126
SPEAG	D835V2	835 MHz SAR Dipole	3/13/2019	Annual	3/13/2020	4d047
SPEAG	D1750V2	1750 MHz SAR Dipole	10/22/2018	Annual	10/22/2019	1150
SPEAG	D1900V2	1900 MHz SAR Dipole	10/23/2018	Annual	10/23/2019	5d080
SPEAG	D2450V2	2450 MHz SAR Dipole	8/17/2017	Biennial	8/17/2019	719
SPEAG	D2600V2	2600 MHz SAR Dipole	4/11/2018	Biennial	4/11/2020	1004
SPEAG	EX3DV4	SAR Probe	1/25/2019	Annual	1/25/2020	3589
SPEAG	EX3DV4	SAR Probe	5/16/2019	Annual	5/16/2020	7406
SPEAG	EX3DV4	SAR Probe	6/19/2019	Annual	6/19/2020	7409
SPEAG	EX3DV4	SAR Probe	2/19/2019	Annual	2/19/2020	3914
SPEAG	EX3DV4	SAR Probe	5/16/2019	Annual	5/16/2020	7538
SPEAG	EX3DV4	SAR Probe	4/24/2019	Annual	4/24/2020	7357
SPEAG	EX3DV4	SAR Probe	1/24/2019	Annual	1/24/2020	7488
SPEAG	EX3DV4	SAR Probe	7/15/2019	Annual	7/15/2020	7547
SPEAG	DAE4	Dasy Data Acquisition Electronics	8/22/2018	Annual	8/22/2019	1450
SPEAG	DAE4	Dasy Data Acquisition Electronics	5/8/2019	Annual	5/8/2020	859
SPEAG	DAE4	Dasy Data Acquisition Electronics	6/20/2019	Annual	6/20/2020	1334
SPEAG	DAE4	Dasy Data Acquisition Electronics	2/14/2019	Annual	2/14/2020	1272
SPEAG	DAE4	Dasy Data Acquisition Electronics	5/8/2019	Annual	5/8/2020	728
SPEAG	DAE4	Dasy Data Acquisition Electronics	4/18/2019	Annual	4/18/2020	1407
SPEAG	DAE4	Dasy Data Acquisition Electronics	1/15/2019	Annual	1/15/2020	1530
SPEAG	DAE4	Dasy Data Acquisition Electronics	7/11/2019	Annual	7/11/2020	1323

Note: CBT (Calibrated Before Testing). Prior to testing, the measurement paths containing a cable, amplifier, attenuator, coupler or filter were connected to a calibrated source (i.e. a signal generator) to determine the losses of the measurement path. The power meter offset was then adjusted to compensate for the measurement system losses. This level offset is stored within the power meter before measurements are made. This calibration verification procedure applies to the system verification and output power measurements. The calibrated reading is then taken directly from the power meter after compensation of the losses for all final power measurements.

All equipment was used solely within its calibration period.

FCC ID: ZNFX320PM		SAR EVALUATION REPORT		Approved by: Quality Manager
Document S/N: 1M1907220127-01.ZNF	Test Dates: 07/22/19 - 08/12/19	DUT Type: Portable Handset	Page 87 of 91	

a	c	d	e= f(d,k)	f	g	h = c x f/e	i = c x g/e	k
Uncertainty Component	Tol. (± %)	Prob. Dist.	Div.	c <sub>i</sub> 1gm	c <sub>i</sub> 10 gms	1gm u <sub>i</sub> (± %)	10gms u <sub>i</sub> (± %)	v <sub>i</sub>
<b>Measurement System</b>								
Probe Calibration	6.55	N	1	1.0	1.0	6.6	6.6	∞
Axial Isotropy	0.25	N	1	0.7	0.7	0.2	0.2	∞
Hemishperical Isotropy	1.3	N	1	0.7	0.7	0.9	0.9	∞
Boundary Effect	2.0	R	1.73	1.0	1.0	1.2	1.2	∞
Linearity	0.3	N	1	1.0	1.0	0.3	0.3	∞
System Detection Limits	0.25	R	1.73	1.0	1.0	0.1	0.1	∞
Readout Electronics	0.3	N	1	1.0	1.0	0.3	0.3	∞
Response Time	0.8	R	1.73	1.0	1.0	0.5	0.5	∞
Integration Time	2.6	R	1.73	1.0	1.0	1.5	1.5	∞
RF Ambient Conditions - Noise	3.0	R	1.73	1.0	1.0	1.7	1.7	∞
RF Ambient Conditions - Reflections	3.0	R	1.73	1.0	1.0	1.7	1.7	∞
Probe Positioner Mechanical Tolerance	0.4	R	1.73	1.0	1.0	0.2	0.2	∞
Probe Positioning w/ respect to Phantom	6.7	R	1.73	1.0	1.0	3.9	3.9	∞
Extrapolation, Interpolation & Integration algorithms for Max. SAR Evaluation	4.0	R	1.73	1.0	1.0	2.3	2.3	∞
<b>Test Sample Related</b>								
Test Sample Positioning	2.7	N	1	1.0	1.0	2.7	2.7	35
Device Holder Uncertainty	1.67	N	1	1.0	1.0	1.7	1.7	5
Output Power Variation - SAR drift measurement	5.0	R	1.73	1.0	1.0	2.9	2.9	∞
SAR Scaling	0.0	R	1.73	1.0	1.0	0.0	0.0	∞
<b>Phantom &amp; Tissue Parameters</b>								
Phantom Uncertainty (Shape & Thickness tolerances)	7.6	R	1.73	1.0	1.0	4.4	4.4	∞
Liquid Conductivity - measurement uncertainty	4.2	N	1	0.78	0.71	3.3	3.0	10
Liquid Permittivity - measurement uncertainty	4.1	N	1	0.23	0.26	1.0	1.1	10
Liquid Conductivity - Temperature Uncertainty	3.4	R	1.73	0.78	0.71	1.5	1.4	∞
Liquid Permittivity - Temperature Uncertainty	0.6	R	1.73	0.23	0.26	0.1	0.1	∞
Liquid Conductivity - deviation from target values	5.0	R	1.73	0.64	0.43	1.8	1.2	∞
Liquid Permittivity - deviation from target values	5.0	R	1.73	0.60	0.49	1.7	1.4	∞
Combined Standard Uncertainty (k=1)	RSS					11.5	11.3	60
Expanded Uncertainty (95% CONFIDENCE LEVEL)	k=2					23.0	22.6	

FCC ID: ZNFX320PM		SAR EVALUATION REPORT		Approved by: Quality Manager
Document S/N: 1M1907220127-01.ZNF	Test Dates: 07/22/19 - 08/12/19	DUT Type: Portable Handset		Page 88 of 91





# 17 CONCLUSION

## 17.1 Measurement Conclusion



The SAR evaluation indicates that the EUT complies with the RF radiation exposure limits of the FCC and Innovation, Science, and Economic Development Canada, with respect to all parameters subject to this test. These measurements were taken to simulate the RF effects of RF exposure under worst-case conditions. Precise laboratory measures were taken to assure repeatability of the tests. The results and statements relate only to the item(s) tested.

Please note that the absorption and distribution of electromagnetic energy in the body are very complex phenomena that depend on the mass, shape, and size of the body, the orientation of the body with respect to the field vectors, and the electrical properties of both the body and the environment. Other variables that may play a substantial role in possible biological effects are those that characterize the environment (e.g. ambient temperature, air velocity, relative humidity, and body insulation) and those that characterize the individual (e.g. age, gender, activity level, debilitation, or disease). Because various factors may interact with one another to vary the specific biological outcome of an exposure to electromagnetic fields, any protection guide should consider maximal amplification of biological effects as a result of field-body interactions, environmental conditions, and physiological variables. [3]



<b>FCC ID:</b> ZNFX320PM	 <b>PCTEST</b> ENGINEERING LABORATORY, INC.	<b>SAR EVALUATION REPORT</b>	 <b>LG</b>	<b>Approved by:</b> Quality Manager
<b>Document S/N:</b> 1M1907220127-01.ZNF	<b>Test Dates:</b> 07/22/19 - 08/12/19	<b>DUT Type:</b> Portable Handset	Page 89 of 91	

## 18 REFERENCES

- [1] Federal Communications Commission, ET Docket 93-62, Guidelines for Evaluating the Environmental Effects of Radiofrequency Radiation, Aug. 1996.
- [2] ANSI/IEEE C95.1-2005, American National Standard safety levels with respect to human exposure to radio frequency electromagnetic fields, 3kHz to 300GHz, New York: IEEE, 2006.
- [3] ANSI/IEEE C95.1-1992, American National Standard safety levels with respect to human exposure to radio frequency electromagnetic fields, 3kHz to 300GHz, New York: IEEE, Sept. 1992.
- [4] ANSI/IEEE C95.3-2002, IEEE Recommended Practice for the Measurement of Potentially Hazardous Electromagnetic Fields - RF and Microwave, New York: IEEE, December 2002.
- [5] IEEE Standards Coordinating Committee 39 –Standards Coordinating Committee 34 – IEEE Std. 1528-2013, IEEE Recommended Practice for Determining the Peak Spatial-Average Specific Absorption Rate (SAR) in the Human Head from Wireless Communications Devices: Measurement Techniques.
- [6] NCRP, National Council on Radiation Protection and Measurements, Biological Effects and Exposure Criteria for RadioFrequency Electromagnetic Fields, NCRP Report No. 86, 1986. Reprinted Feb. 1995.
- [7] T. Schmid, O. Egger, N. Kuster, Automated E-field scanning system for dosimetric assessments, IEEE Transaction on Microwave Theory and Techniques, vol. 44, Jan. 1996, pp. 105-113.
- [8] K. Pokovic, T. Schmid, N. Kuster, Robust setup for precise calibration of E-field probes in tissue simulating liquids at mobile communications frequencies, ICECOM97, Oct. 1997, pp. 1 -124.
- [9] K. Pokovic, T. Schmid, and N. Kuster, E-field Probe with improved isotropy in brain simulating liquids, Proceedings of the ELMAR, Zadar, Croatia, June 23-25, 1996, pp. 172-175.
- [10] Schmid & Partner Engineering AG, Application Note: Data Storage and Evaluation, June 1998, p2.
- [11] V. Hombach, K. Meier, M. Burkhardt, E. Kuhn, N. Kuster, The Dependence of EM Energy Absorption upon Human Modeling at 900 MHz, IEEE Transaction on Microwave Theory and Techniques, vol. 44 no. 10, Oct. 1996, pp. 1865-1873.
- [12] N. Kuster and Q. Balzano, Energy absorption mechanism by biological bodies in the near field of dipole antennas above 300MHz, IEEE Transaction on Vehicular Technology, vol. 41, no. 1, Feb. 1992, pp. 17-23.
- [13] G. Hartsgrove, A. Kraszewski, A. Surowiec, Simulated Biological Materials for Electromagnetic Radiation Absorption Studies, University of Ottawa, Bioelectromagnetics, Canada: 1987, pp. 29-36.
- [14] Q. Balzano, O. Garay, T. Manning Jr., Electromagnetic Energy Exposure of Simulated Users of Portable Cellular Telephones, IEEE Transactions on Vehicular Technology, vol. 44, no.3, Aug. 1995.
- [15] W. Gander, Computermathematik, Birkhaeuser, Basel, 1992.
- [16] W.H. Press, S.A. Teukolsky, W.T. Vetterling, and B.P. Flannery, Numerical Recipes in C, The Art of Scientific Computing, Second edition, Cambridge University Press, 1992.
- [17] N. Kuster, R. Kastle, T. Schmid, Dosimetric evaluation of mobile communications equipment with known precision, IEEE Transaction on Communications, vol. E80-B, no. 5, May 1997, pp. 645-652.

FCC ID: ZNFX320PM	 <b>SAR EVALUATION REPORT</b> 		Approved by: Quality Manager
Document S/N: 1M1907220127-01.ZNF	Test Dates: 07/22/19 - 08/12/19	DUT Type: Portable Handset	Page 90 of 91

- [18] CENELEC CLC/SC111B, European Prestandard (prENV 50166-2), Human Exposure to Electromagnetic Fields High-frequency: 10kHz-300GHz, Jan. 1995.
- [19] Prof. Dr. Niels Kuster, ETH, Eidgenössische Technische Hochschule Zürich, Dosimetric Evaluation of the Cellular Phone.
- [20] IEC 62209-1, Measurement procedure for the assessment of specific absorption rate of human exposure to radio frequency fields from hand-held and body-mounted wireless communication devices - Part 1: Devices used next to the ear (Frequency range of 300 MHz to 6 GHz), July 2016.
- [21] Innovation, Science, Economic Development Canada RSS-102 Radio Frequency Exposure Compliance of Radiocommunication Apparatus (All Frequency Bands) Issue 5, March 2015.
- [22] Health Canada Safety Code 6 Limits of Human Exposure to Radio Frequency Electromagnetic Fields in the Frequency Range from 3 kHz – 300 GHz, 2015
- [23] FCC SAR Test Procedures for 2G-3G Devices, Mobile Hotspot and UMPC Devices KDB Publications 941225, D01-D07
- [24] SAR Measurement Guidance for IEEE 802.11 Transmitters, KDB Publication 248227 D01
- [25] FCC SAR Considerations for Handsets with Multiple Transmitters and Antennas, KDB Publications 648474 D03-D04
- [26] FCC SAR Evaluation Considerations for Laptop, Notebook, Netbook and Tablet Computers, FCC KDB Publication 616217 D04
- [27] FCC SAR Measurement and Reporting Requirements for 100MHz – 6 GHz, KDB Publications 865664 D01-D02
- [28] FCC General RF Exposure Guidance and SAR Procedures for Dongles, KDB Publication 447498, D01-D02
- [29] Anexo à Resolução No. 533, de 10 de Setembro de 2009.
- [30] IEC 62209-2, Human exposure to radio frequency fields from hand-held and body-mounted wireless communication devices - Human models, instrumentation, and procedures - Part 2: Procedure to determine the specific absorption rate (SAR) for wireless communication devices used in close proximity to the human body (frequency range of 30 MHz to 6 GHz), Mar. 2010.

<b>FCC ID:</b> ZNFX320PM	 <b>SAR EVALUATION REPORT</b>		 <b>Approved by:</b> Quality Manager
<b>Document S/N:</b> 1M1907220127-01.ZNF	<b>Test Dates:</b> 07/22/19 - 08/12/19	<b>DUT Type:</b> Portable Handset	Page 91 of 91

## APPENDIX A: SAR TEST DATA

# PCTEST ENGINEERING LABORATORY, INC.

**DUT: ZNFX320PM; Type: Portable Handset; Serial: 04963**

Communication System: UID 0, \_GSM GPRS; 2 Tx slots; Frequency: 836.6 MHz; Duty Cycle: 1:4.15  
Medium: 835 Head Medium parameters used (interpolated):  
 $f = 836.6 \text{ MHz}$ ;  $\sigma = 0.902 \text{ S/m}$ ;  $\epsilon_r = 42.251$ ;  $\rho = 1000 \text{ kg/m}^3$   
Phantom section: Right Section

Test Date: 07-30-2019; Ambient Temp: 22.9°C; Tissue Temp: 20.4°C

Probe: EX3DV4 - SN3589; ConvF(8.39, 8.39, 8.39) @ 836.6 MHz; Calibrated: 1/25/2019  
Sensor-Surface: 1.4mm (Mechanical Surface Detection)  
Electronics: DAE4 Sn1450; Calibrated: 8/22/2018  
Phantom: Twin-SAM V5.0 (30); Type: QD 000 P40 CD; Serial: 1647  
Measurement SW: DASY52, Version 52.10 (2);SEMCAD X Version 14.6.12 (7470)

**Mode: GPRS 850, Right Head, Cheek, Mid.ch, 2 Tx slots**

**Area Scan (9x15x1):** Measurement grid: dx=15mm, dy=15mm

**Zoom Scan (5x5x7)/Cube 0:** Measurement grid: dx=8mm, dy=8mm, dz=5mm

Reference Value = 18.99 V/m; Power Drift = -0.02 dB

Peak SAR (extrapolated) = 0.395 W/kg

**SAR(1 g) = 0.309 W/kg**

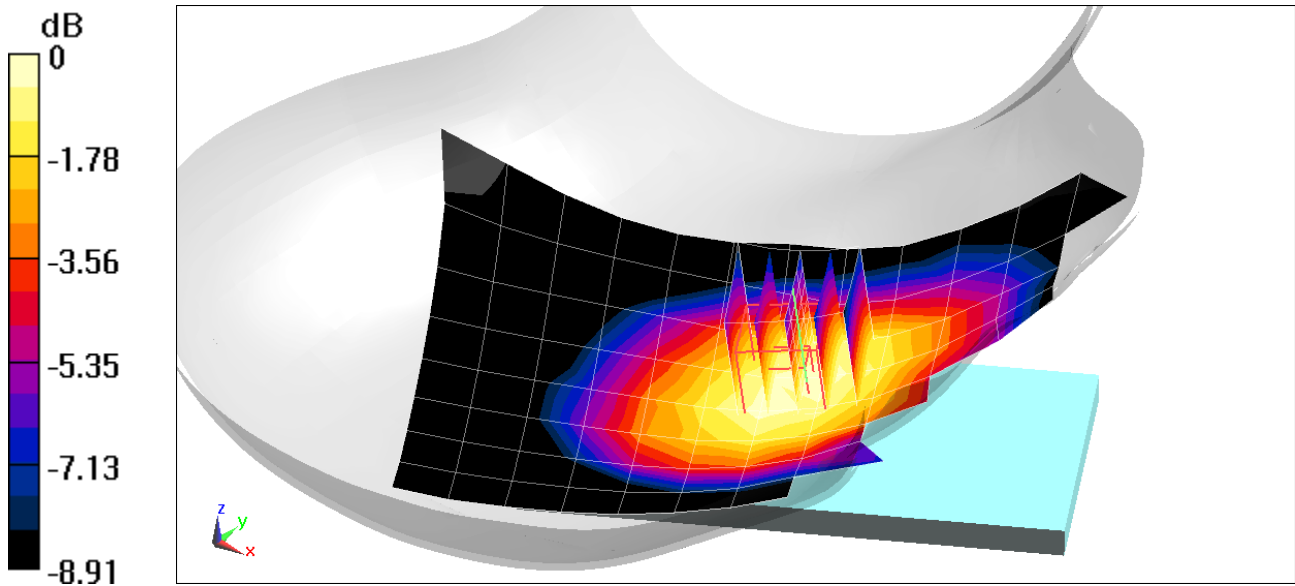

0 dB = 0.363 W/kg = -4.40 dBW/kg

# PCTEST ENGINEERING LABORATORY, INC.

**DUT: ZNFX320PM; Type: Portable Handset; Serial: 04963**

Communication System: UID 0, \_GSM GPRS; 2 Tx slots; Frequency: 1880 MHz; Duty Cycle: 1:4.15  
Medium: 1900 Head Medium parameters used:  
 $f = 1880 \text{ MHz}$ ;  $\sigma = 1.413 \text{ S/m}$ ;  $\epsilon_r = 39.502$ ;  $\rho = 1000 \text{ kg/m}^3$   
Phantom section: Left Section

Test Date: 07-25-2019; Ambient Temp: 21.2°C; Tissue Temp: 20.1°C

Probe: EX3DV4 - SN7406; ConvF(8.18, 8.18, 8.18) @ 1880 MHz; Calibrated: 5/16/2019  
Sensor-Surface: 1.4mm (Mechanical Surface Detection)  
Electronics: DAE4 Sn859; Calibrated: 5/8/2019  
Phantom: Twin-SAM V5.0 Right 20; Type: QD 000 P40 CD; Serial: 1759  
Measurement SW: DASY52, Version 52.10 (2);SEMCAD X Version 14.6.12 (7470)

**Mode: GPRS 1900, Left Head, Cheek, Mid.ch, 2 Tx slots**

**Area Scan (9x15x1):** Measurement grid:  $dx=15\text{mm}$ ,  $dy=15\text{mm}$

**Zoom Scan (5x5x7)/Cube 0:** Measurement grid:  $dx=8\text{mm}$ ,  $dy=8\text{mm}$ ,  $dz=5\text{mm}$

Reference Value = 15.67 V/m; Power Drift = 0.01 dB

Peak SAR (extrapolated) = 0.479 W/kg

**SAR(1 g) = 0.312 W/kg**

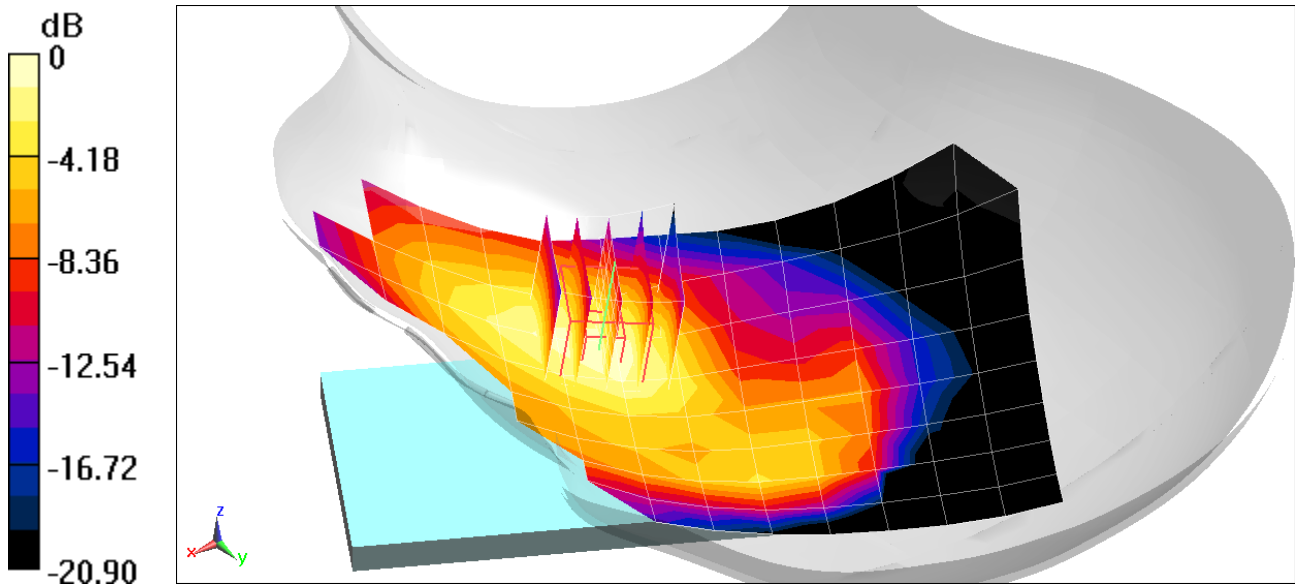

0 dB = 0.426 W/kg = -3.71 dBW/kg

# PCTEST ENGINEERING LABORATORY, INC.

**DUT: ZNFX320PM; Type: Portable Handset; Serial: 04963**

Communication System: UID 0, UMTS; Frequency: 836.6 MHz; Duty Cycle: 1:1  
Medium: 835 Head Medium parameters used (interpolated):  
 $f = 836.6 \text{ MHz}$ ;  $\sigma = 0.902 \text{ S/m}$ ;  $\epsilon_r = 42.251$ ;  $\rho = 1000 \text{ kg/m}^3$   
Phantom section: Right Section

Test Date: 07-30-2019; Ambient Temp: 22.9°C; Tissue Temp: 20.4°C

Probe: EX3DV4 - SN3589; ConvF(8.39, 8.39, 8.39) @ 836.6 MHz; Calibrated: 1/25/2019  
Sensor-Surface: 1.4mm (Mechanical Surface Detection)  
Electronics: DAE4 Sn1450; Calibrated: 8/22/2018  
Phantom: Twin-SAM V5.0 (30); Type: QD 000 P40 CD; Serial: 1647  
Measurement SW: DASY52, Version 52.10 (2); SEMCAD X Version 14.6.12 (7470)

**Mode: UMTS 850, Right Head, Cheek, Mid.ch**

**Area Scan (9x15x1):** Measurement grid:  $dx=15\text{mm}$ ,  $dy=15\text{mm}$

**Zoom Scan (5x5x7)/Cube 0:** Measurement grid:  $dx=8\text{mm}$ ,  $dy=8\text{mm}$ ,  $dz=5\text{mm}$

Reference Value = 19.42 V/m; Power Drift = 0.00 dB

Peak SAR (extrapolated) = 0.422 W/kg

**SAR(1 g) = 0.326 W/kg**

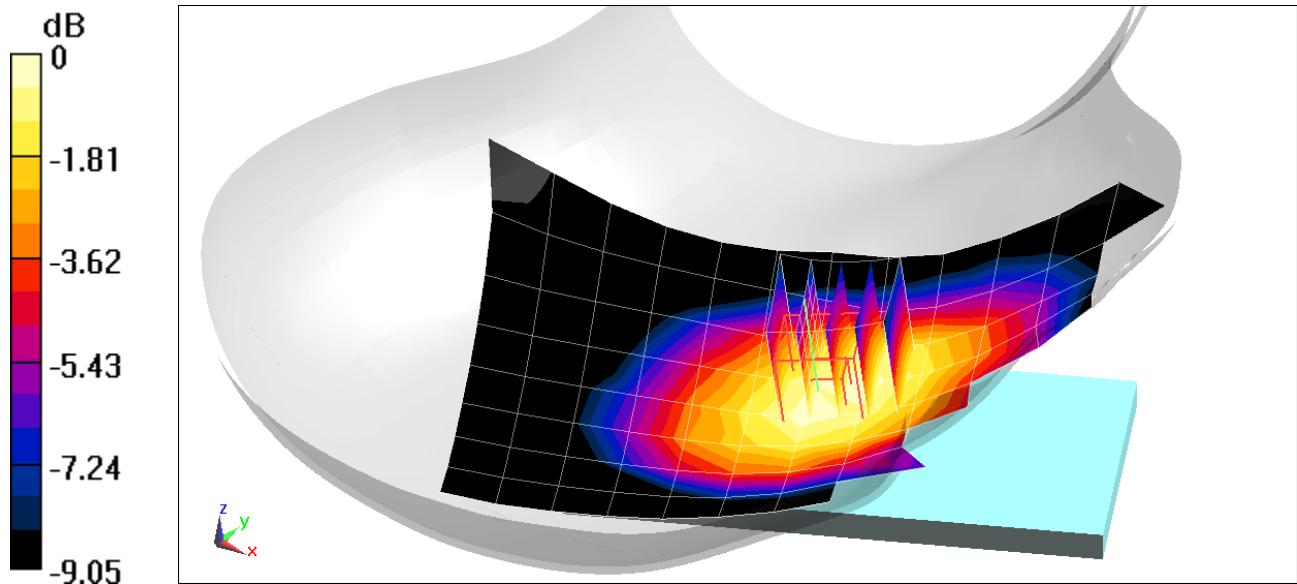

0 dB = 0.390 W/kg = -4.09 dBW/kg

# PCTEST ENGINEERING LABORATORY, INC.

**DUT: ZNFX320PM; Type: Portable Handset; Serial: 04964**

Communication System: UID 0, UMTS; Frequency: 1732.4 MHz; Duty Cycle: 1:1  
Medium: 1750 Head Medium parameters used (interpolated):  
 $f = 1732.4 \text{ MHz}$ ;  $\sigma = 1.359 \text{ S/m}$ ;  $\epsilon_r = 40.461$ ;  $\rho = 1000 \text{ kg/m}^3$   
Phantom section: Left Section

Test Date: 08-07-2019; Ambient Temp: 20.5°C; Tissue Temp: 20.7°C

Probe: EX3DV4 - SN7538; ConvF(8.67, 8.67, 8.67) @ 1732.4 MHz; Calibrated: 5/16/2019  
Sensor-Surface: 1.4mm (Mechanical Surface Detection)  
Electronics: DAE4 Sn728; Calibrated: 5/8/2019  
Phantom: Left Twin-SAM V5.0 30; Type: QD 000 P40 CD; Serial: 1792  
Measurement SW: DASY52, Version 52.10 (2);SEMCAD X Version 14.6.12 (7470)

**Mode: UMTS 1750, Left Head, Cheek, Mid.ch**

**Area Scan (9x15x1):** Measurement grid: dx=15mm, dy=15mm

**Zoom Scan (5x5x7)/Cube 0:** Measurement grid: dx=8mm, dy=8mm, dz=5mm

Reference Value = 20.21 V/m; Power Drift = 0.08 dB

Peak SAR (extrapolated) = 0.779 W/kg

**SAR(1 g) = 0.515 W/kg**

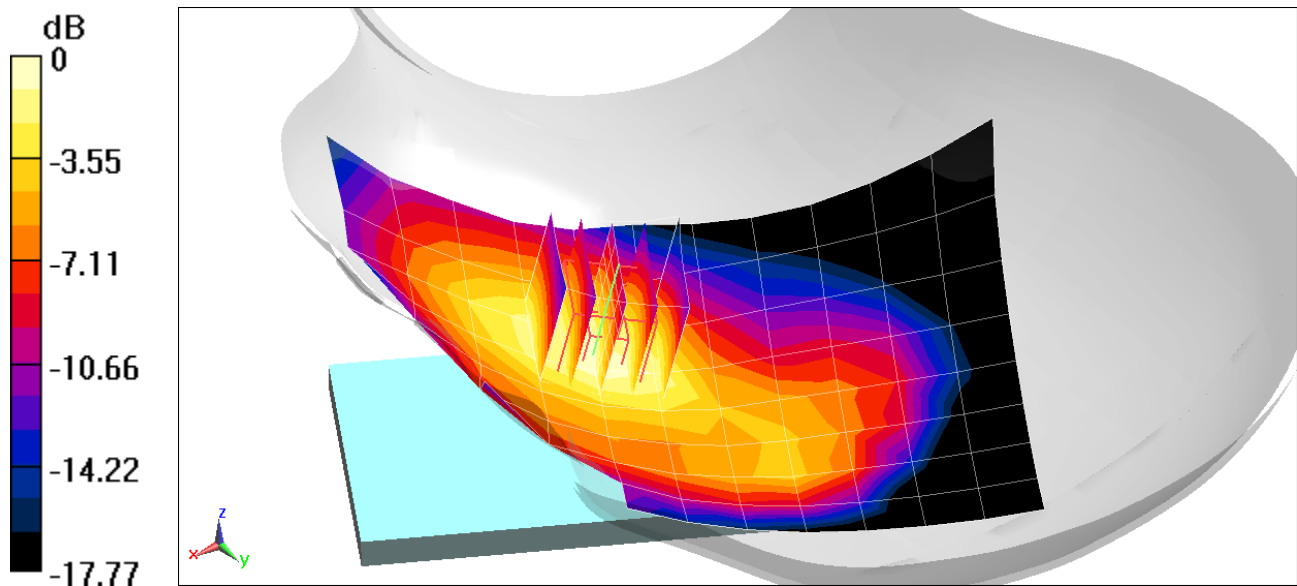

0 dB = 0.666 W/kg = -1.77 dBW/kg



# PCTEST ENGINEERING LABORATORY, INC.

**DUT: ZNFX320PM; Type: Portable Handset; Serial: 04963**

Communication System: UID 0, Frequency: 1852.4 MHz; Duty Cycle: 1:1  
Medium: 1900 Head Medium parameters used (interpolated):  
 $f = 1852.4 \text{ MHz}$ ;  $\sigma = 1.396 \text{ S/m}$ ;  $\epsilon_r = 39.537$ ;  $\rho = 1000 \text{ kg/m}^3$   
Phantom section: Left Section

Test Date: 07-25-2019; Ambient Temp: 21.2°C; Tissue Temp: 20.1°C

Probe: EX3DV4 - SN7406; ConvF(8.18, 8.18, 8.18) @ 1852.4 MHz; Calibrated: 5/16/2019  
Sensor-Surface: 1.4mm (Mechanical Surface Detection)  
Electronics: DAE4 Sn859; Calibrated: 5/8/2019  
Phantom: Twin-SAM V5.0 Right 20; Type: QD 000 P40 CD; Serial: 1759  
Measurement SW: DASY52, Version 52.10 (2);SEMCAD X Version 14.6.12 (7470)

**Mode: UMTS 1900, Left Head, Cheek, Low.ch**

**Area Scan (9x15x1):** Measurement grid: dx=15mm, dy=15mm

**Zoom Scan (6x6x7)/Cube 0:** Measurement grid: dx=8mm, dy=8mm, dz=5mm

Reference Value = 21.37 V/m; Power Drift = -0.03 dB

Peak SAR (extrapolated) = 0.965 W/kg

**SAR(1 g) = 0.619 W/kg**

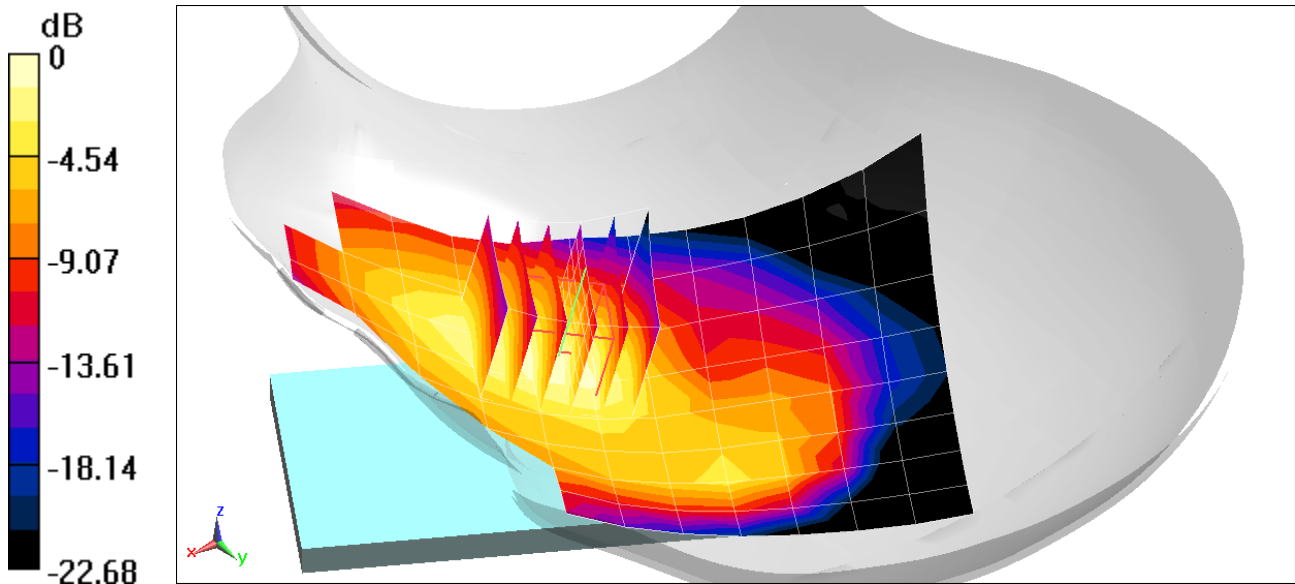

0 dB = 0.827 W/kg = -0.82 dBW/kg

# PCTEST ENGINEERING LABORATORY, INC.

**DUT: ZNFX320PM; Type: Portable Handset; Serial: 04963**

Communication System: UID 0, Cellular CDMA; Frequency: 820.1 MHz; Duty Cycle: 1:1  
Medium: 835 Head Medium parameters used (interpolated):  
 $f = 820.1 \text{ MHz}$ ;  $\sigma = 0.92 \text{ S/m}$ ;  $\epsilon_r = 42.338$ ;  $\rho = 1000 \text{ kg/m}^3$   
Phantom section: Right Section

Test Date: 08-07-2019; Ambient Temp: 20.5°C; Tissue Temp: 20.7°C

Probe: EX3DV4 - SN7538; ConvF(10.3, 10.3, 10.3) @ 820.1 MHz; Calibrated: 5/16/2019  
Sensor-Surface: 1.4mm (Mechanical Surface Detection)  
Electronics: DAE4 Sn728; Calibrated: 5/8/2019  
Phantom: Left Twin-SAM V5.0 30; Type: QD 000 P40 CD; Serial: 1792  
Measurement SW: DASY52, Version 52.10 (2);SEMCAD X Version 14.6.12 (7470)

**Mode: Cell. CDMA, Rule Part 90S, Right Head, Cheek, Mid.ch**

**Area Scan (9x15x1):** Measurement grid: dx=15mm, dy=15mm  
**Zoom Scan (5x5x7)/Cube 0:** Measurement grid: dx=8mm, dy=8mm, dz=5mm  
Reference Value = 21.24 V/m; Power Drift = -0.01 dB  
Peak SAR (extrapolated) = 0.508 W/kg  
**SAR(1 g) = 0.399 W/kg**

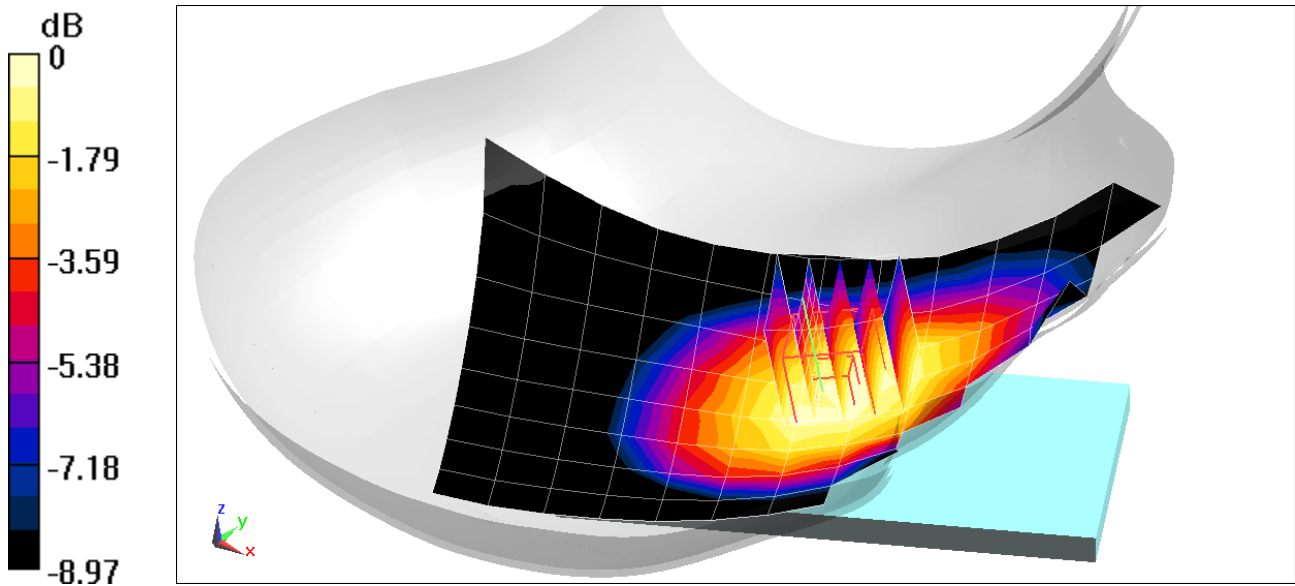

0 dB = 0.465 W/kg = -3.33 dBW/kg

# PCTEST ENGINEERING LABORATORY, INC.

**DUT: ZNFX320PM; Type: Portable Handset; Serial: 04963**

Communication System: UID 0, CDMA; Frequency: 836.52 MHz; Duty Cycle: 1:1  
Medium: 835 Head Medium parameters used (interpolated):  
 $f = 836.52$  MHz;  $\sigma = 0.927$  S/m;  $\epsilon_r = 42.295$ ;  $\rho = 1000$  kg/m<sup>3</sup>  
Phantom section: Right Section

Test Date: 08-07-2019; Ambient Temp: 20.5°C; Tissue Temp: 20.7°C

Probe: EX3DV4 - SN7538; ConvF(10.3, 10.3, 10.3) @ 836.52 MHz; Calibrated: 5/16/2019  
Sensor-Surface: 1.4mm (Mechanical Surface Detection)  
Electronics: DAE4 Sn728; Calibrated: 5/8/2019  
Phantom: Left Twin-SAM V5.0 30; Type: QD 000 P40 CD; Serial: 1792  
Measurement SW: DASY52, Version 52.10 (2);SEMCAD X Version 14.6.12 (7470)

**Mode: Cell. CDMA, Rule Part 22H, Right Head, Cheek, Mid.ch**

**Area Scan (9x15x1):** Measurement grid: dx=15mm, dy=15mm  
**Zoom Scan (5x5x7)/Cube 0:** Measurement grid: dx=8mm, dy=8mm, dz=5mm  
Reference Value = 18.88 V/m; Power Drift = 0.05 dB  
Peak SAR (extrapolated) = 0.416 W/kg  
**SAR(1 g) = 0.323 W/kg**

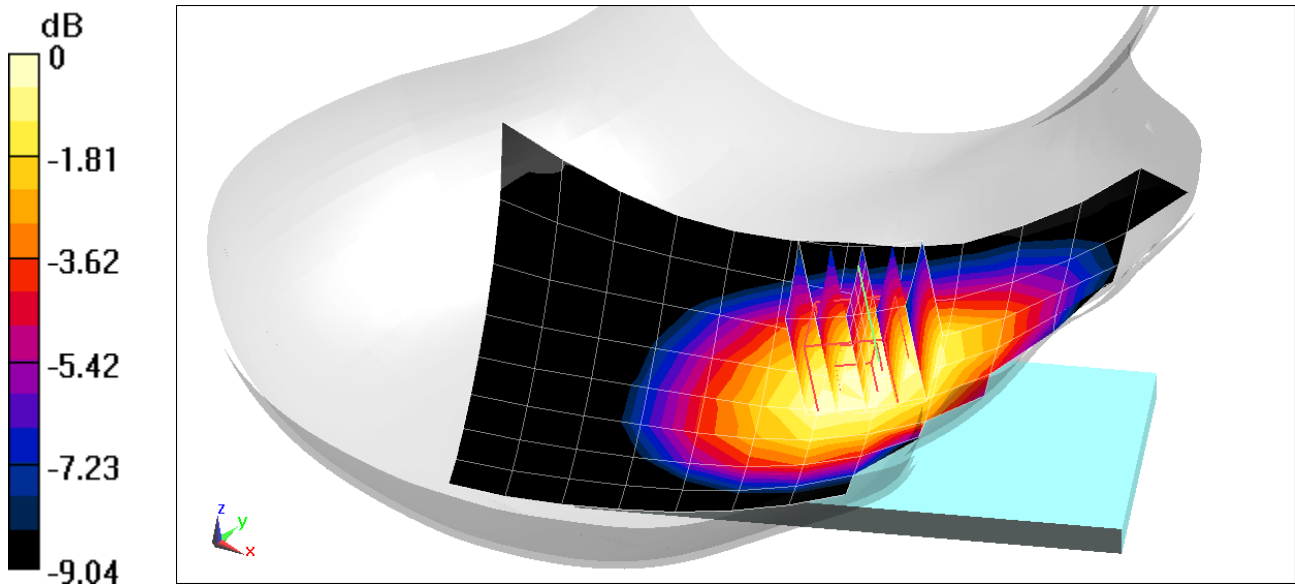

0 dB = 0.382 W/kg = -4.18 dBW/kg

# PCTEST ENGINEERING LABORATORY, INC.

**DUT: ZNFX320PM; Type: Portable Handset; Serial: 04963**

Communication System: UID 0, CDMA; Frequency: 1851.25 MHz; Duty Cycle: 1:1  
Medium: 1900 Head Medium parameters used (interpolated):  
 $f = 1851.25$  MHz;  $\sigma = 1.381$  S/m;  $\epsilon_r = 41.625$ ;  $\rho = 1000$  kg/m<sup>3</sup>  
Phantom section: Left Section

Test Date: 08-06-2019; Ambient Temp: 23.2°C; Tissue Temp: 22.6°C

Probe: EX3DV4 - SN3914; ConvF(7.8, 7.8, 7.8) @ 1851.25 MHz; Calibrated: 2/19/2019  
Sensor-Surface: 1.4mm (Mechanical Surface Detection)  
Electronics: DAE4 Sn1272; Calibrated: 2/14/2019  
Phantom: Twin-SAM V5.0 Left 30; Type: QD 000 P40 CD; Serial: 1687  
Measurement SW: DASY52, Version 52.10 (2);SEMCAD X Version 14.6.12 (7470)

**Mode: PCS EVDO Rev A, Left Head, Cheek, Low.ch**

**Area Scan (9x15x1):** Measurement grid: dx=15mm, dy=15mm

**Zoom Scan (5x5x7)/Cube 0:** Measurement grid: dx=8mm, dy=8mm, dz=5mm

Reference Value = 23.31 V/m; Power Drift = 0.01 dB

Peak SAR (extrapolated) = 1.01 W/kg

**SAR(1 g) = 0.671 W/kg**

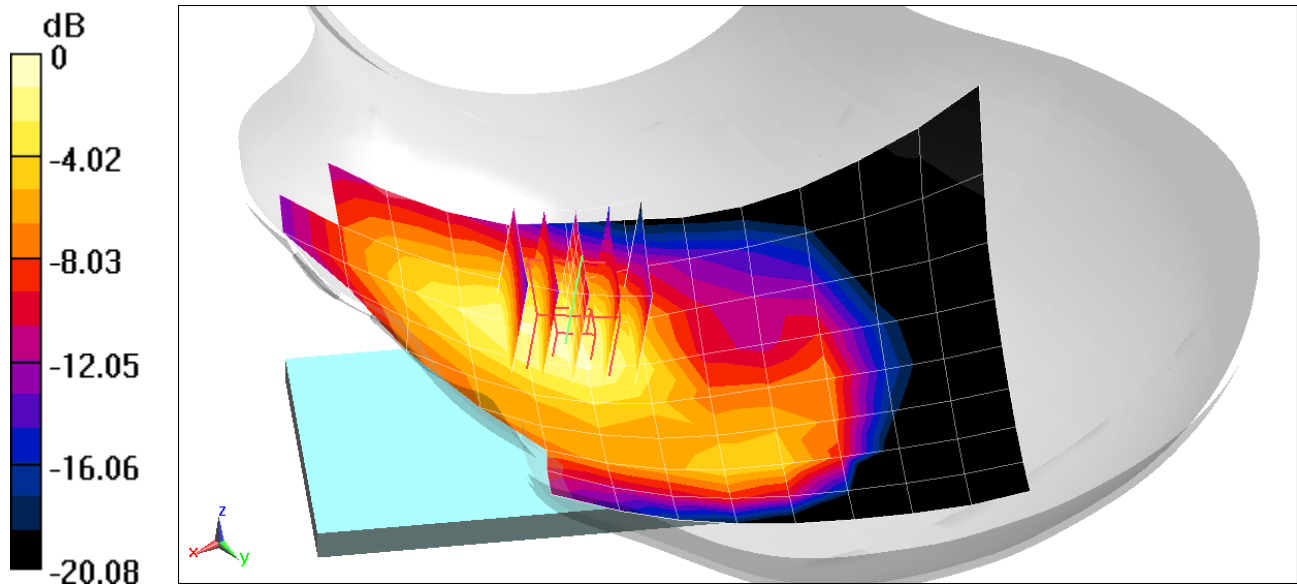

0 dB = 0.907 W/kg = -0.42 dBW/kg

# PCTEST ENGINEERING LABORATORY, INC.

**DUT: ZNFX320PM; Type: Portable Handset; Serial: 04966**

Communication System: UID 0, LTE Band 71; Frequency: 680.5 MHz; Duty Cycle: 1:1  
Medium: 750 Head Medium parameters used (interpolated):  
 $f = 680.5 \text{ MHz}$ ;  $\sigma = 0.845 \text{ S/m}$ ;  $\epsilon_r = 42.715$ ;  $\rho = 1000 \text{ kg/m}^3$   
Phantom section: Right Section

Test Date: 07-29-2019; Ambient Temp: 21.2°C; Tissue Temp: 20.4°C

Probe: EX3DV4 - SN3589; ConvF(8.67, 8.67, 8.67) @ 680.5 MHz; Calibrated: 1/25/2019  
Sensor-Surface: 1.4mm (Mechanical Surface Detection)  
Electronics: DAE4 Sn1450; Calibrated: 8/22/2018  
Phantom: Twin-SAM V5.0 (30); Type: QD 000 P40 CD; Serial: 1647  
Measurement SW: DASY52, Version 52.10 (2); SEMCAD X Version 14.6.12 (7470)

**Mode: LTE Band 71, Right Head, Cheek, Mid.ch, 20 MHz Bandwidth, QPSK, 1 RB, 50 RB Offset**

**Area Scan (9x15x1):** Measurement grid:  $dx=15\text{mm}$ ,  $dy=15\text{mm}$   
**Zoom Scan (5x5x7)/Cube 0:** Measurement grid:  $dx=8\text{mm}$ ,  $dy=8\text{mm}$ ,  $dz=5\text{mm}$   
Reference Value = 15.52 V/m; Power Drift = 0.07 dB  
Peak SAR (extrapolated) = 0.226 W/kg  
**SAR(1 g) = 0.185 W/kg**

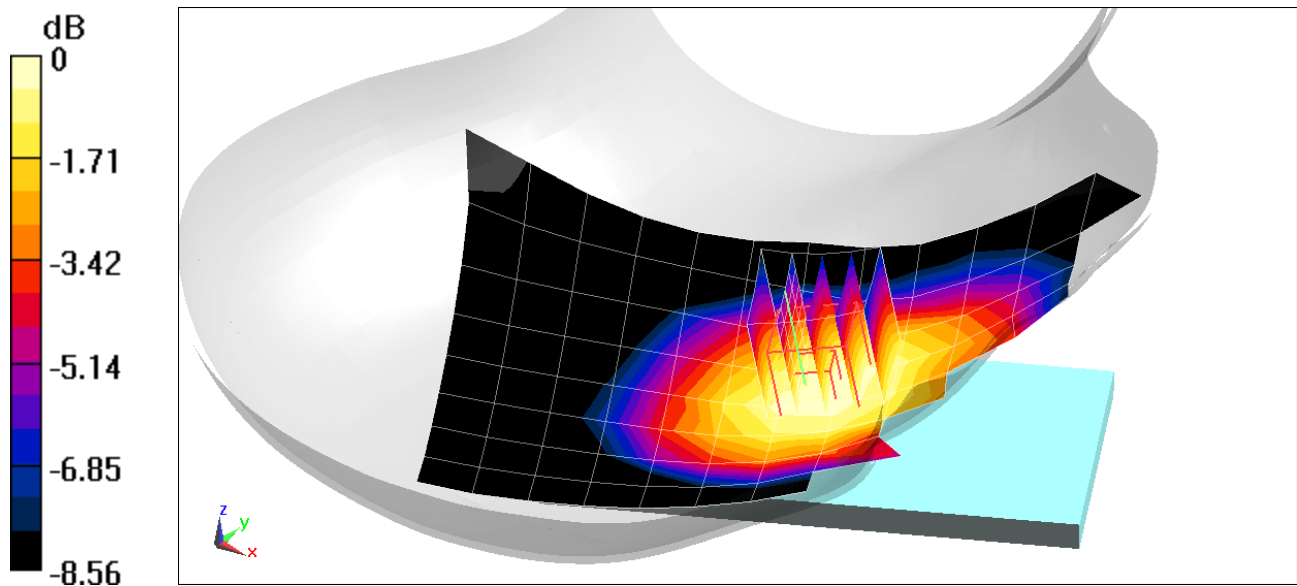

0 dB = 0.211 W/kg = -6.76 dBW/kg

# PCTEST ENGINEERING LABORATORY, INC.

**DUT: ZNFX320PM; Type: Portable Handset; Serial: 04966**

Communication System: UID 0, LTE Band 12; Frequency: 707.5 MHz; Duty Cycle: 1:1  
Medium: 750 Head Medium parameters used (interpolated):  
 $f = 707.5 \text{ MHz}$ ;  $\sigma = 0.855 \text{ S/m}$ ;  $\epsilon_r = 42.635$ ;  $\rho = 1000 \text{ kg/m}^3$   
Phantom section: Right Section

Test Date: 07-29-2019; Ambient Temp: 21.2°C; Tissue Temp: 20.4°C

Probe: EX3DV4 - SN3589; ConvF(8.67, 8.67, 8.67) @ 707.5 MHz; Calibrated: 1/25/2019  
Sensor-Surface: 1.4mm (Mechanical Surface Detection)  
Electronics: DAE4 Sn1450; Calibrated: 8/22/2018  
Phantom: Twin-SAM V5.0 (30); Type: QD 000 P40 CD; Serial: 1647  
Measurement SW: DASY52, Version 52.10 (2); SEMCAD X Version 14.6.12 (7470)

**Mode: LTE Band 12, Right Head, Cheek, Mid.ch, 10 MHz Bandwidth, QPSK, 1 RB, 25 RB Offset**

**Area Scan (9x14x1):** Measurement grid: dx=15mm, dy=15mm

**Zoom Scan (5x5x7)/Cube 0:** Measurement grid: dx=8mm, dy=8mm, dz=5mm

Reference Value = 17.92 V/m; Power Drift = 0.05 dB

Peak SAR (extrapolated) = 0.307 W/kg

**SAR(1 g) = 0.248 W/kg**

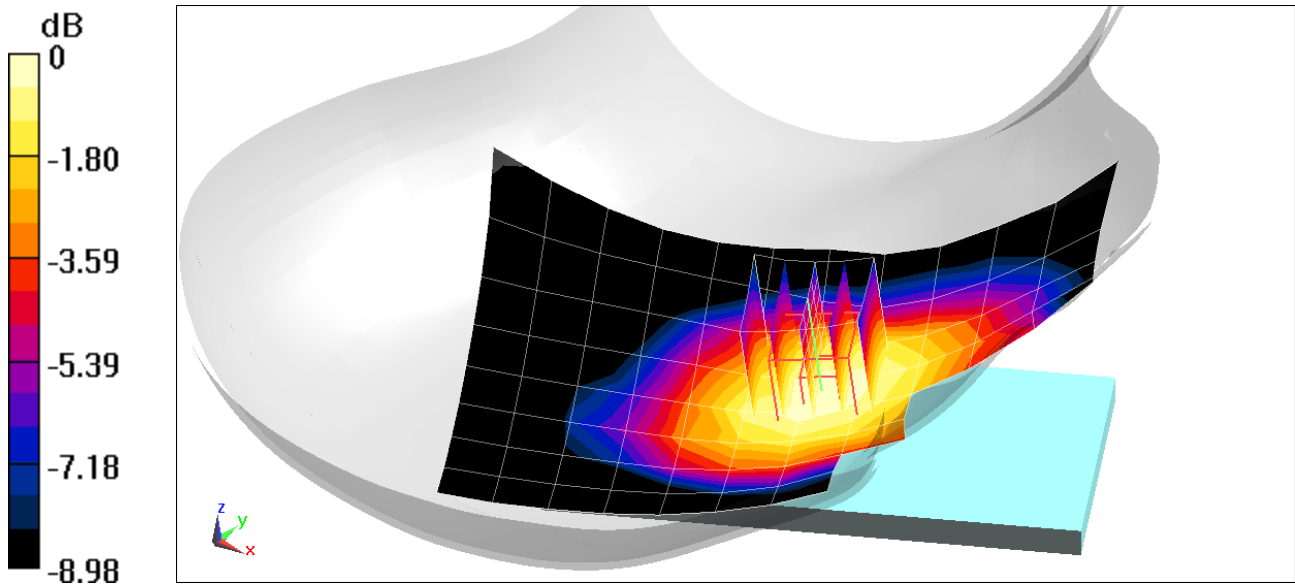

0 dB = 0.289 W/kg = -5.39 dBW/kg

# PCTEST ENGINEERING LABORATORY, INC.

**DUT: ZNFX320PM; Type: Portable Handset; Serial: 04966**

Communication System: UID 0, LTE Band 13; Frequency: 782 MHz; Duty Cycle: 1:1  
Medium: 750 Head Medium parameters used (interpolated):  
 $f = 782 \text{ MHz}$ ;  $\sigma = 0.883 \text{ S/m}$ ;  $\epsilon_r = 42.399$ ;  $\rho = 1000 \text{ kg/m}^3$   
Phantom section: Right Section

Test Date: 07-29-2019; Ambient Temp: 21.2°C; Tissue Temp: 20.4°C

Probe: EX3DV4 - SN3589; ConvF(8.67, 8.67, 8.67) @ 782 MHz; Calibrated: 1/25/2019  
Sensor-Surface: 1.4mm (Mechanical Surface Detection)  
Electronics: DAE4 Sn1450; Calibrated: 8/22/2018  
Phantom: Twin-SAM V5.0 (30); Type: QD 000 P40 CD; Serial: 1647  
Measurement SW: DASY52, Version 52.10 (2); SEMCAD X Version 14.6.12 (7470)

**Mode: LTE Band 13, Right Head, Cheek, Mid.ch, 10 MHz Bandwidth, QPSK, 1 RB, 25 RB Offset**

**Area Scan (9x14x1):** Measurement grid:  $dx=15\text{mm}$ ,  $dy=15\text{mm}$   
**Zoom Scan (5x5x7)/Cube 0:** Measurement grid:  $dx=8\text{mm}$ ,  $dy=8\text{mm}$ ,  $dz=5\text{mm}$   
Reference Value = 19.80 V/m; Power Drift = -0.02 dB  
Peak SAR (extrapolated) = 0.380 W/kg  
**SAR(1 g) = 0.308 W/kg**

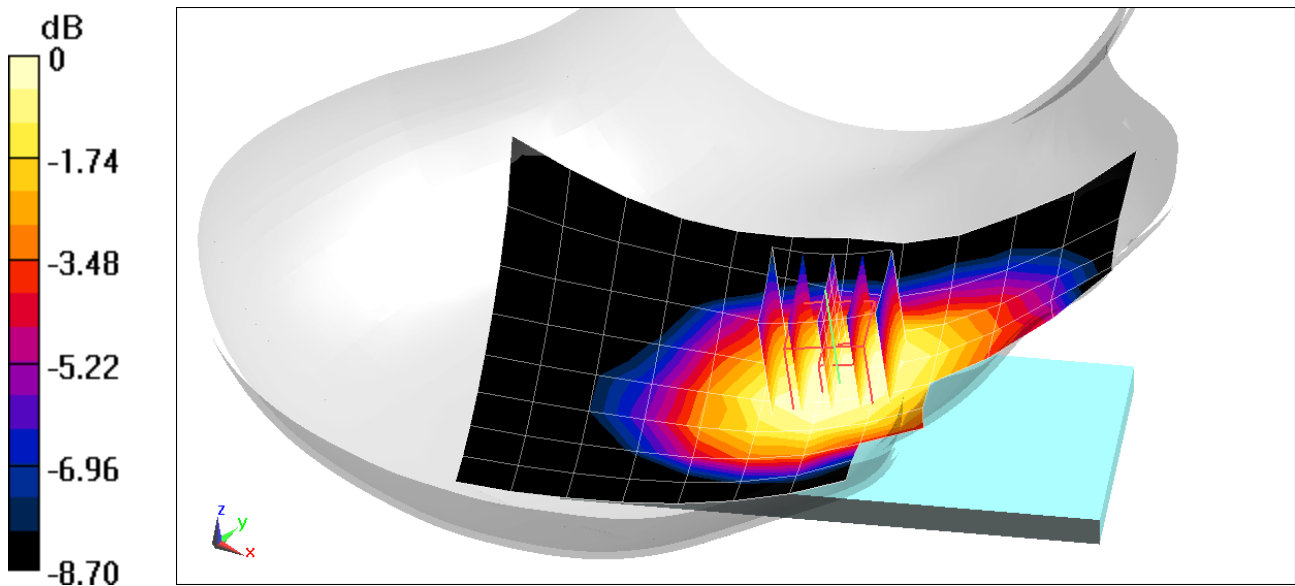

0 dB = 0.357 W/kg = -4.47 dBW/kg

# PCTEST ENGINEERING LABORATORY, INC.

**DUT: ZNFX320PM; Type: Portable Handset; Serial: 04966**

Communication System: UID 0, LTE Band 26; Frequency: 831.5 MHz; Duty Cycle: 1:1

Medium: 835 Head Medium parameters used (interpolated):

$f = 831.5 \text{ MHz}$ ;  $\sigma = 0.9 \text{ S/m}$ ;  $\epsilon_r = 42.264$ ;  $\rho = 1000 \text{ kg/m}^3$

Phantom section: Right Section

Test Date: 07-30-2019; Ambient Temp: 22.9°C; Tissue Temp: 20.4°C

Probe: EX3DV4 - SN3589; ConvF(8.39, 8.39, 8.39) @ 831.5 MHz; Calibrated: 1/25/2019

Sensor-Surface: 1.4mm (Mechanical Surface Detection)

Electronics: DAE4 Sn1450; Calibrated: 8/22/2018

Phantom: Twin-SAM V5.0 (30); Type: QD 000 P40 CD; Serial: 1647

Measurement SW: DASY52, Version 52.10 (2);SEMCAD X Version 14.6.12 (7470)

**Mode: LTE Band 26 (Cell.), Right Head, Cheek, Mid.ch, 15 MHz Bandwidth, QPSK, 1 RB, 36 RB Offset**

**Area Scan (9x14x1):** Measurement grid: dx=15mm, dy=15mm

**Zoom Scan (5x5x7)/Cube 0:** Measurement grid: dx=8mm, dy=8mm, dz=5mm

Reference Value = 23.13 V/m; Power Drift = 0.00 dB

Peak SAR (extrapolated) = 0.555 W/kg

**SAR(1 g) = 0.433 W/kg**

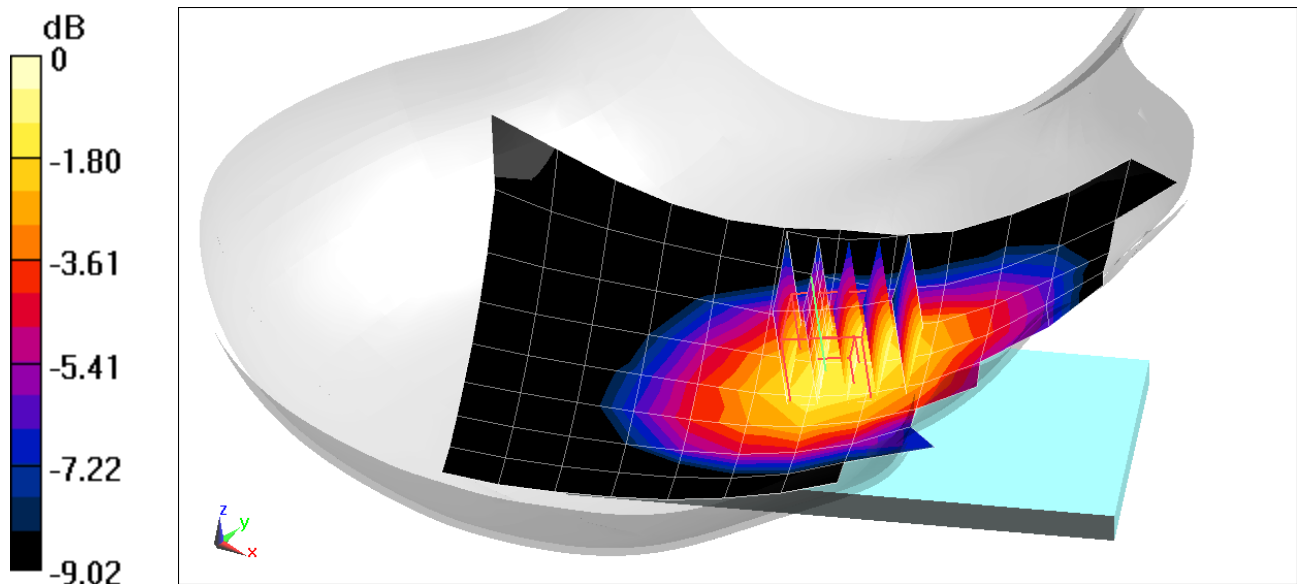

0 dB = 0.513 W/kg = -2.90 dBW/kg



# PCTEST ENGINEERING LABORATORY, INC.

**DUT: ZNFX320PM; Type: Portable Handset; Serial: 04967**

Communication System: UID 0, LTE Band 66 (AWS); Frequency: 1745 MHz; Duty Cycle: 1:1  
Medium: 1750 Head Medium parameters used (interpolated):  
 $f = 1745 \text{ MHz}$ ;  $\sigma = 1.367 \text{ S/m}$ ;  $\epsilon_r = 40.437$ ;  $\rho = 1000 \text{ kg/m}^3$   
Phantom section: Left Section

Test Date: 08-07-2019; Ambient Temp: 20.5°C; Tissue Temp: 20.7°C

Probe: EX3DV4 - SN7538; ConvF(8.67, 8.67, 8.67) @ 1745 MHz; Calibrated: 5/16/2019  
Sensor-Surface: 1.4mm (Mechanical Surface Detection)  
Electronics: DAE4 Sn728; Calibrated: 5/8/2019  
Phantom: Left Twin-SAM V5.0 30; Type: QD 000 P40 CD; Serial: 1792  
Measurement SW: DASY52, Version 52.10 (2);SEMCAD X Version 14.6.12 (7470)

**Mode: LTE Band 66 (AWS), Left Head, Cheek, Mid.ch, 20 MHz Bandwidth, QPSK, 1 RB, 50 RB Offset**

**Area Scan (9x15x1):** Measurement grid: dx=15mm, dy=15mm

**Zoom Scan (5x5x7)/Cube 0:** Measurement grid: dx=8mm, dy=8mm, dz=5mm

Reference Value = 21.22 V/m; Power Drift = 0.17 dB

Peak SAR (extrapolated) = 0.872 W/kg

**SAR(1 g) = 0.563 W/kg**

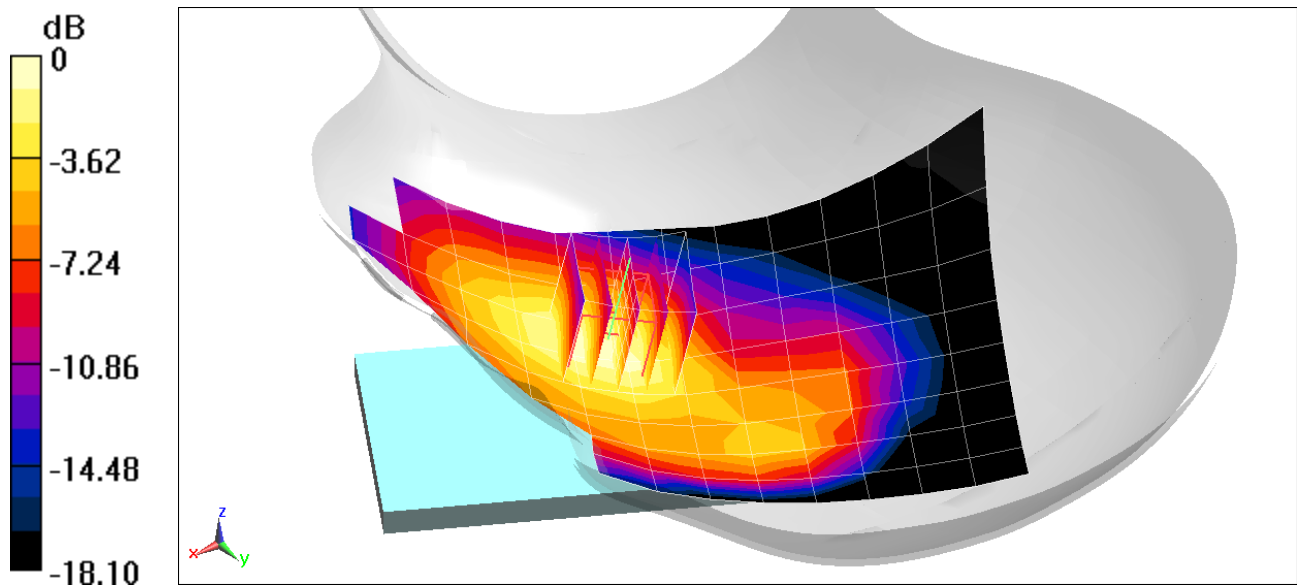

0 dB = 0.749 W/kg = -1.26 dBW/kg

# PCTEST ENGINEERING LABORATORY, INC.

**DUT: ZNFX320PM; Type: Portable Handset; Serial: 04966**

Communication System: UID 0, LTE Band 25 (PCS); Frequency: 1882.5 MHz; Duty Cycle: 1:1  
Medium: 1900 Head Medium parameters used (interpolated):  
 $f = 1882.5 \text{ MHz}$ ;  $\sigma = 1.433 \text{ S/m}$ ;  $\epsilon_r = 39.819$ ;  $\rho = 1000 \text{ kg/m}^3$   
Phantom section: Left Section

Test Date: 07-22-2019; Ambient Temp: 21.6°C; Tissue Temp: 21.3°C

Probe: EX3DV4 - SN7409; ConvF(8.01, 8.01, 8.01) @ 1882.5 MHz; Calibrated: 6/19/2019  
Sensor-Surface: 1.4mm (Mechanical Surface Detection)  
Electronics: DAE4 Sn1334; Calibrated: 6/20/2019  
Phantom: Front; Type: QD 000 P40 CD; Serial: 1686  
Measurement SW: DASY52, Version 52.10 (2);SEMCAD X Version 14.6.12 (7470)

**Mode: LTE Band 25 (PCS), Left Head, Cheek, Mid.ch, 20 MHz Bandwidth, QPSK, 1 RB, 50 RB Offset**

**Area Scan (9x14x1):** Measurement grid:  $dx=15\text{mm}$ ,  $dy=15\text{mm}$   
**Zoom Scan (5x5x7)/Cube 0:** Measurement grid:  $dx=8\text{mm}$ ,  $dy=8\text{mm}$ ,  $dz=5\text{mm}$   
Reference Value = 25.69 V/m; Power Drift = -0.08 dB  
Peak SAR (extrapolated) = 1.21 W/kg  
**SAR(1 g) = 0.769 W/kg**

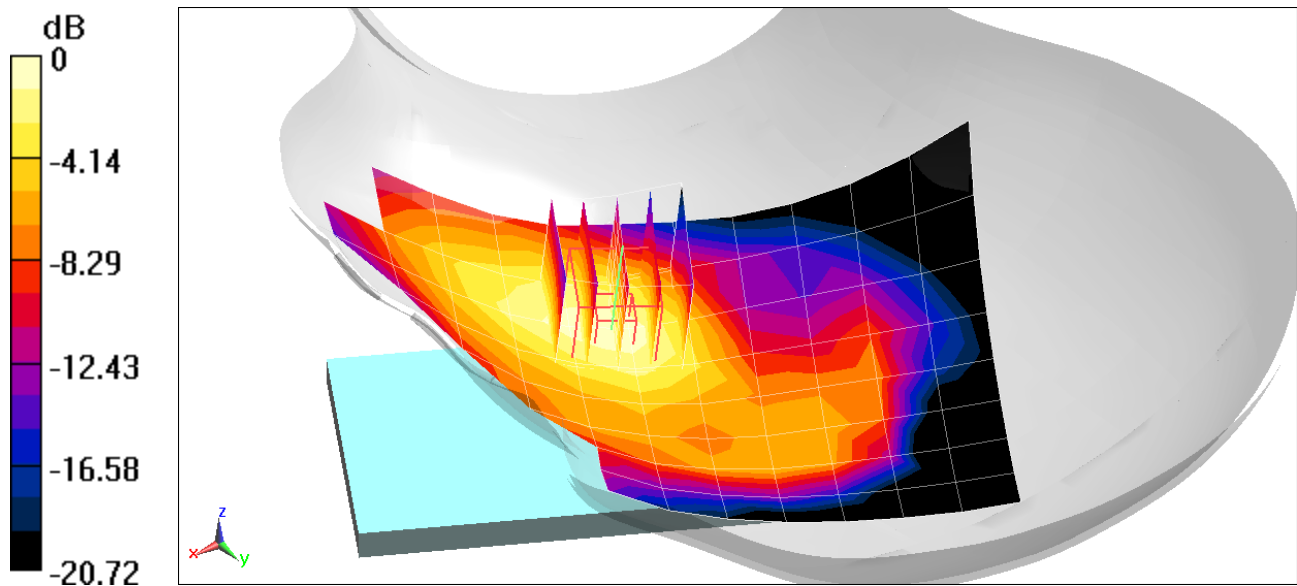

0 dB = 1.06 W/kg = 0.25 dBW/kg

# PCTEST ENGINEERING LABORATORY, INC.

**DUT: ZNFX320PM; Type: Portable Handset; Serial: 04967**

Communication System: UID 0, \_LTE Band 41 (Class 2); Frequency: 2593 MHz; Duty Cycle: 1:2.31  
Medium: 2450 Head Medium parameters used (interpolated):  
 $f = 2593 \text{ MHz}$ ;  $\sigma = 1.936 \text{ S/m}$ ;  $\epsilon_r = 37.393$ ;  $\rho = 1000 \text{ kg/m}^3$   
Phantom section: Left Section

Test Date: 07-23-2019; Ambient Temp: 22.1°C; Tissue Temp: 21.0°C

Probe: EX3DV4 - SN3589; ConvF(6.25, 6.25, 6.25) @ 2593 MHz; Calibrated: 1/25/2019  
Sensor-Surface: 1.4mm (Mechanical Surface Detection)  
Electronics: DAE4 Sn1450; Calibrated: 8/22/2018  
Phantom: Twin-SAM V5.0 (30); Type: QD 000 P40 CD; Serial: 1647  
Measurement SW: DASY52, Version 52.10 (2); SEMCAD X Version 14.6.12 (7470)

**Mode: LTE Band 41 PC2, Left Head, Cheek, Mid.ch, QPSK, 20 MHz Bandwidth, 1 RB, 50 RB Offset**

**Area Scan (10x17x1):** Measurement grid: dx=12mm, dy=12mm

**Zoom Scan (7x7x7)/Cube 0:** Measurement grid: dx=5mm, dy=5mm, dz=5mm

Reference Value = 14.40 V/m; Power Drift = 0.15 dB

Peak SAR (extrapolated) = 0.577 W/kg

**SAR(1 g) = 0.306 W/kg**

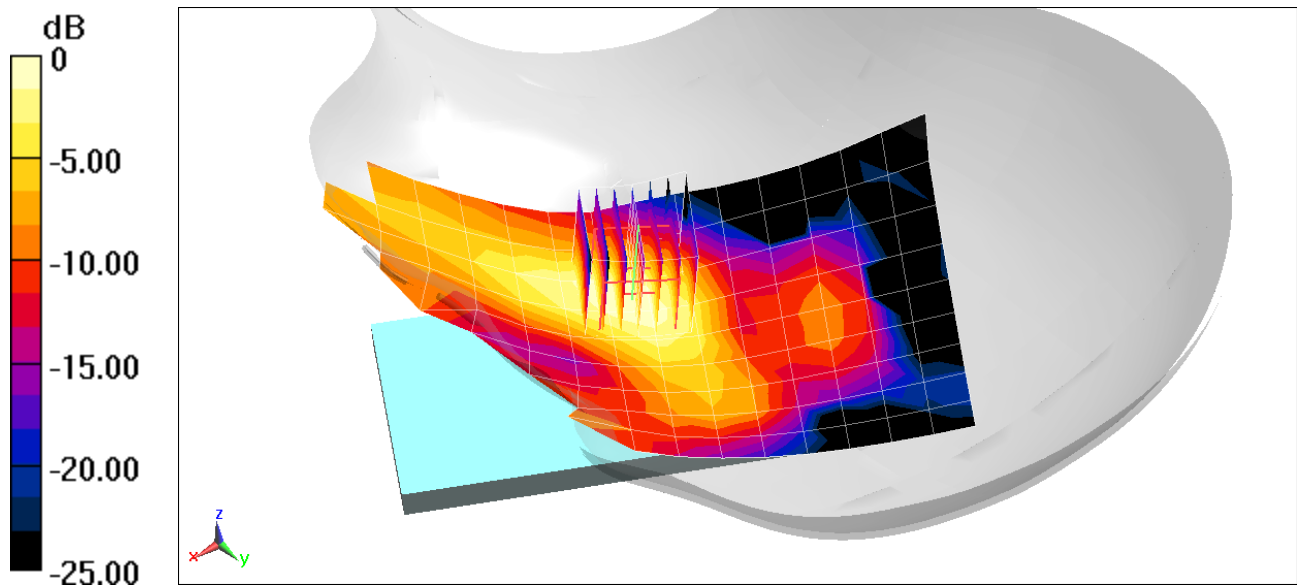

0 dB = 0.474 W/kg = -3.24 dBW/kg

# PCTEST ENGINEERING LABORATORY, INC.

**DUT: ZNFX320PM; Type: Portable Handset; Serial: 22710**

Communication System: UID 0, \_IEEE 802.11b; Frequency: 2437 MHz; Duty Cycle: 1:1  
Medium: 2450 Head Medium parameters used (interpolated):  
 $f = 2437 \text{ MHz}$ ;  $\sigma = 1.778 \text{ S/m}$ ;  $\epsilon_r = 37.934$ ;  $\rho = 1000 \text{ kg/m}^3$   
Phantom section: Left Section

Test Date: 07-26-2019; Ambient Temp: 21.6°C; Tissue Temp: 21.3°C

Probe: EX3DV4 - SN3589; ConvF(6.46, 6.46, 6.46) @ 2437 MHz; Calibrated: 1/25/2019  
Sensor-Surface: 1.4mm (Mechanical Surface Detection)  
Electronics: DAE4 Sn1450; Calibrated: 8/22/2018  
Phantom: Twin-SAM V5.0 (30); Type: QD 000 P40 CD; Serial: 1647  
Measurement SW: DASY52, Version 52.10 (2); SEMCAD X Version 14.6.12 (7470)

**Mode: IEEE 802.11b, 22 MHz Bandwidth, Left Head, Cheek, Ch 6, 1 Mbps**

**Area Scan (11x16x1):** Measurement grid: dx=12mm, dy=12mm

**Zoom Scan (7x8x7)/Cube 0:** Measurement grid: dx=5mm, dy=5mm, dz=5mm

Reference Value = 13.69 V/m; Power Drift = 0.09 dB

Peak SAR (extrapolated) = 1.79 W/kg

**SAR(1 g) = 0.817 W/kg**

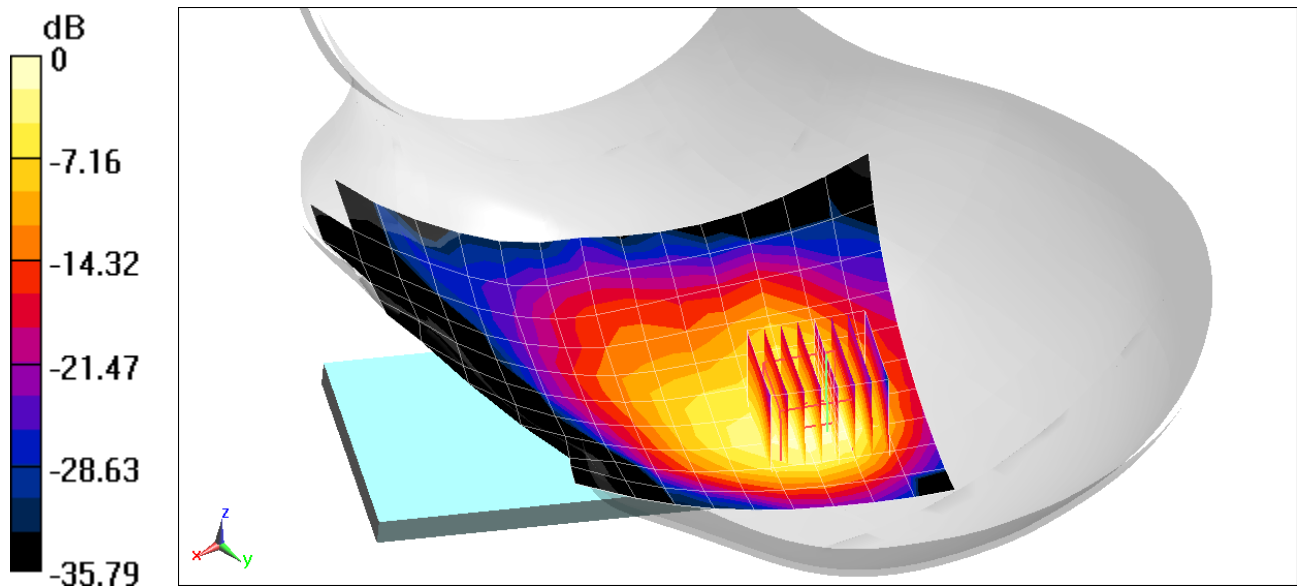

0 dB = 1.36 W/kg = 1.34 dBW/kg

# PCTEST ENGINEERING LABORATORY, INC.

**DUT: ZNFX320PM; Type: Portable Handset; Serial: 22710**

Communication System: UID 0, Bluetooth; Frequency: 2441 MHz; Duty Cycle: 1:1.302  
Medium: 2450 Head Medium parameters used (interpolated):  
 $f = 2441 \text{ MHz}$ ;  $\sigma = 1.781 \text{ S/m}$ ;  $\epsilon_r = 37.927$ ;  $\rho = 1000 \text{ kg/m}^3$   
Phantom section: Left Section

Test Date: 07-26-2019; Ambient Temp: 21.6°C; Tissue Temp: 21.3°C

Probe: EX3DV4 - SN3589; ConvF(6.46, 6.46, 6.46) @ 2441 MHz; Calibrated: 1/25/2019  
Sensor-Surface: 1.4mm (Mechanical Surface Detection)  
Electronics: DAE4 Sn1450; Calibrated: 8/22/2018  
Phantom: Twin-SAM V5.0 (30); Type: QD 000 P40 CD; Serial: 1647  
Measurement SW: DASY52, Version 52.10 (2); SEMCAD X Version 14.6.12 (7470)

**Mode: Bluetooth, Left Head, Cheek, Ch 39, 1 Mbps**

**Area Scan (11x16x1):** Measurement grid: dx=12mm, dy=12mm

**Zoom Scan (7x7x7)/Cube 0:** Measurement grid: dx=5mm, dy=5mm, dz=5mm

Reference Value = 9.860 V/m; Power Drift = 0.03 dB

Peak SAR (extrapolated) = 0.344 W/kg

**SAR(1 g) = 0.157 W/kg**

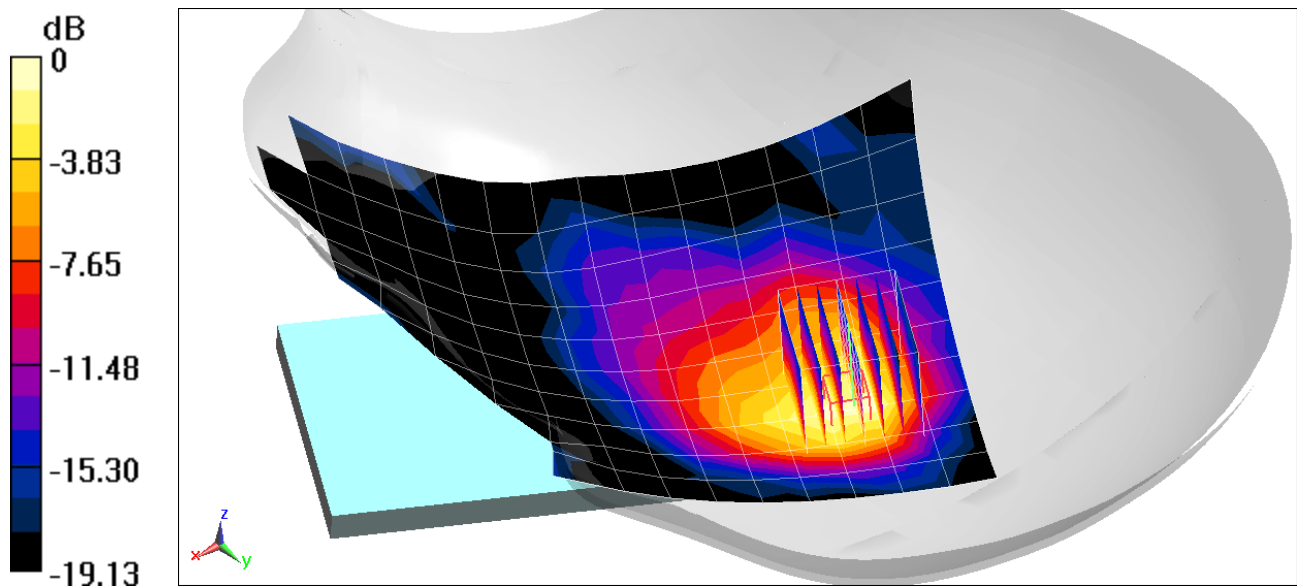

0 dB = 0.260 W/kg = -5.85 dBW/kg

# PCTEST ENGINEERING LABORATORY, INC.

**DUT: ZNFX320PM; Type: Portable Handset; Serial: 04964**

Communication System: UID 0, GSM GPRS; 2 Tx slots; Frequency: 836.6 MHz; Duty Cycle: 1:4.15  
Medium: 835 Body Medium parameters used (interpolated):  
 $f = 836.6 \text{ MHz}$ ;  $\sigma = 1.002 \text{ S/m}$ ;  $\epsilon_r = 53.716$ ;  $\rho = 1000 \text{ kg/m}^3$   
Phantom section: Flat Section; Space: 1.0 cm

Test Date: 07-29-2019; Ambient Temp: 20.5°C; Tissue Temp: 20.6°C

Probe: EX3DV4 - SN7538; ConvF(9.85, 9.85, 9.85) @ 836.6 MHz; Calibrated: 5/16/2019  
Sensor-Surface: 1.4mm (Mechanical Surface Detection)  
Electronics: DAE4 Sn728; Calibrated: 5/8/2019  
Phantom: Left Twin-SAM V5.0 30; Type: QD 000 P40 CD; Serial: 1792  
Measurement SW: DASY52, Version 52.10 (2);SEMCAD X Version 14.6.12 (7470)

**Mode: GPRS 850, Body SAR, Back side, Mid.ch, 2 Tx Slots**

**Area Scan (9x15x1):** Measurement grid: dx=15mm, dy=15mm

**Zoom Scan (6x5x7)/Cube 0:** Measurement grid: dx=8mm, dy=8mm, dz=5mm

Reference Value = 21.70 V/m; Power Drift = -0.06 dB

Peak SAR (extrapolated) = 0.628 W/kg

**SAR(1 g) = 0.461 W/kg**

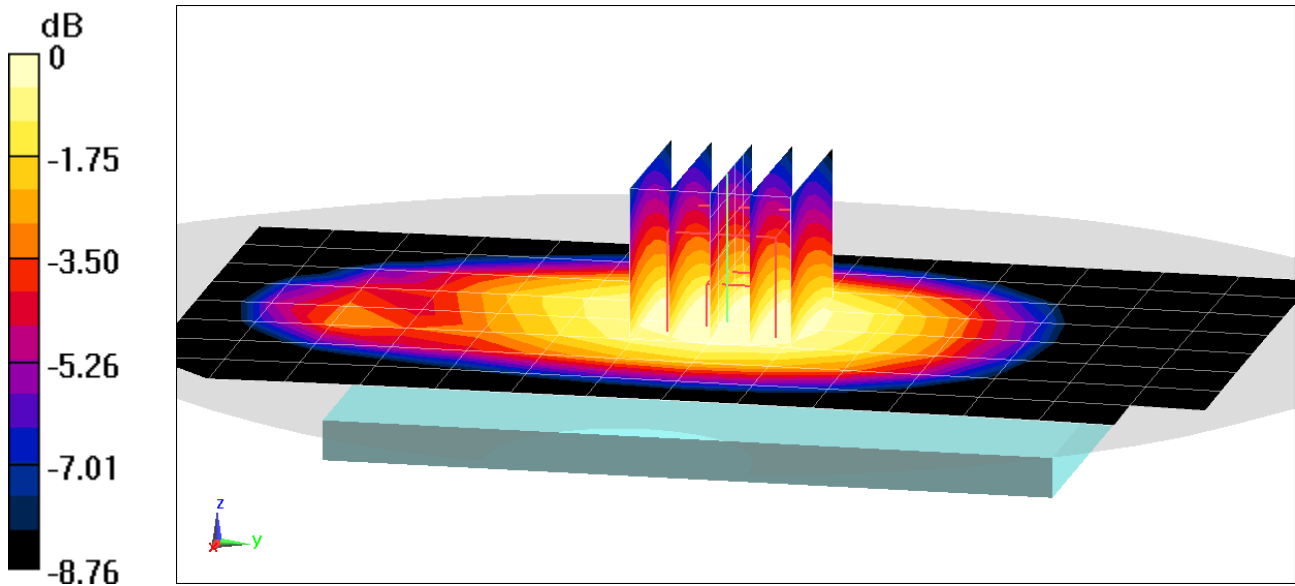

0 dB = 0.563 W/kg = -2.49 dBW/kg

# PCTEST ENGINEERING LABORATORY, INC.

**DUT: ZNFX320PM; Type: Portable Handset; Serial: 04964**

Communication System: UID 0, GSM GPRS; 2 Tx slots; Frequency: 1880 MHz; Duty Cycle: 1:4.15

Medium: 1900 Body Medium parameters used:

$f = 1880 \text{ MHz}$ ;  $\sigma = 1.53 \text{ S/m}$ ;  $\epsilon_r = 52.2$ ;  $\rho = 1000 \text{ kg/m}^3$

Phantom section: Flat Section; Space: 1.0 cm

Test Date: 07-29-2019; Ambient Temp: 20.7°C; Tissue Temp: 23.5°C

Probe: EX3DV4 - SN7488; ConvF(8.37, 8.37, 8.37) @ 1880 MHz; Calibrated: 1/24/2019

Sensor-Surface: 1.4mm (Mechanical Surface Detection)

Electronics: DAE4 Sn1530; Calibrated: 1/15/2019

Phantom: Twin-SAM V5.0; Type: QD 000 P40 CD; Serial: 1800

Measurement SW: DASY52, Version 52.10 (2);SEMCAD X Version 14.6.12 (7470)

**Mode: GPRS 1900, Body SAR, Back side, Mid.ch, 2 Tx Slots**

**Area Scan (8x14x1):** Measurement grid: dx=15mm, dy=15mm

**Zoom Scan (5x5x7)/Cube 0:** Measurement grid: dx=8mm, dy=8mm, dz=5mm

Reference Value = 15.08 V/m; Power Drift = 0.01 dB

Peak SAR (extrapolated) = 0.625 W/kg

**SAR(1 g) = 0.317 W/kg**

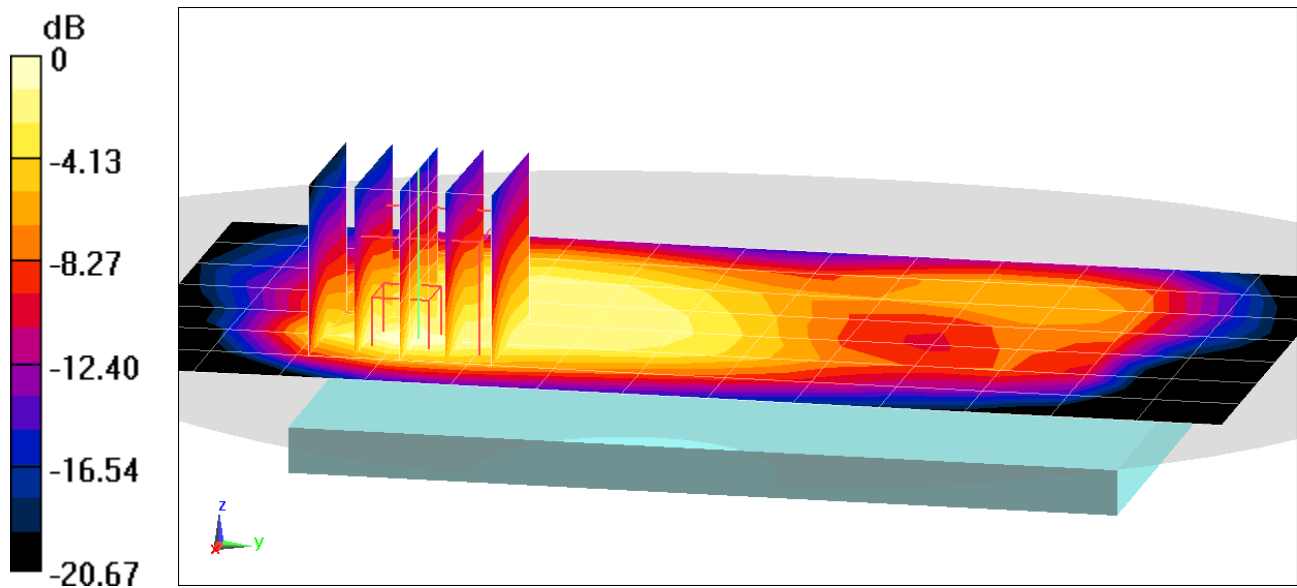

0 dB = 0.488 W/kg = -3.12 dBW/kg

# PCTEST ENGINEERING LABORATORY, INC.

**DUT: ZNFX320PM; Type: Portable Handset; Serial: 04964**

Communication System: UID 0, GSM GPRS; 2 Tx slots; Frequency: 1880 MHz; Duty Cycle: 1:4.15

Medium: 1900 Body Medium parameters used:

$f = 1880 \text{ MHz}$ ;  $\sigma = 1.53 \text{ S/m}$ ;  $\epsilon_r = 52.2$ ;  $\rho = 1000 \text{ kg/m}^3$

Phantom section: Flat Section; Space: 1.0 cm

Test Date: 07-29-2019; Ambient Temp: 20.7°C; Tissue Temp: 23.5°C

Probe: EX3DV4 - SN7488; ConvF(8.37, 8.37, 8.37) @ 1880 MHz; Calibrated: 1/24/2019

Sensor-Surface: 1.4mm (Mechanical Surface Detection)

Electronics: DAE4 Sn1530; Calibrated: 1/15/2019

Phantom: Twin-SAM V5.0; Type: QD 000 P40 CD; Serial: 1800

Measurement SW: DASY52, Version 52.10 (2);SEMCAD X Version 14.6.12 (7470)

**Mode: GPRS 1900, Body SAR, Left Edge, Mid.ch, 2 Tx Slots**

**Area Scan (10x13x1):** Measurement grid: dx=5mm, dy=15mm

**Zoom Scan (5x5x7)/Cube 0:** Measurement grid: dx=8mm, dy=8mm, dz=5mm

Reference Value = 15.24 V/m; Power Drift = -0.13 dB

Peak SAR (extrapolated) = 0.553 W/kg

**SAR(1 g) = 0.320 W/kg**

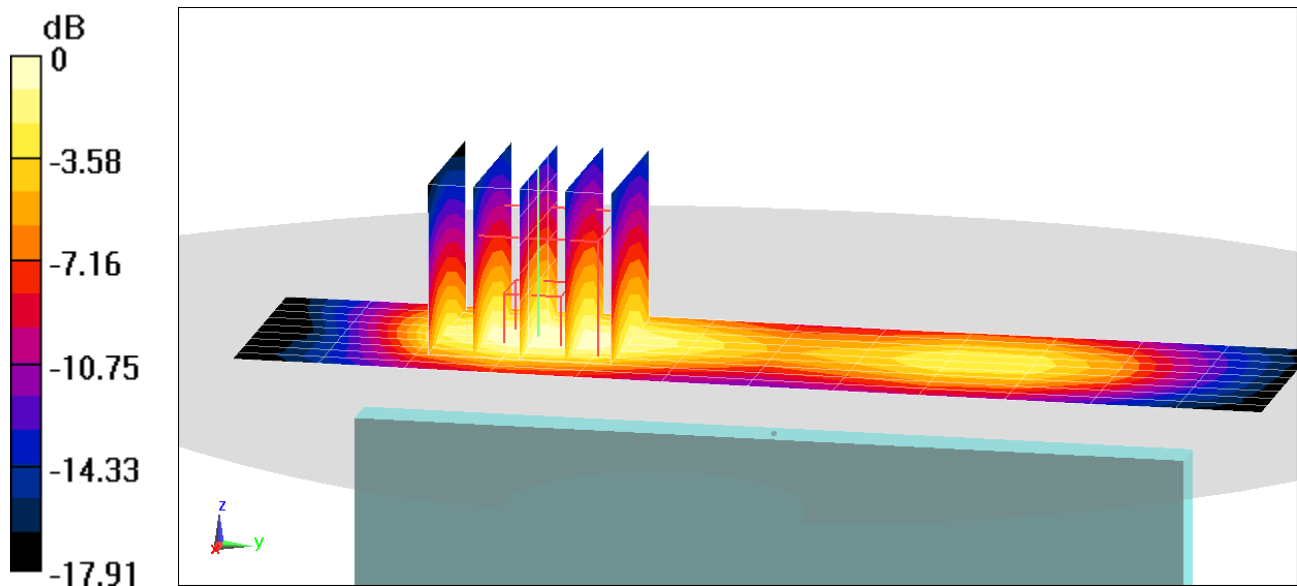

0 dB = 0.469 W/kg = -3.29 dBW/kg



# PCTEST ENGINEERING LABORATORY, INC.

**DUT: ZNFX320PM; Type: Portable Handset; Serial: 04964**

Communication System: UID 0, UMTS; Frequency: 836.6 MHz; Duty Cycle: 1:1

Medium: 835 Body Medium parameters used (interpolated):

$f = 836.6 \text{ MHz}$ ;  $\sigma = 1.002 \text{ S/m}$ ;  $\epsilon_r = 53.716$ ;  $\rho = 1000 \text{ kg/m}^3$

Phantom section: Flat Section; Space: 1.0 cm

Test Date: 07-29-2019; Ambient Temp: 20.5°C; Tissue Temp: 20.6°C

Probe: EX3DV4 - SN7538; ConvF(9.85, 9.85, 9.85) @ 836.6 MHz; Calibrated: 5/16/2019

Sensor-Surface: 1.4mm (Mechanical Surface Detection)

Electronics: DAE4 Sn728; Calibrated: 5/8/2019

Phantom: Left Twin-SAM V5.0 30; Type: QD 000 P40 CD; Serial: 1792

Measurement SW: DASY52, Version 52.10 (2);SEMCAD X Version 14.6.12 (7470)

**Mode: UMTS 850, Body SAR, Back side, Mid.ch**

**Area Scan (9x15x1):** Measurement grid: dx=15mm, dy=15mm

**Zoom Scan (5x5x7)/Cube 0:** Measurement grid: dx=8mm, dy=8mm, dz=5mm

Reference Value = 22.33 V/m; Power Drift = -0.01 dB

Peak SAR (extrapolated) = 0.680 W/kg

**SAR(1 g) = 0.491 W/kg**

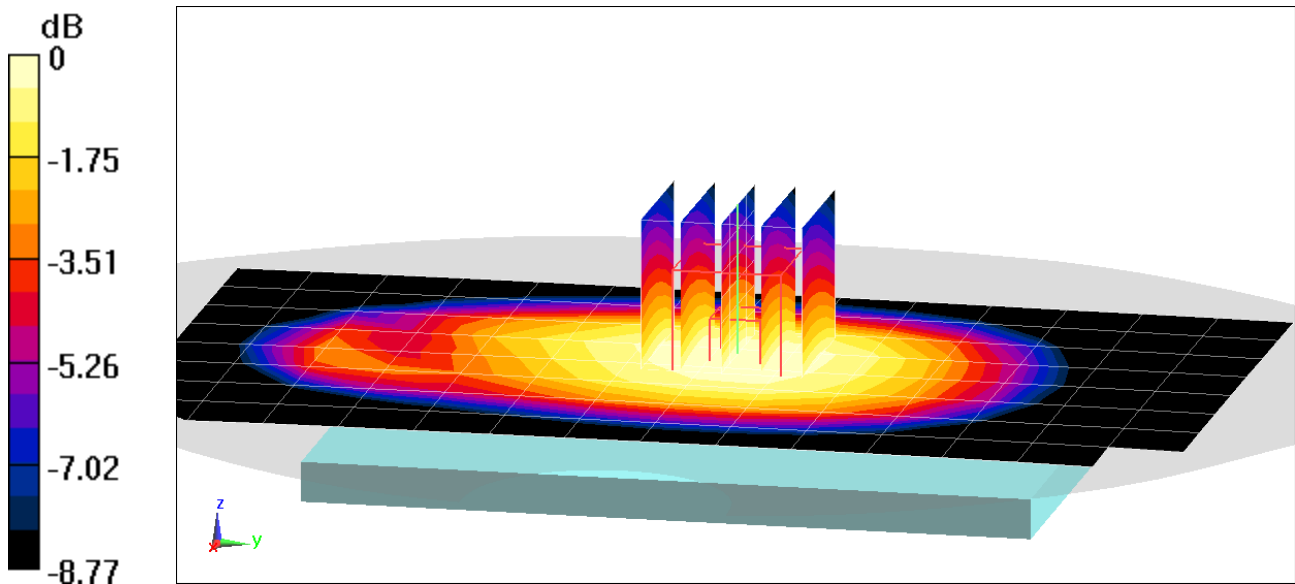

0 dB = 0.608 W/kg = -2.16 dBW/kg

# PCTEST ENGINEERING LABORATORY, INC.

**DUT: ZNFX320PM; Type: Portable Handset; Serial: 04963**

Communication System: UID 0, UMTS; Frequency: 1732.4 MHz; Duty Cycle: 1:1  
Medium: 1750 Body Medium parameters used (interpolated):  
 $f = 1732.4$  MHz;  $\sigma = 1.473$  S/m;  $\epsilon_r = 53.073$ ;  $\rho = 1000$  kg/m<sup>3</sup>  
Phantom section: Flat Section; Space: 1.0 cm

Test Date: 08-07-2019; Ambient Temp: 22.0°C; Tissue Temp: 21.1°C

Probe: EX3DV4 - SN7409; ConvF(7.85, 7.85, 7.85) @ 1732.4 MHz; Calibrated: 6/19/2019  
Sensor-Surface: 1.4mm (Mechanical Surface Detection)  
Electronics: DAE4 Sn1334; Calibrated: 6/20/2019  
Phantom: Front; Type: QD 000 P40 CD; Serial: 1686  
Measurement SW: DASY52, Version 52.10 (2);SEMCAD X Version 14.6.12 (7470)

**Mode: UMTS 1750, Body SAR, Back side, Mid.ch**

**Area Scan (9x14x1):** Measurement grid: dx=15mm, dy=15mm

**Zoom Scan (8x6x7)/Cube 0:** Measurement grid: dx=8mm, dy=8mm, dz=5mm

Reference Value = 24.35 V/m; Power Drift = -0.02 dB

Peak SAR (extrapolated) = 1.49 W/kg

**SAR(1 g) = 0.940 W/kg**

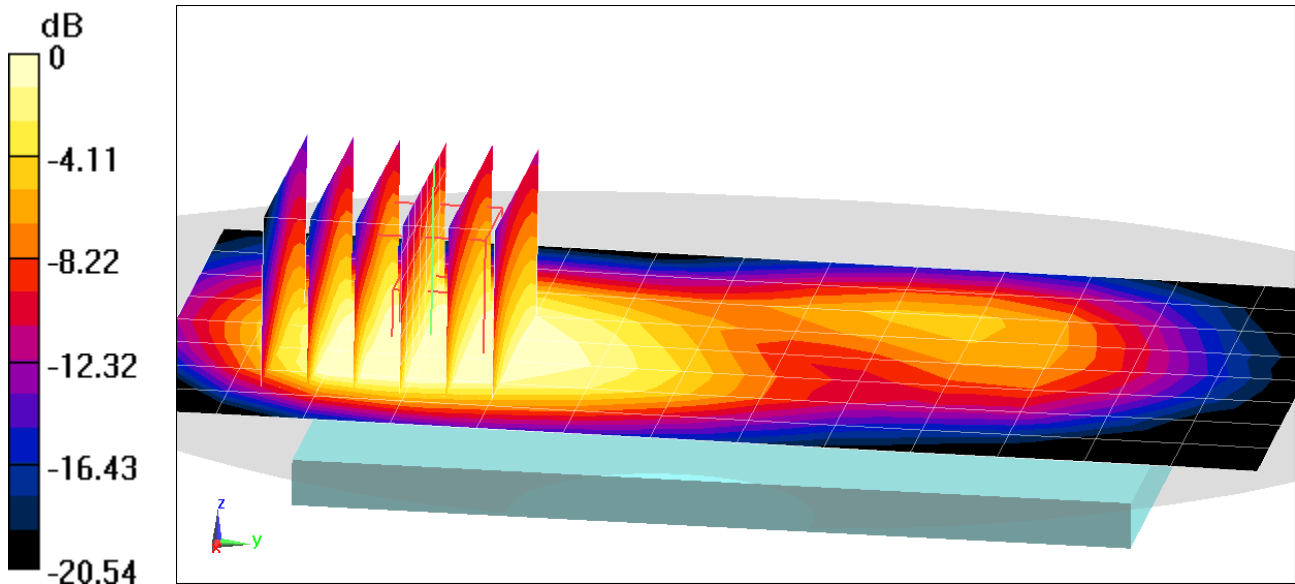

0 dB = 1.26 W/kg = 1.00 dBW/kg

# PCTEST ENGINEERING LABORATORY, INC.

**DUT: ZNFX320PM; Type: Portable Handset; Serial: 04964**

Communication System: UID 0, Frequency: 1907.6 MHz; Duty Cycle: 1:1

Medium: 1900 Body Medium parameters used (interpolated):

$f = 1907.6 \text{ MHz}$ ;  $\sigma = 1.56 \text{ S/m}$ ;  $\epsilon_r = 52.141$ ;  $\rho = 1000 \text{ kg/m}^3$

Phantom section: Flat Section; Space: 1.0 cm

Test Date: 07-29-2019; Ambient Temp: 20.7°C; Tissue Temp: 23.5°C

Probe: EX3DV4 - SN7488; ConvF(8.37, 8.37, 8.37) @ 1907.6 MHz; Calibrated: 1/24/2019

Sensor-Surface: 1.4mm (Mechanical Surface Detection)

Electronics: DAE4 Sn1530; Calibrated: 1/15/2019

Phantom: Twin-SAM V5.0; Type: QD 000 P40 CD; Serial: 1800

Measurement SW: DASY52, Version 52.10 (2);SEMCAD X Version 14.6.12 (7470)

**Mode: UMTS 1900, Body SAR, Back side, High.ch**

**Area Scan (8x14x1):** Measurement grid: dx=15mm, dy=15mm

**Zoom Scan (5x5x7)/Cube 0:** Measurement grid: dx=8mm, dy=8mm, dz=5mm

Reference Value = 21.62 V/m; Power Drift = 0.07 dB

Peak SAR (extrapolated) = 1.33 W/kg

**SAR(1 g) = 0.668 W/kg**

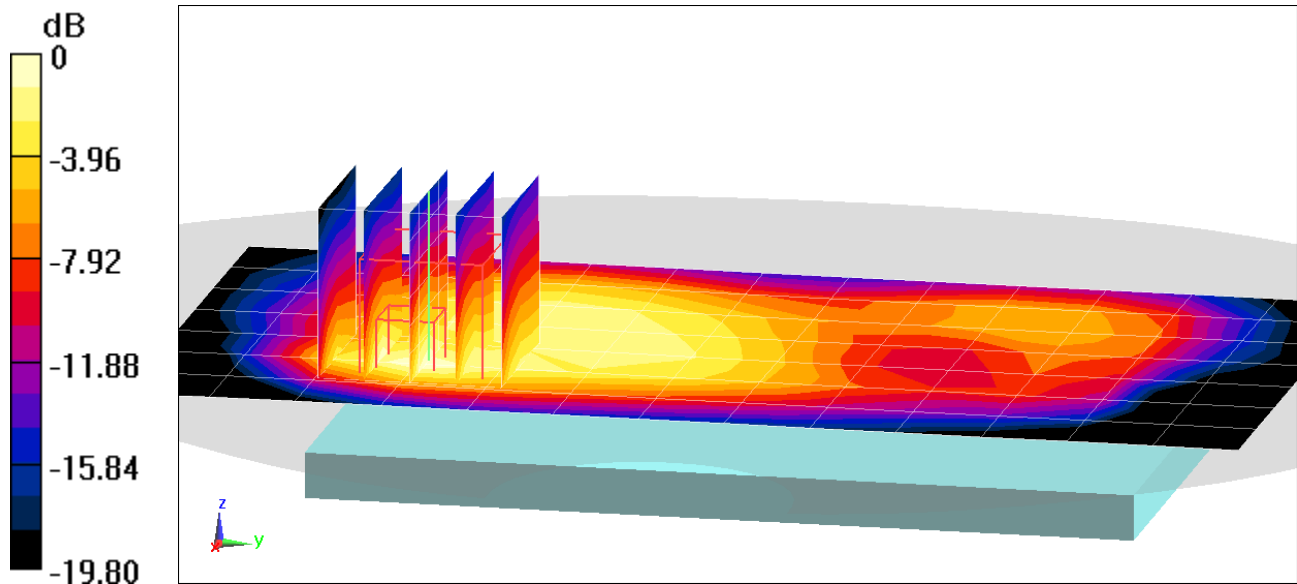

# PCTEST ENGINEERING LABORATORY, INC.

**DUT: ZNFX320PM; Type: Portable Handset; Serial: 04964**

Communication System: UID 0, \_UMTS; Frequency: 1907.6 MHz; Duty Cycle: 1:1  
Medium: 1900 Body Medium parameters used (interpolated):  
 $f = 1907.6 \text{ MHz}$ ;  $\sigma = 1.584 \text{ S/m}$ ;  $\epsilon_r = 52.088$ ;  $\rho = 1000 \text{ kg/m}^3$   
Phantom section: Flat Section; Space: 1.0 cm

Test Date: 08-12-2019; Ambient Temp: 20.0°C; Tissue Temp: 21.3°C

Probe: EX3DV4 - SN7488; ConvF(8.37, 8.37, 8.37) @ 1907.6 MHz; Calibrated: 1/24/2019  
Sensor-Surface: 1.4mm (Mechanical Surface Detection)  
Electronics: DAE4 Sn1530; Calibrated: 1/15/2019  
Phantom: Twin-SAM V5.0; Type: QD 000 P40 CD; Serial: 1800  
Measurement SW: DASY52, Version 52.10 (2);SEMCAD X Version 14.6.12 (7470)

**Mode: UMTS 1900, Body SAR, Left Edge, High.ch**

**Area Scan (10x13x1):** Measurement grid: dx=5mm, dy=15mm

**Zoom Scan (5x6x7)/Cube 0:** Measurement grid: dx=8mm, dy=8mm, dz=5mm

Reference Value = 22.77 V/m; Power Drift = 0.03 dB

Peak SAR (extrapolated) = 1.37 W/kg

**SAR(1 g) = 0.771 W/kg**

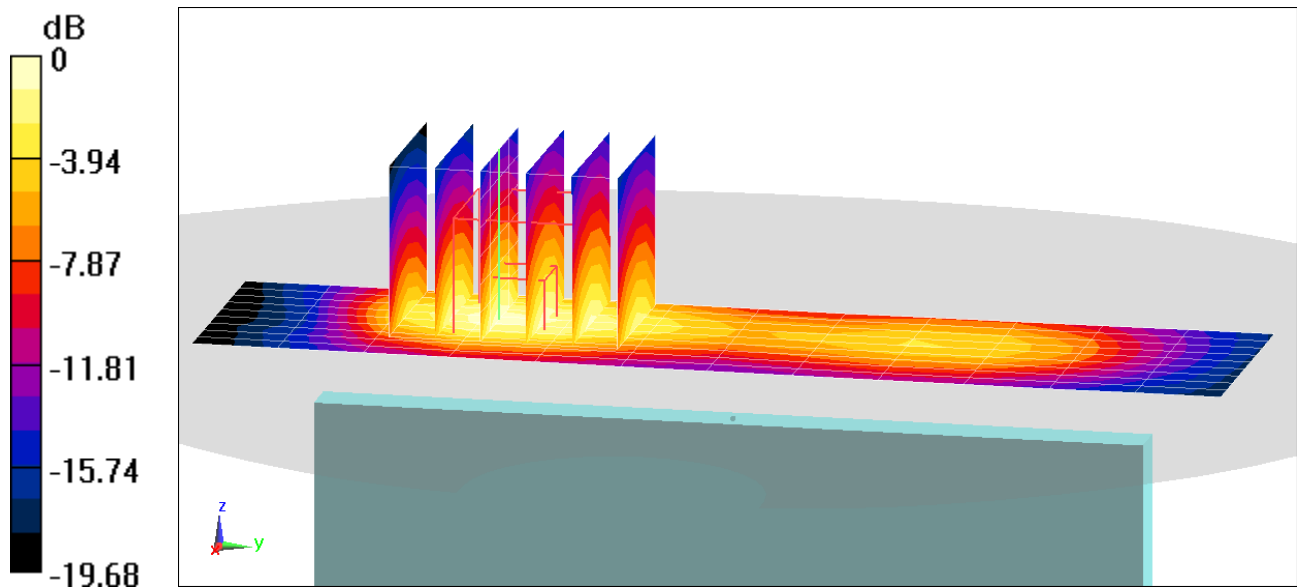

0 dB = 1.13 W/kg = 0.53 dBW/kg

# PCTEST ENGINEERING LABORATORY, INC.

**DUT: ZNFX320PM; Type: Portable Handset; Serial: 04963**

Communication System: UID 0, CDMA; Frequency: 820.1 MHz; Duty Cycle: 1:1  
Medium: 835 Body Medium parameters used (interpolated):  
 $f = 820.1 \text{ MHz}$ ;  $\sigma = 1.003 \text{ S/m}$ ;  $\epsilon_r = 54.511$ ;  $\rho = 1000 \text{ kg/m}^3$   
Phantom section: Flat Section; Space: 1.0 cm

Test Date: 07-31-2019; Ambient Temp: 20.5°C; Tissue Temp: 20.8°C

Probe: EX3DV4 - SN7538; ConvF(9.85, 9.85, 9.85) @ 820.1 MHz; Calibrated: 5/16/2019  
Sensor-Surface: 1.4mm (Mechanical Surface Detection)  
Electronics: DAE4 Sn728; Calibrated: 5/8/2019  
Phantom: Left Twin-SAM V5.0 30; Type: QD 000 P40 CD; Serial: 1792  
Measurement SW: DASY52, Version 52.10 (2);SEMCAD X Version 14.6.12 (7470)

**Mode: Cell. CDMA BC10, Body SAR, Back side, Mid.ch**

**Area Scan (9x15x1):** Measurement grid: dx=15mm, dy=15mm  
**Zoom Scan (5x5x7)/Cube 0:** Measurement grid: dx=8mm, dy=8mm, dz=5mm  
Reference Value = 25.17 V/m; Power Drift = -0.01 dB  
Peak SAR (extrapolated) = 0.867 W/kg  
**SAR(1 g) = 0.635 W/kg**

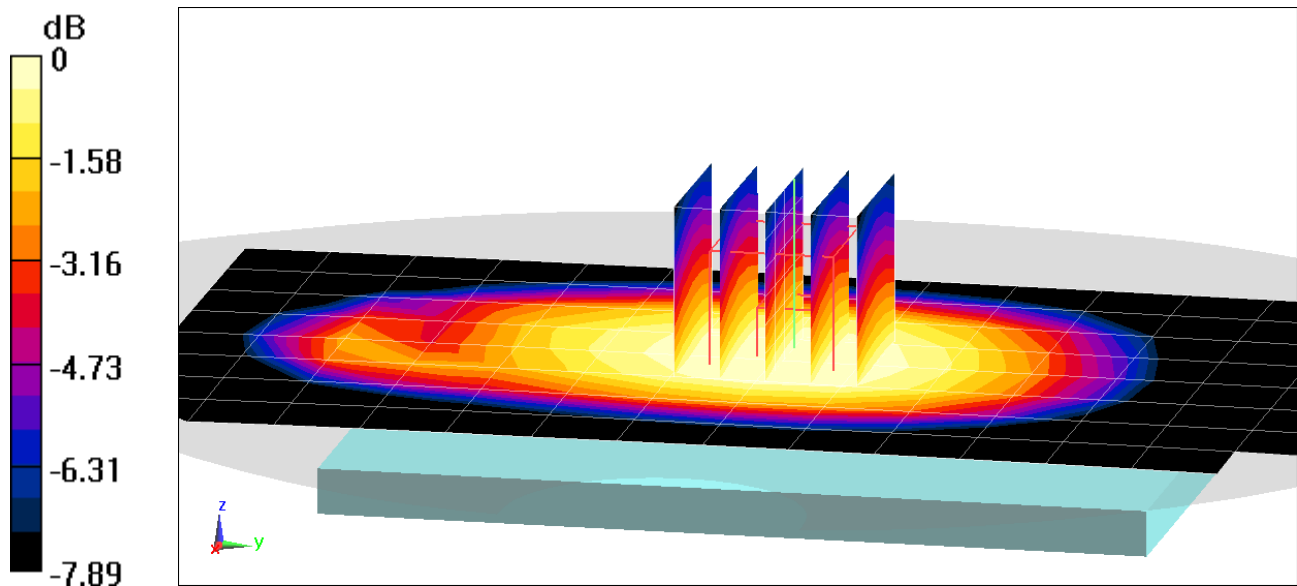

0 dB = 0.780 W/kg = -1.08 dBW/kg

# PCTEST ENGINEERING LABORATORY, INC.

**DUT: ZNFX320PM; Type: Portable Handset; Serial: 04963**

Communication System: UID 0, CDMA; Frequency: 820.1 MHz; Duty Cycle: 1:1  
Medium: 835 Body Medium parameters used (interpolated):  
 $f = 820.1 \text{ MHz}$ ;  $\sigma = 1.003 \text{ S/m}$ ;  $\epsilon_r = 54.511$ ;  $\rho = 1000 \text{ kg/m}^3$   
Phantom section: Flat Section; Space: 1.0 cm

Test Date: 07-31-2019; Ambient Temp: 20.5°C; Tissue Temp: 20.8°C

Probe: EX3DV4 - SN7538; ConvF(9.85, 9.85, 9.85) @ 820.1 MHz; Calibrated: 5/16/2019  
Sensor-Surface: 1.4mm (Mechanical Surface Detection)  
Electronics: DAE4 Sn728; Calibrated: 5/8/2019  
Phantom: Left Twin-SAM V5.0 30; Type: QD 000 P40 CD; Serial: 1792  
Measurement SW: DASY52, Version 52.10 (2);SEMCAD X Version 14.6.12 (7470)

**Mode: Cell. EVDO BC10, Body SAR, Right Edge, Mid.ch**

**Area Scan (10x13x1):** Measurement grid: dx=5mm, dy=15mm  
**Zoom Scan (5x5x7)/Cube 0:** Measurement grid: dx=8mm, dy=8mm, dz=5mm  
Reference Value = 25.77 V/m; Power Drift = -0.04 dB  
Peak SAR (extrapolated) = 0.987 W/kg  
**SAR(1 g) = 0.643 W/kg**

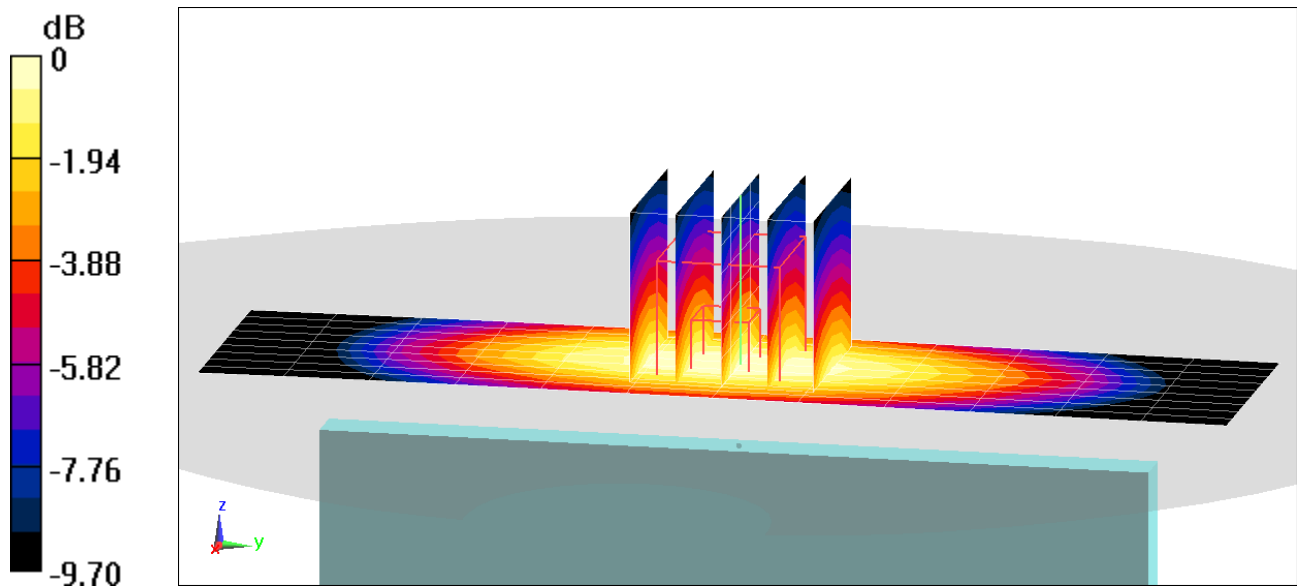

0 dB = 0.858 W/kg = -0.67 dBW/kg

# PCTEST ENGINEERING LABORATORY, INC.

**DUT: ZNFX320PM; Type: Portable Handset; Serial: 04964**

Communication System: UID 0, CDMA; Frequency: 836.52 MHz; Duty Cycle: 1:1  
Medium: 835 Body Medium parameters used (interpolated):  
 $f = 836.52$  MHz;  $\sigma = 1.01$  S/m;  $\epsilon_r = 54.466$ ;  $\rho = 1000$  kg/m<sup>3</sup>  
Phantom section: Flat Section; Space: 1.0 cm

Test Date: 07-31-2019; Ambient Temp: 20.5°C; Tissue Temp: 20.8°C

Probe: EX3DV4 - SN7538; ConvF(9.85, 9.85, 9.85) @ 836.52 MHz; Calibrated: 5/16/2019  
Sensor-Surface: 1.4mm (Mechanical Surface Detection)  
Electronics: DAE4 Sn728; Calibrated: 5/8/2019  
Phantom: Left Twin-SAM V5.0 30; Type: QD 000 P40 CD; Serial: 1792  
Measurement SW: DASY52, Version 52.10 (2);SEMCAD X Version 14.6.12 (7470)

**Mode: Cell. CDMA BC0, Body SAR, Back side, Mid.ch**

**Area Scan (9x15x1):** Measurement grid: dx=15mm, dy=15mm

**Zoom Scan (6x6x7)/Cube 0:** Measurement grid: dx=8mm, dy=8mm, dz=5mm

Reference Value = 21.78 V/m; Power Drift = -0.05 dB

Peak SAR (extrapolated) = 0.658 W/kg

**SAR(1 g) = 0.476 W/kg**

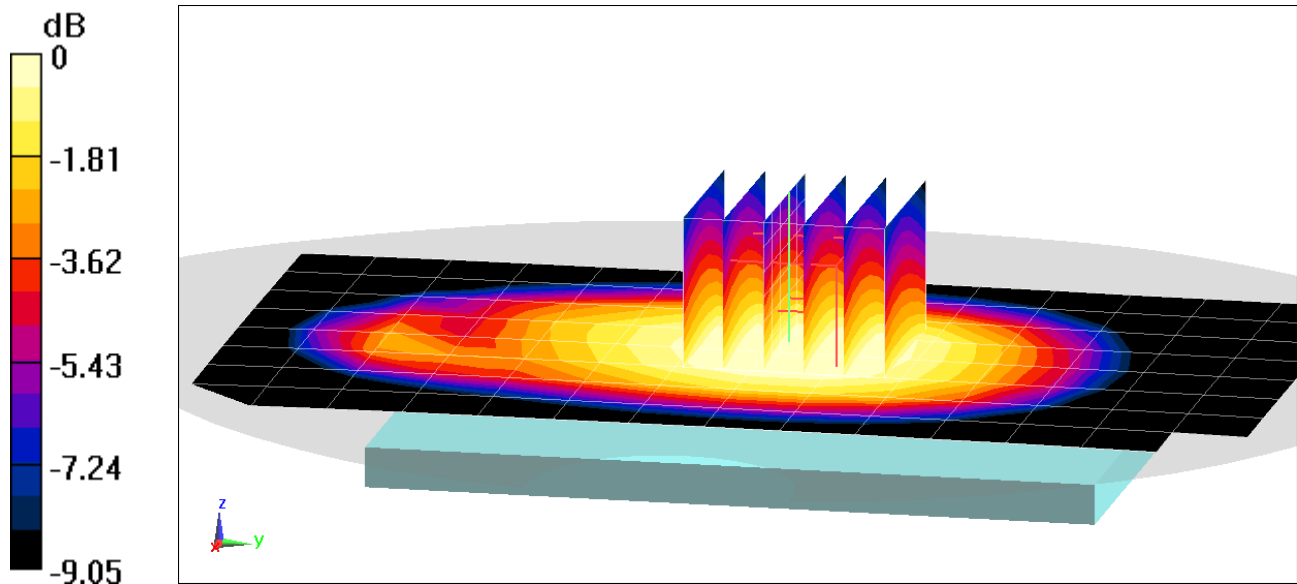

0 dB = 0.586 W/kg = -2.32 dBW/kg

# PCTEST ENGINEERING LABORATORY, INC.

**DUT: ZNFX320PM; Type: Portable Handset; Serial: 04964**

Communication System: UID 0, CDMA; Frequency: 836.52 MHz; Duty Cycle: 1:1  
Medium: 835 Body Medium parameters used (interpolated):  
 $f = 836.52 \text{ MHz}$ ;  $\sigma = 1.01 \text{ S/m}$ ;  $\epsilon_r = 54.466$ ;  $\rho = 1000 \text{ kg/m}^3$   
Phantom section: Flat Section; Space: 1.0 cm

Test Date: 07-31-2019; Ambient Temp: 20.5°C; Tissue Temp: 20.8°C

Probe: EX3DV4 - SN7538; ConvF(9.85, 9.85, 9.85) @ 836.52 MHz; Calibrated: 5/16/2019  
Sensor-Surface: 1.4mm (Mechanical Surface Detection)  
Electronics: DAE4 Sn728; Calibrated: 5/8/2019  
Phantom: Left Twin-SAM V5.0 30; Type: QD 000 P40 CD; Serial: 1792  
Measurement SW: DASY52, Version 52.10 (2);SEMCAD X Version 14.6.12 (7470)

**Mode: Cell. BC0 EVDO, Body SAR, Back side, Mid.ch**

**Area Scan (9x15x1):** Measurement grid: dx=15mm, dy=15mm

**Zoom Scan (7x6x7)/Cube 0:** Measurement grid: dx=8mm, dy=8mm, dz=5mm

Reference Value = 21.51 V/m; Power Drift = -0.07 dB

Peak SAR (extrapolated) = 0.680 W/kg

**SAR(1 g) = 0.490 W/kg**

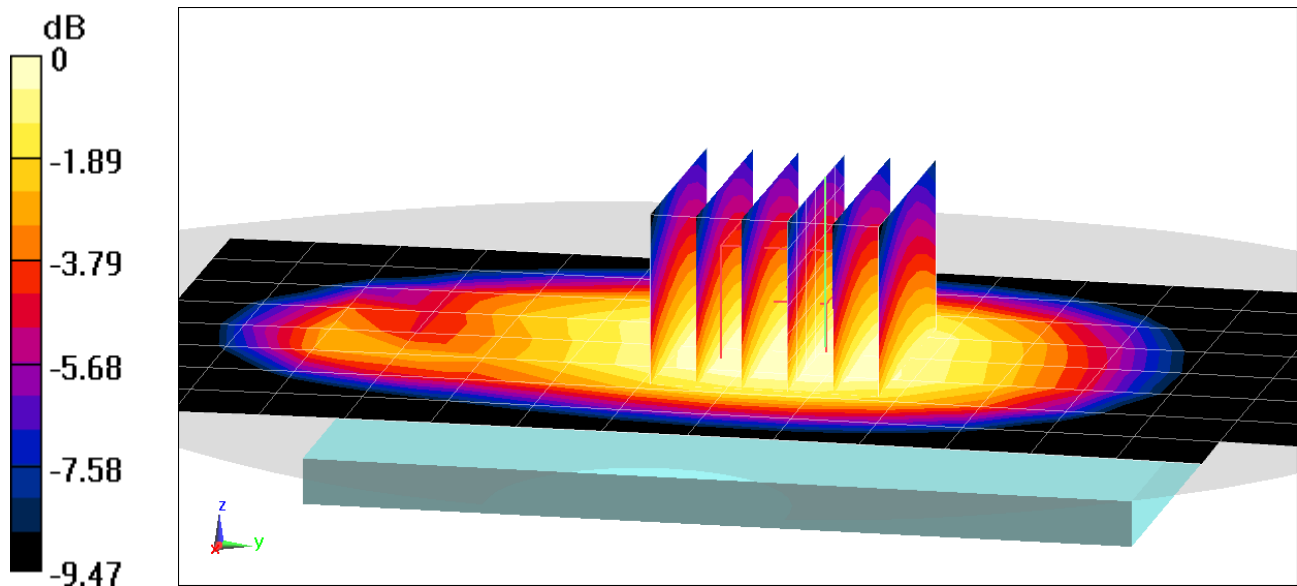

0 dB = 0.605 W/kg = -2.18 dBW/kg



# PCTEST ENGINEERING LABORATORY, INC.

**DUT: ZNFX320PM; Type: Portable Handset; Serial: 04964**

Communication System: UID 0, CDMA; Frequency: 1880 MHz; Duty Cycle: 1:1

Medium: 1900 Body Medium parameters used:

$f = 1880 \text{ MHz}$ ;  $\sigma = 1.537 \text{ S/m}$ ;  $\epsilon_r = 53.726$ ;  $\rho = 1000 \text{ kg/m}^3$

Phantom section: Flat Section; Space: 1.0 cm

Test Date: 07-31-2019; Ambient Temp: 20.5°C; Tissue Temp: 23.9°C

Probe: EX3DV4 - SN7488; ConvF(8.37, 8.37, 8.37) @ 1880 MHz; Calibrated: 1/24/2019

Sensor-Surface: 1.4mm (Mechanical Surface Detection)

Electronics: DAE4 Sn1530; Calibrated: 1/15/2019

Phantom: Twin-SAM V5.0; Type: QD 000 P40 CD; Serial: 1800

Measurement SW: DASY52, Version 52.10 (2);SEMCAD X Version 14.6.12 (7470)

**Mode: PCS CDMA, Body SAR, Back side, Mid.ch**

**Area Scan (8x14x1):** Measurement grid: dx=15mm, dy=15mm

**Zoom Scan (5x5x7)/Cube 0:** Measurement grid: dx=8mm, dy=8mm, dz=5mm

Reference Value = 20.07 V/m; Power Drift = -0.02 dB

Peak SAR (extrapolated) = 1.11 W/kg

**SAR(1 g) = 0.565 W/kg**

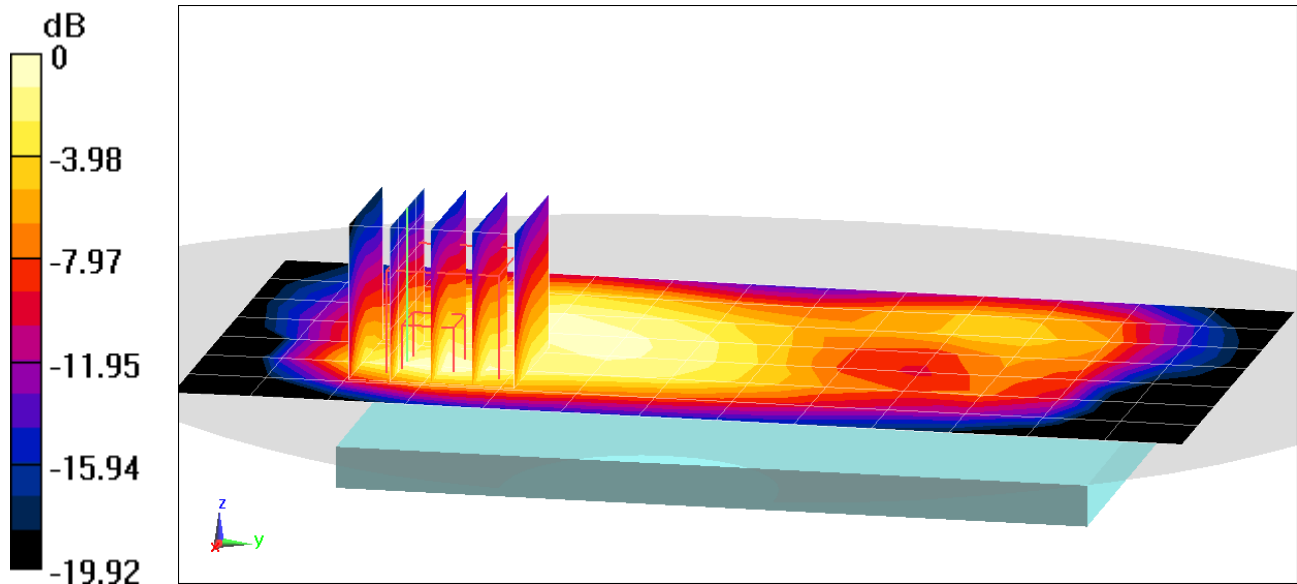

0 dB = 0.859 W/kg = -0.66 dBW/kg

# PCTEST ENGINEERING LABORATORY, INC.

**DUT: ZNFX320PM; Type: Portable Handset; Serial: 04964**

Communication System: UID 0, CDMA; Frequency: 1908.75 MHz; Duty Cycle: 1:1  
Medium: 1900 Body Medium parameters used (interpolated):  
 $f = 1908.75$  MHz;  $\sigma = 1.568$  S/m;  $\epsilon_r = 53.646$ ;  $\rho = 1000$  kg/m<sup>3</sup>  
Phantom section: Flat Section; Space: 1.0 cm

Test Date: 07-31-2019; Ambient Temp: 20.5°C; Tissue Temp: 23.9°C

Probe: EX3DV4 - SN7488; ConvF(8.37, 8.37, 8.37) @ 1908.75 MHz; Calibrated: 1/24/2019  
Sensor-Surface: 1.4mm (Mechanical Surface Detection)  
Electronics: DAE4 Sn1530; Calibrated: 1/15/2019  
Phantom: Twin-SAM V5.0; Type: QD 000 P40 CD; Serial: 1800  
Measurement SW: DASY52, Version 52.10 (2);SEMCAD X Version 14.6.12 (7470)

**Mode: PCS EVDO, Body SAR, Left Edge, High.ch**

**Area Scan (10x13x1):** Measurement grid: dx=5mm, dy=15mm

**Zoom Scan (5x6x7)/Cube 0:** Measurement grid: dx=8mm, dy=8mm, dz=5mm

Reference Value = 22.92 V/m; Power Drift = 0.02 dB

Peak SAR (extrapolated) = 1.36 W/kg

**SAR(1 g) = 0.783 W/kg**

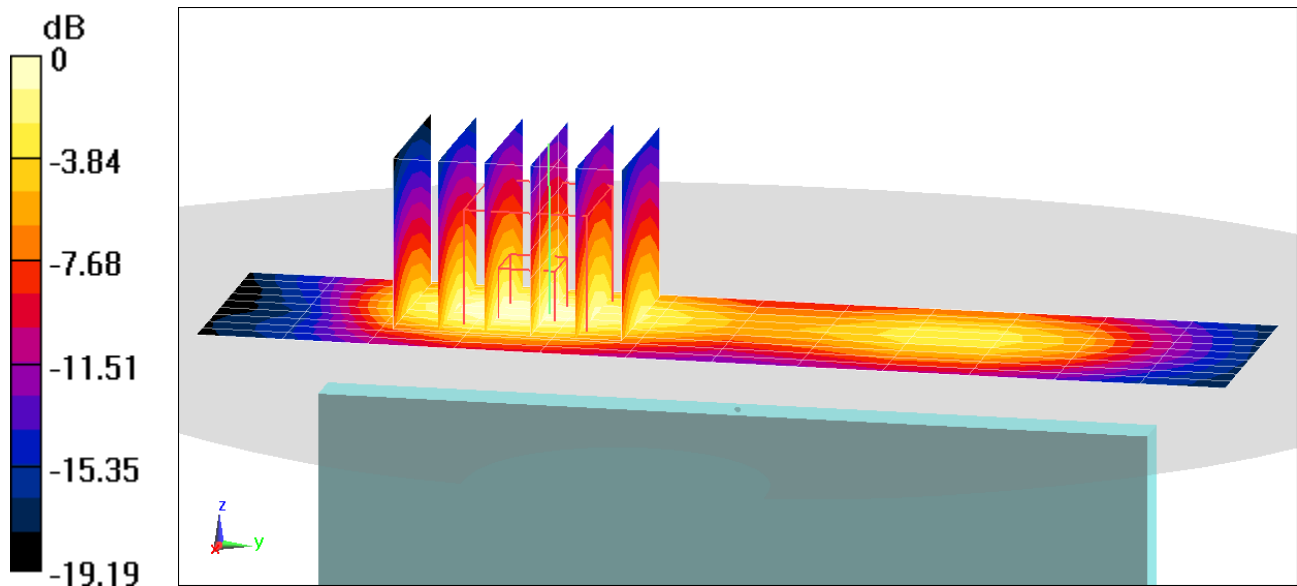

0 dB = 1.14 W/kg = 0.57 dBW/kg

# PCTEST ENGINEERING LABORATORY, INC.

**DUT: ZNFX320PM; Type: Portable Handset; Serial: 04966**

Communication System: UID 0, LTE Band 71; Frequency: 680.5 MHz; Duty Cycle: 1:1  
Medium: 750 Body Medium parameters used (interpolated):  
 $f = 680.5 \text{ MHz}$ ;  $\sigma = 0.916 \text{ S/m}$ ;  $\epsilon_r = 56.233$ ;  $\rho = 1000 \text{ kg/m}^3$   
Phantom section: Flat Section; Space: 1.0 cm

Test Date: 07-23-2019; Ambient Temp: 23.2°C; Tissue Temp: 22.7°C

Probe: EX3DV4 - SN7409; ConvF(9.96, 9.96, 9.96) @ 680.5 MHz; Calibrated: 6/19/2019  
Sensor-Surface: 1.4mm (Mechanical Surface Detection)  
Electronics: DAE4 Sn1334; Calibrated: 6/20/2019  
Phantom: SAM Left; Type: QD000P40CA; Serial: TP:82355  
Measurement SW: DASY52, Version 52.10 (2);SEMCAD X Version 14.6.12 (7470)

**Mode: LTE Band 71, Body SAR, Back side, Mid.ch, 20 MHz Bandwidth, QPSK, 1 RB, 50 RB Offset**

**Area Scan (9x15x1):** Measurement grid: dx=15mm, dy=15mm

**Zoom Scan (6x6x7)/Cube 0:** Measurement grid: dx=8mm, dy=8mm, dz=5mm

Reference Value = 19.90 V/m; Power Drift = 0.04 dB

Peak SAR (extrapolated) = 0.551 W/kg

**SAR(1 g) = 0.357 W/kg**

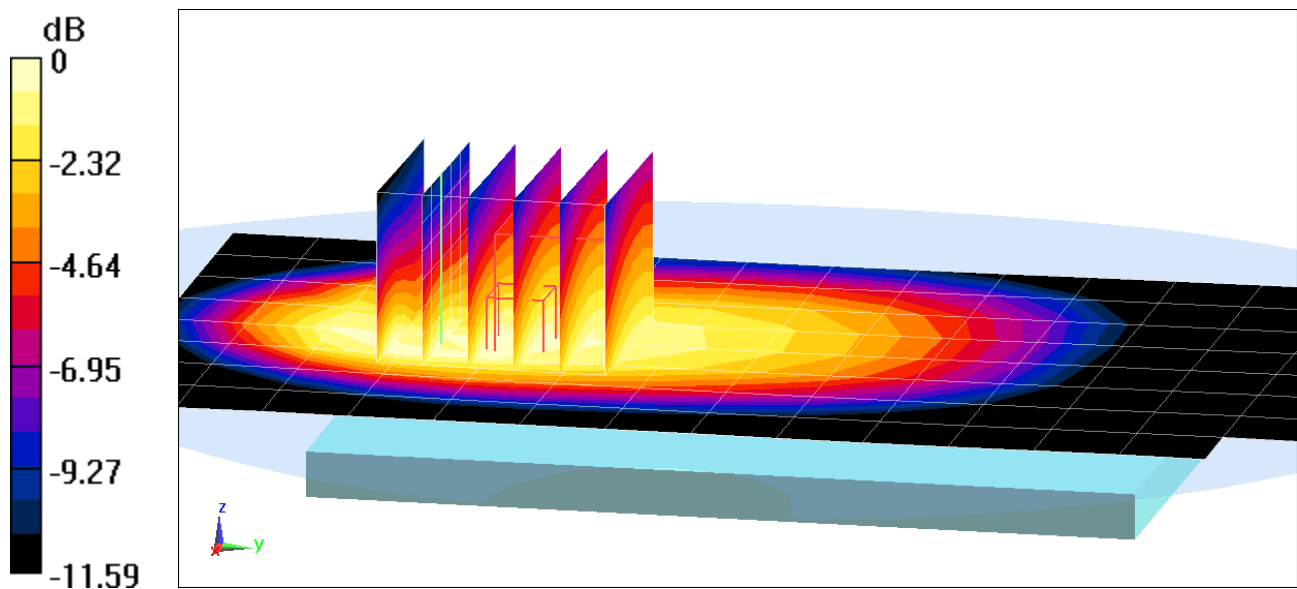

0 dB = 0.469 W/kg = -3.29 dBW/kg

# PCTEST ENGINEERING LABORATORY, INC.

**DUT: ZNFX320PM; Type: Portable Handset; Serial: 04966**

Communication System: UID 0, LTE Band 12; Frequency: 707.5 MHz; Duty Cycle: 1:1  
Medium: 750 Body Medium parameters used (interpolated):  
 $f = 707.5 \text{ MHz}$ ;  $\sigma = 0.925 \text{ S/m}$ ;  $\epsilon_r = 56.157$ ;  $\rho = 1000 \text{ kg/m}^3$   
Phantom section: Flat Section; Space: 1.0 cm

Test Date: 07-23-2019; Ambient Temp: 23.2°C; Tissue Temp: 22.7°C

Probe: EX3DV4 - SN7409; ConvF(9.96, 9.96, 9.96) @ 707.5 MHz; Calibrated: 6/19/2019  
Sensor-Surface: 1.4mm (Mechanical Surface Detection)  
Electronics: DAE4 Sn1334; Calibrated: 6/20/2019  
Phantom: SAM Left; Type: QD000P40CA; Serial: TP:82355  
Measurement SW: DASY52, Version 52.10 (2);SEMCAD X Version 14.6.12 (7470)

**Mode: LTE Band 12, Body SAR, Back side, Mid.ch, 10 MHz Bandwidth, QPSK, 1 RB, 25 RB Offset**

**Area Scan (9x13x1):** Measurement grid: dx=15mm, dy=15mm  
**Zoom Scan (6x7x7)/Cube 0:** Measurement grid: dx=8mm, dy=8mm, dz=5mm  
Reference Value = 19.43 V/m; Power Drift = 0.10 dB  
Peak SAR (extrapolated) = 0.477 W/kg  
**SAR(1 g) = 0.351 W/kg**

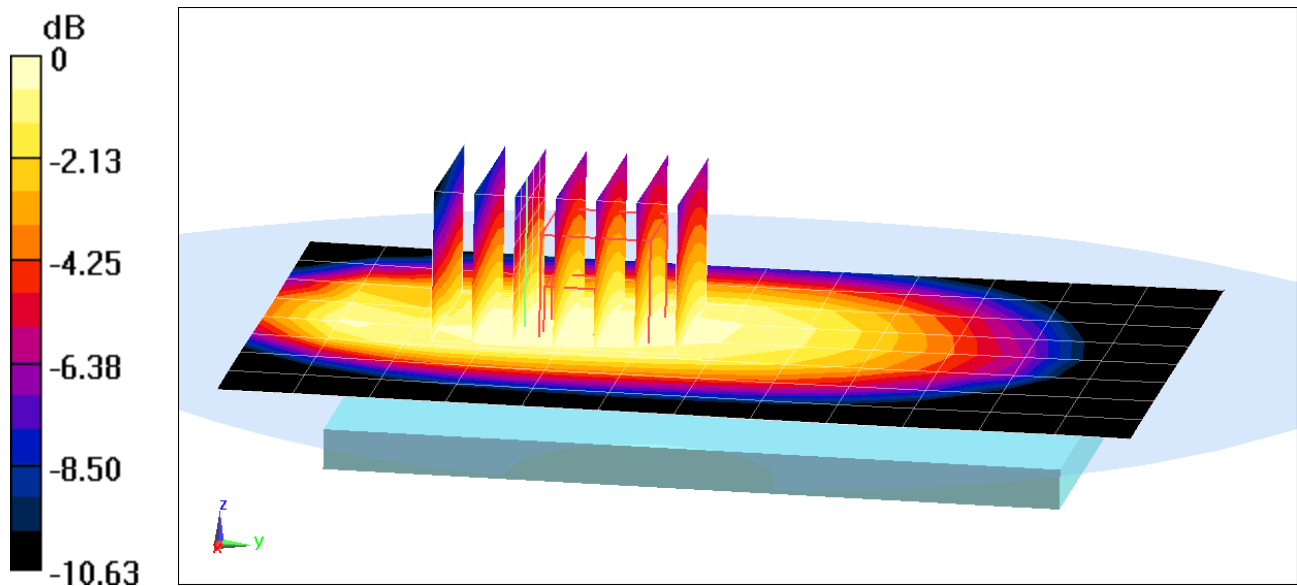

0 dB = 0.429 W/kg = -3.68 dBW/kg

# PCTEST ENGINEERING LABORATORY, INC.

**DUT: ZNFX320PM; Type: Portable Handset; Serial: 04966**

Communication System: UID 0, LTE Band 13; Frequency: 782 MHz; Duty Cycle: 1:1  
Medium: 750 Body Medium parameters used (interpolated):  
 $f = 782 \text{ MHz}$ ;  $\sigma = 0.953 \text{ S/m}$ ;  $\epsilon_r = 55.99$ ;  $\rho = 1000 \text{ kg/m}^3$   
Phantom section: Flat Section; Space: 1.0 cm

Test Date: 07-23-2019; Ambient Temp: 23.2°C; Tissue Temp: 22.7°C

Probe: EX3DV4 - SN7409; ConvF(9.96, 9.96, 9.96) @ 782 MHz; Calibrated: 6/19/2019  
Sensor-Surface: 1.4mm (Mechanical Surface Detection)  
Electronics: DAE4 Sn1334; Calibrated: 6/20/2019  
Phantom: SAM Left; Type: QD000P40CA; Serial: TP:82355  
Measurement SW: DASY52, Version 52.10 (2);SEMCAD X Version 14.6.12 (7470)

**Mode: LTE Band 13, Body SAR, Back side, Mid.ch, 10 MHz Bandwidth, QPSK, 1 RB, 25 RB Offset**

**Area Scan (9x13x1):** Measurement grid: dx=15mm, dy=15mm  
**Zoom Scan (6x6x7)/Cube 0:** Measurement grid: dx=8mm, dy=8mm, dz=5mm  
Reference Value = 23.10 V/m; Power Drift = -0.05 dB  
Peak SAR (extrapolated) = 0.655 W/kg  
**SAR(1 g) = 0.497 W/kg**

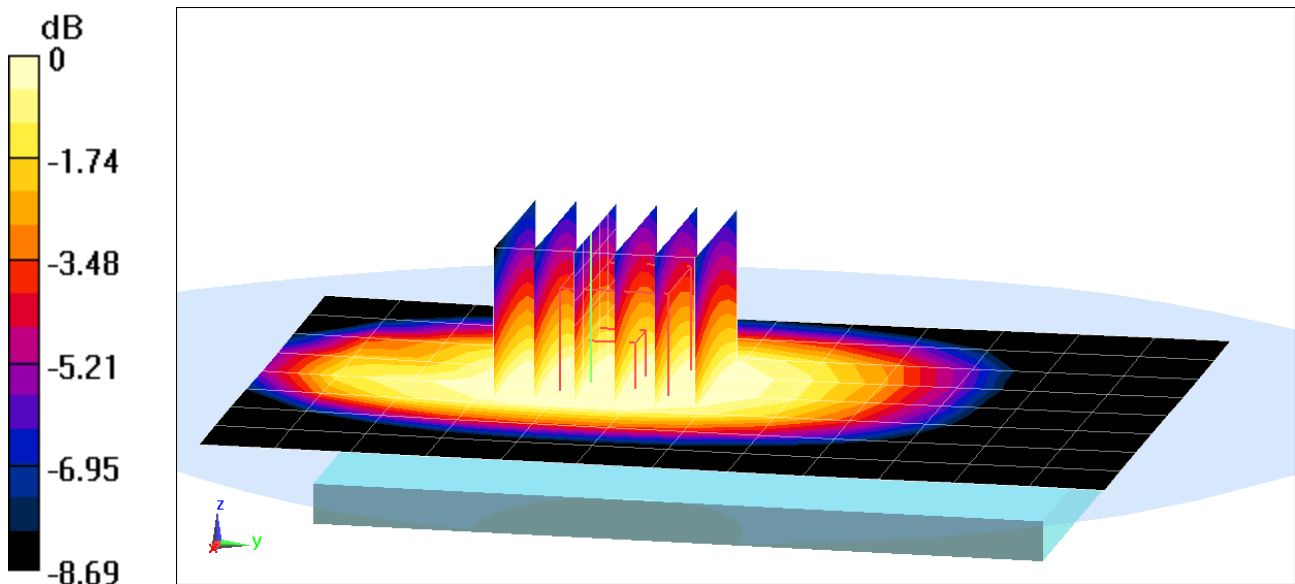

0 dB = 0.596 W/kg = -2.25 dBW/kg

# PCTEST ENGINEERING LABORATORY, INC.

**DUT: ZNFX320PM; Type: Portable Handset; Serial: 04965**

Communication System: UID 0, LTE Band 26; Frequency: 831.5 MHz; Duty Cycle: 1:1  
Medium: 835 Body Medium parameters used (interpolated):  
 $f = 831.5 \text{ MHz}$ ;  $\sigma = 0.958 \text{ S/m}$ ;  $\epsilon_r = 54.304$ ;  $\rho = 1000 \text{ kg/m}^3$   
Phantom section: Flat Section; Space: 1.0 cm

Test Date: 07-25-2019; Ambient Temp: 20.5°C; Tissue Temp: 20.6°C

Probe: EX3DV4 - SN7538; ConvF(9.85, 9.85, 9.85) @ 831.5 MHz; Calibrated: 5/16/2019  
Sensor-Surface: 1.4mm (Mechanical Surface Detection)  
Electronics: DAE4 Sn728; Calibrated: 5/8/2019  
Phantom: Left Twin-SAM V5.0 30; Type: QD 000 P40 CD; Serial: 1792  
Measurement SW: DASY52, Version 52.10 (2);SEMCAD X Version 14.6.12 (7470)

**Mode: LTE Band 26 (Cell.), Body SAR, Back side, Mid.ch, 15 MHz Bandwidth, QPSK, 1 RB,  
36 RB Offset**

**Area Scan (9x15x1):** Measurement grid: dx=15mm, dy=15mm

**Zoom Scan (6x5x7)/Cube 0:** Measurement grid: dx=8mm, dy=8mm, dz=5mm

Reference Value = 24.17 V/m; Power Drift = -0.03 dB

Peak SAR (extrapolated) = 0.780 W/kg

**SAR(1 g) = 0.556 W/kg**

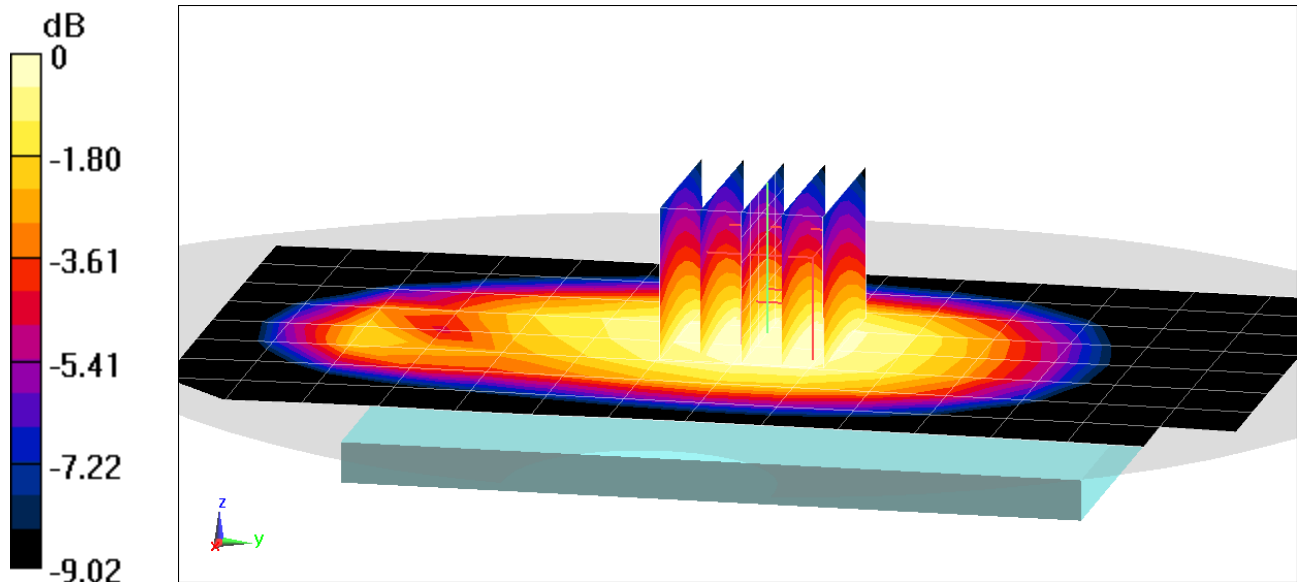

0 dB = 0.694 W/kg = -1.59 dBW/kg

# PCTEST ENGINEERING LABORATORY, INC.

**DUT: ZNFX320PM; Type: Portable Handset; Serial: 04965**

Communication System: UID 0, LTE Band 66 (AWS); Frequency: 1745 MHz; Duty Cycle: 1:1  
Medium: 1750 Body Medium parameters used (interpolated):  
 $f = 1745 \text{ MHz}$ ;  $\sigma = 1.504 \text{ S/m}$ ;  $\epsilon_r = 51.597$ ;  $\rho = 1000 \text{ kg/m}^3$   
Phantom section: Flat Section; Space: 1.0 cm

Test Date: 07-24-2019; Ambient Temp: 23.0°C; Tissue Temp: 21.3°C

Probe: EX3DV4 - SN7357; ConvF(8.26, 8.26, 8.26) @ 1745 MHz; Calibrated: 4/24/2019  
Sensor-Surface: 1.4mm (Mechanical Surface Detection)  
Electronics: DAE4 Sn1407; Calibrated: 4/18/2019  
Phantom: Twin-SAM V4.0 Front Right; Type: QD 000 P40 CC; Serial: 1167  
Measurement SW: DASY52, Version 52.10 (2);SEMCAD X Version 14.6.12 (7470)

**Mode: LTE Band 66 (AWS), Body SAR, Back side, Mid.ch, 20 MHz Bandwidth, QPSK, 1 RB,  
50 RB Offset**

**Area Scan (9x14x1):** Measurement grid: dx=15mm, dy=15mm

**Zoom Scan (5x5x7)/Cube 0:** Measurement grid: dx=8mm, dy=8mm, dz=5mm

Reference Value = 23.74 V/m; Power Drift = 0.00 dB

Peak SAR (extrapolated) = 1.48 W/kg

**SAR(1 g) = 0.830 W/kg**

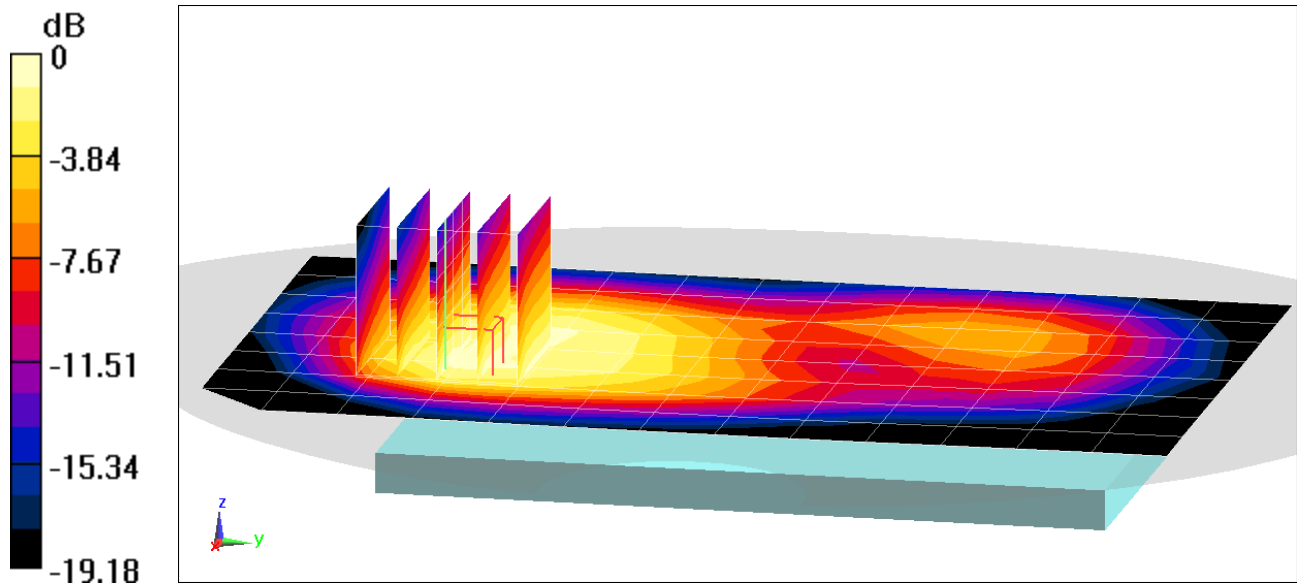

0 dB = 1.18 W/kg = 0.72 dBW/kg

# PCTEST ENGINEERING LABORATORY, INC.

**DUT: ZNFX320PM; Type: Portable Handset; Serial: 04965**

Communication System: UID 0, LTE Band 25 (PCS); Frequency: 1882.5 MHz; Duty Cycle: 1:1  
Medium: 1900 Body Medium parameters used (interpolated):  
 $f = 1882.5 \text{ MHz}$ ;  $\sigma = 1.533 \text{ S/m}$ ;  $\epsilon_r = 52.195$ ;  $\rho = 1000 \text{ kg/m}^3$   
Phantom section: Flat Section; Space: 1.0 cm

Test Date: 07-29-2019; Ambient Temp: 20.7°C; Tissue Temp: 23.5°C

Probe: EX3DV4 - SN7488; ConvF(8.37, 8.37, 8.37) @ 1882.5 MHz; Calibrated: 1/24/2019  
Sensor-Surface: 1.4mm (Mechanical Surface Detection)  
Electronics: DAE4 Sn1530; Calibrated: 1/15/2019  
Phantom: Twin-SAM V5.0; Type: QD 000 P40 CD; Serial: 1800  
Measurement SW: DASY52, Version 52.10 (2);SEMCAD X Version 14.6.12 (7470)

**Mode: LTE Band 25 (PCS), Body SAR, Back side, Mid.ch, 20 MHz Bandwidth, QPSK, 1 RB, 50 RB Offset**

**Area Scan (9x15x1):** Measurement grid: dx=15mm, dy=15mm  
**Zoom Scan (5x5x7)/Cube 0:** Measurement grid: dx=8mm, dy=8mm, dz=5mm  
Reference Value = 22.03 V/m; Power Drift = 0.06 dB  
Peak SAR (extrapolated) = 1.30 W/kg  
**SAR(1 g) = 0.665 W/kg**

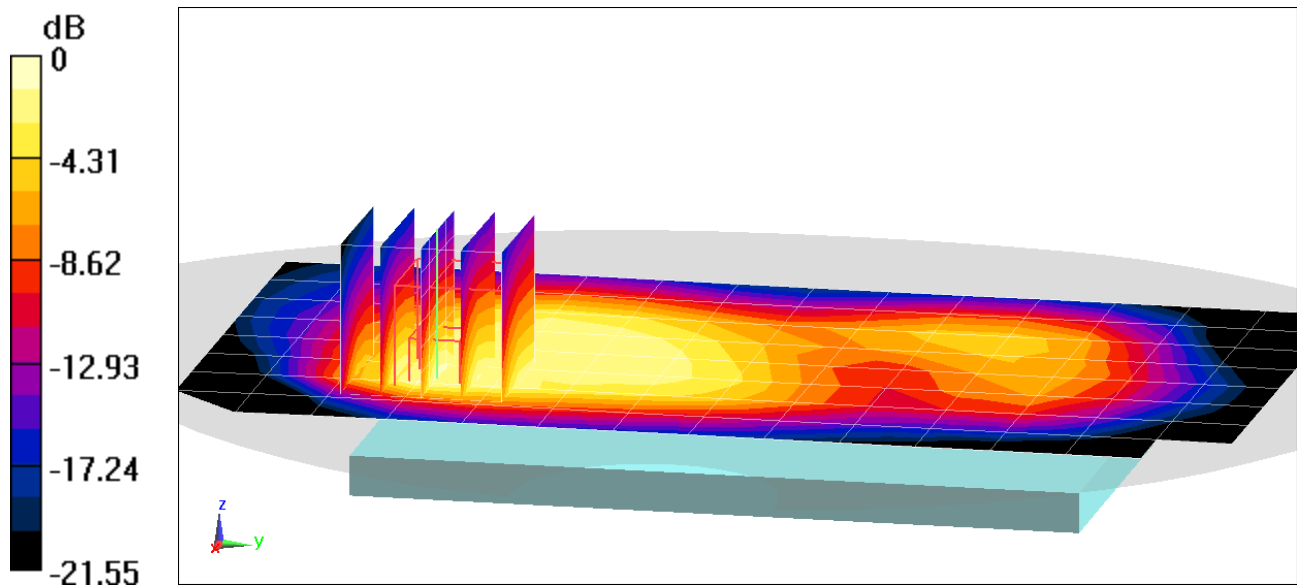

0 dB = 1.05 W/kg = 0.21 dBW/kg



# PCTEST ENGINEERING LABORATORY, INC.

**DUT: ZNFX320PM; Type: Portable Handset; Serial: 04965**

Communication System: UID 0, \_LTE Band 25 (PCS); Frequency: 1905 MHz; Duty Cycle: 1:1  
Medium: 1900 Body Medium parameters used (interpolated):  
 $f = 1905 \text{ MHz}$ ;  $\sigma = 1.564 \text{ S/m}$ ;  $\epsilon_r = 53.657$ ;  $\rho = 1000 \text{ kg/m}^3$   
Phantom section: Flat Section; Space: 1.0 cm

Test Date: 07-31-2019; Ambient Temp: 20.5°C; Tissue Temp: 23.9°C

Probe: EX3DV4 - SN7488; ConvF(8.37, 8.37, 8.37) @ 1905 MHz; Calibrated: 1/24/2019  
Sensor-Surface: 1.4mm (Mechanical Surface Detection)  
Electronics: DAE4 Sn1530; Calibrated: 1/15/2019  
Phantom: Twin-SAM V5.0; Type: QD 000 P40 CD; Serial: 1800  
Measurement SW: DASY52, Version 52.10 (2);SEMCAD X Version 14.6.12 (7470)

**Mode: LTE Band 25 (PCS), Body SAR, Left Edge, High.ch, 20 MHz Bandwidth, QPSK, 1 RB,  
50 RB Offset**

**Area Scan (9x15x1):** Measurement grid: dx=5mm, dy=15mm

**Zoom Scan (6x6x7)/Cube 0:** Measurement grid: dx=8mm, dy=8mm, dz=5mm

Reference Value = 23.63 V/m; Power Drift = -0.05 dB

Peak SAR (extrapolated) = 1.49 W/kg

**SAR(1 g) = 0.861 W/kg**

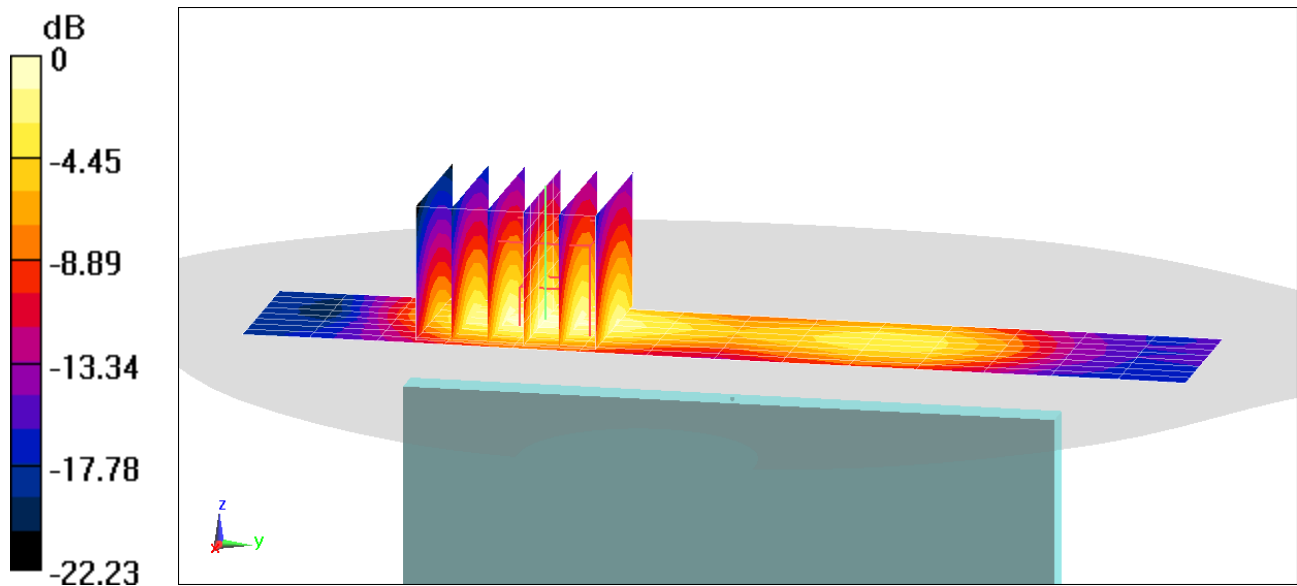

0 dB = 1.26 W/kg = 1.00 dBW/kg

# PCTEST ENGINEERING LABORATORY, INC.

**DUT: ZNFX320PM; Type: Portable Handset; Serial: 04966**

Communication System: UID 0, LTE Band 41 (Class 2); Frequency: 2593 MHz; Duty Cycle: 1:2.31

Medium: 2450 Body Medium parameters used (interpolated):

$f = 2593 \text{ MHz}$ ;  $\sigma = 2.246 \text{ S/m}$ ;  $\epsilon_r = 51.048$ ;  $\rho = 1000 \text{ kg/m}^3$

Phantom section: Flat Section; Space: 1.0 cm

Test Date: 08-05-2019; Ambient Temp: 20.6°C; Tissue Temp: 21.0°C

Probe: EX3DV4 - SN7357; ConvF(7.39, 7.39, 7.39) @ 2593 MHz; Calibrated: 4/24/2019

Sensor-Surface: 1.4mm (Mechanical Surface Detection)

Electronics: DAE4 Sn1407; Calibrated: 4/18/2019

Phantom: Twin-SAM V4.0 Front Right; Type: QD 000 P40 CC; Serial: 1167

Measurement SW: DASY52, Version 52.10 (2); SEMCAD X Version 14.6.12 (7470)

**Mode: LTE Band 41 PC2, Body SAR, Back side, Mid.ch, 20 MHz Bandwidth, QPSK, 1 RB, 50 RB Offset**

**Area Scan (10x16x1):** Measurement grid: dx=12mm, dy=12mm

**Zoom Scan (7x7x7)/Cube 0:** Measurement grid: dx=5mm, dy=5mm, dz=5mm

Reference Value = 19.26 V/m; Power Drift = 0.05 dB

Peak SAR (extrapolated) = 1.49 W/kg

**SAR(1 g) = 0.738 W/kg**

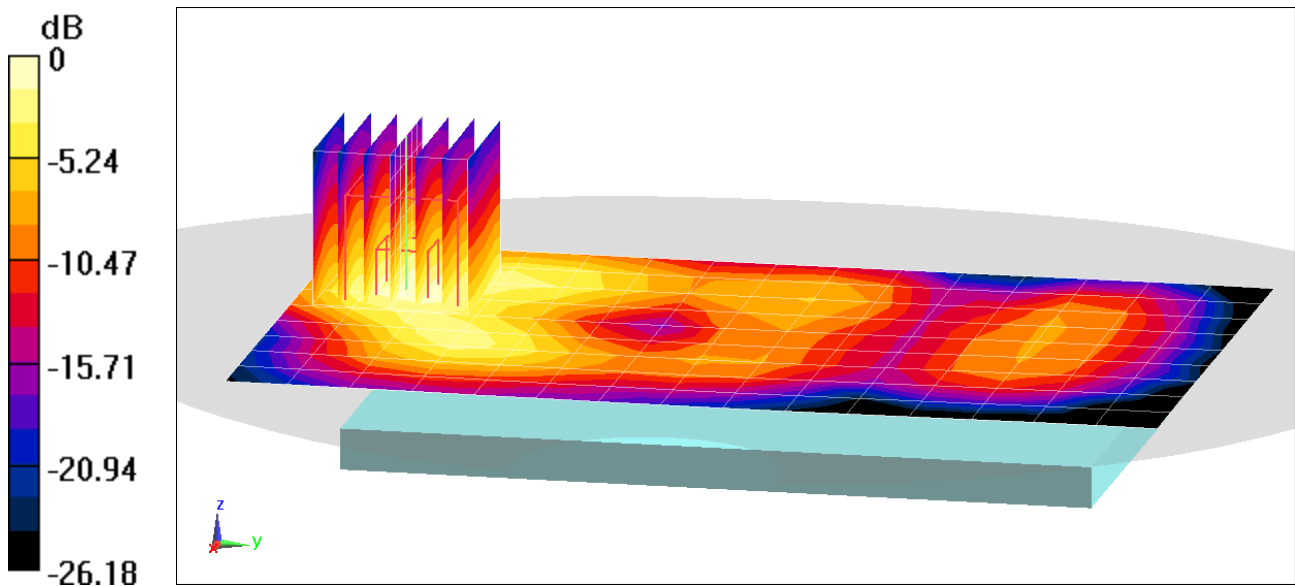

0 dB = 1.20 W/kg = 0.79 dBW/kg

# PCTEST ENGINEERING LABORATORY, INC.

**DUT: ZNFX320PM; Type: Portable Handset; Serial: 04966**

Communication System: UID 0, LTE Band 41 (Class 2); Frequency: 2593 MHz; Duty Cycle: 1:2.31

Medium: 2450 Body Medium parameters used (interpolated):

$f = 2593 \text{ MHz}$ ;  $\sigma = 2.246 \text{ S/m}$ ;  $\epsilon_r = 51.048$ ;  $\rho = 1000 \text{ kg/m}^3$

Phantom section: Flat Section; Space: 1.0 cm

Test Date: 08-05-2019; Ambient Temp: 20.6°C; Tissue Temp: 21.0°C

Probe: EX3DV4 - SN7357; ConvF(7.39, 7.39, 7.39) @ 2593 MHz; Calibrated: 4/24/2019

Sensor-Surface: 1.4mm (Mechanical Surface Detection)

Electronics: DAE4 Sn1407; Calibrated: 4/18/2019

Phantom: Twin-SAM V4.0 Front Right; Type: QD 000 P40 CC; Serial: 1167

Measurement SW: DASY52, Version 52.10 (2); SEMCAD X Version 14.6.12 (7470)

**Mode: LTE Band 41 PC2, Body SAR, Bottom Edge, Mid.ch, 20 MHz Bandwidth, QPSK, 1 RB, 50 RB Offset**

**Area Scan (10x9x1):** Measurement grid: dx=5mm, dy=12mm

**Zoom Scan (7x7x7)/Cube 0:** Measurement grid: dx=5mm, dy=5mm, dz=5mm

Reference Value = 24.60 V/m; Power Drift = 0.08 dB

Peak SAR (extrapolated) = 2.60 W/kg

**SAR(1 g) = 1.23 W/kg**

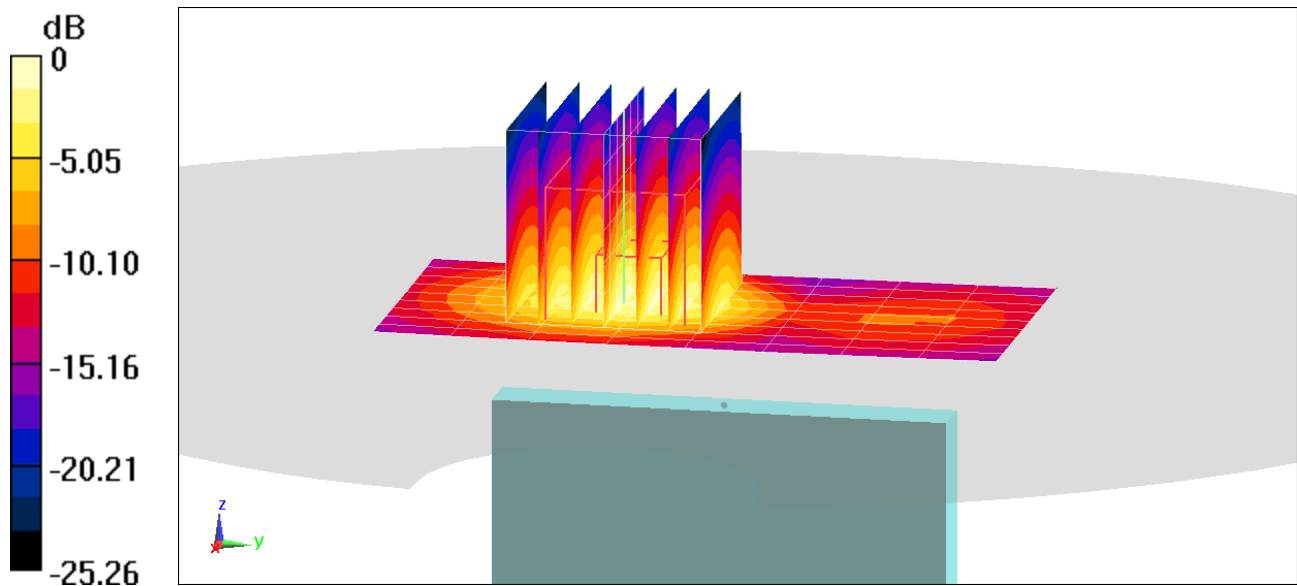

# PCTEST ENGINEERING LABORATORY, INC.

**DUT: ZNFX320PM; Type: Portable Handset; Serial: 22710**

Communication System: UID 0, \_IEEE 802.11b; Frequency: 2412 MHz; Duty Cycle: 1:1  
Medium: 2450 Body Medium parameters used (interpolated):  
 $f = 2412 \text{ MHz}$ ;  $\sigma = 1.89 \text{ S/m}$ ;  $\epsilon_r = 52.611$ ;  $\rho = 1000 \text{ kg/m}^3$   
Phantom section: Flat Section; Space: 1.0 cm

Test Date: 08-07-2019; Ambient Temp: 24.9°C; Tissue Temp: 23.8°C

Probe: EX3DV4 - SN7357; ConvF(7.59, 7.59, 7.59) @ 2412 MHz; Calibrated: 4/24/2019  
Sensor-Surface: 1.4mm (Mechanical Surface Detection)  
Electronics: DAE4 Sn1407; Calibrated: 4/18/2019  
Phantom: Twin-SAM V4.0 Front Right; Type: QD 000 P40 CC; Serial: 1167  
Measurement SW: DASY52, Version 52.10 (2);SEMCAD X Version 14.6.12 (7470)

**Mode: IEEE 802.11b, 22 MHz Bandwidth, Body SAR, Ch 1, 1 Mbps, Back Side**

**Area Scan (11x17x1):** Measurement grid: dx=12mm, dy=12mm

**Zoom Scan (7x7x7)/Cube 0:** Measurement grid: dx=5mm, dy=5mm, dz=5mm

Reference Value = 8.658 V/m; Power Drift = -0.10 dB

Peak SAR (extrapolated) = 0.257 W/kg

**SAR(1 g) = 0.126 W/kg**

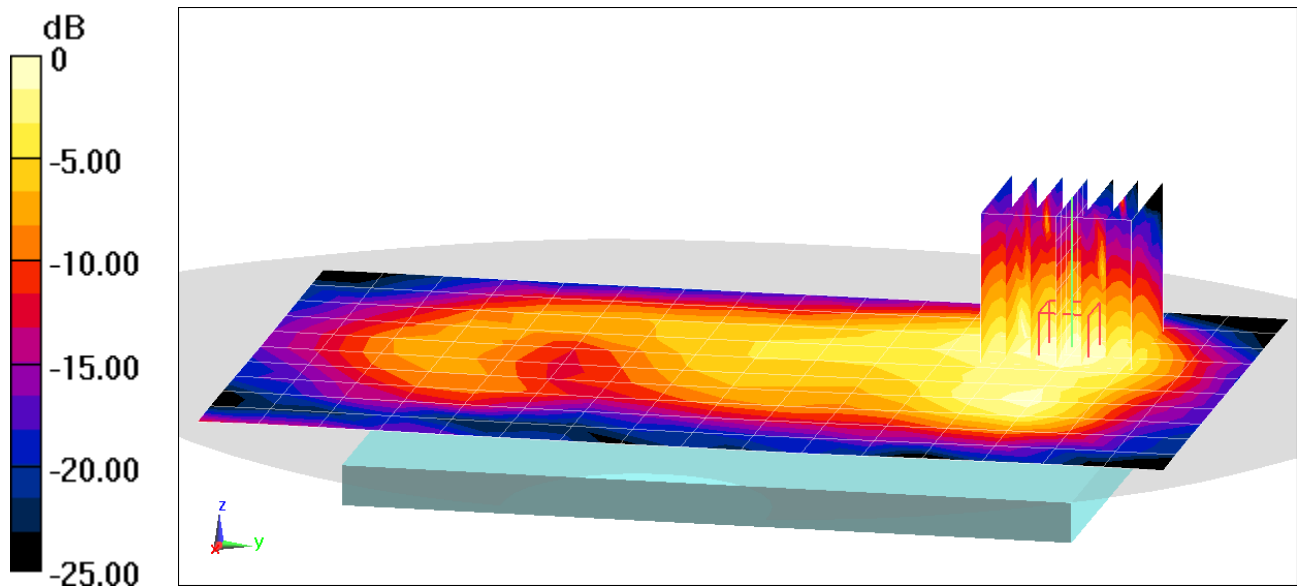

0 dB = 0.204 W/kg = -6.90 dBW/kg

## APPENDIX B: SYSTEM VERIFICATION

# PCTEST ENGINEERING LABORATORY, INC.

**DUT: Dipole 750 MHz; Type: D750V3; Serial: 1003**

Communication System: UID 0, CW; Frequency: 750 MHz; Duty Cycle: 1:1

Medium: 750 Head Medium parameters used (interpolated):

$f = 750 \text{ MHz}$ ;  $\sigma = 0.87 \text{ S/m}$ ;  $\epsilon_r = 42.505$ ;  $\rho = 1000 \text{ kg/m}^3$

Phantom section: Flat Section; Space: 1.5 cm

Test Date: 07-29-2019; Ambient Temp: 21.2°C; Tissue Temp: 20.4°C

Probe: EX3DV4 - SN3589; ConvF(8.67, 8.67, 8.67) @ 750 MHz; Calibrated: 1/25/2019

Sensor-Surface: 1.4mm (Mechanical Surface Detection)

Electronics: DAE4 Sn1450; Calibrated: 8/22/2018

Phantom: Twin-SAM V5.0 (30); Type: QD 000 P40 CD; Serial: 1647

Measurement SW: DASY52, Version 52.10 (2); SEMCAD X Version 14.6.12 (7470)

## 750 MHz System Verification at 23.0 dBm (200 mW)

**Area Scan (7x15x1):** Measurement grid: dx=15mm, dy=15mm

**Zoom Scan (5x5x7)/Cube 0:** Measurement grid: dx=8mm, dy=8mm, dz=5mm

Peak SAR (extrapolated) = 2.28 W/kg

**SAR(1 g) = 1.54 W/kg**

Deviation(1 g) = -7.00%

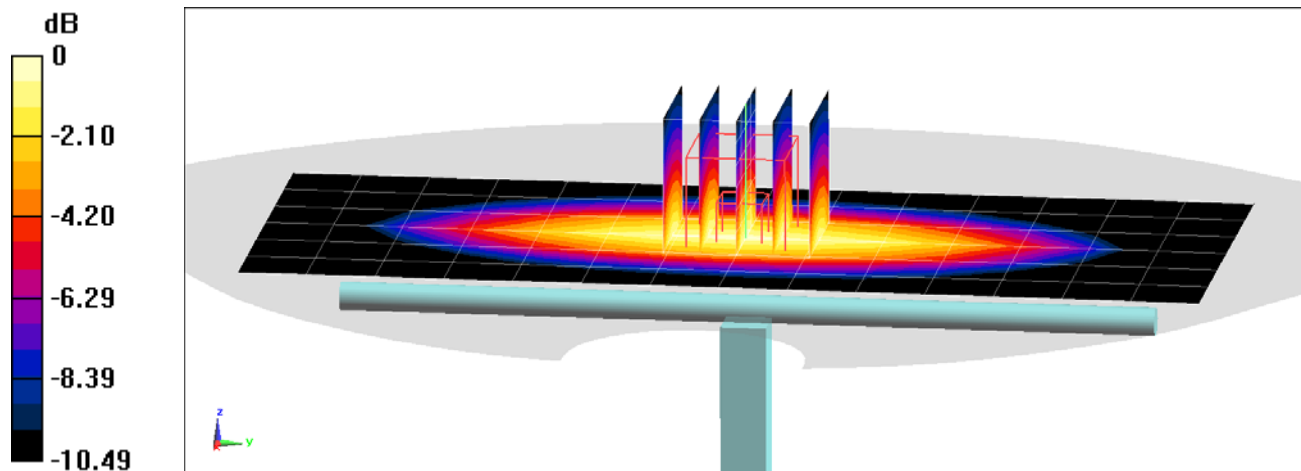

0 dB = 2.05 W/kg = 3.12 dBW/kg

# PCTEST ENGINEERING LABORATORY, INC.

**DUT: Dipole 835 MHz; Type: D835V2; Serial: 4d132**

Communication System: UID 0, CW; Frequency: 835 MHz; Duty Cycle: 1:1

Medium: 835 Head Medium parameters used:

$f = 835 \text{ MHz}$ ;  $\sigma = 0.901 \text{ S/m}$ ;  $\epsilon_r = 42.255$ ;  $\rho = 1000 \text{ kg/m}^3$

Phantom section: Flat Section; Space: 1.5 cm

Test Date: 07-30-2019; Ambient Temp: 22.9°C; Tissue Temp: 20.4°C

Probe: EX3DV4 - SN3589; ConvF(8.39, 8.39, 8.39) @ 835 MHz; Calibrated: 1/25/2019

Sensor-Surface: 1.4mm (Mechanical Surface Detection)

Electronics: DAE4 Sn1450; Calibrated: 8/22/2018

Phantom: Twin-SAM V5.0 (30); Type: QD 000 P40 CD; Serial: 1647

Measurement SW: DASY52, Version 52.10 (2); SEMCAD X Version 14.6.12 (7470)

## 835 MHz System Verification at 23.0 dBm (200 mW)

**Area Scan (7x14x1):** Measurement grid: dx=15mm, dy=15mm

**Zoom Scan (5x5x7)/Cube 0:** Measurement grid: dx=8mm, dy=8mm, dz=5mm

Peak SAR (extrapolated) = 3.05 W/kg

**SAR(1 g) = 1.96 W/kg**

Deviation(1 g) = 2.19%

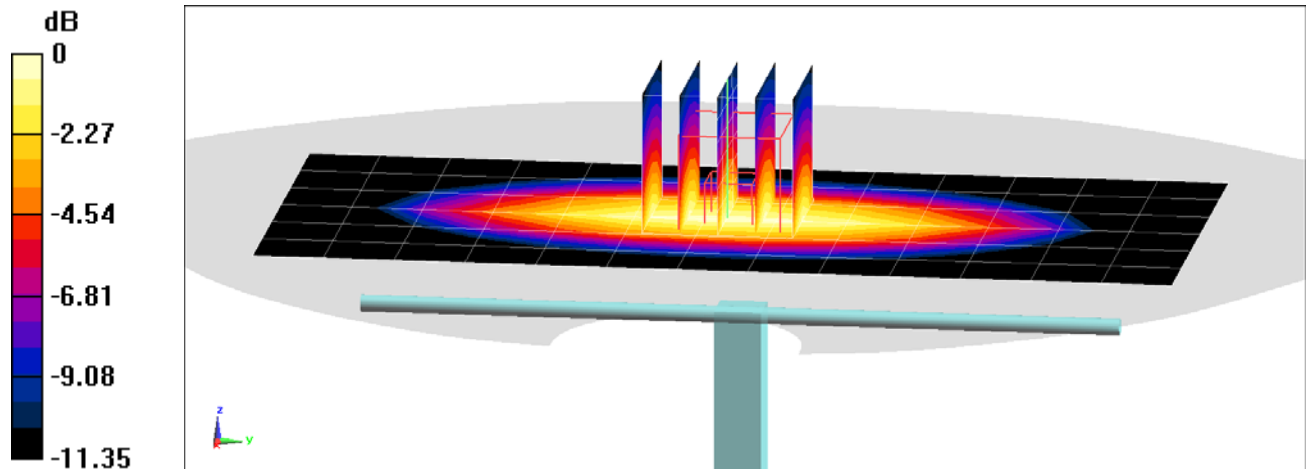

0 dB = 2.68 W/kg = 4.28 dBW/kg

# PCTEST ENGINEERING LABORATORY, INC.

**DUT: Dipole 835 MHz; Type: D835V2; Serial: 4d047**

Communication System: UID 0, CW; Frequency: 835 MHz; Duty Cycle: 1:1

Medium: 835 Head Medium parameters used:

$f = 835 \text{ MHz}$ ;  $\sigma = 0.926 \text{ S/m}$ ;  $\epsilon_r = 42.299$ ;  $\rho = 1000 \text{ kg/m}^3$

Phantom section: Flat Section; Space: 1.5 cm

Test Date: 08-07-2019; Ambient Temp: 20.5°C; Tissue Temp: 20.7°C

Probe: EX3DV4 - SN7538; ConvF(10.3, 10.3, 10.3) @ 835 MHz; Calibrated: 5/16/2019

Sensor-Surface: 1.4mm (Mechanical Surface Detection)

Electronics: DAE4 Sn728; Calibrated: 5/8/2019

Phantom: Left Twin-SAM V5.0 30; Type: QD 000 P40 CD; Serial: 1792

Measurement SW: DASY52, Version 52.10 (2); SEMCAD X Version 14.6.12 (7470)

## 835 MHz System Verification at 23.0 dBm (200 mW)

**Area Scan (7x14x1):** Measurement grid: dx=15mm, dy=15mm

**Zoom Scan (5x5x7)/Cube 0:** Measurement grid: dx=8mm, dy=8mm, dz=5mm

Peak SAR (extrapolated) = 3.04 W/kg

**SAR(1 g) = 1.98 W/kg**

Deviation(1 g) = 5.10%

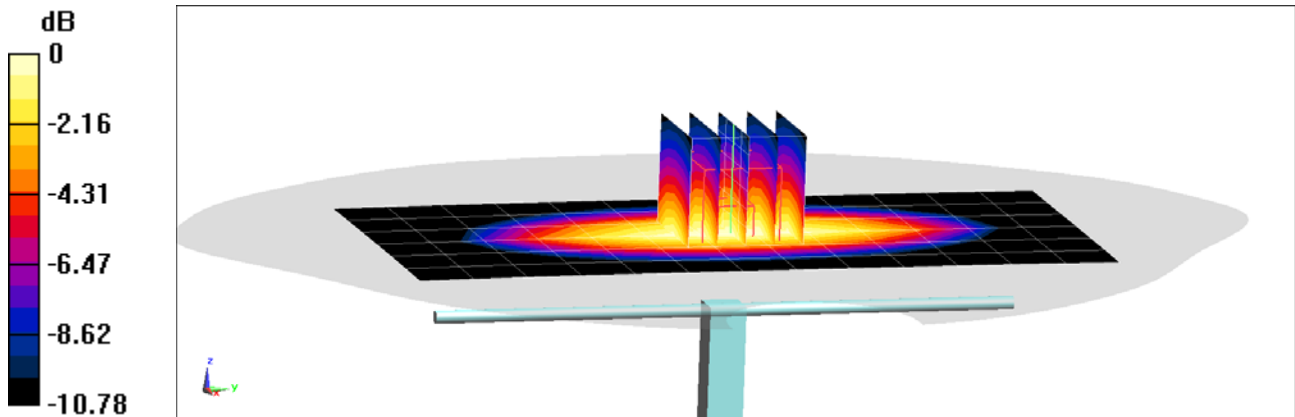

0 dB = 2.67 W/kg = 4.27 dBW/kg



# PCTEST ENGINEERING LABORATORY, INC.

**DUT: Dipole 1750 MHz; Type: D1750V2; Serial: 1148**

Communication System: UID 0, CW; Frequency: 1750 MHz; Duty Cycle: 1:1

Medium: 1750 Head Medium parameters used:

$f = 1750 \text{ MHz}$ ;  $\sigma = 1.37 \text{ S/m}$ ;  $\epsilon_r = 40.428$ ;  $\rho = 1000 \text{ kg/m}^3$

Phantom section: Flat Section; Space: 1.0 cm

Test Date: 08-07-2019; Ambient Temp: 20.5°C; Tissue Temp: 20.7°C

Probe: EX3DV4 - SN7538; ConvF(8.67, 8.67, 8.67) @ 1750 MHz; Calibrated: 5/16/2019

Sensor-Surface: 1.4mm (Mechanical Surface Detection)

Electronics: DAE4 Sn728; Calibrated: 5/8/2019

Phantom: Left Twin-SAM V5.0 30; Type: QD 000 P40 CD; Serial: 1792

Measurement SW: DASY52, Version 52.10 (2);SEMCAD X Version 14.6.12 (7470)

## 1750 MHz System Verification at 20.0 dBm (100 mW)

**Area Scan (7x9x1):** Measurement grid: dx=15mm, dy=15mm

**Zoom Scan (5x5x7)/Cube 0:** Measurement grid: dx=8mm, dy=8mm, dz=5mm

Peak SAR (extrapolated) = 7.01 W/kg

**SAR(1 g) = 3.7 W/kg**

Deviation(1 g) = 0.00%

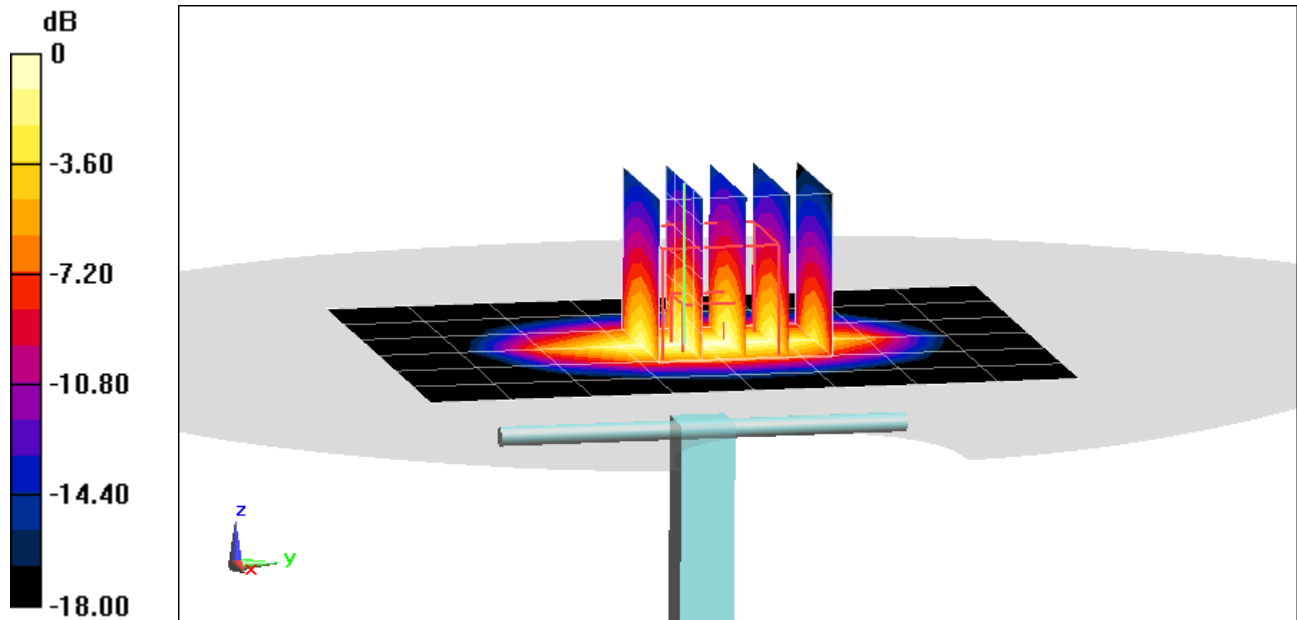

0 dB = 5.72 W/kg = 7.57 dBW/kg

# PCTEST ENGINEERING LABORATORY, INC.

**DUT: Dipole 1900 MHz; Type: D1900V2; Serial: 5d148**

Communication System: UID 0, CW; Frequency: 1900 MHz; Duty Cycle: 1:1  
Medium: 1900 Head Medium parameters used (interpolated):  
 $f = 1900 \text{ MHz}$ ;  $\sigma = 1.444 \text{ S/m}$ ;  $\epsilon_r = 39.801$ ;  $\rho = 1000 \text{ kg/m}^3$   
Phantom section: Flat Section; Space: 1.0 cm

Test Date: 07-22-2019; Ambient Temp: 21.6°C; Tissue Temp: 21.3°C

Probe: EX3DV4 - SN7409; ConvF(8.01, 8.01, 8.01) @ 1900 MHz; Calibrated: 6/19/2019  
Sensor-Surface: 1.4mm (Mechanical Surface Detection)  
Electronics: DAE4 Sn1334; Calibrated: 6/20/2019  
Phantom: Front; Type: QD 000 P40 CD; Serial: 1686  
Measurement SW: DASY52, Version 52.10 (2);SEMCAD X Version 14.6.12 (7470)

## 1900 MHz System Verification at 20.0 dBm (100 mW)

**Area Scan (7x11x1):** Measurement grid: dx=15mm, dy=15mm  
**Zoom Scan (5x5x7)/Cube 0:** Measurement grid: dx=8mm, dy=8mm, dz=5mm  
Peak SAR (extrapolated) = 8.07 W/kg  
**SAR(1 g) = 4.13 W/kg**  
Deviation(1 g) = 5.63%

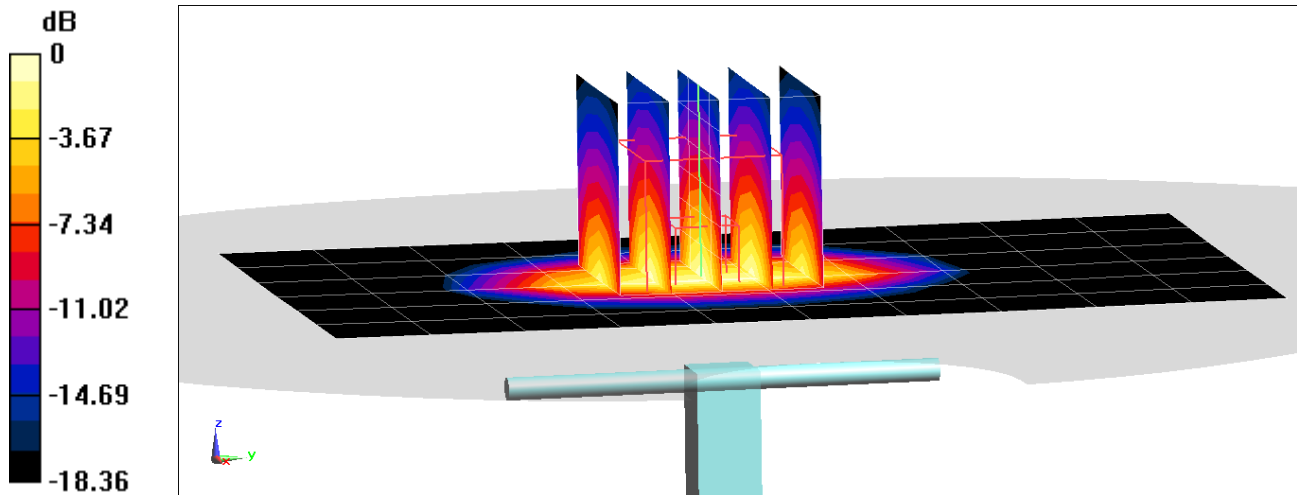

0 dB = 6.65 W/kg = 8.23 dBW/kg

# PCTEST ENGINEERING LABORATORY, INC.

**DUT: Dipole 1900 MHz; Type: D1900V2; Serial: 5d080**

Communication System: UID 0, CW; Frequency: 1900 MHz; Duty Cycle: 1:1  
Medium: 1900 Head; Medium parameters used (interpolated):  
 $f = 1900$  MHz;  $\sigma = 1.424$  S/m;  $\epsilon_r = 39.483$ ;  $\rho = 1000$  kg/m<sup>3</sup>  
Phantom section: Flat Section; Space: 1.0 cm

Test Date: 07-25-2019; Ambient Temp: 21.2°C; Tissue Temp: 20.1°C

Probe: EX3DV4 - SN7406; ConvF(8.18, 8.18, 8.18) @ 1900 MHz; Calibrated: 5/16/2019  
Sensor-Surface: 1.4mm (Mechanical Surface Detection)  
Electronics: DAE4 Sn859; Calibrated: 5/8/2019  
Phantom: Twin-SAM V5.0 Right 20; Type: QD 000 P40 CD; Serial: 1759  
Measurement SW: DASY52, Version 52.10 (2); SEMCAD X Version 14.6.12 (7470)

## 1900 MHz System Verification at 20.0 dBm (100 mW)

**Area Scan (7x11x1):** Measurement grid: dx=15mm, dy=15mm  
**Zoom Scan (5x5x7)/Cube 0:** Measurement grid: dx=8mm, dy=8mm, dz=5mm  
Peak SAR (extrapolated) = 8.19 W/kg  
**SAR(1 g) = 4.27 W/kg**  
Deviation(1 g) = 7.29%

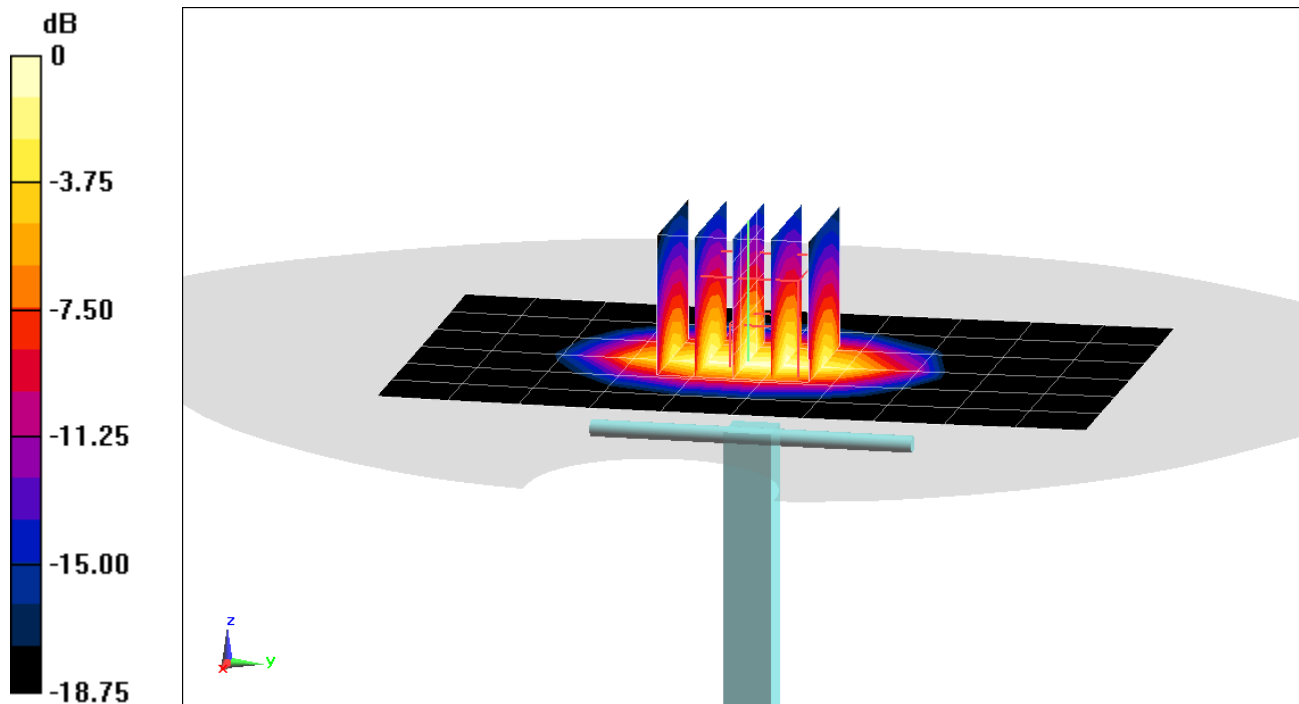

0 dB = 6.74 W/kg = 8.29 dBW/kg

# PCTEST ENGINEERING LABORATORY, INC.

**DUT: Dipole 1900 MHz; Type: D1900V2; Serial: 5d080**

Communication System: UID 0, CW; Frequency: 1900 MHz; Duty Cycle: 1:1

Medium: 1900 Head Medium parameters used (interpolated):

$f = 1900$  MHz;  $\sigma = 1.433$  S/m;  $\epsilon_r = 41.422$ ;  $\rho = 1000$  kg/m<sup>3</sup>

Phantom section: Flat Section; Space: 1.0 cm

Test Date: 08-06-2019; Ambient Temp: 23.2°C; Tissue Temp: 22.6°C

Probe: EX3DV4 - SN3914; ConvF(7.8, 7.8, 7.8) @ 1900 MHz; Calibrated: 2/19/2019

Sensor-Surface: 1.4mm (Mechanical Surface Detection)

Electronics: DAE4 Sn1272; Calibrated: 2/14/2019

Phantom: Twin-SAM V5.0 Left 30; Type: QD 000 P40 CD; Serial: 1687

Measurement SW: DASY52, Version 52.10 (2);SEMCAD X Version 14.6.12 (7470)

## 1900 MHz System Verification at 20.0 dBm (100 mW)

**Area Scan (7x11x1):** Measurement grid: dx=15mm, dy=15mm

**Zoom Scan (5x5x7)/Cube 0:** Measurement grid: dx=8mm, dy=8mm, dz=5mm

Peak SAR (extrapolated) = 7.95 W/kg

**SAR(1 g) = 4.21 W/kg**

Deviation(1 g) = 5.78%

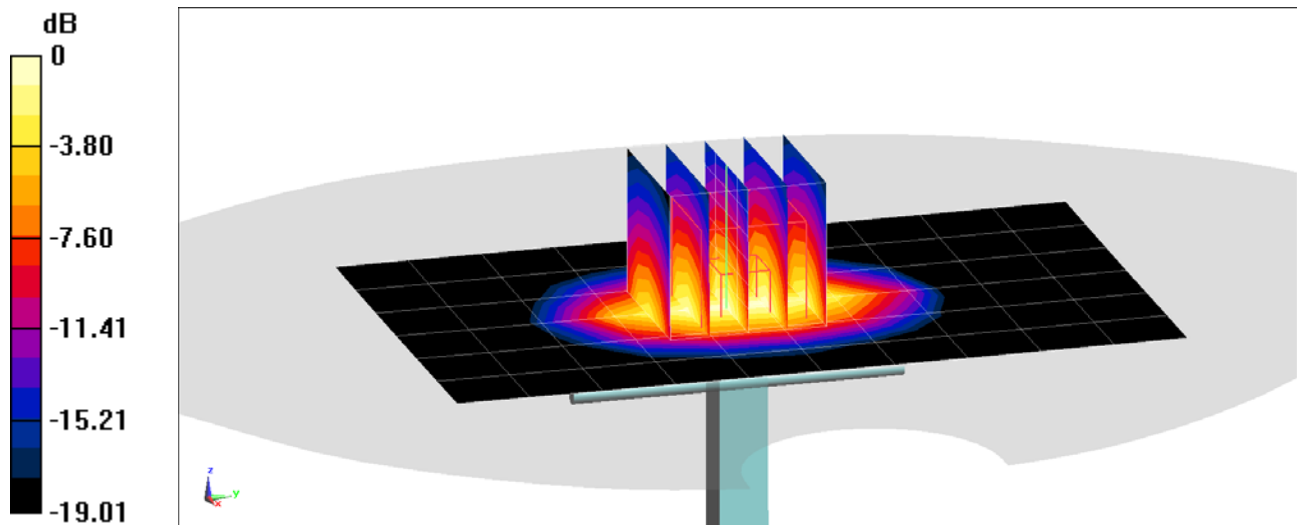

0 dB = 6.59 W/kg = 8.19 dBW/kg

# PCTEST ENGINEERING LABORATORY, INC.

**DUT: Dipole 2450 MHz; Type: D2450V2; Serial: 797**

Communication System: UID 0, CW; Frequency: 2450 MHz; Duty Cycle: 1:1

Medium: 2450 Head Medium parameters used:

$f = 2450$  MHz;  $\sigma = 1.787$  S/m;  $\epsilon_r = 37.912$ ;  $\rho = 1000$  kg/m<sup>3</sup>

Phantom section: Flat Section; Space: 1.0 cm

Test Date: 07-26-2019; Ambient Temp: 21.6°C; Tissue Temp: 21.3°C

Probe: EX3DV4 - SN3589; ConvF(6.46, 6.46, 6.46) @ 2450 MHz; Calibrated: 1/25/2019

Sensor-Surface: 1.4mm (Mechanical Surface Detection)

Electronics: DAE4 Sn1450; Calibrated: 8/22/2018

Phantom: Twin-SAM V5.0 (30); Type: QD 000 P40 CD; Serial: 1647

Measurement SW: DASY52, Version 52.10 (2); SEMCAD X Version 14.6.12 (7470)

## 2450 MHz System Verification at 20.0 dBm (100 mW)

**Area Scan (8x9x1):** Measurement grid: dx=12mm, dy=12mm

**Zoom Scan (7x7x7)/Cube 0:** Measurement grid: dx=5mm, dy=5mm, dz=5mm

Peak SAR (extrapolated) = 11.4 W/kg

**SAR(1 g) = 5.3 W/kg**

Deviation(1 g) = 0.57%

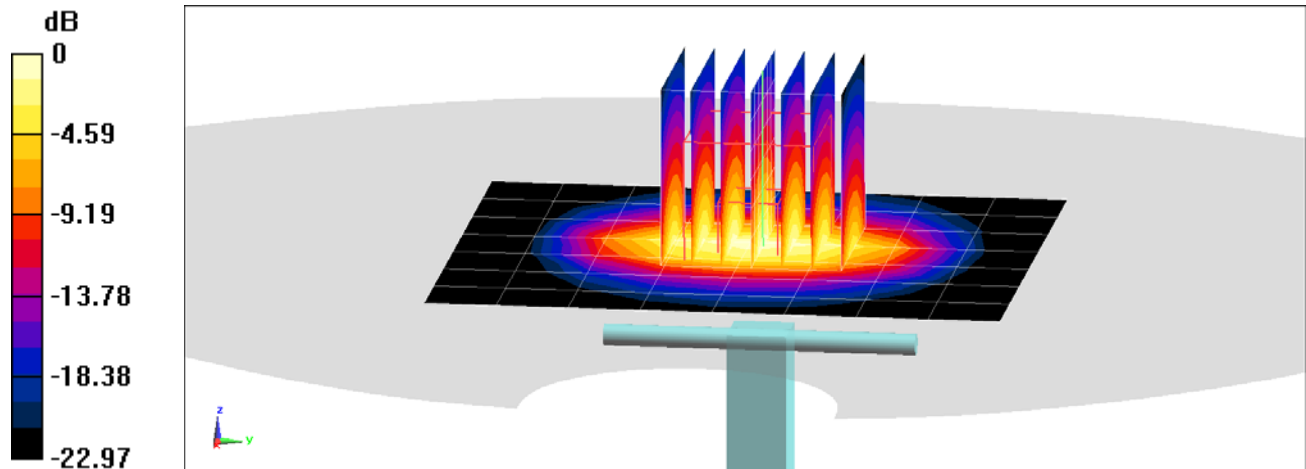

0 dB = 9.03 W/kg = 9.56 dBW/kg

# PCTEST ENGINEERING LABORATORY, INC.

**DUT: Dipole 2450 MHz; Type: D2450V2; Serial: 797**

Communication System: UID 0, CW; Frequency: 2450 MHz; Duty Cycle: 1:1

Medium: 2450 Head Medium parameters used:

$f = 2450$  MHz;  $\sigma = 1.802$  S/m;  $\epsilon_r = 37.944$ ;  $\rho = 1000$  kg/m<sup>3</sup>

Phantom section: Flat Section; Space: 1.0 cm

Test Date: 08-07-2019; Ambient Temp: 23.8°C; Tissue Temp: 21.7°C

Probe: EX3DV4 - SN7547; ConvF(7.17, 7.17, 7.17) @ 2450 MHz; Calibrated: 7/15/2019

Sensor-Surface: 1.4mm (Mechanical Surface Detection)

Electronics: DAE4 Sn1323; Calibrated: 7/11/2019

Phantom: Twin-SAM V5.0 (30); Type: QD 000 P40 CD; Serial: 1647

Measurement SW: DASY52, Version 52.10 (2); SEMCAD X Version 14.6.12 (7470)

## 2450 MHz System Verification at 20.0 dBm (100 mW)

**Area Scan (8x9x1):** Measurement grid: dx=12mm, dy=12mm

**Zoom Scan (7x7x7)/Cube 0:** Measurement grid: dx=5mm, dy=5mm, dz=5mm

Peak SAR (extrapolated) = 11.6 W/kg

**SAR(1 g) = 5.62 W/kg**

Deviation(1 g) = 6.64%

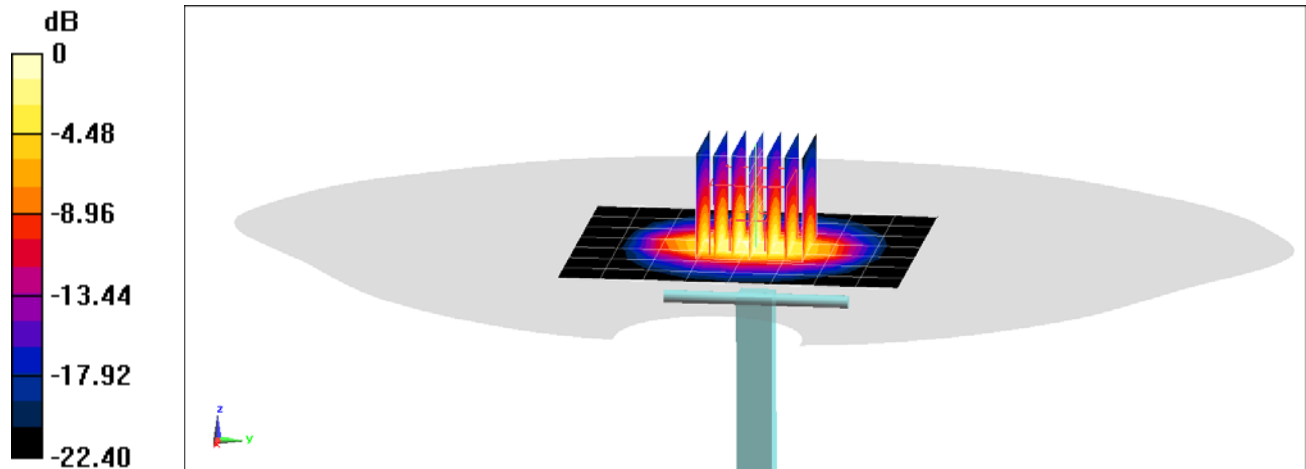

# PCTEST ENGINEERING LABORATORY, INC.

**DUT: Dipole 2600 MHz; Type: D2600V2; Serial: 1126**

Communication System: UID 0, CW; Frequency: 2600 MHz; Duty Cycle: 1:1

Medium: 2450 Head Medium parameters used:

$f = 2600 \text{ MHz}$ ;  $\sigma = 1.941 \text{ S/m}$ ;  $\epsilon_r = 37.38$ ;  $\rho = 1000 \text{ kg/m}^3$

Phantom section: Flat Section; Space: 1.0 cm

Test Date: 07-23-2019; Ambient Temp: 22.1°C; Tissue Temp: 21.0°C

Probe: EX3DV4 - SN3589; ConvF(6.25, 6.25, 6.25) @ 2600 MHz; Calibrated: 1/25/2019

Sensor-Surface: 1.4mm (Mechanical Surface Detection)

Electronics: DAE4 Sn1450; Calibrated: 8/22/2018

Phantom: Twin-SAM V5.0 (30); Type: QD 000 P40 CD; Serial: 1647

Measurement SW: DASY52, Version 52.10 (2); SEMCAD X Version 14.6.12 (7470)

## 2600 MHz System Verification at 20.0 dBm (100 mW)

**Area Scan (8x9x1):** Measurement grid: dx=12mm, dy=12mm

**Zoom Scan (7x7x7)/Cube 0:** Measurement grid: dx=5mm, dy=5mm, dz=5mm

Peak SAR (extrapolated) = 12.5 W/kg

**SAR(1 g) = 5.69 W/kg**

Deviation(1 g) = 4.40%

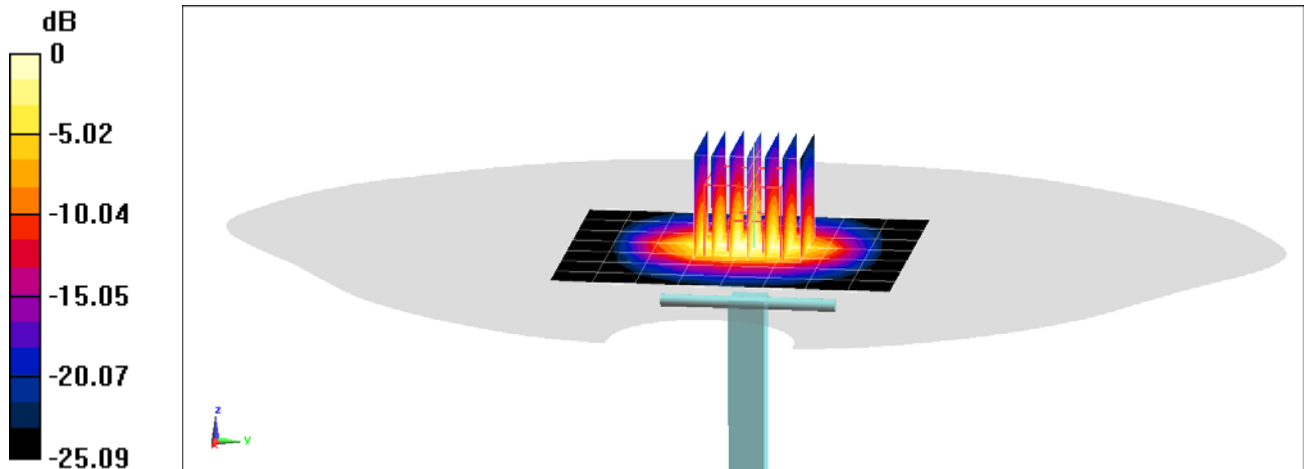

0 dB = 9.75 W/kg = 9.89 dBW/kg

# PCTEST ENGINEERING LABORATORY, INC.

**DUT: Dipole 750 MHz; Type: D750V3; Serial: 1003**

Communication System: UID 0, CW; Frequency: 750 MHz; Duty Cycle: 1:1  
Medium: 750 Body Medium parameters used (interpolated):  
 $f = 750 \text{ MHz}$ ;  $\sigma = 0.941 \text{ S/m}$ ;  $\epsilon_r = 56.074$ ;  $\rho = 1000 \text{ kg/m}^3$   
Phantom section: Flat Section; Space: 1.5 cm

Test Date: 07-23-2019; Ambient Temp: 23.2°C; Tissue Temp: 22.7°C

Probe: EX3DV4 - SN7409; ConvF(9.96, 9.96, 9.96) @ 750 MHz; Calibrated: 6/19/2019  
Sensor-Surface: 1.4mm (Mechanical Surface Detection)  
Electronics: DAE4 Sn1334; Calibrated: 6/20/2019  
Phantom: SAM Left; Type: QD000P40CA; Serial: TP:82355  
Measurement SW: DASY52, Version 52.10 (2);SEMCAD X Version 14.6.12 (7470)

## 750 MHz System Verification at 23.0 dBm (200 mW)

**Area Scan (7x15x1):** Measurement grid: dx=15mm, dy=15mm  
**Zoom Scan (5x5x7)/Cube 0:** Measurement grid: dx=8mm, dy=8mm, dz=5mm  
Peak SAR (extrapolated) = 2.60 W/kg  
**SAR(1 g) = 1.7 W/kg**  
Deviation(1 g) = -0.93%

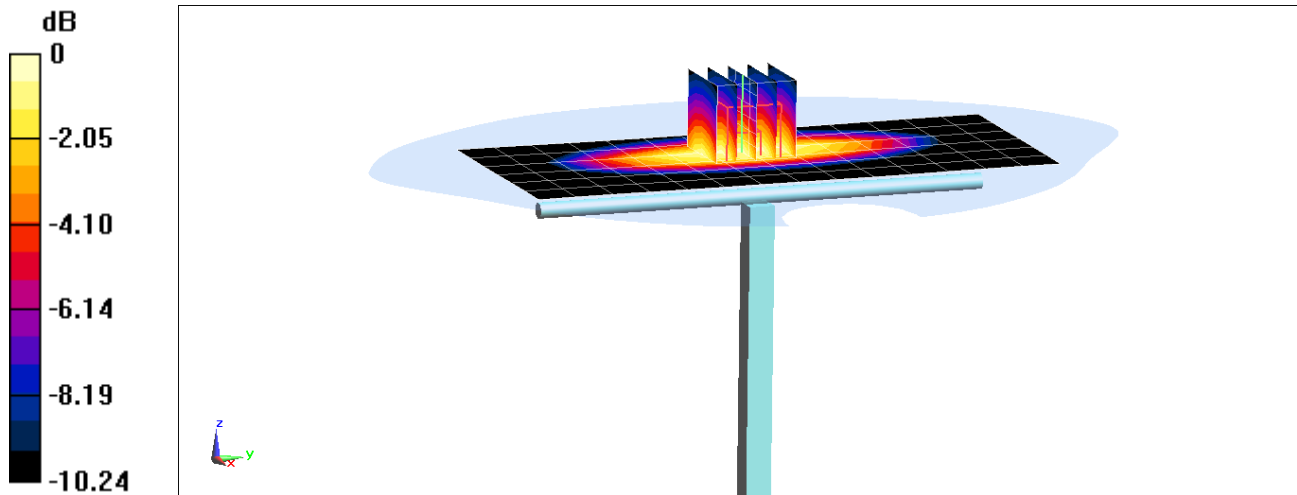

0 dB = 2.29 W/kg = 3.60 dBW/kg



# PCTEST ENGINEERING LABORATORY, INC.

**DUT: Dipole 835 MHz; Type: D835V2; Serial: 4d047**

Communication System: UID 0, CW; Frequency: 835 MHz; Duty Cycle: 1:1

Medium: 835 Body Medium parameters used:

$f = 835 \text{ MHz}$ ;  $\sigma = 0.959 \text{ S/m}$ ;  $\epsilon_r = 54.297$ ;  $\rho = 1000 \text{ kg/m}^3$

Phantom section: Flat Section; Space: 1.5 cm

Test Date: 07-25-2019; Ambient Temp: 20.5°C; Tissue Temp: 20.6°C

Probe: EX3DV4 - SN7538; ConvF(9.85, 9.85, 9.85) @ 835 MHz; Calibrated: 5/16/2019

Sensor-Surface: 1.4mm (Mechanical Surface Detection)

Electronics: DAE4 Sn728; Calibrated: 5/8/2019

Phantom: Left Twin-SAM V5.0 30; Type: QD 000 P40 CD; Serial: 1792

Measurement SW: DASY52, Version 52.10 (2); SEMCAD X Version 14.6.12 (7470)

## 835 MHz System Verification at 23.0 dBm (200 mW)

**Area Scan (7x14x1):** Measurement grid: dx=15mm, dy=15mm

**Zoom Scan (5x5x7)/Cube 0:** Measurement grid: dx=8mm, dy=8mm, dz=5mm

Peak SAR (extrapolated) = 3.22 W/kg

**SAR(1 g) = 2.02 W/kg**

Deviation(1 g) = 6.65%

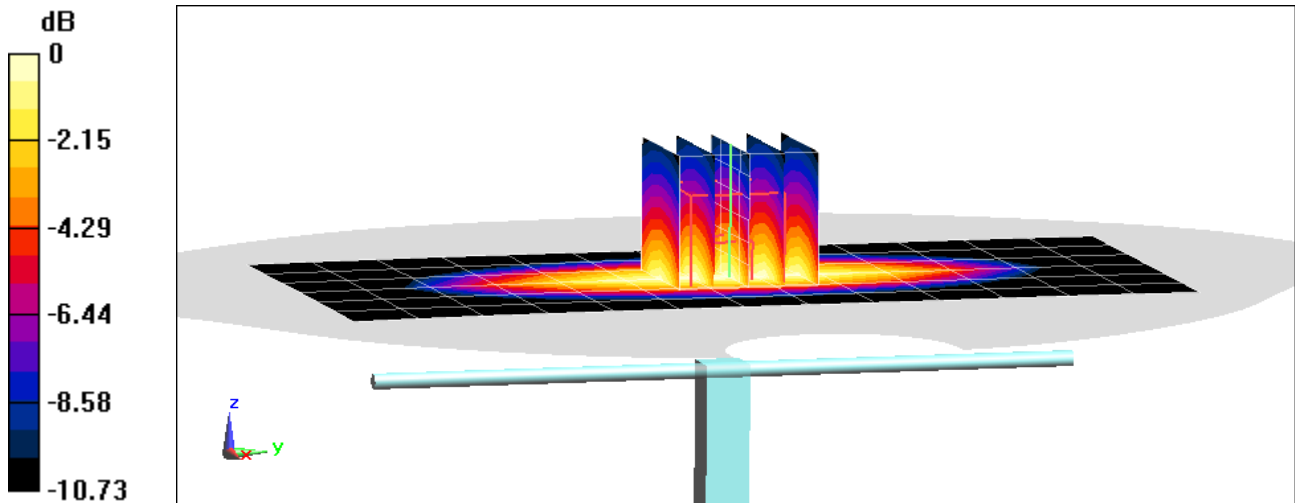

0 dB = 2.76 W/kg = 4.41 dBW/kg

# PCTEST ENGINEERING LABORATORY, INC.

**DUT: Dipole 835 MHz; Type: D835V2; Serial: 4d047**

Communication System: UID 0, CW; Frequency: 835 MHz; Duty Cycle: 1:1

Medium: 835 Body Medium parameters used:

$f = 835 \text{ MHz}$ ;  $\sigma = 1.001 \text{ S/m}$ ;  $\epsilon_r = 53.721$ ;  $\rho = 1000 \text{ kg/m}^3$

Phantom section: Flat Section; Space: 1.5 cm

Test Date: 07-29-2019; Ambient Temp: 20.5°C; Tissue Temp: 20.6°C

Probe: EX3DV4 - SN7538; ConvF(9.85, 9.85, 9.85) @ 835 MHz; Calibrated: 5/16/2019

Sensor-Surface: 1.4mm (Mechanical Surface Detection)

Electronics: DAE4 Sn728; Calibrated: 5/8/2019

Phantom: Left Twin-SAM V5.0 30; Type: QD 000 P40 CD; Serial: 1792

Measurement SW: DASY52, Version 52.10 (2);SEMCAD X Version 14.6.12 (7470)

## 835 MHz System Verification at 23.0 dBm (200 mW)

**Area Scan (7x14x1):** Measurement grid: dx=15mm, dy=15mm

**Zoom Scan (5x5x7)/Cube 0:** Measurement grid: dx=8mm, dy=8mm, dz=5mm

Peak SAR (extrapolated) = 3.26 W/kg

**SAR(1 g) = 2.06 W/kg**

Deviation(1 g) = 8.76%

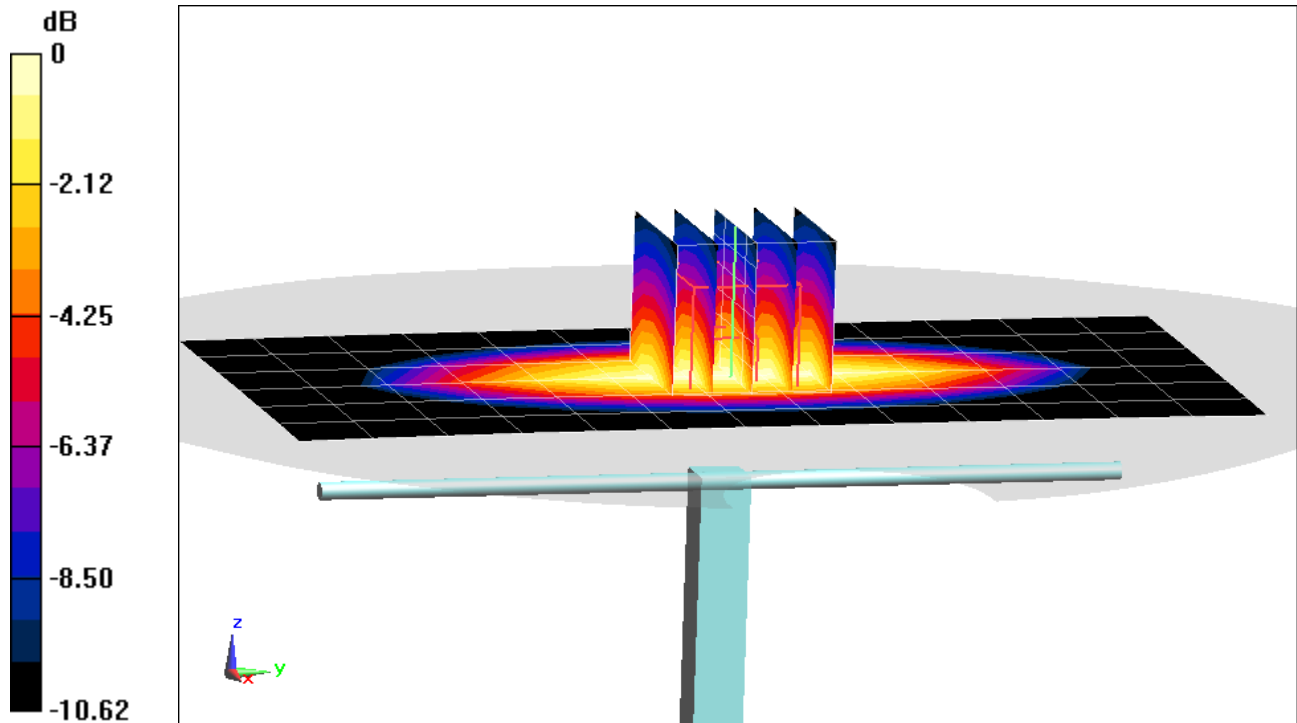

0 dB = 2.81 W/kg = 4.49 dBW/kg

# PCTEST ENGINEERING LABORATORY, INC.

**DUT: Dipole 835 MHz; Type: D835V2; Serial: 4d047**

Communication System: UID 0, CW; Frequency: 835 MHz; Duty Cycle: 1:1

Medium: 835 Body Medium parameters used:

$f = 835 \text{ MHz}$ ;  $\sigma = 1.009 \text{ S/m}$ ;  $\epsilon_r = 54.471$ ;  $\rho = 1000 \text{ kg/m}^3$

Phantom section: Flat Section; Space: 1.5 cm

Test Date: 07-31-2019; Ambient Temp: 20.5°C; Tissue Temp: 20.8°C

Probe: EX3DV4 - SN7538; ConvF(9.85, 9.85, 9.85) @ 835 MHz; Calibrated: 5/16/2019

Sensor-Surface: 1.4mm (Mechanical Surface Detection)

Electronics: DAE4 Sn728; Calibrated: 5/8/2019

Phantom: Left Twin-SAM V5.0 30; Type: QD 000 P40 CD; Serial: 1792

Measurement SW: DASY52, Version 52.10 (2);SEMCAD X Version 14.6.12 (7470)

## 835 MHz System Verification at 23.0 dBm (200 mW)

**Area Scan (7x14x1):** Measurement grid: dx=15mm, dy=15mm

**Zoom Scan (5x5x7)/Cube 0:** Measurement grid: dx=8mm, dy=8mm, dz=5mm

Peak SAR (extrapolated) = 3.10 W/kg

**SAR(1 g) = 2.02 W/kg**

Deviation(1 g) = 6.65%

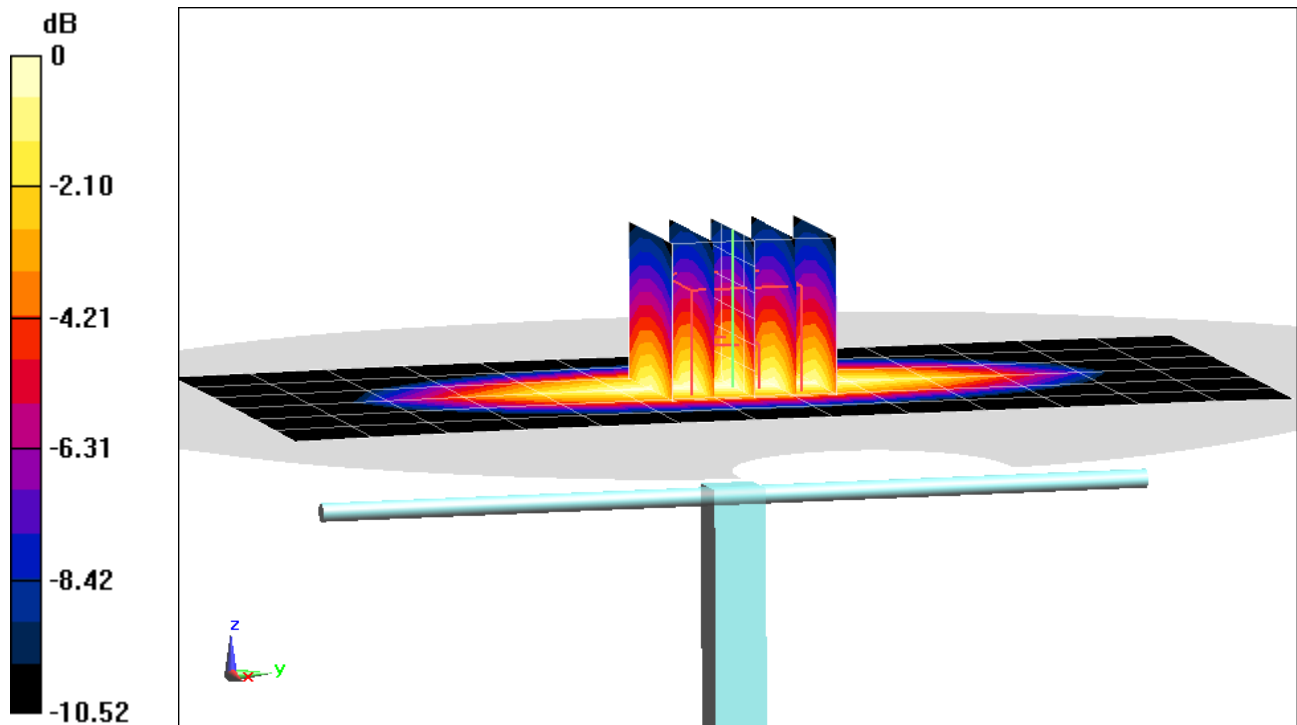

0 dB = 2.72 W/kg = 4.35 dBW/kg

# PCTEST ENGINEERING LABORATORY, INC.

**DUT: Dipole 1750 MHz; Type: D1750V2; Serial: 1150**

Communication System: UID 0, CW; Frequency: 1750 MHz; Duty Cycle: 1:1

Medium: 1750 Body; Medium parameters used:

$f = 1750 \text{ MHz}$ ;  $\sigma = 1.509 \text{ S/m}$ ;  $\epsilon_r = 51.575$ ;  $\rho = 1000 \text{ kg/m}^3$

Phantom section: Flat Section; Space: 1.0 cm

Test Date: 07-24-2019; Ambient Temp: 23.0°C; Tissue Temp: 21.3°C

Probe: EX3DV4 - SN7357; ConvF(8.26, 8.26, 8.26) @ 1750 MHz; Calibrated: 4/24/2019

Sensor-Surface: 1.4mm (Mechanical Surface Detection)

Electronics: DAE4 Sn1407; Calibrated: 4/18/2019

Phantom: Twin-SAM V4.0 Front Right; Type: QD 000 P40 CC; Serial: 1167

Measurement SW: DASY52, Version 52.10 (2);SEMCAD X Version 14.6.12 (7470)

## 1750 MHz System Verification at 20.0 dBm (100 mW)

**Area Scan (7x9x1):** Measurement grid: dx=15mm, dy=15mm

**Zoom Scan (5x5x7)/Cube 0:** Measurement grid: dx=8mm, dy=8mm, dz=5mm

Peak SAR (extrapolated) = 6.59 W/kg

**SAR(1 g) = 3.55 W/kg**

Deviation(1 g) = -3.01%

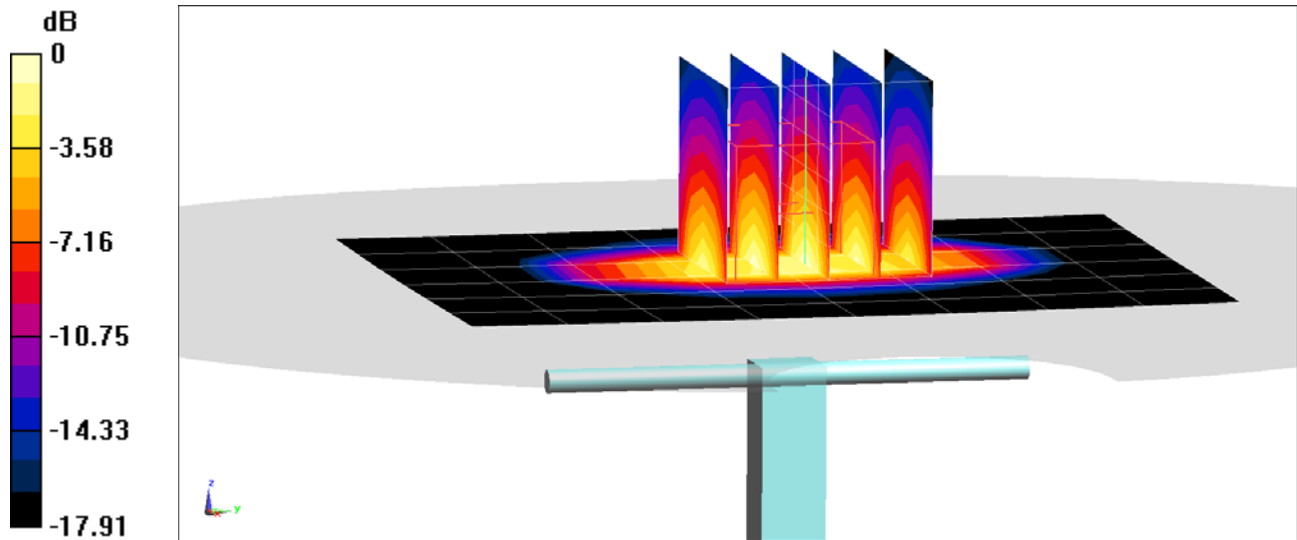

0 dB = 5.49 W/kg = 7.40 dBW/kg

# PCTEST ENGINEERING LABORATORY, INC.

**DUT: Dipole 1750 MHz; Type: D1750V2; Serial: 1148**

Communication System: UID 0, CW; Frequency: 1750 MHz; Duty Cycle: 1:1

Medium: 1750 Body Medium parameters used:

$f = 1750$  MHz;  $\sigma = 1.486$  S/m;  $\epsilon_r = 53.046$ ;  $\rho = 1000$  kg/m<sup>3</sup>

Phantom section: Flat Section; Space: 1.0 cm

Test Date: 08-07-2019; Ambient Temp: 22.0°C; Tissue Temp: 21.1°C

Probe: EX3DV4 - SN7409; ConvF(7.85, 7.85, 7.85) @ 1750 MHz; Calibrated: 6/19/2019

Sensor-Surface: 1.4mm (Mechanical Surface Detection)

Electronics: DAE4 Sn1334; Calibrated: 6/20/2019

Phantom: Front; Type: QD 000 P40 CD; Serial: 1686

Measurement SW: DASY52, Version 52.10 (2);SEMCAD X Version 14.6.12 (7470)

## 1750 MHz System Verification at 20.0 dBm (100 mW)

**Area Scan (7x9x1):** Measurement grid: dx=15mm, dy=15mm

**Zoom Scan (5x5x7)/Cube 0:** Measurement grid: dx=8mm, dy=8mm, dz=5mm

Peak SAR (extrapolated) = 7.60 W/kg

**SAR(1 g) = 3.99 W/kg**

Deviation(1 g) = 5.84%

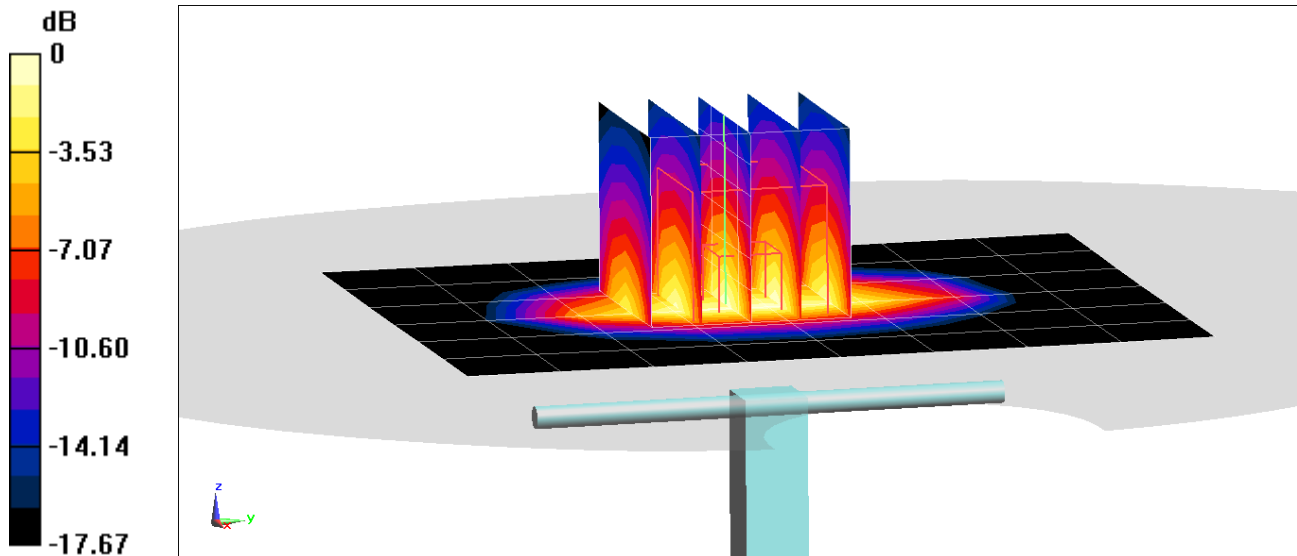

0 dB = 6.21 W/kg = 7.93 dBW/kg

# PCTEST ENGINEERING LABORATORY, INC.

**DUT: Dipole 1900 MHz; Type: D1900V2; Serial: 5d080**

Communication System: UID 0, CW; Frequency: 1900 MHz; Duty Cycle: 1:1

Medium: 1900 Body Medium parameters used (interpolated):

$f = 1900$  MHz;  $\sigma = 1.552$  S/m;  $\epsilon_r = 52.157$ ;  $\rho = 1000$  kg/m<sup>3</sup>

Phantom section: Flat Section; Space: 1.0 cm

Test Date: 07-29-2019; Ambient Temp: 20.7°C; Tissue Temp: 23.5°C

Probe: EX3DV4 - SN7488; ConvF(8.37, 8.37, 8.37) @ 1900 MHz; Calibrated: 1/24/2019

Sensor-Surface: 1.4mm (Mechanical Surface Detection)

Electronics: DAE4 Sn1530; Calibrated: 1/15/2019

Phantom: Twin-SAM V5.0; Type: QD 000 P40 CD; Serial: 1800

Measurement SW: DASY52, Version 52.10 (2); SEMCAD X Version 14.6.12 (7470)

## 1900 MHz System Verification at 20.0 dBm (100 mW)

**Area Scan (7x11x1):** Measurement grid: dx=15mm, dy=15mm

**Zoom Scan (5x5x7)/Cube 0:** Measurement grid: dx=8mm, dy=8mm, dz=5mm

Peak SAR (extrapolated) = 7.94 W/kg

**SAR(1 g) = 4.1 W/kg**

Deviation(1 g) = 4.59%

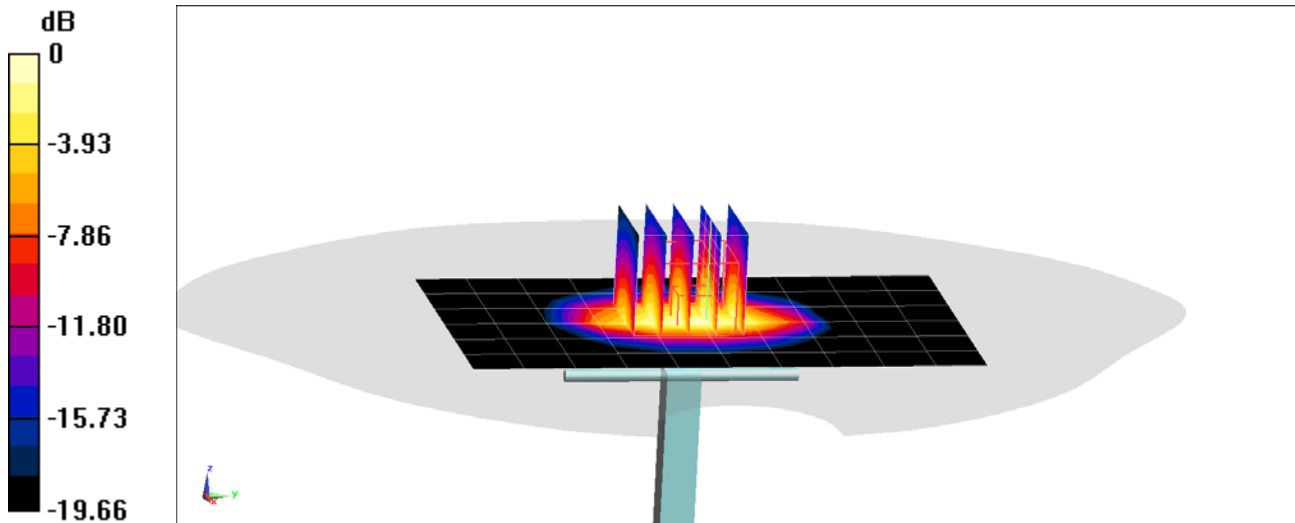

0 dB = 6.42 W/kg = 8.08 dBW/kg

# PCTEST ENGINEERING LABORATORY, INC.

**DUT: Dipole 1900 MHz; Type: D1900V2; Serial: 5d080**

Communication System: UID 0, CW; Frequency: 1900 MHz; Duty Cycle: 1:1

Medium: 1900 Body Medium parameters used (interpolated):

$f = 1900 \text{ MHz}$ ;  $\sigma = 1.558 \text{ S/m}$ ;  $\epsilon_r = 53.671$ ;  $\rho = 1000 \text{ kg/m}^3$

Phantom section: Flat Section; Space: 1.0 cm

Test Date: 07-31-2019; Ambient Temp: 20.5°C; Tissue Temp: 23.9°C

Probe: EX3DV4 - SN7488; ConvF(8.37, 8.37, 8.37) @ 1900 MHz; Calibrated: 1/24/2019

Sensor-Surface: 1.4mm (Mechanical Surface Detection)

Electronics: DAE4 Sn1530; Calibrated: 1/15/2019

Phantom: Twin-SAM V5.0; Type: QD 000 P40 CD; Serial: 1800

Measurement SW: DASY52, Version 52.10 (2);SEMCAD X Version 14.6.12 (7470)

## 1900 MHz System Verification at 20.0 dBm (100 mW)

**Area Scan (7x11x1):** Measurement grid: dx=15mm, dy=15mm

**Zoom Scan (5x5x7)/Cube 0:** Measurement grid: dx=8mm, dy=8mm, dz=5mm

Peak SAR (extrapolated) = 7.91 W/kg

**SAR(1 g) = 4.14 W/kg**

Deviation(1 g) = 5.61%

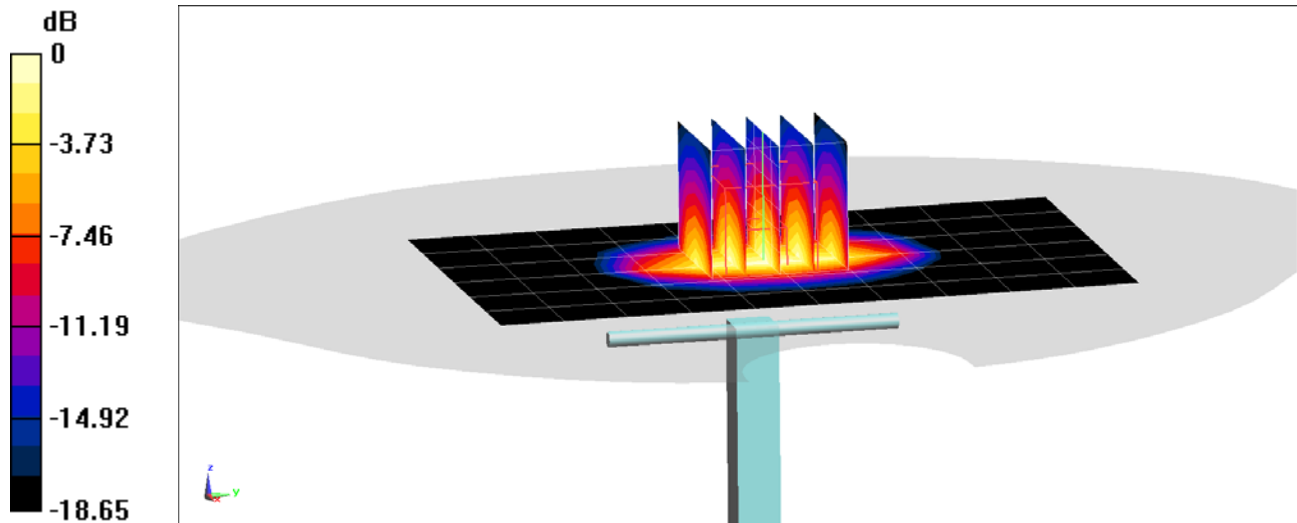

0 dB = 6.57 W/kg = 8.18 dBW/kg

# PCTEST ENGINEERING LABORATORY, INC.

**DUT: Dipole 1900 MHz; Type: D1900V2; Serial: 5d080**

Communication System: UID 0, CW; Frequency: 1900 MHz; Duty Cycle: 1:1  
Medium: 1900 Body Medium parameters used (interpolated):  
 $f = 1900 \text{ MHz}$ ;  $\sigma = 1.576 \text{ S/m}$ ;  $\epsilon_r = 52.113$ ;  $\rho = 1000 \text{ kg/m}^3$   
Phantom section: Flat Section; Space: 1.0 cm

Test Date: 08-12-2019; Ambient Temp: 20.0°C; Tissue Temp: 21.3°C

Probe: EX3DV4 - SN7488; ConvF(8.37, 8.37, 8.37) @ 1900 MHz; Calibrated: 1/24/2019  
Sensor-Surface: 1.4mm (Mechanical Surface Detection)  
Electronics: DAE4 Sn1530; Calibrated: 1/15/2019  
Phantom: Twin-SAM V5.0; Type: QD 000 P40 CD; Serial: 1800  
Measurement SW: DASY52, Version 52.10 (2); SEMCAD X Version 14.6.12 (7470)

## 1900 MHz System Verification at 20.0 dBm (100 mW)

**Area Scan (7x11x1):** Measurement grid: dx=15mm, dy=15mm  
**Zoom Scan (5x5x7)/Cube 0:** Measurement grid: dx=8mm, dy=8mm, dz=5mm  
Peak SAR (extrapolated) = 7.90 W/kg  
**SAR(1 g) = 4.16 W/kg**  
Deviation(1 g) = 6.12%

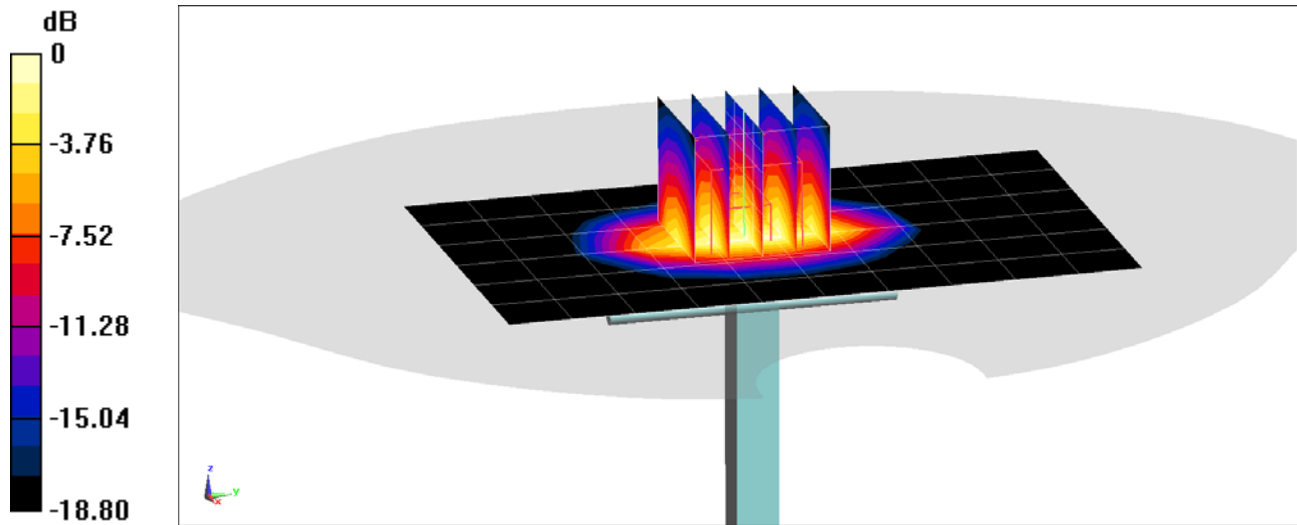

0 dB = 6.62 W/kg = 8.21 dBW/kg



# PCTEST ENGINEERING LABORATORY, INC.

**DUT: Dipole 2450 MHz; Type: D2450V2; Serial: 797**

Communication System: UID 0, CW; Frequency: 2450 MHz; Duty Cycle: 1:1

Medium: 2450 Body Medium parameters used:

$f = 2450$  MHz;  $\sigma = 2.047$  S/m;  $\epsilon_r = 51.621$ ;  $\rho = 1000$  kg/m<sup>3</sup>

Phantom section: Flat Section; Space: 1.0 cm

Test Date: 08-05-2019; Ambient Temp: 20.6°C; Tissue Temp: 21.0°C

Probe: EX3DV4 - SN7357; ConvF(7.59, 7.59, 7.59) @ 2450 MHz; Calibrated: 4/24/2019

Sensor-Surface: 1.4mm (Mechanical Surface Detection)

Electronics: DAE4 Sn1407; Calibrated: 4/18/2019

Phantom: Twin-SAM V4.0 Front Right; Type: QD 000 P40 CC; Serial: 1167

Measurement SW: DASY52, Version 52.10 (2); SEMCAD X Version 14.6.12 (7450)

## 2450 MHz System Verification at 20.0 dBm (100 mW)

**Area Scan (8x9x1):** Measurement grid: dx=12mm, dy=12mm

**Zoom Scan (7x7x7)/Cube 0:** Measurement grid: dx=5mm, dy=5mm, dz=5mm

Peak SAR (extrapolated) = 11.1 W/kg

**SAR(1 g) = 5.12 W/kg**

Deviation(1 g) = 0.20%

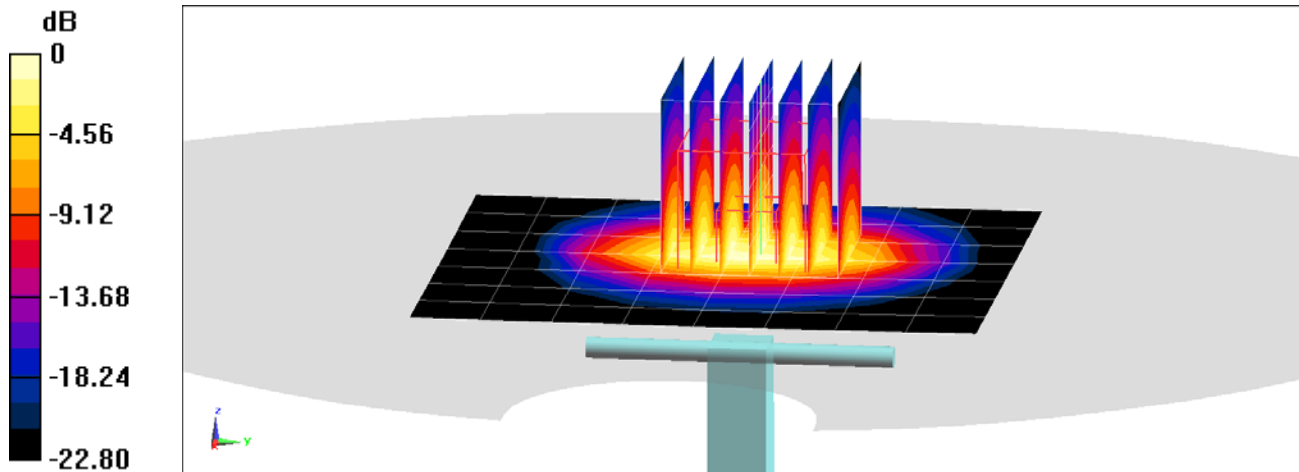

0 dB = 8.67 W/kg = 9.38 dBW/kg

# PCTEST ENGINEERING LABORATORY, INC.

**DUT: Dipole 2450 MHz; Type: D2450V2; Serial: 719**

Communication System: UID 0, CW; Frequency: 2450 MHz; Duty Cycle: 1:1

Medium: 2450 Body; Medium parameters used:

$f = 2450 \text{ MHz}$ ;  $\sigma = 1.94 \text{ S/m}$ ;  $\epsilon_r = 52.495$ ;  $\rho = 1000 \text{ kg/m}^3$

Phantom section: Flat Section; Space: 1.0 cm

Test Date: 08-07-2019; Ambient Temp: 24.9°C; Tissue Temp: 23.8°C

Probe: EX3DV4 - SN7357; ConvF(7.59, 7.59, 7.59) @ 2450 MHz; Calibrated: 4/24/2019

Sensor-Surface: 1.4mm (Mechanical Surface Detection)

Electronics: DAE4 Sn1407; Calibrated: 4/18/2019

Phantom: Twin-SAM V4.0 Front Right; Type: QD 000 P40 CC; Serial: 1167

Measurement SW: DASY52, Version 52.10 (2);SEMCAD X Version 14.6.12 (7470)

## 2450 MHz System Verification at 20.0 dBm (100 mW)

**Area Scan (8x9x1):** Measurement grid: dx=12mm, dy=12mm

**Zoom Scan (7x7x7)/Cube 0:** Measurement grid: dx=5mm, dy=5mm, dz=5mm

Peak SAR (extrapolated) = 11.0 W/kg

**SAR(1 g) = 5.4 W/kg**

Deviation(1 g) = 7.78%

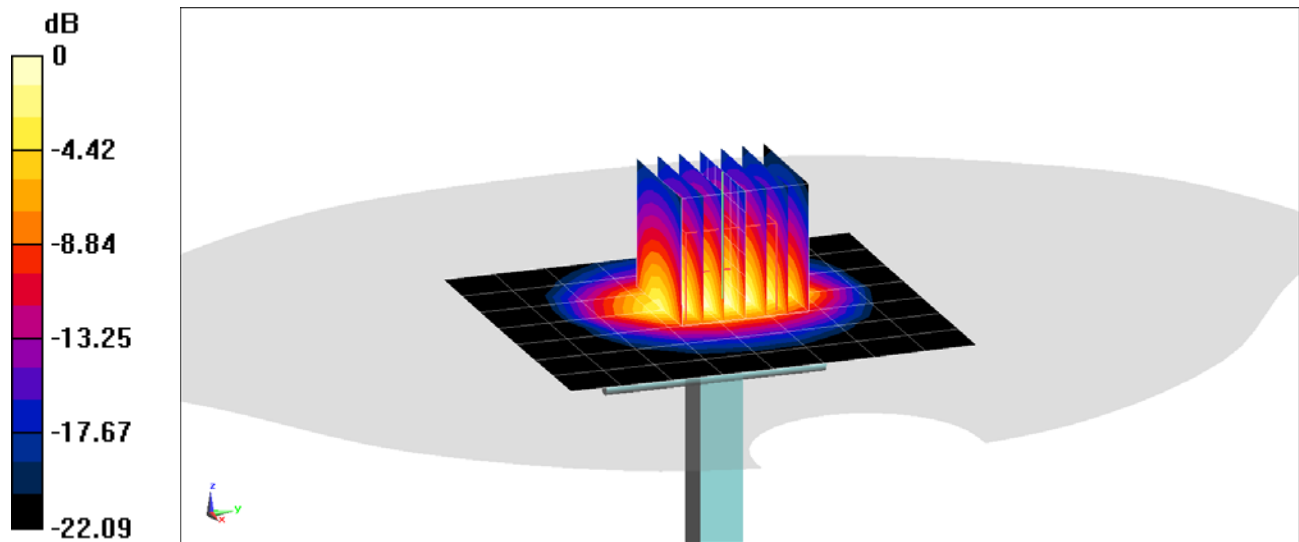

0 dB = 8.89 W/kg = 9.49 dBW/kg

# PCTEST ENGINEERING LABORATORY, INC.

**DUT: Dipole 2600 MHz; Type: D2600V2; Serial: 1004**

Communication System: UID 0, CW; Frequency: 2600 MHz; Duty Cycle: 1:1

Medium: 2450 Body; Medium parameters used:

$f = 2600 \text{ MHz}$ ;  $\sigma = 2.256 \text{ S/m}$ ;  $\epsilon_r = 51.02$ ;  $\rho = 1000 \text{ kg/m}^3$

Phantom section: Flat Section; Space: 1.0 cm

Test Date: 08-05-2019; Ambient Temp: 20.6°C; Tissue Temp: 21.0°C

Probe: EX3DV4 - SN7357; ConvF(7.39, 7.39, 7.39) @ 2600 MHz; Calibrated: 4/24/2019

Sensor-Surface: 1.4mm (Mechanical Surface Detection)

Electronics: DAE4 Sn1407; Calibrated: 4/18/2019

Phantom: Twin-SAM V4.0 Front Right; Type: QD 000 P40 CC; Serial: 1167

Measurement SW: DASY52, Version 52.10 (2);SEMCAD X Version 14.6.12 (7470)

## 2600 MHz System Verification at 20.0 dBm (100 mW)

**Area Scan (8x9x1):** Measurement grid: dx=12mm, dy=12mm

**Zoom Scan (7x7x7)/Cube 0:** Measurement grid: dx=5mm, dy=5mm, dz=5mm

Peak SAR (extrapolated) = 12.7 W/kg

**SAR(1 g) = 5.55 W/kg**

Deviation(1 g) = 1.28%

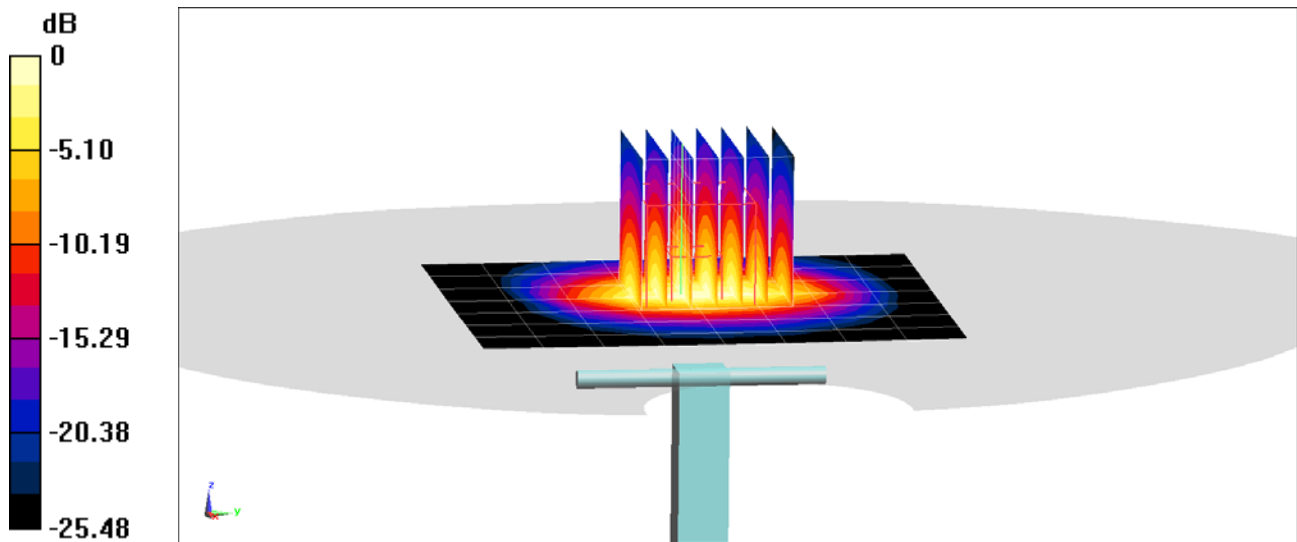

0 dB = 9.61 W/kg = 9.83 dBW/kg

## APPENDIX C: PROBE CALIBRATION



Accredited by the Swiss Accreditation Service (SAS)  
The Swiss Accreditation Service is one of the signatories to the EA  
Multilateral Agreement for the recognition of calibration certificates

Accreditation No.: **SCS 0108**

Client **PC Test**

Certificate No: **D750V3-1003\_Jan18**

**CALIBRATION CERTIFICATE**

Object **D750V3 - SN:1003**

Calibration procedure(s) **QA CAL-05.v9  
Calibration procedure for dipole validation kits above 700 MHz**

Calibration date: **January 15, 2018**

*BN ✓*  
*01-25-2018*  
*BN ✓*  
*02/06/2019*

This calibration certificate documents the traceability to national standards, which realize the physical units of measurements (SI).  
The measurements and the uncertainties with confidence probability are given on the following pages and are part of the certificate.

All calibrations have been conducted in the closed laboratory facility: environment temperature (22 ± 3)°C and humidity < 70%.

Calibration Equipment used (M&TE critical for calibration)

Primary Standards	ID #	Cal Date (Certificate No.)	Scheduled Calibration
Power meter NRP	SN: 104778	04-Apr-17 (No. 217-02521/02522)	Apr-18
Power sensor NRP-Z91	SN: 103244	04-Apr-17 (No. 217-02521)	Apr-18
Power sensor NRP-Z91	SN: 103245	04-Apr-17 (No. 217-02522)	Apr-18
Reference 20 dB Attenuator	SN: 5058 (20k)	07-Apr-17 (No. 217-02528)	Apr-18
Type-N mismatch combination	SN: 5047.2 / 06327	07-Apr-17 (No. 217-02529)	Apr-18
Reference Probe EX3DV4	SN: 7349	30-Dec-17 (No. EX3-7349_Dec17)	Dec-18
DAE4	SN: 601	26-Oct-17 (No. DAE4-601_Oct17)	Oct-18
Secondary Standards	ID #	Check Date (in house)	Scheduled Check
Power meter EPM-442A	SN: GB37480704	07-Oct-15 (in house check Oct-16)	In house check: Oct-18
Power sensor HP 8481A	SN: US37292783	07-Oct-15 (in house check Oct-16)	In house check: Oct-18
Power sensor HP 8481A	SN: MY41092317	07-Oct-15 (in house check Oct-16)	In house check: Oct-18
RF generator R&S SMT-06	SN: 100972	15-Jun-15 (in house check Oct-16)	In house check: Oct-18
Network Analyzer HP 8753E	SN: US37390585	18-Oct-01 (in house check Oct-17)	In house check: Oct-18

Calibrated by: **Lefi Klysner** Laboratory Technician  
Approved by: **Katja Pokovic** Technical Manager

Signature  
*Lefi Klysner*  
*Katja Pokovic*

Issued: January 15, 2018

This calibration certificate shall not be reproduced except in full without written approval of the laboratory.



Accredited by the Swiss Accreditation Service (SAS)

Accreditation No.: **SCS 0108**

The Swiss Accreditation Service is one of the signatories to the EA  
Multilateral Agreement for the recognition of calibration certificates

### Glossary:

TSL	tissue simulating liquid
ConvF	sensitivity in TSL / NORM x,y,z
N/A	not applicable or not measured

### Calibration is Performed According to the Following Standards:

- IEEE Std 1528-2013, "IEEE Recommended Practice for Determining the Peak Spatial-Averaged Specific Absorption Rate (SAR) in the Human Head from Wireless Communications Devices: Measurement Techniques", June 2013
- IEC 62209-1, "Measurement procedure for the assessment of Specific Absorption Rate (SAR) from hand-held and body-mounted devices used next to the ear (frequency range of 300 MHz to 6 GHz)", July 2016
- IEC 62209-2, "Procedure to determine the Specific Absorption Rate (SAR) for wireless communication devices used in close proximity to the human body (frequency range of 30 MHz to 6 GHz)", March 2010
- KDB 865664, "SAR Measurement Requirements for 100 MHz to 6 GHz"

### Additional Documentation:

- DASY4/5 System Handbook

### Methods Applied and Interpretation of Parameters:

- Measurement Conditions:** Further details are available from the Validation Report at the end of the certificate. All figures stated in the certificate are valid at the frequency indicated.
- Antenna Parameters with TSL:** The dipole is mounted with the spacer to position its feed point exactly below the center marking of the flat phantom section, with the arms oriented parallel to the body axis.
- Feed Point Impedance and Return Loss:** These parameters are measured with the dipole positioned under the liquid filled phantom. The impedance stated is transformed from the measurement at the SMA connector to the feed point. The Return Loss ensures low reflected power. No uncertainty required.
- Electrical Delay:** One-way delay between the SMA connector and the antenna feed point. No uncertainty required.
- SAR measured:** SAR measured at the stated antenna input power.
- SAR normalized:** SAR as measured, normalized to an input power of 1 W at the antenna connector.
- SAR for nominal TSL parameters:** The measured TSL parameters are used to calculate the nominal SAR result.

The reported uncertainty of measurement is stated as the standard uncertainty of measurement multiplied by the coverage factor  $k=2$ , which for a normal distribution corresponds to a coverage probability of approximately 95%.

## Measurement Conditions

DASY system configuration, as far as not given on page 1.

<b>DASY Version</b>	DASY5	V52.10.0
<b>Extrapolation</b>	Advanced Extrapolation	
<b>Phantom</b>	Modular Flat Phantom	
<b>Distance Dipole Center - TSL</b>	15 mm	with Spacer
<b>Zoom Scan Resolution</b>	dx, dy, dz = 5.0 mm	
<b>Frequency</b>	750 MHz $\pm$ 1 MHz	

## Head TSL parameters

The following parameters and calculations were applied.

	Temperature	Permittivity	Conductivity
<b>Nominal Head TSL parameters</b>	22.0 °C	41.9	0.89 mho/m
<b>Measured Head TSL parameters</b>	(22.0 $\pm$ 0.2) °C	40.9 $\pm$ 6 %	0.90 mho/m $\pm$ 6 %
<b>Head TSL temperature change during test</b>	< 0.5 °C	----	----

## SAR result with Head TSL

<b>SAR averaged over 1 cm<sup>3</sup> (1 g) of Head TSL</b>	Condition	
SAR measured	250 mW input power	2.10 W/kg
SAR for nominal Head TSL parameters	normalized to 1W	<b>8.28 W/kg <math>\pm</math> 17.0 % (k=2)</b>

<b>SAR averaged over 10 cm<sup>3</sup> (10 g) of Head TSL</b>	condition	
SAR measured	250 mW input power	1.37 W/kg
SAR for nominal Head TSL parameters	normalized to 1W	<b>5.42 W/kg <math>\pm</math> 16.5 % (k=2)</b>

## Body TSL parameters

The following parameters and calculations were applied.

	Temperature	Permittivity	Conductivity
<b>Nominal Body TSL parameters</b>	22.0 °C	55.5	0.96 mho/m
<b>Measured Body TSL parameters</b>	(22.0 $\pm$ 0.2) °C	55.0 $\pm$ 6 %	0.96 mho/m $\pm$ 6 %
<b>Body TSL temperature change during test</b>	< 0.5 °C	----	----

## SAR result with Body TSL

<b>SAR averaged over 1 cm<sup>3</sup> (1 g) of Body TSL</b>	Condition	
SAR measured	250 mW input power	2.15 W/kg
SAR for nominal Body TSL parameters	normalized to 1W	<b>8.58 W/kg <math>\pm</math> 17.0 % (k=2)</b>

<b>SAR averaged over 10 cm<sup>3</sup> (10 g) of Body TSL</b>	condition	
SAR measured	250 mW input power	1.43 W/kg
SAR for nominal Body TSL parameters	normalized to 1W	<b>5.71 W/kg <math>\pm</math> 16.5 % (k=2)</b>

## Appendix (Additional assessments outside the scope of SCS 0108)

### Antenna Parameters with Head TSL

Impedance, transformed to feed point	53.8 $\Omega$ - 2.1 j $\Omega$
Return Loss	- 27.6 dB

### Antenna Parameters with Body TSL

Impedance, transformed to feed point	49.2 $\Omega$ - 6.2 j $\Omega$
Return Loss	- 24.0 dB

### General Antenna Parameters and Design

Electrical Delay (one direction)	1.043 ns
----------------------------------	----------

After long term use with 100W radiated power, only a slight warming of the dipole near the feedpoint can be measured.

The dipole is made of standard semirigid coaxial cable. The center conductor of the feeding line is directly connected to the second arm of the dipole. The antenna is therefore short-circuited for DC-signals. On some of the dipoles, small end caps are added to the dipole arms in order to improve matching when loaded according to the position as explained in the "Measurement Conditions" paragraph. The SAR data are not affected by this change. The overall dipole length is still according to the Standard.

No excessive force must be applied to the dipole arms, because they might bend or the soldered connections near the feedpoint may be damaged.

### Additional EUT Data

Manufactured by	SPEAG
Manufactured on	January 21, 2009



## Appendix (Additional assessments outside the scope of SCS 0108)

### Measurement Conditions

DASY system configuration, as far as not given on page 1 and 3.

Phantom	SAM Head Phantom	For usage with cSAR3DV2-R/L
---------	------------------	-----------------------------

### SAR result with SAM Head (Top)

SAR averaged over 1 cm <sup>3</sup> (1 g) of Head TSL	Condition	
SAR measured	250 mW input power	1.98 W/kg
SAR for nominal Head TSL parameters	normalized to 1W	7.94 W/kg ± 17.5 % (k=2)

SAR averaged over 10 cm <sup>3</sup> (10 g) of Head TSL	condition	
SAR measured	250 mW input power	1.33 W/kg
SAR for nominal Head TSL parameters	normalized to 1W	5.32 W/kg ± 16.9 % (k=2)

### SAR result with SAM Head (Mouth)

SAR averaged over 1 cm <sup>3</sup> (1 g) of Head TSL	Condition	
SAR measured	250 mW input power	2.05 W/kg
SAR for nominal Head TSL parameters	normalized to 1W	8.22 W/kg ± 17.5 % (k=2)

SAR averaged over 10 cm <sup>3</sup> (10 g) of Head TSL	condition	
SAR measured	250 mW input power	1.38 W/kg
SAR for nominal Head TSL parameters	normalized to 1W	5.52 W/kg ± 16.9 % (k=2)

### SAR result with SAM Head (Neck)

SAR averaged over 1 cm <sup>3</sup> (1 g) of Head TSL	Condition	
SAR measured	250 mW input power	2.01 W/kg
SAR for nominal Head TSL parameters	normalized to 1W	8.06 W/kg ± 17.5 % (k=2)

SAR averaged over 10 cm <sup>3</sup> (10 g) of Head TSL	condition	
SAR measured	250 mW input power	1.38 W/kg
SAR for nominal Head TSL parameters	normalized to 1W	5.52 W/kg ± 16.9 % (k=2)

### SAR result with SAM Head (Ear)

SAR averaged over 1 cm <sup>3</sup> (1 g) of Head TSL	Condition	
SAR measured	250 mW input power	1.67 W/kg
SAR for nominal Head TSL parameters	normalized to 1W	6.70 W/kg ± 17.5 % (k=2)

SAR averaged over 10 cm <sup>3</sup> (10 g) of Head TSL	condition	
SAR measured	250 mW input power	1.15 W/kg
SAR for nominal Head TSL parameters	normalized to 1W	4.60 W/kg ± 16.9 % (k=2)

# DASY5 Validation Report for Head TSL

Date: 12.01.2018

Test Laboratory: SPEAG, Zurich, Switzerland

**DUT: Dipole 750 MHz; Type: D750V3; Serial: D750V3 - SN:1003**

Communication System: UID 0 - CW; Frequency: 750 MHz

Medium parameters used:  $f = 750$  MHz;  $\sigma = 0.9$  S/m;  $\epsilon_r = 40.9$ ;  $\rho = 1000$  kg/m<sup>3</sup>

Phantom section: Flat Section

Measurement Standard: DASY5 (IEEE/IEC/ANSI C63.19-2011)

DASY52 Configuration:

- Probe: EX3DV4 - SN7349; ConvF(10.22, 10.22, 10.22); Calibrated: 30.12.2017;
- Sensor-Surface: 1.4mm (Mechanical Surface Detection)
- Electronics: DAE4 Sn601; Calibrated: 26.10.2017
- Phantom: Flat Phantom 4.9 (front); Type: QD 00L P49 AA; Serial: 1001
- DASY52 52.10.0(1446); SEMCAD X 14.6.10(7417)

## Dipole Calibration for Head Tissue/Pin=250 mW, d=15mm/Zoom Scan (7x7x7)/Cube 0:

Measurement grid: dx=5mm, dy=5mm, dz=5mm

Reference Value = 59.11 V/m; Power Drift = -0.04 dB

Peak SAR (extrapolated) = 3.15 W/kg

**SAR(1 g) = 2.1 W/kg; SAR(10 g) = 1.37 W/kg**

Maximum value of SAR (measured) = 2.80 W/kg

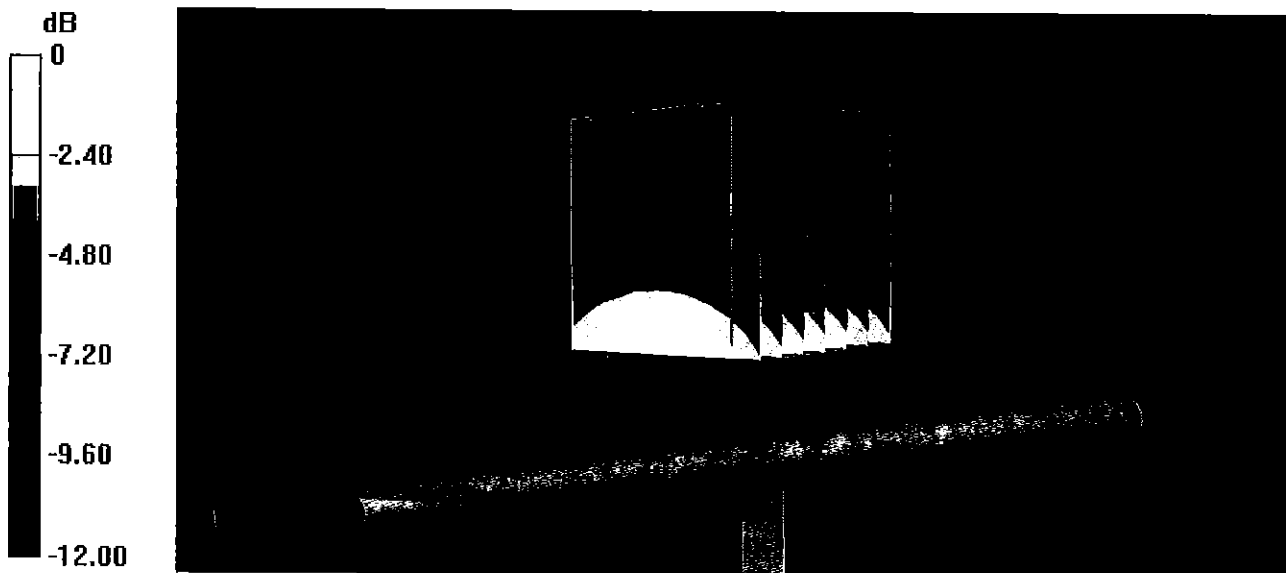

0 dB = 2.80 W/kg = 4.47 dBW/kg

# Impedance Measurement Plot for Head TSL

12 Jan 2018 13:14:07  
 CH1 S11 1 U FS 1: 53.754  $\Omega$  -2.0996  $\Omega$  101.07 pF 750.000 000 MHz

\*  
 Del  
 CA  
 Avg  
 16  
 Hld

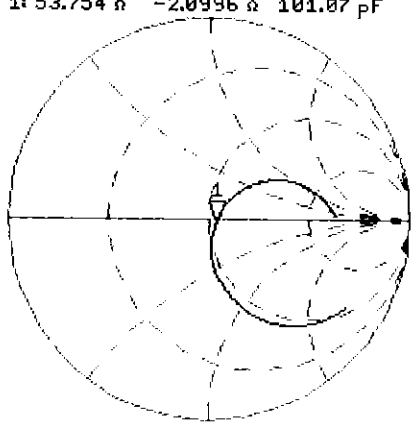

CH2 S11 LOG 5 dB/REF -20 dB 1:-27.643 dB 750.000 000 MHz

CA  
 Avg  
 16  
 Hld

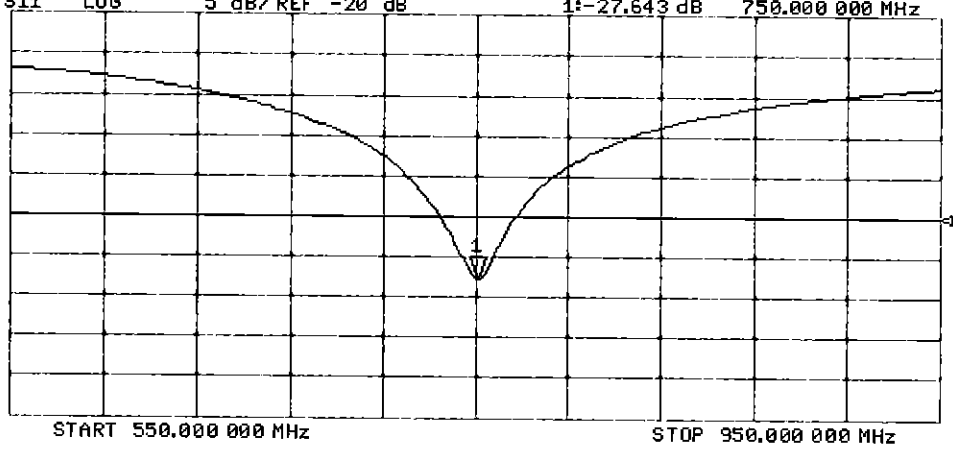

# DASY5 Validation Report for Body TSL

Date: 12.01.2018

Test Laboratory: SPEAG, Zurich, Switzerland

**DUT: Dipole 750 MHz; Type: D750V3; Serial: D750V3 - SN:1003**

Communication System: UID 0 - CW; Frequency: 750 MHz

Medium parameters used:  $f = 750$  MHz;  $\sigma = 0.96$  S/m;  $\epsilon_r = 55$ ;  $\rho = 1000$  kg/m<sup>3</sup>

Phantom section: Flat Section

Measurement Standard: DASY5 (IEEE/IEC/ANSI C63.19-2011)

DASY52 Configuration:

- Probe: EX3DV4 - SN7349; ConvF(10.19, 10.19, 10.19); Calibrated: 30.12.2017;
- Sensor-Surface: 1.4mm (Mechanical Surface Detection)
- Electronics: DAE4 Sn601; Calibrated: 26.10.2017
- Phantom: Flat Phantom 4.9 (Back); Type: QD 00R P49 AA; Serial: 1005
- DASY52 52.10.0(1446); SEMCAD X 14.6.10(7417)

## Dipole Calibration for Body Tissue/Pin=250 mW, d=15mm/Zoom Scan (7x8x7)/Cube 0:

Measurement grid: dx=5mm, dy=5mm, dz=5mm

Reference Value = 57.31 V/m; Power Drift = -0.01 dB

Peak SAR (extrapolated) = 3.17 W/kg

**SAR(1 g) = 2.15 W/kg; SAR(10 g) = 1.43 W/kg**

Maximum value of SAR (measured) = 2.83 W/kg

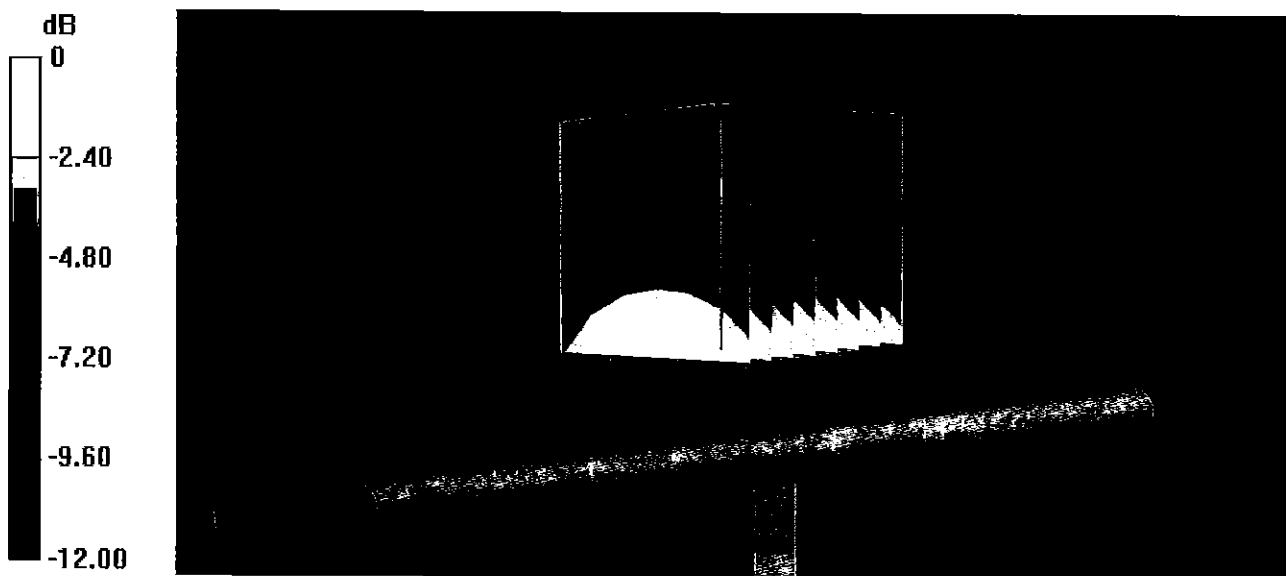

0 dB = 2.83 W/kg = 4.52 dBW/kg

# Impedance Measurement Plot for Body TSL

12 Jan 2018 13:13:21  
CH1 S11 1 U FS 1: 49.234  $\Omega$  -6.1934  $\Omega$  34.264 pF 750.000 000 MHz

\*  
De1

CA

Avg  
16

H1d

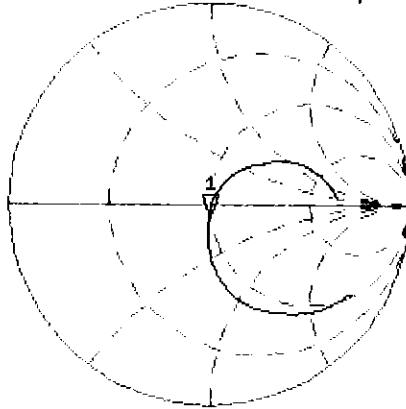

CH2 S11 LOG 5 dB/REF -20 dB 1: -24.047 dB 750.000 000 MHz

CA

Avg  
16

H1d

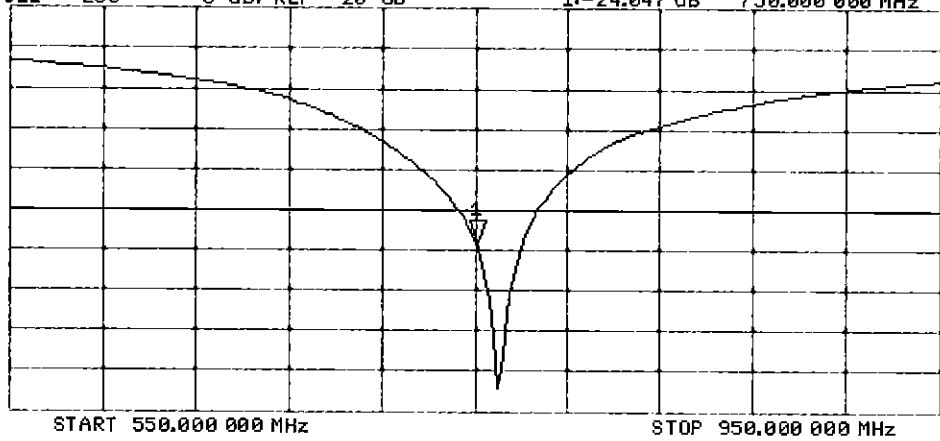

## DASY5 Validation Report for SAM Head

Date: 15.01.2018

Test Laboratory: SPEAG, Zurich, Switzerland

**DUT: Dipole 750 MHz; Type: D750V3; Serial: D750V3 - SN:1003**

Communication System: UID 0 - CW; Frequency: 750 MHz

Medium parameters used:  $f = 750$  MHz;  $\sigma = 0.9$  S/m;  $\epsilon_r = 44.2$ ;  $\rho = 1000$  kg/m<sup>3</sup>

Measurement Standard: DASY5 (IEEE/IEC/ANSI C63.19-2011)

DASY52 Configuration:

- Probe: EX3DV4 - SN7349; ConvF(10.22, 10.22, 10.22); Calibrated: 30.12.2017;
- Sensor-Surface: 1.4mm (Mechanical Surface Detection)
- Electronics: DAE4 Sn601; Calibrated: 26.10.2017
- Phantom: SAM Head
- DASY52 52.10.0(1446); SEMCAD X 14.6.10(7417)

**SAM Head/Top/Zoom Scan (7x7x7)/Cube 0:** Measurement grid: dx=5mm, dy=5mm, dz=5mm

Reference Value = 56.79 V/m; Power Drift = -0.01 dB

Peak SAR (extrapolated) = 2.89 W/kg

**SAR(1 g) = 1.98 W/kg; SAR(10 g) = 1.33 W/kg**

Maximum value of SAR (measured) = 2.58 W/kg

**SAM Head/Mouth/Zoom Scan (7x7x7)/Cube 0:** Measurement grid: dx=5mm, dy=5mm, dz=5mm

Reference Value = 56.85 V/m; Power Drift = -0.06 dB

Peak SAR (extrapolated) = 2.94 W/kg

**SAR(1 g) = 2.05 W/kg; SAR(10 g) = 1.38 W/kg**

Maximum value of SAR (measured) = 2.62 W/kg

**SAM Head/Neck/Zoom Scan (7x7x7)/Cube 0:** Measurement grid: dx=5mm, dy=5mm, dz=5mm

Reference Value = 56.29 V/m; Power Drift = 0.04 dB

Peak SAR (extrapolated) = 2.78 W/kg

**SAR(1 g) = 2.01 W/kg; SAR(10 g) = 1.38 W/kg**

Maximum value of SAR (measured) = 2.56 W/kg

**SAM Head/Ear/Zoom Scan (7x7x7)/Cube 0:** Measurement grid: dx=5mm, dy=5mm, dz=5mm

Reference Value = 51.01 V/m; Power Drift = 0.02 dB

Peak SAR (extrapolated) = 2.31 W/kg

**SAR(1 g) = 1.67 W/kg; SAR(10 g) = 1.15 W/kg**

Maximum value of SAR (measured) = 2.11 W/kg

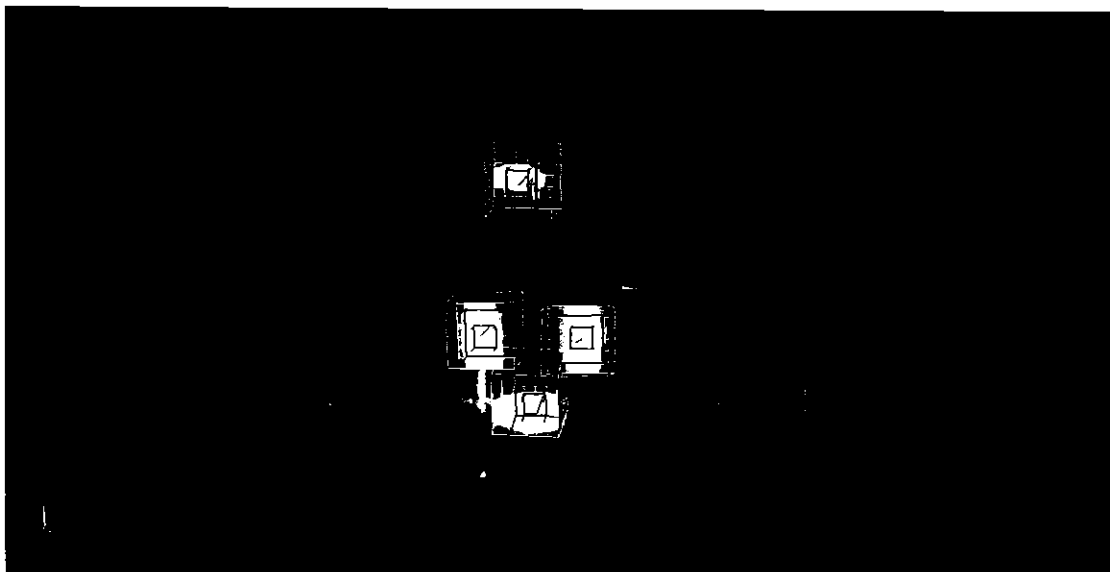
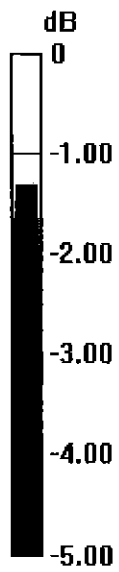

0 dB = 2.58 W/kg = 4.12 dBW/kg

## Certification of Calibration

Object: D750V3 – SN: 1003

Calibration procedure(s): Procedure for Calibration Extension for SAR Dipoles.

Extension Calibration date: 1/15/2019

Description: SAR Validation Dipole at 750 MHz.

### Calibration Equipment used:

Manufacturer	Model	Description	Cal Date	Cal Interval	Cal Due	Serial Number
Agilent	8753ES	S-Parameter Network Analyzer	2/8/2018	Annual	2/8/2019	US39170122
Agilent	N5182A	MXG Vector Signal Generator	4/18/2018	Annual	4/18/2019	MY47420800
Amplifier Research	15S1G6	Amplifier	CBT	N/A	CBT	433971
Anritsu	MA2411B	Pulse Power Sensor	3/2/2018	Annual	3/2/2019	1207364
Anritsu	MA2411B	Pulse Power Sensor	3/2/2018	Annual	3/2/2019	1339018
Anritsu	ML2495A	Power Meter	10/21/2018	Annual	10/21/2019	941001
Control Company	4040	Therm./Clock/Humidity Monitor	3/31/2017	Biennial	3/31/2019	170232394
Control Company	4352	Ultra Long Stem Thermometer	5/2/2017	Biennial	5/2/2019	170330156
Keysight	772D	Dual Directional Coupler	CBT	N/A	CBT	MY52180215
Keysight Technologies	85033E	Standard Mechanical Calibration Kit (DC to 9GHz, 3.5mm)	6/4/2018	Annual	6/4/2019	MY53401181
MiniCircuits	VLF-6000+	Low Pass Filter	CBT	N/A	CBT	N/A
Mini-Circuits	BW-N20W5+	DC to 18 GHz Precision Fixed 20 dB Attenuator	CBT	N/A	CBT	N/A
Narda	4772-3	Attenuator (3dB)	CBT	N/A	CBT	9406
Pasternack	PE2208-6	Bidirectional Coupler	CBT	N/A	CBT	N/A
Seekonk	NC-100	Torque Wrench	7/11/2018	Annual	7/11/2019	N/A
SPEAG	DAE4	Dasy Data Acquisition Electronics	10/3/2018	Annual	10/3/2019	1558
SPEAG	DAE4	Dasy Data Acquisition Electronics	6/18/2018	Annual	6/18/2019	1334
SPEAG	DAK-3.5	Dielectric Assessment Kit	9/11/2018	Annual	9/11/2019	1091
SPEAG	EX3DV4	SAR Probe	8/23/2018	Annual	8/23/2019	7308
SPEAG	EX3DV4	SAR Probe	6/25/2018	Annual	6/25/2019	7409

Measurement Uncertainty =  $\pm 23\%$  (k=2)

	Name	Function	Signature
Calibrated By:	Brodie Halfoster	Test Engineer	<i>BRODIE HALFOSTER</i>
Approved By:	Kaitlin O'Keefe	Senior Technical Manager	<i>KOK</i>



# DIPOLE CALIBRATION EXTENSION

Per KDB 865664 D01, calibration intervals of up to three years may be considered for reference dipoles when it is demonstrated that the SAR target, impedance and return loss of a dipole have remained stable according to the following requirements:

1. The measured SAR does not deviate more than 10% from the target on the calibration certificate.
2. The return-loss does not deviate more than 20% from the previous measurement and meets the required 20dB minimum return-loss requirement.
3. The measurement of real or imaginary parts of impedance does not deviate more than 5Ω from the previous measurement.

The following dipole was checked to pass the above 3 requirements to have 2-year calibration period from the calibration date:

Calibration Date	Extension Date	Certificate Electrical Delay (ns)	Certificate SAR Target Head (1g) W/kg @ 23.0 dBm	Measured Head SAR (1g) W/kg @ 23.0 dBm	Deviation 1g (%)	Certificate SAR Target Head (10g) W/kg @ 23.0 dBm	Measured Head SAR (10g) W/kg @ 23.0 dBm	Deviation 10g (%)	Certificate Impedance Head (Ohm) Real	Measured Impedance Head (Ohm) Real	Difference (Ohm) Real	Certificate Impedance Head (Ohm) Imaginary	Measured Impedance Head (Ohm) Imaginary	Difference (Ohm) Imaginary	Certificate Return Loss Head (dB)	Measured Return Loss Head (dB)	Deviation (%)	PASS/FAIL
1/15/2018	1/15/2019	1.043	1.656	1.75	5.68%	1.08	1.15	6.09%	53.8	54.8	1	-2.1	-2.2	0.1	-27.6	-25.8	6.50%	PASS
Calibration Date	Extension Date	Certificate Electrical Delay (ns)	Certificate SAR Target Body (1g) W/kg @ 23.0 dBm	Measured Body SAR (1g) W/kg @ 23.0 dBm	Deviation 1g (%)	Certificate SAR Target Body (10g) W/kg @ 23.0 dBm	Measured Body SAR (10g) W/kg @ 23.0 dBm	Deviation 10g (%)	Certificate Impedance Body (Ohm) Real	Measured Impedance Body (Ohm) Real	Difference (Ohm) Real	Certificate Impedance Body (Ohm) Imaginary	Measured Impedance Body (Ohm) Imaginary	Difference (Ohm) Imaginary	Certificate Return Loss Body (dB)	Measured Return Loss Body (dB)	Deviation (%)	PASS/FAIL
1/15/2018	1/15/2019	1.043	1.716	1.84	7.23%	1.14	1.23	7.71%	49.2	49	0.2	-6.2	-5.1	1.1	-24	-25.6	-6.80%	PASS