



FCC RF Test Report

APPLICANT : LG Electronics Mobile Comm USA
EQUIPMENT : Smart phone
BRAND NAME : LG
MODEL NAME : LG-X240YK
FCC ID : ZNFX240YK
STANDARD : FCC 47 CFR Part 2, 22(H), 24(E)
CLASSIFICATION : PCS Licensed Transmitter Held to Ear (PCE)

The product was received on Dec. 10, 2016 and testing was completed on Feb. 17, 2017. We, SPORTON INTERNATIONAL INC., would like to declare that the tested sample has been evaluated in accordance with the test procedures given in ANSI / TIA / EIA-603-D-2010 and has been in compliance with the applicable technical standards.

The test results in this report apply exclusively to the tested model / sample. Without written approval of SPORTON INTERNATIONAL INC., the test report shall not be reproduced except in full.

Reviewed by: Joseph Lin / Supervisor

Approved by: Jones Tsai / Manager



SPORTON INTERNATIONAL INC.

No. 52, Hwa Ya 1st Rd., Hwa Ya Technology Park, Kwei-Shan District, Tao Yuan City, Taiwan, R.O.C.

SPORTON INTERNATIONAL INC.

TEL : 886-3-327-3456

FAX : 886-3-328-4978

FCC ID : ZNFX240YK

Page Number : 1 of 24

Report Issued Date : Mar. 17, 2017

Report Version : Rev. 02

Report Template No.: BU5-FG22/24/27 Version 1.2



TABLE OF CONTENTS

REVISION HISTORY.....3

SUMMARY OF TEST RESULT4

1 GENERAL DESCRIPTION5

 1.1 Applicant.....5

 1.2 Manufacturer5

 1.3 Product Feature of Equipment Under Test5

 1.4 Product Specification of Equipment Under Test6

 1.5 Modification of EUT6

 1.6 Maximum ERP/EIRP Power, Frequency Tolerance, and Emission Designator7

 1.7 Testing Location7

 1.8 Applicable Standards8

2 TEST CONFIGURATION OF EQUIPMENT UNDER TEST.....9

 2.1 Test Mode.....9

 2.2 Connection Diagram of Test System10

 2.3 Support Unit used in test configuration10

 2.4 Measurement Results Explanation Example10

 2.5 Frequency List of Low/Middle/High Channels.....11

3 CONDUCTED TEST RESULT.....12

 3.1 Measuring Instruments.....12

 3.2 Test Setup12

 3.3 Test Result of Conducted Test.....12

 3.4 Conducted Output Power13

 3.5 Peak-to-Average Ratio14

 3.6 99% Occupied Bandwidth and 26dB Bandwidth Measurement.....15

 3.7 Conducted Band Edge16

 3.8 Conducted Spurious Emission17

 3.9 Frequency Stability.....18

4 RADIATED TEST ITEMS19

 4.1 Measuring Instruments.....19

 4.2 Test Setup19

 4.3 Test Result of Radiated Test.....19

 4.4 Effective Radiated Power and Effective Isotropic Radiated Power Measurement20

 4.5 Field Strength of Spurious Radiation Measurement22

5 LIST OF MEASURING EQUIPMENT23

6 UNCERTAINTY OF EVALUATION24

APPENDIX A. TEST RESULTS OF CONDUCTED TEST

APPENDIX B. TEST RESULTS OF RADIATED TEST

APPENDIX C. TEST SETUP PHOTOGRAPHS



REVISION HISTORY

REPORT NO.	VERSION	DESCRIPTION	ISSUED DATE
FG6D1013A	Rev. 01	Initial issue of report	Mar. 13, 2017
FG6D1013A	Rev. 02	Revising conducted output power and 99% OBW in the Appendix A	Mar. 17, 2017



SUMMARY OF TEST RESULT

Report Section	FCC Rule	Description	Limit	Result	Remark
3.4	§2.1046	Conducted Output Power	Reporting Only	PASS	-
3.5	§24.232(d)	Peak-to-Average Ratio	< 13 dB	PASS	-
3.6	§2.1049 §22.917(b) §24.238(b)	Occupied Bandwidth	Reporting Only	PASS	-
3.7	§2.1051 §22.917(a) §24.238(a)	Band Edge Measurement	< 43+10log10(P[Watts])	PASS	-
3.8	§2.1051 §22.917(a) §24.238(a)	Conducted Emission	< 43+10log10(P[Watts])	PASS	-
3.9	§2.1055 §22.355	Frequency Stability for Temperature & Voltage	< 2.5 ppm for Part 22	PASS	-
	§2.1055 §24.235		Within Authorized Band		
4.4	§22.913(a)(2)	Effective Radiated Power	< 7 Watts	PASS	-
	§24.232(c)	Equivalent Isotropic Radiated Power	< 2 Watts	PASS	-
4.5	§2.1053 §22.917(a) §24.238(a)	Field Strength of Spurious Radiation	< 43+10log10(P[Watts])	PASS	Under limit 22.86 dB at 7641.000 MHz



1 General Description

1.1 Applicant

LG Electronics Mobile Comm USA

LG Twin Towers 20, Yeouido-Dong Youngdeungpo-Gu, Seoul 150-721, Republic Of Korea

1.2 Manufacturer

Arima Communications Corp.

6F, No. 866, Jhongjheng Rd., Jhonghe Dist., New Taipei City 23586, Taiwan

1.3 Product Feature of Equipment Under Test

Product Feature	
Equipment	Smart phone
Brand Name	LG
Model Name	LG-X240YK
FCC ID	ZNFX240YK
EUT supports Radios application	GSM/EGPRS/WCDMA/HSPA/LTE WLAN 11b/g/n HT20/HT40 Bluetooth BR/EDR/LE
HW Version	Rev. 1.0
SW Version	LGX240YKAT-00-V08a-CIS-XX-NOV-17-2016+0
EUT Stage	Production Unit

Remark: The above EUT's information was declared by manufacturer. Please refer to the specifications or user's manual for more detailed description.



1.4 Product Specification of Equipment Under Test

Standards-related Product Specification	
Tx Frequency	GSM/GPRS/EDGE: 850: 824.2 MHz ~ 848.8 MHz 1900: 1850.2 MHz ~ 1909.8MHz WCDMA: Band V: 826.4 MHz ~ 846.6 MHz
Rx Frequency	GSM/GPRS/EDGE: 850: 869.2 MHz ~ 893.8 MHz 1900: 1930.2 MHz ~ 1989.8 MHz WCDMA: Band V: 871.4 MHz ~ 891.6 MHz
Maximum Output Power to Antenna	GSM/GPRS/EDGE: 850: 33.87 dBm 1900: 29.92 dBm WCDMA: Band V: 24.98 dBm
Antenna Type	PIFA Antenna
Type of Modulation	GSM: GMSK GPRS: GMSK EDGE: GMSK / 8PSK WCDMA: BPSK (Uplink) HSDPA: QPSK (Uplink) HSUPA: QPSK (Uplink)

1.5 Modification of EUT

No modifications are made to the EUT during all test items.



1.6 Maximum ERP/EIRP Power, Frequency Tolerance, and Emission Designator

FCC Rule	Frequency Range (MHz)	System	Type of Modulation	Maximum ERP/EIRP (W)	Frequency Tolerance (ppm)	Emission Designator
Part 22	824.2 ~848.8	GSM850 GPRS class 8	GMSK	0.5420	0.0036 ppm	252KGXW
Part 22	824.2 ~848.8	GSM850 EDGE class 8	8PSK	0.1866	0.0143 ppm	258KG7W
Part 22	826.4 ~846.6	WCDMA Band V RMC 12.2Kbps	BPSK	0.0977	0.0048 ppm	4M21F9W
Part 24	1850.2 ~1909.8	GSM1900 GPRS class 8	GMSK	0.8954	0.0090 ppm	246KGXW
Part 24	1850.2 ~1909.8	GSM1900 EDGE class 8	8PSK	0.2891	0.0106 ppm	246KG7W

1.7 Testing Location

Sporton Lab is accredited to ISO 17025 by Taiwan Accreditation Foundation (TAF code : 1190) and the FCC designation No. TW0007 under the FCC 2.948(e) by Mutual Recognition Agreement (MRA) in FCC Test.

Test Site	SPORTON INTERNATIONAL INC.
Test Site Location	No. 52, Hwa Ya 1 st Rd., Hwa Ya Technology Park, Kwei-Shan District, Tao Yuan City, Taiwan, R.O.C. TEL: +886-3-327-3456 FAX: +886-3-328-4978
Test Site No.	Sporton Site No. TH03-HY

Test Site	SPORTON INTERNATIONAL INC.
Test Site Location	No.58, Aly. 75, Ln. 564, Wenhua 3rd Rd. Guishan Dist, Taoyuan City, Taiwan (R.O.C.) TEL: +886-3-327-0868 FAX: +886-3-327-0855
Test Site No.	Sporton Site No. 03CH13-HY



1.8 Applicable Standards

According to the specifications of the manufacturer, the EUT must comply with the requirements of the following standards:

- ♦ 47 CFR Part 2, 22(H), 24(E)
- ♦ ANSI / TIA / EIA-603-D-2010
- ♦ FCC KDB 971168 D01 Power Meas. License Digital Systems v02r02

Remark:

1. All test items were verified and recorded according to the standards and without any deviation during the test.
2. This EUT has also been tested and complied with the requirements of FCC Part 15, Subpart B, recorded in a separate test report.



2 Test Configuration of Equipment Under Test

2.1 Test Mode

Antenna port conducted and radiated test items were performed according to KDB 971168 D01 Power Meas. License Digital Systems v02r02 with maximum output power.

Radiated measurements were performed with rotating EUT in different three orthogonal test planes to find the maximum emission.

From 9 kHz to 30 MHz was verified, the amplitude of spurious emissions, which has attenuated more than 20 dB under the permissible value, with the test result, it shall not be the essential information in the report

Radiated emissions were investigated as following frequency range:

1. 30 MHz to 9000 MHz for GSM850 and WCDMA Band V.
2. 30 MHz to 19100 MHz for GSM1900.

All modes and data rates and positions were investigated.

Test modes are chosen to be reported as the worst case configuration below:

Test Modes		
Band	Radiated TCs	Conducted TCs
GSM 850	<ul style="list-style-type: none">■ GPRS class 8 Link■ EDGE class 8 Link	<ul style="list-style-type: none">■ GPRS class 8 Link■ EDGE class 8 Link
GSM 1900	<ul style="list-style-type: none">■ GPRS class 8 Link■ EDGE class 8 Link	<ul style="list-style-type: none">■ GPRS class 8 Link■ EDGE class 8 Link
WCDMA Band V	<ul style="list-style-type: none">■ RMC 12.2Kbps Link	<ul style="list-style-type: none">■ RMC 12.2Kbps Link

2.2 Connection Diagram of Test System

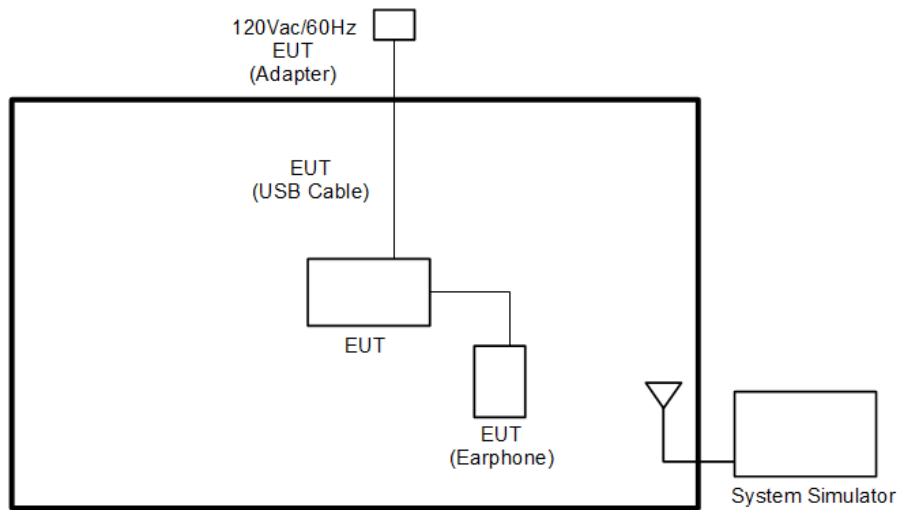

2.3 Support Unit used in test configuration

Item	Equipment	Trade Name	Model No.	FCC ID	Data Cable	Power Cord
1.	System Simulator	R&S	CMU 200	N/A	N/A	Unshielded, 1.8 m

2.4 Measurement Results Explanation Example

For all conducted test items:

The offset level is set in the spectrum analyzer to compensate the RF cable loss and attenuator factor between RF conducted output port and spectrum analyzer. With the offset compensation, the spectrum analyzer reading level will be exactly the RF output level.

The spectrum analyzer offset is derived from RF cable loss and attenuator factor.

Offset = RF cable loss + attenuator factor.

The following shows an offset computation example with RF cable loss 4.2 dB and a 10dB attenuator.

Example :

Offset(dB) = RF cable loss(dB) + attenuator factor(dB).

$$= 4.2 + 10 = 14.2 \text{ (dB)}$$



2.5 Frequency List of Low/Middle/High Channels

Frequency List				
Band	Channel/Frequency(MHz)	Lowest	Middle	Highest
GSM850	Channel	128	189	251
	Frequency	824.2	836.4	848.8
WCDMA Band V	Channel	4132	4182	4233
	Frequency	826.4	836.4	846.6
GSM1900	Channel	512	661	810
	Frequency	1850.2	1880.0	1909.8

3 Conducted Test Result

3.1 Measuring Instruments

See list of measuring instruments of this test report.

3.2 Test Setup

3.2.1 Conducted Output Power

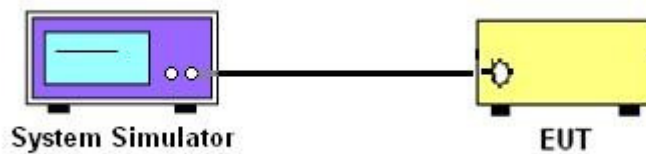

3.2.2 Peak-to-Average Ratio, Occupied Bandwidth, Conducted Band-Edge and Conducted Spurious Emission

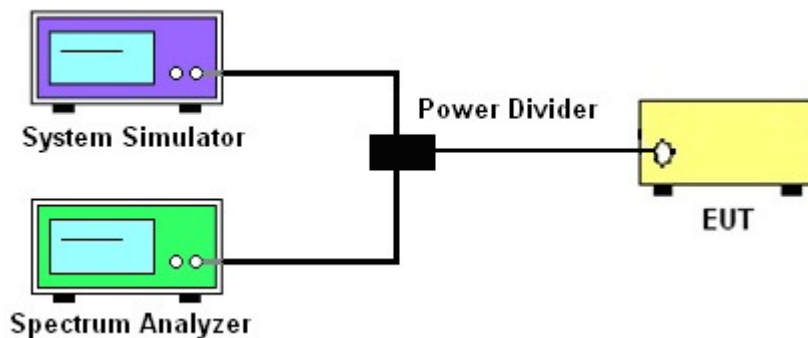

3.2.3 Frequency Stability



3.3 Test Result of Conducted Test

Please refer to Appendix A.



3.4 Conducted Output Power

3.4.1 Description of the Conducted Output Power

A system simulator was used to establish communication with the EUT. Its parameters were set to enforce EUT transmitting at the maximum power. The measured power in the radio frequency on the transmitter output terminals shall be reported.

3.4.2 Test Procedures

1. The transmitter output port was connected to the system simulator.
2. Set EUT at maximum power through system simulator.
3. Select lowest, middle, and highest channels for each band and different modulation.
4. Measure the maximum burst average power for GSM and maximum average power for other modulation signal.



3.5 Peak-to-Average Ratio

3.5.1 Description of the PAR Measurement

The peak-to-average ratio (PAR) of the transmission may not exceed 13 dB.

3.5.2 Test Procedures

1. The testing follows FCC KDB 971168 D01 v02r02 Section 5.7.1.
2. The EUT was connected to spectrum analyzer and system simulator via a power divider.
3. Set EUT to transmit at maximum output power.
4. When the duty cycle is less than 98%, then signal gating will be implemented on the spectrum analyzer by triggering from the system simulator.
5. Set the CCDF (Complementary Cumulative Distribution Function) option of the spectrum analyzer.
Record the maximum PAPR level associated with a probability of 0.1%.



3.6 99% Occupied Bandwidth and 26dB Bandwidth Measurement

3.6.1 Description of 99% Occupied Bandwidth and 26dB Bandwidth Measurement

The occupied bandwidth is the width of a frequency band such that, below the lower and above the upper frequency limits, the mean powers emitted are each equal to a specified percentage 0.5% of the total mean transmitted power.

The 26 dB emission bandwidth is defined as the frequency range between two points, one above and one below the carrier frequency, at which the spectral density of the emission is attenuated 26 dB below the maximum in-band spectral density of the modulated signal. Spectral density (power per unit bandwidth) is to be measured with a detector of resolution bandwidth equal to approximately 1.0% of the emission bandwidth.

3.6.2 Test Procedures

1. The testing follows FCC KDB 971168 v02r02 Section 4.2.
2. The EUT was connected to spectrum analyzer and system simulator via a power divider.
3. The spectrum analyzer center frequency is set to the nominal EUT channel center frequency. The span range for the spectrum analyzer shall be between two and five times the anticipated OBW.
4. The nominal resolution bandwidth (RBW) shall be in the range of 1 to 5 % of the anticipated OBW, and the VBW shall be at least 3 times the RBW.
5. Set the detection mode to peak, and the trace mode to max hold.
6. Determine the reference value: Set the EUT to transmit a modulated signal. Allow the trace to stabilize. Set the spectrum analyzer marker to the highest level of the displayed trace.
(this is the reference value)
7. Determine the “-26 dB down amplitude” as equal to (Reference Value – X).
8. Place two markers, one at the lowest and the other at the highest frequency of the envelope of the spectral display such that each marker is at or slightly below the “-X dB down amplitude” determined in step 6. If a marker is below this “-X dB down amplitude” value it shall be placed as close as possible to this value. The OBW is the positive frequency difference between the two markers.
9. Use the 99 % power bandwidth function of the spectrum analyzer and report the measured bandwidth.



3.7 Conducted Band Edge

3.7.1 Description of Conducted Band Edge Measurement

The power of any emission outside of the authorized operating frequency ranges must be lower than the transmitter power (P) by a factor of at least $43 + 10 \log (P)$ dB.

3.7.2 Test Procedures

1. The testing follows FCC KDB 971168 D01 v02r02 Section 6.0.
2. The EUT was connected to the spectrum analyzer and system simulator via a power divider.
3. The RF output of EUT was connected to the spectrum analyzer by an RF cable and attenuator. The path loss was compensated to the results for each measurement.
4. The band edges of low and high channels for the highest RF powers were measured.
5. The RF fundamental frequency should be excluded against the limit line in the operating frequency band.
6. The limit line is derived from $43 + 10\log(P)$ dB below the transmitter power P(Watts)



3.8 Conducted Spurious Emission

3.8.1 Description of Conducted Spurious Emission Measurement

The power of any emission outside of the authorized operating frequency ranges must be lower than the transmitter power (P) by a factor of at least $43 + 10 \log (P)$ dB.

It is measured by means of a calibrated spectrum analyzer and scanned from 30 MHz up to a frequency including its 10th harmonic.

3.8.2 Test Procedures

1. The testing follows FCC KDB 971168 D01 v02r02 Section 6.0.
2. The EUT was connected to the spectrum analyzer and system simulator via a power divider.
3. The RF output of EUT was connected to the spectrum analyzer by an RF cable and attenuator. The path loss was compensated to the results for each measurement.
4. The middle channel for the highest RF power within the transmitting frequency was measured.
5. The conducted spurious emission for the whole frequency range was taken.
6. The RF fundamental frequency should be excluded against the limit line in the operating frequency band.
7. The limit line is derived from $43 + 10\log(P)$ dB below the transmitter power P(Watts)



3.9 Frequency Stability

3.9.1 Description of Frequency Stability Measurement

The frequency stability shall be measured by variation of ambient temperature and variation of primary supply voltage to ensure that the fundamental emission stays within the authorized frequency block. The frequency stability of the transmitter shall be maintained within $\pm 0.00025\%$ ($\pm 2.5\text{ppm}$) of the center frequency.

3.9.2 Test Procedures for Temperature Variation

1. The testing follows FCC KDB 971168 D01 v02r02 Section 9.0.
2. The EUT was set up in the thermal chamber and connected with the system simulator.
3. With power OFF, the temperature was decreased to -30°C and the EUT was stabilized before testing. Power was applied and the maximum change in frequency was recorded within one minute.
4. With power OFF, the temperature was raised in 10°C steps up to 50°C . The EUT was stabilized at each step for at least half an hour. Power was applied and the maximum frequency change was recorded within one minute.

3.9.3 Test Procedures for Voltage Variation

1. The testing follows FCC KDB 971168 D01 v02r02 Section 9.0.
2. The EUT was placed in a temperature chamber at $20\pm 5^{\circ}\text{C}$ and connected with the system simulator.
3. The power supply voltage to the EUT was varied from 85% to 115% of the nominal value measured at the input to the EUT.
4. The variation in frequency was measured for the worst case.

4 Radiated Test Items

4.1 Measuring Instruments

See list of measuring instruments of this test report.

4.2 Test Setup

4.2.1 For radiated test from 30MHz to 1GHz



4.2.2 For radiated test above 1GHz

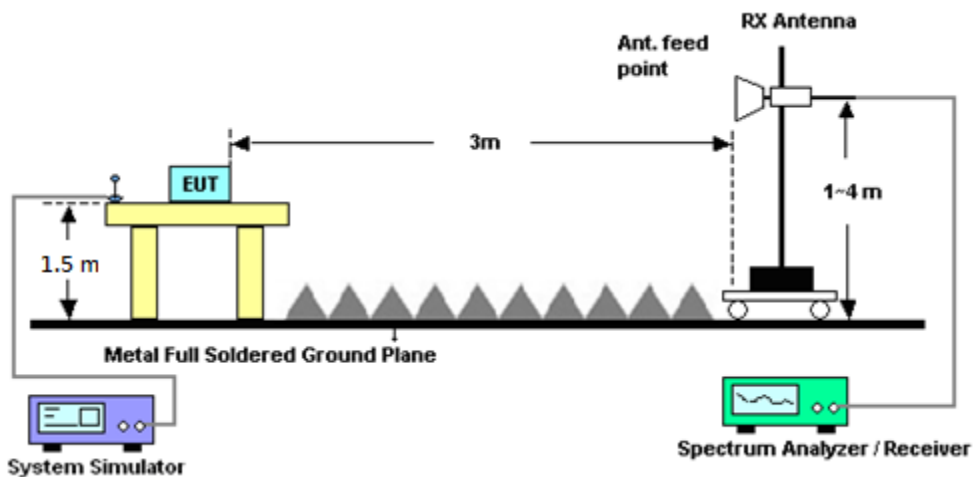

4.3 Test Result of Radiated Test

Please refer to Appendix B.



4.4 Effective Radiated Power and Effective Isotropic Radiated Power Measurement

4.4.1 Description of the ERP/EIRP Measurement

The substitution method, in ANSI / TIA / EIA-603-D-2010, was used for ERP/EIRP measurement, and the spectrum analyzer configuration follows KDB 971168 D01 Power Meas. License Digital Systems v02r02. The ERP of mobile transmitters must not exceed 7 Watts (Cellular Band) and the EIRP of mobile transmitters are limited to 2 Watts (PCS Band).

4.4.2 Test Procedures

1. The testing follows FCC KDB 971168 D01 v02r02 Section 5.2.1. (for CDMA/WCDMA), Section 5.2.2.2 (for GSM/GPRS/EDGE) and ANSI / TIA-603-D-2010 Section 2.2.17.
2. The EUT was placed on a non-conductive rotating platform (0.8 meters for frequency below 1GHz and 1.5 meter for frequency above 1GHz) in a semi-anechoic chamber. The radiated emission at the fundamental frequency was measured at 3 m with a test antenna and a spectrum analyzer with RMS detector per section 5. of KDB 971168 D01.
3. During the measurement, the system simulator parameters were set to force the EUT transmitting at maximum output power. The maximum emission was recorded from analyzer power level (LVL) from the 360 degrees rotation of the turntable and the test antenna raised and lowered over a range from 1 to 4 meters in both horizontally and vertically polarized orientations.
4. Effective Isotropic Radiated Power (EIRP) was measured by substitution method according to TIA/EIA-603-D. The EUT was replaced by the substitution antenna at same location, and then a known power from S.G. was applied into the dipole antenna through a Tx cable, and then recorded the maximum Analyzer reading through raised and lowered the test antenna. The correction factor (in dB) = S.G. - Tx Cable loss + Substitution antenna gain - Analyzer reading. Then the EUT's EIRP was calculated with the correction factor, $EIRP = LVL + \text{Correction factor}$ and $ERP = EIRP - 2.15$. Take the record of the output power at substitution antenna.



	GSM/GPRS/EDGE	WCDMA/HSPA
SPAN	500kHz	10MHz
RBW	10kHz	100kHz
VBW	30kHz	300kHz
Detector	RMS	RMS
Trace	Average	Average
Average Type	Power	Power
Sweep Count	100	100



4.5 Field Strength of Spurious Radiation Measurement

4.5.1 Description of Field Strength of Spurious Radiated Measurement

The power of any emission outside of the authorized operating frequency ranges must be attenuated below the transmitter power (P) by a factor of at least $43 + 10 \log (P)$ dB. The spectrum is scanned from 30 MHz up to a frequency including its 10th harmonic.

4.5.2 Test Procedures

1. The testing follows FCC KDB 971168 D01 v02r02 Section 5.8 and ANSI / TIA-603-D-2010 Section 2.2.12.
2. The EUT was placed on a rotatable wooden table 0.8 meters for frequency below 1GHz and 1.5 meter for frequency above 1GHz above the ground.
3. The EUT was set 3 meters from the receiving antenna, which was mounted on the antenna tower.
4. The table was rotated 360 degrees to determine the position of the highest spurious emission.
5. The height of the receiving antenna is varied between one meter and four meters to search for the maximum spurious emission for both horizontal and vertical polarizations.
6. Make the measurement with the spectrum analyzer's RBW = 1MHz, VBW = 3MHz, taking record of maximum spurious emission.
7. A horn antenna was substituted in place of the EUT and was driven by a signal generator.
8. Tune the output power of signal generator to the same emission level with EUT maximum spurious emission.
9. Taking the record of output power at antenna port.
10. Repeat step 7 to step 8 for another polarization.
11. $EIRP \text{ (dBm)} = S.G. \text{ Power} - Tx \text{ Cable Loss} + Tx \text{ Antenna Gain}$
12. $ERP \text{ (dBm)} = EIRP - 2.15$
13. The RF fundamental frequency should be excluded against the limit line in the operating frequency band.
14. The limit line is derived from $43 + 10\log(P)$ dB below the transmitter power P(Watts)



5 List of Measuring Equipment

Instrument	Manufacturer	Model No.	Serial No.	Characteristics	Calibration Date	Test Date	Due Date	Remark
Spectrum Analyzer	Rohde & Schwarz	FSP30	101329	9kHz~30GHz	Jun. 27, 2016	Feb. 06, 2017	Jun. 26, 2017	Conducted (TH03-HY)
Temperature Chamber	ESPEC	SU-641	92013721	-30°C ~70°C	Nov. 16, 2016	Feb. 06, 2017	Nov. 15, 2017	Conducted (TH03-HY)
Programmable Power Supply	GW Instek	PSS-2005	EL883644	Voltage:0~20V;Current:0~5A	Nov. 22, 2016	Feb. 06, 2017	Nov. 21, 2017	Conducted (TH03-HY)
Base Station(Measu	Rohde & Schwarz	CMU200	117995	GSM / GPRS / WCDMA / CDMA	Aug. 03, 2016	Feb. 06, 2017	Aug,04, 2017	Conducted (TH03-HY)
Horn Antenna	SCHWARZBECK	BBHA 9120 D	9120D-1325	1GHz ~ 18GHz	Sep. 30, 2016	Feb. 04, 2017 ~ Feb. 17, 2017	Sep. 29, 2017	Radiation (03CH13-HY)
Amplifier	Sonoma-Instrument	310 N	187282	9KHz~1GHz	Dec. 21, 2016	Feb. 04, 2017 ~ Feb. 17, 2017	Dec. 20, 2017	Radiation (03CH13-HY)
Bilog Antenna	TESEQ	CBL 6111D&00800	40103&04	30MHz to 1GHz	Jan. 07, 2017	Feb. 04, 2017 ~ Feb. 17, 2017	Jan. 06, 2018	Radiation (03CH13-HY)
Preamplifier	MITEQ	AMF-7D-0010 1800-30-10P	1590074	1GHz~18GHz	Jun. 27, 2016	Feb. 04, 2017 ~ Feb. 17, 2017	Jun. 26, 2017	Radiation (03CH13-HY)
Preamplifier	MITEQ	JS44-1800400 0-33-8P	1840917	18GHz ~ 40GHz	Jun. 14, 2016	Feb. 04, 2017 ~ Feb. 17, 2017	Jun. 13, 2017	Radiation (03CH13-HY)
Preamplifier	Keysight	83017A	MY53270147	1GHz~26.5GHz	Jan. 09, 2017	Feb. 04, 2017 ~ Feb. 17, 2017	Jan. 08, 2018	Radiation (03CH13-HY)
Spectrum Analyzer	Keysight	N9010A	MY55370526	N/A	Mar. 14, 2016	Feb. 04, 2017 ~ Feb. 17, 2017	Mar. 13, 2017	Radiation (03CH13-HY)
Antenna Mast	EMEC	AM-BS-4500-B	N/A	1m~4m	N/A	Feb. 04, 2017 ~ Feb. 17, 2017	N/A	Radiation (03CH13-HY)
Turn Table	EMEC	TT2000	N/A	0~360 Degree	N/A	Feb. 04, 2017 ~ Feb. 17, 2017	N/A	Radiation (03CH13-HY)
SHF-EHF Horn Antenna	SCHWARZBECK	BBHA 9170	BBHA9170251	18GHz- 40GHz	Nov. 08, 2016	Feb. 04, 2017 ~ Feb. 17, 2017	Nov. 07, 2017	Radiation (03CH13-HY)
Horn Antenna	SCHWARZBECK	BBHA 9120 D	9120D-1522	1G~18GHz	Mar. 31, 2016	Feb. 04, 2017 ~ Feb. 17, 2017	Mar. 30, 2017	Radiation (03CH13-HY)
SHF-EHF Horn Antenna	SCHWARZBECK	BBHA 9170	BBHA9170584	18GHz- 40GHz	Nov. 08, 2016	Feb. 04, 2017 ~ Feb. 17, 2017	Nov. 07, 2017	Radiation (03CH13-HY)
Signal Generator	Anritsu	MG3694C	163401	0.1Hz~40GHz	Jan. 04, 2017	Feb. 04, 2017 ~ Feb. 17, 2017	Jan. 03, 2018	Radiation (03CH13-HY)



6 Uncertainty of Evaluation

Uncertainty of Radiated Emission Measurement (30 MHz ~ 1000 MHz)

Measuring Uncertainty for a Level of Confidence of 95% ($U = 2Uc(y)$)	3.07
---	------

Uncertainty of Radiated Emission Measurement (1 GHz ~ 18 GHz)

Measuring Uncertainty for a Level of Confidence of 95% ($U = 2Uc(y)$)	3.48
---	------

Uncertainty of Radiated Emission Measurement (18 GHz ~ 40 GHz)

Measuring Uncertainty for a Level of Confidence of 95% ($U = 2Uc(y)$)	3.92
---	------



Appendix A. Test Results of Conducted Test

Conducted Output Power(Average power)

Conducted Power (*Unit: dBm)						
Band	GSM850			GSM1900		
Channel	128	189	251	512	661	810
Frequency	824.2	836.4	848.8	1850.2	1880	1909.8
GSM	33.73	33.8	33.81	29.9	29.84	29.8
GPRS class 8	33.87	33.83	33.86	29.83	29.87	29.92
GPRS class 10	30.32	30.13	30.1	27.17	27.23	27.26
GPRS class 11	28.48	28.47	28.48	25.37	25.47	25.56
GPRS class 12	27.91	27.92	27.93	24.71	24.81	24.92
EGPRS class 8	26.92	26.83	26.8	25.78	25.84	25.9
EGPRS class 10	24.79	24.81	24.77	23.57	23.78	23.78
EGPRS class 11	23.17	23.11	23.04	21.83	21.98	21.95
EGPRS class 12	21.99	21.93	21.84	20.66	20.87	20.9

Conducted Power (*Unit: dBm)						
Band	WCDMA Band V			WCDMA Band II		
Channel	4132	4182	4233	9262	9400	9538
Frequency	826.4	836.4	846.6	1852.4	1880	1907.6
RMC 12.2K	24.89	24.86	24.98	-	-	-
HSDPA Subtest-1	23.94	23.83	23.87	-	-	-
HSDPA Subtest-2	23.93	23.85	23.91	-	-	-
HSDPA Subtest-3	23.5	23.44	23.45	-	-	-
HSDPA Subtest-4	23.41	23.38	23.47	-	-	-
HSUPA Subtest-1	21.89	21.86	21.97	-	-	-
HSUPA Subtest-2	21.93	21.9	21.91	-	-	-
HSUPA Subtest-3	22.92	22.89	22.88	-	-	-
HSUPA Subtest-4	21.41	21.37	21.47	-	-	-
HSUPA Subtest-5	23.9	23.8	23.9	-	-	-



A1. GSM

Peak-to-Average Ratio

Mode	GSM850		Limit: 13dB
Mod.	GPRS class 8	EDGE class 8	Result
Lowest CH	0.16	3.00	PASS
Middle CH	0.16	3.28	
Highest CH	0.16	2.96	

Mode	GSM1900		Limit: 13dB
Mod.	GPRS class 8	EDGE class 8	Result
Lowest CH	0.12	3.24	PASS
Middle CH	0.16	3.04	
Highest CH	0.16	2.92	

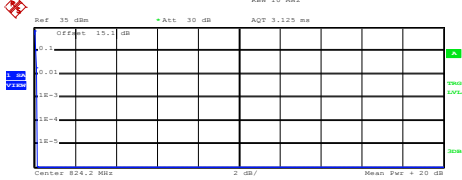
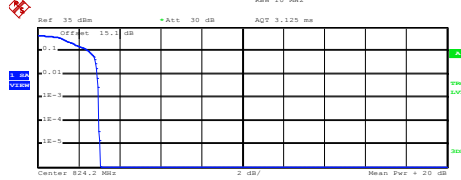
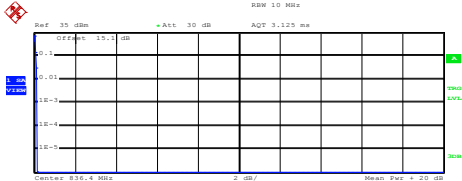
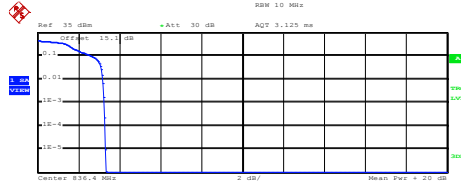
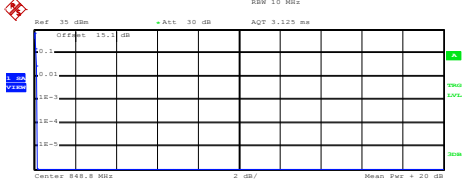
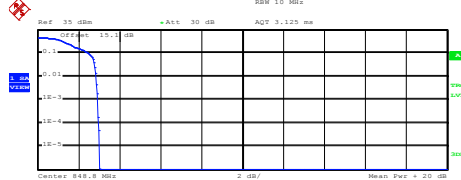

GSM850 (GPRS class 8)	GSM850 (EDGE class 8)																
<p style="text-align: center;">Lowest Channel</p>  <p>Complementary Cumulative Distribution Function (100000 samples) Trace 1 Mean 32.62 dBm Peak 32.78 dBm Crest 0.16 dB</p> <table border="1"> <tr><td>10 %</td><td>0.08 dB</td></tr> <tr><td>1 %</td><td>0.12 dB</td></tr> <tr><td>.1 %</td><td>0.16 dB</td></tr> <tr><td>.01 %</td><td>0.16 dB</td></tr> </table> <p>Date: 6.FEB.2017 11:50:52</p>	10 %	0.08 dB	1 %	0.12 dB	.1 %	0.16 dB	.01 %	0.16 dB	<p style="text-align: center;">Lowest Channel</p>  <p>Complementary Cumulative Distribution Function (100000 samples) Trace 1 Mean 26.05 dBm Peak 29.11 dBm Crest 3.06 dB</p> <table border="1"> <tr><td>10 %</td><td>2.48 dB</td></tr> <tr><td>1 %</td><td>2.92 dB</td></tr> <tr><td>.1 %</td><td>3.00 dB</td></tr> <tr><td>.01 %</td><td>3.00 dB</td></tr> </table> <p>Date: 6.FEB.2017 12:35:30</p>	10 %	2.48 dB	1 %	2.92 dB	.1 %	3.00 dB	.01 %	3.00 dB
10 %	0.08 dB																
1 %	0.12 dB																
.1 %	0.16 dB																
.01 %	0.16 dB																
10 %	2.48 dB																
1 %	2.92 dB																
.1 %	3.00 dB																
.01 %	3.00 dB																
<p style="text-align: center;">Middle Channel</p>  <p>Complementary Cumulative Distribution Function (100000 samples) Trace 1 Mean 32.72 dBm Peak 32.85 dBm Crest 0.13 dB</p> <table border="1"> <tr><td>10 %</td><td>0.08 dB</td></tr> <tr><td>1 %</td><td>0.16 dB</td></tr> <tr><td>.1 %</td><td>0.16 dB</td></tr> <tr><td>.01 %</td><td>0.16 dB</td></tr> </table> <p>Date: 6.FEB.2017 11:51:20</p>	10 %	0.08 dB	1 %	0.16 dB	.1 %	0.16 dB	.01 %	0.16 dB	<p style="text-align: center;">Middle Channel</p>  <p>Complementary Cumulative Distribution Function (100000 samples) Trace 1 Mean 25.66 dBm Peak 28.97 dBm Crest 3.32 dB</p> <table border="1"> <tr><td>10 %</td><td>2.68 dB</td></tr> <tr><td>1 %</td><td>3.20 dB</td></tr> <tr><td>.1 %</td><td>3.28 dB</td></tr> <tr><td>.01 %</td><td>3.32 dB</td></tr> </table> <p>Date: 6.FEB.2017 12:35:53</p>	10 %	2.68 dB	1 %	3.20 dB	.1 %	3.28 dB	.01 %	3.32 dB
10 %	0.08 dB																
1 %	0.16 dB																
.1 %	0.16 dB																
.01 %	0.16 dB																
10 %	2.68 dB																
1 %	3.20 dB																
.1 %	3.28 dB																
.01 %	3.32 dB																
<p style="text-align: center;">Highest Channel</p>  <p>Complementary Cumulative Distribution Function (100000 samples) Trace 1 Mean 32.79 dBm Peak 32.92 dBm Crest 0.13 dB</p> <table border="1"> <tr><td>10 %</td><td>0.08 dB</td></tr> <tr><td>1 %</td><td>0.16 dB</td></tr> <tr><td>.1 %</td><td>0.16 dB</td></tr> <tr><td>.01 %</td><td>0.16 dB</td></tr> </table> <p>Date: 6.FEB.2017 11:51:48</p>	10 %	0.08 dB	1 %	0.16 dB	.1 %	0.16 dB	.01 %	0.16 dB	<p style="text-align: center;">Highest Channel</p>  <p>Complementary Cumulative Distribution Function (100000 samples) Trace 1 Mean 25.96 dBm Peak 28.97 dBm Crest 3.01 dB</p> <table border="1"> <tr><td>10 %</td><td>2.48 dB</td></tr> <tr><td>1 %</td><td>2.84 dB</td></tr> <tr><td>.1 %</td><td>2.96 dB</td></tr> <tr><td>.01 %</td><td>3.00 dB</td></tr> </table> <p>Date: 6.FEB.2017 12:36:27</p>	10 %	2.48 dB	1 %	2.84 dB	.1 %	2.96 dB	.01 %	3.00 dB
10 %	0.08 dB																
1 %	0.16 dB																
.1 %	0.16 dB																
.01 %	0.16 dB																
10 %	2.48 dB																
1 %	2.84 dB																
.1 %	2.96 dB																
.01 %	3.00 dB																

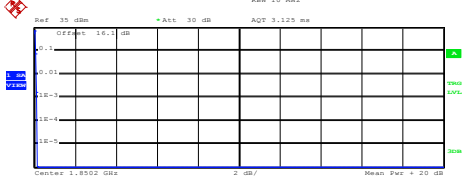
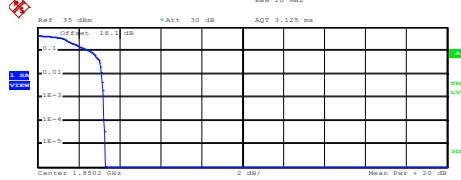
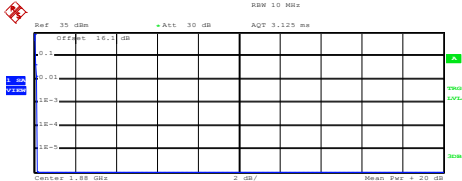
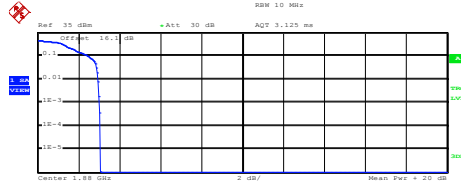
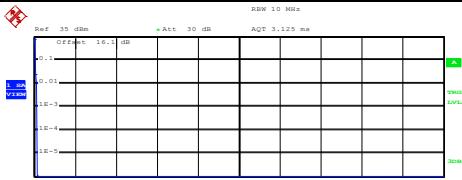
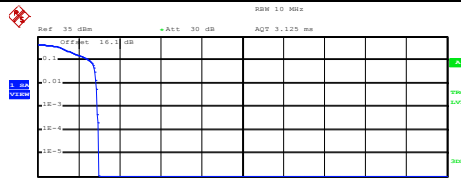

GSM1900 (GPRS class 8)	GSM1900 (EDGE class 8)																
<p align="center">Lowest Channel</p>  <p>Complementary Cumulative Distribution Function (100000 samples) Trace 1 Mean 28.95 dBm Peak 29.11 dBm Crest 0.16 dB</p> <table border="1"> <tr><td>10 %</td><td>0.08 dB</td></tr> <tr><td>1 %</td><td>0.12 dB</td></tr> <tr><td>.1 %</td><td>0.12 dB</td></tr> <tr><td>.01 %</td><td>0.16 dB</td></tr> </table> <p>Date: 6.FEB.2017 12:06:05</p>	10 %	0.08 dB	1 %	0.12 dB	.1 %	0.12 dB	.01 %	0.16 dB	<p align="center">Lowest Channel</p>  <p>Complementary Cumulative Distribution Function (100000 samples) Trace 1 Mean 24.55 dBm Peak 27.84 dBm Crest 3.29 dB</p> <table border="1"> <tr><td>10 %</td><td>2.56 dB</td></tr> <tr><td>1 %</td><td>3.12 dB</td></tr> <tr><td>.1 %</td><td>3.24 dB</td></tr> <tr><td>.01 %</td><td>3.24 dB</td></tr> </table> <p>Date: 6.FEB.2017 12:17:56</p>	10 %	2.56 dB	1 %	3.12 dB	.1 %	3.24 dB	.01 %	3.24 dB
10 %	0.08 dB																
1 %	0.12 dB																
.1 %	0.12 dB																
.01 %	0.16 dB																
10 %	2.56 dB																
1 %	3.12 dB																
.1 %	3.24 dB																
.01 %	3.24 dB																
<p align="center">Middle Channel</p>  <p>Complementary Cumulative Distribution Function (100000 samples) Trace 1 Mean 28.90 dBm Peak 29.04 dBm Crest 0.14 dB</p> <table border="1"> <tr><td>10 %</td><td>0.08 dB</td></tr> <tr><td>1 %</td><td>0.12 dB</td></tr> <tr><td>.1 %</td><td>0.16 dB</td></tr> <tr><td>.01 %</td><td>0.16 dB</td></tr> </table> <p>Date: 6.FEB.2017 12:06:26</p>	10 %	0.08 dB	1 %	0.12 dB	.1 %	0.16 dB	.01 %	0.16 dB	<p align="center">Middle Channel</p>  <p>Complementary Cumulative Distribution Function (100000 samples) Trace 1 Mean 24.59 dBm Peak 27.63 dBm Crest 3.04 dB</p> <table border="1"> <tr><td>10 %</td><td>2.48 dB</td></tr> <tr><td>1 %</td><td>2.96 dB</td></tr> <tr><td>.1 %</td><td>3.04 dB</td></tr> <tr><td>.01 %</td><td>3.08 dB</td></tr> </table> <p>Date: 6.FEB.2017 12:18:16</p>	10 %	2.48 dB	1 %	2.96 dB	.1 %	3.04 dB	.01 %	3.08 dB
10 %	0.08 dB																
1 %	0.12 dB																
.1 %	0.16 dB																
.01 %	0.16 dB																
10 %	2.48 dB																
1 %	2.96 dB																
.1 %	3.04 dB																
.01 %	3.08 dB																
<p align="center">Highest Channel</p>  <p>Complementary Cumulative Distribution Function (100000 samples) Trace 1 Mean 28.40 dBm Peak 28.55 dBm Crest 0.15 dB</p> <table border="1"> <tr><td>10 %</td><td>0.08 dB</td></tr> <tr><td>1 %</td><td>0.12 dB</td></tr> <tr><td>.1 %</td><td>0.16 dB</td></tr> <tr><td>.01 %</td><td>0.16 dB</td></tr> </table> <p>Date: 6.FEB.2017 12:06:47</p>	10 %	0.08 dB	1 %	0.12 dB	.1 %	0.16 dB	.01 %	0.16 dB	<p align="center">Highest Channel</p>  <p>Complementary Cumulative Distribution Function (100000 samples) Trace 1 Mean 24.29 dBm Peak 27.28 dBm Crest 2.98 dB</p> <table border="1"> <tr><td>10 %</td><td>2.52 dB</td></tr> <tr><td>1 %</td><td>2.88 dB</td></tr> <tr><td>.1 %</td><td>2.92 dB</td></tr> <tr><td>.01 %</td><td>3.00 dB</td></tr> </table> <p>Date: 6.FEB.2017 12:18:52</p>	10 %	2.52 dB	1 %	2.88 dB	.1 %	2.92 dB	.01 %	3.00 dB
10 %	0.08 dB																
1 %	0.12 dB																
.1 %	0.16 dB																
.01 %	0.16 dB																
10 %	2.52 dB																
1 %	2.88 dB																
.1 %	2.92 dB																
.01 %	3.00 dB																



26dB Bandwidth

Mode	GSM850 : 26dB BW(MHz)	
Mod.	GPRS class 8	EDGE class 8
Lowest CH	0.301	0.302
Middle CH	0.305	0.289
Highest CH	0.296	0.287

Mode	GSM1900 : 26dB BW(MHz)	
Mod.	GPRS class 8	EDGE class 8
Lowest CH	0.298	0.306
Middle CH	0.309	0.302
Highest CH	0.313	0.306

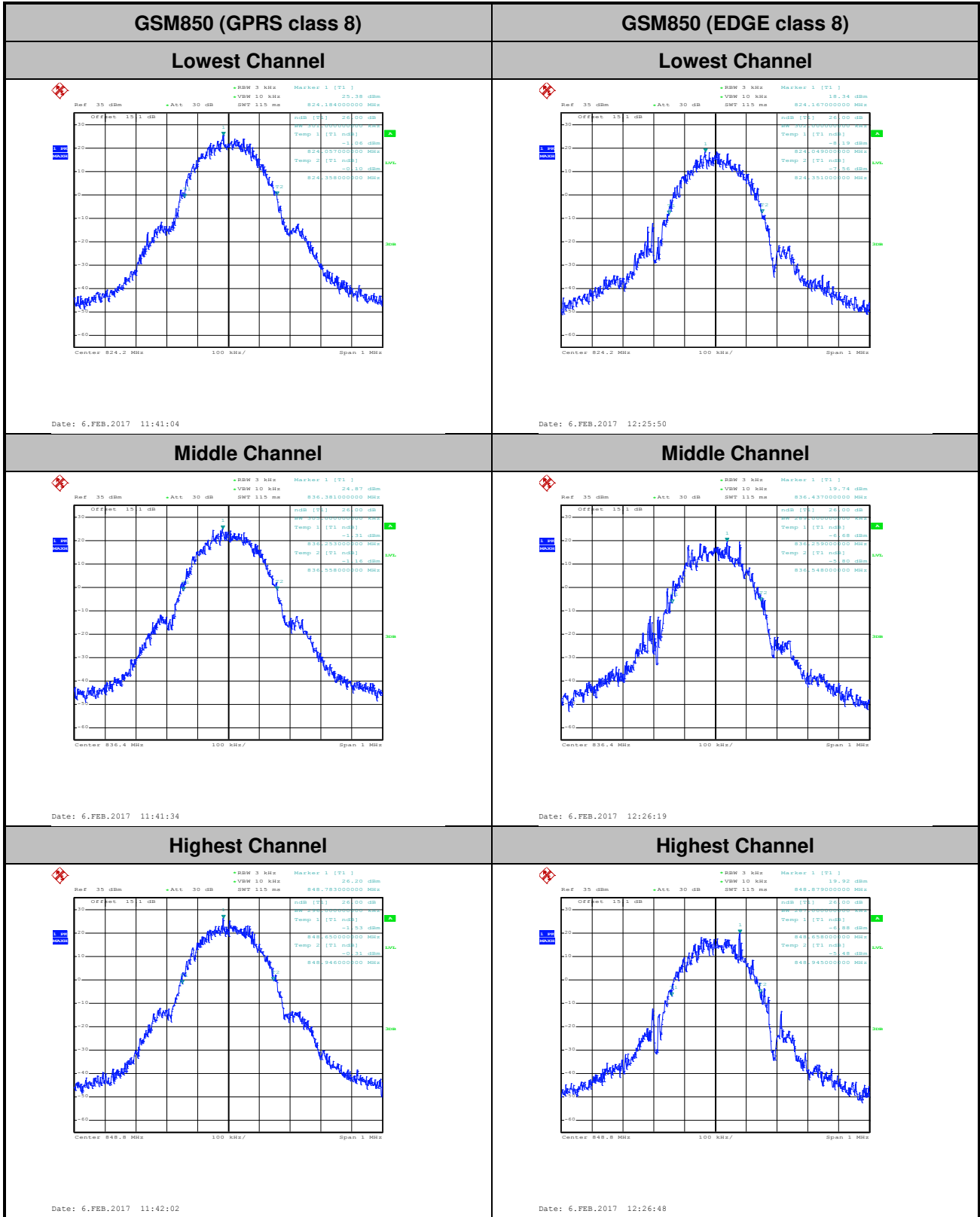

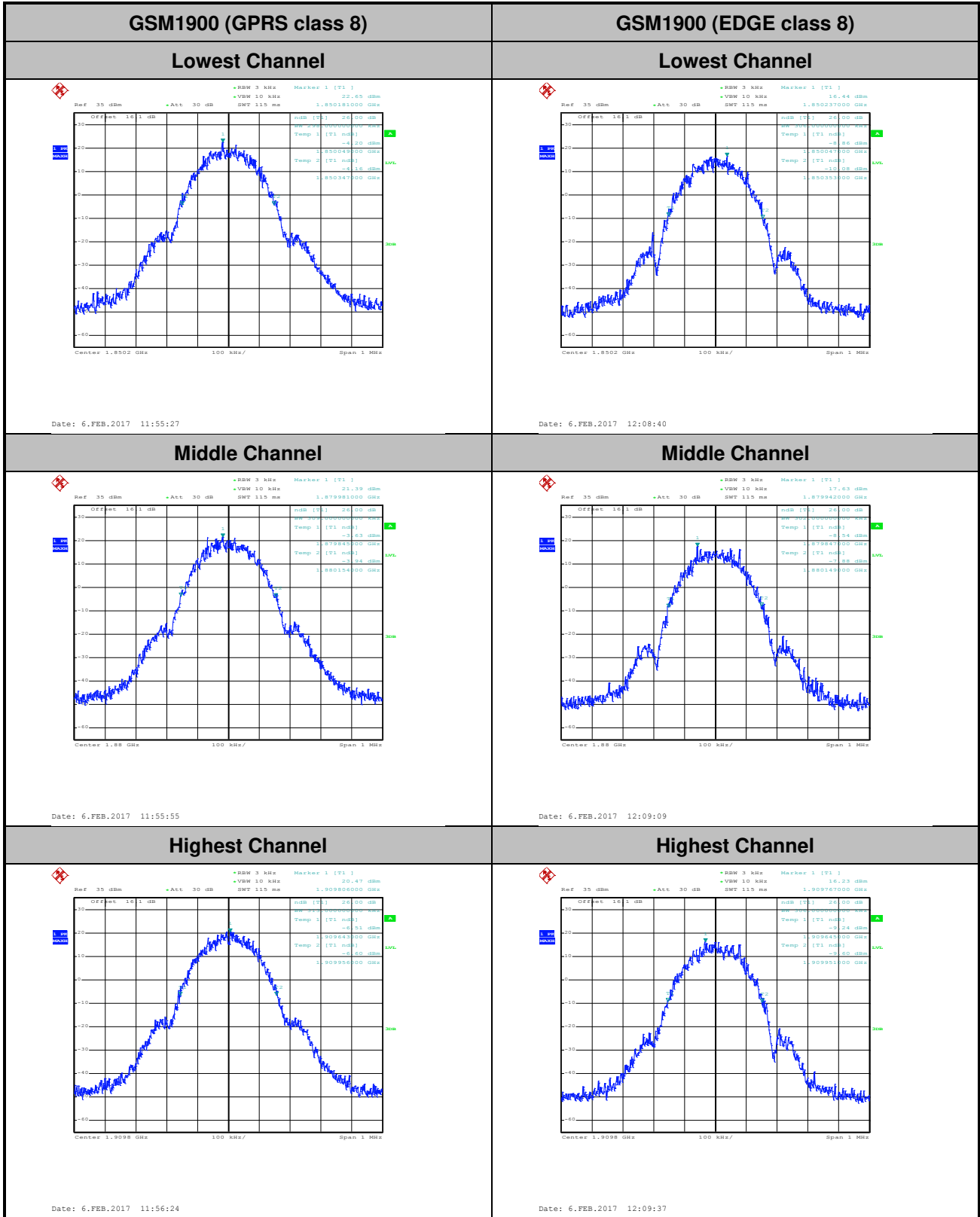



Occupied Bandwidth

Mode	GSM850 : 99%OBW(MHz)	
Mod.	GPRS class 8	EDGE class 8
Lowest CH	0.247	0.257
Middle CH	0.252	0.258
Highest CH	0.245	0.239

Mode	GSM1900 : 99%OBW(MHz)	
Mod.	GPRS class 8	EDGE class 8
Lowest CH	0.243	0.246
Middle CH	0.246	0.243
Highest CH	0.245	0.242

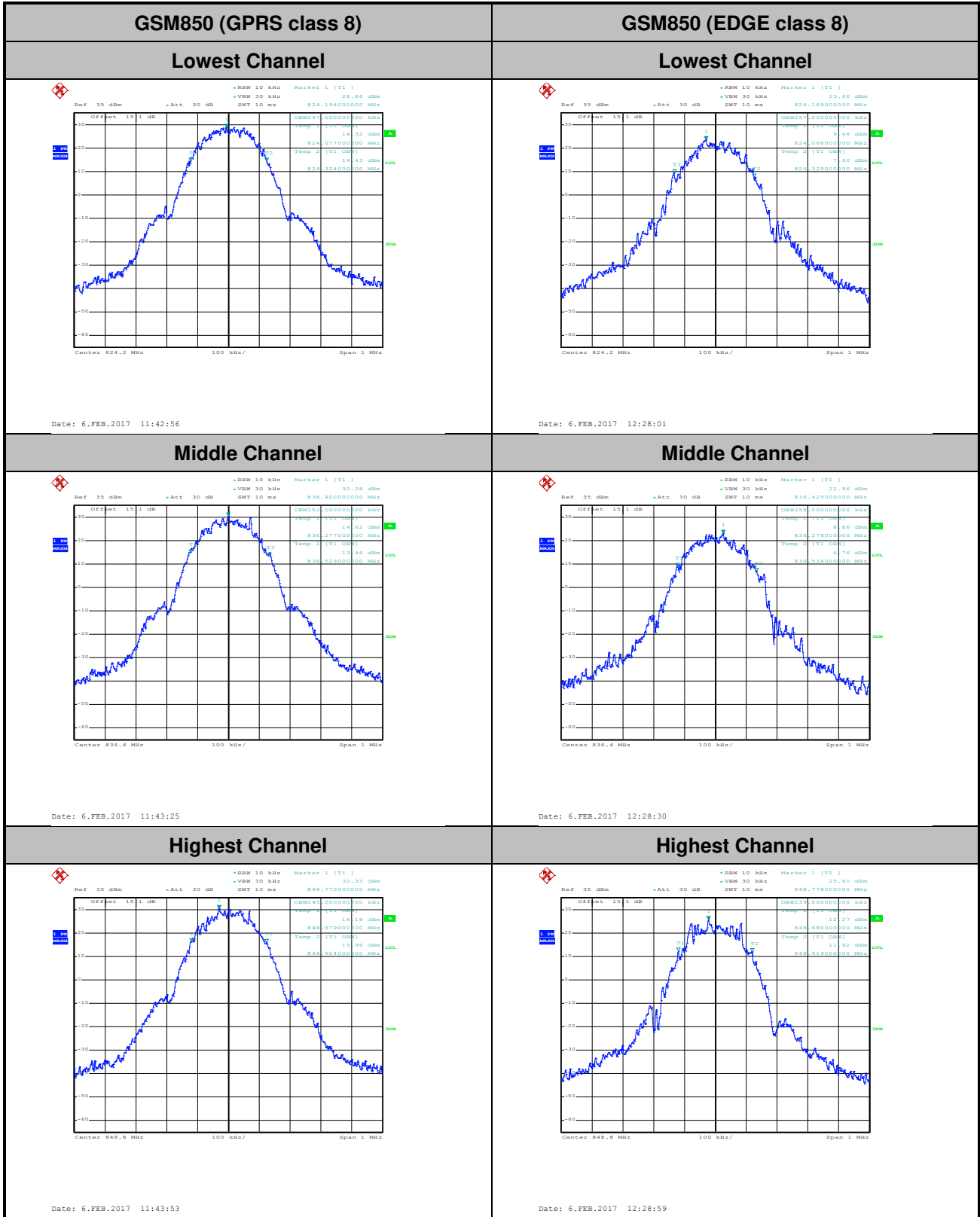

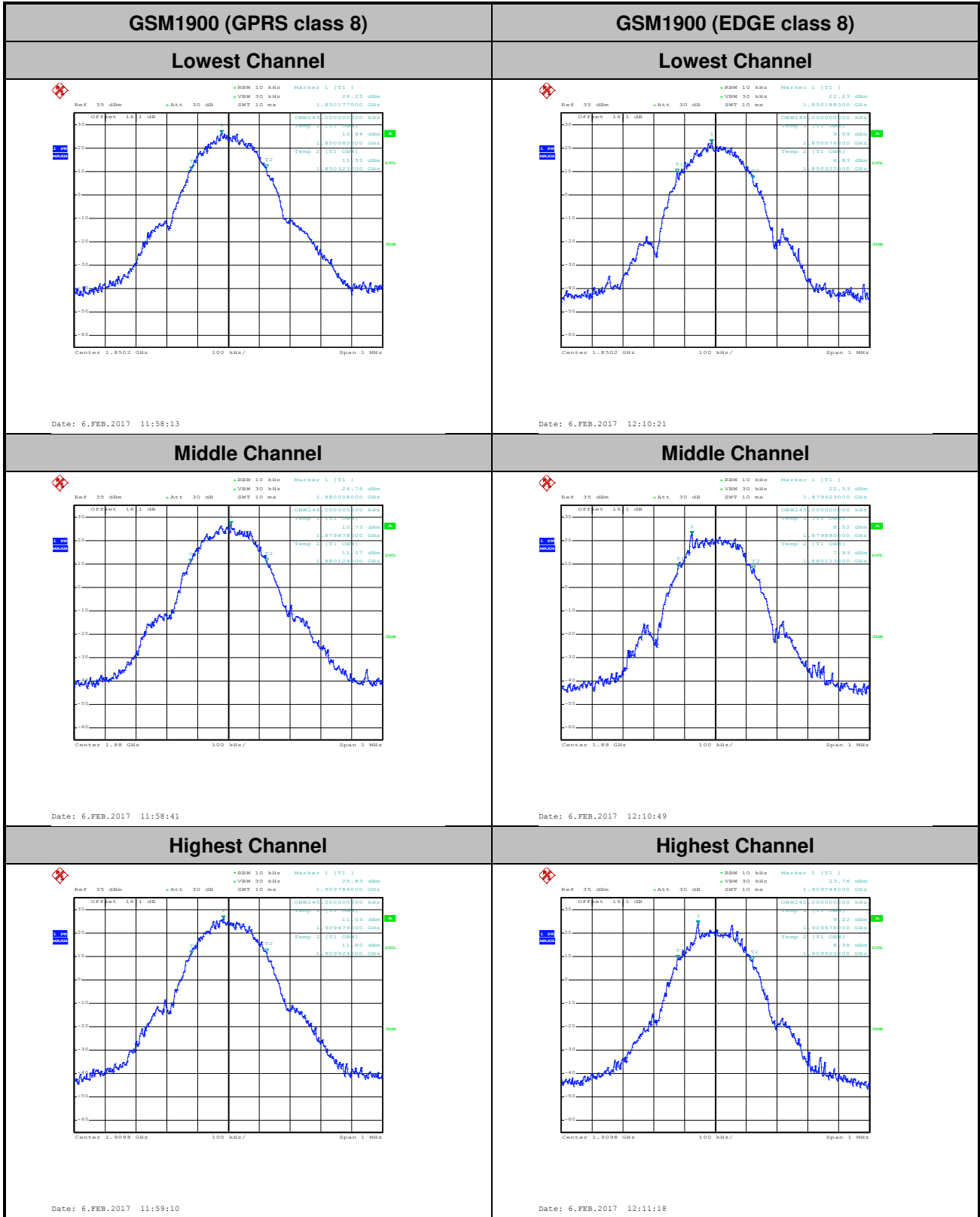



Conducted Band Edge

GSM850 (GPRS class 8)

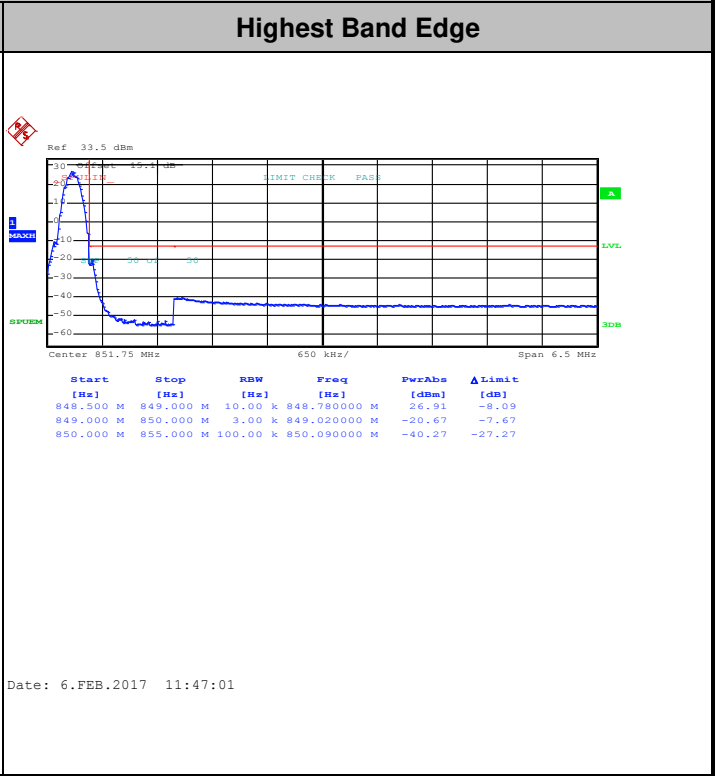
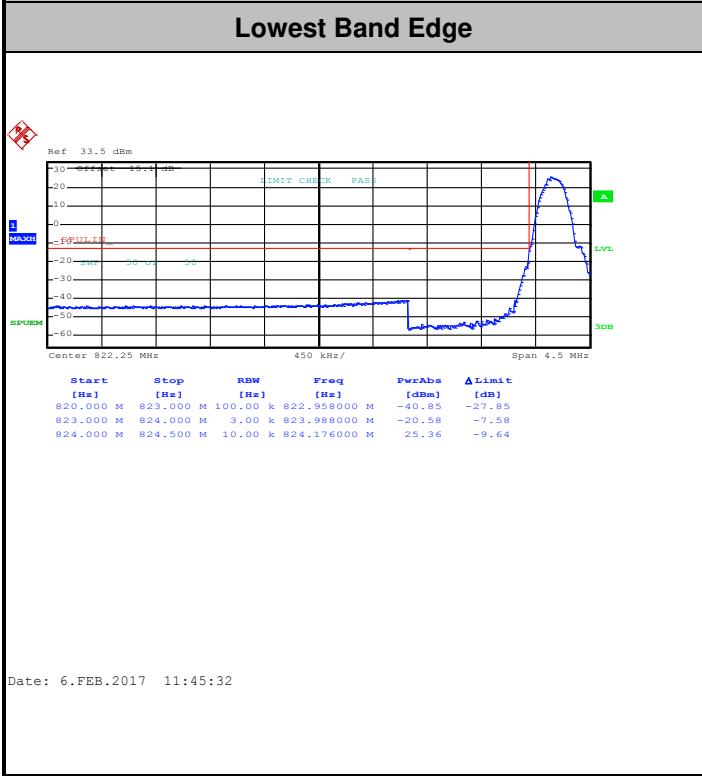

GSM850 (EDGE class 8)

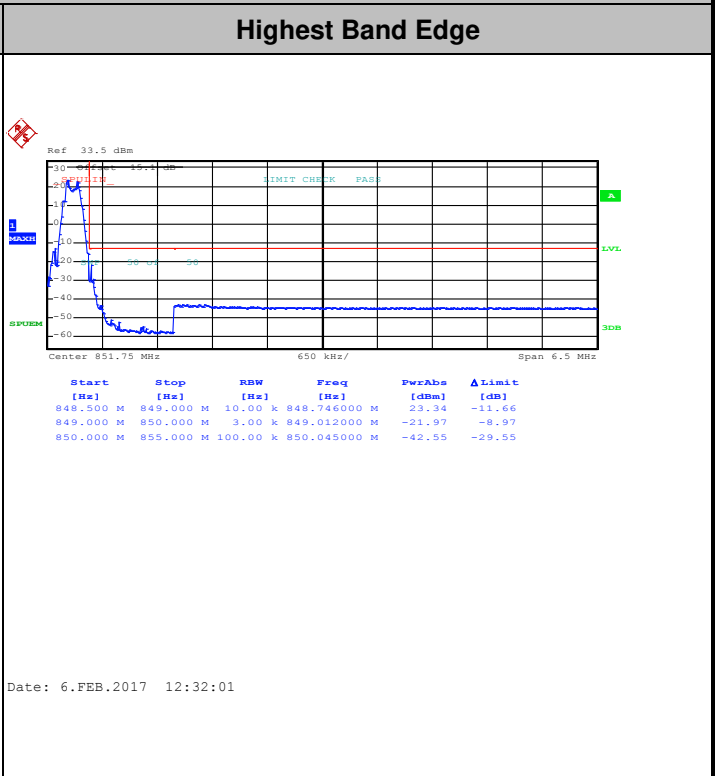
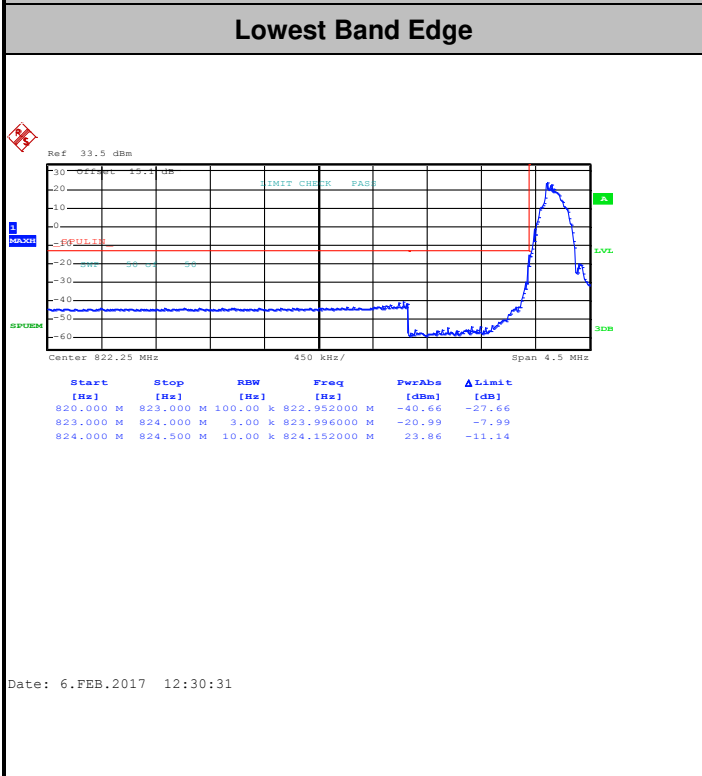



GSM1900 (GPRS class 8)

Lowest Band Edge

Highest Band Edge

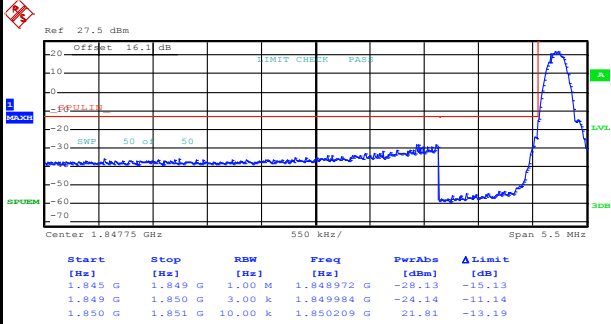

Date: 6.FEB.2017 12:01:24

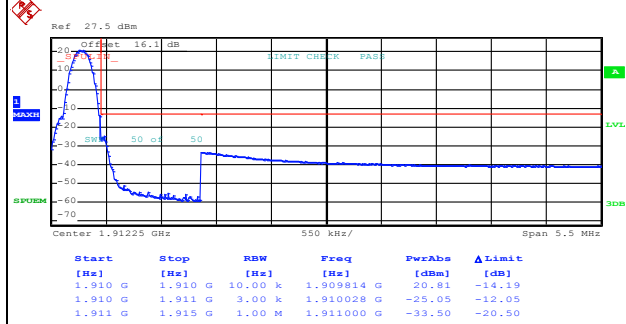

Date: 6.FEB.2017 12:02:51

GSM1900 (EDGE class 8)

Lowest Band Edge

Highest Band Edge

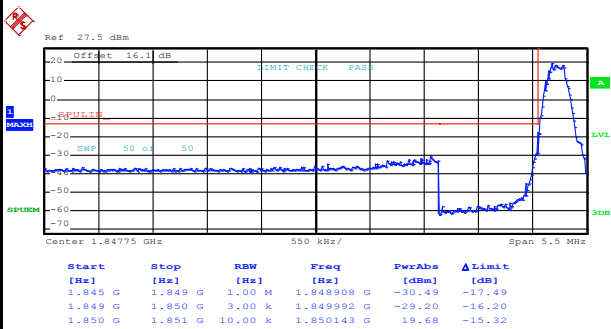

Date: 6.FEB.2017 12:12:48

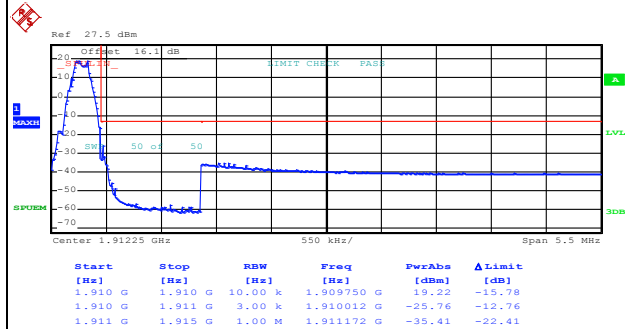

Date: 6.FEB.2017 12:14:16



Conducted Spurious Emission

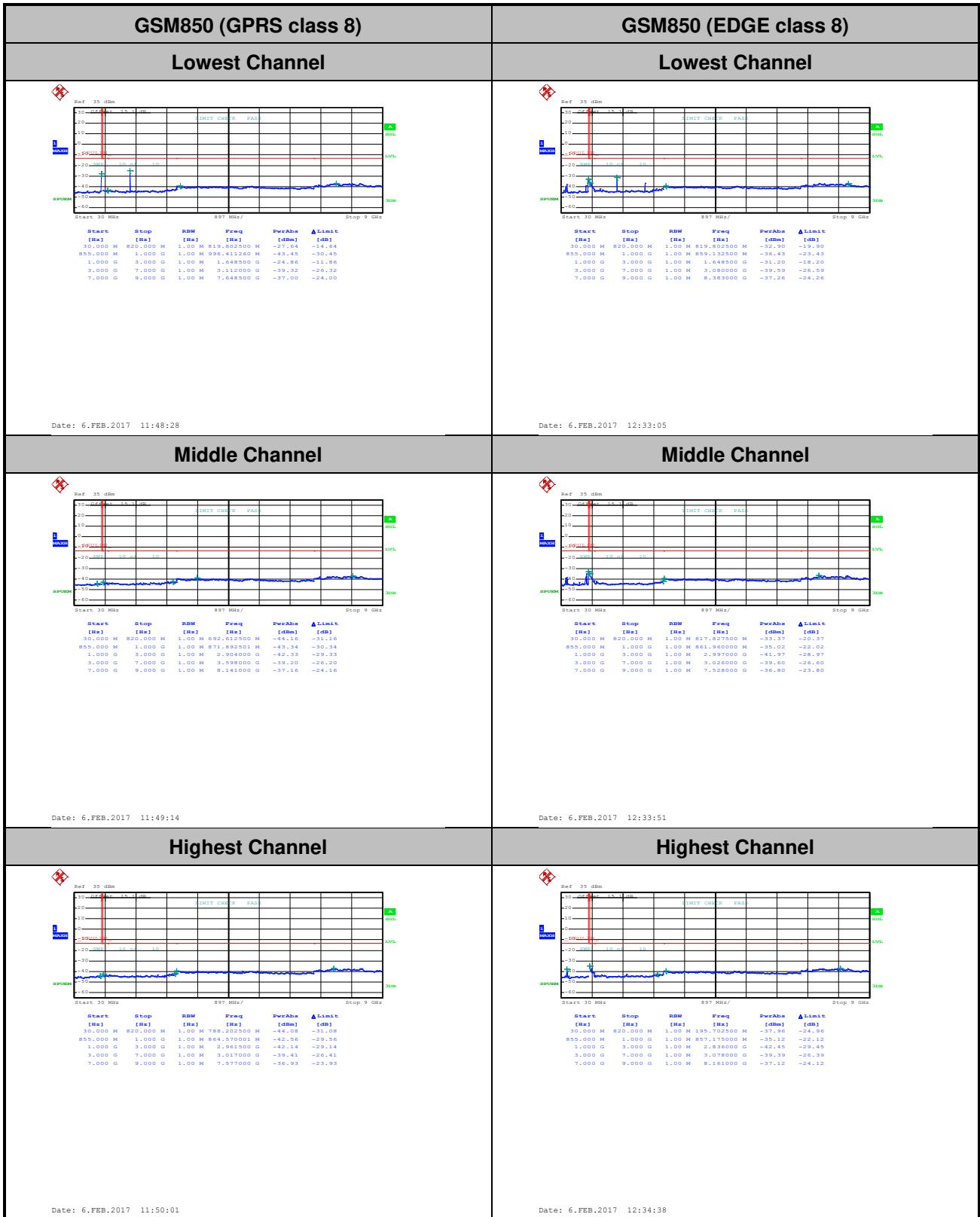

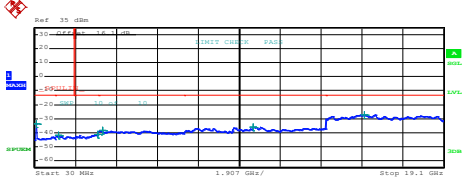
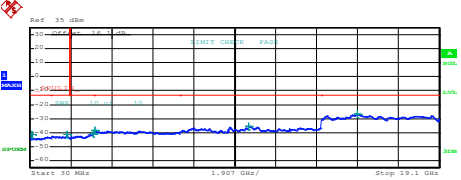
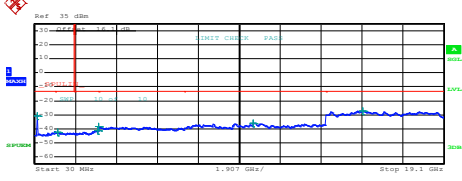
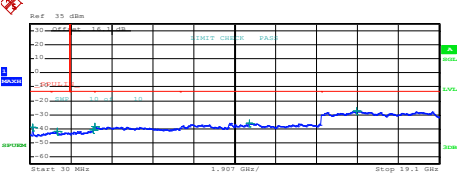
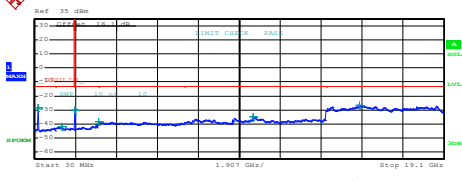
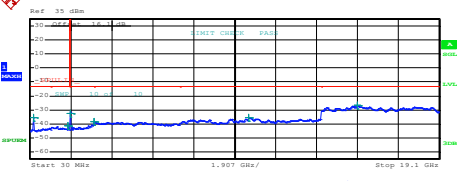

GSM1900 (GPRS class 8)	GSM1900 (EDGE class 8)																																																																																				
Lowest Channel	Lowest Channel																																																																																				
 <table border="1" data-bbox="239 577 638 672"> <thead> <tr> <th>Start [Hz]</th> <th>Stop [Hz]</th> <th>RBW [Hz]</th> <th>Freq [Hz]</th> <th>PwrAve [dBm]</th> <th>ΔLimit [dB]</th> </tr> </thead> <tbody> <tr><td>30,000 M</td><td>1,000 G</td><td>1,000 M</td><td>111,965000 M</td><td>-33.73</td><td>-29.73</td></tr> <tr><td>1,000 G</td><td>1,845 G</td><td>1,000 M</td><td>1,132876 G</td><td>-41.93</td><td>-28.93</td></tr> <tr><td>1,845 G</td><td>3,000 G</td><td>1,000 M</td><td>2,193278 G</td><td>-42.06</td><td>-28.06</td></tr> <tr><td>3,000 G</td><td>7,000 G</td><td>1,000 M</td><td>3,205000 G</td><td>-38.67</td><td>-25.67</td></tr> <tr><td>7,000 G</td><td>13,600 G</td><td>1,000 M</td><td>10,215025 G</td><td>-35.95</td><td>-22.95</td></tr> <tr><td>13,600 G</td><td>19,100 G</td><td>1,000 M</td><td>15,182687 G</td><td>-27.28</td><td>-14.28</td></tr> </tbody> </table> <p>Date: 6.FEB.2017 12:03:52</p>	Start [Hz]	Stop [Hz]	RBW [Hz]	Freq [Hz]	PwrAve [dBm]	ΔLimit [dB]	30,000 M	1,000 G	1,000 M	111,965000 M	-33.73	-29.73	1,000 G	1,845 G	1,000 M	1,132876 G	-41.93	-28.93	1,845 G	3,000 G	1,000 M	2,193278 G	-42.06	-28.06	3,000 G	7,000 G	1,000 M	3,205000 G	-38.67	-25.67	7,000 G	13,600 G	1,000 M	10,215025 G	-35.95	-22.95	13,600 G	19,100 G	1,000 M	15,182687 G	-27.28	-14.28	 <table border="1" data-bbox="893 577 1292 672"> <thead> <tr> <th>Start [Hz]</th> <th>Stop [Hz]</th> <th>RBW [Hz]</th> <th>Freq [Hz]</th> <th>PwrAve [dBm]</th> <th>ΔLimit [dB]</th> </tr> </thead> <tbody> <tr><td>30,000 M</td><td>1,000 G</td><td>1,000 M</td><td>111,722500 M</td><td>-41.50</td><td>-28.50</td></tr> <tr><td>1,000 G</td><td>1,845 G</td><td>1,000 M</td><td>1,744656 G</td><td>-41.52</td><td>-28.52</td></tr> <tr><td>1,845 G</td><td>3,000 G</td><td>1,000 M</td><td>2,995061 G</td><td>-40.92</td><td>-27.92</td></tr> <tr><td>3,000 G</td><td>7,000 G</td><td>1,000 M</td><td>3,031000 G</td><td>-38.53</td><td>-25.53</td></tr> <tr><td>7,000 G</td><td>13,600 G</td><td>1,000 M</td><td>10,216675 G</td><td>-35.37</td><td>-22.37</td></tr> <tr><td>13,600 G</td><td>19,100 G</td><td>1,000 M</td><td>15,102938 G</td><td>-26.84</td><td>-13.84</td></tr> </tbody> </table> <p>Date: 6.FEB.2017 12:15:20</p>	Start [Hz]	Stop [Hz]	RBW [Hz]	Freq [Hz]	PwrAve [dBm]	ΔLimit [dB]	30,000 M	1,000 G	1,000 M	111,722500 M	-41.50	-28.50	1,000 G	1,845 G	1,000 M	1,744656 G	-41.52	-28.52	1,845 G	3,000 G	1,000 M	2,995061 G	-40.92	-27.92	3,000 G	7,000 G	1,000 M	3,031000 G	-38.53	-25.53	7,000 G	13,600 G	1,000 M	10,216675 G	-35.37	-22.37	13,600 G	19,100 G	1,000 M	15,102938 G	-26.84	-13.84
Start [Hz]	Stop [Hz]	RBW [Hz]	Freq [Hz]	PwrAve [dBm]	ΔLimit [dB]																																																																																
30,000 M	1,000 G	1,000 M	111,965000 M	-33.73	-29.73																																																																																
1,000 G	1,845 G	1,000 M	1,132876 G	-41.93	-28.93																																																																																
1,845 G	3,000 G	1,000 M	2,193278 G	-42.06	-28.06																																																																																
3,000 G	7,000 G	1,000 M	3,205000 G	-38.67	-25.67																																																																																
7,000 G	13,600 G	1,000 M	10,215025 G	-35.95	-22.95																																																																																
13,600 G	19,100 G	1,000 M	15,182687 G	-27.28	-14.28																																																																																
Start [Hz]	Stop [Hz]	RBW [Hz]	Freq [Hz]	PwrAve [dBm]	ΔLimit [dB]																																																																																
30,000 M	1,000 G	1,000 M	111,722500 M	-41.50	-28.50																																																																																
1,000 G	1,845 G	1,000 M	1,744656 G	-41.52	-28.52																																																																																
1,845 G	3,000 G	1,000 M	2,995061 G	-40.92	-27.92																																																																																
3,000 G	7,000 G	1,000 M	3,031000 G	-38.53	-25.53																																																																																
7,000 G	13,600 G	1,000 M	10,216675 G	-35.37	-22.37																																																																																
13,600 G	19,100 G	1,000 M	15,102938 G	-26.84	-13.84																																																																																
Middle Channel	Middle Channel																																																																																				
 <table border="1" data-bbox="239 1102 638 1196"> <thead> <tr> <th>Start [Hz]</th> <th>Stop [Hz]</th> <th>RBW [Hz]</th> <th>Freq [Hz]</th> <th>PwrAve [dBm]</th> <th>ΔLimit [dB]</th> </tr> </thead> <tbody> <tr><td>30,000 M</td><td>1,000 G</td><td>1,000 M</td><td>141,792500 M</td><td>-30.78</td><td>-17.78</td></tr> <tr><td>1,000 G</td><td>1,845 G</td><td>1,000 M</td><td>1,080886 G</td><td>-42.37</td><td>-28.37</td></tr> <tr><td>1,845 G</td><td>3,000 G</td><td>1,000 M</td><td>2,983996 G</td><td>-41.26</td><td>-28.26</td></tr> <tr><td>3,000 G</td><td>7,000 G</td><td>1,000 M</td><td>3,015000 G</td><td>-38.63</td><td>-25.63</td></tr> <tr><td>7,000 G</td><td>13,600 G</td><td>1,000 M</td><td>10,217500 G</td><td>-36.00</td><td>-23.00</td></tr> <tr><td>13,600 G</td><td>19,100 G</td><td>1,000 M</td><td>15,132500 G</td><td>-27.09</td><td>-14.09</td></tr> </tbody> </table> <p>Date: 6.FEB.2017 12:04:38</p>	Start [Hz]	Stop [Hz]	RBW [Hz]	Freq [Hz]	PwrAve [dBm]	ΔLimit [dB]	30,000 M	1,000 G	1,000 M	141,792500 M	-30.78	-17.78	1,000 G	1,845 G	1,000 M	1,080886 G	-42.37	-28.37	1,845 G	3,000 G	1,000 M	2,983996 G	-41.26	-28.26	3,000 G	7,000 G	1,000 M	3,015000 G	-38.63	-25.63	7,000 G	13,600 G	1,000 M	10,217500 G	-36.00	-23.00	13,600 G	19,100 G	1,000 M	15,132500 G	-27.09	-14.09	 <table border="1" data-bbox="893 1102 1292 1196"> <thead> <tr> <th>Start [Hz]</th> <th>Stop [Hz]</th> <th>RBW [Hz]</th> <th>Freq [Hz]</th> <th>PwrAve [dBm]</th> <th>ΔLimit [dB]</th> </tr> </thead> <tbody> <tr><td>30,000 M</td><td>1,000 G</td><td>1,000 M</td><td>141,550000 M</td><td>-38.90</td><td>-25.90</td></tr> <tr><td>1,000 G</td><td>1,845 G</td><td>1,000 M</td><td>1,020081 G</td><td>-42.51</td><td>-29.51</td></tr> <tr><td>1,845 G</td><td>3,000 G</td><td>1,000 M</td><td>2,985081 G</td><td>-40.88</td><td>-27.88</td></tr> <tr><td>3,000 G</td><td>7,000 G</td><td>1,000 M</td><td>3,056000 G</td><td>-38.40</td><td>-25.40</td></tr> <tr><td>7,000 G</td><td>13,600 G</td><td>1,000 M</td><td>10,216625 G</td><td>-35.86</td><td>-22.86</td></tr> <tr><td>13,600 G</td><td>19,100 G</td><td>1,000 M</td><td>15,262375 G</td><td>-27.16</td><td>-14.16</td></tr> </tbody> </table> <p>Date: 6.FEB.2017 12:16:06</p>	Start [Hz]	Stop [Hz]	RBW [Hz]	Freq [Hz]	PwrAve [dBm]	ΔLimit [dB]	30,000 M	1,000 G	1,000 M	141,550000 M	-38.90	-25.90	1,000 G	1,845 G	1,000 M	1,020081 G	-42.51	-29.51	1,845 G	3,000 G	1,000 M	2,985081 G	-40.88	-27.88	3,000 G	7,000 G	1,000 M	3,056000 G	-38.40	-25.40	7,000 G	13,600 G	1,000 M	10,216625 G	-35.86	-22.86	13,600 G	19,100 G	1,000 M	15,262375 G	-27.16	-14.16
Start [Hz]	Stop [Hz]	RBW [Hz]	Freq [Hz]	PwrAve [dBm]	ΔLimit [dB]																																																																																
30,000 M	1,000 G	1,000 M	141,792500 M	-30.78	-17.78																																																																																
1,000 G	1,845 G	1,000 M	1,080886 G	-42.37	-28.37																																																																																
1,845 G	3,000 G	1,000 M	2,983996 G	-41.26	-28.26																																																																																
3,000 G	7,000 G	1,000 M	3,015000 G	-38.63	-25.63																																																																																
7,000 G	13,600 G	1,000 M	10,217500 G	-36.00	-23.00																																																																																
13,600 G	19,100 G	1,000 M	15,132500 G	-27.09	-14.09																																																																																
Start [Hz]	Stop [Hz]	RBW [Hz]	Freq [Hz]	PwrAve [dBm]	ΔLimit [dB]																																																																																
30,000 M	1,000 G	1,000 M	141,550000 M	-38.90	-25.90																																																																																
1,000 G	1,845 G	1,000 M	1,020081 G	-42.51	-29.51																																																																																
1,845 G	3,000 G	1,000 M	2,985081 G	-40.88	-27.88																																																																																
3,000 G	7,000 G	1,000 M	3,056000 G	-38.40	-25.40																																																																																
7,000 G	13,600 G	1,000 M	10,216625 G	-35.86	-22.86																																																																																
13,600 G	19,100 G	1,000 M	15,262375 G	-27.16	-14.16																																																																																
Highest Channel	Highest Channel																																																																																				
 <table border="1" data-bbox="239 1626 638 1720"> <thead> <tr> <th>Start [Hz]</th> <th>Stop [Hz]</th> <th>RBW [Hz]</th> <th>Freq [Hz]</th> <th>PwrAve [dBm]</th> <th>ΔLimit [dB]</th> </tr> </thead> <tbody> <tr><td>30,000 M</td><td>1,000 G</td><td>1,000 M</td><td>171,620000 M</td><td>-28.58</td><td>-15.58</td></tr> <tr><td>1,000 G</td><td>1,845 G</td><td>1,000 M</td><td>1,269978 G</td><td>-41.90</td><td>-28.90</td></tr> <tr><td>1,845 G</td><td>3,000 G</td><td>1,000 M</td><td>1,932071 G</td><td>-30.35</td><td>-17.35</td></tr> <tr><td>3,000 G</td><td>7,000 G</td><td>1,000 M</td><td>3,021000 G</td><td>-38.46</td><td>-25.46</td></tr> <tr><td>7,000 G</td><td>13,600 G</td><td>1,000 M</td><td>10,210900 G</td><td>-35.52</td><td>-22.52</td></tr> <tr><td>13,600 G</td><td>19,100 G</td><td>1,000 M</td><td>15,159250 G</td><td>-26.65</td><td>-13.65</td></tr> </tbody> </table> <p>Date: 6.FEB.2017 12:05:24</p>	Start [Hz]	Stop [Hz]	RBW [Hz]	Freq [Hz]	PwrAve [dBm]	ΔLimit [dB]	30,000 M	1,000 G	1,000 M	171,620000 M	-28.58	-15.58	1,000 G	1,845 G	1,000 M	1,269978 G	-41.90	-28.90	1,845 G	3,000 G	1,000 M	1,932071 G	-30.35	-17.35	3,000 G	7,000 G	1,000 M	3,021000 G	-38.46	-25.46	7,000 G	13,600 G	1,000 M	10,210900 G	-35.52	-22.52	13,600 G	19,100 G	1,000 M	15,159250 G	-26.65	-13.65	 <table border="1" data-bbox="893 1626 1292 1720"> <thead> <tr> <th>Start [Hz]</th> <th>Stop [Hz]</th> <th>RBW [Hz]</th> <th>Freq [Hz]</th> <th>PwrAve [dBm]</th> <th>ΔLimit [dB]</th> </tr> </thead> <tbody> <tr><td>30,000 M</td><td>1,000 G</td><td>1,000 M</td><td>171,620000 M</td><td>-35.87</td><td>-22.87</td></tr> <tr><td>1,000 G</td><td>1,845 G</td><td>1,000 M</td><td>1,791414 G</td><td>-41.38</td><td>-28.38</td></tr> <tr><td>1,845 G</td><td>3,000 G</td><td>1,000 M</td><td>1,932071 G</td><td>-32.65</td><td>-19.65</td></tr> <tr><td>3,000 G</td><td>7,000 G</td><td>1,000 M</td><td>3,021000 G</td><td>-38.46</td><td>-25.46</td></tr> <tr><td>7,000 G</td><td>13,600 G</td><td>1,000 M</td><td>10,210900 G</td><td>-35.52</td><td>-22.52</td></tr> <tr><td>13,600 G</td><td>19,100 G</td><td>1,000 M</td><td>15,287325 G</td><td>-26.65</td><td>-13.65</td></tr> </tbody> </table> <p>Date: 6.FEB.2017 12:16:53</p>	Start [Hz]	Stop [Hz]	RBW [Hz]	Freq [Hz]	PwrAve [dBm]	ΔLimit [dB]	30,000 M	1,000 G	1,000 M	171,620000 M	-35.87	-22.87	1,000 G	1,845 G	1,000 M	1,791414 G	-41.38	-28.38	1,845 G	3,000 G	1,000 M	1,932071 G	-32.65	-19.65	3,000 G	7,000 G	1,000 M	3,021000 G	-38.46	-25.46	7,000 G	13,600 G	1,000 M	10,210900 G	-35.52	-22.52	13,600 G	19,100 G	1,000 M	15,287325 G	-26.65	-13.65
Start [Hz]	Stop [Hz]	RBW [Hz]	Freq [Hz]	PwrAve [dBm]	ΔLimit [dB]																																																																																
30,000 M	1,000 G	1,000 M	171,620000 M	-28.58	-15.58																																																																																
1,000 G	1,845 G	1,000 M	1,269978 G	-41.90	-28.90																																																																																
1,845 G	3,000 G	1,000 M	1,932071 G	-30.35	-17.35																																																																																
3,000 G	7,000 G	1,000 M	3,021000 G	-38.46	-25.46																																																																																
7,000 G	13,600 G	1,000 M	10,210900 G	-35.52	-22.52																																																																																
13,600 G	19,100 G	1,000 M	15,159250 G	-26.65	-13.65																																																																																
Start [Hz]	Stop [Hz]	RBW [Hz]	Freq [Hz]	PwrAve [dBm]	ΔLimit [dB]																																																																																
30,000 M	1,000 G	1,000 M	171,620000 M	-35.87	-22.87																																																																																
1,000 G	1,845 G	1,000 M	1,791414 G	-41.38	-28.38																																																																																
1,845 G	3,000 G	1,000 M	1,932071 G	-32.65	-19.65																																																																																
3,000 G	7,000 G	1,000 M	3,021000 G	-38.46	-25.46																																																																																
7,000 G	13,600 G	1,000 M	10,210900 G	-35.52	-22.52																																																																																
13,600 G	19,100 G	1,000 M	15,287325 G	-26.65	-13.65																																																																																



Frequency Stability

Test Conditions	Middle Channel	GSM850 (GPRS class 8)	GSM850 (EDGE class 8)	Limit 2.5ppm
Temperature (°C)	Voltage (Volt)	Deviation (ppm)		Result
50	Normal Voltage	0.0012	0.0048	PASS
40	Normal Voltage	0.0036	0.0060	
30	Normal Voltage	0.0036	0.0000	
20(Ref.)	Normal Voltage	0.0000	0.0000	
10	Normal Voltage	0.0036	0.0060	
0	Normal Voltage	0.0012	0.0048	
-10	Normal Voltage	0.0000	0.0072	
-20	Normal Voltage	0.0024	0.0143	
-30	Normal Voltage	0.0000	0.0120	
20	Maximum Voltage	0.0012	0.0024	
20	Normal Voltage	0.0000	0.0000	
20	Battery End Point	0.0000	0.0024	

Test Conditions	Middle Channel	GSM1900 (GPRS class 8)	GSM1900 (EDGE class 8)	Limit Note 2.
Temperature (°C)	Voltage (Volt)	Deviation (ppm)		Result
50	Normal Voltage	0.0011	0.0021	PASS
40	Normal Voltage	0.0005	0.0005	
30	Normal Voltage	0.0005	0.0027	
20(Ref.)	Normal Voltage	0.0000	0.0000	
10	Normal Voltage	0.0090	0.0011	
0	Normal Voltage	0.0085	0.0090	
-10	Normal Voltage	0.0053	0.0090	
-20	Normal Voltage	0.0064	0.0101	
-30	Normal Voltage	0.0074	0.0106	
20	Maximum Voltage	0.0011	0.0005	
20	Normal Voltage	0.0000	0.0000	
20	Battery End Point	0.0005	0.0005	

Note:

1. Normal Voltage = 3.8V. ; Battery End Point (BEP) = 3.5 V. ; Maximum Voltage =4.2 V
2. The frequency fundamental emissions stay within the authorized frequency block.



A2. WCDMA

Peak-to-Average Ratio

Mode	WCDMA Band V	Limit: 13dB
Mod.	RMC 12.2Kbps	Result
Lowest CH	2.60	PASS
Middle CH	2.60	
Highest CH	2.60	



WCDMA Band V (RMC 12.2Kbps)

Lowest Channel

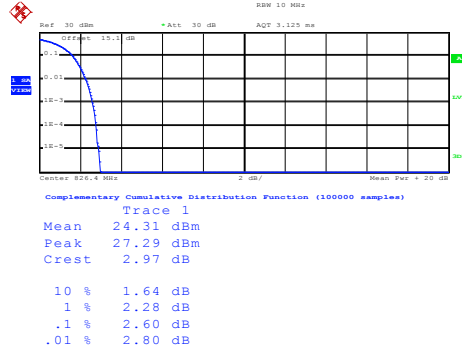

Date: 6.FEB.2017 13:48:49

Middle Channel

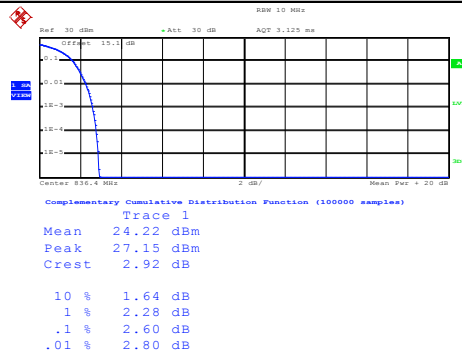

Date: 6.FEB.2017 13:49:06

Highest Channel

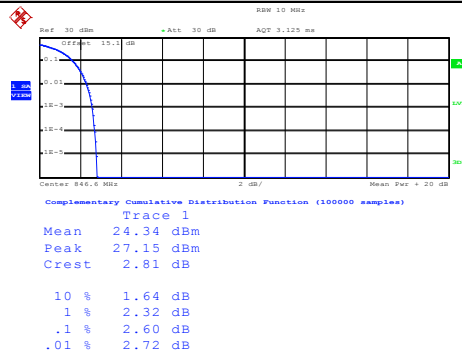

Date: 6.FEB.2017 13:49:24



26dB Bandwidth

Mode	WCDMA Band V 26dB BW(MHz)
Mod.	RMC 12.2Kbps
Lowest CH	4.87
Middle CH	4.89
Highest CH	4.89



WCDMA Band V (RMC 12.2Kbps)

Lowest Channel

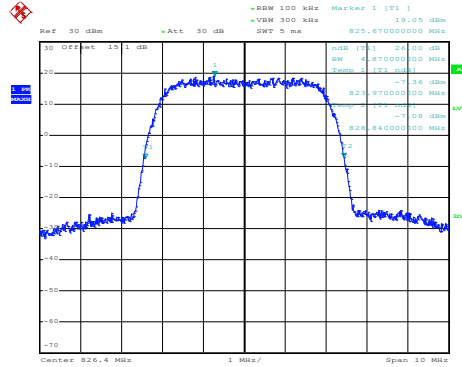

Date: 6.FEB.2017 12:03:59

Middle Channel

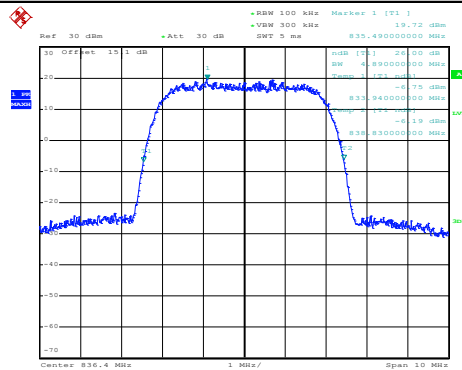

Date: 6.FEB.2017 12:04:27

Highest Channel

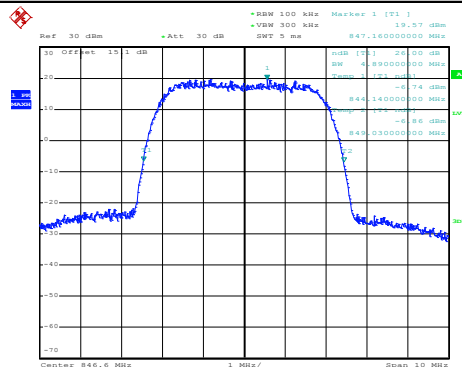

Date: 6.FEB.2017 12:04:55



Occupied Bandwidth

Mode	WCDMA Band V 99%OBW(MHz)
Mod.	RMC 12.2Kbps
Lowest CH	4.20
Middle CH	4.21
Highest CH	4.20



WCDMA Band V (RMC 12.2Kbps)

Lowest Channel

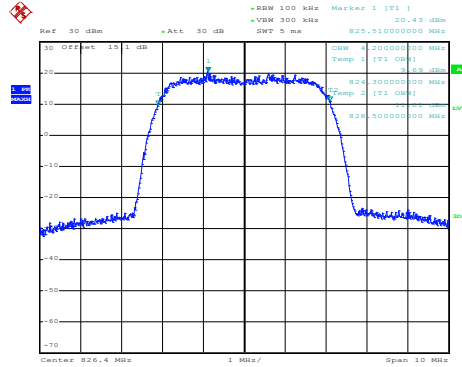

Date: 6.FEB.2017 13:39:17

Middle Channel

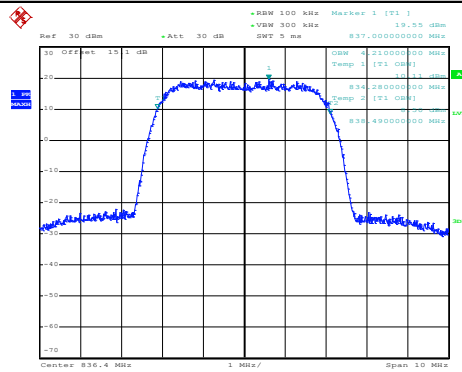

Date: 6.FEB.2017 13:39:45

Highest Channel

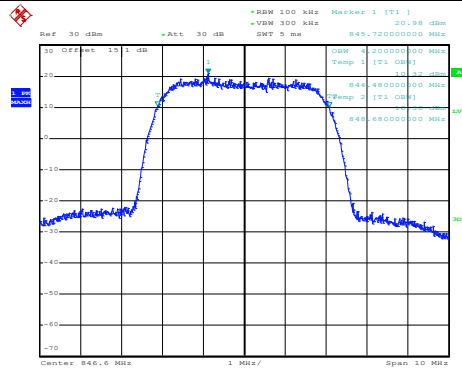

Date: 6.FEB.2017 13:40:13



Conducted Band Edge

WCDMA Band V (RMC 12.2Kbps)

Lowest Band Edge

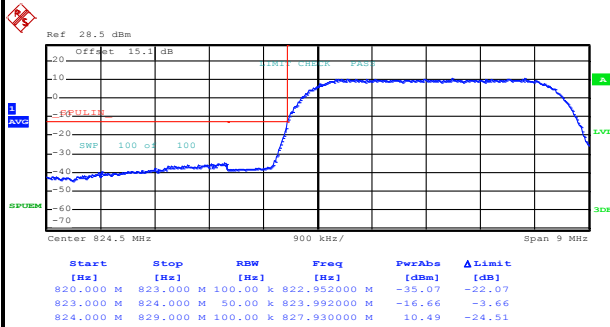

Date: 6.FEB.2017 13:43:04

Highest Band Edge

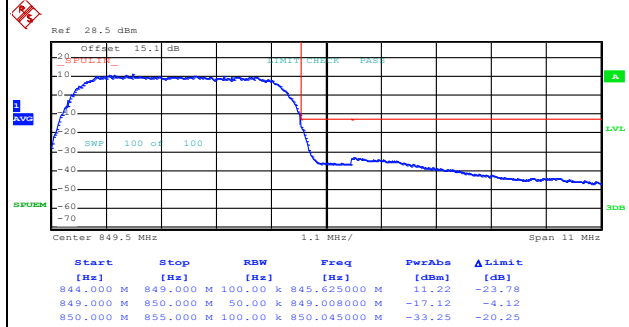

Date: 6.FEB.2017 13:45:46





Conducted Spurious Emission

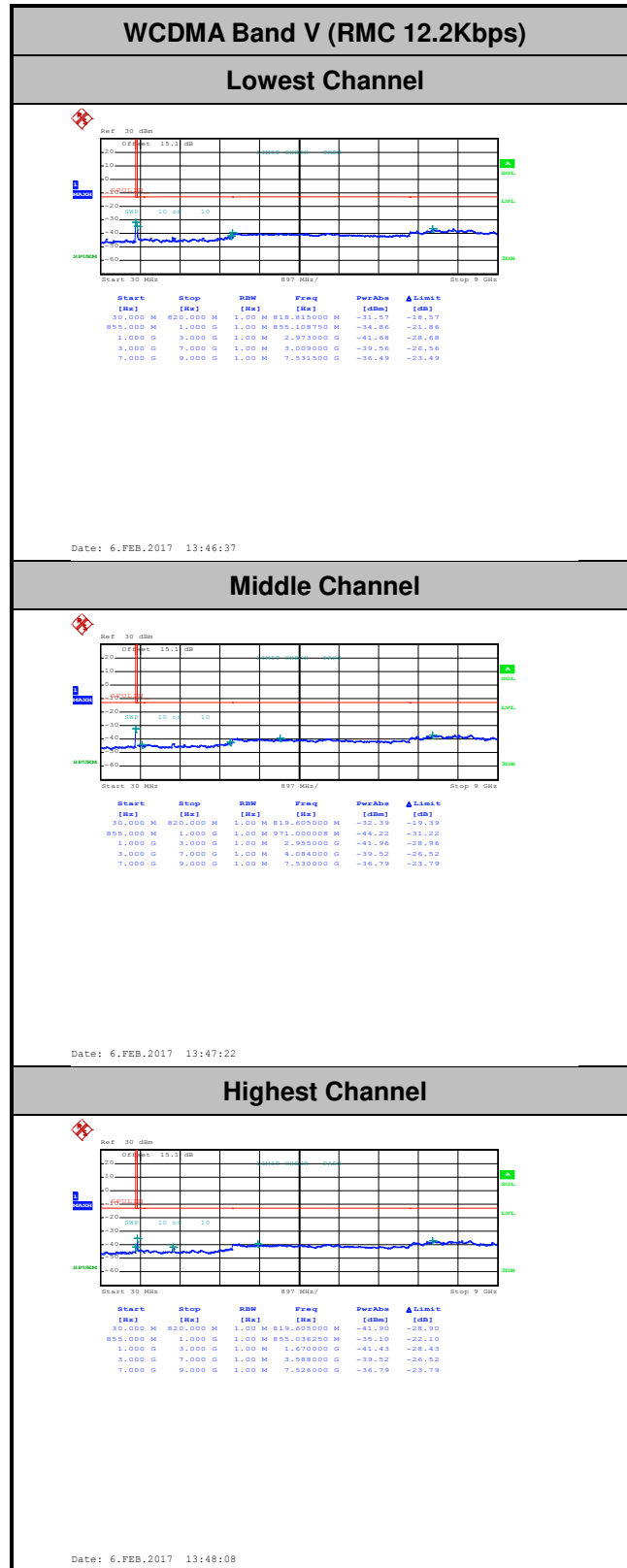



Frequency Stability

Test Conditions	Middle Channel	WCDMA Band V (RMC 12.2Kbps)	Limit 2.5ppm
Temperature (°C)	Voltage (Volt)	Deviation (ppm)	Result
50	Normal Voltage	0.0012	PASS
40	Normal Voltage	0.0036	
30	Normal Voltage	0.0024	
20(Ref.)	Normal Voltage	0.0000	
10	Normal Voltage	0.0012	
0	Normal Voltage	0.0036	
-10	Normal Voltage	0.0036	
-20	Normal Voltage	0.0048	
-30	Normal Voltage	0.0000	
20	Maximum Voltage	0.0012	
20	Normal Voltage	0.0000	
20	Battery End Point	0.0048	

Note:

- 1. Normal Voltage = 3.8V. ; Battery End Point (BEP) = 3.5 V. ; Maximum Voltage =4.2 V
- 2. The frequency fundamental emissions stay within the authorized frequency block.



Appendix B. Test Results of ERP/EIRP and Radiated Test

ERP/EIRP

Channel	Mode	Horizontal		Vertical	
		ERP(dBm)	ERP(W)	ERP(dBm)	ERP(W)
Lowest	GSM850 GPRS class 8	13.16	0.0207	26.04	0.4018
Middle		14.04	0.0254	26.29	0.4256
Highest		14.97	0.0314	27.34	0.5420
Lowest	GSM850 EDGE class 8	8.46	0.0070	21.81	0.1517
Middle		9.74	0.0094	22.19	0.1656
Highest		10.52	0.0113	22.71	0.1866
Lowest	WCDMA Band V AMR 12.2Kbps	6.36	0.0043	19.34	0.0859
Middle		6.67	0.0046	19.62	0.0916
Highest		7.42	0.0055	19.90	0.0977
Limit	ERP < 7W	Result		PASS	

Channel	Mode	Horizontal		Vertical	
		EIRP(dBm)	EIRP(W)	EIRP(dBm)	EIRP(W)
Lowest	GSM1900 GPRS class 8	29.06	0.8054	27.24	0.5297
Middle		29.52	0.8954	27.15	0.5188
Highest		28.91	0.7780	26.76	0.4742
Lowest	GSM1900 EDGE class 8	24.59	0.2877	22.86	0.1932
Middle		24.61	0.2891	22.38	0.1730
Highest		23.87	0.2438	21.80	0.1514
Limit	EIRP < 2W	Result		PASS	



Radiated Spurious Emission

GSM850 (GPRS class 8)									
Channel	Frequency (MHz)	ERP (dBm)	Limit (dBm)	Over Limit (dB)	SPA Reading (dBm)	S.G. Power (dBm)	TX Cable loss (dB)	TX Antenna Gain (dBi)	Polarization (H/V)
Lowest	1648	-45.91	-13	-32.91	-59.41	-47.67	0.98	4.89	H
	2472	-53.82	-13	-40.82	-70.45	-55.7	1.28	5.32	H
	3296	-57.17	-13	-44.17	-77.15	-60.58	1.54	7.10	H
	4120	-54.56	-13	-41.56	-76.33	-59.2	1.83	8.62	H
									H
									H
	1648	-49.64	-13	-36.64	-63.14	-51.4	0.98	4.89	V
	2472	-53.13	-13	-40.13	-69.76	-55.01	1.28	5.32	V
	3296	-58.75	-13	-45.75	-78.73	-62.16	1.54	7.10	V
	4120	-55.30	-13	-42.30	-77.07	-59.94	1.83	8.62	V
									V
									V

Remark: Spurious emissions within 30-1000MHz were found more than 20dB below limit line.



GSM850 (EDGE class 8)									
Channel	Frequency (MHz)	ERP (dBm)	Limit (dBm)	Over Limit (dB)	SPA Reading (dBm)	S.G. Power (dBm)	TX Cable loss (dB)	TX Antenna Gain (dBi)	Polarization (H/V)
Lowest	1648	-49.29	-13	-36.29	-62.79	-51.05	0.98	4.89	H
	2472	-61.54	-13	-48.54	-78.17	-63.42	1.28	5.32	H
	3296	-59.28	-13	-46.28	-79.26	-62.69	1.54	7.10	H
									H
									H
									H
	1648	-53.57	-13	-40.57	-67.07	-55.33	0.98	4.89	V
	2472	-61.68	-13	-48.68	-78.31	-63.56	1.28	5.32	V
	3296	-59.36	-13	-46.36	-79.34	-62.77	1.54	7.10	V
									V
									V
									V

Remark: Spurious emissions within 30-1000MHz were found more than 20dB below limit line.



GSM1900 (GPRS class 8)									
Channel	Frequency (MHz)	EIRP (dBm)	Limit (dBm)	Over Limit (dB)	SPA Reading (dBm)	S.G. Power (dBm)	TX Cable loss (dB)	TX Antenna Gain (dBi)	Polarization (H/V)
Highest	3819	-43.05	-13	-30.05	-64.04	-49.73	1.70	8.38	H
	5730	-49.01	-13	-36.01	-76.5	-56.04	2.76	9.79	H
	7641	-40.85	-13	-27.85	-74.78	-50.35	2.38	11.88	H
									H
									H
									H
	3819	-43.43	-13	-30.43	-64.42	-50.11	1.70	8.38	V
	5730	-49.53	-13	-36.53	-77.02	-56.56	2.76	9.79	V
	7641	-35.86	-13	-22.86	-69.79	-45.36	2.38	11.88	V
									V
									V
									V

Remark: Spurious emissions within 30-1000MHz were found more than 20dB below limit line.



GSM1900 (EDGE class 8)									
Channel	Frequency (MHz)	EIRP (dBm)	Limit (dBm)	Over Limit (dB)	SPA Reading (dBm)	S.G. Power (dBm)	TX Cable loss (dB)	TX Antenna Gain (dBi)	Polarization (H/V)
Highest	3819	-50.35	-13	-37.35	-71.34	-57.03	1.70	8.38	H
	5730	-49.58	-13	-36.58	-77.07	-56.61	2.76	9.79	H
	7641	-42.89	-13	-29.89	-76.82	-52.39	2.38	11.88	H
									H
									H
									H
	3819	-52.84	-13	-39.84	-64.42	-59.52	1.70	8.38	V
	5730	-51.72	-13	-38.72	-77.02	-58.75	2.76	9.79	V
	7641	-43.65	-13	-30.65	-69.79	-53.15	2.38	11.88	V
									V
									V
									V

Remark: Spurious emissions within 30-1000MHz were found more than 20dB below limit line.



WCDMA Band V(RMC 12.2Kbps)									
Channel	Frequency (MHz)	ERP (dBm)	Limit (dBm)	Over Limit (dB)	SPA Reading (dBm)	S.G. Power (dBm)	TX Cable loss (dB)	TX Antenna Gain (dBi)	Polarization (H/V)
Highest	1696	-49.78	-13	-36.78	-63.41	-51.38	1.00	4.75	H
	2536	-61.48	-13	-48.48	-78.36	-63.46	1.30	5.43	H
	3384	-59.00	-13	-46.00	-79.21	-62.77	1.57	7.49	H
									H
									H
									H
	1696	-53.53	-13	-40.53	-67.16	-55.13	1.00	4.75	V
	2536	-61.29	-13	-48.29	-78.17	-63.27	1.30	5.43	V
	3384	-58.80	-13	-45.80	-79.01	-62.57	1.57	7.49	V
									V
									V
									V

Remark: Spurious emissions within 30-1000MHz were found more than 20dB below limit line.