



FCC RF Test Report

APPLICANT : LG Electronics Mobile Comm USA
EQUIPMENT : Smart phone
BRAND NAME : LG
MODEL NAME : LG-X240H
FCC ID : ZNFX240H
STANDARD : FCC Part 15 Subpart C §15.247
CLASSIFICATION : (DTS) Digital Transmission System

The product was received on Oct. 18, 2016 and testing was completed on Feb. 24, 2017. We, SPORTON INTERNATIONAL INC., would like to declare that the tested sample has been evaluated in accordance with the test procedures and has been in compliance with the applicable technical standards.

The test results in this report apply exclusively to the tested model / sample. Without written approval of SPORTON INTERNATIONAL INC., the test report shall not be reproduced except in full.

Reviewed by: Joseph Lin / Supervisor

Approved by: Jones Tsai / Manager



SPORTON INTERNATIONAL INC.

No. 52, Hwa Ya 1st Rd., Hwa Ya Technology Park, Kwei-Shan District, Tao Yuan City, Taiwan, R.O.C.



TABLE OF CONTENTS

REVISION HISTORY..... 3

SUMMARY OF TEST RESULT 4

1 GENERAL DESCRIPTION 5

 1.1 Applicant 5

 1.2 Manufacturer 5

 1.3 Product Feature of Equipment Under Test..... 5

 1.4 Product Specification of Equipment Under Test..... 5

 1.5 Modification of EUT 5

 1.6 Testing Location 6

 1.7 Applicable Standards 6

2 TEST CONFIGURATION OF EQUIPMENT UNDER TEST 7

 2.1 Carrier Frequency and Channel 7

 2.2 Test Mode 7

 2.3 Connection Diagram of Test System 8

 2.4 Support Unit used in test configuration and system 9

 2.5 EUT Operation Test Setup 9

 2.6 Measurement Results Explanation Example 9

3 TEST RESULT 10

 3.1 6dB and 99% Bandwidth Measurement 10

 3.2 Output Power Measurement..... 12

 3.3 Power Spectral Density Measurement 13

 3.4 Conducted Band Edges and Spurious Emission Measurement 15

 3.5 Radiated Band Edges and Spurious Emission Measurement 28

 3.6 AC Conducted Emission Measurement..... 32

 3.7 Antenna Requirements 36

4 LIST OF MEASURING EQUIPMENT 37

5 UNCERTAINTY OF EVALUATION 38

APPENDIX A. CONDUCTED TEST RESULTS

APPENDIX B. RADIATED SPURIOUS EMISSION

APPENDIX C. RADIATED SPURIOUS EMISSION PLOTS

APPENDIX D. DUTY CYCLE PLOTS

APPENDIX E. SETUP PHOTOGRAPHS



REVISION HISTORY

REPORT NO.	VERSION	DESCRIPTION	ISSUED DATE
FR6O1802C	Rev. 01	Initial issue of report	Feb. 17, 2017
FR6O1802C	Rev. 02	Revising conducted and radiated emission of 802.11b	Feb. 27, 2017
FR6O1802C	Rev. 03	Revising maximum output power of 802.11b	Mar. 24, 2017



SUMMARY OF TEST RESULT

Report Section	FCC Rule	Description	Limit	Result	Remark
3.1	15.247(a)(2)	6dB Bandwidth	$\geq 0.5\text{MHz}$	Pass	-
3.1	-	99% Bandwidth	-	Pass	-
3.2	15.247(b)	Power Output Measurement	$\leq 30\text{dBm}$	Pass	-
3.3	15.247(e)	Power Spectral Density	$\leq 8\text{dBm}/3\text{kHz}$	Pass	-
3.4	15.247(d)	Conducted Band Edges	$\leq 20\text{dBc}$	Pass	-
		Conducted Spurious Emission		Pass	-
3.5	15.247(d)	Radiated Band Edges and Radiated Spurious Emission	15.209(a) & 15.247(d)	Pass	Under limit 7.24 dB at 2389.380 MHz
3.6	15.207	AC Conducted Emission	15.207(a)	Pass	Under limit 14.80 dB at 0.406 MHz
3.7	15.203 & 15.247(b)	Antenna Requirement	N/A	Pass	-



1 General Description

1.1 Applicant

LG Electronics Mobile Comm USA

LG Twin Towers 20, Yeouido-Dong Youngdeungpo-Gu, Seoul 150-721, Republic Of Korea

1.2 Manufacturer

Arima Communications Corp.

6F, No. 866, Jhongjheng Rd., Jhonghe Dist., New Taipei City 23586, Taiwan

1.3 Product Feature of Equipment Under Test

Product Feature	
Equipment	Smart phone
Brand Name	LG
Model Name	LG-X240H
FCC ID	ZNFX240H
EUT supports Radios application	GSM/EGPRS/WCDMA/HSPA/LTE WLAN 11b/g/n HT20/HT40 Bluetooth BR/EDR/LE
HW Version	PP2
SW Version	LGX240HAT-00-V08a-CIS-XX-NOV-17-2016+0
EUT Stage	Production Unit

Remark: The above EUT's information was declared by manufacturer. Please refer to the specifications or user's manual for more detailed description.

1.4 Product Specification of Equipment Under Test

Standards-related Product Specification	
Tx/Rx Channel Frequency Range	2412 MHz ~ 2462 MHz
Maximum (Peak) Output Power to antenna	802.11b : 19.85 dBm (0.0966 W) 802.11g : 22.58 dBm (0.1811 W) 802.11n HT20 : 20.97 dBm (0.1250 W) 802.11n HT40 : 21.52 dBm (0.1419 W)
99% Occupied Bandwidth	802.11b : 12.65MHz 802.11g : 17.85MHz 802.11n HT20 : 18.55MHz 802.11n HT40 : 36.60MHz
Antenna Type / Gain	PIFA Antenna type with gain -2.10 dBi
Type of Modulation	802.11b : DSSS (DBPSK / DQPSK / CCK) 802.11g/n : OFDM (BPSK / QPSK / 16QAM / 64QAM)

1.5 Modification of EUT

No modifications are made to the EUT during all test items.



1.6 Testing Location

Sporton Lab is accredited to ISO 17025 by Taiwan Accreditation Foundation (TAF code : 1190) and the FCC designation No. TW1022 under the FCC 2.948(e) by Mutual Recognition Agreement (MRA) in FCC Test.

Test Site	SPORTON INTERNATIONAL INC.	
Test Site Location	No. 52, Hwa Ya 1 st Rd., Hwa Ya Technology Park, Kwei-Shan District, Tao Yuan City, Taiwan, R.O.C. TEL: +886-3-327-3456 FAX: +886-3-328-4978	
Test Site No.	Sporton Site No.	
	TH05-HY	CO05-HY

Note: The test site complies with ANSI C63.4 2014 requirement.

Test Site	SPORTON INTERNATIONAL INC.	
Test Site Location	No.58, Aly. 75, Ln. 564, Wenhua 3rd Rd. Guishan Dist, Taoyuan City, Taiwan (R.O.C.) TEL: +886-3-327-0868 FAX: +886-3-327-0855	
Test Site No.	Sporton Site No.	
	03CH11-HY	

Note: The test site complies with ANSI C63.4 2014 requirement.

1.7 Applicable Standards

According to the specifications of the manufacturer, the EUT must comply with the requirements of the following standards:

- FCC Part 15 Subpart C §15.247
- FCC KDB Publication No. 558074 D01 DTS Meas. Guidance v03r05
- ANSI C63.10-2013

Remark:

1. All test items were verified and recorded according to the standards and without any deviation during the test.
2. This EUT has also been tested and complied with the requirements of FCC Part 15, Subpart B, recorded in a separate test report.



2 Test Configuration of Equipment Under Test

The EUT has been associated with peripherals and configuration operated in a manner tended to maximize its emission characteristics in a typical application. Frequency range investigated: conducted emission (150 kHz to 30 MHz) and radiated emission (9 kHz to the 10th harmonic of the highest fundamental frequency or to 40 GHz, whichever is lower). For radiated measurement, pre-scanned in three orthogonal panels, X, Y, Z. The worst cases (Y plane) were recorded in this report.

2.1 Carrier Frequency and Channel

Frequency Band	Channel	Freq. (MHz)	Channel	Freq. (MHz)
2400-2483.5 MHz	1	2412	7	2442
	2	2417	8	2447
	3	2422	9	2452
	4	2427	10	2457
	5	2432	11	2462
	6	2437	-	-

2.2 Test Mode

Final test mode of conducted test items and radiated spurious emissions are considering the modulation and worse data rates as below table.

Modulation	Data Rate
802.11b	1 Mbps
802.11g	6 Mbps
802.11n HT20	MCS0
802.11n HT40	MCS0

Test Cases	
AC Conducted Emission	Mode 1: WCDMA Band II Idle + Bluetooth Link + WLAN Link + Camera (Front) + Earphone + Battery + USB Cable (Charging from Adapter)

2.3 Connection Diagram of Test System

<WLAN Tx Mode>

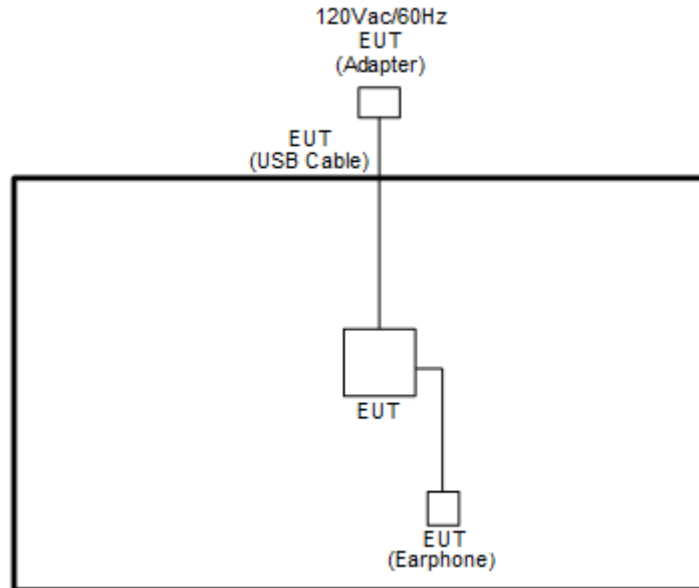

<AC Conducted Emission Mode>

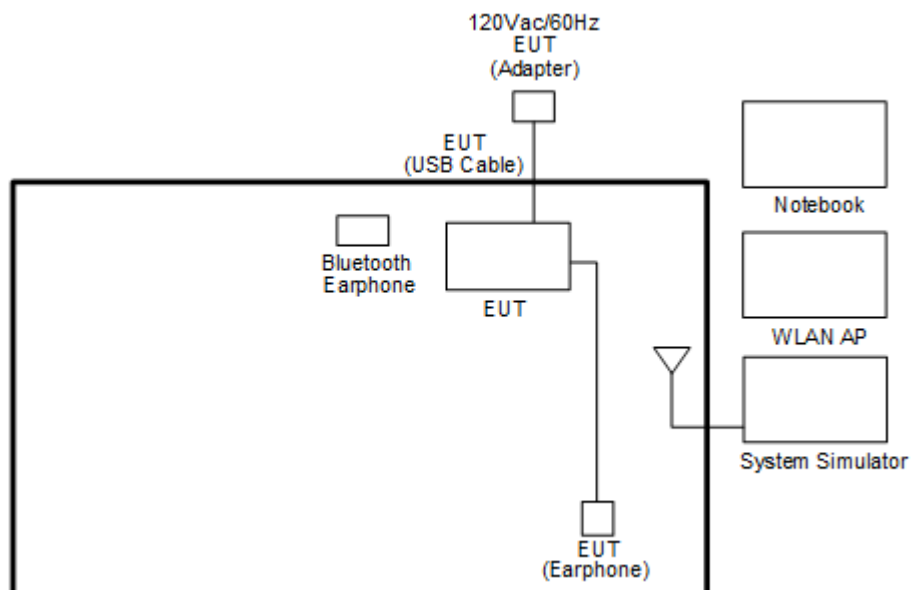



2.4 Support Unit used in test configuration and system

Item	Equipment	Trade Name	Model Name	FCC ID	Data Cable	Power Cord
1.	System Simulator	Anritsu	MT8820C	N/A	N/A	Unshielded, 1.8 m
2.	Bluetooth Earphone	Sony Ericsson	MW600	PY7DDA-2029	N/A	N/A
3.	WLAN AP	ASUS	RT-AC66U	MSQ-RTAC66U	N/A	Unshielded, 1.8 m
4.	Notebook	DELL	Latitude E6320	FCC DoC/ Contains FCC ID: QDS-BRCM1054	N/A	AC I/P: Unshielded, 1.2 m DC O/P: Shielded, 1.8 m
5.	SD Card	SanDisk	MicroSD HC	FCC DoC	N/A	N/A

2.5 EUT Operation Test Setup

For WLAN RF test items, an engineering test program was provided and enabled to make EUT continuous transmit/receive.

2.6 Measurement Results Explanation Example

For all conducted test items:

The offset level is set in the spectrum analyzer to compensate the RF cable loss and attenuator factor between EUT conducted output port and spectrum analyzer. With the offset compensation, the spectrum analyzer reading level is exactly the EUT RF output level.

Example :

The spectrum analyzer offset is derived from RF cable loss and attenuator factor.

Offset = RF cable loss + attenuator factor.

Following shows an offset computation example with cable loss 4.2 dB and 10dB attenuator.

$$\begin{aligned} \text{Offset(dB)} &= \text{RF cable loss(dB)} + \text{attenuator factor(dB)}. \\ &= 4.2 + 10 = 14.2 \text{ (dB)} \end{aligned}$$

3 Test Result

3.1 6dB and 99% Bandwidth Measurement

3.1.1 Limit of 6dB and 99% Bandwidth

The minimum 6 dB bandwidth shall be at least 500 kHz.

3.1.2 Measuring Instruments

The measuring equipment is listed in the section 4 of this test report.

3.1.3 Test Procedures

1. The testing follows FCC KDB Publication No. 558074 DTS D01 Meas. Guidance v03r05.
2. The RF output of EUT was connected to the spectrum analyzer by RF cable and attenuator. The path loss was compensated to the results for each measurement.
3. Set to the maximum power setting and enable the EUT transmit continuously.
4. Make the measurement with the spectrum analyzer's resolution bandwidth (RBW) = 100 kHz. Set the Video bandwidth (VBW) = 300 kHz. In order to make an accurate measurement. The 6 dB bandwidth must be greater than 500 kHz.
5. For 99% Bandwidth Measurement, the spectrum analyzer's resolution bandwidth (RBW) = 1MHz and set the Video bandwidth (VBW) = 3MHz.
6. Measure and record the results in the test report.

3.1.4 Test Setup





3.1.5 Test Result of 6dB and 99% Occupied Bandwidth

Please refer to Appendix A.

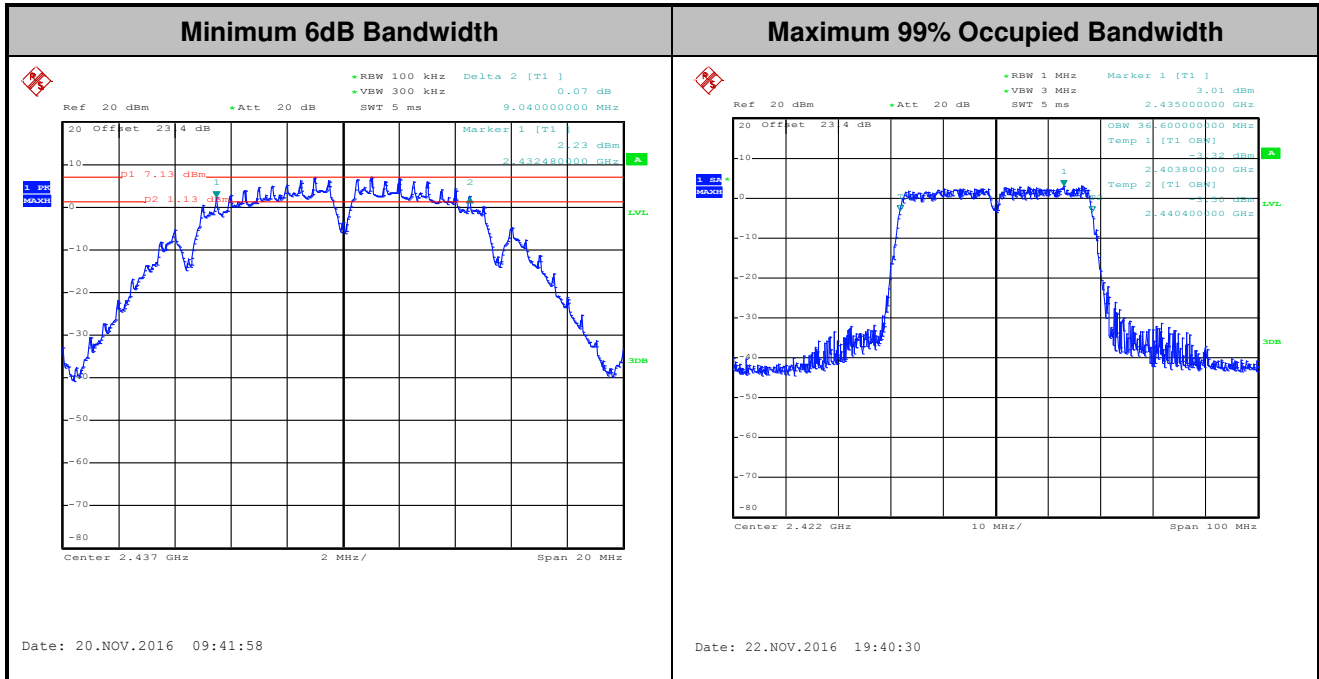

Note: The occupied channel bandwidth is maintained within the band of operation for all of the modulations.

3.2 Output Power Measurement

3.2.1 Limit of Output Power

For systems using digital modulation in the 2400-2483.5MHz, the limit for peak output power is 30dBm. If transmitting antenna of directional gain greater than 6dBi are used the peak output power from the intentional radiator shall be reduced below the above stated value by the amount in dB that the directional gain of the antenna exceeds 6 dBi. In case of point-to-point operation, the limit has to be reduced by 1dB for every 3dB that the directional gain of the antenna exceeds 6dBi.

3.2.2 Measuring Instruments

The measuring equipment is listed in the section 4 of this test report.

3.2.3 Test Procedures

1. The testing follows the Measurement Procedure of FCC KDB No. 558074 DTS D01 Meas. Guidance v03r05 section 9.1.2 PKPM1 Peak power meter method.
2. The RF output of EUT was connected to the power meter by RF cable and attenuator. The path loss was compensated to the results for each measurement.
3. Set to the maximum power setting and enable the EUT transmit continuously.
4. Measure the conducted output power and record the results in the test report.

3.2.4 Test Setup

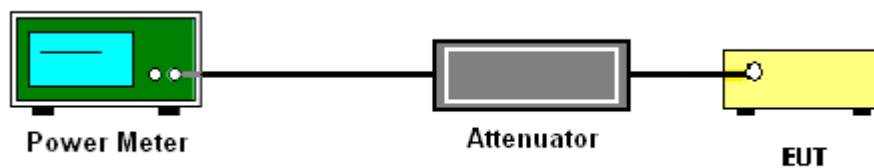

3.2.5 Test Result of Peak Output Power

Please refer to Appendix A.

3.2.6 Test Result of Average output Power (Reporting Only)

Please refer to Appendix A.

3.3 Power Spectral Density Measurement

3.3.1 Limit of Power Spectral Density

The peak power spectral density shall not be greater than 8dBm in any 3kHz band at any time interval of continuous transmission.

3.3.2 Measuring Instruments

The measuring equipment is listed in the section 4 of this test report.

3.3.3 Test Procedures

1. The testing follows Measurement Procedure 10.2 Method PKPSD of FCC KDB Publication No. 558074 D01 DTS Meas. Guidance v03r05
2. The RF output of EUT was connected to the spectrum analyzer by RF cable and attenuator. The path loss was compensated to the results for each measurement.
3. Set to the maximum power setting and enable the EUT transmit continuously.
4. Make the measurement with the spectrum analyzer's resolution bandwidth (RBW) = 3 kHz. Video bandwidth VBW = 10 kHz In order to make an accurate measurement, set the span to 1.5 times DTS Channel Bandwidth. (6dB BW)
5. Detector = peak, Sweep time = auto couple, Trace mode = max hold, Allow trace to fully stabilize. Use the peak marker function to determine the maximum power level.
6. Measure and record the results in the test report.

3.3.4 Test Setup





3.3.5 Test Result of Power Spectral Density

Please refer to Appendix A.

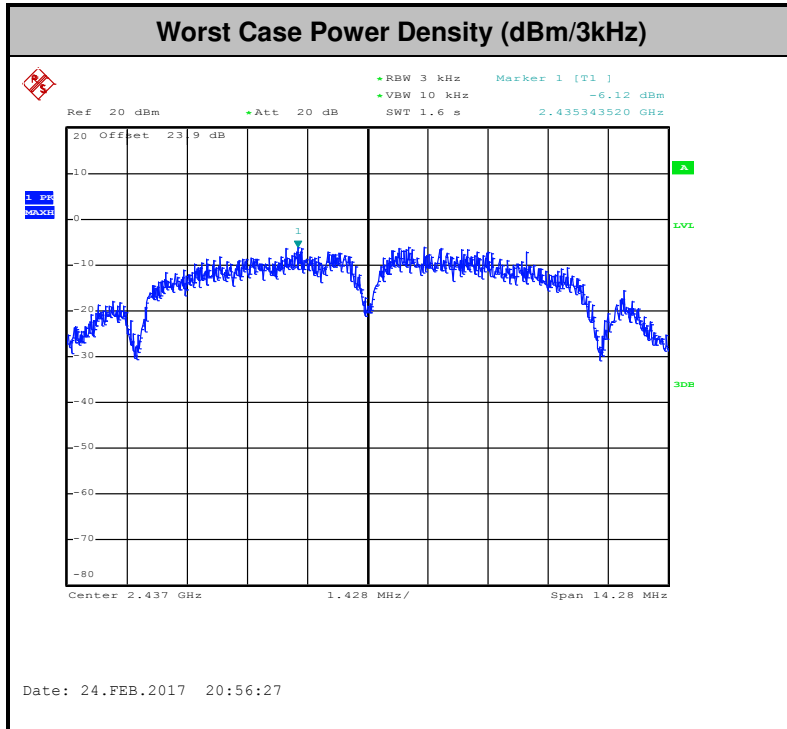

3.4 Conducted Band Edges and Spurious Emission Measurement

3.4.1 Limit of Conducted Band Edges and Spurious Emission Measurement

In any 100 kHz bandwidth outside of the authorized frequency band, the emissions which fall in the non-restricted bands shall be attenuated at least 20 dB / 30dB relative to the maximum PSD level in 100 kHz by RF conducted measurement and radiated emissions which fall in the restricted bands, as defined in Section 15.205(a), must also comply with the radiated emission limits specified in Section 15.209(a).

3.4.2 Measuring Instruments

The measuring equipment is listed in the section 4 of this test report.

3.4.3 Test Procedures

1. The testing follows FCC KDB Publication No. 558074 D01 DTS Meas. Guidance v03r05.
2. The RF output of EUT was connected to the spectrum analyzer by RF cable and attenuator. The path loss was compensated to the results for each measurement.
3. Set to the maximum power setting and enable the EUT transmit continuously.
4. Set RBW = 100 kHz, VBW=300 kHz, Peak Detector. Unwanted Emissions measured in any 100 kHz bandwidth outside of the authorized frequency band shall be attenuated by at least 20 dB relative to the maximum in-band peak PSD level in 100 kHz when maximum peak conducted output power procedure is used. If the transmitter complies with the conducted power limits based on the use of RMS averaging over a time interval, the attenuation required under this paragraph shall be 30 dB instead of 20 dB per 15.247(d).
5. Measure and record the results in the test report.
6. The RF fundamental frequency should be excluded against the limit line in the operating frequency band.

3.4.4 Test Setup

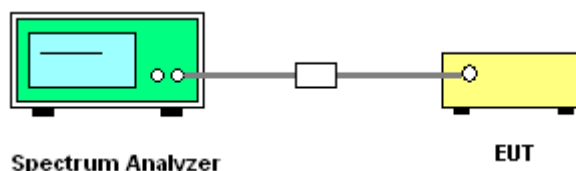



3.4.5 Test Result of Conducted Band Edges and Spurious Emission

Test Mode :	802.11b	Temperature :	21~25°C
Test Band :	2.4GHz Low	Relative Humidity :	51~54%
Test Channel :	01	Test Engineer :	Aking Chang

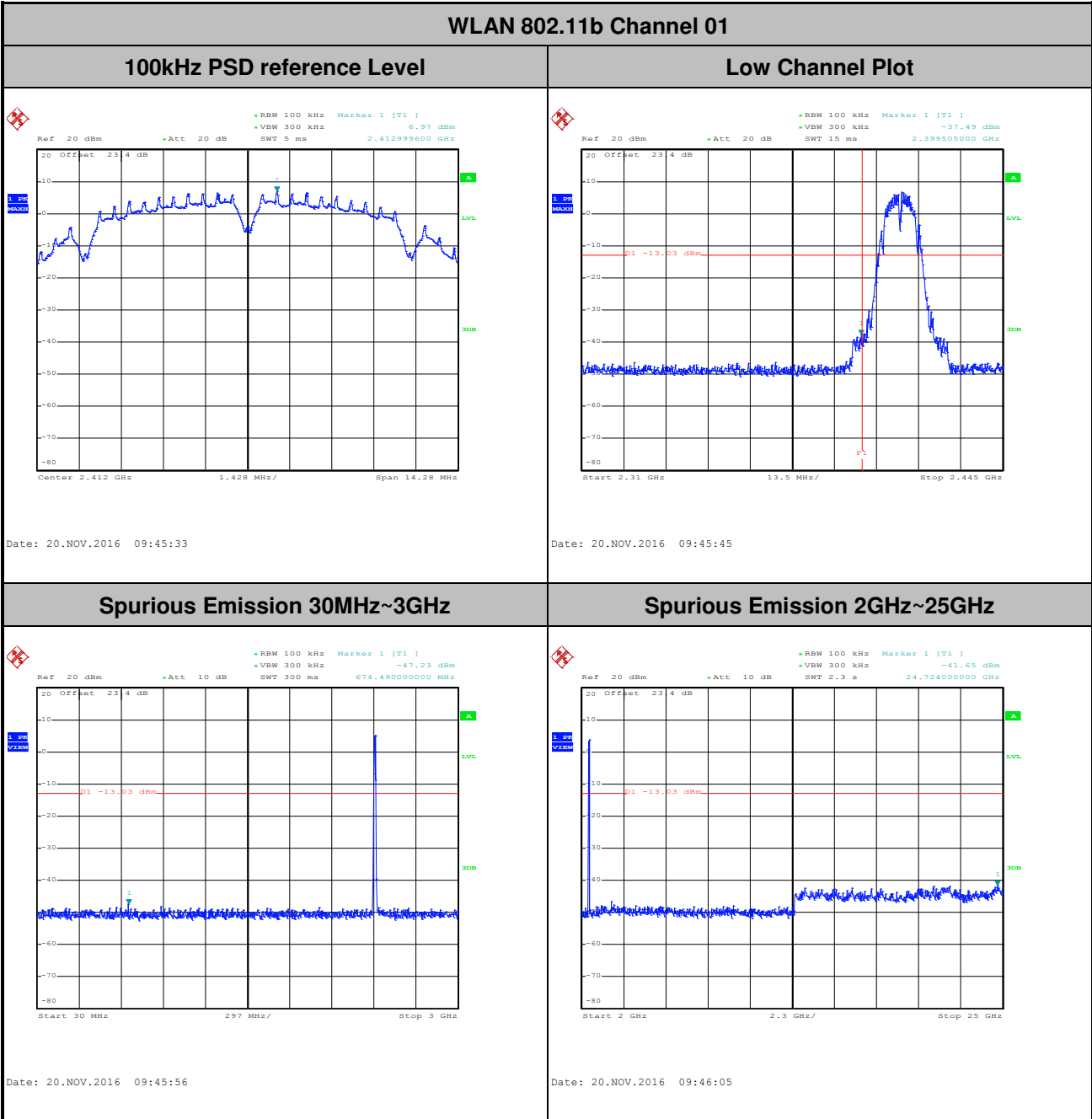



Test Mode :	802.11b	Temperature :	21~25°C
Test Band :	2.4GHz Mid	Relative Humidity :	51~54%
Test Channel :	06	Test Engineer :	Aking Chang

WLAN 802.11b Channel 06

100kHz PSD reference Level

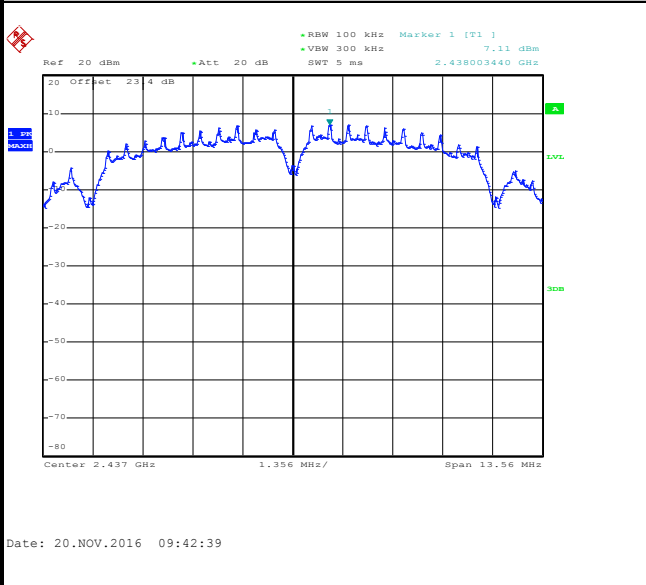

Spurious Emission 30MHz~3GHz

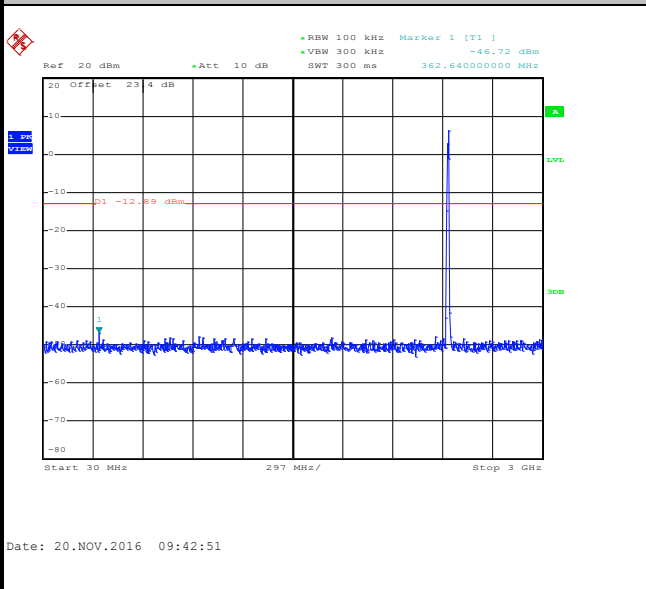

Spurious Emission 2GHz~25GHz

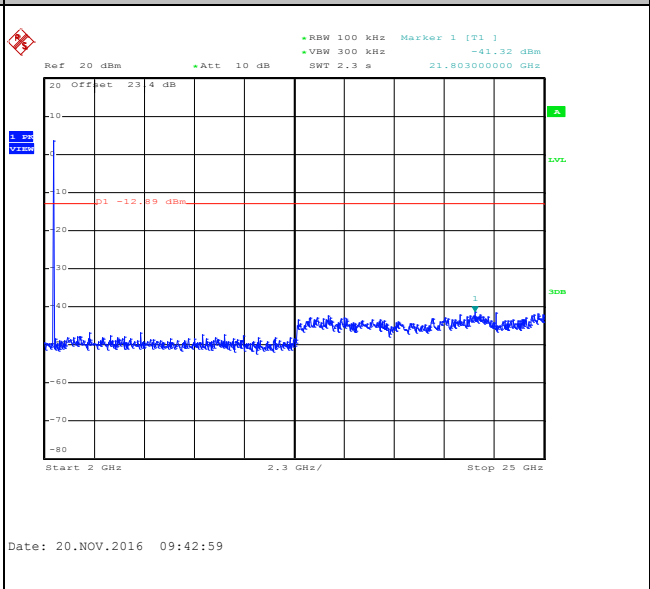



Test Mode :	802.11b	Temperature :	21~25°C
Test Band :	2.4GHz High	Relative Humidity :	51~54%
Test Channel :	11	Test Engineer :	Aking Chang

WLAN 802.11b Channel 11

100kHz PSD reference Level

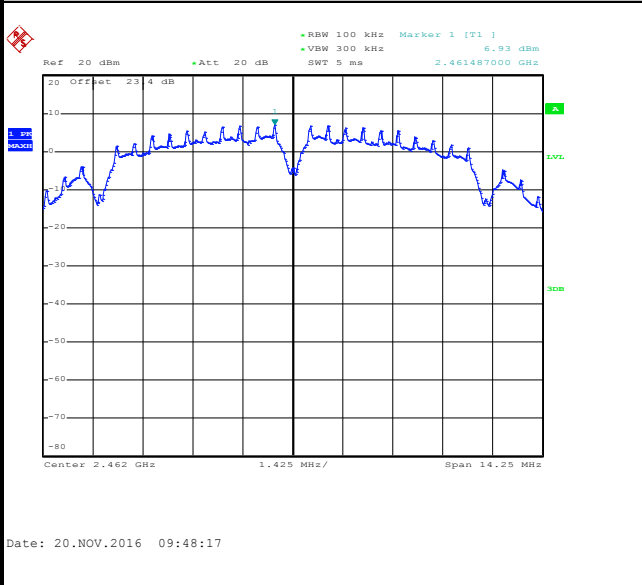

High Channel Plot

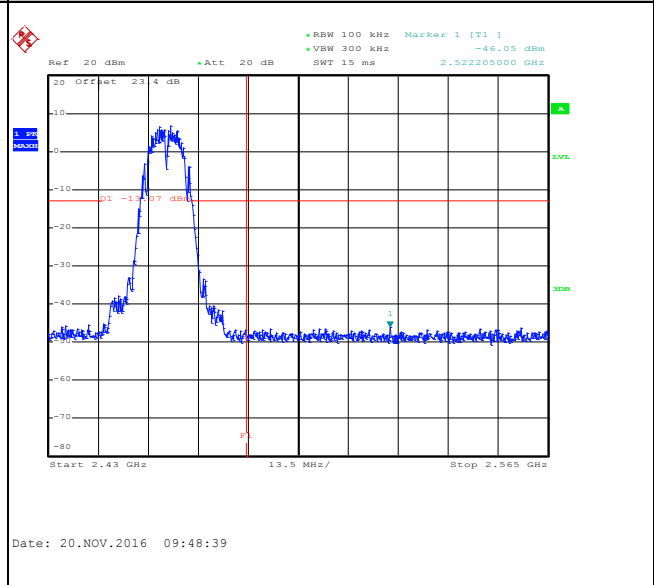

Spurious Emission 30MHz~3GHz

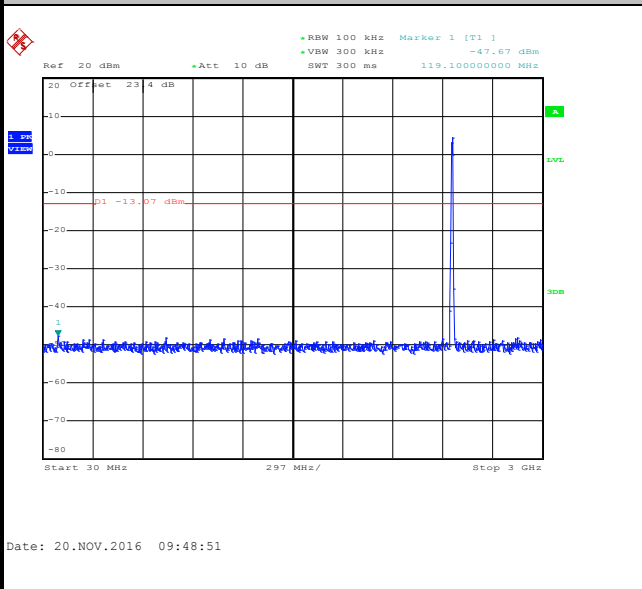

Spurious Emission 2GHz~25GHz

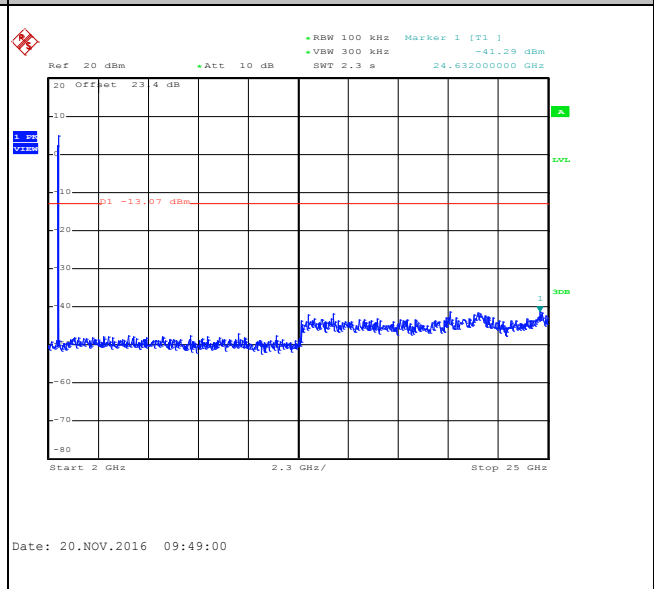



Test Mode :	802.11g	Temperature :	21~25°C
Test Band :	2.4GHz Low	Relative Humidity :	51~54%
Test Channel :	01	Test Engineer :	Aking Chang

WLAN 802.11g Channel 01

100kHz PSD reference Level

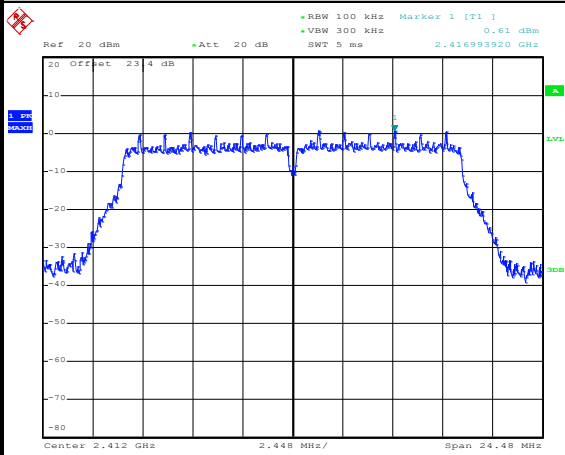

Date: 22.NOV.2016 19:30:32

Low Channel Plot

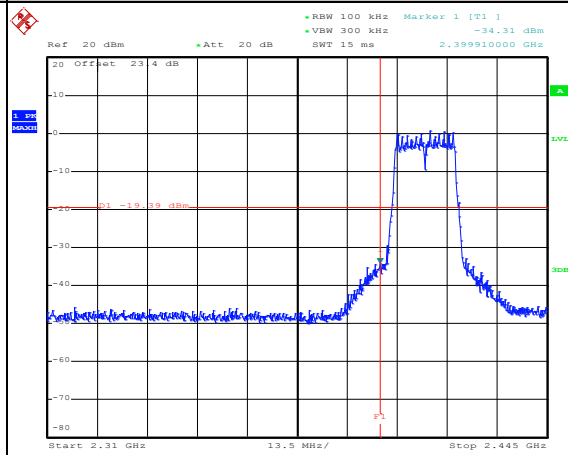

Date: 22.NOV.2016 19:31:06

Spurious Emission 30MHz~3GHz

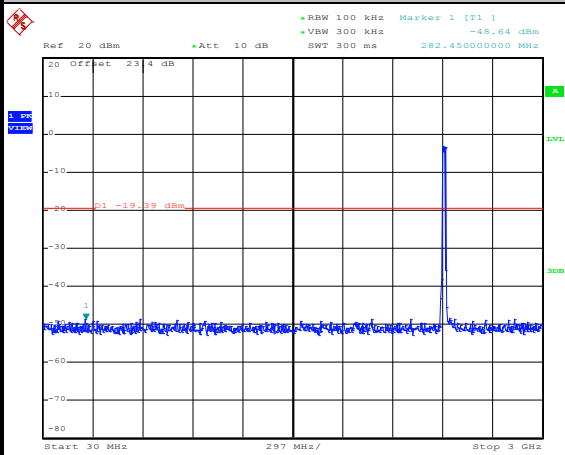

Date: 22.NOV.2016 19:32:04

Spurious Emission 2GHz~25GHz

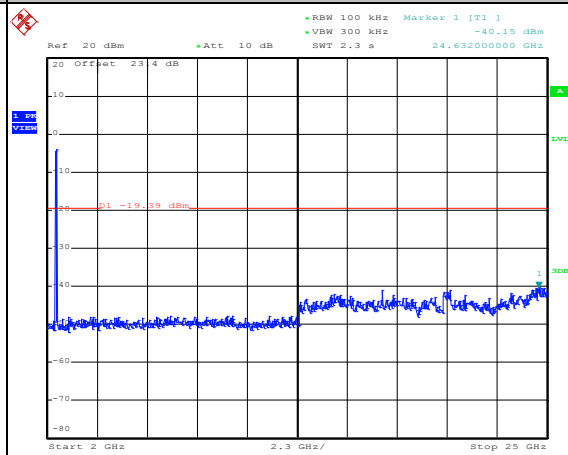

Date: 22.NOV.2016 19:32:12



Test Mode :	802.11g	Temperature :	21~25°C
Test Band :	2.4GHz Mid	Relative Humidity :	51~54%
Test Channel :	06	Test Engineer :	Aking Chang

WLAN 802.11g Channel 06

100kHz PSD reference Level

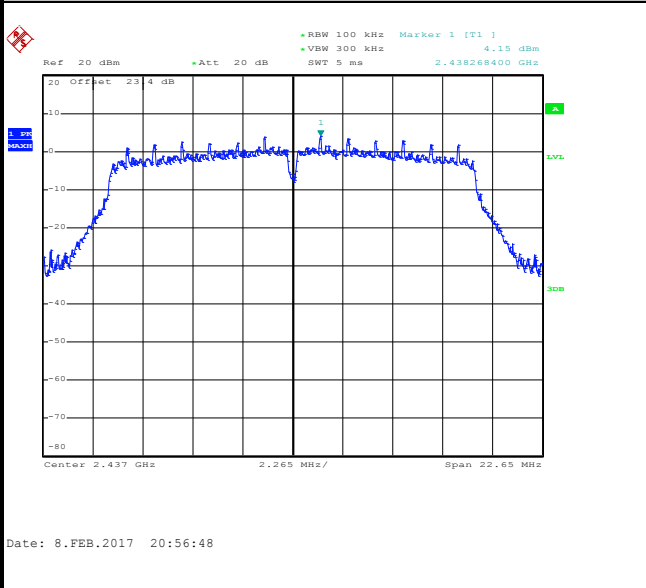

Spurious Emission 30MHz~3GHz

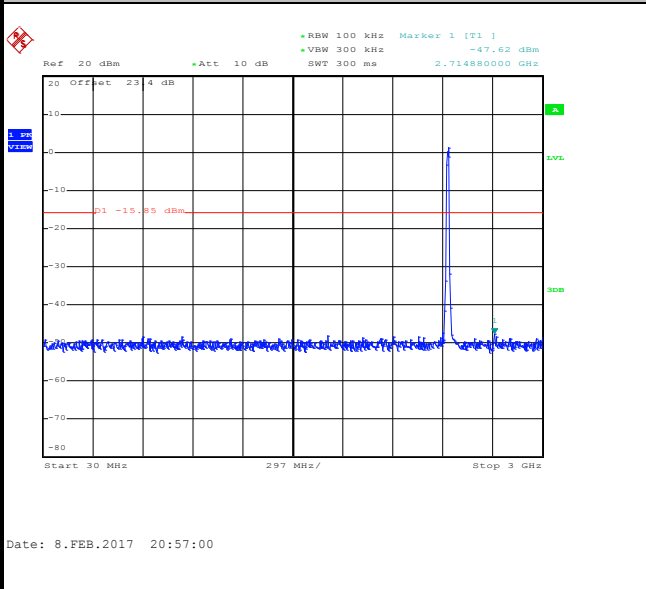

Spurious Emission 2GHz~25GHz

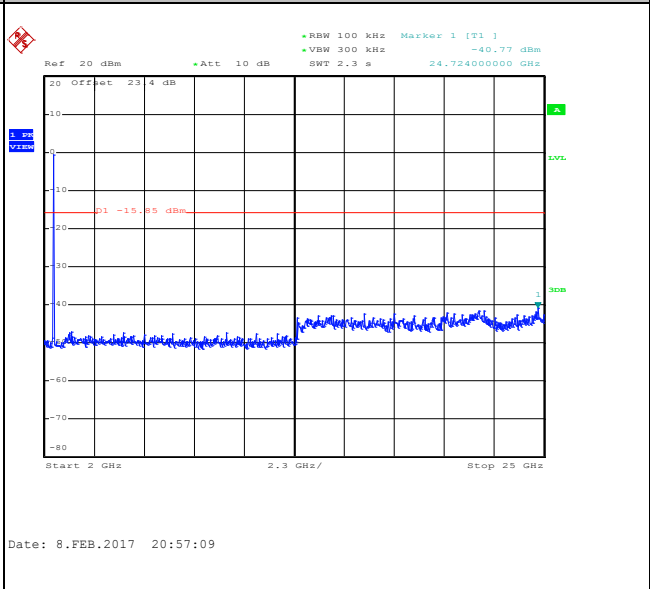



Test Mode :	802.11g	Temperature :	21~25°C
Test Band :	2.4GHz High	Relative Humidity :	51~54%
Test Channel :	11	Test Engineer :	Aking Chang

WLAN 802.11g Channel 11

100kHz PSD reference Level

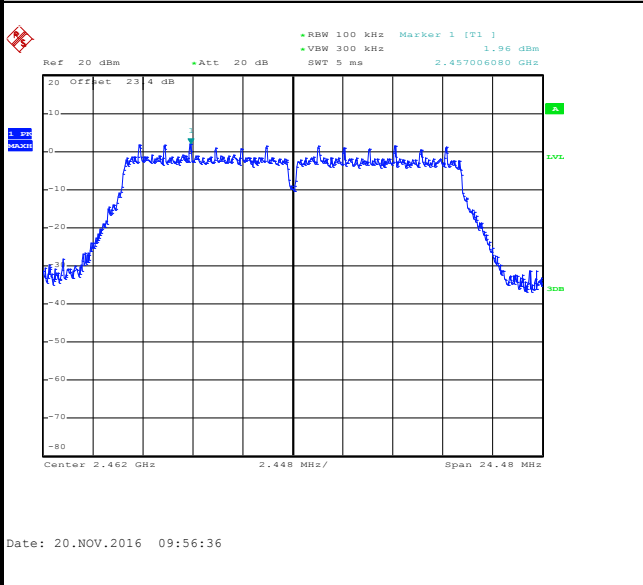

High Channel Plot

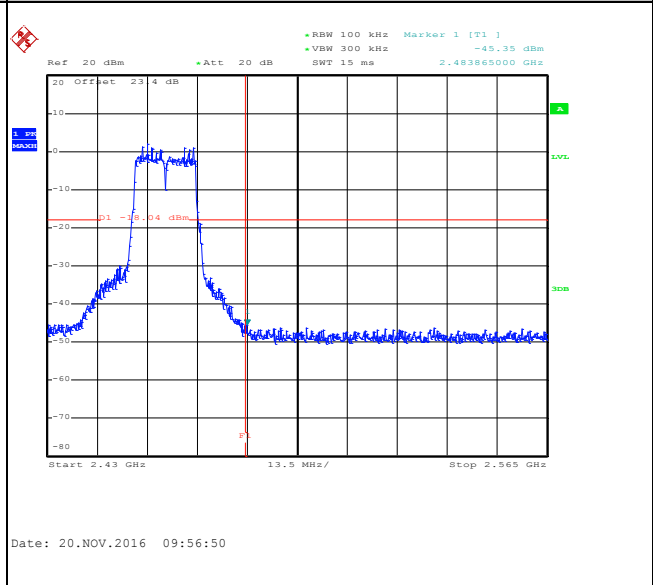

Spurious Emission 30MHz~3GHz

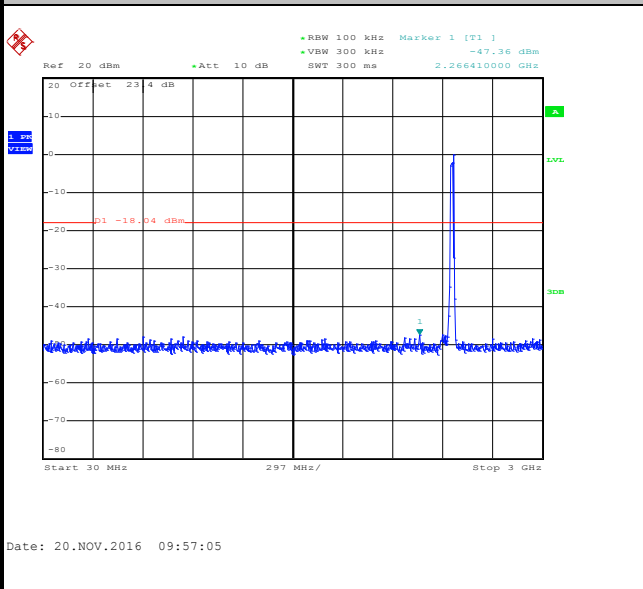

Spurious Emission 2GHz~25GHz

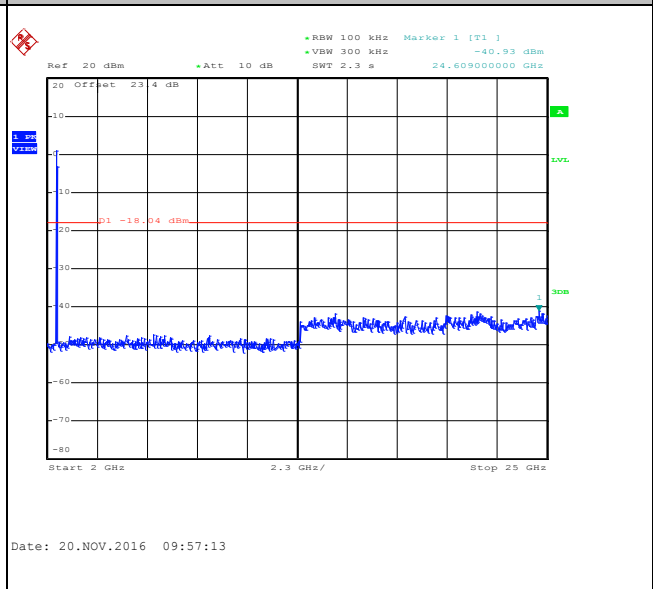



Test Mode :	802.11n HT20	Temperature :	21~25°C
Test Band :	2.4GHz Low	Relative Humidity :	51~54%
Test Channel :	01	Test Engineer :	Aking Chang

WLAN 802.11n HT20 Channel 01

100kHz PSD reference Level

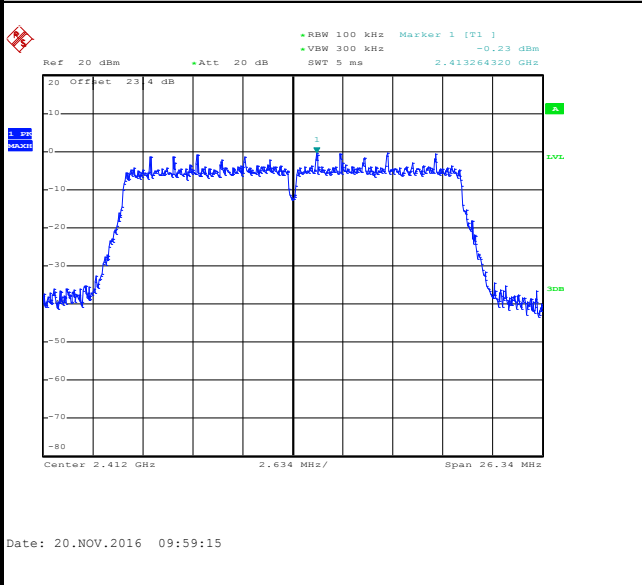

Low Channel Plot

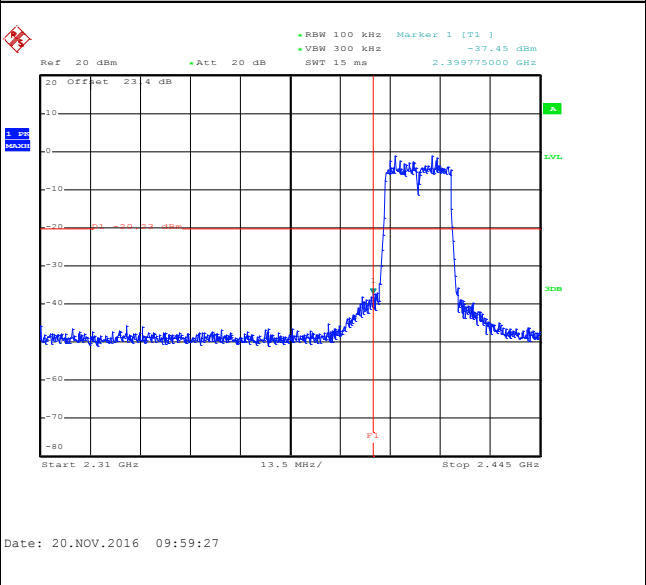

Spurious Emission 30MHz~3GHz

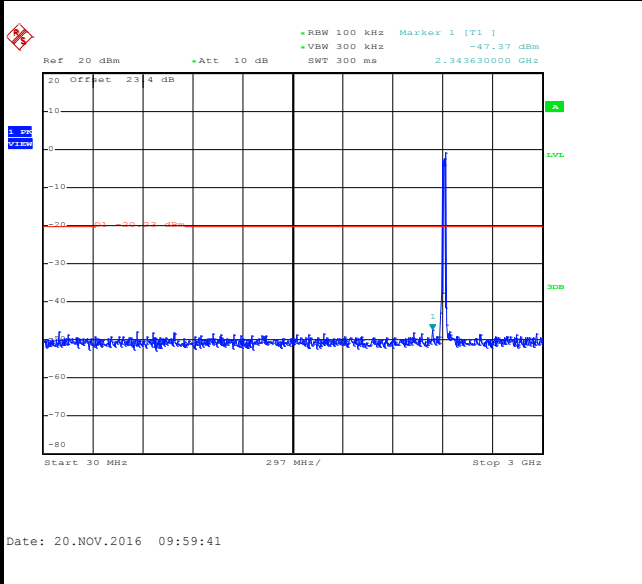

Spurious Emission 2GHz~25GHz

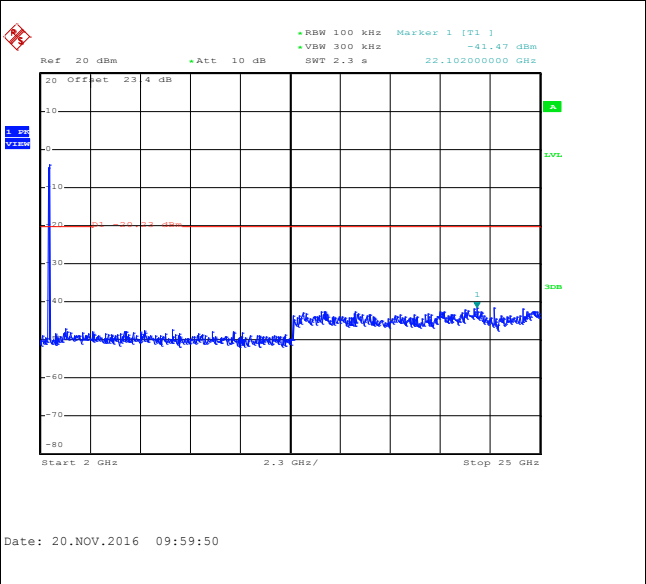



Test Mode :	802.11n HT20	Temperature :	21~25°C
Test Band :	2.4GHz Mid	Relative Humidity :	51~54%
Test Channel :	06	Test Engineer :	Aking Chang

WLAN 802.11n HT20 Channel 06

100kHz PSD reference Level

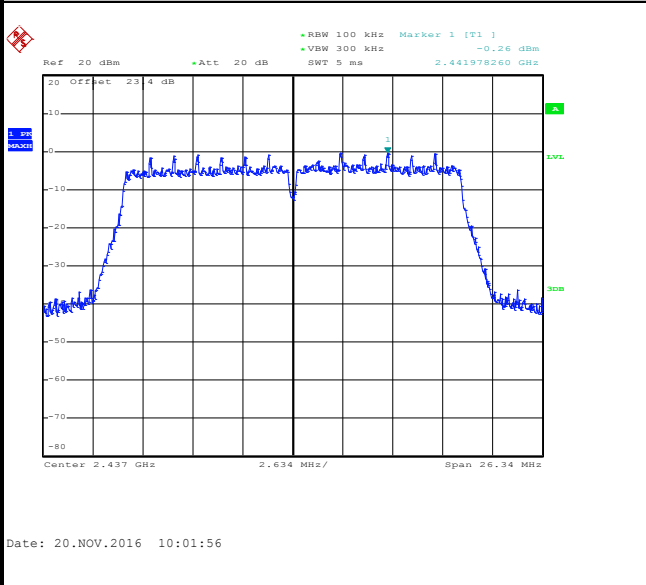

Spurious Emission 30MHz~3GHz

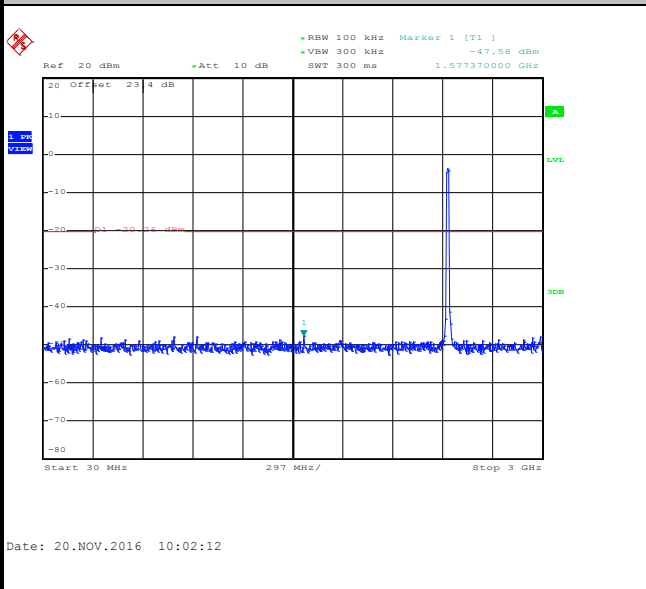

Spurious Emission 2GHz~25GHz

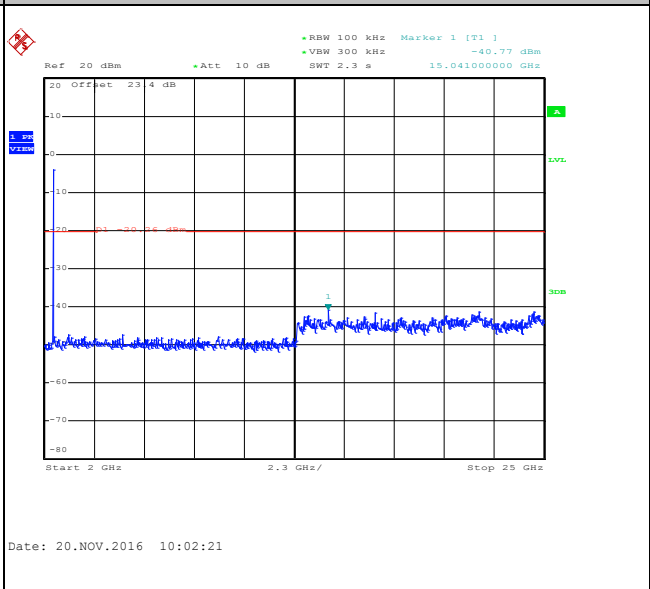



Test Mode :	802.11n HT20	Temperature :	21~25°C
Test Band :	2.4GHz High	Relative Humidity :	51~54%
Test Channel :	11	Test Engineer :	Aking Chang

WLAN 802.11n HT20 Channel 11

100kHz PSD reference Level

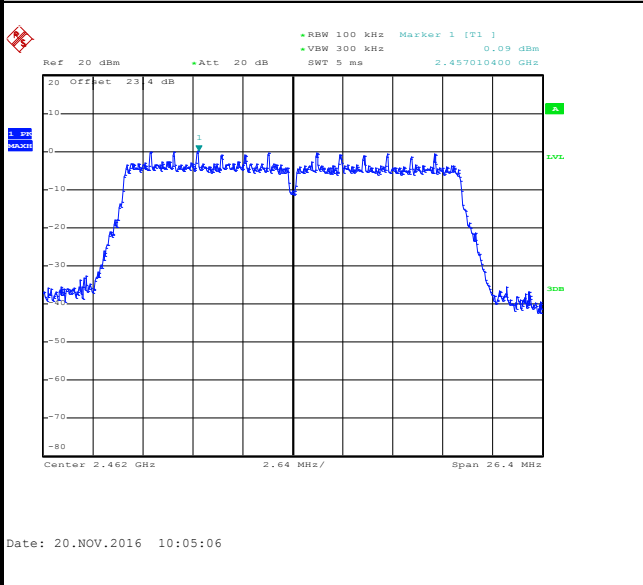

High Channel Plot

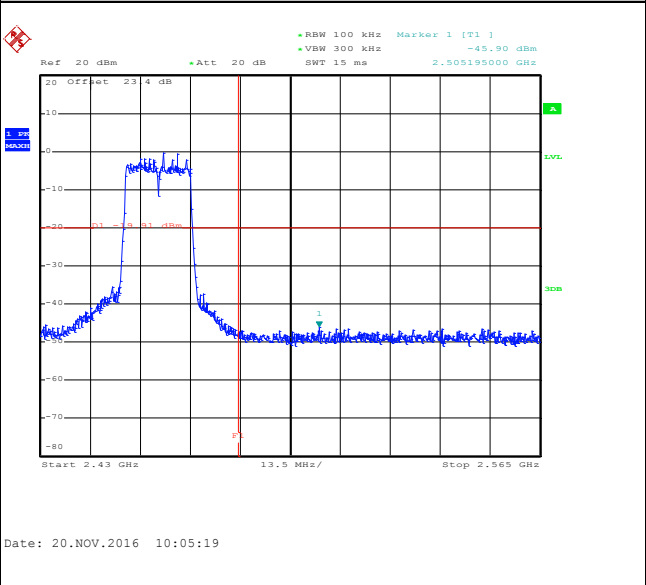

Spurious Emission 30MHz~3GHz

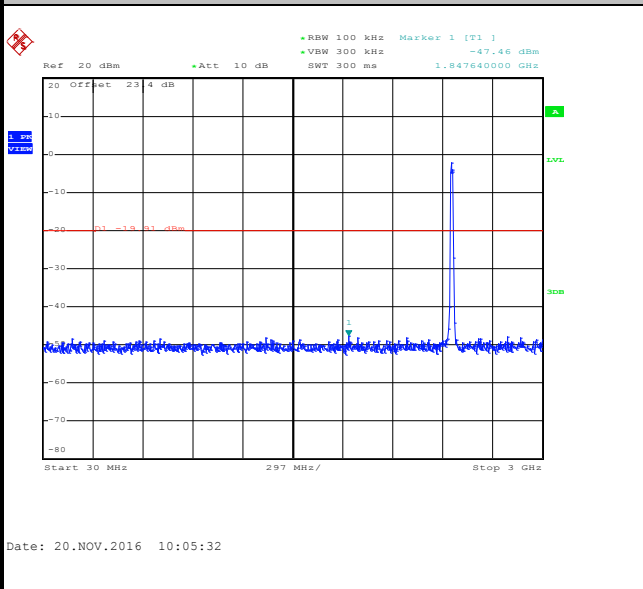

Spurious Emission 2GHz~25GHz

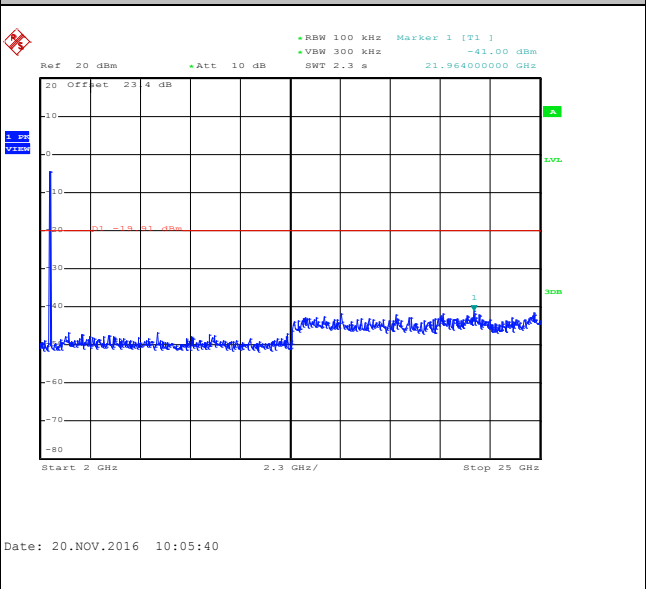



Test Mode :	802.11n HT40	Temperature :	21~25°C
Test Band :	2.4GHz Low	Relative Humidity :	51~54%
Test Channel :	03	Test Engineer :	Aking Chang

WLAN 802.11n HT40 Channel 03

100kHz PSD reference Level

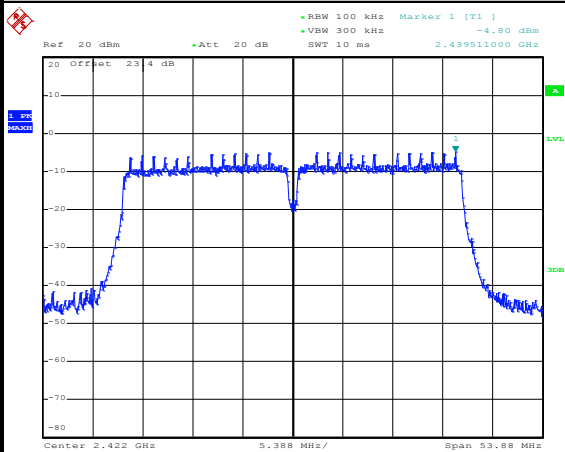

Date: 22.NOV.2016 19:37:42

Low Channel Plot

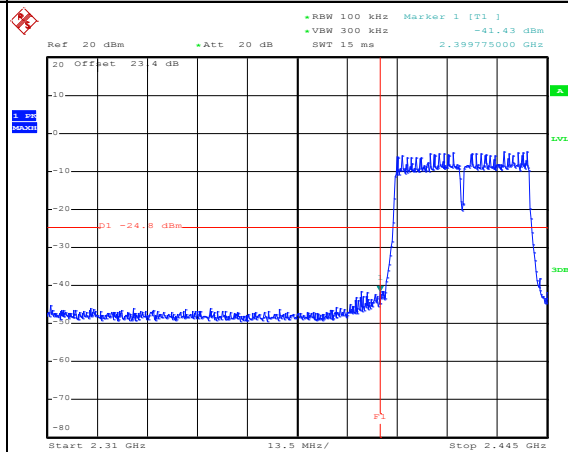

Date: 22.NOV.2016 19:38:17

Spurious Emission 30MHz~3GHz

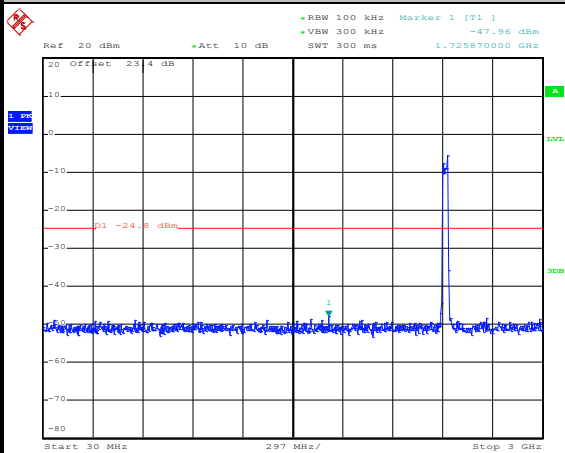

Date: 22.NOV.2016 19:39:14

Spurious Emission 2GHz~25GHz

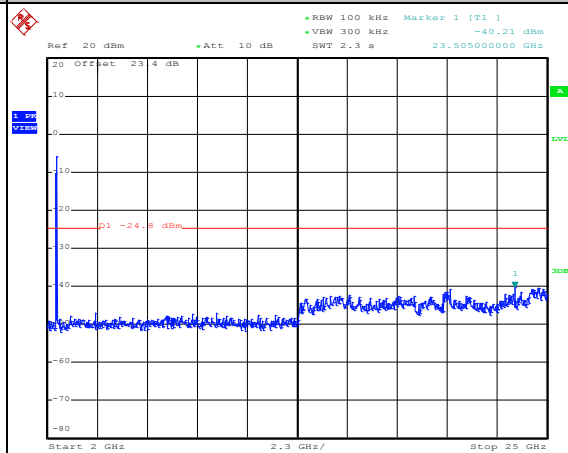

Date: 22.NOV.2016 19:39:23



Test Mode :	802.11n HT40	Temperature :	21~25°C
Test Band :	2.4GHz Mid	Relative Humidity :	51~54%
Test Channel :	06	Test Engineer :	Aking Chang

WLAN 802.11n HT40 Channel 06

100kHz PSD reference Level

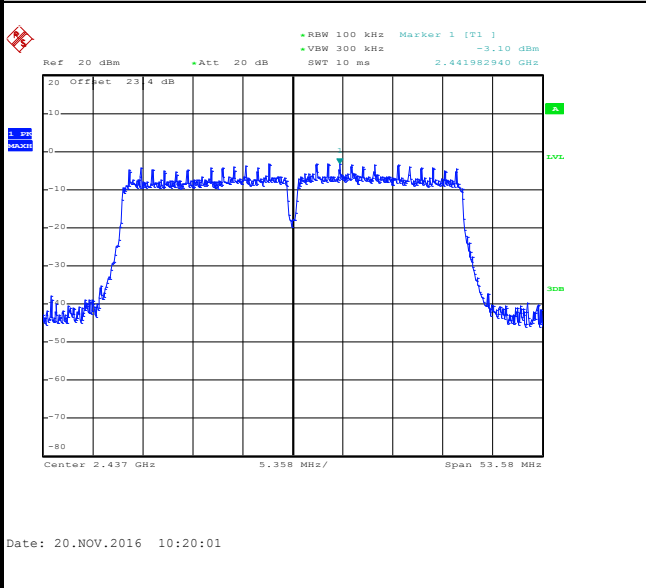

Spurious Emission 30MHz~3GHz

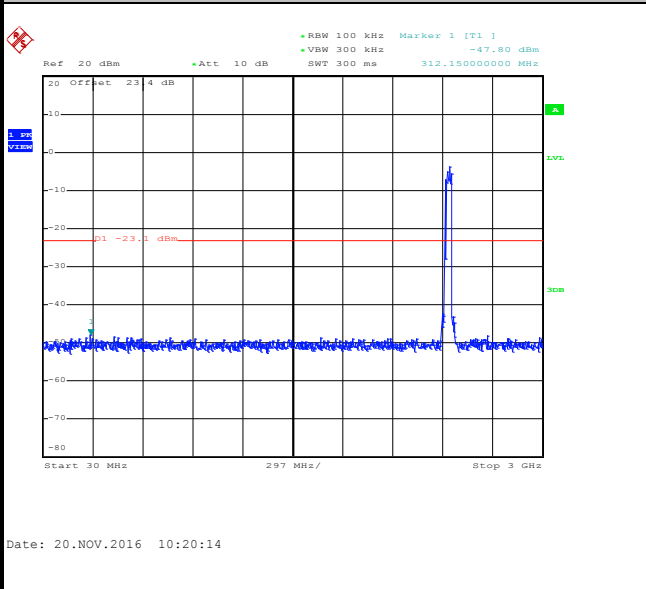

Spurious Emission 2GHz~25GHz

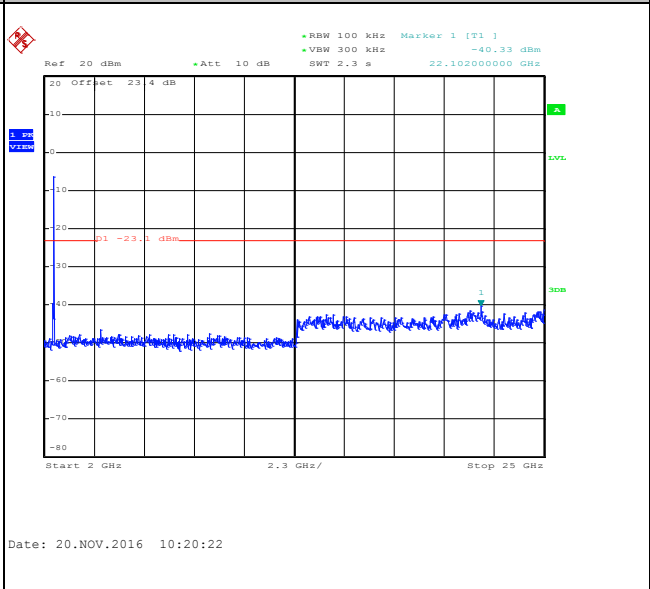



Test Mode :	802.11n HT40	Temperature :	21~25°C
Test Band :	2.4GHz High	Relative Humidity :	51~54%
Test Channel :	09	Test Engineer :	Aking Chang

WLAN 802.11n HT40 Channel 09

100kHz PSD reference Level

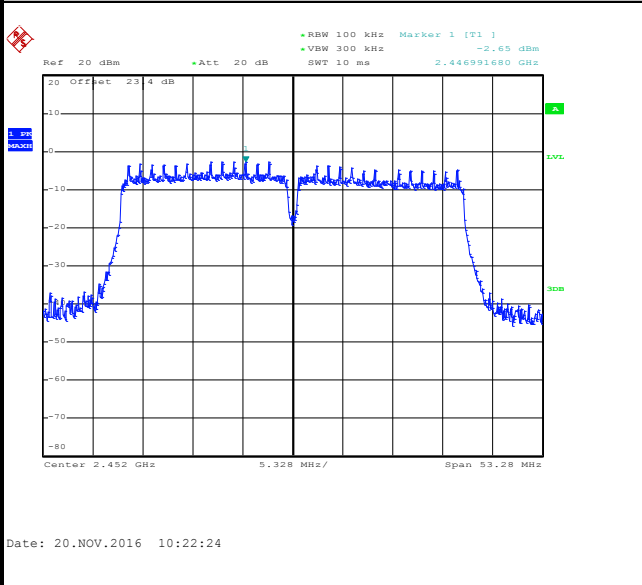

High Channel Plot

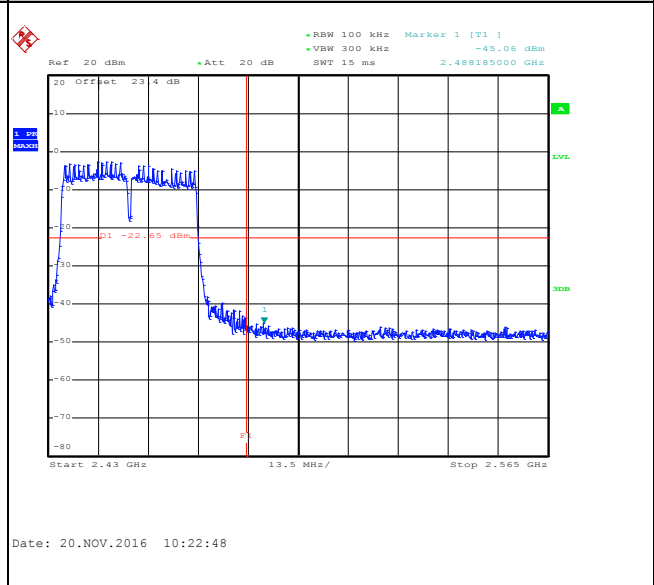

Spurious Emission 30MHz~3GHz

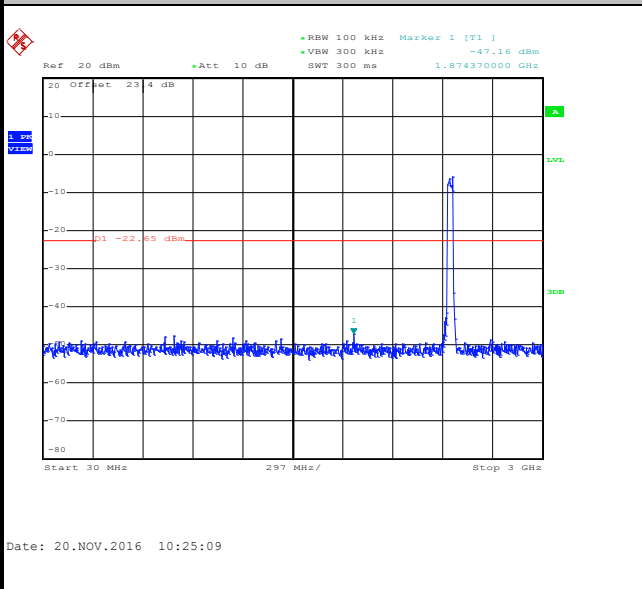

Spurious Emission 2GHz~25GHz

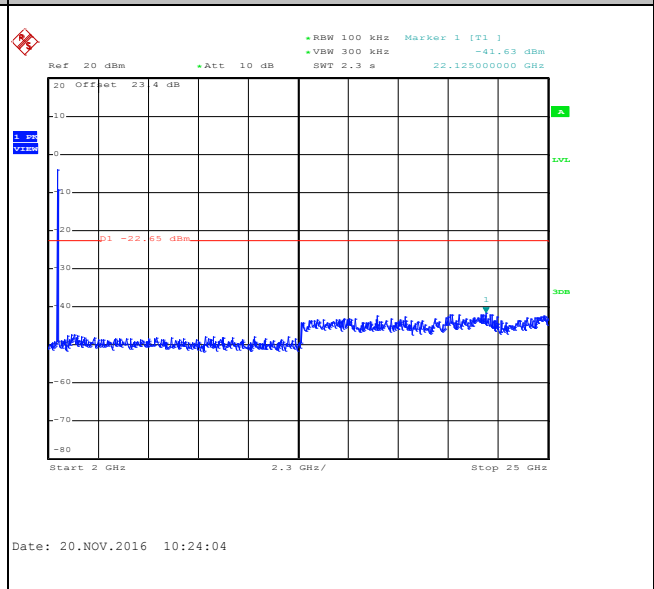



3.5 Radiated Band Edges and Spurious Emission Measurement

3.5.1 Limit of Radiated band edge and Spurious Emission Measurement

In any 100 kHz bandwidth outside the intentional radiator frequency band, all harmonics/spurious must be at least 20 dB below the highest emission level within the authorized band. If the output power of this device was measured by spectrum analyzer, the attenuation under this paragraph shall be 30 dB instead of 20 dB. In addition, radiated emissions which fall in the restricted bands must also comply with the FCC section 15.209 limits as below.

Frequency (MHz)	Field Strength (microvolts/meter)	Measurement Distance (meters)
0.009 – 0.490	2400/F(kHz)	300
0.490 – 1.705	24000/F(kHz)	30
1.705 – 30.0	30	30
30 – 88	100	3
88 – 216	150	3
216 - 960	200	3
Above 960	500	3

3.5.2 Measuring Instruments

The measuring equipment is listed in the section 4 of this test report.



3.5.3 Test Procedures

1. The testing follows FCC KDB Publication No. 558074 D01 DTS Meas. Guidance v03r05.
2. The EUT was arranged to its worst case and then tune the antenna tower (from 1 m to 4 m) and turntable (from 0 degree to 360 degrees) to find the maximum reading. A pre-amp and a high pass filter are used for the test in order to get better signal level.
3. The EUT was placed on a turntable with 0.8 meter for frequency below 1GHz and 1.5 meter for frequency above 1GHz respectively above ground.
4. The EUT was set 3 meters from the interference receiving antenna, which was mounted on the top of a variable height antenna tower.
5. Corrected Reading: Antenna Factor + Cable Loss + Read Level - Preamp Factor = Level
6. For measurement below 1GHz, If the emission level of the EUT measured by the peak detector is 3 dB lower than the applicable limit, the peak emission level will be reported. Otherwise, the emission measurement will be repeated using the quasi-peak detector and reported.
7. Use the following spectrum analyzer settings:
 - (1) Span shall wide enough to fully capture the emission being measured;
 - (2) Set RBW=100 kHz for $f < 1$ GHz; VBW \geq RBW; Sweep = auto; Detector function = peak; Trace = max hold;
 - (3) Set RBW = 1 MHz, VBW= 3MHz for $f \geq 1$ GHz for peak measurement.
For average measurement:
 - VBW = 10 Hz, when duty cycle is no less than 98 percent.
 - VBW $\geq 1/T$, when duty cycle is less than 98 percent where T is the minimum transmission duration over which the transmitter is on and is transmitting at its maximum power control level for the tested mode of operation.

3.5.4 Test Setup

For radiated emissions below 30MHz



For radiated emissions from 30MHz to 1GHz

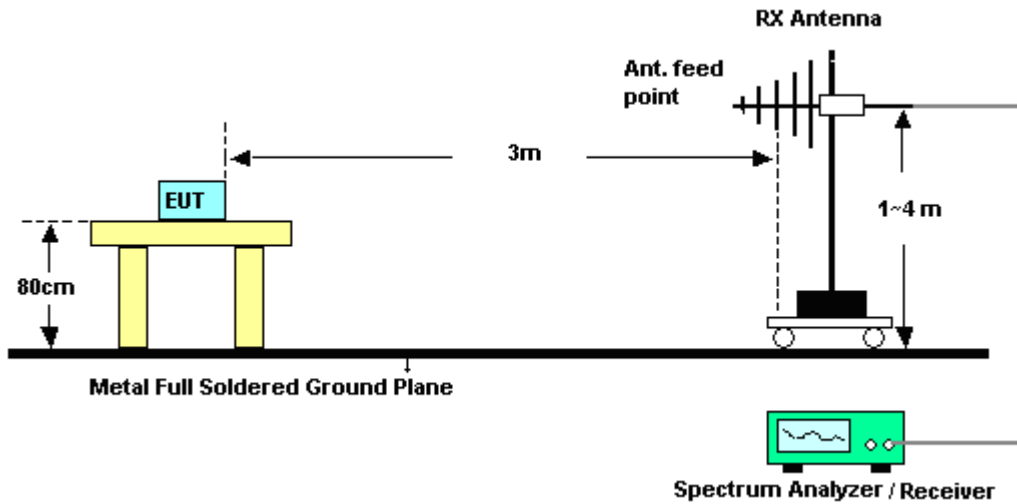

For radiated emissions above 1GHz

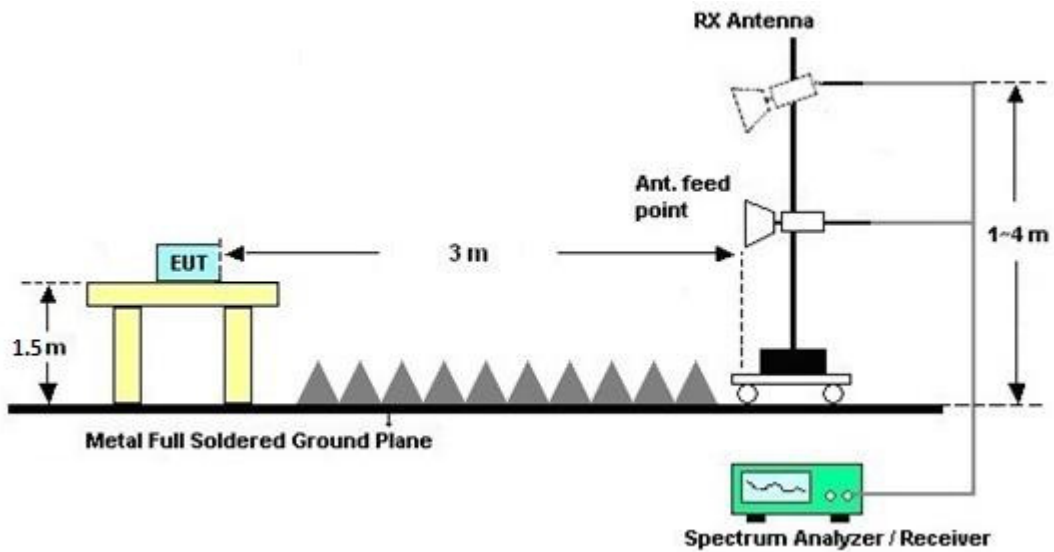

3.5.5 Test Results of Radiated Spurious Emissions (9kHz ~ 30MHz)

The low frequency, which started from 9 kHz to 30MHz, was pre-scanned and the result which was 20dB lower than the limit line per 15.31(o) was not reported.

3.5.6 Test Result of Radiated Spurious at Band Edges

Please refer to Appendix B and C.

3.5.7 Duty Cycle

Please refer to Appendix D.

3.5.8 Test Result of Radiated Spurious Emission (30MHz ~ 10th Harmonic)

Please refer to Appendix B and C.



3.6 AC Conducted Emission Measurement

3.6.1 Limit of AC Conducted Emission

For equipment that is designed to be connected to the public utility (AC) power line, the radio frequency voltage that is conducted back onto the AC power line on any frequency or frequencies within the band 150 kHz to 30 MHz shall not exceed the limits in the following table.

Frequency of Emission (MHz)	Conducted Limit (dBµV)	
	Quasi-Peak	Average
0.15-0.5	66 to 56*	56 to 46*
0.5-5	56	46
5-30	60	50

*Decreases with the logarithm of the frequency.

3.6.2 Measuring Instruments

The measuring equipment is listed in the section 4 of this test report.

3.6.3 Test Procedures

1. The EUT was placed 0.4 meter from the conducting wall of the shielding room, and it was kept at least 80 centimeters from any other grounded conducting surface.
2. Connect EUT to the power mains through a line impedance stabilization network (LISN).
3. All the support units are connecting to the other LISN.
4. The LISN provides 50 ohm coupling impedance for the measuring instrument.
5. The FCC states that a 50 ohm, 50 microhenry LISN should be used.
6. Both sides of AC line were checked for maximum conducted interference.
7. The frequency range from 150 kHz to 30 MHz was searched.
8. Set the test-receiver system to Peak Detect Function and specified bandwidth (IF bandwidth = 9kHz) with Maximum Hold Mode.

3.6.4 Test Setup

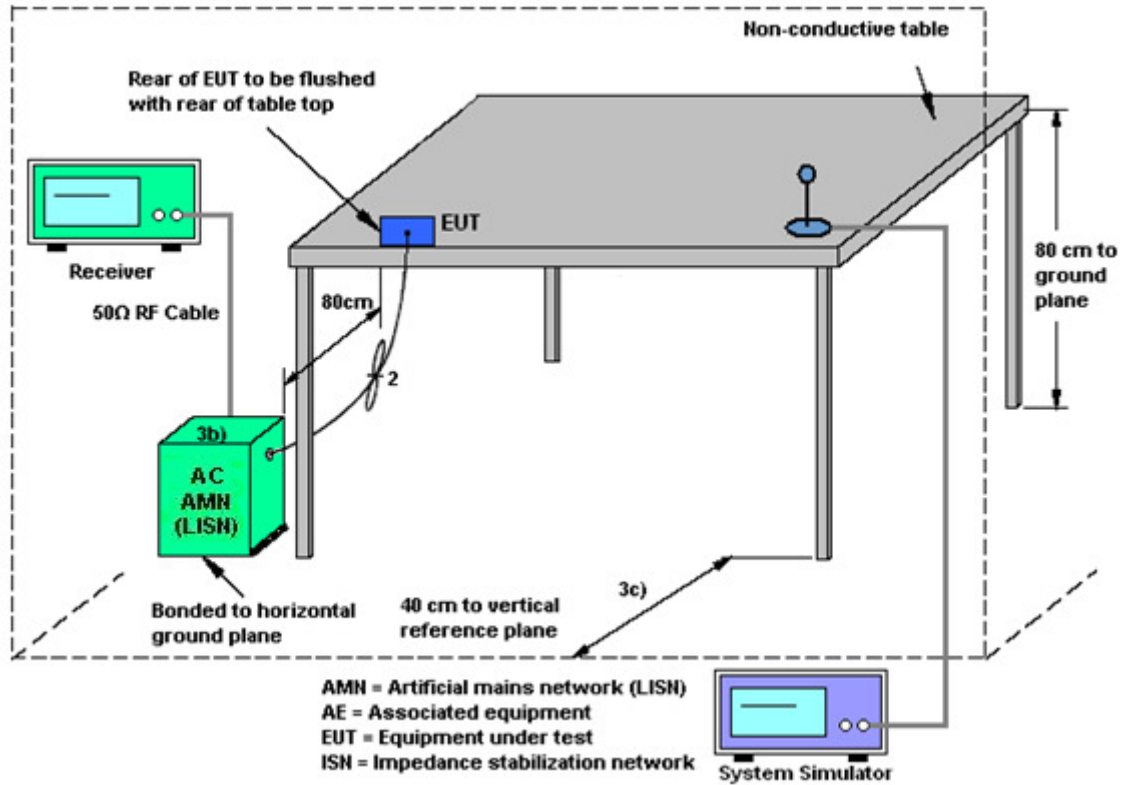



3.6.5 Test Result of AC Conducted Emission

Test Mode :	Mode 1	Temperature :	21~23°C
Test Engineer :	Arthur Hsieh	Relative Humidity :	51~53%
Test Voltage :	120Vac / 60Hz	Phase :	Line
Function Type :	WCDMA Band II Idle + Bluetooth Link + WLAN Link + Camera (Front) + Earphone + Battery + USB Cable (Charging from Adapter)		

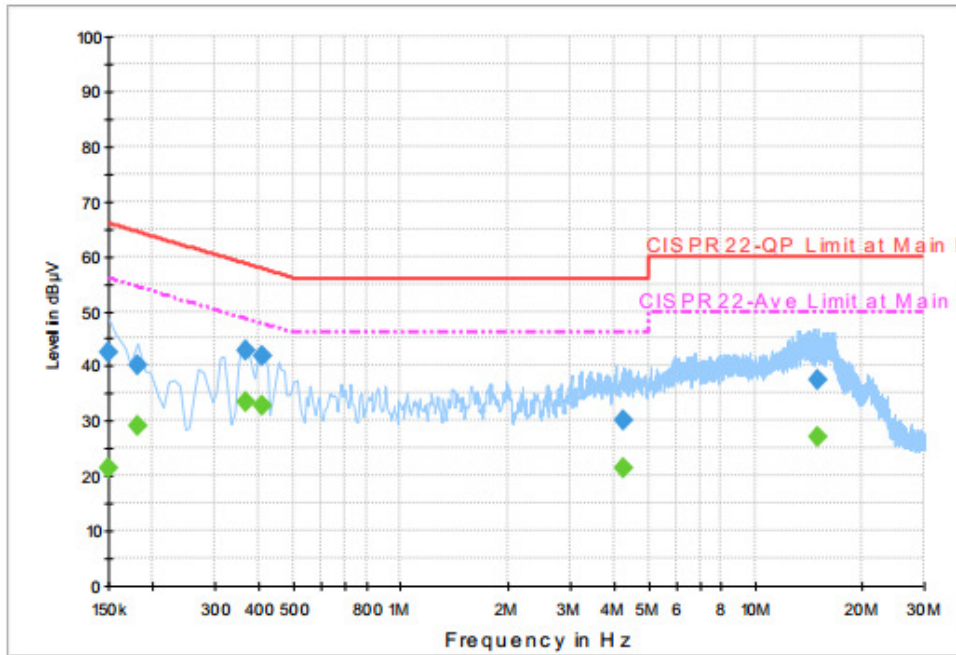

Final Result : Quasi-Peak

Frequency (MHz)	Quasi-Peak (dBµV)	Filter	Line	Corr. (dB)	Margin (dB)	Limit (dBµV)
0.150000	42.5	Off	L1	19.6	23.5	66.0
0.182000	40.0	Off	L1	19.6	24.4	64.4
0.366000	42.8	Off	L1	19.6	15.8	58.6
0.406000	41.9	Off	L1	19.6	15.8	57.7
4.246000	30.1	Off	L1	19.8	25.9	56.0
15.126000	37.6	Off	L1	20.4	22.4	60.0

Final Result : Average

Frequency (MHz)	Average (dBµV)	Filter	Line	Corr. (dB)	Margin (dB)	Limit (dBµV)
0.150000	21.2	Off	L1	19.6	34.8	56.0
0.182000	29.2	Off	L1	19.6	25.2	54.4
0.366000	33.5	Off	L1	19.6	15.1	48.6
0.406000	32.9	Off	L1	19.6	14.8	47.7
4.246000	21.5	Off	L1	19.8	24.5	46.0
15.126000	27.0	Off	L1	20.4	23.0	50.0



Test Mode :	Mode 1	Temperature :	21~23°C
Test Engineer :	Arthur Hsieh	Relative Humidity :	51~53%
Test Voltage :	120Vac / 60Hz	Phase :	Neutral
Function Type :	WCDMA Band II Idle + Bluetooth Link + WLAN Link + Camera (Front) + Earphone + Battery + USB Cable (Charging from Adapter)		

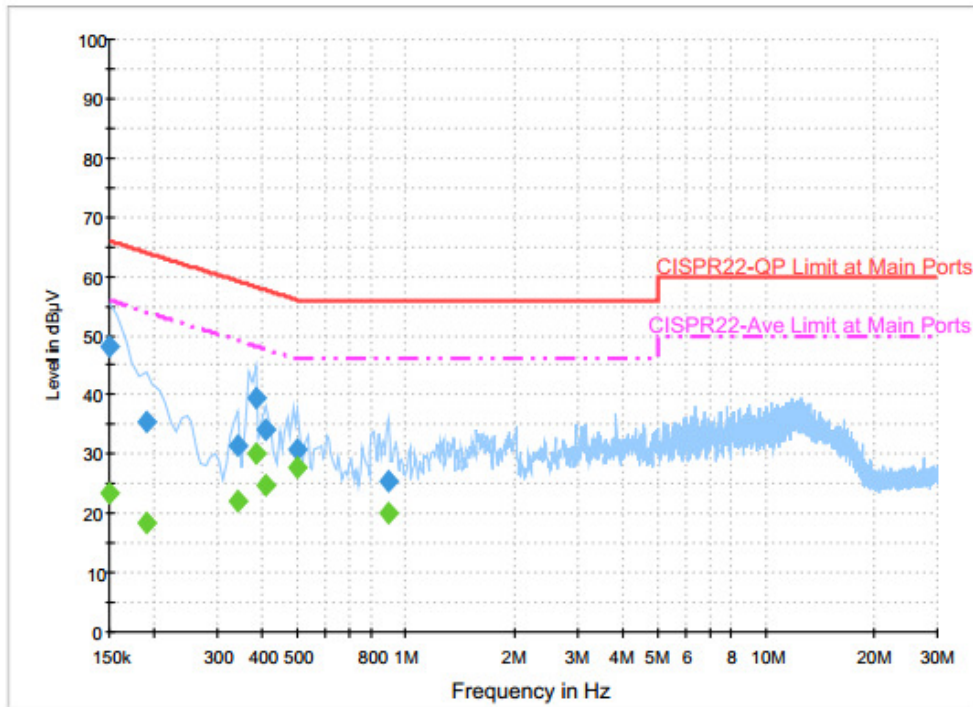

Final Result : Quasi-Peak

Frequency (MHz)	Quasi-Peak (dBµV)	Filter	Line	Corr. (dB)	Margin (dB)	Limit (dBµV)
0.150000	48.2	Off	N	19.6	17.8	66.0
0.190000	35.4	Off	N	19.6	28.6	64.0
0.342000	31.3	Off	N	19.6	27.9	59.2
0.382000	39.4	Off	N	19.6	18.8	58.2
0.406000	34.0	Off	N	19.6	23.7	57.7
0.502000	30.8	Off	N	19.6	25.2	56.0
0.894000	25.4	Off	N	19.6	30.6	56.0

Final Result : Average

Frequency (MHz)	Average (dBµV)	Filter	Line	Corr. (dB)	Margin (dB)	Limit (dBµV)
0.150000	23.4	Off	N	19.6	32.6	56.0
0.190000	18.5	Off	N	19.6	35.5	54.0
0.342000	21.9	Off	N	19.6	27.3	49.2
0.382000	30.2	Off	N	19.6	18.0	48.2
0.406000	24.9	Off	N	19.6	22.8	47.7
0.502000	27.6	Off	N	19.6	18.4	46.0
0.894000	20.1	Off	N	19.6	25.9	46.0



3.7 Antenna Requirements

3.7.1 Standard Applicable

If directional gain of transmitting antennas is greater than 6dBi, the power shall be reduced by the same level in dB comparing to gain minus 6dBi. For the fixed point-to-point operation, the power shall be reduced by one dB for every 3 dB that the directional gain of the antenna exceeds 6 dBi. The use of a permanently attached antenna or of an antenna that uses a unique coupling to the intentional radiator shall be considered sufficient to comply with the FCC rule.

3.7.2 Antenna Anti-Replacement Construction

An embedded-in antenna design is used.

3.7.3 Antenna Gain

The antenna peak gain of EUT is less than 6 dBi. Therefore, it is not necessary to reduce maximum peak output power limit.



4 List of Measuring Equipment

Instrument	Manufacturer	Model No.	Serial No.	Characteristics	Calibration Date	Test Date	Due Date	Remark
Power Meter	Anritsu	ML2495A	0932001	300MHz~40GHz	Sep. 29, 2016	Nov. 03, 2016 ~ Feb. 24, 2017	Sep. 28, 2017	Conducted (TH05-HY)
Power Sensor	Anritsu	MA2411B	0846202	300MHz~40GHz	Sep. 29, 2016	Nov. 03, 2016 ~ Feb. 24, 2017	Sep. 28, 2017	Conducted (TH05-HY)
Spectrum Analyzer	Rohde & Schwarz	FSP40	100055	9kHz-40GHz	Jul. 17, 2016	Nov. 03, 2016 ~ Feb. 24, 2017	Jul. 16, 2017	Conducted (TH05-HY)
AC Power Source	ChainTek	APC-1000W	N/A	N/A	N/A	Oct. 22, 2016	N/A	Conduction (CO05-HY)
EMI Test Receiver	Rohde & Schwarz	ESCI 7	100724	9kHz~7GHz	Aug. 30, 2016	Oct. 22, 2016	Aug. 29, 2017	Conduction (CO05-HY)
LISN	Rohde & Schwarz	ENV216	100080	9kHz~30MHz	Dec. 02, 2015	Oct. 22, 2016	Dec. 01, 2016	Conduction (CO05-HY)
Amplifier	SONOMA	310N	187312	9kHz~1GHz	Nov. 10, 2016	Nov. 12, 2016 ~ Feb. 24, 2017	Nov. 09, 2017	Radiation (03CH11-HY)
Bilog Antenna	TESEQ	CBL 6111D&N-6-06	35414&AT-N0602	30MHz~1GHz	Oct. 15, 2016	Nov. 12, 2016 ~ Feb. 24, 2017	Oct. 14, 2017	Radiation (03CH11-HY)
Horn Antenna	SCHWARZBECK	BBHA 9120 D	9120D-1326	1GHz ~ 18GHz	Oct. 07, 2016	Nov. 12, 2016 ~ Feb. 24, 2017	Oct. 06, 2017	Radiation (03CH11-HY)
Preamplifier	Keysight	83017A	MY53270080	1GHz~26.5GHz	Nov. 10, 2016	Nov. 12, 2016 ~ Feb. 24, 2017	Nov. 09, 2017	Radiation (03CH11-HY)
Spectrum Analyzer	Keysight	N9010A	MY54200486	10Hz ~ 44GHz	Oct. 12, 2016	Nov. 12, 2016 ~ Feb. 24, 2017	Oct. 11, 2017	Radiation (03CH11-HY)
Antenna Mast	EMEC	AM-BS-4500-B	N/A	1~4m	N/A	Nov. 12, 2016 ~ Feb. 24, 2017	N/A	Radiation (03CH11-HY)
Turn Table	EMEC	TT 2000	N/A	0~360 Degree	N/A	Nov. 12, 2016 ~ Feb. 24, 2017	N/A	Radiation (03CH11-HY)
SHF-EHF Horn Antenna	SCHWARZBECK	BBHA 9170	BBHA9170576	18GHz- 40GHz	Apr. 15, 2016	Nov. 12, 2016 ~ Feb. 24, 2017	Apr. 14, 2017	Radiation (03CH11-HY)
Preamplifier	MITEQ	TTA0204	1872107	2GHz~40GHz	Feb. 15, 2016	Nov. 12, 2016 ~ Feb. 09, 2017	Feb. 14, 2017	Radiation (03CH11-HY)
Preamplifier	MITEQ	AMF-7D-0010 1800-30-10P	1815698	1GHz~18GHz	Dec. 01, 2016	Feb. 20, 2017 ~ Feb. 24, 2017	Nov. 30, 2017	Radiation (03CH11-HY)
Loop Antenna	Rohde & Schwarz	HFH2-Z2	100488	9 kHz~30 MHz	Oct. 20, 2016	Nov. 12, 2016 ~ Feb. 24, 2017	Oct. 19, 2018	Radiation (03CH11-HY)



5 Uncertainty of Evaluation

Uncertainty of Conducted Emission Measurement (150kHz ~ 30MHz)

Measuring Uncertainty for a Level of Confidence of 95% ($U = 2Uc(y)$)	2.7
---	-----

Uncertainty of Radiated Emission Measurement (30 MHz ~ 1000 MHz)

Measuring Uncertainty for a Level of Confidence of 95% ($U = 2Uc(y)$)	5.2
---	-----

Uncertainty of Radiated Emission Measurement (1000 MHz ~ 18000 MHz)

Measuring Uncertainty for a Level of Confidence of 95% ($U = 2Uc(y)$)	5.5
---	-----

Uncertainty of Radiated Emission Measurement (18000 MHz ~ 40000 MHz)

Measuring Uncertainty for a Level of Confidence of 95% ($U = 2Uc(y)$)	5.2
---	-----



Appendix A. Conducted Test Results

Test Engineer:	Aking Chang	Temperature:	21~25	°C
Test Date:	2016/11/03~2017/02/24	Relative Humidity:	51~54	%

TEST RESULTS DATA
6dB and 99% Occupied Bandwidth

2.4GHz Band								
Mod.	Data Rate	N _{TX}	CH.	Freq. (MHz)	99% Occupied BW (MHz)	6dB BW (MHz)	6dB BW Limit (MHz)	Pass/Fail
11b	1Mbps	1	1	2412	12.50	9.52	0.50	Pass
11b	1Mbps	1	6	2437	12.65	9.04	0.50	Pass
11b	1Mbps	1	11	2462	12.60	9.50	0.50	Pass
11g	6Mbps	1	1	2412	17.85	16.32	0.50	Pass
11g	6Mbps	1	6	2437	17.55	15.10	0.50	Pass
11g	6Mbps	1	11	2462	17.85	16.32	0.50	Pass
HT20	MCS0	1	1	2412	18.55	17.56	0.50	Pass
HT20	MCS0	1	6	2437	18.45	17.56	0.50	Pass
HT20	MCS0	1	11	2462	18.50	17.60	0.50	Pass
HT40	MCS0	1	3	2422	36.60	35.92	0.50	Pass
HT40	MCS0	1	6	2437	36.50	35.72	0.50	Pass
HT40	MCS0	1	9	2452	36.50	35.52	0.50	Pass

TEST RESULTS DATA
Peak Power Table

2.4GHz Band										
Mod.	Data Rate	N _{TX}	CH.	Freq. (MHz)	Peak Conducted Power (dBm)	Conducted Power Limit (dBm)	DG (dBi)	EIRP Power (dBm)	EIRP Power Limit (dBm)	Pass /Fail
11b	1Mbps	1	1	2412	18.77	30.00	-2.10	16.67	36.00	Pass
11b	1Mbps	1	6	2437	19.85	30.00	-2.10	17.75	36.00	Pass
11b	1Mbps	1	11	2462	18.99	30.00	-2.10	16.89	36.00	Pass
11g	6Mbps	1	1	2412	21.17	30.00	-2.10	19.07	36.00	Pass
11g	6Mbps	1	6	2437	22.58	30.00	-2.10	20.48	36.00	Pass
11g	6Mbps	1	11	2462	22.02	30.00	-2.10	19.92	36.00	Pass
HT20	MCS0	1	1	2412	20.45	30.00	-2.10	18.35	36.00	Pass
HT20	MCS0	1	6	2437	20.95	30.00	-2.10	18.85	36.00	Pass
HT20	MCS0	1	11	2462	20.97	30.00	-2.10	18.87	36.00	Pass
HT40	MCS0	1	3	2422	20.45	30.00	-2.10	18.35	36.00	Pass
HT40	MCS0	1	6	2437	21.36	30.00	-2.10	19.26	36.00	Pass
HT40	MCS0	1	9	2452	21.52	30.00	-2.10	19.42	36.00	Pass

TEST RESULTS DATA
Average Power Table
(Reporting Only)

2.4GHz Band						
Mod.	Data Rate	N _{TX}	CH.	Freq. (MHz)	Duty Factor (dB)	Average Conducted Power (dBm)
11b	1Mbps	1	1	2412	0.00	15.93
11b	1Mbps	1	6	2437	0.00	16.97
11b	1Mbps	1	11	2462	0.00	15.99
11g	6Mbps	1	1	2412	0.15	11.94
11g	6Mbps	1	6	2437	0.15	14.63
11g	6Mbps	1	11	2462	0.15	13.26
HT20	MCS0	1	1	2412	0.13	11.13
HT20	MCS0	1	6	2437	0.13	11.35
HT20	MCS0	1	11	2462	0.13	11.43
HT40	MCS0	1	3	2422	0.28	9.14
HT40	MCS0	1	6	2437	0.28	10.94
HT40	MCS0	1	9	2452	0.28	10.99

TEST RESULTS DATA
Peak Power Density

2.4GHz Band								
Mod.	Data Rate	N _{TX}	CH.	Freq. (MHz)	Peak PSD (dBm /3kHz)	DG (dBi)	Peak PSD Limit (dBm /3kHz)	Pass/Fail
11b	1Mbps	1	1	2412	-6.96	-2.10	8.00	Pass
11b	1Mbps	1	6	2437	-6.12	-2.10	8.00	Pass
11b	1Mbps	1	11	2462	-6.22	-2.10	8.00	Pass
11g	6Mbps	1	1	2412	-13.75	-2.10	8.00	Pass
11g	6Mbps	1	6	2437	-10.14	-2.10	8.00	Pass
11g	6Mbps	1	11	2462	-11.33	-2.10	8.00	Pass
HT20	MCS0	1	1	2412	-14.85	-2.10	8.00	Pass
HT20	MCS0	1	6	2437	-14.64	-2.10	8.00	Pass
HT20	MCS0	1	11	2462	-14.21	-2.10	8.00	Pass
HT40	MCS0	1	3	2422	-18.83	-2.10	8.00	Pass
HT40	MCS0	1	6	2437	-18.22	-2.10	8.00	Pass
HT40	MCS0	1	9	2452	-17.07	-2.10	8.00	Pass



Appendix B. Radiated Spurious Emission

Test Engineer :	J.C. Liang and Jacky Hung	Temperature :	20~24°C
		Relative Humidity :	50~58%

2.4GHz 2400~2483.5MHz

WIFI 802.11b (Band Edge @ 3m)

WIFI Ant. 1	Note	Frequency (MHz)	Level (dBμV/m)	Over Limit (dB)	Limit Line (dBμV/m)	Read Level (dBμV)	Antenna Factor (dB/m)	Cable Loss (dB)	Preamp Factor (dB)	Ant Pos (cm)	Table Pos (deg)	Peak Avg. (P/A)	Pol. (H/V)	
802.11b CH 01 2412MHz		2382.35	53.65	-20.35	74	51.61	27.14	8.89	33.99	218	195	P	H	
		2390	43.92	-10.08	54	41.82	27.19	8.89	33.98	218	195	A	H	
	*	2412	108.08	-	-	105.93	27.24	8.89	33.98	218	195	P	H	
	*	2412	104.52	-	-	102.37	27.24	8.89	33.98	218	195	A	H	
													H	
														H
			2388.44	53.58	-20.42	74	51.49	27.19	8.89	33.99	271	205	P	V
			2389.91	43.17	-10.83	54	41.07	27.19	8.89	33.98	271	205	A	V
	*		2412	105.01	-	-	102.86	27.24	8.89	33.98	271	205	P	V
	*		2412	101.37	-	-	99.22	27.24	8.89	33.98	271	205	A	V
														V
														V
802.11b CH 06 2437MHz		2389.52	55.44	-18.56	74	52.96	27.19	8.89	33.6	191	325	P	H	
		2389.8	45.71	-8.29	54	43.22	27.19	8.89	33.59	191	325	A	H	
	*	2417	109.25	-	-	106.71	27.24	8.89	33.59	191	325	P	H	
	*	2416	101.11	-	-	98.57	27.24	8.89	33.59	191	325	A	H	
			2498.32	54.59	-19.41	74	51.68	27.5	8.98	33.57	191	325	P	H
			2483.55	44.78	-9.22	54	41.93	27.45	8.98	33.58	191	325	A	H
			2389.1	53.9	-20.1	74	51.42	27.19	8.89	33.6	202	336	P	V
			2389.8	45.11	-8.89	54	42.62	27.19	8.89	33.59	202	336	A	V
	*		2417	106.49	-	-	103.95	27.24	8.89	33.59	202	336	P	V
	*		2417	98.12	-	-	95.58	27.24	8.89	33.59	202	336	A	V
			2485.65	54.1	-19.9	74	51.25	27.45	8.98	33.58	202	336	P	V
			2483.83	44.27	-9.73	54	41.42	27.45	8.98	33.58	202	336	A	V



802.11b CH 11 2462MHz	*	2462	105.45	-	-	103.03	27.4	8.98	33.96	302	203	P	H
	*	2462	101.9	-	-	99.48	27.4	8.98	33.96	302	203	A	H
		2498.8	54.07	-19.93	74	51.53	27.5	8.98	33.94	302	203	P	H
		2485.92	43.51	-10.49	54	41.03	27.45	8.98	33.95	302	203	A	H
													H
													H
	*	2462	103.81	-	-	101.39	27.4	8.98	33.96	324	214	P	V
	*	2462	100.26	-	-	97.84	27.4	8.98	33.96	324	214	A	V
		2489.64	53.41	-20.59	74	50.88	27.5	8.98	33.95	324	214	P	V
		2485.64	43.41	-10.59	54	40.93	27.45	8.98	33.95	324	214	A	V
													V
													V
Remark	1. No other spurious found. 2. All results are PASS against Peak and Average limit line.												



2.4GHz 2400~2483.5MHz

WIFI 802.11b (Harmonic @ 3m)

WIFI Ant. 1	Note	Frequency (MHz)	Level (dBμV/m)	Over Limit (dB)	Limit Line (dBμV/m)	Read Level (dBμV)	Antenna Factor (dB/m)	Cable Loss (dB)	Preamp Factor (dB)	Ant Pos (cm)	Table Pos (deg)	Peak Avg. (P/A)	Pol. (H/V)	
802.11b CH 01 2412MHz		4824	31.99	-42.01	74	40.62	31.69	10.77	51.09	100	0	P	H	
													H	
													H	
													H	
			4824	31.87	-42.13	74	40.5	31.69	10.77	51.09	100	0	P	V
														V
														V
802.11b CH 06 2437MHz		4874	32.86	-41.14	74	41.26	31.78	10.88	51.06	100	0	P	H	
		7311	37.4	-36.6	74	37.85	37.27	12.79	50.51	100	0	P	H	
													H	
													H	
			4874	33.13	-40.87	74	41.53	31.78	10.88	51.06	100	0	P	V
			7311	38.53	-35.47	74	38.98	37.27	12.79	50.51	100	0	P	V
														V
802.11b CH 11 2462MHz		4924	32.55	-41.45	74	40.71	31.88	11	51.04	100	0	P	H	
		7386	38.51	-35.49	74	38.76	37.38	12.88	50.51	100	0	P	H	
													H	
													H	
			4924	32.61	-41.39	74	40.77	31.88	11	51.04	100	0	P	V
			7386	38.75	-35.25	74	39	37.38	12.88	50.51	100	0	P	V
														V
Remark	1. No other spurious found.													
	2. All results are PASS against Peak and Average limit line.													



2.4GHz 2400~2483.5MHz

WIFI 802.11g (Band Edge @ 3m)

WIFI Ant. 1	Note	Frequency (MHz)	Level (dBμV/m)	Over Limit (dB)	Limit Line (dBμV/m)	Read Level (dBμV)	Antenna Factor (dB/m)	Cable Loss (dB)	Preamp Factor (dB)	Ant Pos (cm)	Table Pos (deg)	Peak Avg. (P/A)	Pol. (H/V)	
802.11g CH 01 2412MHz		2389.59	57.56	-16.44	74	55.47	27.19	8.89	33.99	167	191	P	H	
		2390	46.31	-7.69	54	44.21	27.19	8.89	33.98	167	191	A	H	
	*	2412	106.3	-	-	104.15	27.24	8.89	33.98	167	191	P	H	
	*	2412	98.43	-	-	96.28	27.24	8.89	33.98	167	191	A	H	
													H	
														H
			2367.44	53.57	-20.43	74	51.65	27.09	8.82	33.99	346	214	P	V
			2390	44.68	-9.32	54	42.58	27.19	8.89	33.98	346	214	A	V
	*		2412	102.52	-	-	100.37	27.24	8.89	33.98	346	214	P	V
	*		2412	93.93	-	-	91.78	27.24	8.89	33.98	346	214	A	V
														V
														V
802.11g CH 06 2437MHz		2386.72	54.03	-19.97	74	51.55	27.19	8.89	33.6	212	343	P	H	
		2389.66	44.72	-9.28	54	42.24	27.19	8.89	33.6	212	343	A	H	
	*	2437	108.39	-	-	105.7	27.34	8.94	33.59	212	343	P	H	
	*	2437	99.93	-	-	97.24	27.34	8.94	33.59	212	343	A	H	
			2487.82	55.09	-18.91	74	52.19	27.5	8.98	33.58	212	343	P	H
			2483.52	44.78	-9.22	54	41.93	27.45	8.98	33.58	212	343	A	H
			2364.74	54.15	-19.85	74	51.84	27.09	8.82	33.6	200	357	P	V
			2388.68	44.23	-9.77	54	41.75	27.19	8.89	33.6	200	357	A	V
	*		2437	105.7	-	-	103.01	27.34	8.94	33.59	200	357	P	V
	*		2437	97.33	-	-	94.64	27.34	8.94	33.59	200	357	A	V
			2500	54.08	-19.92	74	51.17	27.5	8.98	33.57	200	357	P	V
			2499.02	44.61	-9.39	54	41.7	27.5	8.98	33.57	200	357	A	V



802.11g CH 11 2462MHz	*	2462	108.47	-	-	106.05	27.4	8.98	33.96	189	193	P	H
	*	2462	100.16	-	-	97.74	27.4	8.98	33.96	189	193	A	H
		2483.56	57.32	-16.68	74	54.84	27.45	8.98	33.95	189	193	P	H
		2483.52	46.6	-7.4	54	44.12	27.45	8.98	33.95	189	193	A	H
													H
													H
	*	2462	105.12	-	-	102.7	27.4	8.98	33.96	367	219	P	V
	*	2462	96.48	-	-	94.06	27.4	8.98	33.96	367	219	A	V
		2483.72	55.08	-18.92	74	52.6	27.45	8.98	33.95	367	219	P	V
		2483.72	45.28	-8.72	54	42.8	27.45	8.98	33.95	367	219	A	V
													V
													V
Remark	1. No other spurious found. 2. All results are PASS against Peak and Average limit line.												



2.4GHz 2400~2483.5MHz

WIFI 802.11g (Harmonic @ 3m)

WIFI Ant. 1	Note	Frequency (MHz)	Level (dBμV/m)	Over Limit (dB)	Limit Line (dBμV/m)	Read Level (dBμV)	Antenna Factor (dB/m)	Cable Loss (dB)	Preamp Factor (dB)	Ant Pos (cm)	Table Pos (deg)	Peak Avg. (P/A)	Pol. (H/V)	
802.11g CH 01 2412MHz		4824	31.58	-42.42	74	40.21	31.69	10.77	51.09	100	0	P	H	
													H	
													H	
													H	
			4824	32.16	-41.84	74	40.79	31.69	10.77	51.09	100	0	P	V
														V
														V
802.11g CH 06 2437MHz		4874	34.72	-39.28	74	43.12	31.78	10.88	51.06	100	0	P	H	
		7311	39.84	-34.16	74	40.29	37.27	12.79	50.51	100	0	P	H	
													H	
													H	
			4874	34.36	-39.64	74	42.76	31.78	10.88	51.06	100	0	P	V
			7311	38.9	-35.1	74	39.35	37.27	12.79	50.51	100	0	P	V
														V
802.11g CH 11 2462MHz		4924	34.75	-39.25	74	42.91	31.88	11	51.04	100	0	P	H	
		7386	39.96	-34.04	74	40.21	37.38	12.88	50.51	100	0	P	H	
													H	
													H	
			4924	35.47	-38.53	74	43.63	31.88	11	51.04	100	0	P	V
			7386	39.41	-34.59	74	39.66	37.38	12.88	50.51	100	0	P	V
														V
Remark	1. No other spurious found.													
	2. All results are PASS against Peak and Average limit line.													



2.4GHz 2400~2483.5MHz

WIFI 802.11n HT20 (Band Edge @ 3m)

WIFI Ant. 1	Note	Frequency (MHz)	Level (dBμV/m)	Over Limit (dB)	Limit Line (dBμV/m)	Read Level (dBμV)	Antenna Factor (dB/m)	Cable Loss (dB)	Preamp Factor (dB)	Ant Pos (cm)	Table Pos (deg)	Peak Avg. (P/A)	Pol. (H/V)	
802.11n HT20 CH 01 2412MHz		2390	58.61	-15.39	74	56.51	27.19	8.89	33.98	165	191	P	H	
		2390	46.66	-7.34	54	44.56	27.19	8.89	33.98	165	191	A	H	
	*	2412	105.45	-	-	103.3	27.24	8.89	33.98	165	191	P	H	
	*	2412	96.95	-	-	94.8	27.24	8.89	33.98	165	191	A	H	
													H	
														H
			2389.17	55.29	-18.71	74	53.2	27.19	8.89	33.99	347	216	P	V
			2389.91	45.18	-8.82	54	43.08	27.19	8.89	33.98	347	216	A	V
		*	2412	101.71	-	-	99.56	27.24	8.89	33.98	347	216	P	V
		*	2412	93.25	-	-	91.1	27.24	8.89	33.98	347	216	A	V
802.11n HT20 CH 06 2437MHz		2389.1	54.19	-19.81	74	52.1	27.19	8.89	33.99	163	191	P	H	
		2388.82	44.46	-9.54	54	42.37	27.19	8.89	33.99	163	191	A	H	
		*	2437	106.46	-	-	104.15	27.34	8.94	33.97	163	191	P	H
		*	2437	98.03	-	-	95.72	27.34	8.94	33.97	163	191	A	H
			2485.51	54.29	-19.71	74	51.81	27.45	8.98	33.95	163	191	P	H
			2484.25	44.29	-9.71	54	41.81	27.45	8.98	33.95	163	191	A	H
			2350.6	53.4	-20.6	74	51.54	27.03	8.82	33.99	303	211	P	V
			2388.68	43.53	-10.47	54	41.44	27.19	8.89	33.99	303	211	A	V
		*	2437	102.61	-	-	100.3	27.34	8.94	33.97	303	211	P	V
		*	2437	94.16	-	-	91.85	27.34	8.94	33.97	303	211	A	V
		2490.27	53.9	-20.1	74	51.37	27.5	8.98	33.95	303	211	P	V	
		2484.32	44.11	-9.89	54	41.63	27.45	8.98	33.95	303	211	A	V	



802.11n HT20 CH 11 2462MHz	*	2462	105.62	-	-	103.2	27.4	8.98	33.96	142	192	P	H
	*	2462	97.41	-	-	94.99	27.4	8.98	33.96	142	192	A	H
		2484.88	54.62	-19.38	74	52.14	27.45	8.98	33.95	142	192	P	H
		2483.72	45.36	-8.64	54	42.88	27.45	8.98	33.95	142	192	A	H
													H
													H
	*	2462	103.31	-	-	100.89	27.4	8.98	33.96	292	209	P	V
	*	2462	94.72	-	-	92.3	27.4	8.98	33.96	292	209	A	V
		2483.84	54.27	-19.73	74	51.79	27.45	8.98	33.95	292	209	P	V
		2483.84	44.81	-9.19	54	42.33	27.45	8.98	33.95	292	209	A	V
													V
													V
Remark	1. No other spurious found. 2. All results are PASS against Peak and Average limit line.												



2.4GHz 2400~2483.5MHz

WIFI 802.11n HT20 (Harmonic @ 3m)

WIFI Ant. 1	Note	Frequency (MHz)	Level (dBμV/m)	Over Limit (dB)	Limit Line (dBμV/m)	Read Level (dBμV)	Antenna Factor (dB/m)	Cable Loss (dB)	Preamp Factor (dB)	Ant Pos (cm)	Table Pos (deg)	Peak Avg. (P/A)	Pol. (H/V)	
802.11n HT20 CH 01 2412MHz		4824	32.06	-41.94	74	40.69	31.69	10.77	51.09	100	0	P	H	
													H	
													H	
													H	
			4824	32.43	-41.57	74	41.06	31.69	10.77	51.09	100	0	P	V
														V
														V
802.11n HT20 CH 06 2437MHz		4874	33.26	-40.74	74	41.66	31.78	10.88	51.06	100	0	P	H	
		7311	37.83	-36.17	74	38.28	37.27	12.79	50.51	100	0	P	H	
													H	
													H	
			4874	33.94	-40.06	74	42.34	31.78	10.88	51.06	100	0	P	V
			7311	38.63	-35.37	74	39.08	37.27	12.79	50.51	100	0	P	V
														V
802.11n HT20 CH 11 2462MHz		4924	32.24	-41.76	74	40.4	31.88	11	51.04	100	0	P	H	
		7386	37.44	-36.56	74	37.69	37.38	12.88	50.51	100	0	P	H	
													H	
													H	
			4924	33.27	-40.73	74	41.43	31.88	11	51.04	100	0	P	V
			7386	39.01	-34.99	74	39.26	37.38	12.88	50.51	100	0	P	V
														V
Remark	1. No other spurious found.													
	2. All results are PASS against Peak and Average limit line.													



2.4GHz 2400~2483.5MHz

WIFI 802.11n HT40 (Band Edge @ 3m)

WIFI Ant. 1	Note	Frequency (MHz)	Level (dBμV/m)	Over Limit (dB)	Limit Line (dBμV/m)	Read Level (dBμV)	Antenna Factor (dB/m)	Cable Loss (dB)	Preamp Factor (dB)	Ant Pos (cm)	Table Pos (deg)	Peak Avg. (P/A)	Pol. (H/V)
802.11n HT40 CH 03 2422MHz		2389.94	59.53	-14.47	74	57.43	27.19	8.89	33.98	143	191	P	H
		2389.38	46.76	-7.24	54	44.67	27.19	8.89	33.99	143	191	A	H
	*	2422	101.29	-	-	99.03	27.29	8.94	33.97	143	191	P	H
	*	2422	92.68	-	-	90.42	27.29	8.94	33.97	143	191	A	H
		2494.33	53.41	-20.59	74	50.87	27.5	8.98	33.94	143	191	P	H
		2485.93	44.77	-9.23	54	42.29	27.45	8.98	33.95	143	191	A	H
		2389.24	58.21	-15.79	74	56.12	27.19	8.89	33.99	303	210	P	V
		2387.7	45.01	-8.99	54	42.92	27.19	8.89	33.99	303	210	A	V
	*	2422	97.92	-	-	95.66	27.29	8.94	33.97	303	210	P	V
	*	2422	89.53	-	-	87.27	27.29	8.94	33.97	303	210	A	V
		2498.39	53.87	-20.13	74	51.33	27.5	8.98	33.94	303	210	P	V
		2487.47	44.93	-9.07	54	42.45	27.45	8.98	33.95	303	210	A	V
802.11n HT40 CH 06 2437MHz		2346.4	53.55	-20.45	74	51.69	27.03	8.82	33.99	272	200	P	H
		2389.52	44.53	-9.47	54	42.44	27.19	8.89	33.99	272	200	A	H
	*	2437	102.55	-	-	100.24	27.34	8.94	33.97	272	200	P	H
	*	2437	93.51	-	-	91.2	27.34	8.94	33.97	272	200	A	H
		2499.09	54.56	-19.44	74	52.02	27.5	8.98	33.94	272	200	P	H
		2483.52	44.87	-9.13	54	42.39	27.45	8.98	33.95	272	200	A	H
		2388.26	52.96	-21.04	74	50.87	27.19	8.89	33.99	304	212	P	V
		2371.46	44.31	-9.69	54	42.34	27.14	8.82	33.99	304	212	A	V
	*	2437	100.07	-	-	97.76	27.34	8.94	33.97	304	212	P	V
	*	2437	91.91	-	-	89.6	27.34	8.94	33.97	304	212	A	V
	2493	53.55	-20.45	74	51.01	27.5	8.98	33.94	304	212	P	V	
	2488.8	44.71	-9.29	54	42.18	27.5	8.98	33.95	304	212	A	V	



802.11n HT40 CH 09 2452MHz		2359.42	53.58	-20.42	74	51.66	27.09	8.82	33.99	272	199	P	H
		2388.82	44.75	-9.25	54	42.66	27.19	8.89	33.99	272	199	A	H
	*	2452	102.93	-	-	100.61	27.34	8.94	33.96	272	199	P	H
	*	2452	94.72	-	-	92.4	27.34	8.94	33.96	272	199	A	H
		2484.25	58.09	-15.91	74	55.61	27.45	8.98	33.95	272	199	P	H
		2484.67	46.52	-7.48	54	44.04	27.45	8.98	33.95	272	199	A	H
		2383.78	53.55	-20.45	74	51.51	27.14	8.89	33.99	264	206	P	V
		2389.8	44.29	-9.71	54	42.19	27.19	8.89	33.98	264	206	A	V
	*	2452	101.04	-	-	98.72	27.34	8.94	33.96	264	206	P	V
	*	2452	92.64	-	-	90.32	27.34	8.94	33.96	264	206	A	V
		2485.02	56.52	-17.48	74	54.04	27.45	8.98	33.95	264	206	P	V
		2484.67	45.67	-8.33	54	43.19	27.45	8.98	33.95	264	206	A	V
Remark	1. No other spurious found. 2. All results are PASS against Peak and Average limit line.												



2.4GHz 2400~2483.5MHz

WIFI 802.11n HT40 (Harmonic @ 3m)

WIFI Ant. 1	Note	Frequency (MHz)	Level (dBμV/m)	Over Limit (dB)	Limit Line (dBμV/m)	Read Level (dBμV)	Antenna Factor (dB/m)	Cable Loss (dB)	Preamp Factor (dB)	Ant Pos (cm)	Table Pos (deg)	Peak Avg. (P/A)	Pol. (H/V)
802.11n HT40 CH 03 2422MHz		4844	33.11	-40.89	74	41.7	31.72	10.77	51.08	100	0	P	H
		7266	37.88	-36.12	74	38.42	37.23	12.74	50.51	100	0	P	H
													H
													H
		4844	31.4	-42.6	74	39.99	31.72	10.77	51.08	100	0	P	V
		7266	37.41	-36.59	74	37.95	37.23	12.74	50.51	100	0	P	V
802.11n HT40 CH 06 2437MHz		4874	33.66	-40.34	74	42.06	31.78	10.88	51.06	100	0	P	H
		7311	38.13	-35.87	74	38.58	37.27	12.79	50.51	100	0	P	H
													H
													H
		4874	33.16	-40.84	74	41.56	31.78	10.88	51.06	100	0	P	V
		7311	38.22	-35.78	74	38.67	37.27	12.79	50.51	100	0	P	V
802.11n HT40 CH 09 2452MHz		4904	32.04	-41.96	74	40.26	31.84	11	51.06	100	0	P	H
		7356	38.29	-35.71	74	38.64	37.33	12.83	50.51	100	0	P	H
													H
													H
		4904	32.82	-41.18	74	41.04	31.84	11	51.06	100	0	P	V
		7356	37.72	-36.28	74	38.07	37.33	12.83	50.51	100	0	P	V
Remark	1. No other spurious found.												
	2. All results are PASS against Peak and Average limit line.												



Emission below 1GHz

2.4GHz WIFI 802.11n HT40 (LF)

WIFI	Note	Frequency	Level	Over	Limit	Read	Antenna	Cable	Preamp	Ant	Table	Peak	Pol.	
Ant.				Limit	Line	Level	Factor	Loss	Factor	Pos	Pos	Avg.		
1		(MHz)	(dBμV/m)	(dB)	(dBμV/m)	(dBμV)	(dB/m)	(dB)	(dB)	(cm)	(deg)	(P/A)	(H/V)	
2.4GHz 802.11n HT40 LF		30	23.36	-16.64	40	28.87	25.7	1.29	32.5	-	-	P	H	
		98.31	20.7	-22.8	43.5	35.81	15.86	1.51	32.48	-	-	P	H	
		138	19.8	-23.7	43.5	32.74	17.92	1.78	32.64	-	-	P	H	
		540.1	25.94	-20.06	46	30.22	24.66	3.47	32.41	-	-	P	H	
		710.9	29.09	-16.91	46	30.59	26.92	4.02	32.44	-	-	P	H	
		958.7	33.24	-12.76	46	29.09	30.58	4.69	31.12	283	172	P	H	
														H
														H
														H
														H
														H
														H
														H
			40.8	35.67	-	-	47.13	19.74	1.29	32.49	150	314	P	V
			40.8	32.08	-7.92	40	43.54	19.74	1.29	32.49	150	314	QP	V
			81.57	26.52	-13.48	40	43.67	13.82	1.51	32.48	-	-	P	V
			98.31	22.47	-21.03	43.5	37.58	15.86	1.51	32.48	-	-	P	V
			727	29.54	-16.46	46	30.66	27.25	4.02	32.39	-	-	P	V
			845.3	31.61	-14.39	46	30.32	28.85	4.39	31.95	-	-	P	V
			960.8	33.94	-20.06	54	29.77	30.58	4.69	31.1	-	-	P	V
													V	
													V	
													V	
													V	
													V	
Remark	1. No other spurious found. 2. All results are PASS against limit line.													



Note symbol

*	Fundamental Frequency which can be ignored. However, the level of any unwanted emissions shall not exceed the level of the fundamental frequency.
!	Test result is over limit line.
P/A	Peak or Average
H/V	Horizontal or Vertical



A calculation example for radiated spurious emission is shown as below:

WIFI	Note	Frequency	Level	Over	Limit	Read	Antenna	Cable	Preamp	Ant	Table	Peak	Pol.
Ant.				Limit	Line	Level	Factor	Loss	Factor	Pos	Pos	Avg.	
1		(MHz)	(dBμV/m)	(dB)	(dBμV/m)	(dBμV)	(dB/m)	(dB)	(dB)	(cm)	(deg)	(P/A)	(H/V)
802.11b		2390	55.45	-18.55	74	54.51	32.22	4.58	35.86	103	308	P	H
CH 01													
2412MHz		2390	43.54	-10.46	54	42.6	32.22	4.58	35.86	103	308	A	H

- Level(dBμV/m) =
Antenna Factor(dB/m) + Cable Loss(dB) + Read Level(dBμV) - Preamp Factor(dB)
- Over Limit(dB) = Level(dBμV/m) – Limit Line(dBμV/m)

For Peak Limit @ 2390MHz:

- Level(dBμV/m)
= Antenna Factor(dB/m) + Cable Loss(dB) + Read Level(dBμV) - Preamp Factor(dB)
= 32.22(dB/m) + 4.58(dB) + 54.51(dBμV) – 35.86 (dB)
= 55.45 (dBμV/m)
- Over Limit(dB)
= Level(dBμV/m) – Limit Line(dBμV/m)
= 55.45(dBμV/m) – 74(dBμV/m)
= -18.55(dB)

For Average Limit @ 2390MHz:

- Level(dBμV/m)
= Antenna Factor(dB/m) + Cable Loss(dB) + Read Level(dBμV) - Preamp Factor(dB)
= 32.22(dB/m) + 4.58(dB) + 42.6(dBμV) – 35.86 (dB)
= 43.54 (dBμV/m)
- Over Limit(dB)
= Level(dBμV/m) – Limit Line(dBμV/m)
= 43.54(dBμV/m) – 54(dBμV/m)
= -10.46(dB)

Both peak and average measured complies with the limit line, so test result is “PASS”.



Appendix C. Radiated Spurious Emission Plots

Test Engineer :	J.C. Liang and Jacky Hung	Temperature :	20~24°C
		Relative Humidity :	50~58%

Note symbol

-L	Low channel location
-R	High channel location



2.4GHz 2400~2483.5MHz

WIFI 802.11b (Band Edge @ 3m)

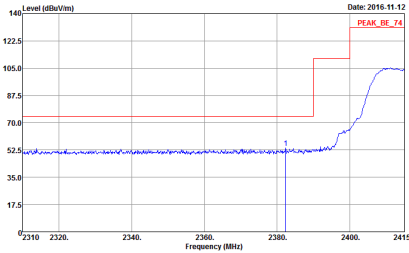
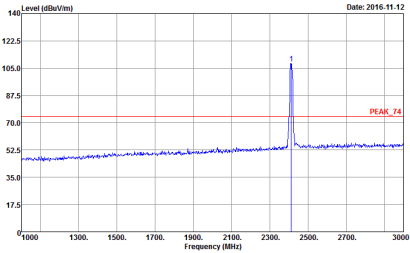
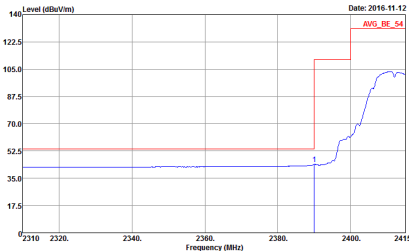
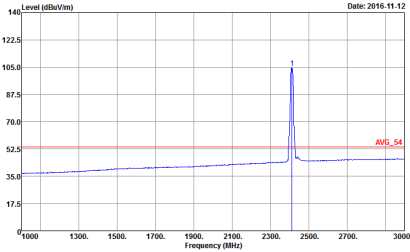
WIFI	2.4GHz 2400~2483.5MHz Band Edge @ 3m	
ANT	802.11b CH01 2412MHz	
1	Horizontal	Fundamental
Peak	 <p>Date: 2016-11-12 PEAK_BE_74</p> <p>Site : 03CH11-HY Condition : PEAK_BE_74 3m HORN 91200-HF HORIZONTAL Detector : RBW:1000.000KHz VBW:3000.000KHz SWT:Auto Project : 601802</p>	 <p>Date: 2016-11-12 PEAK_74</p> <p>Site : 03CH11-HY Condition : PEAK_74 3m HORN 91200-HF HORIZONTAL Detector : RBW:1000.000KHz VBW:3000.000KHz SWT:Auto Project : 601802</p>
Avg.	 <p>Date: 2016-11-12 AVG_BE_54</p> <p>Site : 03CH11-HY Condition : AVG_BE_54 3m HORN 91200-HF HORIZONTAL Detector : RBW:1000.000KHz VBW:0.010KHz SWT:Auto Project : 601802</p>	 <p>Date: 2016-11-12 AVG_54</p> <p>Site : 03CH11-HY Condition : AVG_54 3m HORN 91200-HF HORIZONTAL Detector : RBW:1000.000KHz VBW:0.010KHz SWT:Auto Project : 601802</p>

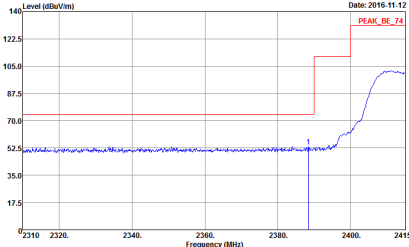
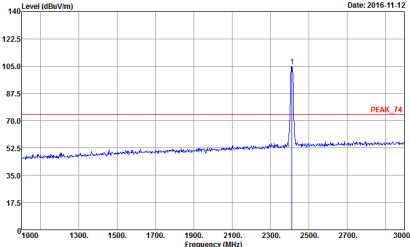
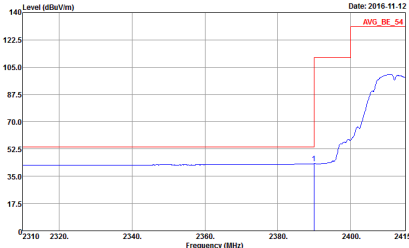
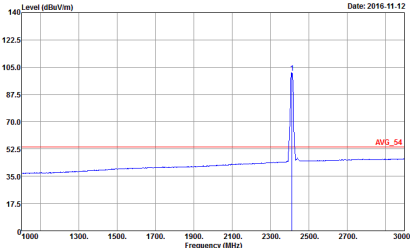

WIFI	2.4GHz 2400~2483.5MHz Band Edge @ 3m	
ANT	802.11b CH01 2412MHz	
1	<p style="text-align: center;">Vertical</p>  <p style="text-align: right;">Date: 2016-11-12 PEAK_BE_74</p> <p>Site : 03CH11-HY Condition : PEAK_BE_74 3m HORN 9120D-HF VERTICAL RBW:1000.000KHz VBW:3000.000KHz SWT:Auto Detector : Peak Project : 6O1802</p>	<p style="text-align: center;">Fundamental</p>  <p style="text-align: right;">Date: 2016-11-12 PEAK_74</p> <p>Site : 03CH11-HY Condition : PEAK_74 3m HORN 9120D-HF VERTICAL RBW:1000.000KHz VBW:3000.000KHz SWT:Auto Detector : Peak Project : 6O1802</p>
Avg.	 <p style="text-align: right;">Date: 2016-11-12 AVG_BE_54</p> <p>Site : 03CH11-HY Condition : AVG_BE_54 3m HORN 9120D-HF VERTICAL RBW:1000.000KHz VBW:0.010KHz SWT:Auto Detector : Peak Project : 6O1802</p>	 <p style="text-align: right;">Date: 2016-11-12 AVG_54</p> <p>Site : 03CH11-HY Condition : AVG_54 3m HORN 9120D-HF VERTICAL RBW:1000.000KHz VBW:0.010KHz SWT:Auto Detector : Peak Project : 6O1802</p>



WIFI	2.4GHz 2400~2483.5MHz Band Edge @ 3m	
ANT	802.11b CH06 2437MHz - L	
1	Horizontal	Fundamental
Peak	<p>Date: 2017.02.24</p> <p>Site : 03CH11-HY Condition : PEAK_BE_74 3m HORN 91200-HF HORIZONTAL RBW:1000.000KHz VBW:3000.000KHz SWT:Auto Detector : Peak Project : 6O1802 Setting : 18</p>	<p>Date: 2017.02.24</p> <p>Site : 03CH11-HY Condition : PEAK_74 3m HORN 91200-HF HORIZONTAL RBW:1000.000KHz VBW:3000.000KHz SWT:Auto Detector : Peak Project : 6O1802 Setting : 18</p>
Avg.	<p>Date: 2017.02.24</p> <p>Site : 03CH11-HY Condition : AVG_BE_54 3m HORN 91200-HF HORIZONTAL RBW:1000.000KHz VBW:0.010KHz SWT:Auto Detector : Peak Project : 6O1802 Setting : 18</p>	<p>Date: 2017.02.24</p> <p>Site : 03CH11-HY Condition : AVG_54 3m HORN 91200-HF HORIZONTAL RBW:1000.000KHz VBW:0.010KHz SWT:Auto Detector : Peak Project : 6O1802 Setting : 18</p>



WIFI	2.4GHz 2400~2483.5MHz Band Edge @ 3m	
ANT	802.11b CH06 2437MHz - R	
1	Horizontal	Fundamental
Peak	<p>Date: 2017-02-24</p> <p>Site : 03CH11-HY Condition : PEAK_BE_74 3m HORN 9120D-HF HORIZONTAL Detector : Peak Project : 601802 Setting : 18</p>	Left blank
Avg.	<p>Date: 2017-02-24</p> <p>Site : 03CH11-HY Condition : AVG_BE_54 3m HORN 9120D-HF HORIZONTAL Detector : Peak Project : 601802 Setting : 18</p>	Left blank

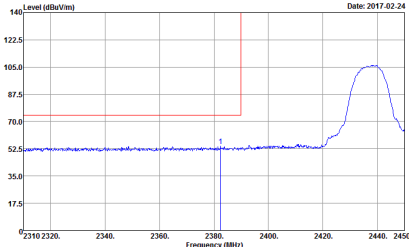
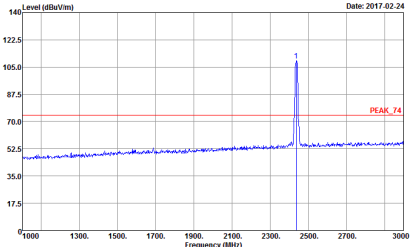
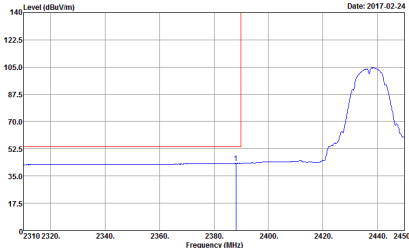
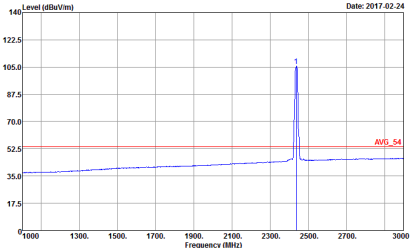

WIFI	2.4GHz 2400~2483.5MHz Band Edge @ 3m	
ANT	802.11b CH06 2437MHz - L	
1	Vertical	Fundamental
Peak	 <p>Date: 2017-02-24</p> <p>Site : 03CH11-HY Condition : PEAK_BE_74 3m HORN 9120D-HF VERTICAL RBW:1000.000KHz VBW:3000.000KHz SWT:Auto Detector : Peak Project : 601802 Setting : 18</p>	 <p>Date: 2017-02-24</p> <p>Site : 03CH11-HY Condition : PEAK_74 3m HORN 9120D-HF VERTICAL RBW:1000.000KHz VBW:3000.000KHz SWT:Auto Detector : Peak Project : 601802 Setting : 18</p>
Avg.	 <p>Date: 2017-02-24</p> <p>Site : 03CH11-HY Condition : AVG_BE_54 3m HORN 9120D-HF VERTICAL RBW:1000.000KHz VBW:0.010KHz SWT:Auto Detector : Peak Project : 601802 Setting : 18</p>	 <p>Date: 2017-02-24</p> <p>Site : 03CH11-HY Condition : AVG_54 3m HORN 9120D-HF VERTICAL RBW:1000.000KHz VBW:0.010KHz SWT:Auto Detector : Peak Project : 601802 Setting : 18</p>

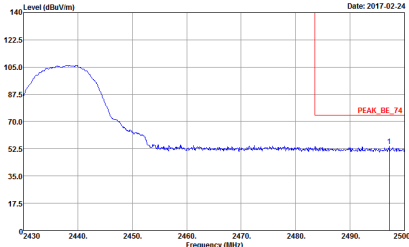
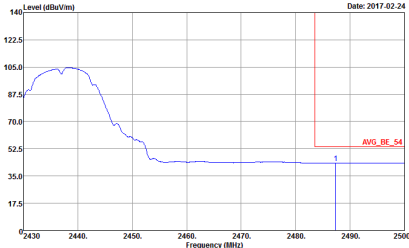

WIFI	2.4GHz 2400~2483.5MHz Band Edge @ 3m	
ANT	802.11b CH06 2437MHz - R	
1	Vertical	Fundamental
Peak	 <p>Date: 2017-02-24</p> <p>Site : 03CH11-HY Condition : PEAK_BE_74 3m HORN 9120D-HF VERTICAL Detector : Peak Project : 601802 Setting : 18</p>	Left blank
Avg.	 <p>Date: 2017-02-24</p> <p>Site : 03CH11-HY Condition : AVG_BE_54 3m HORN 9120D-HF VERTICAL Detector : Peak Project : 601802 Setting : 18</p>	Left blank

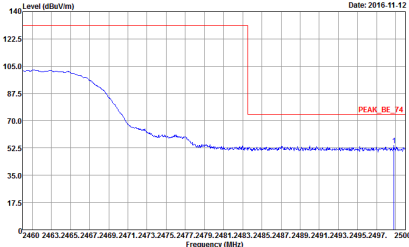
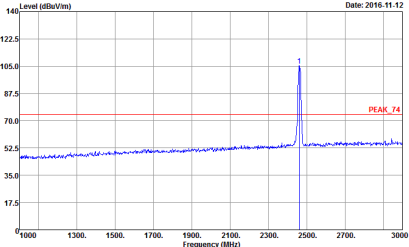
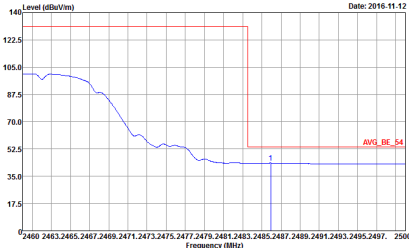
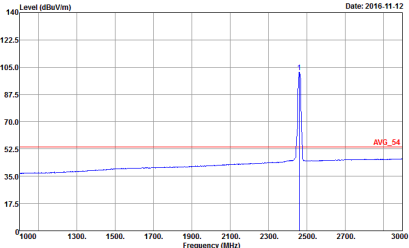

WIFI	2.4GHz 2400~2483.5MHz Band Edge @ 3m	
ANT	802.11b CH11 2462MHz	
1	Horizontal	Fundamental
Peak	 <p>Date: 2016-11-12</p> <p>Site : 03CH11-HY Condition : PEAK_BE_74 3m HORN 9120D-HF HORIZONTAL Detector : Peak Project : 6O1802</p>	 <p>Date: 2016-11-12</p> <p>Site : 03CH11-HY Condition : PEAK_74 3m HORN 9120D-HF HORIZONTAL Detector : Peak Project : 6O1802</p>
Avg.	 <p>Date: 2016-11-12</p> <p>Site : 03CH11-HY Condition : AVG_BE_54 3m HORN 9120D-HF HORIZONTAL Detector : Peak Project : 6O1802</p>	 <p>Date: 2016-11-12</p> <p>Site : 03CH11-HY Condition : AVG_54 3m HORN 9120D-HF HORIZONTAL Detector : Peak Project : 6O1802</p>

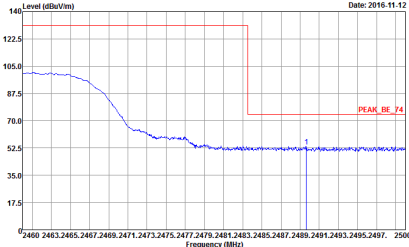
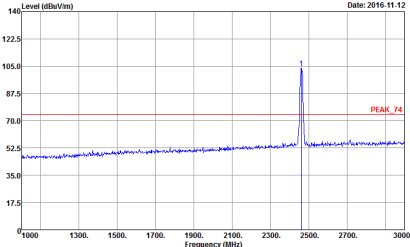
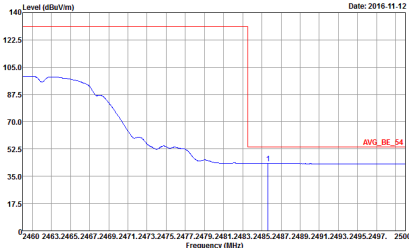
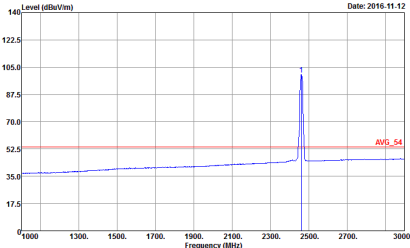

WIFI	2.4GHz 2400~2483.5MHz Band Edge @ 3m	
ANT	802.11b CH11 2462MHz	
1	Vertical	Fundamental
Peak	 <p>Site : 03CH11-HY Condition : PEAK_BE_74 3m HORN 9120D-HF VERTICAL Detector : Peak Project : 6O1802</p>	 <p>Site : 03CH11-HY Condition : PEAK_74 3m HORN 9120D-HF VERTICAL Detector : Peak Project : 6O1802</p>
Avg.	 <p>Site : 03CH11-HY Condition : AVG_BE_54 3m HORN 9120D-HF VERTICAL Detector : Peak Project : 6O1802</p>	 <p>Site : 03CH11-HY Condition : AVG_54 3m HORN 9120D-HF VERTICAL Detector : Peak Project : 6O1802</p>



2.4GHz 2400~2483.5MHz

WIFI 802.11g (Band Edge @ 3m)

WIFI	2.4GHz 2400~2483.5MHz Band Edge @ 3m	
ANT	802.11g CH01 2412MHz	
1	Horizontal	Fundamental
Peak	<p>Site : 03CH11-HY Condition : PEAK_BE_74 3m HORN 91200-HF HORIZONTAL Detector : Peak Project : 601802 Setting : 13</p>	<p>Site : 03CH11-HY Condition : PEAK_74 3m HORN 91200-HF HORIZONTAL Detector : Peak Project : 601802 Setting : 13</p>
Avg.	<p>Site : 03CH11-HY Condition : AVG_BE_54 3m HORN 91200-HF HORIZONTAL Detector : Peak Project : 601802 Setting : 13</p>	<p>Site : 03CH11-HY Condition : AVG_54 3m HORN 91200-HF HORIZONTAL Detector : Peak Project : 601802 Setting : 13</p>

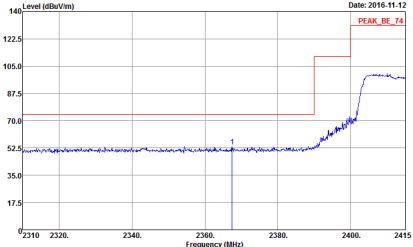
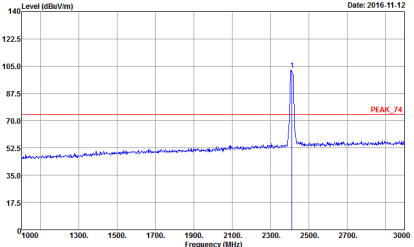
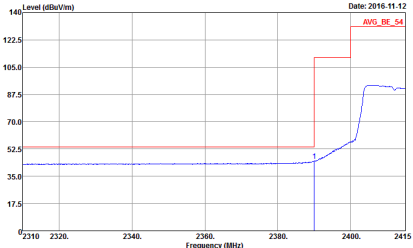
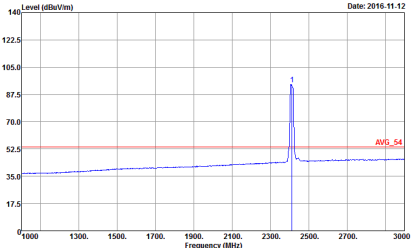

WIFI	2.4GHz 2400~2483.5MHz Band Edge @ 3m	
ANT	802.11g CH01 2412MHz	
1	Vertical	Fundamental
Peak	 <p>Date: 2016-11-12 PEAK_BE_74</p> <p>Site : 03CH11-HY Condition : PEAK_BE_74 3m HORN 9120D-HF VERTICAL RBW:1000.000KHz VBW:3000.000KHz SWT:Auto Detector : Peak Project : 6O1802 Setting : 13</p>	 <p>Date: 2016-11-12 PEAK_74</p> <p>Site : 03CH11-HY Condition : PEAK_74 3m HORN 9120D-HF VERTICAL RBW:1000.000KHz VBW:3000.000KHz SWT:Auto Detector : Peak Project : 6O1802 Setting : 13</p>
Avg.	 <p>Date: 2016-11-12 AVG_BE_54</p> <p>Site : 03CH11-HY Condition : AVG_BE_54 3m HORN 9120D-HF VERTICAL RBW:1000.000KHz VBW:1.000KHz SWT:Auto Detector : Peak Project : 6O1802 Setting : 13</p>	 <p>Date: 2016-11-12 AVG_54</p> <p>Site : 03CH11-HY Condition : AVG_54 3m HORN 9120D-HF VERTICAL RBW:1000.000KHz VBW:1.000KHz SWT:Auto Detector : Peak Project : 6O1802 Setting : 13</p>

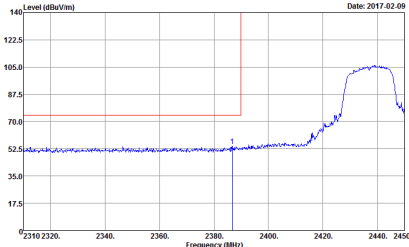
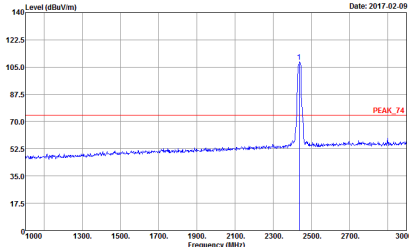
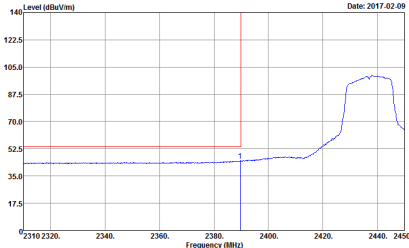
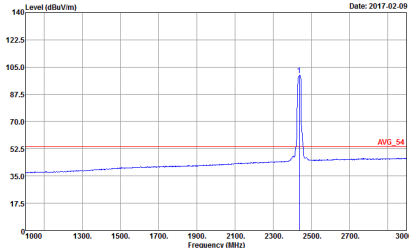

WIFI	2.4GHz 2400~2483.5MHz Band Edge @ 3m	
ANT	802.11g CH06 2437MHz - L	
1	Horizontal	Fundamental
Peak	 <p>Date: 2017-02-09</p> <p>Site : 03CH11-HY Condition : PEAK_BE_74 3m HORN 9120D-HF HORIZONTAL Detector : Peak Project : 601802</p>	 <p>Date: 2017-02-09</p> <p>Site : 03CH11-HY Condition : PEAK_74 3m HORN 9120D-HF HORIZONTAL Detector : Peak Project : 601802</p>
Avg.	 <p>Date: 2017-02-09</p> <p>Site : 03CH11-HY Condition : AVG_BE_54 3m HORN 9120D-HF HORIZONTAL Detector : Peak Project : 601802</p>	 <p>Date: 2017-02-09</p> <p>Site : 03CH11-HY Condition : AVG_54 3m HORN 9120D-HF HORIZONTAL Detector : Peak Project : 601802</p>

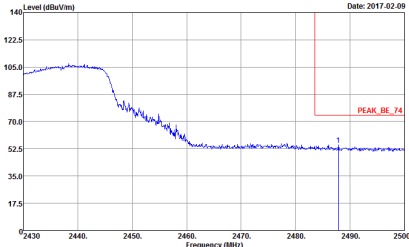
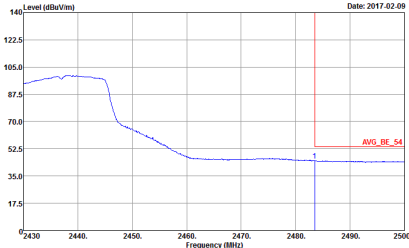

WIFI	2.4GHz 2400~2483.5MHz Band Edge @ 3m	
ANT	802.11g CH06 2437MHz - R	
1	Horizontal	Fundamental
Peak	 <p>Date: 2017-02-09</p> <p>Site : 03CH11-HY Condition : PEAK_BE_74 3m HORN 9120D-HF HORIZONTAL Detector : Peak Project : 601802</p>	Left blank
Avg.	 <p>Date: 2017-02-09</p> <p>Site : 03CH11-HY Condition : AVG_BE_54 3m HORN 9120D-HF HORIZONTAL Detector : Peak Project : 601802</p>	Left blank

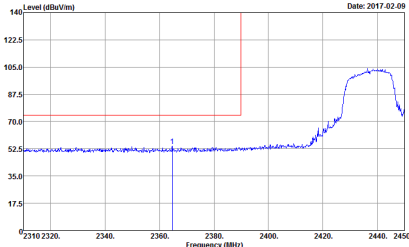
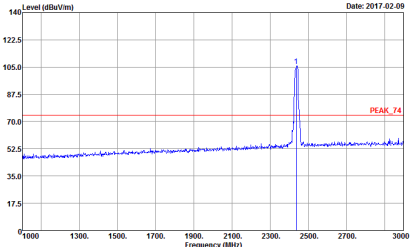
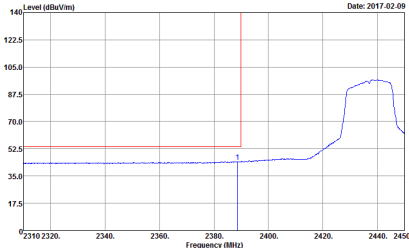
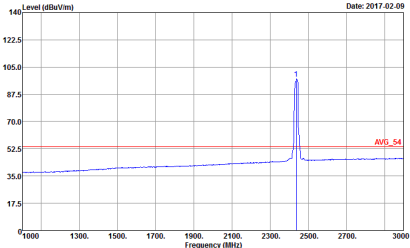

WIFI	2.4GHz 2400~2483.5MHz Band Edge @ 3m	
ANT	802.11g CH06 2437MHz - L	
1	Vertical	Fundamental
Peak	 <p>Date: 2017-02-09</p> <p>Site : 03CH11-HY Condition : PEAK_BE_74 3m HORN 9120D-HF VERTICAL RBW:1000.000KHz VBW:3000.000KHz SWT:Auto Detector : Peak Project : 601802</p>	 <p>Date: 2017-02-09</p> <p>Site : 03CH11-HY Condition : PEAK_74 3m HORN 9120D-HF VERTICAL RBW:1000.000KHz VBW:3000.000KHz SWT:Auto Detector : Peak Project : 601802</p>
Avg.	 <p>Date: 2017-02-09</p> <p>Site : 03CH11-HY Condition : AVG_BE_54 3m HORN 9120D-HF VERTICAL RBW:1000.000KHz VBW:1.000KHz SWT:Auto Detector : Peak Project : 601802</p>	 <p>Date: 2017-02-09</p> <p>Site : 03CH11-HY Condition : AVG_54 3m HORN 9120D-HF VERTICAL RBW:1000.000KHz VBW:1.000KHz SWT:Auto Detector : Peak Project : 601802</p>

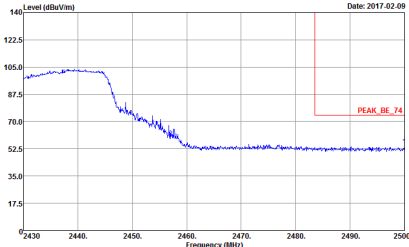
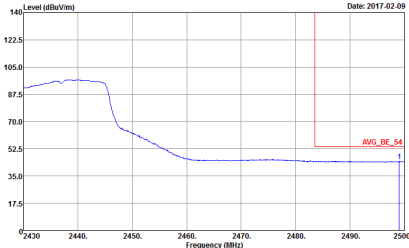

WIFI	2.4GHz 2400~2483.5MHz Band Edge @ 3m	
ANT	802.11g CH06 2437MHz - R	
1	Vertical	Fundamental
Peak	 <p>Date: 2017-02-09</p> <p>Site : 03CH11-HY Condition : PEAK_BE_74 3m HORN 9120D-HF VERTICAL Detector : Peak Project : 601802</p>	Left Blank
Avg.	 <p>Date: 2017-02-09</p> <p>Site : 03CH11-HY Condition : AVG_BE_54 3m HORN 9120D-HF VERTICAL Detector : Peak Project : 601802</p>	Left Blank

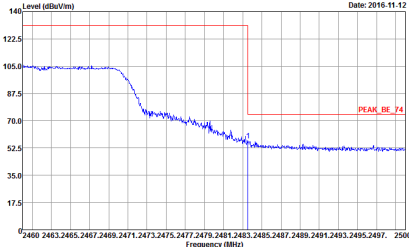
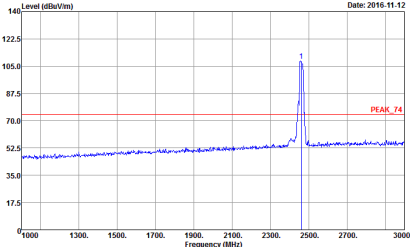
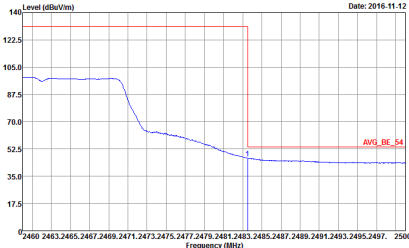
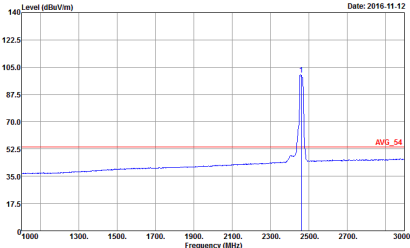

WIFI	2.4GHz 2400~2483.5MHz Band Edge @ 3m	
ANT	802.11g CH11 2462MHz	
1	Horizontal	Fundamental
Peak	 <p>Date: 2016-11-12</p> <p>Site : 03CH11-HY Condition : PEAK_BE_74 3m HORN 9120D-HF HORIZONTAL Detector : Peak Project : 6O1802</p>	 <p>Date: 2016-11-12</p> <p>Site : 03CH11-HY Condition : PEAK_74 3m HORN 9120D-HF HORIZONTAL Detector : Peak Project : 6O1802</p>
Avg.	 <p>Date: 2016-11-12</p> <p>Site : 03CH11-HY Condition : AVG_BE_54 3m HORN 9120D-HF HORIZONTAL Detector : Peak Project : 6O1802</p>	 <p>Date: 2016-11-12</p> <p>Site : 03CH11-HY Condition : AVG_54 3m HORN 9120D-HF HORIZONTAL Detector : Peak Project : 6O1802</p>

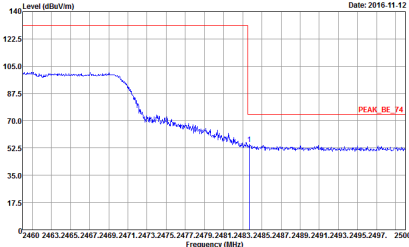
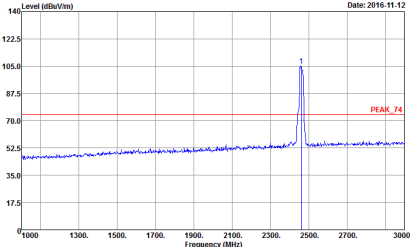
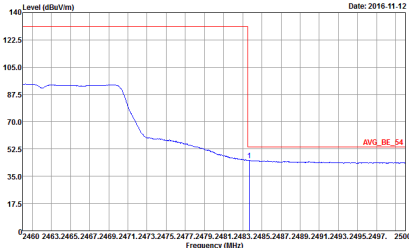
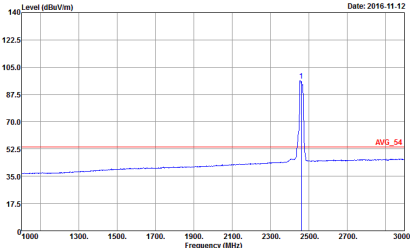

WIFI	2.4GHz 2400~2483.5MHz Band Edge @ 3m	
ANT	802.11g CH11 2462MHz	
1	Vertical	Fundamental
Peak	 <p>Date: 2016.11.12</p> <p>Site : 03CH11-HY Condition : PEAK_BE_74 3m HORN 9120D-HF VERTICAL RBW:1000.000KHz VBW:3000.000KHz SWT:Auto Detector : Peak Project : 6O1802</p>	 <p>Date: 2016.11.12</p> <p>Site : 03CH11-HY Condition : PEAK_74 3m HORN 9120D-HF VERTICAL RBW:1000.000KHz VBW:3000.000KHz SWT:Auto Detector : Peak Project : 6O1802</p>
Avg.	 <p>Date: 2016.11.12</p> <p>Site : 03CH11-HY Condition : AVG_BE_54 3m HORN 9120D-HF VERTICAL RBW:1000.000KHz VBW:1.000KHz SWT:Auto Detector : Peak Project : 6O1802</p>	 <p>Date: 2016.11.12</p> <p>Site : 03CH11-HY Condition : AVG_54 3m HORN 9120D-HF VERTICAL RBW:1000.000KHz VBW:1.000KHz SWT:Auto Detector : Peak Project : 6O1802</p>



2.4GHz 2400~2483.5MHz

WIFI 802.11n HT20 (Band Edge @ 3m)

WIFI	2.4GHz 2400~2483.5MHz Band Edge @ 3m	
ANT	802.11n HT20 CH01 2412MHz	
1	Horizontal	Fundamental
Peak	<p>Date: 2016-11-12 PEAK_BE_74</p> <p>Site : 03CH11-HY Condition : PEAK_BE_74 3m HORN 91200-HF HORIZONTAL Detector : RBW:1000.000KHz VBW:3000.000KHz SWT:Auto Project : 601802</p>	<p>Date: 2016-11-12 PEAK_74</p> <p>Site : 03CH11-HY Condition : PEAK_74 3m HORN 91200-HF HORIZONTAL Detector : RBW:1000.000KHz VBW:3000.000KHz SWT:Auto Project : 601802</p>
Avg.	<p>Date: 2016-11-12 AVG_BE_54</p> <p>Site : 03CH11-HY Condition : AVG_BE_54 3m HORN 91200-HF HORIZONTAL Detector : RBW:1000.000KHz VBW:1.000KHz SWT:Auto Project : 601802</p>	<p>Date: 2016-11-12 AVG_54</p> <p>Site : 03CH11-HY Condition : AVG_54 3m HORN 91200-HF HORIZONTAL Detector : RBW:1000.000KHz VBW:1.000KHz SWT:Auto Project : 601802</p>

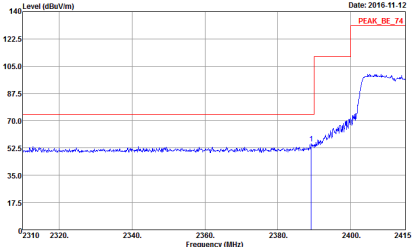
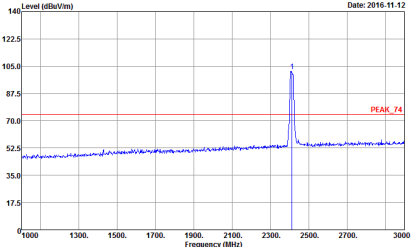
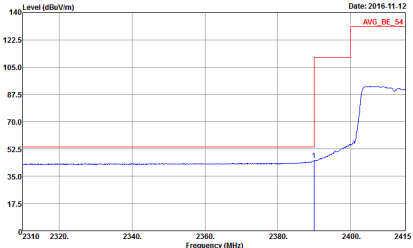
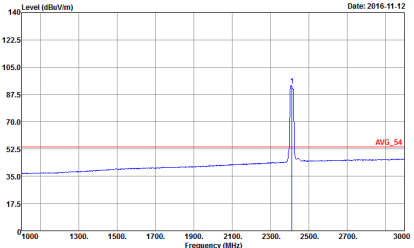

WIFI	2.4GHz 2400~2483.5MHz Band Edge @ 3m	
ANT	802.11n HT20 CH01 2412MHz	
1	Vertical	Fundamental
Peak	 <p>Date: 2016-11-12 PEAK_BE_74</p> <p>Site : 03CH11-HY Condition : PEAK_BE_74 3m HORN 9120D-HF VERTICAL RBW:1000.000KHz VBW:3000.000KHz SWT:Auto Detector : Peak Project : 6O1802</p>	 <p>Date: 2016-11-12 PEAK_74</p> <p>Site : 03CH11-HY Condition : PEAK_74 3m HORN 9120D-HF VERTICAL RBW:1000.000KHz VBW:3000.000KHz SWT:Auto Detector : Peak Project : 6O1802</p>
Avg.	 <p>Date: 2016-11-12 AVG_BE_54</p> <p>Site : 03CH11-HY Condition : AVG_BE_54 3m HORN 9120D-HF VERTICAL RBW:1000.000KHz VBW:1.000KHz SWT:Auto Detector : Peak Project : 6O1802</p>	 <p>Date: 2016-11-12 AVG_54</p> <p>Site : 03CH11-HY Condition : AVG_54 3m HORN 9120D-HF VERTICAL RBW:1000.000KHz VBW:1.000KHz SWT:Auto Detector : Peak Project : 6O1802</p>



WIFI	2.4GHz 2400~2483.5MHz Band Edge @ 3m	
ANT	802.11n HT20 CH06 2437MHz - L	
1	Horizontal	Fundamental
Peak	<p>Date: 2016-11-12</p> <p>Site : 03CHI1-HY Condition : PEAK_BE_74 3m HORN 9120D-HF HORIZONTAL Detector : Peak Project : 6O1802</p>	<p>Date: 2016-11-12</p> <p>Site : 03CHI1-HY Condition : PEAK_74 3m HORN 9120D-HF HORIZONTAL Detector : Peak Project : 6O1802</p>
Avg.	<p>Date: 2016-11-12</p> <p>Site : 03CHI1-HY Condition : AVG_BE_54 3m HORN 9120D-HF HORIZONTAL Detector : Peak Project : 6O1802</p>	<p>Date: 2016-11-12</p> <p>Site : 03CHI1-HY Condition : AVG_54 3m HORN 9120D-HF HORIZONTAL Detector : Peak Project : 6O1802</p>



WIFI	2.4GHz 2400~2483.5MHz Band Edge @ 3m	
ANT	802.11n HT20 CH06 2437MHz - R	
1	Horizontal	Fundamental
Peak	<p>Site : 03CH11-HY Condition : PEAK_BE_74 3m HORN 9120D-HF HORIZONTAL Detector : Peak Project : 601802</p>	Left blank
Avg.	<p>Site : 03CH11-HY Condition : AVG_BE_54 3m HORN 9120D-HF HORIZONTAL Detector : Peak Project : 601802</p>	Left blank

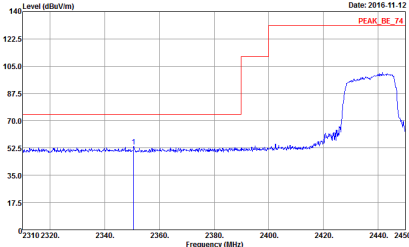
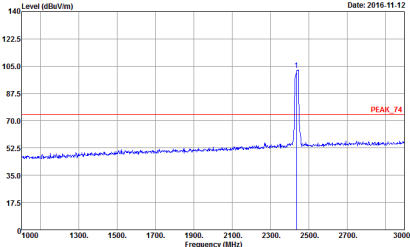
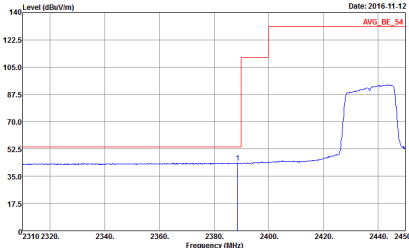
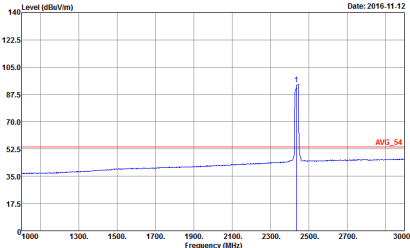

WIFI	2.4GHz 2400~2483.5MHz Band Edge @ 3m	
ANT	802.11n HT20 CH06 2437MHz - L	
1	Vertical	Fundamental
Peak	 <p>Date: 2016-11-12 PEAK_BE_74</p> <p>Site : 03CH11-HY Condition : PEAK_BE_74 3m HORN 9120D-HF VERTICAL RBW:1000.000KHz VBW:3000.000KHz SWT:Auto Detector : Peak Project : 6O1802</p>	 <p>Date: 2016-11-12 PEAK_74</p> <p>Site : 03CH11-HY Condition : PEAK_74 3m HORN 9120D-HF VERTICAL RBW:1000.000KHz VBW:3000.000KHz SWT:Auto Detector : Peak Project : 6O1802</p>
Avg.	 <p>Date: 2016-11-12 AVG_BE_54</p> <p>Site : 03CH11-HY Condition : AVG_BE_54 3m HORN 9120D-HF VERTICAL RBW:1000.000KHz VBW:1.000KHz SWT:Auto Detector : Peak Project : 6O1802</p>	 <p>Date: 2016-11-12 AVG_54</p> <p>Site : 03CH11-HY Condition : AVG_54 3m HORN 9120D-HF VERTICAL RBW:1000.000KHz VBW:1.000KHz SWT:Auto Detector : Peak Project : 6O1802</p>

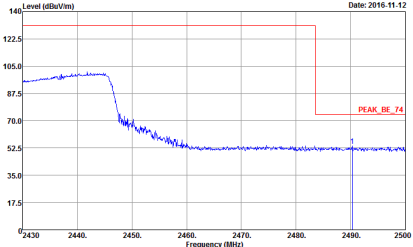
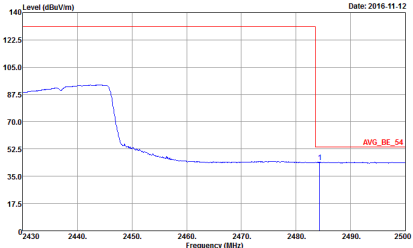

WIFI	2.4GHz 2400~2483.5MHz Band Edge @ 3m	
ANT	802.11n HT20 CH06 2437MHz - R	
1	Vertical	Fundamental
Peak	 <p>Date: 2016.11.12</p> <p>Site : 03CH11-HY Condition : PEAK_BE_74 3m HORN 9120D-HF VERTICAL Detector : Peak Project : 601802</p>	Left Blank
Avg.	 <p>Date: 2016.11.12</p> <p>Site : 03CH11-HY Condition : AVG_BE_54 3m HORN 9120D-HF VERTICAL Detector : Peak Project : 601802</p>	Left Blank

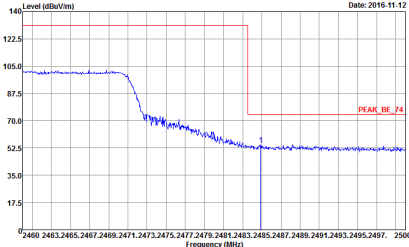
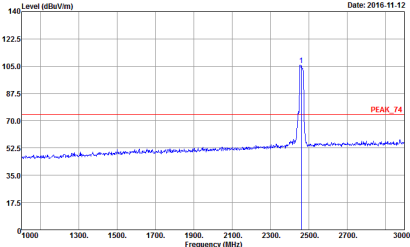
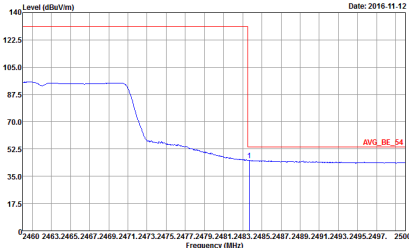
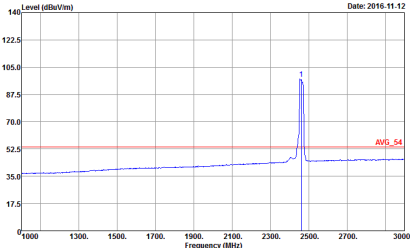

WIFI	2.4GHz 2400~2483.5MHz Band Edge @ 3m	
ANT	802.11n HT20 CH11 2462MHz	
1	Horizontal	Fundamental
Peak	 <p>Date: 2016.11.12</p> <p>Level (dBuV/m)</p> <p>Frequency (MHz)</p> <p>PEAK_BE_74</p> <p>Site : 03CH11-HY Condition : PEAK_BE_74 3m HORN 9120D-HF HORIZONTAL Detector : Peak Project : 6O1802</p>	 <p>Date: 2016.11.12</p> <p>Level (dBuV/m)</p> <p>Frequency (MHz)</p> <p>PEAK_74</p> <p>Site : 03CH11-HY Condition : PEAK_74 3m HORN 9120D-HF HORIZONTAL Detector : Peak Project : 6O1802</p>
Avg.	 <p>Date: 2016.11.12</p> <p>Level (dBuV/m)</p> <p>Frequency (MHz)</p> <p>AVG_BE_54</p> <p>Site : 03CH11-HY Condition : AVG_BE_54 3m HORN 9120D-HF HORIZONTAL Detector : Peak Project : 6O1802</p>	 <p>Date: 2016.11.12</p> <p>Level (dBuV/m)</p> <p>Frequency (MHz)</p> <p>AVG_54</p> <p>Site : 03CH11-HY Condition : AVG_54 3m HORN 9120D-HF HORIZONTAL Detector : Peak Project : 6O1802</p>

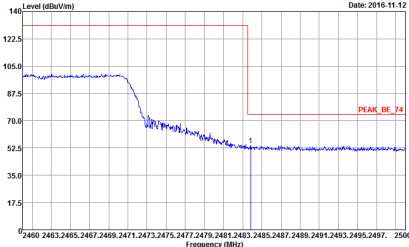
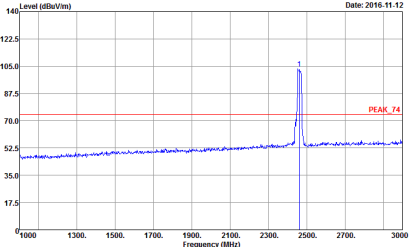
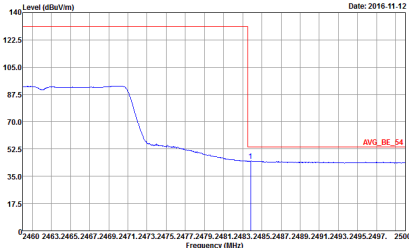
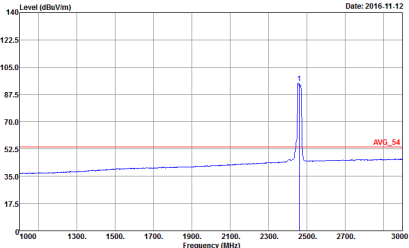

WIFI	2.4GHz 2400~2483.5MHz Fundamental @ 3m	
ANT	802.11n HT20 CH11 2462MHz	
1	Vertical	Fundamental
Peak	 <p>Date: 2016.11.12</p> <p>Site : 03CH11-HY Condition : PEAK_BE_74 3m HORN 9120D-HF VERTICAL RBW:1000.000KHz VBW:3000.000KHz SWT:Auto Detector : Peak Project : 6O1802</p>	 <p>Date: 2016.11.12</p> <p>Site : 03CH11-HY Condition : PEAK_74 3m HORN 9120D-HF VERTICAL RBW:1000.000KHz VBW:3000.000KHz SWT:Auto Detector : Peak Project : 6O1802</p>
Avg.	 <p>Date: 2016.11.12</p> <p>Site : 03CH11-HY Condition : AVG_BE_54 3m HORN 9120D-HF VERTICAL RBW:1000.000KHz VBW:1.000KHz SWT:Auto Detector : Peak Project : 6O1802</p>	 <p>Date: 2016.11.12</p> <p>Site : 03CH11-HY Condition : AVG_54 3m HORN 9120D-HF VERTICAL RBW:1000.000KHz VBW:1.000KHz SWT:Auto Detector : Peak Project : 6O1802</p>



2.4GHz 2400~2483.5MHz

WIFI 802.11n HT40 (Band Edge @ 3m)

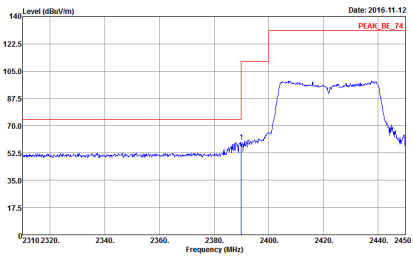
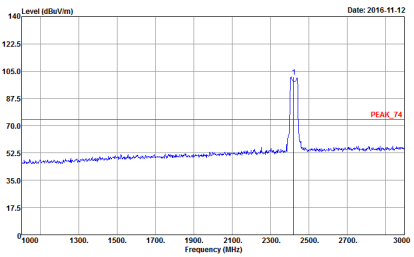
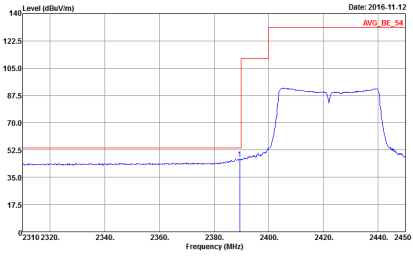
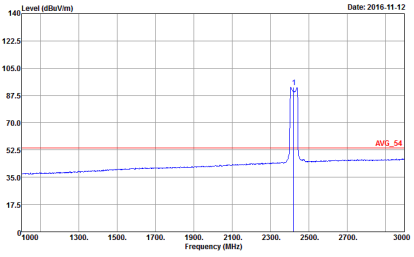
WIFI	2.4GHz 2400~2483.5MHz Band Edge @ 3m	
ANT	802.11n HT40 CH03 2422MHz - L	
1	Horizontal	Fundamental
Peak	 <p>Level (dBuV/m) vs Frequency (MHz) plot showing a peak at approximately 2422 MHz. The y-axis ranges from 17.5 to 140 dBuV/m, and the x-axis ranges from 2310 to 2450 MHz. A red line indicates the peak level at approximately 135 dBuV/m.</p> <p>Site : 03CH11-HY Condition : PEAK_BE_74 3m HORN 91200-HF HORIZONTAL RBW:1000.000KHz VBW:3000.000KHz SWT:Auto Detector : Peak Project : 601802 Setting : 10.5</p>	 <p>Level (dBuV/m) vs Frequency (MHz) plot showing a sharp peak at approximately 2422 MHz. The y-axis ranges from 17.5 to 140 dBuV/m, and the x-axis ranges from 1000 to 3000 MHz. A red line indicates the peak level at approximately 80 dBuV/m.</p> <p>Site : 03CH11-HY Condition : PEAK_74 3m HORN 91200-HF HORIZONTAL RBW:1000.000KHz VBW:3000.000KHz SWT:Auto Detector : Peak Project : 601802 Setting : 10.5</p>
Avg.	 <p>Level (dBuV/m) vs Frequency (MHz) plot showing the average spectrum. The y-axis ranges from 17.5 to 140 dBuV/m, and the x-axis ranges from 2310 to 2450 MHz. A red line indicates the average level at approximately 135 dBuV/m.</p> <p>Site : 03CH11-HY Condition : AVG_BE_54 3m HORN 91200-HF HORIZONTAL RBW:1000.000KHz VBW:3.000KHz SWT:Auto Detector : Peak Project : 601802 Setting : 10.5</p>	 <p>Level (dBuV/m) vs Frequency (MHz) plot showing the average spectrum. The y-axis ranges from 17.5 to 140 dBuV/m, and the x-axis ranges from 1000 to 3000 MHz. A red line indicates the average level at approximately 55 dBuV/m.</p> <p>Site : 03CH11-HY Condition : AVG_54 3m HORN 91200-HF HORIZONTAL RBW:1000.000KHz VBW:3.000KHz SWT:Auto Detector : Peak Project : 601802 Setting : 10.5</p>

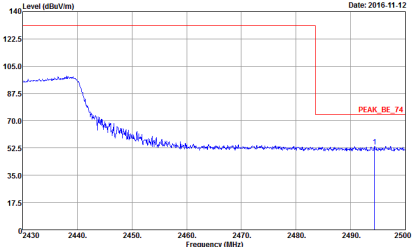
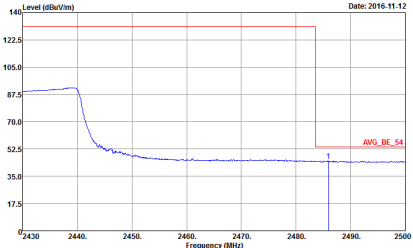

WIFI	2.4GHz 2400~2483.5MHz Band Edge @ 3m	
ANT	802.11n HT40 CH03 2422MHz - R	
1	Horizontal	Fundamental
Peak	 <p>Date: 2016.11.12</p> <p>Site : 03CH11-HY Condition : PEAK_BE_74 3m HORN 9120D-HF HORIZONTAL RBW:1000.000KHz VBW:3000.000KHz SWT:Auto Detector : Peak Project : 601802 Setting : 10.5</p>	Left Blank
Avg.	 <p>Date: 2016.11.12</p> <p>Site : 03CH11-HY Condition : AVG_BE_54 3m HORN 9120D-HF HORIZONTAL RBW:1000.000KHz VBW:3.000KHz SWT:Auto Detector : Peak Project : 601802 Setting : 10.5</p>	Left Blank

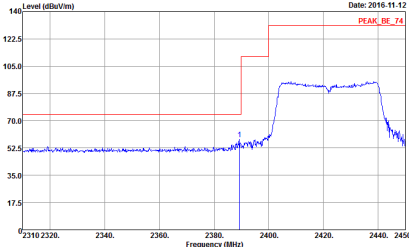
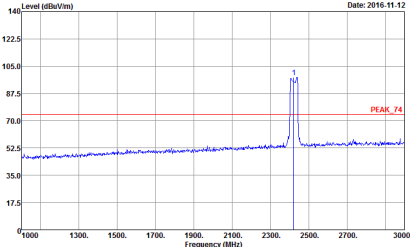
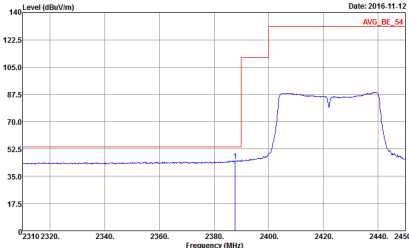
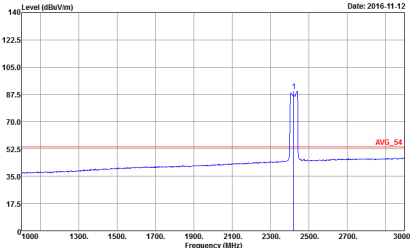

WIFI	2.4GHz 2400~2483.5MHz Band Edge @ 3m	
ANT	802.11n HT40 CH03 2422MHz - L	
1	Vertical	Fundamental
Peak	 <p>Date: 2016-11-12 PEAK_BE_74</p> <p>Site : 03CH11-HY Condition : PEAK_BE_74 3m HORN 91200-HF VERTICAL RBW:1000.000KHz VBW:3000.000KHz SWT:Auto Detector : Peak Project : 6O1802 Setting : 10.5</p>	 <p>Date: 2016-11-12 PEAK_74</p> <p>Site : 03CH11-HY Condition : PEAK_74 3m HORN 91200-HF VERTICAL RBW:1000.000KHz VBW:3000.000KHz SWT:Auto Detector : Peak Project : 6O1802 Setting : 10.5</p>
Avg.	 <p>Date: 2016-11-12 AVG_BE_54</p> <p>Site : 03CH11-HY Condition : AVG_BE_54 3m HORN 91200-HF VERTICAL RBW:1000.000KHz VBW:3.000KHz SWT:Auto Detector : Peak Project : 6O1802 Setting : 10.5</p>	 <p>Date: 2016-11-12 AVG_54</p> <p>Site : 03CH11-HY Condition : AVG_54 3m HORN 91200-HF VERTICAL RBW:1000.000KHz VBW:3.000KHz SWT:Auto Detector : Peak Project : 6O1802 Setting : 10.5</p>

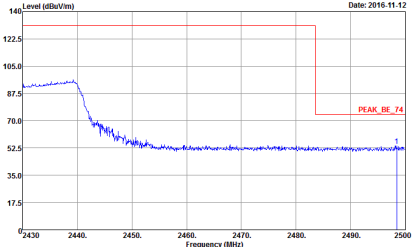
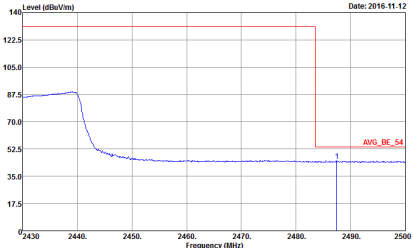

WIFI	2.4GHz 2400~2483.5MHz Band Edge @ 3m	
ANT	802.11n HT40 CH03 2422MHz - R	
1	Vertical	Fundamental
Peak	 <p>Date: 2016.11.12</p> <p>Site : 03CH11-HY Condition : PEAK_BE_74 3m HORN 9120D-HF VERTICAL RBW:1000.000KHz VBW:3000.000KHz SWT:Auto Detector : Peak Project : 601802 Setting : 10.5</p>	Left blank
Avg.	 <p>Date: 2016.11.12</p> <p>Site : 03CH11-HY Condition : AVG_BE_54 3m HORN 9120D-HF VERTICAL RBW:1000.000KHz VBW:3.000KHz SWT:Auto Detector : Peak Project : 601802 Setting : 10.5</p>	Left blank



WIFI	2.4GHz 2400~2483.5MHz Band Edge @ 3m	
ANT	802.11n HT40 CH06 2437MHz - L	
1	Horizontal	Fundamental
Peak	<p>Date: 2016-11-12 PEAK_BE_74</p> <p>Site : 03CH11-HY Condition : PEAK_BE_74 3m HORN 9120D-HF HORIZONTAL Detector : Peak Project : 6O1802</p>	<p>Date: 2016-11-12 PEAK_74</p> <p>Site : 03CH11-HY Condition : PEAK_74 3m HORN 9120D-HF HORIZONTAL Detector : Peak Project : 6O1802</p>
Avg.	<p>Date: 2016-11-12 AVG_BE_54</p> <p>Site : 03CH11-HY Condition : AVG_BE_54 3m HORN 9120D-HF HORIZONTAL Detector : Peak Project : 6O1802</p>	<p>Date: 2016-11-12 AVG_54</p> <p>Site : 03CH11-HY Condition : AVG_54 3m HORN 9120D-HF HORIZONTAL Detector : Peak Project : 6O1802</p>

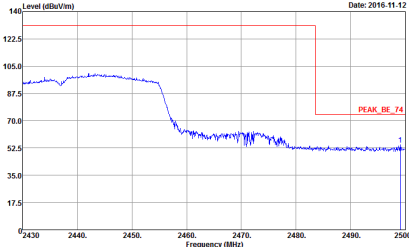
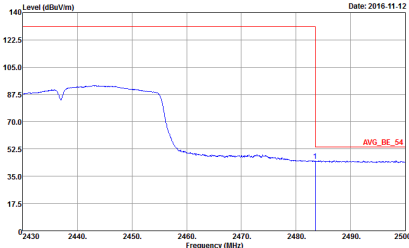

WIFI	2.4GHz 2400~2483.5MHz Band Edge @ 3m	
ANT	802.11n HT40 CH06 2437MHz - R	
1	Horizontal	Fundamental
Peak	 <p>Date: 2016.11.12</p> <p>Site : 03CH11-HY Condition : PEAK_BE_74 3m HORN 9120D-HF HORIZONTAL Detector : Peak Project : 601802</p>	Left blank
Avg.	 <p>Date: 2016.11.12</p> <p>Site : 03CH11-HY Condition : AVG_BE_54 3m HORN 9120D-HF HORIZONTAL Detector : Peak Project : 601802</p>	Left blank

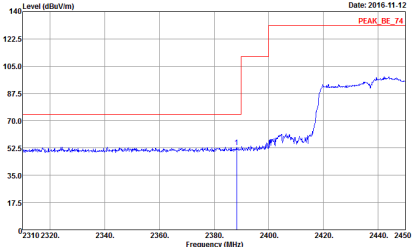
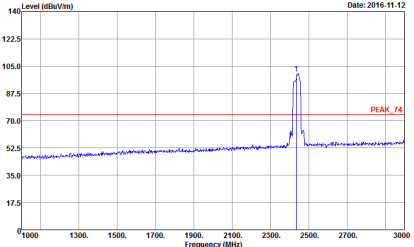
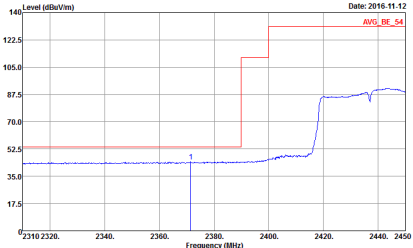
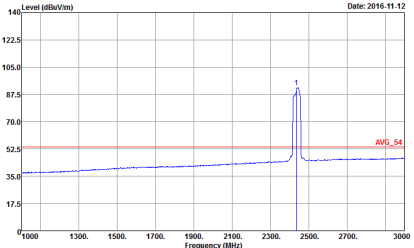

WIFI	2.4GHz 2400~2483.5MHz Band Edge @ 3m	
ANT	802.11n HT40 CH06 2437MHz - L	
1	Vertical	Fundamental
Peak	 <p>Date: 2016-11-12 PEAK_BE_74</p> <p>Site : 03CH11-HY Condition : PEAK_BE_74 3m HORN 9120D-HF VERTICAL RBW:1000.000KHz VBW:3000.000KHz SWT:Auto Detector : Peak Project : 6O1802</p>	 <p>Date: 2016-11-12 PEAK_74</p> <p>Site : 03CH11-HY Condition : PEAK_74 3m HORN 9120D-HF VERTICAL RBW:1000.000KHz VBW:3000.000KHz SWT:Auto Detector : Peak Project : 6O1802</p>
Avg.	 <p>Date: 2016-11-12 AVG_BE_54</p> <p>Site : 03CH11-HY Condition : AVG_BE_54 3m HORN 9120D-HF VERTICAL RBW:1000.000KHz VBW:3000.000KHz SWT:Auto Detector : Peak Project : 6O1802</p>	 <p>Date: 2016-11-12 AVG_54</p> <p>Site : 03CH11-HY Condition : AVG_54 3m HORN 9120D-HF VERTICAL RBW:1000.000KHz VBW:3000.000KHz SWT:Auto Detector : Peak Project : 6O1802</p>

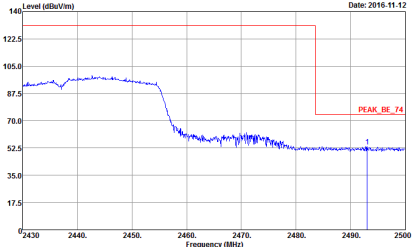
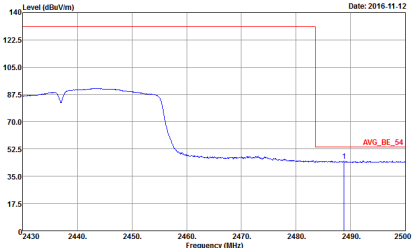

WIFI	2.4GHz 2400~2483.5MHz Band Edge @ 3m	
ANT	802.11n HT40 CH06 2437MHz - R	
1	Vertical	Fundamental
Peak	 <p>Date: 2016.11.12</p> <p>Site : 03CH11-HY Condition : PEAK_BE_74 3m HORN 9120D-HF VERTICAL Detector : Peak Project : 601802</p>	Left blank
Avg.	 <p>Date: 2016.11.12</p> <p>Site : 03CH11-HY Condition : AVG_BE_54 3m HORN 9120D-HF VERTICAL Detector : Peak Project : 601802</p>	Left blank

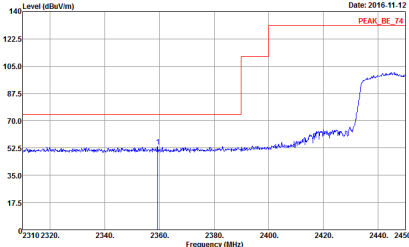
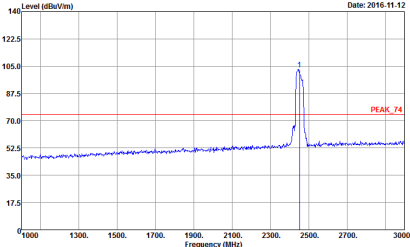
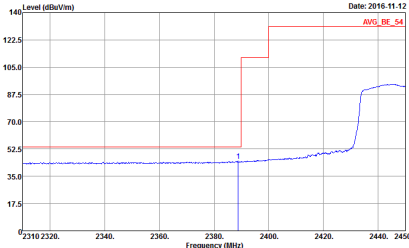
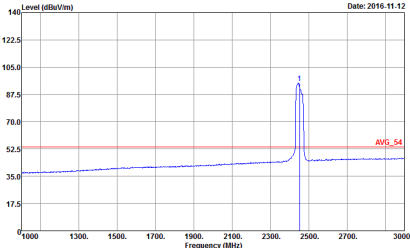

WIFI	2.4GHz 2400~2483.5MHz Band Edge @ 3m	
ANT	802.11n HT40 CH09 2452MHz - L	
1	Horizontal	Fundamental
Peak	 <p>Date: 2016-11-12 PEAK_BE_74</p> <p>Site : 03CHI1-HY Condition : PEAK_BE_74 3m HORN 9120D-HF HORIZONTAL Detector : Peak Project : 6O1802</p>	 <p>Date: 2016-11-12 PEAK_74</p> <p>Site : 03CHI1-HY Condition : PEAK_74 3m HORN 9120D-HF HORIZONTAL Detector : Peak Project : 6O1802</p>
Avg.	 <p>Date: 2016-11-12 AVG_BE_54</p> <p>Site : 03CHI1-HY Condition : AVG_BE_54 3m HORN 9120D-HF HORIZONTAL Detector : Peak Project : 6O1802</p>	 <p>Date: 2016-11-12 AVG_54</p> <p>Site : 03CHI1-HY Condition : AVG_54 3m HORN 9120D-HF HORIZONTAL Detector : Peak Project : 6O1802</p>

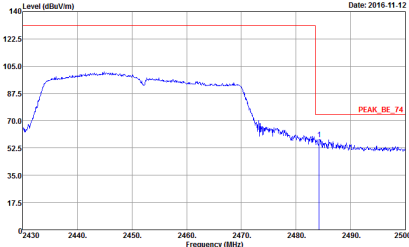
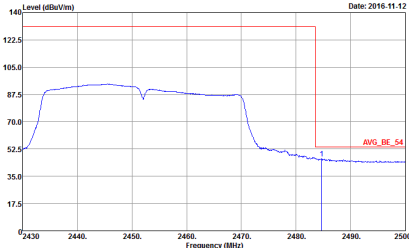

WIFI	2.4GHz 2400~2483.5MHz Band Edge @ 3m	
ANT	802.11n HT40 CH09 2452MHz - R	
1	Horizontal	Fundamental
Peak	 <p>Date: 2016.11.12</p> <p>Site : 03CH11-HY Condition : PEAK_BE_74 3m HORN 9120D-HF HORIZONTAL Detector : Peak Project : 601802</p>	Left blank
Avg.	 <p>Date: 2016.11.12</p> <p>Site : 03CH11-HY Condition : AVG_BE_54 3m HORN 9120D-HF HORIZONTAL Detector : Peak Project : 601802</p>	Left blank

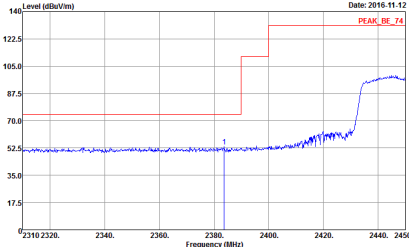
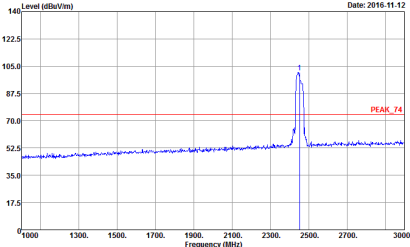
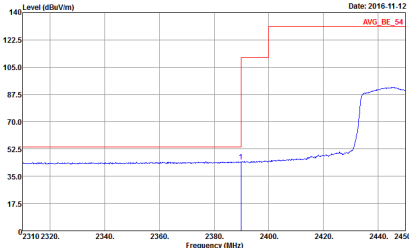
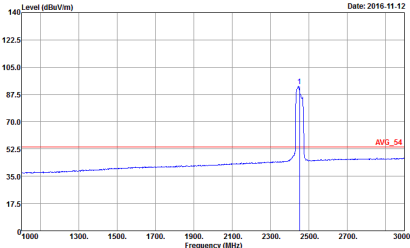

WIFI	2.4GHz 2400~2483.5MHz Band Edge @ 3m	
ANT	802.11n HT40 CH09 2452MHz - L	
1	Vertical	Fundamental
Peak	 <p>Date: 2016-11-12 PEAK_BE_74</p> <p>Site : 03CH11-HY Condition : PEAK_BE_74 3m HORN 9120D-HF VERTICAL Detector : RBW:1000.000KHz VBW:3000.000KHz SWT:Auto Project : 6O1802</p>	 <p>Date: 2016-11-12 PEAK_74</p> <p>Site : 03CH11-HY Condition : PEAK_74 3m HORN 9120D-HF VERTICAL Detector : RBW:1000.000KHz VBW:3000.000KHz SWT:Auto Project : 6O1802</p>
Avg.	 <p>Date: 2016-11-12 AVG_BE_54</p> <p>Site : 03CH11-HY Condition : AVG_BE_54 3m HORN 9120D-HF VERTICAL Detector : RBW:1000.000KHz VBW:3000.000KHz SWT:Auto Project : 6O1802</p>	 <p>Date: 2016-11-12 AVG_54</p> <p>Site : 03CH11-HY Condition : AVG_54 3m HORN 9120D-HF VERTICAL Detector : RBW:1000.000KHz VBW:3000.000KHz SWT:Auto Project : 6O1802</p>

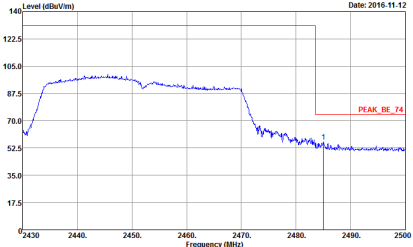
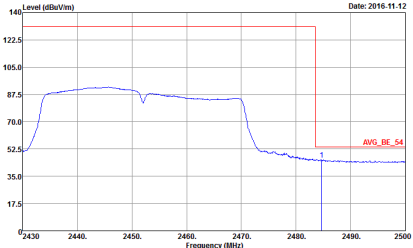

WIFI	2.4GHz 2400~2483.5MHz Band Edge @ 3m	
ANT	802.11n HT40 CH09 2452MHz - R	
1	Vertical	Fundamental
Peak	 <p>Date: 2016.11.12</p> <p>Site : 03CH11-HY Condition : PEAK_BE_74 3m HORN 9120D-HF VERTICAL Detector : Peak Project : 6O1802</p>	Left blank
Avg.	 <p>Date: 2016.11.12</p> <p>Site : 03CH11-HY Condition : AVG_BE_54 3m HORN 9120D-HF VERTICAL Detector : Peak Project : 6O1802</p>	Left blank



2.4GHz 2400~2483.5MHz
WIFI 802.11b (Harmonic @ 3m)

WIFI	2.4GHz 2400~2483.5MHz Harmonic @ 3m	
ANT	802.11b CH01 2412MHz	
1	Horizontal	Vertical
Peak Avg.	<p>Site : 03CH11-HY Condition : PEAK_74 3m 9170 SHF HORM_150809 HORIZONTAL Detector : Peak Project : 6O1802</p>	<p>Site : 03CH11-HY Condition : PEAK_74 3m 9170 SHF HORM_150809 VERTICAL Detector : Peak Project : 6O1802</p>



WIFI	2.4GHz 2400~2483.5MHz Harmonic @ 3m	
ANT	802.11b CH06 2437MHz	
1	Horizontal	Vertical
Peak Avg.	<p>Site : 03CH11-4Y Condition : PEAK_74 3m 9170 SHF HORM_150809 HORIZONTAL Detector : Peak Project : 6O1802</p>	<p>Site : 03CH11-4Y Condition : PEAK_74 3m 9170 SHF HORM_150809 VERTICAL Detector : Peak Project : 6O1802</p>

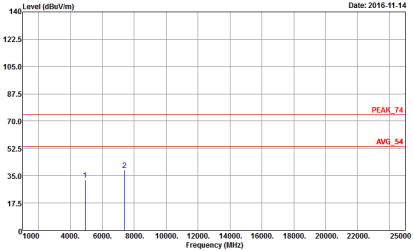
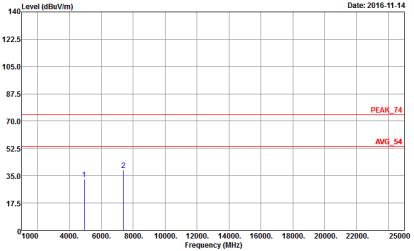

WIFI	2.4GHz 2400~2483.5MHz Harmonic @ 3m	
ANT	802.11b CH11 2462MHz	
1	Horizontal	Vertical
Peak Avg.	 <p>Site : 03CH11-HY Condition : PEAK_74 3m 9170 SHF HORM_150809 HORIZONTAL Detector : Peak Project : 601802</p>	 <p>Site : 03CH11-HY Condition : PEAK_74 3m 9170 SHF HORM_150809 VERTICAL Detector : Peak Project : 601802</p>



2.4GHz 2400~2483.5MHz

WIFI 802.11g (Harmonic @ 3m)

WIFI	2.4GHz 2400~2483.5MHz Harmonic @ 3m	
ANT	802.11g CH01 2412MHz	
1	Horizontal	Vertical
<p>Peak</p> <p>Avg.</p>	<p>Site : 03CH11-HY Condition : PEAK_74 3m 9170 SHF HORM_150809 HORIZONTAL Detector : Peak Project : 601802</p>	<p>Site : 03CH11-HY Condition : PEAK_74 3m 9170 SHF HORM_150809 VERTICAL Detector : Peak Project : 601802</p>



WIFI	2.4GHz 2400~2483.5MHz Harmonic @ 3m	
ANT	802.11g CH06 2437MHz	
1	Horizontal	Vertical
Peak Avg.	<p>Horizontal spectrum plot showing Level (dBuV/m) vs Frequency (MHz). The plot includes two peaks labeled 1 and 2. The y-axis ranges from 17.5 to 140 dBuV/m, and the x-axis ranges from 1000 to 25000 MHz. Two horizontal reference lines are shown: PEAK_74 at approximately 75 dBuV/m and AVG_54 at approximately 55 dBuV/m. The plot is dated 2017.02.09.</p> <p>Site : 03CH11-HY Condition : PEAK_74 3m 9170 SHF HORM_150809 HORIZONTAL Detector : Peak Project : 6O1802</p>	<p>Vertical spectrum plot showing Level (dBuV/m) vs Frequency (MHz). The plot includes two peaks labeled 1 and 2. The y-axis ranges from 17.5 to 140 dBuV/m, and the x-axis ranges from 1000 to 25000 MHz. Two horizontal reference lines are shown: PEAK_74 at approximately 75 dBuV/m and AVG_54 at approximately 55 dBuV/m. The plot is dated 2017.02.09.</p> <p>Site : 03CH11-HY Condition : PEAK_74 3m 9170 SHF HORM_150809 VERTICAL Detector : Peak Project : 6O1802</p>

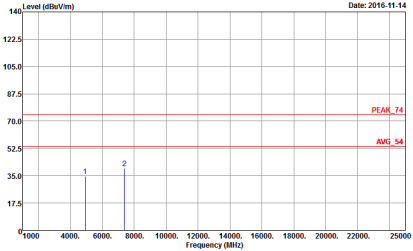
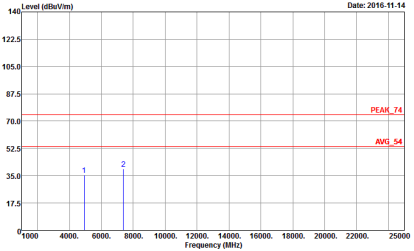

WIFI	2.4GHz 2400~2483.5MHz Harmonic @ 3m	
ANT	802.11g CH11 2462MHz	
1	Horizontal	Vertical
Peak Avg.	 <p>Site : 03CH11-HY Condition : PEAK_74 3m 9170 SHF HORM_150809 HORIZONTAL Detector : Peak Project : 601802</p>	 <p>Site : 03CH11-HY Condition : PEAK_74 3m 9170 SHF HORM_150809 VERTICAL Detector : Peak Project : 601802</p>



2.4GHz 2400~2483.5MHz

WIFI 802.11n HT20 (Harmonic @ 3m)

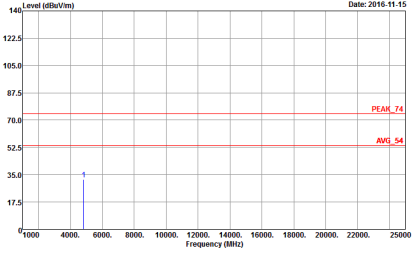
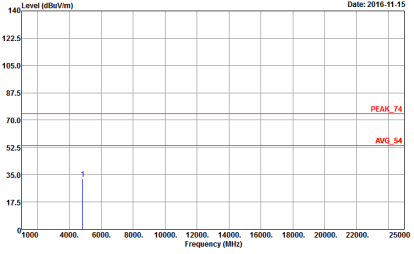
WIFI	2.4GHz 2400~2483.5MHz Harmonic @ 3m	
ANT	802.11n HT20 CH01 2412MHz	
1	Horizontal	Vertical
<p>Peak</p> <p>Avg.</p>	 <p>Site : 03CH11-HY Condition : PEAK_74 3m 9170 SHF HORM_150809 HORIZONTAL Detector : Peak Project : 601802</p>	 <p>Site : 03CH11-HY Condition : PEAK_74 3m 9170 SHF HORM_150809 VERTICAL Detector : Peak Project : 601802</p>



WIFI	2.4GHz 2400~2483.5MHz Harmonic @ 3m	
ANT	802.11n HT20 CH06 2437MHz	
1	Horizontal	Vertical
Peak Avg.	<p>Site : 03CH11-HY Condition : PEAK_74 3m 9170 SHF HORM_150809 HORIZONTAL Detector : Peak Project : 601802</p>	<p>Site : 03CH11-HY Condition : PEAK_74 3m 9170 SHF HORM_150809 VERTICAL Detector : Peak Project : 601802</p>

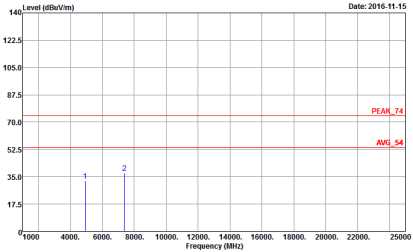
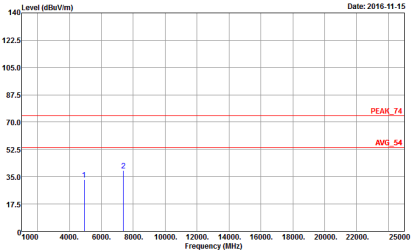

WIFI	2.4GHz 2400~2483.5MHz Harmonic @ 3m	
ANT	802.11n HT20 CH11 2462MHz	
1	Horizontal	Vertical
<p>Peak</p> <p>Avg.</p>	 <p>Site : 03CH11-4Y Condition : PEAK_74 3m 9170 SHF HORM_150809 HORIZONTAL Detector : Peak Project : 6O1802</p>	 <p>Site : 03CH11-4Y Condition : PEAK_74 3m 9170 SHF HORM_150809 VERTICAL Detector : Peak Project : 6O1802</p>



2.4GHz 2400~2483.5MHz

WIFI 802.11n HT40 (Harmonic @ 3m)

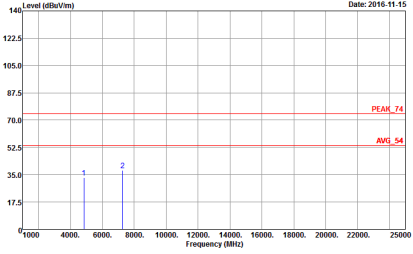
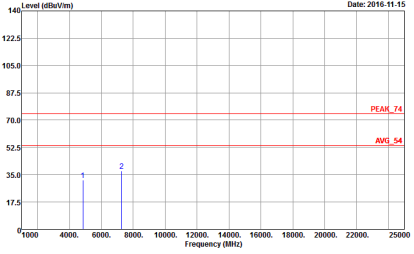
WIFI	2.4GHz 2400~2483.5MHz Harmonic @ 3m	
ANT	802.11n HT40 CH03 2422MHz	
1	Horizontal	Vertical
<p>Peak</p> <p>Avg.</p>	 <p>Site : 03CH11-HY Condition : PEAK_74 3m 9170 SHF HORM_150809 HORIZONTAL Detector : Peak Project : 6O1802</p>	 <p>Site : 03CH11-HY Condition : PEAK_74 3m 9170 SHF HORM_150809 VERTICAL Detector : Peak Project : 6O1802</p>



WIFI	2.4GHz 2400~2483.5MHz Harmonic @ 3m	
ANT	802.11n HT40 CH06 2437MHz	
1	Horizontal	Vertical
Peak Avg.	<p>Site : 03CH11-HY Condition : PEAK_74 3m 9170 SHF HORM_150809 HORIZONTAL Detector : Peak Project : 6O1802</p>	<p>Site : 03CH11-HY Condition : PEAK_74 3m 9170 SHF HORM_150809 VERTICAL Detector : Peak Project : 6O1802</p>



WIFI	2.4GHz 2400~2483.5MHz Harmonic @ 3m	
ANT	802.11n HT40 CH09 2452MHz	
1	Horizontal	Vertical
Peak Avg.	<p>Site : 03CH11-HY Condition : PEAK_74 3m 9170 SHF HORM_150809 HORIZONTAL Detector : Peak Project : 601802</p>	<p>Site : 03CH11-HY Condition : PEAK_74 3m 9170 SHF HORM_150809 VERTICAL Detector : Peak Project : 601802</p>

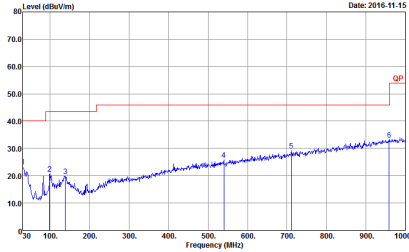
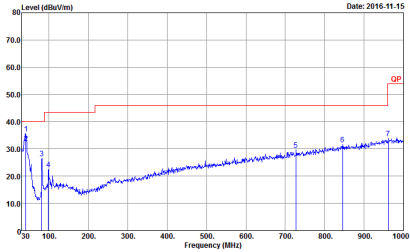

Emission below 1GHz
2.4GHz WIFI 802.11n HT40 (LF)

WIFI	2.4GHz 2400~2483.5MHz	
ANT	802.11n HT40 LF	
1	Horizontal	Vertical
<p>QP / Peak</p>	 <p>Site : 03CH11-HY Condition : QP 3m BI-LOG 6111D-LF_ETC HORIZONTAL Detector : Peak Project : 601802</p>	 <p>Site : 03CH11-HY Condition : QP 3m BI-LOG 6111D-LF_ETC VERTICAL Detector : Peak Project : 601802</p>



Appendix D. Duty Cycle Plots

Band	Duty Cycle(%)	T(us)	1/T(kHz)	VBW Setting
802.11b	100.00	-	-	10Hz
802.11g	96.67	1392.00	0.72	1kHz
2.4GHz 802.11n HT20	97.02	1300.00	0.77	1kHz
2.4GHz 802.11n HT40	93.86	642.00	1.56	3kHz



802.11b

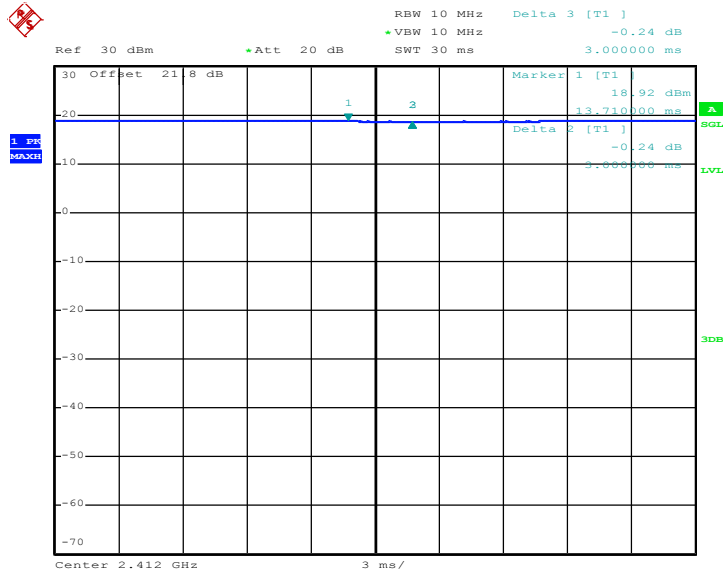

Date: 1.NOV.2016 00:46:23

802.11g

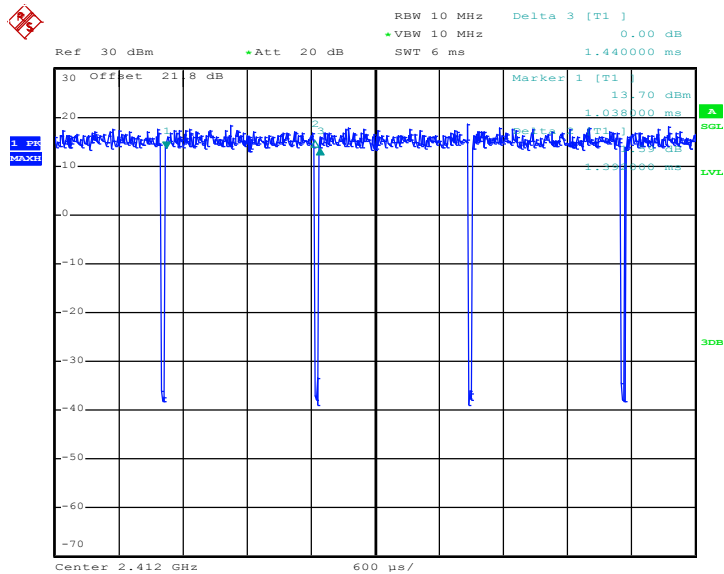

Date: 1.NOV.2016 00:53:14



802.11n HT20

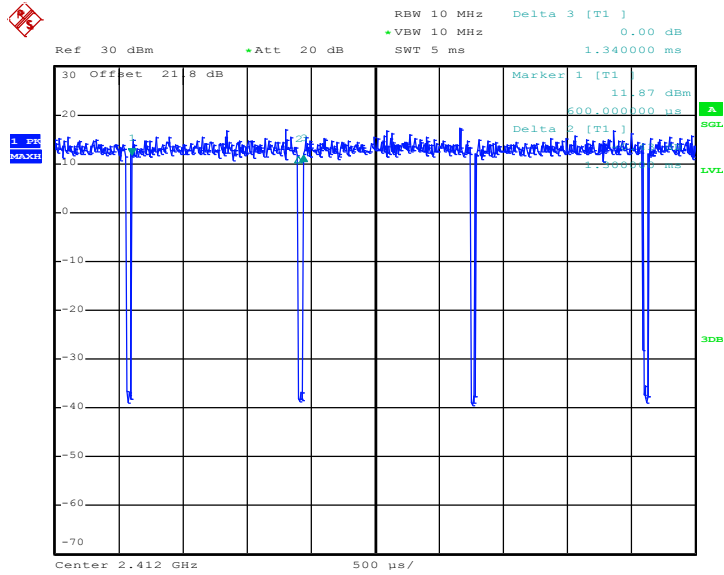

Date: 1.NOV.2016 00:56:52

802.11n HT40

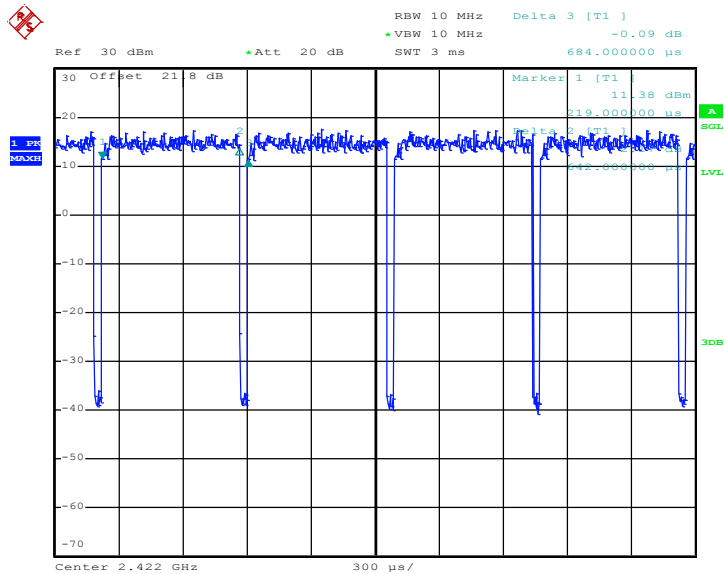

Date: 1.NOV.2016 00:59:53