



# FCC RF Test Report

**APPLICANT** : LG Electronics Mobile Comm USA  
**EQUIPMENT** : Smart phone  
**BRAND NAME** : LG  
**MODEL NAME** : LG-X240H  
**FCC ID** : ZNFX240H  
**STANDARD** : FCC Part 15 Subpart C §15.247  
**CLASSIFICATION** : (DSS) Spread Spectrum Transmitter

The product was received on Oct. 18, 2016 and testing was completed on Nov. 20, 2016. We, SPORTON INTERNATIONAL INC., would like to declare that the tested sample has been evaluated in accordance with the test procedures and has been in compliance with the applicable technical standards.

The test results in this report apply exclusively to the tested model / sample. Without written approval of SPORTON INTERNATIONAL INC., the test report shall not be reproduced except in full.

Reviewed by: Joseph Lin / Supervisor

Approved by: Jones Tsai / Manager



## **SPORTON INTERNATIONAL INC.**

**No. 52, Hwa Ya 1<sup>st</sup> Rd., Hwa Ya Technology Park, Kwei-Shan District, Tao Yuan City, Taiwan, R.O.C.**

**SPORTON INTERNATIONAL INC.**

TEL : 886-3-327-3456

FAX : 886-3-328-4978

FCC ID : ZNFX240H

Page Number : 1 of 67

Report Issued Date : Feb. 17, 2017

Report Version : Rev. 01

Report Template No.: BU5-FR15CBT Version 1.1



# TABLE OF CONTENTS

**REVISION HISTORY..... 3**

**SUMMARY OF TEST RESULT ..... 4**

**1 GENERAL DESCRIPTION..... 5**

    1.1 Applicant ..... 5

    1.2 Manufacturer..... 5

    1.3 Product Feature of Equipment Under Test..... 5

    1.4 Product Specification of Equipment Under Test..... 5

    1.5 Modification of EUT ..... 6

    1.6 Testing Location ..... 6

    1.7 Applicable Standards..... 7

**2 TEST CONFIGURATION OF EQUIPMENT UNDER TEST..... 8**

    2.1 Descriptions of Test Mode ..... 8

    2.2 Test Mode..... 9

    2.3 Connection Diagram of Test System..... 10

    2.4 Support Unit used in test configuration and system ..... 11

    2.5 EUT Operation Test Setup ..... 11

    2.6 Measurement Results Explanation Example..... 11

**3 TEST RESULT ..... 12**

    3.1 Number of Channel Measurement ..... 12

    3.2 Hopping Channel Separation Measurement ..... 14

    3.3 Dwell Time Measurement..... 21

    3.4 20dB and 99% Bandwidth Measurement ..... 23

    3.5 Peak Output Power Measurement ..... 36

    3.6 Conducted Band Edges Measurement..... 38

    3.7 Conducted Spurious Emission Measurement ..... 45

    3.8 Radiated Band Edges and Spurious Emission Measurement ..... 55

    3.9 AC Conducted Emission Measurement..... 61

    3.10 Antenna Requirements..... 65

**4 LIST OF MEASURING EQUIPMENT..... 66**

**5 UNCERTAINTY OF EVALUATION..... 67**

**APPENDIX A. RADIATED SPURIOUS EMISSION**

**APPENDIX B. RADIATED SPURIOUS EMISSION PLOTS**

**APPENDIX C. SETUP PHOTOGRAPHS**





### SUMMARY OF TEST RESULT

| Report Section | FCC Rule           | Description  | Limit                      | Result | Remark                                  |
|----------------|--------------------|--|----------------------------|--------|---|
| 3.1            | 15.247(a)(1)       | Number of Channels                                 | ≥ 15Chs                    | Pass   | -                                       |
| 3.2            | 15.247(a)(1)       | Hopping Channel Separation                         | ≥ 2/3 of 20dB BW           | Pass   | -                                       |
| 3.3            | 15.247(a)(1)       | Dwell Time of Each Channel                         | ≤ 0.4sec in 31.6sec period | Pass   | -                                       |
| 3.4            | 15.247(a)(1)       | 20dB Bandwidth                                     | NA                         | Pass   | -                                       |
| 3.4            | -                  | 99% Bandwidth                                      | -                          | Pass   | -                                       |
| 3.5            | 15.247(b)(1)       | Peak Output Power                                  | ≤ 125 mW                   | Pass   | -                                       |
| 3.6            | 15.247(d)          | Conducted Band Edges                               | ≤ 20dBc                    | Pass   | -                                       |
| 3.7            | 15.247(d)          | Conducted Spurious Emission                        | ≤ 20dBc                    | Pass   | -                                       |
| 3.8            | 15.247(d)          | Radiated Band Edges and Radiated Spurious Emission | 15.209(a) & 15.247(d)      | Pass   | Under limit<br>7.95 dB at<br>40.800 MHz |
| 3.9            | 15.207             | AC Conducted Emission                              | 15.207(a)                  | Pass   | Under limit<br>14.80 dB at<br>0.406 MHz |
| 3.10           | 15.203 & 15.247(b) | Antenna Requirement                                | N/A                        | Pass   | -                                       |



# 1 General Description

## 1.1 Applicant

**LG Electronics Mobile Comm USA**

LG Twin Towers 20, Yeouido-Dong Youngdeungpo-Gu, Seoul 150-721, Republic Of Korea

## 1.2 Manufacturer

**Arima Communications Corp.**

6F, No. 866, Jhongjheng Rd., Jhonghe Dist., New Taipei City 23586, Taiwan

## 1.3 Product Feature of Equipment Under Test

| Product Feature                 |   |
|---------------------------------|---|
| Equipment                       | Smart phone   |
| Brand Name                      | LG  |
| Model Name                      | LG-X240H  |
| FCC ID                          | ZNFX240H  |
| EUT supports Radios application | GSM/EGPRS/WCDMA/HSPA/LTE<br>WLAN 11b/g/n HT20/HT40<br>Bluetooth BR/EDR/LE |
| HW Version                      | PP2   |
| SW Version                      | LGX240HAT-00-V08a-CIS-XX-NOV-17-2016+0                                    |
| EUT Stage                       | Production Unit   |

**Remark:** The above EUT's information was declared by manufacturer. Please refer to the specifications or user's manual for more detailed description.

## 1.4 Product Specification of Equipment Under Test

| Standards-related Product Specification |   |
|---|---|
| Tx/Rx Frequency Range                   | 2402 MHz ~ 2480 MHz   |
| Number of Channels                      | 79  |
| Carrier Frequency of Each Channel       | 2402+n*1 MHz; n=0~78  |
| Maximum Output Power to Antenna         | Bluetooth BR(1Mbps) : 7.25 dBm (0.0053 W)<br>Bluetooth EDR (2Mbps) : 6.49 dBm (0.0045 W)<br>Bluetooth EDR (3Mbps) : 6.73 dBm (0.0047 W) |
| 99% Occupied Bandwidth                  | Bluetooth BR(1Mbps) : 0.860MHz<br>Bluetooth EDR (2Mbps) : 1.164MHz<br>Bluetooth EDR (3Mbps) : 1.152MHz                                  |
| Antenna Type / Gain                     | PIFA Antenna type with gain -2.10 dBi   |
| Type of Modulation                      | Bluetooth BR (1Mbps) : GFSK<br>Bluetooth EDR (2Mbps) : $\pi/4$ -DQPSK<br>Bluetooth EDR (3Mbps) : 8-DPSK                                 |



### 1.5 Modification of EUT

No modifications are made to the EUT during all test items.

### 1.6 Testing Location

Sporton Lab is accredited to ISO 17025 by Taiwan Accreditation Foundation (TAF code : 1190) and the FCC designation No. TW1022 under the FCC 2.948(e) by Mutual Recognition Agreement (MRA) in FCC Test.

|                           |  |         |
|---------------------------|--|---------|
| <b>Test Site</b>          | SPORTON INTERNATIONAL INC.   |         |
| <b>Test Site Location</b> | No. 52, Hwa Ya 1 <sup>st</sup> Rd., Hwa Ya Technology Park,<br>Kwei-Shan District, Tao Yuan City, Taiwan, R.O.C.<br>TEL: +886-3-327-3456<br>FAX: +886-3-328-4978 |         |
| <b>Test Site No.</b>      | <b>Sporton Site No.</b>  |         |
|                           | TH05-HY  | CO05-HY |

**Note:** The test site complies with ANSI C63.4 2014 requirement.

|                           |  |  |
|---------------------------|--|--|
| <b>Test Site</b>          | SPORTON INTERNATIONAL INC.   |  |
| <b>Test Site Location</b> | No.58, Aly. 75, Ln. 564, Wenhua 3rd Rd. Guishan Dist,<br>Taoyuan City, Taiwan (R.O.C.)<br>TEL: +886-3-327-0868<br>FAX: +886-3-327-0855 |  |
| <b>Test Site No.</b>      | <b>Sporton Site No.</b>  |  |
|                           | 03CH11-HY  |  |

**Note:** The test site complies with ANSI C63.4 2014 requirement.



## 1.7 Applicable Standards

According to the specifications of the manufacturer, the EUT must comply with the requirements of the following standards:

- ♦ FCC Part 15 Subpart C §15.247
- ♦ ANSI C63.10-2013

### **Remark:**

1. All test items were verified and recorded according to the standards and without any deviation during the test.
2. This EUT has also been tested and complied with the requirements of FCC Part 15, Subpart B, recorded in a separate test report.



## 2 Test Configuration of Equipment Under Test

### 2.1 Descriptions of Test Mode

Preliminary tests were performed in different data rates and recorded the RF output power in the following table:

| Channel | Frequency | Bluetooth RF Output Power |                |          |
|---------|-----------|---------------------------|----------------|----------|
|         |           | Data Rate / Modulation    |                |          |
|         |           | GFSK                      | $\pi$ /4-DQPSK | 8-DPSK   |
|         |           | 1Mbps                     | 2Mbps          | 3Mbps    |
| Ch00    | 2402MHz   | 6.25 dBm                  | 5.55 dBm       | 5.70 dBm |
| Ch39    | 2441MHz   | 7.25 dBm                  | 6.49 dBm       | 6.73 dBm |
| Ch78    | 2480MHz   | 6.08 dBm                  | 5.29 dBm       | 5.47 dBm |

**Remark:**

1. All the test data for each data rate were verified, but only the worst case was reported.
  2. The data rate was set in 1Mbps for all the test items due to the highest RF output power.
- a. The EUT has been associated with peripherals and configuration operated in a manner tended to maximize its emission characteristics in a typical application. Frequency range investigated: conduction (150 kHz to 30 MHz), radiation (9 kHz to the 10th harmonic of the highest fundamental frequency or to 40 GHz, whichever is lower). Pre-scanned tests, X, Y, Z in three orthogonal panels, and different data rates were conducted to determine the final configuration (Y plane as worst plane) from all possible combinations, and the worst mode of radiated spurious emissions is Bluetooth 1Mbps mode, and recorded in this report.
- b. AC power line Conducted Emission was tested under maximum output power.





## 2.2 Test Mode

The following summary table is showing all test modes to demonstrate in compliance with the standard.

| Summary table of Test Cases   |  |   |   |
|---|--|---|---|
| Test Item   | Data Rate / Modulation   |   |   |
|   | Bluetooth BR 1Mbps<br>GFSK   | Bluetooth EDR 2Mbps<br>$\pi/4$ -DQPSK                                   | Bluetooth EDR 3Mbps<br>8-DPSK   |
| Conducted Test Cases  | Mode 1: CH00_2402 MHz<br>Mode 2: CH39_2441 MHz<br>Mode 3: CH78_2480 MHz  | Mode 4: CH00_2402 MHz<br>Mode 5: CH39_2441 MHz<br>Mode 6: CH78_2480 MHz | Mode 7: CH00_2402 MHz<br>Mode 8: CH39_2441 MHz<br>Mode 9: CH78_2480 MHz |
| Radiated Test Cases   | Bluetooth BR 1Mbps GFSK  |   |   |
|   | Mode 1: CH00_2402 MHz<br>Mode 2: CH39_2441 MHz<br>Mode 3: CH78_2480 MHz  |   |   |
| AC Conducted Emission   | Mode 1 : WCDMA Band II Idle + Bluetooth Link + WLAN Link + Camera (Front) + Earphone + Battery + USB Cable (Charging from Adapter) |   |   |
| <p><b>Remark:</b> For radiated test cases, the worst mode data rate 1Mbps was reported only, because this data rate has the highest RF output power at preliminary tests, and the conducted spurious emissions and conducted band edge measurement for each data rate are no worse than 1Mbps, and no other significantly frequencies found in conducted spurious emission.</p> |  |   |   |

## 2.3 Connection Diagram of Test System

<Bluetooth Tx Mode>

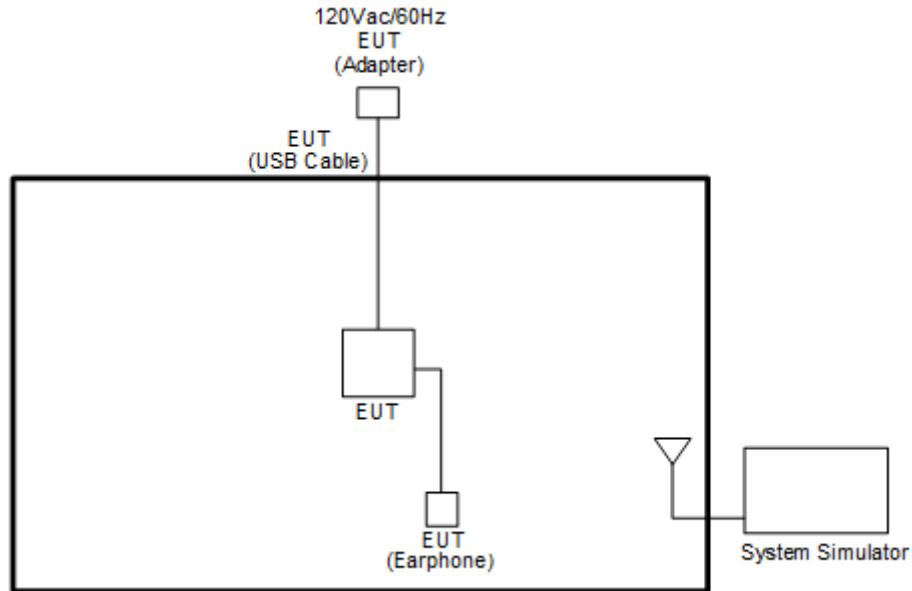

<AC Conducted Emission Mode>

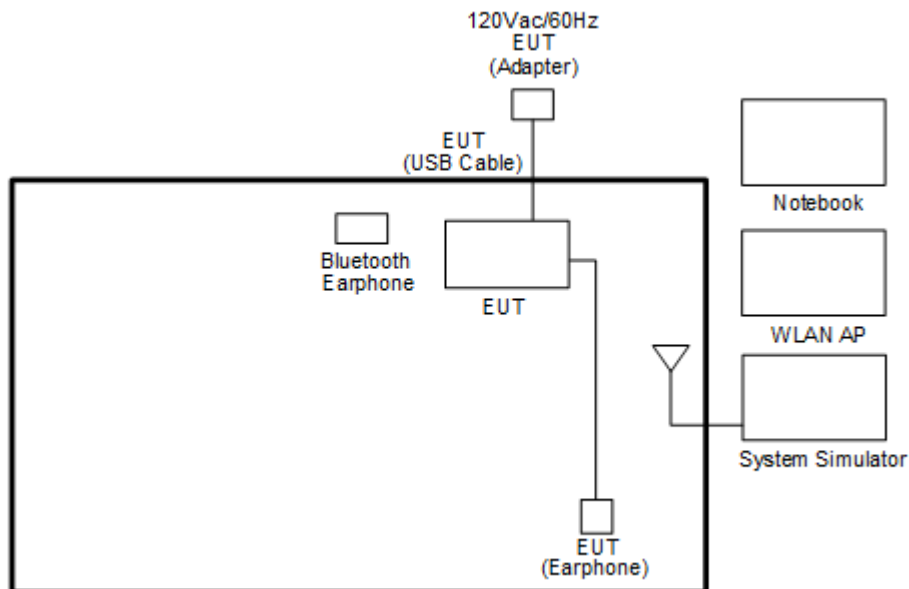

## 2.4 Support Unit used in test configuration and system

| Item | Equipment              | Trade Name    | Model Name     | FCC ID                                       | Data Cable | Power Cord   |
|------|------------------------|---------------|----------------|--|------------|--|
| 1.   | Bluetooth Base Station | R&S           | CBT32          | N/A  | N/A        | Unshielded, 1.8 m  |
| 2.   | System Simulator       | Anritsu       | MT8820C        | N/A  | N/A        | Unshielded, 1.8 m  |
| 3.   | Bluetooth Earphone     | Sony Ericsson | MW600          | PY7DDA-2029                                  | N/A        | N/A  |
| 4.   | WLAN AP                | ASUS          | RT-AC66U       | MSQ-RTAC66U                                  | N/A        | Unshielded, 1.8 m  |
| 5.   | Notebook               | DELL          | Latitude E6320 | FCC DoC/<br>Contains FCC ID:<br>QDS-BRCM1054 | N/A        | AC I/P:<br>Unshielded, 1.2 m<br>DC O/P:<br>Shielded, 1.8 m |
| 6.   | SD Card                | SanDisk       | MicroSD HC     | FCC DoC                                      | N/A        | N/A  |

## 2.5 EUT Operation Test Setup

For WLAN RF test items, an engineering test program was provided and enabled to make EUT transmitting and receiving signals.

## 2.6 Measurement Results Explanation Example

**For all conducted test items:**

The offset level is set in the spectrum analyzer to compensate the RF cable loss and attenuator factor between EUT conducted output port and spectrum analyzer. With the offset compensation, the spectrum analyzer reading level is exactly the EUT RF output level.

Example:

The spectrum analyzer offset is derived from RF cable loss and attenuator factor.

*Offset = RF cable loss + attenuator factor.*

Following shows an offset computation example with cable loss 4.2 dB and 10dB attenuator.

$$\begin{aligned}
 \text{Offset(dB)} &= \text{RF cable loss(dB)} + \text{attenuator factor(dB)}. \\
 &= 4.2 + 10 = 14.2 \text{ (dB)}
 \end{aligned}$$

### 3 Test Result

#### 3.1 Number of Channel Measurement

##### 3.1.1 Limits of Number of Hopping Frequency

Frequency hopping systems in the 2400-2483.5 MHz band shall use at least 15 channels.

##### 3.1.2 Measuring Instruments

The measuring equipment is listed in the section 4 of this test report.

##### 3.1.3 Test Procedure

1. The testing follows ANSI C63.10-2013 clause 7.8.3.
2. The RF output of EUT was connected to the spectrum analyzer by RF cable and attenuator. The path loss was compensated to the results for each measurement.
3. Set to the maximum power setting and enable the EUT transmit continuously.
4. Enable the EUT hopping function.
5. Use the following spectrum analyzer settings: Span = the frequency band of operation; RBW = 300kHz; VBW  $\geq$  RBW; Sweep = auto; Detector function = peak; Trace = max hold.
6. The number of hopping frequency used is defined as the number of total channel.
7. Record the measurement data derived from spectrum analyzer.

##### 3.1.4 Test Setup



##### 3.1.5 Test Result of Number of Hopping Frequency

|                                    |   |                            |                  |
|------------------------------------|---|----------------------------|------------------|
| <b>Test Mode :</b>                 | 1Mbps                                       | <b>Temperature :</b>       | 24~26°C          |
| <b>Test Engineer :</b>             | Aking chang                                 | <b>Relative Humidity :</b> | 48~51%           |
| <b>Number of Hopping (Channel)</b> | <b>Adaptive Frequency Hopping (Channel)</b> | <b>Limits (Channel)</b>    | <b>Pass/Fail</b> |
| 79                                 | 20  | > 15                       | Pass             |



Number of Hopping Channel Plot on Channel 00 - 78

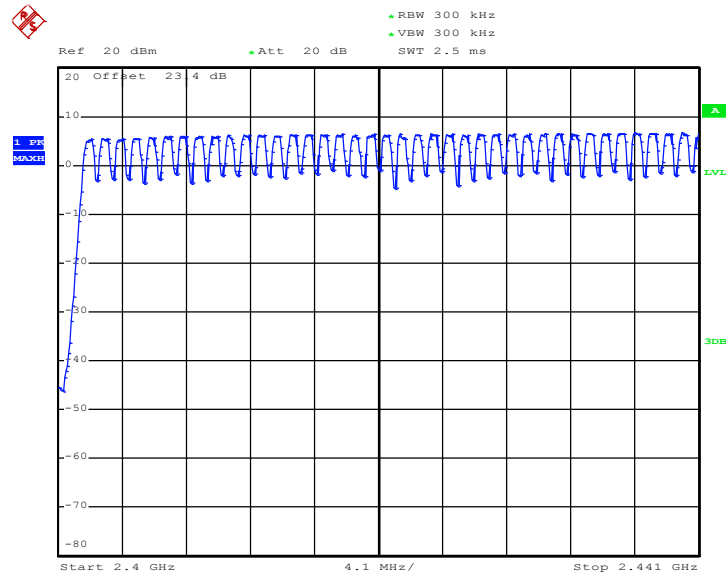

Date: 20.NOV.2016 07:41:28

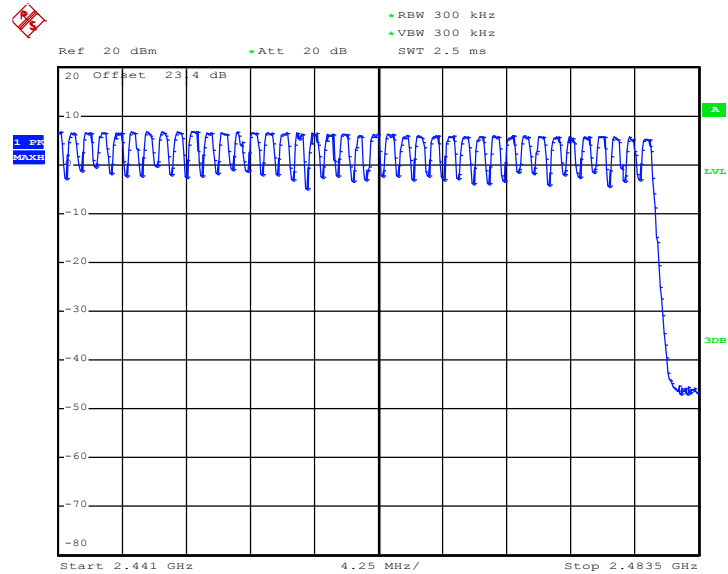

Date: 20.NOV.2016 07:42:11

## 3.2 Hopping Channel Separation Measurement

### 3.2.1 Limit of Hopping Channel Separation

Frequency hopping systems operating in the 2400-2483.5 MHz band may have hopping channel carrier frequencies that are separated by 25 kHz or two-thirds of the 20 dB bandwidth of the hopping channel, whichever is greater.

### 3.2.2 Measuring Instruments

The measuring equipment is listed in the section 4 of this test report.

### 3.2.3 Test Procedures

1. The testing follows ANSI C63.10-2013 clause 7.8.2.
2. The RF output of EUT was connected to the spectrum analyzer by RF cable and attenuator. The path loss was compensated to the results for each measurement.
3. Set to the maximum power setting and enable the EUT transmit continuously.
4. Enable the EUT hopping function.
5. Use the following spectrum analyzer settings:  
Span = wide enough to capture the peaks of two adjacent channels;  
RBW = 300kHz; VBW  $\geq$  RBW; Sweep = auto; Detector function = peak; Trace = max hold.
6. Measure and record the results in the test report.

### 3.2.4 Test Setup

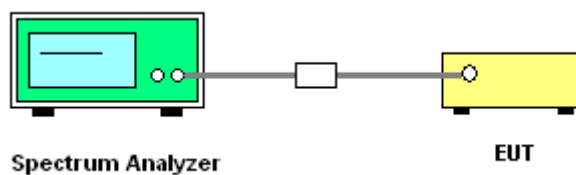



### 3.2.5 Test Result of Hopping Channel Separation

|                 |             |                     |         |
|-----------------|-------------|---------------------|---------|
| Test Mode :     | 1Mbps       | Temperature :       | 24~26°C |
| Test Engineer : | Aking chang | Relative Humidity : | 48~51%  |

| Channel | Frequency (MHz) | Frequency Separation (MHz) | (2/3 of 20dB BW) Limits (MHz) | Pass/Fail |
|---------|-----------------|----------------------------|-------------------------------|-----------|
| 00      | 2402            | 0.996                      | 0.5947                        | Pass      |
| 39      | 2441            | 1.008                      | 0.6133                        | Pass      |
| 78      | 2480            | 0.996                      | 0.6133                        | Pass      |

Channel Separation Plot on Channel 00 - 01

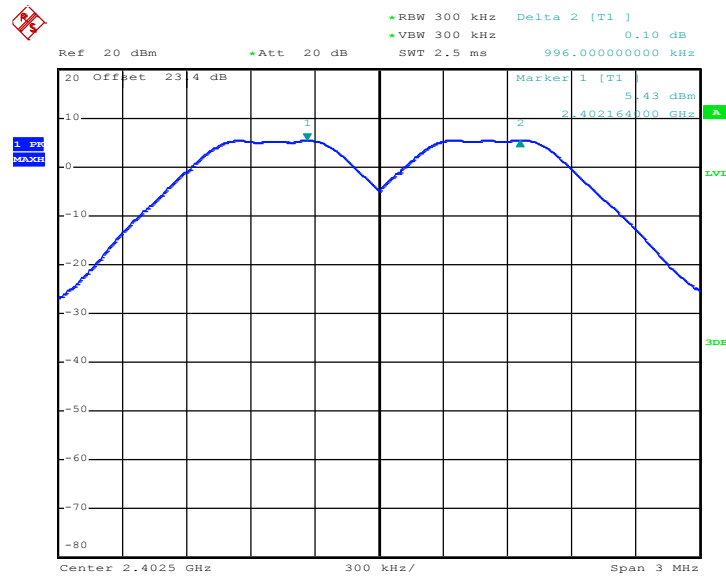

Date: 20.NOV.2016 08:01:38







|                 |             |                     |         |
|-----------------|-------------|---------------------|---------|
| Test Mode :     | 2Mbps       | Temperature :       | 24~26°C |
| Test Engineer : | Aking chang | Relative Humidity : | 48~51%  |

| Channel | Frequency (MHz) | Frequency Separation (MHz) | (2/3 of 20dB BW) Limits (MHz) | Pass/Fail |
|---------|-----------------|----------------------------|-------------------------------|-----------|
| 00      | 2402            | 0.990                      | 0.8240                        | Pass      |
| 39      | 2441            | 0.996                      | 0.8400                        | Pass      |
| 78      | 2480            | 0.990                      | 0.8400                        | Pass      |

Channel Separation Plot on Channel 00 - 01

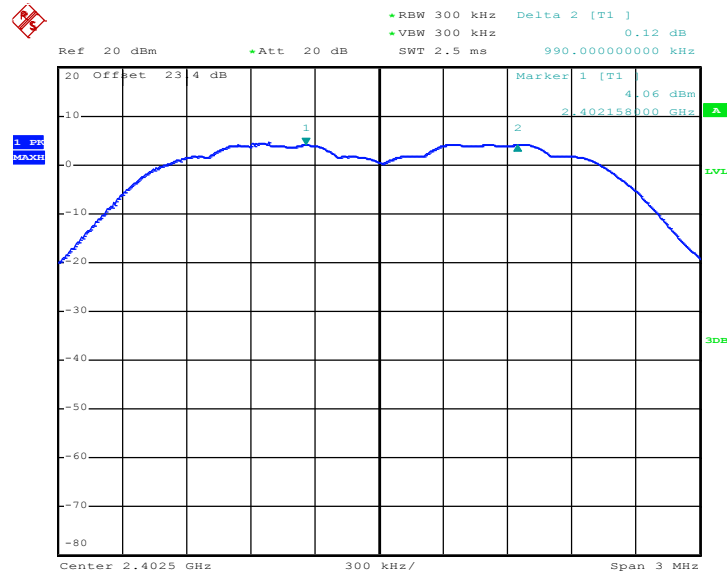

Date: 20.NOV.2016 08:18:55



Channel Separation Plot on Channel 39 - 40

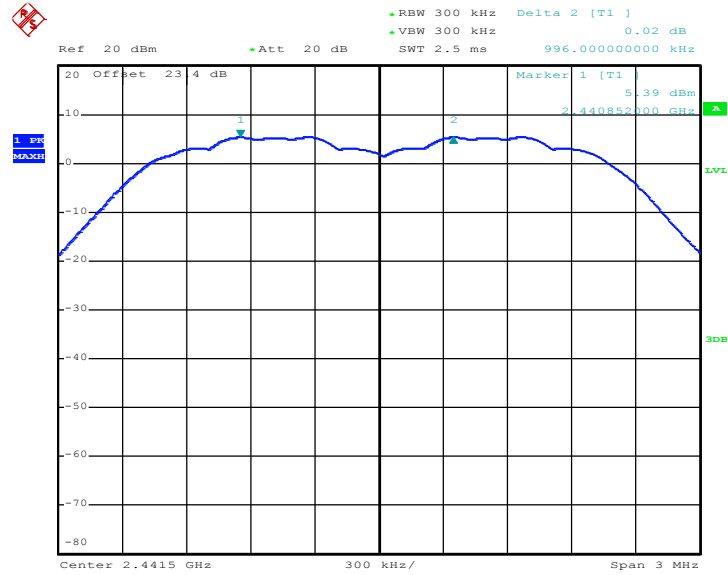

Date: 20.NOV.2016 08:22:53

Channel Separation Plot on Channel 77 - 78

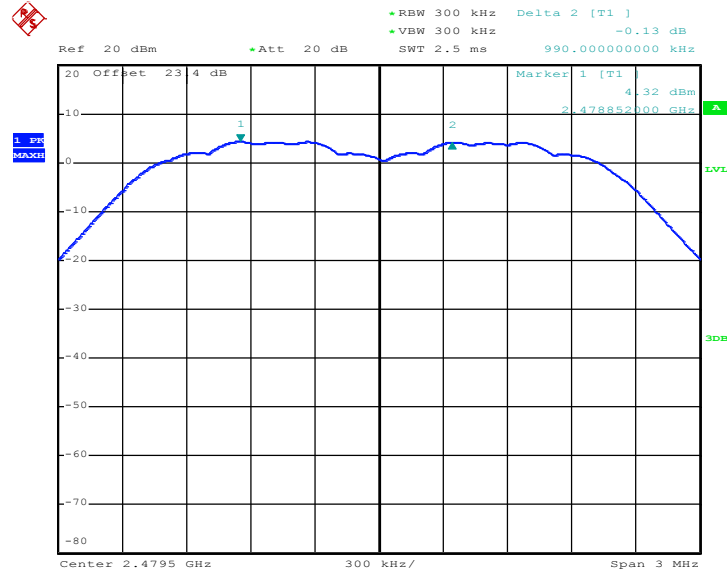

Date: 20.NOV.2016 08:23:48



|                 |             |                     |         |
|-----------------|-------------|---------------------|---------|
| Test Mode :     | 3Mbps       | Temperature :       | 24~26°C |
| Test Engineer : | Aking chang | Relative Humidity : | 48~51%  |

| Channel | Frequency (MHz) | Frequency Separation (MHz) | (2/3 of 20dB BW) Limits (MHz) | Pass/Fail |
|---------|-----------------|----------------------------|-------------------------------|-----------|
| 00      | 2402            | 1.002                      | 0.8320                        | Pass      |
| 39      | 2441            | 0.996                      | 0.8320                        | Pass      |
| 78      | 2480            | 1.014                      | 0.8320                        | Pass      |

Channel Separation Plot on Channel 00 - 01

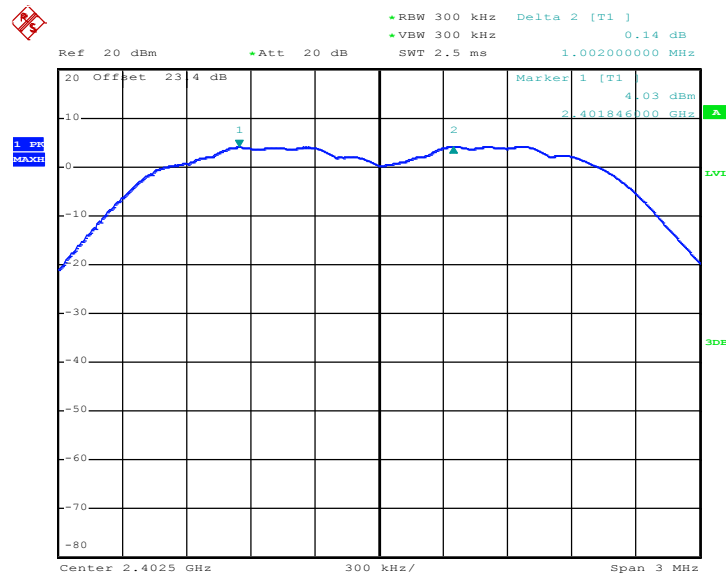

Date: 20.NOV.2016 08:36:42



Channel Separation Plot on Channel 39 - 40

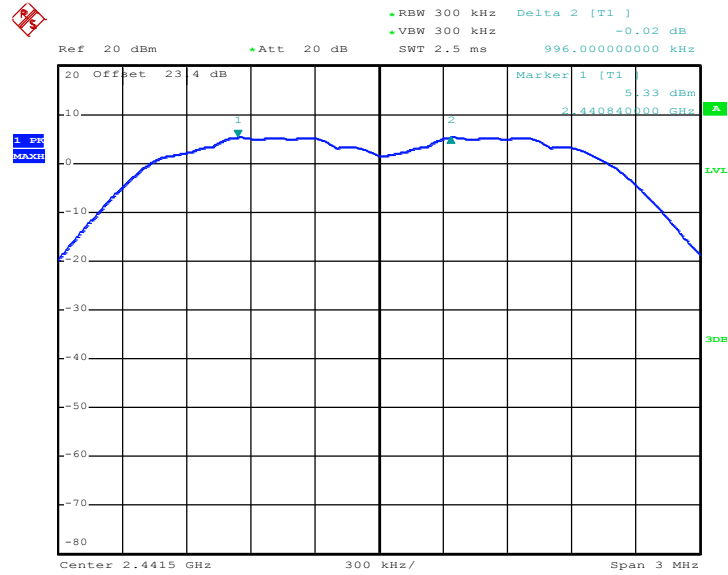

Date: 20.NOV.2016 08:46:36

Channel Separation Plot on Channel 77 - 78

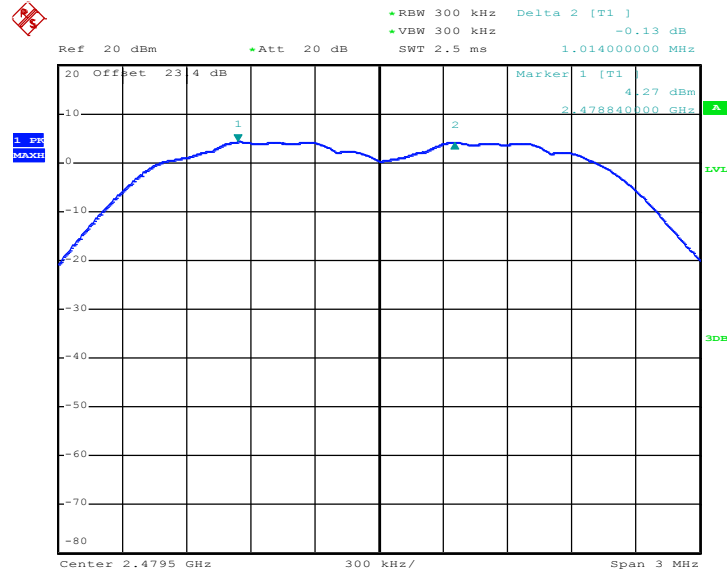

Date: 20.NOV.2016 08:47:39

### 3.3 Dwell Time Measurement

#### 3.3.1 Limit of Dwell Time

The average time of occupancy on any channel shall not be greater than 0.4 seconds within a period of 0.4 seconds multiplied by the number of hopping channels employed.

#### 3.3.2 Measuring Instruments

The measuring equipment is listed in the section 4 of this test report.

#### 3.3.3 Test Procedures

1. The testing follows ANSI C63.10-2013 clause 7.8.4.
2. The RF output of EUT was connected to the spectrum analyzer by RF cable and attenuator. The path loss was compensated to the results for each measurement.
3. Set to the maximum power setting and enable the EUT transmit continuously.
4. Enable the EUT hopping function.
5. Use the following spectrum analyzer settings: Span = zero span, centered on a hopping channel; RBW = 1 MHz; VBW  $\geq$  RBW; Sweep = as necessary to capture the entire dwell time per hopping channel; Detector function = peak; Trace = max hold.
6. Measure and record the results in the test report.

#### 3.3.4 Test Setup





3.3.5 Test Result of Dwell Time

|                 |             |                     |         |
|-----------------|-------------|---------------------|---------|
| Test Mode :     | DH5         | Temperature :       | 24~26°C |
| Test Engineer : | Aking chang | Relative Humidity : | 48~51%  |

| Mode   | Hopping Channel Number | Hops Over Occupancy Time(hops) | Package Transfer Time (msec) | Dwell Time (sec) | Limits (sec) | Pass/Fail |
|--------|------------------------|--------------------------------|------------------------------|------------------|--------------|-----------|
| Normal | 79                     | 106.67                         | 2.90                         | 0.31             | 0.4          | Pass      |
| AFH    | 20                     | 53.33                          | 2.90                         | 0.15             | 0.4          | Pass      |

Remark:

- In normal mode, hopping rate is 1600 hops/s with 6 slots in 79 hopping channels.  
With channel hopping rate (1600 / 6 / 79) in Occupancy Time Limit (0.4 x 79) (s),  
Hops Over Occupancy Time comes to (1600 / 6 / 79) x (0.4 x 79) = 106.67 hops.
- In AFH mode, hopping rate is 800 hops/s with 6 slots in 20 hopping channels.  
With channel hopping rate (800 / 6 / 20) in Occupancy Time Limit (0.4 x 20) (s),  
Hops Over Occupancy Time comes to (800 / 6 / 20) x (0.4 x 20) = 53.33 hops.
- Dwell Time(s) = Hops Over Occupancy Time (hops) x Package Transfer Time

Package Transfer Time Plot

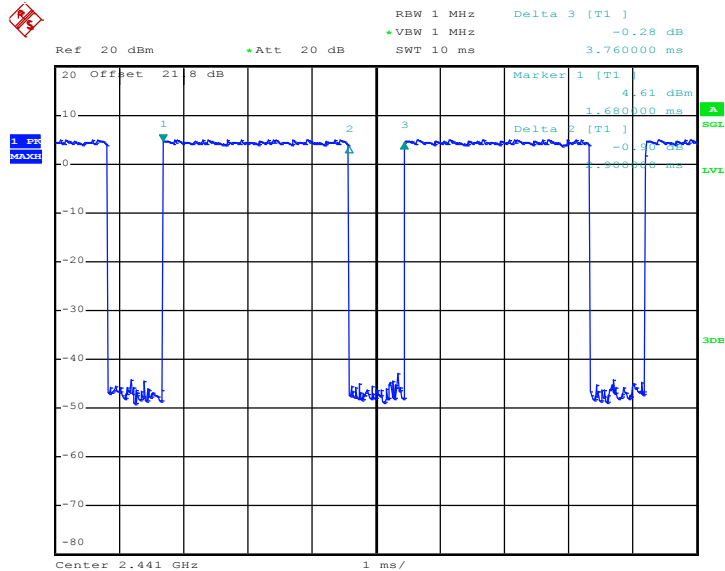

Date: 4.NOV.2016 11:36:14

### 3.4 20dB and 99% Bandwidth Measurement

#### 3.4.1 Limit of 20dB and 99% Bandwidth

Reporting only

#### 3.4.2 Measuring Instruments

The measuring equipment is listed in the section 4 of this test report.

#### 3.4.3 Test Procedures

1. The testing follows ANSI C63.10-2013 clause 6.9.2 and 6.9.3.
2. The RF output of EUT was connected to the spectrum analyzer by RF cable and attenuator. The path loss was compensated to the results for each measurement.
3. Set to the maximum power setting and enable the EUT transmit continuously.
4. Use the following spectrum analyzer settings for 20dB Bandwidth measurement.  
Span = approximately 2 to 5 times the 20 dB bandwidth, centered on a hopping channel;  
RBW  $\geq$  1% of the 20 dB bandwidth; VBW  $\geq$  RBW; Sweep = auto; Detector function = peak;  
Trace = max hold.
5. Use the following spectrum analyzer settings for 99 % Bandwidth measurement.  
Span = approximately 1.5 to 5 times the 99% bandwidth, centered on a hopping channel;  
RBW  $\geq$  1% of the 99% bandwidth; VBW  $\geq$  RBW; Sweep = auto; Detector function = peak;  
Trace = max hold.
6. Measure and record the results in the test report.

#### 3.4.4 Test Setup









20 dB Bandwidth Plot on Channel 39

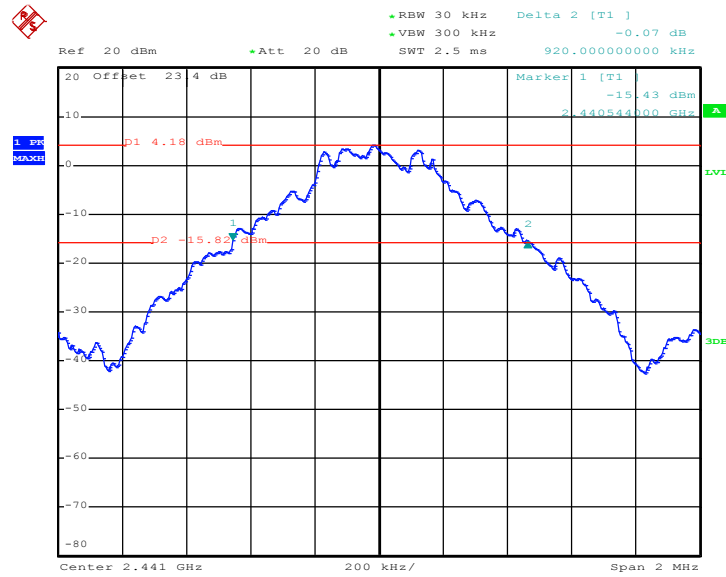

Date: 20.NOV.2016 08:06:04

20 dB Bandwidth Plot on Channel 78

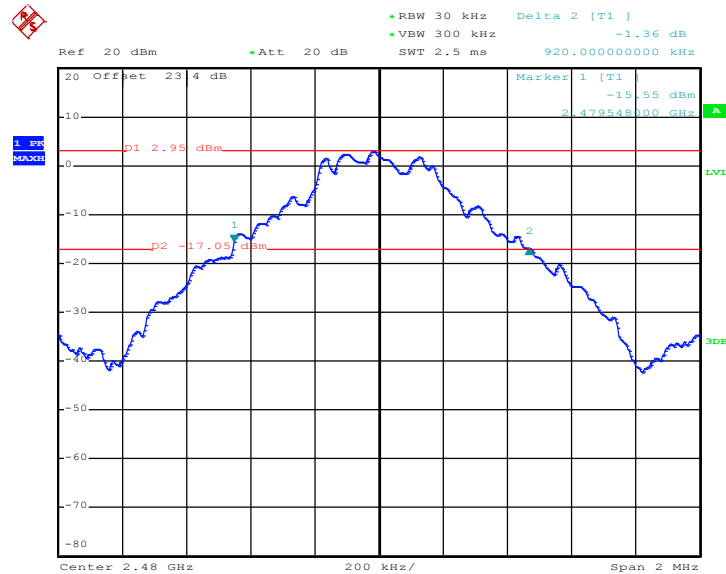

Date: 20.NOV.2016 08:12:07



|                 |             |                     |         |
|-----------------|-------------|---------------------|---------|
| Test Mode :     | 2Mbps       | Temperature :       | 24~26°C |
| Test Engineer : | Aking chang | Relative Humidity : | 48~51%  |

| Channel | Frequency (MHz) | 20dB Bandwidth (MHz) |
|---------|-----------------|----------------------|
| 00      | 2402            | 1.236                |
| 39      | 2441            | 1.260                |
| 78      | 2480            | 1.260                |

20 dB Bandwidth Plot on Channel 00

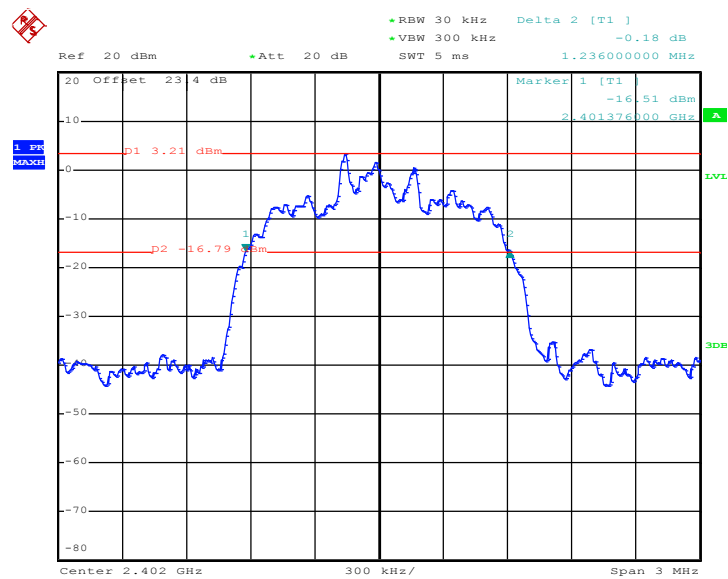

Date: 20.NOV.2016 08:17:46



20 dB Bandwidth Plot on Channel 39

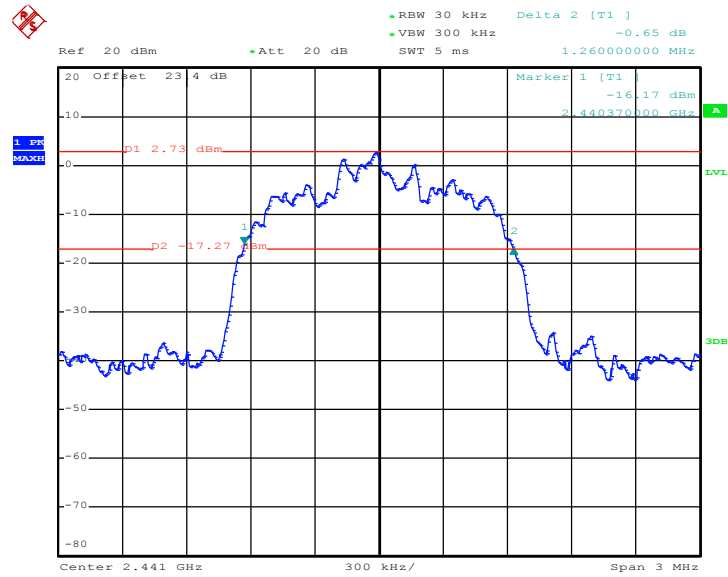

Date: 20.NOV.2016 08:21:43

20 dB Bandwidth Plot on Channel 78

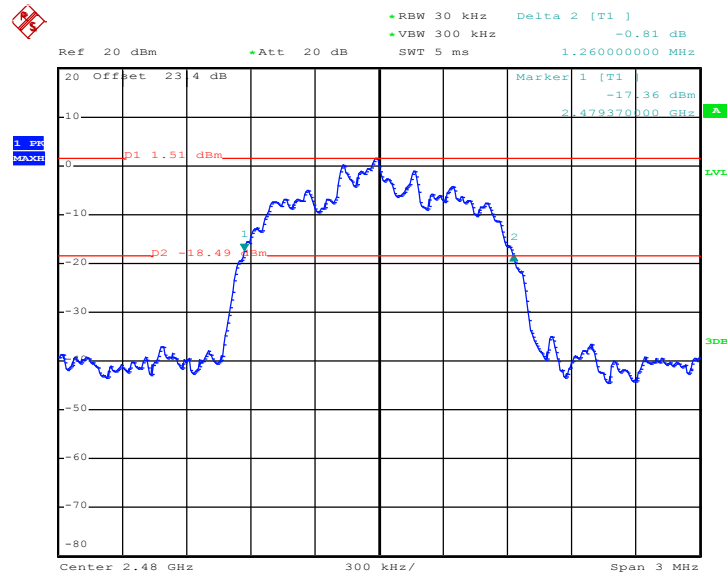

Date: 20.NOV.2016 08:29:36



|                 |             |                     |         |
|-----------------|-------------|---------------------|---------|
| Test Mode :     | 3Mbps       | Temperature :       | 24~26°C |
| Test Engineer : | Aking chang | Relative Humidity : | 48~51%  |

| Channel | Frequency (MHz) | 20dB Bandwidth (MHz) |
|---------|-----------------|----------------------|
| 00      | 2402            | 1.248                |
| 39      | 2441            | 1.248                |
| 78      | 2480            | 1.248                |

20 dB Bandwidth Plot on Channel 00

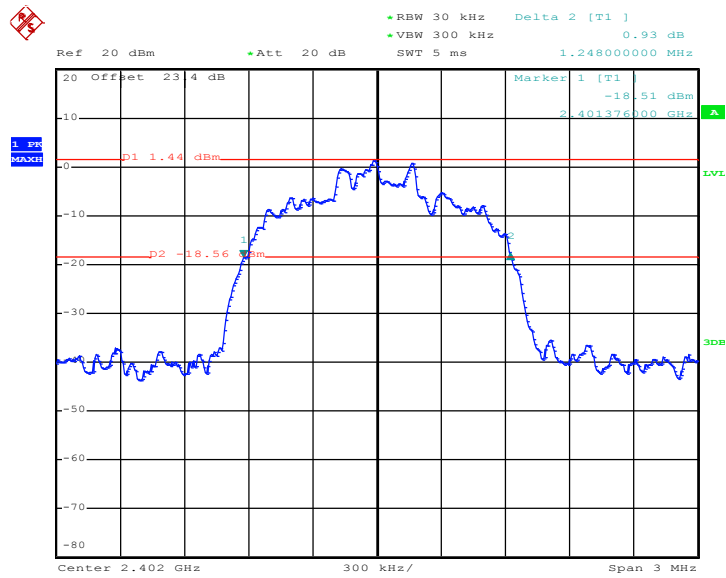

Date: 20.NOV.2016 08:34:09



20 dB Bandwidth Plot on Channel 39

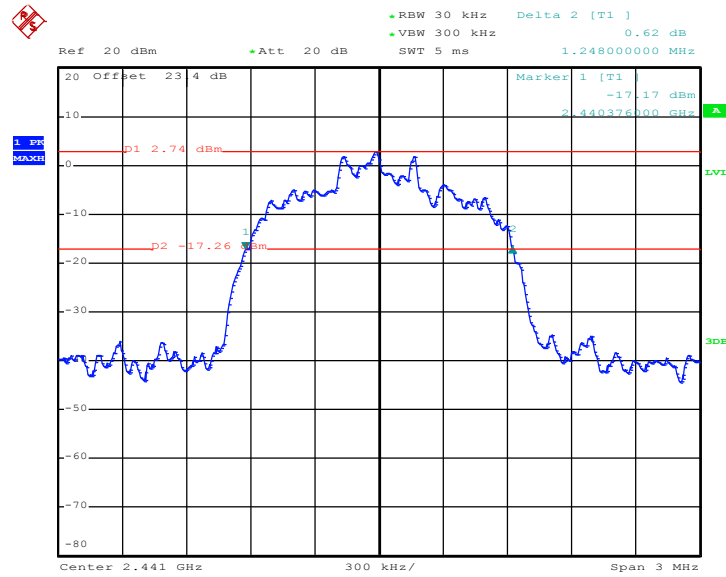

Date: 20.NOV.2016 08:45:26

20 dB Bandwidth Plot on Channel 78

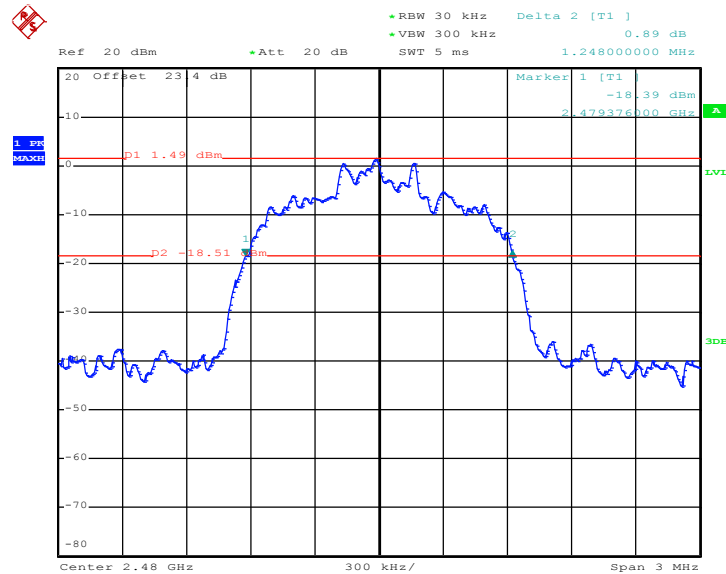

Date: 20.NOV.2016 08:50:58



### 3.4.6 Test Result of 99% Occupied Bandwidth

|                 |             |                     |         |
|-----------------|-------------|---------------------|---------|
| Test Mode :     | 1Mbps       | Temperature :       | 24~26°C |
| Test Engineer : | Aking chang | Relative Humidity : | 48~51%  |

| Channel | Frequency (MHz) | 99% Occupied Bandwidth (MHz) |
|---------|-----------------|------------------------------|
| 00      | 2402            | 0.848                        |
| 39      | 2441            | 0.860                        |
| 78      | 2480            | 0.860                        |

99% Occupied Bandwidth Plot on Channel 00

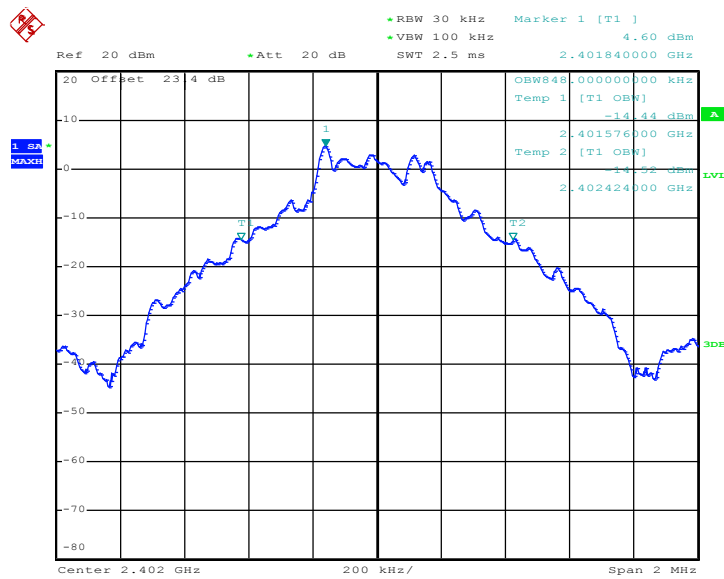

Date: 20.NOV.2016 07:54:44



99% Occupied Bandwidth Plot on Channel 39

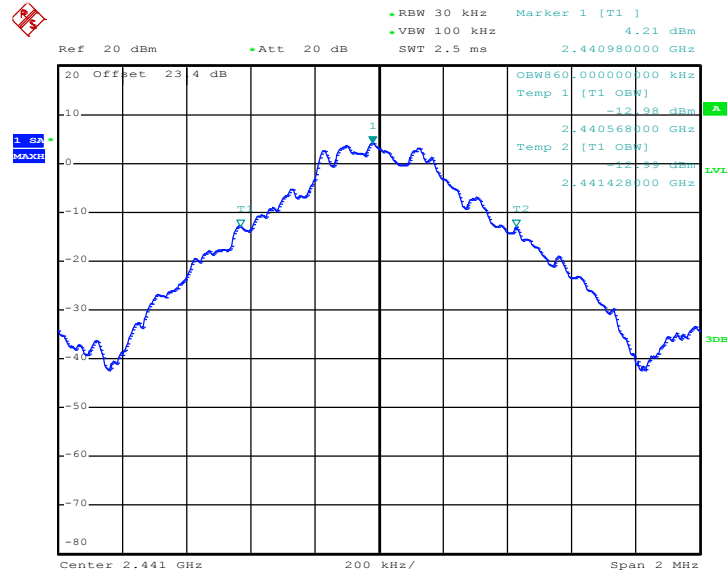

Date: 20.NOV.2016 08:04:52

99% Occupied Bandwidth Plot on Channel 78

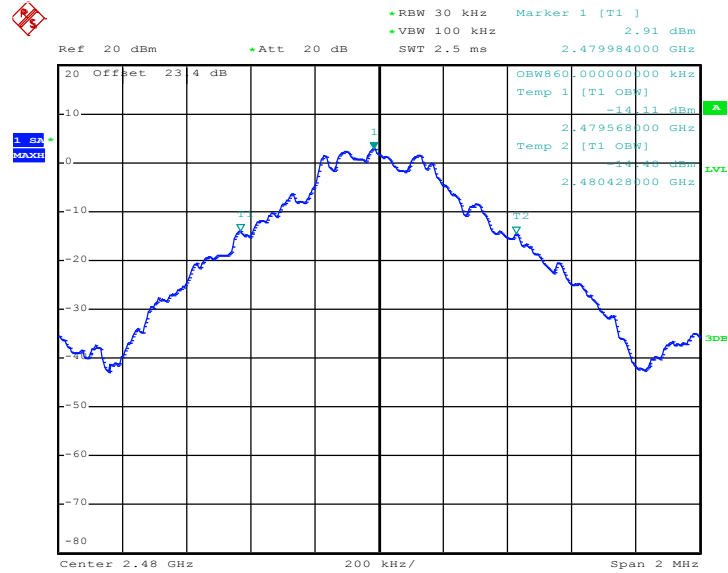

Date: 20.NOV.2016 08:09:48



|                 |             |                     |         |
|-----------------|-------------|---------------------|---------|
| Test Mode :     | 2Mbps       | Temperature :       | 24~26°C |
| Test Engineer : | Aking chang | Relative Humidity : | 48~51%  |

| Channel | Frequency (MHz) | 99% Occupied Bandwidth (MHz) |
|---------|-----------------|------------------------------|
| 00      | 2402            | 1.156                        |
| 39      | 2441            | 1.164                        |
| 78      | 2480            | 1.164                        |

99% Occupied Bandwidth Plot on Channel 00

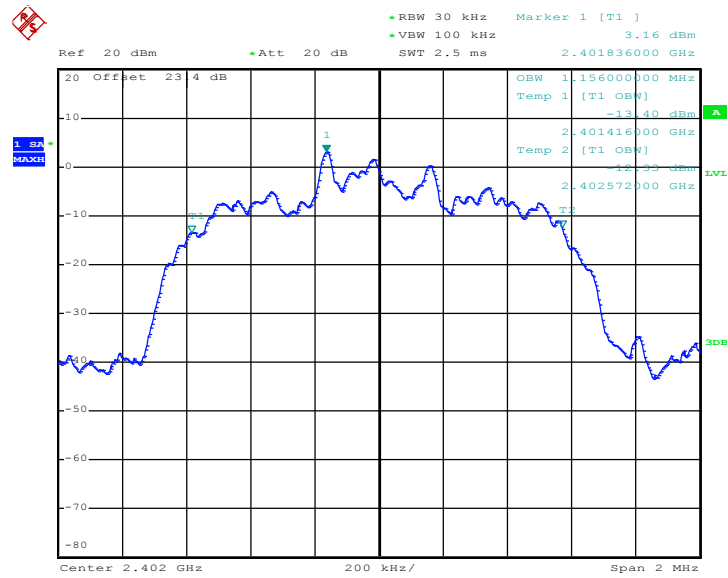

Date: 20.NOV.2016 08:14:54





99% Occupied Bandwidth Plot on Channel 39

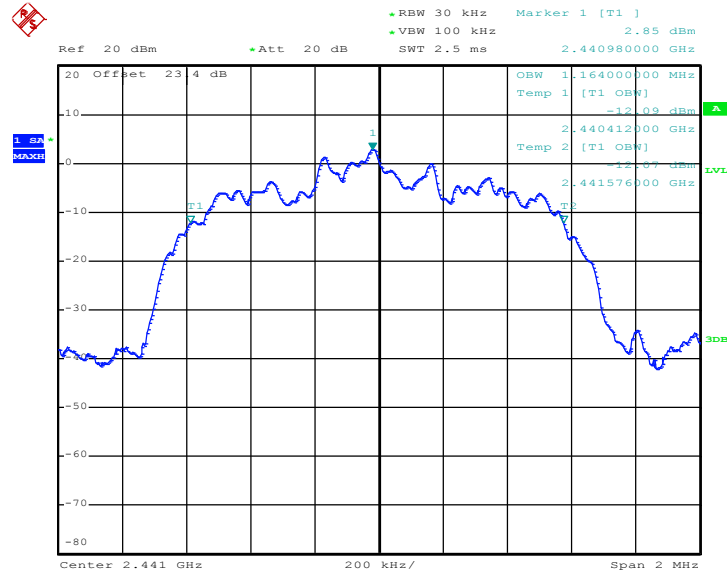

Date: 20.NOV.2016 08:20:40

99% Occupied Bandwidth Plot on Channel 78

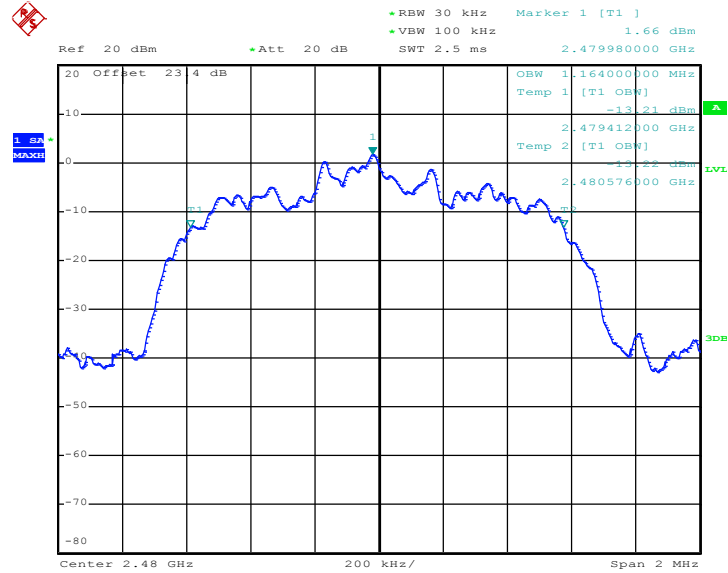

Date: 20.NOV.2016 08:27:16



|                 |             |                     |         |
|-----------------|-------------|---------------------|---------|
| Test Mode :     | 3Mbps       | Temperature :       | 24~26°C |
| Test Engineer : | Aking chang | Relative Humidity : | 48~51%  |

| Channel | Frequency (MHz) | 99% Occupied Bandwidth (MHz) |
|---------|-----------------|------------------------------|
| 00      | 2402            | 1.148                        |
| 39      | 2441            | 1.148                        |
| 78      | 2480            | 1.152                        |

99% Occupied Bandwidth Plot on Channel 00

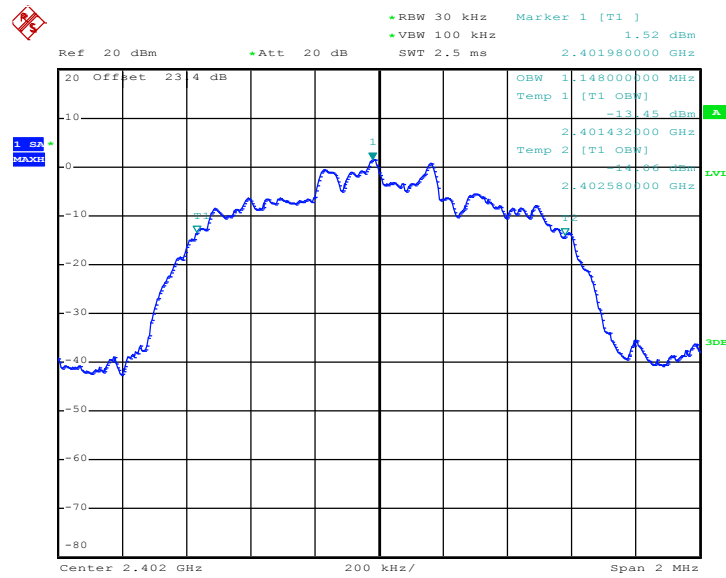

Date: 20.NOV.2016 08:32:10



99% Occupied Bandwidth Plot on Channel 39

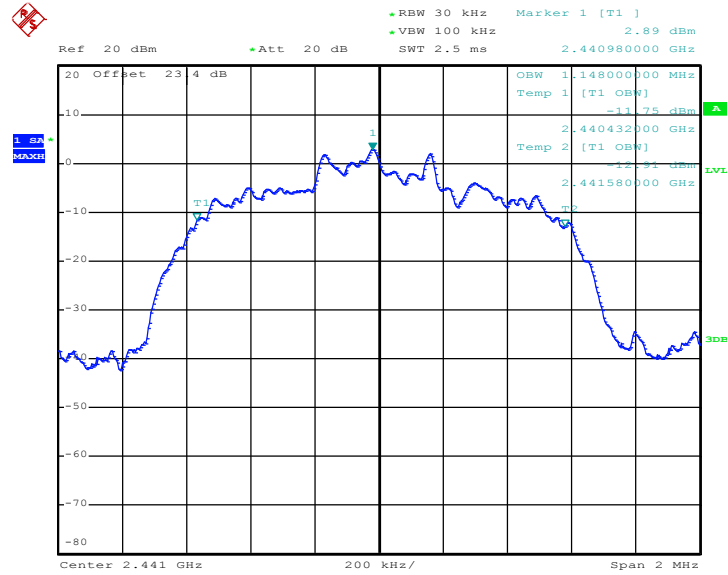

Date: 20.NOV.2016 08:44:00

99% Occupied Bandwidth Plot on Channel 78

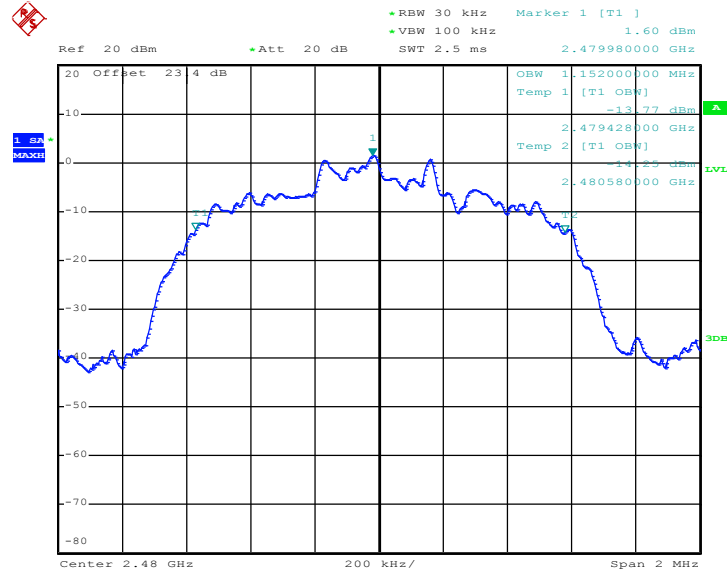

Date: 20.NOV.2016 08:49:14

Note : The occupied channel bandwidth is maintained within the band of operation for all of the modulations.

### 3.5 Peak Output Power Measurement

#### 3.5.1 Limit of Peak Output Power

Section 15.247 (b) The maximum peak conducted output power of the intentional radiator shall not exceed the following: (1) For frequency hopping systems operating in the 2400-2483.5 MHz band employing at least 75 non-overlapping hopping channels, and all frequency hopping systems in the 5725-5850 MHz band: 1 watt. For all other frequency hopping systems in the 2400-2483.5 MHz band 0.125 watts. The power limit for 1Mbps, 2Mbps, 3Mbps and AFH modes are 0.125 watts.

#### 3.5.2 Measuring Instruments

The measuring equipment is listed in the section 4 of this test report.

#### 3.5.3 Test Procedures

1. The testing follows ANSI C63.10-2013 clause 7.8.5.
2. The RF output of EUT was connected to the power meter by RF cable and attenuator. The path loss was compensated to the results for each measurement.
3. Set to the maximum power setting and enable the EUT transmit continuously.
4. Measure the conducted output power with cable loss and record the results in the test report.
5. Measure and record the results in the test report.

#### 3.5.4 Test Setup

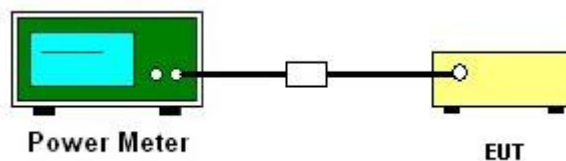



3.5.5 Test Result of Peak Output Power

|                 |             |                     |         |
|-----------------|-------------|---------------------|---------|
| Test Mode :     | 1Mbps       | Temperature :       | 24~26°C |
| Test Engineer : | Aking chang | Relative Humidity : | 48~51%  |

| Channel | Frequency (MHz) | RF Power (dBm) |                   |           |
|---------|-----------------|----------------|-------------------|-----------|
|         |                 | GFSK           | Max. Limits (dBm) | Pass/Fail |
|         |                 | 1 Mbps         |                   |           |
| 00      | 2402            | 6.25           | 20.97             | Pass      |
| 39      | 2441            | 7.25           | 20.97             | Pass      |
| 78      | 2480            | 6.08           | 20.97             | Pass      |

Note: For AFH mode using 20 hopping channels, the maximum output power limit is 20.97dBm.

|                 |             |                     |         |
|-----------------|-------------|---------------------|---------|
| Test Mode :     | 2Mbps       | Temperature :       | 24~26°C |
| Test Engineer : | Aking chang | Relative Humidity : | 48~51%  |

| Channel | Frequency (MHz) | RF Power (dBm) |                   |           |
|---------|-----------------|----------------|-------------------|-----------|
|         |                 | $\pi/4$ -DQPSK | Max. Limits (dBm) | Pass/Fail |
|         |                 | 2 Mbps         |                   |           |
| 00      | 2402            | 5.55           | 20.97             | Pass      |
| 39      | 2441            | 6.49           | 20.97             | Pass      |
| 78      | 2480            | 5.29           | 20.97             | Pass      |

|                 |             |                     |         |
|-----------------|-------------|---------------------|---------|
| Test Mode :     | 3Mbps       | Temperature :       | 24~26°C |
| Test Engineer : | Aking chang | Relative Humidity : | 48~51%  |

| Channel | Frequency (MHz) | RF Power (dBm) |                   |           |
|---------|-----------------|----------------|-------------------|-----------|
|         |                 | 8-DPSK         | Max. Limits (dBm) | Pass/Fail |
|         |                 | 3 Mbps         |                   |           |
| 00      | 2402            | 5.70           | 20.97             | Pass      |
| 39      | 2441            | 6.73           | 20.97             | Pass      |
| 78      | 2480            | 5.47           | 20.97             | Pass      |

## 3.6 Conducted Band Edges Measurement

### 3.6.1 Limit of Band Edges

In any 100 kHz bandwidth outside the intentional radiation frequency band, the radio frequency power shall be at least 20 dB below the highest level of the radiated power. In addition, radiated emissions which fall in the restricted bands must also comply with the radiated emission limits.

### 3.6.2 Measuring Instruments

The measuring equipment is listed in the section 4 of this test report.

### 3.6.3 Test Procedures

1. The testing follows ANSI C63.10-2013 clause 7.8.6.
2. Set to the maximum power setting and enable the EUT transmit continuously.
3. Set RBW = 100kHz, VBW = 300kHz. Band edge emissions must be at least 20 dB down from the highest emission level within the authorized band as measured with a 100kHz RBW. The attenuation shall be 30 dB instead of 20 dB when RMS conducted output power procedure is used.
4. Enable hopping function of the EUT and then repeat step 2. and 3.
5. Measure and record the results in the test report.

### 3.6.4 Test Setup





### 3.6.5 Test Result of Conducted Band Edges

|                |           |                     |             |
|----------------|-----------|---------------------|-------------|
| Test Mode :    | 1Mbps     | Temperature :       | 24~26°C     |
| Test Channel : | 00 and 78 | Relative Humidity : | 48~51%      |
|                |           | Test Engineer :     | Aking chang |

Low Band Edge Plot on Channel 00

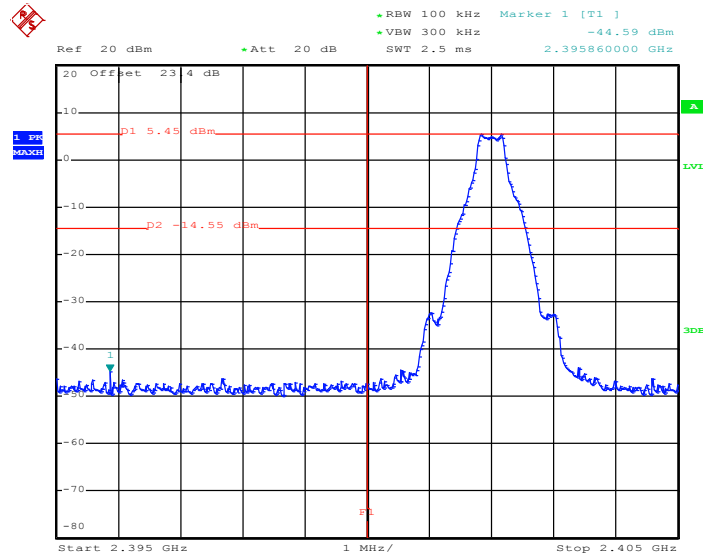

Date: 20.NOV.2016 07:55:22

High Band Edge Plot on Channel 78

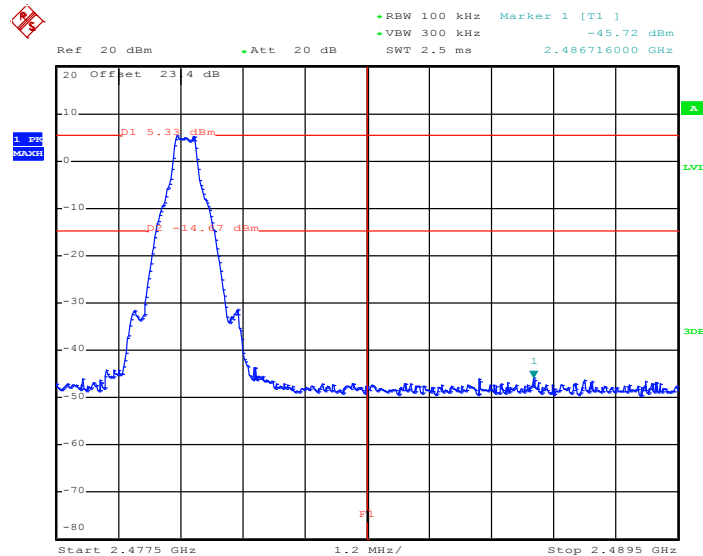

Date: 20.NOV.2016 08:10:56



|                |           |                     |             |
|----------------|-----------|---------------------|-------------|
| Test Mode :    | 2Mbps     | Temperature :       | 24~26°C     |
| Test Channel : | 00 and 78 | Relative Humidity : | 48~51%      |
|                |           | Test Engineer :     | Aking chang |

Low Band Edge Plot on Channel 00

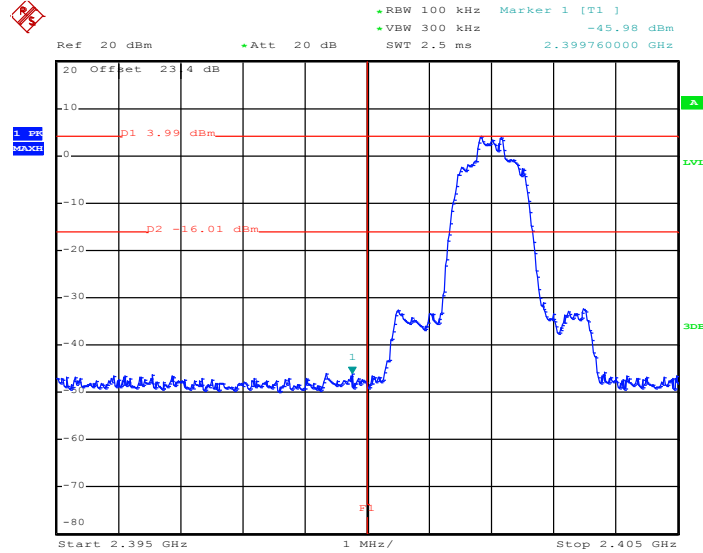

Date: 20.NOV.2016 08:15:13

High Band Edge Plot on Channel 78

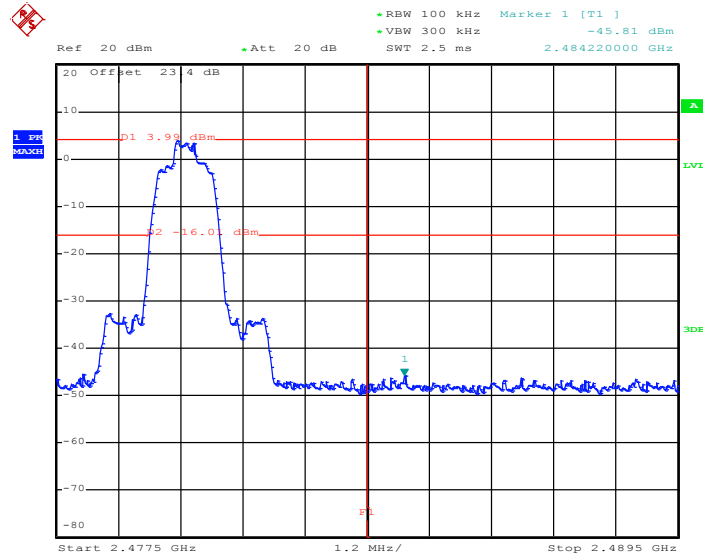

Date: 20.NOV.2016 08:27:49





|                |           |                     |             |
|----------------|-----------|---------------------|-------------|
| Test Mode :    | 3Mbps     | Temperature :       | 24~26°C     |
| Test Channel : | 00 and 78 | Relative Humidity : | 48~51%      |
|                |           | Test Engineer :     | Aking chang |

Low Band Edge Plot on Channel 00

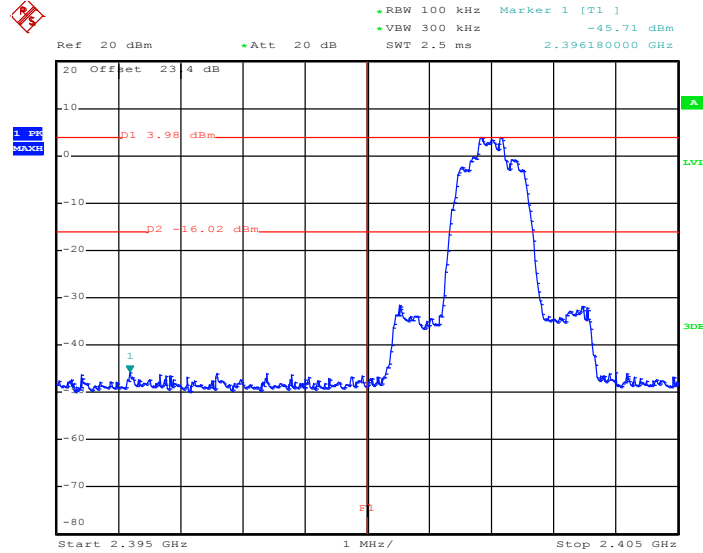

Date: 20.NOV.2016 08:32:45

High Band Edge Plot on Channel 78

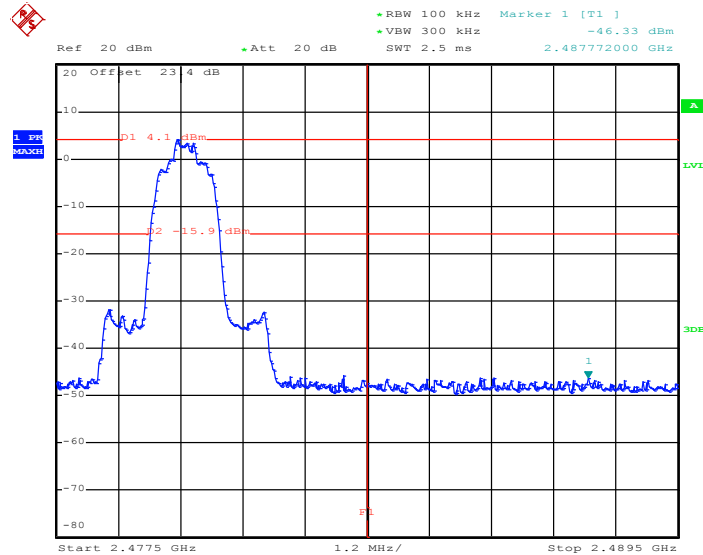

Date: 20.NOV.2016 08:49:36



### 3.6.6 Test Result of Conducted Hopping Mode Band Edges

|                 |             |                     |         |
|-----------------|-------------|---------------------|---------|
| Test Mode :     | 1Mbps       | Temperature :       | 24~26°C |
| Test Engineer : | Aking chang | Relative Humidity : | 48~51%  |

#### 1Mbps Hopping Mode Low Band Edge Plot

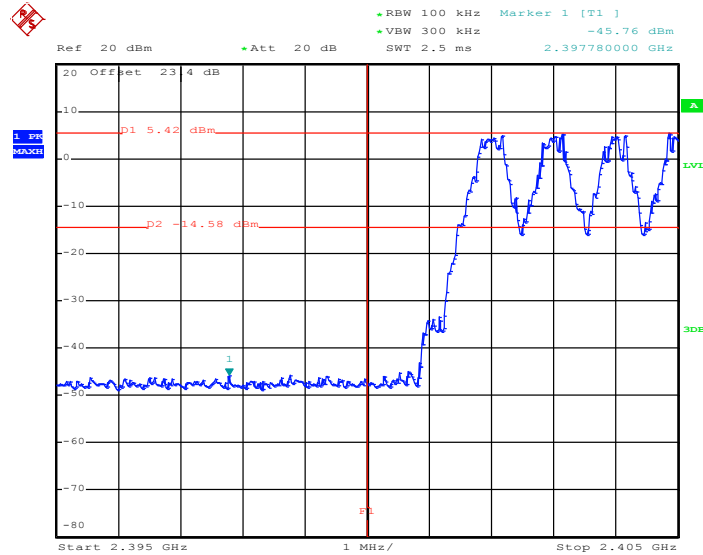

Date: 20.NOV.2016 07:43:25

#### 1Mbps Hopping Mode High Band Edge Plot

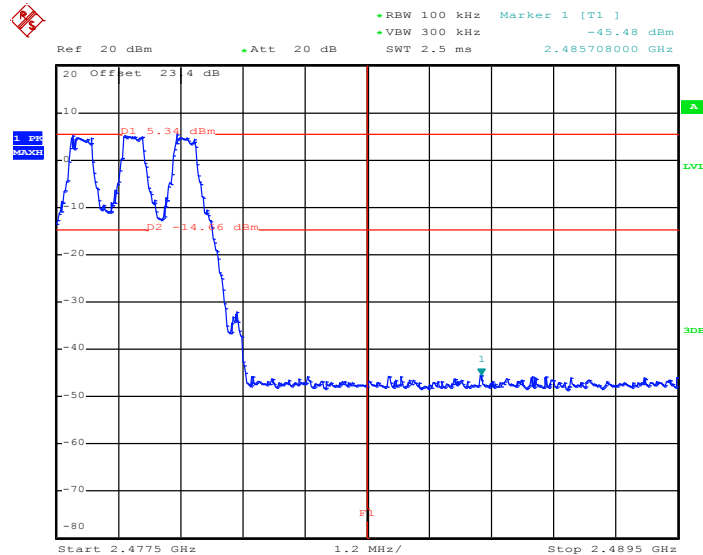

Date: 20.NOV.2016 07:44:49



|                 |             |                     |         |
|-----------------|-------------|---------------------|---------|
| Test Mode :     | 2Mbps       | Temperature :       | 24~26°C |
| Test Engineer : | Aking chang | Relative Humidity : | 48~51%  |

2Mbps Hopping Mode Low Band Edge Plot

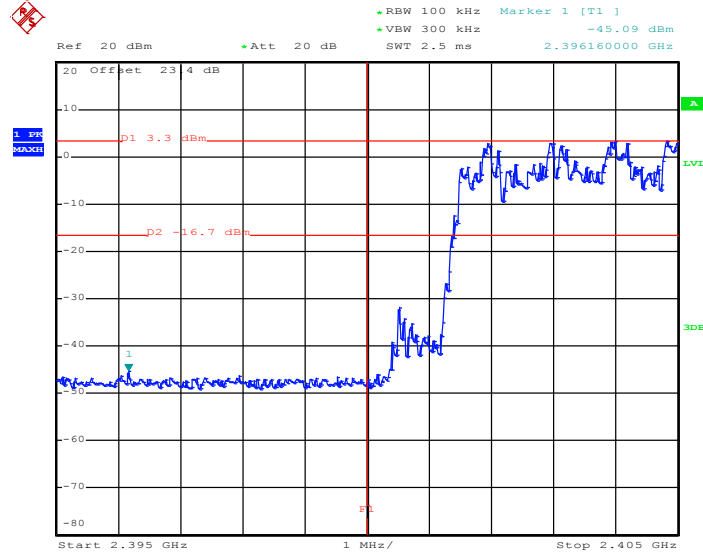

Date: 20.NOV.2016 07:48:22

2Mbps Hopping Mode High Band Edge Plot

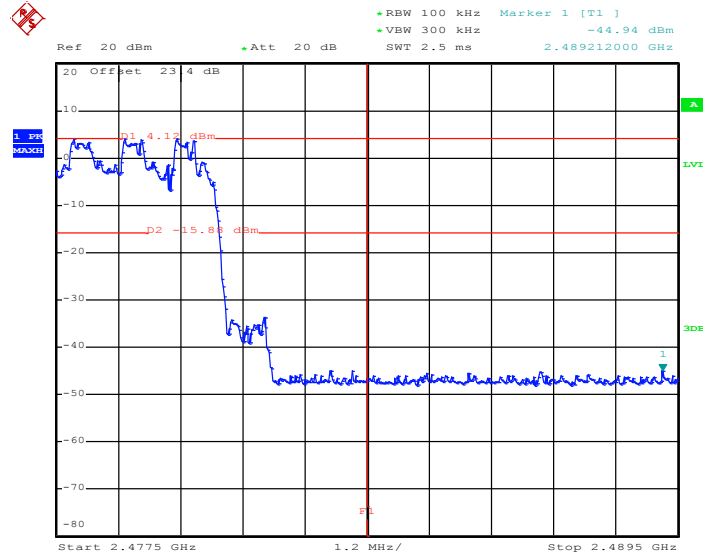

Date: 20.NOV.2016 07:47:21



|                 |             |                     |         |
|-----------------|-------------|---------------------|---------|
| Test Mode :     | 3Mbps       | Temperature :       | 24~26°C |
| Test Engineer : | Aking chang | Relative Humidity : | 48~51%  |

3Mbps Hopping Mode Low Band Edge Plot

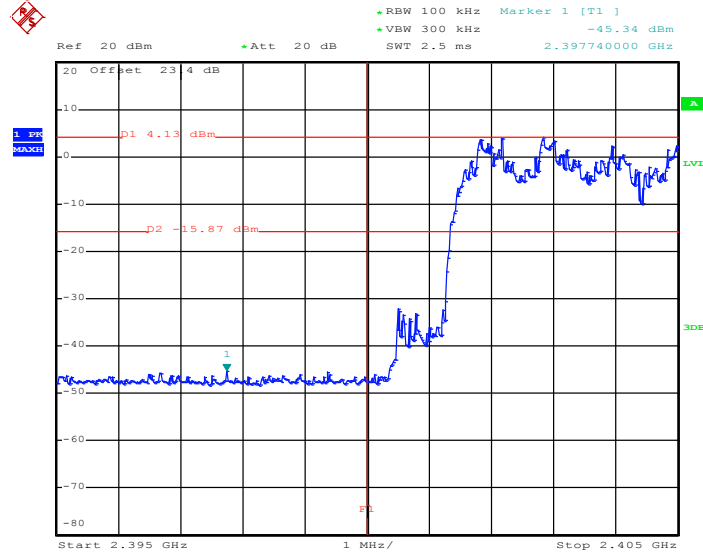

Date: 20.NOV.2016 07:50:38

3Mbps Hopping Mode High Band Edge Plot

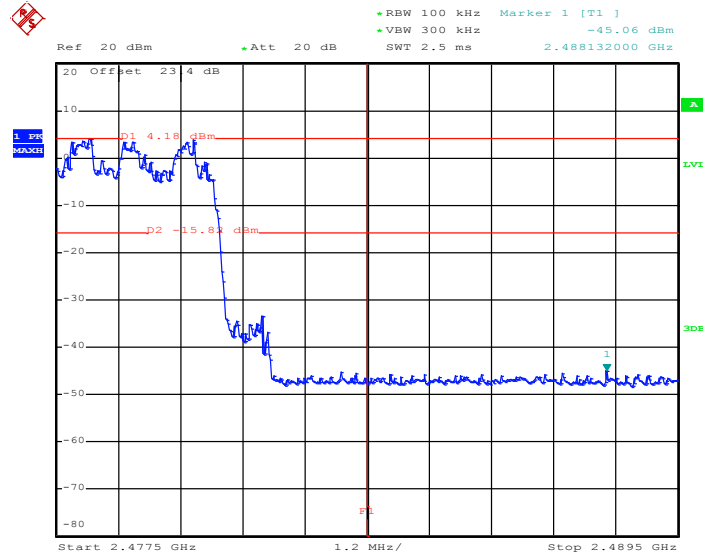

Date: 20.NOV.2016 07:52:59

## 3.7 Conducted Spurious Emission Measurement

### 3.7.1 Limit of Spurious Emission Measurement

In any 100 kHz bandwidth outside the intentional radiation frequency band, the radio frequency power shall be at least 20 dB below the highest level of the radiated power. In addition, radiated emissions which fall in the restricted bands must also comply with the radiated emission limits.

### 3.7.2 Measuring Instruments

The measuring equipment is listed in the section 4 of this test report.

### 3.7.3 Test Procedure

1. The testing follows ANSI C63.10-2013 clause 7.8.8.
2. The RF output of EUT was connected to the spectrum analyzer by RF cable and attenuator. The path loss was compensated to the results for each measurement.
3. Set to the maximum power setting and enable the EUT transmit continuously.
4. Set RBW = 100 kHz, VBW = 300kHz, scan up through 10th harmonic. All harmonics / spurs must be at least 20 dB down from the highest emission level within the authorized band as measured with a 100 kHz RBW.
5. Measure and record the results in the test report.
6. The RF fundamental frequency should be excluded against the limit line in the operating frequency band.

### 3.7.4 Test Setup

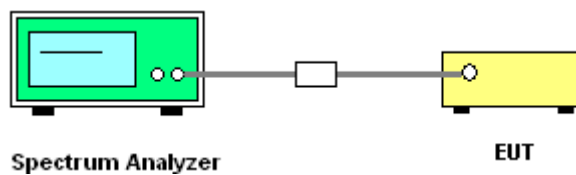



### 3.7.5 Test Result of Conducted Spurious Emission

|                |       |                     |             |
|----------------|-------|---------------------|-------------|
| Test Mode :    | 1Mbps | Temperature :       | 24~26°C     |
| Test Channel : | 00    | Relative Humidity : | 48~51%      |
|                |       | Test Engineer :     | Aking chang |

1Mbps CSE Plot on Ch 00 between 30MHz ~ 3 GHz

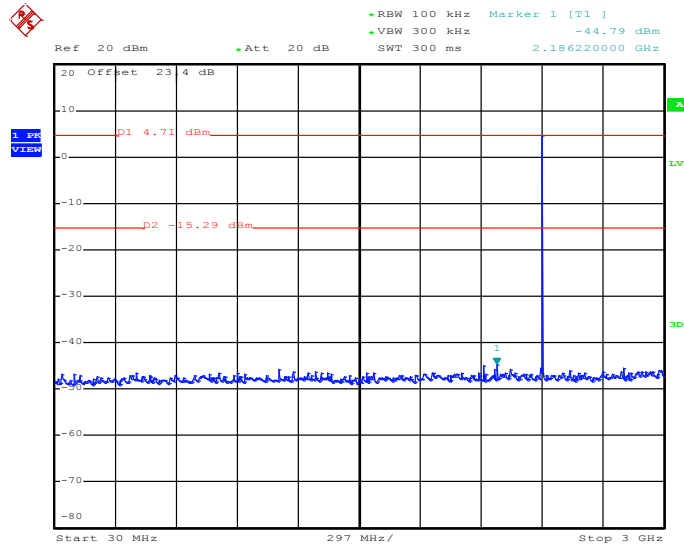

Date: 20.NOV.2016 07:57:56

1Mbps CSE Plot on Ch 00 between 2 GHz ~ 25 GHz

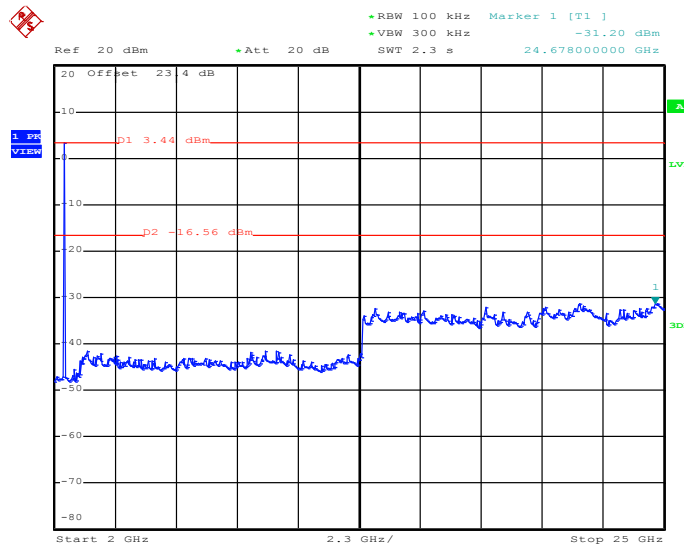

Date: 20.NOV.2016 07:58:18



|                |       |                     |             |
|----------------|-------|---------------------|-------------|
| Test Mode :    | 1Mbps | Temperature :       | 24~26°C     |
| Test Channel : | 39    | Relative Humidity : | 48~51%      |
|                |       | Test Engineer :     | Aking chang |

1Mbps CSE Plot on Ch 39 between 30MHz ~ 3 GHz

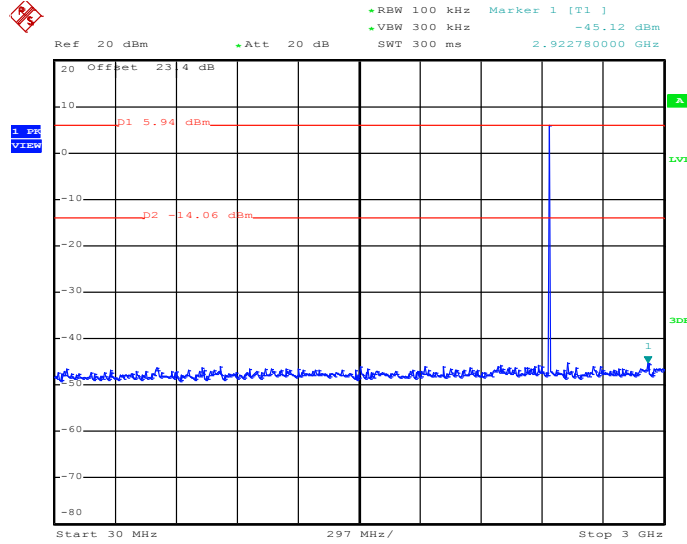

Date: 20.NOV.2016 08:02:34

1Mbps CSE Plot on Ch 39 between 2 GHz ~ 25 GHz

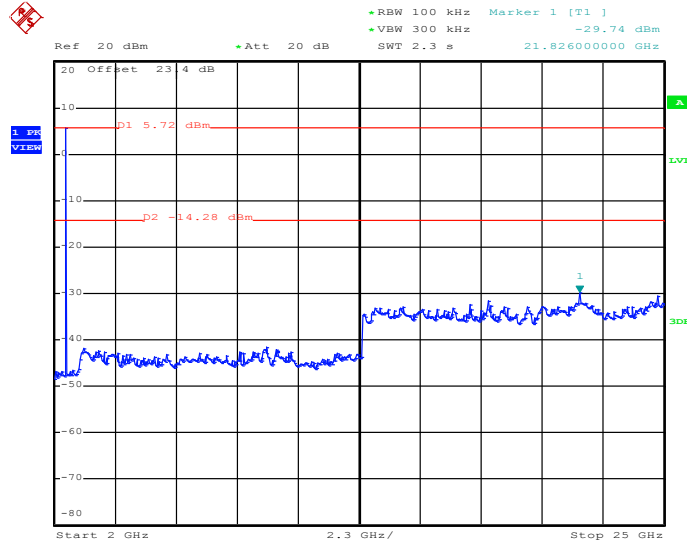

Date: 20.NOV.2016 08:02:55



|                |       |                     |             |
|----------------|-------|---------------------|-------------|
| Test Mode :    | 1Mbps | Temperature :       | 24~26°C     |
| Test Channel : | 78    | Relative Humidity : | 48~51%      |
|                |       | Test Engineer :     | Aking chang |

1Mbps CSE Plot on Ch 78 between 30MHz ~ 3 GHz

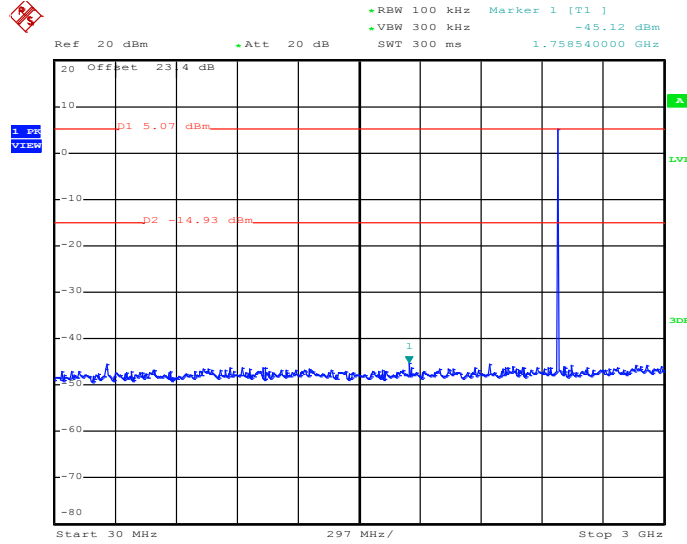

Date: 20.NOV.2016 08:10:12

1Mbps CSE Plot on Ch 78 between 2 GHz ~ 25 GHz

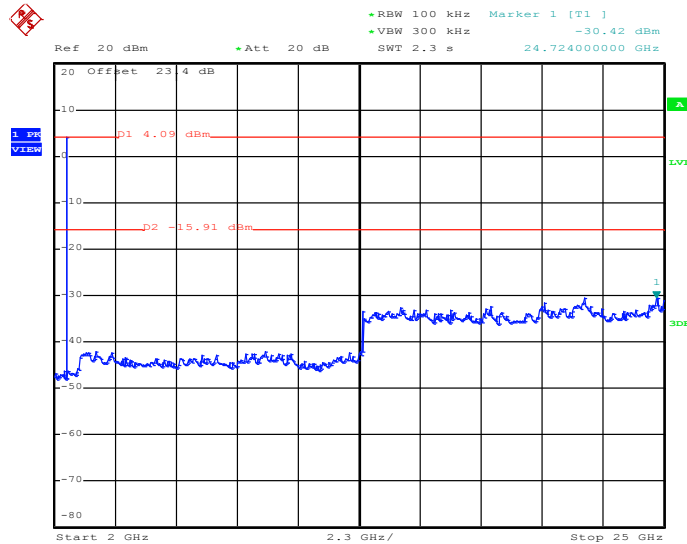

Date: 20.NOV.2016 08:10:34





|                |       |                     |             |
|----------------|-------|---------------------|-------------|
| Test Mode :    | 2Mbps | Temperature :       | 24~26°C     |
| Test Channel : | 00    | Relative Humidity : | 48~51%      |
|                |       | Test Engineer :     | Aking chang |

2Mbps CSE Plot on Ch 00 between 30MHz ~ 3 GHz

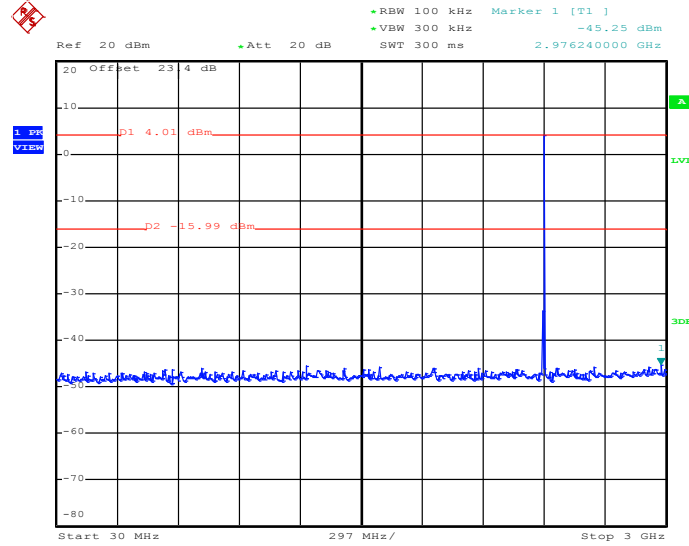

Date: 20.NOV.2016 08:13:05

2Mbps CSE Plot on Ch 00 between 2 GHz ~ 25 GHz

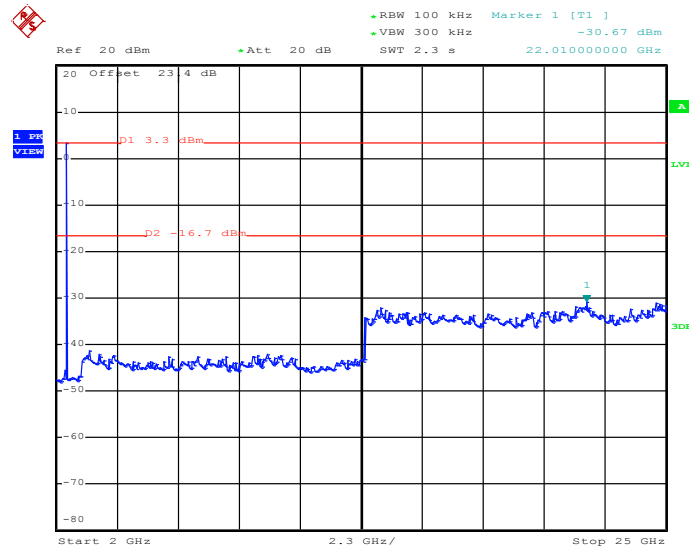

Date: 20.NOV.2016 08:13:26



|                |       |                     |             |
|----------------|-------|---------------------|-------------|
| Test Mode :    | 2Mbps | Temperature :       | 24~26°C     |
| Test Channel : | 39    | Relative Humidity : | 48~51%      |
|                |       | Test Engineer :     | Aking chang |

2Mbps CSE Plot on Ch 39 between 30MHz ~ 3 GHz

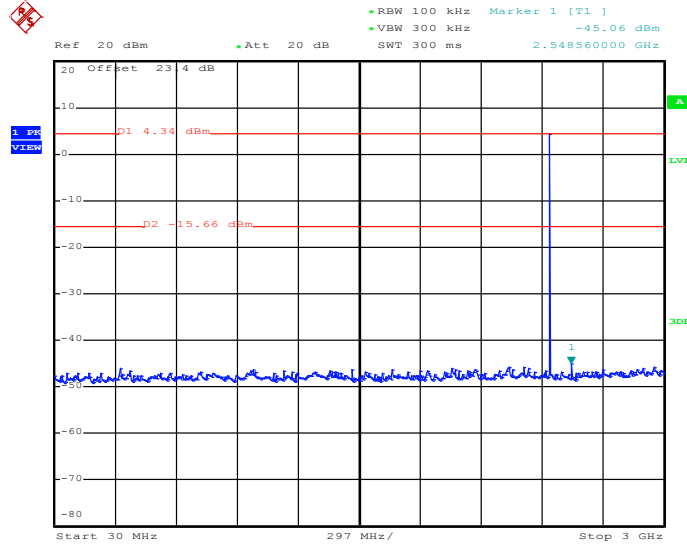

Date: 20.NOV.2016 08:19:29

2Mbps CSE Plot on Ch 39 between 2 GHz ~ 25 GHz

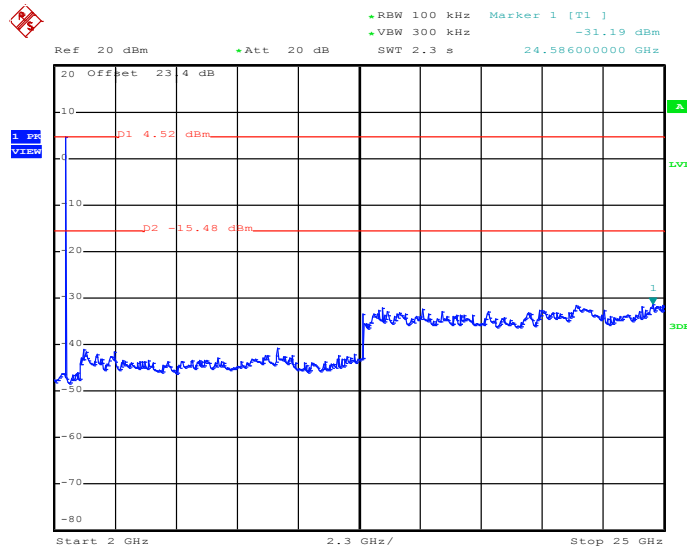

Date: 20.NOV.2016 08:19:51



|                |       |                     |             |
|----------------|-------|---------------------|-------------|
| Test Mode :    | 2Mbps | Temperature :       | 24~26°C     |
| Test Channel : | 78    | Relative Humidity : | 48~51%      |
|                |       | Test Engineer :     | Aking chang |

2Mbps CSE Plot on Ch 78 between 30MHz ~ 3 GHz

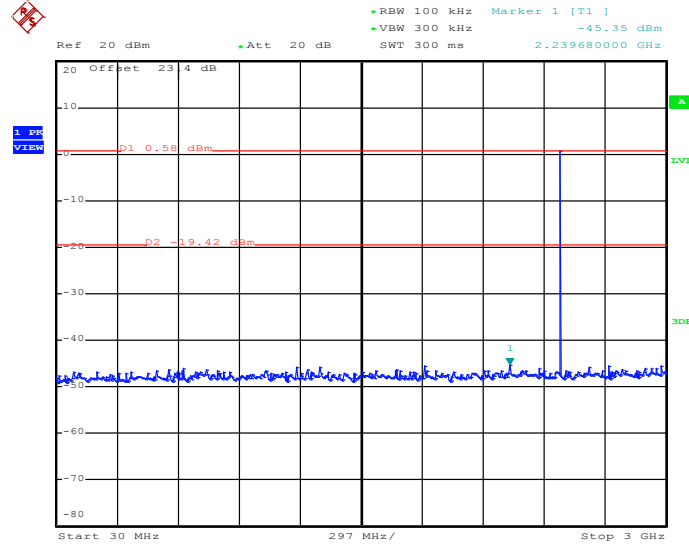

Date: 20.NOV.2016 08:26:07

2Mbps CSE Plot on Ch 78 between 2 GHz ~ 25 GHz

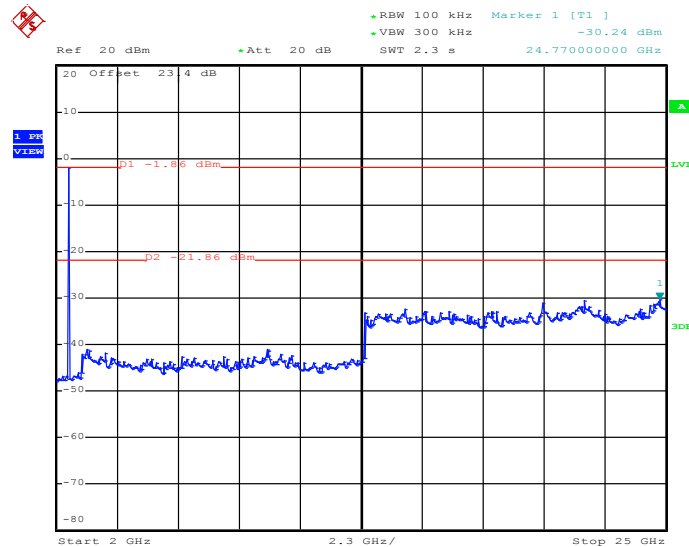

Date: 20.NOV.2016 08:26:29



|                |       |                     |             |
|----------------|-------|---------------------|-------------|
| Test Mode :    | 3Mbps | Temperature :       | 24~26°C     |
| Test Channel : | 00    | Relative Humidity : | 48~51%      |
|                |       | Test Engineer :     | Aking chang |

3Mbps CSE Plot on Ch 00 between 30MHz ~ 3 GHz

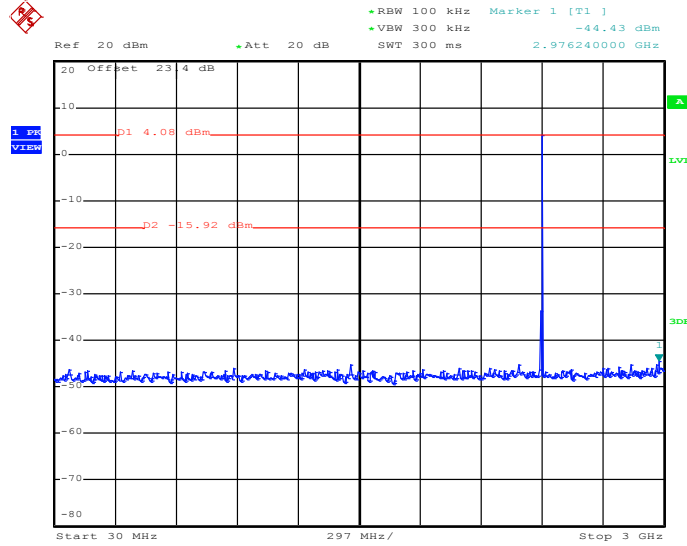

Date: 20.NOV.2016 08:30:23

3Mbps CSE Plot on Ch 00 between 2 GHz ~ 25 GHz

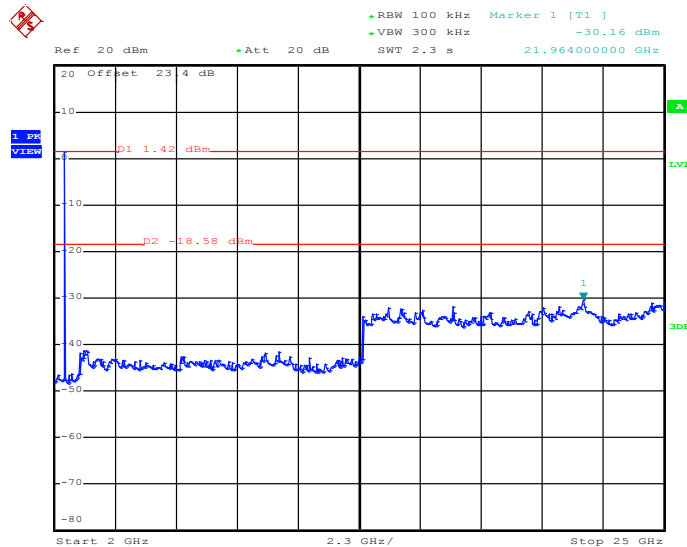

Date: 20.NOV.2016 08:30:45



|                |       |                     |             |
|----------------|-------|---------------------|-------------|
| Test Mode :    | 3Mbps | Temperature :       | 24~26°C     |
| Test Channel : | 39    | Relative Humidity : | 48~51%      |
|                |       | Test Engineer :     | Aking chang |

3Mbps CSE Plot on Ch 39 between 30MHz ~ 3 GHz

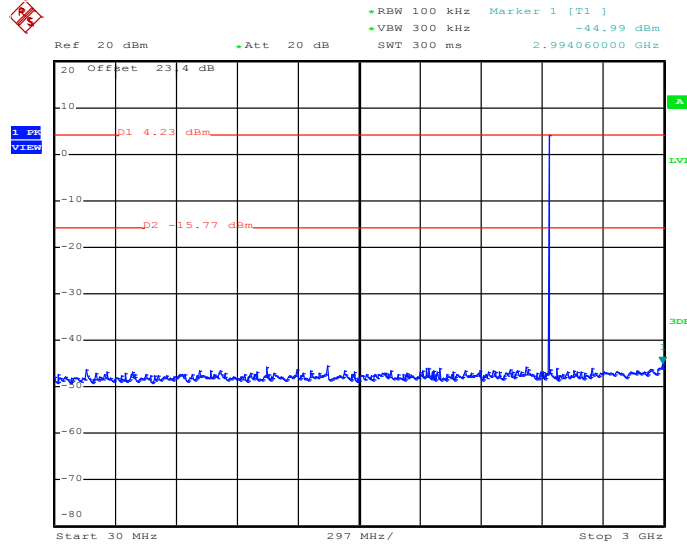

Date: 20.NOV.2016 08:37:15

3Mbps CSE Plot on Ch 39 between 2 GHz ~ 25 GHz

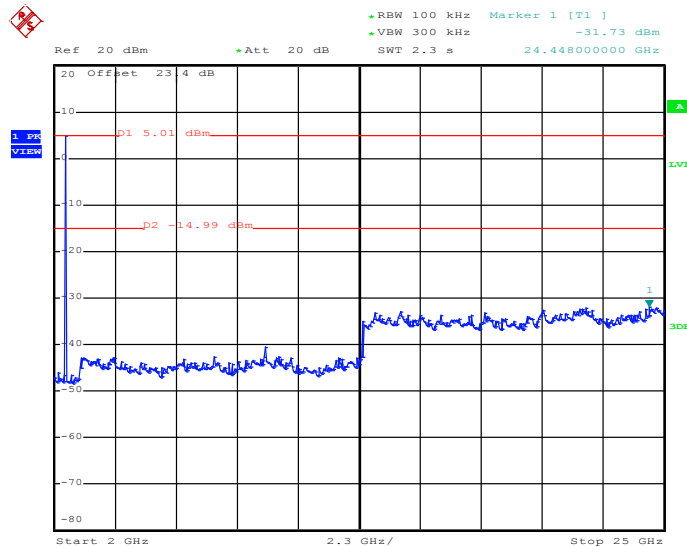

Date: 20.NOV.2016 08:40:44



|                |       |                     |             |
|----------------|-------|---------------------|-------------|
| Test Mode :    | 3Mbps | Temperature :       | 24~26°C     |
| Test Channel : | 78    | Relative Humidity : | 48~51%      |
|                |       | Test Engineer :     | Aking chang |

3Mbps CSE Plot on Ch 78 between 30MHz ~ 3 GHz

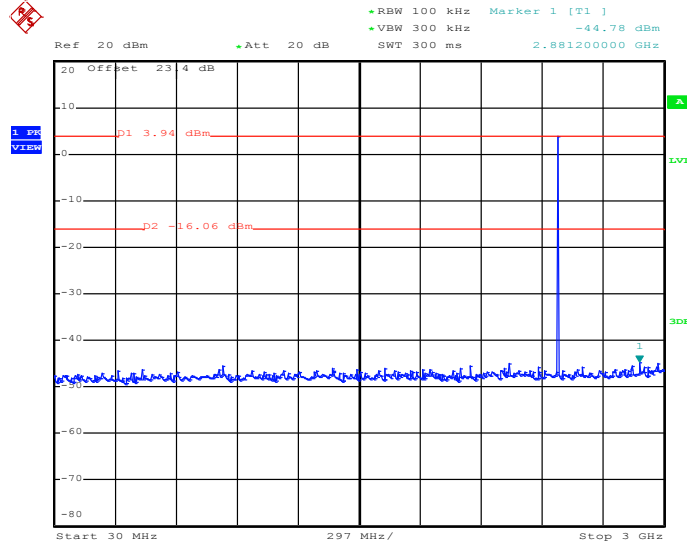

Date: 20.NOV.2016 08:48:06

3Mbps CSE Plot on Ch 78 between 2 GHz ~ 25 GHz

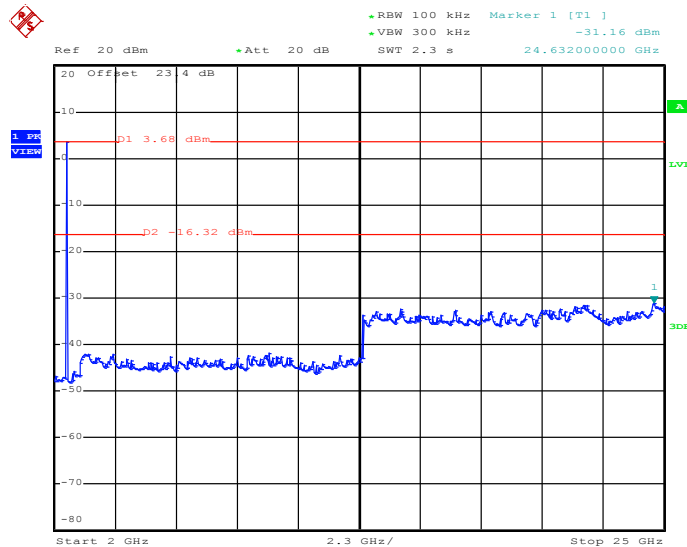

Date: 20.NOV.2016 08:48:28



### 3.8 Radiated Band Edges and Spurious Emission Measurement

#### 3.8.1 Limit of Radiated Band Edges and Spurious Emission

In any 100 kHz bandwidth outside the intentional radiator frequency band, all harmonics/spurious must be at least 20 dB below the highest emission level within the authorized band. In addition, radiated emissions which fall in the restricted bands must also comply with the FCC section 15.209 limits as below.

| Frequency (MHz) | Field Strength (microvolts/meter) | Measurement Distance (meters) |
|-----------------|-----------------------------------|-------------------------------|
| 0.009 – 0.490   | 2400/F(kHz)                       | 300                           |
| 0.490 – 1.705   | 24000/F(kHz)                      | 30                            |
| 1.705 – 30.0    | 30                                | 30                            |
| 30 – 88         | 100                               | 3                             |
| 88 – 216        | 150                               | 3                             |
| 216 - 960       | 200                               | 3                             |
| Above 960       | 500                               | 3                             |

#### 3.8.2 Measuring Instruments

The measuring equipment is listed in the section 4 of this test report.



### 3.8.3 Test Procedures

1. The EUT was placed on a turntable with 0.8 meter for frequency below 1GHz and 1.5 meter for frequency above 1GHz respectively above ground.
2. The EUT was set 3 meters from the interference receiving antenna, which was mounted on the top of a variable height antenna tower.
3. For each suspected emission, the EUT was arranged to its worst case and then tune the Antenna tower (from 1 m to 4 m) and turntable (from 0 degree to 360 degrees) to find the maximum reading. A pre-amp and a high pass filter are used for the test in order to get better signal level to comply with the guidelines.
4. Set to the maximum power setting and enable the EUT transmit continuously.
5. Use the following spectrum analyzer settings:
  - (1) Span shall wide enough to fully capture the emission being measured;
  - (2) Set RBW=100 kHz for  $f < 1 \text{ GHz}$ , RBW=1MHz for  $f > 1\text{GHz}$  ; VBW  $\geq$  RBW; Sweep = auto; Detector function = peak; Trace = max hold for peak
  - (3) For average measurement: use duty cycle correction factor method per 15.35(c).  
Duty cycle = On time/100 milliseconds  
On time =  $N_1 * L_1 + N_2 * L_2 + \dots + N_{n-1} * L_{n-1} + N_n * L_n$   
Where  $N_1$  is number of type 1 pulses,  $L_1$  is length of type 1 pulses, etc.  
Average Emission Level = Peak Emission Level +  $20 * \log(\text{Duty cycle})$
6. Corrected Reading: Antenna Factor + Cable Loss + Read Level - Preamp Factor = Level

Note: The average levels were calculated from the peak level corrected with duty cycle correction factor (-24.82dB) derived from  $20 \log(\text{dwell time}/100\text{ms})$ . This correction is only for signals that hop with the fundamental signal, such as band-edge and harmonic. Other spurious signals that are independent of the hopping signal would not use this correction.



### 3.8.4 Test Setup

For radiated emissions below 30MHz

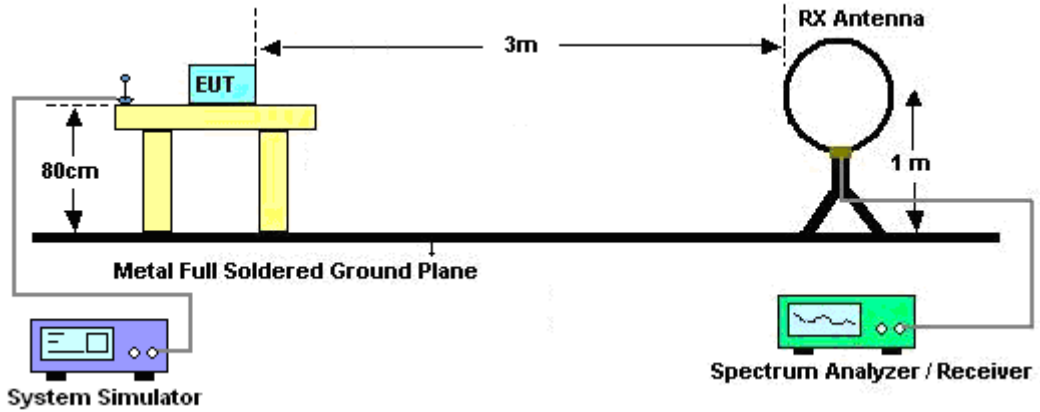

For radiated emissions from 30MHz to 1GHz

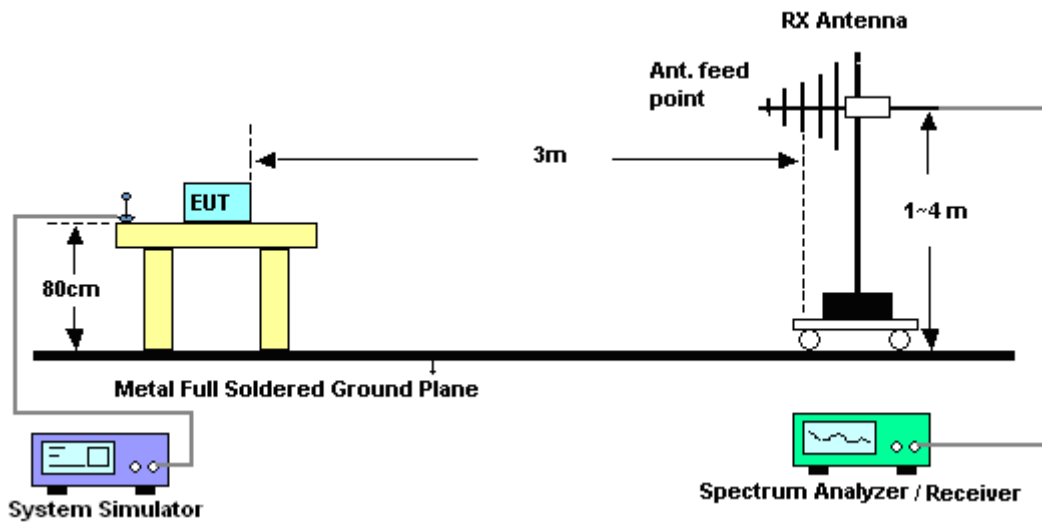

For radiated emissions above 1GHz

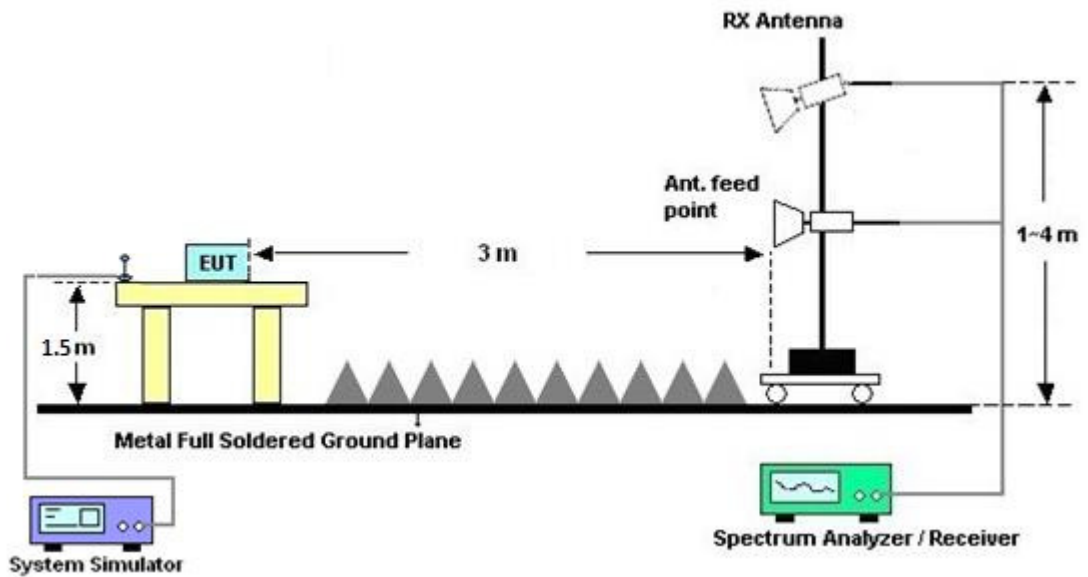

### 3.8.5 Test Results of Radiated Spurious Emissions (9 kHz ~ 30 MHz)

The low frequency, which started from 9 kHz to 30MHz, was pre-scanned and the result which was 20dB lower than the limit line per 15.31(o) was not reported.



### 3.8.6 Duty cycle correction factor for average measurement

DH5 on time (One Pulse) Plot on Channel 39

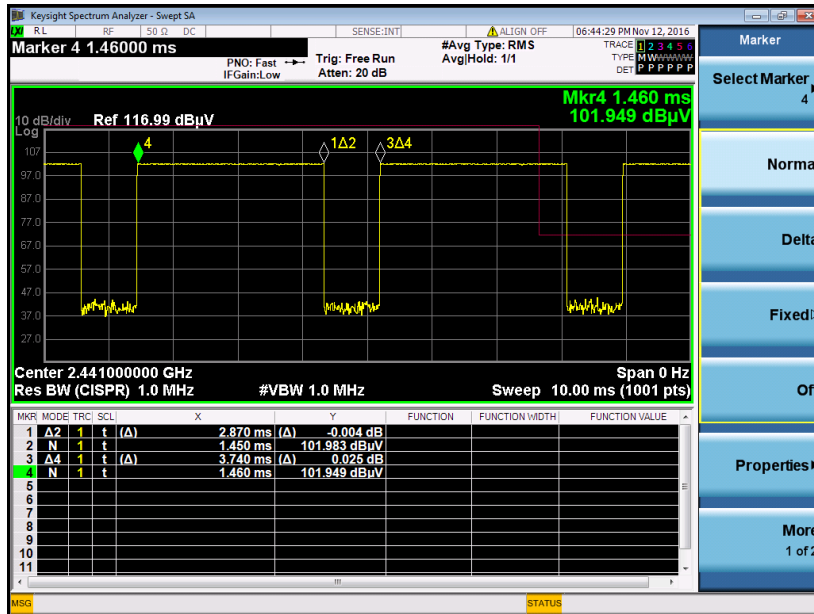

DH5 on time (Count Pulses) Plot on Channel 39

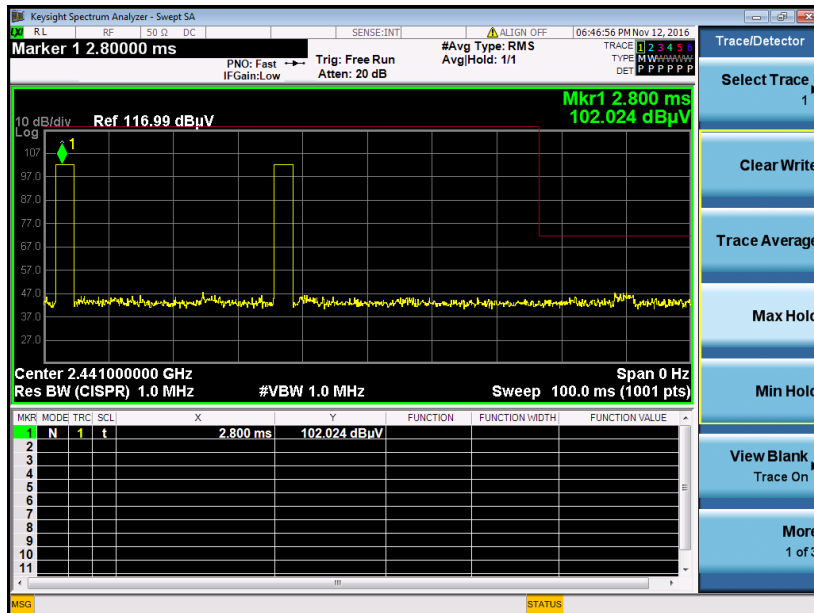

**Note:**

1. Worst case Duty cycle = on time/100 milliseconds =  $2 * 2.87 / 100 = 5.74 \%$
2. Worst case Duty cycle correction factor =  $20 * \log(\text{Duty cycle}) = -24.82 \text{ dB}$
3. DH5 has the highest duty cycle worst case and is reported.



**Duty Cycle Correction Factor Consideration for AFH mode:**

Bluetooth normal hopping rate is 1600Hz and reduced to 800Hz in AFH mode; due to the reduced number of hopping frequencies, with the same packet configuration the dwell time in each channel frequency within 100msec period is longer in AFH mode than normal mode.

In AFH mode, the minimum hopping frequencies are 20, to get the longest dwell time DH5 packet is observed; the period to have DH5 packet completing one hopping sequence is

$$2.87 \text{ ms} \times 20 \text{ channels} = 57.4 \text{ ms}$$

There cannot be 2 complete hopping sequences within 100ms period, considering the random hopping behavior, maximum 2 hops can be possibly observed within the period.  $[100\text{ms} / 57.6\text{ms}] = 2 \text{ hops}$

Thus, the maximum possible ON time:

$$2.87 \text{ ms} \times 2 = 5.74 \text{ ms}$$

Worst case Duty Cycle Correction factor, which is derived from the maximum possible ON time,

$$20 \times \log(5.74 \text{ ms}/100\text{ms}) = -24.82 \text{ dB}$$

**3.8.7 Test Result of Radiated Spurious at Band Edges**

Please refer to Appendix A and B.

**3.8.8 Test Result of Radiated Spurious Emission (30MHz ~ 10<sup>th</sup> Harmonic)**

Please refer to Appendix A and B.



### 3.9 AC Conducted Emission Measurement

#### 3.9.1 Limit of AC Conducted Emission

For equipment that is designed to be connected to the public utility (AC) power line, the radio frequency voltage that is conducted back onto the AC power line on any frequency or frequencies within the band 150 kHz to 30 MHz shall not exceed the limits in the following table.

| Frequency of emission (MHz) | Conducted limit (dBµV) |           |
|-----------------------------|------------------------|-----------|
|                             | Quasi-peak             | Average   |
| 0.15-0.5                    | 66 to 56*              | 56 to 46* |
| 0.5-5                       | 56                     | 46        |
| 5-30                        | 60                     | 50        |

\*Decreases with the logarithm of the frequency.

#### 3.9.2 Measuring Instruments

The measuring equipment is listed in the section 4 of this test report.

#### 3.9.3 Test Procedures

1. The EUT was placed 0.4 meter from the conducting wall of the shielding room was kept at least 80 centimeters from any other grounded conducting surface.
2. Connect EUT to the power mains through a line impedance stabilization network (LISN).
3. All the support units are connecting to the other LISN.
4. The LISN provides 50 ohm coupling impedance for the measuring instrument.
5. The FCC states that a 50 ohm, 50 microhenry LISN should be used.
6. Both sides of AC line were checked for maximum conducted interference.
7. The frequency range from 150 kHz to 30 MHz was searched.
8. Set the test-receiver system to Peak Detect Function and specified bandwidth (IF Bandwidth = 9kHz) with Maximum Hold Mode. Then measurement is also conducted by Average Detector and Quasi-Peak Detector Function respectively.

### 3.9.4 Test Setup

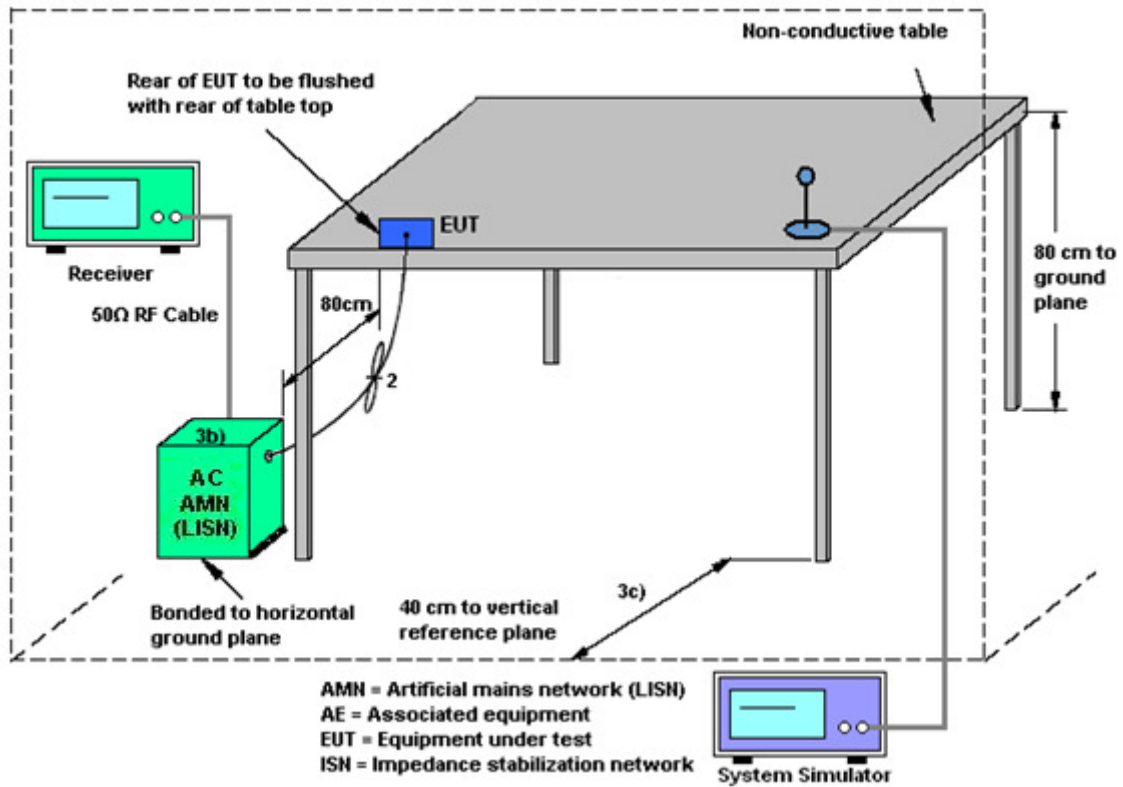



### 3.9.5 Test Result of AC Conducted Emission

|                 |   |                     |         |
|-----------------|---|---------------------|---------|
| Test Mode :     | Mode 1  | Temperature :       | 21~23°C |
| Test Engineer : | Arthur Hsieh  | Relative Humidity : | 51~53%  |
| Test Voltage :  | 120Vac / 60Hz   | Phase :             | Line    |
| Function Type : | WCDMA Band II Idle + Bluetooth Link + WLAN Link + Camera (Front) + Earphone + Battery + USB Cable (Charging from Adapter) |                     |         |

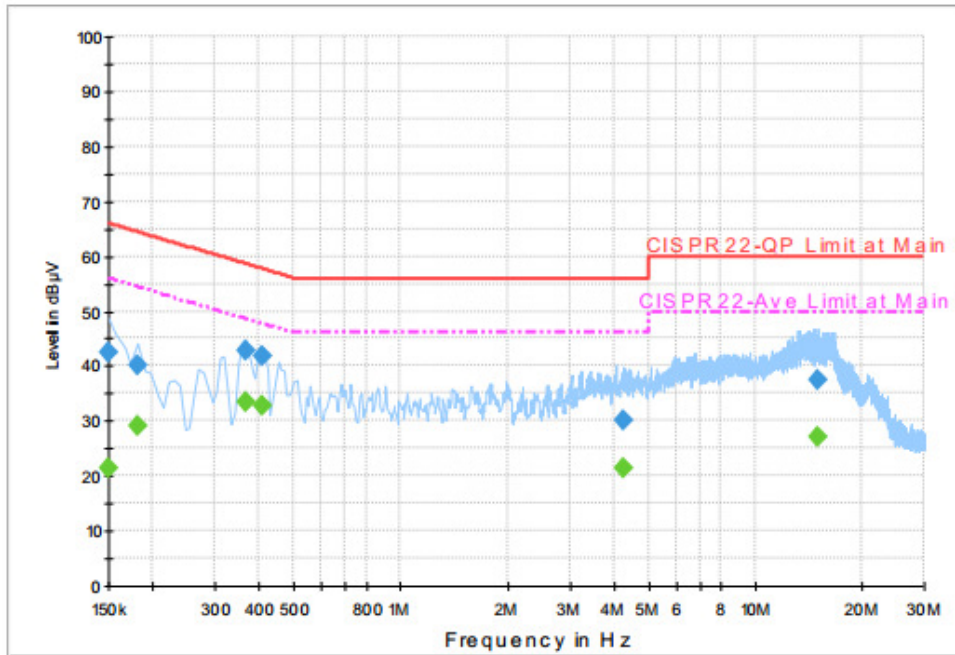

**Final Result : Quasi-Peak**

| Frequency (MHz) | Quasi-Peak (dBµV) | Filter | Line | Corr. (dB) | Margin (dB) | Limit (dBµV) |
|-----------------|-------------------|--------|------|------------|-------------|--------------|
| 0.150000        | 42.5              | Off    | L1   | 19.6       | 23.5        | 66.0         |
| 0.182000        | 40.0              | Off    | L1   | 19.6       | 24.4        | 64.4         |
| 0.366000        | 42.8              | Off    | L1   | 19.6       | 15.8        | 58.6         |
| 0.406000        | 41.9              | Off    | L1   | 19.6       | 15.8        | 57.7         |
| 4.246000        | 30.1              | Off    | L1   | 19.8       | 25.9        | 56.0         |
| 15.126000       | 37.6              | Off    | L1   | 20.4       | 22.4        | 60.0         |

**Final Result : Average**

| Frequency (MHz) | Average (dBµV) | Filter | Line | Corr. (dB) | Margin (dB) | Limit (dBµV) |
|-----------------|----------------|--------|------|------------|-------------|--------------|
| 0.150000        | 21.2           | Off    | L1   | 19.6       | 34.8        | 56.0         |
| 0.182000        | 29.2           | Off    | L1   | 19.6       | 25.2        | 54.4         |
| 0.366000        | 33.5           | Off    | L1   | 19.6       | 15.1        | 48.6         |
| 0.406000        | 32.9           | Off    | L1   | 19.6       | 14.8        | 47.7         |
| 4.246000        | 21.5           | Off    | L1   | 19.8       | 24.5        | 46.0         |
| 15.126000       | 27.0           | Off    | L1   | 20.4       | 23.0        | 50.0         |



|                 |   |                     |         |
|-----------------|---|---------------------|---------|
| Test Mode :     | Mode 1  | Temperature :       | 21~23°C |
| Test Engineer : | Arthur Hsieh  | Relative Humidity : | 51~53%  |
| Test Voltage :  | 120Vac / 60Hz   | Phase :             | Neutral |
| Function Type : | WCDMA Band II Idle + Bluetooth Link + WLAN Link + Camera (Front) + Earphone + Battery + USB Cable (Charging from Adapter) |                     |         |

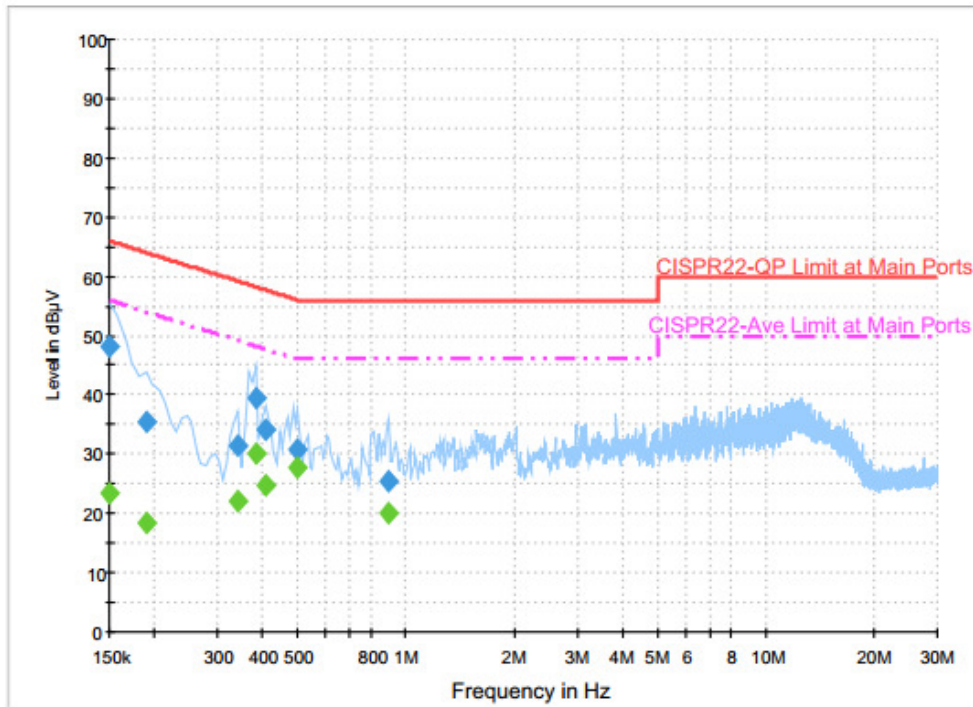

**Final Result : Quasi-Peak**

| Frequency (MHz) | Quasi-Peak (dBµV) | Filter | Line | Corr. (dB) | Margin (dB) | Limit (dBµV) |
|-----------------|-------------------|--------|------|------------|-------------|--------------|
| 0.150000        | 48.2              | Off    | N    | 19.6       | 17.8        | 66.0         |
| 0.190000        | 35.4              | Off    | N    | 19.6       | 28.6        | 64.0         |
| 0.342000        | 31.3              | Off    | N    | 19.6       | 27.9        | 59.2         |
| 0.382000        | 39.4              | Off    | N    | 19.6       | 18.8        | 58.2         |
| 0.406000        | 34.0              | Off    | N    | 19.6       | 23.7        | 57.7         |
| 0.502000        | 30.8              | Off    | N    | 19.6       | 25.2        | 56.0         |
| 0.894000        | 25.4              | Off    | N    | 19.6       | 30.6        | 56.0         |

**Final Result : Average**

| Frequency (MHz) | Average (dBµV) | Filter | Line | Corr. (dB) | Margin (dB) | Limit (dBµV) |
|-----------------|----------------|--------|------|------------|-------------|--------------|
| 0.150000        | 23.4           | Off    | N    | 19.6       | 32.6        | 56.0         |
| 0.190000        | 18.5           | Off    | N    | 19.6       | 35.5        | 54.0         |
| 0.342000        | 21.9           | Off    | N    | 19.6       | 27.3        | 49.2         |
| 0.382000        | 30.2           | Off    | N    | 19.6       | 18.0        | 48.2         |
| 0.406000        | 24.9           | Off    | N    | 19.6       | 22.8        | 47.7         |
| 0.502000        | 27.6           | Off    | N    | 19.6       | 18.4        | 46.0         |
| 0.894000        | 20.1           | Off    | N    | 19.6       | 25.9        | 46.0         |





## **3.10 Antenna Requirements**

### **3.10.1 Standard Applicable**

If directional gain of transmitting antennas is greater than 6dBi, the power shall be reduced by the same level in dB comparing to gain minus 6dBi. The use of a permanently attached antenna or of an antenna that uses a unique coupling to the intentional radiator shall be considered sufficient to comply with the FCC rule.

### **3.10.2 Antenna Anti-Replacement Construction**

An embedded-in antenna design is used.

### **3.10.3 Antenna Gain**

The antenna peak gain of EUT is less than 6 dBi. Therefore, it is not necessary to reduce maximum peak output power limit.



## 4 List of Measuring Equipment

| Instrument           | Manufacturer    | Model No.               | Serial No.         | Characteristics | Calibration Date | Test Date                        | Due Date      | Remark                   |
|----------------------|-----------------|-------------------------|--------------------|-----------------|------------------|----------------------------------|---------------|--------------------------|
| Power Meter          | Agilent         | E4416A                  | GB412923<br>44     | 300MHz~40GHz    | Jan. 08, 2016    | Nov. 04, 2016 ~<br>Nov. 20, 2016 | Jan. 07, 2017 | Conducted<br>(TH05-HY)   |
| Power Sensor         | Agilent         | E9327A                  | US404415<br>48     | 300MHz~40GHz    | Jan. 07, 2016    | Nov. 04, 2016 ~<br>Nov. 20, 2016 | Jan. 06, 2017 | Conducted<br>(TH05-HY)   |
| Spectrum Analyzer    | Rohde & Schwarz | FSP40                   | 100055             | 9kHz-40GHz      | Jul. 17, 2016    | Nov. 04, 2016 ~<br>Nov. 20, 2016 | Jul. 16, 2017 | Conducted<br>(TH05-HY)   |
| AC Power Source      | ChainTek        | APC-1000W               | N/A                | N/A             | N/A              | Oct. 22, 2016                    | N/A           | Conduction<br>(CO05-HY)  |
| EMI Test Receiver    | Rohde & Schwarz | ESCI 7                  | 100724             | 9kHz~7GHz       | Aug. 30, 2016    | Oct. 22, 2016                    | Aug. 29, 2017 | Conduction<br>(CO05-HY)  |
| LISN                 | Rohde & Schwarz | ENV216                  | 100080             | 9kHz~30MHz      | Dec. 02, 2015    | Oct. 22, 2016                    | Dec. 01, 2016 | Conduction<br>(CO05-HY)  |
| Amplifier            | SONOMA          | 310N                    | 187312             | 9kHz~1GHz       | Nov. 20, 2015    | Nov. 12, 2016 ~<br>Nov. 15, 2016 | Nov. 19, 2016 | Radiation<br>(03CH11-HY) |
| Bilog Antenna        | TESEQ           | CBL<br>6111D&N-6-0<br>6 | 35414&AT-<br>N0602 | 30MHz~1GHz      | Oct. 15, 2016    | Nov. 12, 2016 ~<br>Nov. 15, 2016 | Oct. 14, 2017 | Radiation<br>(03CH11-HY) |
| Horn Antenna         | SCHWARZBE<br>CK | BBHA 9120 D             | 9120D-132<br>6     | 1GHz ~ 18GHz    | Oct. 07, 2016    | Nov. 12, 2016 ~<br>Nov. 15, 2016 | Oct. 06, 2017 | Radiation<br>(03CH11-HY) |
| Preamplifier         | Keysight        | 83017A                  | MY532700<br>80     | 1GHz~26.5GHz    | Nov. 19, 2015    | Nov. 12, 2016 ~<br>Nov. 15, 2016 | Nov. 18, 2016 | Radiation<br>(03CH11-HY) |
| Spectrum Analyzer    | Keysight        | N9010A                  | MY542004<br>86     | 10Hz ~ 44GHz    | Oct. 12, 2016    | Nov. 12, 2016 ~<br>Nov. 15, 2016 | Oct. 11, 2017 | Radiation<br>(03CH11-HY) |
| Antenna Mast         | EMEC            | AM-BS-4500-<br>B        | N/A                | 1~4m            | N/A              | Nov. 12, 2016 ~<br>Nov. 15, 2016 | N/A           | Radiation<br>(03CH11-HY) |
| Turn Table           | EMEC            | TT 2000                 | N/A                | 0~360 Degree    | N/A              | Nov. 12, 2016 ~<br>Nov. 15, 2016 | N/A           | Radiation<br>(03CH11-HY) |
| SHF-EHF Horn Antenna | SCHWARZBE<br>CK | BBHA 9170               | BBHA9170<br>576    | 18GHz- 40GHz    | Apr. 15, 2016    | Nov. 12, 2016 ~<br>Nov. 15, 2016 | Apr. 14, 2017 | Radiation<br>(03CH11-HY) |
| Preamplifier         | MITEQ           | TTA0204                 | 1872107            | 2GHz~40GHz      | Feb. 15, 2016    | Nov. 12, 2016 ~<br>Nov. 15, 2016 | Feb. 14, 2017 | Radiation<br>(03CH11-HY) |
| Loop Antenna         | Rohde & Schwarz | HFH2-Z2                 | 100488             | 9 kHz~30 MHz    | Oct. 20, 2016    | Nov. 12, 2016 ~<br>Nov. 15, 2016 | Oct. 19, 2018 | Radiation<br>(03CH11-HY) |



## 5 Uncertainty of Evaluation

### Uncertainty of Conducted Emission Measurement (150kHz ~ 30MHz)

|   |     |
|---|-----|
| Measuring Uncertainty for a Level of Confidence of 95% ( $U = 2Uc(y)$ ) | 2.7 |
|---|-----|

### Uncertainty of Radiated Emission Measurement (30 MHz ~ 1000 MHz)

|   |     |
|---|-----|
| Measuring Uncertainty for a Level of Confidence of 95% ( $U = 2Uc(y)$ ) | 5.2 |
|---|-----|

### Uncertainty of Radiated Emission Measurement (1000 MHz ~ 18000 MHz)

|   |     |
|---|-----|
| Measuring Uncertainty for a Level of Confidence of 95% ( $U = 2Uc(y)$ ) | 5.5 |
|---|-----|

### Uncertainty of Radiated Emission Measurement (18000 MHz ~ 40000 MHz)

|   |     |
|---|-----|
| Measuring Uncertainty for a Level of Confidence of 95% ( $U = 2Uc(y)$ ) | 5.2 |
|---|-----|



## Appendix A. Radiated Spurious Emission

|                 |                           |                     |         |
|-----------------|---------------------------|---------------------|---------|
| Test Engineer : | J.C. Liang and Jacky Hung | Temperature :       | 20~24°C |
|                 |                           | Relative Humidity : | 50~58%  |

2.4GHz 2400~2483.5MHz

BT (Band Edge @ 3m)

| BT                     | Note | Frequency<br>( MHz ) | Level<br>( dBμV/m ) | Over<br>Limit<br>( dB ) | Limit<br>Line<br>( dBμV/m ) | Read<br>Level<br>( dBμV ) | Antenna<br>Factor<br>( dB/m ) | Cable<br>Loss<br>( dB ) | Preamp<br>Factor<br>( dB ) | Ant<br>Pos<br>( cm ) | Table<br>Pos<br>( deg ) | Peak<br>Avg.<br>( P/A ) | Pol.<br>( H/V ) |   |
|------------------------|------|----------------------|---------------------|-------------------------|-----------------------------|---------------------------|-------------------------------|-------------------------|----------------------------|----------------------|-------------------------|-------------------------|-----------------|---|
| BT<br>CH00<br>2402MHz  |      | 2318.51              | 42.89               | -31.11                  | 74                          | 41.16                     | 26.98                         | 8.75                    | 34                         | 283                  | 324                     | P                       | H               |   |
|                        |      | 2318.51              | 18.07               | -35.93                  | 54                          | -                         | -                             | -                       | -                          | -                    | -                       | A                       | H               |   |
|                        | *    | 2402                 | 102.01              | -                       | -                           | 99.91                     | 27.19                         | 8.89                    | 33.98                      | 283                  | 324                     | P                       | H               |   |
|                        | *    | 2402                 | 77.19               | -                       | -                           | -                         | -                             | -                       | -                          | -                    | -                       | A                       | H               |   |
|                        |      |                      |                     |                         |                             |                           |                               |                         |                            |                      |                         |                         | H               |   |
|                        |      |                      |                     |                         |                             |                           |                               |                         |                            |                      |                         |                         |                 | H |
|                        |      |                      | 2389.91             | 43.03                   | -30.97                      | 74                        | 40.93                         | 27.19                   | 8.89                       | 33.98                | 214                     | 225                     | P               | V |
|                        |      |                      | 2389.91             | 18.21                   | -35.79                      | 54                        | -                             | -                       | -                          | -                    | -                       | -                       | A               | V |
|                        | *    |                      | 2402                | 97.59                   | -                           | -                         | 95.49                         | 27.19                   | 8.89                       | 33.98                | 214                     | 225                     | P               | V |
|                        | *    |                      | 2402                | 72.77                   | -                           | -                         | -                             | -                       | -                          | -                    | -                       | -                       | A               | V |
|                        |      |                      |                     |                         |                             |                           |                               |                         |                            |                      |                         |                         |                 | V |
|                        |      |                      |                     |                         |                             |                           |                               |                         |                            |                      |                         |                         |                 | V |
| BT<br>CH 39<br>2441MHz |      | 2367.12              | 43.52               | -30.48                  | 74                          | 41.6                      | 27.09                         | 8.82                    | 33.99                      | 199                  | 325                     | P                       | H               |   |
|                        |      | 2367.12              | 18.7                | -35.3                   | 54                          | -                         | -                             | -                       | -                          | -                    | -                       | A                       | H               |   |
|                        | *    | 2441                 | 104.61              | -                       | -                           | 102.29                    | 27.34                         | 8.94                    | 33.96                      | 199                  | 325                     | P                       | H               |   |
|                        | *    | 2441                 | 79.79               | -                       | -                           | -                         | -                             | -                       | -                          | -                    | -                       | A                       | H               |   |
|                        |      |                      | 2496.43             | 43.38                   | -30.62                      | 74                        | 40.84                         | 27.5                    | 8.98                       | 33.94                | 199                     | 325                     | P               | H |
|                        |      |                      | 2496.43             | 18.56                   | -35.44                      | 54                        | -                             | -                       | -                          | -                    | -                       | -                       | A               | H |
|                        |      |                      | 2361.66             | 43.19                   | -30.81                      | 74                        | 41.27                         | 27.09                   | 8.82                       | 33.99                | 260                     | 175                     | P               | V |
|                        |      |                      | 2361.66             | 18.37                   | -35.63                      | 54                        | -                             | -                       | -                          | -                    | -                       | -                       | A               | V |
|                        | *    |                      | 2441                | 96.42                   | -                           | -                         | 94.1                          | 27.34                   | 8.94                       | 33.96                | 260                     | 175                     | P               | V |
|                        | *    |                      | 2441                | 71.6                    | -                           | -                         | -                             | -                       | -                          | -                    | -                       | -                       | A               | V |
|                        |      |                      | 2493.07             | 43.55                   | -30.45                      | 74                        | 41.01                         | 27.5                    | 8.98                       | 33.94                | 260                     | 175                     | P               | V |
|                        |      |                      | 2493.07             | 18.73                   | -35.27                      | 54                        | -                             | -                       | -                          | -                    | -                       | -                       | A               | V |



| BT                     | Note          | Frequency<br>( MHz )  | Level<br>( dBμV/m ) | Over<br>Limit<br>( dB ) | Limit<br>Line<br>( dBμV/m ) | Read<br>Level<br>( dBμV ) | Antenna<br>Factor<br>( dB/m ) | Cable<br>Loss<br>( dB ) | Preamp<br>Factor<br>( dB ) | Ant<br>Pos<br>( cm ) | Table<br>Pos<br>( deg ) | Peak<br>Avg.<br>( P/A ) | Pol.<br>( H/V ) |   |
|------------------------|---------------|---|---------------------|-------------------------|-----------------------------|---------------------------|-------------------------------|-------------------------|----------------------------|----------------------|-------------------------|-------------------------|-----------------|---|
| BT<br>CH 78<br>2480MHz | *             | 2480  | 102.19              | -                       | -                           | 99.71                     | 27.45                         | 8.98                    | 33.95                      | 214                  | 325                     | P                       | H               |   |
|                        | *             | 2480  | 77.37               | -                       | -                           | -                         | -                             | -                       | -                          | -                    | -                       | A                       | H               |   |
|                        |               | 2484.64   | 44.26               | -29.74                  | 74                          | 41.78                     | 27.45                         | 8.98                    | 33.95                      | 214                  | 325                     | P                       | H               |   |
|                        |               | 2484.64   | 19.44               | -34.56                  | 54                          | -                         | -                             | -                       | -                          | -                    | -                       | A                       | H               |   |
|                        |               |   |                     |                         |                             |                           |                               |                         |                            |                      |                         |                         | H               |   |
|                        |               |   |                     |                         |                             |                           |                               |                         |                            |                      |                         |                         | H               |   |
|                        | *             | 2480  | 98.33               | -                       | -                           | 95.85                     | 27.45                         | 8.98                    | 33.95                      | 353                  | 25                      | P                       | V               |   |
|                        | *             | 2480  | 73.51               | -                       | -                           | -                         | -                             | -                       | -                          | -                    | -                       | -                       | A               | V |
|                        |               | 2483.56   | 43.49               | -30.51                  | 74                          | 41.01                     | 27.45                         | 8.98                    | 33.95                      | 353                  | 25                      | P                       | V               |   |
|                        |               | 2483.56   | 18.67               | -35.33                  | 54                          | -                         | -                             | -                       | -                          | -                    | -                       | A                       | V               |   |
|                        |               |   |                     |                         |                             |                           |                               |                         |                            |                      |                         |                         | V               |   |
|                        |               |   |                     |                         |                             |                           |                               |                         |                            |                      |                         |                         | V               |   |
|                        | <b>Remark</b> | 1. No other spurious found.<br>2. All results are PASS against Peak and Average limit line. |                     |                         |                             |                           |                               |                         |                            |                      |                         |                         |                 |   |



2.4GHz 2400~2483.5MHz

BT (Harmonic @ 3m)

| BT                     | Note  | Frequency<br>( MHz ) | Level<br>( dBμV/m ) | Over<br>Limit<br>( dB ) | Limit<br>Line<br>( dBμV/m ) | Read<br>Level<br>( dBμV ) | Antenna<br>Factor<br>( dB/m ) | Cable<br>Loss<br>( dB ) | Preamp<br>Factor<br>( dB ) | Ant<br>Pos<br>( cm ) | Table<br>Pos<br>( deg ) | Peak<br>Avg.<br>( P/A ) | Pol.<br>( H/V ) |
|------------------------|---|----------------------|---------------------|-------------------------|-----------------------------|---------------------------|-------------------------------|-------------------------|----------------------------|----------------------|-------------------------|-------------------------|-----------------|
| BT<br>CH 00<br>2402MHz |   | 4804                 | 32.83               | -41.17                  | 74                          | 41.61                     | 31.66                         | 10.65                   | 51.09                      | 100                  | 0                       | P                       | H               |
|                        |   | 4804                 | 8.01                | -45.99                  | 54                          | -                         | -                             | -                       | -                          | -                    | -                       | A                       | H               |
|                        |   |                      |                     |                         |                             |                           |                               |                         |                            |                      |                         |                         | H               |
|                        |   |                      |                     |                         |                             |                           |                               |                         |                            |                      |                         |                         | H               |
|                        |   | 4804                 | 32.02               | -41.98                  | 74                          | 40.8                      | 31.66                         | 10.65                   | 51.09                      | 100                  | 0                       | P                       | V               |
|                        |   | 4804                 | 7.2                 | -46.8                   | 54                          | -                         | -                             | -                       | -                          | -                    | -                       | A                       | V               |
|                        |   |                      |                     |                         |                             |                           |                               |                         |                            |                      |                         |                         | V               |
|                        |   |                      |                     |                         |                             |                           |                               |                         |                            |                      |                         |                         | V               |
| BT<br>CH 39<br>2441MHz |   | 4884                 | 33.13               | -40.87                  | 74                          | 41.53                     | 31.78                         | 10.88                   | 51.06                      | 100                  | 0                       | P                       | H               |
|                        |   | 4884                 | 8.31                | -45.69                  | 54                          | -                         | -                             | -                       | -                          | -                    | -                       | A                       | H               |
|                        |   | 7323                 | 38.1                | -35.9                   | 74                          | 38.53                     | 37.29                         | 12.79                   | 50.51                      | 100                  | 0                       | P                       | H               |
|                        |   | 7323                 | 13.28               | -40.72                  | 54                          | -                         | -                             | -                       | -                          | -                    | -                       | A                       | H               |
|                        |   | 4884                 | 32.36               | -41.64                  | 74                          | 40.76                     | 31.78                         | 10.88                   | 51.06                      | 100                  | 0                       | P                       | V               |
|                        |   | 4884                 | 7.54                | -46.46                  | 54                          | -                         | -                             | -                       | -                          | -                    | -                       | A                       | V               |
|                        |   | 7323                 | 38.67               | -35.33                  | 74                          | 39.1                      | 37.29                         | 12.79                   | 50.51                      | 100                  | 0                       | P                       | V               |
|                        |   | 7323                 | 13.85               | -40.15                  | 54                          | -                         | -                             | -                       | -                          | -                    | -                       | A                       | V               |
| BT<br>CH 78<br>2480MHz |   | 4960                 | 33                  | -41                     | 74                          | 40.97                     | 31.94                         | 11.12                   | 51.03                      | 100                  | 0                       | P                       | H               |
|                        |   | 4960                 | 8.18                | -45.82                  | 54                          | -                         | -                             | -                       | -                          | -                    | -                       | A                       | H               |
|                        |   | 7440                 | 37.97               | -36.03                  | 74                          | 38.16                     | 37.44                         | 12.88                   | 50.51                      | 100                  | 0                       | P                       | H               |
|                        |   | 7440                 | 13.15               | -40.85                  | 54                          | -                         | -                             | -                       | -                          | -                    | -                       | A                       | H               |
|                        |   | 4960                 | 33                  | -41                     | 74                          | 40.97                     | 31.94                         | 11.12                   | 51.03                      | 100                  | 0                       | P                       | V               |
|                        |   | 4960                 | 8.18                | -45.82                  | 54                          | -                         | -                             | -                       | -                          | -                    | -                       | A                       | V               |
|                        |   | 7440                 | 38.86               | -35.14                  | 74                          | 39.05                     | 37.44                         | 12.88                   | 50.51                      | 100                  | 0                       | P                       | V               |
|                        |   | 7440                 | 14.04               | -39.96                  | 54                          | -                         | -                             | -                       | -                          | -                    | -                       | A                       | V               |
| Remark                 | 1. No other spurious found.<br>2. All results are PASS against Peak and Average limit line. |                      |                     |                         |                             |                           |                               |                         |                            |                      |                         |                         |                 |



Emission below 1GHz

2.4GHz BT (LF)

| BT                 | Note   | Frequency | Level      | Over   | Limit      | Read     | Antenna  | Cable  | Preamp | Ant    | Table   | Peak    | Pol.    |   |
|--------------------|--|-----------|------------|--------|------------|----------|----------|--------|--------|--------|---------|---------|---------|---|
|                    |  | ( MHz )   | ( dBμV/m ) | ( dB ) | ( dBμV/m ) | ( dBμV ) | ( dB/m ) | ( dB ) | ( dB ) | ( cm ) | ( deg ) | ( P/A ) | ( H/V ) |   |
| 2.4GHz<br>BT<br>LF |  | 30        | 23.62      | -16.38 | 40         | 29.13    | 25.7     | 1.29   | 32.5   | -      | -       | P       | H       |   |
|                    |  | 81.57     | 19.88      | -20.12 | 40         | 37.03    | 13.82    | 1.51   | 32.48  | -      | -       | P       | H       |   |
|                    |  | 98.31     | 21.09      | -22.41 | 43.5       | 36.2     | 15.86    | 1.51   | 32.48  | -      | -       | P       | H       |   |
|                    |  | 578.6     | 26.83      | -19.17 | 46         | 30.48    | 25.32    | 3.47   | 32.44  | -      | -       | P       | H       |   |
|                    |  | 829.2     | 30.9       | -15.1  | 46         | 29.89    | 28.65    | 4.39   | 32.03  | -      | -       | P       | H       |   |
|                    |  | 956.6     | 33.54      | -12.46 | 46         | 29.4     | 30.59    | 4.69   | 31.14  | 172    | 214     | P       | H       |   |
|                    |  |           |            |        |            |          |          |        |        |        |         |         |         | H |
|                    |  |           |            |        |            |          |          |        |        |        |         |         |         | H |
|                    |  |           |            |        |            |          |          |        |        |        |         |         |         | H |
|                    |  |           |            |        |            |          |          |        |        |        |         |         |         | H |
|                    |  |           |            |        |            |          |          |        |        |        |         |         |         | H |
|                    |  |           |            |        |            |          |          |        |        |        |         |         |         | H |
|                    |  |           | 40.8       | 35.98  | -          | -        | 47.44    | 19.74  | 1.29   | 32.49  | 312     | 158     | P       | V |
|                    |  |           | 40.8       | 32.05  | -7.95      | 40       | 43.51    | 19.74  | 1.29   | 32.49  | 312     | 158     | QP      | V |
|                    |  |           | 81.84      | 24.85  | -15.15     | 40       | 42       | 13.82  | 1.51   | 32.48  | -       | -       | P       | V |
|                    |  |           | 98.31      | 23.78  | -19.72     | 43.5     | 38.89    | 15.86  | 1.51   | 32.48  | -       | -       | P       | V |
|                    |  |           | 592.6      | 27.45  | -18.55     | 46       | 30.67    | 25.56  | 3.67   | 32.45  | -       | -       | P       | V |
|                    |  |           | 864.9      | 32.33  | -13.67     | 46       | 30.61    | 28.99  | 4.57   | 31.84  | -       | -       | P       | V |
|                    |  |           | 953.8      | 33.4   | -12.6      | 46       | 29.28    | 30.59  | 4.69   | 31.16  | -       | -       | P       | V |
|                    |  |           |            |        |            |          |          |        |        |        |         |         |         | V |
|                    |  |           |            |        |            |          |          |        |        |        |         |         | V       |   |
|                    |  |           |            |        |            |          |          |        |        |        |         |         | V       |   |
|                    |  |           |            |        |            |          |          |        |        |        |         |         | V       |   |
|                    |  |           |            |        |            |          |          |        |        |        |         |         | V       |   |
| Remark             | 1. No other spurious found.<br>2. All results are PASS against limit line. |           |            |        |            |          |          |        |        |        |         |         |         |   |



**Note symbol**

|     |  |
|-----|--|
| *   | <b>Fundamental Frequency</b> which can be ignored. However, the level of any unwanted emissions shall not exceed the level of the fundamental frequency. |
| !   | Test result is <b>over limit</b> line.   |
| P/A | <b>Peak</b> or <b>Average</b>  |
| H/V | <b>Horizontal</b> or <b>Vertical</b>   |





A calculation example for radiated spurious emission is shown as below:

| WIFI    | Note | Frequency | Level      | Over   | Limit      | Read     | Antenna  | Cable  | Preamp | Ant    | Table   | Peak    | Pol.    |
|---------|------|-----------|------------|--------|------------|----------|----------|--------|--------|--------|---------|---------|---------|
| Ant.    |      |           |            | Limit  | Line       | Level    | Factor   | Loss   | Factor | Pos    | Pos     | Avg.    |         |
| 1+2     |      | ( MHz )   | ( dBμV/m ) | ( dB ) | ( dBμV/m ) | ( dBμV ) | ( dB/m ) | ( dB ) | ( dB ) | ( cm ) | ( deg ) | ( P/A ) | ( H/V ) |
| 802.11b |      | 2390      | 55.45      | -18.55 | 74         | 54.51    | 32.22    | 4.58   | 35.86  | 103    | 308     | P       | H       |
| CH 01   |      |           |            |        |            |          |          |        |        |        |         |         |         |
| 2412MHz |      | 2390      | 43.54      | -10.46 | 54         | 42.6     | 32.22    | 4.58   | 35.86  | 103    | 308     | A       | H       |

- Level(dBμV/m) =  
Antenna Factor(dB/m) + Cable Loss(dB) + Read Level(dBμV) - Preamp Factor(dB)
- Over Limit(dB) = Level(dBμV/m) – Limit Line(dBμV/m)

**For Peak Limit @ 2390MHz:**

- Level(dBμV/m)  
= Antenna Factor(dB/m) + Cable Loss(dB) + Read Level(dBμV) - Preamp Factor(dB)  
= 32.22(dB/m) + 4.58(dB) + 54.51(dBμV) – 35.86 (dB)  
= 55.45 (dBμV/m)
- Over Limit(dB)  
= Level(dBμV/m) – Limit Line(dBμV/m)  
= 55.45(dBμV/m) – 74(dBμV/m)  
= -18.55(dB)

**For Average Limit @ 2390MHz:**

- Level(dBμV/m)  
= Antenna Factor(dB/m) + Cable Loss(dB) + Read Level(dBμV) - Preamp Factor(dB)  
= 32.22(dB/m) + 4.58(dB) + 42.6(dBμV) – 35.86 (dB)  
= 43.54 (dBμV/m)
- Over Limit(dB)  
= Level(dBμV/m) – Limit Line(dBμV/m)  
= 43.54(dBμV/m) – 54(dBμV/m)  
= -10.46(dB)

**Both peak and average measured complies with the limit line, so test result is “PASS”.**



## Appendix B. Radiated Spurious Emission Plots

|                 |                           |                     |         |
|-----------------|---------------------------|---------------------|---------|
| Test Engineer : | J.C. Liang and Jacky Hung | Temperature :       | 20~24°C |
|                 |                           | Relative Humidity : | 50~58%  |

2.4GHz 2400~2483.5MHz

BT (Band Edge @ 3m)

| BT   | 2.4GHz 2400~2483.5MHz Band Edge @ 3m   |   |
|------|--|---|
| ANT  | BT CH00 2402MHz  |   |
| 1    | Horizontal   | Fundamental   |
| Peak | <p>Site : 03CH11-HY<br/>           Condition : PEAK_BE_74 3m HORN 91200-HF HORIZONTAL<br/>           Detector : Peak<br/>           Project : 6O1802</p> | <p>Site : 03CH11-HY<br/>           Condition : PEAK_74 3m HORN 91200-HF HORIZONTAL<br/>           Detector : Peak<br/>           Project : 6O1802</p> |

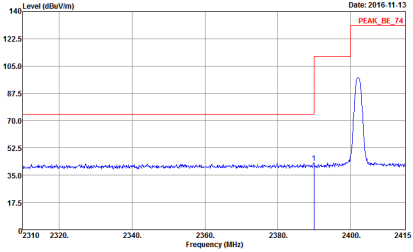
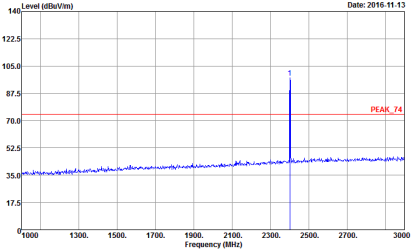

|      |  |   |
|------|--|---|
| BT   | 2.4GHz 2400~2483.5MHz Band Edge @ 3m   |   |
| ANT  | BT CH00 2402MHz  |   |
| 1    | Vertical   | Fundamental   |
| Peak |  <p>Date: 2016-11-13<br/>PEAK_BE_74</p> <p>Site : 03CH11-HY<br/>Condition : PEAK_BE_74 3m HORN 91200-HF VERTICAL<br/>Detector : Peak<br/>Project : 6O1802</p> |  <p>Date: 2016-11-13<br/>PEAK_74</p> <p>Site : 03CH11-HY<br/>Condition : PEAK_74 3m HORN 91200-HF VERTICAL<br/>Detector : Peak<br/>Project : 6O1802</p> |

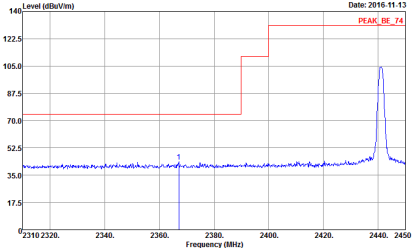
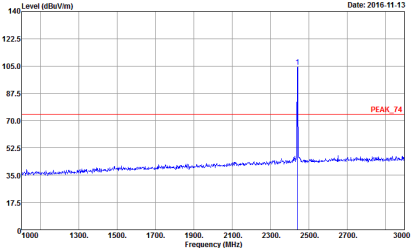
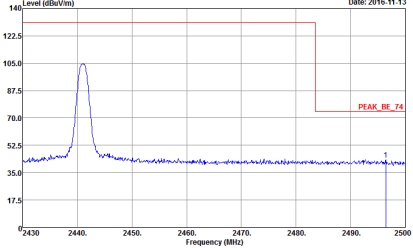

| BT   | 2.4GHz 2400~2483.5MHz Band Edge @ 3m  |   |
|------|---|---|
| ANT  | BT CH39 2441MHz   |   |
| 1    | <p style="text-align: center;"><b>Horizontal</b></p>  <p style="text-align: right;">Date: 2016-11-13<br/>PEAK_BE_74</p> <p>Site : 03CH11-HY<br/>Condition : PEAK_BE_74 3m HORN 9120D-HF HORIZONTAL<br/>RBW:1000.000KHz VBW:3000.000KHz SWT:Auto<br/>Detector : Peak<br/>Project : 6O1802</p> | <p style="text-align: center;"><b>Fundamental</b></p>  <p style="text-align: right;">Date: 2016-11-13<br/>PEAK_74</p> <p>Site : 03CH11-HY<br/>Condition : PEAK_74 3m HORN 9120D-HF HORIZONTAL<br/>RBW:1000.000KHz VBW:3000.000KHz SWT:Auto<br/>Detector : Peak<br/>Project : 6O1802</p> |
| Peak |  <p style="text-align: right;">Date: 2016-11-13<br/>PEAK_BE_74</p> <p>Site : 03CH11-HY<br/>Condition : PEAK_BE_74 3m HORN 9120D-HF HORIZONTAL<br/>RBW:1000.000KHz VBW:3000.000KHz SWT:Auto<br/>Detector : Peak<br/>Project : 6O1802</p>  | <p style="text-align: center;">Left blank</p>   |

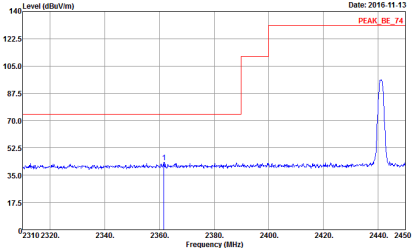
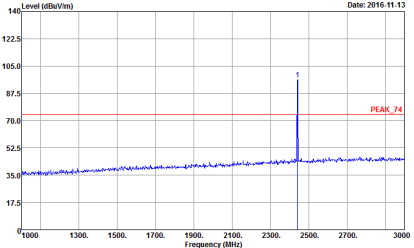
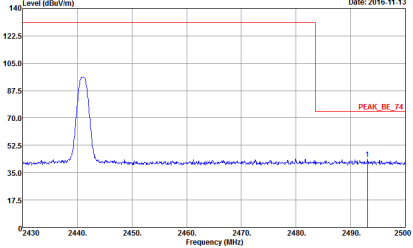

| BT   | 2.4GHz 2400~2483.5MHz Band Edge @ 3m  |  |
|------|---|--|
| ANT  | BT CH39 2441MHz   |  |
| 1    | <p style="text-align: center;"><b>Vertical</b></p>  <p>Site : 03CH11-HY<br/>           Condition : PEAK_BE_74 3m HORN 9120D-HF VERTICAL<br/>           : RBW:1000.000KHz VBW:3000.000KHz SWT:Auto<br/>           Detector : Peak<br/>           Project : 6O1802</p> | <p style="text-align: center;"><b>Fundamental</b></p>  <p>Site : 03CH11-HY<br/>           Condition : PEAK_74 3m HORN 9120D-HF VERTICAL<br/>           : RBW:1000.000KHz VBW:3000.000KHz SWT:Auto<br/>           Detector : Peak<br/>           Project : 6O1802</p> |
| Peak |  <p>Site : 03CH11-HY<br/>           Condition : PEAK_BE_74 3m HORN 9120D-HF VERTICAL<br/>           : RBW:1000.000KHz VBW:3000.000KHz SWT:Auto<br/>           Detector : Peak<br/>           Project : 6O1802</p>  | <p style="text-align: center;">Left blank</p>  |

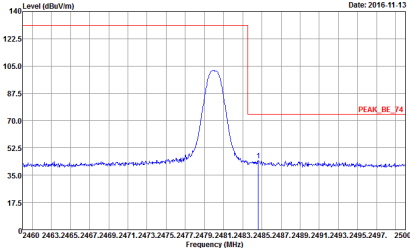
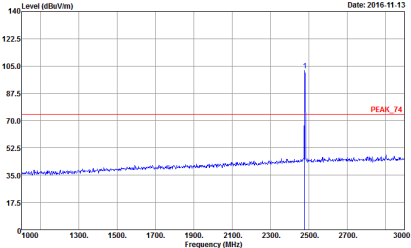

|      |  |  |
|------|--|--|
| BT   | 2.4GHz 2400~2483.5MHz Band Edge @ 3m   |  |
| ANT  | BT CH78 2480MHz  |  |
| 1    | Horizontal   | Fundamental  |
| Peak |  <p>Date: 2016-11-13</p> <p>Site : 03CH11-HY<br/>         Condition : PEAK_9E_74 3m HORN 91200-HF HORIZONTAL<br/>         Detector : Peak<br/>         Project : 6O1802</p> |  <p>Date: 2016-11-13</p> <p>Site : 03CH11-HY<br/>         Condition : PEAK_74 3m HORN 91200-HF HORIZONTAL<br/>         Detector : Peak<br/>         Project : 6O1802</p> |

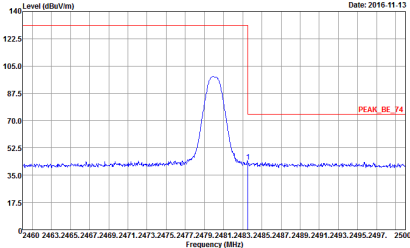
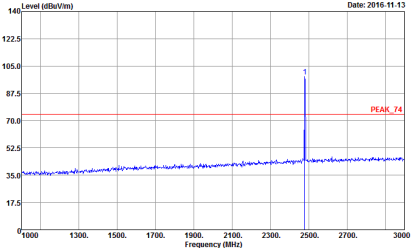

|      |  |  |
|------|--|--|
| BT   | 2.4GHz 2400~2483.5MHz Band Edge @ 3m   |  |
| ANT  | BT CH78 2480MHz  |  |
| 1    | Vertical   | Fundamental  |
| Peak |  <p>Date: 2016-11-13</p> <p>Site : 03CH11-HY<br/> Condition : PEAK_BE_74 3m HORN 91200-HF VERTICAL<br/> Detector : Peak<br/> Project : 6O1802</p> |  <p>Date: 2016-11-13</p> <p>Site : 03CH11-HY<br/> Condition : PEAK_74 3m HORN 91200-HF VERTICAL<br/> Detector : Peak<br/> Project : 6O1802</p> |



2.4GHz 2400~2483.5MHz

BT (Harmonic @ 3m)

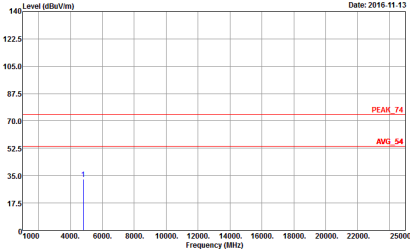
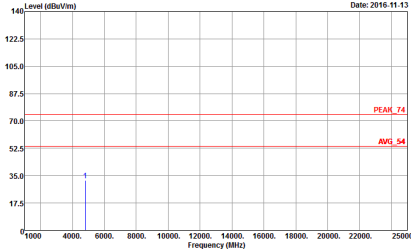
| BT                   | 2.4GHz 2400~2483.5MHz Harmonic @ 3m   |  |
|----------------------|---|--|
| ANT                  | BT CH00 2402MHz   |  |
| 1                    | Horizontal  | Vertical   |
| <p>Peak<br/>Avg.</p> |  <p>Site : 03CH11-HY<br/>Condition : PEAK_74 3m 9170 SHF HORM_150809 HORIZONTAL<br/>Detector : Peak<br/>Project : 6O1802</p> |  <p>Site : 03CH11-HY<br/>Condition : PEAK_74 3m 9170 SHF HORM_150809 VERTICAL<br/>Detector : Peak<br/>Project : 6O1802</p> |



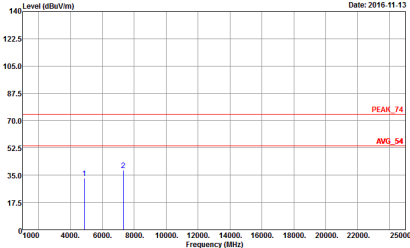
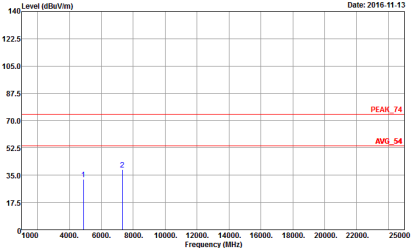

|              |  |   |
|--------------|--|---|
| BT           | 2.4GHz 2400~2483.5MHz Harmonic @ 3m  |   |
| ANT          | BT CH39 2441MHz  |   |
| 1            | Horizontal   | Vertical  |
| Peak<br>Avg. |  <p>           Site : 03CH11-HY<br/>           Condition : PEAK_74 3m 9170 SHF HORM_150809 HORIZONTAL<br/>           Detector : Peak<br/>           Project : 6O1802         </p> |  <p>           Site : 03CH11-HY<br/>           Condition : PEAK_74 3m 9170 SHF HORM_150809 VERTICAL<br/>           Detector : Peak<br/>           Project : 6O1802         </p> |



|              |  |  |
|--------------|--|--|
| BT           | 2.4GHz 2400~2483.5MHz Harmonic @ 3m  |  |
| ANT          | BT CH78 2480MHz  |  |
| 1            | Horizontal   | Vertical   |
| Peak<br>Avg. | <p>Site : 03CH11-HY<br/>         Condition : PEAK_74 3m 9170 SHF HORM_150809 HORIZONTAL<br/>         Detector : Peak<br/>         Project : 6O1802</p> | <p>Site : 03CH11-HY<br/>         Condition : PEAK_74 3m 9170 SHF HORM_150809 VERTICAL<br/>         Detector : Peak<br/>         Project : 6O1802</p> |



Emission below 1GHz

2.4GHz BT (LF)

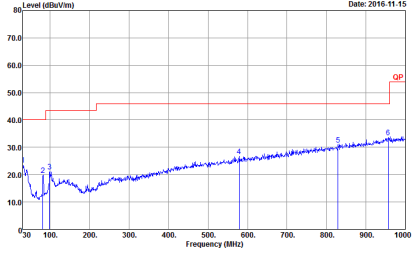
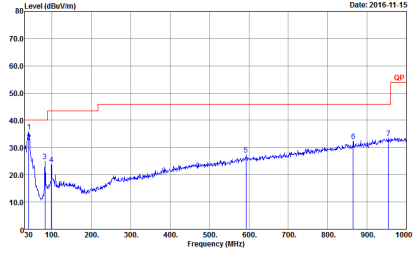
| BT                   | 2.4GHz 2400~2483.5MHz   |  |
|----------------------|---|--|
| ANT                  | BT LF   |  |
| 1                    | Horizontal  | Vertical   |
| <p>QP /<br/>Peak</p> |  <p>Site : 03CH11-HY<br/>Condition : QP 3m BT-LO6 6111D-LF_ETC HORIZONTAL<br/>Detector : Peak<br/>Project : 6O1802</p> |  <p>Site : 03CH11-HY<br/>Condition : QP 3m SE-LO6 6111D-LF_ETC VERTICAL<br/>Detector : Peak<br/>Project : 6O1802</p> |