



## SAR EVALUATION REPORT

**Applicant Name:**  
 LG Electronics U.S.A., Inc.  
 1000 Sylvan Avenue  
 Englewood Cliffs, NJ 07632  
 United States

**Date of Testing:**  
 12/12/18 - 01/02/19  
**Test Site/Location:**  
 PCTEST Lab, Columbia, MD, USA  
**Document Serial No.:**  
 1M1812110223-01-R1.ZNF

**FCC ID:** ZNFX220QM

**APPLICANT:** LG ELECTRONICS U.S.A., INC.

**DUT Type:** Portable Handset  
**Application Type:** Certification  
**FCC Rule Part(s):** CFR §2.1093  
**Model:** LM-X220QM  
**Additional Model(s):** LMX220QM, X220QM

Equipment Class	Band & Mode	Tx Frequency	SAR		
			1g Head (W/kg)	1g Body-Worn (W/kg)	1g Hotspot (W/kg)
PCE	GSM/GPRS/EDGE 850	824.20 - 848.80 MHz	0.42	0.51	0.56
PCE	GSM/GPRS/EDGE 1900	1850.20 - 1909.80 MHz	0.44	0.46	0.51
PCE	UMTS 850	826.40 - 846.60 MHz	0.48	0.60	0.60
PCE	UMTS 1750	1712.4 - 1752.6 MHz	0.56	0.88	0.98
PCE	UMTS 1900	1852.4 - 1907.6 MHz	0.59	0.71	0.72
PCE	Cell. CDMA/EVDO	824.70 - 848.31 MHz	0.49	0.74	0.68
PCE	PCS CDMA/EVDO	1851.25 - 1908.75 MHz	0.78	0.92	0.95
PCE	LTE Band 12	699.7 - 715.3 MHz	0.59	0.75	0.75
PCE	LTE Band 5 (Cell)	824.7 - 848.3 MHz	0.50	0.79	0.79
PCE	LTE Band 4 (AWS)	1710.7 - 1754.3 MHz	0.57	0.76	0.84
PCE	LTE Band 25 (PCS)	1850.7 - 1914.3 MHz	0.76	0.90	0.90
PCE	LTE Band 2 (PCS)	1850.7 - 1909.3 MHz	N/A	N/A	N/A
DTS	2.4 GHz WLAN	2412 - 2462 MHz	1.24	0.18	0.18
DSS/DTS	Bluetooth	2402 - 2480 MHz	0.44	N/A	N/A
<b>Simultaneous SAR per KDB 690783 D01v01r03:</b>			1.59	1.21	1.27

Note: This revised Test Report (S/N 1M1812110223-01-R1.ZNF) supersedes and replaces the previously issued test report on the same subject device for the same type of testing as indicated. Please discard or destroy the previously issued test report(s) and dispose of it accordingly.

This wireless portable device has been shown to be capable of compliance for localized specific absorption rate (SAR) for uncontrolled environment/general population exposure limits specified in ANSI/IEEE C95.1-1992 and has been tested in accordance with the measurement procedures specified in Section 1.7 of this report; for North American frequency bands only.

I attest to the accuracy of data. All measurements reported herein were performed by me or were made under my supervision and are correct to the best of my knowledge and belief. I assume full responsibility for the completeness of these measurements and vouch for the qualifications of all persons taking them. Test results reported herein relate only to the item(s) tested.

Randy Ortanez  
 President





The SAR Tick is an initiative of the Mobile & Wireless Forum (MWF). While a product may be considered eligible, use of the SAR Tick logo requires an agreement with the MWF. Further details can be obtained by emailing: [sartick@mwfai.info](mailto:sartick@mwfai.info).

FCC ID: ZNFX220QM		SAR EVALUATION REPORT		Approved by: Quality Manager
Document S/N: 1M1812110223-01-R1.ZNF	Test Dates: 12/12/18 - 01/02/19	DUT Type: Portable Handset		Page 1 of 67

# TABLE OF CONTENTS

1	DEVICE UNDER TEST .....	3
2	LTE INFORMATION .....	8
3	INTRODUCTION .....	9
4	DOSIMETRIC ASSESSMENT .....	10
5	DEFINITION OF REFERENCE POINTS .....	11
6	TEST CONFIGURATION POSITIONS .....	12
7	RF EXPOSURE LIMITS .....	15
8	FCC MEASUREMENT PROCEDURES.....	16
9	RF CONDUCTED POWERS .....	22
10	SYSTEM VERIFICATION.....	38
11	SAR DATA SUMMARY .....	41
12	FCC MULTI-TX AND ANTENNA SAR CONSIDERATIONS.....	54
13	SAR MEASUREMENT VARIABILITY .....	62
14	EQUIPMENT LIST.....	63
15	MEASUREMENT UNCERTAINTIES.....	64
16	CONCLUSION.....	65
17	REFERENCES .....	66
APPENDIX A: SAR TEST PLOTS		
APPENDIX B: SAR DIPOLE VERIFICATION PLOTS		
APPENDIX C: PROBE AND DIPOLE CALIBRATION CERTIFICATES		
APPENDIX D: SAR TISSUE SPECIFICATIONS		
APPENDIX E: SAR SYSTEM VALIDATION		
APPENDIX F: DUT ANTENNA DIAGRAM & SAR TEST SETUP PHOTOGRAPHS		

FCC ID: ZNFX220QM		SAR EVALUATION REPORT		Approved by: Quality Manager
Document S/N: 1M1812110223-01-R1.ZNF	Test Dates: 12/12/18 - 01/02/19	DUT Type: Portable Handset	Page 2 of 67	

# 1 DEVICE UNDER TEST

## 1.1 Device Overview

Band & Mode	Operating Modes	Tx Frequency
GSM/GPRS/EDGE 850	Voice/Data	824.20 - 848.80 MHz
GSM/GPRS/EDGE 1900	Voice/Data	1850.20 - 1909.80 MHz
UMTS 850	Voice/Data	826.40 - 846.60 MHz
UMTS 1750	Voice/Data	1712.4 - 1752.6 MHz
UMTS 1900	Voice/Data	1852.4 - 1907.6 MHz
Cell. CDMA/EVDO	Voice/Data	824.70 - 848.31 MHz
PCS CDMA/EVDO	Voice/Data	1851.25 - 1908.75 MHz
LTE Band 12	Voice/Data	699.7 - 715.3 MHz
LTE Band 5 (Cell)	Voice/Data	824.7 - 848.3 MHz
LTE Band 4 (AWS)	Voice/Data	1710.7 - 1754.3 MHz
LTE Band 25 (PCS)	Voice/Data	1850.7 - 1914.3 MHz
LTE Band 2 (PCS)	Voice/Data	1850.7 - 1909.3 MHz
2.4 GHz WLAN	Data	2412 - 2462 MHz
Bluetooth	Data	2402 - 2480 MHz

## 1.2 Power Reduction for SAR



There is no power reduction used for any band/mode implemented in this device for SAR purposes.

## 1.3 Nominal and Maximum Output Power Specifications

This device operates using the following maximum and nominal output power specifications. SAR values were scaled to the maximum allowed power to determine compliance per KDB Publication 447498 D01v06.

### 1.3.1 Maximum Output Power



Mode / Band		Voice (dBm)	Burst Average GMSK (dBm)		Burst Average 8-PSK (dBm)	
		1 TX Slot	1 TX Slots	2 TX Slots	1 TX Slots	2 TX Slots
GSM/GPRS/EDGE 850	Maximum	<b>33.2</b>	<b>33.2</b>	<b>31.7</b>	<b>27.7</b>	<b>26.7</b>
	Nominal	<b>32.7</b>	<b>32.7</b>	<b>31.2</b>	<b>27.2</b>	<b>26.2</b>
GSM/GPRS/EDGE 1900	Maximum	<b>30.2</b>	<b>30.2</b>	<b>28.7</b>	<b>26.7</b>	<b>25.7</b>
	Nominal	<b>29.7</b>	<b>29.7</b>	<b>28.2</b>	<b>26.2</b>	<b>25.2</b>

FCC ID: ZNFX220QM	 <b>PCTEST</b> ENGINEERING LABORATORY, INC.	<b>SAR EVALUATION REPORT</b>	 <b>LG</b>	Approved by: Quality Manager
Document S/N: 1M1812110223-01-R1.ZNF	Test Dates: 12/12/18 - 01/02/19	DUT Type: Portable Handset	Page 3 of 67	

Mode / Band		Modulated Average (dBm)		
		3GPP WCDMA	3GPP HSDPA	3GPP HSUPA
UMTS Band 5 (850 MHz)	Maximum	<b>24.7</b>	<b>24.7</b>	<b>24.7</b>
	Nominal	<b>24.2</b>	<b>24.2</b>	<b>24.2</b>
UMTS Band 4 (1750 MHz)	Maximum	<b>24.7</b>	<b>24.7</b>	<b>24.7</b>
	Nominal	<b>24.2</b>	<b>24.2</b>	<b>24.2</b>
UMTS Band 2 (1900 MHz)	Maximum	<b>24.7</b>	<b>24.7</b>	<b>24.7</b>
	Nominal	<b>24.2</b>	<b>24.2</b>	<b>24.2</b>

Mode / Band		Modulated Average (dBm)
Cell. CDMA/EVDO	Maximum	<b>24.7</b>
	Nominal	<b>24.2</b>
PCS CDMA/EVDO	Maximum	<b>24.7</b>
	Nominal	<b>24.2</b>

Mode / Band		Modulated Average (dBm)
LTE Band 12	Maximum	<b>24.7</b>
	Nominal	<b>24.2</b>
LTE Band 5 (Cell)	Maximum	<b>24.7</b>
	Nominal	<b>24.2</b>
LTE Band 4 (AWS)	Maximum	<b>24.7</b>
	Nominal	<b>24.2</b>
LTE Band 25 (PCS)	Maximum	<b>24.7</b>
	Nominal	<b>24.2</b>
LTE Band 2 (PCS)	Maximum	<b>24.7</b>
	Nominal	<b>24.2</b>

FCC ID: ZNFX220QM	 <b>PCTEST</b> ENGINEERING LABORATORY, INC.	<b>SAR EVALUATION REPORT</b>	 <b>LG</b>	Approved by: Quality Manager
Document S/N: 1M1812110223-01-R1.ZNF	Test Dates: 12/12/18 - 01/02/19	DUT Type: Portable Handset		Page 4 of 67

Mode / Band		Modulated Average (dBm)		
	Channel	1	2-10	11
IEEE 802.11b (2.4 GHz)	Maximum	15.5		
	Nominal	14.5		
IEEE 802.11g (2.4 GHz)	Maximum	12.0	12.5	10.0
	Nominal	11.0	11.5	9.0
IEEE 802.11n (2.4 GHz)	Maximum	11.0	11.5	8.5
	Nominal	10.0	10.5	7.5

Mode / Band		Modulated Average (dBm)		
Bluetooth	Maximum	11.5		
	Nominal	10.5		
Bluetooth LE	Maximum	3.0		
	Nominal	2.0		



#### 1.4 DUT Antenna Locations

The overall dimensions of this device are > 9 x 5 cm. The overall diagonal dimension of the device is ≤160 mm and the diagonal display is ≤150 mm. A diagram showing the location of the device antennas can be found in Appendix F.

**Table 1-1  
Device Edges/Sides for SAR Testing**

Device Sides/Edges for SAR Testing						
Mode	Back	Front	Top	Bottom	Right	Left
GPRS 850	Yes	Yes	No	Yes	Yes	Yes
GPRS 1900	Yes	Yes	No	Yes	No	Yes
UMTS 850	Yes	Yes	No	Yes	Yes	Yes
UMTS 1750	Yes	Yes	No	Yes	No	Yes
UMTS 1900	Yes	Yes	No	Yes	No	Yes
Cell. EVDO	Yes	Yes	No	Yes	Yes	Yes
PCS EVDO	Yes	Yes	No	Yes	No	Yes
LTE Band 12	Yes	Yes	No	Yes	Yes	Yes
LTE Band 5 (Cell)	Yes	Yes	No	Yes	Yes	Yes
LTE Band 4 (AWS)	Yes	Yes	No	Yes	No	Yes
LTE Band 25 (PCS)	Yes	Yes	No	Yes	No	Yes
2.4 GHz WLAN	Yes	Yes	Yes	No	Yes	No

Note: Particular DUT edges were not required to be evaluated for wireless router SAR if the edges were greater than 2.5 cm from the transmitting antenna according to FCC KDB Publication 941225 D06v02r01 Section III. The distances between the transmit antennas and the edges of the device are included in the filing.

FCC ID: ZNFX220QM	 PCTEST ENGINEERING LABORATORY, INC.	SAR EVALUATION REPORT	 LG	Approved by: Quality Manager
Document S/N: 1M1812110223-01-R1-ZNF	Test Dates: 12/12/18 - 01/02/19	DUT Type: Portable Handset	Page 5 of 67	

## 1.5 Simultaneous Transmission Capabilities

According to FCC KDB Publication 447498 D01v06, transmitters are considered to be operating simultaneously when there is overlapping transmission, with the exception of transmissions during network hand-offs with maximum hand-off duration less than 30 seconds.

This device contains multiple transmitters that may operate simultaneously, and therefore requires a simultaneous transmission analysis according to FCC KDB Publication 447498 D01v06 4.3.2 procedures.

**Table 1-2  
Simultaneous Transmission Scenarios**

No.	Capable Transmit Configuration	Head	Body-Worn Accessory	Wireless Router	Notes
1	1x CDMA voice + 2.4 GHz WI-FI	Yes	Yes	N/A	
2	1x CDMA voice + 2.4 GHz Bluetooth	Yes <sup>^</sup>	Yes	N/A	<sup>^</sup> Bluetooth Tethering is considered
3	GSM voice + 2.4 GHz WI-FI	Yes	Yes	N/A	
4	GSM voice + 2.4 GHz Bluetooth	Yes <sup>^</sup>	Yes	N/A	<sup>^</sup> Bluetooth Tethering is considered
5	UMTS + 2.4 GHz WI-FI	Yes	Yes	Yes	
6	UMTS + 2.4 GHz Bluetooth	Yes <sup>^</sup>	Yes	Yes <sup>^</sup>	<sup>^</sup> Bluetooth Tethering is considered
7	LTE + 2.4 GHz WI-FI	Yes <sup>*</sup>	Yes <sup>*</sup>	Yes	
8	LTE + 2.4 GHz Bluetooth	Yes <sup>*^</sup>	Yes <sup>*</sup>	Yes <sup>^</sup>	<sup>^</sup> Bluetooth Tethering is considered
9	CDMA/EVDO data + 2.4 GHz WI-FI	Yes <sup>*</sup>	Yes <sup>*</sup>	Yes	<sup>*</sup> Pre-installed VOIP applications are considered
10	CDMA/EVDO data + 2.4 GHz Bluetooth	Yes <sup>*^</sup>	Yes <sup>*</sup>	Yes <sup>^</sup>	<sup>*</sup> Pre-installed VOIP applications are considered <sup>^</sup> Bluetooth Tethering is considered
11	GPRS/EDGE + 2.4 GHz WI-FI	Yes <sup>*</sup>	Yes <sup>*</sup>	Yes	<sup>*</sup> Pre-installed VOIP applications are considered
12	GPRS/EDGE + 2.4 GHz Bluetooth	Yes <sup>*^</sup>	Yes <sup>*</sup>	Yes <sup>^</sup>	<sup>*</sup> Pre-installed VOIP applications are considered <sup>^</sup> Bluetooth Tethering is considered

- 2.4 GHz WLAN, and 2.4 GHz Bluetooth share the same antenna path and cannot transmit simultaneously.
- All licensed modes share the same antenna path and cannot transmit simultaneously.
- When the user utilizes multiple services in UMTS 3G mode it uses multi-Radio Access Bearer or multi-RAB. The power control is based on a physical control channel (Dedicated Physical Control Channel [DPCCH]) and power control will be adjusted to meet the needs of both services. Therefore, the UMTS+WLAN scenario also represents the UMTS Voice/DATA + WLAN Hotspot scenario.
- Per the manufacturer, WIFI Direct is expected to be used in conjunction with a held-to-ear or body-worn accessory voice call. There are no simultaneous transmission scenarios involving WIFI direct beyond those listed in the above table.
- This device supports Bluetooth Tethering.
- This device supports VOLTE



## 1.6 Miscellaneous SAR Test Considerations

### (A) WIFI/BT

Per FCC KDB 447498 D01v06, the 1g SAR exclusion threshold for distances <50mm is defined by the following equation:

$$\frac{\text{Max Power of Channel (mW)}}{\text{Test Separation Dist (mm)}} * \sqrt{\text{Frequency(GHz)}} \leq 3.0$$

Based on the maximum conducted power of Bluetooth (rounded to the nearest mW) and the antenna to user separation distance, body-worn Bluetooth SAR was not required;  $[(14/10) * \sqrt{2.480}] = 2.2 < 3.0$ . Per KDB Publication 447498 D01v06, the maximum power of the channel was rounded to the nearest mW before calculation.

FCC ID: ZNFX220QM	 PCTEST ENGINEERING LABORATORY, INC.	SAR EVALUATION REPORT	 LG	Approved by: Quality Manager
Document S/N: 1M1812110223-01-R1-ZNF	Test Dates: 12/12/18 - 01/02/19	DUT Type: Portable Handset		Page 6 of 67

## (B) Licensed Transmitter(s)

GSM/GPRS/EDGE DTM is not supported for US bands. Therefore, the GSM Voice modes in this report do not transmit simultaneously with GPRS/EDGE Data.

This device is only capable of QPSK HSUPA in the uplink. Therefore, no additional SAR tests are required beyond that described for devices with HSUPA in KDB 941225 D01v03r01.

LTE SAR for the higher modulations and lower bandwidths were not tested since the maximum average output power of all required channels and configurations was not more than 0.5 dB higher than the highest bandwidth; and the reported LTE SAR for the highest bandwidth was less than 1.45 W/kg for all configurations according to FCC KDB 941225 D05v02r04.



This device supports LTE capabilities with overlapping transmission frequency ranges. When the supported frequency range of an LTE Band falls completely within an LTE band with a larger transmission frequency range, both LTE bands have the same target power (or the band with the larger transmission frequency range has a higher target power), and both LTE bands share the same transmission path and signal characteristics, SAR was only assessed for the band with the larger transmission frequency range.

## 1.7 Guidance Applied

- IEEE 1528-2013
- FCC KDB Publication 941225 D01v03r01, D05v02r04, D06v02r01 (2G/3G/4G and Hotspot)
- FCC KDB Publication 248227 D01v02r02 (SAR Considerations for 802.11 Devices)
- FCC KDB Publication 447498 D01v06 (General SAR Guidance)
- FCC KDB Publication 865664 D01v01r04, D02v01r02 (SAR Measurements up to 6 GHz)
- October 2013 TCB Workshop Notes (GPRS Testing Considerations)

## 1.8 Device Serial Numbers

Several samples with identical hardware were used to support SAR testing. The manufacturer has confirmed that the device(s) tested have the same physical, mechanical and thermal characteristics and are within operational tolerances expected for production units. The serial numbers used for each test are indicated alongside the results in Section 11.



FCC ID: ZNFX220QM		SAR EVALUATION REPORT		Approved by: Quality Manager
Document S/N: 1M1812110223-01-R1.ZNF	Test Dates: 12/12/18 - 01/02/19	DUT Type: Portable Handset		Page 7 of 67



# 2

# LTE INFORMATION

LTE Information			
Form Factor	Portable Handset		
Frequency Range of each LTE transmission band	LTE Band 12 (699.7 - 715.3 MHz)		
	LTE Band 5 (Cell) (824.7 - 848.3 MHz)		
	LTE Band 4 (AWS) (1710.7 - 1754.3 MHz)		
	LTE Band 25 (PCS) (1850.7 - 1914.3 MHz)		
	LTE Band 2 (PCS) (1850.7 - 1909.3 MHz)		
Channel Bandwidths	LTE Band 12: 1.4 MHz, 3 MHz, 5 MHz, 10 MHz		
	LTE Band 5 (Cell): 1.4 MHz, 3 MHz, 5 MHz, 10 MHz		
	LTE Band 4 (AWS): 1.4 MHz, 3 MHz, 5 MHz, 10 MHz, 15 MHz, 20		
	LTE Band 25 (PCS): 1.4 MHz, 3 MHz, 5 MHz, 10 MHz, 15 MHz, 20		
	LTE Band 2 (PCS): 1.4 MHz, 3 MHz, 5 MHz, 10 MHz, 15 MHz, 20		
Channel Numbers and Frequencies (MHz)	Low	Mid	High
LTE Band 12: 1.4 MHz	699.7 (23017)	707.5 (23095)	715.3 (23173)
LTE Band 12: 3 MHz	700.5 (23025)	707.5 (23095)	714.5 (23165)
LTE Band 12: 5 MHz	701.5 (23035)	707.5 (23095)	713.5 (23155)
LTE Band 12: 10 MHz	704 (23060)	707.5 (23095)	711 (23130)
LTE Band 5 (Cell): 1.4 MHz	824.7 (20407)	836.5 (20525)	848.3 (20643)
LTE Band 5 (Cell): 3 MHz	825.5 (20415)	836.5 (20525)	847.5 (20635)
LTE Band 5 (Cell): 5 MHz	826.5 (20425)	836.5 (20525)	846.5 (20625)
LTE Band 5 (Cell): 10 MHz	829 (20450)	836.5 (20525)	844 (20600)
LTE Band 4 (AWS): 1.4 MHz	1710.7 (19957)	1732.5 (20175)	1754.3 (20393)
LTE Band 4 (AWS): 3 MHz	1711.5 (19965)	1732.5 (20175)	1753.5 (20385)
LTE Band 4 (AWS): 5 MHz	1712.5 (19975)	1732.5 (20175)	1752.5 (20375)
LTE Band 4 (AWS): 10 MHz	1715 (20000)	1732.5 (20175)	1750 (20350)
LTE Band 4 (AWS): 15 MHz	1717.5 (20025)	1732.5 (20175)	1747.5 (20325)
LTE Band 4 (AWS): 20 MHz	1720 (20050)	1732.5 (20175)	1745 (20300)
LTE Band 25 (PCS): 1.4 MHz	1850.7 (26047)	1882.5 (26365)	1914.3 (26683)
LTE Band 25 (PCS): 3 MHz	1851.5 (26055)	1882.5 (26365)	1913.5 (26675)
LTE Band 25 (PCS): 5 MHz	1852.5 (26065)	1882.5 (26365)	1912.5 (26665)
LTE Band 25 (PCS): 10 MHz	1855 (26090)	1882.5 (26365)	1910 (26640)
LTE Band 25 (PCS): 15 MHz	1857.5 (26115)	1882.5 (26365)	1907.5 (26615)
LTE Band 25 (PCS): 20 MHz	1860 (26140)	1882.5 (26365)	1905 (26590)
LTE Band 2 (PCS): 1.4 MHz	1850.7 (18607)	1880 (18900)	1909.3 (19193)
LTE Band 2 (PCS): 3 MHz	1851.5 (18615)	1880 (18900)	1908.5 (19185)
LTE Band 2 (PCS): 5 MHz	1852.5 (18625)	1880 (18900)	1907.5 (19175)
LTE Band 2 (PCS): 10 MHz	1855 (18650)	1880 (18900)	1905 (19150)
LTE Band 2 (PCS): 15 MHz	1857.5 (18675)	1880 (18900)	1902.5 (19125)
LTE Band 2 (PCS): 20 MHz	1860 (18700)	1880 (18900)	1900 (19100)
UE Category	4		
Modulations Supported in UL	QPSK, 16QAM		
LTE MPR Permanently implemented per 3GPP TS 36.101 section 6.2.3~6.2.5? (manufacturer attestation to be provided)	YES		
A-MPR (Additional MPR) disabled for SAR Testing?	YES		
LTE Carrier Aggregation Possible Combinations	The technical description includes all the possible carrier aggregation combinations		
LTE Additional Information	This device does not support full CA features on 3GPP Release 10. All uplink communications are identical to the Release 8 Specifications. The following LTE Release 10 Features are not supported: Carrier Aggregation, Relay, HetNet, Enhanced MIMO, eICIC, WIFI Offloading, eMBMS, Cross-Carrier Scheduling, Enhanced SC-FDMA.		

FCC ID: ZNFX220QM		SAR EVALUATION REPORT		Approved by: Quality Manager
Document S/N: 1M1812110223-01-R1.ZNF	Test Dates: 12/12/18 - 01/02/19	DUT Type: Portable Handset	Page 8 of 67	



The FCC and Innovation, Science, and Economic Development Canada have adopted the guidelines for evaluating the environmental effects of radio frequency (RF) radiation in ET Docket 93-62 on Aug. 6, 1996 and Health Canada Safety Code 6 to protect the public and workers from the potential hazards of RF emissions due to FCC-regulated portable devices. [1]

The safety limits used for the environmental evaluation measurements are based on the criteria published by the American National Standards Institute (ANSI) for localized specific absorption rate (SAR) in IEEE/ANSI C95.1-1992 Standard for Safety Levels with Respect to Human Exposure to Radio Frequency Electromagnetic Fields, 3 kHz to 300 GHz [3] and Health Canada RF Exposure Guidelines Safety Code 6 [22]. The measurement procedure described in IEEE/ANSI C95.3-2002 Recommended Practice for the Measurement of Potentially Hazardous Electromagnetic Fields - RF and Microwave [4] is used for guidance in measuring the Specific Absorption Rate (SAR) due to the RF radiation exposure from the Equipment Under Test (EUT). These criteria for SAR evaluation are similar to those recommended by the International Committee for Non-Ionizing Radiation Protection (ICNIRP) in Biological Effects and Exposure Criteria for Radiofrequency Electromagnetic Fields,” Report No. Vol 74. SAR is a measure of the rate of energy absorption due to exposure to an RF transmitting source. SAR values have been related to threshold levels for potential biological hazards.

### 3.1 SAR Definition

Specific Absorption Rate is defined as the time derivative (rate) of the incremental energy (dU) absorbed by (dissipated in) an incremental mass (dm) contained in a volume element (dV) of a given density ( $\rho$ ). It is also defined as the rate of RF energy absorption per unit mass at a point in an absorbing body (see Equation 3-1).

**Equation 3-1**  
**SAR Mathematical Equation**

$$SAR = \frac{d}{dt} \left( \frac{dU}{dm} \right) = \frac{d}{dt} \left( \frac{dU}{\rho dv} \right)$$



SAR is expressed in units of Watts per Kilogram (W/kg).

$$SAR = \frac{\sigma \cdot E^2}{\rho}$$

where:

- $\sigma$  = conductivity of the tissue-simulating material (S/m)
- $\rho$  = mass density of the tissue-simulating material (kg/m<sup>3</sup>)
- E = Total RMS electric field strength (V/m)

NOTE: The primary factors that control rate of energy absorption were found to be the wavelength of the incident field in relation to the dimensions and geometry of the irradiated organism, the orientation of the organism in relation to the polarity of field vectors, the presence of reflecting surfaces, and whether conductive contact is made by the organism with a ground plane.[6]

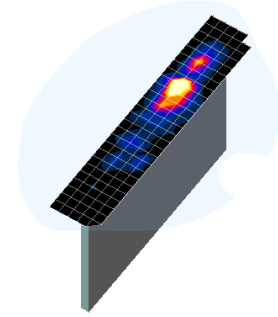
FCC ID: ZNFX220QM		SAR EVALUATION REPORT		Approved by: Quality Manager
Document S/N: 1M1812110223-01-R1.ZNF	Test Dates: 12/12/18 - 01/02/19	DUT Type: Portable Handset		Page 9 of 67

# 4 DOSIMETRIC ASSESSMENT

## 4.1 Measurement Procedure

The evaluation was performed using the following procedure compliant to FCC KDB Publication 865664 D01v01r04 and IEEE 1528-2013:

1. The SAR distribution at the exposed side of the head or body was measured at a distance no greater than 5.0 mm from the inner surface of the shell. The area covered the entire dimension of the device-head and body interface and the horizontal grid resolution was determined per FCC KDB Publication 865664 D01v01r04 (See Table 4-1) and IEEE 1528-2013.
2. The point SAR measurement was taken at the maximum SAR region determined from Step 1 to enable the monitoring of SAR fluctuations/drifts during the 1g/10g cube evaluation. SAR at this fixed point was measured and used as a reference value.
3. Based on the area scan data, the peak of the region with maximum SAR was determined by spline interpolation. Around this point, a volume was assessed according to the measurement resolution and volume size requirements of FCC KDB Publication 865664 D01v01r04 (See Table 4-1) and IEEE 1528-2013. On the basis of this data set, the spatial peak SAR value was evaluated with the following procedure (see references or the DASY manual online for more details):
  - a. SAR values at the inner surface of the phantom are extrapolated from the measured values along the line away from the surface with spacing no greater than that in Table 4-1. The extrapolation was based on a least-squares algorithm. A polynomial of the fourth order was calculated through the points in the z-axis (normal to the phantom shell).
  - b. After the maximum interpolated values were calculated between the points in the cube, the SAR was averaged over the spatial volume (1g or 10g) using a 3D-Spline interpolation algorithm. The 3D-spline is composed of three one-dimensional splines with the “Not a knot” condition (in x, y, and z directions). The volume was then integrated with the trapezoidal algorithm. One thousand points (10 x 10 x 10) were obtained through interpolation, in order to calculate the averaged SAR.
  - c. All neighboring volumes were evaluated until no neighboring volume with a higher average value was found.
4. The SAR reference value, at the same location as step 2, was re-measured after the zoom scan was complete to calculate the SAR drift. If the drift deviated by more than 5%, the SAR test and drift measurements were repeated.





**Figure 4-1**  
Sample SAR Area Scan

**Table 4-1**  
Area and Zoom Scan Resolutions per FCC KDB Publication 865664 D01v01r04\*

Frequency	Maximum Area Scan Resolution (mm) ( $\Delta x_{area}, \Delta y_{area}$ )	Maximum Zoom Scan Resolution (mm) ( $\Delta x_{zoom}, \Delta y_{zoom}$ )	Maximum Zoom Scan Spatial Resolution (mm)			Minimum Zoom Scan Volume (mm) (x,y,z)
			Uniform Grid	Graded Grid		
			$\Delta z_{zoom}(n)$	$\Delta z_{zoom}(1)^*$	$\Delta z_{zoom}(n>1)^*$	
≤ 2 GHz	≤ 15	≤ 8	≤ 5	≤ 4	≤ 1.5* $\Delta z_{zoom}(n-1)$	≥ 30
2-3 GHz	≤ 12	≤ 5	≤ 5	≤ 4	≤ 1.5* $\Delta z_{zoom}(n-1)$	≥ 30
3-4 GHz	≤ 12	≤ 5	≤ 4	≤ 3	≤ 1.5* $\Delta z_{zoom}(n-1)$	≥ 28
4-5 GHz	≤ 10	≤ 4	≤ 3	≤ 2.5	≤ 1.5* $\Delta z_{zoom}(n-1)$	≥ 25
5-6 GHz	≤ 10	≤ 4	≤ 2	≤ 2	≤ 1.5* $\Delta z_{zoom}(n-1)$	≥ 22

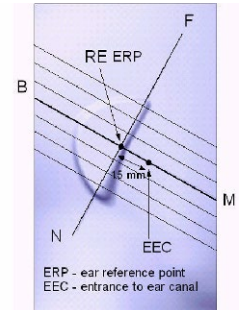
\*Also compliant to IEEE 1528-2013 Table 6

FCC ID: ZNFX220QM	 <b>SAR EVALUATION REPORT</b> 		Approved by: Quality Manager
Document S/N: 1M1812110223-01-R1.ZNF	Test Dates: 12/12/18 - 01/02/19	DUT Type: Portable Handset	Page 10 of 67 REV 21.2 M 12/05/2018

## 5 DEFINITION OF REFERENCE POINTS

### 5.1 EAR REFERENCE POINT

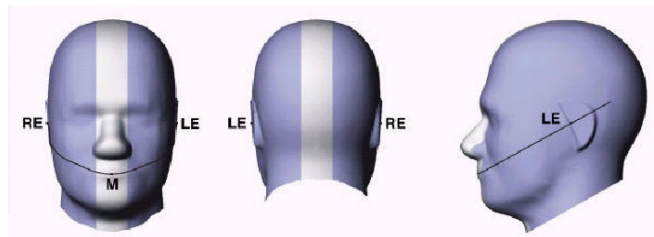
Figure 5-2 shows the front, back and side views of the SAM Twin Phantom. The point “M” is the reference point for the center of the mouth, “LE” is the left ear reference point (ERP), and “RE” is the right ERP. The ERP is 15mm posterior to the entrance to the ear canal (EEC) along the B-M line (Back-Mouth), as shown in Figure 5-1. The plane passing through the two ear canals and M is defined as the Reference Plane. The line N-F (Neck-Front), also called the Reference Pivoting Line, is not perpendicular to the reference plane (see Figure 5-1). Line B-M is perpendicular to the N-F line. Both N-F and B-M lines are marked on the external phantom shell to facilitate handset positioning [5].



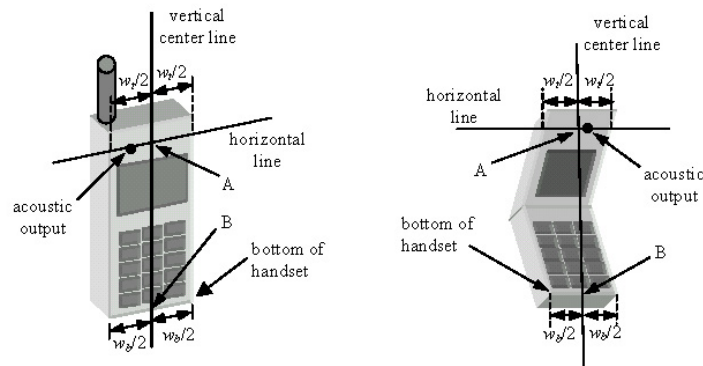
**Figure 5-1**  
Close-Up Side view of ERP

### 5.2 HANDSET REFERENCE POINTS



Two imaginary lines on the handset were established: the vertical centerline and the horizontal line. The test device was placed in a normal operating position with the acoustic output located along the “vertical centerline” on the front of the device aligned to the “ear reference point” (See Figure 5-3). The acoustic output was then located at the same level as the center of the ear reference point. The test device was positioned so that the “vertical centerline” was bisecting the front surface of the handset at its top and bottom edges, positioning the “ear reference point” on the outer surface of the both the left and right head phantoms on the ear reference point.



**Figure 5-2**  
Front, back and side view of SAM Twin Phantom



**Figure 5-3**  
Handset Vertical Center & Horizontal Line Reference Points

FCC ID: ZNFX220QM	 PCTEST ENGINEERING LABORATORY, INC.	SAR EVALUATION REPORT	 LG	Approved by: Quality Manager
Document S/N: 1M1812110223-01-R1.ZNF	Test Dates: 12/12/18 - 01/02/19	DUT Type: Portable Handset		Page 11 of 67

## 6 TEST CONFIGURATION POSITIONS

### 6.1 Device Holder

The device holder is made out of low-loss POM material having the following dielectric parameters: relative permittivity  $\epsilon = 3$  and loss tangent  $\delta = 0.02$ .

### 6.2 Positioning for Cheek

1. The test device was positioned with the device close to the surface of the phantom such that point A is on the (virtual) extension of the line passing through points RE and LE on the phantom (see Figure 6-1), such that the plane defined by the vertical center line and the horizontal line of the phone is approximately parallel to the sagittal plane of the phantom.

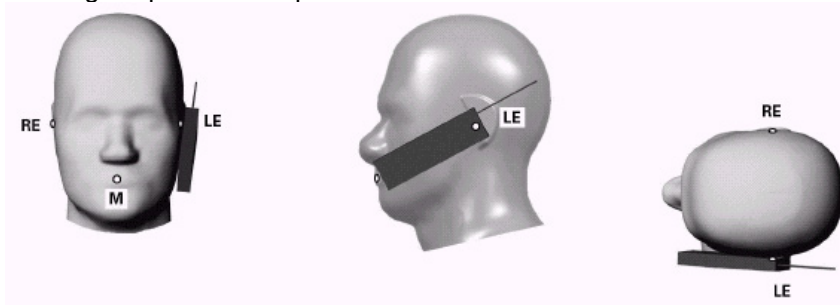




Figure 6-1 Front, Side and Top View of Cheek Position

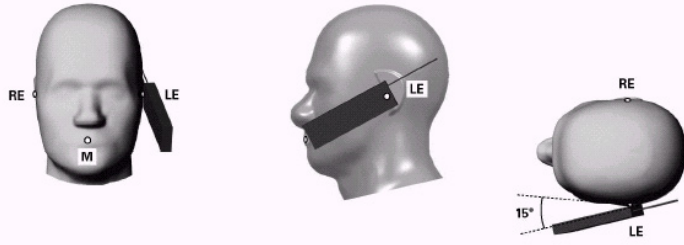
2. The handset was translated towards the phantom along the line passing through RE & LE until the handset touches the pinna.
3. While maintaining the handset in this plane, the handset was rotated around the LE-RE line until the vertical centerline was in the reference plane.
4. The phone was then rotated around the vertical centerline until the phone (horizontal line) was symmetrical with respect to the line NF.
5. While maintaining the vertical centerline in the reference plane, keeping point A on the line passing through RE and LE, and maintaining the device contact with the ear, the device was rotated about the NF line until any point on the handset made contact with a phantom point below the ear (cheek) (See Figure 6-2).

### 6.3 Positioning for Ear / 15° Tilt

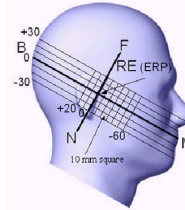
With the test device aligned in the “Cheek Position”:

1. While maintaining the orientation of the phone, the phone was retracted parallel to the reference plane far enough to enable a rotation of the phone by 15 degrees.
2. The phone was then rotated around the horizontal line by 15 degrees.
3. While maintaining the orientation of the phone, the phone was moved parallel to the reference plane until any part of the handset touched the head. (In this position, point A was located on the line RE-LE). The tilted position is obtained when the contact is on the pinna. If the contact was at any location other than the pinna, the angle of the phone would then be reduced. In this situation, the tilted position was obtained when any part of the phone was in contact of the ear as well as a second part of the phone was in contact with the head (see Figure 6-2).

FCC ID: ZNFX220QM		SAR EVALUATION REPORT		Approved by: Quality Manager
Document S/N: 1M1812110223-01-R1.ZNF	Test Dates: 12/12/18 - 01/02/19	DUT Type: Portable Handset		Page 12 of 67



**Figure 6-2 Front, Side and Top View of Ear/15° Tilt Position**



**Figure 6-3 Side view w/ relevant markings**

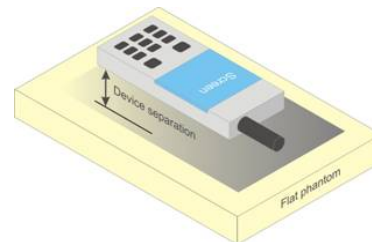
### 6.4 SAR Evaluations near the Mouth/Jaw Regions of the SAM Phantom

Antennas located near the bottom of a phone may require SAR measurements around the mouth and jaw regions of the SAM head phantom. This typically applies to clam-shell style phones that are generally longer in the unfolded normal use positions or to certain older style long rectangular phones. Per IEEE 1528-2013, a rotated SAM phantom is necessary to allow probe access to such regions. Both SAM heads of the TwinSAM-Chin20 are rotated 20 degrees around the NF line. Each head can be removed from the table for emptying and cleaning.

Under these circumstances, the following procedures apply, adopted from the FCC guidance on SAR handsets document FCC KDB Publication 648474 D04v01r03. The SAR required in these regions of SAM should be measured using a flat phantom. The phone should be positioned with a separation distance of 4 mm between the ear reference point (ERP) and the outer surface of the flat phantom shell. While maintaining this distance at the ERP location, the low (bottom) edge of the phone should be lowered from the phantom to establish the same separation distance between the peak SAR location identified by the truncated partial SAR distribution measured with the SAM phantom. The distance from the peak SAR location to the phone is determined by the straight line passing perpendicularly through the phantom surface. When it is not feasible to maintain 4 mm separation at the ERP while also establishing the required separation at the peak SAR location, the top edge of the phone will be allowed to touch the phantom with a separation < 4 mm at the ERP. The phone should not be tilted to the left or right while placed in this inclined position to the flat phantom.



### 6.5 Body-Worn Accessory Configurations

Body-worn operating configurations are tested with the belt-clips and holsters attached to the device and positioned against a flat phantom in a normal use configuration (see Figure 6-4). Per FCC KDB Publication 648474 D04v01r03, Body-worn accessory exposure is typically related to voice mode operations when handsets are carried in body-worn accessories. The body-worn accessory procedures in FCC KDB Publication 447498 D01v06 should be used to test for body-worn accessory SAR compliance, without a headset connected to it. This enables the test results for such configuration to be compatible with that required for hotspot mode when the body-worn accessory test separation distance is greater than or equal to that required for hotspot mode, when applicable. When the reported SAR for a body-worn accessory, measured without a headset connected to the handset, is > 1.2 W/kg, the highest reported SAR configuration for that wireless mode and frequency band should be repeated for that body-worn accessory with a headset attached to the handset.



**Figure 6-4 Sample Body-Worn Diagram**

Accessories for Body-worn operation configurations are divided into two categories: those that do not contain metallic components and those that do contain metallic components. When multiple accessories that do not

FCC ID: ZNFX220QM	 PCTEST ENGINEERING LABORATORY, INC.	SAR EVALUATION REPORT	 LG	Approved by: Quality Manager
Document S/N: 1M1812110223-01-R1.ZNF	Test Dates: 12/12/18 - 01/02/19	DUT Type: Portable Handset		Page 13 of 67



contain metallic components are supplied with the device, the device is tested with only the accessory that dictates the closest spacing to the body. Then multiple accessories that contain metallic components are tested with the device with each accessory. If multiple accessories share an identical metallic component (i.e. the same metallic belt-clip used with different holsters with no other metallic components) only the accessory that dictates the closest spacing to the body is tested.

Body-worn accessories may not always be supplied or available as options for some devices intended to be authorized for body-worn use. In this case, a test configuration with a separation distance between the back of the device and the flat phantom is used. Test position spacing was documented. Transmitters that are designed to operate in front of a person's face, as in push-to-talk configurations, are tested for SAR compliance with the front of the device positioned to face the flat phantom in head fluid. For devices that are carried next to the body such as a shoulder, waist or chest-worn transmitters, SAR compliance is tested with the accessories, including headsets and microphones, attached to the device and positioned against a flat phantom in a normal use configuration.

## 6.6 Extremity Exposure Configurations



Devices that are designed or intended for use on extremities or mainly operated in extremity only exposure conditions; i.e., hands, wrists, feet and ankles, may require extremity SAR evaluation. When the device also operates in close proximity to the user's body, SAR compliance for the body is also required. The 1g body and 10g extremity SAR Exclusion Thresholds found in KDB Publication 447498 D01v06 should be applied to determine SAR test requirements.

Per KDB Publication 447498 D01v06, Cell phones (handsets) are not normally designed to be used on extremities or operated in extremity only exposure conditions. The maximum output power levels of handsets generally do not require extremity SAR testing to show compliance. Therefore, extremity SAR was not evaluated for this device.

## 6.7 Wireless Router Configurations

Some battery-operated handsets have the capability to transmit and receive user data through simultaneous transmission of WIFI simultaneously with a separate licensed transmitter. The FCC has provided guidance in FCC KDB Publication 941225 D06v02r01 where SAR test considerations for handsets ( $L \times W \geq 9 \text{ cm} \times 5 \text{ cm}$ ) are based on a composite test separation distance of 10 mm from the front, back and edges of the device containing transmitting antennas within 2.5 cm of their edges, determined from general mixed use conditions for this type of devices. Since the hotspot SAR results may overlap with the body-worn accessory SAR requirements, the more conservative configurations can be considered, thus excluding some body-worn accessory SAR tests.

When the user enables the personal wireless router functions for the handset, actual operations include simultaneous transmission of both the WIFI transmitter and another licensed transmitter. Both transmitters often do not transmit at the same transmitting frequency and thus cannot be evaluated for SAR under actual use conditions due to the limitations of the SAR assessment probes. Therefore, SAR must be evaluated for each frequency transmission and mode separately and spatially summed with the WIFI transmitter according to FCC KDB Publication 447498 D01v06 procedures. The "Portable Hotspot" feature on the handset was NOT activated during SAR assessments, to ensure the SAR measurements were evaluated for a single transmission frequency RF signal at a time.

FCC ID: ZNFX220QM		SAR EVALUATION REPORT		Approved by: Quality Manager
Document S/N: 1M1812110223-01-R1.ZNF	Test Dates: 12/12/18 - 01/02/19	DUT Type: Portable Handset	Page 14 of 67	

# 7 RF EXPOSURE LIMITS

## 7.1 Uncontrolled Environment

UNCONTROLLED ENVIRONMENTS are defined as locations where there is the exposure of individuals who have no knowledge or control of their exposure. The general population/uncontrolled exposure limits are applicable to situations in which the general public may be exposed or in which persons who are exposed as a consequence of their employment may not be made fully aware of the potential for exposure or cannot exercise control over their exposure. Members of the general public would come under this category when exposure is not employment-related; for example, in the case of a wireless transmitter that exposes persons in its vicinity.



## 7.2 Controlled Environment

CONTROLLED ENVIRONMENTS are defined as locations where there is exposure that may be incurred by persons who are aware of the potential for exposure, (i.e. as a result of employment or occupation). In general, occupational/controlled exposure limits are applicable to situations in which persons are exposed as a consequence of their employment, who have been made fully aware of the potential for exposure and can exercise control over their exposure. This exposure category is also applicable when the exposure is of a transient nature due to incidental passage through a location where the exposure levels may be higher than the general population/uncontrolled limits, but the exposed person is fully aware of the potential for exposure and can exercise control over his or her exposure by leaving the area or by some other appropriate means.

**Table 7-1  
SAR Human Exposure Specified in ANSI/IEEE C95.1-1992 and Health Canada Safety Code 6**

HUMAN EXPOSURE LIMITS		
	UNCONTROLLED ENVIRONMENT <i>General Population</i> (W/kg) or (mW/g)	CONTROLLED ENVIRONMENT <i>Occupational</i> (W/kg) or (mW/g)
<b>Peak Spatial Average SAR</b> Head	1.6	8.0
<b>Whole Body SAR</b>	0.08	0.4
<b>Peak Spatial Average SAR</b> Hands, Feet, Ankle, Wrists, etc.	4.0	20

1. The Spatial Peak value of the SAR averaged over any 1 gram of tissue (defined as a tissue volume in the shape of a cube) and over the appropriate averaging time.
2. The Spatial Average value of the SAR averaged over the whole body.
3. The Spatial Peak value of the SAR averaged over any 10 grams of tissue (defined as a tissue volume in the shape of a cube) and over the appropriate averaging time.

FCC ID: ZNFX220QM	 PCTEST ENGINEERING LABORATORY, INC.	SAR EVALUATION REPORT	 LG	Approved by: Quality Manager
Document S/N: 1M1812110223-01-R1.ZNF	Test Dates: 12/12/18 - 01/02/19	DUT Type: Portable Handset		Page 15 of 67



## 8 FCC MEASUREMENT PROCEDURES

Power measurements for licensed transmitters are performed using a base station simulator under digital average power.

### 8.1 Measured and Reported SAR

Per FCC KDB Publication 447498 D01v06, when SAR is not measured at the maximum power level allowed for production units, the results must be scaled to the maximum tune-up tolerance limit according to the power applied to the individual channels tested to determine compliance. For simultaneous transmission, the measured aggregate SAR must be scaled according to the sum of the differences between the maximum tune-up tolerance and actual power used to test each transmitter. When SAR is measured at or scaled to the maximum tune-up tolerance limit, the results are referred to as *reported* SAR. The highest *reported* SAR results are identified on the grant of equipment authorization according to procedures in KDB 690783 D01v01r03.

### 8.2 3G SAR Test Reduction Procedure

In FCC KDB Publication 941225 D01v03r01, certain transmission modes within a frequency band and wireless mode evaluated for SAR are defined as primary modes. The equivalent modes considered for SAR test reduction are denoted as secondary modes. When the maximum output power including tune-up tolerance specified for production units in a secondary mode is  $\leq 0.25$  dB higher than the primary mode or when the highest reported SAR of the primary mode, scaled by the ratio of specified maximum output power and tune-up tolerance of secondary to primary mode, is  $\leq 1.2$  W/kg, SAR measurements are not required for the secondary mode. These criteria are referred to as the 3G SAR test reduction procedure. When the 3G SAR test reduction procedure is not satisfied, SAR measurements are additionally required for the secondary mode.

### 8.3 Procedures Used to Establish RF Signal for SAR

The following procedures are according to FCC KDB Publication 941225 D01v03r01 “3G SAR Measurement Procedures.”



The device is placed into a simulated call using a base station simulator in a RF shielded chamber. Establishing connections in this manner ensure a consistent means for testing SAR and are recommended for evaluating SAR [4]. Devices under test are evaluated prior to testing, with a fully charged battery and were configured to operate at maximum output power. In order to verify that the device is tested throughout the SAR test at maximum output power, the SAR measurement system measures a “point SAR” at an arbitrary reference point at the start and end of the 1 gram SAR evaluation, to assess for any power drifts during the evaluation. If the power drift deviates by more than 5%, the SAR test and drift measurements are repeated.

### 8.4 SAR Measurement Conditions for CDMA2000

The following procedures were performed according to FCC KDB Publication 941225 D01v03r01 “3G SAR Measurement Procedures.”

#### 8.4.1 Output Power Verification

See 3GPP2 C.S0011/TIA-98-E as recommended by FCC KDB Publication 941225 D01v03r01 “3G SAR Measurement Procedures.” Maximum output power is verified on the High, Middle and Low channels according to procedures in section 4.4.5.2 of 3GPP2 C.S0011/TIA-98-E. SO55 tests were measured with power control bits in the “All Up” condition.

FCC ID: ZNFX220QM		SAR EVALUATION REPORT		Approved by: Quality Manager
Document S/N: 1M1812110223-01-R1.ZNF	Test Dates: 12/12/18 - 01/02/19	DUT Type: Portable Handset		Page 16 of 67

1. If the mobile station (MS) supports Reverse TCH RC 1 and Forward TCH RC 1, set up a call using Fundamental Channel Test Mode 1 (RC=1/1) with 9600 bps data rate only.
2. Under RC1, C.S0011 Table 4.4.5.2-1, Table 8-1 parameters were applied.
3. If the MS supports the RC 3 Reverse FCH, RC3 Reverse SCH<sub>0</sub> and demodulation of RC 3,4, or 5, set up a call using Supplemental Channel Test Mode 3 (RC 3/3) with 9600 bps Fundamental Channel and 9600 bps SCH<sub>0</sub> data rate.
4. Under RC3, C.S0011 Table 4.4.5.2-2, Table 8-2 was applied.

**Table 8-1**  
**Parameters for Max. Power for RC1**

Parameter	Units	Value
$\frac{I_{or}}{I_{or}}$	dBm/1.23 MHz	-104
$\frac{Pilot E_c}{I_{or}}$	dB	-7
$\frac{Traffic E_c}{I_{or}}$	dB	-7.4

**Table 8-2**  
**Parameters for Max. Power for RC3**

Parameter	Units	Value
$\frac{I_{or}}{I_{or}}$	dBm/1.23 MHz	-86
$\frac{Pilot E_c}{I_{or}}$	dB	-7
$\frac{Traffic E_c}{I_{or}}$	dB	-7.4

5. FCHs were configured at full rate for maximum SAR with “All Up” power control bits.

### 8.4.2 Head SAR Measurements

SAR for next to the ear head exposure is measured in RC3 with the handset configured to transmit at fullrate in SO55. The 3G SAR test reduction procedure is applied to RC1 with RC3 as the primary mode; otherwise, SAR is required for the channel with maximum measured output in RC1 using the head exposure configuration that results in the highest reported SAR in RC3.

Head SAR is additionally evaluated using EVDO Rev. A to support compliance for VoIP operations. See Section 8.4.5 for EVDO Rev. A configuration parameters.

### 8.4.3 Body-worn SAR Measurements



SAR for body-worn exposure configurations is measured in RC3 with the DUT configured to transmit at full rate on FCH with all other code channels disabled using TDSO / SO32. The 3G SAR test reduction procedure is applied to the multiple code channel configuration (FCH+SCH<sub>n</sub>), with FCH only as the primary mode. Otherwise, SAR is required for multiple code channel configuration (FCH + SCH<sub>n</sub>), with FCH at full rate and SCH<sub>0</sub> enabled at 9600 bps, using the highest reported SAR configuration for FCH only. When multiple code channels are enabled, the transmitter output can shift by more than 0.5 dB and may lead to higher SAR drifts and SCH dropouts.

The 3G SAR test reduction procedure is applied to body-worn accessory SAR in RC1 with RC3 as the primary mode. Otherwise, SAR is required for RC1, with SO55 and full rate, using the highest reported SAR configuration for body-worn accessory exposure in RC3.

### 8.4.4 Body-worn SAR Measurements for EVDO Devices

For handsets with EVDO capabilities, the 3G SAR test reduction procedure is applied to EVDO Rev. 0 with 1x RTT RC3 as the primary mode to determine body-worn accessory test requirements. Otherwise, body-worn accessory SAR is required for Rev. 0, at 153.6 kbps, using the highest reported SAR configuration for body-worn accessory exposure in RC3.

The 3G SAR test reduction procedure is applied to Rev. A, with Rev. 0 as the primary mode to determine body-worn accessory SAR test requirements. When SAR is not required for Rev. 0, the 3G SAR test reduction is applied with 1x RTT RC3 as the primary mode.

FCC ID: ZNFX220QM		SAR EVALUATION REPORT		Approved by: Quality Manager
Document S/N: 1M1812110223-01-R1.ZNF	Test Dates: 12/12/18 - 01/02/19	DUT Type: Portable Handset		Page 17 of 67

When SAR is required for EVDO Rev. A, SAR is measured with a Reverse Data Channel payload size of 4096 bits and a Termination Target of 16 slots defined for Subtype 2 Physical Layer configurations, using the highest reported SAR configuration for body-worn accessory exposure in Rev. 0 or 1x RTT RC3, as appropriate.

### 8.4.5 Body SAR Measurements for EVDO Hotspot

Hotspot Body SAR is measured using Subtype 0/1 Physical Layer configurations for Rev. 0. The 3G SAR test reduction procedure is applied to Rev. A, Subtype 2 Physical layer configuration, with Rev. 0 as the primary mode; otherwise, SAR is measured for Rev. A using the highest reported SAR configuration for body-worn accessory exposure in Rev. 0. The AT is tested with a Reverse Data Channel rate of 153.6 kbps in Subtype 0/1 Physical Layer configurations; and a Reverse Data Channel payload size of 4096 bits and Termination Target of 16 slots in Subtype 2 Physical Layer configurations.

For EVDO data devices that also support 1x RTT voice and/or data operations, the 3G SAR test reduction procedure is applied to 1x RTT RC3 and RC1 with EVDO Rev. 0 and Rev. A as the respective primary modes. Otherwise, the 'Body-Worn Accessory SAR' procedures in the '3GPP2 CDMA 2000 1x Handsets' section are applied.

## 8.5 SAR Measurement Conditions for UMTS

### 8.5.1 Output Power Verification

Maximum output power is verified on the High, Middle and Low channels according to the general descriptions in section 5.2 of 3GPP TS 34.121, using the appropriate RMC with TPC (transmit power control) set to all "1s" or applying the required inner loop power control procedures to maintain maximum output power while HSUPA is active. Results for all applicable physical channel configurations (DPCCH, DPDCHn and spreading codes, HS-DPCCH etc) are tabulated in this test report. All configurations that are not supported by the DUT or cannot be measured due to technical or equipment limitations are identified.

### 8.5.2 Head SAR Measurements



SAR for next to the ear head exposure is measured using a 12.2 kbps RMC with TPC bits configured to all "1s". The 3G SAR test reduction procedure is applied to AMR configurations with 12.2 kbps RMC as the primary mode. Otherwise, SAR is measured for 12.2 kbps AMR in 3.4 kbps SRB (signaling radio bearer) using the highest reported SAR configuration in 12.2 kbps RMC for head exposure.

### 8.5.3 Body SAR Measurements

SAR for body exposure configurations is measured using the 12.2 kbps RMC with the TPC bits all "1s". The 3G SAR test reduction procedure is applied to other spreading codes and multiple DPDCHn configurations supported by the handset with 12.2 kbps RMC as the primary mode. Otherwise, SAR is measured using an applicable RMC configuration with the corresponding spreading code or DPDCHn, for the highest reported SAR configuration in 12.2 kbps RMC.

### 8.5.4 SAR Measurements with Rel 5 HSDPA

The 3G SAR test reduction procedure is applied to HSDPA body configurations with 12.2 kbps RMC as the primary mode. Otherwise, Body SAR for HSDPA is measured using an FRC with H-Set 1 in Sub-test 1 and a 12.2 kbps RMC configured in Test Loop Mode 1, for the highest reported SAR configuration in 12.2 kbps RMC without HSDPA. Handsets with both HSDPA and HSUPA are tested according to Release 6 HSPA test procedures.

FCC ID: ZNFX220QM	 PCTEST ENGINEERING LABORATORY, INC.	SAR EVALUATION REPORT	 LG	Approved by: Quality Manager
Document S/N: 1M1812110223-01-R1.ZNF	Test Dates: 12/12/18 - 01/02/19	DUT Type: Portable Handset	Page 18 of 67	

## 8.5.5 SAR Measurements with Rel 6 HSUPA

The 3G SAR test reduction procedure is applied to HSPA (HSUPA/HSDPA with RMC) body configurations with 12.2 kbps RMC as the primary mode. Otherwise, Body SAR for HSPA is measured with E-DCH Sub-test 5, using H-Set 1 and QPSK for FRC and a 12.2 kbps RMC configured in Test Loop Mode 1 and power control algorithm 2, according to the highest reported body SAR configuration in 12.2 kbps RMC without HSPA.

When VOIP applies to head exposure, the 3G SAR test reduction procedure is applied with 12.2 kbps RMC as the primary mode; otherwise, the same HSPA configuration used for body SAR measurements are applied to head exposure testing.

## 8.6 SAR Measurement Conditions for LTE

LTE modes are tested according to FCC KDB 941225 D05v02r04 publication. Establishing connections with base station simulators ensure a consistent means for testing SAR and are recommended for evaluating SAR [4]. The R&S CMW500 or Anritsu MT8820C simulators are used for LTE output power measurements and SAR testing. Closed loop power control was used so the UE transmits with maximum output power during SAR testing. SAR tests were performed with the same number of RB and RB offsets transmitting on all TTI frames (maximum TTI).

### 8.6.1 Spectrum Plots for RB Configurations

A properly configured base station simulator was used for SAR tests and power measurements. Therefore, spectrum plots for RB configurations were not required to be included in this report.

### 8.6.2 MPR

MPR is permanently implemented for this device by the manufacturer. The specific manufacturer target MPR is indicated alongside the SAR results. MPR is enabled for this device, according to 3GPP TS36.101 Section 6.2.3 – 6.2.5 under Table 6.2.3-1.



### 8.6.3 A-MPR

A-MPR (Additional MPR) has been disabled for all SAR tests by setting NS=01 on the base station simulator.

### 8.6.4 Required RB Size and RB Offsets for SAR Testing

According to FCC KDB 941225 D05v02r04:

- a. Per Section 5.2.1, SAR is required for QPSK 1 RB Allocation for the largest bandwidth
  - i. The required channel and offset combination with the highest maximum output power is required for SAR.
  - ii. When the reported SAR is  $\leq 0.8$  W/kg, testing of the remaining RB offset configurations and required test channels is not required. Otherwise, SAR is required for the remaining required test channels using the RB offset configuration with highest output power for that channel.
  - iii. When the reported SAR for a required test channel is  $> 1.45$  W/kg, SAR is required for all RB offset configurations for that channel.
- b. Per Section 5.2.2, SAR is required for 50% RB allocation using the largest bandwidth following the same procedures outlined in Section 5.2.1.

FCC ID: ZNFX220QM	 PCTEST ENGINEERING LABORATORY, INC.	SAR EVALUATION REPORT	 LG	Approved by: Quality Manager
Document S/N: 1M1812110223-01-R1.ZNF	Test Dates: 12/12/18 - 01/02/19	DUT Type: Portable Handset		Page 19 of 67

- c. Per Section 5.2.3, QPSK SAR is not required for the 100% allocation when the highest maximum output power for the 100% allocation is less than the highest maximum output power of the 1 RB and 50% RB allocations and the reported SAR for the 1 RB and 50% RB allocations is < 0.8 W/kg.
- d. Per Section 5.2.4 and 5.3, SAR tests for higher order modulations and lower bandwidths configurations are not required when the conducted power of the required test configurations determined by Sections 5.2.1 through 5.2.3 is less than or equal to ½ dB higher than the equivalent configuration using QPSK modulation and when the QPSK SAR for those configurations is <1.45 W/kg.

## 8.7 SAR Testing with 802.11 Transmitters

The normal network operating configurations of 802.11 transmitters are not suitable for SAR measurements. Unpredictable fluctuations in network traffic and antenna diversity conditions can introduce undesirable variations in SAR results. The SAR for these devices should be measured using chipset based test mode software to ensure the results are consistent and reliable. See KDB Publication 248227 D01v02r02 for more details.

### 8.7.1 General Device Setup

Chipset based test mode software is hardware dependent and generally varies among manufacturers. The device operating parameters established in test mode for SAR measurements must be identical to those programmed in production units, including output power levels, amplifier gain settings and other RF performance tuning parameters.

A periodic duty factor is required for current generation SAR systems to measure SAR. When 802.11 frame gaps are accounted for in the transmission, a maximum transmission duty factor of 92 - 96% is typically achievable in most test mode configurations. A minimum transmission duty factor of 85% is required to avoid certain hardware and device implementation issues related to wide range SAR scaling. The reported SAR is scaled to 100% transmission duty factor to determine compliance at the maximum tune-up tolerance limit.



### 8.7.2 Initial Test Position Procedure

For exposure conditions with multiple test positions, such as handset operating next to the ear, devices with hotspot mode or UMPC mini-tablet, procedures for initial test position can be applied. Using the transmission mode determined by the DSSS procedure or initial test configuration, area scans are measured for all positions in an exposure condition. The test position with the highest extrapolated (peak) SAR is used as the initial test position. When reported SAR for the initial test position is ≤ 0.4 W/kg, no additional testing for the remaining test positions is required. Otherwise, SAR is evaluated at the subsequent highest peak SAR positions until the reported SAR result is ≤ 0.8 W/kg or all test positions are measured. When 10g SAR measurement is considered, a factor of 2.5 is applied to the thresholds above.

### 8.7.3 2.4 GHz SAR Test Requirements

SAR is measured for 2.4 GHz 802.11b DSSS using either the fixed test position or, when applicable, the initial test position procedure. SAR test reduction is determined according to the following:

- 1) When the reported SAR of the highest measured maximum output power channel for the exposure configuration is ≤ 0.8 W/kg, no further SAR testing is required for 802.11b DSSS in that exposure configuration.
- 2) When the reported SAR is > 0.8 W/kg, SAR is required for that position using the next highest measured output power channel. When any reported SAR is > 1.2 W/kg, SAR is required for the third channel; i.e., all channels require testing.

FCC ID: ZNFX220QM	 PCTEST ENGINEERING LABORATORY, INC.	SAR EVALUATION REPORT	 LG	Approved by: Quality Manager
Document S/N: 1M1812110223-01-R1.ZNF	Test Dates: 12/12/18 - 01/02/19	DUT Type: Portable Handset		Page 20 of 67



2.4 GHz 802.11 g/n OFDM are additionally evaluated for SAR if the highest reported SAR for 802.11b, adjusted by the ratio of the OFDM to DSSS specified maximum output power, is > 1.2 W/kg. When SAR is required for OFDM modes in 2.4 GHz band, the Initial Test Configuration Procedures should be followed. When 10g SAR measurement is considered, a factor of 2.5 is applied to the thresholds above.

### 8.7.4 OFDM Transmission Mode and SAR Test Channel Selection

When the same maximum output power was specified for multiple OFDM transmission mode configurations in a frequency band or aggregated band, SAR is measured using the configuration with the largest channel bandwidth, lowest order modulation and lowest data rate. When the maximum output power of a channel is the same for equivalent OFDM configurations; for example, 802.11a, 802.11n and 802.11ac or 802.11g and 802.11n with the same channel bandwidth, modulation and data rate etc., the lower order 802.11 mode i.e., 802.11a, then 802.11n and 802.11ac or 802.11g then 802.11n, is used for SAR measurement. When the maximum output power are the same for multiple test channels, either according to the default or additional power measurement requirements, SAR is measured using the channel closest to the middle of the frequency band or aggregated band. When there are multiple channels with the same maximum output power, SAR is measured using the higher number channel.



### 8.7.5 Initial Test Configuration Procedure

For OFDM, an initial test configuration is determined for each frequency band and aggregated band, according to the transmission mode with the highest maximum output power specified for SAR measurements. When the same maximum output power is specified for multiple OFDM transmission mode configurations in a frequency band or aggregated band, SAR is measured using the configuration(s) with the largest channel bandwidth, lowest order modulation, lowest data rate and lowest order IEEE 802.11 mode. The channel of the transmission mode with the highest average RF output conducted power will be the initial test configuration.

When the reported SAR is  $\leq 0.8$  W/kg, no additional measurements on other test channels are required. Otherwise, SAR is evaluated using the subsequent highest average RF output channel until the reported SAR result is  $\leq 1.2$  W/kg or all channels are measured. When there are multiple untested channels having the same subsequent highest average RF output power, the channel with higher frequency from the lowest 802.11 mode is considered for SAR measurements (See Section 8.7.4). When 10g SAR measurement is considered, a factor of 2.5 is applied to the thresholds above.

### 8.7.6 Subsequent Test Configuration Procedures

For OFDM configurations in each frequency band and aggregated band, SAR is evaluated for initial test configuration using the fixed test position or the initial test position procedure. When the highest reported SAR (for the initial test configuration), adjusted by the ratio of the specified maximum output power of the subsequent test configuration to initial test configuration, is  $\leq 1.2$  W/kg, no additional SAR tests for the subsequent test configurations are required. When 10g SAR measurement is considered, a factor of 2.5 is applied to the thresholds above.

FCC ID: ZNFX220QM	 PCTEST ENGINEERING LABORATORY, INC.	SAR EVALUATION REPORT	 LG	Approved by: Quality Manager
Document S/N: 1M1812110223-01-R1.ZNF	Test Dates: 12/12/18 - 01/02/19	DUT Type: Portable Handset	Page 21 of 67	

# 9 RF CONDUCTED POWERS

## 9.1 CDMA Conducted Powers



**Table 9-1  
Maximum Conducted Power**

Band	Channel	Frequency	SO55 [dBm]	SO55 [dBm]	TDSO SO32 [dBm]	TDSO SO32 [dBm]	1x EvDO Rev. 0 [dBm]	1x EvDO Rev. A [dBm]
	F-RC	MHz	RC1	RC3	FCH+SCH	FCH	(RTAP)	(RETAP)
Cellular	1013	824.7	24.55	24.45	24.50	24.42	24.59	24.50
	384	836.52	24.47	24.50	24.25	24.52	24.53	24.52
	777	848.31	24.57	24.42	24.26	24.45	24.64	24.50
PCS	25	1851.25	24.27	24.20	24.21	24.52	24.36	24.26
	600	1880	24.24	24.38	24.37	24.48	24.28	24.41
	1175	1908.75	24.28	24.29	24.27	24.57	24.38	24.37

Note: RC1 is only applicable for IS-95 compatibility.



**Figure 9-1  
Power Measurement Setup**

FCC ID: ZNFX220QM	 PCTEST ENGINEERING LABORATORY, INC.	SAR EVALUATION REPORT	 LG	Approved by: Quality Manager
Document S/N: 1M1812110223-01-R1.ZNF	Test Dates: 12/12/18 - 01/02/19	DUT Type: Portable Handset	Page 22 of 67	





## 9.2 GSM Conducted Powers

**Table 9-2  
Maximum Conducted Power**

Maximum Burst-Averaged Output Power						
Band	Channel	Voice	GPRS/EDGE Data (GMSK)		EDGE Data (8-PSK)	
		GSM [dBm] CS (1 Slot)	GPRS [dBm] 1 Tx Slot	GPRS [dBm] 2 Tx Slot	EDGE [dBm] 1 Tx Slot	EDGE [dBm] 2 Tx Slot
<b>GSM 850</b>	128	33.13	33.02	<b>31.37</b>	27.38	26.22
	190	33.05	32.91	<b>31.56</b>	27.52	26.33
	251	33.01	33.00	<b>31.21</b>	27.37	26.21
<b>GSM 1900</b>	512	29.87	29.82	<b>28.18</b>	26.47	25.45
	661	29.91	29.77	<b>28.06</b>	26.43	25.39
	810	30.01	29.88	<b>28.31</b>	26.40	25.39

Calculated Maximum Frame-Averaged Output Power						
Band	Channel	Voice	GPRS/EDGE Data (GMSK)		EDGE Data (8-PSK)	
		GSM [dBm] CS (1 Slot)	GPRS [dBm] 1 Tx Slot	GPRS [dBm] 2 Tx Slot	EDGE [dBm] 1 Tx Slot	EDGE [dBm] 2 Tx Slot
<b>GSM 850</b>	128	24.09	23.99	<b>25.35</b>	18.34	20.20
	190	24.02	23.88	<b>25.54</b>	18.49	20.30
	251	23.98	23.97	<b>25.19</b>	18.34	20.19
<b>GSM 1900</b>	512	20.84	20.79	<b>22.16</b>	17.44	19.43
	661	20.88	20.74	<b>22.04</b>	17.40	19.37
	810	20.98	20.85	<b>22.29</b>	17.37	19.36

<b>GSM 850</b>	<b>Frame</b>	23.67	23.67	<b>25.18</b>	18.17	20.18
<b>GSM 1900</b>	<b>Avg. Targets:</b>	20.67	20.67	<b>22.18</b>	17.17	19.18

FCC ID: ZNFX220QM	 <b>PCTEST</b> ENGINEERING LABORATORY, INC.	SAR EVALUATION REPORT		 <b>LG</b>	Approved by: Quality Manager
Document S/N: 1M1812110223-01-R1.ZNF	Test Dates: 12/12/18 - 01/02/19	DUT Type: Portable Handset		Page 23 of 67	



Note:

1. Both burst-averaged and calculated frame-averaged powers are included. Frame-averaged power was calculated from the measured burst-averaged power by converting the slot powers into linear units and calculating the energy over 8 timeslots.
2. GPRS/EDGE (GMSK) output powers were measured with coding scheme setting of 1 (CS1) on the base station simulator. CS1 was configured to measure GPRS output power measurements and SAR to ensure GMSK modulation in the signal. Our Investigation has shown that CS1 - CS4 settings do not have any impact on the output levels or modulation in the GPRS modes.
3. EDGE (8-PSK) output powers were measured with MCS7 on the base station simulator. MCS7 coding scheme was used to measure the output powers for EDGE since investigation has shown that choosing MCS7 coding scheme will ensure 8-PSK modulation. It has been shown that MCS levels that produce 8PSK modulation do not have an impact on output power.

**GSM Class: B**  
**GPRS Multislot class: 10 (Max 2 Tx uplink slots)**  
**EDGE Multislot class: 10 (Max 2 Tx uplink slots)**  
**DTM Multislot Class: N/A**



**Figure 9-2**  
**Power Measurement Setup**

FCC ID: ZNFX220QM	 <b>PCTEST</b> ENGINEERING LABORATORY, INC.	<b>SAR EVALUATION REPORT</b>	 <b>LG</b>	<b>Approved by:</b> Quality Manager
<b>Document S/N:</b> 1M1812110223-01-R1.ZNF	<b>Test Dates:</b> 12/12/18 - 01/02/19	<b>DUT Type:</b> Portable Handset	Page 24 of 67	

### 9.3 UMTS Conducted Powers

**Table 9-3  
Maximum Conducted Power**



3GPP Release Version	Mode	3GPP 34.121 Subtest	Cellular Band [dBm]			AWS Band [dBm]			PCS Band [dBm]			3GPP MPR [dB]
			4132	4183	4233	1312	1412	1513	9262	9400	9538	
99	WCDMA	12.2 kbps RMC	24.51	24.49	24.46	24.59	24.51	24.53	24.45	24.57	24.61	-
99		12.2 kbps AMR	24.49	24.51	24.50	24.60	24.51	24.54	24.46	24.57	24.61	-
6	HSDPA	Subtest 1	24.49	24.59	24.54	24.57	24.50	24.52	24.44	24.48	24.68	0
6		Subtest 2	24.59	24.57	24.53	24.54	24.45	24.61	24.36	24.46	24.62	0
6		Subtest 3	24.09	24.07	24.14	24.04	23.98	23.94	23.95	23.96	24.05	0.5
6		Subtest 4	24.12	24.10	24.13	24.04	23.97	23.93	23.96	23.99	24.16	0.5
6	HSUPA	Subtest 1	23.75	24.07	23.67	23.55	23.82	23.98	23.97	23.70	23.82	0
6		Subtest 2	22.93	22.38	22.92	22.98	22.94	22.98	22.36	22.95	23.17	2
6		Subtest 3	23.21	23.04	23.13	23.07	23.44	22.99	23.04	23.27	23.47	1
6		Subtest 4	22.91	23.19	23.01	23.11	23.04	23.20	22.66	22.87	23.09	2
6		Subtest 5	24.45	24.64	24.54	24.59	24.57	24.48	24.56	24.38	24.58	0

This device does not support DC-HSDPA.

It is expected by the manufacturer that MPR for some HSPA subtests may be up to 1 dB more than specified by 3GPP, but also as low as 0 dB according to the chipset implementation in this model.



**Figure 9-3  
Power Measurement Setup**

FCC ID: ZNFX220QM	 PCTEST ENGINEERING LABORATORY, INC.	SAR EVALUATION REPORT	 LG	Approved by: Quality Manager
Document S/N: 1M1812110223-01-R1.ZNF	Test Dates: 12/12/18 - 01/02/19	DUT Type: Portable Handset	Page 25 of 67	

## 9.4 LTE Conducted Powers

### 9.4.1 LTE Band 12



**Table 9-4  
LTE Band 12 Conducted Powers - 10 MHz Bandwidth**

LTE Band 12 10 MHz Bandwidth					
Modulation	RB Size	RB Offset	Mid Channel	MPR Allowed per 3GPP [dB]	MPR [dB]
			23095 (707.5 MHz)		
			Conducted Power [dBm]		
QPSK	1	0	24.39	0	0
	1	25	<b>24.49</b>		0
	1	49	24.33		0
	25	0	23.23	0-1	1
	25	12	<b>23.41</b>		1
	25	25	23.29		1
16QAM	50	0	23.27	0-1	1
	1	0	23.39		1
	1	25	23.58		1
	1	49	23.45	0-2	1
	25	0	22.67		2
	25	12	22.54		2
	25	25	22.43		2
	50	0	22.42		2

Note: LTE Band 12 at 10 MHz bandwidth does not support three non-overlapping channels. Per KDB Publication 941225 D05v02, when a device supports overlapping channel assignment in a channel bandwidth configuration, the middle channel of the group of overlapping channels should be selected for testing.

**Table 9-5  
LTE Band 12 Conducted Powers - 5 MHz Bandwidth**

LTE Band 12 5 MHz Bandwidth								
Modulation	RB Size	RB Offset	Low Channel	Mid Channel	High Channel	MPR Allowed per 3GPP [dB]	MPR [dB]	
			23035 (701.5 MHz)	23095 (707.5 MHz)	23155 (713.5 MHz)			
			Conducted Power [dBm]					
QPSK	1	0	24.30	24.18	24.50	0	0	
	1	12	24.49	24.60	24.51		0	
	1	24	24.23	24.60	24.61		0	
	QPSK	12	0	23.44	23.42	23.41	0-1	1
		12	6	23.40	23.47	23.47		1
		12	13	23.40	23.45	23.43		1
		25	0	23.38	23.45	23.38		1
16QAM	1	0	23.07	23.29	23.02	0-1	1	
	1	12	23.16	23.40	23.10		1	
	1	24	23.17	22.97	23.00		1	
	16QAM	12	0	22.31	22.43	22.54	0-2	2
		12	6	22.28	22.55	22.48		2
		12	13	22.21	22.45	22.47		2
		25	0	22.43	22.46	22.62		2
				22.43	22.46	22.62		2



FCC ID: ZNFX220QM	 PCTEST ENGINEERING LABORATORY, INC.	SAR EVALUATION REPORT	 LG	Approved by: Quality Manager
Document S/N: 1M1812110223-01-R1.ZNF	Test Dates: 12/12/18 - 01/02/19	DUT Type: Portable Handset		Page 26 of 67

**Table 9-6**  
**LTE Band 12 Conducted Powers - 3 MHz Bandwidth**

LTE Band 12 3 MHz Bandwidth							
Modulation	RB Size	RB Offset	Low Channel	Mid Channel	High Channel	MPR Allowed per 3GPP [dB]	MPR [dB]
			23025 (700.5 MHz)	23095 (707.5 MHz)	23165 (714.5 MHz)		
			Conducted Power [dBm]				
QPSK	1	0	24.44	24.33	24.42	0	0
	1	7	24.47	24.48	24.43		0
	1	14	24.25	24.40	24.61		0
	8	0	23.44	23.47	23.62	0-1	1
	8	4	23.45	23.54	23.33		1
	8	7	23.36	23.48	23.22		1
16QAM	15	0	23.38	23.40	23.36	0-1	1
	1	0	23.52	23.44	23.31		1
	1	7	23.68	23.49	23.64		1
	1	14	23.23	23.35	23.45	0-2	1
	8	0	22.56	22.20	22.40		2
	8	4	22.58	22.22	22.50		2
	8	7	22.46	22.31	22.57	2	
	15	0	22.40	22.33	22.33	2	

**Table 9-7**  
**LTE Band 12 Conducted Powers -1.4 MHz Bandwidth**

LTE Band 12 1.4 MHz Bandwidth							
Modulation	RB Size	RB Offset	Low Channel	Mid Channel	High Channel	MPR Allowed per 3GPP [dB]	MPR [dB]
			23017 (699.7 MHz)	23095 (707.5 MHz)	23173 (715.3 MHz)		
			Conducted Power [dBm]				
QPSK	1	0	24.52	24.50	24.31	0	0
	1	2	24.50	24.40	24.36		0
	1	5	24.41	24.34	24.52		0
	3	0	24.44	24.36	24.26		0
	3	2	24.66	24.33	24.37		0
	3	3	24.37	24.38	24.41		0
16QAM	6	0	23.39	23.39	23.40	0-1	1
	1	0	23.06	23.48	23.29	0-1	1
	1	2	23.10	23.60	23.65		1
	1	5	23.18	23.49	23.42		1
	3	0	23.45	23.68	22.96		1
	3	2	23.50	23.63	23.09		1
	3	3	23.48	23.67	23.11		1
	6	0	22.37	22.44	22.17		0-2

FCC ID: ZNFX220QM		SAR EVALUATION REPORT		Approved by: Quality Manager
Document S/N: 1M1812110223-01-R1.ZNF	Test Dates: 12/12/18 - 01/02/19	DUT Type: Portable Handset		Page 27 of 67

## 9.4.2 LTE Band 5 (Cell)



**Table 9-8**  
**LTE Band 5 (Cell) Conducted Powers - 10 MHz Bandwidth**

LTE Band 5 (Cell) 10 MHz Bandwidth					
Modulation	RB Size	RB Offset	Mid Channel	MPR Allowed per 3GPP [dB]	MPR [dB]
			20525 (836.5 MHz)		
			Conducted Power [dBm]		
QPSK	1	0	24.61	0	0
	1	25	<b>24.69</b>		0
	1	49	24.57		0
	25	0	23.61	0-1	1
	25	12	<b>23.69</b>		1
	25	25	23.60		1
16QAM	50	0	23.56	0-1	1
	1	0	23.54		1
	1	25	23.65		1
	1	49	23.38	0-2	1
	25	0	22.62		2
	25	12	22.61		2
	25	25	22.62		2
		50	0	22.64	2

Note: LTE Band 5 (Cell) at 10 MHz bandwidth does not support three non-overlapping channels. Per KDB Publication 941225 D05v02, when a device supports overlapping channel assignment in a channel bandwidth configuration, the middle channel of the group of overlapping channels should be selected for testing.

**Table 9-9**  
**LTE Band 5 (Cell) Conducted Powers - 5 MHz Bandwidth**

LTE Band 5 (Cell) 5 MHz Bandwidth							
Modulation	RB Size	RB Offset	Low Channel	Mid Channel	High Channel	MPR Allowed per 3GPP [dB]	MPR [dB]
			20425 (826.5 MHz)	20525 (836.5 MHz)	20625 (846.5 MHz)		
			Conducted Power [dBm]				
QPSK	1	0	24.19	24.43	24.64	0	0
	1	12	24.43	24.36	24.45		0
	1	24	24.34	24.41	24.65		0
	12	0	23.47	23.69	23.65	0-1	1
	12	6	23.60	23.62	23.70		1
	12	13	23.56	23.67	23.47		1
16QAM	25	0	23.54	23.65	23.60	0-1	1
	1	0	22.99	23.42	23.32		1
	1	12	23.11	23.55	23.33		1
	1	24	23.09	23.42	23.01	0-2	1
	12	0	22.43	22.46	22.57		2
	12	6	22.37	22.50	22.62		2
	12	13	22.40	22.38	22.46		2
	25	0	22.51	22.51	22.53	2	



FCC ID: ZNFX220QM	 PCTEST ENGINEERING LABORATORY, INC.	SAR EVALUATION REPORT	 LG	Approved by: Quality Manager
Document S/N: 1M1812110223-01-R1.ZNF	Test Dates: 12/12/18 - 01/02/19	DUT Type: Portable Handset		Page 28 of 67

**Table 9-10**  
**LTE Band 5 (Cell) Conducted Powers - 3 MHz Bandwidth**

LTE Band 5 (Cell) 3 MHz Bandwidth							
Modulation	RB Size	RB Offset	Low Channel	Mid Channel	High Channel	MPR Allowed per 3GPP [dB]	MPR [dB]
			20415 (825.5 MHz)	20525 (836.5 MHz)	20635 (847.5 MHz)		
			Conducted Power [dBm]				
QPSK	1	0	24.63	24.54	24.64	0	0
	1	7	24.68	24.67	24.70		0
	1	14	24.59	24.61	24.43		0
	8	0	23.54	23.66	23.51	0-1	1
	8	4	23.54	23.67	23.48		1
	8	7	23.62	23.70	23.51		1
	15	0	23.58	23.61	23.54		1
16QAM	1	0	23.36	23.65	23.61	0-1	1
	1	7	23.33	23.61	23.52		1
	1	14	23.30	23.65	23.63		1
	8	0	22.63	22.43	22.51	0-2	2
	8	4	22.65	22.32	22.58		2
	8	7	22.61	22.39	22.65		2
	15	0	22.55	22.66	22.51		2

**Table 9-11**  
**LTE Band 5 (Cell) Conducted Powers -1.4 MHz Bandwidth**

LTE Band 5 (Cell) 1.4 MHz Bandwidth							
Modulation	RB Size	RB Offset	Low Channel	Mid Channel	High Channel	MPR Allowed per 3GPP [dB]	MPR [dB]
			20407 (824.7 MHz)	20525 (836.5 MHz)	20643 (848.3 MHz)		
			Conducted Power [dBm]				
QPSK	1	0	24.41	24.47	24.43	0	0
	1	2	24.70	24.53	24.49		0
	1	5	24.39	24.45	24.38		0
	3	0	24.51	24.59	24.58		0
	3	2	24.66	24.64	24.65		0
	3	3	24.63	24.59	24.61		0
	6	0	23.59	23.59	23.52	0-1	1
16QAM	1	0	23.41	23.38	23.35	0-1	1
	1	2	23.41	23.50	23.43		1
	1	5	23.33	23.47	23.33		1
	3	0	22.95	23.69	23.10		1
	3	2	23.25	23.35	23.08		1
	3	3	23.50	23.69	23.03		1
	6	0	22.32	22.50	22.23	0-2	2

FCC ID: ZNFX220QM		SAR EVALUATION REPORT		Approved by: Quality Manager
Document S/N: 1M1812110223-01-R1.ZNF	Test Dates: 12/12/18 - 01/02/19	DUT Type: Portable Handset		Page 29 of 67



9.4.3

LTE Band 4 (AWS)



**Table 9-12**  
**LTE Band 4 (AWS) Conducted Powers - 20 MHz Bandwidth**

LTE Band 4 (AWS) 20 MHz Bandwidth					
Modulation	RB Size	RB Offset	Mid Channel	MPR Allowed per 3GPP [dB]	MPR [dB]
			20175 (1732.5 MHz)		
			Conducted Power [dBm]		
QPSK	1	0	24.22	0	0
	1	50	24.61		0
	1	99	24.16		0
	50	0	23.44	0-1	1
	50	25	23.51		1
	50	50	23.46		1
16QAM	100	0	23.42	0-1	1
	1	0	23.06		1
	1	50	23.59		1
	1	99	23.03	0-2	1
	50	0	22.41		2
	50	25	22.57		2
	50	50	22.40		2
	100	0	22.42	2	

Note: LTE Band 4 (AWS) at 20 MHz bandwidth does not support three non-overlapping channels. Per KDB Publication 941225 D05v02, when a device supports overlapping channel assignment in a channel bandwidth configuration, the middle channel of the group of overlapping channels should be selected for testing.

**Table 9-13**  
**LTE Band 4 (AWS) Conducted Powers - 15 MHz Bandwidth**

LTE Band 4 (AWS) 15 MHz Bandwidth							
Modulation	RB Size	RB Offset	Low Channel	Mid Channel	High Channel	MPR Allowed per 3GPP [dB]	MPR [dB]
			20025 (1717.5 MHz)	20175 (1732.5 MHz)	20325 (1747.5 MHz)		
			Conducted Power [dBm]				
QPSK	1	0	24.19	24.42	24.60	0	0
	1	36	24.54	24.49	24.10		0
	1	74	24.38	24.42	24.61		0
	36	0	23.49	23.51	23.33	0-1	1
	36	18	23.47	23.51	23.43		1
	36	37	23.45	23.38	23.25		1
	75	0	23.36	23.34	23.28		1
16QAM	1	0	23.58	23.47	23.31	0-1	1
	1	36	23.53	23.55	23.50		1
	1	74	23.41	23.33	23.56		1
	36	0	22.61	22.47	22.28	0-2	2
	36	18	22.58	22.64	22.50		2
	36	37	22.45	22.34	22.34		2
	75	0	22.47	22.43	22.37		2



FCC ID: ZNFX220QM		SAR EVALUATION REPORT		Approved by: Quality Manager
Document S/N: 1M1812110223-01-R1.ZNF	Test Dates: 12/12/18 - 01/02/19	DUT Type: Portable Handset		Page 30 of 67

**Table 9-14**  
**LTE Band 4 (AWS) Conducted Powers - 10 MHz Bandwidth**

LTE Band 4 (AWS) 10 MHz Bandwidth							
Modulation	RB Size	RB Offset	Low Channel	Mid Channel	High Channel	MPR Allowed per 3GPP [dB]	MPR [dB]
			20000 (1715.0 MHz)	20175 (1732.5 MHz)	20350 (1750.0 MHz)		
			Conducted Power [dBm]				
QPSK	1	0	24.39	24.33	24.50	0	0
	1	25	24.61	24.60	24.64		0
	1	49	24.37	24.49	24.62		0
	25	0	23.61	23.56	23.35	0-1	1
	25	12	23.45	23.51	23.36		1
	25	25	23.34	23.36	23.29		1
16QAM	50	0	23.40	23.44	23.38	0-1	1
	1	0	23.24	23.05	23.45		1
	1	25	23.30	23.66	23.60		1
	1	49	23.00	23.16	23.51	0-2	1
	25	0	22.64	22.51	22.31		2
	25	12	22.65	22.56	22.36		2
	25	25	22.52	22.53	22.22	2	
	50	0	22.50	22.45	22.47	2	

**Table 9-15**  
**LTE Band 4 (AWS) Conducted Powers - 5 MHz Bandwidth**

LTE Band 4 (AWS) 5 MHz Bandwidth							
Modulation	RB Size	RB Offset	Low Channel	Mid Channel	High Channel	MPR Allowed per 3GPP [dB]	MPR [dB]
			19975 (1712.5 MHz)	20175 (1732.5 MHz)	20375 (1752.5 MHz)		
			Conducted Power [dBm]				
QPSK	1	0	24.40	24.35	24.16	0	0
	1	12	24.68	24.55	24.61		0
	1	24	24.04	24.54	24.51		0
	12	0	23.43	23.45	23.32	0-1	1
	12	6	23.54	23.46	23.38		1
	12	13	23.54	23.52	23.35		1
16QAM	25	0	23.50	23.44	23.32	0-1	1
	1	0	23.41	23.24	22.82		1
	1	12	23.51	23.49	22.97		1
	1	24	23.32	23.37	22.91	0-2	1
	12	0	22.33	22.26	22.32		2
	12	6	22.30	22.34	22.38		2
	12	13	22.31	22.41	22.46	2	
	25	0	22.46	22.36	22.53	2	



FCC ID: ZNFX220QM	 <b>PCTEST</b> <small>ENGINEERING LABORATORY, INC.</small>	<b>SAR EVALUATION REPORT</b>	 <b>LG</b>	<b>Approved by:</b> Quality Manager
<b>Document S/N:</b> 1M1812110223-01-R1.ZNF	<b>Test Dates:</b> 12/12/18 - 01/02/19	<b>DUT Type:</b> Portable Handset	Page 31 of 67	

**Table 9-16**  
**LTE Band 4 (AWS) Conducted Powers - 3 MHz Bandwidth**

LTE Band 4 (AWS) 3 MHz Bandwidth							
Modulation	RB Size	RB Offset	Low Channel	Mid Channel	High Channel	MPR Allowed per 3GPP [dB]	MPR [dB]
			19965 (1711.5 MHz)	20175 (1732.5 MHz)	20385 (1753.5 MHz)		
			Conducted Power [dBm]				
QPSK	1	0	24.49	24.56	24.18	0	0
	1	7	24.57	24.64	24.55		0
	1	14	24.52	24.60	24.49		0
	8	0	23.42	23.50	23.35	0-1	1
	8	4	23.47	23.52	23.41		1
	8	7	23.47	23.59	23.28		1
	15	0	23.44	23.52	23.21		1
16QAM	1	0	23.21	23.45	23.35	0-1	1
	1	7	23.25	23.51	23.45		1
	1	14	23.18	23.38	23.53		1
	8	0	22.39	22.21	22.34	0-2	2
	8	4	22.45	22.22	22.35		2
	8	7	22.43	22.53	22.39		2
	15	0	22.58	22.35	22.27		2

**Table 9-17**  
**LTE Band 4 (AWS) Conducted Powers - 1.4 MHz Bandwidth**

LTE Band 4 (AWS) 1.4 MHz Bandwidth							
Modulation	RB Size	RB Offset	Low Channel	Mid Channel	High Channel	MPR Allowed per 3GPP [dB]	MPR [dB]
			19957 (1710.7 MHz)	20175 (1732.5 MHz)	20393 (1754.3 MHz)		
			Conducted Power [dBm]				
QPSK	1	0	24.51	24.50	24.40	0	0
	1	2	24.57	24.61	24.34		0
	1	5	24.44	24.61	24.41		0
	3	0	24.55	24.39	24.43		0
	3	2	24.54	24.46	24.42		0
	3	3	24.55	24.52	24.46		0
	6	0	23.40	23.44	23.24	0-1	1
16QAM	1	0	23.18	23.42	23.47	0-1	1
	1	2	23.14	23.44	23.54		1
	1	5	23.16	23.56	23.26		1
	3	0	22.99	23.23	22.80		1
	3	2	23.06	23.61	22.91		1
	3	3	23.01	23.67	22.85		1
	6	0	22.22	22.70	22.38	0-2	2

FCC ID: ZNFX220QM	 <b>PCTEST</b> <small>ENGINEERING LABORATORY, INC.</small>	<b>SAR EVALUATION REPORT</b>	 <b>LG</b>	<b>Approved by:</b> Quality Manager
<b>Document S/N:</b> 1M1812110223-01-R1.ZNF	<b>Test Dates:</b> 12/12/18 - 01/02/19	<b>DUT Type:</b> Portable Handset	Page 32 of 67	

9.4.4



LTE Band 25 (PCS)

**Table 9-18**  
**LTE Band 25 (PCS) Conducted Powers - 20 MHz Bandwidth**

LTE Band 25 (PCS) 20 MHz Bandwidth							
Modulation	RB Size	RB Offset	Low Channel	Mid Channel	High Channel	MPR Allowed per 3GPP [dB]	MPR [dB]
			26140 (1860.0 MHz)	26365 (1882.5 MHz)	26590 (1905.0 MHz)		
Conducted Power [dBm]							
QPSK	1	0	24.41	24.11	24.06	0	0
	1	50	<b>24.47</b>	24.35	24.06		0
	1	99	24.17	24.00	24.23		0
	50	0	23.21	23.08	23.11	0-1	1
	50	25	<b>23.31</b>	23.27	23.18		1
	50	50	23.10	23.25	23.08		1
16QAM	100	0	23.20	23.05	23.15	0-1	1
	1	0	23.16	23.05	23.12		1
	1	50	23.36	23.65	23.22		1
	1	99	22.99	22.91	23.06	0-2	1
	50	0	22.09	22.13	22.11		2
	50	25	22.39	22.11	22.35		2
	50	50	22.29	22.07	22.07	2	
	100	0	22.19	22.12	22.16	2	

**Table 9-19**  
**LTE Band 25 (PCS) Conducted Powers - 15 MHz Bandwidth**

LTE Band 25 (PCS) 15 MHz Bandwidth							
Modulation	RB Size	RB Offset	Low Channel	Mid Channel	High Channel	MPR Allowed per 3GPP [dB]	MPR [dB]
			26115 (1857.5 MHz)	26365 (1882.5 MHz)	26615 (1907.5 MHz)		
Conducted Power [dBm]							
QPSK	1	0	24.13	24.02	24.51	0	0
	1	36	24.39	24.17	24.36		0
	1	74	24.03	23.98	24.30		0
	36	0	23.40	23.04	23.14	0-1	1
	36	18	23.35	23.22	23.23		1
	36	37	23.17	23.36	23.10		1
16QAM	75	0	23.26	23.25	23.16	0-1	1
	1	0	23.00	23.55	22.98		1
	1	36	23.53	23.57	23.41		1
	1	74	23.52	23.61	23.36	0-2	1
	36	0	22.30	21.99	22.08		2
	36	18	22.45	22.24	22.29		2
	36	37	22.27	22.26	22.09	2	
	75	0	22.16	22.19	22.13	2	



FCC ID: ZNFX220QM	 PCTEST ENGINEERING LABORATORY, INC.	SAR EVALUATION REPORT	 LG	Approved by: Quality Manager
Document S/N: 1M1812110223-01-R1.ZNF	Test Dates: 12/12/18 - 01/02/19	DUT Type: Portable Handset		Page 33 of 67

**Table 9-20**  
**LTE Band 25 (PCS) Conducted Powers - 10 MHz Bandwidth**

LTE Band 25 (PCS) 10 MHz Bandwidth							
Modulation	RB Size	RB Offset	Low Channel	Mid Channel	High Channel	MPR Allowed per 3GPP [dB]	MPR [dB]
			26090 (1855.0 MHz)	26365 (1882.5 MHz)	26640 (1910.0 MHz)		
			Conducted Power [dBm]				
QPSK	1	0	24.18	24.23	24.38	0	0
	1	25	24.57	24.36	24.58		0
	1	49	24.12	24.01	24.37		0
	25	0	23.24	23.08	23.19	0-1	1
	25	12	23.50	23.29	23.27		1
	25	25	23.29	23.31	23.23		1
16QAM	50	0	23.36	23.27	23.15	0-1	1
	1	0	23.60	22.97	23.26		1
	1	25	23.64	23.17	23.43		1
	1	49	23.10	23.16	23.35	0-2	1
	25	0	22.24	22.23	22.44		2
	25	12	22.67	22.44	22.34		2
	25	25	22.48	22.45	22.31		2
	50	0	22.56	22.24	22.33	2	

**Table 9-21**  
**LTE Band 25 (PCS) Conducted Powers - 5 MHz Bandwidth**

LTE Band 25 (PCS) 5 MHz Bandwidth							
Modulation	RB Size	RB Offset	Low Channel	Mid Channel	High Channel	MPR Allowed per 3GPP [dB]	MPR [dB]
			26065 (1852.5 MHz)	26365 (1882.5 MHz)	26665 (1912.5 MHz)		
			Conducted Power [dBm]				
QPSK	1	0	24.11	23.85	24.47	0	0
	1	12	24.17	24.15	24.52		0
	1	24	24.20	24.03	24.17		0
	12	0	23.23	22.97	23.26	0-1	1
	12	6	23.35	23.17	23.20		1
	12	13	23.25	23.24	23.19		1
16QAM	25	0	23.20	23.21	23.25	0-1	1
	1	0	22.81	22.95	23.06		1
	1	12	23.09	23.22	23.16		1
	1	24	22.96	23.07	22.70	0-2	1
	12	0	22.13	21.99	22.21		2
	12	6	22.34	22.09	22.16		2
	12	13	22.26	22.16	22.22		2
25	0	22.32	22.34	22.34	2		



FCC ID: ZNFX220QM		SAR EVALUATION REPORT		Approved by: Quality Manager
Document S/N: 1M1812110223-01-R1.ZNF	Test Dates: 12/12/18 - 01/02/19	DUT Type: Portable Handset		Page 34 of 67

**Table 9-22**  
**LTE Band 25 (PCS) Conducted Powers - 3 MHz Bandwidth**

LTE Band 25 (PCS) 3 MHz Bandwidth							
Modulation	RB Size	RB Offset	Low Channel	Mid Channel	High Channel	MPR Allowed per 3GPP [dB]	MPR [dB]
			26055 (1851.5 MHz)	26365 (1882.5 MHz)	26675 (1913.5 MHz)		
			Conducted Power [dBm]				
QPSK	1	0	24.45	24.04	24.34	0	0
	1	7	24.44	24.44	24.42		0
	1	14	24.40	24.37	24.10		0
	8	0	23.39	23.09	23.22	0-1	1
	8	4	23.36	23.15	23.09		1
	8	7	23.38	23.33	23.11		1
	15	0	23.32	23.22	23.18		1
16QAM	1	0	23.07	23.14	23.54	0-1	1
	1	7	23.60	23.18	23.50		1
	1	14	23.61	23.13	23.30		1
	8	0	22.42	22.20	22.61	0-2	2
	8	4	22.41	22.27	22.36		2
	8	7	22.41	22.35	21.97		2
	15	0	22.33	22.05	22.15		2

**Table 9-23**  
**LTE Band 25 (PCS) Conducted Powers -1.4 MHz Bandwidth**

LTE Band 25 (PCS) 1.4 MHz Bandwidth							
Modulation	RB Size	RB Offset	Low Channel	Mid Channel	High Channel	MPR Allowed per 3GPP [dB]	MPR [dB]
			26047 (1850.7 MHz)	26365 (1882.5 MHz)	26683 (1914.3 MHz)		
			Conducted Power [dBm]				
QPSK	1	0	24.46	24.30	24.24	0	0
	1	2	24.42	24.16	24.18		0
	1	5	24.28	24.23	24.09		0
	3	0	24.44	24.08	24.21		0
	3	2	24.56	24.15	24.12		0
	3	3	24.42	24.22	24.21		0
	6	0	23.29	23.10	23.04	0-1	1
16QAM	1	0	22.99	23.00	23.66	0-1	1
	1	2	23.06	23.05	23.24		1
	1	5	23.05	23.16	22.93		1
	3	0	23.63	23.35	23.02		1
	3	2	23.39	23.26	22.86		1
	3	3	23.33	23.25	22.90		1
	6	0	22.25	22.25	22.51	0-2	2

FCC ID: ZNFX220QM		SAR EVALUATION REPORT		Approved by: Quality Manager
Document S/N: 1M1812110223-01-R1.ZNF	Test Dates: 12/12/18 - 01/02/19	DUT Type: Portable Handset		Page 35 of 67

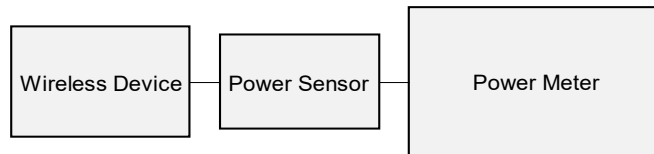
## 9.5 WLAN Conducted Powers

**Table 9-24**  
**2.4 GHz WLAN Average RF Power**

2.4GHz Conducted Power [dBm]				
Freq [MHz]	Channel	IEEE Transmission Mode		
		802.11b	802.11g	802.11n
2412	1	14.85	11.55	10.56
2417	2	N/A	11.95	11.17
2437	6	14.98	12.11	10.99
2457	10	N/A	12.14	10.83
2462	11	<b>15.05</b>	9.46	7.63

Justification for test configurations for WLAN per KDB Publication 248227 D01v02r02:

- Power measurements were performed for the transmission mode configuration with the highest maximum output power specified for production units.
- For transmission modes with the same maximum output power specification, powers were measured for the largest channel bandwidth, lowest order modulation and lowest data rate.
- For transmission modes with identical maximum specified output power, channel bandwidth, modulation and data rates, power measurements were required for all identical configurations.
- For each transmission mode configuration, powers were measured for the highest and lowest channels; and at the mid-band channel(s) when there were at least 3 channels supported. For configurations with multiple mid-band channels, due to an even number of channels, both channels were measured.
- The bolded data rate and channel above were tested for SAR.





**Figure 9-4**  
**Power Measurement Setup**

## 9.6 Bluetooth Conducted Powers

**Table 9-25**  
**Bluetooth Average RF Power**

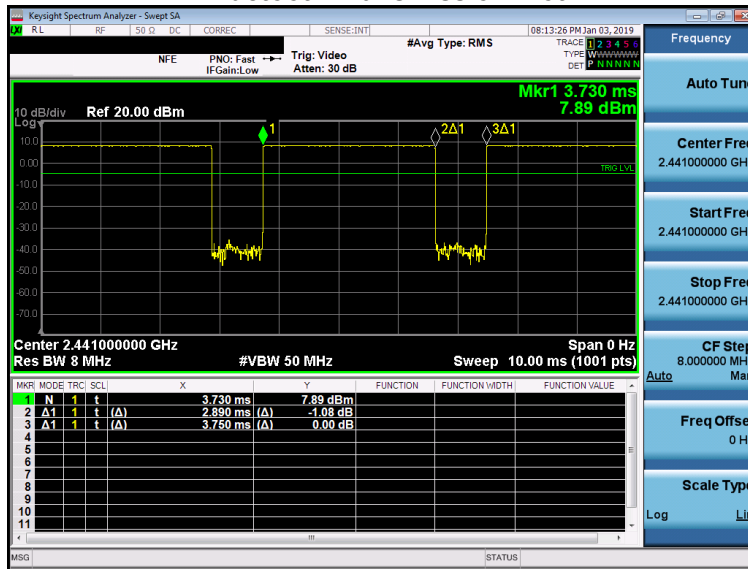
Frequency [MHz]	Data Rate [Mbps]	Channel No.	Avg Conducted Power	
			[dBm]	[mW]
2402	1.0	0	9.69	9.319
2441	1.0	39	<b>10.97</b>	12.512
2480	1.0	78	9.24	8.400
2402	2.0	0	9.42	8.751
2441	2.0	39	10.51	11.255
2480	2.0	78	8.69	7.392
2402	3.0	0	9.52	8.946
2441	3.0	39	10.59	11.445
2480	3.0	78	8.77	7.534

Note: The bolded data rates and channel above were tested for SAR.

FCC ID: ZNFX220QM	 <b>PCTEST</b> ENGINEERING LABORATORY, INC.	<b>SAR EVALUATION REPORT</b>		<b>Approved by:</b> Quality Manager
<b>Document S/N:</b> 1M1812110223-01-R1.ZNF	<b>Test Dates:</b> 12/12/18 - 01/02/19	<b>DUT Type:</b> Portable Handset	Page 36 of 67	

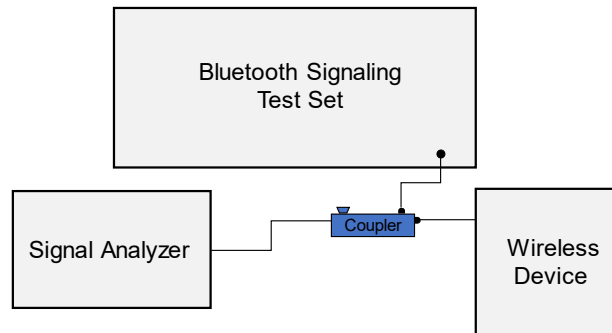


**Figure 9-5  
Bluetooth Transmission Plot**



**Equation 9-1  
Bluetooth Duty Cycle Calculation**

$$Duty\ Cycle = \frac{Pulse\ Width}{Period} * 100\% = \frac{2.89ms}{3.75ms} * 100\% = 77.1\%$$



**Figure 9-6  
Power Measurement Setup**



FCC ID: ZNFX220QM		SAR EVALUATION REPORT		Approved by: Quality Manager
Document S/N: 1M1812110223-01-R1.ZNF	Test Dates: 12/12/18 - 01/02/19	DUT Type: Portable Handset		Page 37 of 67

# 10 SYSTEM VERIFICATION

## 10.1 Tissue Verification

**Table 10-1  
Measured Tissue Properties – Head**



Calibrated for Tests Performed on:	Tissue Type	Tissue Temp During Calibration (°C)	Measured Frequency (MHz)	Measured Conductivity, $\sigma$ (S/m)	Measured Dielectric Constant, $\epsilon$	TARGET Conductivity, $\sigma$ (S/m)	TARGET Dielectric Constant, $\epsilon$	% dev $\sigma$	% dev $\epsilon$
12/19/2018	750H	19.8	700	0.860	42.519	0.889	42.201	-3.26%	0.75%
			710	0.863	42.476	0.890	42.149	-3.03%	0.78%
			740	0.874	42.354	0.893	41.994	-2.13%	0.86%
			755	0.880	42.310	0.894	41.916	-1.57%	0.94%
12/19/2018	835H	21.9	820	0.914	43.153	0.899	41.578	1.67%	3.79%
			835	0.929	42.966	0.900	41.500	3.22%	3.53%
			850	0.944	42.786	0.916	41.500	3.06%	3.10%
12/26/2018	835H	20.3	820	0.897	42.927	0.899	41.578	-0.22%	3.24%
			835	0.912	42.746	0.900	41.500	1.33%	3.00%
			850	0.927	42.554	0.916	41.500	1.20%	2.54%
12/25/2018	1750H	20.8	1710	1.356	39.031	1.348	40.142	0.59%	-2.77%
			1750	1.382	38.985	1.371	40.079	0.80%	-2.73%
			1790	1.405	38.885	1.394	40.016	0.79%	-2.83%
12/31/2018	1750H	20.8	1710	1.341	38.791	1.348	40.142	-0.52%	-3.37%
			1750	1.364	38.734	1.371	40.079	-0.51%	-3.36%
			1790	1.386	38.661	1.394	40.016	-0.57%	-3.39%
12/22/2018	1900H	22.3	1850	1.373	39.993	1.400	40.000	-1.93%	-0.02%
			1880	1.404	39.859	1.400	40.000	0.29%	-0.35%
			1910	1.434	39.745	1.400	40.000	2.43%	-0.64%
12/31/2018	1900H	20.8	1850	1.423	38.587	1.400	40.000	1.64%	-3.53%
			1880	1.440	38.549	1.400	40.000	2.86%	-3.63%
			1910	1.458	38.496	1.400	40.000	4.14%	-3.76%
12/17/2018	2450H	22.7	2400	1.805	38.467	1.756	39.289	2.79%	-2.09%
			2450	1.862	38.272	1.800	39.200	3.44%	-2.37%
			2500	1.914	38.094	1.855	39.136	3.18%	-2.66%
12/31/2018	2450H	22.5	2400	1.770	38.636	1.756	39.289	0.80%	-1.66%
			2450	1.828	38.467	1.800	39.200	1.56%	-1.87%
			2500	1.882	38.270	1.855	39.136	1.46%	-2.21%

FCC ID: ZNFX220QM	 PCTEST ENGINEERING LABORATORY, INC.	SAR EVALUATION REPORT	 LG	Approved by: Quality Manager
Document S/N: 1M1812110223-01-R1.ZNF	Test Dates: 12/12/18 - 01/02/19	DUT Type: Portable Handset		Page 38 of 67

**Table 10-2  
Measured Tissue Properties - Body**

Calibrated for Tests Performed on:	Tissue Type	Tissue Temp During Calibration (°C)	Measured Frequency (MHz)	Measured Conductivity, $\sigma$ (S/m)	Measured Dielectric Constant, $\epsilon$	TARGET Conductivity, $\sigma$ (S/m)	TARGET Dielectric Constant, $\epsilon$	% dev $\sigma$	% dev $\epsilon$
12/17/2018	750B	20.5	700	0.925	54.652	0.959	55.726	-3.55%	-1.93%
			710	0.928	54.624	0.960	55.687	-3.33%	-1.91%
			740	0.940	54.506	0.963	55.570	-2.39%	-1.91%
			755	0.946	54.462	0.964	55.512	-1.87%	-1.89%
12/13/2018	835B	20.0	820	0.997	54.975	0.969	55.258	2.89%	-0.51%
			835	1.003	54.950	0.970	55.200	3.40%	-0.45%
			850	1.010	54.918	0.988	55.154	2.23%	-0.43%
12/26/2018	835B	19.1	820	0.959	53.645	0.969	55.258	-1.03%	-2.92%
			835	0.965	53.598	0.970	55.200	-0.52%	-2.90%
			850	0.972	53.536	0.988	55.154	-1.62%	-2.93%
1/2/2019	1750B	21.5	1710	1.464	52.622	1.463	53.537	0.07%	-1.71%
			1750	1.512	52.517	1.488	53.432	1.61%	-1.71%
			1790	1.556	52.347	1.514	53.326	2.77%	-1.84%
12/12/2018	1900B	23.0	1850	1.496	51.280	1.520	53.300	-1.58%	-3.79%
			1880	1.529	51.157	1.520	53.300	0.59%	-4.02%
			1910	1.570	51.100	1.520	53.300	3.29%	-4.13%
12/31/2018	1900B	22.0	1850	1.522	53.166	1.520	53.300	0.13%	-0.25%
			1880	1.555	53.074	1.520	53.300	2.30%	-0.42%
			1910	1.589	52.976	1.520	53.300	4.54%	-0.61%
1/2/2019	1900B	22.3	1850	1.488	52.635	1.520	53.300	-2.11%	-1.25%
			1880	1.521	52.539	1.520	53.300	0.07%	-1.43%
			1910	1.554	52.423	1.520	53.300	2.24%	-1.65%
12/30/2018	2450B	23.8	2400	1.953	50.822	1.902	52.767	2.68%	-3.69%
			2450	2.007	50.738	1.950	52.700	2.92%	-3.72%
			2500	2.073	50.562	2.021	52.636	2.57%	-3.94%

The above measured tissue parameters were used in the DASY software. The DASY software was used to perform interpolation to determine the dielectric parameters at the SAR test device frequencies (per KDB Publication 865664 D01v01r04 and IEEE 1528-2013 6.6.1.2). The tissue parameters listed in the SAR test plots may slightly differ from the table above due to significant digit rounding in the software.

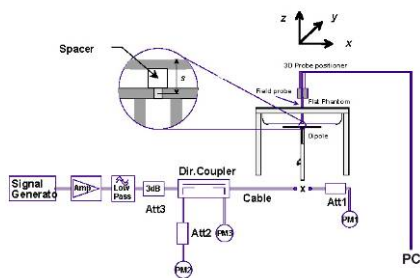
FCC ID: ZNFX220QM		SAR EVALUATION REPORT		Approved by: Quality Manager
Document S/N: 1M1812110223-01-R1.ZNF	Test Dates: 12/12/18 - 01/02/19	DUT Type: Portable Handset		Page 39 of 67

## 10.2 Test System Verification

Prior to SAR assessment, the system is verified to  $\pm 10\%$  of the SAR measurement on the reference dipole at the time of calibration by the calibration facility. Full system validation status and result summary can be found in Appendix E.

**Table 10-3  
System Verification Results**



System Verification TARGET & MEASURED												
SAR System #	Tissue Frequency (MHz)	Tissue Type	Date	Amb. Temp (°C)	Liquid Temp (°C)	Input Power (W)	Source SN	Probe SN	Measured SAR <sub>1g</sub> (W/kg)	1 W Target SAR <sub>1g</sub> (W/kg)	1 W Normalized SAR <sub>1g</sub> (W/kg)	Deviation <sub>1g</sub> (%)
M	750	HEAD	12/19/2018	21.3	19.8	0.200	1054	3287	1.730	8.370	8.650	3.35%
G	835	HEAD	12/19/2018	23.0	22.1	0.200	4d047	7410	2.040	9.470	10.200	7.71%
G	835	HEAD	12/26/2018	21.7	20.3	0.200	4d047	7410	1.970	9.470	9.850	4.01%
M	1750	HEAD	12/25/2018	19.8	19.8	0.100	1148	3287	3.660	36.400	36.600	0.55%
M	1750	HEAD	12/31/2018	21.7	20.8	0.100	1148	3287	3.350	36.400	33.500	-7.97%
H	1900	HEAD	12/22/2018	20.7	22.3	0.100	5d080	7409	3.970	39.800	39.700	-0.25%
M	1900	HEAD	12/31/2018	21.7	20.8	0.100	5d148	3287	4.190	40.100	41.900	4.49%
G	2450	HEAD	12/17/2018	21.9	22.0	0.100	981	7410	5.250	52.300	52.500	0.38%
I	2450	HEAD	12/31/2018	20.5	20.7	0.100	719	7406	5.100	51.900	51.000	-1.73%
I	750	BODY	12/17/2018	20.1	20.1	0.200	1054	7406	1.780	8.610	8.900	3.37%
I	835	BODY	12/13/2018	20.4	20.0	0.200	4d047	7406	2.000	9.710	10.000	2.99%
J	835	BODY	12/26/2018	19.9	19.1	0.200	4d133	3347	1.960	9.750	9.800	0.51%
D	1750	BODY	01/02/2019	22.3	21.5	0.100	1150	7357	3.710	36.600	37.100	1.37%
E	1900	BODY	12/12/2018	23.6	22.0	0.100	5d080	3332	4.200	39.200	42.000	7.14%
E	1900	BODY	12/31/2018	21.1	22.0	0.100	5d148	3332	4.130	39.600	41.300	4.29%
E	1900	BODY	01/02/2019	22.9	22.4	0.100	5d080	3332	3.860	39.200	38.600	-1.53%
K	2450	BODY	12/30/2018	21.9	22.5	0.100	797	3319	5.150	51.100	51.500	0.78%



**Figure 10-1  
System Verification Setup Diagram**



**Figure 10-2  
System Verification Setup Photo**

FCC ID: ZNFX220QM	 PCTEST ENGINEERING LABORATORY, INC.	SAR EVALUATION REPORT	 LG	Approved by: Quality Manager
Document S/N: 1M1812110223-01-R1-ZNF	Test Dates: 12/12/18 - 01/02/19	DUT Type: Portable Handset	Page 40 of 67	

# 11 SAR DATA SUMMARY



## 11.1 Standalone Head SAR Data

**Table 11-1  
GSM 850 Head SAR**

MEASUREMENT RESULTS															
FREQUENCY		Mode/Band	Service	Maximum Allowed Power [dBm]	Conducted Power [dBm]	Power Drift [dB]	Side	Test Position	Device Serial Number	# of Time Slots	Duty Cycle	SAR (1g)	Scaling Factor	Reported SAR (1g)	Plot #
MHz	Ch.											(W/kg)		(W/kg)	
836.60	190	GSM 850	GSM	33.2	33.05	-0.06	Right	Cheek	03058	1	1:8.3	0.368	1.035	0.381	
836.60	190	GSM 850	GSM	33.2	33.05	0.09	Right	Tilt	03058	1	1:8.3	0.167	1.035	0.173	
836.60	190	GSM 850	GSM	33.2	33.05	0.08	Left	Cheek	03058	1	1:8.3	0.267	1.035	0.276	
836.60	190	GSM 850	GSM	33.2	33.05	0.08	Left	Tilt	03058	1	1:8.3	0.151	1.035	0.156	
836.60	190	GSM 850	GPRS	31.7	31.56	-0.01	Right	Cheek	03058	2	1:4.15	0.410	1.033	0.424	A1
836.60	190	GSM 850	GPRS	31.7	31.56	-0.02	Right	Tilt	03058	2	1:4.15	0.191	1.033	0.197	
836.60	190	GSM 850	GPRS	31.7	31.56	0.15	Left	Cheek	03058	2	1:4.15	0.336	1.033	0.347	
836.60	190	GSM 850	GPRS	31.7	31.56	0.03	Left	Tilt	03058	2	1:4.15	0.178	1.033	0.184	
ANSI / IEEE C95.1 1992 - SAFETY LIMIT Spatial Peak Uncontrolled Exposure/General Population								Head 1.6 W/kg (mW/g) averaged over 1 gram							

**Table 11-2  
GSM 1900 Head SAR**

MEASUREMENT RESULTS															
FREQUENCY		Mode/Band	Service	Maximum Allowed Power [dBm]	Conducted Power [dBm]	Power Drift [dB]	Side	Test Position	Device Serial Number	# of Time Slots	Duty Cycle	SAR (1g)	Scaling Factor	Reported SAR (1g)	Plot #
MHz	Ch.											(W/kg)		(W/kg)	
1880.00	661	GSM 1900	GSM	30.2	29.91	0.08	Right	Cheek	00306	1	1:8.3	0.172	1.069	0.184	
1880.00	661	GSM 1900	GSM	30.2	29.91	0.05	Right	Tilt	00306	1	1:8.3	0.067	1.069	0.072	
1880.00	661	GSM 1900	GSM	30.2	29.91	0.05	Left	Cheek	00306	1	1:8.3	0.271	1.069	0.290	
1880.00	661	GSM 1900	GSM	30.2	29.91	0.06	Left	Tilt	00306	1	1:8.3	0.125	1.069	0.134	
1880.00	661	GSM 1900	GPRS	28.7	28.06	0.14	Right	Cheek	00306	2	1:4.15	0.245	1.159	0.284	
1880.00	661	GSM 1900	GPRS	28.7	28.06	0.08	Right	Tilt	00306	2	1:4.15	0.091	1.159	0.105	
1880.00	661	GSM 1900	GPRS	28.7	28.06	0.11	Left	Cheek	00306	2	1:4.15	0.380	1.159	0.440	A2
1880.00	661	GSM 1900	GPRS	28.7	28.06	0.01	Left	Tilt	00306	2	1:4.15	0.177	1.159	0.205	
ANSI / IEEE C95.1 1992 - SAFETY LIMIT Spatial Peak Uncontrolled Exposure/General Population								Head 1.6 W/kg (mW/g) averaged over 1 gram							

FCC ID: ZNFX220QM		SAR EVALUATION REPORT		Approved by: Quality Manager
Document S/N: 1M1812110223-01-R1.ZNF	Test Dates: 12/12/18 - 01/02/19	DUT Type: Portable Handset	Page 41 of 67	

**Table 11-3  
UMTS 850 Head SAR**



MEASUREMENT RESULTS														
FREQUENCY		Mode/Band	Service	Maximum Allowed Power [dBm]	Conducted Power [dBm]	Power Drift [dB]	Side	Test Position	Device Serial Number	Duty Cycle	SAR (1g)	Scaling Factor	Reported SAR (1g)	Plot #
MHz	Ch.										(W/kg)		(W/kg)	
836.60	4183	UMTS 850	RMC	24.7	24.49	-0.05	Right	Cheek	00305	1:1	0.456	1.050	0.479	A3
836.60	4183	UMTS 850	RMC	24.7	24.49	0.01	Right	Tilt	00305	1:1	0.220	1.050	0.231	
836.60	4183	UMTS 850	RMC	24.7	24.49	0.03	Left	Cheek	00305	1:1	0.366	1.050	0.384	
836.60	4183	UMTS 850	RMC	24.7	24.49	0.04	Left	Tilt	00305	1:1	0.201	1.050	0.211	
ANSI / IEEE C95.1 1992 - SAFETY LIMIT Spatial Peak Uncontrolled Exposure/General Population							Head 1.6 W/kg (W/kg) averaged over 1 gram							

**Table 11-4  
UMTS 1750 Head SAR**

MEASUREMENT RESULTS														
FREQUENCY		Mode/Band	Service	Maximum Allowed Power [dBm]	Conducted Power [dBm]	Power Drift [dB]	Side	Test Position	Device Serial Number	Duty Cycle	SAR (1g)	Scaling Factor	Reported SAR (1g)	Plot #
MHz	Ch.										(W/kg)		(W/kg)	
1732.40	1412	UMTS 1750	RMC	24.7	24.51	0.05	Right	Cheek	03066	1:1	0.386	1.045	0.403	
1732.40	1412	UMTS 1750	RMC	24.7	24.51	-0.10	Right	Tilt	03066	1:1	0.255	1.045	0.266	
1732.40	1412	UMTS 1750	RMC	24.7	24.51	-0.04	Left	Cheek	03066	1:1	0.532	1.045	0.556	A4
1732.40	1412	UMTS 1750	RMC	24.7	24.51	0.13	Left	Tilt	03066	1:1	0.282	1.045	0.295	
ANSI / IEEE C95.1 1992 - SAFETY LIMIT Spatial Peak Uncontrolled Exposure/General Population							Head 1.6 W/kg (mW/g) averaged over 1 gram							

**Table 11-5  
UMTS 1900 Head SAR**

MEASUREMENT RESULTS														
FREQUENCY		Mode/Band	Service	Maximum Allowed Power [dBm]	Conducted Power [dBm]	Power Drift [dB]	Side	Test Position	Device Serial Number	Duty Cycle	SAR (1g)	Scaling Factor	Reported SAR (1g)	Plot #
MHz	Ch.										(W/kg)		(W/kg)	
1880.00	9400	UMTS 1900	RMC	24.7	24.57	0.07	Right	Cheek	00306	1:1	0.410	1.030	0.422	
1880.00	9400	UMTS 1900	RMC	24.7	24.57	0.02	Right	Tilt	00306	1:1	0.153	1.030	0.158	
1880.00	9400	UMTS 1900	RMC	24.7	24.57	0.01	Left	Cheek	00306	1:1	0.569	1.030	0.586	A5
1880.00	9400	UMTS 1900	RMC	24.7	24.57	-0.02	Left	Tilt	00306	1:1	0.248	1.030	0.255	
ANSI / IEEE C95.1 1992 - SAFETY LIMIT Spatial Peak Uncontrolled Exposure/General Population							Head 1.6 W/kg (mW/g) averaged over 1 gram							



FCC ID: ZNFX220QM		SAR EVALUATION REPORT		Approved by: Quality Manager
Document S/N: 1M1812110223-01-R1.ZNF	Test Dates: 12/12/18 - 01/02/19	DUT Type: Portable Handset		Page 42 of 67

**Table 11-6  
Cell. CDMA Head SAR**

MEASUREMENT RESULTS														
FREQUENCY		Mode/Band	Service	Maximum Allowed Power [dBm]	Conducted Power [dBm]	Power Drift [dB]	Side	Test Position	Device Serial Number	Duty Cycle	SAR (1g)	Scaling Factor	Reported SAR (1g)	Plot #
MHz	Ch.										(W/kg)		(W/kg)	
836.52	384	Cell. CDMA	RC3 / SO55	24.7	24.50	-0.02	Right	Cheek	03058	1:1	0.456	1.047	0.477	
836.52	384	Cell. CDMA	RC3 / SO55	24.7	24.50	0.03	Right	Tilt	03058	1:1	0.205	1.047	0.215	
836.52	384	Cell. CDMA	RC3 / SO55	24.7	24.50	0.04	Left	Cheek	03058	1:1	0.359	1.047	0.376	
836.52	384	Cell. CDMA	RC3 / SO55	24.7	24.50	-0.05	Left	Tilt	03058	1:1	0.203	1.047	0.213	
836.52	384	Cell. CDMA	EVDO Rev. A	24.7	24.52	-0.05	Right	Cheek	03058	1:1	0.470	1.042	0.490	A6
836.52	384	Cell. CDMA	EVDO Rev. A	24.7	24.52	-0.08	Right	Tilt	03058	1:1	0.275	1.042	0.287	
836.52	384	Cell. CDMA	EVDO Rev. A	24.7	24.52	0.01	Left	Cheek	03058	1:1	0.376	1.042	0.392	
836.52	384	Cell. CDMA	EVDO Rev. A	24.7	24.52	0.20	Left	Tilt	03058	1:1	0.255	1.042	0.266	
ANSI / IEEE C95.1 1992 - SAFETY LIMIT Spatial Peak Uncontrolled Exposure/General Population								Head 1.6 W/kg (mW/g) averaged over 1 gram						

**Table 11-7  
PCS CDMA Head SAR**

MEASUREMENT RESULTS														
FREQUENCY		Mode/Band	Service	Maximum Allowed Power [dBm]	Conducted Power [dBm]	Power Drift [dB]	Side	Test Position	Device Serial Number	Duty Cycle	SAR (1g)	Scaling Factor	Reported SAR (1g)	Plot #
MHz	Ch.										(W/kg)		(W/kg)	
1880.00	600	PCS CDMA	RC3 / SO55	24.7	24.38	0.10	Right	Cheek	00306	1:1	0.459	1.076	0.494	
1880.00	600	PCS CDMA	RC3 / SO55	24.7	24.38	0.05	Right	Tilt	00306	1:1	0.159	1.076	0.171	
1851.25	25	PCS CDMA	RC3 / SO55	24.7	24.20	0.07	Left	Cheek	00306	1:1	0.657	1.122	0.737	
1880.00	600	PCS CDMA	RC3 / SO55	24.7	24.38	0.03	Left	Cheek	00306	1:1	0.729	1.076	0.784	A7
1908.75	1175	PCS CDMA	RC3 / SO55	24.7	24.29	-0.05	Left	Cheek	00306	1:1	0.693	1.099	0.762	
1880.00	600	PCS CDMA	RC3 / SO55	24.7	24.38	0.01	Left	Tilt	00306	1:1	0.302	1.076	0.325	
1880.00	600	PCS CDMA	EVDO Rev. A	24.7	24.41	0.02	Right	Cheek	00306	1:1	0.443	1.069	0.474	
1880.00	600	PCS CDMA	EVDO Rev. A	24.7	24.41	0.01	Right	Tilt	00306	1:1	0.153	1.069	0.164	
1851.25	25	PCS CDMA	EVDO Rev. A	24.7	24.26	-0.03	Left	Cheek	00306	1:1	0.643	1.107	0.712	
1880.00	600	PCS CDMA	EVDO Rev. A	24.7	24.41	0.04	Left	Cheek	00306	1:1	0.722	1.069	0.772	
1908.75	1175	PCS CDMA	EVDO Rev. A	24.7	24.37	-0.11	Left	Cheek	00306	1:1	0.671	1.079	0.724	
1880.00	600	PCS CDMA	EVDO Rev. A	24.7	24.41	0.02	Left	Tilt	00306	1:1	0.291	1.069	0.311	
ANSI / IEEE C95.1 1992 - SAFETY LIMIT Spatial Peak Uncontrolled Exposure/General Population								Head 1.6 W/kg (mW/g) averaged over 1 gram						

FCC ID: ZNFX220QM	 PCTEST ENGINEERING LABORATORY, INC.	SAR EVALUATION REPORT	 LG	Approved by: Quality Manager
Document S/N: 1M1812110223-01-R1.ZNF	Test Dates: 12/12/18 - 01/02/19	DUT Type: Portable Handset	Page 43 of 67	

**Table 11-8  
LTE Band 12 Head SAR**



FREQUENCY		Mode	Bandwidth [MHz]	Maximum Allowed Power [dBm]	Conducted Power [dBm]	Power Drift [dB]	MPR [dB]	Side	Test Position	Modulation	RB Size	RB Offset	Device Serial Number	Duty Cycle	SAR (1g)	Scaling Factor	Reported SAR (1g)	Plot #	
MHz	Ch.														(W/kg)		(W/kg)		
707.50	23095	Mid	LTE Band 12	10	24.7	24.49	0.08	0	Right	Cheek	QPSK	1	25	00303	1:1	0.559	1.050	0.587	A8
707.50	23095	Mid	LTE Band 12	10	23.7	23.41	0.02	1	Right	Cheek	QPSK	25	12	00303	1:1	0.407	1.069	0.435	
707.50	23095	Mid	LTE Band 12	10	24.7	24.49	-0.08	0	Right	Tilt	QPSK	1	25	00303	1:1	0.340	1.050	0.357	
707.50	23095	Mid	LTE Band 12	10	23.7	23.41	0.01	1	Right	Tilt	QPSK	25	12	00303	1:1	0.252	1.069	0.269	
707.50	23095	Mid	LTE Band 12	10	24.7	24.49	0.06	0	Left	Cheek	QPSK	1	25	00303	1:1	0.420	1.050	0.441	
707.50	23095	Mid	LTE Band 12	10	23.7	23.41	-0.11	1	Left	Cheek	QPSK	25	12	00303	1:1	0.311	1.069	0.332	
707.50	23095	Mid	LTE Band 12	10	24.7	24.49	0.01	0	Left	Tilt	QPSK	1	25	00303	1:1	0.270	1.050	0.284	
707.50	23095	Mid	LTE Band 12	10	23.7	23.41	-0.07	1	Left	Tilt	QPSK	25	12	00303	1:1	0.217	1.069	0.232	
ANSI / IEEE C95.1 1992 - SAFETY LIMIT Spatial Peak Uncontrolled Exposure/General Population										Head 1.6 W/kg (mW/g) averaged over 1 gram									

**Table 11-9  
LTE Band 5 (Cell) Head SAR**

FREQUENCY		Mode	Bandwidth [MHz]	Maximum Allowed Power [dBm]	Conducted Power [dBm]	Power Drift [dB]	MPR [dB]	Side	Test Position	Modulation	RB Size	RB Offset	Device Serial Number	Duty Cycle	SAR (1g)	Scaling Factor	Reported SAR (1g)	Plot #	
MHz	Ch.														(W/kg)		(W/kg)		
836.50	20525	Mid	LTE Band 5 (Cell)	10	24.7	24.69	0.02	0	Right	Cheek	QPSK	1	25	03041	1:1	0.495	1.002	0.496	A9
836.50	20525	Mid	LTE Band 5 (Cell)	10	23.7	23.69	0.00	1	Right	Cheek	QPSK	25	12	03041	1:1	0.371	1.002	0.372	
836.50	20525	Mid	LTE Band 5 (Cell)	10	24.7	24.69	0.11	0	Right	Tilt	QPSK	1	25	03041	1:1	0.297	1.002	0.298	
836.50	20525	Mid	LTE Band 5 (Cell)	10	23.7	23.69	-0.05	1	Right	Tilt	QPSK	25	12	03041	1:1	0.207	1.002	0.207	
836.50	20525	Mid	LTE Band 5 (Cell)	10	24.7	24.69	-0.15	0	Left	Cheek	QPSK	1	25	03041	1:1	0.398	1.002	0.399	
836.50	20525	Mid	LTE Band 5 (Cell)	10	23.7	23.69	0.04	1	Left	Cheek	QPSK	25	12	03041	1:1	0.282	1.002	0.283	
836.50	20525	Mid	LTE Band 5 (Cell)	10	24.7	24.69	-0.10	0	Left	Tilt	QPSK	1	25	03041	1:1	0.263	1.002	0.264	
836.50	20525	Mid	LTE Band 5 (Cell)	10	23.7	23.69	0.06	1	Left	Tilt	QPSK	25	12	03041	1:1	0.184	1.002	0.184	
ANSI / IEEE C95.1 1992 - SAFETY LIMIT Spatial Peak Uncontrolled Exposure/General Population										Head 1.6 W/kg (mW/g) averaged over 1 gram									

**Table 11-10  
LTE Band 4 (AWS) Head SAR**

FREQUENCY		Mode	Bandwidth [MHz]	Maximum Allowed Power [dBm]	Conducted Power [dBm]	Power Drift [dB]	MPR [dB]	Side	Test Position	Modulation	RB Size	RB Offset	Device Serial Number	Duty Cycle	SAR (1g)	Scaling Factor	Reported SAR (1g)	Plot #	
MHz	Ch.														(W/kg)		(W/kg)		
1732.50	20175	Mid	LTE Band 4 (AWS)	20	24.7	24.61	-0.02	0	Right	Cheek	QPSK	1	50	00304	1:1	0.411	1.021	0.420	
1732.50	20175	Mid	LTE Band 4 (AWS)	20	23.7	23.51	-0.04	1	Right	Cheek	QPSK	50	25	00304	1:1	0.297	1.045	0.310	
1732.50	20175	Mid	LTE Band 4 (AWS)	20	24.7	24.61	-0.02	0	Right	Tilt	QPSK	1	50	00304	1:1	0.291	1.021	0.297	
1732.50	20175	Mid	LTE Band 4 (AWS)	20	23.7	23.51	0.05	1	Right	Tilt	QPSK	50	25	00304	1:1	0.217	1.045	0.227	
1732.50	20175	Mid	LTE Band 4 (AWS)	20	24.7	24.61	0.01	0	Left	Cheek	QPSK	1	50	00304	1:1	0.556	1.021	0.568	A10
1732.50	20175	Mid	LTE Band 4 (AWS)	20	23.7	23.51	-0.02	1	Left	Cheek	QPSK	50	25	00304	1:1	0.416	1.045	0.435	
1732.50	20175	Mid	LTE Band 4 (AWS)	20	24.7	24.61	-0.04	0	Left	Tilt	QPSK	1	50	00304	1:1	0.338	1.021	0.345	
1732.50	20175	Mid	LTE Band 4 (AWS)	20	23.7	23.51	0.05	1	Left	Tilt	QPSK	50	25	00304	1:1	0.238	1.045	0.249	
ANSI / IEEE C95.1 1992 - SAFETY LIMIT Spatial Peak Uncontrolled Exposure/General Population										Head 1.6 W/kg (mW/g) averaged over 1 gram									

FCC ID: ZNFX220QM		<b>SAR EVALUATION REPORT</b>		<b>Approved by:</b> Quality Manager
<b>Document S/N:</b> 1M1812110223-01-R1.ZNF	<b>Test Dates:</b> 12/12/18 - 01/02/19	<b>DUT Type:</b> Portable Handset	Page 44 of 67	



**Table 11-11  
LTE Band 25 (PCS) Head SAR**

FREQUENCY		Mode	Bandwidth [MHz]	Maximum Allowed Power [dBm]	Conducted Power [dBm]	Power Drift [dB]	MPR [dB]	Side	Test Position	Modulation	RB Size	RB Offset	Device Serial Number	Duty Cycle	SAR (1g)	Scaling Factor	Reported SAR (1g)	Plot #	
MHz	Ch.														(W/kg)		(W/kg)		
1860.00	26140	Low	LTE Band 25 (PCS)	20	24.7	24.47	-0.02	0	Right	Cheek	QPSK	1	50	00304	1:1	0.430	1.054	0.453	
1860.00	26140	Low	LTE Band 25 (PCS)	20	23.7	23.31	-0.04	1	Right	Cheek	QPSK	50	25	00304	1:1	0.325	1.094	0.356	
1860.00	26140	Low	LTE Band 25 (PCS)	20	24.7	24.47	0.03	0	Right	Tilt	QPSK	1	50	00304	1:1	0.184	1.054	0.194	
1860.00	26140	Low	LTE Band 25 (PCS)	20	23.7	23.31	0.18	1	Right	Tilt	QPSK	50	25	00304	1:1	0.131	1.094	0.143	
1860.00	26140	Low	LTE Band 25 (PCS)	20	24.7	24.47	0.01	0	Left	Cheek	QPSK	1	50	00304	1:1	0.631	1.054	0.665	
1882.50	26365	Mid	LTE Band 25 (PCS)	20	24.7	24.35	0.12	0	Left	Cheek	QPSK	1	50	00304	1:1	0.703	1.084	0.762	A11
1905.00	26590	High	LTE Band 25 (PCS)	20	24.7	24.23	-0.01	0	Left	Cheek	QPSK	1	99	00304	1:1	0.620	1.114	0.691	
1860.00	26140	Low	LTE Band 25 (PCS)	20	23.7	23.31	0.05	1	Left	Cheek	QPSK	50	25	00304	1:1	0.479	1.094	0.524	
1860.00	26140	Low	LTE Band 25 (PCS)	20	24.7	24.47	-0.13	0	Left	Tilt	QPSK	1	50	00304	1:1	0.262	1.054	0.276	
1860.00	26140	Low	LTE Band 25 (PCS)	20	23.7	23.31	0.16	1	Left	Tilt	QPSK	50	25	00304	1:1	0.189	1.094	0.207	
ANSI / IEEE C95.1 1992 - SAFETY LIMIT Spatial Peak Uncontrolled Exposure/General Population										Head 1.6 W/kg (mW/g) averaged over 1 gram									



**Table 11-12  
DTS Head SAR**

MEASUREMENT RESULTS																		
FREQUENCY		Mode	Service	Bandwidth [MHz]	Maximum Allowed Power [dBm]	Conducted Power [dBm]	Power Drift [dB]	Side	Test Position	Device Serial Number	Data Rate (Mbps)	Duty Cycle (%)	Peak SAR of Area Scan	SAR (1g)	Scaling Factor (Power)	Scaling Factor (Duty Cycle)	Reported SAR (1g)	Plot #
MHz	Ch.												(W/kg)	(W/kg)			(W/kg)	
2462	11	802.11b	DSSS	22	15.5	15.05	0.17	Right	Cheek	00316	1	99.9	0.640	0.475	1.109	1.001	0.527	
2462	11	802.11b	DSSS	22	15.5	15.05	0.13	Right	Tilt	00316	1	99.9	0.723	0.472	1.109	1.001	0.524	
2412	1	802.11b	DSSS	22	15.5	14.85	0.09	Left	Cheek	00316	1	99.9	1.734	1.010	1.161	1.001	1.174	
2437	6	802.11b	DSSS	22	15.5	14.98	0.14	Left	Cheek	00316	1	99.9	1.882	1.080	1.127	1.001	1.218	
2462	11	802.11b	DSSS	22	15.5	15.05	0.11	Left	Cheek	00316	1	99.9	1.837	1.120	1.109	1.001	1.243	A12
2462	11	802.11b	DSSS	22	15.5	15.05	0.10	Left	Tilt	00316	1	99.9	0.933	0.613	1.109	1.001	0.680	
2462	11	802.11b	DSSS	22	15.5	15.05	-0.02	Left	Cheek	00316	1	99.9	1.514	1.030	1.109	1.001	1.143	
ANSI / IEEE C95.1 1992 - SAFETY LIMIT Spatial Peak Uncontrolled Exposure/General Population										Head 1.6 W/kg (mW/g) averaged over 1 gram								

Note: Blue entry represents variability data

**Table 11-13  
DSS Head SAR**

MEASUREMENT RESULTS																
FREQUENCY		Mode	Service	Maximum Allowed Power [dBm]	Conducted Power [dBm]	Power Drift [dB]	Side	Test Position	Device Serial Number	Data Rate (Mbps)	Duty Cycle (%)	SAR (1g)	Scaling Factor (Cond Power)	Scaling Factor (Duty Cycle)	Reported SAR (1g)	Plot #
MHz	Ch.											(W/kg)			(W/kg)	
2441.00	39	Bluetooth	FHSS	11.5	10.97	0.15	Right	Cheek	00314	1	77.1	0.106	1.130	1.297	0.155	
2441.00	39	Bluetooth	FHSS	11.5	10.97	0.08	Right	Tilt	00314	1	77.1	0.114	1.130	1.297	0.167	
2441.00	39	Bluetooth	FHSS	11.5	10.97	0.06	Left	Cheek	00314	1	77.1	0.297	1.130	1.297	0.435	A13
2441.00	39	Bluetooth	FHSS	11.5	10.97	-0.02	Left	Tilt	00314	1	77.1	0.170	1.130	1.297	0.249	
ANSI / IEEE C95.1 1992 - SAFETY LIMIT Spatial Peak Uncontrolled Exposure/General Population										Head 1.6 W/kg (mW/g) averaged over 1 gram						



FCC ID: ZNFX220QM		<b>SAR EVALUATION REPORT</b>		Approved by: Quality Manager
Document S/N: 1M1812110223-01-R1.ZNF	Test Dates: 12/12/18 - 01/02/19	DUT Type: Portable Handset	Page 45 of 67	

## 11.2 Standalone Body-Worn SAR Data

**Table 11-14  
GSM/UMTS/CDMA Body-Worn SAR Data**

MEASUREMENT RESULTS															
FREQUENCY		Mode	Service	Maximum Allowed Power [dBm]	Conducted Power [dBm]	Power Drift [dB]	Spacing	Device Serial Number	# of Time Slots	Duty Cycle	Side	SAR (1g)	Scaling Factor	Reported SAR (1g)	Plot #
MHz	Ch.											(W/kg)		(W/kg)	
836.60	190	GSM 850	GSM	33.2	33.05	-0.02	10 mm	03058	1	1:8.3	back	0.386	1.035	0.400	
836.60	190	GSM 850	GPRS	31.7	31.56	-0.03	10 mm	03058	2	1:4.15	back	0.491	1.033	0.507	A14
1880.00	661	GSM 1900	GSM	30.2	29.91	-0.02	10 mm	00305	1	1:8.3	back	0.285	1.069	0.305	
1880.00	661	GSM 1900	GPRS	28.7	28.06	-0.03	10 mm	00305	2	1:4.15	back	0.398	1.159	0.461	A16
826.40	4132	UMTS 850	RMC	24.7	24.51	-0.10	10 mm	00306	N/A	1:1	back	0.533	1.045	0.557	
836.60	4183	UMTS 850	RMC	24.7	24.49	-0.05	10 mm	00306	N/A	1:1	back	0.571	1.050	0.600	A18
846.60	4233	UMTS 850	RMC	24.7	24.46	0.04	10 mm	00306	N/A	1:1	back	0.552	1.057	0.583	
1712.40	1312	UMTS 1750	RMC	24.7	24.59	0.03	10 mm	03058	N/A	1:1	back	0.804	1.026	0.825	
1732.40	1412	UMTS 1750	RMC	24.7	24.51	-0.19	10 mm	03058	N/A	1:1	back	0.845	1.045	0.883	A19
1752.60	1513	UMTS 1750	RMC	24.7	24.53	0.17	10 mm	03058	N/A	1:1	back	0.829	1.040	0.862	
1852.40	9262	UMTS 1900	RMC	24.7	24.45	-0.08	10 mm	03058	N/A	1:1	back	0.674	1.059	0.714	A21
1880.00	9400	UMTS 1900	RMC	24.7	24.57	-0.07	10 mm	03058	N/A	1:1	back	0.665	1.030	0.685	
1907.60	9538	UMTS 1900	RMC	24.7	24.61	-0.04	10 mm	03058	N/A	1:1	back	0.598	1.021	0.611	
824.70	1013	Cell. CDMA	TDSO / SO32	24.7	24.42	0.05	10 mm	03058	N/A	1:1	back	0.694	1.067	0.740	A23
836.52	384	Cell. CDMA	TDSO / SO32	24.7	24.52	0.03	10 mm	03058	N/A	1:1	back	0.657	1.042	0.685	
848.31	777	Cell. CDMA	TDSO / SO32	24.7	24.45	-0.09	10 mm	03058	N/A	1:1	back	0.580	1.059	0.614	
1851.25	25	PCS CDMA	TDSO / SO32	24.7	24.52	-0.02	10 mm	00305	N/A	1:1	back	0.879	1.042	0.916	A25
1880.00	600	PCS CDMA	TDSO / SO32	24.7	24.48	-0.02	10 mm	00305	N/A	1:1	back	0.778	1.052	0.818	
1908.75	1175	PCS CDMA	TDSO / SO32	24.7	24.57	0.06	10 mm	00305	N/A	1:1	back	0.642	1.030	0.661	
1851.25	25	PCS CDMA	TDSO / SO32	24.7	24.52	0.00	10 mm	00305	N/A	1:1	back	0.825	1.042	0.860	
ANSI / IEEE C95.1 1992 - SAFETY LIMIT Spatial Peak Uncontrolled Exposure/General Population							Body 1.6 W/kg (mW/g) averaged over 1 gram								

Note: Blue entry represents variability data



FCC ID: ZNFX220QM		SAR EVALUATION REPORT		Approved by: Quality Manager
Document S/N: 1M1812110223-01-R1.ZNF	Test Dates: 12/12/18 - 01/02/19	DUT Type: Portable Handset	Page 46 of 67	

**Table 11-15  
LTE Body-Worn SAR**

FREQUENCY		Mode	Bandwidth [MHz]	Maximum Allowed Power [dBm]	Conducted Power [dBm]	Power Drift [dB]	MPR [dB]	Device Serial Number	Modulation	RB Size	RB Offset	Spacing	Side	Duty Cycle	SAR (1g)	Scaling Factor	Reported SAR (1g)	Plot #	
MHz	Ch.														(W/kg)		(W/kg)		
707.50	23095	Mid	LTE Band 12	10	24.7	24.49	0.01	0	00303	QPSK	1	25	10 mm	back	1:1	0.710	1.050	0.746	A27
707.50	23095	Mid	LTE Band 12	10	23.7	23.41	-0.01	1	00303	QPSK	25	12	10 mm	back	1:1	0.517	1.069	0.553	
836.50	20525	Mid	LTE Band 5 (Cell)	10	24.7	24.69	-0.02	0	00303	QPSK	1	25	10 mm	back	1:1	0.790	1.002	0.792	A28
836.50	20525	Mid	LTE Band 5 (Cell)	10	23.7	23.69	-0.03	1	00303	QPSK	25	12	10 mm	back	1:1	0.590	1.002	0.591	
1732.50	20175	Mid	LTE Band 4 (AWS)	20	24.7	24.61	0.02	0	00304	QPSK	1	50	10 mm	back	1:1	0.743	1.021	0.759	A29
1732.50	20175	Mid	LTE Band 4 (AWS)	20	23.7	23.51	-0.06	1	00304	QPSK	50	25	10 mm	back	1:1	0.554	1.045	0.579	
1860.00	26140	Low	LTE Band 25 (PCS)	20	24.7	24.47	0.06	0	00304	QPSK	1	50	10 mm	back	1:1	0.737	1.054	0.777	
1882.50	26365	Mid	LTE Band 25 (PCS)	20	24.7	24.35	0.13	0	00304	QPSK	1	50	10 mm	back	1:1	0.830	1.084	0.900	A31
1905.00	26590	High	LTE Band 25 (PCS)	20	24.7	24.23	-0.04	0	00304	QPSK	1	99	10 mm	back	1:1	0.671	1.114	0.747	
1860.00	26140	Low	LTE Band 25 (PCS)	20	23.7	23.31	-0.01	1	00304	QPSK	50	25	10 mm	back	1:1	0.545	1.094	0.596	
1860.00	26140	Low	LTE Band 25 (PCS)	20	23.7	23.20	-0.05	1	00304	QPSK	100	0	10 mm	back	1:1	0.604	1.122	0.678	
ANSI / IEEE C95.1 1992 - SAFETY LIMIT Spatial Peak Uncontrolled Exposure/General Population									Body 1.6 W/kg (mW/g) averaged over 1 gram										

**Table 11-16  
DTS Body-Worn SAR**

MEASUREMENT RESULTS																		
FREQUENCY		Mode	Service	Bandwidth [MHz]	Maximum Allowed Power [dBm]	Conducted Power [dBm]	Power Drift [dB]	Spacing	Device Serial Number	Data Rate (Mbps)	Side	Duty Cycle (%)	Peak SAR of Area Scan	SAR (1g)	Scaling Factor (Power)	Scaling Factor (Duty Cycle)	Reported SAR (1g)	Plot #
MHz	Ch.												(W/kg)	(W/kg)			(W/kg)	
2462	11	802.11b	DSSS	22	15.5	15.05	0.18	10 mm	00316	1	back	99.9	0.189	0.160	1.109	1.001	0.178	A32
ANSI / IEEE C95.1 1992 - SAFETY LIMIT Spatial Peak Uncontrolled Exposure/General Population									Body 1.6 W/kg (mW/g) averaged over 1 gram									



FCC ID: ZNFX220QM		SAR EVALUATION REPORT		Approved by: Quality Manager
Document S/N: 1M1812110223-01-R1.ZNF	Test Dates: 12/12/18 - 01/02/19	DUT Type: Portable Handset	Page 47 of 67	

# 11.3 Standalone Hotspot SAR Data

**Table 11-17  
GPRS/UMTS Hotspot SAR Data**

MEASUREMENT RESULTS															
FREQUENCY		Mode	Service	Maximum Allowed Power [dBm]	Conducted Power [dBm]	Power Drift [dB]	Spacing	Device Serial Number	# of GPRS Slots	Duty Cycle	Side	SAR (1g)	Scaling Factor	Reported SAR (1g)	Plot #
MHz	Ch.											(W/kg)		(W/kg)	
836.60	190	GSM 850	GPRS	31.7	31.56	-0.03	10 mm	03058	2	1:4.15	back	0.491	1.033	0.507	
836.60	190	GSM 850	GPRS	31.7	31.56	-0.05	10 mm	03058	2	1:4.15	front	0.397	1.033	0.410	
836.60	190	GSM 850	GPRS	31.7	31.56	-0.02	10 mm	03058	2	1:4.15	bottom	0.207	1.033	0.214	
836.60	190	GSM 850	GPRS	31.7	31.56	0.15	10 mm	03058	2	1:4.15	right	0.541	1.033	0.559	A15
836.60	190	GSM 850	GPRS	31.7	31.56	-0.01	10 mm	03058	2	1:4.15	left	0.202	1.033	0.209	
1880.00	661	GSM 1900	GPRS	28.7	28.06	-0.03	10 mm	00305	2	1:4.15	back	0.398	1.159	0.461	
1880.00	661	GSM 1900	GPRS	28.7	28.06	-0.05	10 mm	00305	2	1:4.15	front	0.440	1.159	0.510	A17
1880.00	661	GSM 1900	GPRS	28.7	28.06	-0.05	10 mm	00305	2	1:4.15	bottom	0.231	1.159	0.268	
1880.00	661	GSM 1900	GPRS	28.7	28.06	-0.07	10 mm	00305	2	1:4.15	left	0.339	1.159	0.393	
826.40	4132	UMTS 850	RMC	24.7	24.51	-0.10	10 mm	00306	N/A	1:1	back	0.533	1.045	0.557	
836.60	4183	UMTS 850	RMC	24.7	24.49	-0.05	10 mm	00306	N/A	1:1	back	0.571	1.050	0.600	A18
846.60	4233	UMTS 850	RMC	24.7	24.46	0.04	10 mm	00306	N/A	1:1	back	0.552	1.057	0.583	
836.60	4183	UMTS 850	RMC	24.7	24.49	0.00	10 mm	00306	N/A	1:1	front	0.427	1.050	0.448	
836.60	4183	UMTS 850	RMC	24.7	24.49	0.02	10 mm	00306	N/A	1:1	bottom	0.228	1.050	0.239	
836.60	4183	UMTS 850	RMC	24.7	24.49	-0.06	10 mm	00306	N/A	1:1	right	0.534	1.050	0.561	
836.60	4183	UMTS 850	RMC	24.7	24.49	0.02	10 mm	00306	N/A	1:1	left	0.244	1.050	0.256	
1712.40	1312	UMTS 1750	RMC	24.7	24.59	0.03	10 mm	03058	N/A	1:1	back	0.804	1.026	0.825	
1732.40	1412	UMTS 1750	RMC	24.7	24.51	-0.19	10 mm	03058	N/A	1:1	back	0.845	1.045	0.883	
1752.60	1513	UMTS 1750	RMC	24.7	24.53	0.17	10 mm	03058	N/A	1:1	back	0.829	1.040	0.862	
1712.40	1312	UMTS 1750	RMC	24.7	24.59	-0.13	10 mm	03058	N/A	1:1	front	0.891	1.026	0.914	
1732.40	1412	UMTS 1750	RMC	24.7	24.51	0.04	10 mm	03058	N/A	1:1	front	0.938	1.045	0.980	A20
1752.60	1513	UMTS 1750	RMC	24.7	24.53	0.13	10 mm	03058	N/A	1:1	front	0.901	1.040	0.937	
1732.40	1412	UMTS 1750	RMC	24.7	24.51	-0.10	10 mm	03058	N/A	1:1	bottom	0.430	1.045	0.449	
1732.40	1412	UMTS 1750	RMC	24.7	24.51	-0.01	10 mm	03058	N/A	1:1	left	0.439	1.045	0.459	
1732.40	1412	UMTS 1750	RMC	24.7	24.51	0.03	10 mm	03058	N/A	1:1	front	0.875	1.045	0.914	
1852.40	9262	UMTS 1900	RMC	24.7	24.45	-0.08	10 mm	03058	N/A	1:1	back	0.674	1.059	0.714	
1880.00	9400	UMTS 1900	RMC	24.7	24.57	-0.07	10 mm	03058	N/A	1:1	back	0.665	1.030	0.685	
1907.60	9538	UMTS 1900	RMC	24.7	24.61	-0.04	10 mm	03058	N/A	1:1	back	0.598	1.021	0.611	
1852.40	9262	UMTS 1900	RMC	24.7	24.45	0.07	10 mm	03058	N/A	1:1	front	0.642	1.059	0.680	
1880.00	9400	UMTS 1900	RMC	24.7	24.57	0.02	10 mm	03058	N/A	1:1	front	0.703	1.030	0.724	A22
1907.60	9538	UMTS 1900	RMC	24.7	24.61	0.07	10 mm	03058	N/A	1:1	front	0.661	1.021	0.675	
1880.00	9400	UMTS 1900	RMC	24.7	24.57	0.00	10 mm	03058	N/A	1:1	bottom	0.339	1.030	0.349	
1880.00	9400	UMTS 1900	RMC	24.7	24.57	0.01	10 mm	03058	N/A	1:1	left	0.556	1.030	0.573	
ANSI / IEEE C95.1 1992 - SAFETY LIMIT							Body								
Spatial Peak							1.6 W/kg (mW/g)								
Uncontrolled Exposure/General Population							averaged over 1 gram								

Note: Blue entry represents variability data



FCC ID: ZNFX220QM		SAR EVALUATION REPORT		Approved by: Quality Manager
Document S/N: 1M1812110223-01-R1.ZNF	Test Dates: 12/12/18 - 01/02/19	DUT Type: Portable Handset	Page 48 of 67	

**Table 11-18  
CDMA Hotspot SAR Data**

MEASUREMENT RESULTS														
FREQUENCY		Mode	Service	Maximum Allowed Power [dBm]	Conducted Power [dBm]	Power Drift [dB]	Spacing	Device Serial Number	Duty Cycle	Side	SAR (1g)	Scaling Factor	Reported SAR (1g)	Plot #
MHz	Ch.										(W/kg)		(W/kg)	
824.70	1013	Cell. CDMA	EVDO Rev. 0	24.7	24.59	0.01	10 mm	03058	1:1	back	0.662	1.026	0.679	A24
836.52	384	Cell. CDMA	EVDO Rev. 0	24.7	24.53	-0.10	10 mm	03058	1:1	back	0.616	1.040	0.641	
848.31	777	Cell. CDMA	EVDO Rev. 0	24.7	24.64	0.07	10 mm	03058	1:1	back	0.556	1.014	0.564	
836.52	384	Cell. CDMA	EVDO Rev. 0	24.7	24.53	0.02	10 mm	03058	1:1	front	0.443	1.040	0.461	
836.52	384	Cell. CDMA	EVDO Rev. 0	24.7	24.53	0.05	10 mm	03058	1:1	bottom	0.204	1.040	0.212	
836.52	384	Cell. CDMA	EVDO Rev. 0	24.7	24.53	0.05	10 mm	03058	1:1	right	0.541	1.040	0.563	
836.52	384	Cell. CDMA	EVDO Rev. 0	24.7	24.53	-0.02	10 mm	03058	1:1	left	0.251	1.040	0.261	
1880.00	600	PCS CDMA	EVDO Rev. 0	24.7	24.28	-0.09	10 mm	00305	1:1	back	0.709	1.102	0.781	
1851.25	25	PCS CDMA	EVDO Rev. 0	24.7	24.36	0.03	10 mm	00305	1:1	front	0.835	1.081	0.903	
1880.00	600	PCS CDMA	EVDO Rev. 0	24.7	24.28	0.02	10 mm	00305	1:1	front	0.860	1.102	0.948	A26
1908.75	1175	PCS CDMA	EVDO Rev. 0	24.7	24.38	0.14	10 mm	00305	1:1	front	0.748	1.076	0.805	
1880.00	600	PCS CDMA	EVDO Rev. 0	24.7	24.28	0.00	10 mm	00305	1:1	bottom	0.448	1.102	0.494	
1880.00	600	PCS CDMA	EVDO Rev. 0	24.7	24.28	0.08	10 mm	00305	1:1	left	0.630	1.102	0.694	
ANSI / IEEE C95.1 1992 - SAFETY LIMIT Spatial Peak Uncontrolled Exposure/General Population							Body 1.6 W/kg (mW/g) averaged over 1 gram							

**Table 11-19  
LTE Band 12 Hotspot SAR**

MEASUREMENT RESULTS																			
FREQUENCY		Mode	Bandwidth [MHz]	Maximum Allowed Power [dBm]	Conducted Power [dBm]	Power Drift [dB]	MPR [dB]	Device Serial Number	Modulation	RB Size	RB Offset	Spacing	Side	Duty Cycle	SAR (1g)	Scaling Factor	Reported SAR (1g)	Plot #	
MHz	Ch.														(W/kg)		(W/kg)		
707.50	23095	Mid	LTE Band 12	10	24.7	24.49	0.01	0	00303	QPSK	1	25	10 mm	back	1:1	0.710	1.050	0.746	A27
707.50	23095	Mid	LTE Band 12	10	23.7	23.41	-0.01	1	00303	QPSK	25	12	10 mm	back	1:1	0.517	1.069	0.553	
707.50	23095	Mid	LTE Band 12	10	24.7	24.49	-0.02	0	00303	QPSK	1	25	10 mm	front	1:1	0.488	1.050	0.512	
707.50	23095	Mid	LTE Band 12	10	23.7	23.41	0.10	1	00303	QPSK	25	12	10 mm	front	1:1	0.361	1.069	0.386	
707.50	23095	Mid	LTE Band 12	10	24.7	24.49	0.04	0	00303	QPSK	1	25	10 mm	bottom	1:1	0.149	1.050	0.156	
707.50	23095	Mid	LTE Band 12	10	23.7	23.41	-0.07	1	00303	QPSK	25	12	10 mm	bottom	1:1	0.118	1.069	0.126	
707.50	23095	Mid	LTE Band 12	10	24.7	24.49	0.06	0	00303	QPSK	1	25	10 mm	right	1:1	0.463	1.050	0.486	
707.50	23095	Mid	LTE Band 12	10	23.7	23.41	0.01	1	00303	QPSK	25	12	10 mm	right	1:1	0.342	1.069	0.366	
707.50	23095	Mid	LTE Band 12	10	24.7	24.49	-0.03	0	00303	QPSK	1	25	10 mm	left	1:1	0.347	1.050	0.364	
707.50	23095	Mid	LTE Band 12	10	23.7	23.41	0.03	1	00303	QPSK	25	12	10 mm	left	1:1	0.252	1.069	0.269	
ANSI / IEEE C95.1 1992 - SAFETY LIMIT Spatial Peak Uncontrolled Exposure/General Population							Body 1.6 W/kg (mW/g) averaged over 1 gram												



FCC ID: ZNFX220QM	 PCTEST ENGINEERING LABORATORY, INC.	SAR EVALUATION REPORT	 LG	Approved by: Quality Manager
Document S/N: 1M1812110223-01-R1.ZNF	Test Dates: 12/12/18 - 01/02/19	DUT Type: Portable Handset	Page 49 of 67	

**Table 11-20  
LTE Band 5 (Cell) Hotspot SAR**

MEASUREMENT RESULTS																			
FREQUENCY		Mode	Bandwidth [MHz]	Maximum Allowed Power [dBm]	Conducted Power [dBm]	Power Drift [dB]	MPR [dB]	Device Serial Number	Modulation	RB Size	RB Offset	Spacing	Side	Duty Cycle	SAR (1g)	Scaling Factor	Reported SAR (1g)	Plot #	
MHz	Ch.														(W/kg)		(W/kg)		
836.50	20525	Mid	LTE Band 5 (Cell)	10	24.7	24.69	-0.02	0	00303	QPSK	1	25	10 mm	back	1:1	0.790	1.002	0.792	A28
836.50	20525	Mid	LTE Band 5 (Cell)	10	23.7	23.69	-0.03	1	00303	QPSK	25	12	10 mm	back	1:1	0.590	1.002	0.591	
836.50	20525	Mid	LTE Band 5 (Cell)	10	24.7	24.69	0.01	0	00303	QPSK	1	25	10 mm	front	1:1	0.590	1.002	0.591	
836.50	20525	Mid	LTE Band 5 (Cell)	10	23.7	23.69	0.03	1	00303	QPSK	25	12	10 mm	front	1:1	0.464	1.002	0.465	
836.50	20525	Mid	LTE Band 5 (Cell)	10	24.7	24.69	0.05	0	00303	QPSK	1	25	10 mm	bottom	1:1	0.291	1.002	0.292	
836.50	20525	Mid	LTE Band 5 (Cell)	10	23.7	23.69	0.02	1	00303	QPSK	25	12	10 mm	bottom	1:1	0.211	1.002	0.211	
836.50	20525	Mid	LTE Band 5 (Cell)	10	24.7	24.69	0.00	0	00303	QPSK	1	25	10 mm	right	1:1	0.722	1.002	0.723	
836.50	20525	Mid	LTE Band 5 (Cell)	10	23.7	23.69	0.02	1	00303	QPSK	25	12	10 mm	right	1:1	0.552	1.002	0.553	
836.50	20525	Mid	LTE Band 5 (Cell)	10	24.7	24.69	-0.08	0	00303	QPSK	1	25	10 mm	left	1:1	0.364	1.002	0.365	
836.50	20525	Mid	LTE Band 5 (Cell)	10	23.7	23.69	0.01	1	00303	QPSK	25	12	10 mm	left	1:1	0.279	1.002	0.280	
ANSI / IEEE C95.1 1992 - SAFETY LIMIT Spatial Peak Uncontrolled Exposure/General Population							Body 1.6 W/kg (mW/g) averaged over 1 gram												

**Table 11-21  
LTE Band 4 (AWS) Hotspot SAR**

MEASUREMENT RESULTS																			
FREQUENCY		Mode	Bandwidth [MHz]	Maximum Allowed Power [dBm]	Conducted Power [dBm]	Power Drift [dB]	MPR [dB]	Device Serial Number	Modulation	RB Size	RB Offset	Spacing	Side	Duty Cycle	SAR (1g)	Scaling Factor	Reported SAR (1g)	Plot #	
MHz	Ch.														(W/kg)		(W/kg)		
1732.50	20175	Mid	LTE Band 4 (AWS)	20	24.7	24.61	0.02	0	00304	QPSK	1	50	10 mm	back	1:1	0.743	1.021	0.759	
1732.50	20175	Mid	LTE Band 4 (AWS)	20	23.7	23.51	-0.06	1	00304	QPSK	50	25	10 mm	back	1:1	0.554	1.045	0.579	
1732.50	20175	Mid	LTE Band 4 (AWS)	20	24.7	24.61	0.14	0	00304	QPSK	1	50	10 mm	front	1:1	0.826	1.021	0.843	A30
1732.50	20175	Mid	LTE Band 4 (AWS)	20	23.7	23.51	-0.07	1	00304	QPSK	50	25	10 mm	front	1:1	0.621	1.045	0.649	
1732.50	20175	Mid	LTE Band 4 (AWS)	20	23.7	23.42	0.02	1	00304	QPSK	100	0	10 mm	front	1:1	0.629	1.067	0.671	
1732.50	20175	Mid	LTE Band 4 (AWS)	20	24.7	24.61	0.04	0	00304	QPSK	1	50	10 mm	bottom	1:1	0.423	1.021	0.432	
1732.50	20175	Mid	LTE Band 4 (AWS)	20	23.7	23.51	0.04	1	00304	QPSK	50	25	10 mm	bottom	1:1	0.314	1.045	0.328	
1732.50	20175	Mid	LTE Band 4 (AWS)	20	24.7	24.61	-0.02	0	00304	QPSK	1	50	10 mm	left	1:1	0.392	1.021	0.400	
1732.50	20175	Mid	LTE Band 4 (AWS)	20	23.7	23.51	-0.07	1	00304	QPSK	50	25	10 mm	left	1:1	0.308	1.045	0.322	
ANSI / IEEE C95.1 1992 - SAFETY LIMIT Spatial Peak Uncontrolled Exposure/General Population							Body 1.6 W/kg (mW/g) averaged over 1 gram												

FCC ID: ZNFX220QM		<b>SAR EVALUATION REPORT</b>		<b>Approved by:</b> Quality Manager
<b>Document S/N:</b> 1M1812110223-01-R1.ZNF	<b>Test Dates:</b> 12/12/18 - 01/02/19	<b>DUT Type:</b> Portable Handset	Page 50 of 67	

**Table 11-22  
LTE Band 25 (PCS) Hotspot SAR**

FREQUENCY		Mode	Bandwidth [MHz]	Maximum Allowed Power [dBm]	Conducted Power [dBm]	Power Drift [dB]	MPR [dB]	Device Serial Number	Modulation	RB Size	RB Offset	Spacing	Side	Duty Cycle	SAR (1g)	Scaling Factor	Reported SAR (1g)	Plot #	
MHz	Ch.														(W/kg)		(W/kg)		
1860.00	26140	Low	LTE Band 25 (PCS)	20	24.7	24.47	0.06	0	00304	QPSK	1	50	10 mm	back	1:1	0.737	1.054	0.777	
1882.50	26365	Mid	LTE Band 25 (PCS)	20	24.7	24.35	0.13	0	00304	QPSK	1	50	10 mm	back	1:1	0.830	1.084	0.900	A31
1905.00	26590	High	LTE Band 25 (PCS)	20	24.7	24.23	-0.04	0	00304	QPSK	1	99	10 mm	back	1:1	0.671	1.114	0.747	
1860.00	26140	Low	LTE Band 25 (PCS)	20	23.7	23.31	-0.01	1	00304	QPSK	50	25	10 mm	back	1:1	0.545	1.094	0.596	
1860.00	26140	Low	LTE Band 25 (PCS)	20	23.7	23.20	-0.05	1	00304	QPSK	100	0	10 mm	back	1:1	0.604	1.122	0.678	
1860.00	26140	Low	LTE Band 25 (PCS)	20	24.7	24.47	0.11	0	00304	QPSK	1	50	10 mm	front	1:1	0.744	1.054	0.784	
1882.50	26365	Mid	LTE Band 25 (PCS)	20	24.7	24.35	0.05	0	00304	QPSK	1	50	10 mm	front	1:1	0.754	1.084	0.817	
1905.00	26590	High	LTE Band 25 (PCS)	20	24.7	24.23	0.14	0	00304	QPSK	1	99	10 mm	front	1:1	0.668	1.114	0.744	
1860.00	26140	Low	LTE Band 25 (PCS)	20	23.7	23.31	-0.04	1	00304	QPSK	50	25	10 mm	front	1:1	0.564	1.094	0.617	
1860.00	26140	Low	LTE Band 25 (PCS)	20	23.7	23.20	0.04	1	00304	QPSK	100	0	10 mm	front	1:1	0.599	1.122	0.672	
1860.00	26140	Low	LTE Band 25 (PCS)	20	24.7	24.47	-0.05	0	00304	QPSK	1	50	10 mm	bottom	1:1	0.387	1.054	0.408	
1860.00	26140	Low	LTE Band 25 (PCS)	20	23.7	23.31	0.02	1	00304	QPSK	50	25	10 mm	bottom	1:1	0.293	1.094	0.321	
1860.00	26140	Low	LTE Band 25 (PCS)	20	24.7	24.47	0.01	0	00304	QPSK	1	50	10 mm	left	1:1	0.611	1.054	0.644	
1860.00	26140	Low	LTE Band 25 (PCS)	20	23.7	23.31	0.02	1	00304	QPSK	50	25	10 mm	left	1:1	0.466	1.094	0.510	
ANSI / IEEE C95.1 1992 - SAFETY LIMIT Spatial Peak Uncontrolled Exposure/General Population										Body 1.6 W/kg (mW/g) averaged over 1 gram									



**Table 11-23  
WLAN Hotspot SAR**

MEASUREMENT RESULTS																		
FREQUENCY		Mode	Service	Bandwidth [MHz]	Maximum Allowed Power [dBm]	Conducted Power [dBm]	Power Drift [dB]	Spacing	Device Serial Number	Data Rate (Mbps)	Side	Duty Cycle (%)	Peak SAR of Area Scan	SAR (1g)	Scaling Factor (Power)	Scaling Factor (Duty Cycle)	Reported SAR (1g)	Plot #
MHz	Ch.												(W/kg)	(W/kg)			(W/kg)	
2462	11	802.11b	DSSS	22	15.5	15.05	0.18	10 mm	00316	1	back	99.9	0.189	-	1.109	1.001	-	
2462	11	802.11b	DSSS	22	15.5	15.05	0.02	10 mm	00316	1	front	99.9	0.199	0.166	1.109	1.001	0.184	A33
2462	11	802.11b	DSSS	22	15.5	15.05	0.08	10 mm	00316	1	top	99.9	0.130	-	1.109	1.001	-	
2462	11	802.11b	DSSS	22	15.5	15.05	0.05	10 mm	00316	1	right	99.9	0.114	-	1.109	1.001	-	
ANSI / IEEE C95.1 1992 - SAFETY LIMIT Spatial Peak Uncontrolled Exposure/General Population										Body 1.6 W/kg (mW/g) averaged over 1 gram								

## 11.4 SAR Test Notes

### General Notes:

- The test data reported are the worst-case SAR values according to test procedures specified in IEEE 1528-2013, and FCC KDB Publication 447498 D01v06.
- Batteries are fully charged at the beginning of the SAR measurements.
- Liquid tissue depth was at least 15.0 cm for all frequencies.
- The manufacturer has confirmed that the device(s) tested have the same physical, mechanical and thermal characteristics and are within operational tolerances expected for production units.
- SAR results were scaled to the maximum allowed power to demonstrate compliance per FCC KDB Publication 447498 D01v06.
- Device was tested using a fixed spacing for body-worn accessory testing. A separation distance of 10 mm was considered because the manufacturer has determined that there will be body-worn accessories available in the marketplace for users to support this separation distance.

FCC ID: ZNFX220QM		SAR EVALUATION REPORT		Approved by: Quality Manager
Document S/N: 1M1812110223-01-R1.ZNF	Test Dates: 12/12/18 - 01/02/19	DUT Type: Portable Handset	Page 51 of 67	



7. Per FCC KDB Publication 648474 D04v01r03, body-worn SAR was evaluated without a headset connected to the device. Since the standalone reported body-worn SAR was  $\leq 1.2$  W/kg, no additional body-worn SAR evaluations using a headset cable were required.
8. Per FCC KDB 865664 D01v01r04, variability SAR tests were performed when the measured SAR results for a frequency band were greater than or equal to 0.8 W/kg. Repeated SAR measurements are highlighted in the tables above for clarity. Please see Section 13 for variability analysis.
9. During SAR Testing for the Wireless Router conditions per FCC KDB Publication 941225 D06v02r01, the actual Portable Hotspot operation (with actual simultaneous transmission of a transmitter with WIFI) was not activated (See Section 6.7 for more details).

**GSM Test Notes:**



1. Body-Worn accessory testing is typically associated with voice operations. Therefore, GSM voice was evaluated for body-worn SAR.
2. Justification for reduced test configurations per KDB Publication 941225 D01v03r01 and October 2013 TCB Workshop Notes: The source-based frame-averaged output power was evaluated for all GPRS/EDGE slot configurations. The configuration with the highest target frame averaged output power was evaluated for hotspot SAR. When the maximum frame-averaged powers are equivalent across two or more slots (within 0.25 dB), the configuration with the most number of time slots was tested.
3. Per FCC KDB Publication 447498 D01v06, if the reported (scaled) SAR measured at the middle channel or highest output power channel for each test configuration is  $\leq 0.8$  W/kg for 1g evaluations then testing at the other channels is not required for such test configuration(s). When the maximum output power variation across the required test channels is  $> \frac{1}{2}$  dB, instead of the middle channel, the highest output power channel was used.
4. GPRS was additionally evaluated for head and body-worn exposure conditions to address possible VoIP scenarios.

**CDMA Notes:**

1. Head SAR for CDMA2000 mode was tested under RC3/SO55 per FCC KDB Publication 941225 D01v03r01.
2. Body-Worn SAR was tested with 1x RTT with TDSO / SO32 FCH Only. EVDO Rev0 and RevA and TDSO / SO32 FCH+SCH SAR tests were not required per the 3G SAR Test Reduction Procedure in FCC KDB Publication 941225 D01v03r01.
3. CDMA Wireless Router SAR is measured using Subtype 0/1 Physical Layer configurations for Rev. 0 according to KDB 941225 D01v03r01 procedures for data devices. Wireless Router SAR tests for Subtype 2 of Rev.A and 1x RTT configurations were not required per the 3G SAR Test Reduction Policy in KDB Publication 941225 D01v03r01.
4. Head SAR was additionally evaluated using EVDO Rev. A to determine compliance for VoIP operations.
5. Per FCC KDB Publication 447498 D01v06, if the reported (scaled) SAR measured at the middle channel or highest output power channel for each test configuration is  $\leq 0.8$  W/kg for 1g evaluations then testing at the other channels is not required for such test configuration(s). When the maximum output power variation across the required test channels is  $> \frac{1}{2}$  dB, instead of the middle channel, the highest output power channel was used.

**UMTS Notes:**

1. UMTS mode in was tested under RMC 12.2 kbps with HSPA Inactive per KDB Publication 941225 D01v03r01. AMR and HSPA SAR was not required per the 3G Test Reduction Procedure in KDB Publication 941225 D01v03r01.
2. Per FCC KDB Publication 447498 D01v06, if the reported (scaled) SAR measured at the middle channel or highest output power channel for each test configuration is  $\leq 0.8$  W/kg for 1g evaluations then testing at the other channels is not required for such test configuration(s). When the maximum output power variation across the required test channels is  $> \frac{1}{2}$  dB, instead of the middle channel, the highest output power channel was used.

FCC ID: ZNFX220QM	 <b>PCTEST</b> ENGINEERING LABORATORY, INC.	<b>SAR EVALUATION REPORT</b>	 <b>LG</b>	<b>Approved by:</b> Quality Manager
<b>Document S/N:</b> 1M1812110223-01-R1-ZNF	<b>Test Dates:</b> 12/12/18 - 01/02/19	<b>DUT Type:</b> Portable Handset	Page 52 of 67	

**LTE Notes:**



1. LTE Considerations: LTE test configurations are determined according to SAR Evaluation Considerations for LTE Devices in FCC KDB Publication 941225 D05v02r04. The general test procedures used for testing can be found in Section 8.6.4.
2. MPR is permanently implemented for this device by the manufacturer. The specific manufacturer target MPR is indicated alongside the SAR results. MPR is enabled for this device, according to 3GPP TS36.101 Section 6.2.3 – 6.2.5 under Table 6.2.3-1.
3. A-MPR was disabled for all SAR tests by setting NS=01 and MCC=001 on the base station simulator. SAR tests were performed with the same number of RB and RB offsets transmitting on all TTI frames (maximum TTI).

**WLAN Notes:**

1. For held-to-ear, and hotspot, and phablet operations, the initial test position procedures were applied. The test position with the highest extrapolated peak SAR will be used as the initial test position. When reported SAR for the initial test position is  $\leq 0.4$  W/kg for 1g evaluations, no additional testing for the remaining test positions was required. Otherwise, SAR is evaluated at the subsequent highest peak SAR positions until the reported SAR result is  $\leq 0.8$  W/kg or all test positions are measured.
2. Justification for test configurations for WLAN per KDB Publication 248227 D01v02r02 for 2.4 GHz WIFI single transmission chain operations, the highest measured maximum output power channel for DSSS was selected for SAR measurement. SAR for OFDM modes (2.4 GHz 802.11g/n) was not required due to the maximum allowed powers and the highest reported DSSS SAR. See Section 8.7.3 for more information.
3. When the maximum reported 1g averaged SAR is  $\leq 0.8$  W/kg, SAR testing on additional channels was not required. Otherwise, SAR for the next highest output power channel was required until the reported SAR result was  $\leq 1.20$  W/kg for 1g evaluations or all test channels were measured.
4. The device was configured to transmit continuously at the required data rate, channel bandwidth and signal modulation, using the highest transmission duty factor supported by the test mode tools. The reported SAR was scaled to the 100% transmission duty factor to determine compliance. Procedures used to measure the duty factor are identical to that in the associated EMC test reports.

**Bluetooth Notes**

1. Bluetooth SAR was measured with the device connected to a call box with hopping disabled with DH5 operation and Tx Tests test mode type. Per October 2016 TCB Workshop Notes, the reported SAR was scaled to the 100% transmission duty factor to determine compliance. See Section 9.6 for the time domain plot and calculation for the duty factor of the device.

FCC ID: ZNFX220QM		SAR EVALUATION REPORT		Approved by: Quality Manager
Document S/N: 1M1812110223-01-R1.ZNF	Test Dates: 12/12/18 - 01/02/19	DUT Type: Portable Handset	Page 53 of 67	

# 12 FCC MULTI-TX AND ANTENNA SAR CONSIDERATIONS

## 12.1 Introduction

The following procedures adopted from FCC KDB Publication 447498 D01v06 are applicable to devices with built-in unlicensed transmitters such as 802.11 and Bluetooth devices which may simultaneously transmit with the licensed transmitter.

## 12.2 Simultaneous Transmission Procedures

This device contains transmitters that may operate simultaneously. Therefore, simultaneous transmission analysis is required. Per FCC KDB Publication 447498 D01v06 4.3.2 and IEEE 1528-2013 Section 6.3.4.1.2, simultaneous transmission SAR test exclusion may be applied when the sum of the 1g SAR for all the simultaneous transmitting antennas in a specific a physical test configuration is  $\leq 1.6$  W/kg. The different test positions in an exposure condition may be considered collectively to determine SAR test exclusion according to the sum of 1g or 10g SAR.



When standalone SAR is not required to be measured, per FCC KDB 447498 D01v06 4.3.2 b), the following equation must be used to estimate the standalone 1g SAR for simultaneous transmission assessment involving that transmitter.

$$\text{Estimated SAR} = \frac{\sqrt{f(\text{GHz})}}{7.5} * \frac{(\text{Max Power of channel, mW})}{\text{Min. Separation Distance, mm}}$$

**Table 12-1  
Estimated SAR**

Mode	Frequency	Maximum Allowed Power	Separation Distance (Body)	Estimated SAR (Body)
	[MHz]	[dBm]	[mm]	[W/kg]
Bluetooth	2480	11.50	10	0.294

Note: Per KDB Publication 447498 D01v06, the maximum power of the channel was rounded to the nearest mW before calculation.

FCC ID: ZNFX220QM	 PCTEST ENGINEERING LABORATORY, INC.	SAR EVALUATION REPORT	 LG	Approved by: Quality Manager
Document S/N: 1M1812110223-01-R1.ZNF	Test Dates: 12/12/18 - 01/02/19	DUT Type: Portable Handset		Page 54 of 67



## 12.3 Head SAR Simultaneous Transmission Analysis

**Table 12-2**  
**Simultaneous Transmission Scenario with 2.4 GHz WLAN (Held to Ear)**

Simult Tx	Configuration	GSM 850 SAR (W/kg)	2.4 GHz WLAN SAR (W/kg)	Σ SAR (W/kg)	Simult Tx	Configuration	GPRS 850 SAR (W/kg)	2.4 GHz WLAN SAR (W/kg)	Σ SAR (W/kg)
		1	2	1+2			1	2	1+2
Head SAR	Right Cheek	0.381	0.527	0.908	Head SAR	Right Cheek	0.424	0.527	0.951
	Right Tilt	0.173	0.524	0.697		Right Tilt	0.197	0.524	0.721
	Left Cheek	0.276	1.243	<b>1.519</b>		Left Cheek	0.347	1.243	<b>1.590</b>
	Left Tilt	0.156	0.680	0.836		Left Tilt	0.184	0.680	0.864

Simult Tx	Configuration	GSM 1900 SAR (W/kg)	2.4 GHz WLAN SAR (W/kg)	Σ SAR (W/kg)
		1	2	1+2
Head SAR	Right Cheek	0.184	0.527	0.711
	Right Tilt	0.072	0.524	0.596
	Left Cheek	0.290	1.243	<b>1.533</b>
	Left Tilt	0.134	0.680	0.814

Simult Tx	Configuration	GPRS 1900 SAR (W/kg)	2.4 GHz WLAN SAR (W/kg)	Σ SAR (W/kg)	SPLSR	Simult Tx	Configuration	UMTS 850 SAR (W/kg)	2.4 GHz WLAN SAR (W/kg)	Σ SAR (W/kg)	SPLSR
		1	2	1+2	1+2			1	2	1+2	1+2
Head SAR	Right Cheek	0.284	0.527	0.811	N/A	Head SAR	Right Cheek	0.479	0.527	<b>1.006</b>	N/A
	Right Tilt	0.105	0.524	0.629	N/A		Right Tilt	0.231	0.524	0.755	N/A
	Left Cheek	0.440	1.243	See Note 1	0.03		Left Cheek	0.384	1.243	See Note 1	0.04
	Left Tilt	0.205	0.680	<b>0.885</b>	N/A		Left Tilt	0.211	0.680	0.891	N/A
Head SAR	Right Cheek	0.403	0.527	0.930	N/A	Head SAR	Right Cheek	0.422	0.527	<b>0.949</b>	N/A
	Right Tilt	0.266	0.524	0.790	N/A		Right Tilt	0.158	0.524	0.682	N/A
	Left Cheek	0.556	1.243	See Note 1	0.03		Left Cheek	0.586	1.243	See Note 1	0.03
	Left Tilt	0.295	0.680	<b>0.975</b>	N/A		Left Tilt	0.255	0.680	0.935	N/A
Head SAR	Right Cheek	0.477	0.527	<b>1.004</b>	N/A	Head SAR	Right Cheek	0.490	0.527	<b>1.017</b>	N/A
	Right Tilt	0.215	0.524	0.739	N/A		Right Tilt	0.287	0.524	0.811	N/A
	Left Cheek	0.376	1.243	See Note 1	0.03		Left Cheek	0.392	1.243	See Note 1	0.03
	Left Tilt	0.213	0.680	0.893	N/A		Left Tilt	0.266	0.680	0.946	N/A
Head SAR	Right Cheek	0.494	0.527	<b>1.021</b>	N/A	Head SAR	Right Cheek	0.474	0.527	<b>1.001</b>	N/A
	Right Tilt	0.171	0.524	0.695	N/A		Right Tilt	0.164	0.524	0.688	N/A
	Left Cheek	0.784	1.243	See Note 1	0.04		Left Cheek	0.772	1.243	See Note 1	0.03
	Left Tilt	0.325	0.680	1.005	N/A		Left Tilt	0.311	0.680	0.991	N/A

FCC ID: ZNFX220QM		SAR EVALUATION REPORT		Approved by: Quality Manager
Document S/N: 1M1812110223-01-R1-ZNF	Test Dates: 12/12/18 - 01/02/19	DUT Type: Portable Handset	Page 55 of 67	

**Table 12-3**  
**Simultaneous Transmission Scenario with 2.4 GHz WLAN (Held to Ear) Continued**



Simult Tx	Configuration	LTE Band 12 SAR (W/kg)	2.4 GHz WLAN SAR (W/kg)	Σ SAR (W/kg)	SPLSR	Simult Tx	Configuration	LTE Band 5 (Cell) SAR (W/kg)	2.4 GHz WLAN SAR (W/kg)	Σ SAR (W/kg)	SPLSR
		1	2	1+2	1+2			1	2	1+2	1+2
Head SAR	Right Cheek	0.587	0.527	<b>1.114</b>	N/A	Head SAR	Right Cheek	0.496	0.527	<b>1.023</b>	N/A
	Right Tilt	0.357	0.524	0.881	N/A		Right Tilt	0.298	0.524	0.822	N/A
	Left Cheek	0.441	1.243	See Note 1	0.03		Left Cheek	0.399	1.243	See Note 1	0.04
	Left Tilt	0.284	0.680	0.964	N/A		Left Tilt	0.264	0.680	0.944	N/A
Simult Tx	Configuration	LTE Band 4 (AWS) SAR (W/kg)	2.4 GHz WLAN SAR (W/kg)	Σ SAR (W/kg)	SPLSR	Simult Tx	Configuration	LTE Band 25 (PCS) SAR (W/kg)	2.4 GHz WLAN SAR (W/kg)	Σ SAR (W/kg)	SPLSR
		1	2	1+2	1+2			1	2	1+2	1+2
Head SAR	Right Cheek	0.420	0.527	0.947	N/A	Head SAR	Right Cheek	0.453	0.527	<b>0.980</b>	N/A
	Right Tilt	0.297	0.524	0.821	N/A		Right Tilt	0.194	0.524	0.718	N/A
	Left Cheek	0.568	1.243	See Note 1	0.03		Left Cheek	0.762	1.243	See Note 1	0.03
	Left Tilt	0.345	0.680	<b>1.025</b>	N/A		Left Tilt	0.276	0.680	0.956	N/A

**Notes:**

1. No evaluation was performed to determine the aggregate 1g SAR for these configurations as the SPLS ratio between the antenna pairs was not greater than 0.04 per FCC KDB 447498 D01v06. See Section 12.6 for detailed SPLS ratio analysis.

**Table 12-4**  
**Simultaneous Transmission Scenario with Bluetooth (Held to Ear)**

Exposure Condition	Mode	2G/3G/4G SAR (W/kg)	Bluetooth SAR (W/kg)	Σ SAR (W/kg)
		1	2	1+2
Head SAR	GSM/GPRS 850	0.424	0.435	0.859
	GSM/GPRS 1900	0.440	0.435	0.875
	UMTS 850	0.479	0.435	0.914
	UMTS 1750	0.556	0.435	0.991
	UMTS 1900	0.586	0.435	1.021
	Cell. CDMA/EVDO	0.490	0.435	0.925
	PCS CDMA/EVDO	0.784	0.435	<b>1.219</b>
	LTE Band 12	0.587	0.435	1.022
	LTE Band 5 (Cell)	0.496	0.435	0.931
	LTE Band 4 (AWS)	0.568	0.435	1.003
	LTE Band 25 (PCS)	0.762	0.435	1.197

FCC ID: ZNFX220QM		SAR EVALUATION REPORT		Approved by: Quality Manager
Document S/N: 1M1812110223-01-R1.ZNF	Test Dates: 12/12/18 - 01/02/19	DUT Type: Portable Handset		Page 56 of 67

## 12.4 Body-Worn Simultaneous Transmission Analysis



**Table 12-5**  
**Simultaneous Transmission Scenario with 2.4 GHz WLAN (Body-Worn at 1.0 cm)**

Exposure Condition	Mode	2G/3G/4G SAR (W/kg)	2.4 GHz WLAN SAR (W/kg)	Σ SAR (W/kg)
		1	2	1+2
Body-Worn	GSM/GPRS 850	0.507	0.178	0.685
	GSM/GPRS 1900	0.461	0.178	0.639
	UMTS 850	0.600	0.178	0.778
	UMTS 1750	0.883	0.178	1.061
	UMTS 1900	0.714	0.178	0.892
	Cell. CDMA	0.740	0.178	0.918
	PCS CDMA	0.916	0.178	<b>1.094</b>
	LTE Band 12	0.746	0.178	0.924
	LTE Band 5 (Cell)	0.792	0.178	0.970
	LTE Band 4 (AWS)	0.759	0.178	0.937
	LTE Band 25 (PCS)	0.900	0.178	1.078

**Table 12-6**  
**Simultaneous Transmission Scenario with Bluetooth (Body-Worn at 1.0 cm)**

Exposure Condition	Mode	2G/3G/4G SAR (W/kg)	Bluetooth SAR (W/kg)	Σ SAR (W/kg)
		1	2	1+2
Body-Worn	GSM/GPRS 850	0.507	0.294	0.801
	GSM/GPRS 1900	0.461	0.294	0.755
	UMTS 850	0.600	0.294	0.894
	UMTS 1750	0.883	0.294	1.177
	UMTS 1900	0.714	0.294	1.008
	Cell. CDMA	0.740	0.294	1.034
	PCS CDMA	0.916	0.294	<b>1.210</b>
	LTE Band 12	0.746	0.294	1.040
	LTE Band 5 (Cell)	0.792	0.294	1.086
	LTE Band 4 (AWS)	0.759	0.294	1.053
	LTE Band 25 (PCS)	0.900	0.294	1.194

Note: Bluetooth SAR was not required to be measured per FCC KDB Publication 447498 D01v06. Estimated SAR results were used in the above table to determine simultaneous transmission SAR test exclusion.

FCC ID: ZNFX220QM		SAR EVALUATION REPORT		Approved by: Quality Manager
Document S/N: 1M1812110223-01-R1.ZNF	Test Dates: 12/12/18 - 01/02/19	DUT Type: Portable Handset		Page 57 of 67

## 12.5 Hotspot SAR Simultaneous Transmission Analysis



**Table 12-7**  
**Simultaneous Transmission Scenario with 2.4 GHz WLAN (Hotspot at 1.0 cm)**

Exposure Condition	Mode	2G/3G/4G SAR (W/kg)	2.4 GHz WLAN SAR (W/kg)	Σ SAR (W/kg)
		1	2	1+2
Hotspot SAR	GPRS 850	0.559	0.184	0.743
	GPRS 1900	0.510	0.184	0.694
	UMTS 850	0.600	0.184	0.784
	UMTS 1750	0.980	0.184	<b>1.164</b>
	UMTS 1900	0.724	0.184	0.908
	Cell. EVDO	0.679	0.184	0.863
	PCS EVDO	0.948	0.184	1.132
	LTE Band 12	0.746	0.184	0.930
	LTE Band 5 (Cell)	0.792	0.184	0.976
	LTE Band 4 (AWS)	0.843	0.184	1.027
	LTE Band 25 (PCS)	0.900	0.184	1.084

**Table 12-8**  
**Simultaneous Transmission Scenario with Bluetooth (Hotspot at 1.0 cm)**

Exposure Condition	Mode	2G/3G/4G SAR (W/kg)	Bluetooth SAR (W/kg)	Σ SAR (W/kg)
		1	2	1+2
Hotspot SAR	GPRS 850	0.559	0.294	0.853
	GPRS 1900	0.510	0.294	0.804
	UMTS 850	0.600	0.294	0.894
	UMTS 1750	0.980	0.294	<b>1.274</b>
	UMTS 1900	0.724	0.294	1.018
	Cell. EVDO	0.679	0.294	0.973
	PCS EVDO	0.948	0.294	1.242
	LTE Band 12	0.746	0.294	1.040
	LTE Band 5 (Cell)	0.792	0.294	1.086
	LTE Band 4 (AWS)	0.843	0.294	1.137
	LTE Band 25 (PCS)	0.900	0.294	1.194

Note: Bluetooth SAR was not required to be measured per FCC KDB Publication 447498 D01v06. Estimated SAR results were used in the above table to determine simultaneous transmission SAR test exclusion.

FCC ID: ZNFX220QM	 <b>PCTEST</b> ENGINEERING LABORATORY, INC.	<b>SAR EVALUATION REPORT</b>	 <b>LG</b>	<b>Approved by:</b> Quality Manager
<b>Document S/N:</b> 1M1812110223-01-R1.ZNF	<b>Test Dates:</b> 12/12/18 - 01/02/19	<b>DUT Type:</b> Portable Handset	Page 58 of 67	



## 12.6 SPLSR Evaluation and Analysis

Per FCC KDB Publication 447498 D01v06, when the sum of the standalone transmitters is more than 1.6 W/kg for 1g, the SAR sum to peak locations can be analyzed to determine SAR distribution overlaps. When the SAR peak to location ratio (shown below) for each pair of antennas is  $\leq 0.04$  for 1g, simultaneous SAR evaluation is not required. The distance between the transmitters was calculated using the following formula.

$$\text{Distance}_{T_{X1} - T_{X2}} = R_i = \sqrt{(x_1 - x_2)^2 + (y_1 - y_2)^2 + (z_1 - z_2)^2} \text{ (Head)}$$

$$\text{SPLS Ratio} = \frac{(SAR_1 + SAR_2)^{1.5}}{R_i}$$



### 12.6.1 Head Left Cheek SPLSR Evaluation and Analysis

**Table 12-9**  
**Peak SAR Locations for Head Left Cheek**

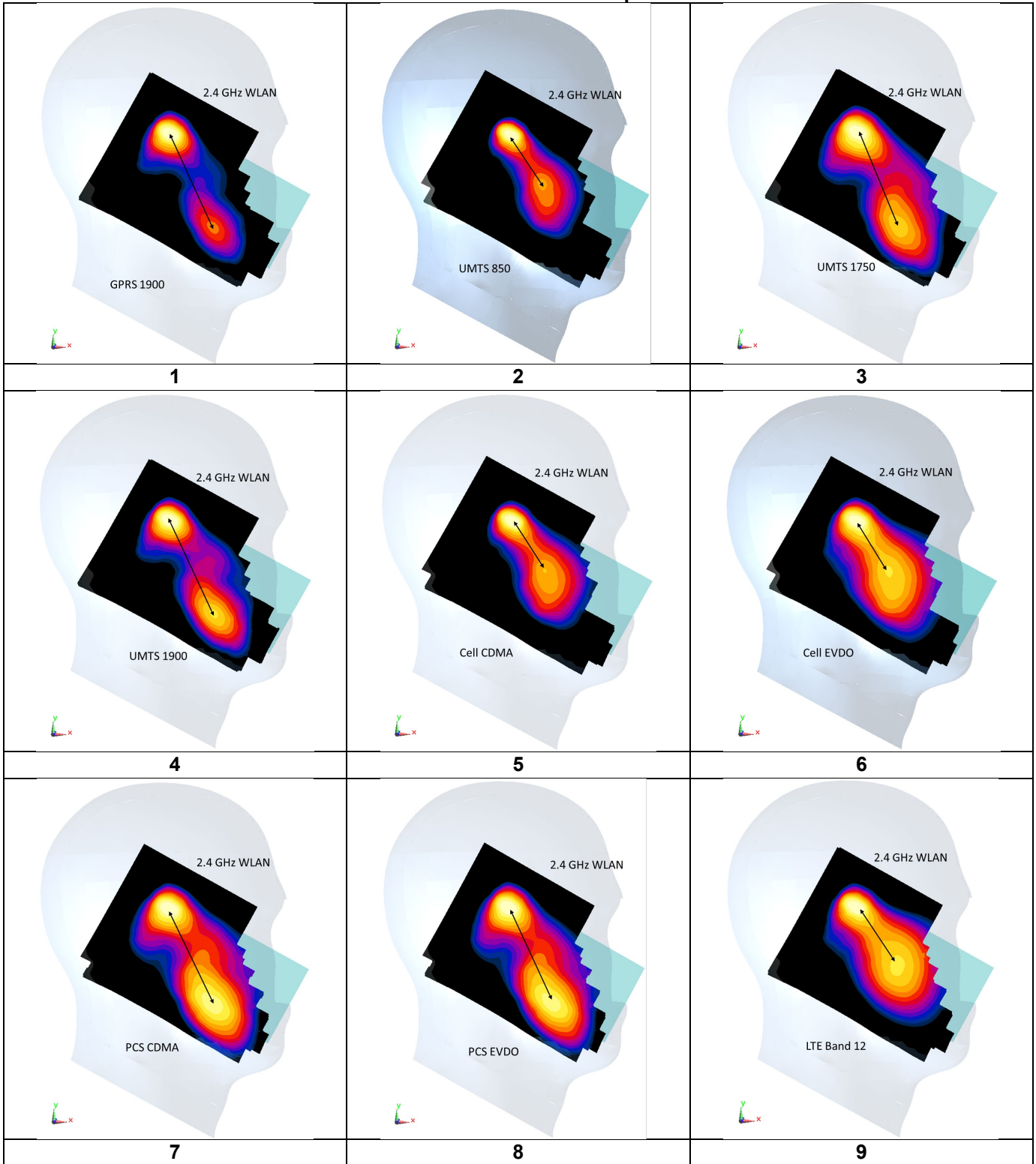
Mode/Band	x (mm)	y (mm)	z (mm)	Reported SAR (W/kg)
2.4 GHz WLAN Left Cheek	13.10	327.00	-176.00	1.243
GPRS 1900 Left Cheek	37.60	249.00	-171.00	0.44
UMTS 850 Left Cheek	45.20	281.00	-178.00	0.384
UMTS 1750 Left Cheek	36.00	250.00	-172.00	0.556
UMTS 1900 Left Cheek	44.10	246.00	-169.00	0.586
Cell CDMA Left Cheek	42.10	273.00	-178.00	0.376
Cell EVDO Left Cheek	41.30	272.00	-177.00	0.392
PCS CDMA Left Cheek	37.60	249.00	-171.00	0.784
PCS EVDO Left Cheek	38.90	249.00	-171.00	0.772
LTE B12 Left Cheek	41.70	269.00	-173.00	0.441
LTE B5 Left Cheek	46.50	280.00	-177.00	0.399
LTE B4 Left Cheek	38.90	250.00	-171.00	0.568
LTE B25 Left Cheek	48.80	253.00	-173.00	0.762



**Table 12-10**  
**Head Left Cheek SAR to Peak Location Separation Ratio Calculations**

Antenna Pair		Standalone SAR (W/kg)		Standalone SAR Sum (W/kg)	Peak SAR Separation Distance (mm)	SPLS Ratio	Plot Number
Ant "a"	Ant "b"	a	b	a+b	$D_{a-b}$	$(a+b)^{1.5}/D_{a-b}$	
2.4 GHz WLAN Left Cheek	GPRS 1900 Left Cheek	1.243	0.44	1.683	81.91	0.03	1
2.4 GHz WLAN Left Cheek	UMTS 850 Left Cheek	1.243	0.384	1.627	56.13	0.04	2
2.4 GHz WLAN Left Cheek	UMTS 1750 Left Cheek	1.243	0.556	1.799	80.43	0.03	3
2.4 GHz WLAN Left Cheek	UMTS 1900 Left Cheek	1.243	0.586	1.829	87.01	0.03	4
2.4 GHz WLAN Left Cheek	Cell CDMA Left Cheek	1.243	0.376	1.619	61.33	0.03	5
2.4 GHz WLAN Left Cheek	Cell EVDO Left Cheek	1.243	0.392	1.635	61.82	0.03	6
2.4 GHz WLAN Left Cheek	PCS CDMA Left Cheek	1.243	0.784	2.027	81.91	0.04	7
2.4 GHz WLAN Left Cheek	PCS EVDO Left Cheek	1.243	0.772	2.015	82.31	0.03	8
2.4 GHz WLAN Left Cheek	LTE B12 Left Cheek	1.243	0.441	1.684	64.74	0.03	9
2.4 GHz WLAN Left Cheek	LTE B5 Left Cheek	1.243	0.399	1.642	57.67	0.04	10
2.4 GHz WLAN Left Cheek	LTE B4 Left Cheek	1.243	0.568	1.811	81.36	0.03	11
2.4 GHz WLAN Left Cheek	LTE B25 Left Cheek	1.243	0.762	2.005	82.22	0.03	12

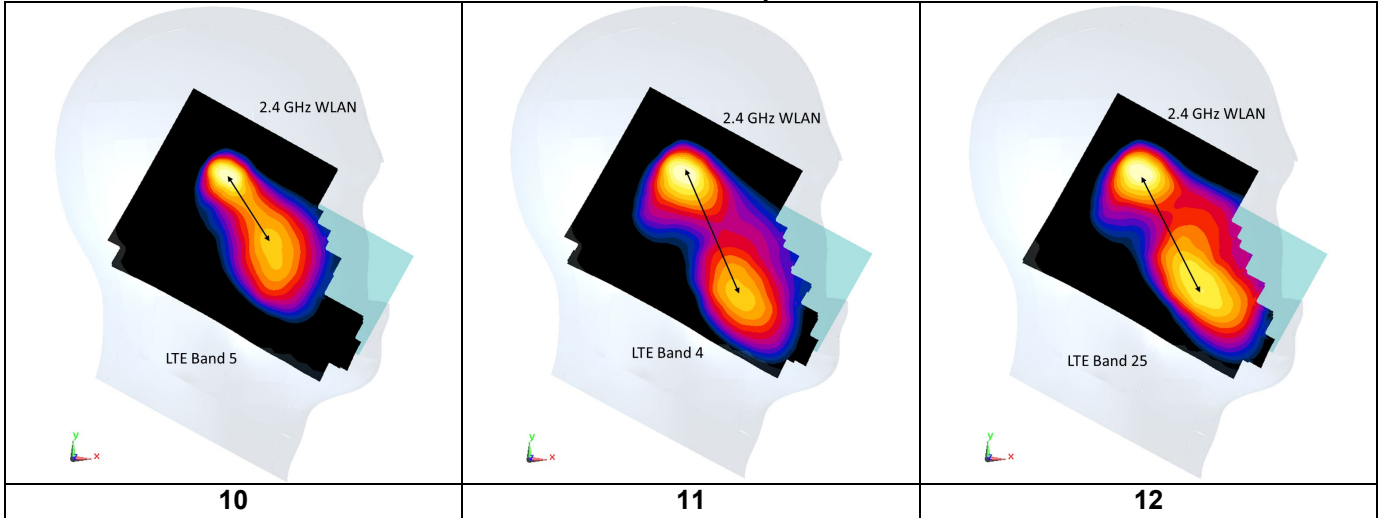
FCC ID: ZNFX220QM	 PCTEST ENGINEERING LABORATORY, INC.	SAR EVALUATION REPORT	 LG	Approved by: Quality Manager
Document S/N: 1M1812110223-01-R1.ZNF	Test Dates: 12/12/18 - 01/02/19	DUT Type: Portable Handset		Page 59 of 67

**Table 12-11**  
**Head Left Cheek SAR to Peak Location Separation Ratio Plots**





FCC ID: ZNFX220QM	 <small>PCTEST ENGINEERING LABORATORY, INC.</small>	<b>SAR EVALUATION REPORT</b>		<b>Approved by:</b> Quality Manager
<b>Document S/N:</b> 1M1812110223-01-R1.ZNF	<b>Test Dates:</b> 12/12/18 - 01/02/19	<b>DUT Type:</b> Portable Handset	Page 60 of 67	

**Table 12-12  
Head Left Cheek SAR to Peak Location Separation Ratio Plots Continued**



### 12.7 Simultaneous Transmission Conclusion

The above numerical summed SAR results and SPLSR analysis are sufficient to determine that simultaneous transmission cases will not exceed the SAR limit and therefore no measured volumetric simultaneous SAR summation is required per FCC KDB Publication 447498 D01v06 and IEEE 1528-2013 Section 6.3.4.1.2.

FCC ID: ZNFX220QM		SAR EVALUATION REPORT		Approved by: Quality Manager
Document S/N: 1M1812110223-01-R1.ZNF	Test Dates: 12/12/18 - 01/02/19	DUT Type: Portable Handset	Page 61 of 67	

# 13 SAR MEASUREMENT VARIABILITY

## 13.1 Measurement Variability

Per FCC KDB Publication 865664 D01v01r04, SAR measurement variability was assessed for each frequency band, which was determined by the SAR probe calibration point and tissue-equivalent medium used for the device measurements. When both head and body tissue-equivalent media were required for SAR measurements in a frequency band, the variability measurement procedures were applied to the tissue medium with the highest measured SAR, using the highest measured SAR configuration for that tissue-equivalent medium. These additional measurements were repeated after the completion of all measurements requiring the same head or body tissue-equivalent medium in a frequency band. The test device was returned to ambient conditions (normal room temperature) with the battery fully charged before it was re-mounted on the device holder for the repeated measurement(s) to minimize any unexpected variations in the repeated results.

SAR Measurement Variability was assessed using the following procedures for each frequency band:

- 1) When the original highest measured SAR is  $\geq 0.80$  W/kg, the measurement was repeated once.
- 2) A second repeated measurement was performed only if the ratio of largest to smallest SAR for the original and first repeated measurements was  $> 1.20$  or when the original or repeated measurement was  $\geq 1.45$  W/kg (~ 10% from the 1g SAR limit).
- 3) A third repeated measurement was performed only if the original, first or second repeated measurement was  $\geq 1.5$  W/kg and the ratio of largest to smallest SAR for the original, first and second repeated measurements is  $> 1.20$ .
- 4) Repeated measurements are not required when the original highest measured SAR is  $< 0.80$  W/kg
- 5) When 10g SAR measurement is considered, a factor of 2.5 is applied to the thresholds above.

**Table 13-1  
Head SAR Measurement Variability Results**



HEAD VARIABILITY RESULTS														
Band	FREQUENCY		Mode/Band	Service	Side	Test Position	Data Rate (Mbps)	Measured SAR (1g)	1st Repeated SAR (1g)	Ratio	2nd Repeated SAR (1g)	Ratio	3rd Repeated SAR (1g)	Ratio
	MHz	Ch.						(W/kg)	(W/kg)		(W/kg)		(W/kg)	
2450	2462.00	11	802.11b, 22 MHz Bandwidth	DSSS	Left	Cheek	1	1.120	1.030	1.09	N/A	N/A	N/A	N/A
ANSI / IEEE C95.1 1992 - SAFETY LIMIT Spatial Peak Uncontrolled Exposure/General Population						Head 1.6 W/kg (mW/g) averaged over 1 gram								

**Table 13-2  
Body SAR Measurement Variability Results**

BODY VARIABILITY RESULTS															
Band	FREQUENCY		Mode	Service	# of Time Slots	Data Rate (Mbps)	Side	Spacing	Measured SAR (1g)	1st Repeated SAR (1g)	Ratio	2nd Repeated SAR (1g)	Ratio	3rd Repeated SAR (1g)	Ratio
	MHz	Ch.							(W/kg)	(W/kg)		(W/kg)		(W/kg)	
1750	1732.40	1412	UMTS 1750	RMC	N/A	N/A	front	10 mm	0.938	0.875	1.07	N/A	N/A	N/A	N/A
1900	1851.25	25	PCS CDMA	TDSO / SO32	N/A	N/A	back	10 mm	0.879	0.825	1.07	N/A	N/A	N/A	N/A
ANSI / IEEE C95.1 1992 - SAFETY LIMIT Spatial Peak Uncontrolled Exposure/General Population								Body 1.6 W/kg (mW/g) averaged over 1 gram							

## 13.2 Measurement Uncertainty



The measured SAR was  $< 1.5$  W/kg for 1g and  $< 3.75$  W/kg for 10g for all frequency bands. Therefore, per KDB Publication 865664 D01v01r04, the extended measurement uncertainty analysis per IEEE 1528-2013 was not required.

FCC ID: ZNFX220QM	 PCTEST ENGINEERING LABORATORY, INC.	SAR EVALUATION REPORT	 LG	Approved by: Quality Manager
Document S/N: 1M1812110223-01-R1.ZNF	Test Dates: 12/12/18 - 01/02/19	DUT Type: Portable Handset	Page 62 of 67	

# 14 EQUIPMENT LIST



Manufacturer	Model	Description	Cal Date	Cal Interval	Cal Due	Serial Number
Agilent	8594A	(9kHz-2.9GHz) Spectrum Analyzer	N/A	N/A	N/A	3051A00187
Agilent	E4438C	ESG Vector Signal Generator	3/24/2017	Biennial	3/24/2019	MY42082385
Agilent	E4432B	ESG-D Series Signal Generator	4/19/2018	Annual	4/19/2019	US40053896
Agilent	N9020A	MXA Signal Analyzer	1/24/2018	Annual	1/24/2019	US46470561
Agilent	N5182A	MXG Vector Signal Generator	11/28/2018	Annual	11/28/2019	MY47420603
Agilent	N5182A-506	MXG Vector Signal Generator	6/19/2018	Annual	6/19/2019	MY48180366
Agilent	8753ES	S-Parameter Network Analyzer	7/30/2018	Annual	7/30/2019	MY40000670
Agilent	8753ES	S-Parameter Vector Network Analyzer	8/30/2018	Annual	8/30/2019	MY40003841
Agilent	E5515C	Wireless Communications Test Set	5/22/2018	Biennial	5/22/2020	GB43193563
Agilent	E5515C	Wireless Communications Test Set	2/7/2018	Triennial	2/7/2021	GB43304447
Agilent	N4010A	Wireless Connectivity Test Set	N/A	N/A	N/A	GB44450273
Agilent	N4010A	Wireless Connectivity Test Set	N/A	N/A	N/A	GB46170464
Amplifier Research	1551G6	Amplifier	CBT	N/A	CBT	433972
Amplifier Research	1551G6	Amplifier	CBT	N/A	CBT	433974
Anritsu	ML2496A	Power Meter	6/19/2018	Annual	6/19/2019	1306009
Anritsu	MA2411B	Pulse Power Sensor	10/30/2018	Annual	10/30/2019	1126066
Anritsu	MT8821C	Radio Communication Analyzer	11/6/2018	Annual	11/6/2019	6200901190
Anritsu	MT8821C	Radio Communication Analyzer	7/26/2018	Annual	7/26/2019	6201144418
Anritsu	MA24106A	USB Power Sensor	6/5/2018	Annual	6/5/2019	1231535
Anritsu	MA24106A	USB Power Sensor	6/5/2018	Annual	6/5/2019	1231538
Anritsu	MA24106A	USB Power Sensor	6/5/2018	Annual	6/5/2019	1244515
Anritsu	MA24106A	USB Power Sensor	6/21/2018	Annual	6/21/2019	1244524
COMTECH	AR85729-5	Solid State Amplifier	CBT	N/A	CBT	M155A00-009
COMTECH	AR85729-5/5759B	Solid State Amplifier	CBT	N/A	CBT	M3W1A00-1002
Control Company	4040	Therm./ Clock/ Humidity Monitor	10/9/2018	Biennial	10/9/2020	181647802
Control Company	4040	Therm./ Clock/ Humidity Monitor	10/9/2018	Biennial	10/9/2020	181647811
Control Company	4352	Ultra Long Stem Thermometer	5/2/2017	Biennial	5/2/2019	170330127
Control Company	4352	Ultra Long Stem Thermometer	5/2/2017	Biennial	5/2/2019	170330131
Keysight	772D	Dual Directional Coupler	CBT	CBT	CBT	MY52180215
Keysight Technologies	85033E	Standard Mechanical Calibration Kit (DC to 9GHz, 3.5mm)	6/4/2018	Annual	6/4/2019	MY53401181
MCL	BW-N6W5+	6dB Attenuator	CBT	CBT	CBT	1139
MiniCircuits	SLP-2400+	Low Pass Filter	CBT	CBT	CBT	R8979500903
MiniCircuits	VLf-6000+	Low Pass Filter	CBT	CBT	CBT	N/A
MiniCircuits	VLf-6000+	Low Pass Filter	CBT	CBT	CBT	N/A
Mini-Circuits	BW-N20W5+	DC to 18 GHz Precision Fixed 20 dB Attenuator	CBT	CBT	CBT	N/A
Mini-Circuits	NLP-1200+	Low Pass Filter DC to 1000 MHz	CBT	CBT	CBT	N/A
Mini-Circuits	NLP-2950+	Low Pass Filter DC to 2700 MHz	CBT	CBT	CBT	N/A
Mini-Circuits	BW-N20W5	Power Attenuator	CBT	CBT	CBT	1226
Mitutoyo	CD-6°CSX	Digital Caliper	4/18/2018	Biennial	4/18/2020	13264165
Narda	4014C-6	4 - 8 GHz SMA 6 dB Directional Coupler	CBT	CBT	CBT	N/A
Narda	4772-3	Attenuator (3dB)	CBT	CBT	CBT	9406
Narda	BW-53W2	Attenuator (3dB)	CBT	CBT	CBT	120
Pasternack	PE2209-10	Bidirectional Coupler	CBT	CBT	CBT	N/A
Pasternack	NC-100	Torque Wrench	4/18/2018	Annual	4/18/2019	1445
Pasternack	PE5011-1	Torque Wrench	7/19/2017	Biennial	7/19/2019	N/A
Rohde & Schwarz	CMW500	Radio Communication Tester	6/8/2018	Annual	6/8/2019	112347
Rohde & Schwarz	CMW500	Radio Communication Tester	11/5/2018	Annual	11/5/2019	140148
Rohde & Schwarz	CMW500	Wideband Radio Communication Tester	5/29/2018	Annual	5/29/2019	161662
SPEAG	D1750V2	1750 MHz SAR Dipole	5/9/2017	Biennial	5/9/2019	1148
SPEAG	D1750V2	1750 MHz SAR Dipole	10/22/2018	Annual	10/22/2019	1150
SPEAG	D1900V2	1900 MHz SAR Dipole	10/23/2018	Annual	10/23/2019	50800
SPEAG	D1900V2	1900 MHz SAR Dipole	2/7/2018	Annual	2/7/2019	5d148
SPEAG	D2450V2	2450 MHz SAR Dipole	8/17/2017	Biennial	8/17/2019	719
SPEAG	D2450V2	2450 MHz SAR Dipole	9/11/2017	Biennial	9/11/2019	797
SPEAG	D2450V2	2450 MHz SAR Dipole	8/16/2018	Annual	8/16/2019	981
SPEAG	D750V3	750 MHz Dipole	3/7/2017	Biennial	3/7/2019	1054
SPEAG	D835V2	835 MHz SAR Dipole	10/19/2018	Annual	10/19/2019	40047
SPEAG	D835V2	835 MHz SAR Dipole	10/19/2018	Annual	10/19/2019	4d133
SPEAG	DAE4	Dasy Data Acquisition Electronics	2/15/2018	Annual	2/15/2019	665
SPEAG	DAE4	Dasy Data Acquisition Electronics	5/22/2018	Annual	5/22/2019	859
SPEAG	DAE4	Dasy Data Acquisition Electronics	2/9/2018	Annual	2/9/2019	1272
SPEAG	DAE4	Dasy Data Acquisition Electronics	7/11/2018	Annual	7/11/2019	1322
SPEAG	DAE4	Dasy Data Acquisition Electronics	10/18/2018	Annual	10/18/2019	1333
SPEAG	DAE4	Dasy Data Acquisition Electronics	6/18/2018	Annual	6/18/2019	1334
SPEAG	DAE4	Dasy Data Acquisition Electronics	3/7/2018	Annual	3/7/2019	1368
SPEAG	DAE4	Dasy Data Acquisition Electronics	4/11/2018	Annual	4/11/2019	1407
SPEAG	DAK-3.5	Dielectric Assessment Kit	9/11/2018	Annual	9/11/2019	1091
SPEAG	ES3DV3	SAR Probe	10/22/2018	Annual	10/22/2019	3287
SPEAG	ES3DV3	SAR Probe	3/13/2018	Annual	3/13/2019	3319
SPEAG	ES3DV3	SAR Probe	8/22/2018	Annual	8/22/2019	3332
SPEAG	ES3DV3	SAR Probe	3/27/2018	Annual	3/27/2019	3347
SPEAG	EX3DV4	SAR Probe	4/18/2018	Annual	4/18/2019	7357
SPEAG	EX3DV4	SAR Probe	5/22/2018	Annual	5/22/2019	7406
SPEAG	EX3DV4	SAR Probe	6/25/2018	Annual	6/25/2019	7409
SPEAG	EX3DV4	SAR Probe	7/20/2018	Annual	7/20/2019	7410

Note: CBT (Calibrated Before Testing). Prior to testing, the measurement paths containing a cable, amplifier, attenuator, coupler or filter were connected to a calibrated source (i.e. a signal generator) to determine the losses of the measurement path. The power meter offset was then adjusted to compensate for the measurement system losses. This level offset is stored within the power meter before measurements are made. This calibration verification procedure applies to the system verification and output power measurements. The calibrated reading is then taken directly from the power meter after compensation of the losses for all final power measurements.

FCC ID: ZNFX220QM		SAR EVALUATION REPORT		Approved by: Quality Manager
Document S/N: 1M1812110223-01-R1.ZNF	Test Dates: 12/12/18 - 01/02/19	DUT Type: Portable Handset		Page 63 of 67

# 15 MEASUREMENT UNCERTAINTIES

a	c	d	e= f(d,k)	f	g	h = c x f/e	i = c x g/e	k
Uncertainty Component	Tol. (± %)	Prob. Dist.	Div.	c <sub>i</sub> 1gm	c <sub>i</sub> 10 gms	1gm u <sub>i</sub> (± %)	10gms u <sub>i</sub> (± %)	v <sub>i</sub>
<b>Measurement System</b>								
Probe Calibration	6.55	N	1	1.0	1.0	6.6	6.6	∞
Axial Isotropy	0.25	N	1	0.7	0.7	0.2	0.2	∞
Hemishperical Isotropy	1.3	N	1	0.7	0.7	0.9	0.9	∞
Boundary Effect	2.0	R	1.73	1.0	1.0	1.2	1.2	∞
Linearity	0.3	N	1	1.0	1.0	0.3	0.3	∞
System Detection Limits	0.25	R	1.73	1.0	1.0	0.1	0.1	∞
Readout Electronics	0.3	N	1	1.0	1.0	0.3	0.3	∞
Response Time	0.8	R	1.73	1.0	1.0	0.5	0.5	∞
Integration Time	2.6	R	1.73	1.0	1.0	1.5	1.5	∞
RF Ambient Conditions - Noise	3.0	R	1.73	1.0	1.0	1.7	1.7	∞
RF Ambient Conditions - Reflections	3.0	R	1.73	1.0	1.0	1.7	1.7	∞
Probe Positioner Mechanical Tolerance	0.4	R	1.73	1.0	1.0	0.2	0.2	∞
Probe Positioning w/ respect to Phantom	6.7	R	1.73	1.0	1.0	3.9	3.9	∞
Extrapolation, Interpolation & Integration algorithms for Max. SAR Evaluation	4.0	R	1.73	1.0	1.0	2.3	2.3	∞
<b>Test Sample Related</b>								
Test Sample Positioning	2.7	N	1	1.0	1.0	2.7	2.7	35
Device Holder Uncertainty	1.67	N	1	1.0	1.0	1.7	1.7	5
Output Power Variation - SAR drift measurement	5.0	R	1.73	1.0	1.0	2.9	2.9	∞
SAR Scaling	0.0	R	1.73	1.0	1.0	0.0	0.0	∞
<b>Phantom &amp; Tissue Parameters</b>								
Phantom Uncertainty (Shape & Thickness tolerances)	7.6	R	1.73	1.0	1.0	4.4	4.4	∞
Liquid Conductivity - measurement uncertainty	4.2	N	1	0.78	0.71	3.3	3.0	10
Liquid Permittivity - measurement uncertainty	4.1	N	1	0.23	0.26	1.0	1.1	10
Liquid Conductivity - Temperature Uncertainty	3.4	R	1.73	0.78	0.71	1.5	1.4	∞
Liquid Permittivity - Temperature Uncertainty	0.6	R	1.73	0.23	0.26	0.1	0.1	∞
Liquid Conductivity - deviation from target values	5.0	R	1.73	0.64	0.43	1.8	1.2	∞
Liquid Permittivity - deviation from target values	5.0	R	1.73	0.60	0.49	1.7	1.4	∞
<b>Combined Standard Uncertainty (k=1)</b>	RSS					11.5	11.3	60
<b>Expanded Uncertainty</b> (95% CONFIDENCE LEVEL)	k=2					23.0	22.6	



FCC ID: ZNFX220QM	 PCTEST ENGINEERING LABORATORY, INC.	SAR EVALUATION REPORT	 LG	Approved by: Quality Manager
Document S/N: 1M1812110223-01-R1.ZNF	Test Dates: 12/12/18 - 01/02/19	DUT Type: Portable Handset		Page 64 of 67

# 16 CONCLUSION

## 16.1 Measurement Conclusion

The SAR evaluation indicates that the EUT complies with the RF radiation exposure limits of the FCC and Innovation, Science, and Economic Development Canada, with respect to all parameters subject to this test. These measurements were taken to simulate the RF effects of RF exposure under worst-case conditions. Precise laboratory measures were taken to assure repeatability of the tests. The results and statements relate only to the item(s) tested.



Please note that the absorption and distribution of electromagnetic energy in the body are very complex phenomena that depend on the mass, shape, and size of the body, the orientation of the body with respect to the field vectors, and the electrical properties of both the body and the environment. Other variables that may play a substantial role in possible biological effects are those that characterize the environment (e.g. ambient temperature, air velocity, relative humidity, and body insulation) and those that characterize the individual (e.g. age, gender, activity level, debilitation, or disease). Because various factors may interact with one another to vary the specific biological outcome of an exposure to electromagnetic fields, any protection guide should consider maximal amplification of biological effects as a result of field-body interactions, environmental conditions, and physiological variables. [3]

FCC ID: ZNFX220QM	 PCTEST ENGINEERING LABORATORY, INC.	SAR EVALUATION REPORT	 LG	Approved by: Quality Manager
Document S/N: 1M1812110223-01-R1.ZNF	Test Dates: 12/12/18 - 01/02/19	DUT Type: Portable Handset		Page 65 of 67





## 17 REFERENCES

- [1] Federal Communications Commission, ET Docket 93-62, Guidelines for Evaluating the Environmental Effects of Radiofrequency Radiation, Aug. 1996.
- [2] ANSI/IEEE C95.1-2005, American National Standard safety levels with respect to human exposure to radio frequency electromagnetic fields, 3kHz to 300GHz, New York: IEEE, 2006.
- [3] ANSI/IEEE C95.1-1992, American National Standard safety levels with respect to human exposure to radio frequency electromagnetic fields, 3kHz to 300GHz, New York: IEEE, Sept. 1992.
- [4] ANSI/IEEE C95.3-2002, IEEE Recommended Practice for the Measurement of Potentially Hazardous Electromagnetic Fields - RF and Microwave, New York: IEEE, December 2002.
- [5] IEEE Standards Coordinating Committee 39 –Standards Coordinating Committee 34 – IEEE Std. 1528-2013, IEEE Recommended Practice for Determining the Peak Spatial-Average Specific Absorption Rate (SAR) in the Human Head from Wireless Communications Devices: Measurement Techniques.
- [6] NCRP, National Council on Radiation Protection and Measurements, Biological Effects and Exposure Criteria for RadioFrequency Electromagnetic Fields, NCRP Report No. 86, 1986. Reprinted Feb. 1995.
- [7] T. Schmid, O. Egger, N. Kuster, Automated E-field scanning system for dosimetric assessments, IEEE Transaction on Microwave Theory and Techniques, vol. 44, Jan. 1996, pp. 105-113.
- [8] K. Pokovic, T. Schmid, N. Kuster, Robust setup for precise calibration of E-field probes in tissue simulating liquids at mobile communications frequencies, ICECOM97, Oct. 1997, pp. 1 -124.
- [9] K. Pokovic, T. Schmid, and N. Kuster, E-field Probe with improved isotropy in brain simulating liquids, Proceedings of the ELMAR, Zadar, Croatia, June 23-25, 1996, pp. 172-175.
- [10] Schmid & Partner Engineering AG, Application Note: Data Storage and Evaluation, June 1998, p2.
- [11] V. Hombach, K. Meier, M. Burkhardt, E. Kuhn, N. Kuster, The Dependence of EM Energy Absorption upon Human Modeling at 900 MHz, IEEE Transaction on Microwave Theory and Techniques, vol. 44 no. 10, Oct. 1996, pp. 1865-1873.
- [12] N. Kuster and Q. Balzano, Energy absorption mechanism by biological bodies in the near field of dipole antennas above 300MHz, IEEE Transaction on Vehicular Technology, vol. 41, no. 1, Feb. 1992, pp. 17-23.
- [13] G. Hartsgrrove, A. Kraszewski, A. Surowiec, Simulated Biological Materials for Electromagnetic Radiation Absorption Studies, University of Ottawa, Bioelectromagnetics, Canada: 1987, pp. 29-36.
- [14] Q. Balzano, O. Garay, T. Manning Jr., Electromagnetic Energy Exposure of Simulated Users of Portable Cellular Telephones, IEEE Transactions on Vehicular Technology, vol. 44, no.3, Aug. 1995.
- [15] W. Gander, Computermathematick, Birkhaeuser, Basel, 1992.
- [16] W.H. Press, S.A. Teukolsky, W.T. Vetterling, and B.P. Flannery, Numerical Recipes in C, The Art of Scientific Computing, Second edition, Cambridge University Press, 1992.
- [17] N. Kuster, R. Kastle, T. Schmid, Dosimetric evaluation of mobile communications equipment with known precision, IEEE Transaction on Communications, vol. E80-B, no. 5, May 1997, pp. 645-652.

FCC ID: ZNFX220QM	 PCTEST ENGINEERING LABORATORY, INC.	SAR EVALUATION REPORT	 LG	Approved by: Quality Manager
Document S/N: 1M1812110223-01-R1.ZNF	Test Dates: 12/12/18 - 01/02/19	DUT Type: Portable Handset		Page 66 of 67

- [18] CENELEC CLC/SC111B, European Prestandard (prENV 50166-2), Human Exposure to Electromagnetic Fields High-frequency: 10kHz-300GHz, Jan. 1995.
- [19] Prof. Dr. Niels Kuster, ETH, Eidgenössische Technische Hochschule Zürich, Dosimetric Evaluation of the Cellular Phone.
- [20] IEC 62209-1, Measurement procedure for the assessment of specific absorption rate of human exposure to radio frequency fields from hand-held and body-mounted wireless communication devices - Part 1: Devices used next to the ear (Frequency range of 300 MHz to 6 GHz), July 2016.
- [21] Innovation, Science, Economic Development Canada RSS-102 Radio Frequency Exposure Compliance of Radiocommunication Apparatus (All Frequency Bands) Issue 5, March 2015.
- [22] Health Canada Safety Code 6 Limits of Human Exposure to Radio Frequency Electromagnetic Fields in the Frequency Range from 3 kHz – 300 GHz, 2015
- [23] FCC SAR Test Procedures for 2G-3G Devices, Mobile Hotspot and UMPC Devices KDB Publications 941225, D01-D07
- [24] SAR Measurement Guidance for IEEE 802.11 Transmitters, KDB Publication 248227 D01
- [25] FCC SAR Considerations for Handsets with Multiple Transmitters and Antennas, KDB Publications 648474 D03-D04
- [26] FCC SAR Evaluation Considerations for Laptop, Notebook, Netbook and Tablet Computers, FCC KDB Publication 616217 D04
- [27] FCC SAR Measurement and Reporting Requirements for 100MHz – 6 GHz, KDB Publications 865664 D01-D02
- [28] FCC General RF Exposure Guidance and SAR Procedures for Dongles, KDB Publication 447498, D01-D02
- [29] Anexo à Resolução No. 533, de 10 de Setembro de 2009.
- [30] IEC 62209-2, Human exposure to radio frequency fields from hand-held and body-mounted wireless communication devices - Human models, instrumentation, and procedures - Part 2: Procedure to determine the specific absorption rate (SAR) for wireless communication devices used in close proximity to the human body (frequency range of 30 MHz to 6 GHz), Mar. 2010.

FCC ID: ZNFX220QM	 <b>SAR EVALUATION REPORT</b> 		<b>Approved by:</b> Quality Manager
Document S/N: 1M1812110223-01-R1.ZNF	Test Dates: 12/12/18 - 01/02/19	DUT Type: Portable Handset	Page 67 of 67

## APPENDIX A: SAR TEST DATA

# PCTEST ENGINEERING LABORATORY, INC.

**DUT: ZNFX220QM; Type: Portable Handset; Serial: 03058**

Communication System: UID 0, GSM GPRS; 2 Tx slots; Frequency: 836.6 MHz; Duty Cycle: 1:4.15  
Medium: 835 Head Medium parameters used (interpolated):  
 $f = 836.6 \text{ MHz}$ ;  $\sigma = 0.914 \text{ S/m}$ ;  $\epsilon_r = 42.726$ ;  $\rho = 1000 \text{ kg/m}^3$   
Phantom section: Right Section

Test Date: 12-26-2018; Ambient Temp: 21.7°C; Tissue Temp: 20.3°C

Probe: EX3DV4 - SN7410; ConvF(9.81, 9.81, 9.81) @ 836.6 MHz; Calibrated: 7/20/2018  
Sensor-Surface: 1.4mm (Mechanical Surface Detection)  
Electronics: DAE4 Sn1322; Calibrated: 7/11/2018  
Phantom: SAM Front; Type: SAM; Serial: 1686  
Measurement SW: DASY52, Version 52.10 (1);SEMCAD X Version 14.6.12 (7450)

**Mode: GPRS 850, Right Head, Cheek, Mid.ch, 2 Tx slots**

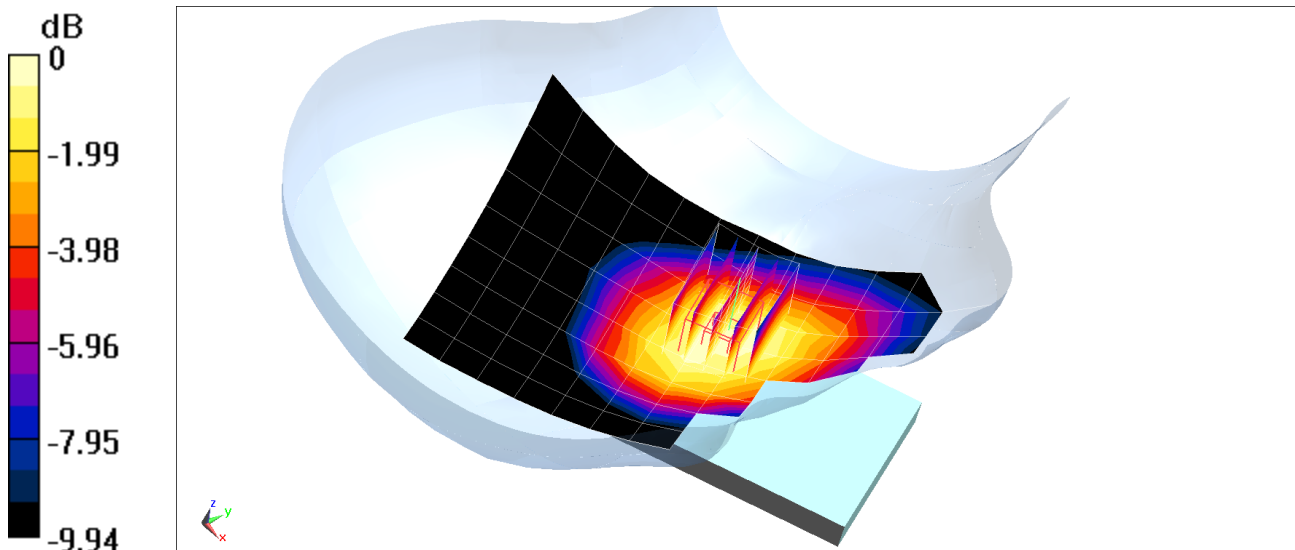
**Area Scan (9x15x1):** Measurement grid: dx=15mm, dy=15mm

**Zoom Scan (6x5x7)/Cube 0:** Measurement grid: dx=8mm, dy=8mm, dz=5mm

Reference Value = 21.53 V/m; Power Drift = -0.01 dB

Peak SAR (extrapolated) = 0.515 W/kg

**SAR(1 g) = 0.410 W/kg**



0 dB = 0.477 W/kg = -3.21 dBW/kg

# PCTEST ENGINEERING LABORATORY, INC.

**DUT: ZNFX220QM; Type: Portable Handset; Serial: 00306**

Communication System: UID 0, GSM GPRS; 2 Tx slots; Frequency: 1880 MHz; Duty Cycle: 1:4.15

Medium: 1900 Head Medium parameters used:

$f = 1880 \text{ MHz}$ ;  $\sigma = 1.44 \text{ S/m}$ ;  $\epsilon_r = 38.549$ ;  $\rho = 1000 \text{ kg/m}^3$

Phantom section: Left Section

Test Date: 12-31-2018; Ambient Temp: 21.7°C; Tissue Temp: 20.8°C

Probe: ES3DV3 - SN3287; ConvF(5.24, 5.24, 5.24) @ 1880 MHz; Calibrated: 10/22/2018

Sensor-Surface: 3mm (Mechanical Surface Detection)

Electronics: DAE4 Sn1333; Calibrated: 10/18/2018

Phantom: Twin-SAM V8.0; Type: QD 000 P41 Ax; Serial: 1964

Measurement SW: DASY52, Version 52.10 (2);SEMCAD X Version 14.6.12 (7450)

**Mode: GPRS 1900, Left Head, Cheek, Mid.ch, 2 Tx slots**

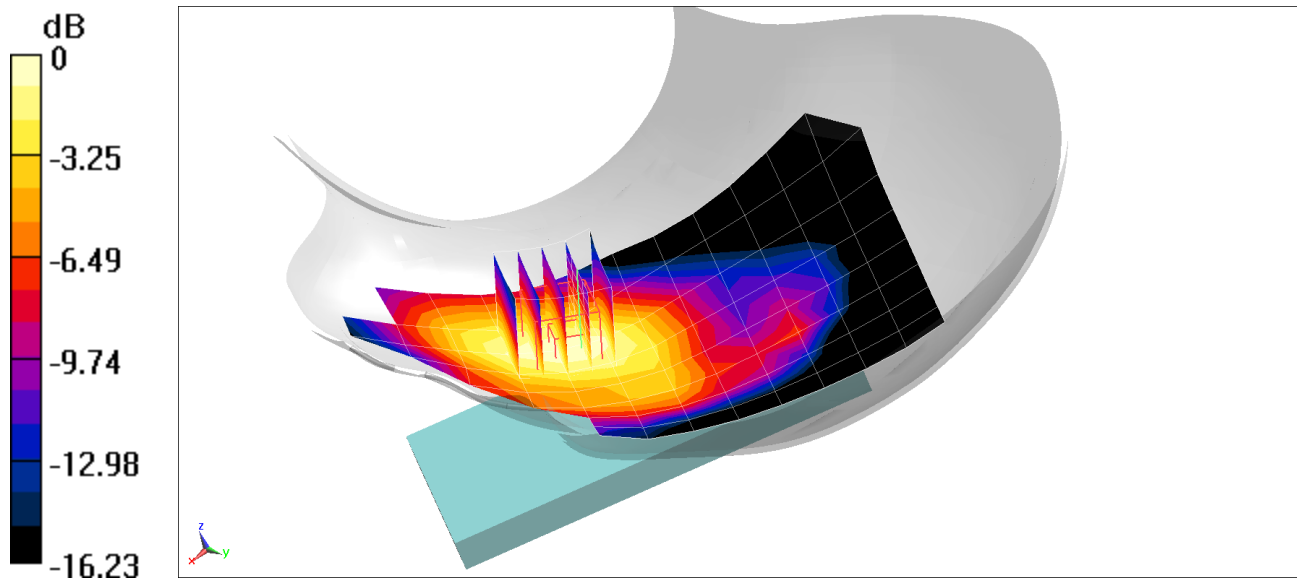
**Area Scan (9x15x1):** Measurement grid: dx=15mm, dy=15mm

**Zoom Scan (5x5x7)/Cube 0:** Measurement grid: dx=8mm, dy=8mm, dz=5mm

Reference Value = 17.05 V/m; Power Drift = 0.11 dB

Peak SAR (extrapolated) = 0.596 W/kg

**SAR(1 g) = 0.380 W/kg**



0 dB = 0.438 W/kg = -3.59 dBW/kg

# PCTEST ENGINEERING LABORATORY, INC.

**DUT: ZNFX220QM; Type: Portable Handset; Serial: 00305**

Communication System: UID 0, UMTS; Frequency: 836.6 MHz; Duty Cycle: 1:1  
Medium: 835 Head Medium parameters used (interpolated):  
 $f = 836.6 \text{ MHz}$ ;  $\sigma = 0.931 \text{ S/m}$ ;  $\epsilon_r = 42.947$ ;  $\rho = 1000 \text{ kg/m}^3$   
Phantom section: Right Section

Test Date: 12-19-2018; Ambient Temp: 23.0°C; Tissue Temp: 22.1°C

Probe: EX3DV4 - SN7410; ConvF(9.81, 9.81, 9.81) @ 836.6 MHz; Calibrated: 7/20/2018  
Sensor-Surface: 1.4mm (Mechanical Surface Detection)  
Electronics: DAE4 Sn1322; Calibrated: 7/11/2018  
Phantom: SAM Front; Type: SAM; Serial: 1686  
Measurement SW: DASY52, Version 52.10 (1);SEMCAD X Version 14.6.12 (7450)

**Mode: UMTS 850, Right Head, Cheek, Mid.ch**

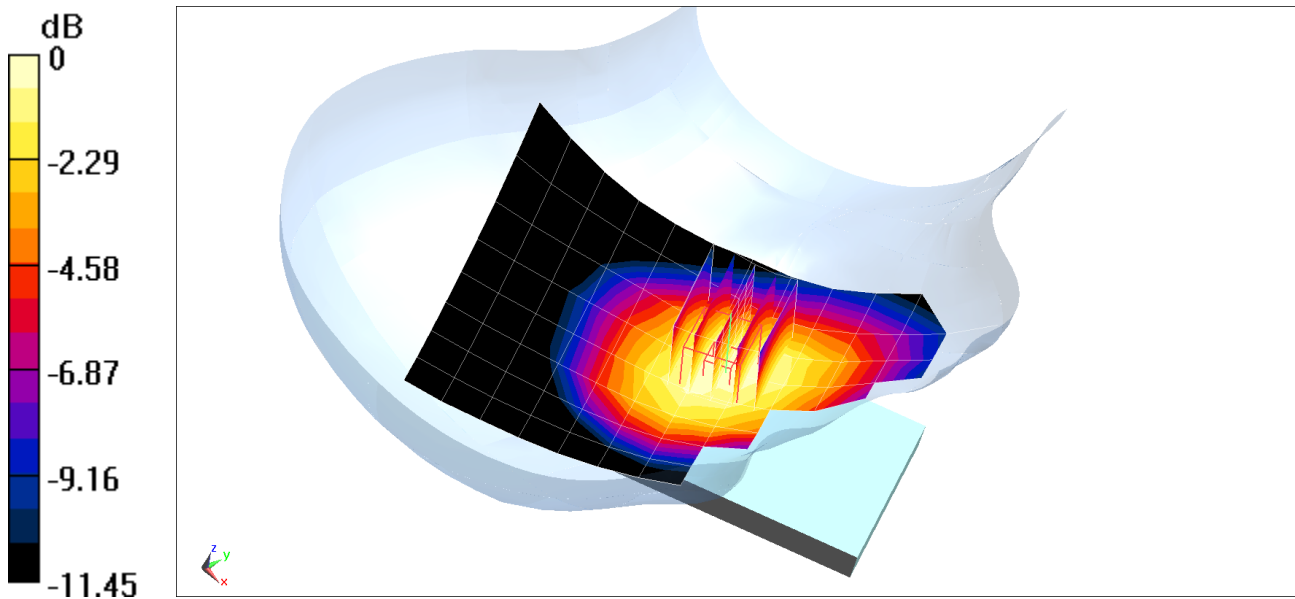
**Area Scan (9x15x1):** Measurement grid: dx=15mm, dy=15mm

**Zoom Scan (6x5x7)/Cube 0:** Measurement grid: dx=8mm, dy=8mm, dz=5mm

Reference Value = 22.12 V/m; Power Drift = -0.05 dB

Peak SAR (extrapolated) = 0.580 W/kg

**SAR(1 g) = 0.456 W/kg**



0 dB = 0.538 W/kg = -2.69 dBW/kg

# PCTEST ENGINEERING LABORATORY, INC.

**DUT: ZNFX220QM; Type: Portable Handset; Serial: 03066**

Communication System: UID 0, UMTS; Frequency: 1732.4 MHz; Duty Cycle: 1:1  
Medium: 1750 Head Medium parameters used (interpolated):  
 $f = 1732.4$  MHz;  $\sigma = 1.371$  S/m;  $\epsilon_r = 39.005$ ;  $\rho = 1000$  kg/m<sup>3</sup>  
Phantom section: Left Section

Test Date: 12-25-2018; Ambient Temp: 19.8°C; Tissue Temp: 19.8°C

Probe: ES3DV3 - SN3287; ConvF(5.48, 5.48, 5.48) @ 1732.4 MHz; Calibrated: 10/22/2018  
Sensor-Surface: 3mm (Mechanical Surface Detection)  
Electronics: DAE4 Sn1333; Calibrated: 10/18/2018  
Phantom: Twin-SAM V8.0; Type: QD 000 P41 Ax; Serial: 1964  
Measurement SW: DASY52, Version 52.10 (2);SEMCAD X Version 14.6.12 (7450)

**Mode: UMTS 1750, Left Head, Cheek, Mid.ch**

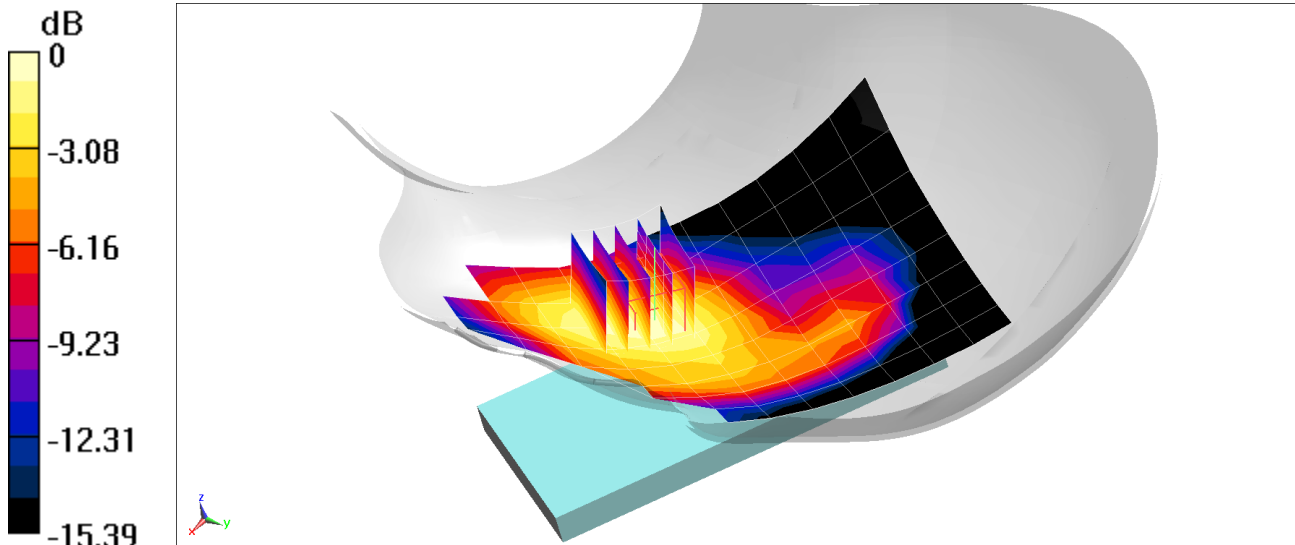
**Area Scan (9x15x1):** Measurement grid: dx=15mm, dy=15mm

**Zoom Scan (5x5x7)/Cube 0:** Measurement grid: dx=8mm, dy=8mm, dz=5mm

Reference Value = 20.36 V/m; Power Drift = -0.04 dB

Peak SAR (extrapolated) = 0.804 W/kg

**SAR(1 g) = 0.532 W/kg**



0 dB = 0.616 W/kg = -2.10 dBW/kg

# PCTEST ENGINEERING LABORATORY, INC.

**DUT: ZNFX220QM; Type: Portable Handset; Serial: 00306**

Communication System: UID 0, UMTS; Frequency: 1880 MHz; Duty Cycle: 1:1

Medium: 1900 Head Medium parameters used:

$f = 1880 \text{ MHz}$ ;  $\sigma = 1.44 \text{ S/m}$ ;  $\epsilon_r = 38.549$ ;  $\rho = 1000 \text{ kg/m}^3$

Phantom section: Left Section

Test Date: 12-31-2018; Ambient Temp: 21.7°C; Tissue Temp: 20.8°C

Probe: ES3DV3 - SN3287; ConvF(5.24, 5.24, 5.24) @ 1880 MHz; Calibrated: 10/22/2018

Sensor-Surface: 3mm (Mechanical Surface Detection)

Electronics: DAE4 Sn1333; Calibrated: 10/18/2018

Phantom: Twin-SAM V8.0; Type: QD 000 P41 Ax; Serial: 1964

Measurement SW: DASY52, Version 52.10 (2);SEMCAD X Version 14.6.12 (7450)

**Mode: UMTS 1900, Left Head, Cheek, Mid.ch**

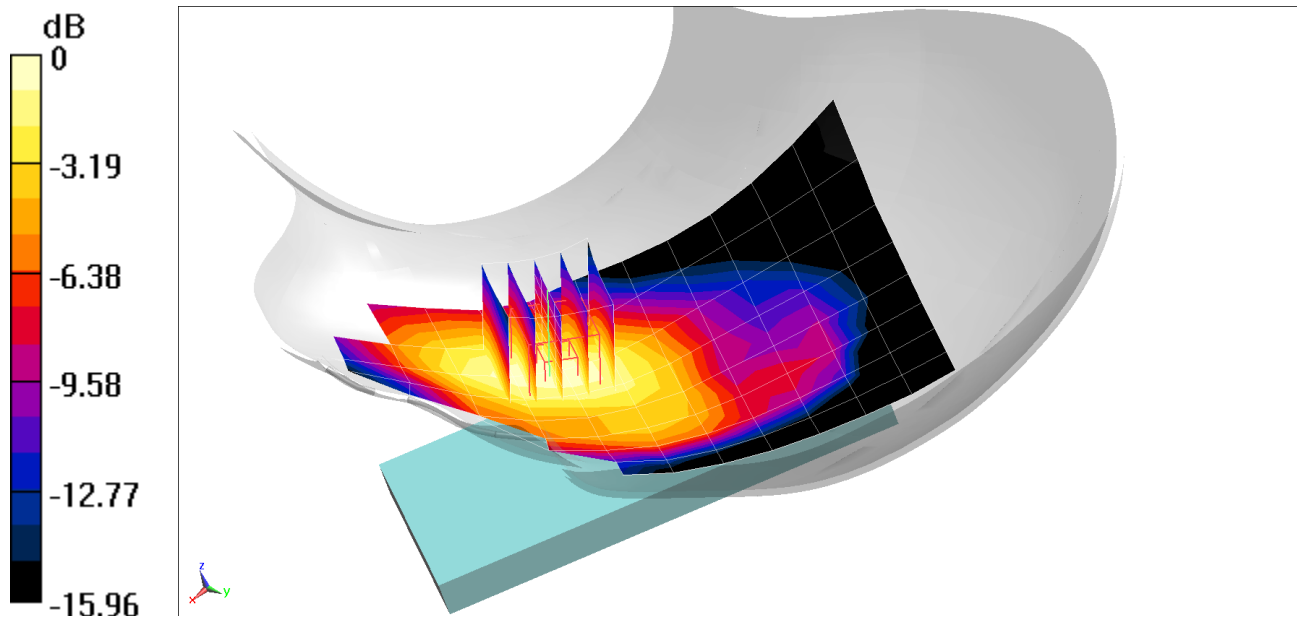
**Area Scan (9x15x1):** Measurement grid:  $dx=15\text{mm}$ ,  $dy=15\text{mm}$

**Zoom Scan (5x5x7)/Cube 0:** Measurement grid:  $dx=8\text{mm}$ ,  $dy=8\text{mm}$ ,  $dz=5\text{mm}$

Reference Value = 20.92 V/m; Power Drift = 0.01 dB

Peak SAR (extrapolated) = 0.897 W/kg

**SAR(1 g) = 0.569 W/kg**



0 dB = 0.661 W/kg = -1.80 dBW/kg



# PCTEST ENGINEERING LABORATORY, INC.

**DUT: ZNFX220QM; Type: Portable Handset; Serial: 03058**

Communication System: UID 0, CDMA; Frequency: 836.52 MHz; Duty Cycle: 1:1  
Medium: 835 Head Medium parameters used (interpolated):  
 $f = 836.52$  MHz;  $\sigma = 0.914$  S/m;  $\epsilon_r = 42.727$ ;  $\rho = 1000$  kg/m<sup>3</sup>  
Phantom section: Right Section

Test Date: 12-26-2018; Ambient Temp: 21.7°C; Tissue Temp: 20.3°C

Probe: EX3DV4 - SN7410; ConvF(9.81, 9.81, 9.81) @ 836.52 MHz; Calibrated: 7/20/2018  
Sensor-Surface: 1.4mm (Mechanical Surface Detection)  
Electronics: DAE4 Sn1322; Calibrated: 7/11/2018  
Phantom: SAM Front; Type: SAM; Serial: 1686  
Measurement SW: DASY52, Version 52.10 (1);SEMCAD X Version 14.6.12 (7450)

**Mode: Cell. EVDO Rev. A, Rule Part 22H, Right Head, Cheek, Mid.ch**

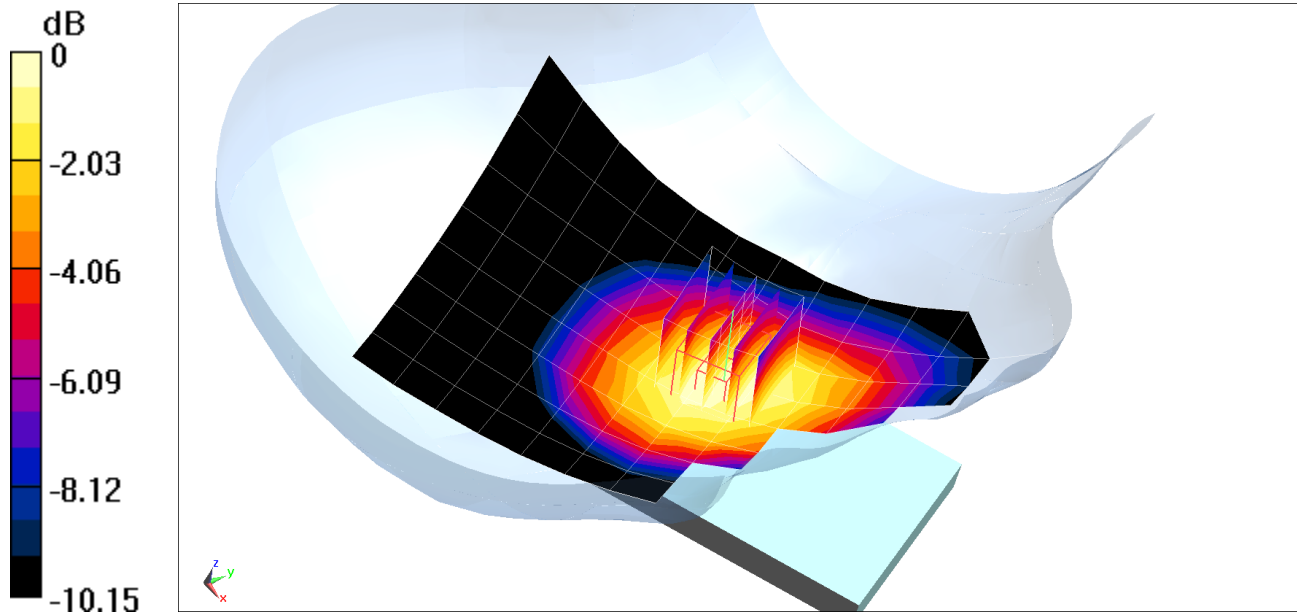
**Area Scan (9x15x1):** Measurement grid: dx=15mm, dy=15mm

**Zoom Scan (5x5x7)/Cube 0:** Measurement grid: dx=8mm, dy=8mm, dz=5mm

Reference Value = 23.25 V/m; Power Drift = -0.05 dB

Peak SAR (extrapolated) = 0.594 W/kg

**SAR(1 g) = 0.470 W/kg**



0 dB = 0.551 W/kg = -2.59 dBW/kg

# PCTEST ENGINEERING LABORATORY, INC.

**DUT: ZNFX220QM; Type: Portable Handset; Serial: 00306**

Communication System: UID 0, PCS CDMA; Frequency: 1880 MHz; Duty Cycle: 1:1  
Medium: 1750 & 1900 Head Medium parameters used:  
f = 1880 MHz;  $\sigma = 1.44$  S/m;  $\epsilon_r = 38.549$ ;  $\rho = 1000$  kg/m<sup>3</sup>  
Phantom section: Left Section

Date: 12-31-2018; Ambient Temp: 21.7°C; Tissue Temp: 20.8°C

Probe: ES3DV3 - SN3287; ConvF(5.24, 5.24, 5.24) @ 1880 MHz; Calibrated: 10/22/2018  
Sensor-Surface: 3mm (Mechanical Surface Detection)  
Electronics: DAE4 Sn1333; Calibrated: 10/18/2018  
Phantom: Twin-SAM V8.0; Type: QD 000 P41 Ax; Serial: 1964  
Measurement SW: DASY52, Version 52.10 (2);SEMCAD X Version 14.6.12 (7450)

**Mode: PCS CDMA, Left Head, Cheek, Mid.ch**

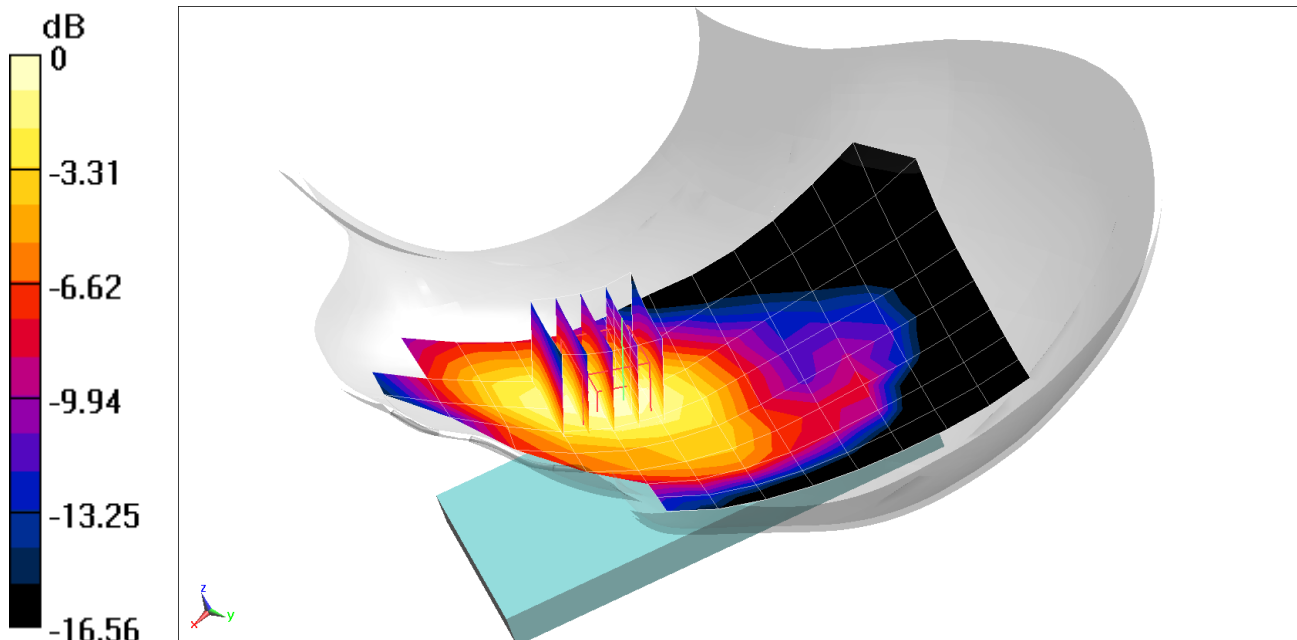
**Area Scan (9x15x1):** Measurement grid: dx=15mm, dy=15mm

**Zoom Scan (5x5x7)/Cube 0:** Measurement grid: dx=8mm, dy=8mm, dz=5mm

Reference Value = 23.47 V/m; Power Drift = 0.03 dB

Peak SAR (extrapolated) = 1.15 W/kg

**SAR(1 g) = 0.729 W/kg**



0 dB = 0.845 W/kg = -0.73 dBW/kg

# PCTEST ENGINEERING LABORATORY, INC.

**DUT: ZNFX220QM; Type: Portable Handset; Serial: 00303**

Communication System: UID 0, LTE Band 12; Frequency: 707.5 MHz; Duty Cycle: 1:1  
Medium: 750 Head Medium parameters used (interpolated):  
 $f = 707.5 \text{ MHz}$ ;  $\sigma = 0.862 \text{ S/m}$ ;  $\epsilon_r = 42.487$ ;  $\rho = 1000 \text{ kg/m}^3$   
Phantom section: Right Section

Test Date: 12-19-2018; Ambient Temp: 21.3°C; Tissue Temp: 19.8°C

Probe: ES3DV3 - SN3287; ConvF(6.76, 6.76, 6.76) @ 707.5 MHz; Calibrated: 10/22/2018  
Sensor-Surface: 3mm (Mechanical Surface Detection)  
Electronics: DAE4 Sn1333; Calibrated: 10/18/2018  
Phantom: Twin-SAM V8.0; Type: QD 000 P41 Ax; Serial: 1964  
Measurement SW: DASY52, Version 52.10 (2);SEMCAD X Version 14.6.12 (7450)

**Mode: LTE Band 12, Right Head, Cheek, Mid.ch, 10 MHz Bandwidth,  
QPSK, 1 RB, 25 RB Offset**

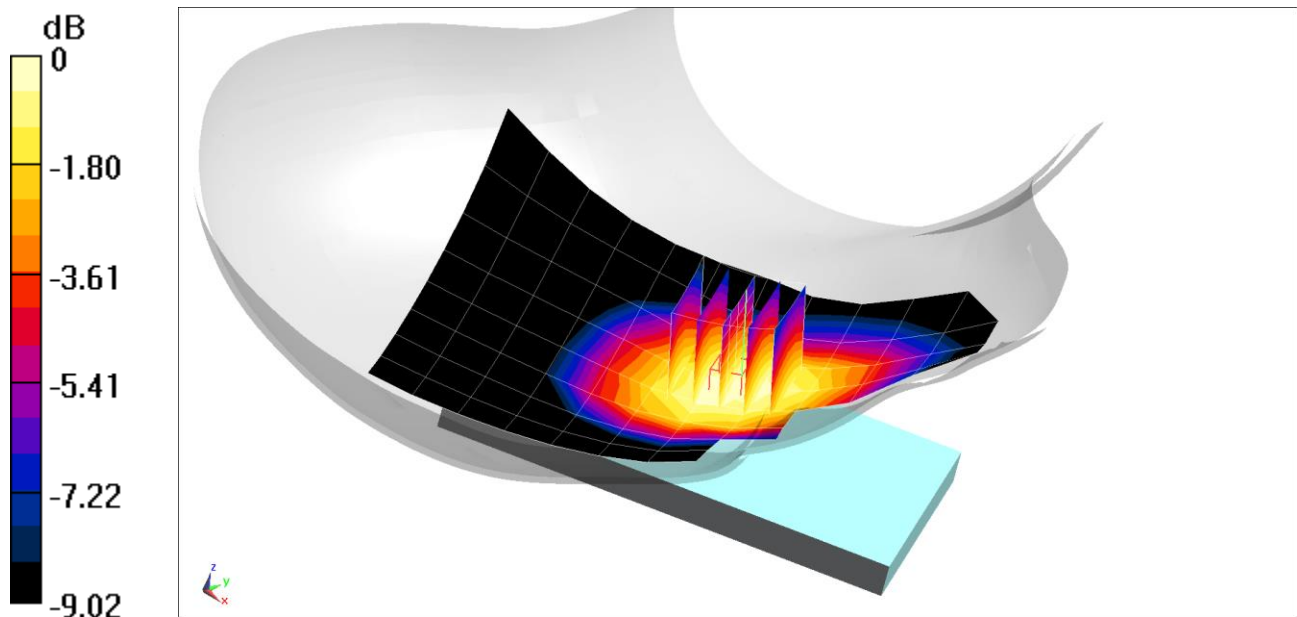
**Area Scan (9x14x1):** Measurement grid: dx=15mm, dy=15mm

**Zoom Scan (5x5x7)/Cube 0:** Measurement grid: dx=8mm, dy=8mm, dz=5mm

Reference Value = 26.84 V/m; Power Drift = 0.08 dB

Peak SAR (extrapolated) = 0.700 W/kg

**SAR(1 g) = 0.559 W/kg**



0 dB = 0.604 W/kg = -2.19 dBW/kg

# PCTEST ENGINEERING LABORATORY, INC.

**DUT: ZNFX220QM; Type: Portable Handset; Serial: 03041**

Communication System: UID 0, LTE Band 5 (Cell.); Frequency: 836.5 MHz; Duty Cycle: 1:1  
Medium: 835 Head Medium parameters used (interpolated):  
 $f = 836.5 \text{ MHz}$ ;  $\sigma = 0.914 \text{ S/m}$ ;  $\epsilon_r = 42.727$ ;  $\rho = 1000 \text{ kg/m}^3$   
Phantom section: Right Section

Test Date: 12-26-2018; Ambient Temp: 21.7°C; Tissue Temp: 20.3°C

Probe: EX3DV4 - SN7410; ConvF(9.81, 9.81, 9.81) @ 836.5 MHz; Calibrated: 7/20/2018  
Sensor-Surface: 1.4mm (Mechanical Surface Detection)  
Electronics: DAE4 Sn1322; Calibrated: 7/11/2018  
Phantom: SAM Front; Type: SAM; Serial: 1686  
Measurement SW: DASY52, Version 52.10 (1);SEMCAD X Version 14.6.12 (7450)

**Mode: LTE Band 5 (Cell.), Right Head, Cheek, Mid.ch, 10 MHz Bandwidth  
QPSK, 1 RB, 25 RB Offset**

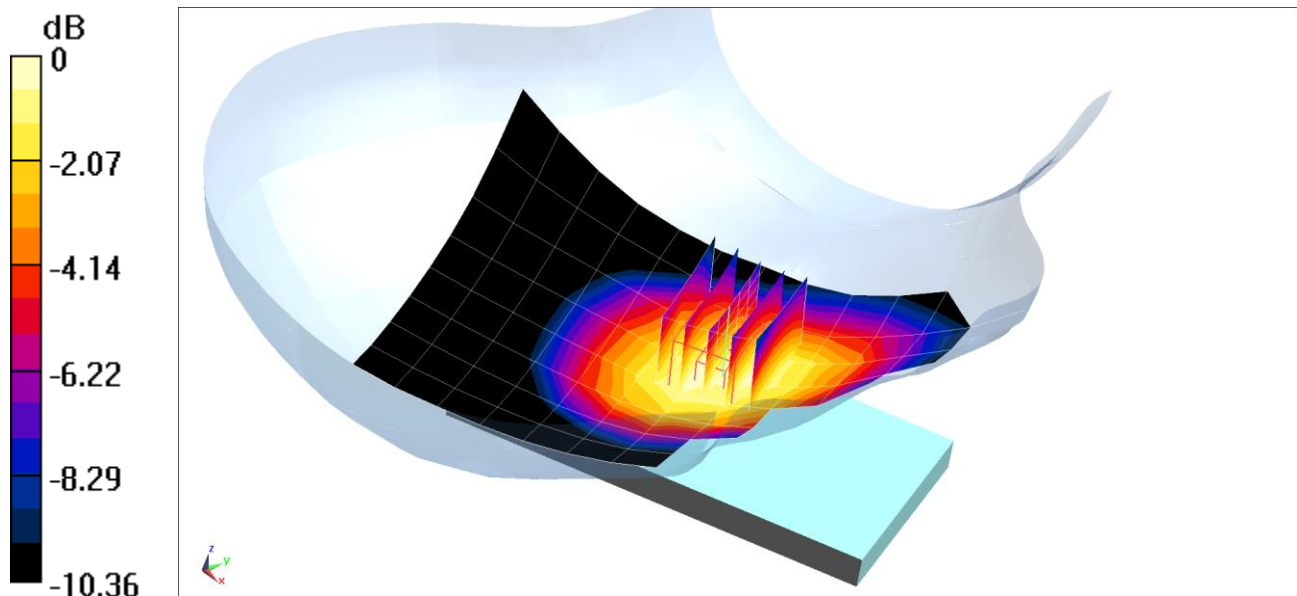
**Area Scan (9x15x1):** Measurement grid: dx=15mm, dy=15mm

**Zoom Scan (6x5x7)/Cube 0:** Measurement grid: dx=8mm, dy=8mm, dz=5mm

Reference Value = 23.93 V/m; Power Drift = 0.02 dB

Peak SAR (extrapolated) = 0.632 W/kg

**SAR(1 g) = 0.495 W/kg**



0 dB = 0.580 W/kg = -2.37 dBW/kg

# PCTEST ENGINEERING LABORATORY, INC.

**DUT: ZNFX220QM; Type: Portable Handset; Serial: 00304**

Communication System: UID 0, LTE Band 4 (AWS); Frequency: 1732.5 MHz; Duty Cycle: 1:1  
Medium: 1750 Head Medium parameters used (interpolated):  
 $f = 1732.5$  MHz;  $\sigma = 1.354$  S/m;  $\epsilon_r = 38.759$ ;  $\rho = 1000$  kg/m<sup>3</sup>  
Phantom section: Left Section

Test Date: 12-31-2018; Ambient Temp: 21.7°C; Tissue Temp: 20.8°C

Probe: ES3DV3 - SN3287; ConvF(5.48, 5.48, 5.48) @ 1732.5 MHz; Calibrated: 10/22/2018  
Sensor-Surface: 3mm (Mechanical Surface Detection)  
Electronics: DAE4 Sn1333; Calibrated: 10/18/2018  
Phantom: Twin-SAM V8.0; Type: QD 000 P41 Ax; Serial: 1964  
Measurement SW: DASY52, Version 52.10 (2); SEMCAD X Version 14.6.12 (7450)

**Mode: LTE Band 4 (AWS), Left Head, Cheek, Mid.ch, 20 MHz Bandwidth,  
QPSK, 1 RB, 50 RB Offset**

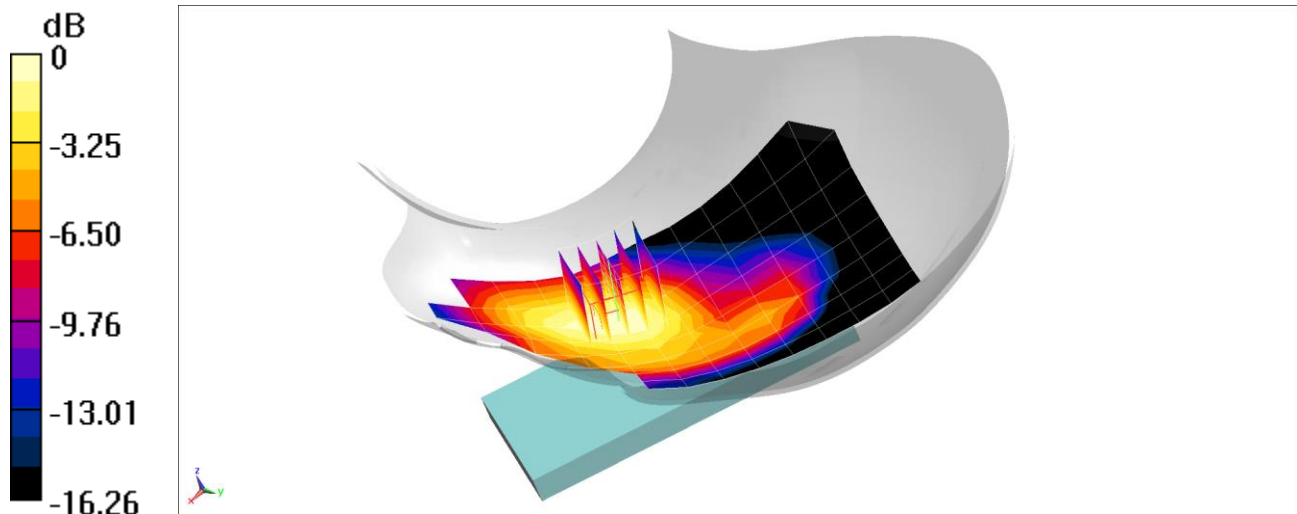
**Area Scan (9x15x1):** Measurement grid: dx=15mm, dy=15mm

**Zoom Scan (5x5x7)/Cube 0:** Measurement grid: dx=8mm, dy=8mm, dz=5mm

Reference Value = 22.50 V/m; Power Drift = 0.01 dB

Peak SAR (extrapolated) = 0.852 W/kg

**SAR(1 g) = 0.556 W/kg**



0 dB = 0.625 W/kg = -2.04 dBW/kg

# PCTEST ENGINEERING LABORATORY, INC.

**DUT: ZNFX220QM; Type: Portable Handset; Serial: 00304**

Communication System: UID 0, LTE Band 25 (PCS); Frequency: 1882.5 MHz; Duty Cycle: 1:1  
Medium: 1900 Head Medium parameters used (interpolated):  
 $f = 1882.5 \text{ MHz}$ ;  $\sigma = 1.407 \text{ S/m}$ ;  $\epsilon_r = 39.849$ ;  $\rho = 1000 \text{ kg/m}^3$   
Phantom section: Left Section

Test Date: 12-22-2018; Ambient Temp: 20.7°C; Tissue Temp: 22.3°C

Probe: EX3DV4 - SN7409; ConvF(8.05, 8.05, 8.05) @ 1882.5 MHz; Calibrated: 6/25/2018  
Sensor-Surface: 1.4mm (Mechanical Surface Detection)  
Electronics: DAE4 Sn1334; Calibrated: 6/18/2018  
Phantom: SAM with CRP (Left); Type: SAM; Serial: 1715  
Measurement SW: DASY52, Version 52.10 (2); SEMCAD X Version 14.6.12 (7450)

**Mode: LTE Band 25 (PCS), Left Head, Cheek, Mid.ch, 20 MHz Bandwidth,  
QPSK, 1 RB, 50 RB Offset**

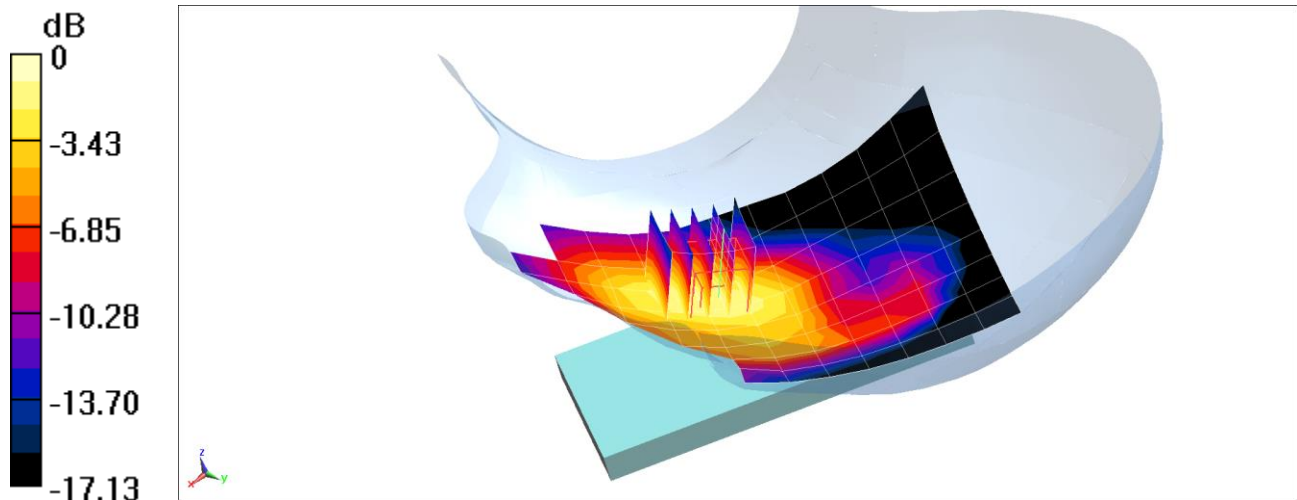
**Area Scan (9x14x1):** Measurement grid: dx=15mm, dy=15mm

**Zoom Scan (5x5x7)/Cube 0:** Measurement grid: dx=8mm, dy=8mm, dz=5mm

Reference Value = 24.27 V/m; Power Drift = 0.12 dB

Peak SAR (extrapolated) = 1.17 W/kg

**SAR(1 g) = 0.703 W/kg**



0 dB = 0.993 W/kg = -0.03 dBW/kg

# PCTEST ENGINEERING LABORATORY, INC.

**DUT: ZNFX220QM; Type: Portable Handset; Serial: 00316**

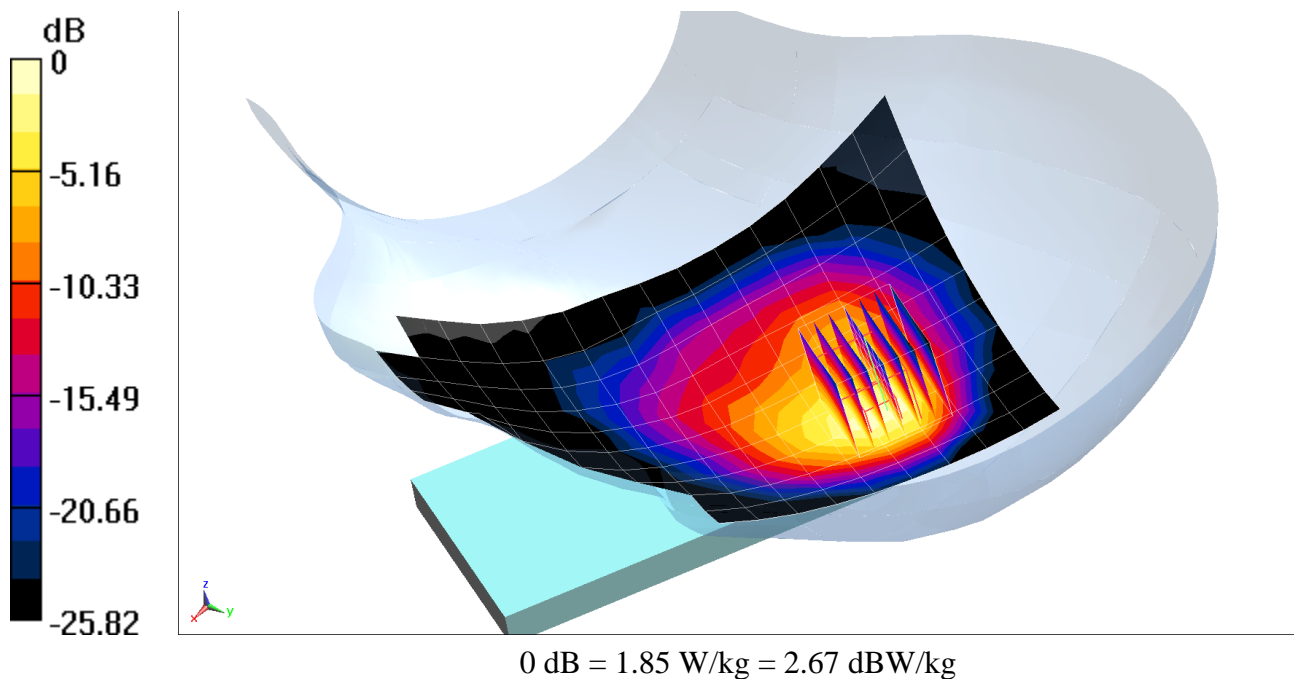
Communication System: UID 0, IEEE 802.11b; Frequency: 2462 MHz; Duty Cycle: 1:1  
Medium: 2450 Head Medium parameters used (interpolated):  
 $f = 2462 \text{ MHz}$ ;  $\sigma = 1.874 \text{ S/m}$ ;  $\epsilon_r = 38.229$ ;  $\rho = 1000 \text{ kg/m}^3$   
Phantom section: Left Section

Test Date: 12-17-2018; Ambient Temp: 21.9°C; Tissue Temp: 22.0°C

Probe: EX3DV4 - SN7410; ConvF(7.5, 7.5, 7.5) @ 2462 MHz; Calibrated: 7/20/2018  
Sensor-Surface: 1.4mm (Mechanical Surface Detection)  
Electronics: DAE4 Sn1322; Calibrated: 7/11/2018  
Phantom: SAM Front; Type: SAM; Serial: 1686  
Measurement SW: DASY52, Version 52.10 (2);SEMCAD X Version 14.6.12 (7450)

**Mode: IEEE 802.11b, 22 MHz Bandwidth, Left Head, Cheek, Ch 11, 1 Mbps**

**Area Scan (11x18x1):** Measurement grid:  $dx=12\text{mm}$ ,  $dy=12\text{mm}$   
**Zoom Scan (7x7x7)/Cube 0:** Measurement grid:  $dx=5\text{mm}$ ,  $dy=5\text{mm}$ ,  $dz=5\text{mm}$   
Reference Value = 14.51 V/m; Power Drift = 0.11 dB  
Peak SAR (extrapolated) = 2.53 W/kg  
**SAR(1 g) = 1.12 W/kg**





# PCTEST ENGINEERING LABORATORY, INC.

**DUT: ZNFX220QM; Type: Portable Handset; Serial: 00314**

Communication System: UID 0, Bluetooth; Frequency: 2441 MHz; Duty Cycle: 1:1.30  
Medium: 2450 Head Medium parameters used (interpolated):  
 $f = 2441$  MHz;  $\sigma = 1.818$  S/m;  $\epsilon_r = 38.497$ ;  $\rho = 1000$  kg/m<sup>3</sup>  
Phantom section: Left Section

Test Date: 12-31-2018; Ambient Temp: 20.5°C; Tissue Temp: 20.7°C

Probe: EX3DV4 - SN7406; ConvF(7.54, 7.54, 7.54) @ 2441 MHz; Calibrated: 5/22/2018  
Sensor-Surface: 1.4mm (Mechanical Surface Detection)  
Electronics: DAE4 Sn859; Calibrated: 5/22/2018  
Phantom: Twin-SAM V4.0 Front Right; Type: QD 000 P40 CC; Serial: 1167  
Measurement SW: DASY52, Version 52.10 (2);SEMCAD X Version 14.6.12 (7450)

**Mode: Bluetooth, Left Head, Cheek, Ch 39, 1 Mbps**

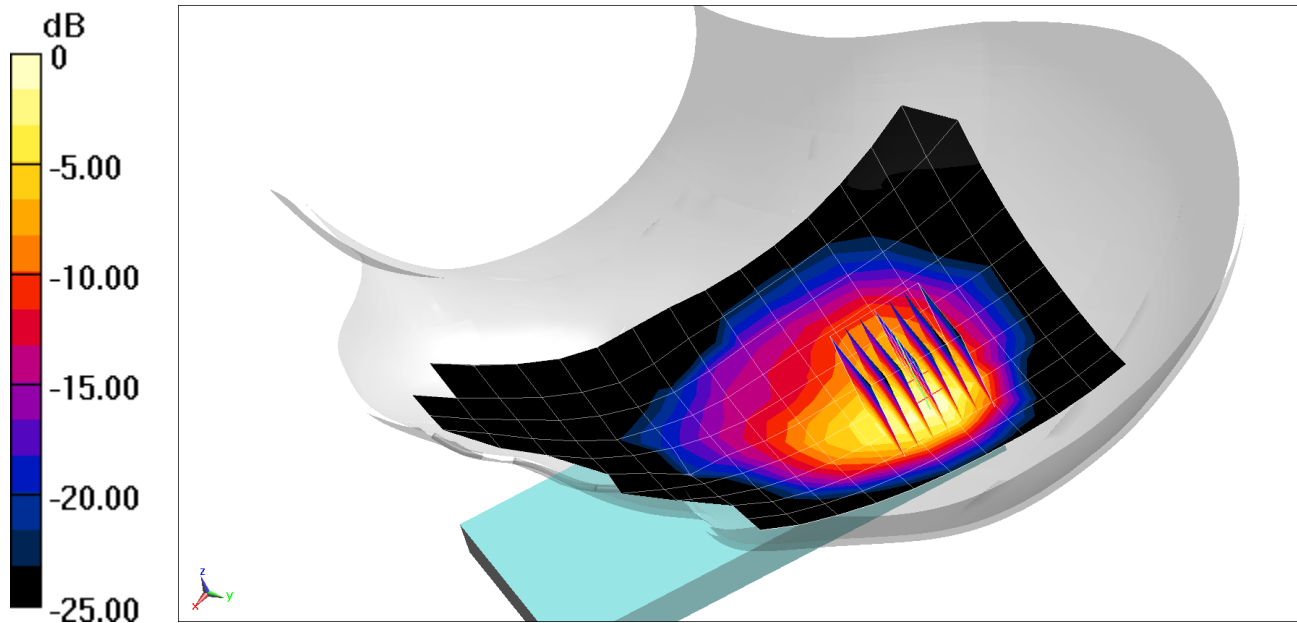
**Area Scan (11x19x1):** Measurement grid: dx=12mm, dy=12mm

**Zoom Scan (7x7x7)/Cube 0:** Measurement grid: dx=5mm, dy=5mm, dz=5mm

Reference Value = 13.61 V/m; Power Drift = 0.06 dB

Peak SAR (extrapolated) = 0.677 W/kg

**SAR(1 g) = 0.297 W/kg**



0 dB = 0.511 W/kg = -2.92 dBW/kg



# PCTEST ENGINEERING LABORATORY, INC.

**DUT: ZNFX220QM; Type: Portable Handset; Serial: 03058**

Communication System: UID 0, GSM GPRS; 2 Tx slots; Frequency: 836.6 MHz; Duty Cycle: 1:4.15  
Medium: 835 Body Medium parameters used (interpolated):  
 $f = 836.6 \text{ MHz}$ ;  $\sigma = 0.966 \text{ S/m}$ ;  $\epsilon_r = 53.591$ ;  $\rho = 1000 \text{ kg/m}^3$   
Phantom section: Flat Section; Space: 1.0 cm

Test Date: 12-26-2018; Ambient Temp: 19.9°C; Tissue Temp: 19.1°C

Probe: ES3DV3 - SN3347; ConvF(6.37, 6.37, 6.37) @ 836.6 MHz; Calibrated: 3/27/2018  
Sensor-Surface: 3mm (Mechanical Surface Detection)  
Electronics: DAE4 Sn665; Calibrated: 2/15/2018  
Phantom: Twin-SAM V5.0; Type: QD 000 P40 CD; Serial: 1800  
Measurement SW: DASY52, Version 52.10 (2);SEMCAD X Version 14.6.12 (7450)

**Mode: GPRS 850, Body SAR, Back side, Mid.ch, 2 Tx Slots**

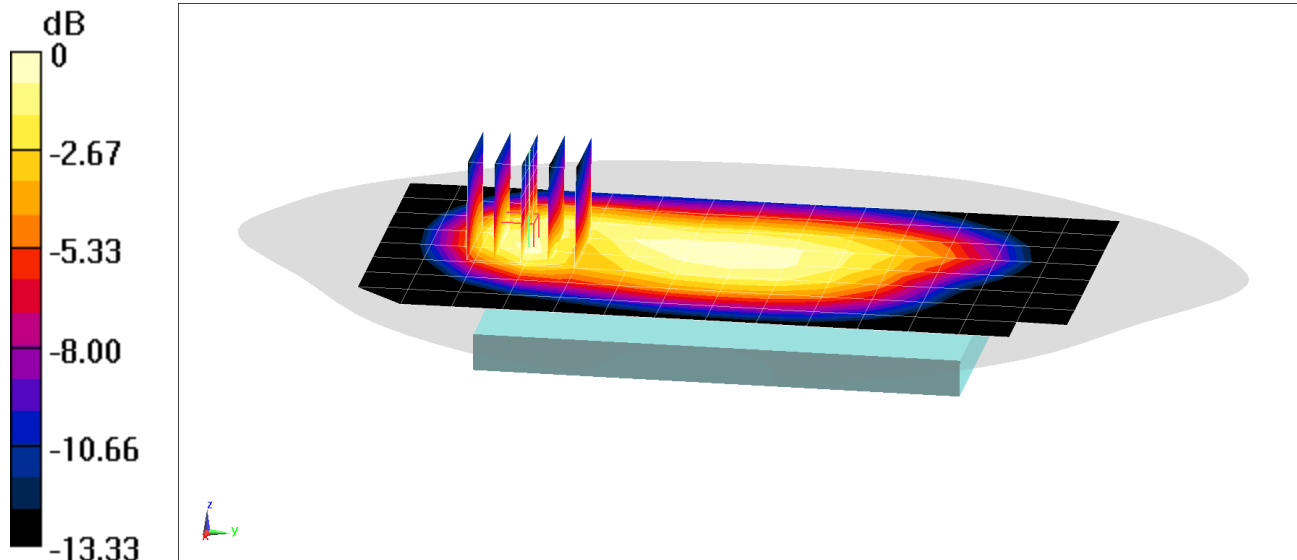
**Area Scan (9x15x1):** Measurement grid: dx=15mm, dy=15mm

**Zoom Scan (5x5x7)/Cube 0:** Measurement grid: dx=8mm, dy=8mm, dz=5mm

Reference Value = 23.26 V/m; Power Drift = -0.03 dB

Peak SAR (extrapolated) = 0.877 W/kg

**SAR(1 g) = 0.491 W/kg**



0 dB = 0.574 W/kg = -2.41 dBW/kg

# PCTEST ENGINEERING LABORATORY, INC.

**DUT: ZNFX220QM; Type: Portable Handset; Serial: 03058**

Communication System: UID 0, GSM GPRS; 2 Tx slots; Frequency: 836.6 MHz; Duty Cycle: 1:4.15

Medium: 835 Body Medium parameters used (interpolated):

$f = 836.6$  MHz;  $\sigma = 0.966$  S/m;  $\epsilon_r = 53.591$ ;  $\rho = 1000$  kg/m<sup>3</sup>

Phantom section: Flat Section; Space: 1.0 cm

Test Date: 12-26-2018; Ambient Temp: 19.9°C; Tissue Temp: 19.1°C

Probe: ES3DV3 - SN3347; ConvF(6.37, 6.37, 6.37) @ 836.6 MHz; Calibrated: 3/27/2018

Sensor-Surface: 3mm (Mechanical Surface Detection)

Electronics: DAE4 Sn665; Calibrated: 2/15/2018

Phantom: Twin-SAM V5.0; Type: QD 000 P40 CD; Serial: 1800

Measurement SW: DASY52, Version 52.10 (2); SEMCAD X Version 14.6.12 (7450)

**Mode: GPRS 850, Body SAR, Right Edge, Mid.ch, 2 Tx Slots**

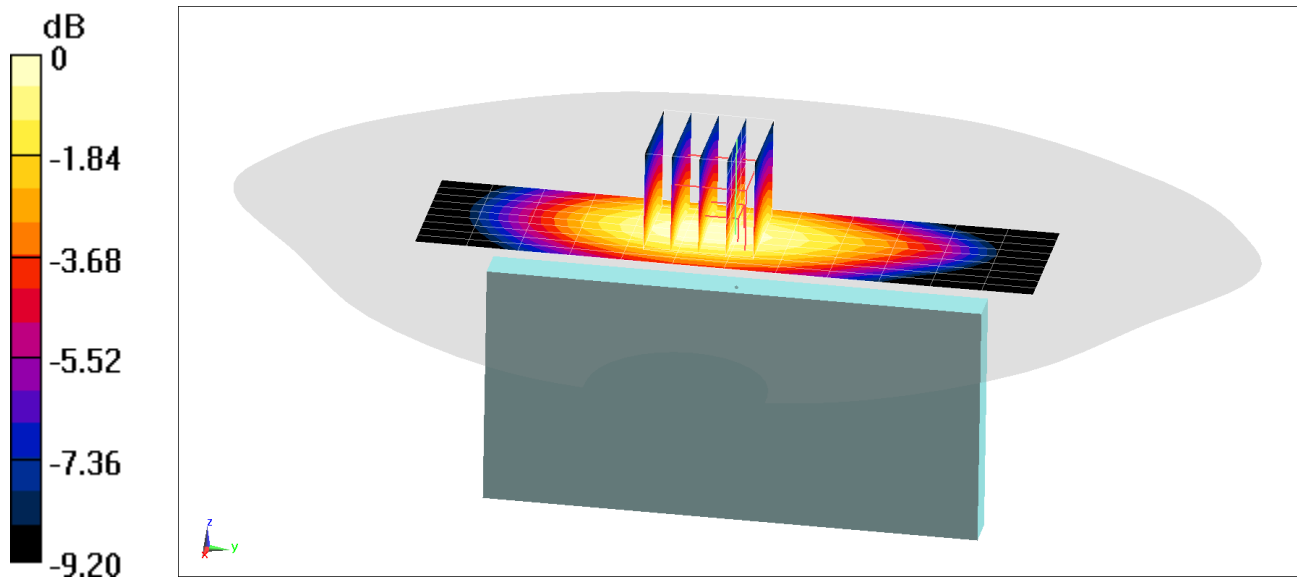
**Area Scan (10x13x1):** Measurement grid: dx=5mm, dy=15mm

**Zoom Scan (5x5x7)/Cube 0:** Measurement grid: dx=8mm, dy=8mm, dz=5mm

Reference Value = 24.27 V/m; Power Drift = 0.15 dB

Peak SAR (extrapolated) = 0.748 W/kg

**SAR(1 g) = 0.541 W/kg**



0 dB = 0.616 W/kg = -2.10 dBW/kg

# PCTEST ENGINEERING LABORATORY, INC.

**DUT: ZNFX220QM; Type: Portable Handset; Serial: 00305**

Communication System: UID 0, GSM GPRS; 2 Tx slots; Frequency: 1880 MHz; Duty Cycle: 1:4.15

Medium: 1900 Body Medium parameters used:

$f = 1880 \text{ MHz}$ ;  $\sigma = 1.555 \text{ S/m}$ ;  $\epsilon_r = 53.074$ ;  $\rho = 1000 \text{ kg/m}^3$

Phantom section: Flat Section; Space: 1.0 cm

Test Date: 12-31-2018; Ambient Temp: 21.1°C; Tissue Temp: 22.0°C

Probe: ES3DV3 - SN3332; ConvF(4.77, 4.77, 4.77) @ 1880 MHz; Calibrated: 8/22/2018

Sensor-Surface: 3mm (Mechanical Surface Detection)

Electronics: DAE4 Sn1272; Calibrated: 2/9/2018

Phantom: SAM V5.0 Right; Type: QD000P40CD; Serial: 1647

Measurement SW: DASY52, Version 52.10 (2);SEMCAD X Version 14.6.12 (7450)

**Mode: GPRS 1900, Body SAR, Back side, Mid.ch, 2 Tx Slots**

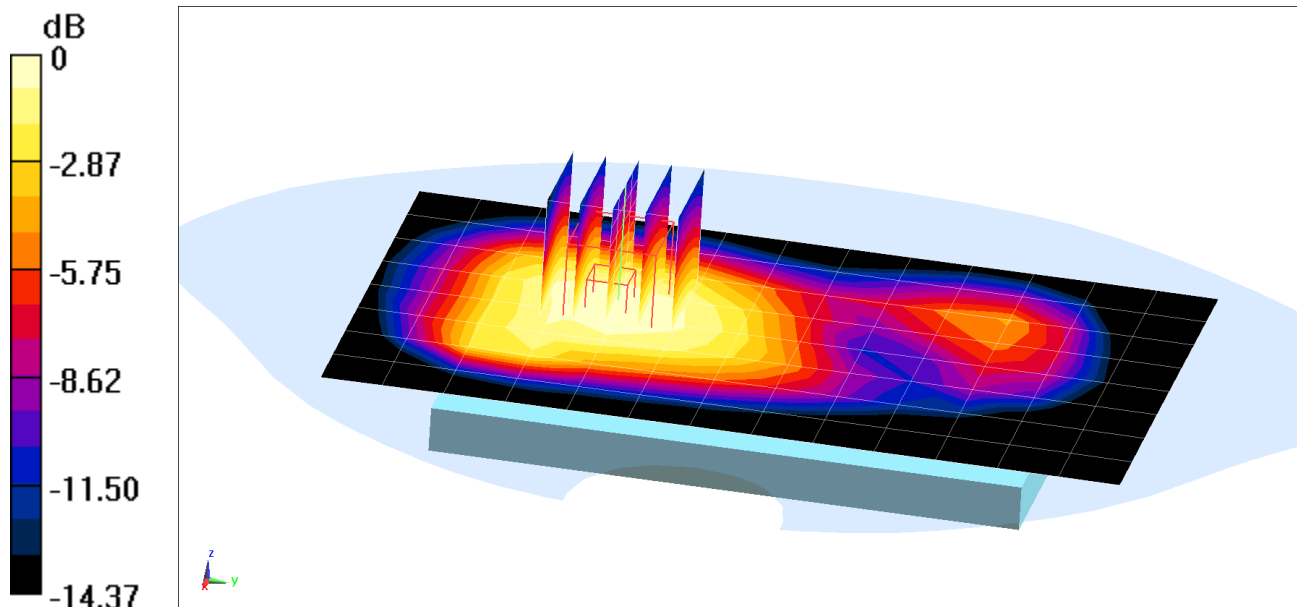
**Area Scan (9x14x1):** Measurement grid: dx=15mm, dy=15mm

**Zoom Scan (5x5x7)/Cube 0:** Measurement grid: dx=8mm, dy=8mm, dz=5mm

Reference Value = 16.88 V/m; Power Drift = -0.03 dB

Peak SAR (extrapolated) = 0.600 W/kg

**SAR(1 g) = 0.398 W/kg**



0 dB = 0.460 W/kg = -3.37 dBW/kg

# PCTEST ENGINEERING LABORATORY, INC.

**DUT: ZNFX220QM; Type: Portable Handset; Serial: 00305**

Communication System: UID 0, GSM GPRS; 2 Tx slots; Frequency: 1880 MHz; Duty Cycle: 1:4.15

Medium: 1900 Body Medium parameters used:

$f = 1880$  MHz;  $\sigma = 1.555$  S/m;  $\epsilon_r = 53.074$ ;  $\rho = 1000$  kg/m<sup>3</sup>

Phantom section: Flat Section; Space: 1.0 cm

Test Date: 12-31-2018; Ambient Temp: 21.1°C; Tissue Temp: 22.0°C

Probe: ES3DV3 - SN3332; ConvF(4.77, 4.77, 4.77) @ 1880 MHz; Calibrated: 8/22/2018

Sensor-Surface: 3mm (Mechanical Surface Detection)

Electronics: DAE4 Sn1272; Calibrated: 2/9/2018

Phantom: SAM V5.0 Right; Type: QD000P40CD; Serial: 1647

Measurement SW: DASY52, Version 52.10 (2); SEMCAD X Version 14.6.12 (7450)

**Mode: GPRS 1900, Body SAR, Front side, Mid.ch, 2 Tx Slots**

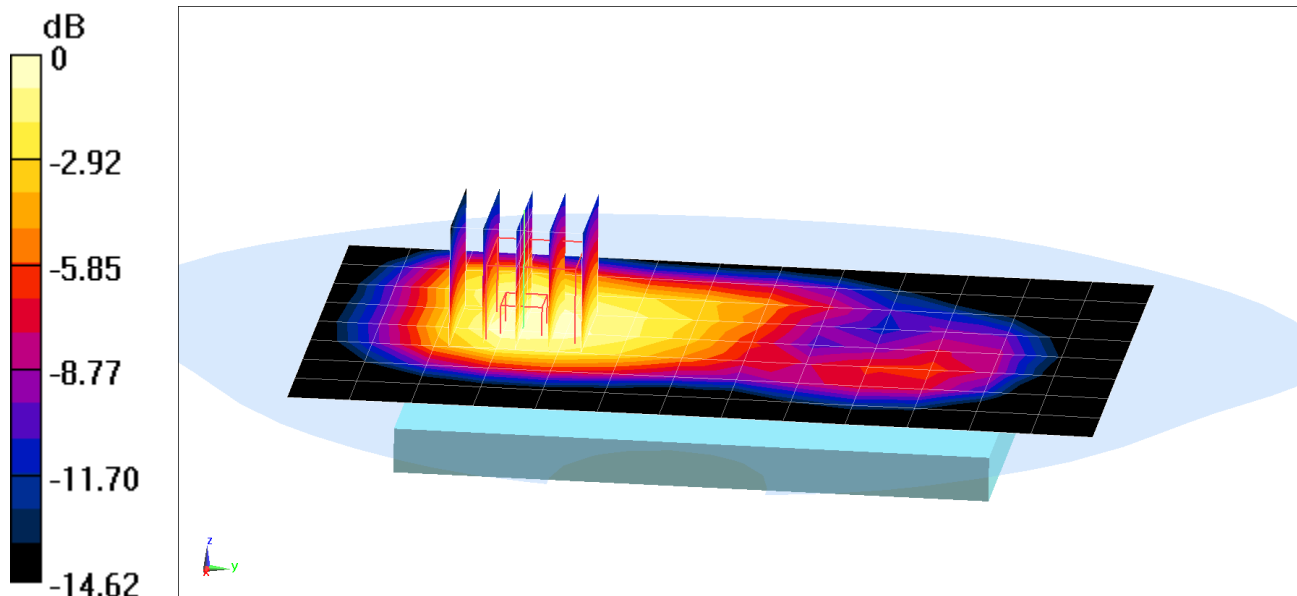
**Area Scan (9x14x1):** Measurement grid: dx=15mm, dy=15mm

**Zoom Scan (5x5x7)/Cube 0:** Measurement grid: dx=8mm, dy=8mm, dz=5mm

Reference Value = 17.86 V/m; Power Drift = -0.05 dB

Peak SAR (extrapolated) = 0.653 W/kg

**SAR(1 g) = 0.440 W/kg**



0 dB = 0.513 W/kg = -2.90 dBW/kg

# PCTEST ENGINEERING LABORATORY, INC.

**DUT: ZNFX220QM; Type: Portable Handset; Serial: 00306**

Communication System: UID 0, UMTS; Frequency: 836.6 MHz; Duty Cycle: 1:1  
Medium: 835 Body Medium parameters used (interpolated):  
 $f = 836.6 \text{ MHz}$ ;  $\sigma = 1.004 \text{ S/m}$ ;  $\epsilon_r = 54.947$ ;  $\rho = 1000 \text{ kg/m}^3$   
Phantom section: Flat Section; Space: 1.0 cm

Test Date: 12-13-2018; Ambient Temp: 20.4°C; Tissue Temp: 20.0°C

Probe: EX3DV4 - SN7406; ConvF(9.61, 9.61, 9.61) @ 836.6 MHz; Calibrated: 5/22/2018  
Sensor-Surface: 1.4mm (Mechanical Surface Detection)  
Electronics: DAE4 Sn859; Calibrated: 5/22/2018  
Phantom: Twin-SAM V4.0 Front Right; Type: QD 000 P40 CC; Serial: 1167  
Measurement SW: DASY52, Version 52.10 (2);SEMCAD X Version 14.6.12 (7450)

**Mode: UMTS 850, Body SAR, Back side, Mid.ch**

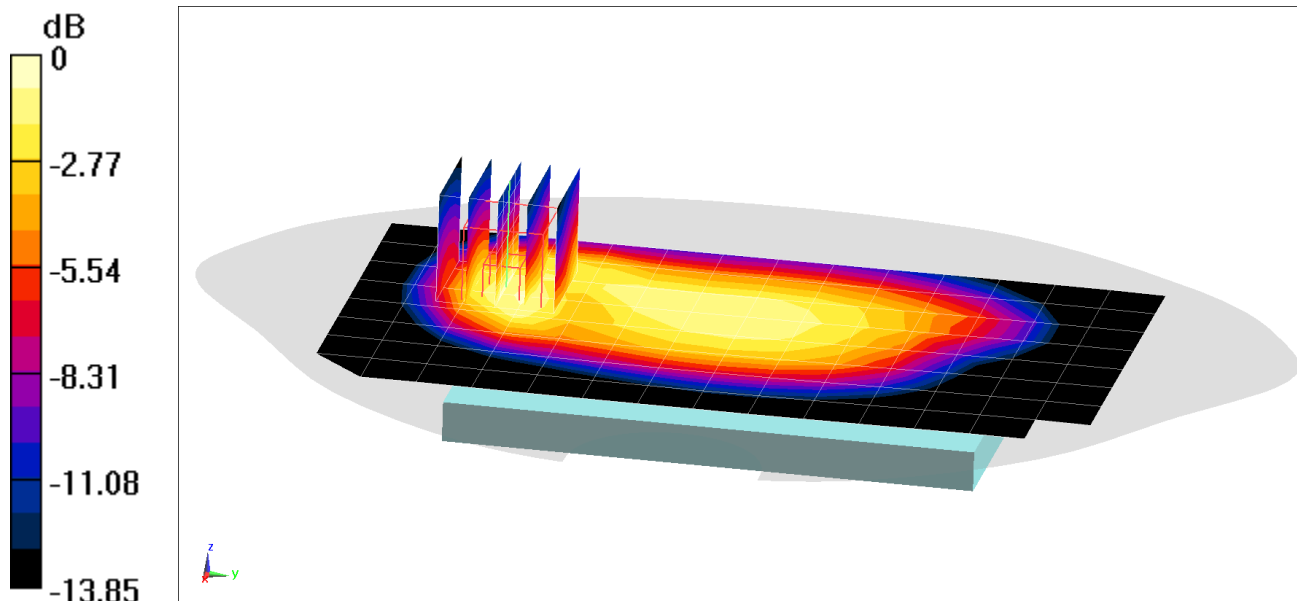
**Area Scan (9x15x1):** Measurement grid: dx=15mm, dy=15mm

**Zoom Scan (5x5x7)/Cube 0:** Measurement grid: dx=8mm, dy=8mm, dz=5mm

Reference Value = 25.13 V/m; Power Drift = -0.05 dB

Peak SAR (extrapolated) = 1.05 W/kg

**SAR(1 g) = 0.571 W/kg**



0 dB = 0.873 W/kg = -0.59 dBW/kg

# PCTEST ENGINEERING LABORATORY, INC.

**DUT: ZNFX220QM; Type: Portable Handset; Serial: 03058**

Communication System: UID 0, UMTS; Frequency: 1732.4 MHz; Duty Cycle: 1:1  
Medium: 1750 Body Medium parameters used (interpolated):  
 $f = 1732.4$  MHz;  $\sigma = 1.491$  S/m;  $\epsilon_r = 52.563$ ;  $\rho = 1000$  kg/m<sup>3</sup>  
Phantom section: Flat Section; Space: 1.0 cm

Test Date: 01-02-2019; Ambient Temp: 22.3°C; Tissue Temp: 21.5°C

Probe: EX3DV4 - SN7357; ConvF(8.43, 8.43, 8.43) @ 1732.4 MHz; Calibrated: 4/18/2018  
Sensor-Surface: 1.4mm (Mechanical Surface Detection)  
Electronics: DAE4 Sn1407; Calibrated: 4/11/2018  
Phantom: SAM with CRP v5.0 Front; Type: QD000P40CD; Serial: 1646  
Measurement SW: DASY52, Version 52.10 (1);SEMCAD X Version 14.6.12 (7450)

**Mode: UMTS 1750, Body SAR, Back side, Mid.ch**

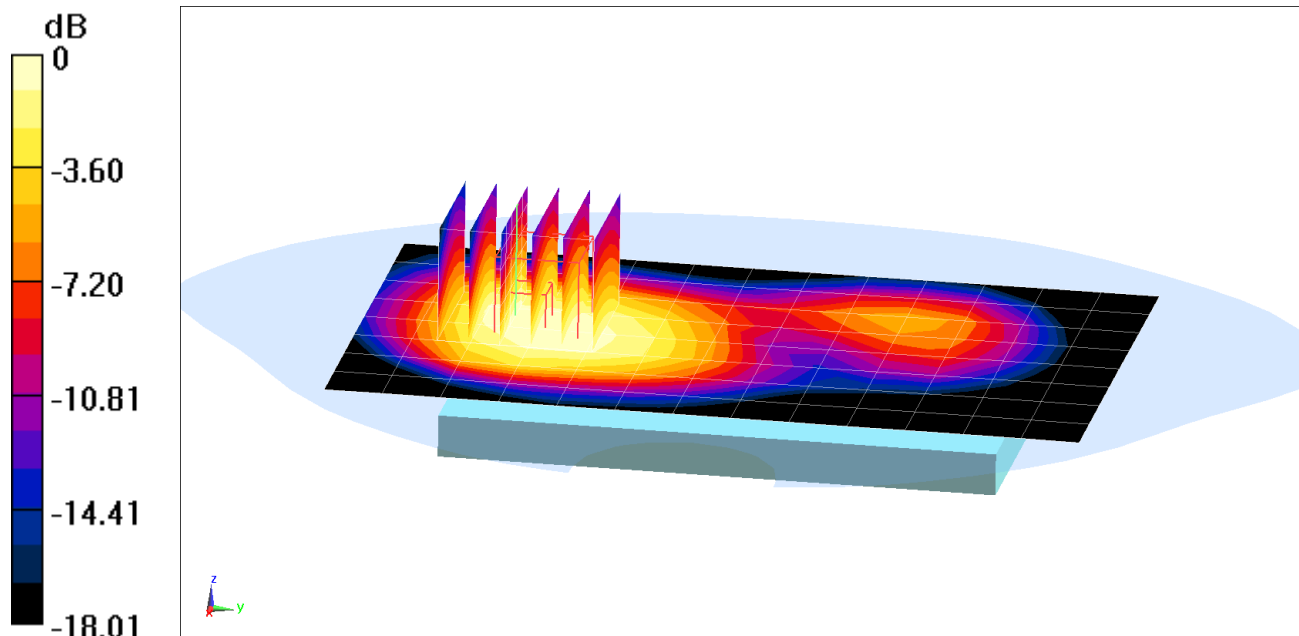
**Area Scan (9x14x1):** Measurement grid: dx=15mm, dy=15mm

**Zoom Scan (6x6x7)/Cube 0:** Measurement grid: dx=8mm, dy=8mm, dz=5mm

Reference Value = 24.56 V/m; Power Drift = -0.19 dB

Peak SAR (extrapolated) = 1.31 W/kg

**SAR(1 g) = 0.845 W/kg**



# PCTEST ENGINEERING LABORATORY, INC.

**DUT: ZNFX220QM; Type: Portable Handset; Serial: 03058**

Communication System: UID 0, UMTS; Frequency: 1732.4 MHz; Duty Cycle: 1:1  
Medium: 1750 Body Medium parameters used (interpolated):  
 $f = 1732.4$  MHz;  $\sigma = 1.491$  S/m;  $\epsilon_r = 52.563$ ;  $\rho = 1000$  kg/m<sup>3</sup>  
Phantom section: Flat Section; Space: 1.0 cm

Test Date: 01-02-2019; Ambient Temp: 22.3°C; Tissue Temp: 21.5°C

Probe: EX3DV4 - SN7357; ConvF(8.43, 8.43, 8.43) @ 1732.4 MHz; Calibrated: 4/18/2018  
Sensor-Surface: 1.4mm (Mechanical Surface Detection)  
Electronics: DAE4 Sn1407; Calibrated: 4/11/2018  
Phantom: SAM with CRP v5.0 Front; Type: QD000P40CD; Serial: 1646  
Measurement SW: DASY52, Version 52.10 (1);SEMCAD X Version 14.6.12 (7450)

**Mode: UMTS 1750, Body SAR, Front side, Mid.ch**

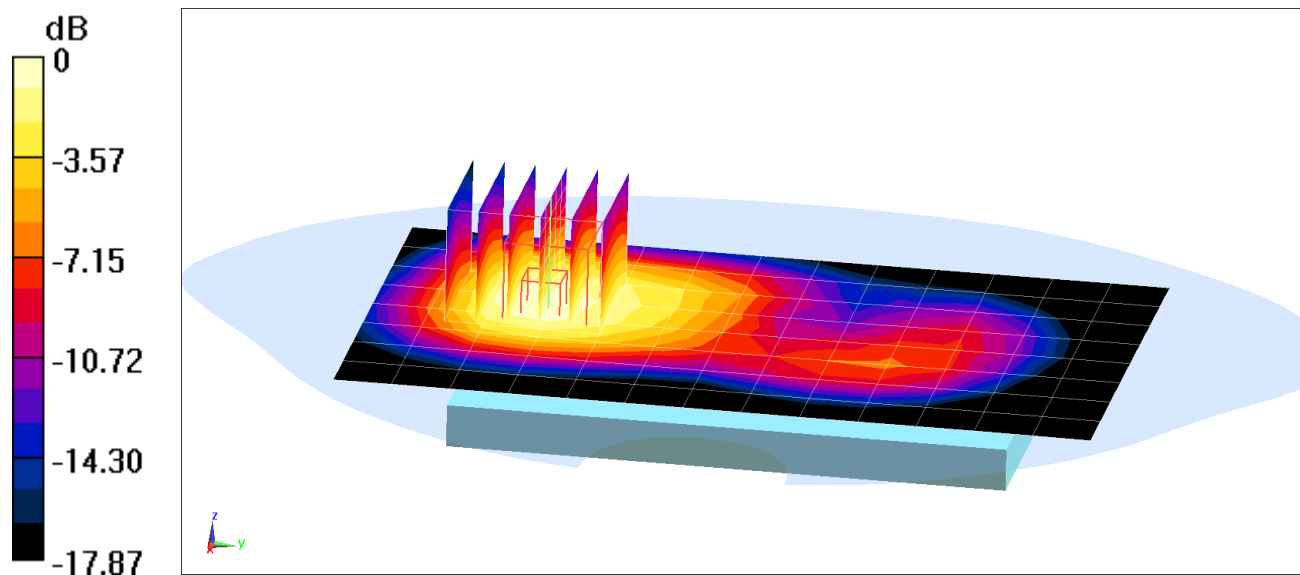
**Area Scan (9x14x1):** Measurement grid: dx=15mm, dy=15mm

**Zoom Scan (6x6x7)/Cube 0:** Measurement grid: dx=8mm, dy=8mm, dz=5mm

Reference Value = 23.23 V/m; Power Drift = 0.04 dB

Peak SAR (extrapolated) = 1.45 W/kg

**SAR(1 g) = 0.938 W/kg**



0 dB = 1.26 W/kg = 1.00 dBW/kg

# PCTEST ENGINEERING LABORATORY, INC.

**DUT: ZNFX220QM; Type: Portable Handset; Serial: 03058**

Communication System: UID 0, UMTS; Frequency: 1852.4 MHz; Duty Cycle: 1:1  
Medium: 1900 Body Medium parameters used (interpolated):  
 $f = 1852.4 \text{ MHz}$ ;  $\sigma = 1.491 \text{ S/m}$ ;  $\epsilon_r = 52.627$ ;  $\rho = 1000 \text{ kg/m}^3$   
Phantom section: Flat Section; Space: 1.0 cm

Test Date: 01-02-2019; Ambient Temp: 22.90°C; Tissue Temp: 22.40°C

Probe: ES3DV3 - SN3332; ConvF(4.77, 4.77, 4.77) @ 1852.4 MHz; Calibrated: 8/22/2018  
Sensor-Surface: 3mm (Mechanical Surface Detection)  
Electronics: DAE4 Sn1272; Calibrated: 2/9/2018  
Phantom: SAM V5.0 Right; Type: QD000P40CD; Serial: 1647  
Measurement SW: DASY52, Version 52.10 (1);SEMCAD X Version 14.6.12 (7450)

**Mode: UMTS 1900, Body SAR, Back side, Low.ch**

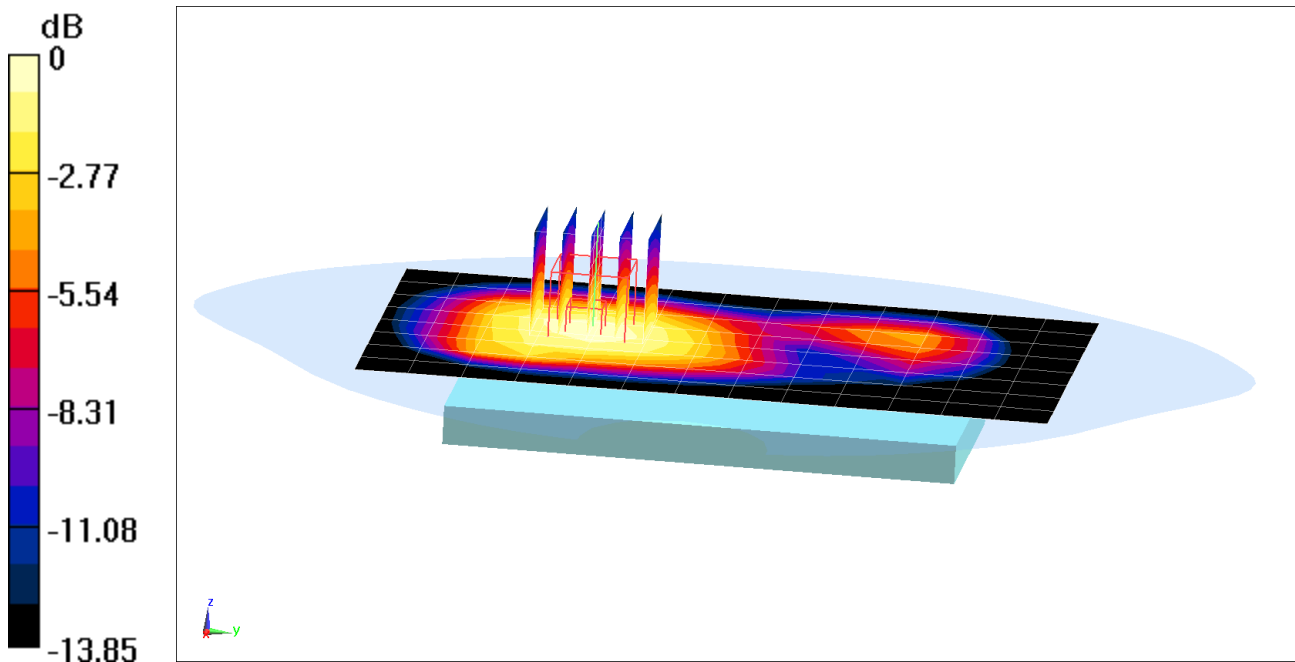
**Area Scan (9x14x1):** Measurement grid: dx=15mm, dy=15mm

**Zoom Scan (5x5x7)/Cube 0:** Measurement grid: dx=8mm, dy=8mm, dz=5mm

Reference Value = 22.26 V/m; Power Drift = -0.08 dB

Peak SAR (extrapolated) = 0.994 W/kg

**SAR(1 g) = 0.674 W/kg**



0 dB = 0.777 W/kg = -1.10 dBW/kg



# PCTEST ENGINEERING LABORATORY, INC.

**DUT: ZNFX220QM; Type: Portable Handset; Serial: 03058**

Communication System: UID 0, UMTS; Frequency: 1880 MHz; Duty Cycle: 1:1

Medium: 1900 Body Medium parameters used:

$f = 1880$  MHz;  $\sigma = 1.529$  S/m;  $\epsilon_r = 51.157$ ;  $\rho = 1000$  kg/m<sup>3</sup>

Phantom section: Flat Section; Space: 1.0 cm

Test Date: 12-12-2018; Ambient Temp: 23.6°C; Tissue Temp: 22.0°C

Probe: ES3DV3 - SN3332; ConvF(4.77, 4.77, 4.77) @ 1880 MHz; Calibrated: 8/22/2018

Sensor-Surface: 3mm (Mechanical Surface Detection)

Electronics: DAE4 Sn1272; Calibrated: 2/9/2018

Phantom: SAM V5.0 Right; Type: QD000P40CD; Serial: 1647

Measurement SW: DASY52, Version 52.10 (2);SEMCAD X Version 14.6.12 (7450)

**Mode: UMTS 1900, Body SAR, Front side, Mid.ch**

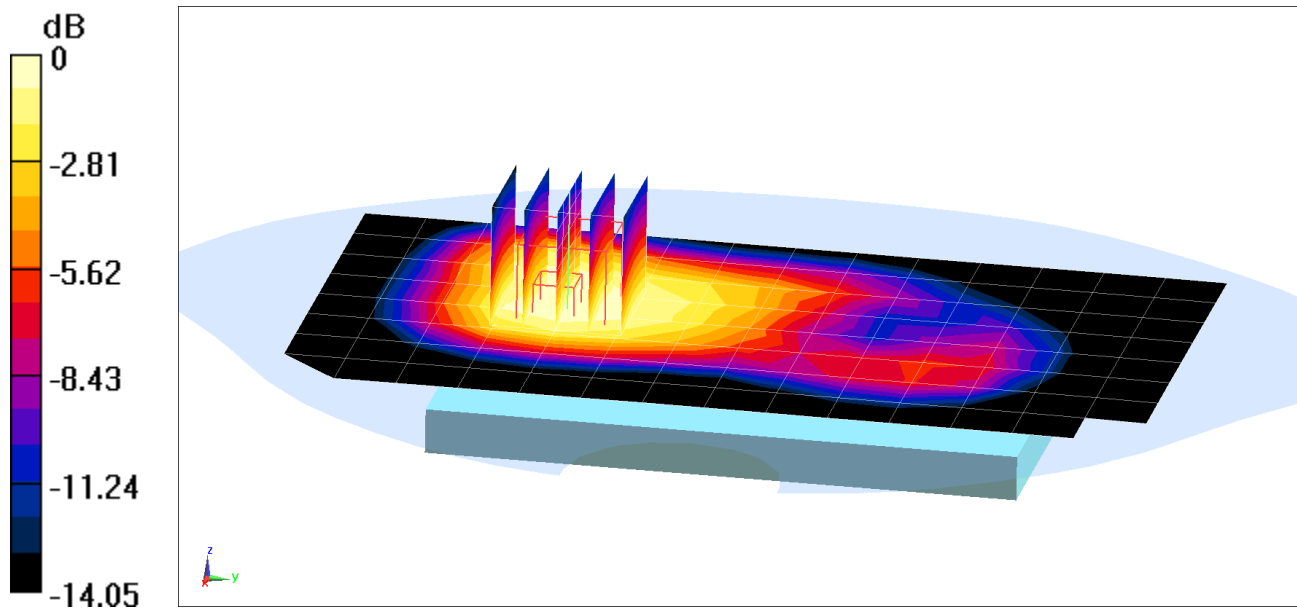
**Area Scan (9x15x1):** Measurement grid: dx=15mm, dy=15mm

**Zoom Scan (5x5x7)/Cube 0:** Measurement grid: dx=8mm, dy=8mm, dz=5mm

Reference Value = 22.55 V/m; Power Drift = 0.02 dB

Peak SAR (extrapolated) = 1.06 W/kg

**SAR(1 g) = 0.703 W/kg**



0 dB = 0.807 W/kg = -0.93 dBW/kg

# PCTEST ENGINEERING LABORATORY, INC.

**DUT: ZNFX220QM; Type: Portable Handset; Serial: 03058**

Communication System: UID 0, CDMA; Frequency: 824.7 MHz; Duty Cycle: 1:1

Medium: 835 Body Medium parameters used (interpolated):

$f = 824.7$  MHz;  $\sigma = 0.961$  S/m;  $\epsilon_r = 53.63$ ;  $\rho = 1000$  kg/m<sup>3</sup>

Phantom section: Flat Section; Space: 1.0 cm

Test Date: 12-26-2018; Ambient Temp: 19.9°C; Tissue Temp: 19.1°C

Probe: ES3DV3 - SN3347; ConvF(6.37, 6.37, 6.37) @ 824.7 MHz; Calibrated: 3/27/2018

Sensor-Surface: 3mm (Mechanical Surface Detection)

Electronics: DAE4 Sn665; Calibrated: 2/15/2018

Phantom: Twin-SAM V5.0; Type: QD 000 P40 CD; Serial: 1800

Measurement SW: DASY52, Version 52.10 (2);SEMCAD X Version 14.6.12 (7450)

**Mode: Cell. CDMA, Body SAR, Back side, Low.ch**

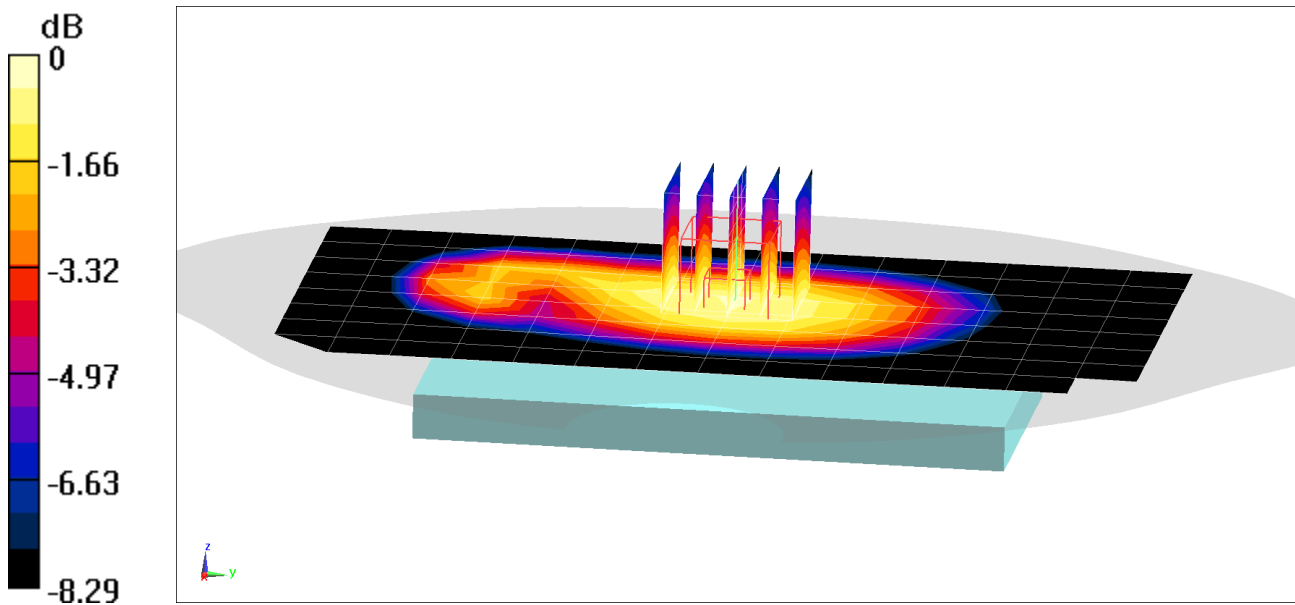
**Area Scan (9x15x1):** Measurement grid: dx=15mm, dy=15mm

**Zoom Scan (5x5x7)/Cube 0:** Measurement grid: dx=8mm, dy=8mm, dz=5mm

Reference Value = 27.87 V/m; Power Drift = 0.05 dB

Peak SAR (extrapolated) = 0.865 W/kg

**SAR(1 g) = 0.694 W/kg**



0 dB = 0.755 W/kg = -1.22 dBW/kg

# PCTEST ENGINEERING LABORATORY, INC.

**DUT: ZNFX220QM; Type: Portable Handset; Serial: 03058**

Communication System: UID 0, CDMA; Frequency: 824.7 MHz; Duty Cycle: 1:1  
Medium: 835 Body Medium parameters used (interpolated):  
 $f = 824.7 \text{ MHz}$ ;  $\sigma = 0.961 \text{ S/m}$ ;  $\epsilon_r = 53.63$ ;  $\rho = 1000 \text{ kg/m}^3$   
Phantom section: Flat Section; Space: 1.0 cm

Test Date: 12-26-2018; Ambient Temp: 19.9°C; Tissue Temp: 19.1°C

Probe: ES3DV3 - SN3347; ConvF(6.37, 6.37, 6.37) @ 824.7 MHz; Calibrated: 3/27/2018  
Sensor-Surface: 3mm (Mechanical Surface Detection)  
Electronics: DAE4 Sn665; Calibrated: 2/15/2018  
Phantom: Twin-SAM V5.0; Type: QD 000 P40 CD; Serial: 1800  
Measurement SW: DASY52, Version 52.10 (2);SEMCAD X Version 14.6.12 (7450)

**Mode: Cell. EVDO, Body SAR, Back side, Low.ch**

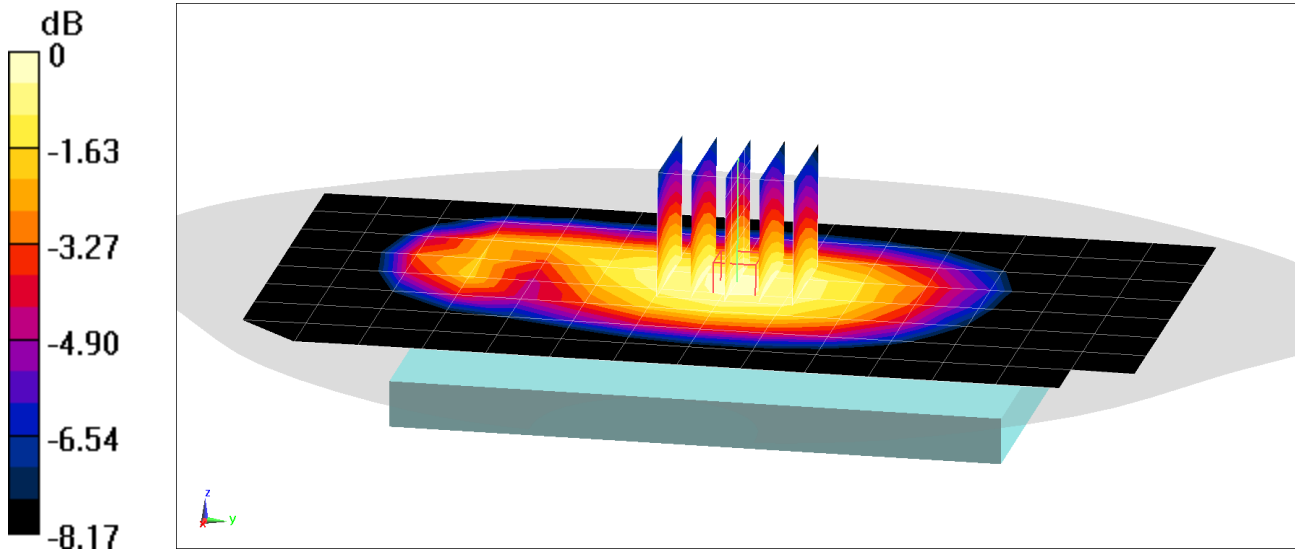
**Area Scan (9x15x1):** Measurement grid: dx=15mm, dy=15mm

**Zoom Scan (5x5x7)/Cube 0:** Measurement grid: dx=8mm, dy=8mm, dz=5mm

Reference Value = 27.07 V/m; Power Drift = 0.01 dB

Peak SAR (extrapolated) = 0.837 W/kg

**SAR(1 g) = 0.662 W/kg**



0 dB = 0.724 W/kg = -1.40 dBW/kg

# PCTEST ENGINEERING LABORATORY, INC.

**DUT: ZNFX220QM; Type: Portable Handset; Serial: 00305**

Communication System: UID 0, CDMA; Frequency: 1851.25 MHz; Duty Cycle: 1:1  
Medium: 1900 Body Medium parameters used:  
 $f = 1851.25 \text{ MHz}$ ;  $\sigma = 1.523 \text{ S/m}$ ;  $\epsilon_r = 53.162$ ;  $\rho = 1000 \text{ kg/m}^3$   
Phantom section: Flat Section; Space: 1.0 cm

Test Date: 12-31-2018; Ambient Temp: 21.1°C; Tissue Temp: 22.0°C

Probe: ES3DV3 - SN3332; ConvF(4.77, 4.77, 4.77) @ 1851.25 MHz; Calibrated: 8/22/2018  
Sensor-Surface: 3mm (Mechanical Surface Detection)  
Electronics: DAE4 Sn1272; Calibrated: 2/9/2018  
Phantom: SAM V5.0 Right; Type: QD000P40CD; Serial: 1647  
Measurement SW: DASY52, Version 52.10 (2);SEMCAD X Version 14.6.12 (7450)

**Mode: PCS CDMA, Body SAR, Back side, Low.ch**

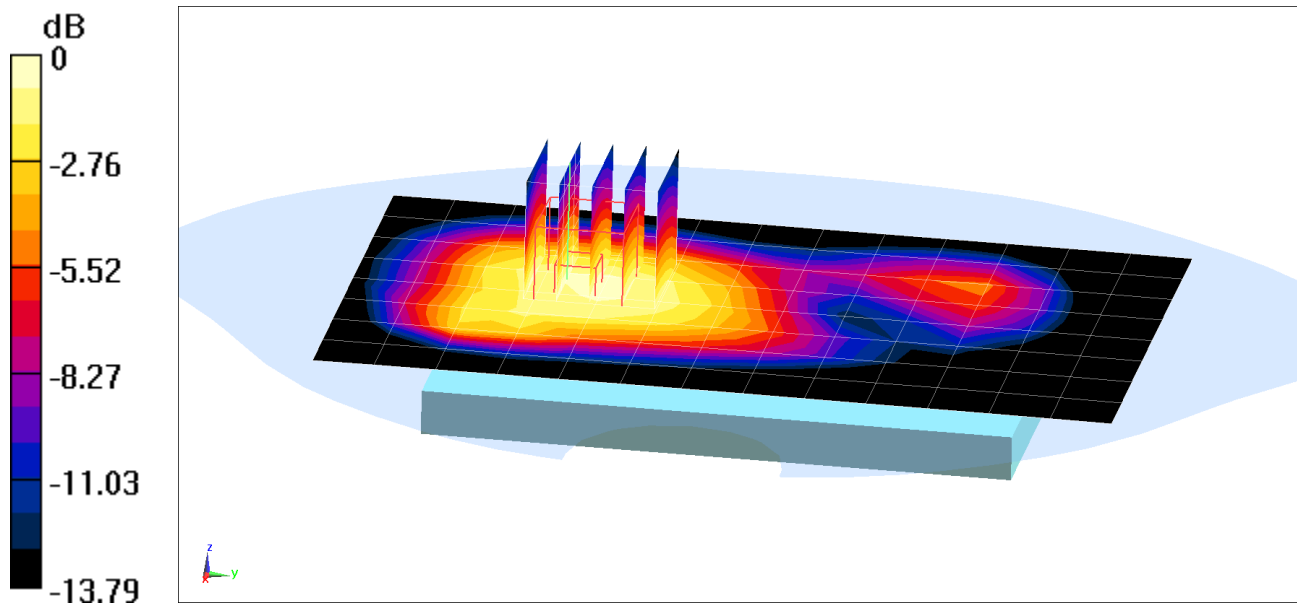
**Area Scan (9x14x1):** Measurement grid: dx=15mm, dy=15mm

**Zoom Scan (5x5x7)/Cube 0:** Measurement grid: dx=8mm, dy=8mm, dz=5mm

Reference Value = 24.86 V/m; Power Drift = -0.02 dB

Peak SAR (extrapolated) = 1.29 W/kg

**SAR(1 g) = 0.879 W/kg**



0 dB = 1.00 W/kg = 0.00 dBW/kg

# PCTEST ENGINEERING LABORATORY, INC.

**DUT: ZNFX220QM; Type: Portable Handset; Serial: 00305**

Communication System: UID 0, CDMA; Frequency: 1880 MHz; Duty Cycle: 1:1

Medium: 1900 Body Medium parameters used:

$f = 1880 \text{ MHz}$ ;  $\sigma = 1.521 \text{ S/m}$ ;  $\epsilon_r = 52.539$ ;  $\rho = 1000 \text{ kg/m}^3$

Phantom section: Flat Section; Space: 1.0 cm

Test Date: 01-02-2019; Ambient Temp: 22.9°C; Tissue Temp: 22.4°C

Probe: ES3DV3 - SN3332; ConvF(4.77, 4.77, 4.77) @ 1880 MHz; Calibrated: 8/22/2018

Sensor-Surface: 3mm (Mechanical Surface Detection)

Electronics: DAE4 Sn1272; Calibrated: 2/9/2018

Phantom: SAM V5.0 Right; Type: QD000P40CD; Serial: 1647

Measurement SW: DASY52, Version 52.10 (1);SEMCAD X Version 14.6.12 (7450)

**Mode: PCS EVDO, Body SAR, Front side, Mid.ch**

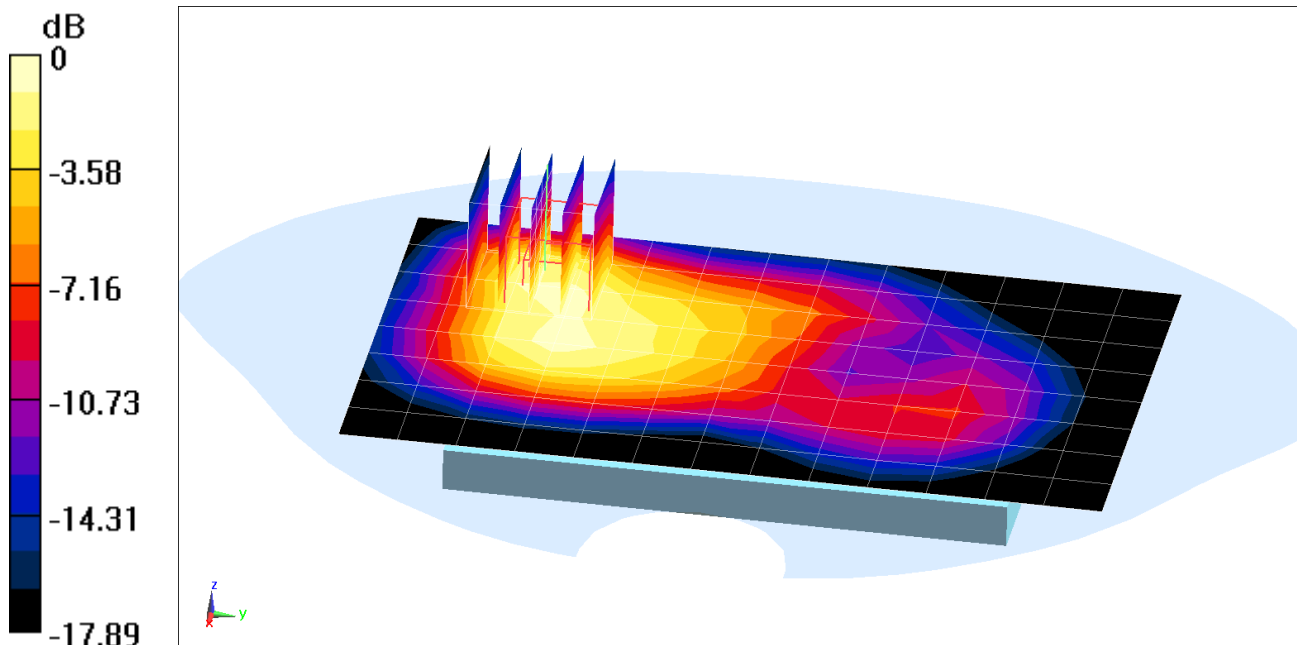
**Area Scan (9x14x1):** Measurement grid: dx=15mm, dy=15mm

**Zoom Scan (5x5x7)/Cube 0:** Measurement grid: dx=8mm, dy=8mm, dz=5mm

Reference Value = 24.44 V/m; Power Drift = 0.02 dB

Peak SAR (extrapolated) = 1.57 W/kg

**SAR(1 g) = 0.860 W/kg**



0 dB = 1.06 W/kg = 0.25 dBW/kg

# PCTEST ENGINEERING LABORATORY, INC.

**DUT: ZNFX220QM; Type: Portable Handset; Serial: 00303**

Communication System: UID 0, LTE Band 12; Frequency: 707.5 MHz; Duty Cycle: 1:1  
Medium: 750 Body Medium parameters used (interpolated):  
 $f = 707.5 \text{ MHz}$ ;  $\sigma = 0.927 \text{ S/m}$ ;  $\epsilon_r = 54.631$ ;  $\rho = 1000 \text{ kg/m}^3$   
Phantom section: Flat Section; Space: 1.0 cm

Test Date: 12-17-2018; Ambient Temp: 20.1°C; Tissue Temp: 20.1°C

Probe: EX3DV4 - SN7406; ConvF(9.91, 9.91, 9.91) @ 707.5 MHz; Calibrated: 5/22/2018  
Sensor-Surface: 1.4mm (Mechanical Surface Detection)  
Electronics: DAE4 Sn859; Calibrated: 5/22/2018  
Phantom: Twin-SAM V4.0 Front Right; Type: QD 000 P40 CC; Serial: 1167  
Measurement SW: DASY52, Version 52.10 (2);SEMCAD X Version 14.6.12 (7450)

**Mode: LTE Band 12, Body SAR, Back side, Mid.ch, 10 MHz Bandwidth,  
QPSK, 1 RB, 25 RB Offset**

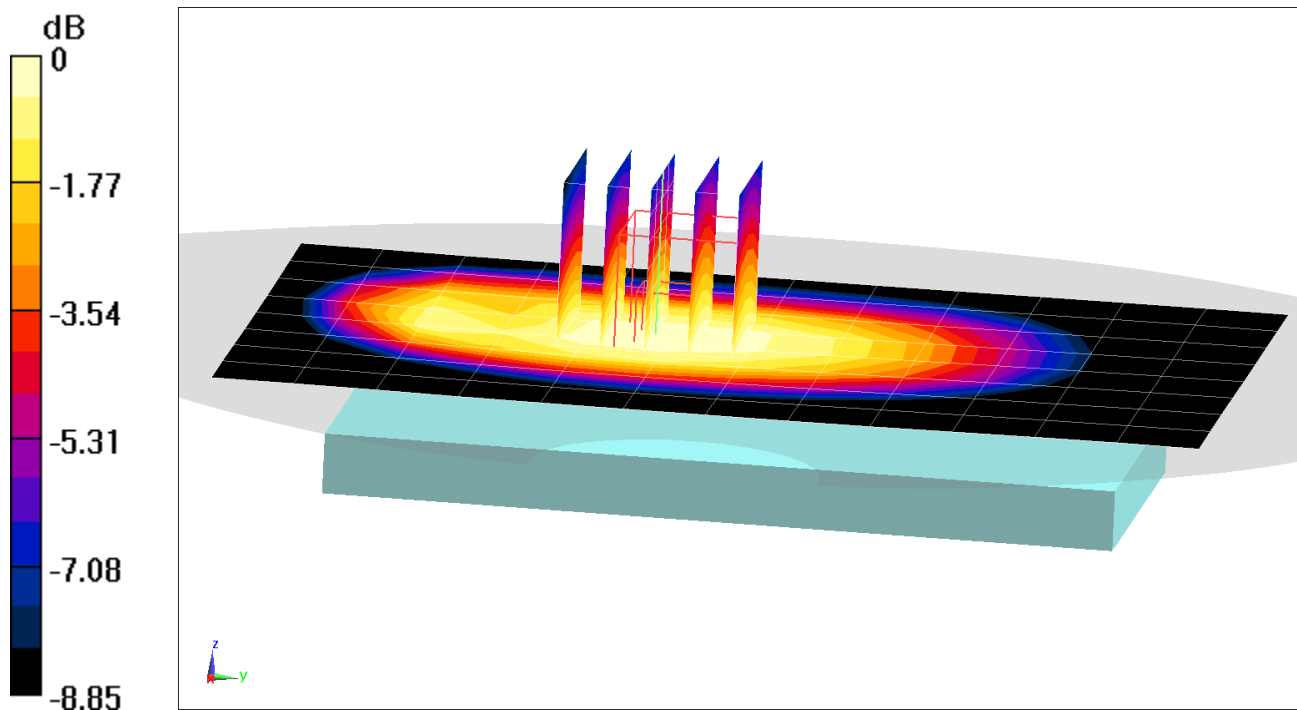
**Area Scan (9x13x1):** Measurement grid: dx=15mm, dy=15mm

**Zoom Scan (5x5x7)/Cube 0:** Measurement grid: dx=8mm, dy=8mm, dz=5mm

Reference Value = 28.21 V/m; Power Drift = 0.01 dB

Peak SAR (extrapolated) = 0.925 W/kg

**SAR(1 g) = 0.710 W/kg**



0 dB = 0.852 W/kg = -0.70 dBW/kg

# PCTEST ENGINEERING LABORATORY, INC.

**DUT: ZNFX220QM; Type: Portable Handset; Serial: 00303**

Communication System: UID 0, LTE Band 5; Frequency: 836.5 MHz; Duty Cycle: 1:1

Medium: 835 Body Medium parameters used (interpolated):

$f = 836.5$  MHz;  $\sigma = 1.004$  S/m;  $\epsilon_r = 54.947$ ;  $\rho = 1000$  kg/m<sup>3</sup>

Phantom section: Flat Section; Space: 1.0 cm

Test Date: 12-13-2018; Ambient Temp: 20.4°C; Tissue Temp: 20.0°C

Probe: EX3DV4 - SN7406; ConvF(9.61, 9.61, 9.61) @ 836.5 MHz; Calibrated: 5/22/2018

Sensor-Surface: 1.4mm (Mechanical Surface Detection)

Electronics: DAE4 Sn859; Calibrated: 5/22/2018

Phantom: Twin-SAM V4.0 Front Right; Type: QD 000 P40 CC; Serial: 1167

Measurement SW: DASY52, Version 52.10 (2);SEMCAD X Version 14.6.12 (7450)

**Mode: LTE Band 5 (Cell.), Body SAR, Back side, Mid.ch, 10 MHz Bandwidth,  
QPSK, 1 RB, 25 RB Offset**

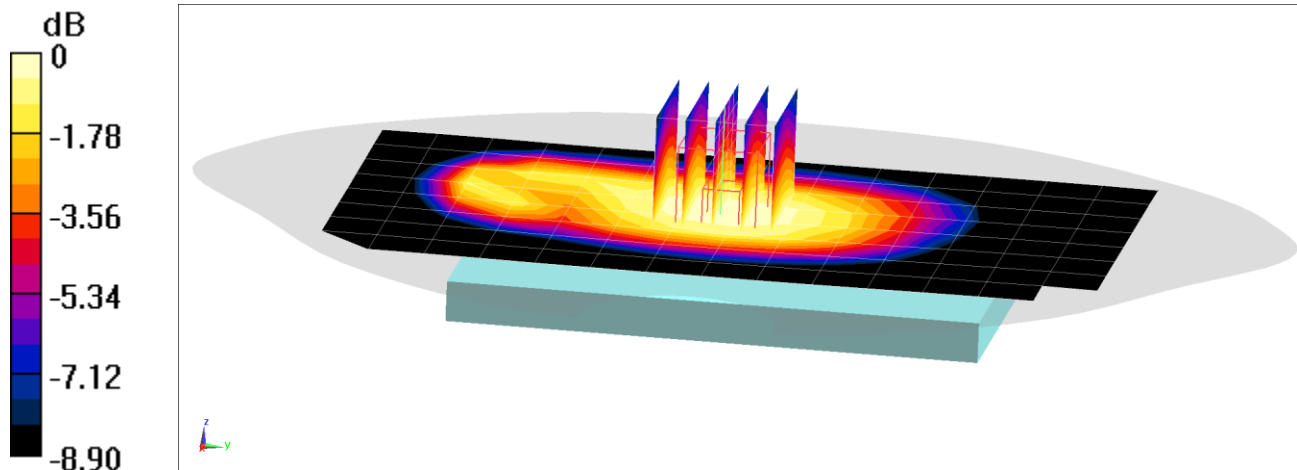
**Area Scan (9x15x1):** Measurement grid: dx=15mm, dy=15mm

**Zoom Scan (6x5x7)/Cube 0:** Measurement grid: dx=8mm, dy=8mm, dz=5mm

Reference Value = 27.96 V/m; Power Drift = -0.02 dB

Peak SAR (extrapolated) = 1.05 W/kg

**SAR(1 g) = 0.790 W/kg**



0 dB = 0.959 W/kg = -0.18 dBW/kg



# PCTEST ENGINEERING LABORATORY, INC.

**DUT: ZNFX220QM; Type: Portable Handset; Serial: 00304**

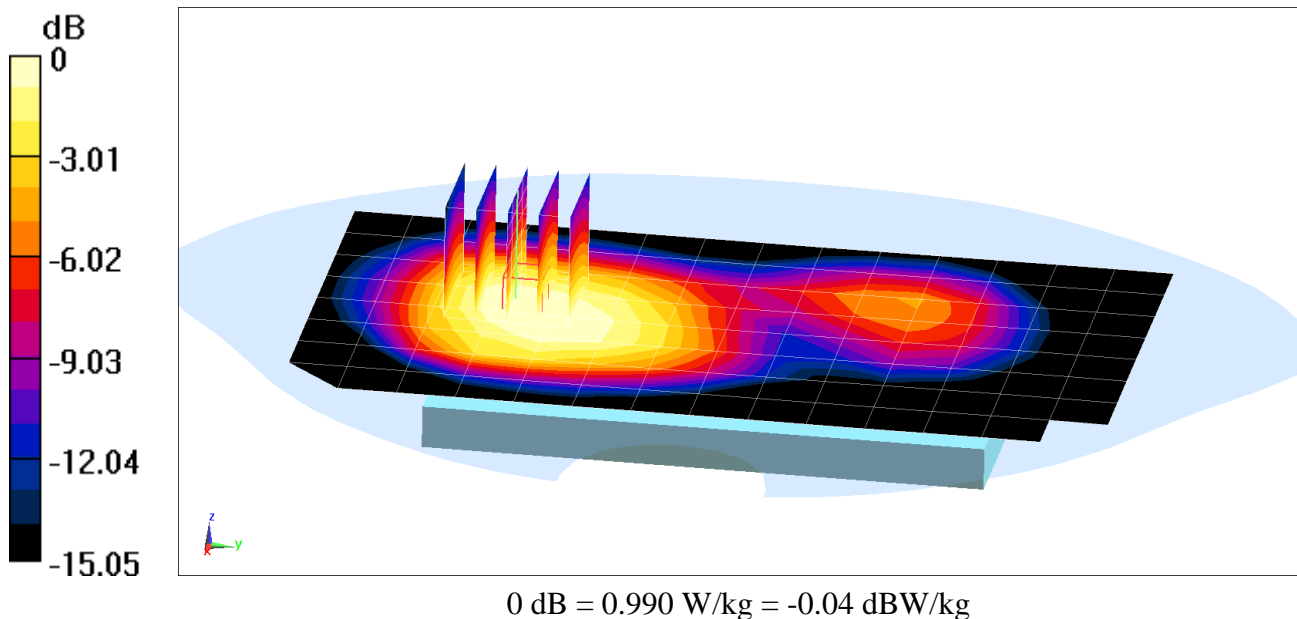
Communication System: UID 0, LTE Band 4 (AWS); Frequency: 1732.5 MHz; Duty Cycle: 1:1  
Medium: 1750 Body Medium parameters used (interpolated):  
 $f = 1732.5$  MHz;  $\sigma = 1.491$  S/m;  $\epsilon_r = 52.563$ ;  $\rho = 1000$  kg/m<sup>3</sup>  
Phantom section: Flat Section; Space: 1.0 cm

Test Date: 01-02-2019; Ambient Temp: 22.3°C; Tissue Temp: 21.5°C

Probe: EX3DV4 - SN7357; ConvF(8.43, 8.43, 8.43) @ 1732.5 MHz; Calibrated: 4/18/2018  
Sensor-Surface: 1.4mm (Mechanical Surface Detection)  
Electronics: DAE4 Sn1407; Calibrated: 4/11/2018  
Phantom: SAM with CRP v5.0 Front; Type: QD000P40CD; Serial: 1646  
Measurement SW: DASY52, Version 52.10 (1);SEMCAD X Version 14.6.12 (7450)

**Mode: LTE Band 4 (AWS), Body SAR, Back side, Mid.ch, 20 MHz Bandwidth,  
QPSK, 1 RB, 50 RB Offset**

**Area Scan (9x15x1):** Measurement grid: dx=15mm, dy=15mm  
**Zoom Scan (5x5x7)/Cube 0:** Measurement grid: dx=8mm, dy=8mm, dz=5mm  
Reference Value = 23.10 V/m; Power Drift = 0.02 dB  
Peak SAR (extrapolated) = 1.13 W/kg  
**SAR(1 g) = 0.743 W/kg**



# PCTEST ENGINEERING LABORATORY, INC.

**DUT: ZNFX220QM; Type: Portable Handset; Serial: 00304**

Communication System: UID 0, LTE Band 4 (AWS); Frequency: 1732.5 MHz; Duty Cycle: 1:1  
Medium: 1750 Body Medium parameters used (interpolated):  
 $f = 1732.5 \text{ MHz}$ ;  $\sigma = 1.491 \text{ S/m}$ ;  $\epsilon_r = 52.563$ ;  $\rho = 1000 \text{ kg/m}^3$   
Phantom section: Flat Section; Space: 1.0 cm

Test Date: 01-02-2019; Ambient Temp: 22.3°C; Tissue Temp: 21.5°C

Probe: EX3DV4 - SN7357; ConvF(8.43, 8.43, 8.43) @ 1732.5 MHz; Calibrated: 4/18/2018  
Sensor-Surface: 1.4mm (Mechanical Surface Detection)  
Electronics: DAE4 Sn1407; Calibrated: 4/11/2018  
Phantom: SAM with CRP v5.0 Front; Type: QD000P40CD; Serial: 1646  
Measurement SW: DASY52, Version 52.10 (1);SEMCAD X Version 14.6.12 (7450)

**Mode: LTE Band 4 (AWS), Body SAR, Front side, Mid.ch, 20 MHz Bandwidth,  
QPSK, 1 RB, 50 RB Offset**

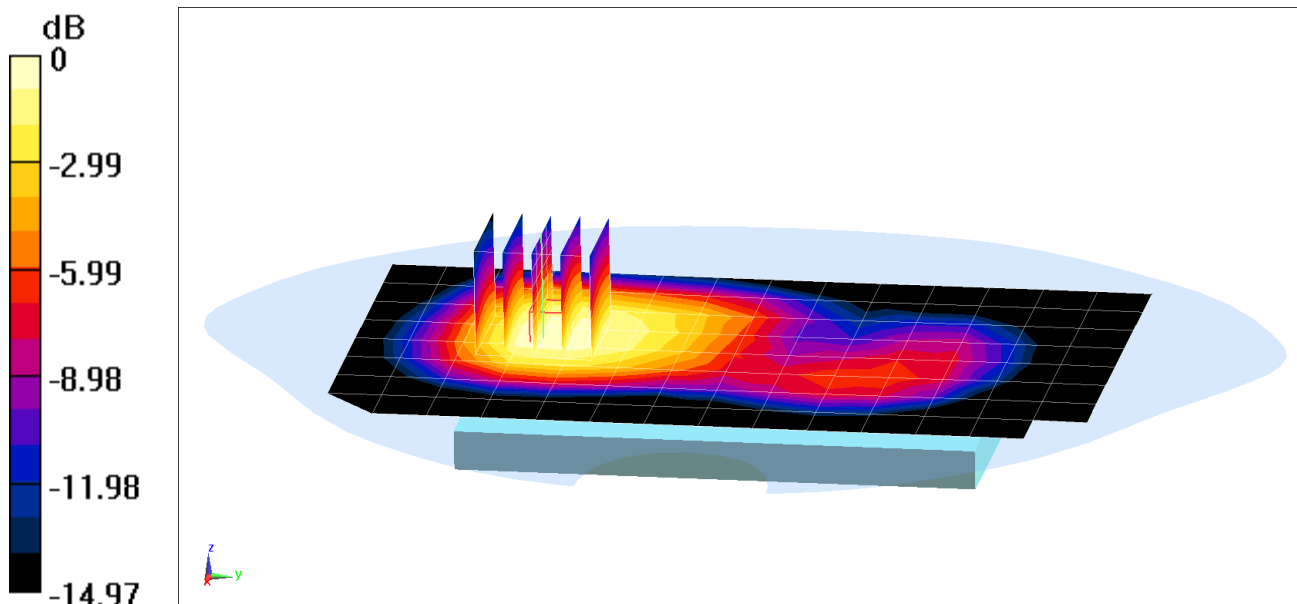
**Area Scan (9x15x1):** Measurement grid: dx=15mm, dy=15mm

**Zoom Scan (5x5x7)/Cube 0:** Measurement grid: dx=8mm, dy=8mm, dz=5mm

Reference Value = 24.13 V/m; Power Drift = 0.14 dB

Peak SAR (extrapolated) = 1.29 W/kg

**SAR(1 g) = 0.826 W/kg**



0 dB = 1.12 W/kg = 0.49 dBW/kg

# PCTEST ENGINEERING LABORATORY, INC.

**DUT: ZNFX220QM; Type: Portable Handset; Serial: 00304**

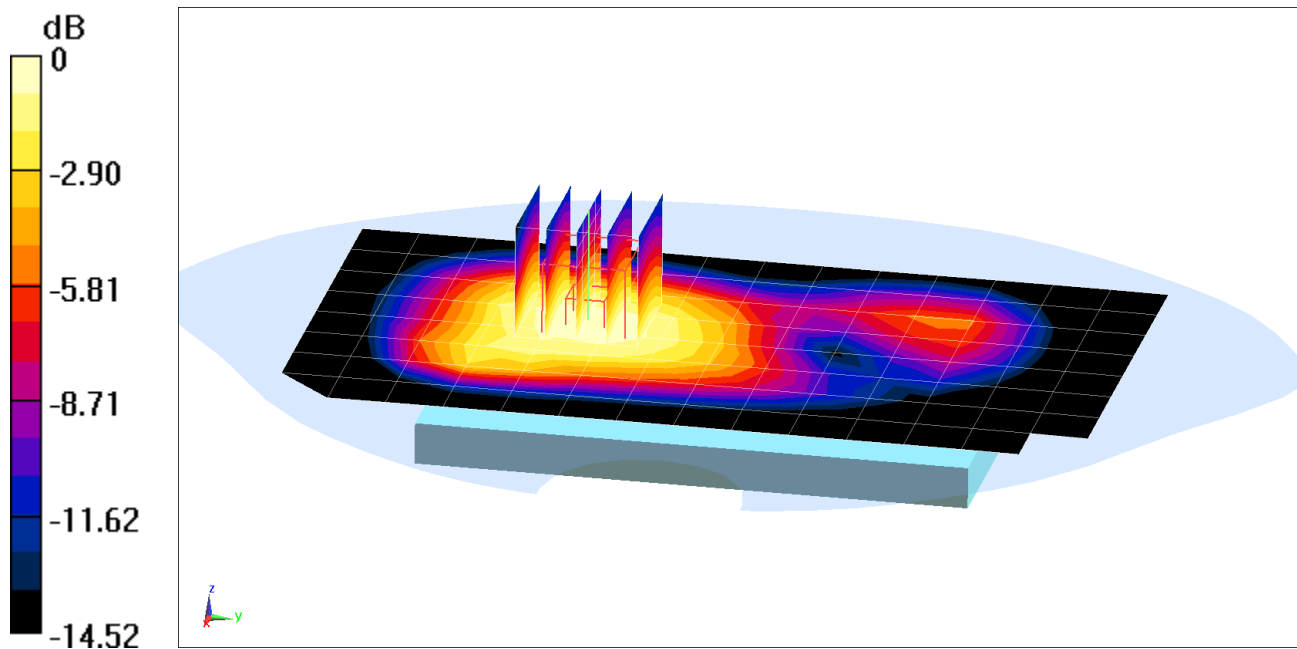
Communication System: UID 0, LTE Band 25 (PCS); Frequency: 1882.5 MHz; Duty Cycle: 1:1  
Medium: 1900 Body Medium parameters used (interpolated):  
 $f = 1882.5$  MHz;  $\sigma = 1.524$  S/m;  $\epsilon_r = 52.529$ ;  $\rho = 1000$  kg/m<sup>3</sup>  
Phantom section: Flat Section; Space: 1.0 cm

Test Date: 01-02-2019; Ambient Temp: 22.90°C; Tissue Temp: 22.40°C

Probe: ES3DV3 - SN3332; ConvF(4.77, 4.77, 4.77) @ 1882.5 MHz; Calibrated: 8/22/2018  
Sensor-Surface: 3mm (Mechanical Surface Detection)  
Electronics: DAE4 Sn1272; Calibrated: 2/9/2018  
Phantom: SAM V5.0 Right; Type: QD000P40CD; Serial: 1647  
Measurement SW: DASY52, Version 52.10 (1);SEMCAD X Version 14.6.12 (7450)

**Mode: LTE Band 25 (PCS), Body SAR, Back side, Mid.ch, 20 MHz Bandwidth,  
QPSK, 1 RB, 50 RB Offset**

**Area Scan (9x15x1):** Measurement grid: dx=15mm, dy=15mm  
**Zoom Scan (5x5x7)/Cube 0:** Measurement grid: dx=8mm, dy=8mm, dz=5mm  
Reference Value = 24.90 V/m; Power Drift = 0.13 dB  
Peak SAR (extrapolated) = 1.22 W/kg  
**SAR(1 g) = 0.830 W/kg**



0 dB = 0.956 W/kg = -0.20 dBW/kg

# PCTEST ENGINEERING LABORATORY, INC.

**DUT: ZNFX220QM; Type: Portable Handset; Serial: 00316**

Communication System: UID 0, IEEE 802.11b; Frequency: 2462 MHz; Duty Cycle: 1:1

Medium: 2450 Body Medium parameters used (interpolated):

$f = 2462 \text{ MHz}$ ;  $\sigma = 2.023 \text{ S/m}$ ;  $\epsilon_r = 50.696$ ;  $\rho = 1000 \text{ kg/m}^3$

Phantom section: Flat Section; Space: 1.0 cm

Test Date: 12-30-2018; Ambient Temp: 21.9°C; Tissue Temp: 22.5°C

Probe: ES3DV3 - SN3319; ConvF(4.51, 4.51, 4.51) @ 2462 MHz; Calibrated: 3/13/2018

Sensor-Surface: 3mm (Mechanical Surface Detection)

Electronics: DAE4 Sn1368; Calibrated: 3/7/2018

Phantom: LeftTwin-SAM V5.0; Type: QD 000 P40 CD; Serial: TP1375

Measurement SW: DASY52, Version 52.10 (2);SEMCAD X Version 14.6.12 (7450)

**Mode: IEEE 802.11b, 22 MHz Bandwidth, Body SAR, Ch 11, 1 Mbps, Back Side**

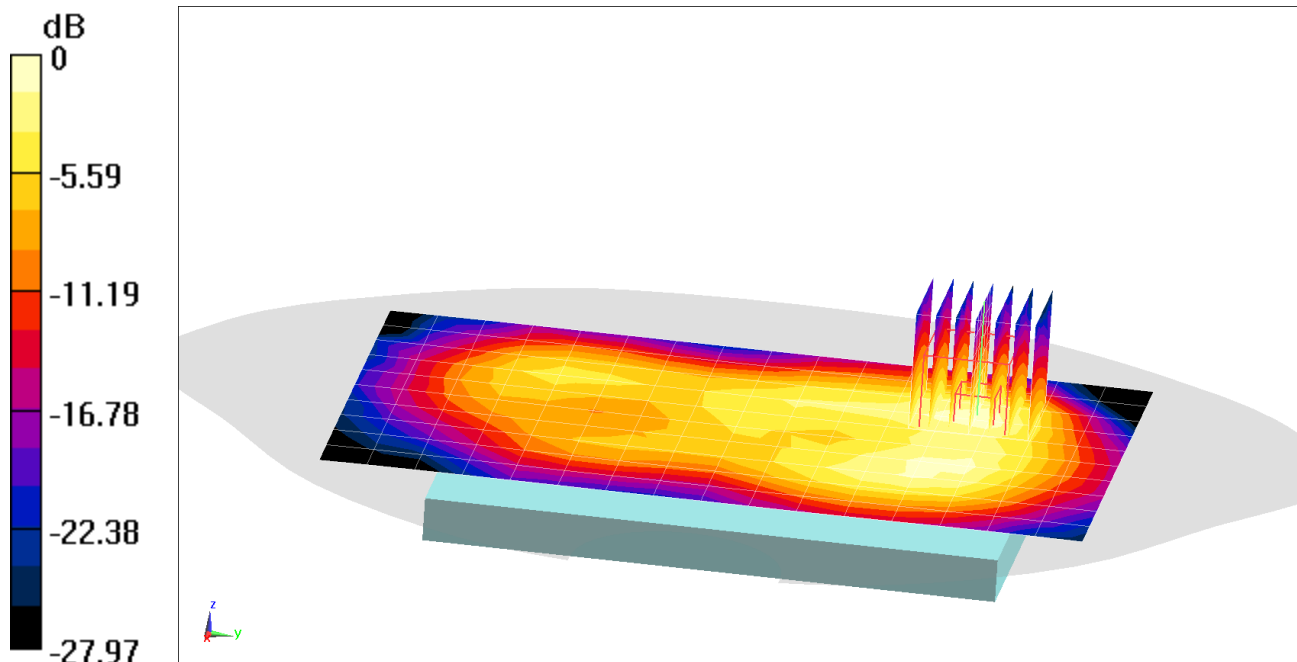
**Area Scan (11x17x1):** Measurement grid: dx=12mm, dy=12mm

**Zoom Scan (7x7x7)/Cube 0:** Measurement grid: dx=5mm, dy=5mm, dz=5mm

Reference Value = 5.401 V/m; Power Drift = 0.18 dB

Peak SAR (extrapolated) = 0.349 W/kg

**SAR(1 g) = 0.160 W/kg**



0 dB = 0.212 W/kg = -6.74 dBW/kg

# PCTEST ENGINEERING LABORATORY, INC.

**DUT: ZNFX220QM; Type: Portable Handset; Serial: 00316**

Communication System: UID 0, IEEE 802.11b; Frequency: 2462 MHz; Duty Cycle: 1:1  
Medium: 2450 Body Medium parameters used (interpolated):  
 $f = 2462 \text{ MHz}$ ;  $\sigma = 2.023 \text{ S/m}$ ;  $\epsilon_r = 50.696$ ;  $\rho = 1000 \text{ kg/m}^3$   
Phantom section: Flat Section; Space: 1.0 cm

Test Date: 12-30-2018; Ambient Temp: 21.9°C; Tissue Temp: 22.5°C

Probe: ES3DV3 - SN3319; ConvF(4.51, 4.51, 4.51) @ 2462 MHz; Calibrated: 3/13/2018  
Sensor-Surface: 3mm (Mechanical Surface Detection)  
Electronics: DAE4 Sn1368; Calibrated: 3/7/2018  
Phantom: LeftTwin-SAM V5.0; Type: QD 000 P40 CD; Serial: TP1375  
Measurement SW: DASY52, Version 52.10 (2);SEMCAD X Version 14.6.12 (7450)

**Mode: IEEE 802.11b, 22 MHz Bandwidth, Body SAR, Ch 11, 1 Mbps, Front Side**

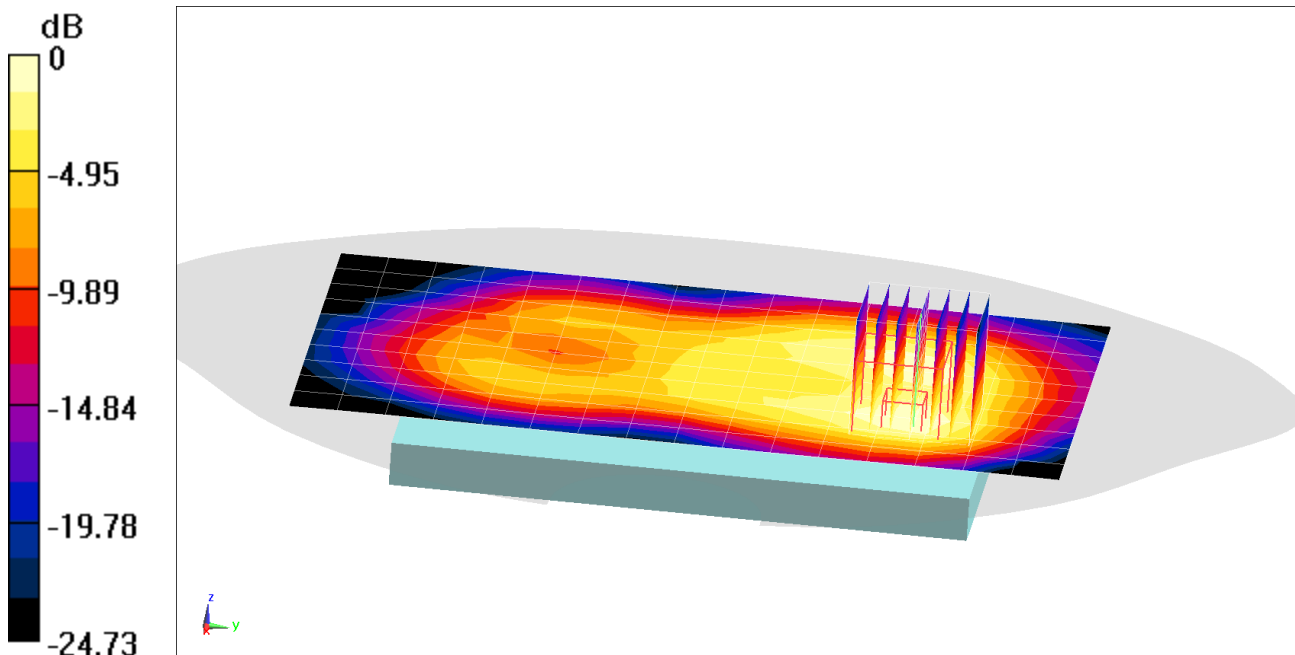
**Area Scan (11x17x1):** Measurement grid: dx=12mm, dy=12mm

**Zoom Scan (7x7x7)/Cube 0:** Measurement grid: dx=5mm, dy=5mm, dz=5mm

Reference Value = 6.197 V/m; Power Drift = 0.02 dB

Peak SAR (extrapolated) = 0.336 W/kg

**SAR(1 g) = 0.166 W/kg**



0 dB = 0.208 W/kg = -6.82 dBW/kg

## APPENDIX B: SYSTEM VERIFICATION

# PCTEST ENGINEERING LABORATORY, INC.

**DUT: Dipole 750 MHz; Type: D750V3; Serial: 1054**

Communication System: UID 0, CW; Frequency: 750 MHz; Duty Cycle: 1:1

Medium: 750 Head; Medium parameters used (interpolated):

$f = 750 \text{ MHz}$ ;  $\sigma = 0.878 \text{ S/m}$ ;  $\epsilon_r = 42.325$ ;  $\rho = 1000 \text{ kg/m}^3$

Phantom section: Flat Section; Space: 1.5 cm

Test Date: 12-19-2018; Ambient Temp: 21.3°C; Tissue Temp: 19.8°C

Probe: ES3DV3 - SN3287; ConvF(6.76, 6.76, 6.76) @ 750 MHz; Calibrated: 10/22/2018

Sensor-Surface: 3mm (Mechanical Surface Detection)

Electronics: DAE4 Sn1333; Calibrated: 10/18/2018

Phantom: Twin-SAM V8.0; Type: QD 000 P41 Ax; Serial: 1964

Measurement SW: DASY52, Version 52.10 (2);SEMCAD X Version 14.6.12 (7450)

## 750 MHz System Verification at 23.0 dBm (200 mW)

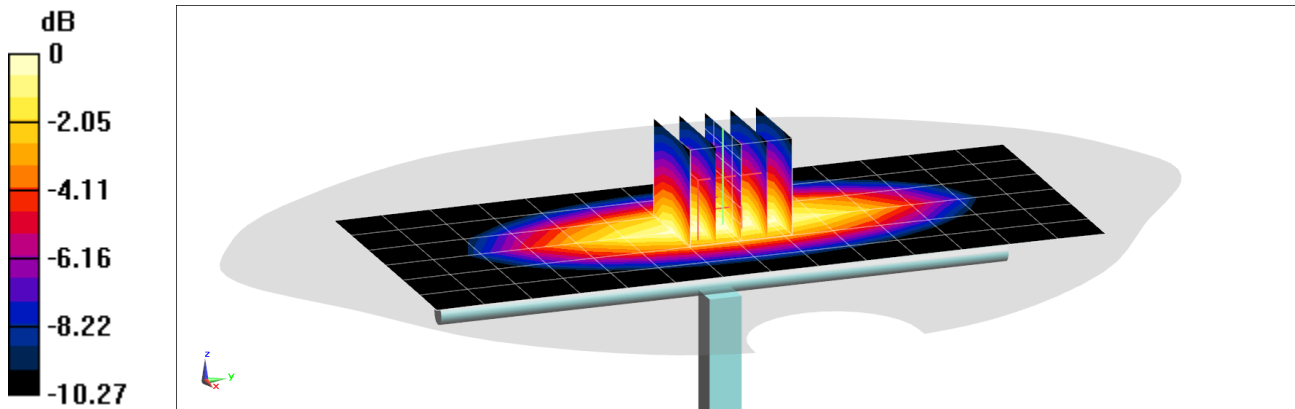
**Area Scan (7x15x1):** Measurement grid: dx=15mm, dy=15mm

**Zoom Scan (5x5x7)/Cube 0:** Measurement grid: dx=8mm, dy=8mm, dz=5mm

Peak SAR (extrapolated) = 2.59 W/kg

**SAR(1 g) = 1.73 W/kg**

Deviation(1 g) = 3.35%



0 dB = 2.03 W/kg = 3.07 dBW/kg

# PCTEST ENGINEERING LABORATORY, INC.

**DUT: Dipole 835 MHz; Type: D835V2; Serial: 4d047**

Communication System: UID 0, CW; Frequency: 835 MHz; Duty Cycle: 1:1

Medium: 835 Head Medium parameters used:

$f = 835 \text{ MHz}$ ;  $\sigma = 0.929 \text{ S/m}$ ;  $\epsilon_r = 42.966$ ;  $\rho = 1000 \text{ kg/m}^3$

Phantom section: Flat Section; Space: 1.5 cm

Test Date: 12-19-2018; Ambient Temp: 23.0°C; Tissue Temp: 22.1°C

Probe: EX3DV4 - SN7410; ConvF(9.81, 9.81, 9.81) @ 835 MHz; Calibrated: 7/20/2018

Sensor-Surface: 1.4mm (Mechanical Surface Detection)

Electronics: DAE4 Sn1322; Calibrated: 7/11/2018

Phantom: SAM Front; Type: SAM; Serial: 1686

Measurement SW: DASY52, Version 52.10 (1); SEMCAD X Version 14.6.12 (7450)

## 835 MHz System Verification at 23.0 dBm (200 mW)

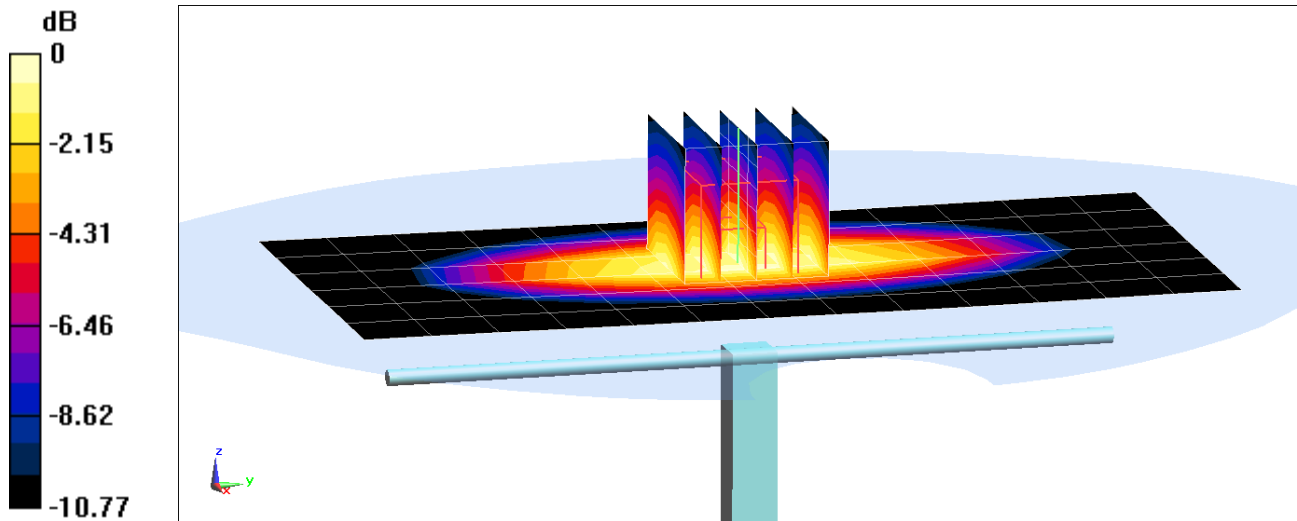
**Area Scan (7x14x1):** Measurement grid: dx=15mm, dy=15mm

**Zoom Scan (5x5x7)/Cube 0:** Measurement grid: dx=8mm, dy=8mm, dz=5mm

Peak SAR (extrapolated) = 3.05 W/kg

**SAR(1 g) = 2.04 W/kg**

Deviation(1 g) = 7.71%



0 dB = 2.71 W/kg = 4.33 dBW/kg



# PCTEST ENGINEERING LABORATORY, INC.

**DUT: Dipole 1750 MHz; Type: D1750V2; Serial: 1148**

Communication System: UID 0, CW; Frequency: 1750 MHz; Duty Cycle: 1:1

Medium: 1750 Head; Medium parameters used:

$f = 1750 \text{ MHz}$ ;  $\sigma = 1.364 \text{ S/m}$ ;  $\epsilon_r = 38.734$ ;  $\rho = 1000 \text{ kg/m}^3$

Phantom section: Flat Section; Space: 1.0 cm

Test Date: 12-31-2018; Ambient Temp: 21.7°C; Tissue Temp: 20.8°C

Probe: ES3DV3 - SN3287; ConvF(5.48, 5.48, 5.48) @ 1750 MHz; Calibrated: 10/22/2018

Sensor-Surface: 3mm (Mechanical Surface Detection)

Electronics: DAE4 Sn1333; Calibrated: 10/18/2018

Phantom: Twin-SAM V8.0; Type: QD 000 P41 Ax; Serial: 1964

Measurement SW: DASY52, Version 52.10 (2); SEMCAD X Version 14.6.12 (7450)

## 1750 MHz System Verification at 20.0 dBm (100 mW)

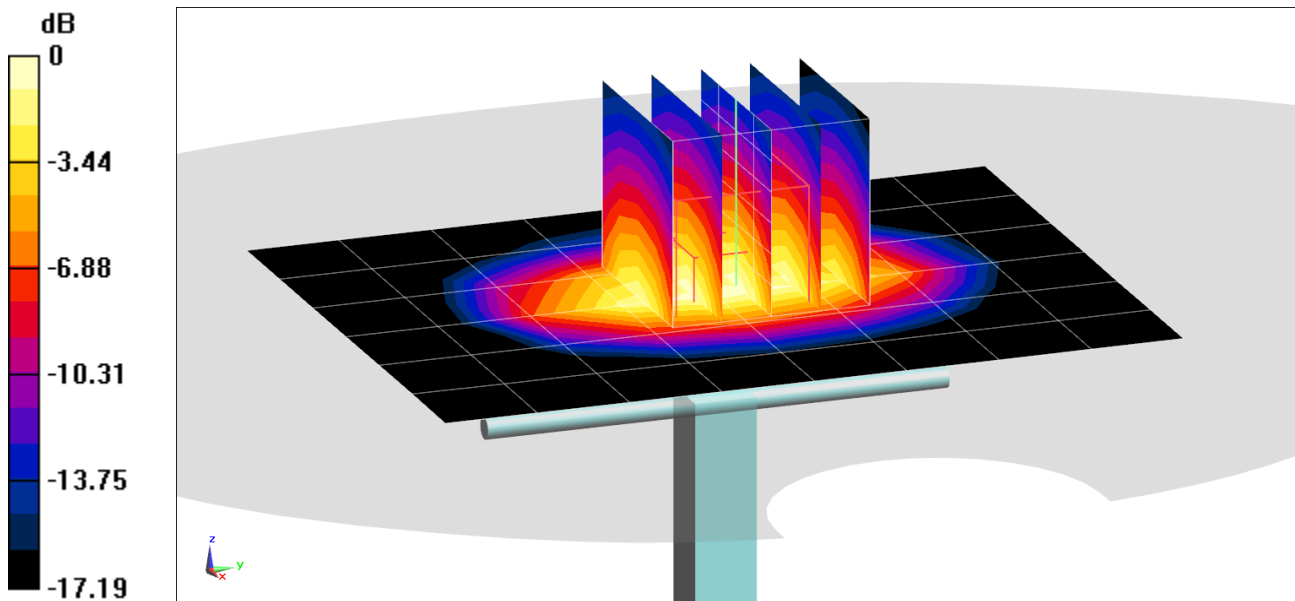
**Area Scan (7x9x1):** Measurement grid: dx=15mm, dy=15mm

**Zoom Scan (5x5x7)/Cube 0:** Measurement grid: dx=8mm, dy=8mm, dz=5mm

Peak SAR (extrapolated) = 6.01 W/kg

**SAR(1 g) = 3.35 W/kg**

Deviation(1 g) = -7.97%



0 dB = 4.16 W/kg = 6.19 dBW/kg

# PCTEST ENGINEERING LABORATORY, INC.

**DUT: Dipole 1900 MHz; Type: D1900V2; Serial: 5d080**

Communication System: UID 0, CW; Frequency: 1900 MHz; Duty Cycle: 1:1

Medium: 1900 Head Medium parameters used (interpolated):

$f = 1900 \text{ MHz}$ ;  $\sigma = 1.424 \text{ S/m}$ ;  $\epsilon_r = 39.783$ ;  $\rho = 1000 \text{ kg/m}^3$

Phantom section: Flat Section; Space: 1.0 cm

Test Date: 12-22-2018; Ambient Temp: 20.7°C; Tissue Temp: 22.3°C

Probe: EX3DV4 - SN7409; ConvF(8.05, 8.05, 8.05) @ 1900 MHz; Calibrated: 6/25/2018

Sensor-Surface: 1.4mm (Mechanical Surface Detection)

Electronics: DAE4 Sn1334; Calibrated: 6/18/2018

Phantom: SAM with CRP (Left); Type: SAM; Serial: 1715

Measurement SW: DASY52, Version 52.10 (2); SEMCAD X Version 14.6.12 (7450)

## 1900 MHz System Verification at 20.0 dBm (100 mW)

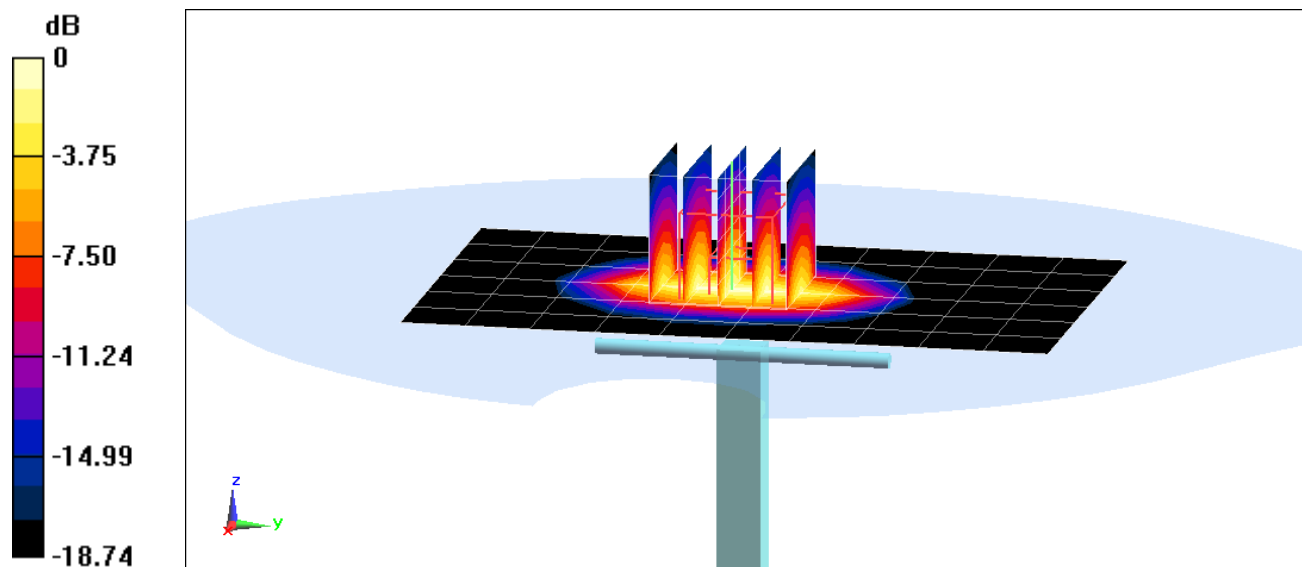
**Area Scan (7x11x1):** Measurement grid: dx=15mm, dy=15mm

**Zoom Scan (5x5x7)/Cube 0:** Measurement grid: dx=8mm, dy=8mm, dz=5mm

Peak SAR (extrapolated) = 7.64 W/kg

**SAR(1 g) = 3.97 W/kg**

Deviation(1 g) = -0.25%



0 dB = 6.34 W/kg = 8.02 dBW/kg

# PCTEST ENGINEERING LABORATORY, INC.

**DUT: Dipole 1900 MHz; Type: D1900V2; Serial: 5d148**

Communication System: UID 0, CW; Frequency: 1900 MHz; Duty Cycle: 1:1

Medium: 1900 Head; Medium parameters used (interpolated):

$f = 1900 \text{ MHz}$ ;  $\sigma = 1.452 \text{ S/m}$ ;  $\epsilon_r = 38.514$ ;  $\rho = 1000 \text{ kg/m}^3$

Phantom section: Flat Section; Space: 1.0 cm

Test Date: 12-31-2018; Ambient Temp: 21.7°C; Tissue Temp: 20.8°C

Probe: ES3DV3 - SN3287; ConvF(5.24, 5.24, 5.24) @ 1900 MHz; Calibrated: 10/22/2018

Sensor-Surface: 3mm (Mechanical Surface Detection)

Electronics: DAE4 Sn1333; Calibrated: 10/18/2018

Phantom: Twin-SAM V8.0; Type: QD 000 P41 Ax; Serial: 1964

Measurement SW: DASY52, Version 52.10 (2); SEMCAD X Version 14.6.12 (7450)

## 1900 MHz System Verification at 20.0 dBm (100 mW)

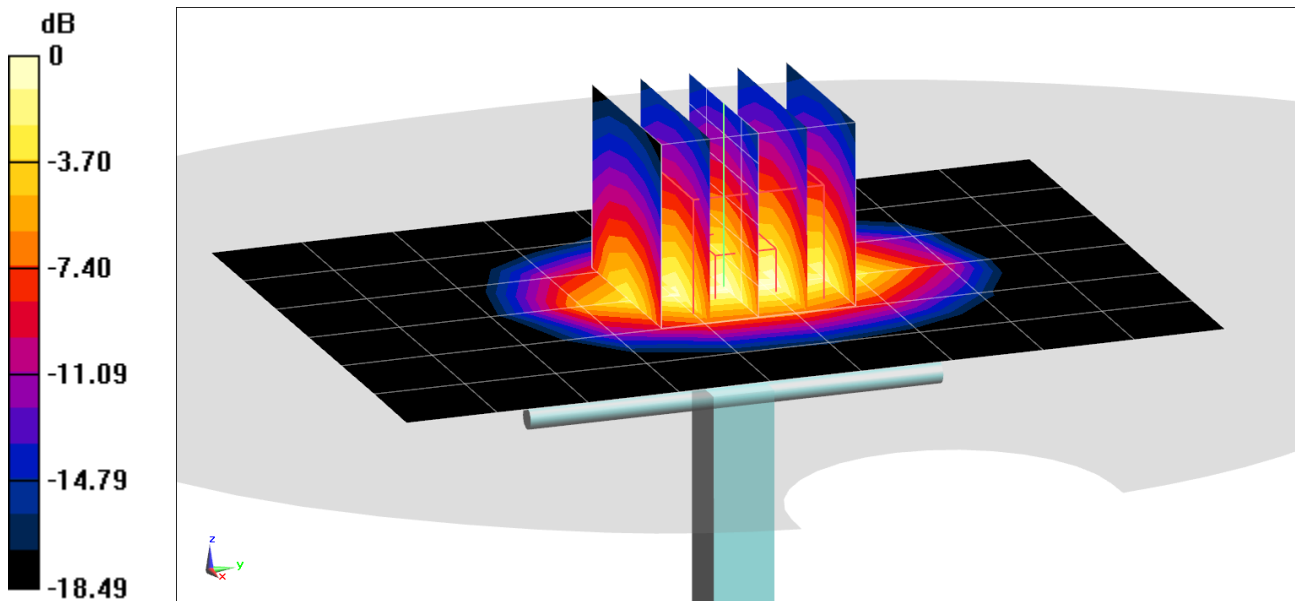
**Area Scan (7x10x1):** Measurement grid: dx=15mm, dy=15mm

**Zoom Scan (5x5x7)/Cube 0:** Measurement grid: dx=8mm, dy=8mm, dz=5mm

Peak SAR (extrapolated) = 7.74 W/kg

**SAR(1 g) = 4.19 W/kg**

Deviation(1 g) = 4.49%



0 dB = 5.31 W/kg = 7.25 dBW/kg

# PCTEST ENGINEERING LABORATORY, INC.

**DUT: Dipole 2450 MHz; Type: D2450V2; Serial: 981**

Communication System: UID 0, CW; Frequency: 2450 MHz; Duty Cycle: 1:1

Medium: 2450 Head Medium parameters used:

$f = 2450 \text{ MHz}$ ;  $\sigma = 1.862 \text{ S/m}$ ;  $\epsilon_r = 38.272$ ;  $\rho = 1000 \text{ kg/m}^3$

Phantom section: Flat Section; Space: 1.0 cm

Test Date: 12-17-2018; Ambient Temp: 21.9°C; Tissue Temp: 22.0°C

Probe: EX3DV4 - SN7410; ConvF(7.5, 7.5, 7.5) @ 2450 MHz; Calibrated: 7/20/2018

Sensor-Surface: 1.4mm (Mechanical Surface Detection)

Electronics: DAE4 Sn1322; Calibrated: 7/11/2018

Phantom: SAM Front; Type: SAM; Serial: 1686

Measurement SW: DASY52, Version 52.10 (1); SEMCAD X Version 14.6.12 (7450)

## 2450 MHz System Verification at 20.0 dBm (100 mW)

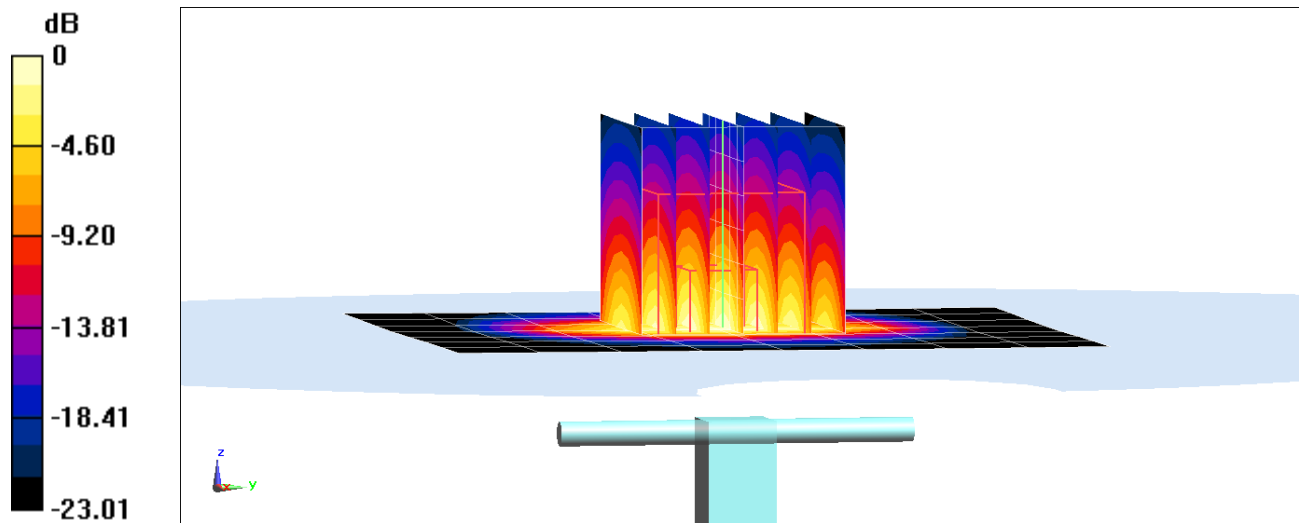
**Area Scan (8x9x1):** Measurement grid: dx=12mm, dy=12mm

**Zoom Scan (7x7x7)/Cube 0:** Measurement grid: dx=5mm, dy=5mm, dz=5mm

Peak SAR (extrapolated) = 11.2 W/kg

**SAR(1 g) = 5.25 W/kg**

Deviation(1 g) = 0.38%



0 dB = 8.96 W/kg = 9.52 dBW/kg

# PCTEST ENGINEERING LABORATORY, INC.

**DUT: Dipole 2450 MHz; Type: D2450V2; Serial: 719**

Communication System: UID 0, CW; Frequency: 2450 MHz; Duty Cycle: 1:1

Medium: 2450 Head; Medium parameters used:

$f = 2450 \text{ MHz}$ ;  $\sigma = 1.828 \text{ S/m}$ ;  $\epsilon_r = 38.467$ ;  $\rho = 1000 \text{ kg/m}^3$

Phantom section: Flat Section; Space: 1.0 cm

Test Date: 12-31-2018; Ambient Temp: 20.5°C; Tissue Temp: 20.7°C

Probe: EX3DV4 - SN7406; ConvF(7.54, 7.54, 7.54) @ 2450 MHz; Calibrated: 5/22/2018

Sensor-Surface: 1.4mm (Mechanical Surface Detection)

Electronics: DAE4 Sn859; Calibrated: 5/22/2018

Phantom: Twin-SAM V4.0 Front Right; Type: QD 000 P40 CC; Serial: 1167

Measurement SW: DASY52, Version 52.10 (2);SEMCAD X Version 14.6.12 (7450)

## 2450 MHz System Verification at 20.0 dBm (100 mW)

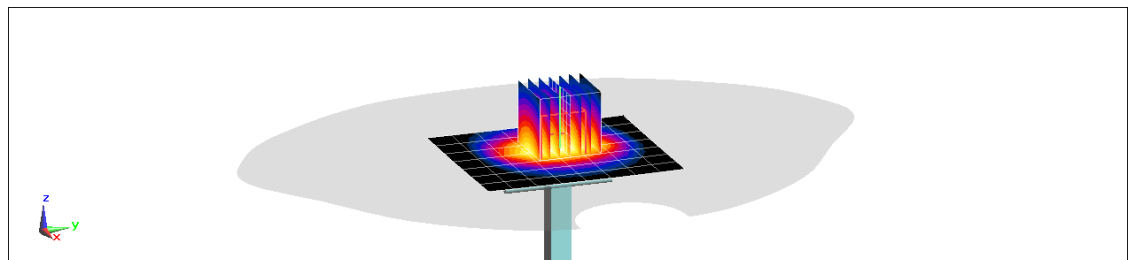
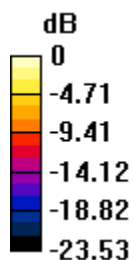
**Area Scan (8x9x1):** Measurement grid: dx=12mm, dy=12mm

**Zoom Scan (7x7x7)/Cube 0:** Measurement grid: dx=5mm, dy=5mm, dz=5mm

Peak SAR (extrapolated) = 11.4 W/kg

**SAR(1 g) = 5.1 W/kg**

Deviation(1 g) = -1.73%



0 dB = 8.84 W/kg = 9.46 dBW/kg

# PCTEST ENGINEERING LABORATORY, INC.

**DUT: Dipole 750 MHz; Type: D750V3; Serial: 1054**

Communication System: UID 0, CW; Frequency: 750 MHz; Duty Cycle: 1:1  
Medium: 835 Body; Medium parameters used (interpolated):  
 $f = 750 \text{ MHz}$ ;  $\sigma = 0.944 \text{ S/m}$ ;  $\epsilon_r = 54.477$ ;  $\rho = 1000 \text{ kg/m}^3$   
Phantom section: Flat Section; Space: 1.5 cm

Test Date: 12-17-2018; Ambient Temp: 20.1°C; Tissue Temp: 20.1°C

Probe: EX3DV4 - SN7406; ConvF(9.91, 9.91, 9.91) @ 750 MHz; Calibrated: 5/22/2018  
Sensor-Surface: 1.4mm (Mechanical Surface Detection)  
Electronics: DAE4 Sn859; Calibrated: 5/22/2018  
Phantom: Twin-SAM V4.0 Front Right; Type: QD 000 P40 CC; Serial: 1167  
Measurement SW: DASY52, Version 52.10 (2);SEMCAD X Version 14.6.12 (7450)

## 750 MHz System Verification at 23.0 dBm (200 mW)

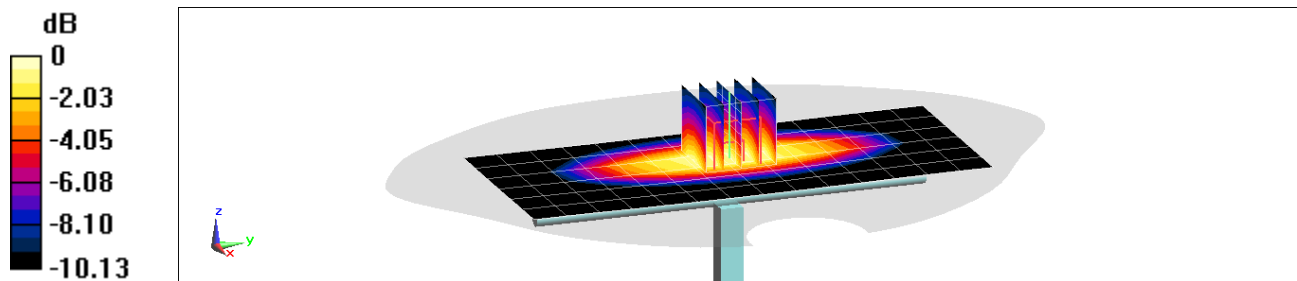
**Area Scan (7x15x1):** Measurement grid: dx=15mm, dy=15mm

**Zoom Scan (5x5x7)/Cube 0:** Measurement grid: dx=8mm, dy=8mm, dz=5mm

Peak SAR (extrapolated) = 2.68 W/kg

**SAR(1 g) = 1.78 W/kg**

Deviation(1 g) = 3.37%



0 dB = 2.37 W/kg = 3.75 dBW/kg

# PCTEST ENGINEERING LABORATORY, INC.

**DUT: Dipole 835 MHz; Type: D835V2; Serial: 4d047**

Communication System: UID 0, CW; Frequency: 835 MHz; Duty Cycle: 1:1

Medium: 835 Body; Medium parameters used:

$f = 835 \text{ MHz}$ ;  $\sigma = 1.003 \text{ S/m}$ ;  $\epsilon_r = 54.95$ ;  $\rho = 1000 \text{ kg/m}^3$

Phantom section: Flat Section; Space: 1.5 cm

Test Date: 12-13-2018; Ambient Temp: 20.4°C; Tissue Temp: 20.0°C

Probe: EX3DV4 - SN7406; ConvF(9.61, 9.61, 9.61) @ 835 MHz; Calibrated: 5/22/2018

Sensor-Surface: 1.4mm (Mechanical Surface Detection)

Electronics: DAE4 Sn859; Calibrated: 5/22/2018

Phantom: Twin-SAM V4.0 Front Right; Type: QD 000 P40 CC; Serial: 1167

Measurement SW: DASY52, Version 52.10 (2);SEMCAD X Version 14.6.12 (7450)

## 835 MHz System Verification at 23.0 dBm (200 mW)

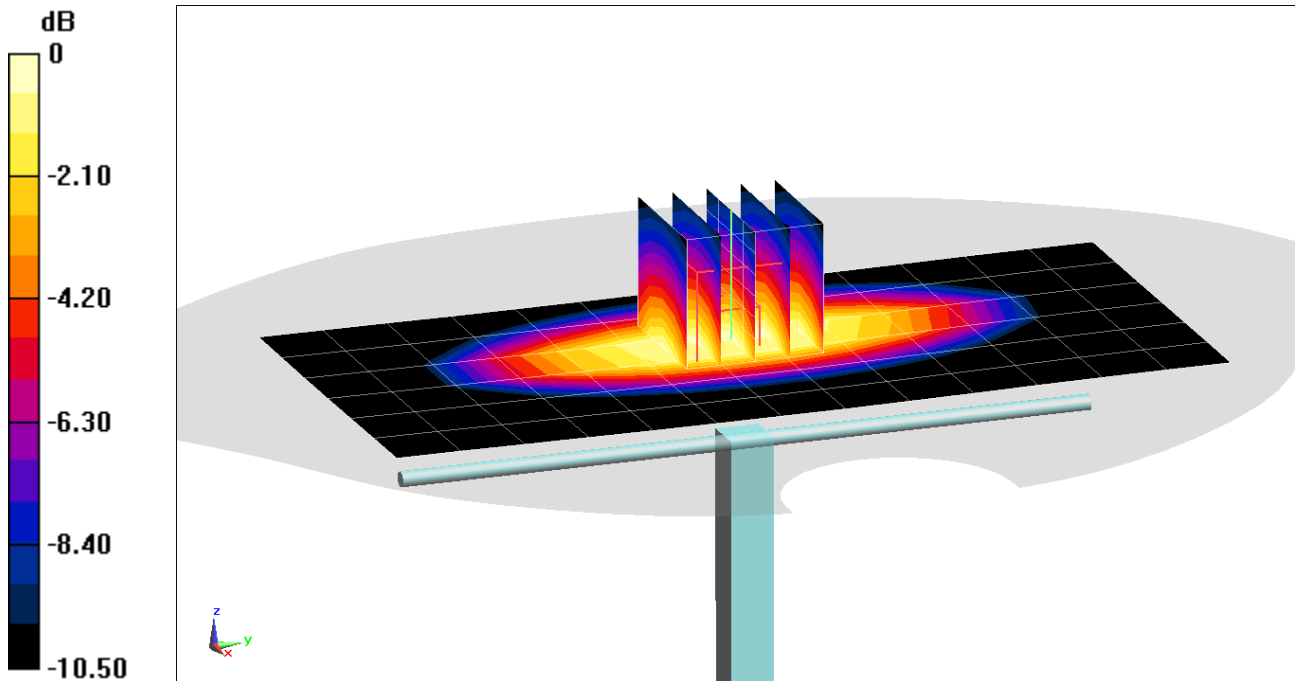
**Area Scan (7x14x1):** Measurement grid: dx=15mm, dy=15mm

**Zoom Scan (5x5x7)/Cube 0:** Measurement grid: dx=8mm, dy=8mm, dz=5mm

Peak SAR (extrapolated) = 3.10 W/kg

**SAR(1 g) = 2 W/kg**

Deviation(1 g) = 2.99%



0 dB = 2.70 W/kg = 4.31 dBW/kg

# PCTEST ENGINEERING LABORATORY, INC.

**DUT: Dipole 835 MHz; Type: D835V2; Serial: 4d133**

Communication System: UID 0, CW; Frequency: 835 MHz; Duty Cycle: 1:1

Medium: 835 Body Medium parameters used:

$f = 835 \text{ MHz}$ ;  $\sigma = 0.965 \text{ S/m}$ ;  $\epsilon_r = 53.598$ ;  $\rho = 1000 \text{ kg/m}^3$

Phantom section: Flat Section; Space: 1.5 cm

Test Date: 12-26-2018; Ambient Temp: 19.9°C; Tissue Temp: 19.1°C

Probe: ES3DV3 - SN3347; ConvF(6.37, 6.37, 6.37) @ 835 MHz; Calibrated: 3/27/2018

Sensor-Surface: 3mm (Mechanical Surface Detection)

Electronics: DAE4 Sn665; Calibrated: 2/15/2018

Phantom: Twin-SAM V5.0; Type: QD 000 P40 CD; Serial: 1800

Measurement SW: DASY52, Version 52.10 (2);SEMCAD X Version 14.6.12 (7450)

## 835 MHz System Verification at 23.0 dBm (200 mW)

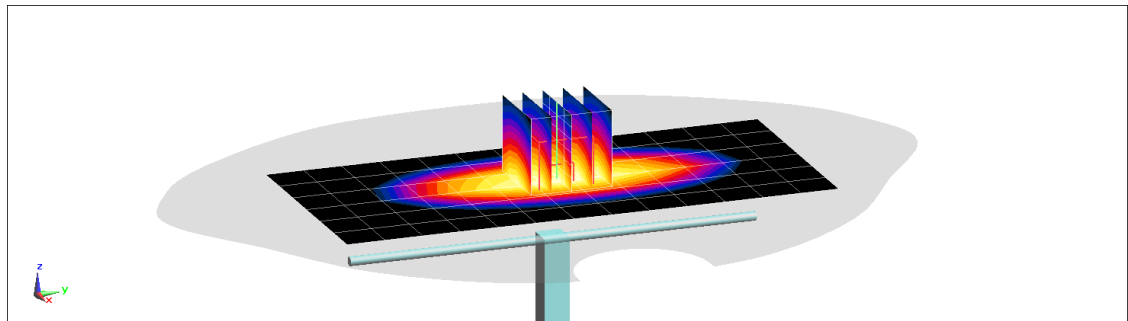
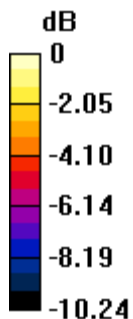
**Area Scan (7x14x1):** Measurement grid: dx=15mm, dy=15mm

**Zoom Scan (5x5x7)/Cube 0:** Measurement grid: dx=8mm, dy=8mm, dz=5mm

Peak SAR (extrapolated) = 2.85 W/kg

**SAR(1 g) = 1.96 W/kg**

Deviation(1 g) = 0.51%



0 dB = 2.28 W/kg = 3.58 dBW/kg



# PCTEST ENGINEERING LABORATORY, INC.

**DUT: Dipole 1750 MHz; Type: D1750V2; Serial: 1150**

Communication System: UID 0, CW; Frequency: 1750 MHz; Duty Cycle: 1:1

Medium: 1750 Body Medium parameters used:

$f = 1750 \text{ MHz}$ ;  $\sigma = 1.512 \text{ S/m}$ ;  $\epsilon_r = 52.517$ ;  $\rho = 1000 \text{ kg/m}^3$

Phantom section: Flat Section; Space: 1.0 cm

Test Date: 01-02-2019; Ambient Temp: 22.3°C; Tissue Temp: 21.5°C

Probe: EX3DV4 - SN7357; ConvF(8.43, 8.43, 8.43) @ 1750 MHz; Calibrated: 4/18/2018

Sensor-Surface: 1.4mm (Mechanical Surface Detection)

Electronics: DAE4 Sn1407; Calibrated: 4/11/2018

Phantom: SAM with CRP v5.0 Front; Type: QD000P40CD; Serial: 1646

Measurement SW: DASY52, Version 52.10 (1); SEMCAD X Version 14.6.12 (7450)

## 1750 MHz System Verification at 20.0 dBm (100 mW)

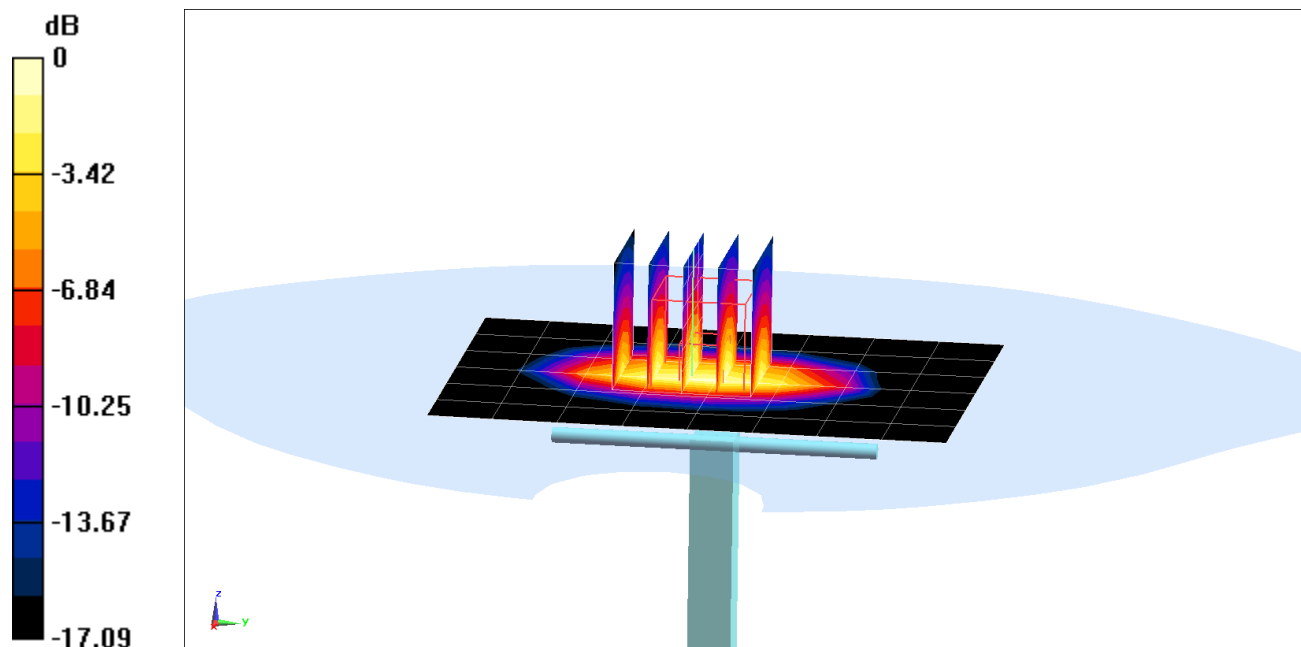
**Area Scan (7x9x1):** Measurement grid: dx=15mm, dy=15mm

**Zoom Scan (5x5x7)/Cube 0:** Measurement grid: dx=8mm, dy=8mm, dz=5mm

Peak SAR (extrapolated) = 6.70 W/kg

**SAR(1 g) = 3.71 W/kg**

Deviation(1 g) = 1.37%



0 dB = 5.64 W/kg = 7.51 dBW/kg

# PCTEST ENGINEERING LABORATORY, INC.

**DUT: Dipole 1900 MHz; Type: D1900V2; Serial: 5d080**

Communication System: UID 0, CW; Frequency: 1900 MHz; Duty Cycle: 1:1

Medium: 1900 Body Medium parameters used (interpolated):

$f = 1900 \text{ MHz}$ ;  $\sigma = 1.556 \text{ S/m}$ ;  $\epsilon_r = 51.119$ ;  $\rho = 1000 \text{ kg/m}^3$

Phantom section: Flat Section; Space: 1.0 cm

Test Date: 12-12-2018; Ambient Temp: 23.6°C; Tissue Temp: 22.0°C

Probe: ES3DV3 - SN3332; ConvF(4.77, 4.77, 4.77) @ 1900 MHz; Calibrated: 8/22/2018

Sensor-Surface: 3mm (Mechanical Surface Detection)

Electronics: DAE4 Sn1272; Calibrated: 2/9/2018

Phantom: SAM V5.0 Right; Type: QD000P40CD; Serial: 1647

Measurement SW: DASY52, Version 52.10 (1); SEMCAD X Version 14.6.12 (7450)

## 1900 MHz System Verification at 20.0 dBm (100 mW)

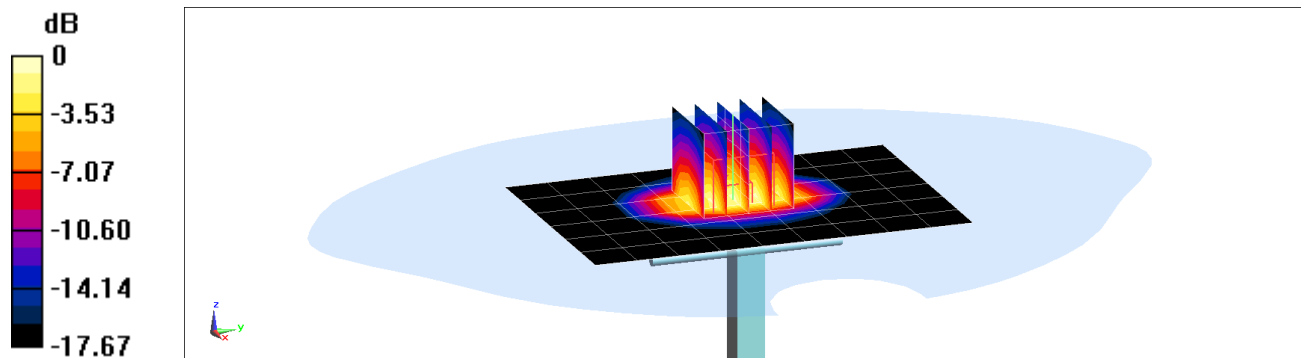
**Area Scan (7x10x1):** Measurement grid: dx=15mm, dy=15mm

**Zoom Scan (5x5x7)/Cube 0:** Measurement grid: dx=8mm, dy=8mm, dz=5mm

Peak SAR (extrapolated) = 7.50 W/kg

**SAR(1 g) = 4.2 W/kg**

Deviation(1 g) = 7.14%



0 dB = 5.36 W/kg = 7.29 dBW/kg

# PCTEST ENGINEERING LABORATORY, INC.

**DUT: Dipole 1900 MHz; Type: D1900V2; Serial: 5d148**

Communication System: UID 0, CW; Frequency: 1900 MHz; Duty Cycle: 1:1

Medium: 1900 Body Medium parameters used (interpolated):

$f = 1900$  MHz;  $\sigma = 1.578$  S/m;  $\epsilon_r = 53.009$ ;  $\rho = 1000$  kg/m<sup>3</sup>

Phantom section: Flat Section; Space: 1.0 cm

Test Date: 12-31-2018; Ambient Temp: 21.1°C; Tissue Temp: 22.0°C

Probe: ES3DV3 - SN3332; ConvF(4.77, 4.77, 4.77) @ 1900 MHz; Calibrated: 8/22/2018

Sensor-Surface: 3mm (Mechanical Surface Detection)

Electronics: DAE4 Sn1272; Calibrated: 2/9/2018

Phantom: SAM V5.0 Right; Type: QD000P40CD; Serial: 1647

Measurement SW: DASY52, Version 52.10 (1); SEMCAD X Version 14.6.12 (7450)

## 1900 MHz System Verification at 20.0 dBm (100 mW)

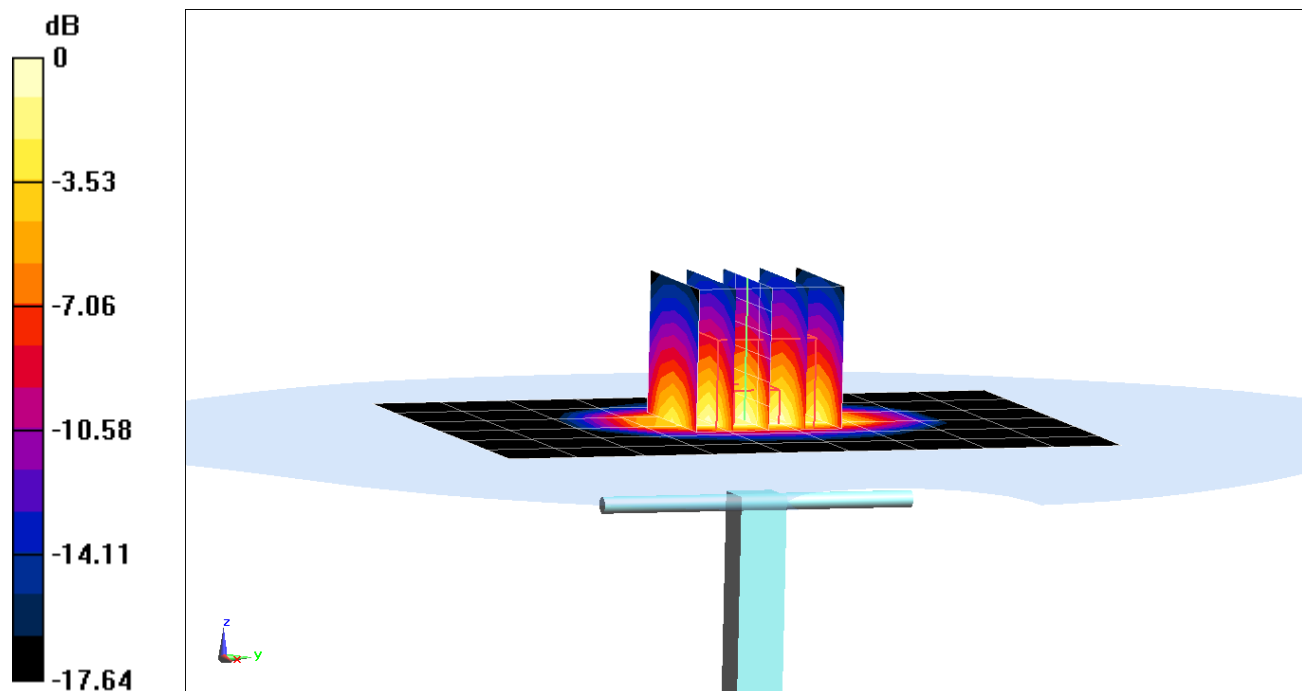
**Area Scan (7x10x1):** Measurement grid: dx=15mm, dy=15mm

**Zoom Scan (5x5x7)/Cube 0:** Measurement grid: dx=8mm, dy=8mm, dz=5mm

Peak SAR (extrapolated) = 7.33 W/kg

**SAR(1 g) = 4.13 W/kg**

Deviation(1 g) = 4.29%



0 dB = 5.25 W/kg = 7.20 dBW/kg

# PCTEST ENGINEERING LABORATORY, INC.

**DUT: Dipole 2450 MHz; Type: D2450V2; Serial: 797**

Communication System: UID 0, CW; Frequency: 2450 MHz; Duty Cycle: 1:1

Medium: 2450 Body Medium parameters used:

$f = 2450$  MHz;  $\sigma = 2.007$  S/m;  $\epsilon_r = 50.738$ ;  $\rho = 1000$  kg/m<sup>3</sup>

Phantom section: Flat Section; Space: 1.0 cm

Test Date: 12-30-2018; Ambient Temp: 21.9°C; Tissue Temp: 22.5°C

Probe: ES3DV3 - SN3319; ConvF(4.51, 4.51, 4.51) @ 2450 MHz; Calibrated: 3/13/2018

Sensor-Surface: 3mm (Mechanical Surface Detection)

Electronics: DAE4 Sn1368; Calibrated: 3/7/2018

Phantom: LeftTwin-SAM V5.0; Type: QD 000 P40 CD; Serial: TP1375

Measurement SW: DASY52, Version 52.10 (2);SEMCAD X Version 14.6.12 (7450)

## 2450 MHz System Verification at 20.0 dBm (100 mW)

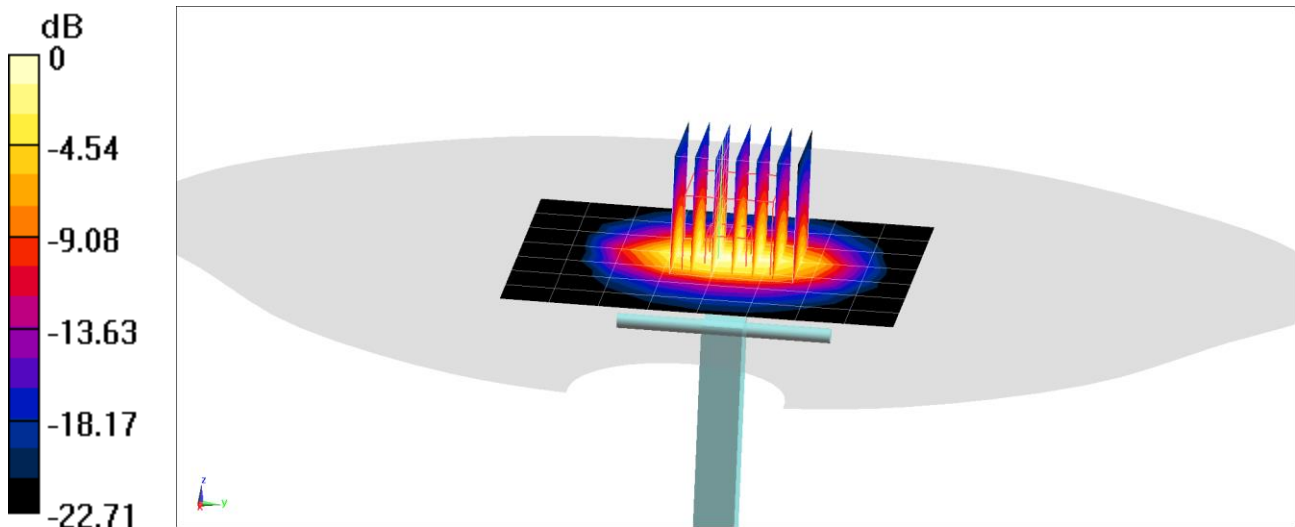
**Area Scan (8x9x1):** Measurement grid: dx=12mm, dy=12mm

**Zoom Scan (7x7x7)/Cube 0:** Measurement grid: dx=5mm, dy=5mm, dz=5mm

Peak SAR (extrapolated) = 10.9 W/kg

**SAR(1 g) = 5.15 W/kg**

Deviation(1 g) = 0.78%



0 dB = 6.75 W/kg = 8.29 dBW/kg

## APPENDIX C: PROBE CALIBRATION



Accredited by the Swiss Accreditation Service (SAS)  
The Swiss Accreditation Service is one of the signatories to the EA  
Multilateral Agreement for the recognition of calibration certificates

Accreditation No.: **SCS 0108**

Client **PC Test**

Certificate No: **D750V3-1054\_Mar17**

**CALIBRATION CERTIFICATE**

Object **D750V3 - SN:1054**

Calibration procedure(s) **QA CAL-05.v9**  
**Calibration procedure for dipole validation kits above 700 MHz**

Calibration date: **March 07, 2017**

*BNV*  
*03-27-2017*  
*BNV*  
*04-04-2018*

This calibration certificate documents the traceability to national standards, which realize the physical units of measurements (SI). The measurements and the uncertainties with confidence probability are given on the following pages and are part of the certificate.

All calibrations have been conducted in the closed laboratory facility: environment temperature (22 ± 3)°C and humidity < 70%.

Calibration Equipment used (M&TE critical for calibration)

Primary Standards	ID #	Cal Date (Certificate No.)	Scheduled Calibration
Power meter NRP	SN: 104778	06-Apr-16 (No. 217-02288/02289)	Apr-17
Power sensor NRP-Z91	SN: 103244	06-Apr-16 (No. 217-02288)	Apr-17
Power sensor NRP-Z91	SN: 103245	06-Apr-16 (No. 217-02289)	Apr-17
Reference 20 dB Attenuator	SN: 5058 (20K)	05-Apr-16 (No. 217-02292)	Apr-17
Type-N mismatch combination	SN: 5047.2 / 06327	05-Apr-16 (No. 217-02295)	Apr-17
Reference Probe EX3DV4	SN: 7349	31-Dec-16 (No. EX3-7349_Dec16)	Dec-17
DAE4	SN: 601	04-Jan-17 (No. DAE4-601_Jan17)	Jan-18
Secondary Standards	ID #	Check Date (In house)	Scheduled Check
Power meter EPM-442A	SN: GB37480704	07-Oct-15 (In house check Oct-16)	In house check: Oct-18
Power sensor HP 8481A	SN: US37292783	07-Oct-15 (In house check Oct-16)	In house check: Oct-18
Power sensor HP 8481A	SN: MY41092317	07-Oct-15 (In house check Oct-16)	In house check: Oct-18
RF generator R&S SMT-06	SN: 100972	15-Jun-15 (In house check Oct-16)	In house check: Oct-18
Network Analyzer HP 8753E	SN: US37390585	18-Oct-01 (In house check Oct-18)	In house check: Oct-17

Calibrated by: **Johannes Kurikka**      Name: Johannes Kurikka      Function: Laboratory Technician      Signature: *Johannes Kurikka*

Approved by: **Katja Pokovic**      Name: Katja Pokovic      Function: Technical Manager      Signature: *Katja Pokovic*

Issued: March 14, 2017

This calibration certificate shall not be reproduced except in full without written approval of the laboratory.



Accredited by the Swiss Accreditation Service (SAS)  
The Swiss Accreditation Service is one of the signatories to the EA  
Multilateral Agreement for the recognition of calibration certificates

Accreditation No.: **SCS 0108**

**Glossary:**

TSL tissue simulating liquid  
ConvF sensitivity in TSL / NORM x,y,z  
N/A not applicable or not measured

**Calibration is Performed According to the Following Standards:**

- a) IEEE Std 1528-2013, "IEEE Recommended Practice for Determining the Peak Spatial-Averaged Specific Absorption Rate (SAR) in the Human Head from Wireless Communications Devices: Measurement Techniques", June 2013
- b) IEC 62209-1, "Procedure to measure the Specific Absorption Rate (SAR) for hand-held devices used in close proximity to the ear (frequency range of 300 MHz to 3 GHz)", February 2005
- c) IEC 62209-2, "Procedure to determine the Specific Absorption Rate (SAR) for wireless communication devices used in close proximity to the human body (frequency range of 30 MHz to 6 GHz)", March 2010
- d) KDB 865664, "SAR Measurement Requirements for 100 MHz to 6 GHz"

**Additional Documentation:**

- e) DASY4/5 System Handbook

**Methods Applied and Interpretation of Parameters:**

- *Measurement Conditions:* Further details are available from the Validation Report at the end of the certificate. All figures stated in the certificate are valid at the frequency indicated.
- *Antenna Parameters with TSL:* The dipole is mounted with the spacer to position its feed point exactly below the center marking of the flat phantom section, with the arms oriented parallel to the body axis.
- *Feed Point Impedance and Return Loss:* These parameters are measured with the dipole positioned under the liquid filled phantom. The impedance stated is transformed from the measurement at the SMA connector to the feed point. The Return Loss ensures low reflected power. No uncertainty required.
- *Electrical Delay:* One-way delay between the SMA connector and the antenna feed point. No uncertainty required.
- *SAR measured:* SAR measured at the stated antenna input power.
- *SAR normalized:* SAR as measured, normalized to an input power of 1 W at the antenna connector.
- *SAR for nominal TSL parameters:* The measured TSL parameters are used to calculate the nominal SAR result.

The reported uncertainty of measurement is stated as the standard uncertainty of measurement multiplied by the coverage factor  $k=2$ , which for a normal distribution corresponds to a coverage probability of approximately 95%.

## Measurement Conditions

DASY system configuration, as far as not given on page 1.

DASY Version	DASY5	V52.8.8
Extrapolation	Advanced Extrapolation	
Phantom	Modular Flat Phantom	
Distance Dipole Center - TSL	15 mm	with Spacer
Zoom Scan Resolution	dx, dy, dz = 5 mm	
Frequency	750 MHz $\pm$ 1 MHz	

## Head TSL parameters

The following parameters and calculations were applied.

	Temperature	Permittivity	Conductivity
Nominal Head TSL parameters	22.0 °C	41.9	0.89 mho/m
Measured Head TSL parameters	(22.0 $\pm$ 0.2) °C	40.9 $\pm$ 6 %	0.91 mho/m $\pm$ 6 %
Head TSL temperature change during test	< 0.5 °C	----	----

## SAR result with Head TSL

SAR averaged over 1 cm <sup>3</sup> (1 g) of Head TSL	Condition	
SAR measured	250 mW input power	2.14 W/kg
SAR for nominal Head TSL parameters	normalized to 1W	<b>8.37 W/kg <math>\pm</math> 17.0 % (k=2)</b>

SAR averaged over 10 cm <sup>3</sup> (10 g) of Head TSL	condition	
SAR measured	250 mW input power	1.40 W/kg
SAR for nominal Head TSL parameters	normalized to 1W	<b>5.60 W/kg <math>\pm</math> 16.5 % (k=2)</b>

## Body TSL parameters

The following parameters and calculations were applied.

	Temperature	Permittivity	Conductivity
Nominal Body TSL parameters	22.0 °C	55.5	0.96 mho/m
Measured Body TSL parameters	(22.0 $\pm$ 0.2) °C	54.6 $\pm$ 6 %	0.99 mho/m $\pm$ 6 %
Body TSL temperature change during test	< 0.5 °C	----	----

## SAR result with Body TSL

SAR averaged over 1 cm <sup>3</sup> (1 g) of Body TSL	Condition	
SAR measured	250 mW input power	2.21 W/kg
SAR for nominal Body TSL parameters	normalized to 1W	<b>8.61 W/kg <math>\pm</math> 17.0 % (k=2)</b>

SAR averaged over 10 cm <sup>3</sup> (10 g) of Body TSL	condition	
SAR measured	250 mW input power	1.45 W/kg
SAR for nominal Body TSL parameters	normalized to 1W	<b>5.68 W/kg <math>\pm</math> 16.5 % (k=2)</b>



## Appendix (Additional assessments outside the scope of SCS 0108)

### Antenna Parameters with Head TSL

Impedance, transformed to feed point	54.7 $\Omega$ - 0.7 j $\Omega$
Return Loss	- 26.8 dB

### Antenna Parameters with Body TSL

Impedance, transformed to feed point	50.7 $\Omega$ - 3.6 j $\Omega$
Return Loss	- 28.7 dB

### General Antenna Parameters and Design

Electrical Delay (one direction)	1.033 ns
----------------------------------	----------

After long term use with 100W radiated power, only a slight warming of the dipole near the feedpoint can be measured.

The dipole is made of standard semirigid coaxial cable. The center conductor of the feeding line is directly connected to the second arm of the dipole. The antenna is therefore short-circuited for DC-signals. On some of the dipoles, small end caps are added to the dipole arms in order to improve matching when loaded according to the position as explained in the "Measurement Conditions" paragraph. The SAR data are not affected by this change. The overall dipole length is still according to the Standard.

No excessive force must be applied to the dipole arms, because they might bend or the soldered connections near the feedpoint may be damaged.

### Additional EUT Data

Manufactured by	SPEAG
Manufactured on	November 08, 2011

# DASY5 Validation Report for Head TSL

Date: 07.03.2017

Test Laboratory: SPEAG, Zurich, Switzerland

**DUT: Dipole 750 MHz; Type: D750V3; Serial: D750V3 - SN:1054**

Communication System: UID 0 - CW ; Frequency: 750 MHz

Medium parameters used:  $f = 750 \text{ MHz}$ ;  $\sigma = 0.91 \text{ S/m}$ ;  $\epsilon_r = 40.9$ ;  $\rho = 1000 \text{ kg/m}^3$

Phantom section: Flat Section

Measurement Standard: DASY5 (IEEE/IEC/ANSI C63.19-2011)

DASY52 Configuration:

- Probe: EX3DV4 - SN7349; ConvF(10.17, 10.17, 10.17); Calibrated: 31.12.2016;
- Sensor-Surface: 1.4mm (Mechanical Surface Detection)
- Electronics: DAE4 Sn601; Calibrated: 04.01.2017
- Phantom: Flat Phantom 4.9 (front); Type: QD 00L P49 AA; Serial: 1001
- DASY52 52.8.8(1222); SEMCAD X 14.6.10(7331)

## Dipole Calibration for Head Tissue/Pin=250 mW, d=15mm/Zoom Scan (7x7x7)/Cube 0:

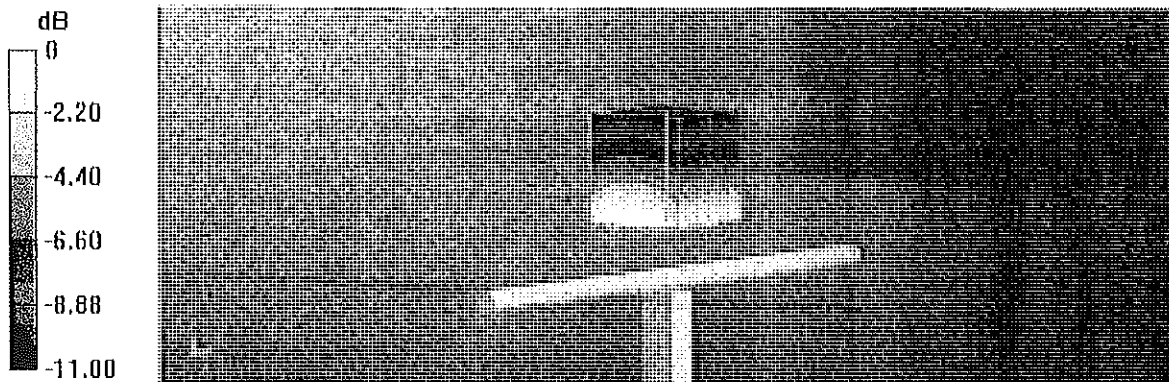
Measurement grid:  $dx=5\text{mm}$ ,  $dy=5\text{mm}$ ,  $dz=5\text{mm}$

Reference Value = 59.71 V/m; Power Drift = 0.01 dB

Peak SAR (extrapolated) = 3.21 W/kg

**SAR(1 g) = 2.14 W/kg; SAR(10 g) = 1.4 W/kg**

Maximum value of SAR (measured) = 2.85 W/kg

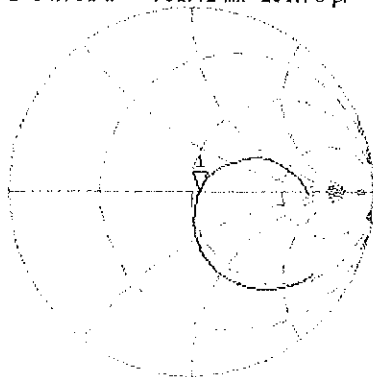


0 dB = 2.85 W/kg = 4.55 dBW/kg

# Impedance Measurement Plot for Head TSL

7 Mar 2017 12:25:14  
 CH1 S11 1 U FS 1: 54.732  $\Omega$  -732.42 m $\Omega$  289.73 pF 750.000 000 MHz

\*  
 Del  
 CA



Avg  
 16

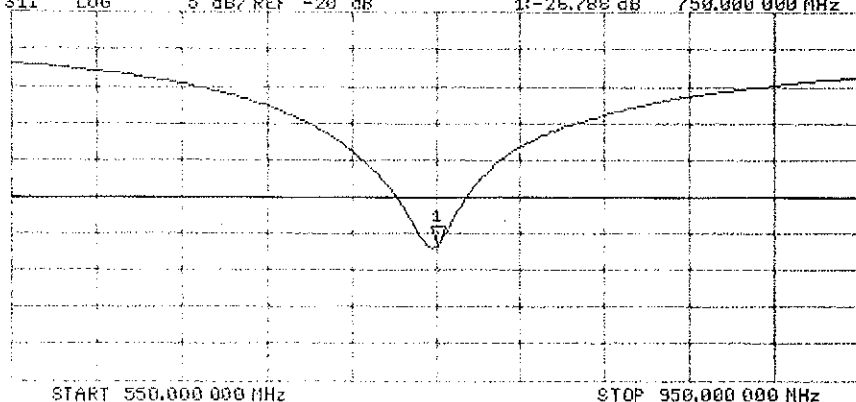
H1d

CH2 S11 LOG 5 dB/REF -20 dB 1: -26.788 dB 750.000 000 MHz

CA

Avg  
 16

H1d



## DASY5 Validation Report for Body TSL

Date: 07.03.2017

Test Laboratory: SPEAG, Zurich, Switzerland

**DUT:** Dipole 750 MHz; Type: D750V3; Serial: D750V3 - SN:1054

Communication System: UID 0 - CW ; Frequency: 750 MHz

Medium parameters used:  $f = 750$  MHz;  $\sigma = 0.99$  S/m;  $\epsilon_r = 54.6$ ;  $\rho = 1000$  kg/m<sup>3</sup>

Phantom section: Flat Section

Measurement Standard: DASY5 (IEEE/IEC/ANSI C63.19-2011)

DASY52 Configuration:

- Probe: EX3DV4 - SN7349; ConvF(9.99, 9.99, 9.99); Calibrated: 31.12.2016;
- Sensor-Surface: 1.4mm (Mechanical Surface Detection)
- Electronics: DAE4 Sn601; Calibrated: 04.01.2017
- Phantom: Flat Phantom 4.9 (Back); Type: QD 00R P49 AA; Serial: 1005
- DASY52 52.8.8(1222); SEMCAD X 14.6.10(7331)

### Dipole Calibration for Body Tissue/Pin=250 mW, d=15mm/Zoom Scan (7x7x7)/Cube 0:

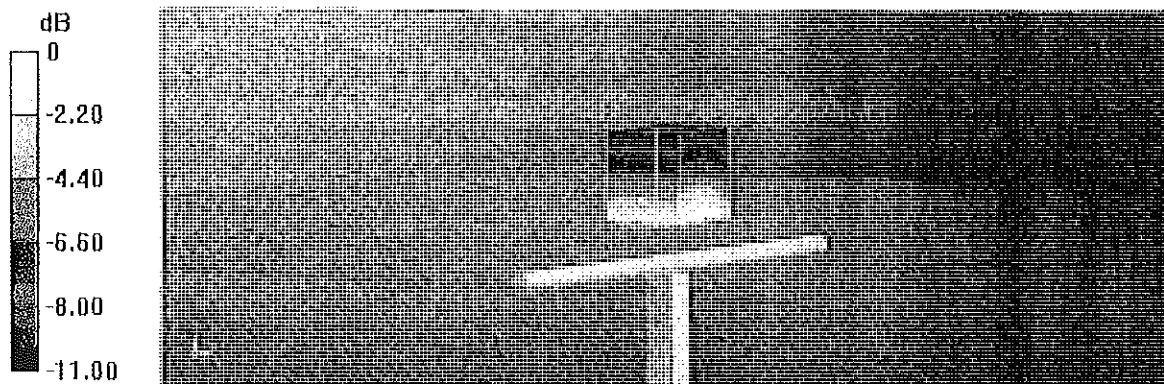
Measurement grid: dx=5mm, dy=5mm, dz=5mm

Reference Value = 57.88 V/m; Power Drift = -0.01 dB

Peak SAR (extrapolated) = 3.31 W/kg

**SAR(1 g) = 2.21 W/kg; SAR(10 g) = 1.45 W/kg**

Maximum value of SAR (measured) = 2.94 W/kg



0 dB = 2.94 W/kg = 4.68 dBW/kg

# Impedance Measurement Plot for Body TSL

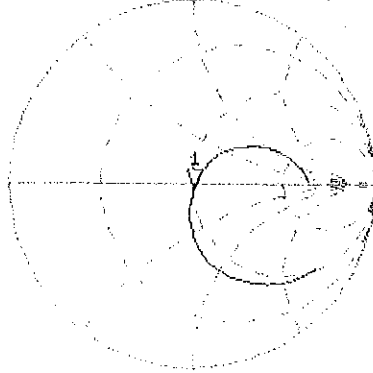
7 Mar 2017 11:51:37  
S11 1 U FS 1150.666  $\Omega$  -3.6309  $\Omega$  58.445 pF 750.000 000 MHz

\*  
De1

Ca

Avg  
16

H1d

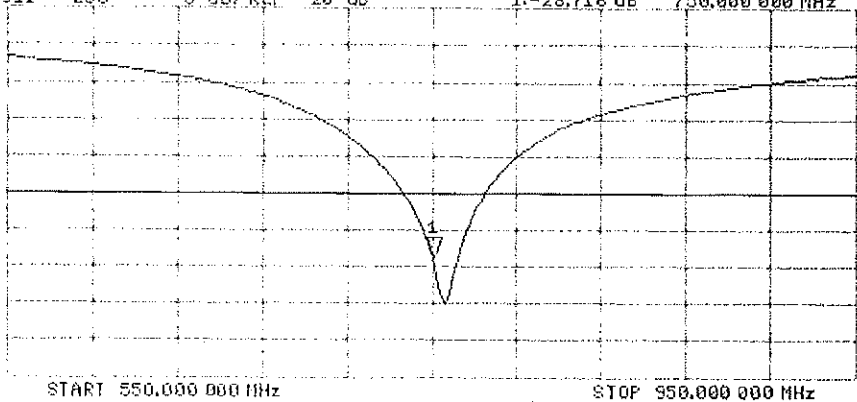


CH2 S11 LOG 5 dB/REF -20 dB 1:-28.716 dB 750.000 000 MHz

Ca

Avg  
16

H1d



## Certification of Calibration

Object: D750V3 – SN:1054

Calibration procedure(s): Procedure for Calibration Extension for SAR Dipoles.

Extended Calibration date: March 07, 2018

Description: SAR Validation Dipole at 750 MHz.

**Calibration Equipment used:**

Manufacturer	Model	Description	Cal Date	Cal Interval	Cal Due	Serial Number
Agilent	8753ES	S-Parameter Network Analyzer	8/3/2017	Annual	8/3/2018	MY40000670
Agilent	N5182A	MXG Vector Signal Generator	1/24/2018	Annual	1/24/2019	MY47420651
Amplifier Research	1551G6	Amplifier	CBT	N/A	CBT	433971
Anritsu	MA2411B	Pulse Power Sensor	3/2/2018	Annual	3/2/2019	1207364
Anritsu	MA2411B	Pulse Power Sensor	10/16/2017	Annual	10/16/2018	1126066
Anritsu	ML2495A	Power Meter	10/22/2017	Annual	10/22/2018	1328004
Keysight Technologies	85033E	Standard Mechanical Calibration Kit (DC to 9GHz, 3.5mm)	6/1/2017	Annual	6/1/2018	MY53401181
Mini-Circuits	BW-N20W5+	DC to 18 GHz Precision Fixed 20 dB Attenuator	CBT	N/A	CBT	N/A
Mini-Circuits	NLP-2950+	Low Pass Filter DC to 2700 MHz	CBT	N/A	CBT	N/A
Narda	4772-3	Attenuator (3dB)	CBT	N/A	CBT	9406
Pasternack	PE2208-6	Bidirectional Coupler	CBT	N/A	CBT	N/A
Seekonk	NC-100	Torque Wrench 5/16", 8" lbs	1/22/2018	Annual	1/22/2019	N/A
SPEAG	DAE4	Dasy Data Acquisition Electronics	7/13/2017	Annual	7/13/2018	1322
SPEAG	DAE4	Dasy Data Acquisition Electronics	6/21/2017	Annual	6/21/2018	1333
SPEAG	EX3DV4	SAR Probe	7/17/2017	Annual	7/17/2018	7410
SPEAG	ES3DV3	SAR Probe	9/18/2017	Annual	9/18/2018	3287

Measurement Uncertainty =  $\pm 23\%$  (k=2)

	Name	Function	Signature
Calibrated By:	Brodie Halfoster	Test Engineer	<i>BRODIE HALFOSTER</i>
Approved By:	Kaitlin O'Keefe	Senior Technical Manager	<i>KOK</i>

## DIPOLE CALIBRATION EXTENSION

Per KDB 865664 D01, calibration intervals of up to three years may be considered for reference dipoles when it is demonstrated that the SAR target, impedance and return loss of a dipole have remained stable according to the following requirements:

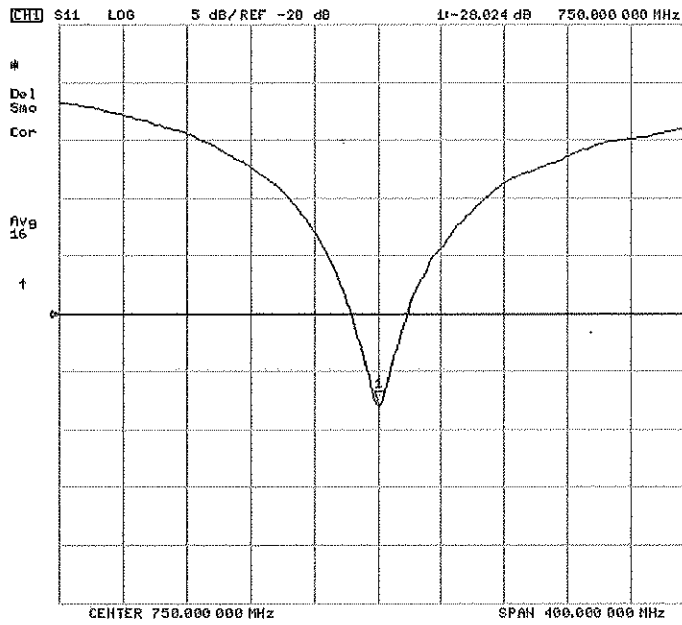
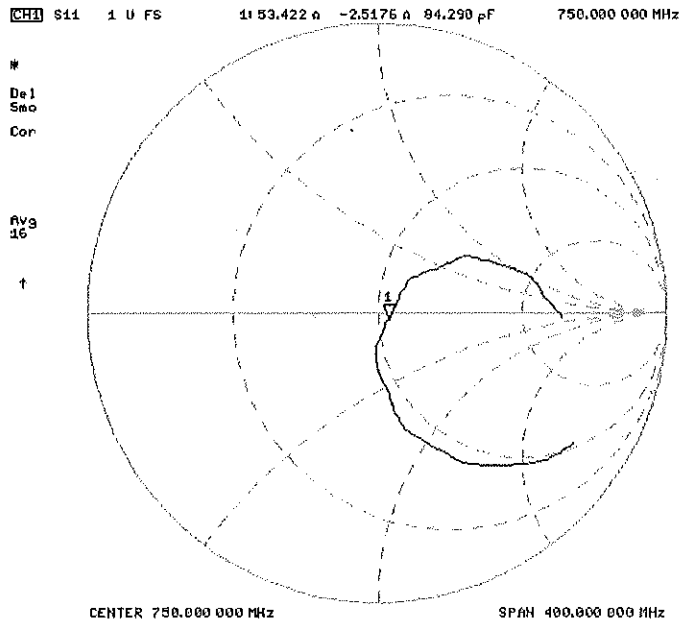
1. The measured SAR does not deviate more than 10% from the target on the calibration certificate.
2. The return-loss does not deviate more than 20% from the previous measurement and meets the required 20dB minimum return-loss requirement.
3. The measurement of real or imaginary parts of impedance does not deviate more than 5Ω from the previous measurement.

The following dipole was checked to pass the above 3 requirements to have 2-year calibration period from the calibration date:

Calibration Date	Expiration Date	Certificate Elect Cal Delay (ns)	Certificate SAR Target Head (150 W/m <sup>2</sup> @ 210 dBm)	Measured Head SAR (150 W/m <sup>2</sup> @ 210 dBm)	Deviation (%)	Certificate SAR Target Body (150 W/m <sup>2</sup> @ 210 dBm)	Measured Body SAR (150 W/m <sup>2</sup> @ 210 dBm)	Deviation (%)	Certificate Impedance Head (Ohm) Real	Measured Impedance Head (Ohm) Real	Difference (Ohm) Real	Certificate Impedance Head (Ohm) Imaginary	Measured Impedance Head (Ohm) Imaginary	Difference (Ohm) Imaginary	Certificate Return Loss Head (dB)	Measured Return Loss Head (dB)	Deviation (%)	PASS/FAIL
3/7/2017	3/7/2018	1.033	1.67	1.70	1.80%	1.10	1.11	0.01%	54.7	53.4	-1.3	-0.7	-2.0	1.8	-20.6	-20.0	-4.00%	PASS

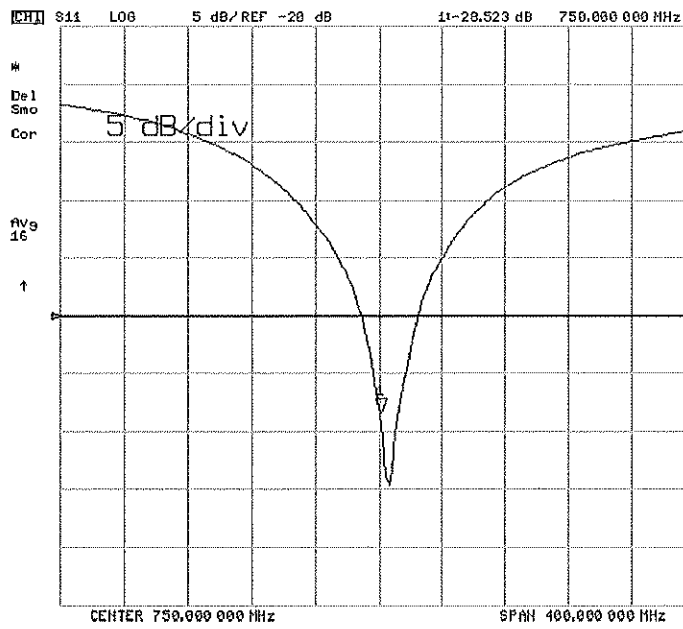
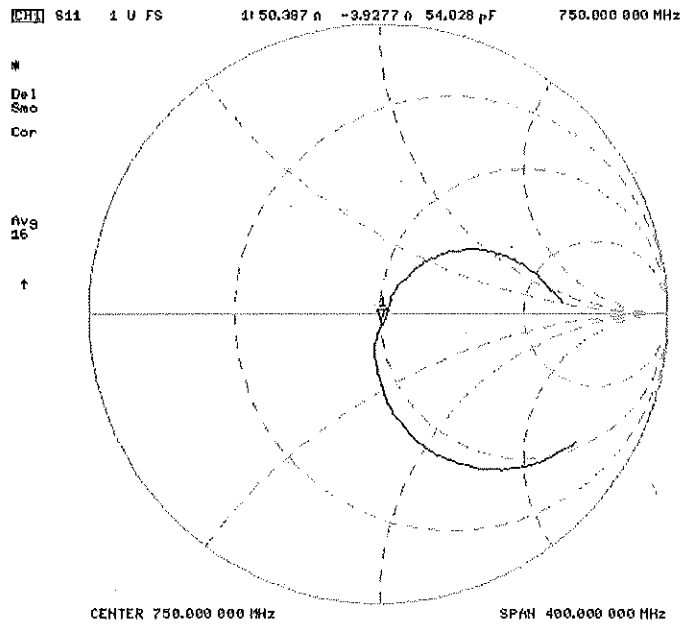
Calibration Date	Expiration Date	Certificate Elect Cal Delay (ns)	Certificate SAR Target Body (150 W/m <sup>2</sup> @ 210 dBm)	Measured Body SAR (150 W/m <sup>2</sup> @ 210 dBm)	Deviation (%)	Certificate Impedance Body (Ohm) Real	Measured Impedance Body (Ohm) Real	Difference (Ohm) Real	Certificate Impedance Body (Ohm) Imaginary	Measured Impedance Body (Ohm) Imaginary	Difference (Ohm) Imaginary	Certificate Return Loss Body (dB)	Measured Return Loss Body (dB)	Deviation (%)	PASS/FAIL			
3/7/2017	3/7/2018	1.033	1.72	1.70	-1.20%	4.14	4.12	-1.41%	50.7	50.4	-0.3	-3.6	-3.0	0.3	-28.7	-28.5	0.69%	PASS

# Impedance & Return-Loss Measurement Plot for Head TSL





# Impedance & Return-Loss Measurement Plot for Body TSL





Accredited by the Swiss Accreditation Service (SAS)  
The Swiss Accreditation Service is one of the signatories to the EA  
Multilateral Agreement for the recognition of calibration certificates

Accreditation No.: **SCS 0108**

Client **PC Test**

Certificate No: **D835V2-4d047\_Oct18**

## CALIBRATION CERTIFICATE

Object **D835V2 - SN:4d047**

Calibration procedure(s) **QA CAL-05.v10  
Calibration procedure for dipole validation kits above 700 MHz**

Calibration date: **October 19, 2018**

BN ✓  
10-30-2018

This calibration certificate documents the traceability to national standards, which realize the physical units of measurements (SI).  
The measurements and the uncertainties with confidence probability are given on the following pages and are part of the certificate.

All calibrations have been conducted in the closed laboratory facility: environment temperature (22 ± 3)°C and humidity < 70%.

Calibration Equipment used (M&TE critical for calibration)

Primary Standards	ID #	Cal Date (Certificate No.)	Scheduled Calibration
Power meter NRP	SN: 104778	04-Apr-18 (No. 217-02672/02673)	Apr-19
Power sensor NRP-Z91	SN: 103244	04-Apr-18 (No. 217-02672)	Apr-19
Power sensor NRP-Z91	SN: 103245	04-Apr-18 (No. 217-02673)	Apr-19
Reference 20 dB Attenuator	SN: 5058 (20k)	04-Apr-18 (No. 217-02682)	Apr-19
Type-N mismatch combination	SN: 5047.2 / 06327	04-Apr-18 (No. 217-02683)	Apr-19
Reference Probe EX3DV4	SN: 7349	30-Dec-17 (No. EX3-7349_Dec17)	Dec-18
DAE4	SN: 601	04-Oct-18 (No. DAE4-601_Oct18)	Oct-19

Secondary Standards	ID #	Check Date (in house)	Scheduled Check
Power meter EPM-442A	SN: GB37480704	07-Oct-15 (in house check Oct-18)	In house check: Oct-20
Power sensor HP 8481A	SN: US37292783	07-Oct-15 (in house check Oct-18)	In house check: Oct-20
Power sensor HP 8481A	SN: MY41092317	07-Oct-15 (in house check Oct-18)	In house check: Oct-20
RF generator R&S SMT-06	SN: 100972	15-Jun-15 (in house check Oct-18)	In house check: Oct-20
Network Analyzer Agilent E8358A	SN: US41080477	31-Mar-14 (in house check Oct-18)	In house check: Oct-19

Calibrated by: **Manu Seitz**      **Manu Seitz**      **Manu Seitz**  
Name      Function      Signature  
Laboratory Technician

Approved by: **Katja Pokovic**      **Katja Pokovic**  
Technical Manager

Issued: October 22, 2018

This calibration certificate shall not be reproduced except in full without written approval of the laboratory.



Accredited by the Swiss Accreditation Service (SAS)  
The Swiss Accreditation Service is one of the signatories to the EA  
Multilateral Agreement for the recognition of calibration certificates

Accreditation No.: **SCS 0108**

**Glossary:**

TSL	tissue simulating liquid
ConvF	sensitivity in TSL / NORM x,y,z
N/A	not applicable or not measured

**Calibration is Performed According to the Following Standards:**

- a) IEEE Std 1528-2013, "IEEE Recommended Practice for Determining the Peak Spatial-Averaged Specific Absorption Rate (SAR) in the Human Head from Wireless Communications Devices: Measurement Techniques", June 2013
- b) IEC 62209-1, "Measurement procedure for the assessment of Specific Absorption Rate (SAR) from hand-held and body-mounted devices used next to the ear (frequency range of 300 MHz to 6 GHz)", July 2016
- c) IEC 62209-2, "Procedure to determine the Specific Absorption Rate (SAR) for wireless communication devices used in close proximity to the human body (frequency range of 30 MHz to 6 GHz)", March 2010
- d) KDB 865664, "SAR Measurement Requirements for 100 MHz to 6 GHz"

**Additional Documentation:**

- e) DASY4/5 System Handbook

**Methods Applied and Interpretation of Parameters:**

- *Measurement Conditions:* Further details are available from the Validation Report at the end of the certificate. All figures stated in the certificate are valid at the frequency indicated.
- *Antenna Parameters with TSL:* The dipole is mounted with the spacer to position its feed point exactly below the center marking of the flat phantom section, with the arms oriented parallel to the body axis.
- *Feed Point Impedance and Return Loss:* These parameters are measured with the dipole positioned under the liquid filled phantom. The impedance stated is transformed from the measurement at the SMA connector to the feed point. The Return Loss ensures low reflected power. No uncertainty required.
- *Electrical Delay:* One-way delay between the SMA connector and the antenna feed point. No uncertainty required.
- *SAR measured:* SAR measured at the stated antenna input power.
- *SAR normalized:* SAR as measured, normalized to an input power of 1 W at the antenna connector.
- *SAR for nominal TSL parameters:* The measured TSL parameters are used to calculate the nominal SAR result.

The reported uncertainty of measurement is stated as the standard uncertainty of measurement multiplied by the coverage factor  $k=2$ , which for a normal distribution corresponds to a coverage probability of approximately 95%.

## Measurement Conditions

DASY system configuration, as far as not given on page 1.

<b>DASY Version</b>	DASY5	V52.10.2
<b>Extrapolation</b>	Advanced Extrapolation	
<b>Phantom</b>	Modular Flat Phantom	
<b>Distance Dipole Center - TSL</b>	15 mm	with Spacer
<b>Zoom Scan Resolution</b>	dx, dy, dz = 5 mm	
<b>Frequency</b>	835 MHz $\pm$ 1 MHz	

## Head TSL parameters

The following parameters and calculations were applied.

	Temperature	Permittivity	Conductivity
<b>Nominal Head TSL parameters</b>	22.0 °C	41.5	0.90 mho/m
<b>Measured Head TSL parameters</b>	(22.0 $\pm$ 0.2) °C	40.6 $\pm$ 6 %	0.91 mho/m $\pm$ 6 %
<b>Head TSL temperature change during test</b>	< 0.5 °C	----	----

## SAR result with Head TSL

<b>SAR averaged over 1 cm<sup>3</sup> (1 g) of Head TSL</b>	Condition	
SAR measured	250 mW input power	2.40 W/kg
SAR for nominal Head TSL parameters	normalized to 1W	<b>9.47 W/kg <math>\pm</math> 17.0 % (k=2)</b>

<b>SAR averaged over 10 cm<sup>3</sup> (10 g) of Head TSL</b>	condition	
SAR measured	250 mW input power	1.55 W/kg
SAR for nominal Head TSL parameters	normalized to 1W	<b>6.14 W/kg <math>\pm</math> 16.5 % (k=2)</b>

## Body TSL parameters

The following parameters and calculations were applied.

	Temperature	Permittivity	Conductivity
<b>Nominal Body TSL parameters</b>	22.0 °C	55.2	0.97 mho/m
<b>Measured Body TSL parameters</b>	(22.0 $\pm$ 0.2) °C	54.9 $\pm$ 6 %	0.98 mho/m $\pm$ 6 %
<b>Body TSL temperature change during test</b>	< 0.5 °C	----	----

## SAR result with Body TSL

<b>SAR averaged over 1 cm<sup>3</sup> (1 g) of Body TSL</b>	Condition	
SAR measured	250 mW input power	2.45 W/kg
SAR for nominal Body TSL parameters	normalized to 1W	<b>9.71 W/kg <math>\pm</math> 17.0 % (k=2)</b>

<b>SAR averaged over 10 cm<sup>3</sup> (10 g) of Body TSL</b>	condition	
SAR measured	250 mW input power	1.60 W/kg
SAR for nominal Body TSL parameters	normalized to 1W	<b>6.36 W/kg <math>\pm</math> 16.5 % (k=2)</b>

## Appendix (Additional assessments outside the scope of SCS 0108)

### Antenna Parameters with Head TSL

Impedance, transformed to feed point	51.0 $\Omega$ - 0.5 j $\Omega$
Return Loss	- 39.6 dB

### Antenna Parameters with Body TSL

Impedance, transformed to feed point	45.6 $\Omega$ - 4.1 j $\Omega$
Return Loss	- 24.0 dB

### General Antenna Parameters and Design

Electrical Delay (one direction)	1.387 ns
----------------------------------	----------

After long term use with 100W radiated power, only a slight warming of the dipole near the feedpoint can be measured.

The dipole is made of standard semirigid coaxial cable. The center conductor of the feeding line is directly connected to the second arm of the dipole. The antenna is therefore short-circuited for DC-signals. On some of the dipoles, small end caps are added to the dipole arms in order to improve matching when loaded according to the position as explained in the "Measurement Conditions" paragraph. The SAR data are not affected by this change. The overall dipole length is still according to the Standard.

No excessive force must be applied to the dipole arms, because they might bend or the soldered connections near the feedpoint may be damaged.

### Additional EUT Data

Manufactured by	SPEAG
Manufactured on	August 16, 2006

## DASY5 Validation Report for Head TSL

Date: 19.10.2018

Test Laboratory: SPEAG, Zurich, Switzerland

**DUT: Dipole 835 MHz; Type: D835V2; Serial: D835V2 - SN:4d047**

Communication System: UID 0 - CW; Frequency: 835 MHz

Medium parameters used:  $f = 835$  MHz;  $\sigma = 0.91$  S/m;  $\epsilon_r = 40.6$ ;  $\rho = 1000$  kg/m<sup>3</sup>

Phantom section: Flat Section

Measurement Standard: DASY5 (IEEE/IEC/ANSI C63.19-2011)

DASY52 Configuration:

- Probe: EX3DV4 - SN7349; ConvF(9.9, 9.9, 9.9) @ 835 MHz; Calibrated: 30.12.2017
- Sensor-Surface: 1.4mm (Mechanical Surface Detection)
- Electronics: DAE4 Sn601; Calibrated: 04.10.2018
- Phantom: Flat Phantom 4.9 (front); Type: QD 00L P49 AA; Serial: 1001
- DASY52 52.10.2(1495); SEMCAD X 14.6.12(7450)

### **Dipole Calibration for Head Tissue/Pin=250 mW, d=15mm/Zoom Scan (7x7x7)/Cube 0:**

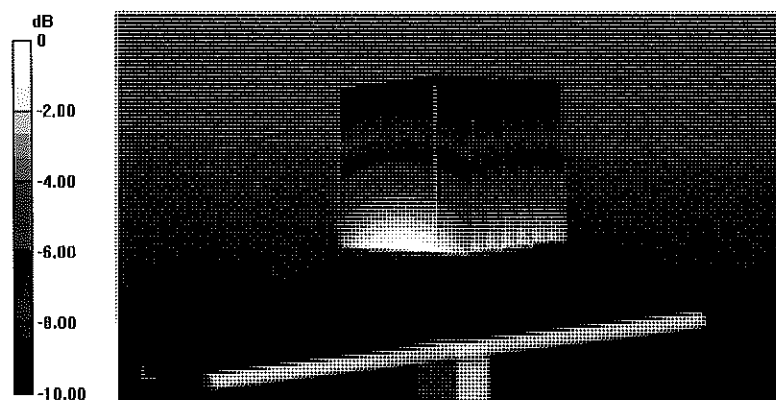
Measurement grid: dx=5mm, dy=5mm, dz=5mm

Reference Value = 62.84 V/m; Power Drift = -0.03 dB

Peak SAR (extrapolated) = 3.69 W/kg

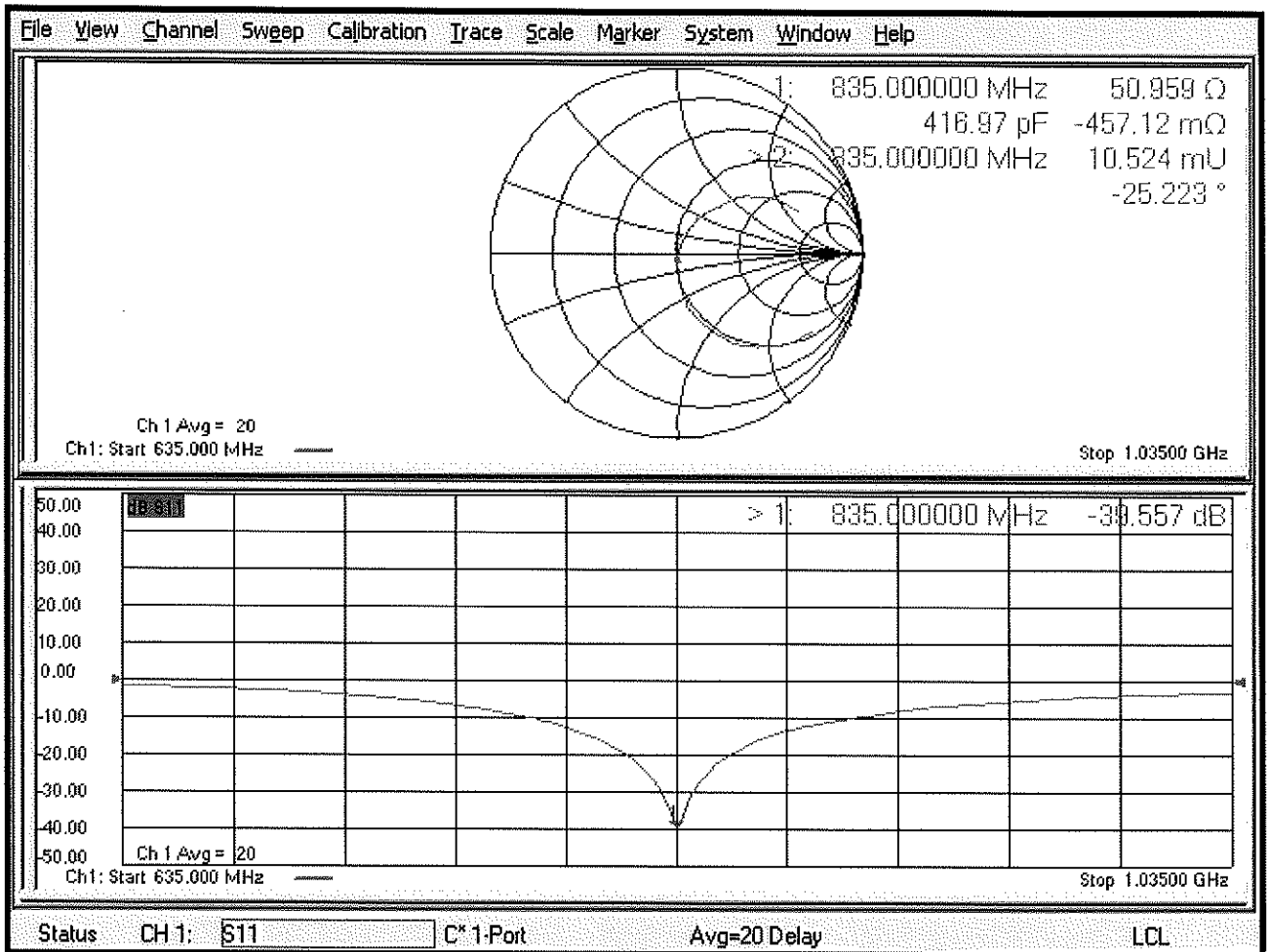
**SAR(1 g) = 2.4 W/kg; SAR(10 g) = 1.55 W/kg**

Maximum value of SAR (measured) = 3.24 W/kg



0 dB = 3.24 W/kg = 5.11 dBW/kg

# Impedance Measurement Plot for Head TSL



## DASY5 Validation Report for Body TSL

Date: 19.10.2018

Test Laboratory: SPEAG, Zurich, Switzerland

**DUT: Dipole 835 MHz; Type: D835V2; Serial: D835V2 - SN:4d047**

Communication System: UID 0 - CW; Frequency: 835 MHz

Medium parameters used:  $f = 835$  MHz;  $\sigma = 0.98$  S/m;  $\epsilon_r = 54.9$ ;  $\rho = 1000$  kg/m<sup>3</sup>

Phantom section: Flat Section

Measurement Standard: DASY5 (IEEE/IEC/ANSI C63.19-2011)

DASY52 Configuration:

- Probe: EX3DV4 - SN7349; ConvF(10.05, 10.05, 10.05) @ 835 MHz; Calibrated: 30.12.2017
- Sensor-Surface: 1.4mm (Mechanical Surface Detection)
- Electronics: DAE4 Sn601; Calibrated: 04.10.2018
- Phantom: Flat Phantom 4.9 (Back); Type: QD 00R P49 AA; Serial: 1005
- DASY52 52.10.2(1495); SEMCAD X 14.6.12(7450)

### Dipole Calibration for Body Tissue/Pin=250 mW, d=15mm/Zoom Scan (7x7x7)/Cube 0:

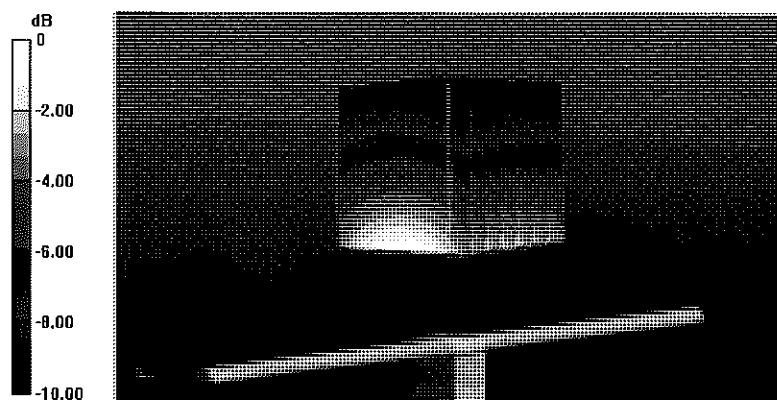
Measurement grid: dx=5mm, dy=5mm, dz=5mm

Reference Value = 61.27 V/m; Power Drift = -0.03 dB

Peak SAR (extrapolated) = 3.68 W/kg

**SAR(1 g) = 2.45 W/kg; SAR(10 g) = 1.6 W/kg**

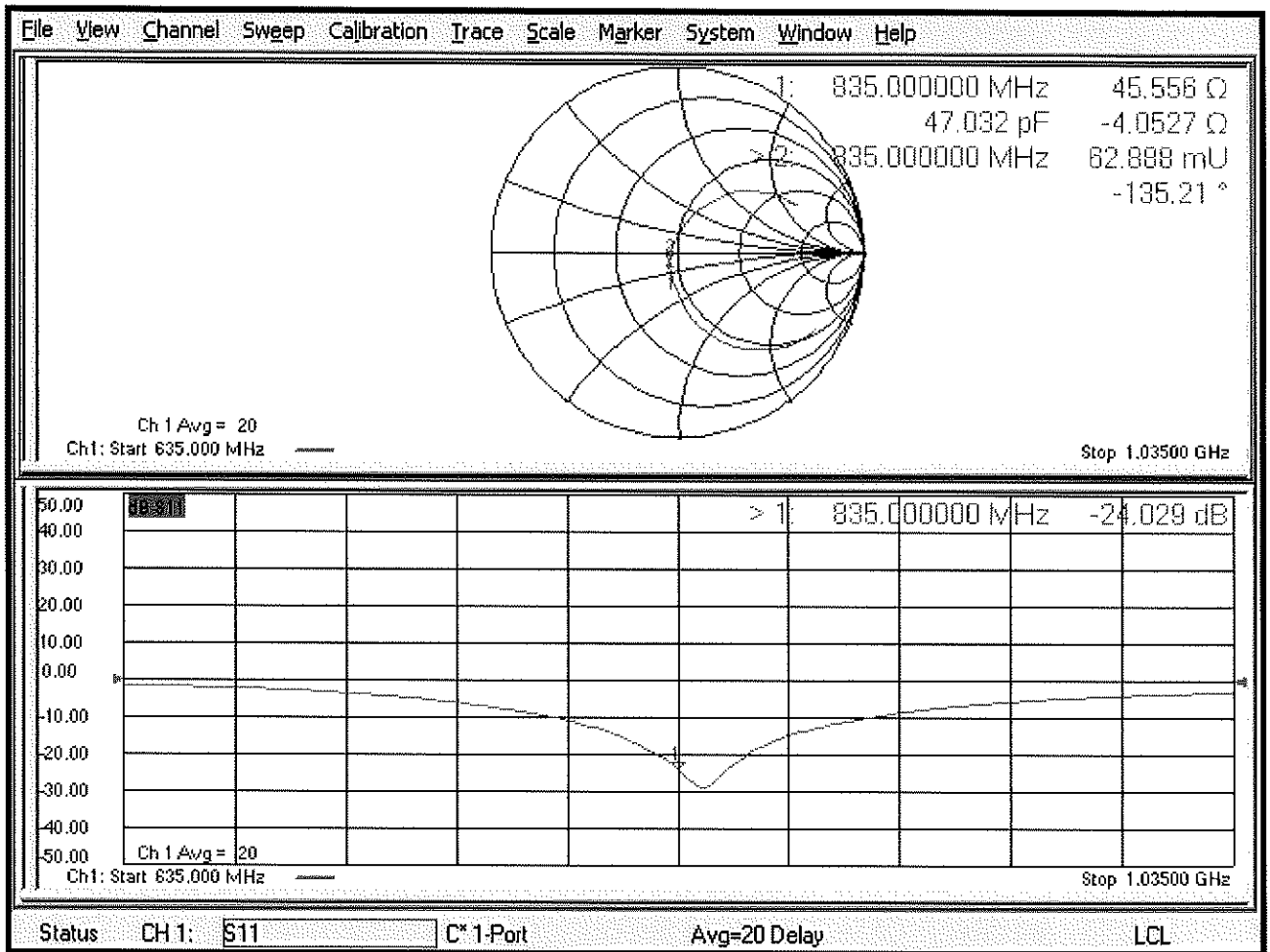
Maximum value of SAR (measured) = 3.28 W/kg



0 dB = 3.28 W/kg = 5.16 dBW/kg



# Impedance Measurement Plot for Body TSL





Accredited by the Swiss Accreditation Service (SAS)  
The Swiss Accreditation Service is one of the signatories to the EA  
Multilateral Agreement for the recognition of calibration certificates

Accreditation No.: **SCS 0108**

Client **PC Test**

Certificate No: **D835V2-4d133\_Oct18**

## CALIBRATION CERTIFICATE

Object **D835V2 - SN:4d133**

Calibration procedure(s) **QA CAL-05.v10  
Calibration procedure for dipole validation kits above 700 MHz**

*BN ✓  
10/30/2018*

Calibration date: **October 19, 2018**

This calibration certificate documents the traceability to national standards, which realize the physical units of measurements (SI).  
The measurements and the uncertainties with confidence probability are given on the following pages and are part of the certificate.

All calibrations have been conducted in the closed laboratory facility: environment temperature ( $22 \pm 3$ )°C and humidity < 70%.

Calibration Equipment used (M&TE critical for calibration)

Primary Standards	ID #	Cal Date (Certificate No.)	Scheduled Calibration
Power meter NRP	SN: 104778	04-Apr-18 (No. 217-02672/02673)	Apr-19
Power sensor NRP-Z91	SN: 103244	04-Apr-18 (No. 217-02672)	Apr-19
Power sensor NRP-Z91	SN: 103245	04-Apr-18 (No. 217-02673)	Apr-19
Reference 20 dB Attenuator	SN: 5058 (20k)	04-Apr-18 (No. 217-02682)	Apr-19
Type-N mismatch combination	SN: 5047.2 / 06327	04-Apr-18 (No. 217-02683)	Apr-19
Reference Probe EX3DV4	SN: 7349	30-Dec-17 (No. EX3-7349_Dec17)	Dec-18
DAE4	SN: 601	04-Oct-18 (No. DAE4-601_Oct18)	Oct-19

Secondary Standards	ID #	Check Date (in house)	Scheduled Check
Power meter EPM-442A	SN: GB37480704	07-Oct-15 (in house check Oct-18)	In house check: Oct-20
Power sensor HP 8481A	SN: US37292783	07-Oct-15 (in house check Oct-18)	In house check: Oct-20
Power sensor HP 8481A	SN: MY41092317	07-Oct-15 (in house check Oct-18)	In house check: Oct-20
RF generator R&S SMT-06	SN: 100972	15-Jun-15 (in house check Oct-18)	In house check: Oct-20
Network Analyzer Agilent E8358A	SN: US41080477	31-Mar-14 (in house check Oct-18)	In house check: Oct-19

Calibrated by: **Manu Seitz**      Name: **Manu Seitz**      Function: **Laboratory Technician**      Signature: *[Signature]*

Approved by: **Katja Pokovic**      Name: **Katja Pokovic**      Function: **Technical Manager**      Signature: *[Signature]*

Issued: October 22, 2018

This calibration certificate shall not be reproduced except in full without written approval of the laboratory.



Accredited by the Swiss Accreditation Service (SAS)

The Swiss Accreditation Service is one of the signatories to the EA Multilateral Agreement for the recognition of calibration certificates

Accreditation No.: **SCS 0108**

### Glossary:

TSL	tissue simulating liquid
ConvF	sensitivity in TSL / NORM x,y,z
N/A	not applicable or not measured

### Calibration is Performed According to the Following Standards:

- IEEE Std 1528-2013, "IEEE Recommended Practice for Determining the Peak Spatial-Averaged Specific Absorption Rate (SAR) in the Human Head from Wireless Communications Devices: Measurement Techniques", June 2013
- IEC 62209-1, "Measurement procedure for the assessment of Specific Absorption Rate (SAR) from hand-held and body-mounted devices used next to the ear (frequency range of 300 MHz to 6 GHz)", July 2016
- IEC 62209-2, "Procedure to determine the Specific Absorption Rate (SAR) for wireless communication devices used in close proximity to the human body (frequency range of 30 MHz to 6 GHz)", March 2010
- KDB 865664, "SAR Measurement Requirements for 100 MHz to 6 GHz"

### Additional Documentation:

- DASY4/5 System Handbook

### Methods Applied and Interpretation of Parameters:

- Measurement Conditions:** Further details are available from the Validation Report at the end of the certificate. All figures stated in the certificate are valid at the frequency indicated.
- Antenna Parameters with TSL:** The dipole is mounted with the spacer to position its feed point exactly below the center marking of the flat phantom section, with the arms oriented parallel to the body axis.
- Feed Point Impedance and Return Loss:** These parameters are measured with the dipole positioned under the liquid filled phantom. The impedance stated is transformed from the measurement at the SMA connector to the feed point. The Return Loss ensures low reflected power. No uncertainty required.
- Electrical Delay:** One-way delay between the SMA connector and the antenna feed point. No uncertainty required.
- SAR measured:** SAR measured at the stated antenna input power.
- SAR normalized:** SAR as measured, normalized to an input power of 1 W at the antenna connector.
- SAR for nominal TSL parameters:** The measured TSL parameters are used to calculate the nominal SAR result.

The reported uncertainty of measurement is stated as the standard uncertainty of measurement multiplied by the coverage factor  $k=2$ , which for a normal distribution corresponds to a coverage probability of approximately 95%.