

**MEASUREMENT REPORT  
 LTE**

**Applicant Name:**  
 LG Electronics USA, Inc.  
 1000 Sylvan Avenue  
 Englewood Cliffs, NJ 07632  
 United States

**Date of Testing:**  
 12/10-12/21-2018  
**Test Site/Location:**  
 PCTEST Lab. Columbia, MD  
**Test Report Serial No.:**  
 1M18110223-03.ZNF

<b>FCC ID:</b>	<b>ZNFX220QM</b>
<b>APPLICANT:</b>	<b>LG Electronics USA, Inc.</b>

**Application Type:** Certification  
**Model:** LM-X220QM  
**Additional Model(s):** LMX220QM, X220QM  
**EUT Type:** Portable Handset  
**FCC Classification:** PCS Licensed Transmitter Held to EAR (PCE)  
**FCC Rule Part(s):** 22, 24, & 27  
**Test Procedure(s):** ANSI C63.26-2015, ANSI/TIA-603-E-2016, KDB 971168 D01 v03r01

This equipment has been shown to be capable of compliance with the applicable technical standards as indicated in the measurement report and was tested in accordance with the measurement procedures specified in §2.947. Test results reported herein relate only to the item(s) tested.

I attest to the accuracy of data. All measurements reported herein were performed by me or were made under my supervision and are correct to the best of my knowledge and belief. I assume full responsibility for the completeness of these measurements and vouch for the qualifications of all persons taking them.

  
 Randy Ortanez  
 President



<b>FCC ID:</b> ZNFX220QM	 <b>MEASUREMENT REPORT (CERTIFICATION)</b>		<b>Approved by:</b> Quality Manager
<b>Test Report S/N:</b> 1M1812110223-03.ZNF	<b>Test Dates:</b> 12/10-12/21/2018	<b>EUT Type:</b> Portable Handset	Page 1 of 134

# TABLE OF CONTENTS

1.0	INTRODUCTION .....	5
1.1	Scope .....	5
1.2	PCTEST Test Location.....	5
1.3	Test Facility / Accreditations.....	5
2.0	PRODUCT INFORMATION.....	6
2.1	Equipment Description .....	6
2.2	Device Capabilities.....	6
3.0	DESCRIPTION OF TESTS .....	7
3.1	Measurement Procedure.....	7
3.2	Block A Frequency Range.....	7
3.3	Cellular - Base Frequency Blocks .....	7
3.4	Cellular - Mobile Frequency Blocks .....	7
3.5	PCS - Base Frequency Blocks .....	7
3.6	PCS - Mobile Frequency Blocks.....	8
3.7	AWS - Base Frequency Blocks .....	8
3.8	AWS - Mobile Frequency Blocks.....	8
3.9	BRS/EBS Frequency Block .....	9
3.10	Radiated Power and Radiated Spurious Emissions .....	9
4.0	MEASUREMENT UNCERTAINTY .....	10
5.0	TEST EQUIPMENT CALIBRATION DATA .....	11
6.0	SAMPLE CALCULATIONS .....	12
7.0	TEST RESULTS .....	13
7.1	Summary.....	13
7.2	Occupied Bandwidth .....	15
7.3	Spurious and Harmonic Emissions at Antenna Terminal .....	36
7.4	Band Edge Emissions at Antenna Terminal.....	57
7.5	Peak-Average Ratio .....	97
7.6	Radiated Power (ERP/EIRP).....	110
7.7	Radiated Spurious Emissions Measurements.....	115
7.8	Frequency Stability / Temperature Variation .....	125
8.0	CONCLUSION.....	134

<b>FCC ID:</b> ZNFX220QM	 <b>MEASUREMENT REPORT (CERTIFICATION)</b>		<b>Approved by:</b> Quality Manager
<b>Test Report S/N:</b> 1M1812110223-03.ZNF	<b>Test Dates:</b> 12/10-12/21/2018	<b>EUT Type:</b> Portable Handset	Page 2 of 134

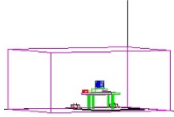

## MEASUREMENT REPORT

### FCC Part 22, 24, & 27

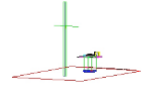

Mode	FCC Rule Part	Tx Frequency (MHz)	ERP		EIRP		Emission Designator	Modulation
			Max. Power (W)	Max. Power (dBm)	Max. Power (W)	Max. Power (dBm)		
LTE Band 12	27	699.7 - 715.3	0.066	18.17	0.108	20.32	1M11G7D	QPSK
LTE Band 12	27	699.7 - 715.3	0.051	17.10	0.084	19.25	1M11W7D	16QAM
LTE Band 12	27	700.5 - 714.5	0.076	18.83	0.125	20.98	2M71G7D	QPSK
LTE Band 12	27	700.5 - 714.5	0.064	18.09	0.106	20.24	2M71W7D	16QAM
LTE Band 12	27	701.5 - 713.5	0.092	19.63	0.151	21.78	4M53G7D	QPSK
LTE Band 12	27	701.5 - 713.5	0.067	18.25	0.110	20.40	4M52W7D	16QAM
LTE Band 12	27	704 - 711	0.085	19.30	0.139	21.45	9M00G7D	QPSK
LTE Band 12	27	704 - 711	0.061	17.88	0.101	20.03	9M02W7D	16QAM
LTE Band 5	22H	824.7 - 848.3	0.080	19.05	0.132	21.20	1M10G7D	QPSK
LTE Band 5	22H	824.7 - 848.3	0.058	17.62	0.095	19.77	1M11W7D	16QAM
LTE Band 5	22H	825.5 - 847.5	0.088	19.43	0.144	21.58	2M72G7D	QPSK
LTE Band 5	22H	825.5 - 847.5	0.062	17.94	0.102	20.09	2M71W7D	16QAM
LTE Band 5	22H	826.5 - 846.5	0.090	19.52	0.147	21.67	4M54G7D	QPSK
LTE Band 5	22H	826.5 - 846.5	0.064	18.03	0.104	20.18	4M53W7D	16QAM
LTE Band 5	22H	829 - 844	0.091	19.59	0.149	21.74	9M01G7D	QPSK
LTE Band 5	22H	829 - 844	0.066	18.21	0.109	20.36	9M00W7D	16QAM

### EUT Overview (<1GHz)

FCC ID: ZNFX220QM	 <b>MEASUREMENT REPORT (CERTIFICATION)</b>			Approved by: Quality Manager
Test Report S/N: 1M1812110223-03.ZNF	Test Dates: 12/10-12/21/2018	EUT Type: Portable Handset	Page 3 of 134	

Mode	FCC Rule Part	Tx Frequency (MHz)	EIRP		Emission Designator	Modulation
			Max. Power (W)	Max. Power (dBm)		
LTE Band 4	27	1710.7 - 1754.3	0.140	21.46	1M11G7D	QPSK
LTE Band 4	27	1710.7 - 1754.3	0.108	20.32	1M11W7D	16QAM
LTE Band 4	27	1711.5 - 1753.5	0.172	22.37	2M71G7D	QPSK
LTE Band 4	27	1711.5 - 1753.5	0.119	20.76	2M71W7D	16QAM
LTE Band 4	27	1712.5 - 1752.5	0.200	23.00	4M52G7D	QPSK
LTE Band 4	27	1712.5 - 1752.5	0.124	20.94	4M52W7D	16QAM
LTE Band 4	27	1715 - 1750	0.192	22.83	9M01G7D	QPSK
LTE Band 4	27	1715 - 1750	0.141	21.50	9M02W7D	16QAM
LTE Band 4	27	1717.5 - 1747.5	0.192	22.83	13M4G7D	QPSK
LTE Band 4	27	1717.5 - 1747.5	0.141	21.50	13M5W7D	16QAM
LTE Band 4	27	1720 - 1745	0.205	23.12	17M9G7D	QPSK
LTE Band 4	27	1720 - 1745	0.140	21.45	17M9W7D	16QAM
LTE Band 25/2	24E	1850.7 - 1914.3	0.136	21.34	1M10G7D	QPSK
LTE Band 25/2	24E	1850.7 - 1914.3	0.110	20.40	1M10W7D	16QAM
LTE Band 25/2	24E	1851.5 - 1913.5	0.171	22.32	2M71G7D	QPSK
LTE Band 25/2	24E	1851.5 - 1913.5	0.118	20.73	2M71W7D	16QAM
LTE Band 25/2	24E	1852.5 - 1912.5	0.183	22.63	4M52G7D	QPSK
LTE Band 25/2	24E	1852.5 - 1912.5	0.124	20.94	4M53W7D	16QAM
LTE Band 25/2	24E	1855 - 1910	0.184	22.64	8M99G7D	QPSK
LTE Band 25/2	24E	1855 - 1910	0.142	21.51	9M01W7D	16QAM
LTE Band 25/2	24E	1857.5 - 1907.5	0.181	22.59	13M4G7D	QPSK
LTE Band 25/2	24E	1857.5 - 1907.5	0.126	20.99	13M5W7D	16QAM
LTE Band 25/2	24E	1860 - 1905	0.165	22.18	17M9G7D	QPSK
LTE Band 25/2	24E	1860 - 1905	0.115	20.62	17M9W7D	16QAM

**EUT Overview (Mid Bands)**

<b>FCC ID:</b> ZNFX220QM		<b>MEASUREMENT REPORT (CERTIFICATION)</b>		<b>Approved by:</b> Quality Manager
<b>Test Report S/N:</b> 1M1812110223-03.ZNF	<b>Test Dates:</b> 12/10-12/21/2018	<b>EUT Type:</b> Portable Handset	Page 4 of 134	

## 1.0 INTRODUCTION

### 1.1 Scope

Measurement and determination of electromagnetic emissions (EMC) of radio frequency devices including intentional and/or unintentional radiators for compliance with the technical rules and regulations of the Federal Communications Commission and the Innovation, Science and Economic Development Canada.

### 1.2 PCTEST Test Location

These measurement tests were conducted at the PCTEST Engineering Laboratory, Inc. facility located at 7185 Oakland Mills Road, Columbia, MD 21046. The measurement facility is compliant with the test site requirements specified in ANSI C63.4-2014.

### 1.3 Test Facility / Accreditations

Measurements were performed at PCTEST Engineering Lab located in Columbia, MD 21046, U.S.A.

- PCTEST is an ISO 17025-2005 accredited test facility under the American Association for Laboratory Accreditation (A2LA) with Certificate number 2041.01 for Specific Absorption Rate (SAR), Hearing Aid Compatibility (HAC) testing, where applicable, and Electromagnetic Compatibility (EMC) testing for FCC and Innovation, Science, and Economic Development Canada rules.
- PCTEST TCB is a Telecommunication Certification Body (TCB) accredited to ISO/IEC 17065-2012 by A2LA (Certificate number 2041.03) in all scopes of FCC Rules and ISED Standards (RSS).
- PCTEST facility is a registered (2451B) test laboratory with the site description on file with ISED.

FCC ID: ZNFX220QM		MEASUREMENT REPORT (CERTIFICATION)		Approved by: Quality Manager
Test Report S/N: 1M1812110223-03.ZNF	Test Dates: 12/10-12/21/2018	EUT Type: Portable Handset	Page 5 of 134	

## 2.0 PRODUCT INFORMATION

### 2.1 Equipment Description

The Equipment Under Test (EUT) is the **LG Portable Handset FCC ID: ZNFX220QM**. The test data contained in this report pertains only to the emissions due to the EUT's LTE function.

**Test Device Serial No.:** 00307, 00313, 00784, 00776

### 2.2 Device Capabilities

This device contains the following capabilities:

850/1900 CDMA (BC0, BC1), 850/1900 GSM/GPRS/EDGE, 850/1700/1900 WCDMA, Multi-band LTE, 802.11b/g/n WLAN, Bluetooth (1x, EDR, LE)

LTE Band 12 (698 - 716 MHz) overlaps the entire frequency range of LTE Band 17 (704 - 716 MHz). Therefore, test data provided in this report covers Band 17 as well as Band 12.

LTE Band 25 (1850 - 1915 MHz) overlaps the entire frequency range of LTE Band 2 (1850 - 1910 MHz). Therefore, test data provided in this report covers Band 2 as well as Band 25.

No EMI suppression device(s) were added and no modifications were made during testing.

FCC ID: ZNFX220QM		MEASUREMENT REPORT (CERTIFICATION)		Approved by: Quality Manager
Test Report S/N: 1M1812110223-03.ZNF	Test Dates: 12/10-12/21/2018	EUT Type: Portable Handset	Page 6 of 134	

## 3.0 DESCRIPTION OF TESTS

### 3.1 Measurement Procedure

The measurement procedures described in the document titled “Land Mobile FM or PM – Communications Equipment – Measurements and Performance Standards” (ANSI/TIA-603-E-2016) and “Procedures for Compliance Measurement of the Fundamental Emission Power of Licensed Wideband (> 1 MHz) Digital Transmission Systems” (KDB 971168 D01 v03r01) were used in the measurement of the EUT.

### 3.2 Block A Frequency Range

698-746 MHz band. The following frequencies are available for licensing pursuant to this part in the 698-746 MHz band: (1) Three paired channel blocks of 12 megahertz each are available for assignment as follows:

Block A: 698-704 MHz and 728-734 MHz;  
 Block B: 704-710 MHz and 734-740 MHz; and  
 Block C: 710-716 MHz and 740-746 MHz.

### 3.3 Cellular - Base Frequency Blocks

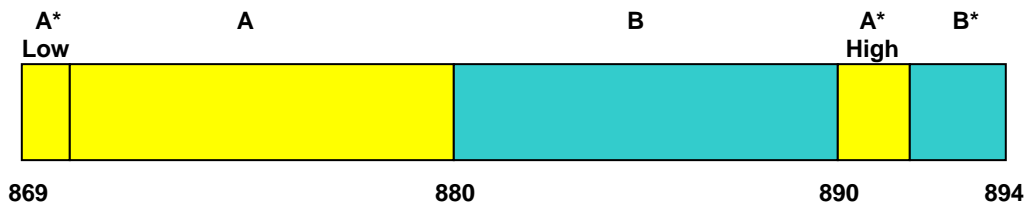

**BLOCK 1:** 869 – 880 MHz (A\* Low + A)                      **BLOCK 3:** 890 – 891.5 MHz (A\* High)  
**BLOCK 2:** 880 – 890 MHz (B)                                      **BLOCK 4:** 891.5 – 894 MHz (B\*)

### 3.4 Cellular - Mobile Frequency Blocks

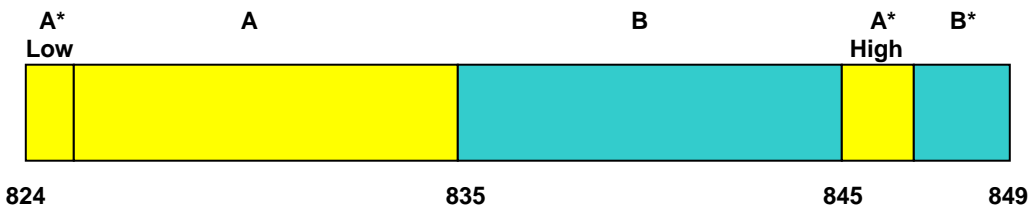

**BLOCK 1:** 824 – 835 MHz (A\* Low + A)                      **BLOCK 3:** 845 – 846.5 MHz (A\* High)  
**BLOCK 2:** 835 – 845 MHz (B)                                      **BLOCK 4:** 846.5 – 849 MHz (B\*)

### 3.5 PCS - Base Frequency Blocks

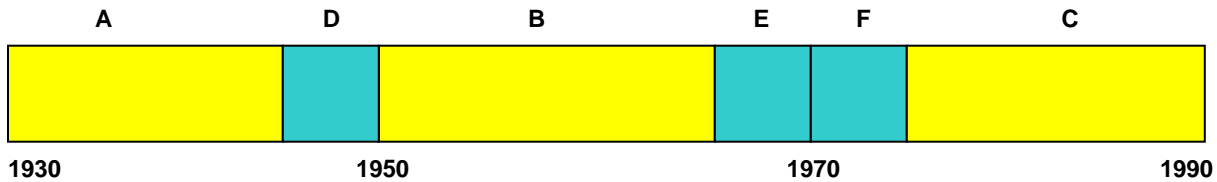

**BLOCK 1:** 1930 – 1945 MHz (A)                                      **BLOCK 4:** 1965 – 1970 MHz (E)

FCC ID: ZNFX220QM		<b>MEASUREMENT REPORT (CERTIFICATION)</b>		Approved by: Quality Manager
Test Report S/N: 1M1812110223-03.ZNF	Test Dates: 12/10-12/21/2018	EUT Type: Portable Handset	Page 7 of 134	

BLOCK 2: 1945 – 1950 MHz (D)  
 BLOCK 3: 1950 – 1965 MHz (B)

BLOCK 5: 1970 – 1975 MHz (F)  
 BLOCK 6: 1975 – 1990 MHz (C)

### 3.6 PCS - Mobile Frequency Blocks

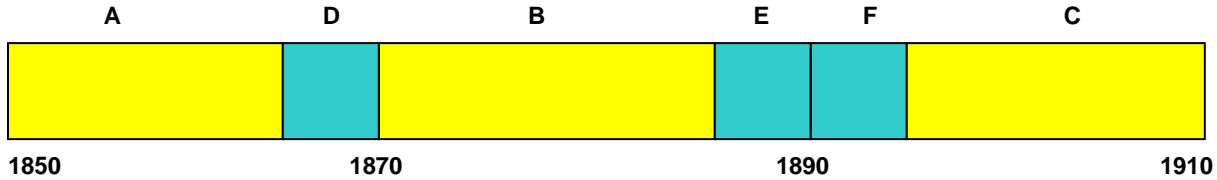

BLOCK 1: 1850 – 1865 MHz (A)  
 BLOCK 2: 1865 – 1870 MHz (D)  
 BLOCK 3: 1870 – 1885 MHz (B)

BLOCK 4: 1885 – 1890 MHz (E)  
 BLOCK 5: 1890 – 1895 MHz (F)  
 BLOCK 6: 1895 – 1910 MHz (C)

### 3.7 AWS - Base Frequency Blocks

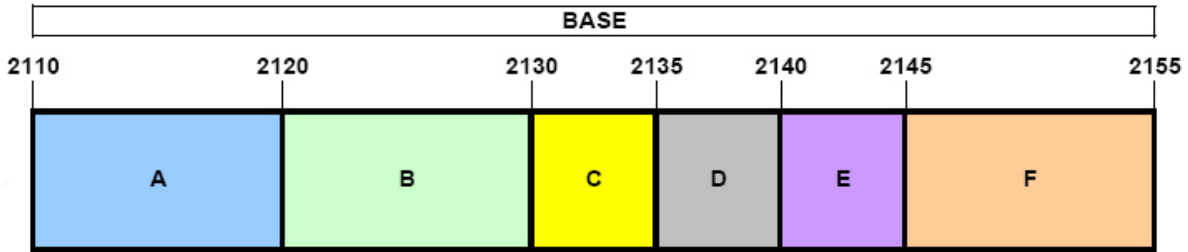

BLOCK 1: 2110 – 2120 MHz (A)  
 BLOCK 2: 2120 – 2130 MHz (B)  
 BLOCK 3: 2130 – 2135 MHz (C)

BLOCK 4: 2135 – 2140 MHz (D)  
 BLOCK 5: 2140 – 2145 MHz (E)  
 BLOCK 6: 2145 – 2155 MHz (F)

### 3.8 AWS - Mobile Frequency Blocks

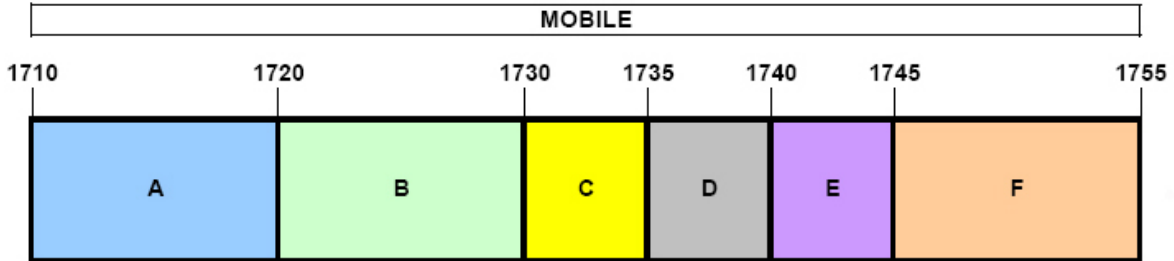

BLOCK 1: 1710 – 1720 MHz (A)  
 BLOCK 2: 1720 – 1730 MHz (B)  
 BLOCK 3: 1730 – 1735 MHz (C)

BLOCK 4: 1735 – 1740 MHz (D)  
 BLOCK 5: 1740 – 1745 MHz (E)  
 BLOCK 6: 1745 – 1755 MHz (F)

FCC ID: ZNFX220QM		MEASUREMENT REPORT (CERTIFICATION)		Approved by: Quality Manager
Test Report S/N: 1M1812110223-03.ZNF	Test Dates: 12/10-12/21/2018	EUT Type: Portable Handset	Page 8 of 134	



### 3.9 BRS/EBS Frequency Block

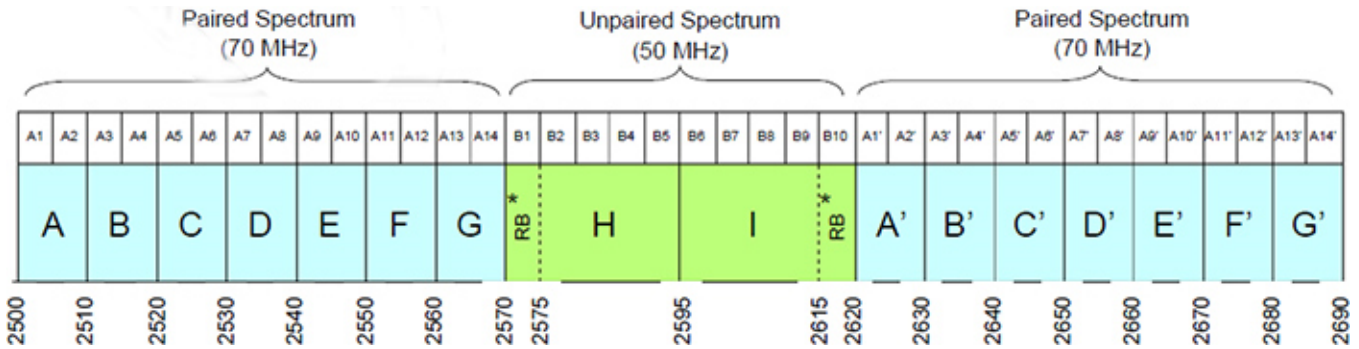

### 3.10 Radiated Power and Radiated Spurious Emissions

The radiated test facilities consisted of an indoor 3 meter semi-anechoic chamber used for final measurements and exploratory measurements, when necessary. The measurement area is contained within the semi-anechoic chamber which is shielded from any ambient interference. The test site inside the chamber is a 6m x 5.2m elliptical, obstruction-free area in accordance with Figure 5.7 of Clause 5 in ANSI C63.4-2014. Absorbers are arranged on the floor between the turn table and the antenna mast in such a way so as to maximize the reduction of reflections for measurements above 1GHz. For measurements below 1GHz, the absorbers are removed. A raised turntable is used for radiated measurement. The turn table is a continuously rotatable, remote-controlled, metallic turntable and 2 meters (6.56 ft.) in diameter. The turn table is flush with the raised floor of the chamber in order to maintain its function as a ground plane. An 80cm tall test table made of Styrodur is placed on top of the turn table. A Styrodur pedestal is placed on top of the test table to bring the total table height to 1.5m.

The equipment under test was transmitting while connected to its integral antenna and is placed on a turntable 3 meters from the receive antenna. The receive antenna height is adjusted between 1 and 4 meter height, the turntable is rotated through 360 degrees, and the EUT is manipulated through all orthogonal planes representative of its typical use to achieve the highest reading on the receive spectrum analyzer. Radiated power levels are also investigated with the receive antenna horizontally and vertically polarized. The maximized power level is recorded using the spectrum analyzer "Channel Power" function with the integration band set to the emissions' occupied bandwidth, a RMS detector, RBW = 100kHz, VBW = 300kHz, and a 1 second sweep time over a minimum of 10 sweeps, per the guidelines of KDB 971168 D01 v03r01. Per the guidelines of KDB 412172 D01 v01r01

Per the guidance of ANSI/TIA-603-E-2016, a half-wave dipole is then substituted in place of the EUT. For emissions above 1GHz, a horn antenna is substituted in place of the EUT. The substitute antenna is driven by a signal generator with the level of the signal generator being adjusted to obtain the same receive spectrum analyzer level previously recorded from the spurious emission from the EUT. The power of the emission is calculated using the following formula:

$$P_d [dBm] = P_g [dBm] - \text{cable loss} [dB] + \text{antenna gain} [dBd/dBi]$$

Where,  $P_d$  is the dipole equivalent power,  $P_g$  is the generator output into the substitution antenna, and the antenna gain is the gain of the substitute antenna used relative to either a half-wave dipole (dBd) or an isotropic source (dBi). The substitute level is equal to  $P_g [dBm] - \text{cable loss} [dB]$ .

The calculated  $P_d$  levels are then compared to the absolute spurious emission limit of -13dBm which is equivalent to the required minimum attenuation of  $43 + 10\log_{10}(\text{Power} [Watts])$ . For Band 7 and 41, the calculated  $P_d$  levels are compared to the absolute spurious emission limit of -25dBm which is equivalent to the required minimum attenuation of  $55 + 10\log_{10}(\text{Power} [Watts])$ .

FCC ID: ZNFX220QM		MEASUREMENT REPORT (CERTIFICATION)		Approved by: Quality Manager
Test Report S/N: 1M1812110223-03.ZNF	Test Dates: 12/10-12/21/2018	EUT Type: Portable Handset	Page 9 of 134	

## 4.0 MEASUREMENT UNCERTAINTY

The measurement uncertainties shown below were calculated in accordance with the requirements of ANSI C63.4-2014. All measurement uncertainty values are shown with a coverage factor of  $k = 2$  to indicate a 95% level of confidence. The measurement uncertainty shown below meets or exceeds the  $U_{\text{CISPR}}$  measurement uncertainty values specified in CISPR 16-4-2 and, thus, can be compared directly to specified limits to determine compliance.

Contribution	Expanded Uncertainty ( $\pm$ dB)
Conducted Bench Top Measurements	1.13
Radiated Disturbance (<1GHz)	4.98
Radiated Disturbance (>1GHz)	5.07
Radiated Disturbance (>18GHz)	5.09

FCC ID: ZNFX220QM		<b>MEASUREMENT REPORT (CERTIFICATION)</b>		<b>Approved by:</b> Quality Manager
<b>Test Report S/N:</b> 1M1812110223-03.ZNF	<b>Test Dates:</b> 12/10-12/21/2018	<b>EUT Type:</b> Portable Handset	Page 10 of 134	

## 5.0 TEST EQUIPMENT CALIBRATION DATA

Test Equipment Calibration is traceable to the National Institute of Standards and Technology (NIST). Measurements antennas used during testing were calibrated in accordance to the requirements of ANSI C63.5-2017.

Manufacturer	Model	Description	Cal Date	Cal Interval	Cal Due	Serial Number
-	LTx1	Licensed Transmitter Cable Set	8/23/2018	Annual	8/23/2019	LTx1
-	LTx2	Licensed Transmitter Cable Set	8/23/2018	Annual	8/23/2019	LTx2
Agilent	N9030A	PXA Signal Analyzer (44GHz)	5/25/2018	Annual	5/25/2019	MY52350166
Com-Power	AL-130	9kHz - 30MHz Loop Antenna	10/10/2017	Biennial	10/10/2019	121034
Emco	3115	Horn Antenna (1-18GHz)	3/28/2018	Biennial	3/28/2020	9704-5182
Emco	3116	Horn Antenna (18 - 40GHz)	6/7/2018	Triennial	6/7/2021	9203-2178
Keysight Technologies	N9030A	3Hz-44GHz PXA Signal Analyzer	3/20/2018	Annual	3/20/2019	MY49430494
Keysight Technologies	N9030A	PXA Signal Analyzer	8/6/2018	Annual	8/6/2019	MY54490576
Mini Circuits	PWR-SEN-4GHS	USB Power Sensor	3/30/2018	Annual	3/30/2019	11401010036
Mini Circuits	TVA-11-422	RF Power Amp	N/A			QA1317001
Mini-Circuits	SSG-4000HP	Synthesized Signal Generator	N/A			11208010032
Rohde & Schwarz	CMW500	Radio Communication Tester	6/8/2018	Annual	6/8/2019	112347
Rohde & Schwarz	CMW500	Wideband Radio Communication Tester	4/30/2018	Annual	4/30/2019	165450
Rohde & Schwarz	ESU26	EMI Test Receiver (26.5GHz)	5/21/2018	Annual	5/21/2019	100342
Rohde & Schwarz	ESU40	EMI Test Receiver (40GHz)	8/9/2018	Annual	8/9/2019	100348
Rohde & Schwarz	SFUNIT-Rx	Shielded Filter Unit	6/18/2018	Annual	6/18/2019	102134
Rohde & Schwarz	SFUNIT-Rx	Shielded Filter Unit	6/25/2018	Annual	6/25/2019	102133
Rohde & Schwarz	SMB100A03	SMB100A Signal Generator	5/30/2018	Annual	5/30/2019	180862
Rohde & Schwarz	TC-TA18	Cross Polarized Vivaldi Test Antenna	7/16/2018	Biennial	7/16/2020	101073
Rohde & Schwarz	TC-TA18	Vivaldi Antenna	8/17/2018	Biennial	8/17/2020	101072
Rohde & Schwarz	TS-PR18	Shielded Filter Unit	7/2/2018	Annual	7/2/2019	102131
Rohde & Schwarz	TS-PR26	18-26.5 GHz Pre-Amplifier	1/24/2018	Annual	1/24/2019	100040
Rohde & Schwarz	TS-PR40	26.5-40 GHz Pre-Amplifier	1/24/2018	Annual	1/24/2019	100037
Seekonk	NC-100	Torque Wrench (8" lb)	5/10/2018	Biennial	5/10/2020	N/A
Sunol	JB5	Bi-Log Antenna (30M - 5GHz)	4/19/2018	Biennial	4/19/2020	A051107

**Table 5-1. Test Equipment**

**Notes:**

1. For equipment listed above that has a calibration date or calibration due date that falls within the test date range, care was taken to ensure that this equipment was used after the calibration date and before the calibration due date.
2. Equipment with a calibration date of "N/A" shown in this list was not used to make direct calibrated measurements.

FCC ID: ZNFX220QM		<b>MEASUREMENT REPORT (CERTIFICATION)</b>		Approved by: Quality Manager
Test Report S/N: 1M1812110223-03.ZNF	Test Dates: 12/10-12/21/2018	EUT Type: Portable Handset	Page 11 of 134	

## 6.0 SAMPLE CALCULATIONS

### Emission Designator

#### QPSK Modulation

**Emission Designator = 8M62G7D**

LTE BW = 8.62 MHz  
 G = Phase Modulation  
 7 = Quantized/Digital Info  
 D = Data transmission, telemetry, telecommand

#### QAM Modulation

**Emission Designator = 8M45W7D**

LTE BW = 8.45 MHz  
 W = Amplitude/Angle Modulated  
 7 = Quantized/Digital Info  
 D = Data transmission, telemetry, telecommand

### Spurious Radiated Emission – LTE Band

#### **Example: Middle Channel LTE Mode 2<sup>nd</sup> Harmonic (1564 MHz)**

The average spectrum analyzer reading at 3 meters with the EUT on the turntable was -81.0 dBm. The gain of the substituted antenna is 8.1 dBi. The signal generator connected to the substituted antenna terminals is adjusted to produce a reading of -81.0 dBm on the spectrum analyzer. The loss of the cable between the signal generator and the terminals of the substituted antenna is 2.0 dB at 1564 MHz. So 6.1 dB is added to the signal generator reading of -30.9 dBm yielding -24.80 dBm. The fundamental EIRP was 25.501 dBm so this harmonic was 25.501 dBm - (-24.80).

FCC ID: ZNFX220QM	 <b>MEASUREMENT REPORT (CERTIFICATION)</b>		Approved by: Quality Manager
Test Report S/N: 1M1812110223-03.ZNF	Test Dates: 12/10-12/21/2018	EUT Type: Portable Handset	Page 12 of 134

## 7.0 TEST RESULTS

### 7.1 Summary

Company Name: LG Electronics USA, Inc.  
 FCC ID: ZNFX220QM  
 FCC Classification: PCS Licensed Transmitter Held to Ear (PCE)  
 Mode(s): LTE

FCC Part Section(s)	Test Description	Test Limit	Test Condition	Test Result	Reference
2.1049	Occupied Bandwidth	N/A	CONDUCTED	PASS	Section 7.2
2.1051 2.917(a) 24.238(a) 27.53(g) 27.53(h)	Out of Band Emissions	> 43 + 10log <sub>10</sub> (P[Watts]) at Band Edge and for all out-of-band emissions		Section 7.3, 7.4	
27.53(m)	Out of Band Emissions	Undesirable emissions must meet the limits detailed in 27.53(m)		Section 7.3, 7.4	
24.232(d)	Peak-Average Ratio	< 13 dB		Section 7.5	
2.1046	Transmitter Conducted Output Power	N/A		See RF Exposure Report	
2.1055 22.355 24.235 27.54	Frequency Stability	< 2.5 ppm (Part 22) and fundamental emissions stay within authorized frequency block (Part 24, 27)		Section 7.8	

**Table 7-1. Summary of Conducted Test Results**

FCC ID: ZNFX220QM		<b>MEASUREMENT REPORT (CERTIFICATION)</b>			Approved by: Quality Manager
Test Report S/N: 1M1812110223-03.ZNF	Test Dates: 12/10-12/21/2018	EUT Type: Portable Handset		Page 13 of 134	

FCC Part Section(s)	Test Description	Test Limit	Test Condition	Test Result	Reference
22.913(a)(5)	Effective Radiated Power / Equivalent Isotropic Radiated Power (Band 5)	< 7 Watts max. ERP	RADIATED		Section 0
27.50(c)(10)	Effective Radiated Power / Equivalent Isotropic Radiated Power (Band 12)	< 3 Watts max. ERP			Section 0
24.232(c) 27.50(h)(2)	Equivalent Isotropic Radiated Power (Band 25/2)	< 2 Watts max. EIRP			Section 0
27.50(d)(4)	Equivalent Isotropic Radiated Power (Band 4)	< 1 Watts max. EIRP			Section 0
2.1053 22.917(a) 24.238(a) 27.53(g) 27.53(h)	Undesirable Emissions	> 43 + 10log <sub>10</sub> (P[Watts]) for all out-of-band emissions		PASS	Section 7.7
27.53(m)	Undesirable Emissions	Undesirable emissions must meet the limits detailed in 27.53(m)			Section 7.7

**Table 7-2. Summary of Radiated Test Results**

**Notes:**

- 1) All modes of operation and data rates were investigated. The test results shown in the following sections represent the worst case emissions.
- 2) The analyzer plots (Sections 7.2, 7.3, 7.4, 7.5) were all taken with a correction table loaded into the analyzer. The correction table was used to account for the losses of the cables, directional couplers, and attenuators used as part of the system to maintain a link between the call box and the EUT at all frequencies of interest.
- 3) All antenna port conducted emissions testing was performed on a test bench with the antenna port of the EUT connected to the spectrum analyzer through calibrated cables, attenuators, and couplers.
- 4) For conducted spurious emissions, automated test software was used to measure emissions and capture the corresponding plots necessary to show compliance. The measurement software utilized is PCTEST “LTE Automation,” Version 4.8.
- 5) For operation <1GHz, the EIRP limits in the table above are referenced to the specifications written in the relevant Radio Standards Specifications for Innovation, Science, and Economic Development Canada.

FCC ID: ZNFX220QM		MEASUREMENT REPORT (CERTIFICATION)		Approved by: Quality Manager
Test Report S/N: 1M1812110223-03.ZNF	Test Dates: 12/10-12/21/2018	EUT Type: Portable Handset	Page 14 of 134	

## 7.2 Occupied Bandwidth

### Test Overview

The occupied bandwidth, that is the frequency bandwidth such that, below its lower and above its upper frequency limits, the mean powers radiated are each equal to 0.5 percent of the total mean power radiated by a given emission shall be measured. All modes of operation were investigated and the worst case configuration results are reported in this section.

### Test Procedure Used

KDB 971168 D01 v03r01 – Section 4.2

### Test Settings

1. The signal analyzer’s automatic bandwidth measurement capability was used to perform the 99% occupied bandwidth and the 26dB bandwidth. The bandwidth measurement was not influenced by any intermediate power nulls in the fundamental emission.
2. RBW = 1 – 5% of the expected OBW
3. VBW  $\geq 3 \times$  RBW
4. Detector = Peak
5. Trace mode = max hold
6. Sweep = auto couple
7. The trace was allowed to stabilize
8. If necessary, steps 2 – 7 were repeated after changing the RBW such that it would be within 1 – 5% of the 99% occupied bandwidth observed in Step 7

### Test Setup

The EUT and measurement equipment were set up as shown in the diagram below.

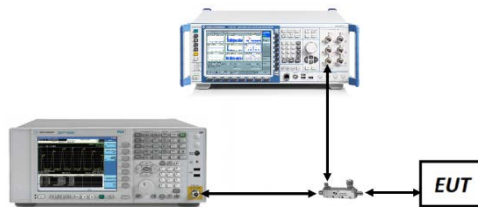

**Figure 7-1. Test Instrument & Measurement Setup**

### Test Notes

None.

FCC ID: ZNFX220QM		MEASUREMENT REPORT (CERTIFICATION)		Approved by: Quality Manager
Test Report S/N: 1M1812110223-03.ZNF	Test Dates: 12/10-12/21/2018	EUT Type: Portable Handset	Page 15 of 134	

## Band 12

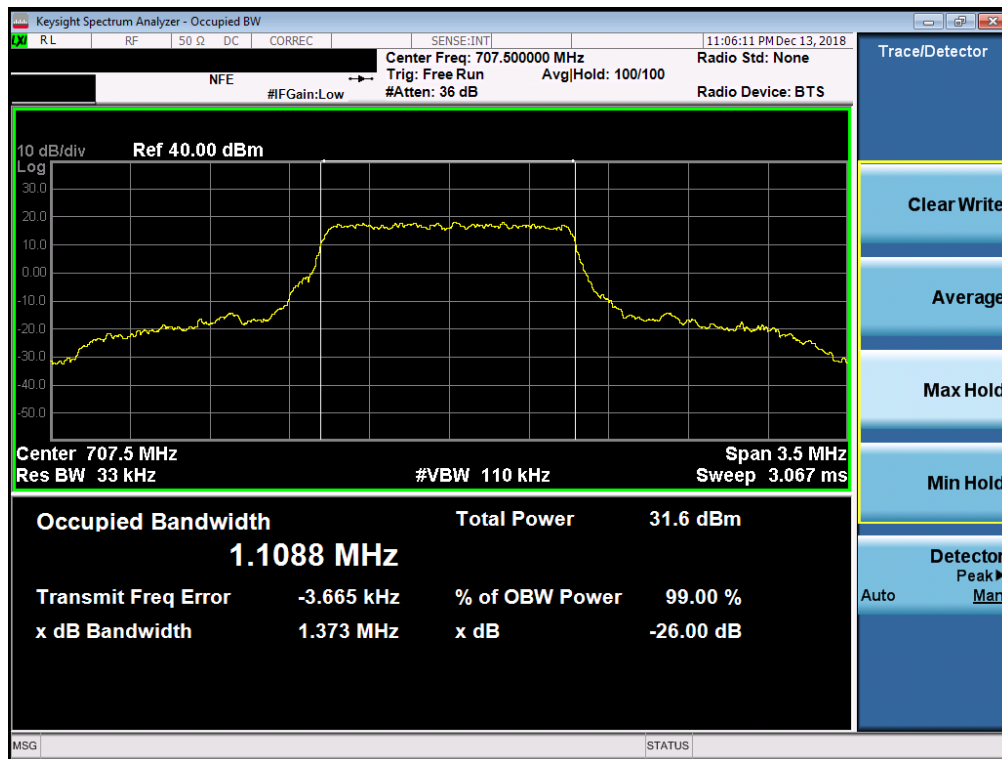

Plot 7-1. Occupied Bandwidth Plot (Band 12 - 1.4MHz QPSK - Full RB Configuration)

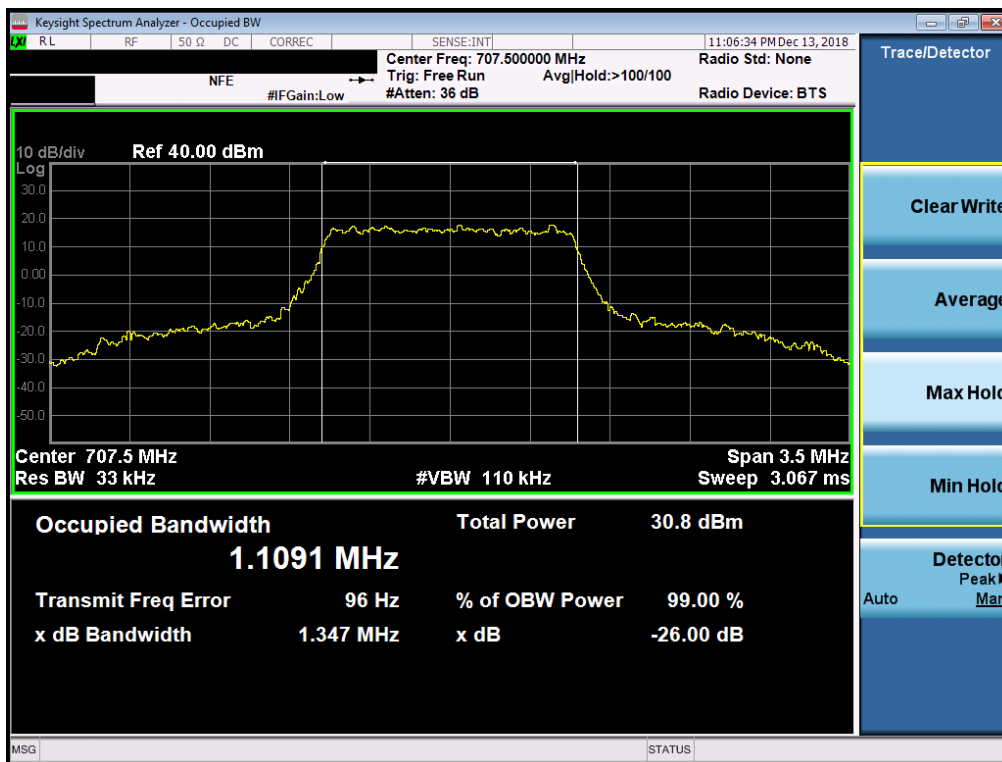

Plot 7-2. Occupied Bandwidth Plot (Band 12 - 1.4MHz 16-QAM - Full RB Configuration)

FCC ID: ZNFX220QM		MEASUREMENT REPORT (CERTIFICATION)		Approved by: Quality Manager
Test Report S/N: 1M1812110223-03.ZNF	Test Dates: 12/10-12/21/2018	EUT Type: Portable Handset		Page 16 of 134



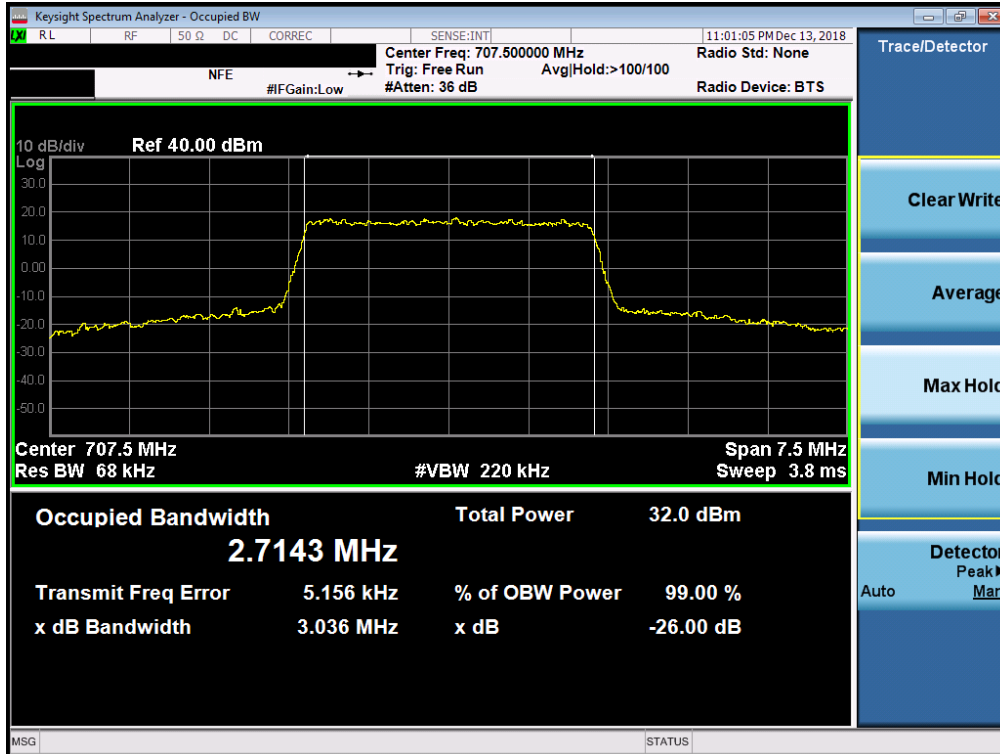

Plot 7-3. Occupied Bandwidth Plot (Band 12 - 3.0MHz QPSK - Full RB Configuration)

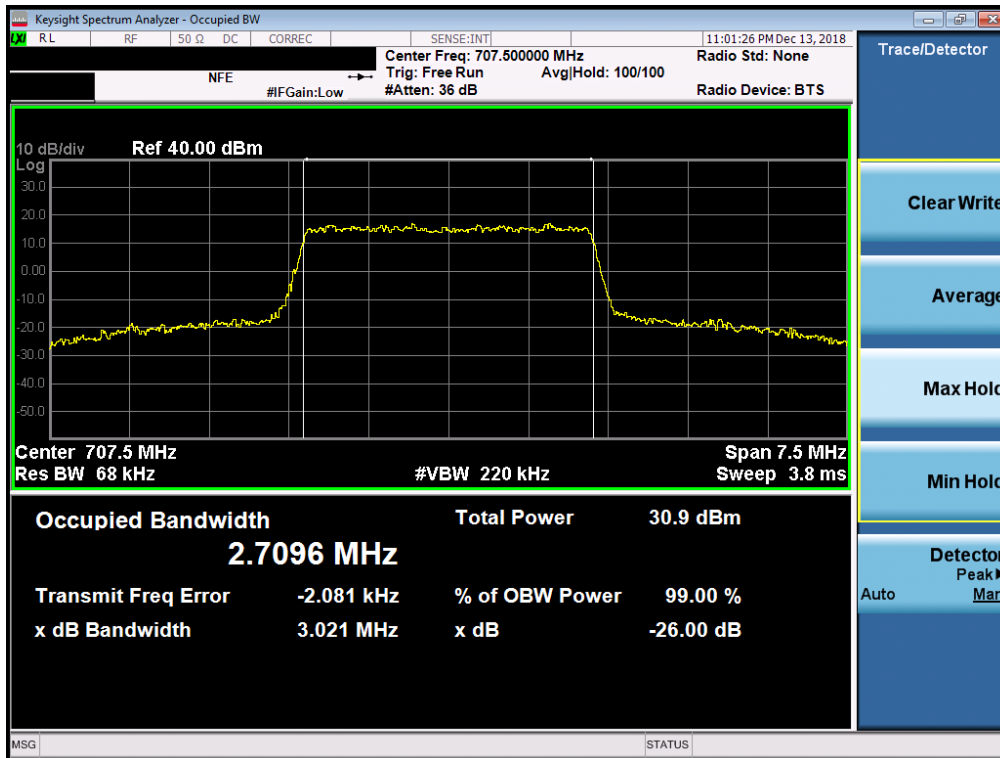

Plot 7-4. Occupied Bandwidth Plot (Band 12 - 3.0MHz 16-QAM - Full RB Configuration)

FCC ID: ZNFX220QM		MEASUREMENT REPORT (CERTIFICATION)		Approved by: Quality Manager
Test Report S/N: 1M1812110223-03.ZNF	Test Dates: 12/10-12/21/2018	EUT Type: Portable Handset		Page 17 of 134

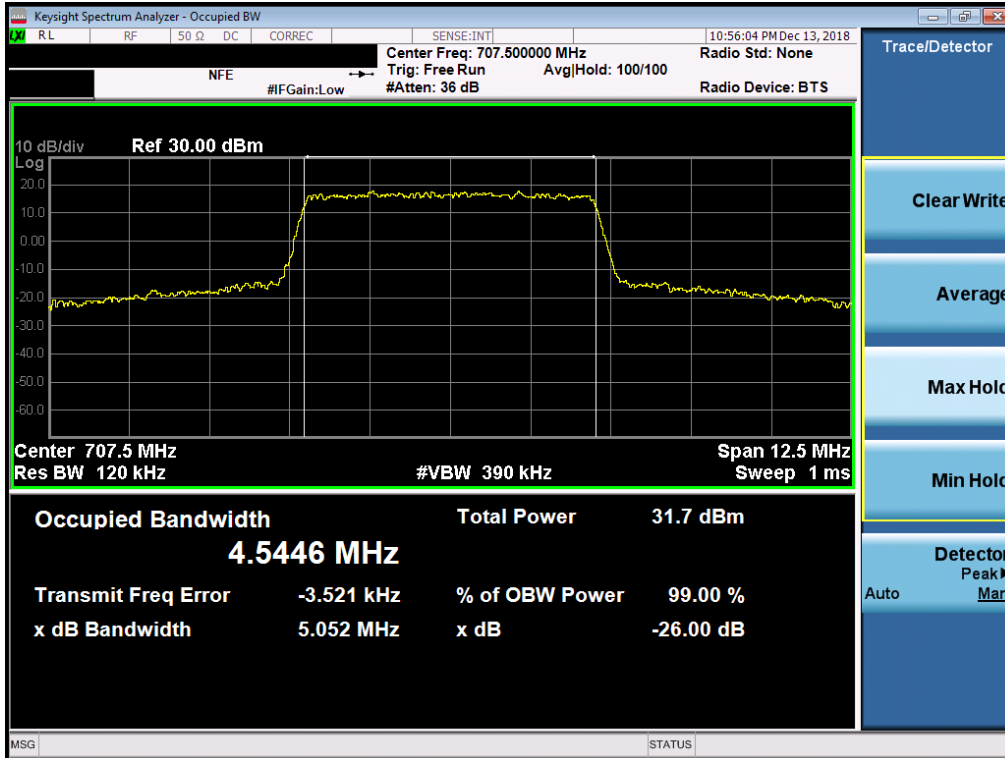

Plot 7-5. Occupied Bandwidth Plot (Band 12 - 5.0MHz QPSK - Full RB Configuration)

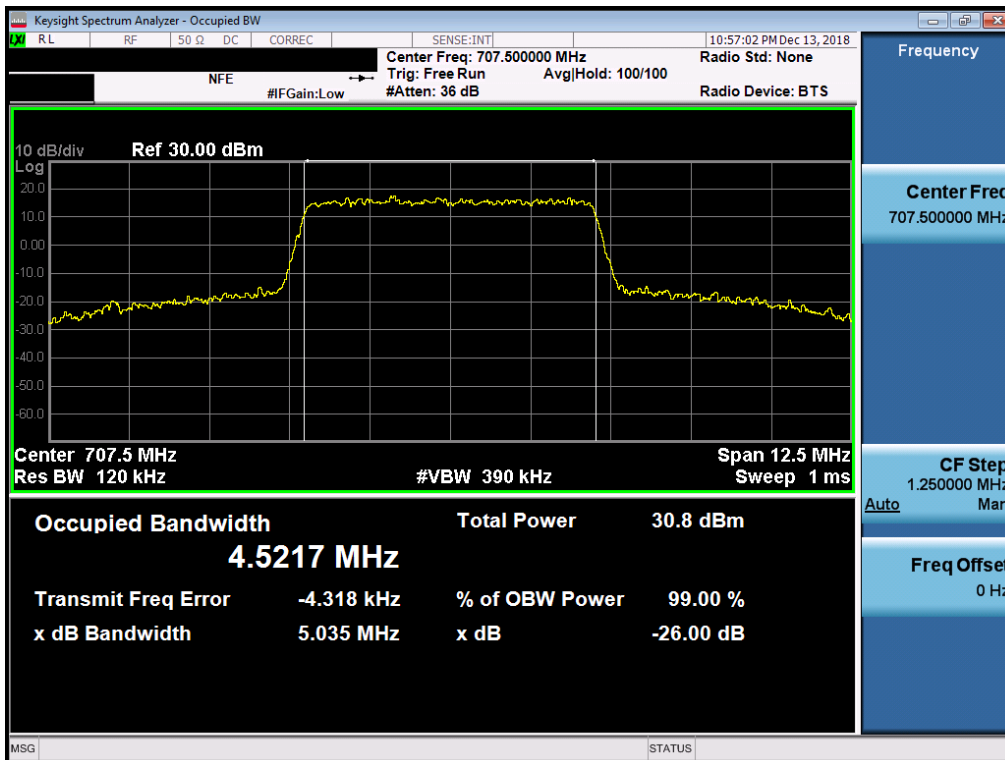

Plot 7-6. Occupied Bandwidth Plot (Band 12 - 5.0MHz 16-QAM - Full RB Configuration)

FCC ID: ZNFX220QM		MEASUREMENT REPORT (CERTIFICATION)		Approved by: Quality Manager
Test Report S/N: 1M1812110223-03.ZNF	Test Dates: 12/10-12/21/2018	EUT Type: Portable Handset		Page 18 of 134

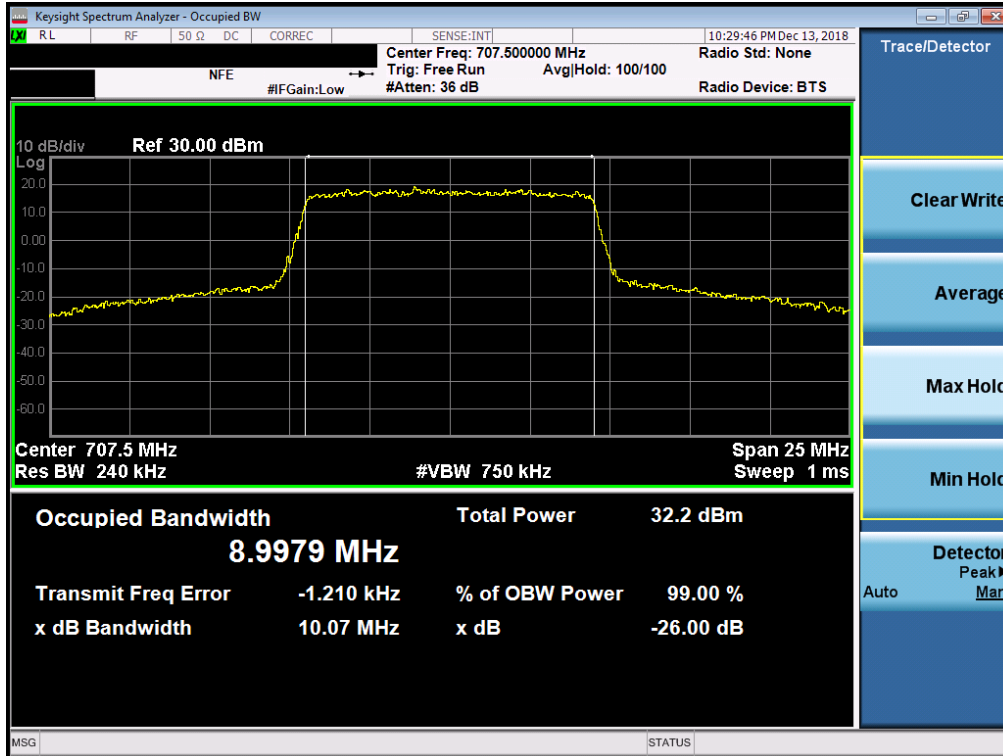

Plot 7-7. Occupied Bandwidth Plot (Band 12 - 10.0MHz QPSK - Full RB Configuration)

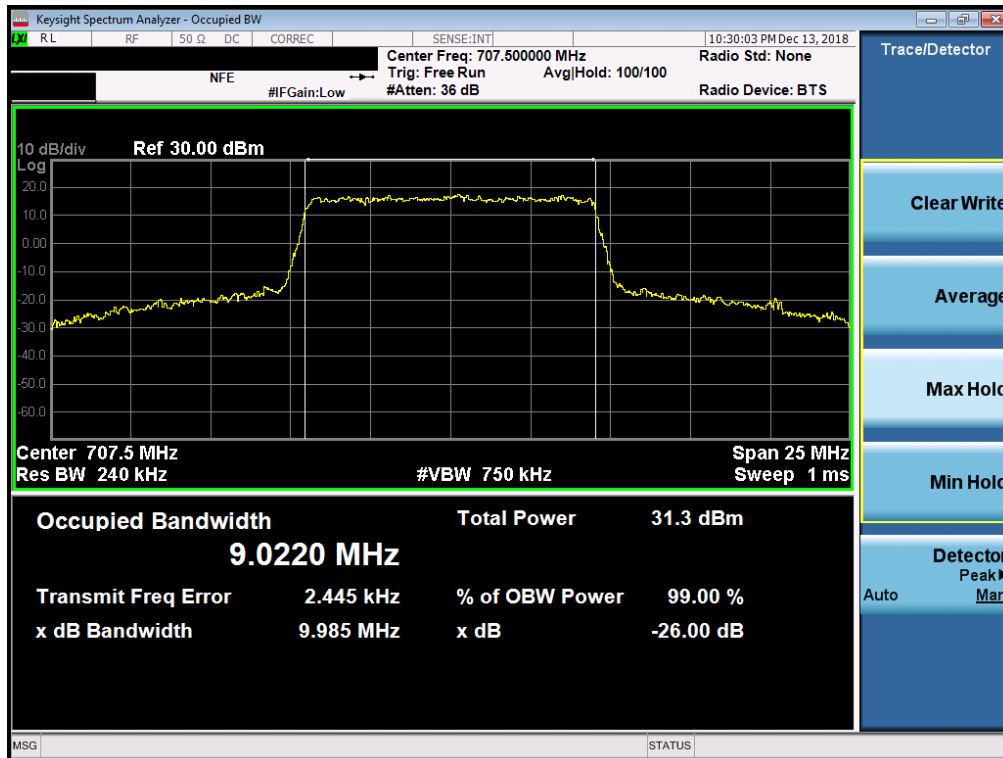

Plot 7-8. Occupied Bandwidth Plot (Band 12 - 10.0MHz 16-QAM - Full RB Configuration)

FCC ID: ZNFX220QM		MEASUREMENT REPORT (CERTIFICATION)		Approved by: Quality Manager
Test Report S/N: 1M1812110223-03.ZNF	Test Dates: 12/10-12/21/2018	EUT Type: Portable Handset		Page 19 of 134

**Band 5**

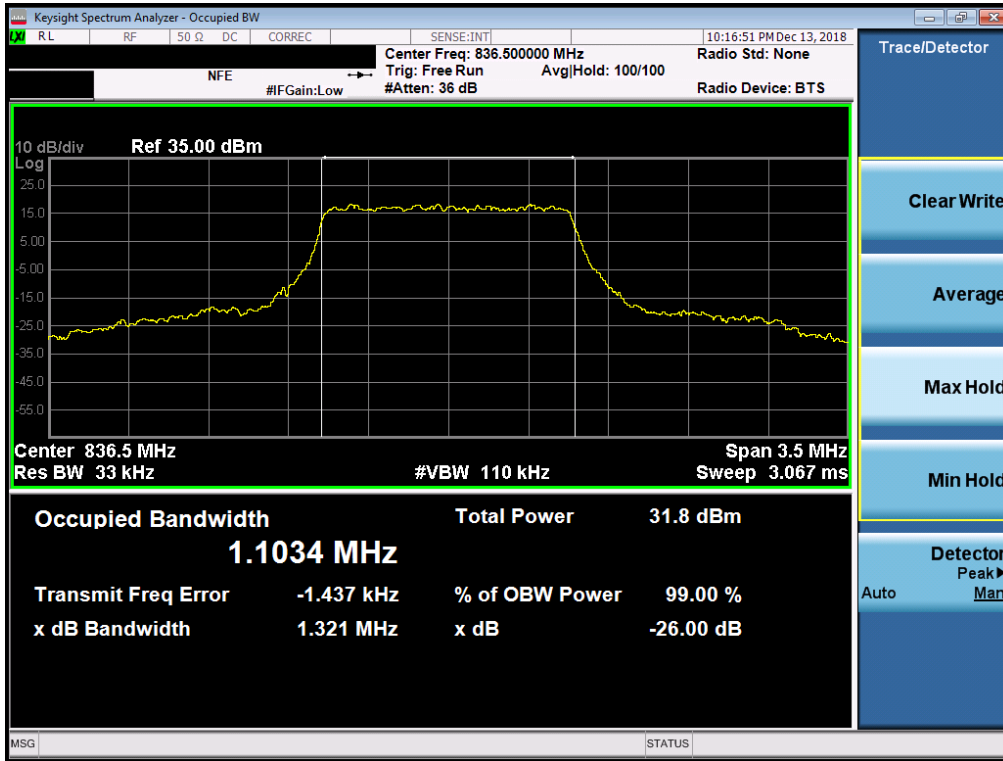

**Plot 7-9. Occupied Bandwidth Plot (Band 5 - 1.4MHz QPSK - Full RB Configuration)**

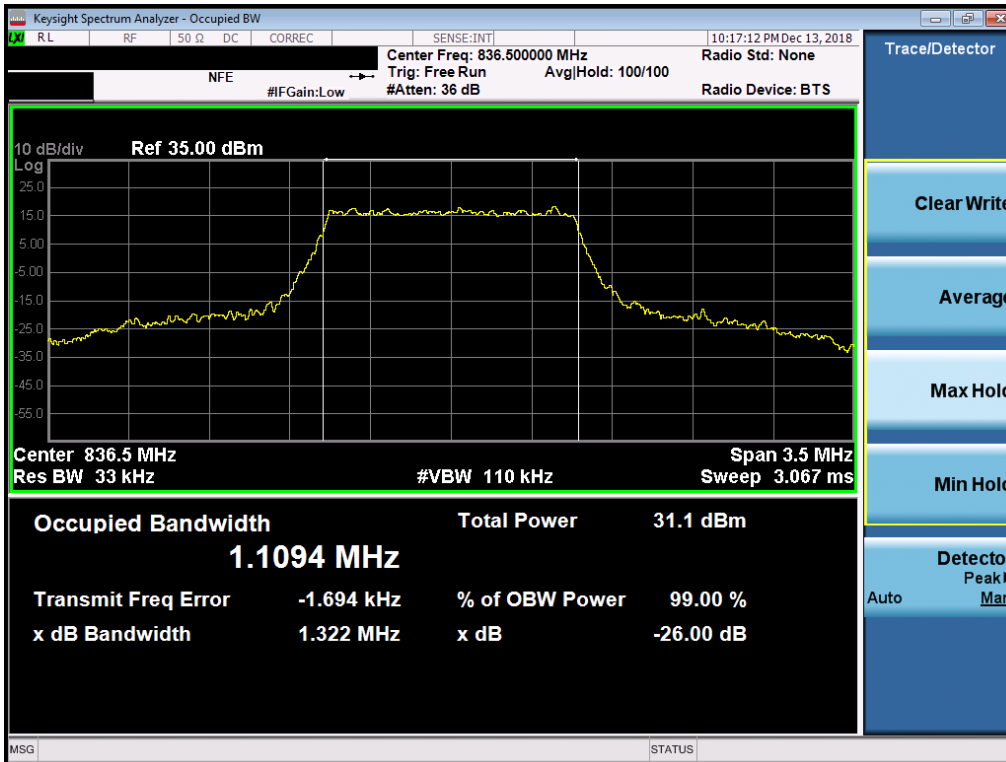

**Plot 7-10. Occupied Bandwidth Plot (Band 5 - 1.4MHz 16-QAM - Full RB Configuration)**

FCC ID: ZNFX220QM		MEASUREMENT REPORT (CERTIFICATION)		Approved by: Quality Manager
Test Report S/N: 1M1812110223-03.ZNF	Test Dates: 12/10-12/21/2018	EUT Type: Portable Handset		Page 20 of 134

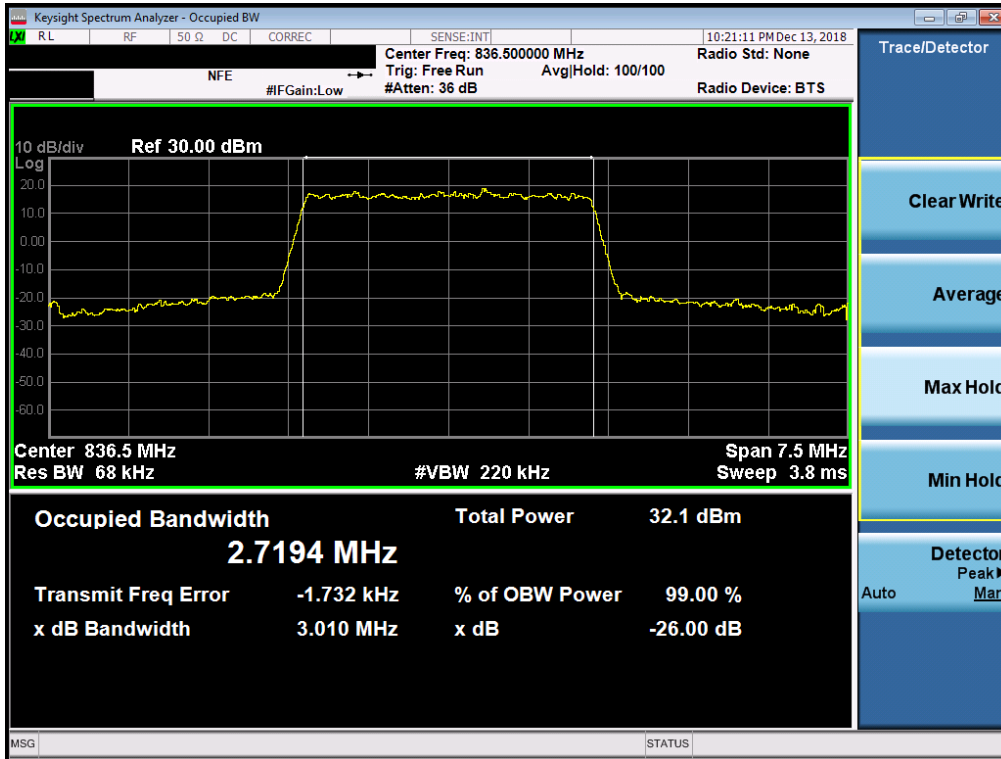

Plot 7-11. Occupied Bandwidth Plot (Band 5 - 3.0MHz QPSK - Full RB Configuration)

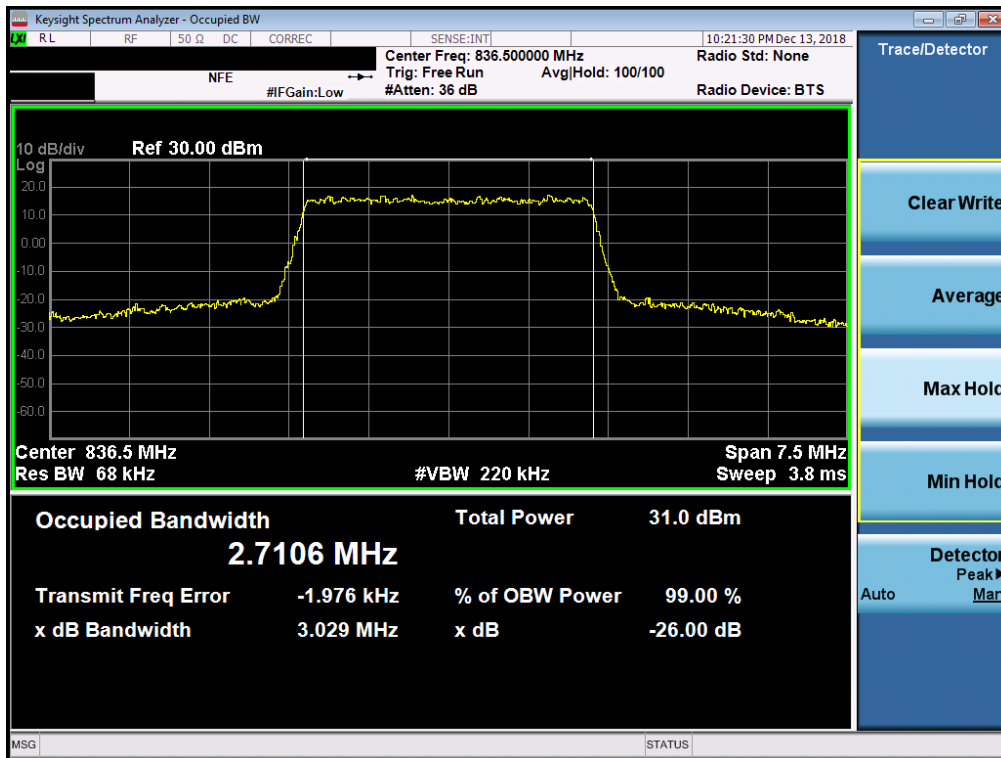

Plot 7-12. Occupied Bandwidth Plot (Band 5 - 3.0MHz 16-QAM - Full RB Configuration)

FCC ID: ZNFX220QM		MEASUREMENT REPORT (CERTIFICATION)		Approved by: Quality Manager
Test Report S/N: 1M1812110223-03.ZNF	Test Dates: 12/10-12/21/2018	EUT Type: Portable Handset		Page 21 of 134

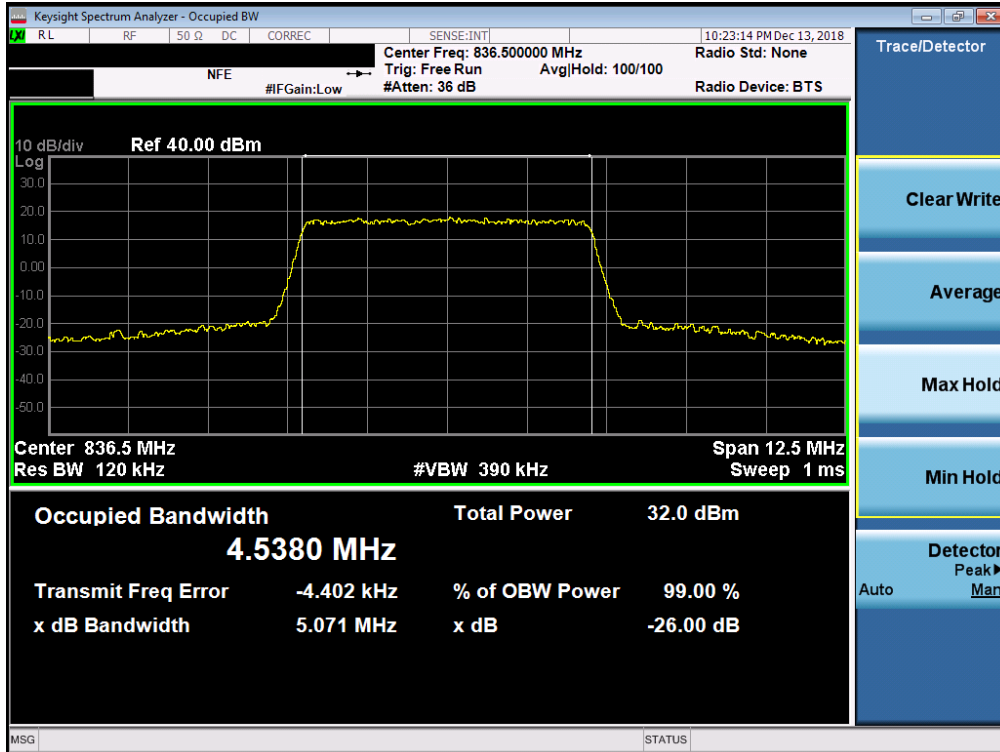

Plot 7-13. Occupied Bandwidth Plot (Band 5 - 5.0MHz QPSK - Full RB Configuration)



Plot 7-14. Occupied Bandwidth Plot (Band 5 - 5.0MHz 16-QAM - Full RB Configuration)

FCC ID: ZNFX220QM		MEASUREMENT REPORT (CERTIFICATION)		Approved by: Quality Manager
Test Report S/N: 1M1812110223-03.ZNF	Test Dates: 12/10-12/21/2018	EUT Type: Portable Handset		Page 22 of 134

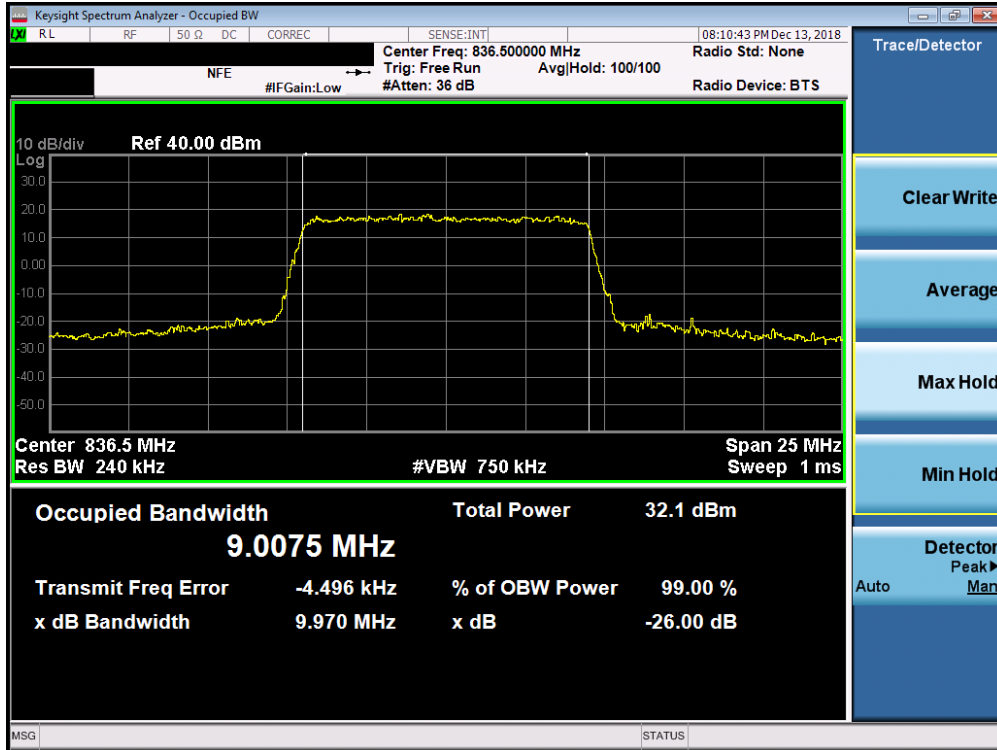

Plot 7-15. Occupied Bandwidth Plot (Band 5 - 10.0MHz QPSK - Full RB Configuration)



Plot 7-16. Occupied Bandwidth Plot (Band 5 - 10.0MHz 16-QAM - Full RB Configuration)

FCC ID: ZNFX220QM		MEASUREMENT REPORT (CERTIFICATION)		Approved by: Quality Manager
Test Report S/N: 1M1812110223-03.ZNF	Test Dates: 12/10-12/21/2018	EUT Type: Portable Handset		Page 23 of 134

**Band 4**

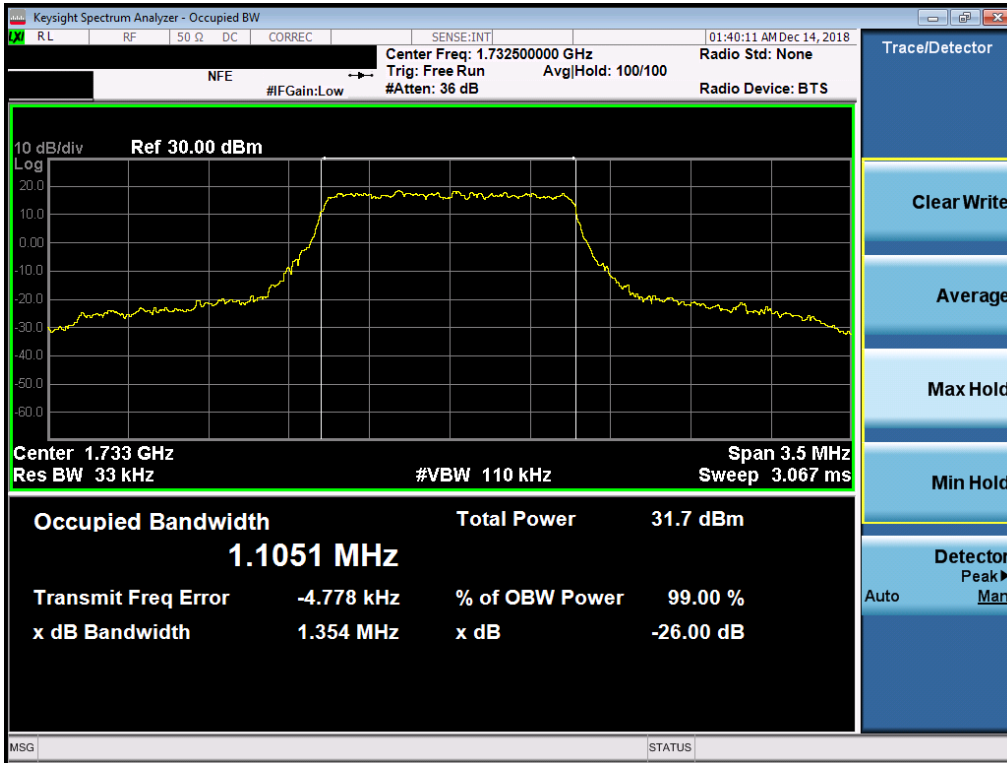

**Plot 7-17. Occupied Bandwidth Plot (Band 4 - 1.4MHz QPSK - Full RB Configuration)**

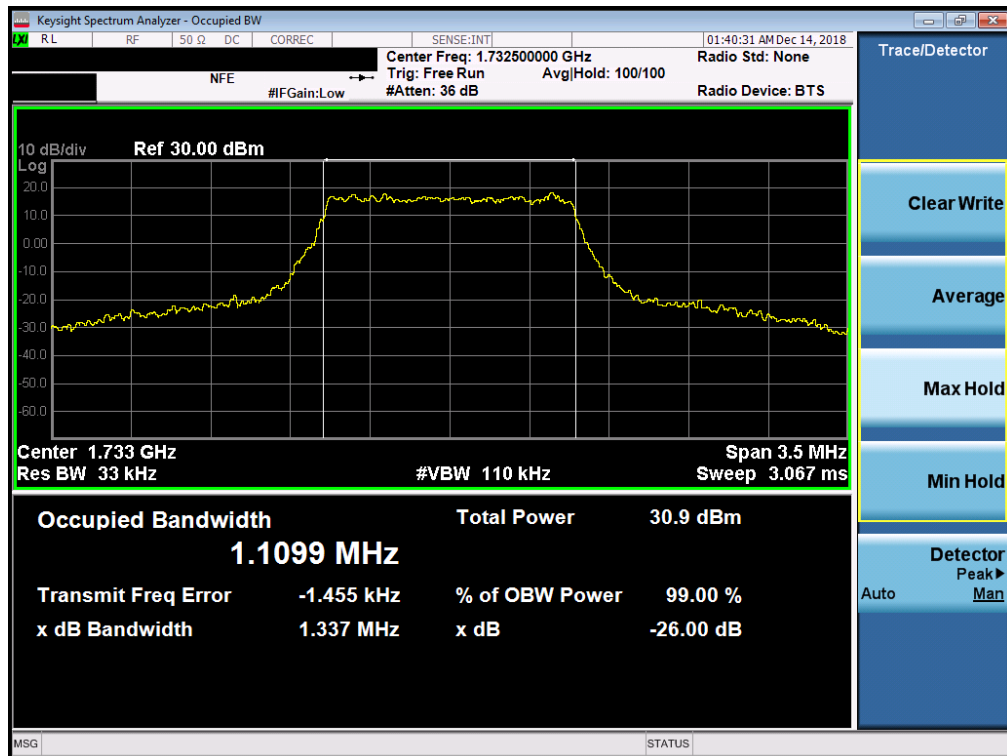

**Plot 7-18. Occupied Bandwidth Plot (Band 4 - 1.4MHz 16-QAM - Full RB Configuration)**

FCC ID: ZNFX220QM		MEASUREMENT REPORT (CERTIFICATION)		Approved by: Quality Manager
Test Report S/N: 1M1812110223-03.ZNF	Test Dates: 12/10-12/21/2018	EUT Type: Portable Handset		Page 24 of 134



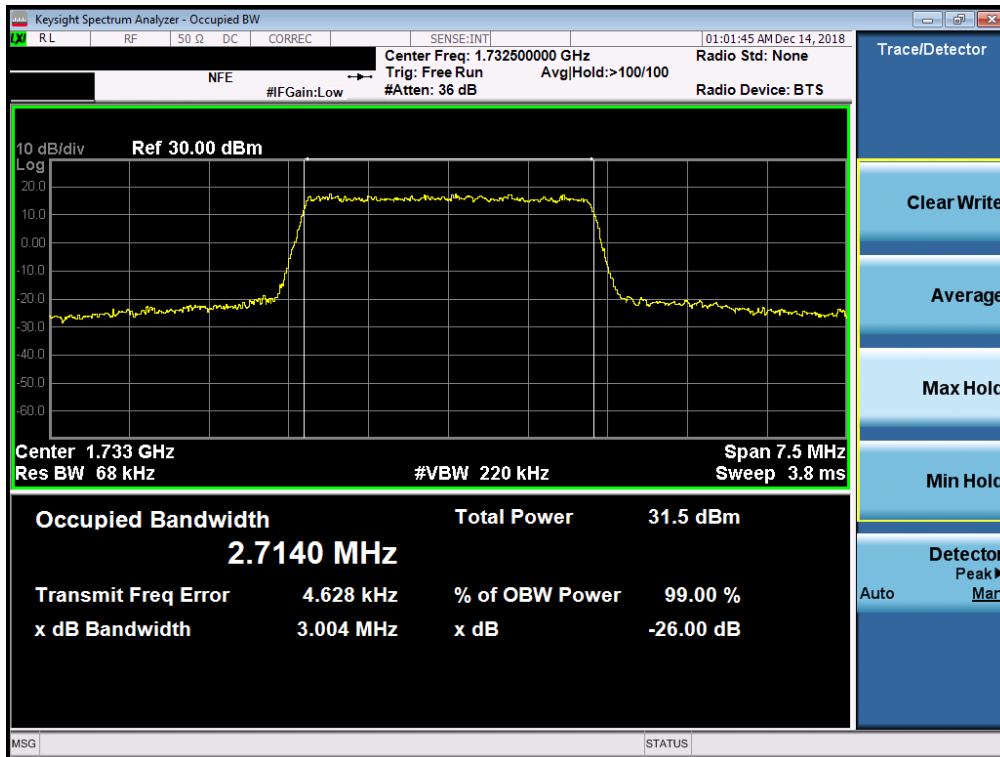

Plot 7-19. Occupied Bandwidth Plot (Band 4 - 3.0MHz QPSK - Full RB Configuration)

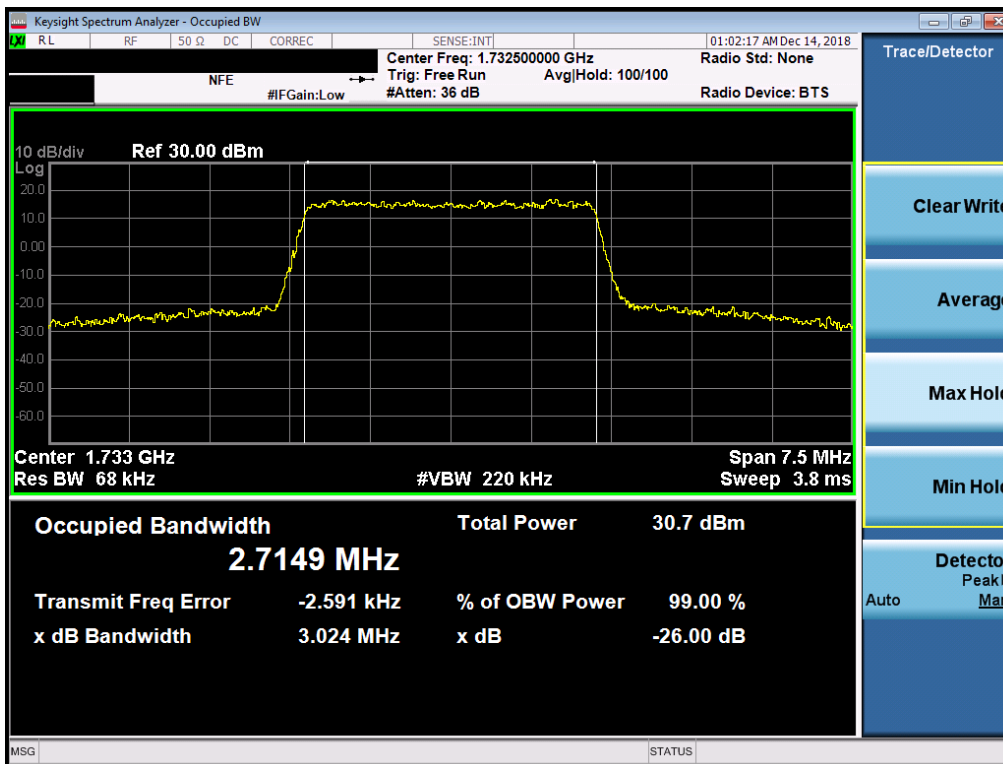

Plot 7-20. Occupied Bandwidth Plot (Band 4 - 3.0MHz 16-QAM - Full RB Configuration)

FCC ID: ZNFX220QM		MEASUREMENT REPORT (CERTIFICATION)		Approved by: Quality Manager
Test Report S/N: 1M1812110223-03.ZNF	Test Dates: 12/10-12/21/2018	EUT Type: Portable Handset		Page 25 of 134



Plot 7-21. Occupied Bandwidth Plot (Band 4 - 5.0MHz QPSK - Full RB Configuration)

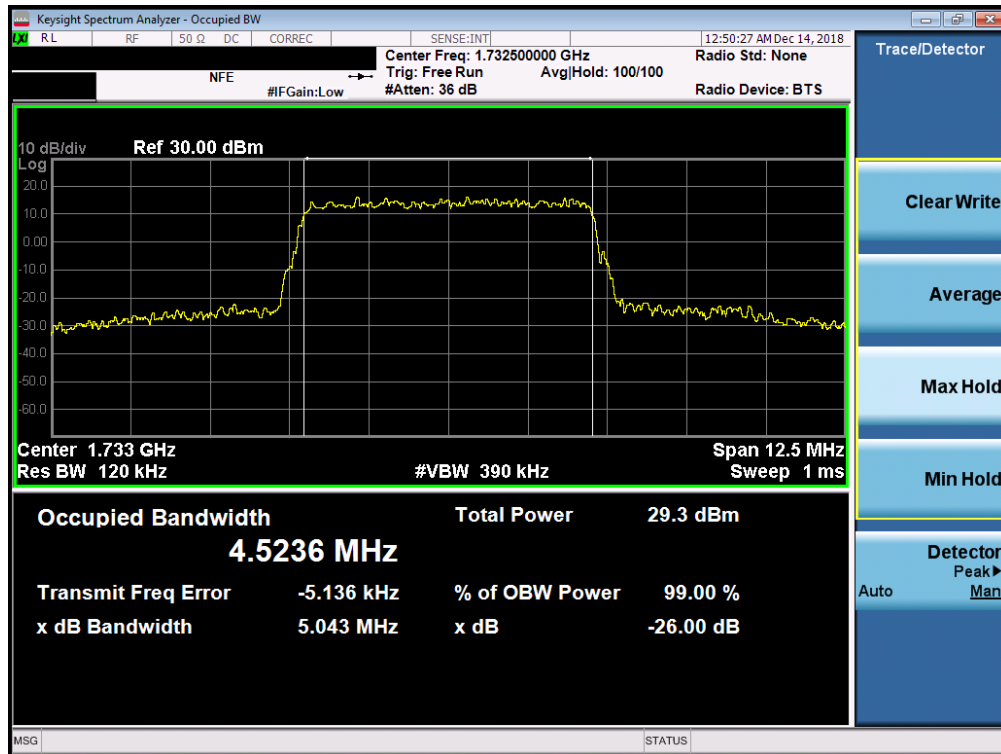

Plot 7-22. Occupied Bandwidth Plot (Band 4 - 5.0MHz 16-QAM - Full RB Configuration)

FCC ID: ZNFX220QM		MEASUREMENT REPORT (CERTIFICATION)		Approved by: Quality Manager
Test Report S/N: 1M1812110223-03.ZNF	Test Dates: 12/10-12/21/2018	EUT Type: Portable Handset		Page 26 of 134

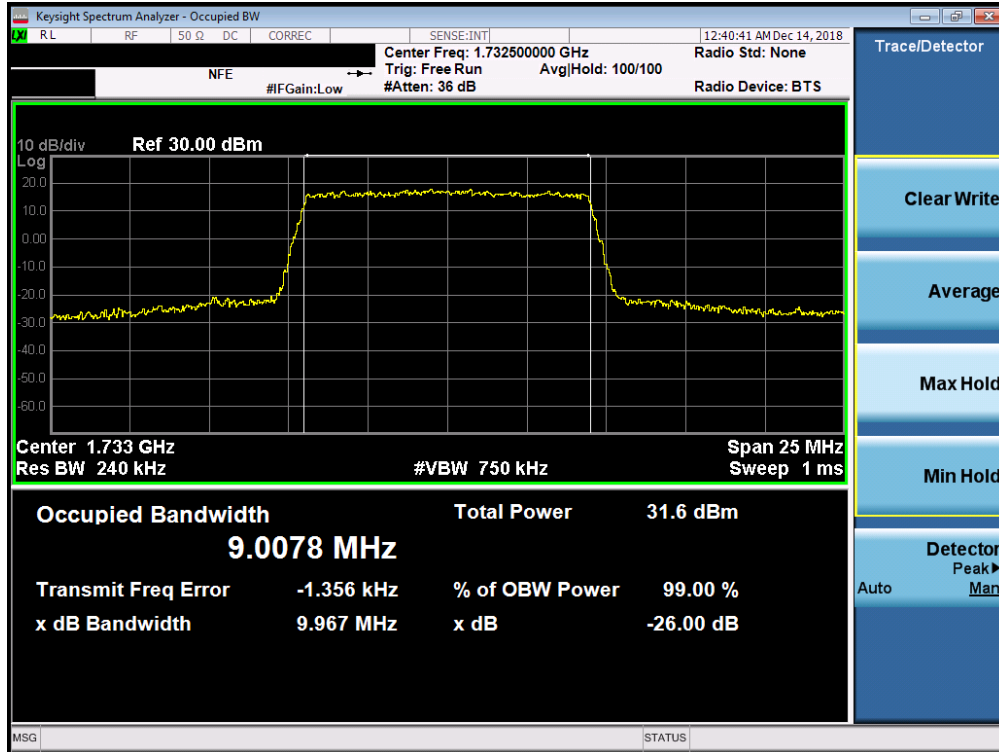

Plot 7-23. Occupied Bandwidth Plot (Band 4 - 10.0MHz QPSK - Full RB Configuration)

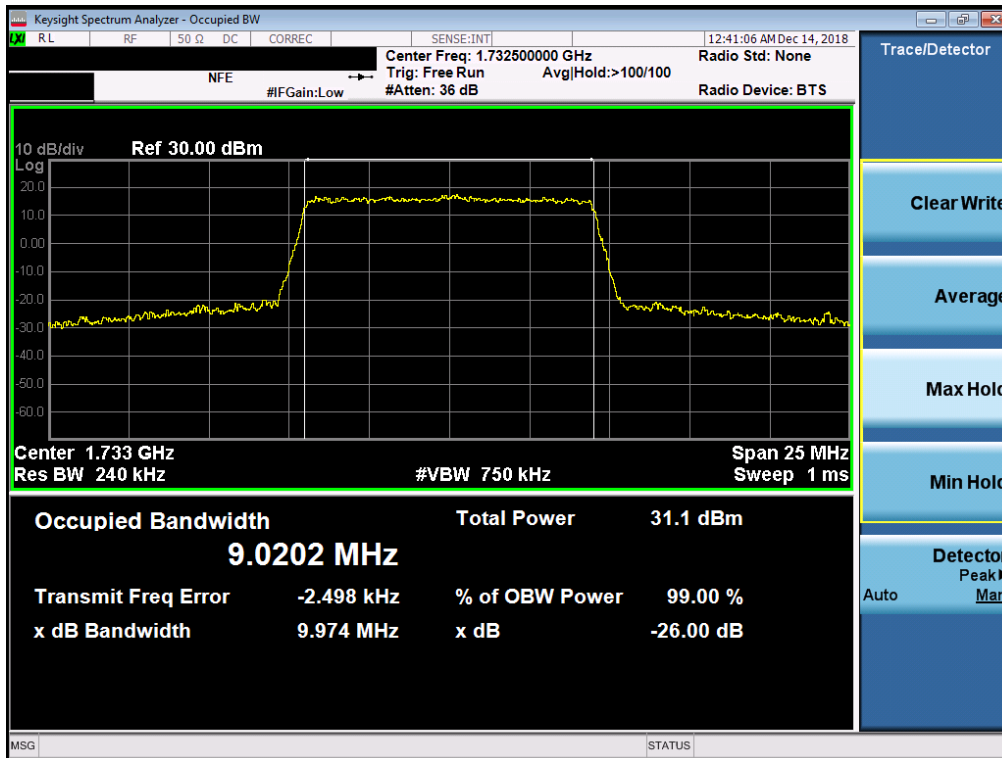

Plot 7-24. Occupied Bandwidth Plot (Band 4 - 10.0MHz 16-QAM - Full RB Configuration)

FCC ID: ZNFX220QM		MEASUREMENT REPORT (CERTIFICATION)		Approved by: Quality Manager
Test Report S/N: 1M1812110223-03.ZNF	Test Dates: 12/10-12/21/2018	EUT Type: Portable Handset		Page 27 of 134

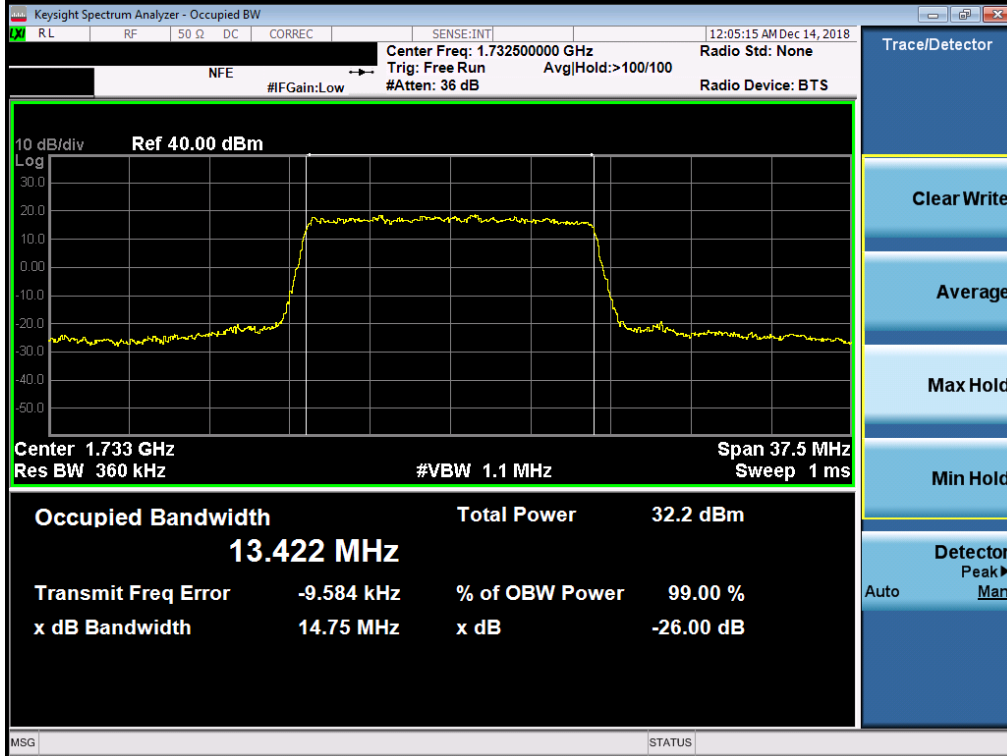

Plot 7-25. Occupied Bandwidth Plot (Band 4 - 15.0MHz QPSK - Full RB Configuration)

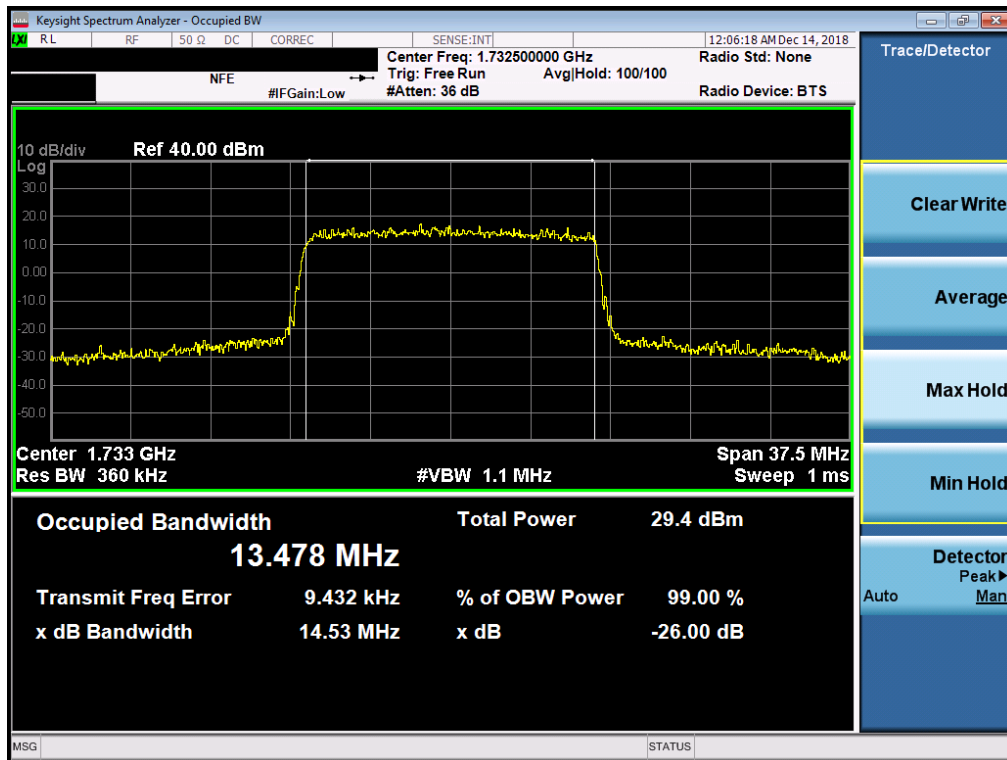

Plot 7-26. Occupied Bandwidth Plot (Band 4 - 15.0MHz 16-QAM - Full RB Configuration)

FCC ID: ZNFX220QM		MEASUREMENT REPORT (CERTIFICATION)		Approved by: Quality Manager
Test Report S/N: 1M1812110223-03.ZNF	Test Dates: 12/10-12/21/2018	EUT Type: Portable Handset		Page 28 of 134

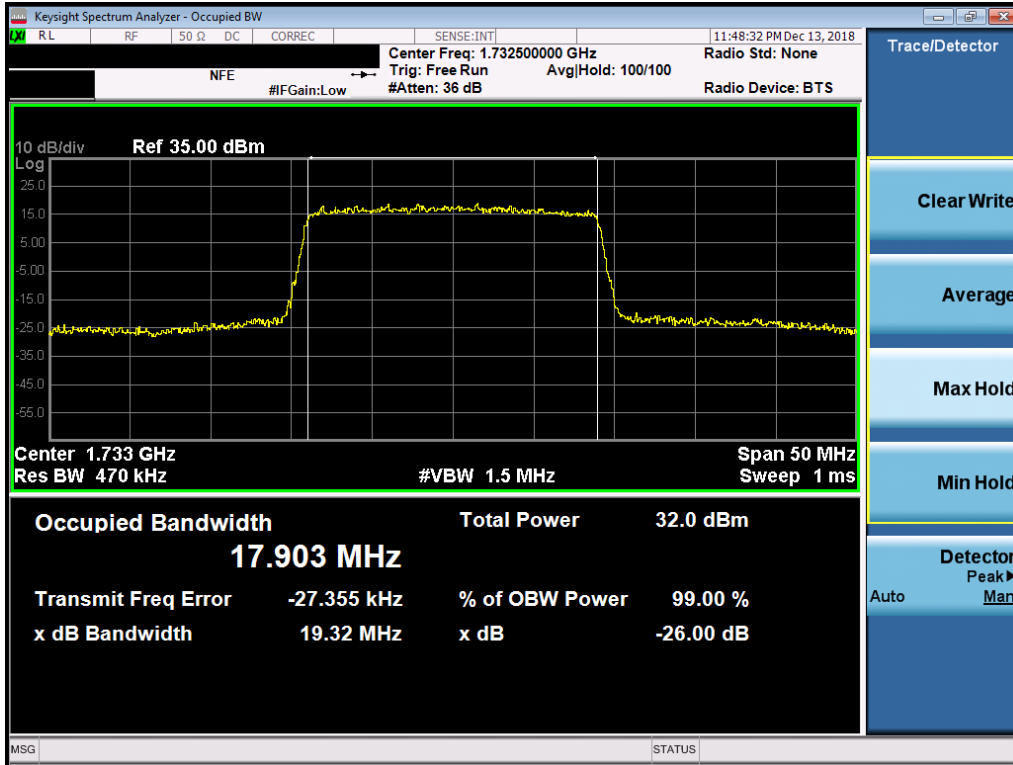

Plot 7-27. Occupied Bandwidth Plot (Band 4 - 20.0MHz QPSK - Full RB Configuration)

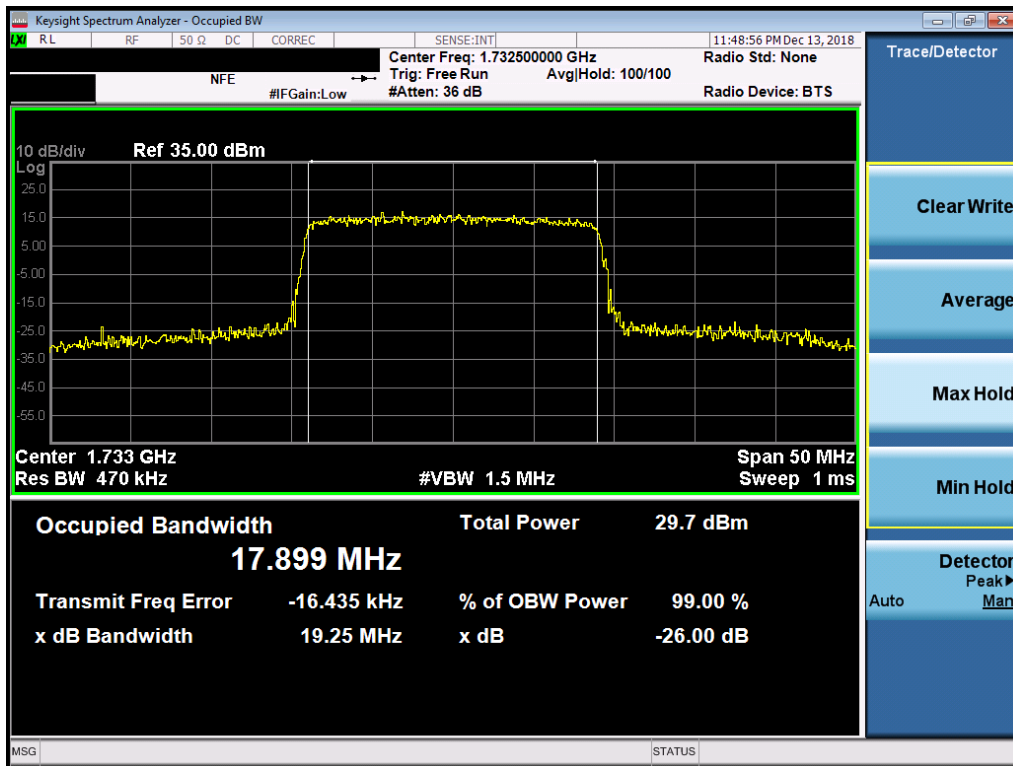

Plot 7-28. Occupied Bandwidth Plot (Band 4 - 20.0MHz 16-QAM - Full RB Configuration)

FCC ID: ZNFX220QM		MEASUREMENT REPORT (CERTIFICATION)		Approved by: Quality Manager
Test Report S/N: 1M1812110223-03.ZNF	Test Dates: 12/10-12/21/2018	EUT Type: Portable Handset		Page 29 of 134

**Band 25/2**

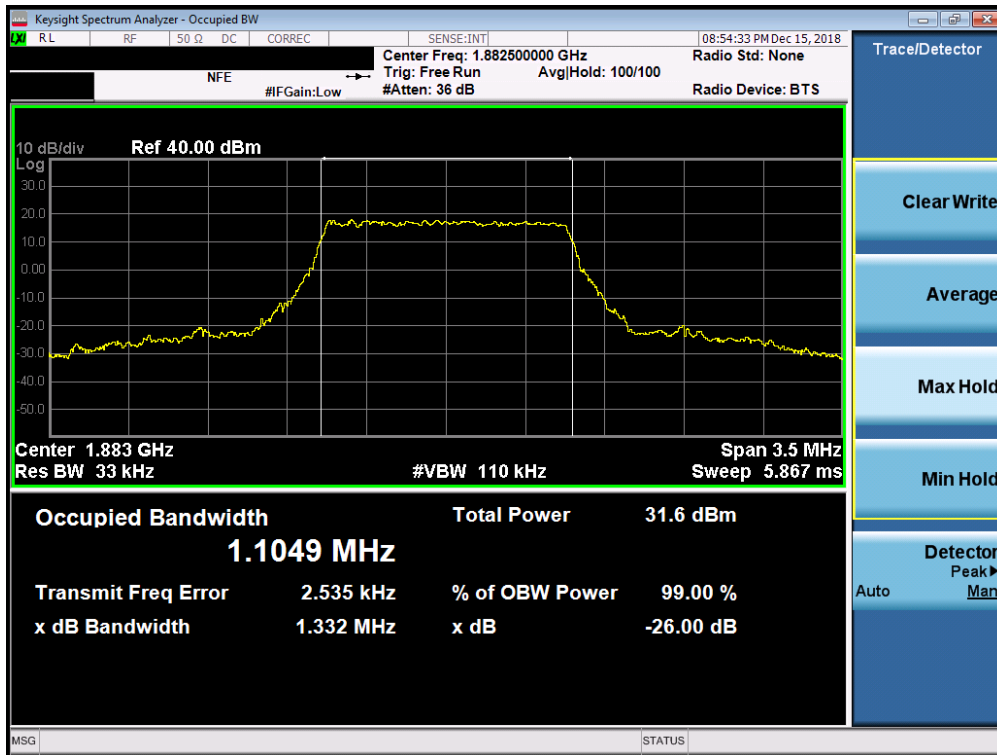

**Plot 7-29. Occupied Bandwidth Plot (Band 25/2 - 1.4MHz QPSK - Full RB Configuration)**

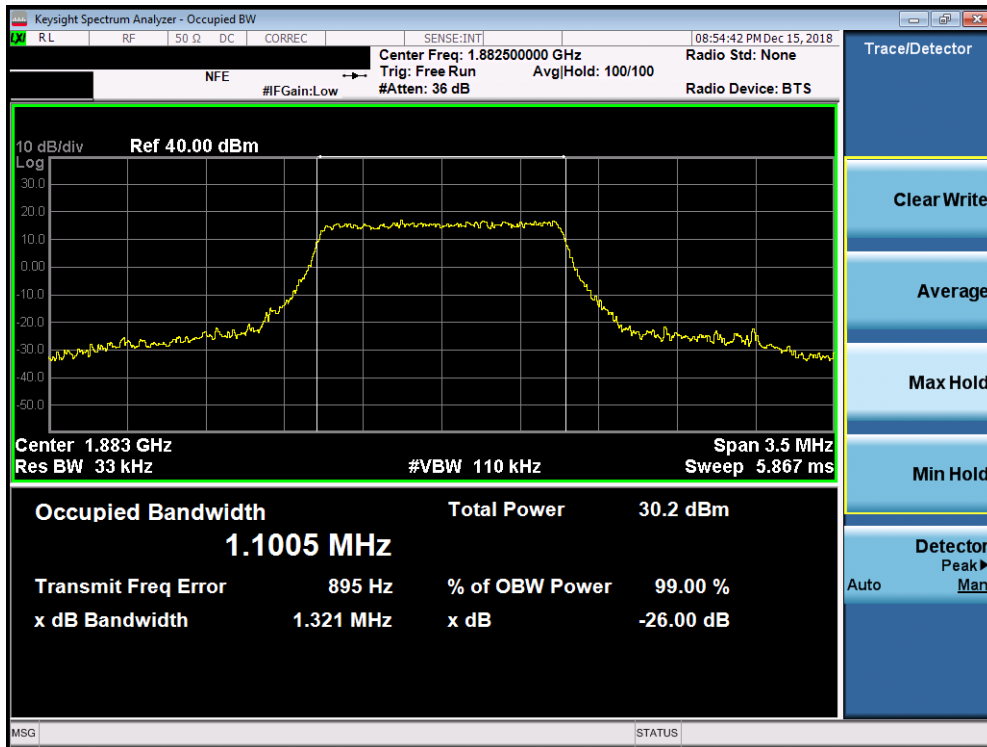

**Plot 7-30. Occupied Bandwidth Plot (Band 25/2 - 1.4MHz 16-QAM - Full RB Configuration)**

FCC ID: ZNFX220QM	PCTEST ENGINEERING LABORATORY, INC.	MEASUREMENT REPORT (CERTIFICATION)	LG	Approved by: Quality Manager
Test Report S/N: 1M1812110223-03.ZNF	Test Dates: 12/10-12/21/2018	EUT Type: Portable Handset		Page 30 of 134

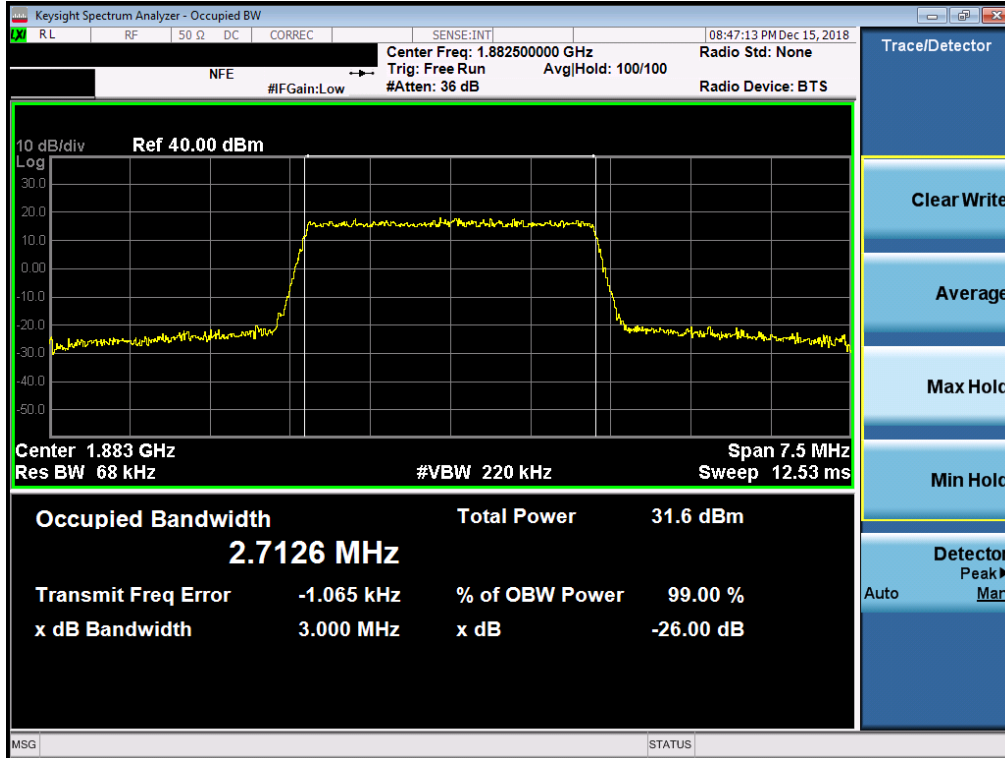

Plot 7-31. Occupied Bandwidth Plot (Band 25/2 - 3.0MHz QPSK - Full RB Configuration)

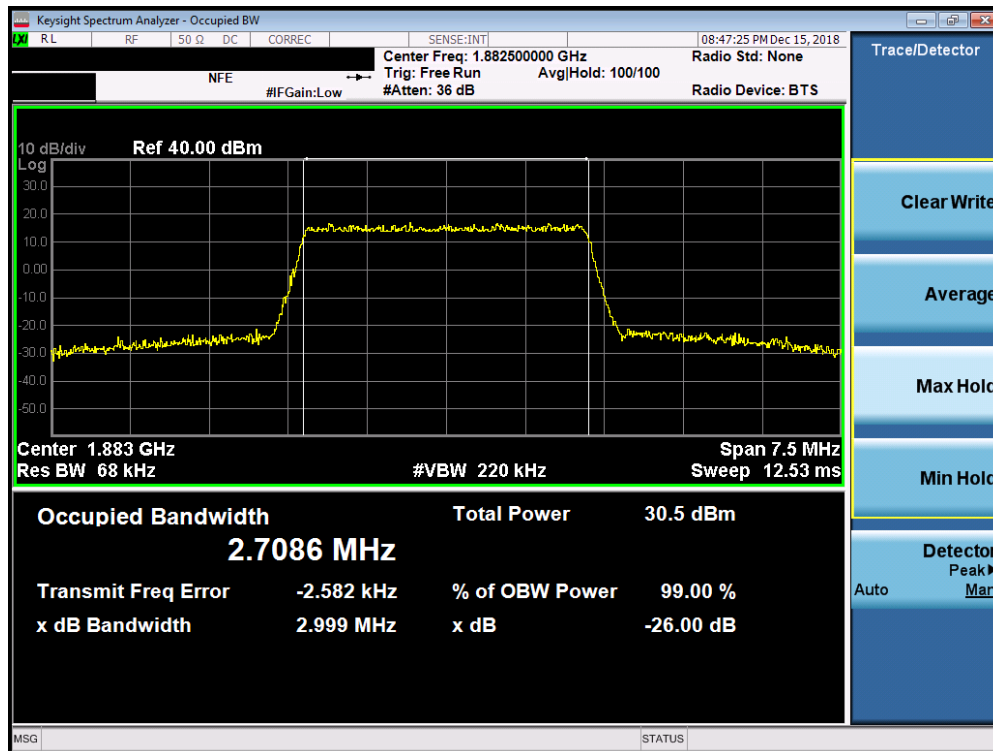

Plot 7-32. Occupied Bandwidth Plot (Band 25/2 - 3.0MHz 16-QAM - Full RB Configuration)

FCC ID: ZNFX220QM		<b>MEASUREMENT REPORT (CERTIFICATION)</b>		Approved by: Quality Manager
Test Report S/N: 1M1812110223-03.ZNF	Test Dates: 12/10-12/21/2018	EUT Type: Portable Handset		Page 31 of 134

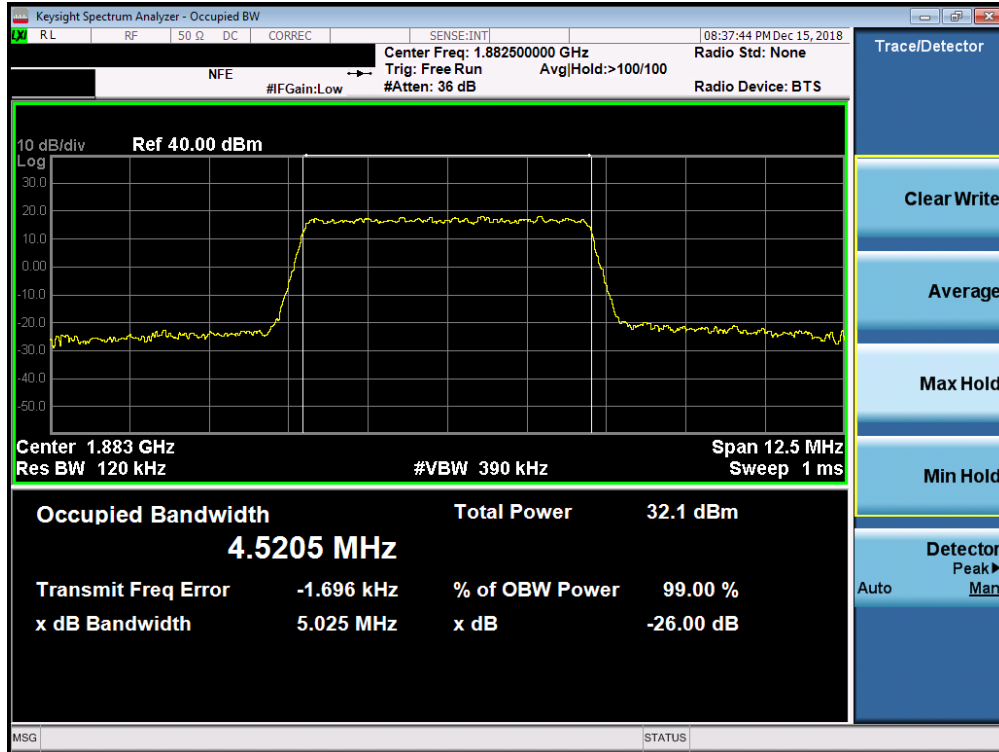

Plot 7-33. Occupied Bandwidth Plot (Band 25/2 - 5.0MHz QPSK - Full RB Configuration)

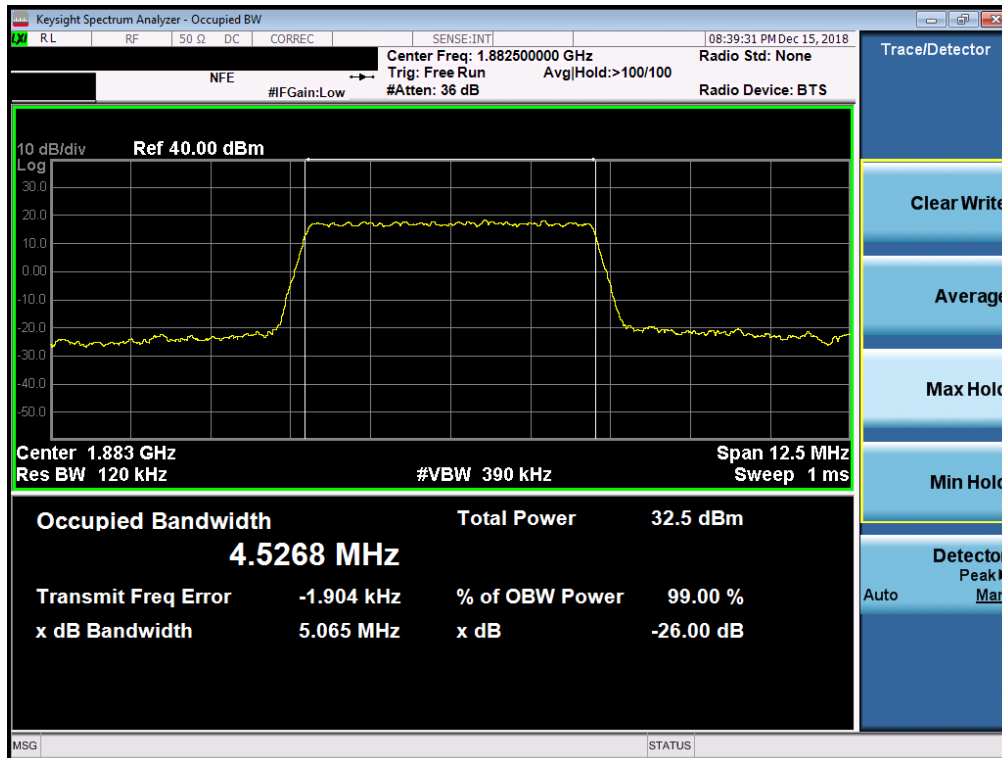

Plot 7-34. Occupied Bandwidth Plot (Band 25/2 - 5.0MHz 16-QAM - Full RB Configuration)

FCC ID: ZNFX220QM		MEASUREMENT REPORT (CERTIFICATION)		Approved by: Quality Manager
Test Report S/N: 1M1812110223-03.ZNF	Test Dates: 12/10-12/21/2018	EUT Type: Portable Handset		Page 32 of 134



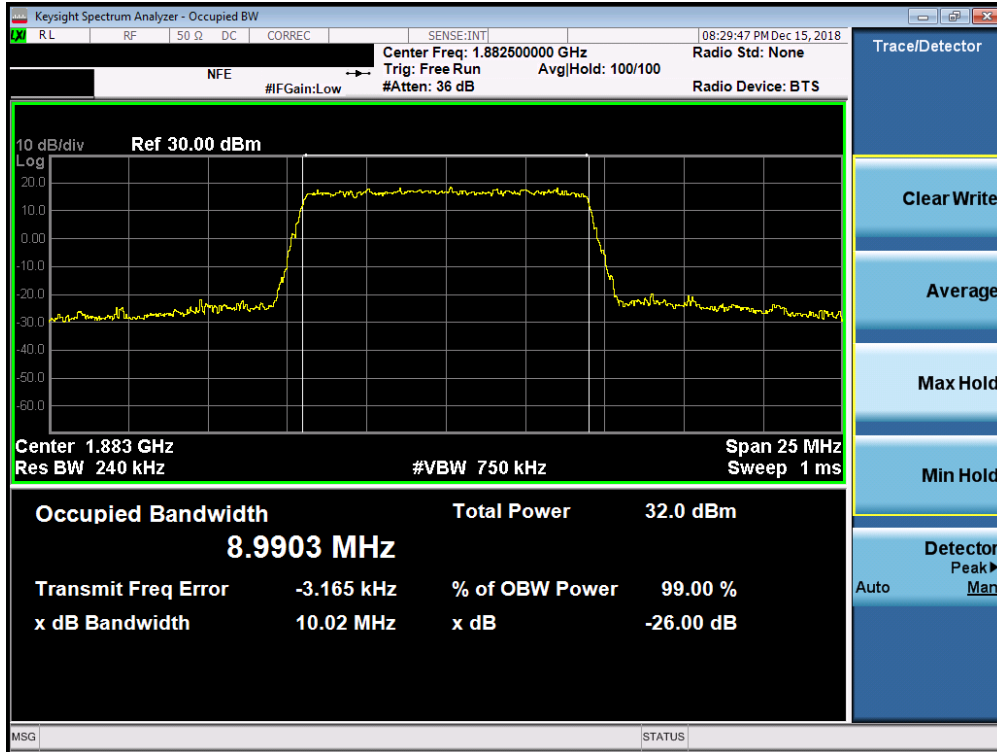

Plot 7-35. Occupied Bandwidth Plot (Band 25/2 - 10.0MHz QPSK - Full RB Configuration)

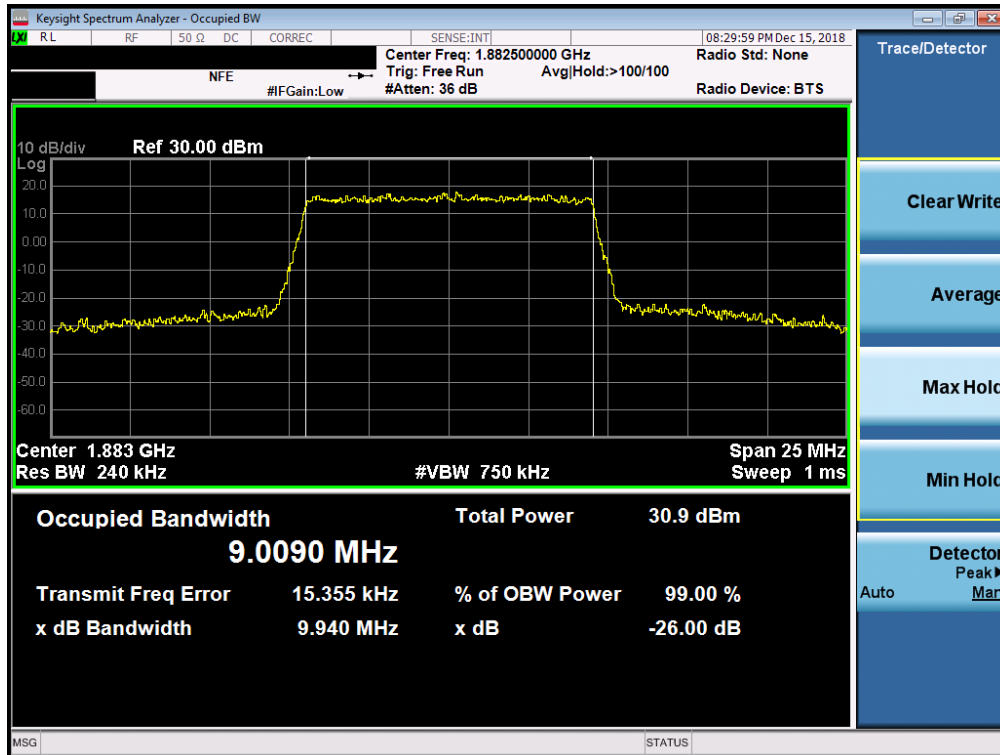

Plot 7-36. Occupied Bandwidth Plot (Band 25/2 - 10.0MHz 16-QAM - Full RB Configuration)

FCC ID: ZNFX220QM		MEASUREMENT REPORT (CERTIFICATION)		Approved by: Quality Manager
Test Report S/N: 1M1812110223-03.ZNF	Test Dates: 12/10-12/21/2018	EUT Type: Portable Handset		Page 33 of 134

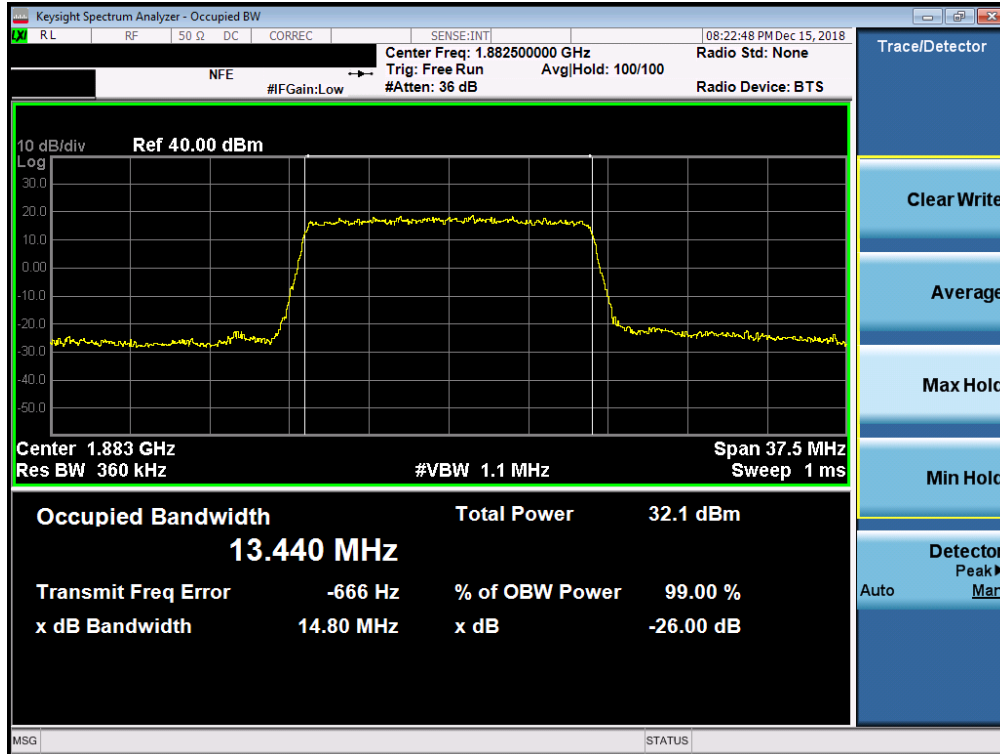

Plot 7-37. Occupied Bandwidth Plot (Band 25/2 - 15.0MHz QPSK - Full RB Configuration)

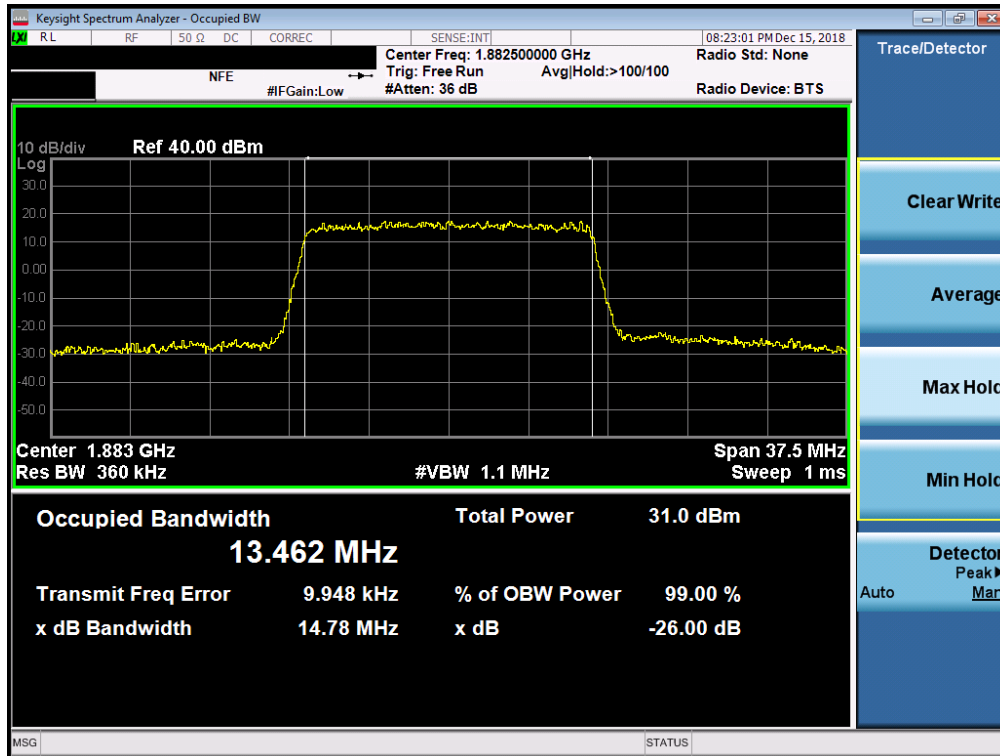

Plot 7-38. Occupied Bandwidth Plot (Band 25/2 - 15.0MHz 16-QAM - Full RB Configuration)

FCC ID: ZNFX220QM		MEASUREMENT REPORT (CERTIFICATION)		Approved by: Quality Manager
Test Report S/N: 1M1812110223-03.ZNF	Test Dates: 12/10-12/21/2018	EUT Type: Portable Handset		Page 34 of 134

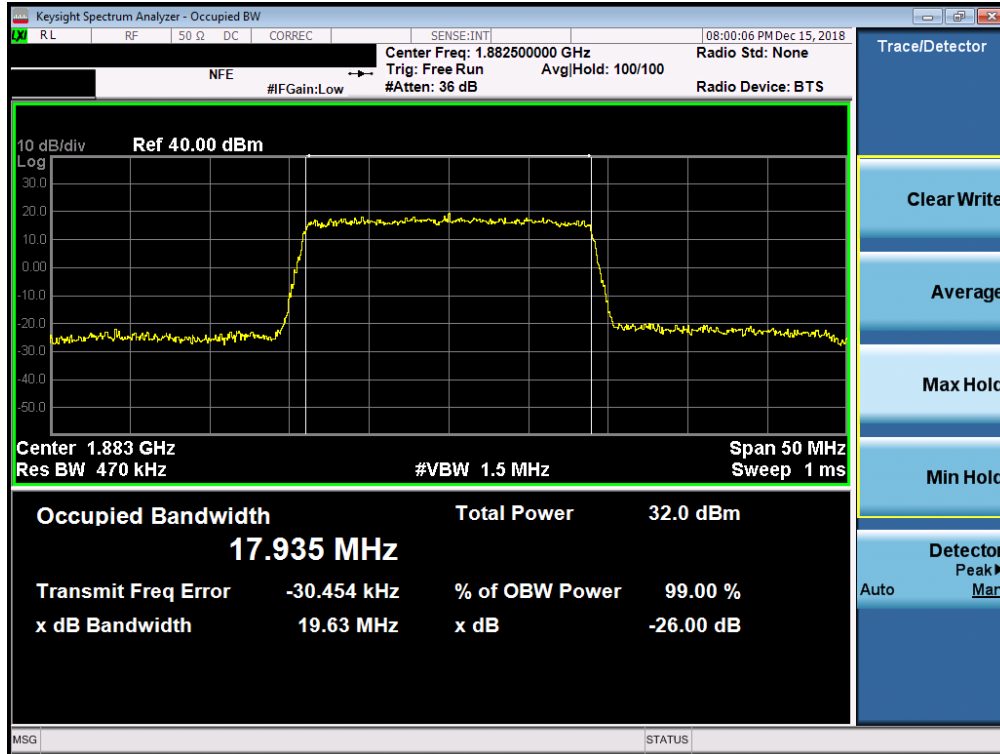

Plot 7-39. Occupied Bandwidth Plot (Band 25/2 - 20.0MHz QPSK - Full RB Configuration)

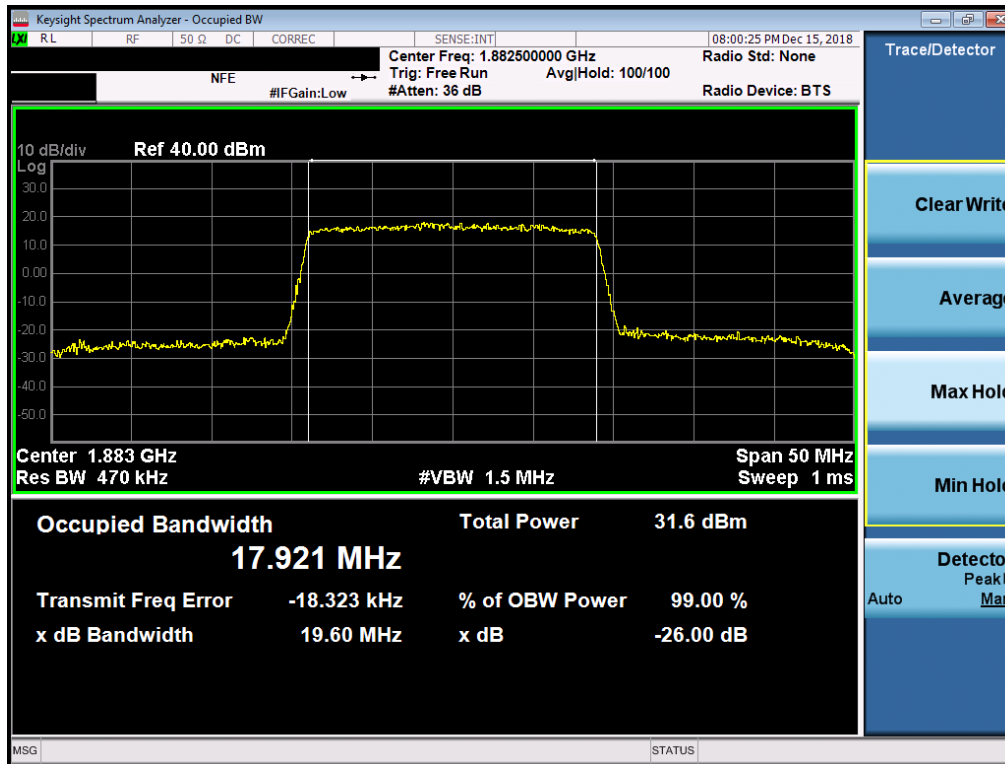

Plot 7-40. Occupied Bandwidth Plot (Band 25/2 - 20.0MHz 16-QAM - Full RB Configuration)

FCC ID: ZNFX220QM		MEASUREMENT REPORT (CERTIFICATION)		Approved by: Quality Manager
Test Report S/N: 1M1812110223-03.ZNF	Test Dates: 12/10-12/21/2018	EUT Type: Portable Handset		Page 35 of 134

### 7.3 Spurious and Harmonic Emissions at Antenna Terminal

#### Test Overview

The level of the carrier and the various conducted spurious and harmonic frequencies is measured by means of a calibrated spectrum analyzer. The spectrum is scanned from the lowest frequency generated in the equipment up to a frequency including its 10<sup>th</sup> harmonic. All out of band emissions are measured with a spectrum analyzer connected to the antenna terminal of the EUT while the EUT is operating at its maximum duty cycle, at maximum power, and at the appropriate frequencies. All data rates were investigated to determine the worst case configuration. All modes of operation were investigated and the worst case configuration results are reported in this section.

**The minimum permissible attenuation level of any spurious emission is  $43 + 10\log_{10}(P_{[Watts]})$ , where P is the transmitter power in Watts.**

#### Test Procedure Used

KDB 971168 D01 v03r01 – Section 6.0

#### Test Settings

1. Start frequency was set to 30MHz and stop frequency was set to at least 10 \* the fundamental frequency (separated into at least two plots per channel)
2. Detector = RMS
3. Trace mode = trace average for continuous emissions, max hold for pulse emissions
4. Sweep time = auto couple
5. The trace was allowed to stabilize
6. Please see test notes below for RBW and VBW settings

#### Test Setup

The EUT and measurement equipment were set up as shown in the diagram below.

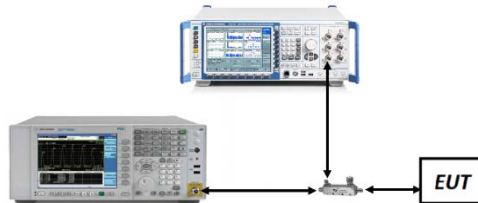

Figure 7-2. Test Instrument & Measurement Setup

#### Test Notes

Compliance with the applicable limits is based on the use of measurement instrumentation employing a resolution bandwidth of 100 kHz or greater for frequencies less than 1 GHz and 1 MHz or greater for frequencies greater than 1 GHz. However, in the 1 MHz bands immediately outside and adjacent to the frequency block a resolution bandwidth of at least one percent of the emission bandwidth of the fundamental emission of the transmitter may be employed. The emission bandwidth is defined as the width of the signal between two points, one below the carrier center frequency and one above the carrier center frequency, outside of which all emission are attenuated at least 26 dB below the transmitter power.

FCC ID: ZNFX220QM		MEASUREMENT REPORT (CERTIFICATION)		Approved by: Quality Manager
Test Report S/N: 1M1812110223-03.ZNF	Test Dates: 12/10-12/21/2018	EUT Type: Portable Handset	Page 36 of 134	

**Band 12**

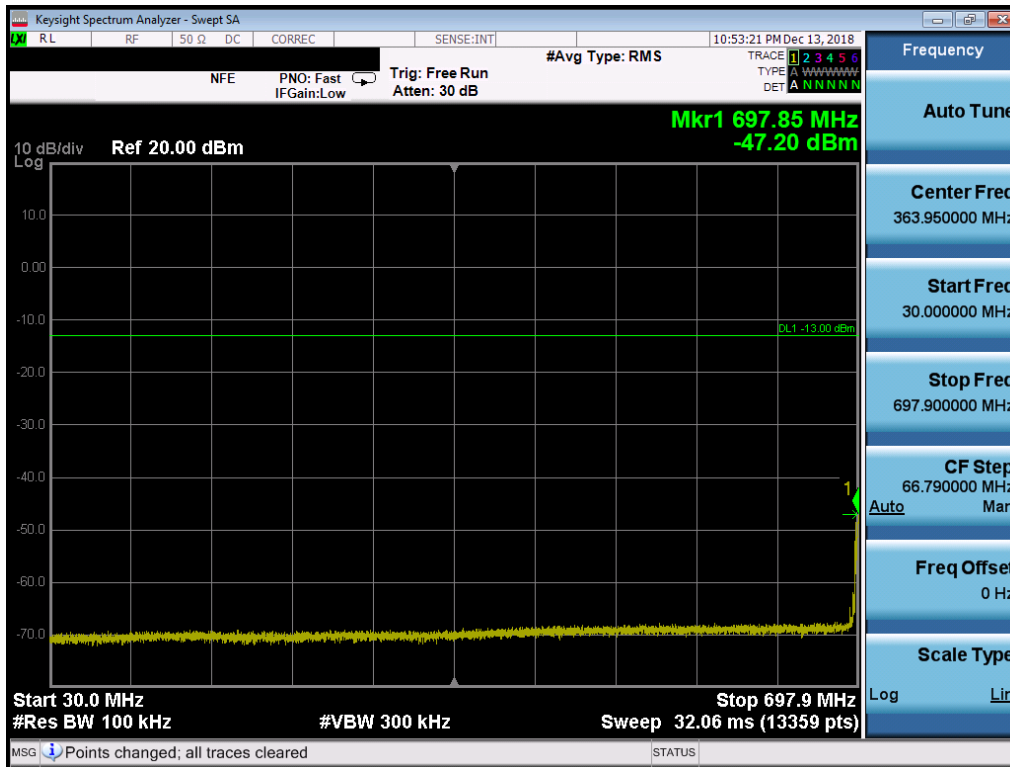

**Plot 7-41. Conducted Spurious Plot (Band 12 - 10MHz QPSK - RB Size 1, RB Offset 0 - Low Channel)**

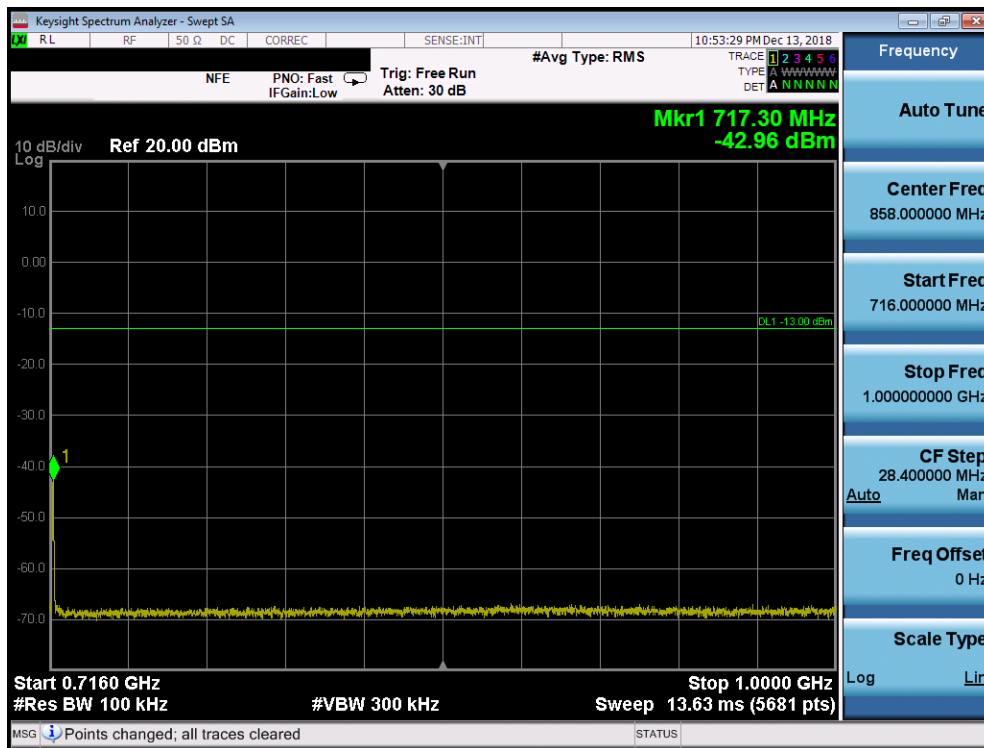

**Plot 7-42. Conducted Spurious Plot (Band 12 - 10MHz QPSK - RB Size 1, RB Offset 0 - Low Channel)**

FCC ID: ZNFX220QM		MEASUREMENT REPORT (CERTIFICATION)		Approved by: Quality Manager
Test Report S/N: 1M1812110223-03.ZNF	Test Dates: 12/10-12/21/2018	EUT Type: Portable Handset		Page 37 of 134

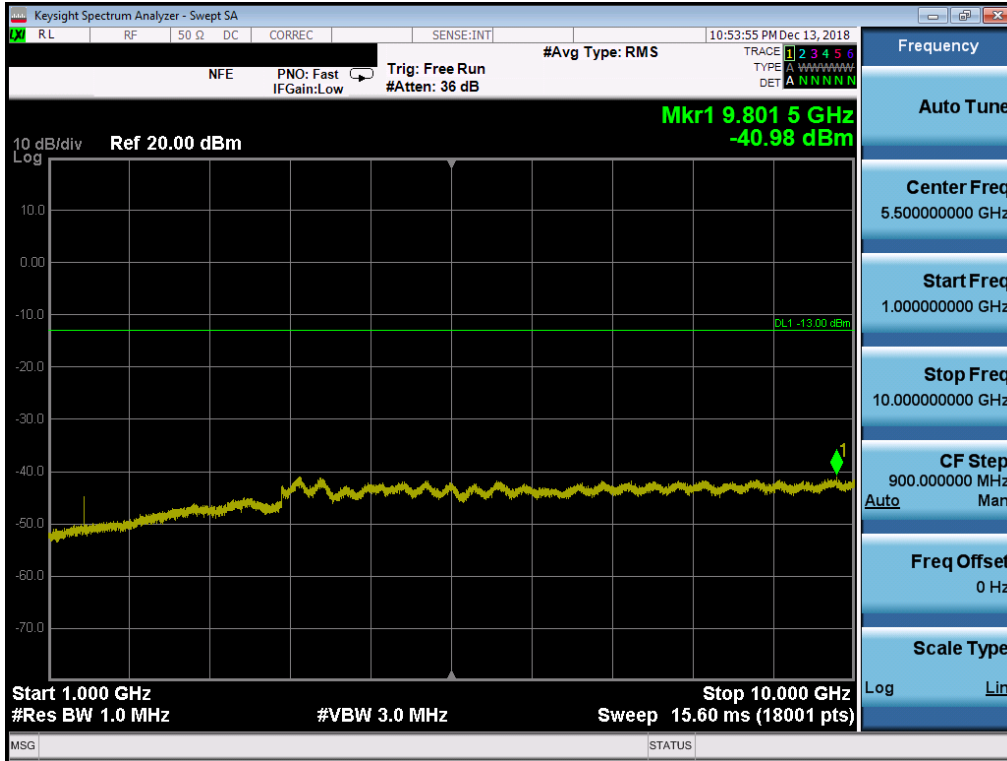

Plot 7-43. Conducted Spurious Plot (Band 12 - 10MHz QPSK - RB Size 1, RB Offset 0 - Low Channel)

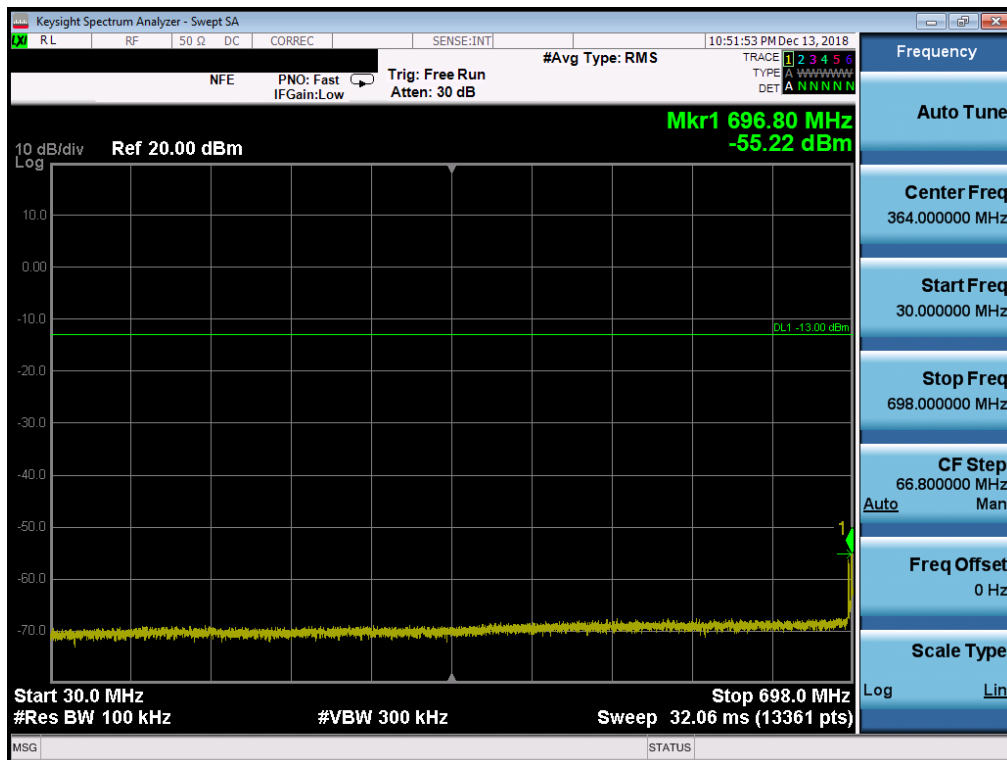

Plot 7-44. Conducted Spurious Plot (Band 12 - 10MHz QPSK - RB Size 1, RB Offset 0 - Mid Channel)

FCC ID: ZNFX220QM	PCTEST ENGINEERING LABORATORY, INC.	MEASUREMENT REPORT (CERTIFICATION)	LG	Approved by: Quality Manager
Test Report S/N: 1M1812110223-03.ZNF	Test Dates: 12/10-12/21/2018	EUT Type: Portable Handset		Page 38 of 134

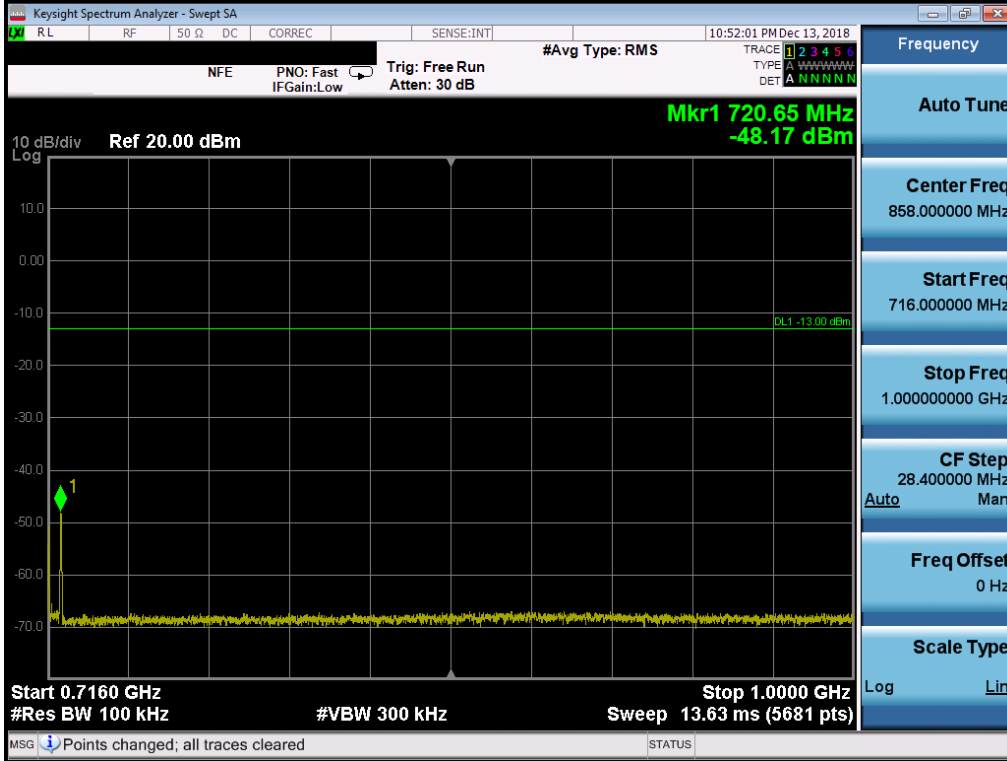

Plot 7-45. Conducted Spurious Plot (Band 12 - 10MHz QPSK - RB Size 1, RB Offset 0 - Mid Channel)

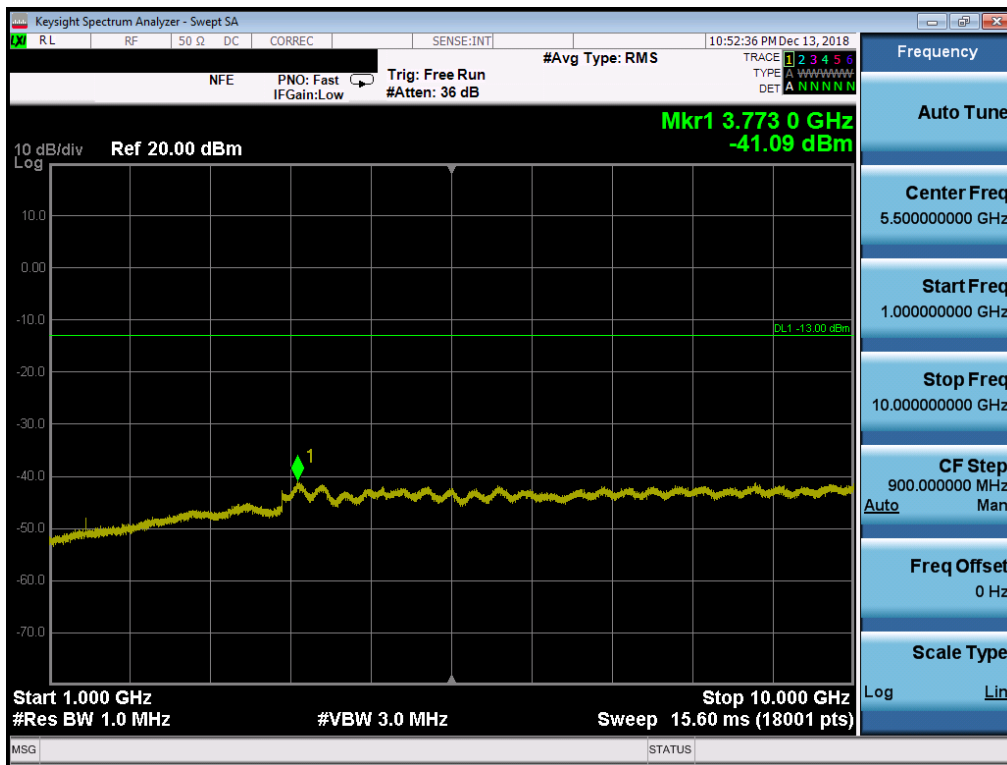

Plot 7-46. Conducted Spurious Plot (Band 12 - 10MHz QPSK - RB Size 1, RB Offset 0 - Mid Channel)

FCC ID: ZNFX220QM		MEASUREMENT REPORT (CERTIFICATION)		Approved by: Quality Manager
Test Report S/N: 1M1812110223-03.ZNF	Test Dates: 12/10-12/21/2018	EUT Type: Portable Handset		Page 39 of 134

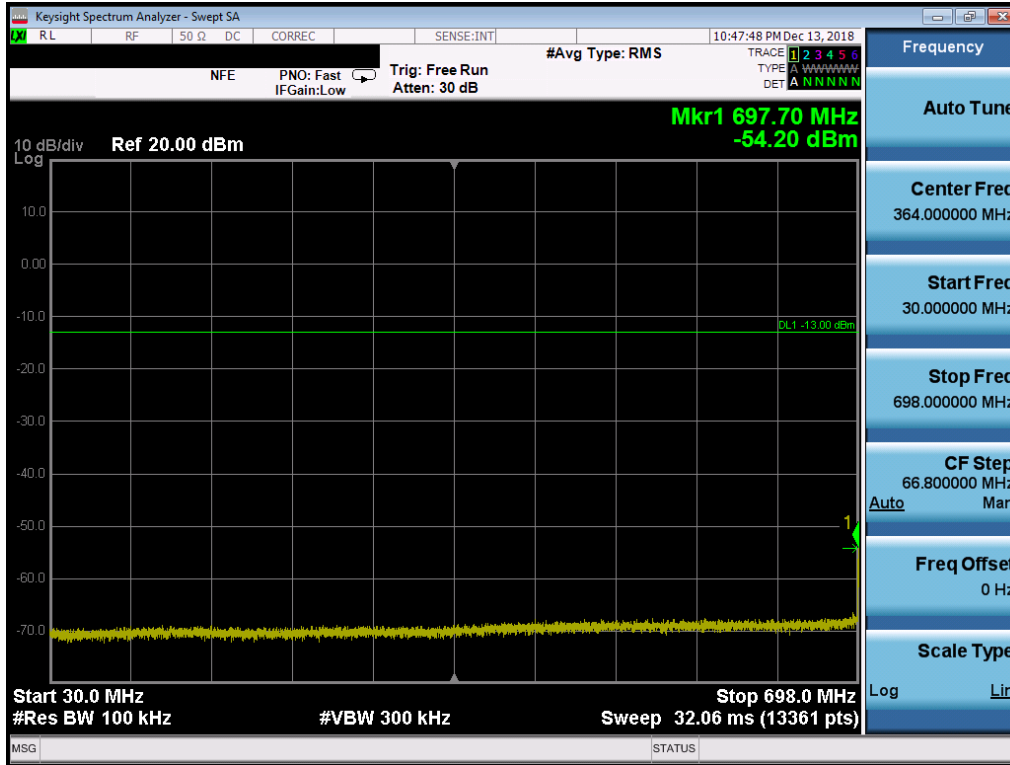

Plot 7-47. Conducted Spurious Plot (Band 12 - 10MHz QPSK - RB Size 1, RB Offset 0 - High Channel)

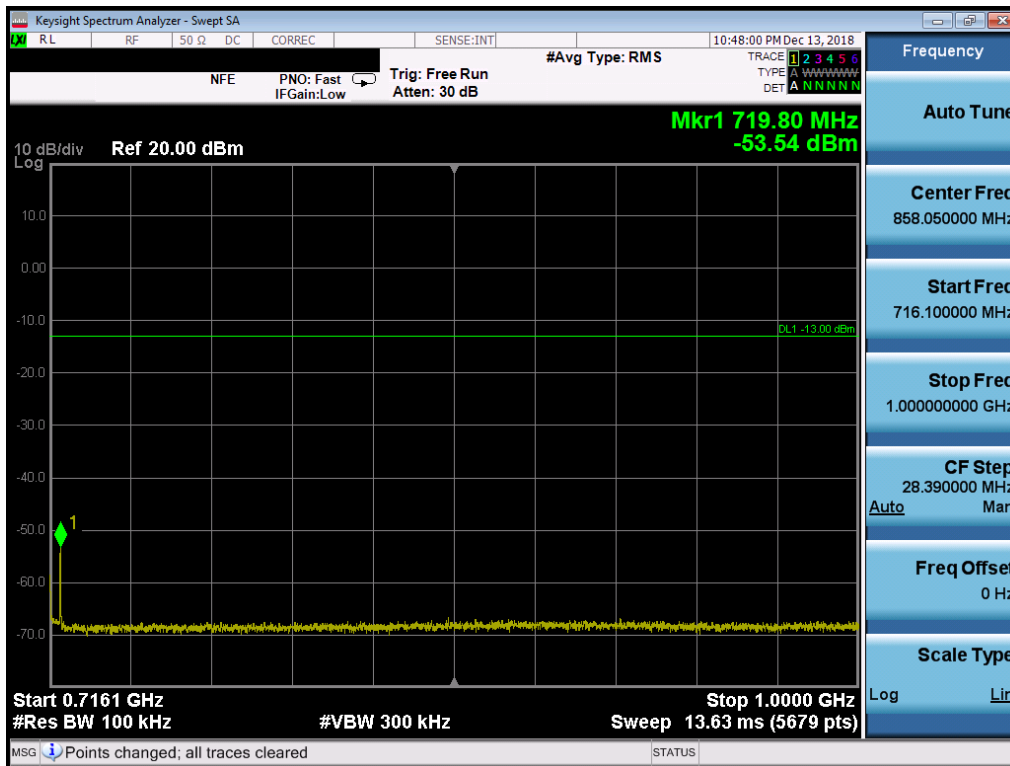

Plot 7-48. Conducted Spurious Plot (Band 12 - 10MHz QPSK - RB Size 1, RB Offset 0 - High Channel)

FCC ID: ZNFX220QM		MEASUREMENT REPORT (CERTIFICATION)		Approved by: Quality Manager
Test Report S/N: 1M1812110223-03.ZNF	Test Dates: 12/10-12/21/2018	EUT Type: Portable Handset		Page 40 of 134



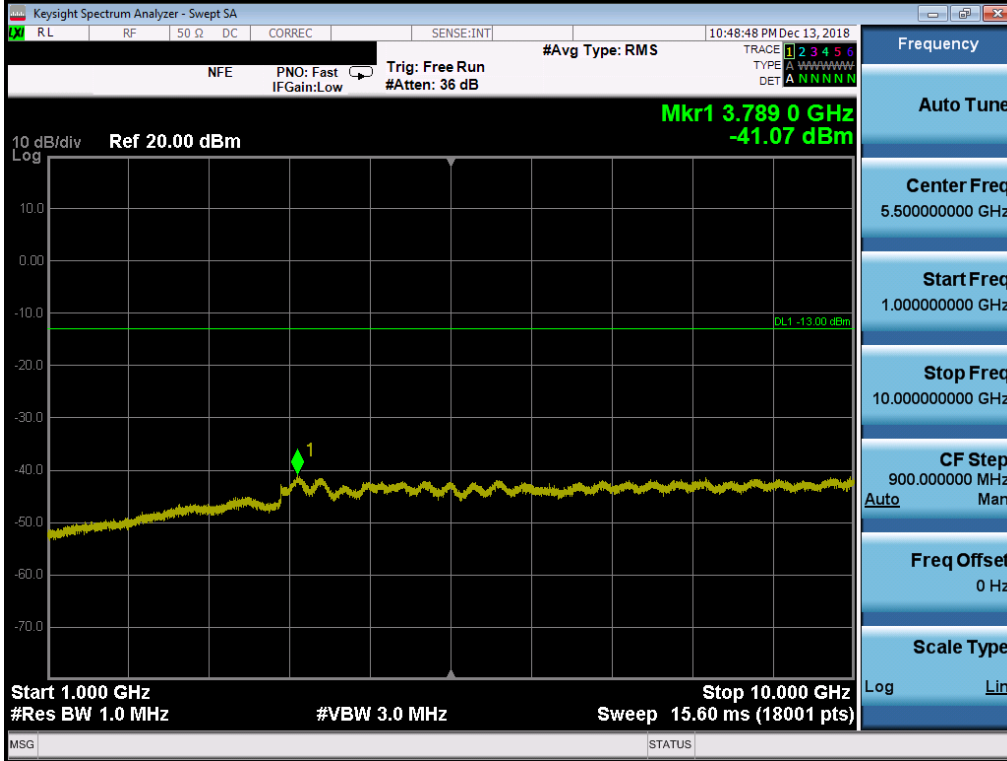

Plot 7-49. Conducted Spurious Plot (Band 12 - 10MHz QPSK - RB Size 1, RB Offset 0 - High Channel)

FCC ID: ZNFX220QM		MEASUREMENT REPORT (CERTIFICATION)		Approved by: Quality Manager
Test Report S/N: 1M1812110223-03.ZNF	Test Dates: 12/10-12/21/2018	EUT Type: Portable Handset		Page 41 of 134

**Band 5**

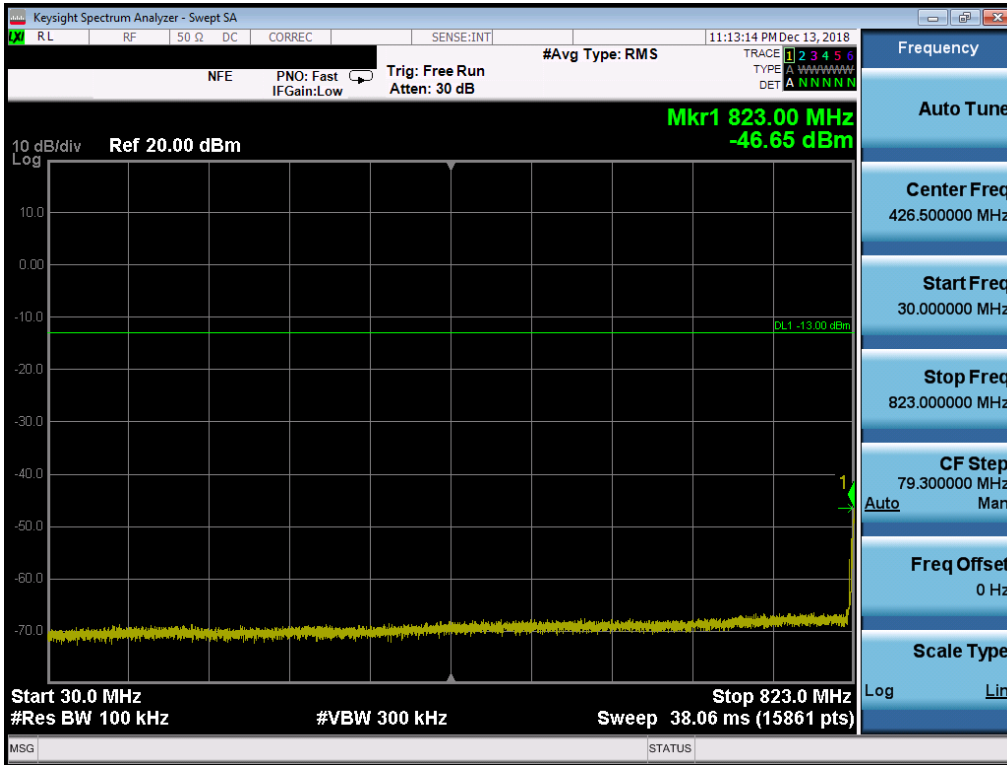

Plot 7-50. Conducted Spurious Plot (Band 5 - 10MHz QPSK - RB Size 1, RB Offset 0 - Low Channel)

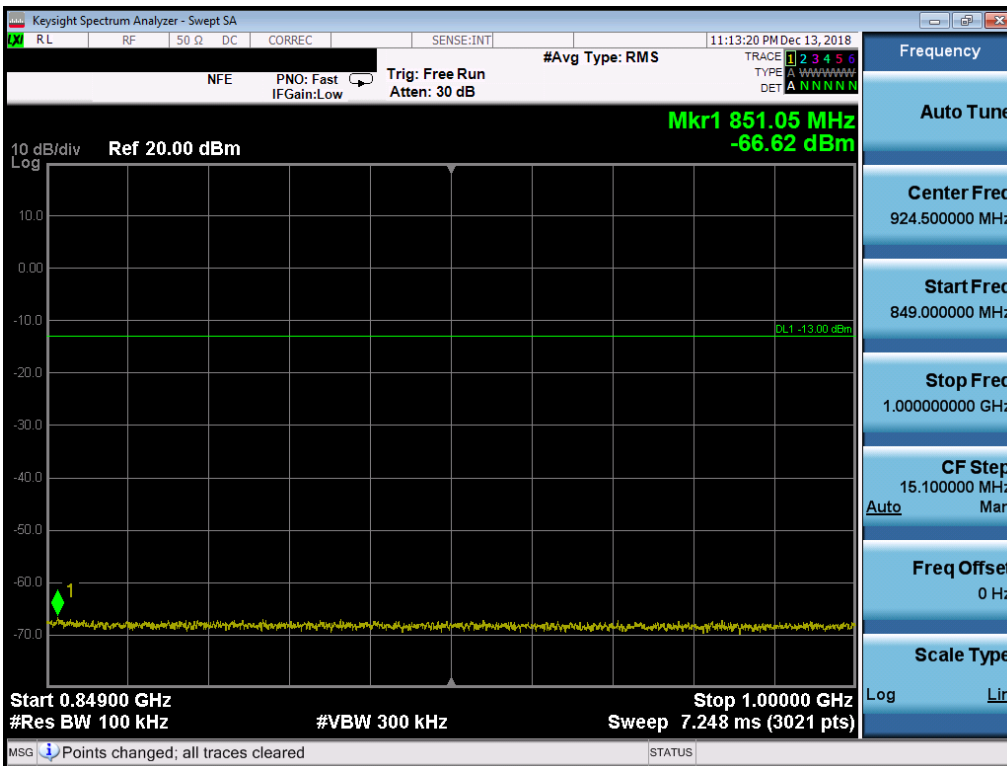

Plot 7-51. Conducted Spurious Plot (Band 5 - 10MHz QPSK - RB Size 1, RB Offset 0 - Low Channel)

FCC ID: ZNFX220QM	PCTEST ENGINEERING LABORATORY, INC.	MEASUREMENT REPORT (CERTIFICATION)	LG	Approved by: Quality Manager
Test Report S/N: 1M1812110223-03.ZNF	Test Dates: 12/10-12/21/2018	EUT Type: Portable Handset		Page 42 of 134

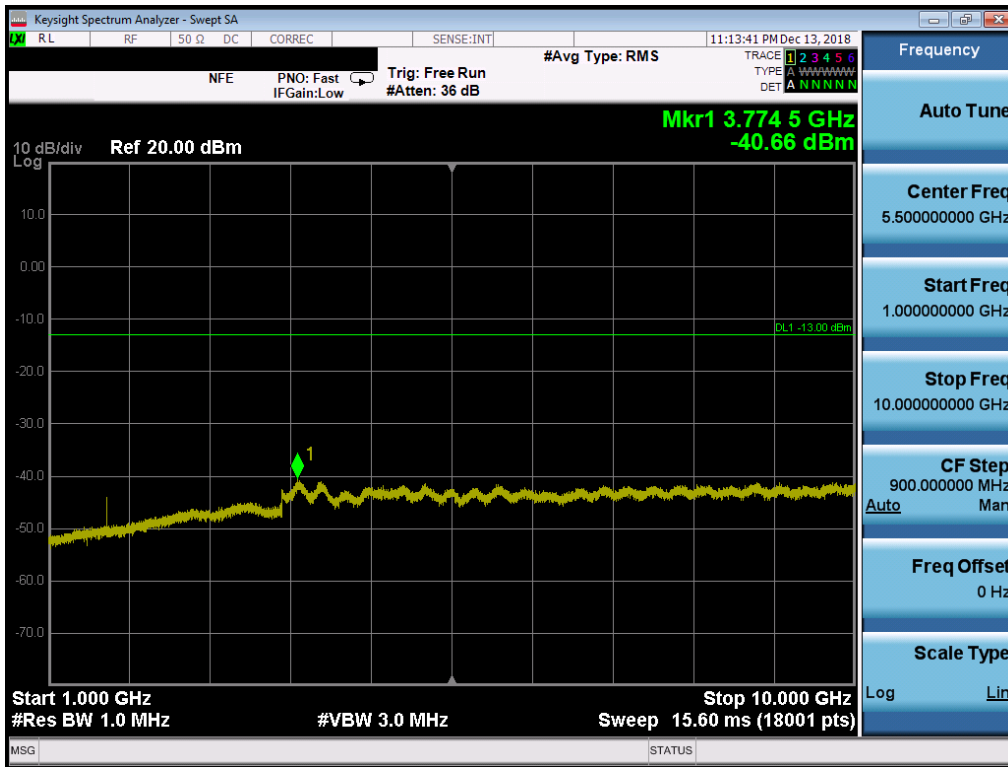

Plot 7-52. Conducted Spurious Plot (Band 5 - 10MHz QPSK - RB Size 1, RB Offset 0 - Low Channel)

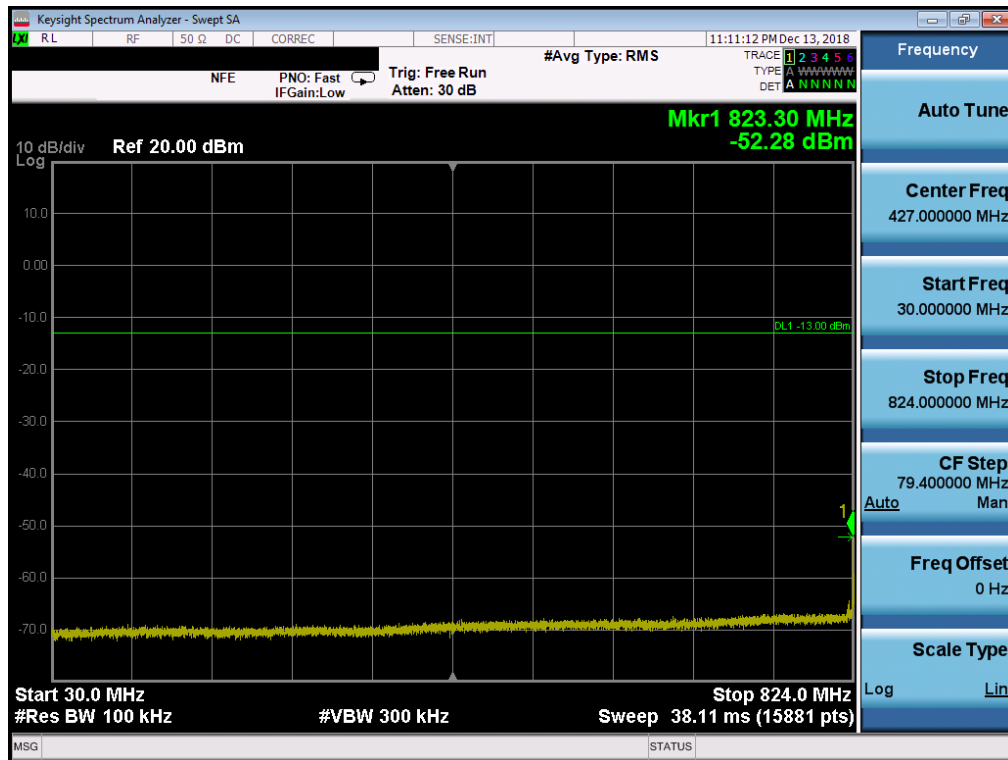

Plot 7-53. Conducted Spurious Plot (Band 5 - 10MHz QPSK - RB Size 1, RB Offset 0 - Mid Channel)

FCC ID: ZNFX220QM		MEASUREMENT REPORT (CERTIFICATION)		Approved by: Quality Manager
Test Report S/N: 1M1812110223-03.ZNF	Test Dates: 12/10-12/21/2018	EUT Type: Portable Handset		Page 43 of 134

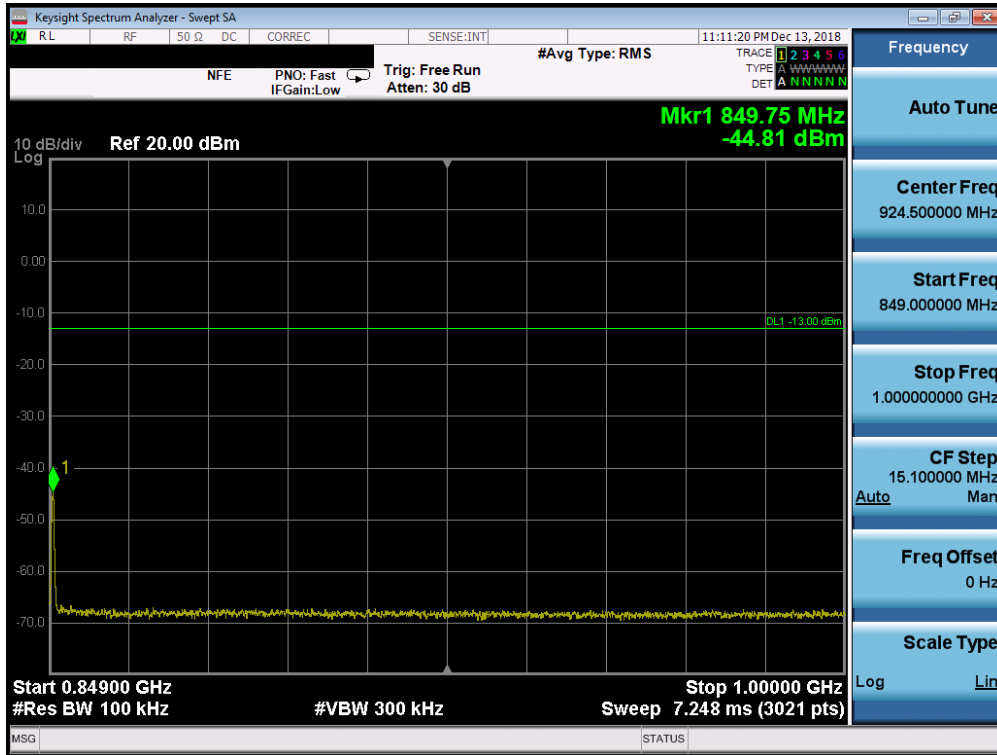

Plot 7-54. Conducted Spurious Plot (Band 5 - 10MHz QPSK - RB Size 1, RB Offset 0 - Mid Channel)

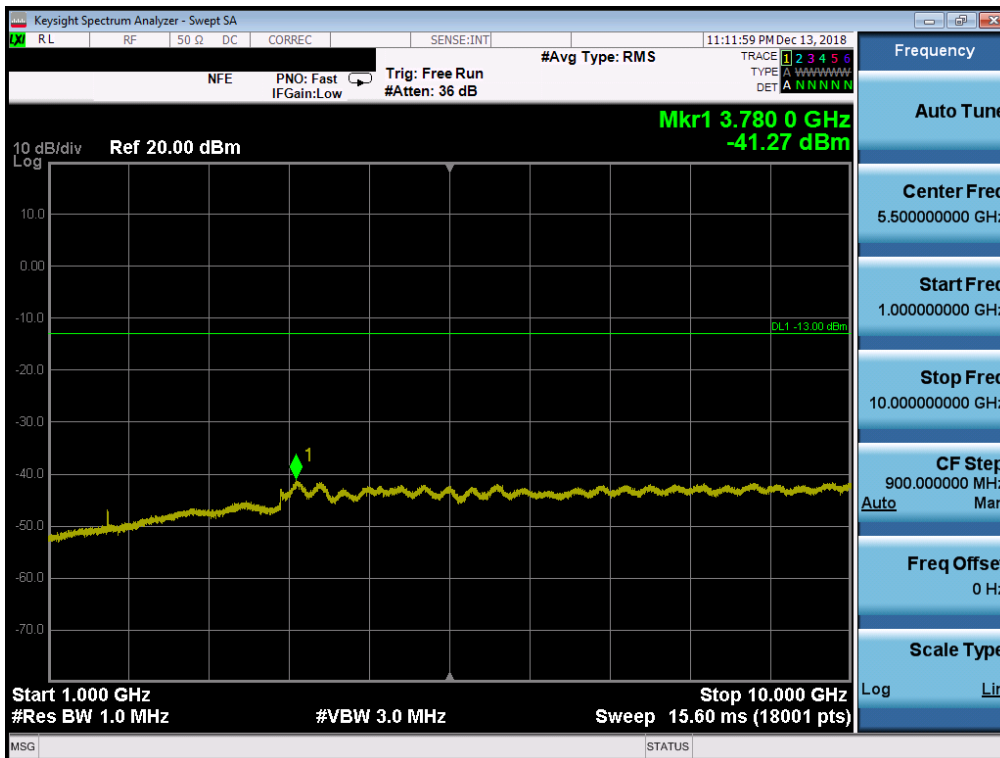

Plot 7-55. Conducted Spurious Plot (Band 26/5 - 5.0MHz QPSK - RB Size 1, RB Offset 0 - Mid Channel)

FCC ID: ZNFX220QM		MEASUREMENT REPORT (CERTIFICATION)		Approved by: Quality Manager
Test Report S/N: 1M1812110223-03.ZNF	Test Dates: 12/10-12/21/2018	EUT Type: Portable Handset		Page 44 of 134

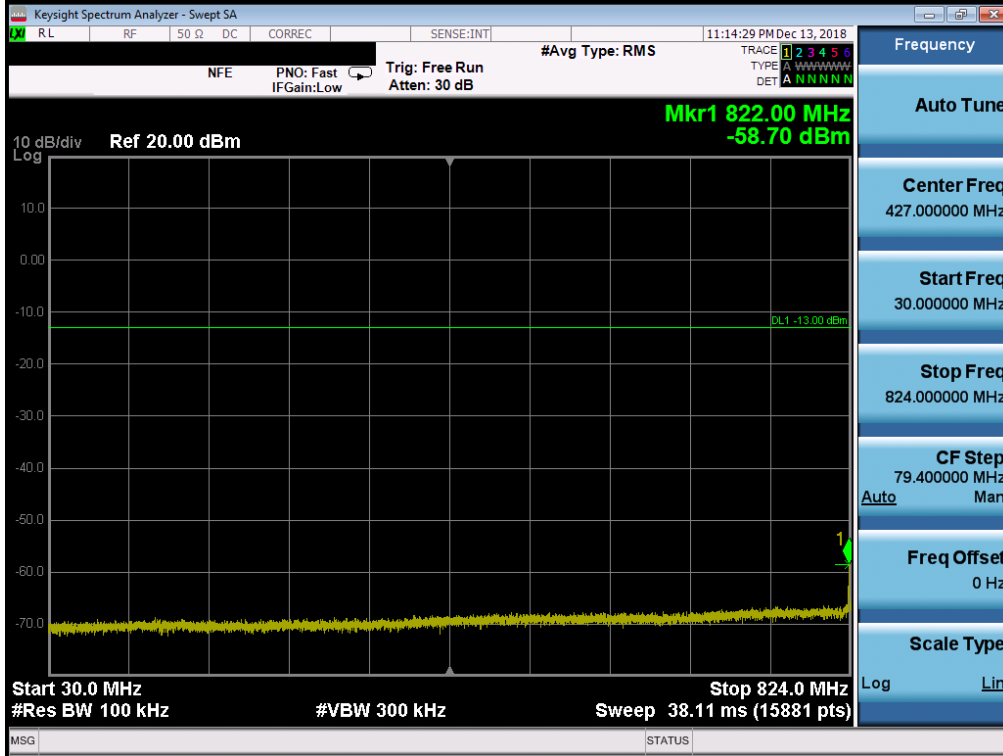

Plot 7-56. Conducted Spurious Plot (Band 5 - 10MHz QPSK - RB Size 1, RB Offset 0 - High Channel)

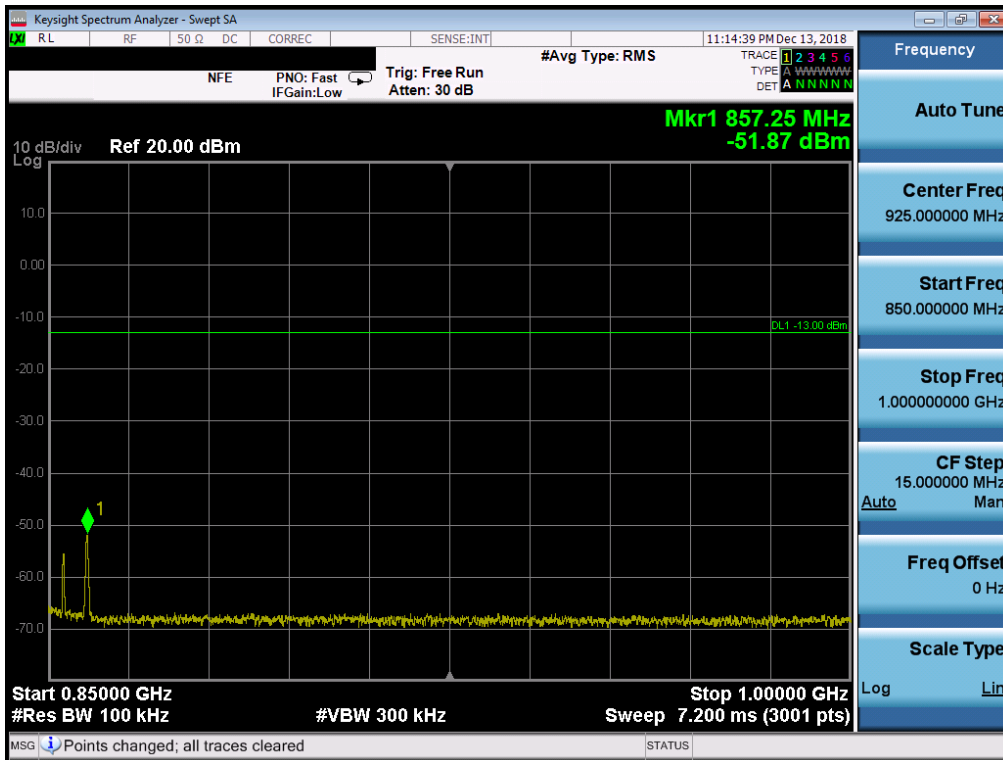

Plot 7-57. Conducted Spurious Plot (Band 5 - 10MHz QPSK - RB Size 1, RB Offset 0 - High Channel)

FCC ID: ZNFX220QM		MEASUREMENT REPORT (CERTIFICATION)		Approved by: Quality Manager
Test Report S/N: 1M1812110223-03.ZNF	Test Dates: 12/10-12/21/2018	EUT Type: Portable Handset		Page 45 of 134

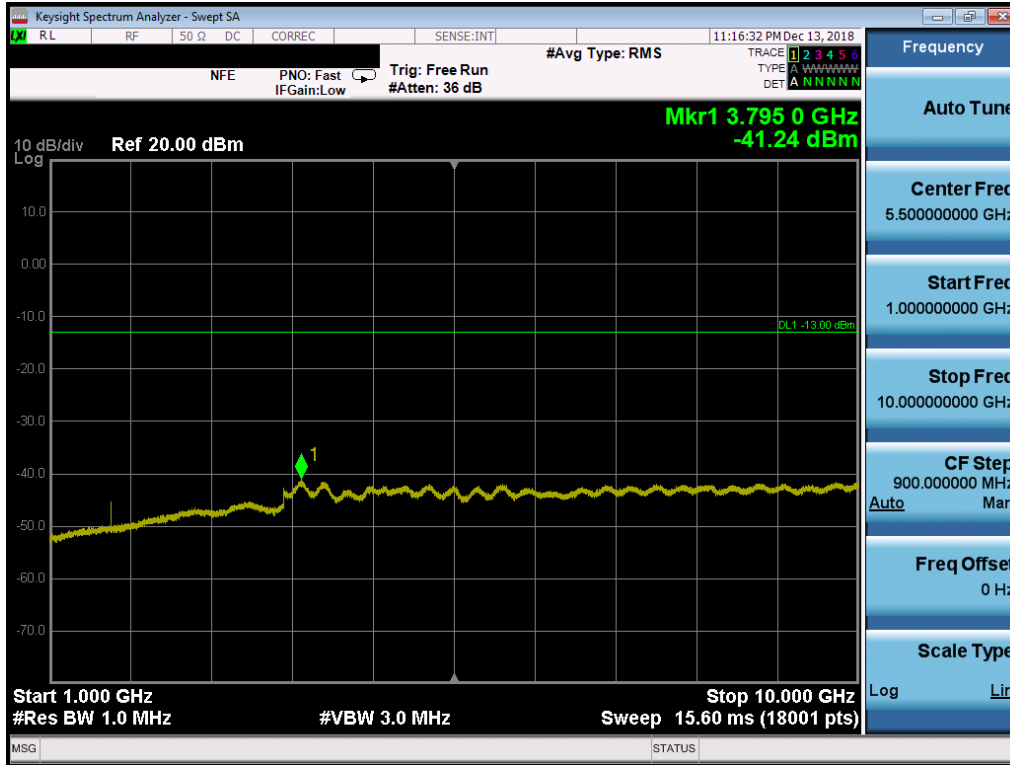

**Plot 7-58. Conducted Spurious Plot (Band 5 - 10MHz QPSK - RB Size 1, RB Offset 0 - High Channel)**

FCC ID: ZNFX220QM		MEASUREMENT REPORT (CERTIFICATION)		Approved by: Quality Manager
Test Report S/N: 1M1812110223-03.ZNF	Test Dates: 12/10-12/21/2018	EUT Type: Portable Handset		Page 46 of 134

**Band 4**

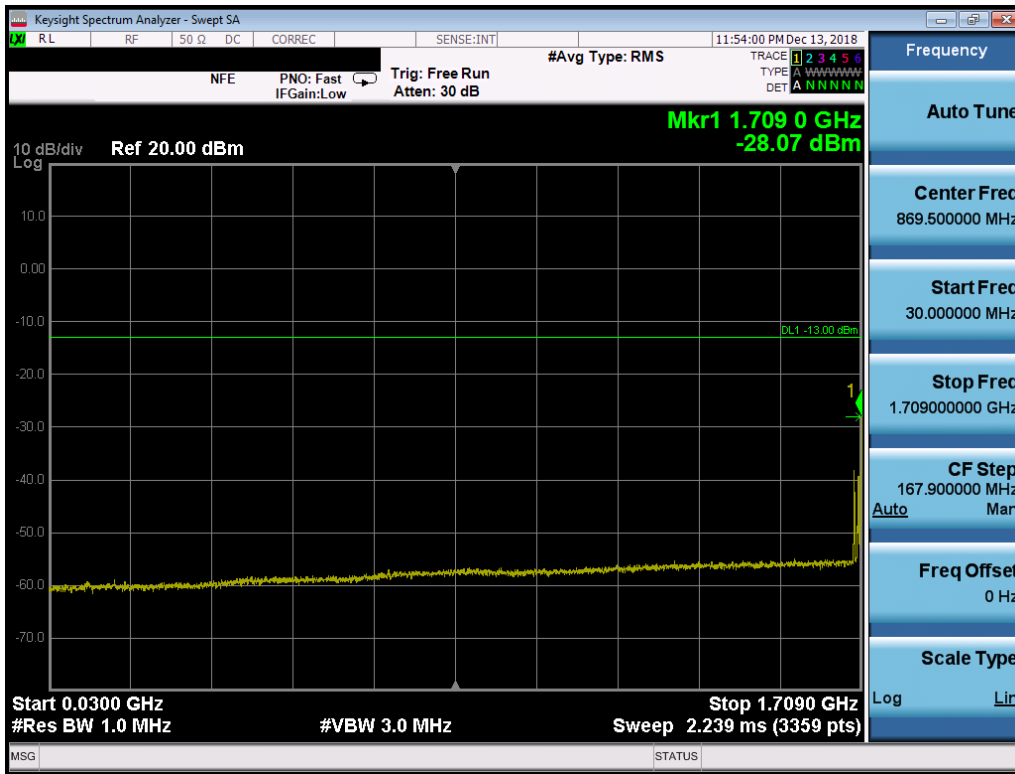

**Plot 7-59. Conducted Spurious Plot (Band 4 - 20MHz QPSK - RB Size 1, RB Offset 0 - Low Channel)**

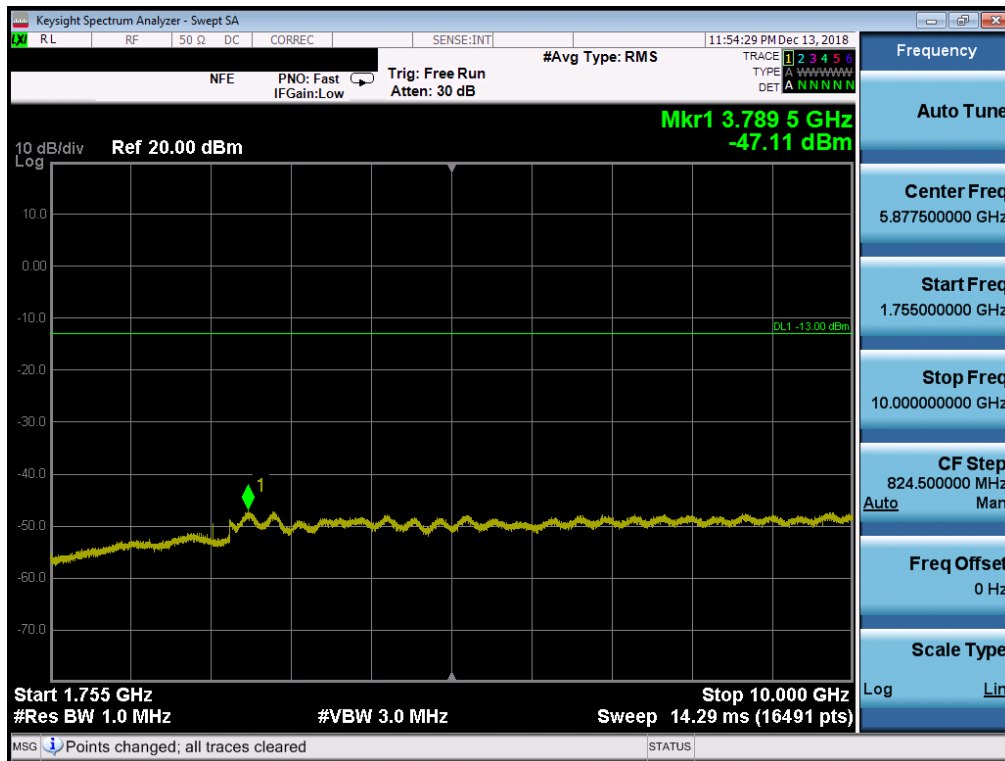

**Plot 7-60. Conducted Spurious Plot (Band 4 - 20MHz QPSK - RB Size 1, RB Offset 0 - Low Channel)**

FCC ID: ZNFX220QM		MEASUREMENT REPORT (CERTIFICATION)		Approved by: Quality Manager
Test Report S/N: 1M1812110223-03.ZNF	Test Dates: 12/10-12/21/2018	EUT Type: Portable Handset		Page 47 of 134

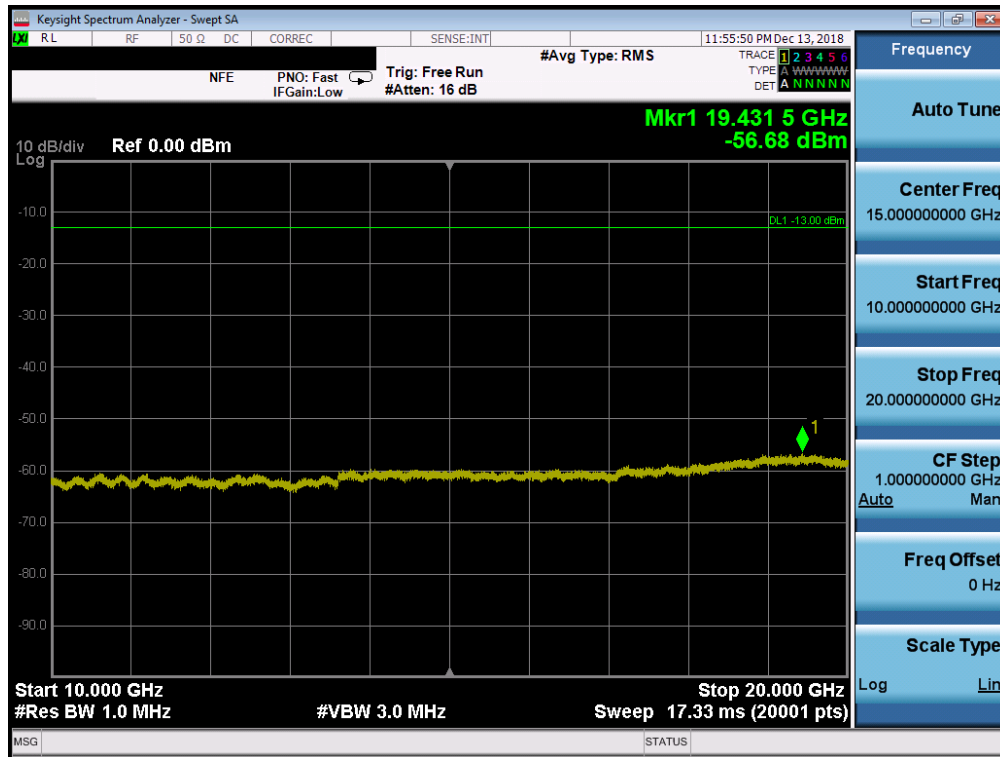

Plot 7-61. Conducted Spurious Plot (Band 4 - 20MHz QPSK - RB Size 1, RB Offset 0 - Low Channel)

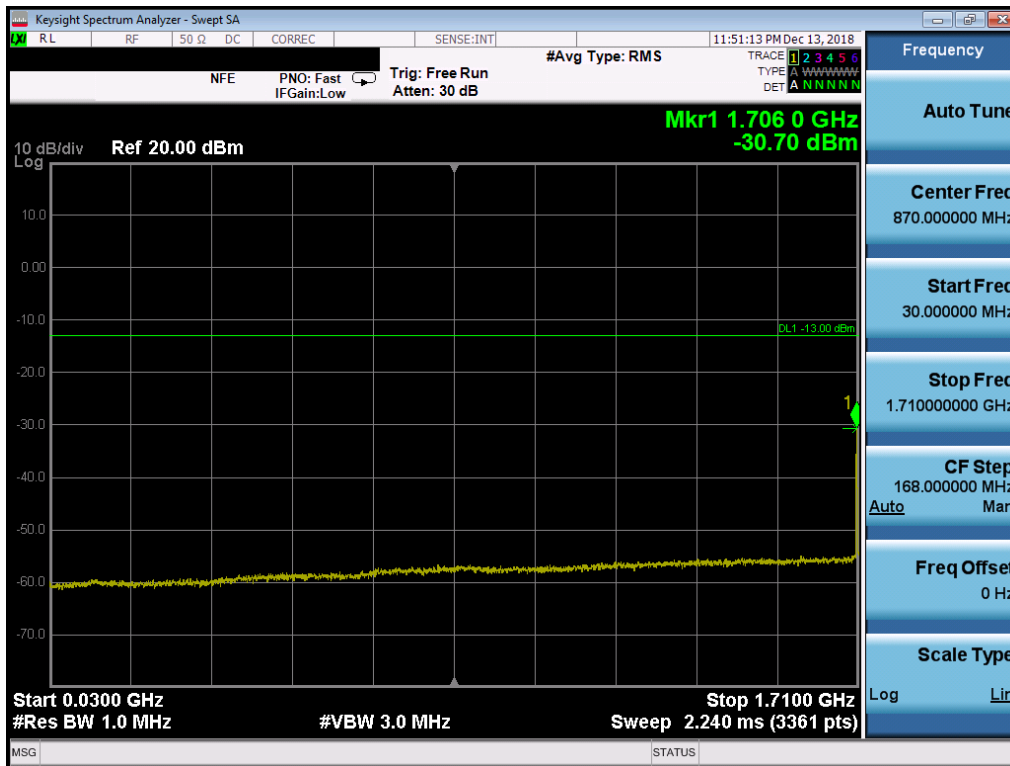

Plot 7-62. Conducted Spurious Plot (Band 4 - 20MHz QPSK - RB Size 1, RB Offset 0 - Mid Channel)

FCC ID: ZNFX220QM	PCTEST ENGINEERING LABORATORY, INC.	MEASUREMENT REPORT (CERTIFICATION)	LG	Approved by: Quality Manager
Test Report S/N: 1M1812110223-03.ZNF	Test Dates: 12/10-12/21/2018	EUT Type: Portable Handset		Page 48 of 134



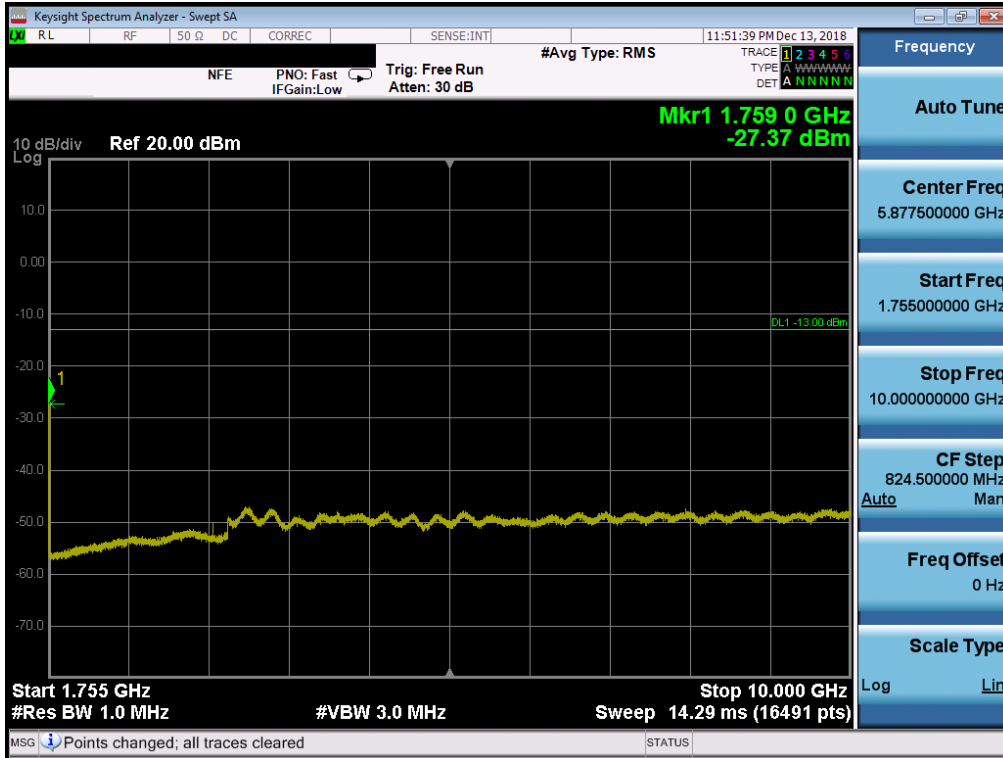

Plot 7-63. Conducted Spurious Plot (Band 4 - 20MHz QPSK - RB Size 1, RB Offset 0 - Mid Channel)

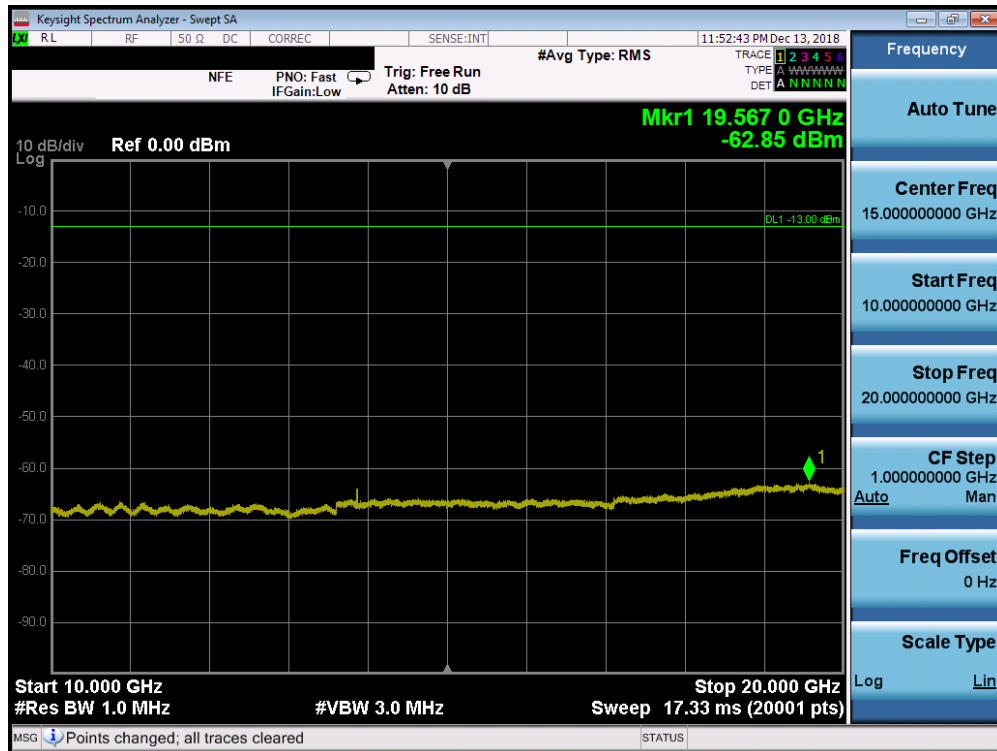

Plot 7-64. Conducted Spurious Plot (Band 4 - 20MHz QPSK - RB Size 1, RB Offset 0 - Mid Channel)

FCC ID: ZNFX220QM		MEASUREMENT REPORT (CERTIFICATION)		Approved by: Quality Manager
Test Report S/N: 1M1812110223-03.ZNF	Test Dates: 12/10-12/21/2018	EUT Type: Portable Handset		Page 49 of 134

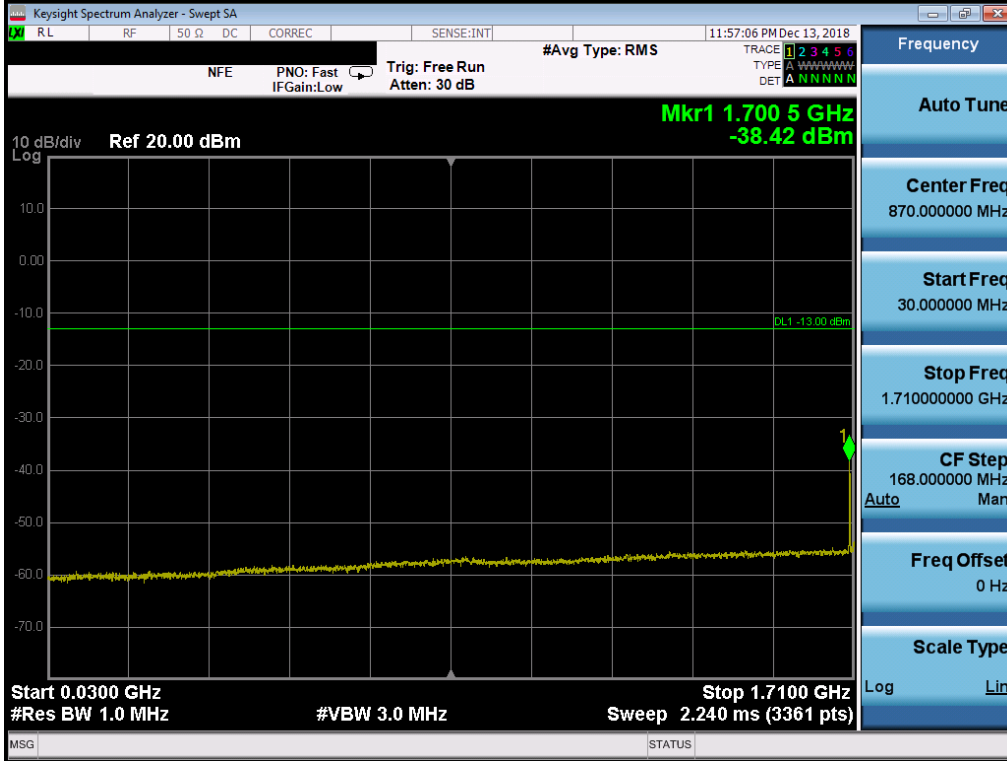

Plot 7-65. Conducted Spurious Plot (Band 4 - 20MHz QPSK - RB Size 1, RB Offset 0 - High Channel)

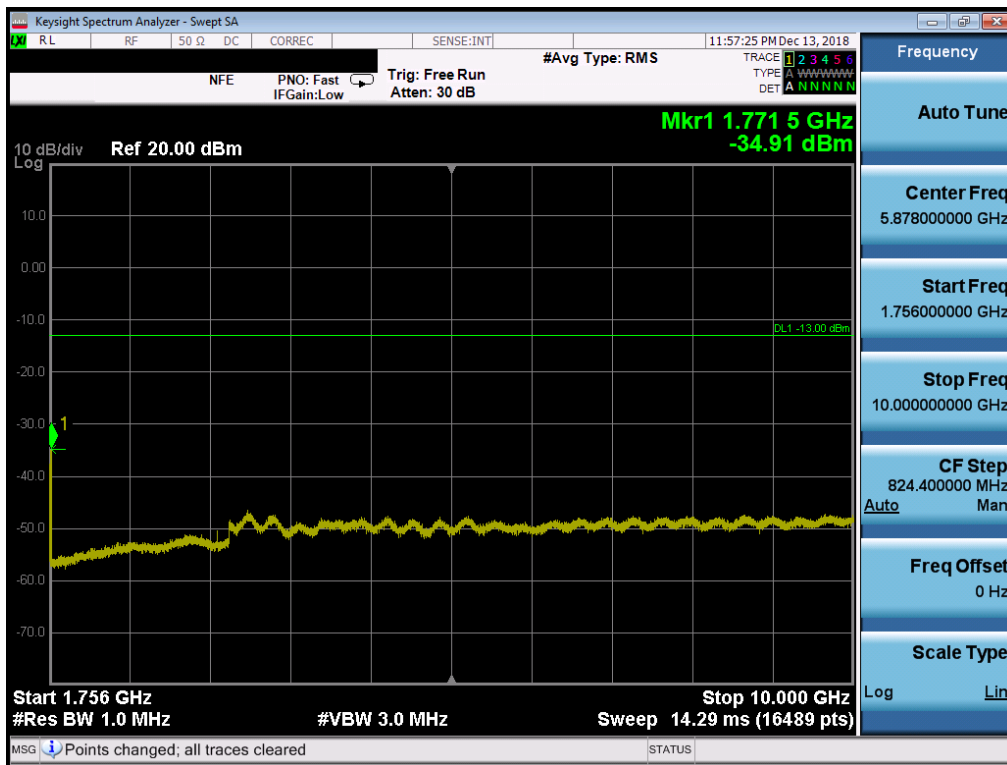

Plot 7-66. Conducted Spurious Plot (Band 4 - 20MHz QPSK - RB Size 1, RB Offset 0 - High Channel)

FCC ID: ZNFX220QM		MEASUREMENT REPORT (CERTIFICATION)		Approved by: Quality Manager
Test Report S/N: 1M1812110223-03.ZNF	Test Dates: 12/10-12/21/2018	EUT Type: Portable Handset		Page 50 of 134

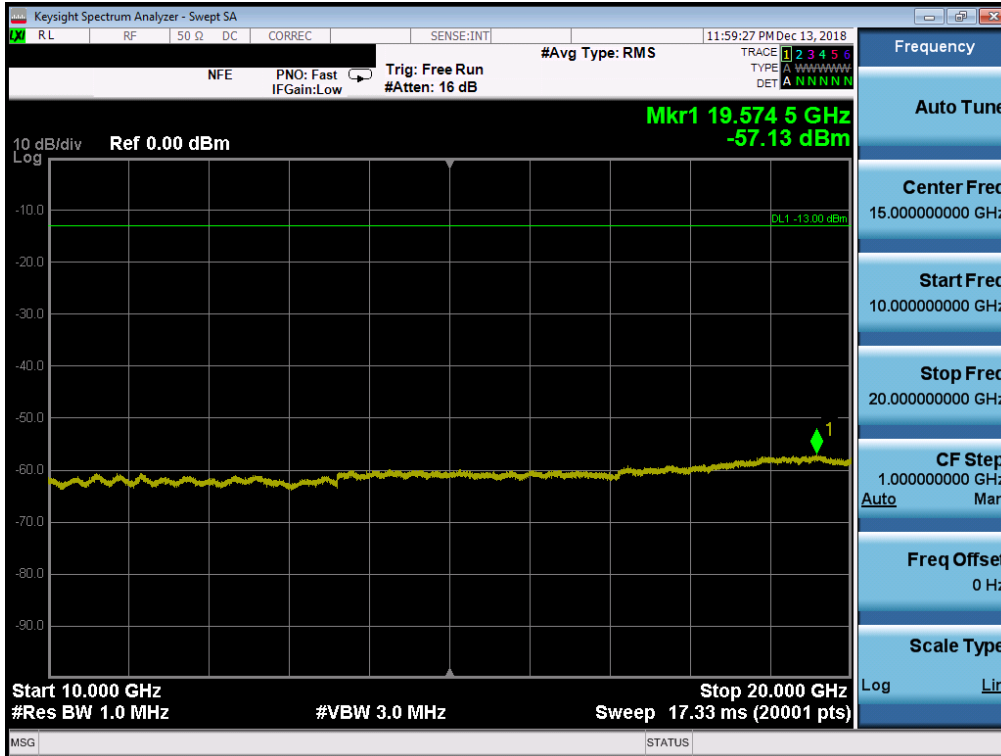

Plot 7-67. Conducted Spurious Plot (Band 4 - 20MHz QPSK - RB Size 1, RB Offset 0 - High Channel)

FCC ID: ZNFX220QM		MEASUREMENT REPORT (CERTIFICATION)		Approved by: Quality Manager
Test Report S/N: 1M1812110223-03.ZNF	Test Dates: 12/10-12/21/2018	EUT Type: Portable Handset		Page 51 of 134

**Band 25/2**

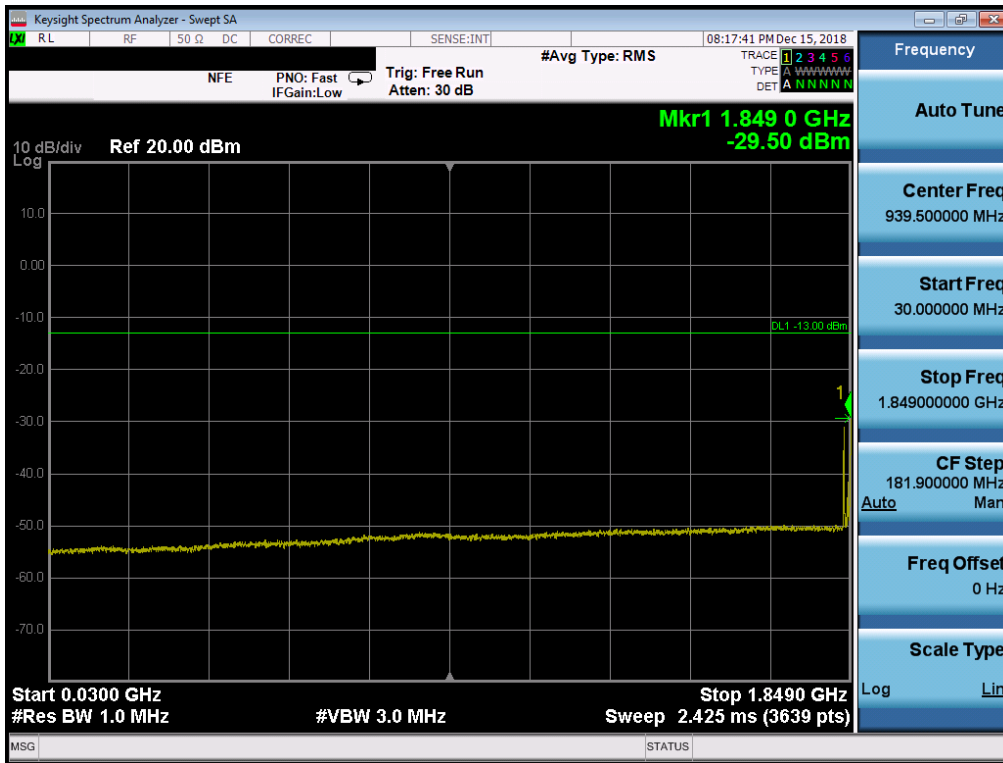

**Plot 7-68. Conducted Spurious Plot (Band 25/2 - 20MHz QPSK - RB Size 1, RB Offset 0 - Low Channel)**

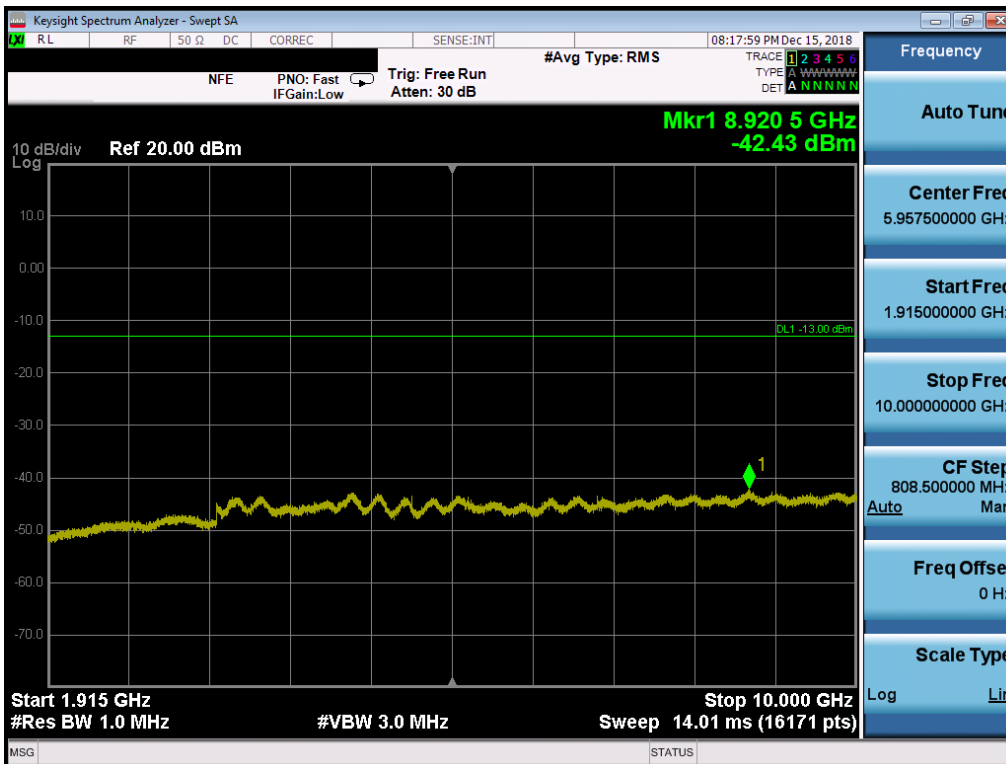

**Plot 7-69. Conducted Spurious Plot (Band 25/2 - 20MHz QPSK - RB Size 1, RB Offset 0 - Low Channel)**

FCC ID: ZNFX220QM		MEASUREMENT REPORT (CERTIFICATION)		Approved by: Quality Manager
Test Report S/N: 1M1812110223-03.ZNF	Test Dates: 12/10-12/21/2018	EUT Type: Portable Handset		Page 52 of 134

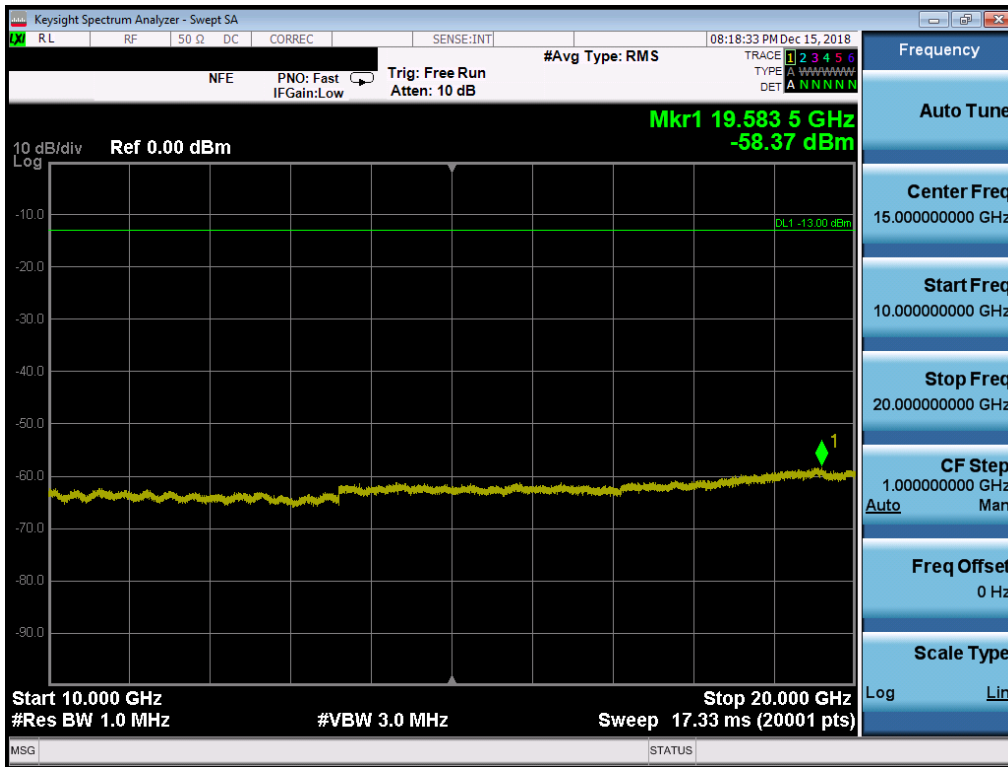

Plot 7-70. Conducted Spurious Plot (Band 25/2 - 20MHz QPSK - RB Size 1, RB Offset 0 - Low Channel)

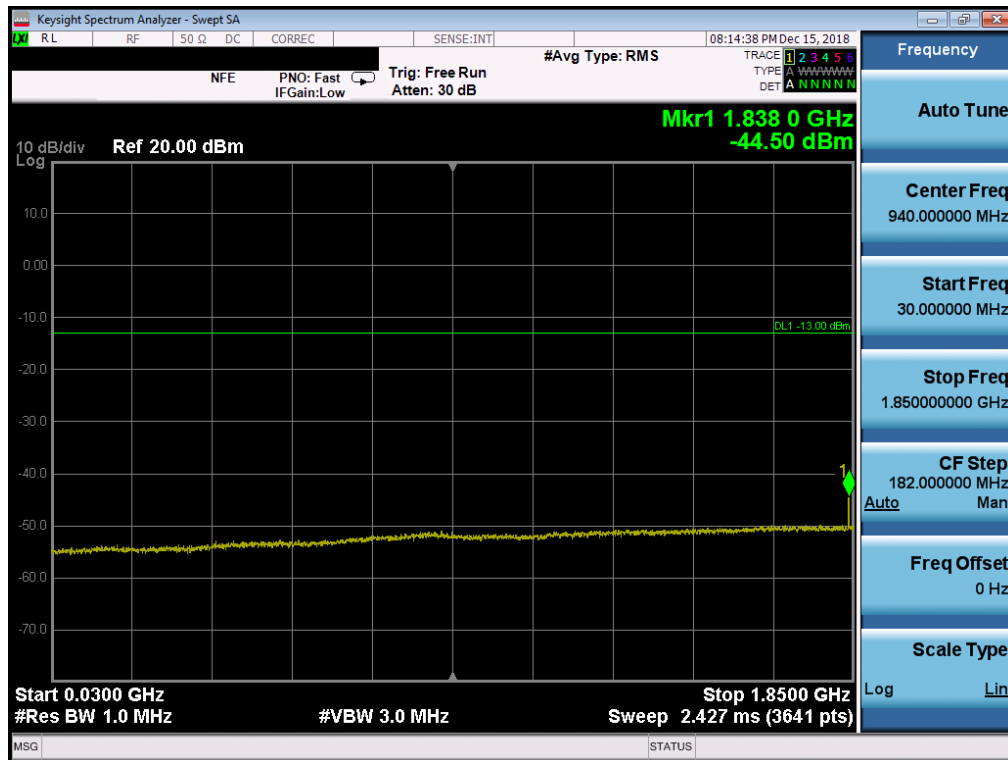

Plot 7-71. Conducted Spurious Plot (Band 25/2 - 20MHz QPSK - RB Size 1, RB Offset 0 - Mid Channel)

FCC ID: ZNFX220QM		MEASUREMENT REPORT (CERTIFICATION)		Approved by: Quality Manager
Test Report S/N: 1M1812110223-03.ZNF	Test Dates: 12/10-12/21/2018	EUT Type: Portable Handset		Page 53 of 134

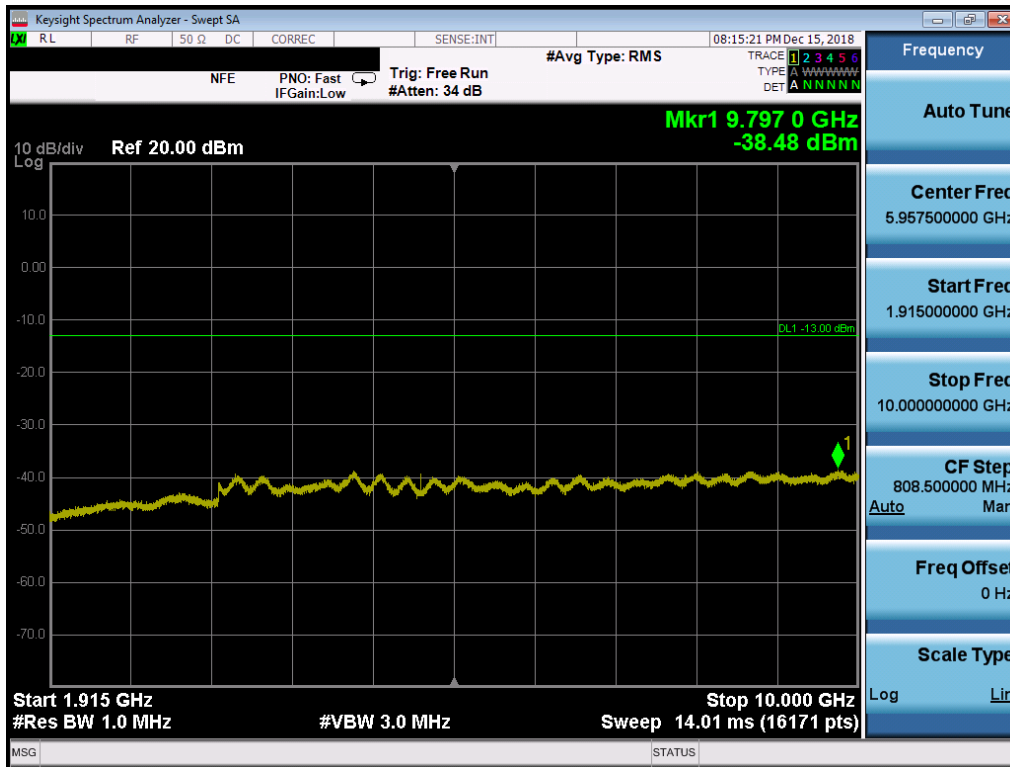

Plot 7-72. Conducted Spurious Plot (Band 25/2 - 20MHz QPSK - RB Size 1, RB Offset 0 - Mid Channel)

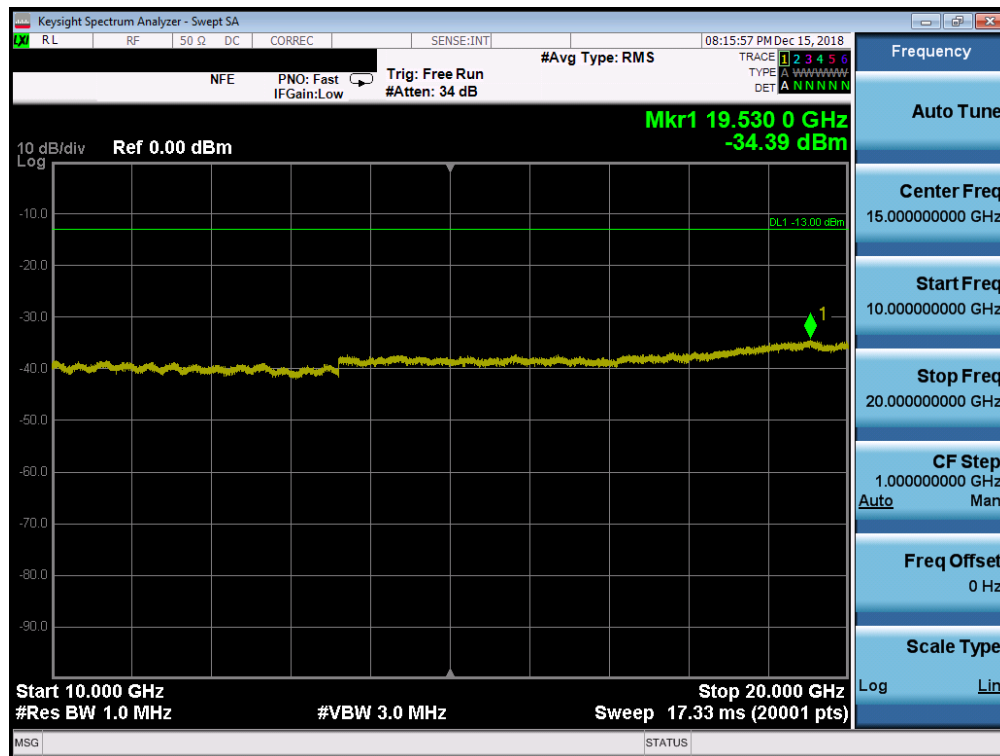

Plot 7-73. Conducted Spurious Plot (Band 25/2 - 20MHz QPSK - RB Size 1, RB Offset 0 - Mid Channel)

FCC ID: ZNFX220QM		MEASUREMENT REPORT (CERTIFICATION)		Approved by: Quality Manager
Test Report S/N: 1M1812110223-03.ZNF	Test Dates: 12/10-12/21/2018	EUT Type: Portable Handset		Page 54 of 134

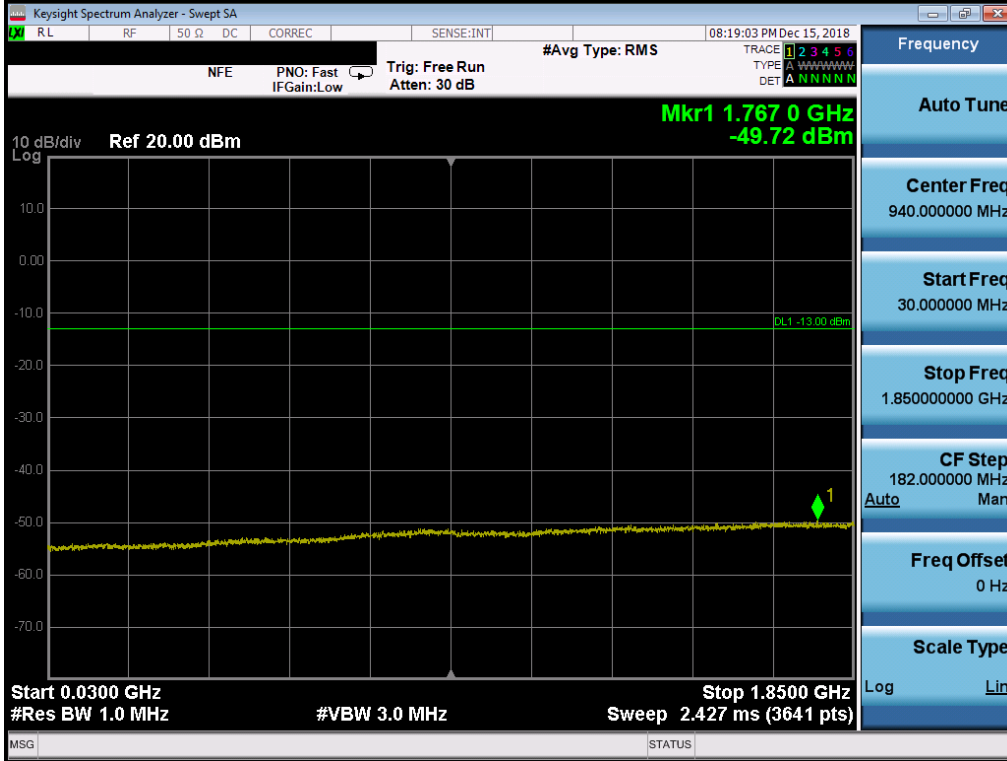

Plot 7-74. Conducted Spurious Plot (Band 25/2 - 20MHz QPSK - RB Size 1, RB Offset 0 - High Channel)

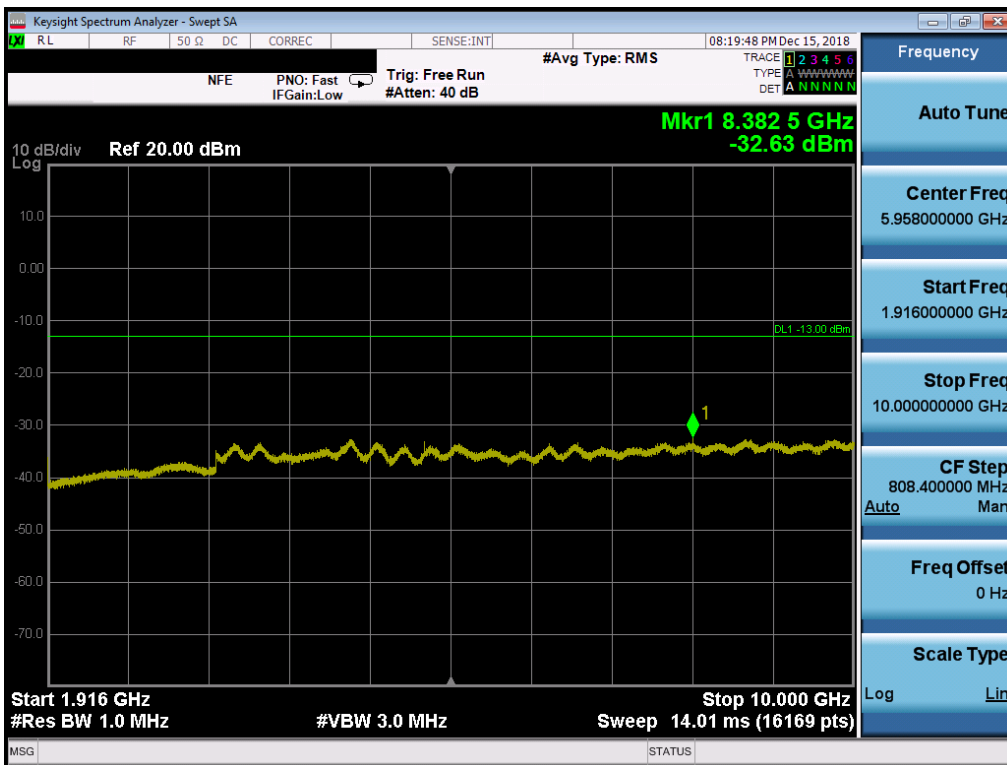

Plot 7-75. Conducted Spurious Plot (Band 25/2 - 20MHz QPSK - RB Size 1, RB Offset 0 - High Channel)

FCC ID: ZNFX220QM		MEASUREMENT REPORT (CERTIFICATION)		Approved by: Quality Manager
Test Report S/N: 1M1812110223-03.ZNF	Test Dates: 12/10-12/21/2018	EUT Type: Portable Handset		Page 55 of 134

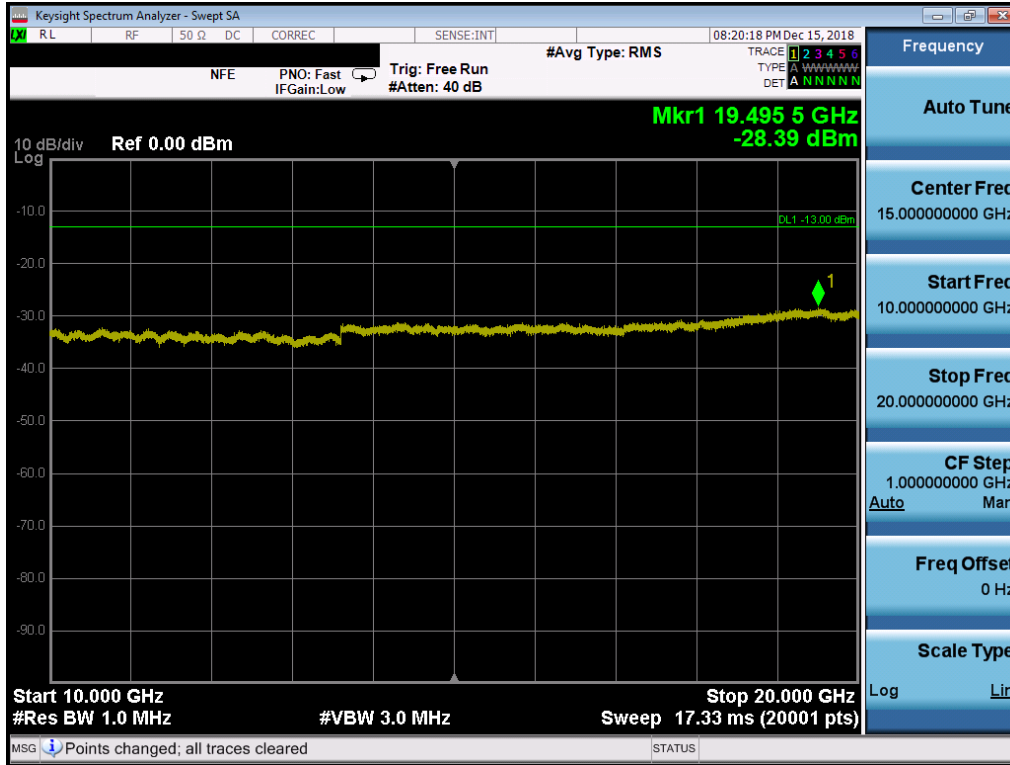

Plot 7-76. Conducted Spurious Plot (Band 25/2 - 20MHz QPSK - RB Size 1, RB Offset 0 - High Channel)

FCC ID: ZNFX220QM		MEASUREMENT REPORT (CERTIFICATION)		Approved by: Quality Manager
Test Report S/N: 1M1812110223-03.ZNF	Test Dates: 12/10-12/21/2018	EUT Type: Portable Handset		Page 56 of 134



## 7.4 Band Edge Emissions at Antenna Terminal

### Test Overview

All out of band emissions are measured with a spectrum analyzer connected to the antenna terminal of the EUT while the EUT is operating at its maximum duty cycle, at maximum power, and at the appropriate frequencies. All data rates were investigated to determine the worst case configuration. All modes of operation were investigated and the worst case configuration results are reported in this section.

***The minimum permissible attenuation level of any spurious emission is  $43 + 10\log_{10}(P_{[Watts]})$ , where P is the transmitter power in Watts.***

### Test Procedure Used

KDB 971168 D01 v03r01 – Section 6.0

### Test Settings

1. Start and stop frequency were set such that the band edge would be placed in the center of the plot
2. Span was set large enough so as to capture all out of band emissions near the band edge
3. RBW  $\geq 1\%$  of the emission bandwidth
4. VBW  $\geq 3 \times$  RBW
5. Detector = RMS
6. Number of sweep points  $\geq 2 \times$  Span/RBW
7. Trace mode = trace average for continuous emissions, max hold for pulse emissions
8. Sweep time = auto couple
9. The trace was allowed to stabilize

### Test Setup

The EUT and measurement equipment were set up as shown in the diagram below.

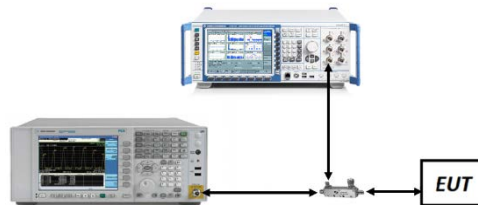

**Figure 7-3. Test Instrument & Measurement Setup**

FCC ID: ZNFX220QM		MEASUREMENT REPORT (CERTIFICATION)		Approved by: Quality Manager
Test Report S/N: 1M1812110223-03.ZNF	Test Dates: 12/10-12/21/2018	EUT Type: Portable Handset		Page 57 of 134

**Test Notes**

Per 22.917(b), 24.238(a), 27.53(h) in the 1 MHz bands immediately outside and adjacent to the frequency block a resolution bandwidth of at least one percent of the emission bandwidth of the fundamental emission of the transmitter may be employed to demonstrate compliance with the out-of-band emissions limit. The emission bandwidth is defined as the width of the signal between two points, one below the carrier center frequency and one above the carrier center frequency, outside of which all emission are attenuated at least 26 dB below the transmitter power.

Per 27.53(g) for operations in the 698-746 MHz band, in the 100 kHz bands immediately outside and adjacent to the frequency block a resolution bandwidth of at least 30 kHz may be employed to demonstrate compliance with the out-of-band emissions limit.

FCC ID: ZNFX220QM		<b>MEASUREMENT REPORT (CERTIFICATION)</b>		<b>Approved by:</b> Quality Manager
<b>Test Report S/N:</b> 1M1812110223-03.ZNF	<b>Test Dates:</b> 12/10-12/21/2018	<b>EUT Type:</b> Portable Handset		Page 58 of 134

**Band 12**

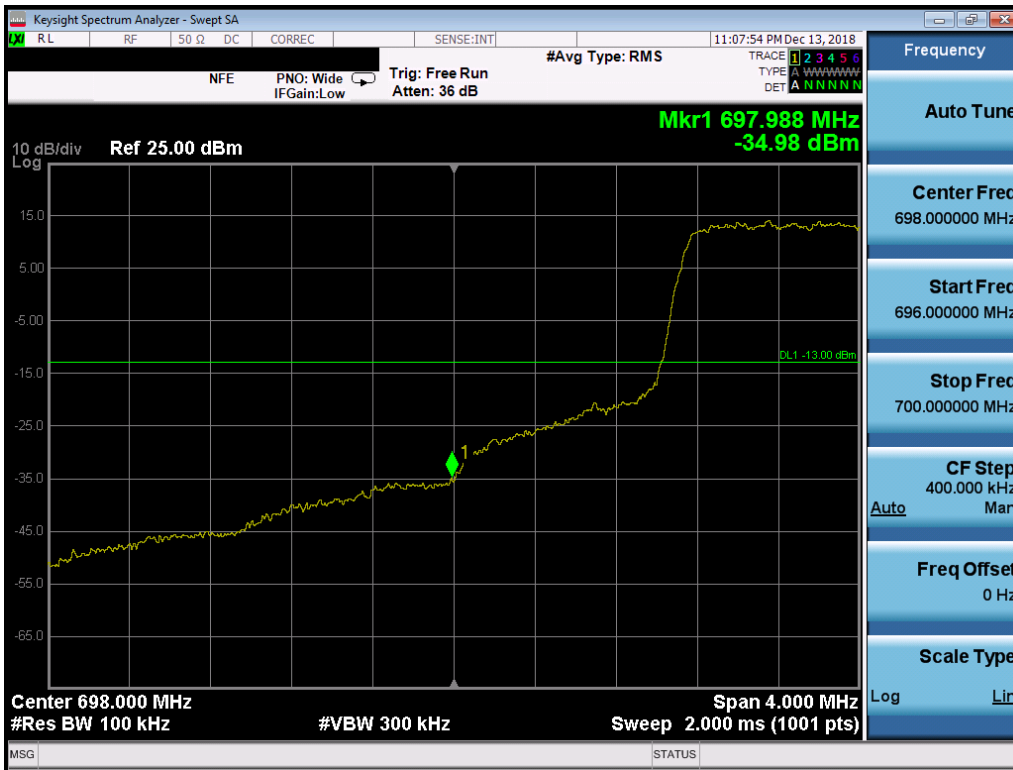

**Plot 7-77. Lower Band Edge Plot (Band 12 - 1.4MHz QPSK - Full RB Configuration)**



**Plot 7-78. Upper Band Edge Plot (Band 12 - 1.4MHz QPSK - Full RB Configuration)**

FCC ID: ZNFX220QM	PCTEST ENGINEERING LABORATORY, INC.	MEASUREMENT REPORT (CERTIFICATION)	LG	Approved by: Quality Manager
Test Report S/N: 1M1812110223-03.ZNF	Test Dates: 12/10-12/21/2018	EUT Type: Portable Handset		Page 59 of 134

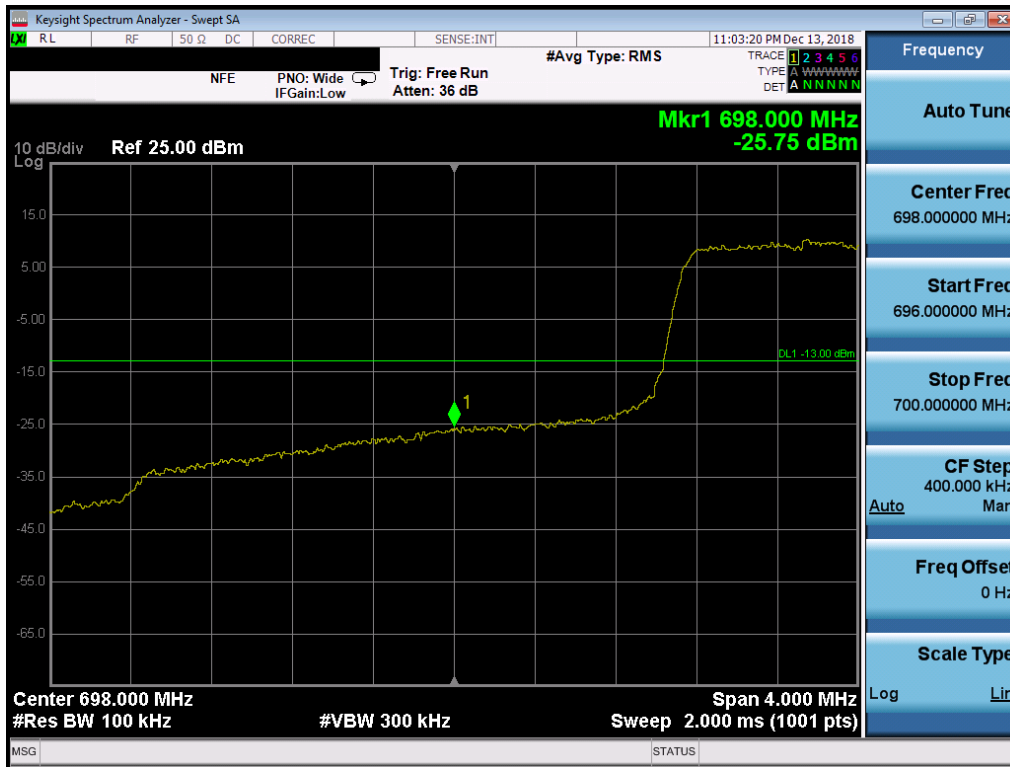

Plot 7-79. Lower Band Edge Plot (Band 12 - 3.0MHz QPSK - Full RB Configuration)

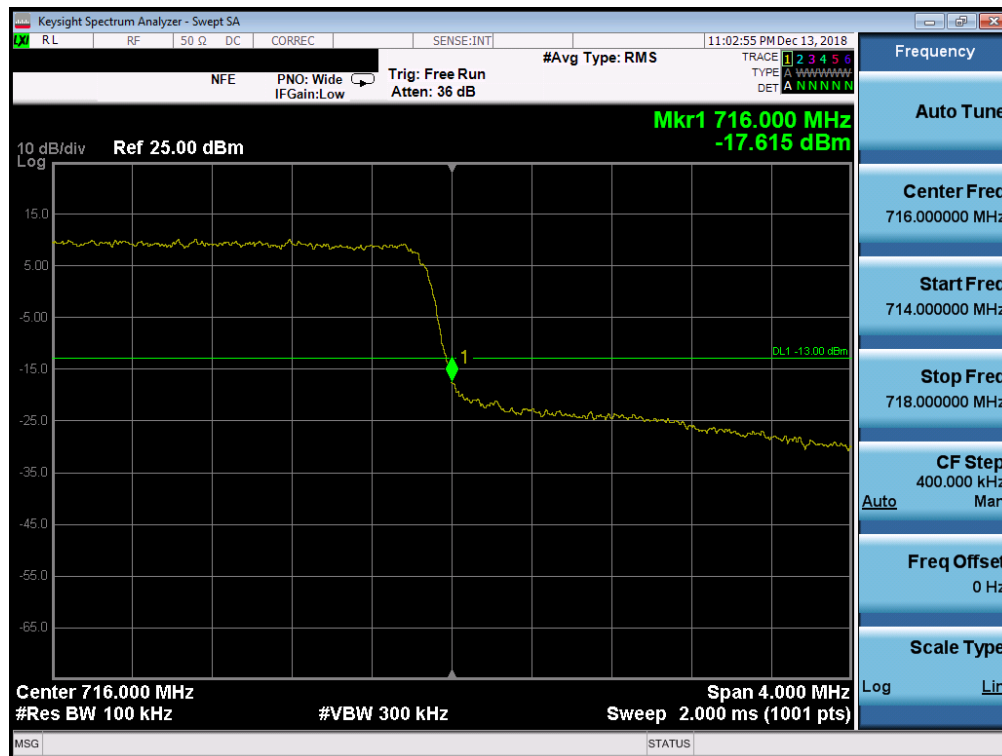

Plot 7-80. Upper Band Edge Plot (Band 12 - 3.0MHz QPSK - Full RB Configuration)

FCC ID: ZNFX220QM		MEASUREMENT REPORT (CERTIFICATION)		Approved by: Quality Manager
Test Report S/N: 1M1812110223-03.ZNF	Test Dates: 12/10-12/21/2018	EUT Type: Portable Handset		Page 60 of 134

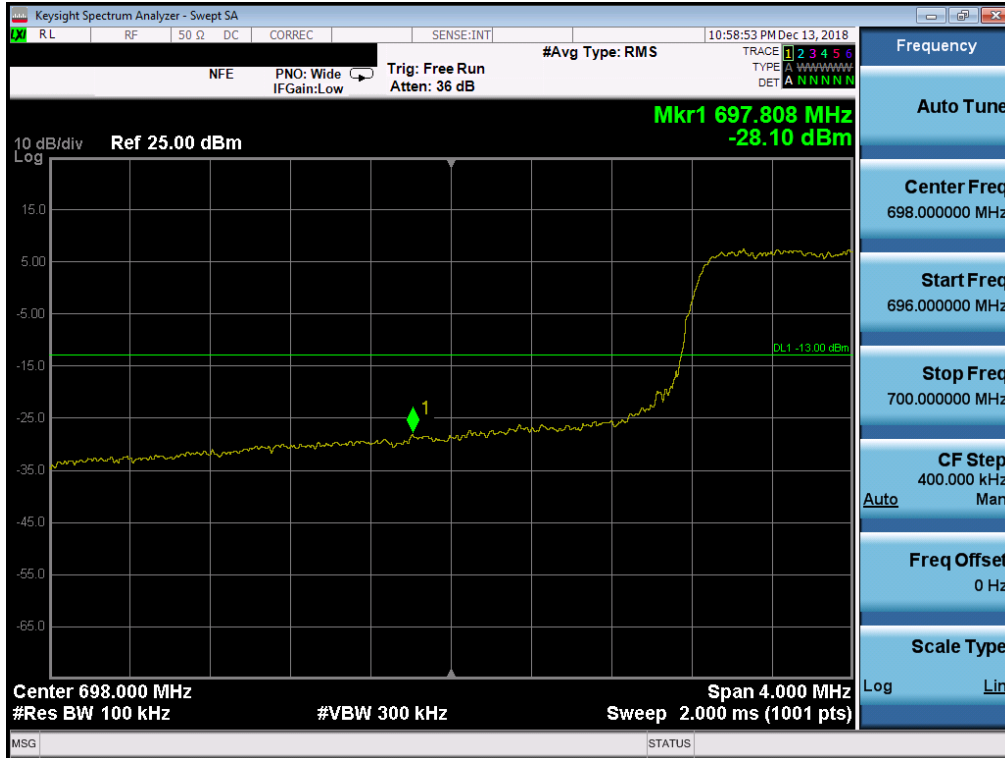

Plot 7-81. Lower Band Edge Plot (Band 12 - 5.0MHz QPSK - Full RB Configuration)



Plot 7-82. Upper Band Edge Plot (Band 12 - 5.0MHz QPSK - Full RB Configuration)

FCC ID: ZNFX220QM		MEASUREMENT REPORT (CERTIFICATION)		Approved by: Quality Manager
Test Report S/N: 1M1812110223-03.ZNF	Test Dates: 12/10-12/21/2018	EUT Type: Portable Handset		Page 61 of 134