



FCC RF Test Report

APPLICANT : LG Electronics Mobile Comm USA
EQUIPMENT : Smart phone
BRAND NAME : LG
MODEL NAME : LG-X220g
FCC ID : ZNFX220G
STANDARD : FCC 47 CFR Part 2, 22(H), 24(E)
CLASSIFICATION : PCS Licensed Transmitter Held to Ear (PCE)

The product was received on Dec. 03, 2015 and testing was completed on Dec. 11, 2015. We, SPORTON INTERNATIONAL (KUNSHAN) INC., would like to declare that the tested sample has been evaluated in accordance with the test procedures given in ANSI / TIA / EIA-603-D-2010 and has been in compliance with the applicable technical standards.

The test results in this report apply exclusively to the tested model / sample. Without written approval of SPORTON INTERNATIONAL (KUNSHAN) INC., the test report shall not be reproduced except in full.

Prepared by: James Huang / Manager

Approved by: Jones Tsai / Manager



SPORTON INTERNATIONAL (KUNSHAN) INC.
No. 3-2, PingXiang Road, Kunshan, Jiangsu Province, P. R. China



TABLE OF CONTENTS

- 1 GENERAL DESCRIPTION 5**
 - 1.1 Applicant..... 5
 - 1.2 Manufacturer 5
 - 1.3 Product Feature of Equipment Under Test 5
 - 1.4 Product Specification subjective to this standard 6
 - 1.5 Modification of EUT 6
 - 1.6 Maximum ERP/EIRP Power, Frequency Tolerance, and Emission Designator 7
 - 1.7 Testing Location 7
 - 1.8 Applicable Standards 7
- 2 TEST CONFIGURATION OF EQUIPMENT UNDER TEST 8**
 - 2.1 Test Mode..... 8
 - 2.2 Connection Diagram of Test System 9
 - 2.3 Support Unit used in test configuration 10
 - 2.4 Measurement Results Explanation Example 10
- 3 CONDUCTED TEST RESULT 11**
 - 3.1 Measuring Instruments..... 11
 - 3.2 Test Setup 11
 - 3.3 Test Result of Conducted Test..... 11
 - 3.4 Conducted Output Power 12
 - 3.5 Peak-to-Average Ratio 12
 - 3.6 99% Occupied Bandwidth and 26dB Bandwidth Measurement..... 13
 - 3.7 Conducted Band Edge 14
 - 3.8 Conducted Spurious Emission 15
 - 3.9 Frequency Stability..... 16
- 4 RADIATED TEST ITEMS 17**
 - 4.1 Measuring Instruments..... 17
 - 4.2 Test Setup 17
 - 4.3 Test Result of Radiated Test..... 17
 - 4.4 Effective Radiated Power and Effective Isotropic Radiated Power Measurement 18
 - 4.5 Field Strength of Spurious Radiation Measurement 20
- 5 LIST OF MEASURING EQUIPMENT 21**
- 6 UNCERTAINTY OF EVALUATION 22**

APPENDIX A. TEST RESULTS OF CONDUCTED TEST

APPENDIX B. TEST RESULTS OF RADIATED TEST



REVISION HISTORY

REPORT NO.	VERSION	DESCRIPTION	ISSUED DATE
FG5D0302	Rev. 01	Initial issue of report	Jan. 19, 2016



SUMMARY OF TEST RESULT

Report Section	FCC Rule	Description	Limit	Result	Remark
3.4	§2.1046	Conducted Output Power	Reporting Only	PASS	-
3.5	§24.232(d)	Peak-to-Average Ratio	< 13 dB	PASS	-
3.6	§2.1049 §22.917(b) §24.238(b)	Occupied Bandwidth	Reporting Only	PASS	-
3.7	§2.1051 §22.917(a) §24.238(a)	Band Edge Measurement	< 43+10log10(P[Watts])	PASS	-
3.8	§2.1051 §22.917(a) §24.238(a)	Conducted Emission	< 43+10log10(P[Watts])	PASS	-
3.9	§2.1055 §22.355	Frequency Stability for Temperature & Voltage	< 2.5 ppm for Part 22H	PASS	-
	§2.1055 §24.235		Within Authorized Band		
4.4	§22.913(a)(2)	Effective Radiated Power	< 7 Watts	PASS	-
	§24.232(c)	Equivalent Isotropic Radiated Power	< 2 Watts	PASS	-
4.5	§2.1053 §22.917(a) §24.238(a)	Field Strength of Spurious Radiation	< 43+10log10(P[Watts])	PASS	Under limit 30.53 dB at 7521.000 MHz



1 General Description

1.1 Applicant

LG Electronics Mobile Comm USA
1000 Sylvan Avenue Englewood Cliffs, NJ 07632

1.2 Manufacturer

Arima Communications Corp.
6F, No.866,Jhongjheng Rd., Jhonghe Dist., New Taipei City 23586, Taiwan

1.3 Product Feature of Equipment Under Test

Product Feature	
Equipment	Smart phone
Brand Name	LG
Model Name	LG-X220g
FCC ID	ZNFX220G
EUT supports Radios application	GSM/GPRS/EGPRS(Downlink Only)/WCDMA/HSPA/HSPA+(16QAM uplink is not supported)/WLAN 2.4GHz 802.11b/g/n HT20/HT40/Bluetooth v3.0 + EDR/Bluetooth v4.0 LE
IMEI Code	Conducted: 353468062997343 Radiation: 353468062997004 ERP&EIRP: 353468062997285
HW Version	5542MB-003
SW Version	LGX220g-00-V08a-334-20-NOV-11-2015+0
EUT Stage	Production Unit

Remark: The above EUT's information was declared by manufacturer. Please refer to the specifications or user's manual for more detailed description.

1.4 Product Specification subjective to this standard

Product Specification subjective to this standard	
Tx Frequency	GSM/GPRS: 850: 824.2 MHz ~ 848.8 MHz 1900: 1850.2 MHz ~ 1909.8MHz WCDMA: Band V: 826.4 MHz ~ 846.6 MHz Band II: 1852.4 MHz ~ 1907.6 MHz
Rx Frequency	GSM/GPRS: 850: 869.2 MHz ~ 893.8 MHz 1900: 1930.2 MHz ~ 1989.8 MHz WCDMA: Band V: 871.4 MHz ~ 891.6 MHz Band II: 1932.4 MHz ~ 1987.6 MHz
Maximum Output Power to Antenna	GSM/GPRS: 850: 33.02 dBm 1900: 30.06 dBm WCDMA: Band V: 23.14 dBm Band II: 23.06 dBm
Antenna Type	IFA Antenna
Type of Modulation	GSM: GMSK GPRS: GMSK EDGE: GMSK / 8PSK(Downlink Only) WCDMA: QPSK (Uplink) HSDPA: QPSK (Uplink) HSUPA: QPSK (Uplink) HSPA+: 16QAM (16QAM uplink is not supported)

1.5 Modification of EUT

No modifications are made to the EUT during all test items.



1.6 Maximum ERP/EIRP Power, Frequency Tolerance, and Emission Designator

FCC Rule	System	Type of Modulation	Maximum ERP/EIRP (W)	Frequency Tolerance (ppm)	Emission Designator
Part 22H	GSM850 GSM	GMSK	0.9750	0.0299 ppm	245KGXW
Part 22H	WCDMA Band V RMC 12.2Kbps	QPSK	0.1041	0.0526 ppm	4M14F9W
Part 24E	GSM1900 GSM	GMSK	0.6982	0.0122 ppm	245KGXW
Part 24E	WCDMA Band II RMC 12.2Kbps	QPSK	0.1405	0.0191 ppm	4M16F9W

1.7 Testing Location

Test Site	SPORTON INTERNATIONAL (KUNSHAN) INC.		
Test Site Location	No. 3-2, PingXiang Road, Kunshan, Jiangsu Province, P. R. China TEL: +86-0512-5790-0158 FAX: +86-0512-5790-0958		
Test Site No.	Sporton Site No.		FCC Registration No.
	TH01-KS	03CH02-KS	418269

1.8 Applicable Standards

According to the specifications of the manufacturer, the EUT must comply with the requirements of the following standards:

- 47 CFR Part 2, 22(H), 24(E)
- ANSI / TIA / EIA-603-D-2010
- FCC KDB 971168 D01 Power Meas. License Digital Systems v02r02

Remark:

1. All test items were verified and recorded according to the standards and without any deviation during the test.
2. This EUT has also been tested and complied with the requirements of FCC Part 15, Subpart B, recorded in a separate test report.



2 Test Configuration of Equipment Under Test

2.1 Test Mode

Antenna port conducted and radiated test items were performed according to KDB 971168 D01 Power Meas. License Digital Systems v02r02 with maximum output power.

Radiated measurements were performed with rotating EUT in different three orthogonal test planes to find the maximum emission.

Radiated emissions were investigated as following frequency range:

1. 30 MHz to 10th harmonic for GSM850 and WCDMA Band V.
2. 30 MHz to 10th harmonic for GSM1900 and WCDMA Band II.

All modes and data rates and positions were investigated.

Test modes are chosen to be reported as the worst case configuration below:

Test Modes		
Band	Radiated TCs	Conducted TCs
GSM 850	■ GSM Link	■ GSM Link
GSM 1900	■ GSM Link	■ GSM Link
WCDMA Band V	■ RMC 12.2Kbps Link	■ RMC 12.2Kbps Link
WCDMA Band II	■ RMC 12.2Kbps Link	■ RMC 12.2Kbps Link

2.2 Connection Diagram of Test System

Part 22H

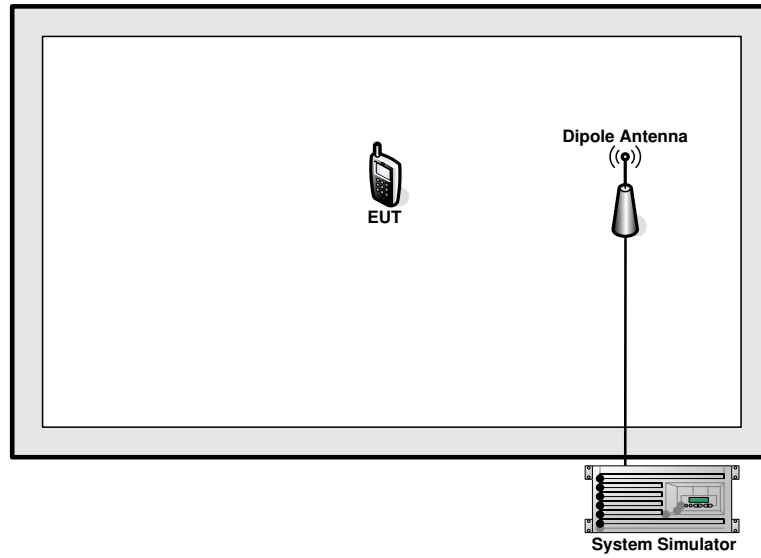

Part 24E

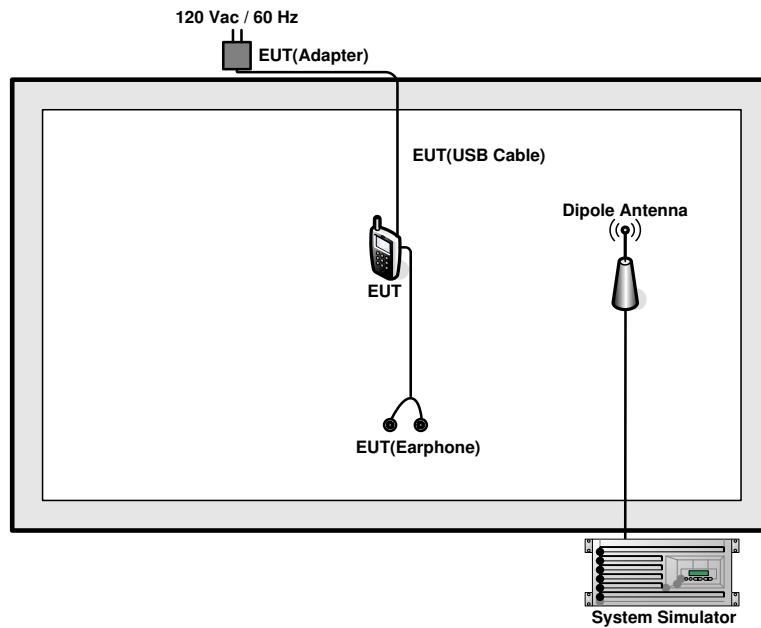



2.3 Support Unit used in test configuration

Item	Equipment	Trade Name	Model No.	FCC ID	Data Cable	Power Cord
1.	System Simulator	R&S	CMU 200	N/A	N/A	Unshielded, 1.8 m
2.	DC Power Supply	GW INSTEK	GPS-3030D	N/A	N/A	Unshielded, 1.8 m

2.4 Measurement Results Explanation Example

For all conducted test items:

The offset level is set in the spectrum analyzer to compensate the RF cable loss and attenuator factor between RF conducted output port and spectrum analyzer. With the offset compensation, the spectrum analyzer reading level will be exactly the RF output level.

The spectrum analyzer offset is derived from RF cable loss and attenuator factor.

$$\text{Offset} = \text{RF cable loss} + \text{attenuator factor}.$$

The following shows an offset computation example with RF cable loss 4.2 dB and a 10dB attenuator.

Example :

$$\begin{aligned} \text{Offset(dB)} &= \text{RF cable loss(dB)} + \text{attenuator factor(dB)}. \\ &= 4.2 + 10 = 14.2 \text{ (dB)} \end{aligned}$$

3 Conducted Test Result

3.1 Measuring Instruments

See list of measuring instruments of this test report.

3.2 Test Setup

3.2.1 Conducted Output Power

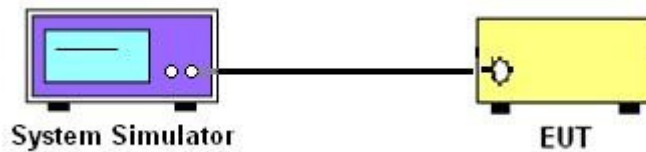

3.2.2 Peak-to-Average Ratio, Occupied Bandwidth, Conducted Band-Edge and Conducted Spurious Emission

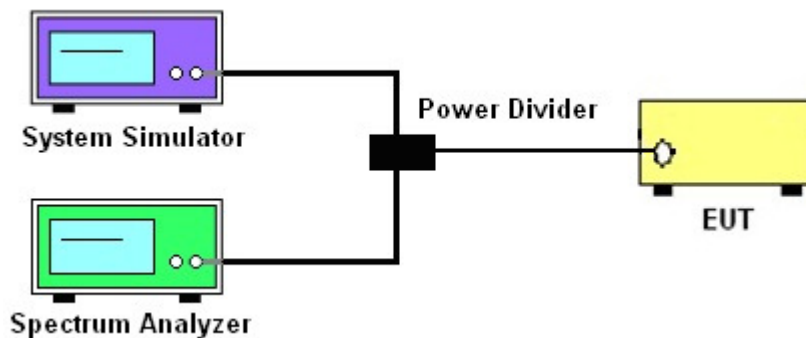

3.2.3 Frequency Stability

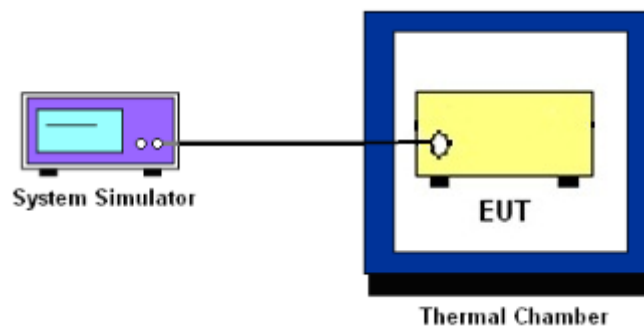

3.3 Test Result of Conducted Test

Please refer to Appendix A.



3.4 Conducted Output Power

3.4.1 Description of the Conducted Output Power

A system simulator was used to establish communication with the EUT. Its parameters were set to enforce EUT transmitting at the maximum power. The measured power in the radio frequency on the transmitter output terminals shall be reported.

3.4.2 Test Procedures

1. The transmitter output port was connected to the system simulator.
2. Set EUT at maximum power through system simulator.
3. Select lowest, middle, and highest channels for each band and different modulation.
4. Measure the maximum burst average power for GSM and maximum average power for other modulation signal.

3.5 Peak-to-Average Ratio

3.5.1 Description of the PAR Measurement

The peak-to-average ratio (PAR) of the transmission may not exceed 13 dB.

3.5.2 Test Procedures

1. The testing follows FCC KDB 971168 D01 v02r02 Section 5.7.1.
2. The EUT was connected to spectrum analyzer and system simulator via a power divider.
3. Set EUT to transmit at maximum output power.
4. When the duty cycle is less than 98%, then signal gating will be implemented on the spectrum analyzer by triggering from the system simulator.
5. Set the CCDF (Complementary Cumulative Distribution Function) option of the spectrum analyzer.
Record the maximum PAPR level associated with a probability of 0.1%.



3.6 99% Occupied Bandwidth and 26dB Bandwidth Measurement

3.6.1 Description of 99% Occupied Bandwidth and 26dB Bandwidth Measurement

The occupied bandwidth is the width of a frequency band such that, below the lower and above the upper frequency limits, the mean powers emitted are each equal to a specified percentage 0.5% of the total mean transmitted power.

The 26 dB emission bandwidth is defined as the frequency range between two points, one above and one below the carrier frequency, at which the spectral density of the emission is attenuated 26 dB below the maximum in-band spectral density of the modulated signal. Spectral density (power per unit bandwidth) is to be measured with a detector of resolution bandwidth equal to approximately 1.0% of the emission bandwidth.

3.6.2 Test Procedures

1. The testing follows FCC KDB 971168 v02r02 Section 4.2.
2. The EUT was connected to spectrum analyzer and system simulator via a power divider.
3. The spectrum analyzer center frequency is set to the nominal EUT channel center frequency. The span range for the spectrum analyzer shall be between two and five times the anticipated OBW.
4. The nominal resolution bandwidth (RBW) shall be in the range of 1 to 5 % of the anticipated OBW, and the VBW shall be at least 3 times the RBW.
5. Set the detection mode to peak, and the trace mode to max hold.
6. Determine the reference value: Set the EUT to transmit a modulated signal. Allow the trace to stabilize. Set the spectrum analyzer marker to the highest level of the displayed trace.
(this is the reference value)
7. Determine the “-26 dB down amplitude” as equal to (Reference Value – X).
8. Place two markers, one at the lowest and the other at the highest frequency of the envelope of the spectral display such that each marker is at or slightly below the “-X dB down amplitude” determined in step 6. If a marker is below this “-X dB down amplitude” value it shall be placed as close as possible to this value. The OBW is the positive frequency difference between the two markers.
9. Use the 99 % power bandwidth function of the spectrum analyzer and report the measured bandwidth.



3.7 Conducted Band Edge

3.7.1 Description of Conducted Band Edge Measurement

The power of any emission outside of the authorized operating frequency ranges must be lower than the transmitter power (P) by a factor of at least $43 + 10 \log (P)$ dB.

3.7.2 Test Procedures

1. The testing follows FCC KDB 971168 D01 v02r02 Section 6.0.
2. The EUT was connected to the spectrum analyzer and system simulator via a power divider.
3. The RF output of EUT was connected to the spectrum analyzer by an RF cable and attenuator. The path loss was compensated to the results for each measurement.
4. The band edges of low and high channels for the highest RF powers were measured.
5. The RF fundamental frequency should be excluded against the limit line in the operating frequency band.
6. The limit line is derived from $43 + 10\log(P)$ dB below the transmitter power P(Watts)
= $P(W) - [43 + 10\log(P)]$ (dB)
= $[30 + 10\log(P)]$ (dBm) - $[43 + 10\log(P)]$ (dB)
= -13dBm.



3.8 Conducted Spurious Emission

3.8.1 Description of Conducted Spurious Emission Measurement

The power of any emission outside of the authorized operating frequency ranges must be lower than the transmitter power (P) by a factor of at least $43 + 10 \log (P)$ dB.

It is measured by means of a calibrated spectrum analyzer and scanned from 30 MHz up to a frequency including its 10th harmonic.

3.8.2 Test Procedures

1. The testing follows FCC KDB 971168 D01 v02r02 Section 6.0.
2. The EUT was connected to the spectrum analyzer and system simulator via a power divider.
3. The RF output of EUT was connected to the spectrum analyzer by an RF cable and attenuator. The path loss was compensated to the results for each measurement.
4. The middle channel for the highest RF power within the transmitting frequency was measured.
5. The conducted spurious emission for the whole frequency range was taken.
6. The RF fundamental frequency should be excluded against the limit line in the operating frequency band.
7. The limit line is derived from $43 + 10\log(P)$ dB below the transmitter power P(Watts)
= $P(W) - [43 + 10\log(P)]$ (dB)
= $[30 + 10\log(P)]$ (dBm) - $[43 + 10\log(P)]$ (dB)
= -13dBm.



3.9 Frequency Stability

3.9.1 Description of Frequency Stability Measurement

The frequency stability shall be measured by variation of ambient temperature and variation of primary supply voltage to ensure that the fundamental emission stays within the authorized frequency block. The frequency stability of the transmitter shall be maintained within $\pm 0.00025\%$ ($\pm 2.5\text{ppm}$) of the center frequency.

3.9.2 Test Procedures for Temperature Variation

1. The testing follows FCC KDB 971168 D01 v02r02 Section 9.0.
2. The EUT was set up in the thermal chamber and connected with the system simulator.
3. With power OFF, the temperature was decreased to -30°C and the EUT was stabilized before testing. Power was applied and the maximum change in frequency was recorded within one minute.
4. With power OFF, the temperature was raised in 10°C steps up to 50°C . The EUT was stabilized at each step for at least half an hour. Power was applied and the maximum frequency change was recorded within one minute.

3.9.3 Test Procedures for Voltage Variation

1. The testing follows FCC KDB 971168 D01 v02r02 Section 9.0.
2. The EUT was placed in a temperature chamber at $25\pm 5^{\circ}\text{C}$ and connected with the system simulator.
3. The power supply voltage to the EUT was varied from 85% to 115% of the nominal value measured at the input to the EUT.
4. The variation in frequency was measured for the worst case.

4 Radiated Test Items

4.1 Measuring Instruments

See list of measuring instruments of this test report.

4.2 Test Setup

4.2.1 For radiated test from 30MHz to 1GHz

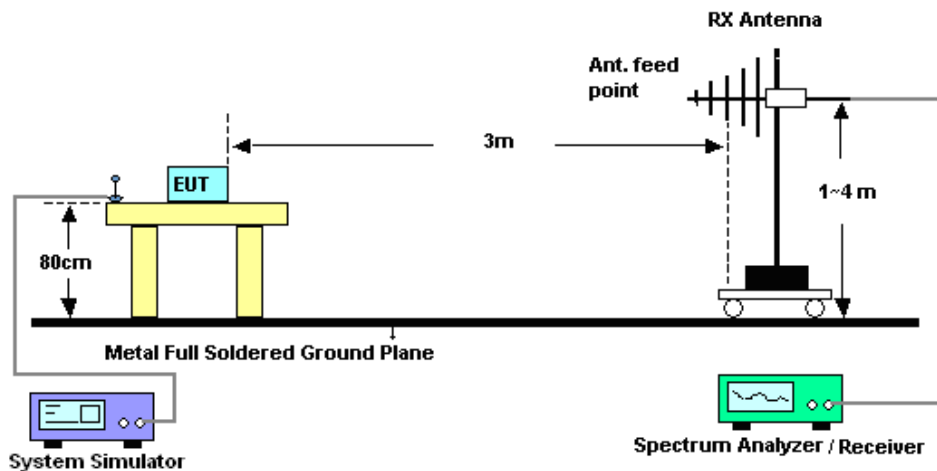

4.2.2 For radiated test above 1GHz

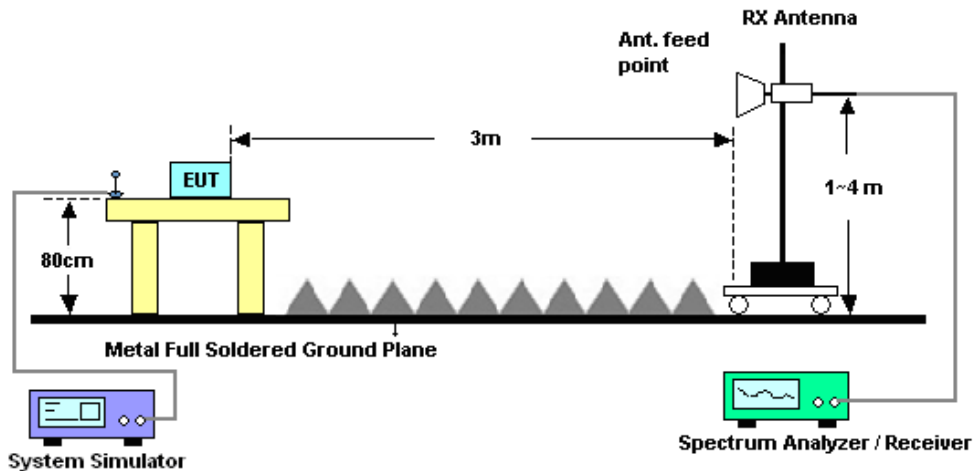

4.3 Test Result of Radiated Test

Please refer to Appendix B.



4.4 Effective Radiated Power and Effective Isotropic Radiated Power Measurement

4.4.1 Description of the ERP/EIRP Measurement

The substitution method, in ANSI / TIA / EIA-603-D-2010, was used for ERP/EIRP measurement, and the spectrum analyzer configuration follows KDB 971168 D01 Power Meas. License Digital Systems v02r02. The ERP of mobile transmitters must not exceed 7 Watts (Cellular Band) and the EIRP of mobile transmitters are limited to 2 Watts (PCS Band).

4.4.2 Test Procedures

1. The testing follows FCC KDB 971168 D01 v02r02 Section 5.2.1. (for CDMA/WCDMA), Section 5.2.2.2 (for GSM/GPRS/EDGE) and ANSI / TIA-603-D-2010 Section 2.2.17.
2. The EUT was placed on a non-conductive rotating platform 0.8 meters high in a semi-anechoic chamber. The radiated emission at the fundamental frequency was measured at 3 m with a test antenna and a spectrum analyzer with RMS detector per section 5. of KDB 971168 D01.
3. During the measurement, the system simulator parameters were set to force the EUT transmitting at maximum output power. The maximum emission was recorded from analyzer power level (LVL) from the 360 degrees rotation of the turntable and the test antenna raised and lowered over a range from 1 to 4 meters in both horizontally and vertically polarized orientations.
4. Effective Isotropic Radiated Power (EIRP) was measured by substitution method according to TIA/EIA-603-D. The EUT was replaced by the substitution antenna at same location, and then a known power from S.G. was applied into the dipole antenna through a Tx cable, and then recorded the maximum Analyzer reading through raised and lowered the test antenna. The correction factor (in dB) = S.G. - Tx Cable loss + Substitution antenna gain - Analyzer reading. Then the EUT's EIRP was calculated with the correction factor, $EIRP = LVL + \text{Correction factor}$ and $ERP = EIRP - 2.15$. Take the record of the output power at substitution antenna.



	GSM/GPRS/EDGE	WCDMA/HSPA
SPAN	500kHz	10MHz
RBW	10kHz	100kHz
VBW	30kHz	300kHz
Detector	RMS	RMS
Trace	Average	Average
Average Type	Power	Power
Sweep Count	100	100



4.5 Field Strength of Spurious Radiation Measurement

4.5.1 Description of Field Strength of Spurious Radiated Measurement

The power of any emission outside of the authorized operating frequency ranges must be attenuated below the transmitter power (P) by a factor of at least $43 + 10 \log (P)$ dB. The spectrum is scanned from 30 MHz up to a frequency including its 10th harmonic.

4.5.2 Test Procedures

1. The testing follows FCC KDB 971168 D01 v02r02 Section 5.8 and ANSI / TIA-603-D-2010 Section 2.2.12.
2. The EUT was placed on a rotatable wooden table 0.8 meters above the ground.
3. The EUT was set 3 meters from the receiving antenna, which was mounted on the antenna tower.
4. The table was rotated 360 degrees to determine the position of the highest spurious emission.
5. The height of the receiving antenna is varied between one meter and four meters to search for the maximum spurious emission for both horizontal and vertical polarizations.
6. Make the measurement with the spectrum analyzer's RBW = 1MHz, VBW = 3MHz, taking record of maximum spurious emission.
7. A horn antenna was substituted in place of the EUT and was driven by a signal generator.
8. Tune the output power of signal generator to the same emission level with EUT maximum spurious emission.
9. Taking the record of output power at antenna port.
10. Repeat step 7 to step 8 for another polarization.
11. $EIRP \text{ (dBm)} = S.G. \text{ Power} - Tx \text{ Cable Loss} + Tx \text{ Antenna Gain}$
12. $ERP \text{ (dBm)} = EIRP - 2.15$
13. The RF fundamental frequency should be excluded against the limit line in the operating frequency band.
14. The limit line is derived from $43 + 10\log(P)$ dB below the transmitter power P(Watts)
= $P(W) - [43 + 10\log(P)] \text{ (dB)}$
= $[30 + 10\log(P)] \text{ (dBm)} - [43 + 10\log(P)] \text{ (dB)}$
= -13dBm.



5 List of Measuring Equipment

Instrument	Manufacturer	Model No.	Serial No.	Characteristics	Calibration Date	Test Date	Due Date	Remark
Spectrum Analyzer	R&S	FSV30	101338	9kHz~30GHz	May 04, 2015	Dec. 04, 2015	May 03, 2016	Conducted (TH01-KS)
Thermal Chamber	Ten Billion	TTC-B3S	TBN-960502	-40~+150°C	Oct. 24, 2015	Dec. 04, 2015	Oct. 23, 2016	Conducted (TH01-KS)
Spectrum Analyzer	R&S	FSV40	101040	10kHz~40GHz;Max x 30dBm	Sep. 10, 2015	Dec. 11, 2015	Sep. 09, 2016	Radiation (03CH02-KS)
Bilog Antenna	TeseQ	CBL6112D	37879	30MHz-2GHz	Sep. 12, 2015	Dec. 11, 2015	Sep. 11, 2016	Radiation (03CH02-KS)
Double Ridge Horn Antenna	ETS-Lindgren	3117	75957	1GHz~18GHz	Nov. 07, 2015	Dec. 11, 2015	Nov. 06, 2016	Radiation (03CH02-KS)
SHF-EHF Horn	Schwarzbeck	BBHA 9170	BBHA170249	15GHz ~40GHz	Mar. 03, 2015	Dec. 11, 2015	Mar. 02, 2016	Radiation (03CH02-KS)
Amplifier	com-power	PA-103A	161069	1kHz ~1000MHz / 32 dB	May 04, 2015	Dec. 11, 2015	May 03, 2016	Radiation (03CH02-KS)
Amplifier	Agilent	8449B	3008A02384	1-26.5GHz Gain 30dB	Oct. 24, 2015	Dec. 11, 2015	Oct. 23, 2016	Radiation (03CH02-KS)
AC Power Source	Chroma	61601	61601000247 3	N/A	NCR	Dec. 11, 2015	NCR	Radiation (03CH02-KS)
Turn Table	MF	MF7802	N/A	0~360 degree	NCR	Dec. 11, 2015	NCR	Radiation (03CH02-KS)
Antenna Mast	MF	MF7802	N/A	1 m~4 m	NCR	Dec. 11, 2015	NCR	Radiation (03CH02-KS)



6 Uncertainty of Evaluation

Uncertainty of Radiated Emission Measurement (30 MHz ~ 1000 MHz)

Measuring Uncertainty for a Level of Confidence of 95% ($U = 2Uc(y)$)	5.1dB
---	-------



Appendix A. Test Results of Conducted Test

Conducted Output Power(Average power)

Conducted Power (*Unit: dBm)						
Band	GSM850			GSM1900		
Channel	128	189	251	512	661	810
Frequency	824.2	836.4	848.8	1850.2	1880.0	1909.8
GSM	32.98	32.99	33.02	29.97	29.99	30.06
GPRS class 8	32.97	32.93	32.99	30.00	29.99	30.05
GPRS class 10	31.44	31.46	31.55	28.69	28.74	28.83
GPRS class 11	28.32	28.34	28.43	25.62	25.69	25.81
GPRS class 12	26.78	26.80	26.90	24.03	24.14	24.23

Conducted Power (*Unit: dBm)						
Band	WCDMA Band V			WCDMA Band II		
Channel	4132	4182	4233	9262	9400	9538
Frequency	826.4	836.4	846.6	1852.4	1880	1907.6
AMR 12.2K	23.10	23.12	23.08	23.00	23.05	23.03
RMC 12.2K	23.12	23.14	23.10	23.02	23.06	23.05
HSDPA Subtest-1	22.11	22.16	22.15	22.01	22.07	22.04
HSDPA Subtest-2	22.12	22.15	22.16	22.01	22.07	22.05
HSDPA Subtest-3	22.12	22.15	22.16	22.02	22.06	22.04
HSDPA Subtest-4	22.12	22.16	22.15	22.01	22.07	22.05
HSUPA Subtest-1	21.19	21.22	21.25	21.38	21.42	21.41
HSUPA Subtest-2	21.18	21.22	21.25	21.38	21.42	21.42
HSUPA Subtest-3	22.16	22.23	22.25	22.36	22.42	22.37
HSUPA Subtest-4	20.64	20.71	20.73	20.86	20.91	20.95
HSUPA Subtest-5	22.62	22.66	22.68	22.73	22.76	22.78



Peak-to-Average Ratio

Mode	GSM850	GSM1900	Limit: 13dB
Mod.	GSM	GSM	Result
Lowest CH	0.12	0.12	PASS
Middle CH	0.12	0.12	
Highest CH	0.12	0.14	

Mode	WCDMA Band V	WCDMA Band II	Limit: 13dB
Mod.	RMC 12.2Kbps	RMC 12.2Kbps	Result
Lowest CH	3.01	2.90	PASS
Middle CH	2.90	2.99	
Highest CH	3.01	2.90	

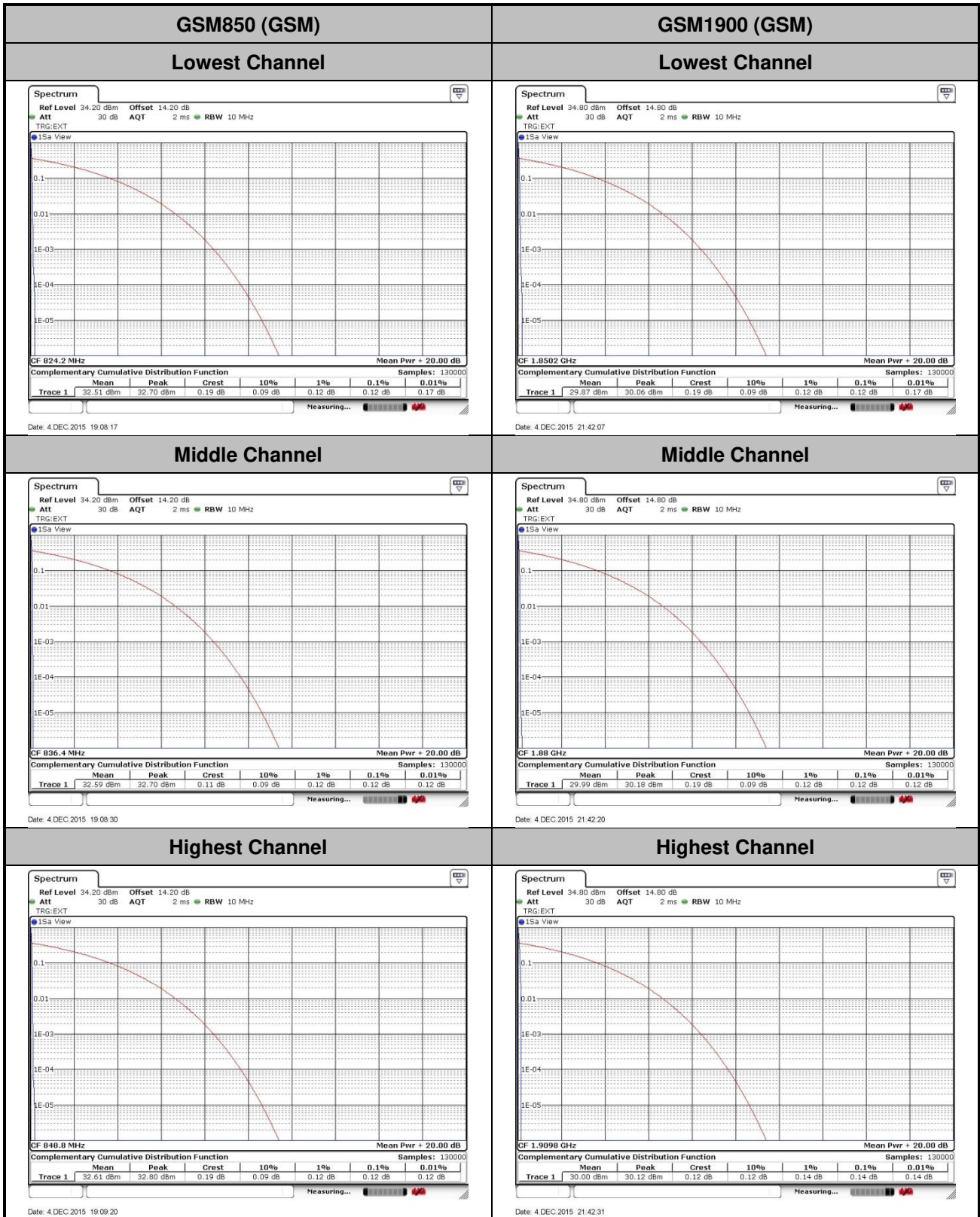

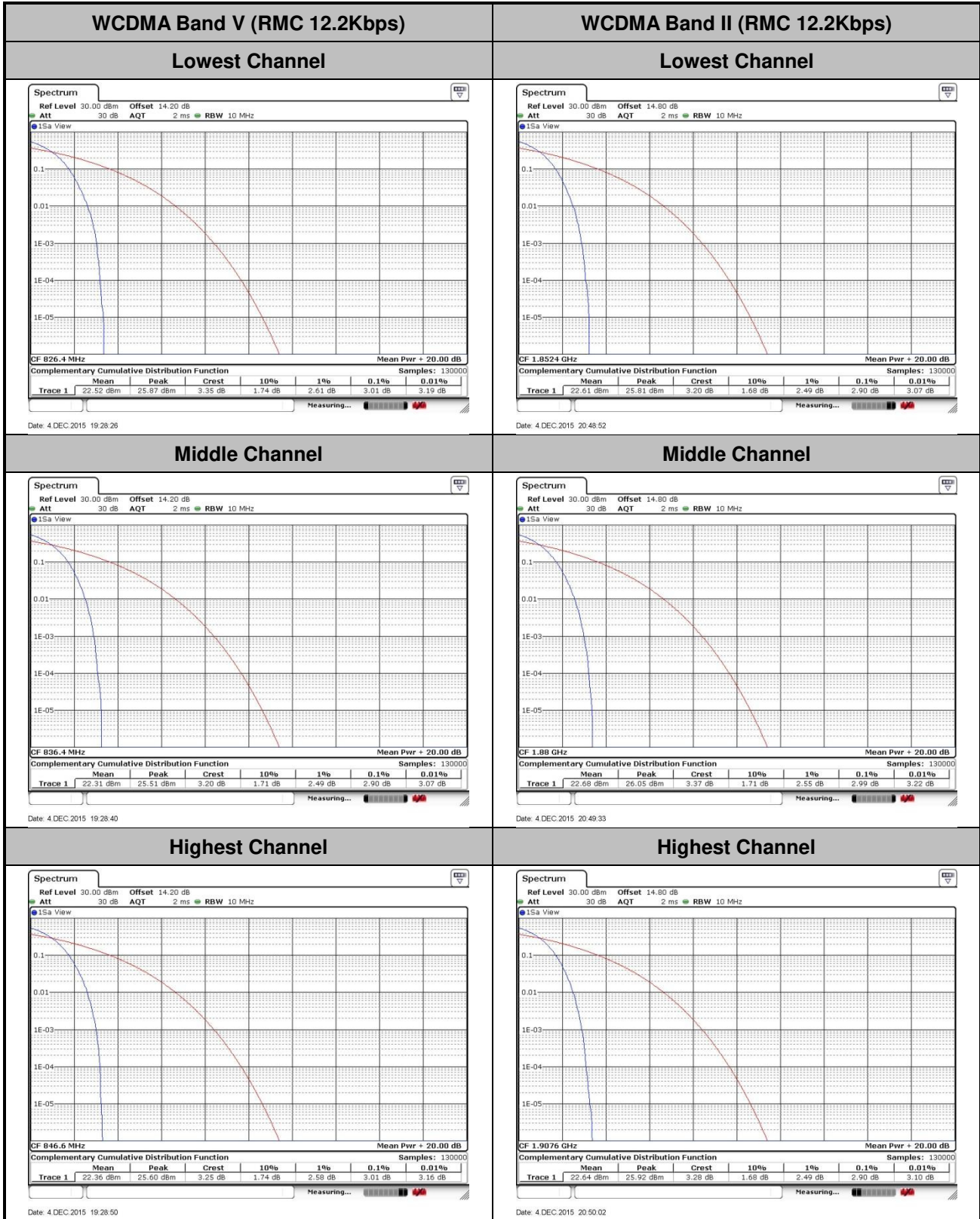



26dB Bandwidth

Mode	GSM850	GSM1900
Mod.	GSM	GSM
Lowest CH	0.317	0.320
Middle CH	0.317	0.318
Highest CH	0.316	0.316

Mode	WCDMA Band V	WCDMA Band II
Mod.	RMC 12.2Kbps	RMC 12.2Kbps
Lowest CH	4.68	4.69
Middle CH	4.68	4.69
Highest CH	4.68	4.69



GSM850 (GSM)

Lowest Channel

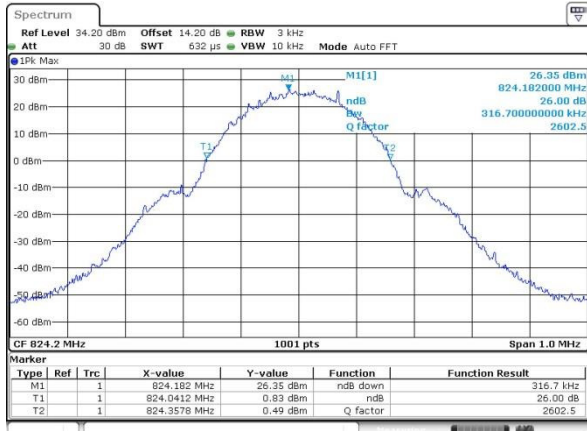

Date: 4 DEC 2015 18:51:47

GSM1900 (GSM)

Lowest Channel

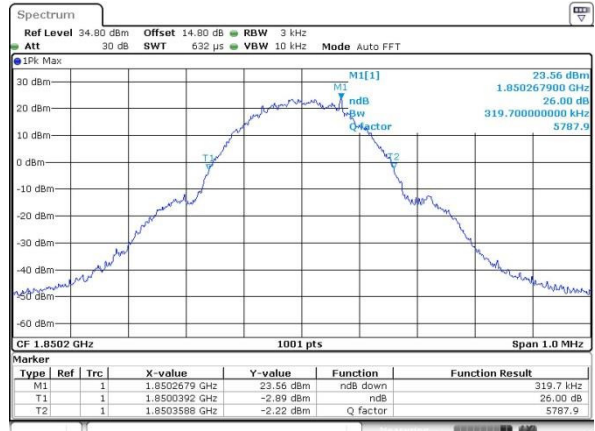

Date: 4 DEC 2015 21:18:49

Middle Channel

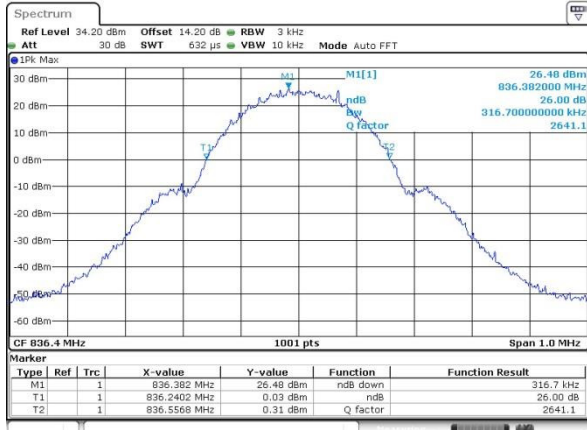

Date: 4 DEC 2015 18:52:15

Middle Channel

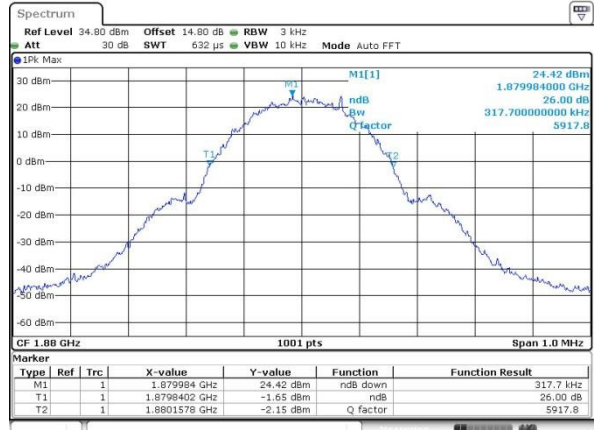

Date: 4 DEC 2015 21:19:17

Highest Channel

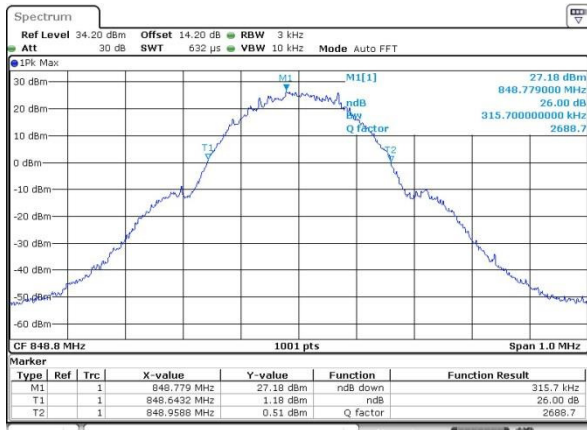

Date: 4 DEC 2015 18:52:43

Highest Channel

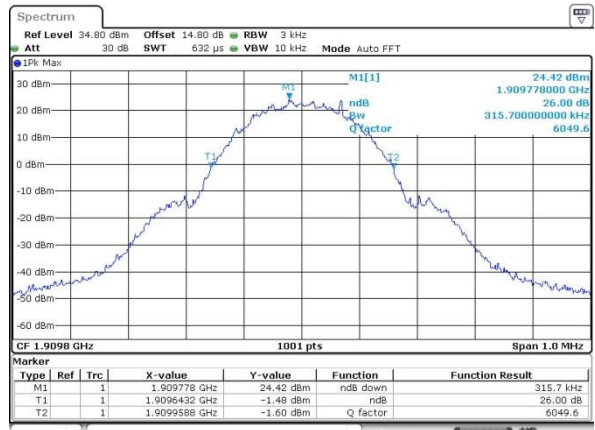

Date: 4 DEC 2015 21:16:58



WCDMA Band V (RMC 12.2Kbps)

Lowest Channel

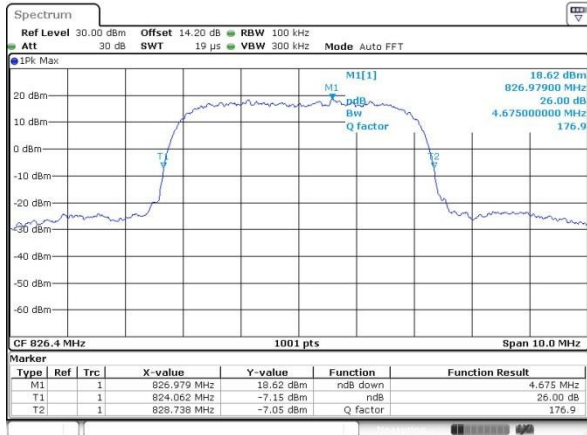

Date: 4 DEC 2015 19:15:17

WCDMA Band II (RMC 12.2Kbps)

Lowest Channel

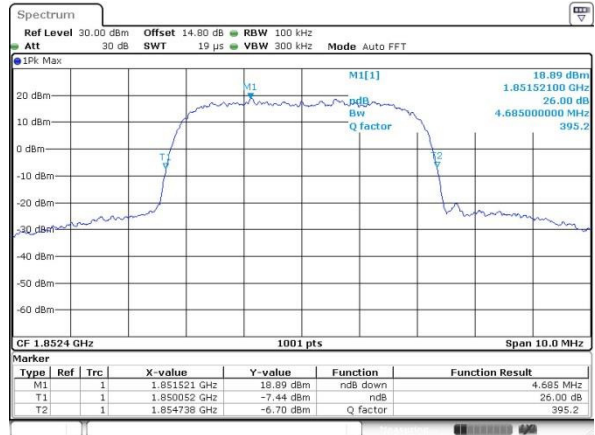

Date: 4 DEC 2015 19:31:22

Middle Channel

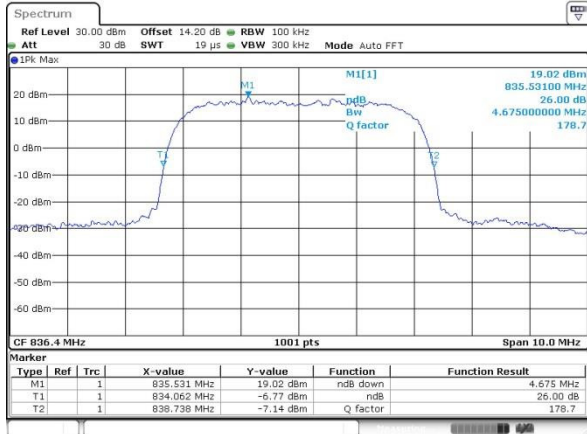

Date: 4 DEC 2015 19:15:45

Middle Channel

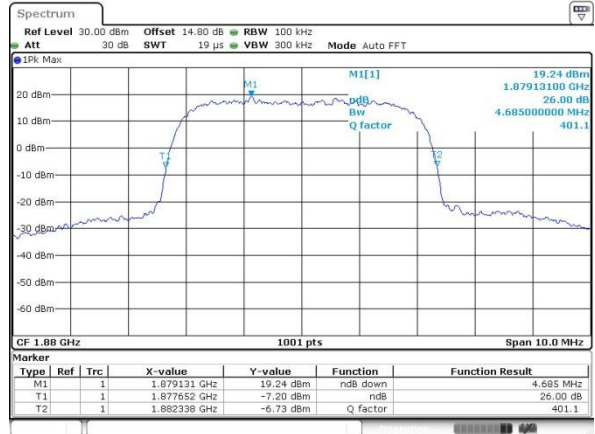

Date: 4 DEC 2015 19:31:51

Highest Channel

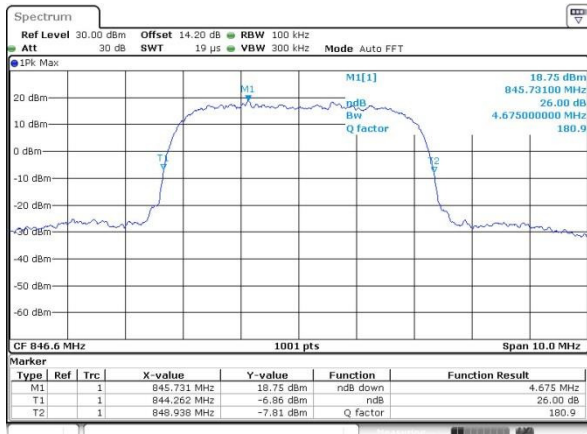

Date: 4 DEC 2015 19:16:14

Highest Channel

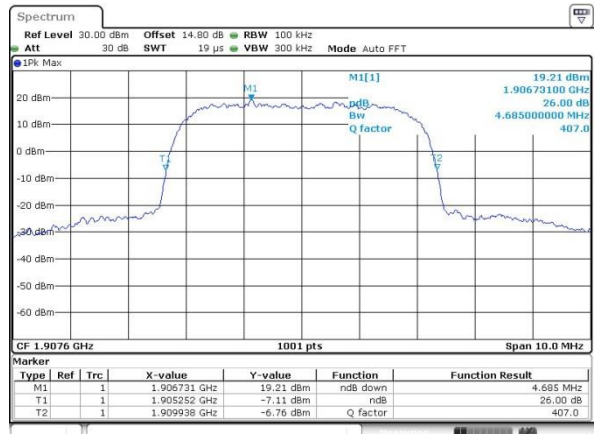

Date: 4 DEC 2015 19:32:19



Occupied Bandwidth

Mode	GSM850	GSM1900
Mod.	GSM	GSM
Lowest CH	0.244	0.242
Middle CH	0.245	0.245
Highest CH	0.244	0.244

Mode	WCDMA Band V	WCDMA Band II
Mod.	RMC 12.2Kbps	RMC 12.2Kbps
Lowest CH	4.14	4.16
Middle CH	4.14	4.15
Highest CH	4.14	4.16



GSM850 (GSM)

Lowest Channel

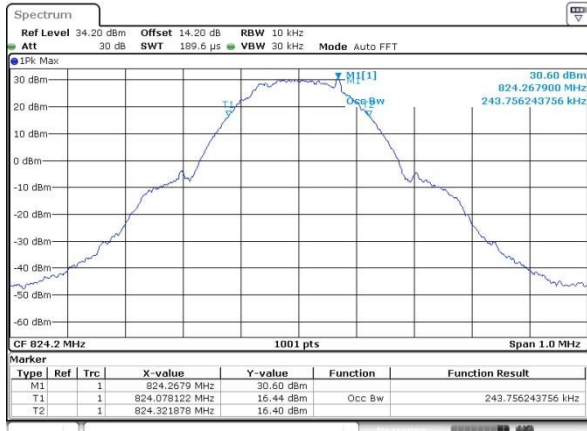

Date: 4 DEC 2015 18:58:11

GSM1900 (GSM)

Lowest Channel

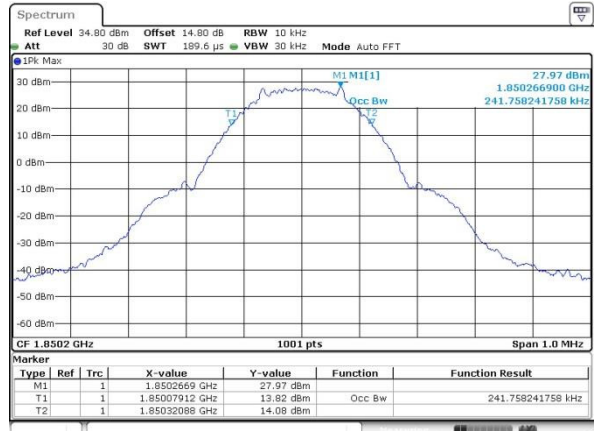

Date: 4 DEC 2015 21:22:14

Middle Channel

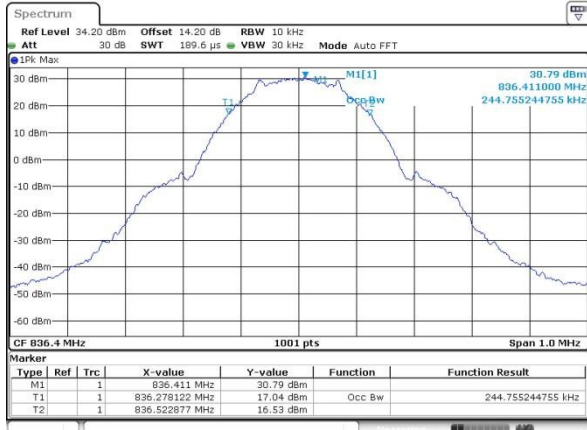

Date: 4 DEC 2015 18:58:39

Middle Channel



Date: 4 DEC 2015 21:24:58

Highest Channel

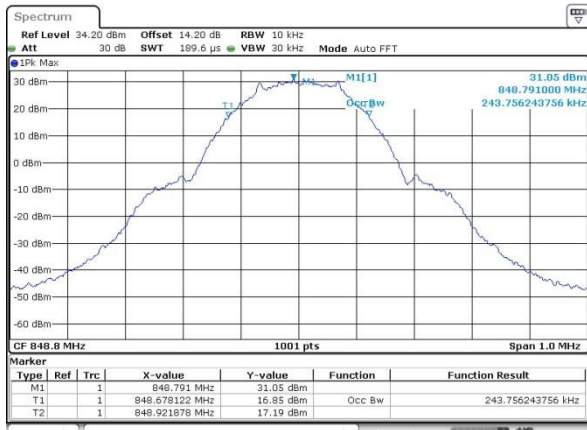

Date: 4 DEC 2015 18:59:07

Highest Channel

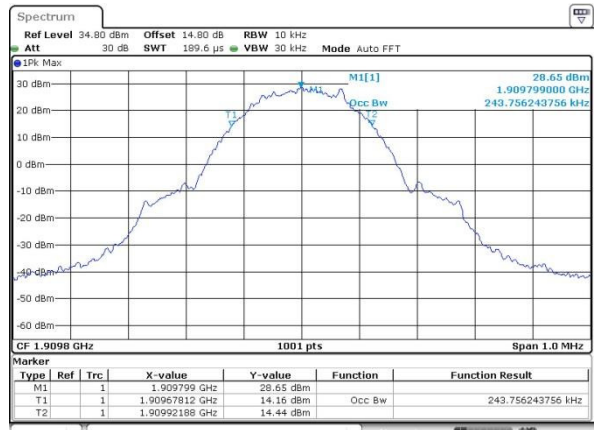

Date: 4 DEC 2015 21:23:11



WCDMA Band V (RMC 12.2Kbps)

Lowest Channel

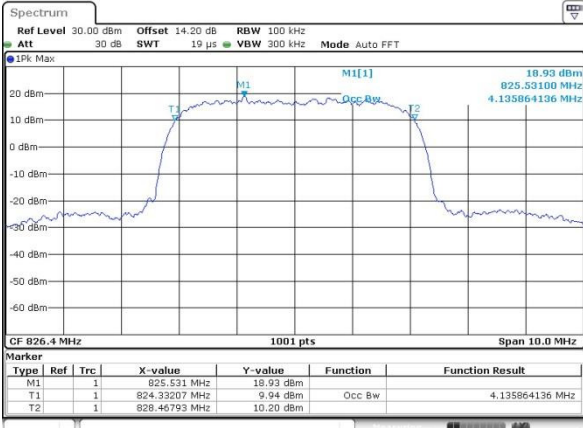

Date: 4 DEC 2015 19:17:13

WCDMA Band II (RMC 12.2Kbps)

Lowest Channel

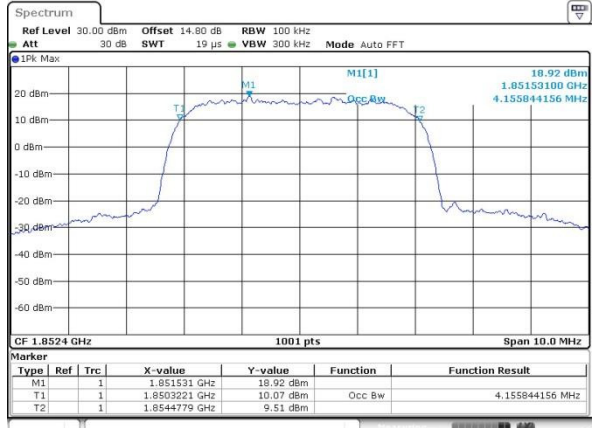

Date: 4 DEC 2015 19:32:51

Middle Channel

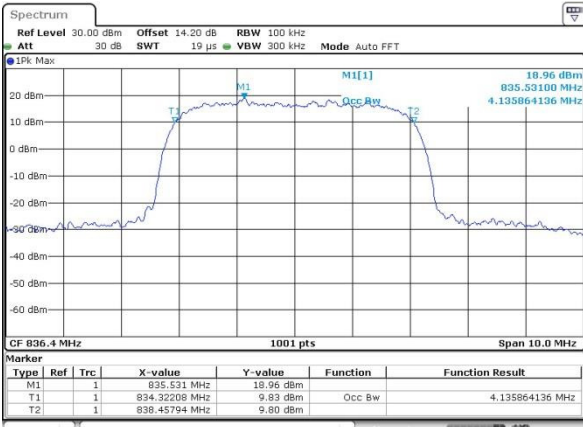

Date: 4 DEC 2015 19:17:42

Middle Channel

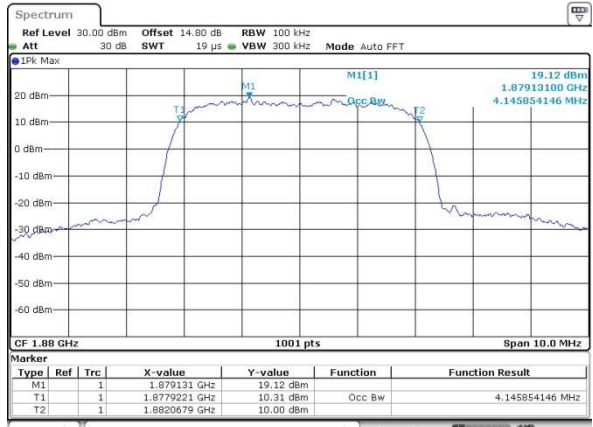

Date: 4 DEC 2015 19:33:19

Highest Channel

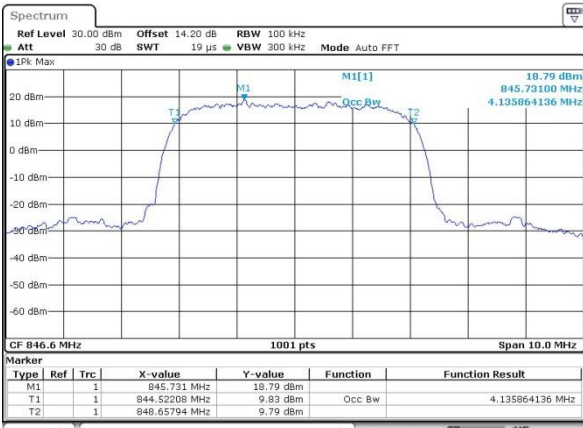

Date: 4 DEC 2015 19:18:10

Highest Channel

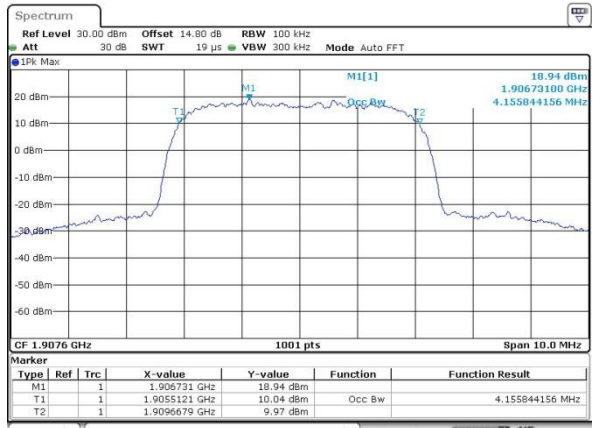

Date: 4 DEC 2015 19:33:48



Conducted Band Edge

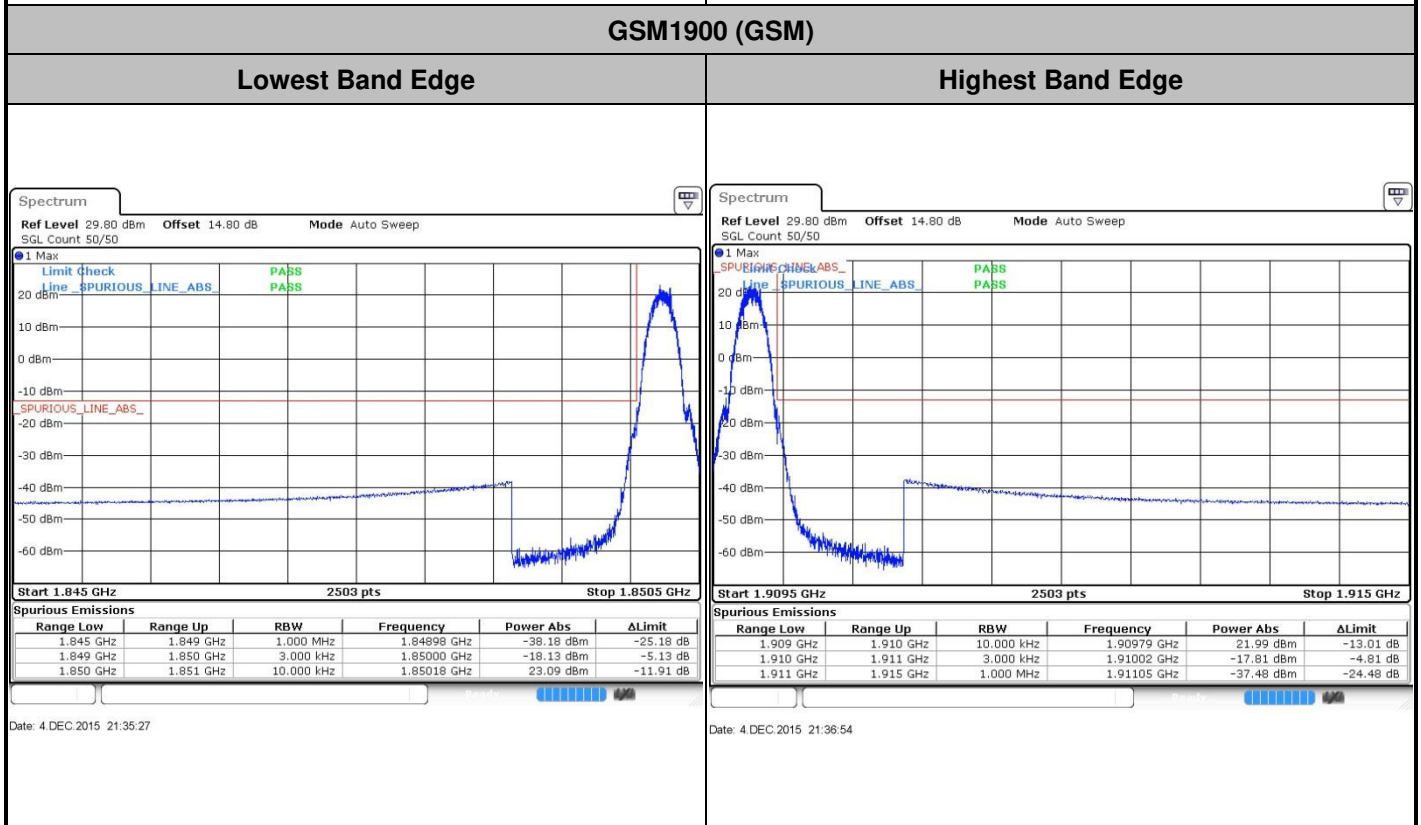
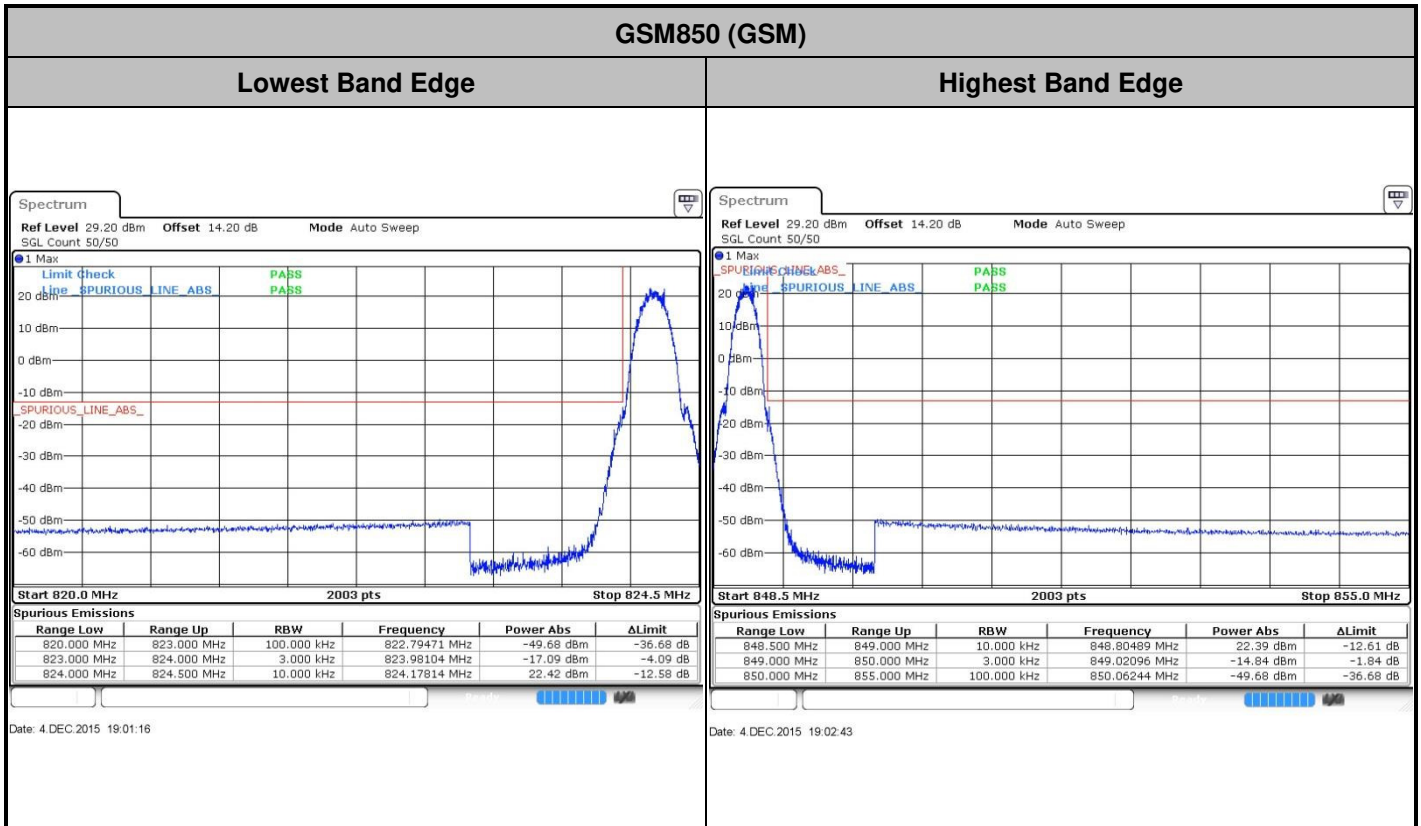



WCDMA Band V (RMC 12.2Kbps)

Lowest Band Edge

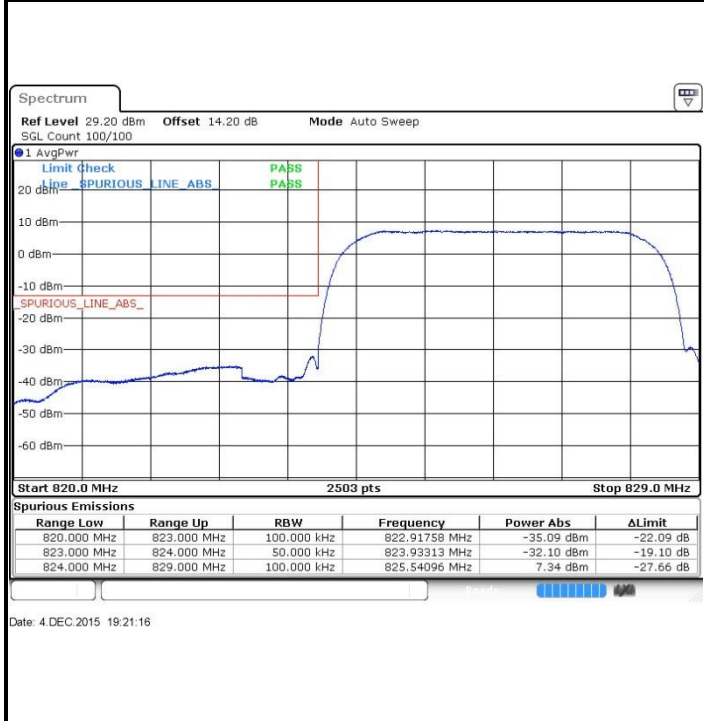

Highest Band Edge

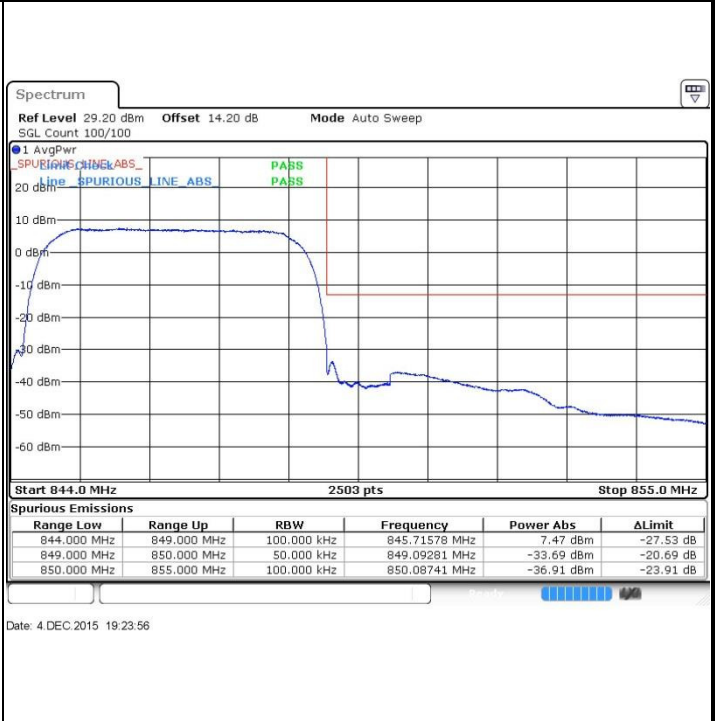

WCDMA Band II (RMC 12.2Kbps)

Lowest Band Edge

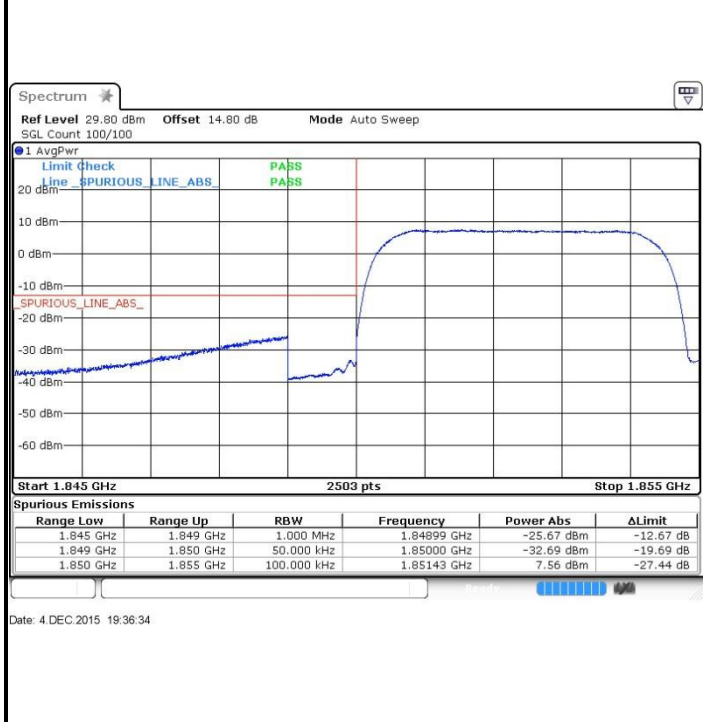

Highest Band Edge

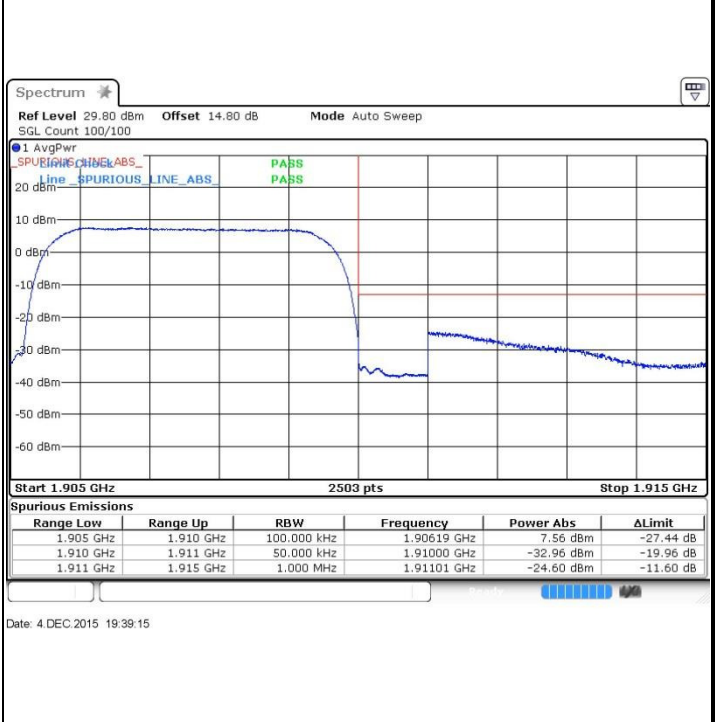



Conducted Spurious Emission

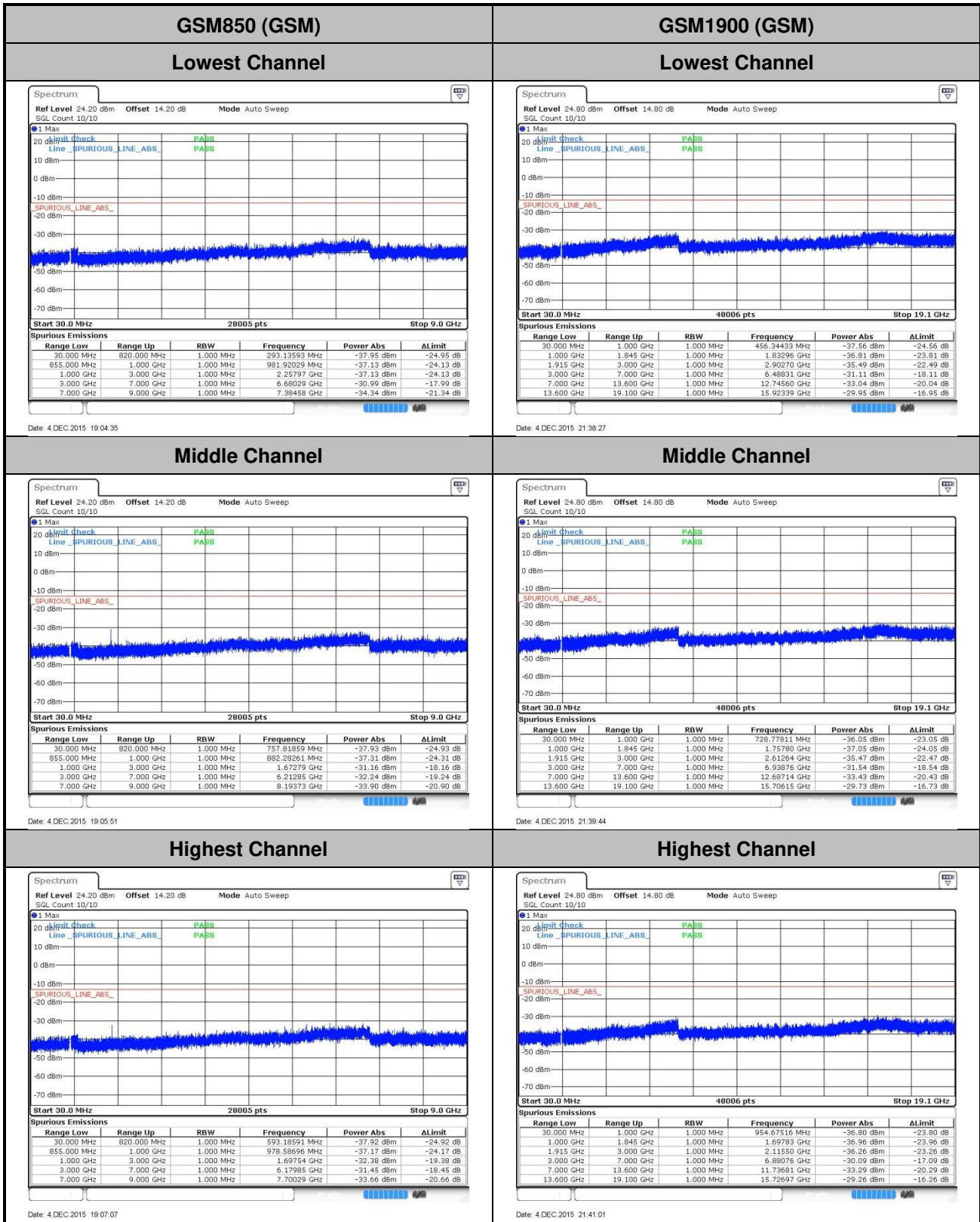



WCDMA Band V (RMC 12.2Kbps)

Lowest Channel

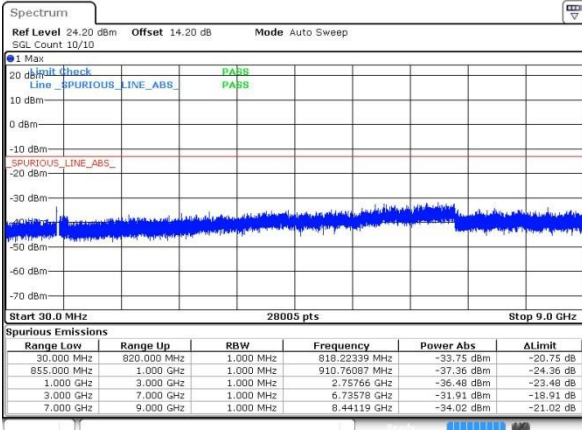

Date: 4 DEC 2015 19:25:40

WCDMA Band II (RMC 12.2Kbps)

Lowest Channel

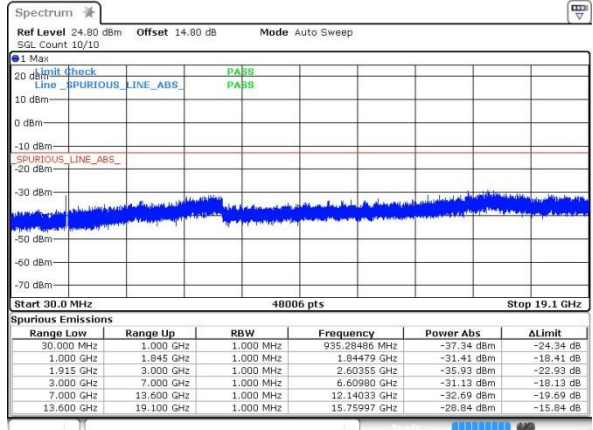

Date: 4 DEC 2015 20:42:16

Middle Channel

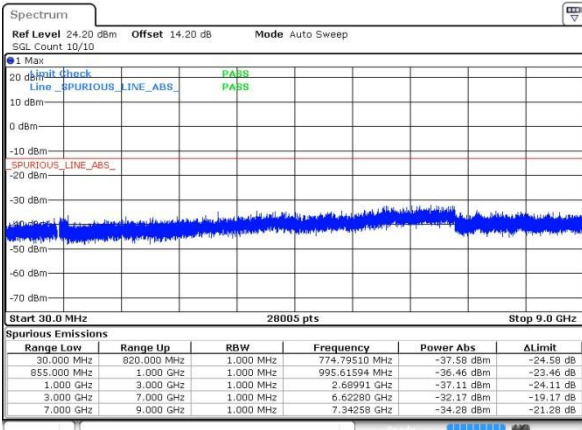

Date: 4 DEC 2015 19:26:56

Middle Channel

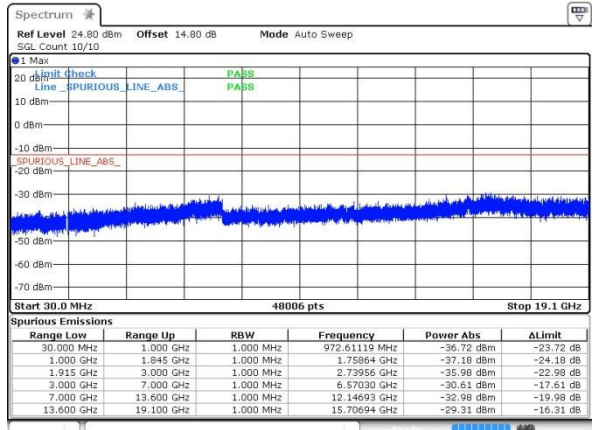

Date: 4 DEC 2015 20:38:44

Highest Channel

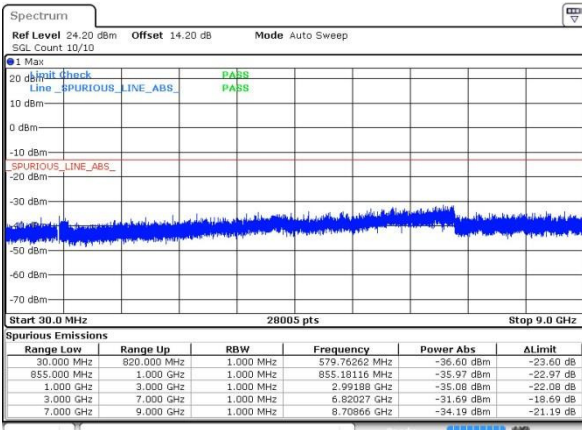

Date: 4 DEC 2015 19:28:12

Highest Channel

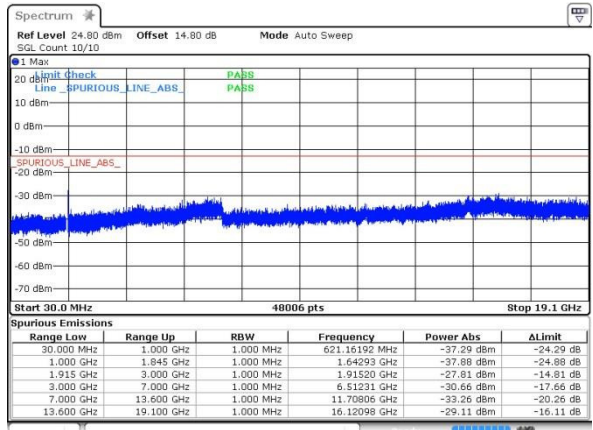

Date: 4 DEC 2015 20:40:01



Frequency Stability

Test Conditions	Middle Channel	GSM850 (GSM)	Limit 2.5ppm
Temperature (°C)	Voltage (Volt)	Deviation (ppm)	Result
50	Normal Voltage	0.0012	PASS
40	Normal Voltage	0.0072	
30	Normal Voltage	0.0072	
20(Ref.)	Normal Voltage	0.0000	
10	Normal Voltage	0.0167	
0	Normal Voltage	0.0096	
-10	Normal Voltage	0.0108	
-20	Normal Voltage	0.0120	
-30	Normal Voltage	0.0143	
20	Maximum Voltage	0.0132	
20	Normal Voltage	0.0227	
20	Battery End Point	0.0299	

Note: Normal Voltage = 3.8V. : Battery End Point (BEP) = 3.5 V. : Maximum Voltage =4.3V



Test Conditions	Middle Channel	GSM1900 (GSM)	Limit Note 2.
Temperature (°C)	Voltage (Volt)	Deviation (ppm)	Result
50	Normal Voltage	0.0016	PASS
40	Normal Voltage	0.0064	
30	Normal Voltage	0.0032	
20(Ref.)	Normal Voltage	0.0000	
10	Normal Voltage	0.0021	
0	Normal Voltage	0.0112	
-10	Normal Voltage	0.0053	
-20	Normal Voltage	0.0005	
-30	Normal Voltage	0.0122	
20	Maximum Voltage	0.0080	
20	Normal Voltage	0.0090	
20	Battery End Point	0.0032	

Note:

1. Normal Voltage = 3.8V. ; Battery End Point (BEP) = 3.5 V. ; Maximum Voltage =4.3V
2. The frequency fundamental emissions stay within the authorized frequency block based on the frequency deviation measured is small.



Test Conditions	Middle Channel	WCDMA Band V (RMC 12.2KbpsRMC 12.2Kbps)	Limit 2.5ppm
Temperature (°C)	Voltage (Volt)	Deviation (ppm)	Result
50	Normal Voltage	0.0024	PASS
40	Normal Voltage	0.0024	
30	Normal Voltage	0.0024	
20(Ref.)	Normal Voltage	0.0000	
10	Normal Voltage	0.0084	
0	Normal Voltage	0.0012	
-10	Normal Voltage	0.0335	
-20	Normal Voltage	0.0036	
-30	Normal Voltage	0.0526	
20	Maximum Voltage	0.0048	
20	Normal Voltage	0.0000	
20	Battery End Point	0.0012	

Note: Normal Voltage = 3.8V. : Battery End Point (BEP) = 3.5 V. : Maximum Voltage =4.3V



Test Conditions	Middle Channel	WCDMA Band II (RMC 12.2Kbps)	Limit Note 2.
Temperature (°C)	Voltage (Volt)	Deviation (ppm)	Result
50	Normal Voltage	0.0170	PASS
40	Normal Voltage	0.0154	
30	Normal Voltage	0.0144	
20(Ref.)	Normal Voltage	0.0000	
10	Normal Voltage	0.0021	
0	Normal Voltage	0.0154	
-10	Normal Voltage	0.0191	
-20	Normal Voltage	0.0160	
-30	Normal Voltage	0.0186	
20	Maximum Voltage	0.0138	
20	Normal Voltage	0.0154	
20	Battery End Point	0.0144	

Note:

1. Normal Voltage = 3.8V. ; Battery End Point (BEP) = 3.5 V. ; Maximum Voltage =4.3 V
2. The frequency fundamental emissions stay within the authorized frequency block based on the frequency deviation measured is small.



Appendix B. Test Results of Radiated Test

ERP/EIRP

Channel	Mode	Horizontal		Vertical	
		ERP(dBm)	ERP(W)	ERP(dBm)	ERP(W)
Lowest	GSM850 GSM	28.73	0.7464	13.94	0.0248
Middle		29.12	0.8169	14.62	0.0290
Highest		29.89	0.9750	15.78	0.0379
Lowest	WCDMA Band V RMC 12.2Kbps	20.18	0.1041	5.31	0.0034
Middle		19.64	0.0921	5.14	0.0033
Highest		19.69	0.0932	5.55	0.0036
Limit	ERP < 7W	Result		PASS	

Channel	Mode	Horizontal		Vertical	
		EIRP(dBm)	EIRP(W)	EIRP(dBm)	EIRP(W)
Lowest	GSM1900 GSM	28.10	0.6458	25.79	0.3795
Middle		28.44	0.6982	25.49	0.3543
Highest		28.10	0.6463	25.40	0.3464
Lowest	WCDMA Band II RMC 12.2Kbps	21.04	0.1270	18.96	0.0787
Middle		21.48	0.1405	18.49	0.0707
Highest		21.19	0.1316	18.50	0.0709
Limit	EIRP < 2W	Result		PASS	



Radiated Spurious Emission

GSM850 (GSM)									
Channel	Frequency (MHz)	ERP (dBm)	Limit (dBm)	Over Limit (dB)	SPA Reading (dBm)	S.G. Power (dBm)	TX Cable loss (dB)	TX Antenna Gain (dBi)	Polarization (H/V)
Middle	1672	-54.19	-13	-41.19	-56.37	-56.08	1.86	5.90	H
	2509	-52.72	-13	-39.72	-61.75	-55.06	2.31	6.80	H
	3345	-54.08	-13	-41.08	-66.71	-56.48	2.85	7.40	H
	1672	-58.25	-13	-45.25	-57.11	-60.14	1.86	5.90	V
	2508	-50.82	-13	-37.82	-61.79	-53.16	2.31	6.80	V
	3345	-52.85	-13	-39.85	-66.83	-55.25	2.85	7.40	V

Remark: Spurious emissions within 30-1000MHz were found more than 20dB below limit line.

GSM1900 (GSM)									
Channel	Frequency (MHz)	EIRP (dBm)	Limit (dBm)	Over Limit (dB)	SPA Reading (dBm)	S.G. Power (dBm)	TX Cable loss (dB)	TX Antenna Gain (dBi)	Polarization (H/V)
Middle	3759	-50.86	-13	-37.86	-65.06	-55.46	3	7.60	H
	5640	-47.82	-13	-34.82	-61.61	-54.08	3.84	10.10	H
	7521	-43.53	-13	-30.53	-63.31	-51.03	4.43	11.93	H
	3760	-52.02	-13	-39.02	-64.51	-56.62	3	7.60	V
	5640	-47.64	-13	-34.64	-60.05	-53.90	3.84	10.10	V
	7521	-47.31	-13	-34.31	-65.1	-54.81	4.43	11.93	V

Remark: Spurious emissions within 30-1000MHz were found more than 20dB below limit line.



WCDMA Band V(RMC 12.2Kbps)									
Channel	Frequency (MHz)	ERP (dBm)	Limit (dBm)	Over Limit (dB)	SPA Reading (dBm)	S.G. Power (dBm)	TX Cable loss (dB)	TX Antenna Gain (dBi)	Polarization (H/V)
Middle	1672	-54.97	-13	-41.97	-57.15	-56.86	1.86	5.90	H
	2509	-53.30	-13	-40.30	-62.33	-55.64	2.31	6.80	H
	3345	-52.90	-13	-39.90	-65.53	-55.30	2.85	7.40	H
	1672	-58.28	-13	-45.28	-57.14	-60.17	1.86	5.90	V
	2509	-52.20	-13	-39.20	-63.17	-54.54	2.31	6.80	V
	3345	-52.26	-13	-39.26	-66.24	-54.66	2.85	7.40	V

Remark: Spurious emissions within 30-1000MHz were found more than 20dB below limit line.

WCDMA Band II(RMC 12.2Kbps)									
Channel	Frequency (MHz)	EIRP (dBm)	Limit (dBm)	Over Limit (dB)	SPA Reading (dBm)	S.G. Power (dBm)	TX Cable loss (dB)	TX Antenna Gain (dBi)	Polarization (H/V)
Middle	3759	-50.39	-13	-37.39	-64.59	-54.99	3	7.60	H
	5640	-47.28	-13	-34.28	-61.07	-53.54	3.84	10.10	H
	7521	-43.99	-13	-30.99	-63.77	-51.49	4.43	11.93	H
	3759	-53.50	-13	-40.50	-65.99	-58.10	3	7.60	V
	5640	-48.89	-13	-35.89	-61.3	-55.15	3.84	10.10	V
	7521	-44.83	-13	-31.83	-62.62	-52.33	4.43	11.93	V

Remark: Spurious emissions within 30-1000MHz were found more than 20dB below limit line.