



FCC RF Test Report

APPLICANT : LG Electronics Mobile Comm USA
EQUIPMENT : Smart phone
BRAND NAME : LG
MODEL NAME : LG-X220g
FCC ID : ZNFX220G
STANDARD : FCC Part 15 Subpart C §15.247
CLASSIFICATION : (DTS) Digital Transmission System

The product was received on Dec. 03, 2015 and testing was completed on Jan. 19, 2016. We, SPORTON INTERNATIONAL (KUNSHAN) INC., would like to declare that the tested sample has been evaluated in accordance with the test procedures and has been in compliance with the applicable technical standards.

The test results in this report apply exclusively to the tested model / sample. Without written approval of SPORTON INTERNATIONAL (KUNSHAN) INC., the test report shall not be reproduced except in full.

Prepared by: James Huang / Manager

Approved by: Jones Tsai / Manager



SPORTON INTERNATIONAL (KUNSHAN) INC.
No. 3-2, PingXiang Road, Kunshan, Jiangsu Province, P. R. China



TABLE OF CONTENTS

1 GENERAL DESCRIPTION 5

1.1 Applicant 5

1.2 Manufacturer 5

1.3 Product Feature of Equipment Under Test 5

1.4 Product Specification subjective to this standard 5

1.5 Modification of EUT 6

1.6 Testing Location 6

1.7 Applicable Standards 6

2 TEST CONFIGURATION OF EQUIPMENT UNDER TEST 7

2.1 Carrier Frequency Channel 7

2.2 Pre-Scanned RF Power 8

2.3 Test Mode 9

2.4 Connection Diagram of Test System 10

2.5 Support Unit used in test configuration and system 12

2.6 EUT Operation Test Setup 12

2.7 Measurement Results Explanation Example 12

3 TEST RESULT 13

3.1 6dB Bandwidth Measurement 13

3.2 Output Power Measurement 15

3.3 Power Spectral Density Measurement 16

3.4 Conducted Band Edges and Spurious Emission Measurement 18

3.5 Radiated Band Edges and Spurious Emission Measurement 33

3.6 AC Conducted Emission Measurement 41

3.7 Antenna Requirements 47

4 LIST OF MEASURING EQUIPMENT 48

5 UNCERTAINTY OF EVALUATION 49

APPENDIX A. CONDUCTED TEST RESULTS

APPENDIX B. RADIATED TEST RESULTS



REVISION HISTORY

REPORT NO.	VERSION	DESCRIPTION	ISSUED DATE
FR5D0302C	Rev. 01	Initial issue of report	Jan. 19, 2016



SUMMARY OF TEST RESULT

Report Section	FCC Rule	Description	Limit	Result	Remark
3.1	15.247(a)(2)	6dB Bandwidth	$\geq 0.5\text{MHz}$	Pass	-
3.2	15.247(b)	Power Output Measurement	$\leq 30\text{dBm}$	Pass	-
3.3	15.247(e)	Power Spectral Density	$\leq 8\text{dBm}/3\text{kHz}$	Pass	-
3.4	15.247(d)	Conducted Band Edges	$\leq 20\text{dBc}$	Pass	-
		Conducted Spurious Emission		Pass	-
3.5	15.247(d)	Radiated Band Edges and Radiated Spurious Emission	15.209(a) & 15.247(d)	Pass	Under limit 2.18 dB at 2483.760 MHz
3.6	15.207	AC Conducted Emission	15.207(a)	Pass	Under limit 7.34 dB at 4.360 MHz
3.7	15.203 & 15.247(b)	Antenna Requirement	N/A	Pass	-



1 General Description

1.1 Applicant

LG Electronics Mobile Comm USA
1000 Sylvan Avenue Englewood Cliffs, NJ 07632

1.2 Manufacturer

Arima Communications Corp.
6F, No.866, Jhongjheng Rd., Jhonghe Dist., New Taipei City 23586, Taiwan

1.3 Product Feature of Equipment Under Test

Product Feature	
Equipment	Smart phone
Brand Name	LG
Model Name	LG-X220g
FCC ID	ZNFX220G
EUT supports Radios application	GSM/GPRS/EGPRS(Downlink Only)/WCDMA/HSPA/HSPA+(16QAM uplink is not supported)/WLAN 2.4GHz 802.11b/g/n HT20/HT40/Bluetooth v3.0 + EDR/Bluetooth v4.0 LE
IMEI Code	Conducted: 353468062997251 Radiation: 353468062997100 Conduction: 353468062997145
HW Version	5542MB-002
SW Version	LGX220g-00-V08a-334-20-NOV-11-2015+0
EUT Stage	Production Unit

Remark: The above EUT's information was declared by manufacturer. Please refer to the specifications or user's manual for more detailed description.

1.4 Product Specification subjective to this standard

Product Specification subjective to this standard	
Tx/Rx Channel Frequency Range	802.11b/g/n : 2412 MHz ~ 2462 MHz
Maximum (Peak) Output Power to Antenna	802.11b : 18.82 dBm (0.0762 W) 802.11g : 22.59 dBm (0.1816 W) 802.11n HT20 : 21.46 dBm (0.1400 W) 802.11n HT40 : 21.77 dBm (0.1503 W)
Antenna Type/Gain	802.11b/g/n : IFA Antenna with gain -0.10 dBi
Type of Modulation	802.11b : DSSS (DBPSK / DQPSK / CCK) 802.11g/n : OFDM (BPSK / QPSK / 16QAM / 64QAM)



1.5 Modification of EUT

No modifications are made to the EUT during all test items.

1.6 Testing Location

Test Site	SPORTON INTERNATIONAL (KUNSHAN) INC.			
Test Site Location	No. 3-2, PingXiang Road, Kunshan, Jiangsu Province, P. R. China TEL: +86-0512-5790-0158 FAX: +86-0512-5790-0958			
Test Site No.	Sporton Site No.			FCC Registration No.
	TH01-KS	03CH03-KS	CO01-KS	306251

Note: The test site complies with ANSI C63.4 2009 requirement.

1.7 Applicable Standards

According to the specifications of the manufacturer, the EUT must comply with the requirements of the following standards:

- ♦ FCC Part 15 Subpart C §15.247
- ♦ FCC KDB Publication No. 558074 D01 DTS Meas. Guidance v03r03
- ♦ ANSI C63.10-2013

Remark:

1. All test items were verified and recorded according to the standards and without any deviation during the test.
2. This EUT has also been tested and complied with the requirements of FCC Part 15, Subpart B, recorded in a separate test report.



2 Test Configuration of Equipment Under Test

The EUT has been associated with peripherals and configuration operated in a manner tended to maximize its emission characteristics in a typical application. Frequency range investigated: conducted emission (150 kHz to 30 MHz) and radiated emission (9 kHz to the 10th harmonic of the highest fundamental frequency or to 40 GHz, whichever is lower). For radiated measurement, pre-scanned in three orthogonal panels, X, Y, Z. The worst cases were recorded in this report.

The final configuration from all the combinations and the worst-case data rates were investigated by measuring the maximum power across all the data rates and modulation modes under section 2.2.

Based on the worst configuration found above, the RF power setting is set individually to meet FCC compliance limit for the final conducted and radiated tests shown in section 2.3.

2.1 Carrier Frequency Channel

Frequency Band	Channel	Freq. (MHz)	Channel	Freq. (MHz)
2400-2483.5 MHz	1	2412	7	2442
	2	2417	8	2447
	3	2422	9	2452
	4	2427	10	2457
	5	2432	11	2462
	6	2437	-	-



2.2 Pre-Scanned RF Power

Preliminary tests were performed in different data rate and data rate associated with the highest power were chosen for full test shown in the following tables.

2.4GHz 802.11b RF Output Power (dBm)						
Power vs. Channel			Power vs. Data Rate			
Channel	Frequency (MHz)	Data Rate	Channel	2Mbps	5.5Mbps	11Mbps
		1Mbps				
CH 01	2412 MHz	18.26	CH 06	18.81	18.75	18.74
CH 06	2437 MHz	18.82				
CH 11	2462 MHz	18.18				

2.4GHz 802.11g RF Output Power (dBm)										
Power vs. Channel			Power vs. Data Rate							
Channel	Frequency (MHz)	Data Rate	Channel	9Mbps	12Mbps	18Mbps	24Mbps	36Mbps	48Mbps	54Mbps
		6Mbps								
CH 01	2412 MHz	19.62	CH 02	19.75	19.65	19.53	19.56	19.67	19.81	19.81
CH 02	2417 MHz	21.51								22.59
CH 06	2437 MHz	20.95								22.18
CH 10	2457 MHz	21.45								22.54
CH 11	2462 MHz	19.88								20.04

2.4GHz 802.11n HT20 RF Output Power (dBm)										
Power vs. Channel			Power vs. MCS Index							
Channel	Frequency (MHz)	MCS Index	Channel	MCS1	MCS2	MCS3	MCS4	MCS5	MCS6	MCS7
		MCS0								
CH 01	2412 MHz	20.51	CH 01	20.06	20.27	20.39	20.44	21.36	21.44	21.46
CH 06	2437 MHz	20.18								21.12
CH 11	2462 MHz	20.47								21.38

2.4GHz 802.11n HT40 RF Output Power (dBm)										
Power vs. Channel			Power vs. MCS Index							
Channel	Frequency (MHz)	MCS Index	Channel	MCS1	MCS2	MCS3	MCS4	MCS5	MCS6	MCS7
		MCS0								
CH 03	2422 MHz	21.04	CH 03	20.48	20.53	20.55	20.46	21.57	21.65	21.77
CH 06	2437 MHz	20.87								21.34
CH 09	2452 MHz	20.92								21.52



2.3 Test Mode

Final test mode of conducted test items and radiated spurious emissions are considering the modulation and worse data rates from the power table described in section 2.2.

<2.4GHz>

Modulation	Data Rate
802.11b	1 Mbps
802.11g	54 Mbps
802.11n HT20	MCS7
802.11n HT40	MCS7

Test Cases	
AC Conducted Emission	Mode 1: GSM850 Idle + Bluetooth Link + WLAN Link + Earphone + USB Cable (Charging from Adapter)
Remark: For Radiated Test Cases, The tests were performance with Adapter, Earphone, and USB Cable.	

2.4 Connection Diagram of Test System

<WLAN 802.11g/n HT40 Tx Mode>

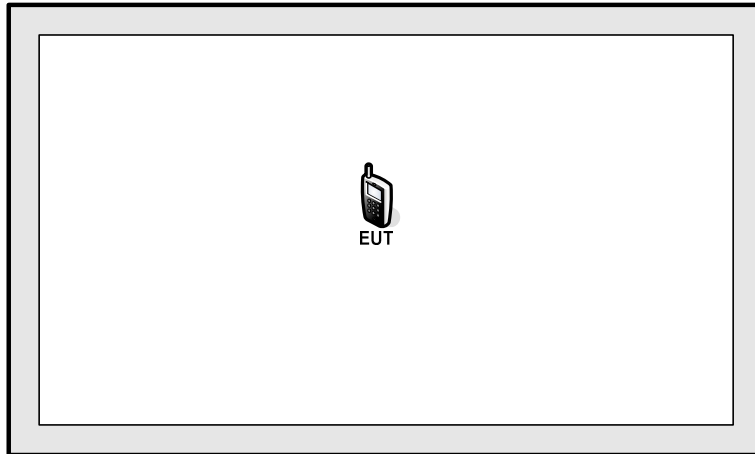

<WLAN 802.11b/n HT20 Tx Mode>

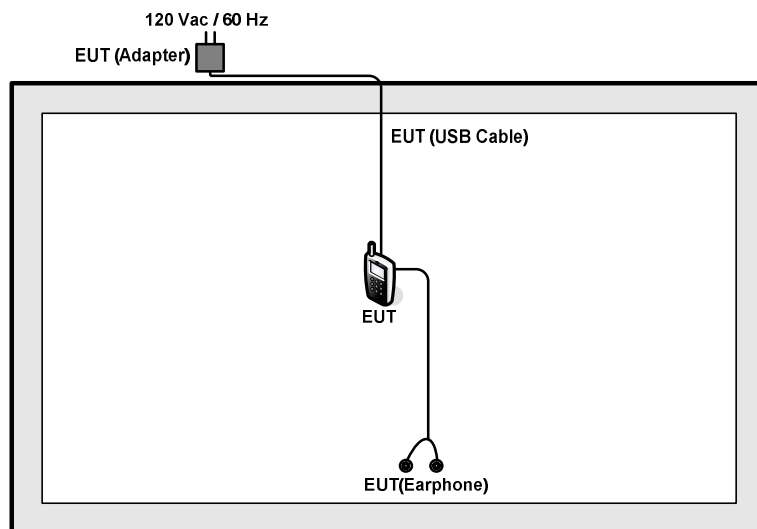

<AC Conducted Emission Mode>

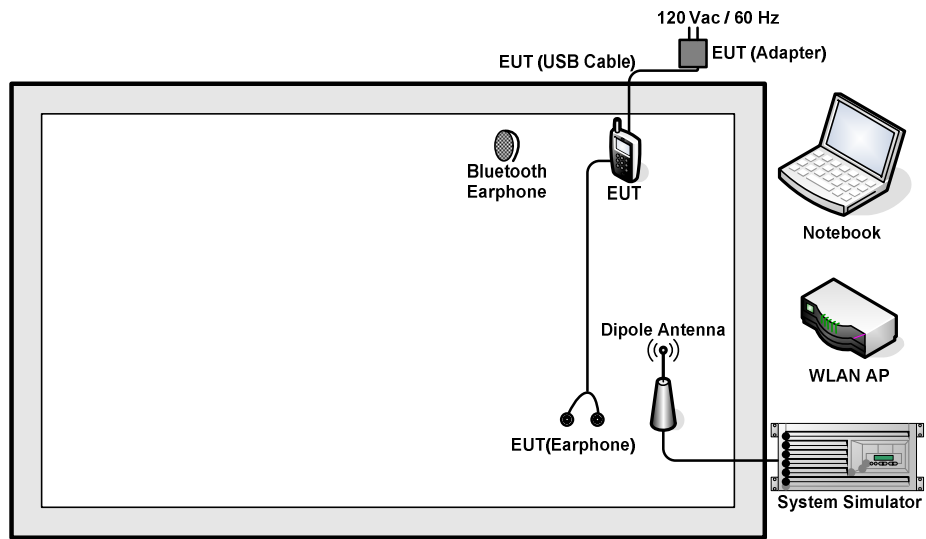

2.5 Support Unit used in test configuration and system

Item	Equipment	Trade Name	Model Name	FCC ID	Data Cable	Power Cord
1.	System Simulator	Anritsu	MT8820C	FCC DoC	N/A	Shielded, 1.5 m
2.	Bluetooth Earphone	Nokia	BH-102	PYAHS-107W	N/A	N/A
3.	WLAN AP	D-Link	DIR-855	KA2DIR855A2	N/A	Shielded, 1.8 m
4.	Notebook	Lenovo	G480	N/A	N/A	AC I/P: Unshielded, 1.8 m DC O/P: Shielded, 1.8 m
5.	SD Card	Kingston	4GB	N/A	N/A	N/A

2.6 EUT Operation Test Setup

For WLAN function, the engineering test program was provided and enabled to make EUT continuous transmit/receive.

For AC power line conducted emissions, the EUT was set to connect with the WLAN AP under large package sizes transmission.

2.7 Measurement Results Explanation Example

For all conducted test items:

The offset level is set in the spectrum analyzer to compensate the RF cable loss and attenuator factor between EUT conducted output port and spectrum analyzer. With the offset compensation, the spectrum analyzer reading level is exactly the EUT RF output level.

Example :

The spectrum analyzer offset is derived from RF cable loss.

Offset = RF cable loss.

Following shows an offset computation example with cable loss 5.5 dB.

$$\begin{aligned} \text{Offset(dB)} &= \text{RF cable loss(dB)}. \\ &= 5.5 \text{ (dB)} \end{aligned}$$

3 Test Result

3.1 6dB Bandwidth Measurement

3.1.1 Limit of 6dB Bandwidth

The minimum 6 dB bandwidth shall be at least 500 kHz.

3.1.2 Measuring Instruments

The measuring equipment is listed in the section 4 of this test report.

3.1.3 Test Procedures

1. The testing follows FCC KDB Publication No. 558074 DTS D01 Meas. Guidance v03r03.
2. The RF output of EUT was connected to the spectrum analyzer by RF cable and attenuator. The path loss was compensated to the results for each measurement.
3. Set to the maximum power setting and enable the EUT transmit continuously.
4. Make the measurement with the spectrum analyzer's resolution bandwidth (RBW) = 100 kHz. Set the Video bandwidth (VBW) = 300 kHz. In order to make an accurate measurement. The 6 dB bandwidth must be greater than 500 kHz.
5. Measure and record the results in the test report.

3.1.4 Test Setup





3.1.5 Test Result of 6dB Bandwidth

Please refer to Appendix A of this test report.

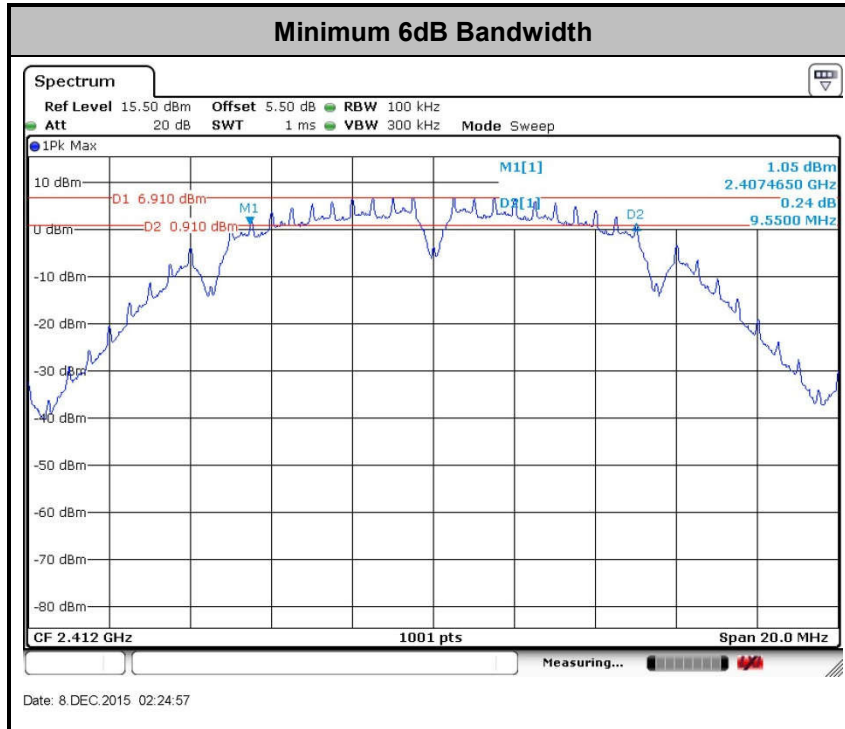

3.2 Output Power Measurement

3.2.1 Limit of Output Power

For systems using digital modulation in the 2400-2483.5MHz, the limit for peak output power is 30dBm. If transmitting Antenna of directional gain greater than 6dBi are used the peak output power from the intentional radiator shall be reduced below the above stated value by the amount in dB that the directional gain of the Antenna exceeds 6 dBi. In case of point-to-point operation, the limit has to be reduced by 1dB for every 3dB that the directional gain of the Antenna exceeds 6dBi.

3.2.2 Measuring Instruments

The measuring equipment is listed in the section 4 of this test report.

3.2.3 Test Procedures

1. The testing follows the Measurement Procedure of FCC KDB No. 558074 DTS D01 Meas. Guidance v03r03 section 9.1.2 PKPM1 Peak power meter method.
2. The RF output of EUT was connected to the power meter by RF cable and attenuator. The path loss was compensated to the results for each measurement.
3. Set to the maximum power setting and enable the EUT transmit continuously.
4. Measure the conducted output power and record the results in the test report.

3.2.4 Test Setup

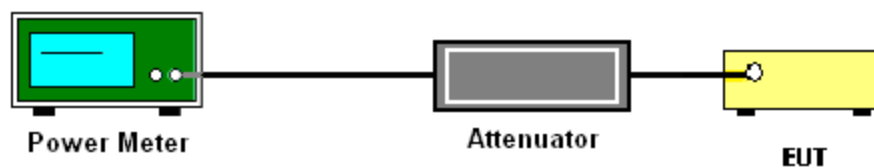

3.2.5 Test Result of Peak Output Power

Please refer to Appendix A of this test report.

3.2.6 Test Result of Average output Power (Reporting Only)

Please refer to Appendix A of this test report.

3.3 Power Spectral Density Measurement

3.3.1 Limit of Power Spectral Density

The peak power spectral density shall not be greater than 8dBm in any 3kHz band at any time interval of continuous transmission.

3.3.2 Measuring Instruments

The measuring equipment is listed in the section 4 of this test report.

3.3.3 Test Procedures

1. The testing follows Measurement Procedure 10.2 Method PKPSD of FCC KDB Publication No. 558074 D01 DTS Meas. Guidance v03r03
2. The RF output of EUT was connected to the spectrum analyzer by RF cable and attenuator. The path loss was compensated to the results for each measurement.
3. Set to the maximum power setting and enable the EUT transmit continuously.
4. Make the measurement with the spectrum analyzer's resolution bandwidth (RBW) = 3 kHz. Video bandwidth VBW = 10 kHz In order to make an accurate measurement, set the span to 1.5 times DTS Channel Bandwidth. (6dB BW)
5. Detector = peak, Sweep time = auto couple, Trace mode = max hold, Allow trace to fully stabilize. Use the peak marker function to determine the maximum power level.
6. Measure and record the results in the test report.

3.3.4 Test Setup

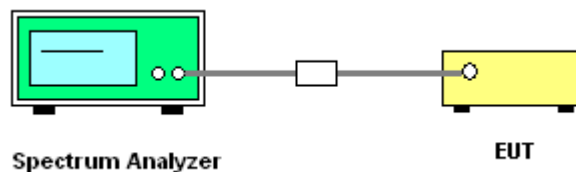



3.3.5 Test Result of Power Spectral Density

Please refer to Appendix A of this test report.

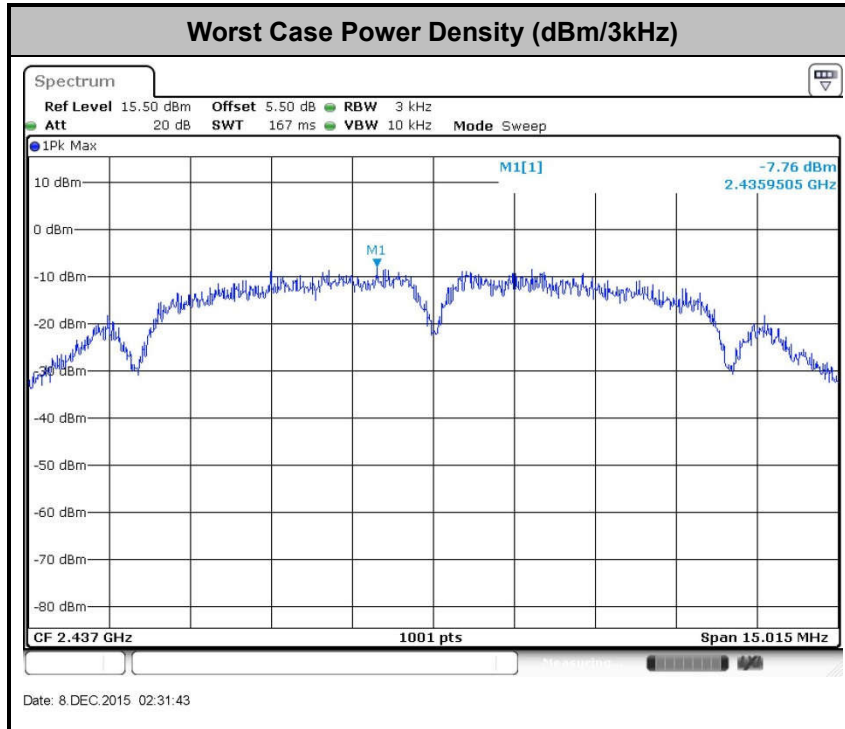

3.4 Conducted Band Edges and Spurious Emission Measurement

3.4.1 Limit of Conducted Band Edges and Spurious Emission Measurement

In any 100 kHz bandwidth outside of the authorized frequency band, the emissions which fall in the non-restricted bands shall be attenuated at least 20 dB / 30dB relative to the maximum PSD level in 100 kHz by RF conducted measurement and radiated emissions which fall in the restricted bands, as defined in Section 15.205(a), must also comply with the radiated emission limits specified in Section 15.209(a).

3.4.2 Measuring Instruments

The measuring equipment is listed in the section 4 of this test report.

3.4.3 Test Procedures

1. The testing follows FCC KDB Publication No. 558074 D01 DTS Meas. Guidance v03r03.
2. The RF output of EUT was connected to the spectrum analyzer by RF cable and attenuator. The path loss was compensated to the results for each measurement.
3. Set to the maximum power setting and enable the EUT transmit continuously.
4. Set RBW = 100 kHz, VBW=300 kHz, Peak Detector. Unwanted Emissions measured in any 100 kHz bandwidth outside of the authorized frequency band shall be attenuated by at least 20 dB relative to the maximum in-band peak PSD level in 100 kHz when maximum peak conducted output power procedure is used. If the transmitter complies with the conducted power limits based on the use of RMS averaging over a time interval, the attenuation required under this paragraph shall be 30 dB instead of 20 dB per 15.247(d).
5. Measure and record the results in the test report.
6. The RF fundamental frequency should be excluded against the limit line in the operating frequency band.

3.4.4 Test Setup

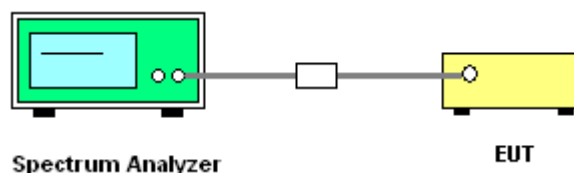



3.4.5 Test Result of Conducted Band Edges and Spurious Emission

Test Mode :	802.11b	Temperature :	24~25°C
Test Band :	2.4GHz Low	Relative Humidity :	49~51%
Test Channel :	01	Test Engineer :	Issac Song

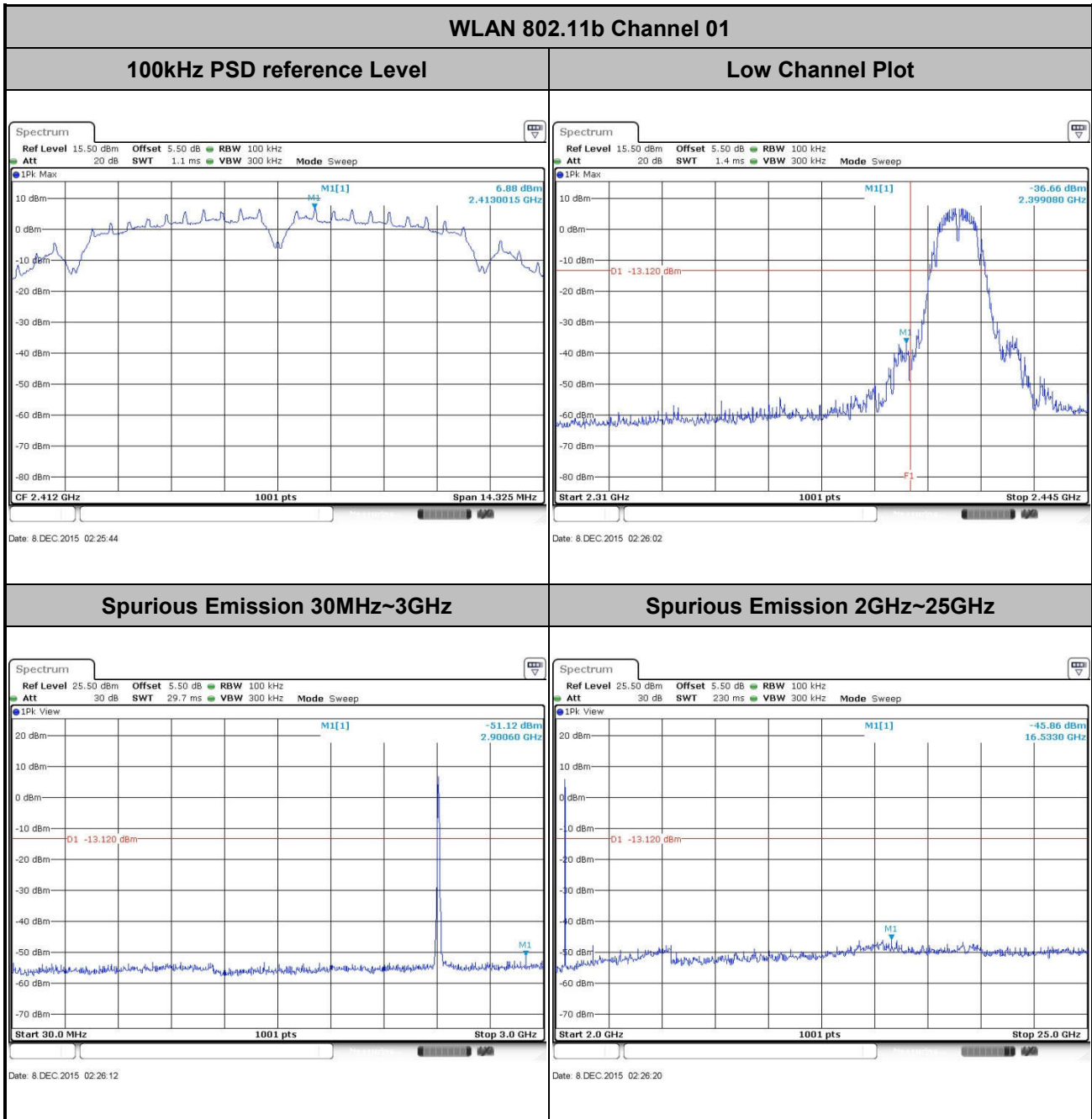



Test Mode :	802.11b	Temperature :	24~25°C
Test Band :	2.4GHz Mid	Relative Humidity :	49~51%
Test Channel :	06	Test Engineer :	Issac Song

WLAN 802.11b Channel 06

100kHz PSD reference Level

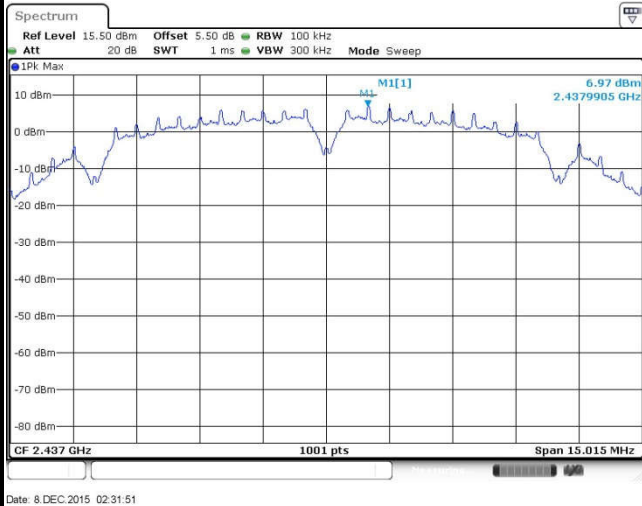

Spurious Emission 30MHz~3GHz

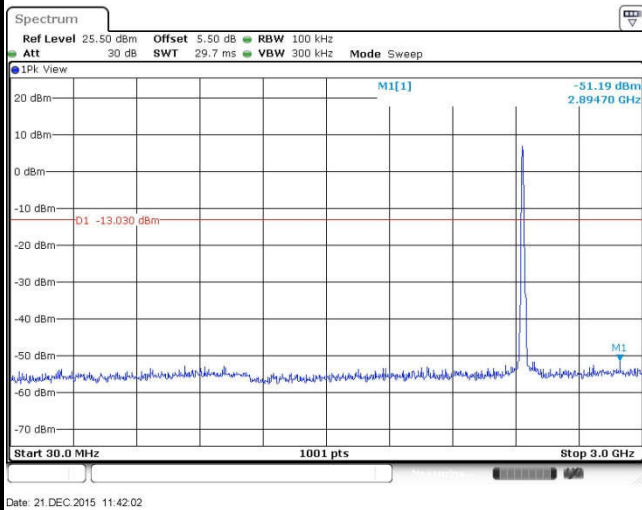

Spurious Emission 2GHz~25GHz

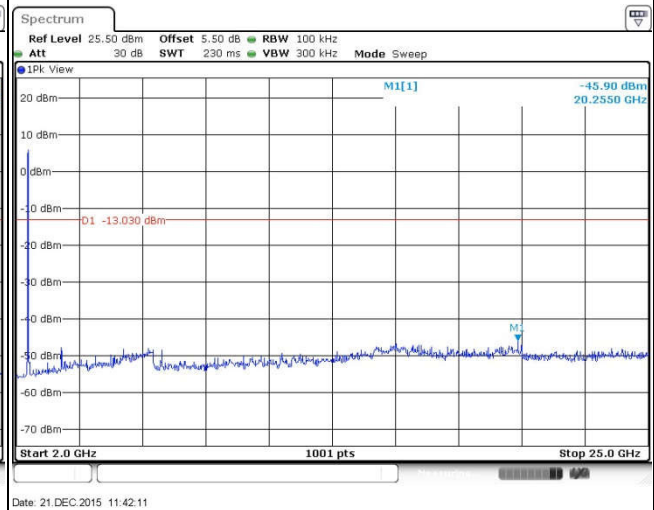



Test Mode :	802.11b	Temperature :	24~25°C
Test Band :	2.4GHz High	Relative Humidity :	49~51%
Test Channel :	11	Test Engineer :	Issac Song

WLAN 802.11b Channel 11

100kHz PSD reference Level

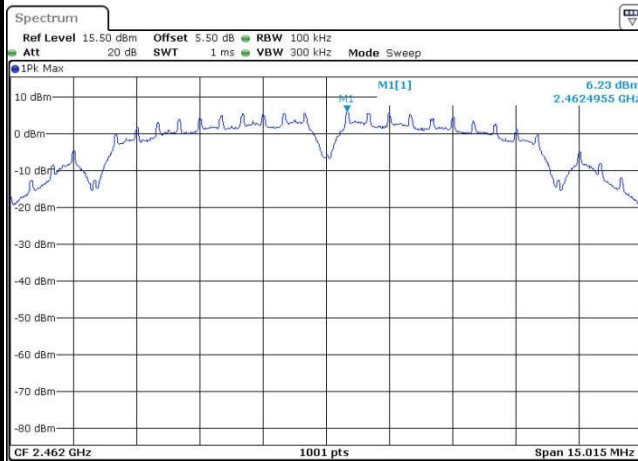

Date: 8 DEC.2015 02:34:07

High Channel Plot

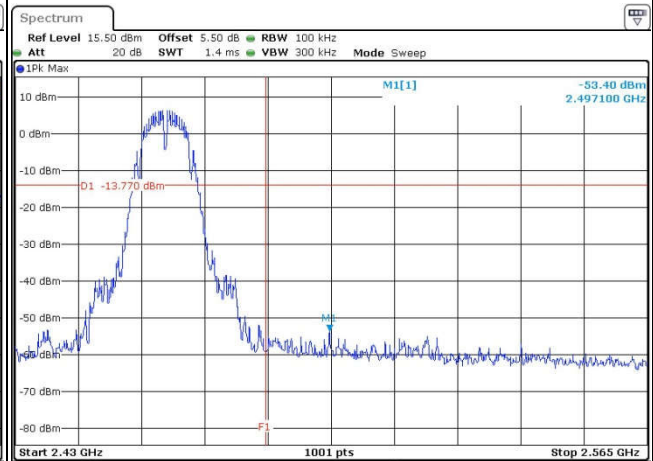

Date: 8 DEC.2015 02:34:21

Spurious Emission 30MHz~3GHz

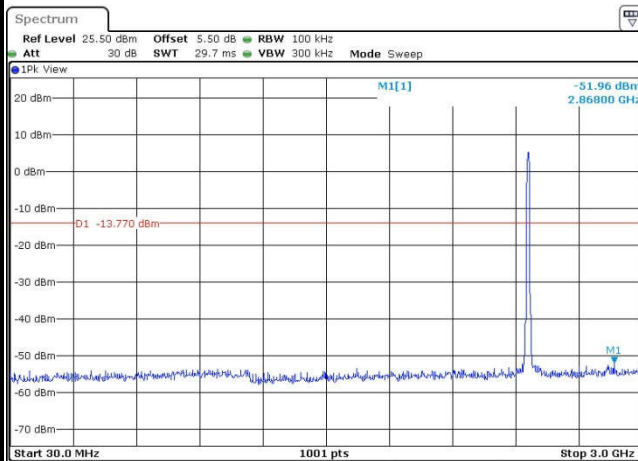

Date: 8 DEC.2015 02:34:32

Spurious Emission 2GHz~25GHz

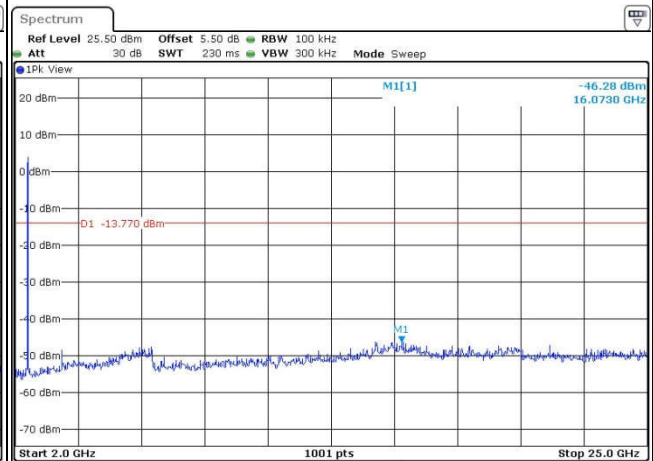

Date: 8 DEC.2015 02:34:40



Test Mode :	802.11g	Temperature :	24~25°C
Test Band :	2.4GHz Low	Relative Humidity :	49~51%
Test Channel :	01	Test Engineer :	Issac Song

WLAN 802.11g Channel 01

100kHz PSD reference Level

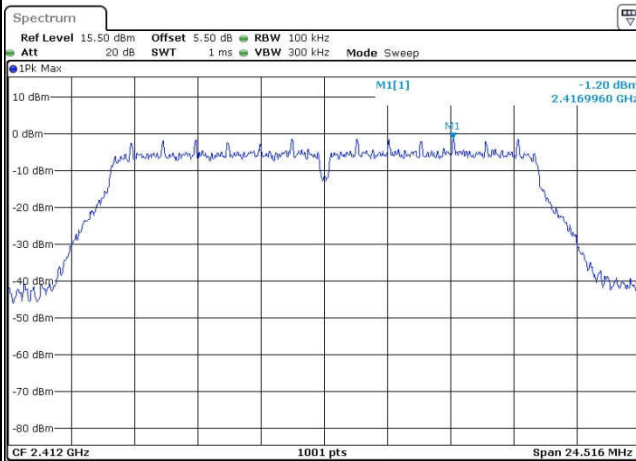

Date: 19 DEC.2015 03:15:49

Low Channel Plot

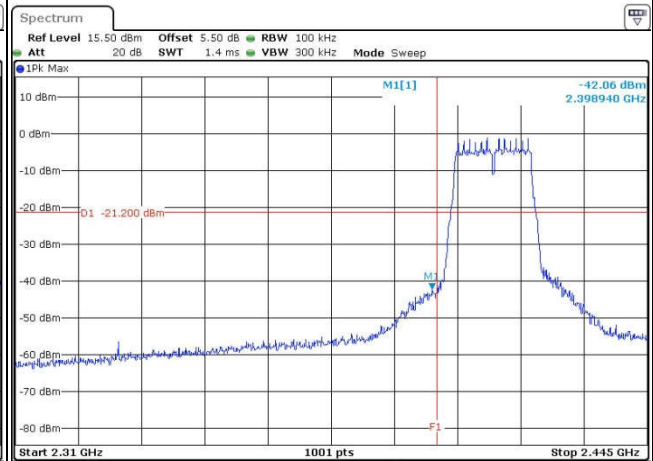

Date: 19 DEC.2015 03:16:30

Spurious Emission 30MHz~3GHz

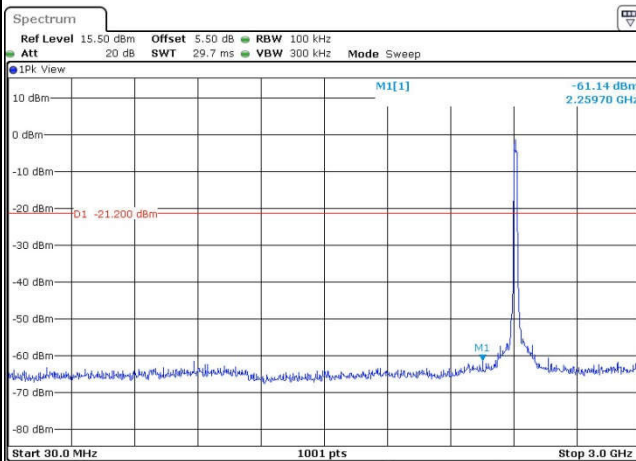

Date: 19 DEC.2015 03:19:28

Spurious Emission 2GHz~25GHz

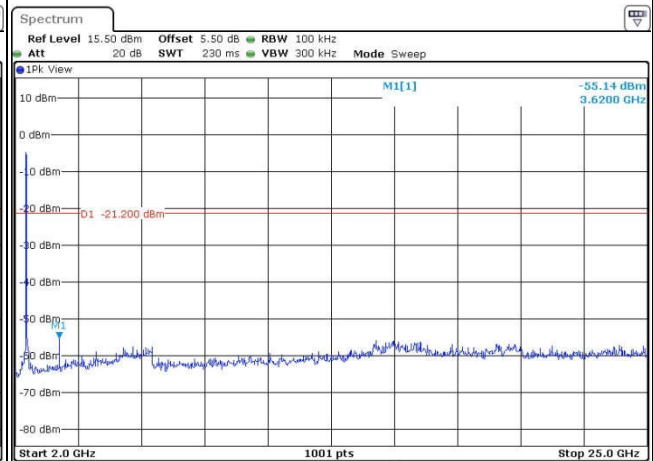

Date: 19 DEC.2015 03:19:37



Test Mode :	802.11g	Temperature :	24~25°C
Test Band :	2.4GHz Low	Relative Humidity :	49~51%
Test Channel :	02	Test Engineer :	Issac Song

WLAN 802.11g Channel 01

100kHz PSD reference Level

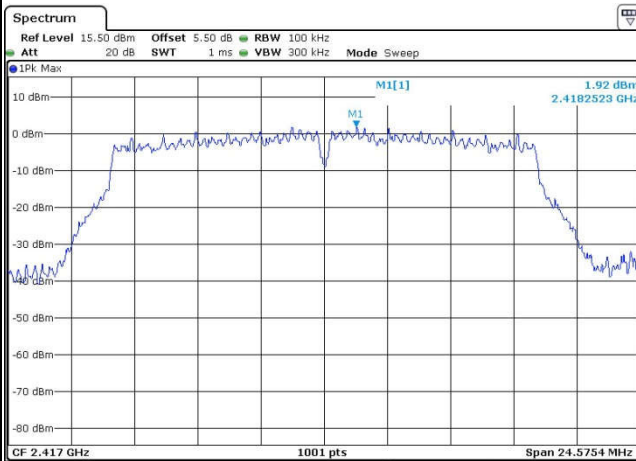

Date: 19 JAN 2016 13:39:59

Low Channel Plot

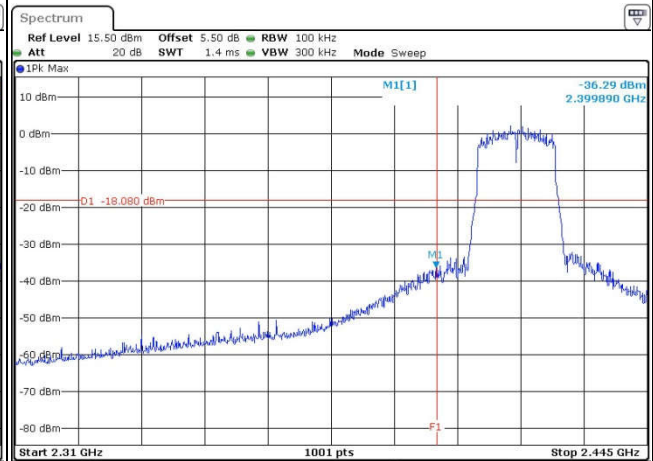

Date: 19 JAN 2016 13:42:57

Spurious Emission 30MHz~3GHz

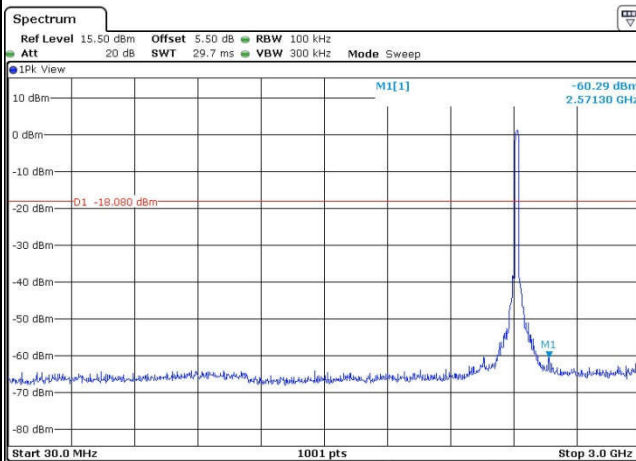

Date: 19 JAN 2016 13:46:14

Spurious Emission 2GHz~25GHz

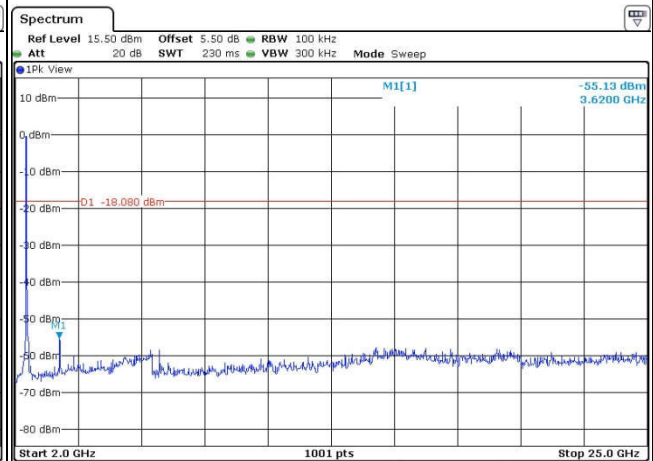

Date: 19 JAN 2016 13:47:52



Test Mode :	802.11g	Temperature :	24~25°C
Test Band :	2.4GHz Mid	Relative Humidity :	49~51%
Test Channel :	06	Test Engineer :	Issac Song

WLAN 802.11g Channel 06

100kHz PSD reference Level

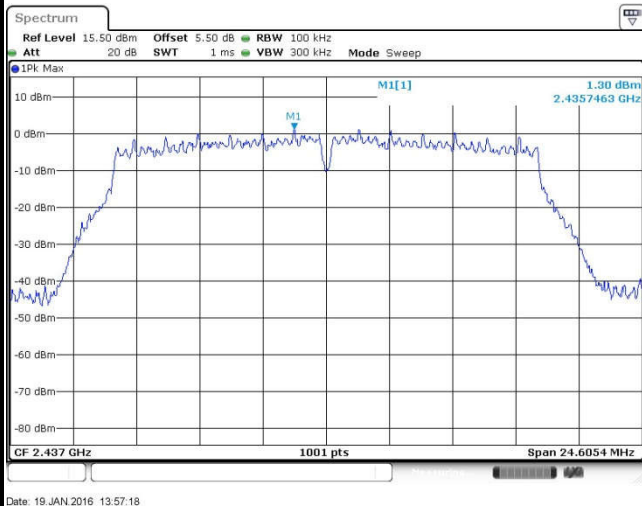

Spurious Emission 30MHz~3GHz

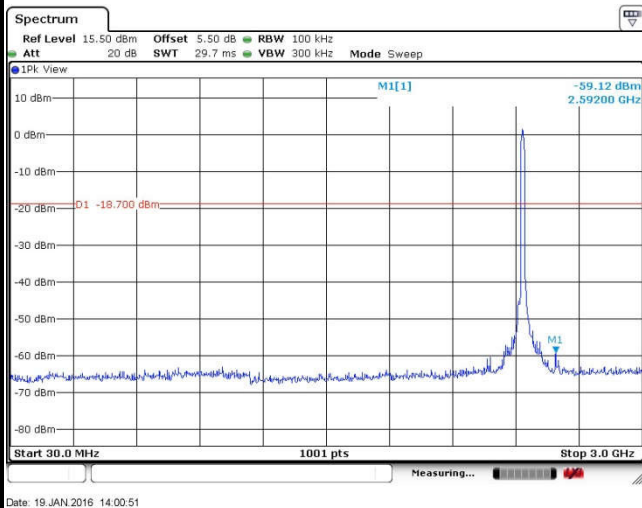

Spurious Emission 2GHz~25GHz

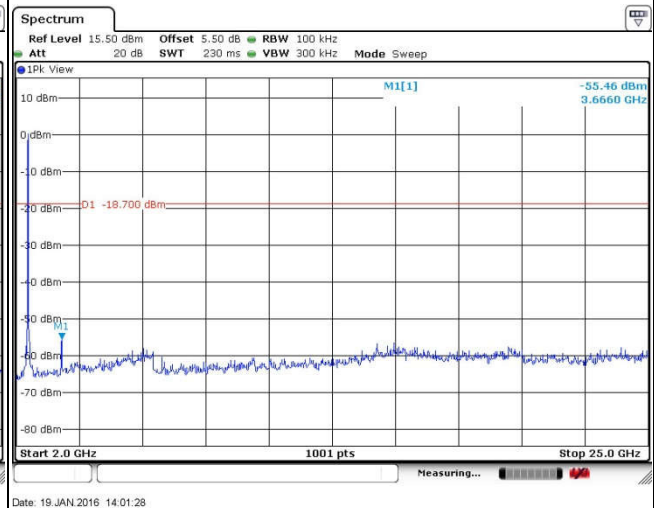



Test Mode :	802.11g	Temperature :	24~25°C
Test Band :	2.4GHz High	Relative Humidity :	49~51%
Test Channel :	10	Test Engineer :	Issac Song

WLAN 802.11g Channel 11

100kHz PSD reference Level

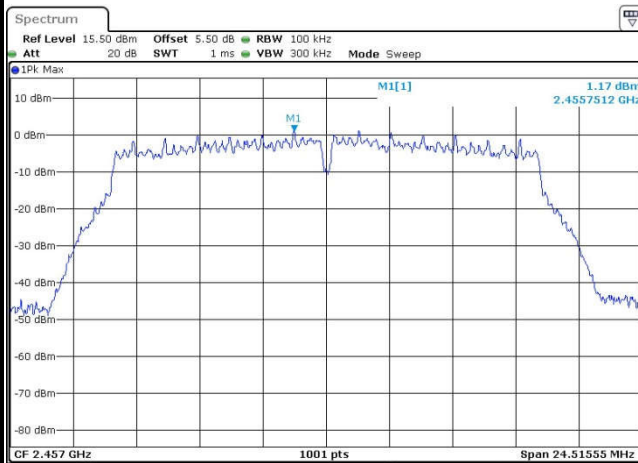

Date: 19.JAN.2016 14:06:49

High Channel Plot

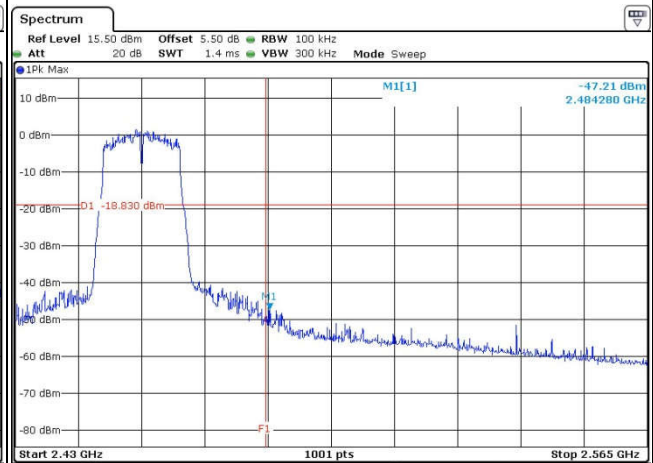

Date: 19.JAN.2016 14:09:38

Spurious Emission 30MHz~3GHz

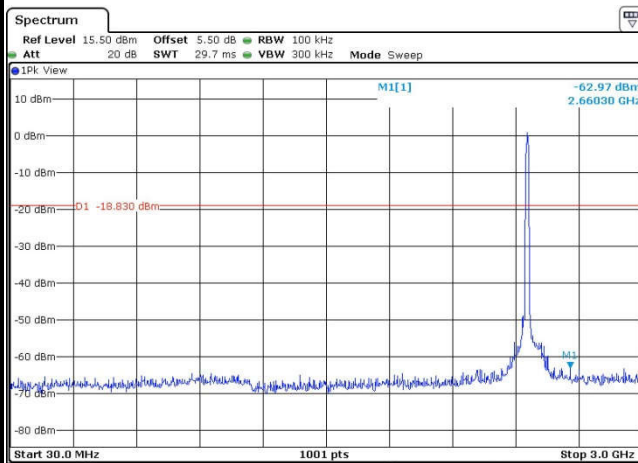

Date: 19.JAN.2016 14:12:49

Spurious Emission 2GHz~25GHz

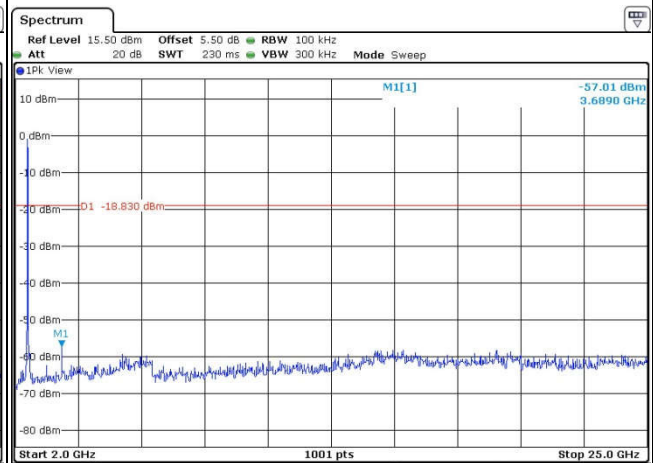

Date: 19.JAN.2016 14:13:30



Test Mode :	802.11g	Temperature :	24~25°C
Test Band :	2.4GHz High	Relative Humidity :	49~51%
Test Channel :	11	Test Engineer :	Issac Song

WLAN 802.11g Channel 11

100kHz PSD reference Level

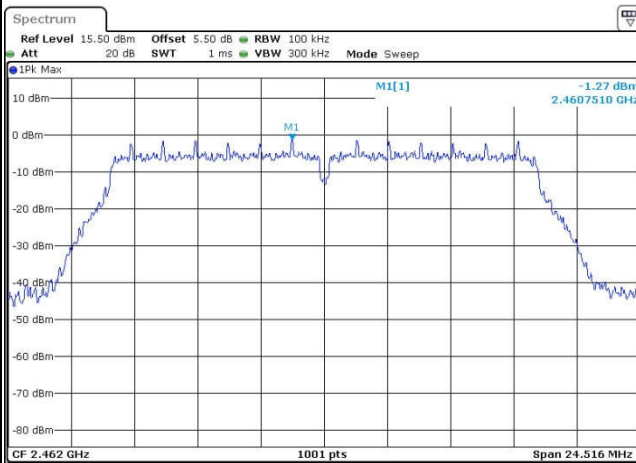

Date: 19 DEC.2015 03:30:21

High Channel Plot

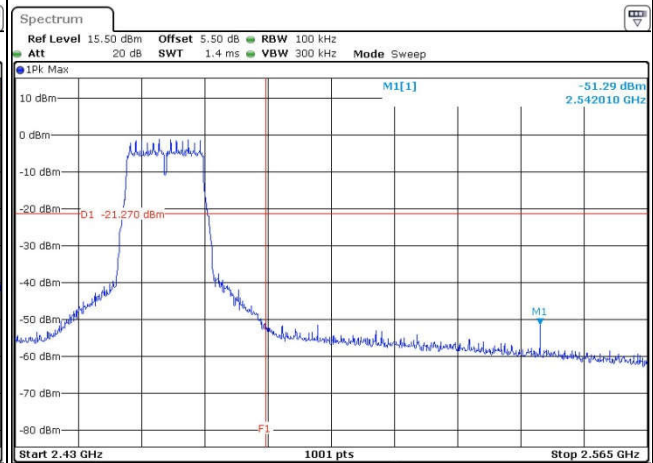

Date: 19 DEC.2015 03:30:40

Spurious Emission 30MHz~3GHz

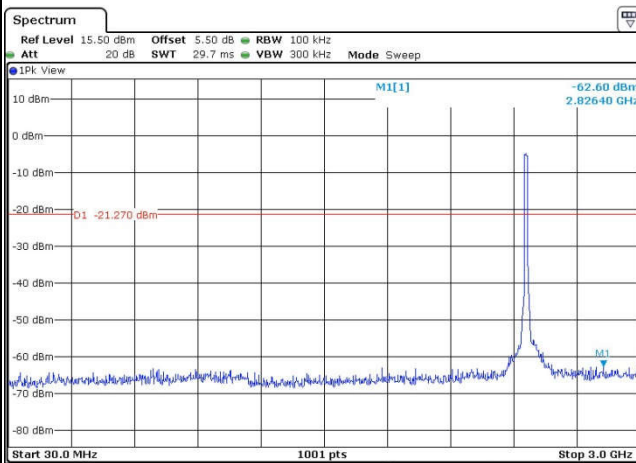

Date: 19 DEC.2015 03:32:19

Spurious Emission 2GHz~25GHz

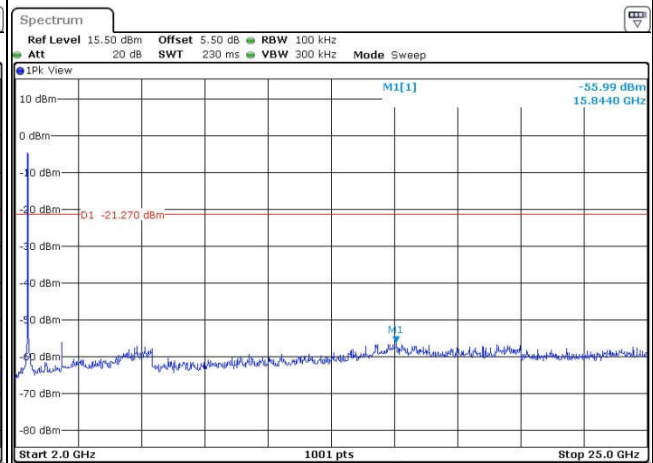

Date: 19 DEC.2015 03:31:37



Test Mode :	802.11n HT20	Temperature :	24~25°C
Test Band :	2.4GHz Low	Relative Humidity :	49~51%
Test Channel :	01	Test Engineer :	Issac Song

WLAN 802.11n HT20 Channel 01

100kHz PSD reference Level

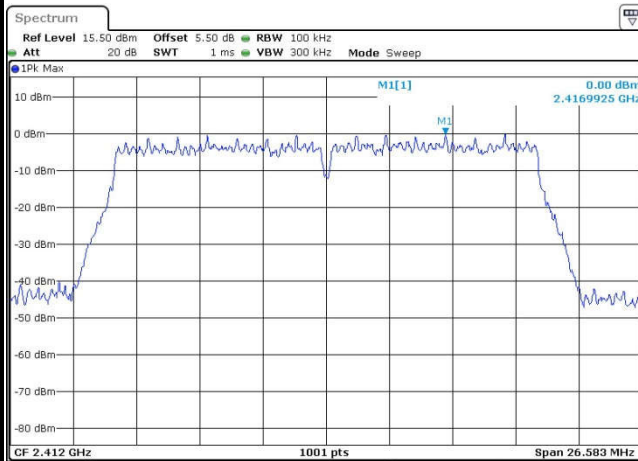

Date: 19 DEC. 2015 03:38:25

Low Channel Plot

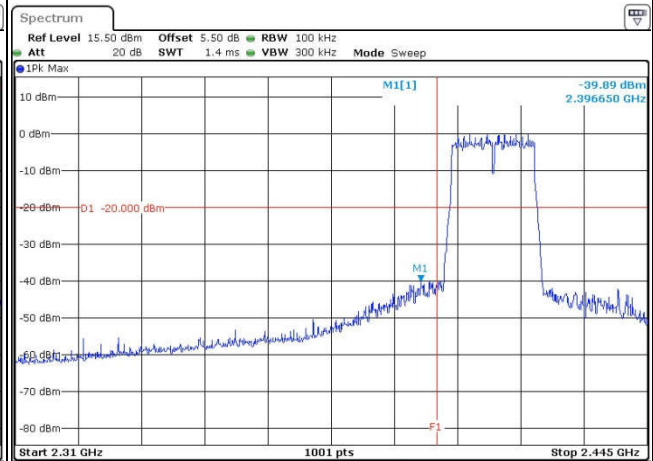

Date: 19 DEC. 2015 03:38:45

Spurious Emission 30MHz~3GHz

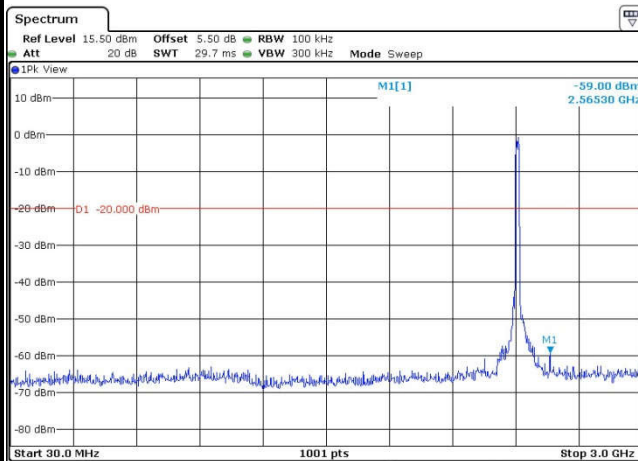

Date: 19 DEC. 2015 03:40:41

Spurious Emission 2GHz~25GHz

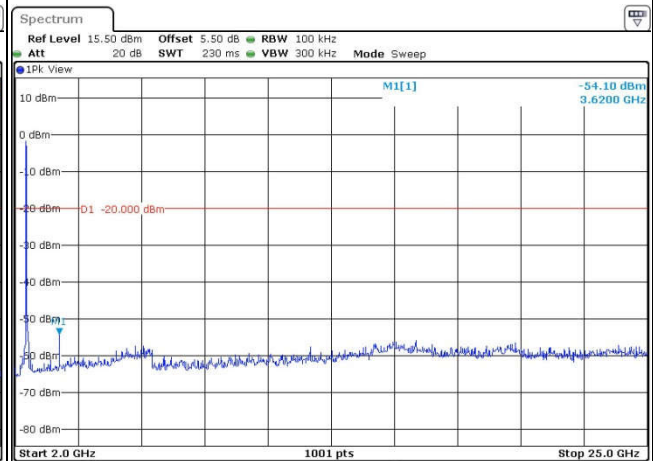

Date: 19 DEC. 2015 03:39:44



Test Mode :	802.11n HT20	Temperature :	24~25°C
Test Band :	2.4GHz Mid	Relative Humidity :	49~51%
Test Channel :	06	Test Engineer :	Issac Song

WLAN 802.11n HT20 Channel 06

100kHz PSD reference Level

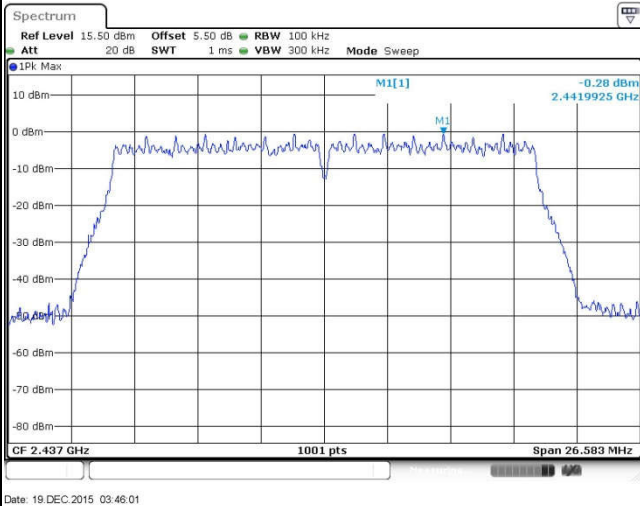

Date: 19 DEC.2015 03:46:01

Spurious Emission 30MHz~3GHz

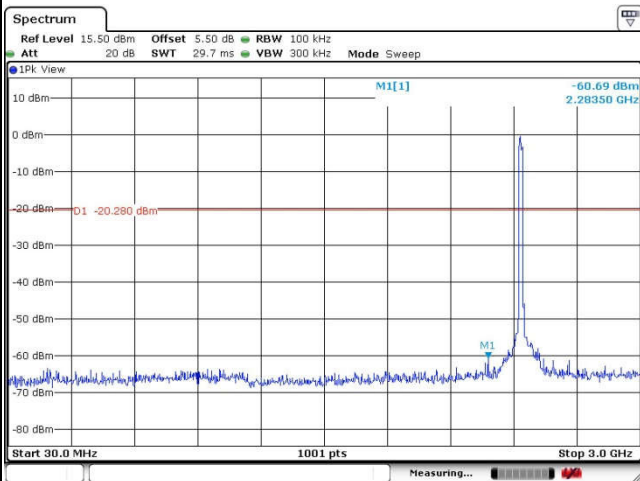

Date: 19 DEC.2015 03:47:56

Spurious Emission 2GHz~25GHz

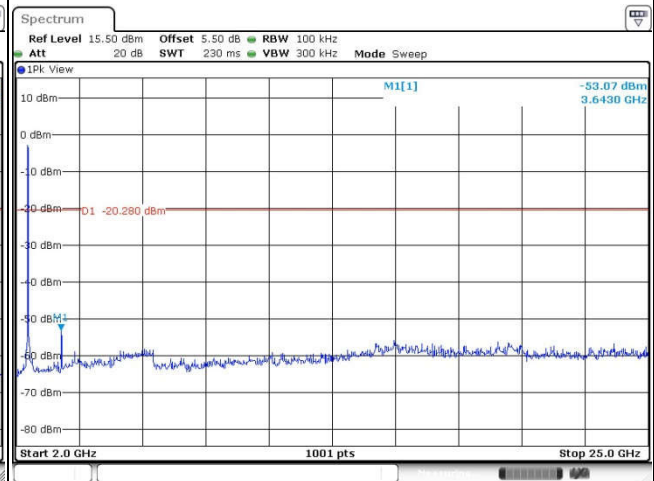

Date: 19 DEC.2015 03:47:20



Test Mode :	802.11n HT20	Temperature :	24~25°C
Test Band :	2.4GHz High	Relative Humidity :	49~51%
Test Channel :	11	Test Engineer :	Issac Song

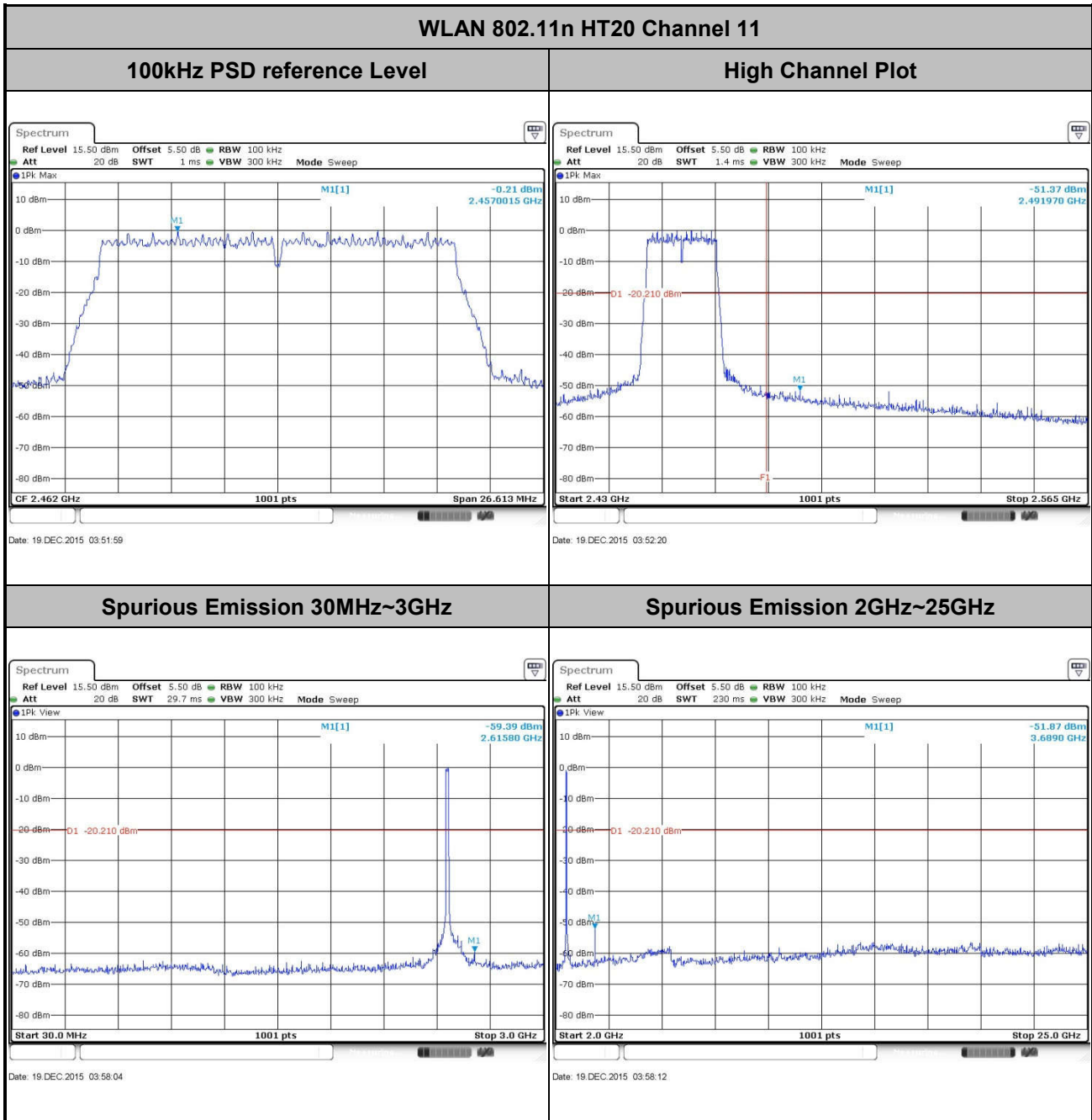



Test Mode :	802.11n HT40	Temperature :	24~25°C
Test Band :	2.4GHz Low	Relative Humidity :	49~51%
Test Channel :	03	Test Engineer :	Issac Song

WLAN 802.11n HT40 Channel 03

100kHz PSD reference Level

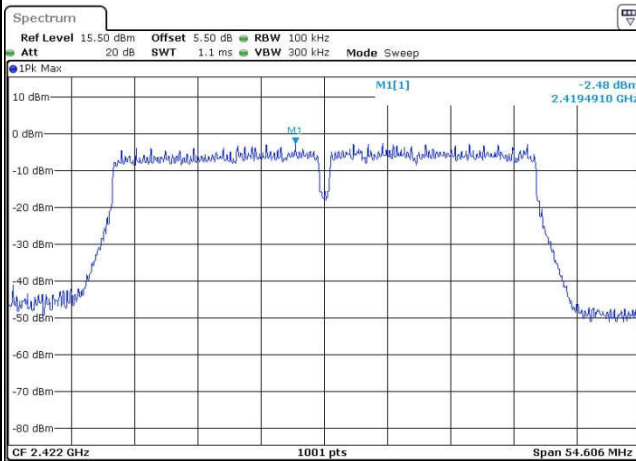

Date: 19 DEC. 2015 04:01:13

Low Channel Plot

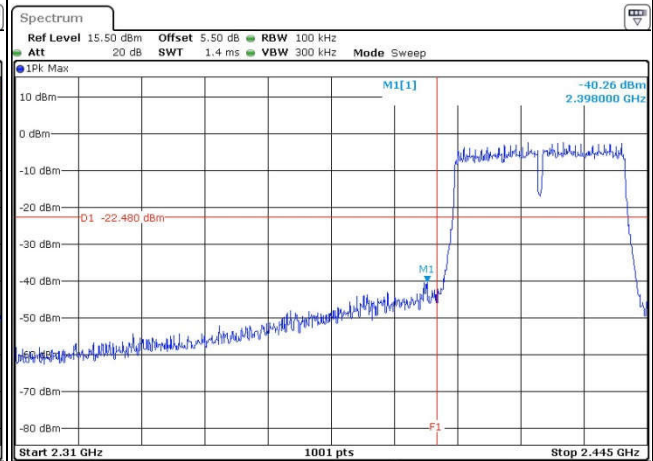

Date: 19 DEC. 2015 04:01:34

Spurious Emission 30MHz~3GHz

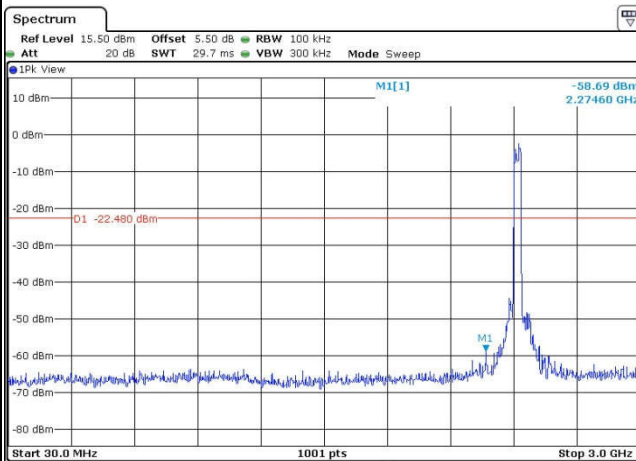

Date: 19 DEC. 2015 04:04:01

Spurious Emission 2GHz~25GHz

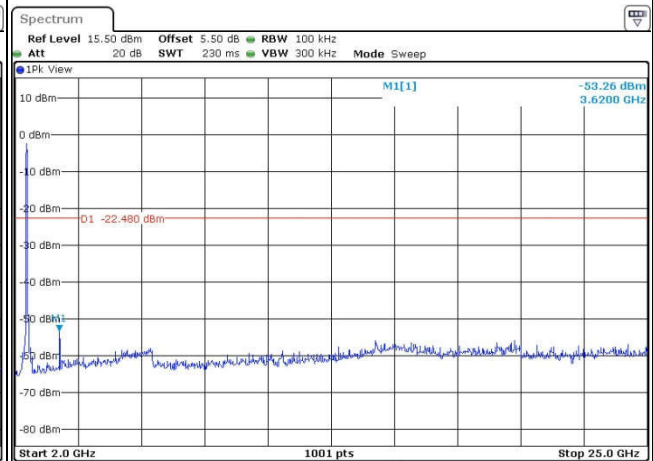

Date: 19 DEC. 2015 04:02:30



Test Mode :	802.11n HT40	Temperature :	24~25°C
Test Band :	2.4GHz Mid	Relative Humidity :	49~51%
Test Channel :	06	Test Engineer :	Issac Song

WLAN 802.11n HT40 Channel 06

100kHz PSD reference Level

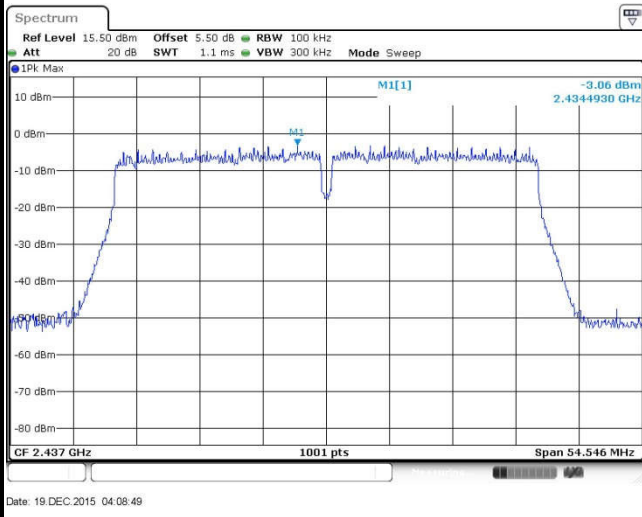

Spurious Emission 30MHz~3GHz

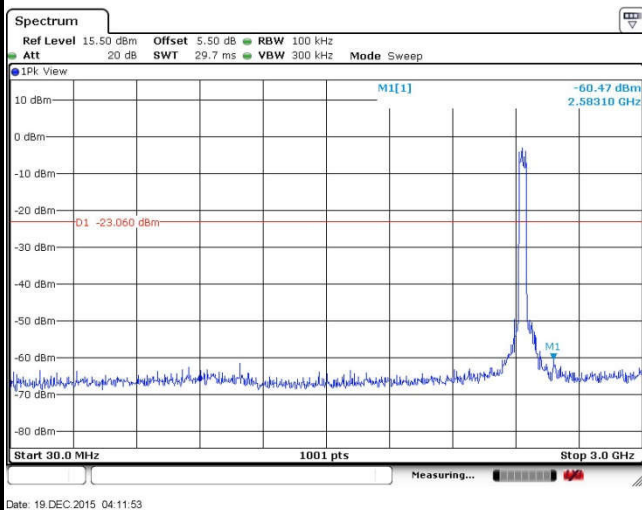

Spurious Emission 2GHz~25GHz

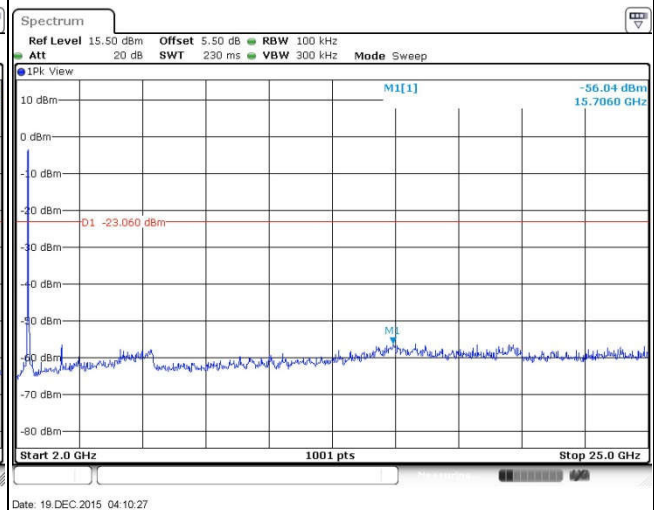



Test Mode :	802.11n HT40	Temperature :	24~25°C
Test Band :	2.4GHz High	Relative Humidity :	49~51%
Test Channel :	09	Test Engineer :	Issac Song

WLAN 802.11n HT40 Channel 09

100kHz PSD reference Level

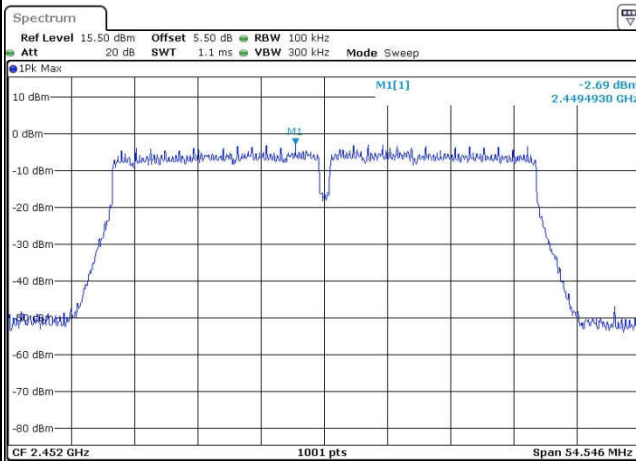

Date: 19 DEC.2015 04:18:07

High Channel Plot

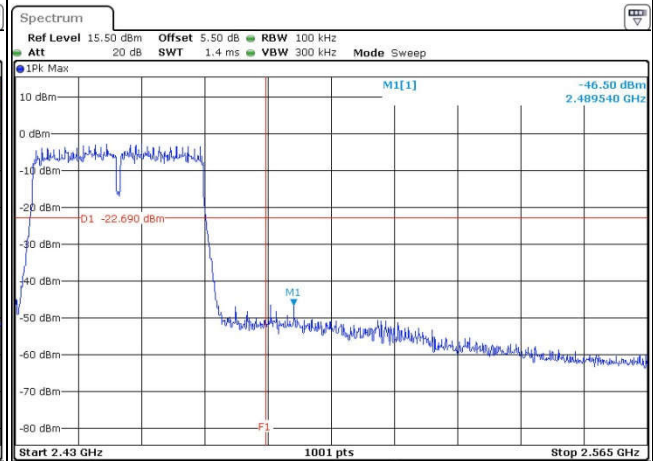

Date: 19 DEC.2015 04:18:19

Spurious Emission 30MHz~3GHz

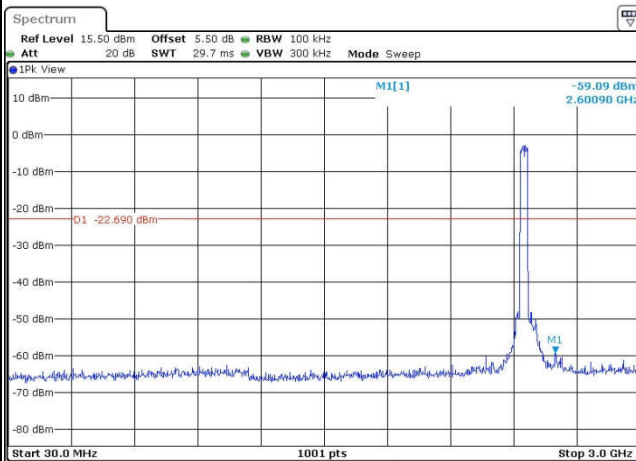

Date: 19 DEC.2015 04:18:48

Spurious Emission 2GHz~25GHz

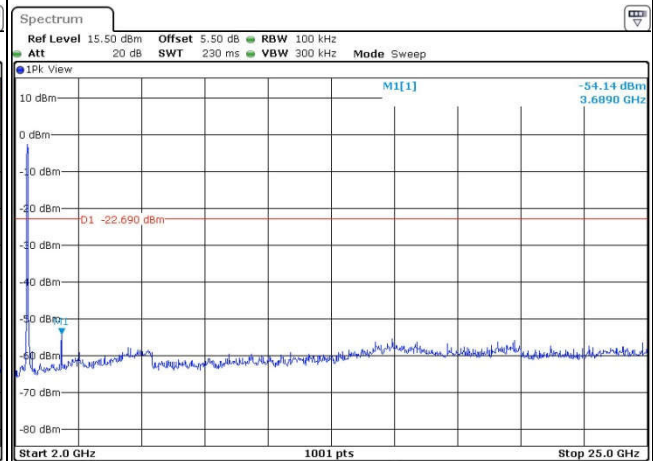

Date: 19 DEC.2015 04:18:57



3.5 Radiated Band Edges and Spurious Emission Measurement

3.5.1 Limit of Radiated band edge and Spurious Emission Measurement

In any 100 kHz bandwidth outside the intentional radiator frequency band, all harmonics/spurious must be at least 20 dB below the highest emission level within the authorized band. If the output power of this device was measured by spectrum analyzer, the attenuation under this paragraph shall be 30 dB instead of 20 dB. In addition, radiated emissions which fall in the restricted bands must also comply with the FCC section 15.209 limits as below.

Frequency (MHz)	Field Strength (microvolts/meter)	Measurement Distance (meters)
0.009 – 0.490	2400/F(kHz)	300
0.490 – 1.705	24000/F(kHz)	30
1.705 – 30.0	30	30
30 – 88	100	3
88 – 216	150	3
216 - 960	200	3
Above 960	500	3

3.5.2 Measuring Instruments

The measuring equipment is listed in the section 4 of this test report.



3.5.3 Test Procedures

1. The testing follows FCC KDB Publication No. 558074 D01 DTS Meas. Guidance v03r03.
2. The EUT was arranged to its worst case and then tune the antenna tower (from 1 m to 4 m) and turntable (from 0 degree to 360 degrees) to find the maximum reading. A pre-amp and a high pass filter are used for the test in order to get better signal level.
3. The EUT was placed on a turntable with 0.8 meter for frequency below 1GHz and 1.5 meter for frequency above 1GHz respectively above ground.
4. The EUT was set 3 meters from the interference receiving antenna, which was mounted on the top of a variable height antenna tower.
5. Corrected Reading: Antenna Factor + Cable Loss + Read Level - Preamp Factor = Level
6. For measurement below 1GHz, If the emission level of the EUT measured by the peak detector is 3 dB lower than the applicable limit, the peak emission level will be reported. Otherwise, the emission measurement will be repeated using the quasi-peak detector and reported.
7. Use the following spectrum analyzer settings:
 - (1) Span shall wide enough to fully capture the emission being measured;
 - (2) Set RBW=100 kHz for $f < 1$ GHz; $VBW \geq RBW$; Sweep = auto; Detector function = peak; Trace = max hold;
 - (3) Set RBW = 1 MHz, VBW= 3MHz for $f \geq 1$ GHz for peak measurement.

For average measurement:

 - $VBW = 10$ Hz, when duty cycle is no less than 98 percent.
 - $VBW \geq 1/T$, when duty cycle is less than 98 percent where T is the minimum transmission duration over which the transmitter is on and is transmitting at its maximum power control level for the tested mode of operation.

Band	Duty Cycle(%)	T(ms)	1/T(kHz)	VBW Setting
802.11b	99.05	-	-	10Hz
802.11g	82.98	0.18	5.70	10kHz
2.4GHz 802.11n HT20	81.82	0.16	6.17	10kHz
2.4GHz 802.11n HT40	72.59	0.10	10.20	11kHz

3.5.4 Test Setup

For radiated emissions below 30MHz

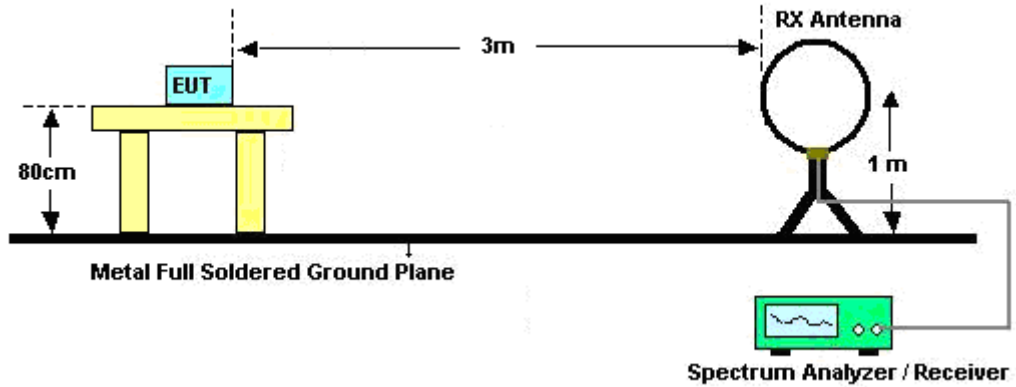

For radiated emissions from 30MHz to 1GHz

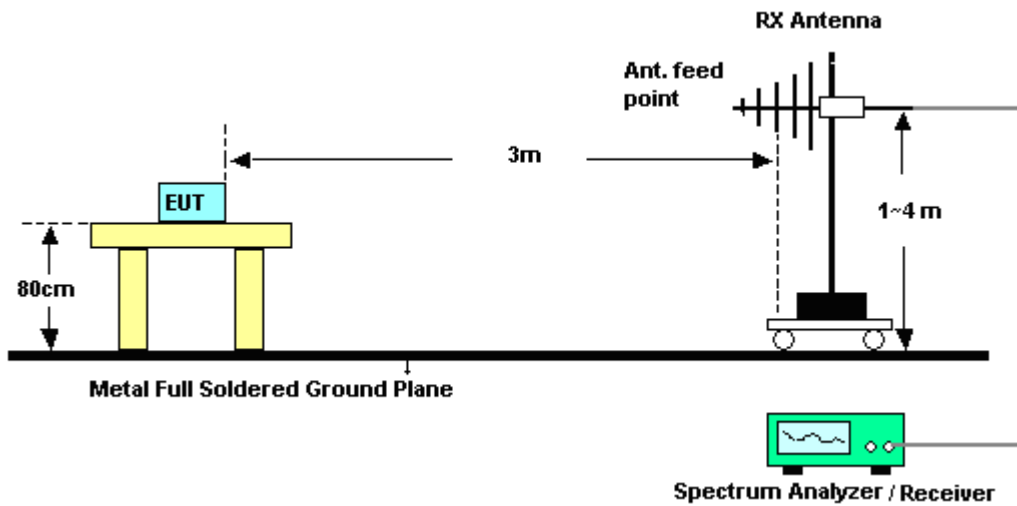

For radiated emissions above 1GHz

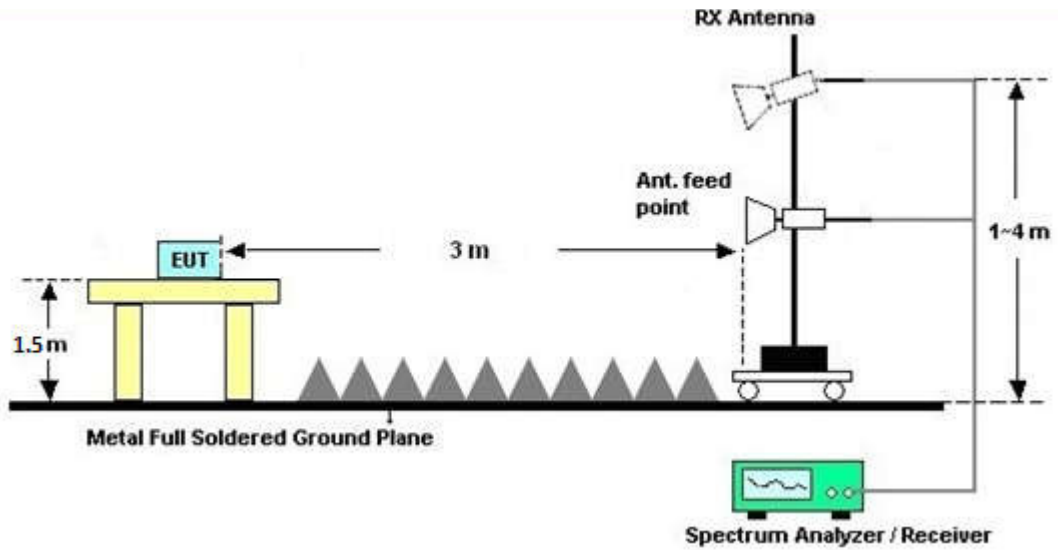

3.5.5 Test Results of Radiated Spurious Emissions (9kHz ~ 30MHz)

The low frequency, which started from 9 kHz to 30MHz, was pre-scanned and the result which was 20dB lower than the limit line per 15.31(o) was not reported.

3.5.6 Test Result of Radiated Spurious at Band Edges

Please refer to Appendix B.



3.5.7 Duty Cycle Plot

802.11b

Data Rate: 1Mbps

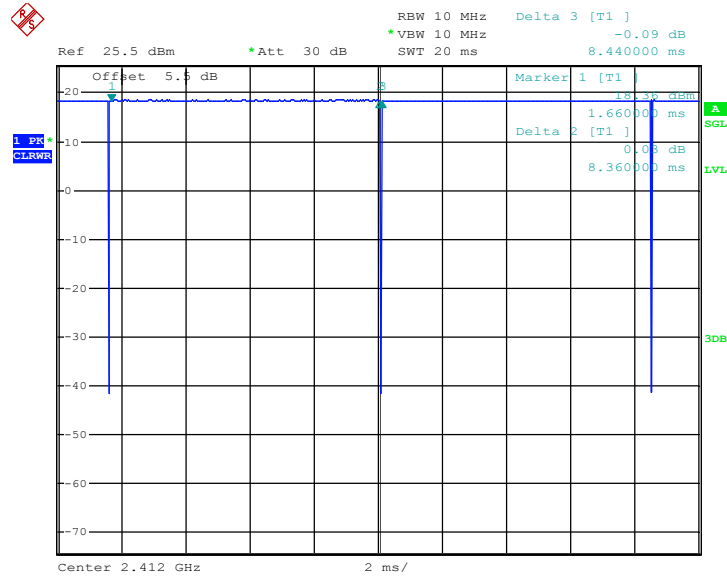

Date: 5.DEC.2015 00:46:24



802.11g

Data Rate: 54Mbps

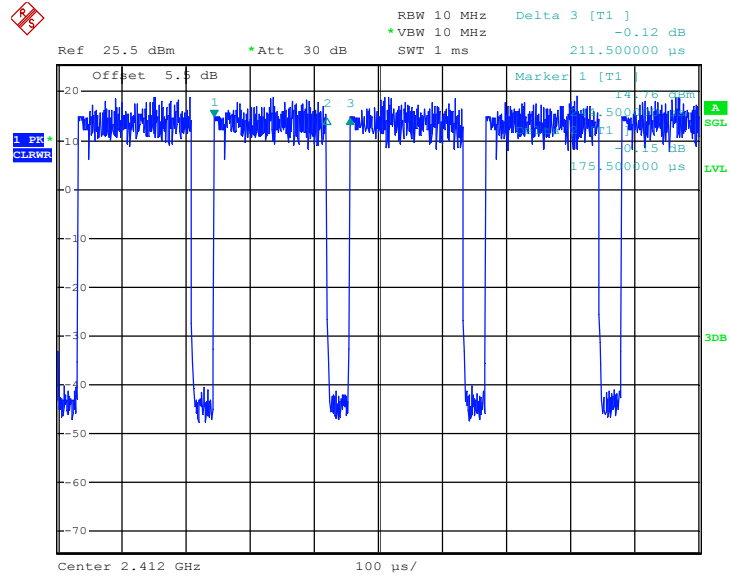

Date: 5.DEC.2015 00:54:38



802.11n HT20

Data Rate: MCS7

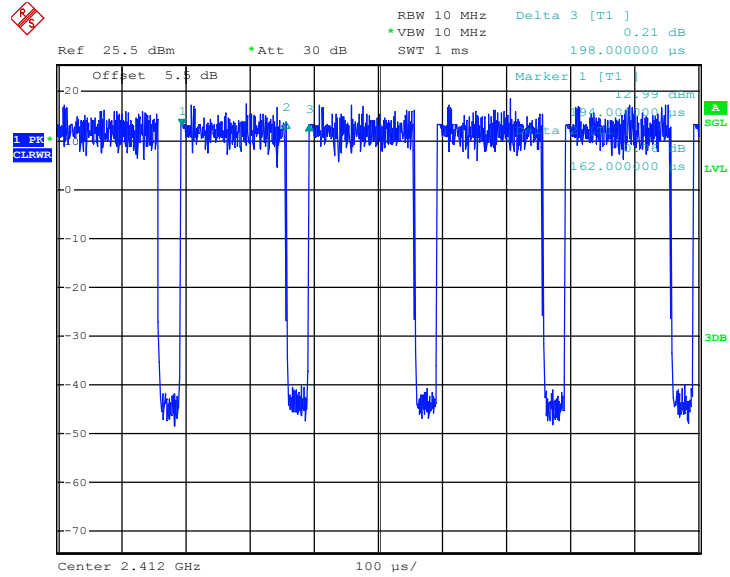

Date: 5.DEC.2015 00:59:59



802.11n HT40

Data Rate: MCS7

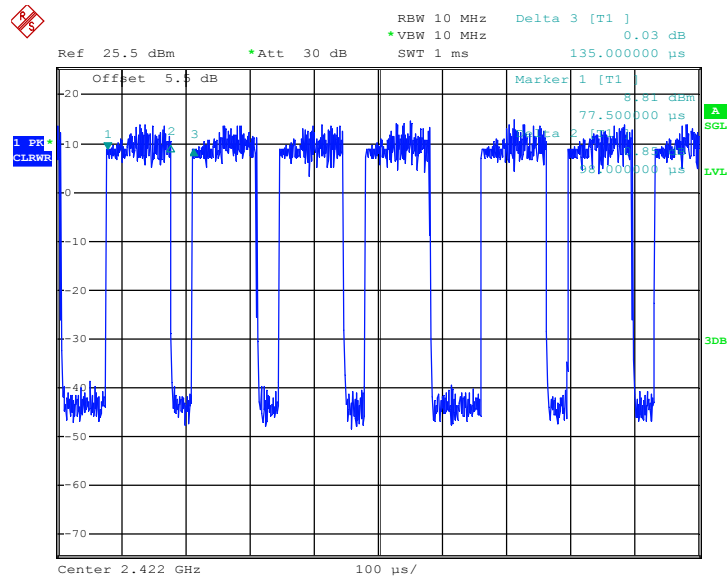

Date: 5.DEC.2015 01:09:22

3.5.8 Test Result of Radiated Spurious Emission (30MHz ~ 10th Harmonic)

Please refer to Appendix B.



3.6 AC Conducted Emission Measurement

3.6.1 Limit of AC Conducted Emission

For equipment that is designed to be connected to the public utility (AC) power line, the radio frequency voltage that is conducted back onto the AC power line on any frequency or frequencies within the band 150 kHz to 30 MHz shall not exceed the limits in the following table.

Frequency of Emission (MHz)	Conducted Limit (dB μ V)	
	Quasi-Peak	Average
0.15-0.5	66 to 56*	56 to 46*
0.5-5	56	46
5-30	60	50

*Decreases with the logarithm of the frequency.

3.6.2 Measuring Instruments

The measuring equipment is listed in the section 4 of this test report.

3.6.3 Test Procedures

1. The EUT was placed 0.4 meter from the conducting wall of the shielding room, and it was kept at least 80 centimeters from any other grounded conducting surface.
2. Connect EUT to the power mains through a line impedance stabilization network (LISN).
3. All the support units are connecting to the other LISN.
4. The LISN provides 50 ohm coupling impedance for the measuring instrument.
5. The FCC states that a 50 ohm, 50 microhenry LISN should be used.
6. Both sides of AC line were checked for maximum conducted interference.
7. The frequency range from 150 kHz to 30 MHz was searched.
8. Set the test-receiver system to Peak Detect Function and specified bandwidth (IF bandwidth = 9kHz) with Maximum Hold Mode.

3.6.4 Test Setup

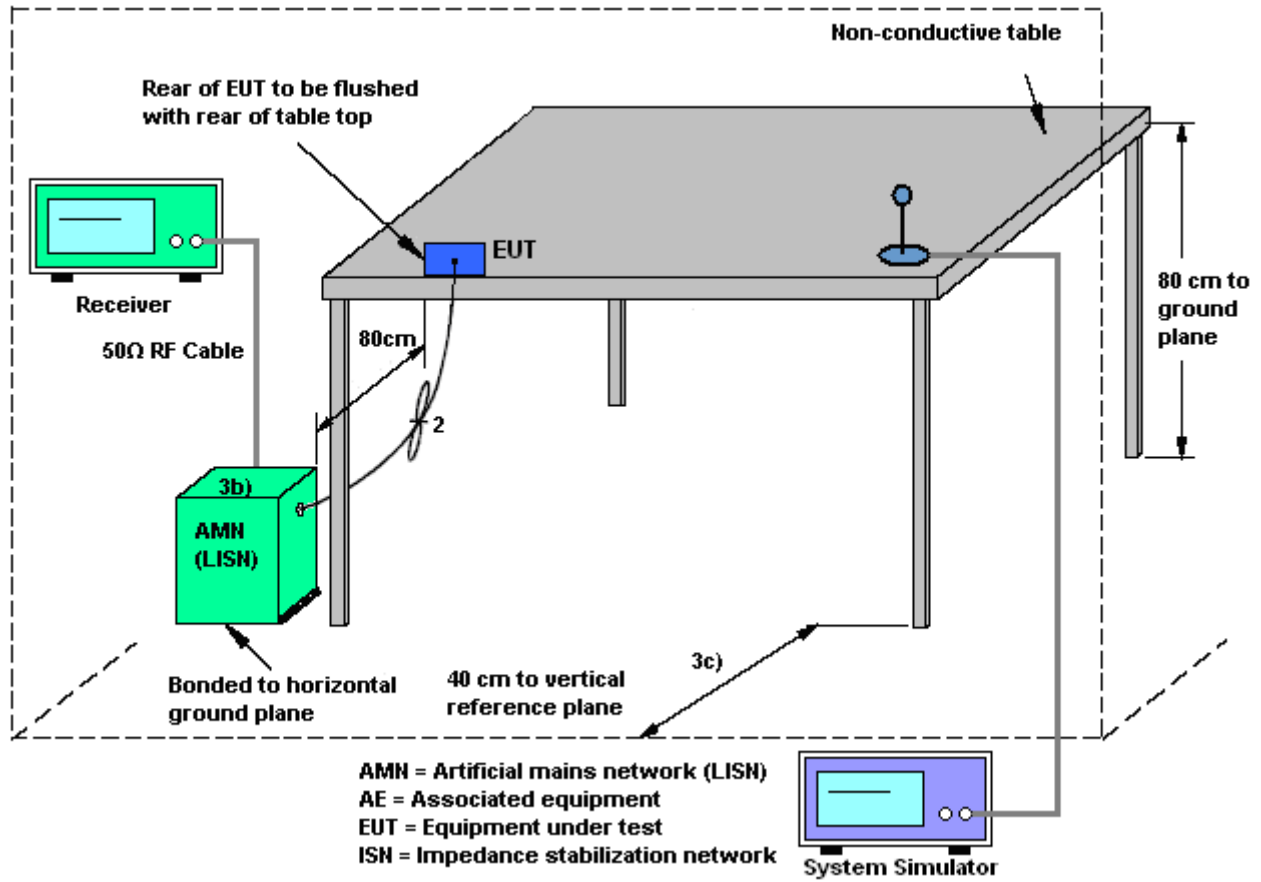



3.6.5 Test Result of AC Conducted Emission

Test Mode :	Mode 1	Temperature :	22~24°C
Test Engineer :	Amos Zhang	Relative Humidity :	43~45%
Test Voltage :	120Vac / 60Hz	Phase :	Line
Function Type :	GSM850 Idle + Bluetooth Link + WLAN Link + Earphone + USB Cable (Charging from Adapter)		

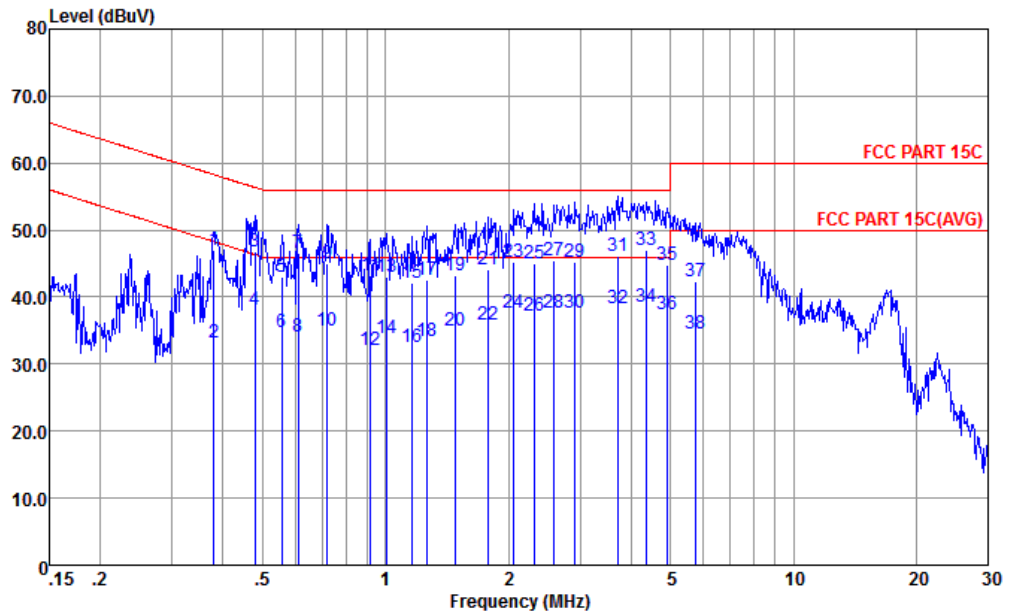

Site : CO01-kS
 Condition : FCC PART 15C LISN-L-20151024 LINE

	Freq	Level	Over Limit	Limit Line	Read Level	LISN Factor	Cable Loss	Remark
	MHz	dBuV	dB	dBuV	dBuV	dB	dB	
1	0.38	47.10	-11.20	58.30	36.70	0.23	10.17	QP
2	0.38	33.30	-15.00	48.30	22.90	0.23	10.17	Average
3	0.48	46.69	-9.67	56.36	36.30	0.23	10.16	QP
4	0.48	38.19	-8.17	46.36	27.80	0.23	10.16	Average
5	0.56	42.99	-13.01	56.00	32.60	0.23	10.16	QP
6	0.56	34.69	-11.31	46.00	24.30	0.23	10.16	Average
7	0.61	46.59	-9.41	56.00	36.19	0.24	10.16	QP
8	0.61	34.19	-11.81	46.00	23.79	0.24	10.16	Average
9	0.72	44.99	-11.01	56.00	34.60	0.24	10.15	QP
10	0.72	34.89	-11.11	46.00	24.50	0.24	10.15	Average
11	0.92	43.19	-12.81	56.00	32.80	0.25	10.14	QP
12	0.92	31.99	-14.01	46.00	21.60	0.25	10.14	Average
13	1.00	42.99	-13.01	56.00	32.60	0.25	10.14	QP
14	1.00	33.89	-12.11	46.00	23.50	0.25	10.14	Average
15	1.17	42.07	-13.93	56.00	31.70	0.23	10.14	QP
16	1.17	32.57	-13.43	46.00	22.20	0.23	10.14	Average
17	1.27	42.46	-13.54	56.00	32.09	0.23	10.14	QP



Test Mode :	Mode 1	Temperature :	22~24°C
Test Engineer :	Amos Zhang	Relative Humidity :	43~45%
Test Voltage :	120Vac / 60Hz	Phase :	Line
Function Type :	GSM850 Idle + Bluetooth Link + WLAN Link + Earphone + USB Cable (Charging from Adapter)		

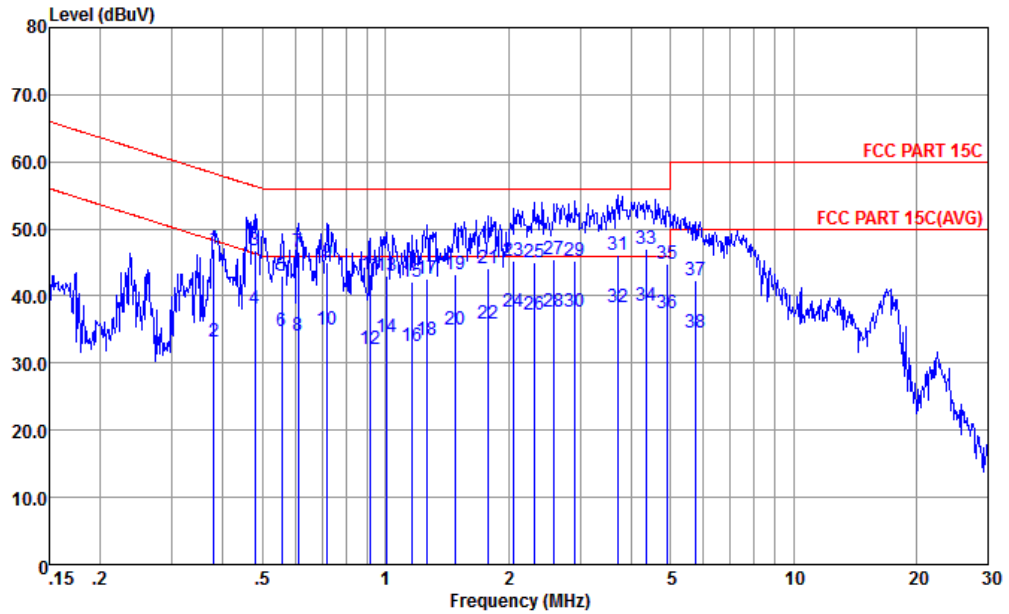

Site : CO01-kS
 Condition : FCC PART 15C LISN-L-20151024 LINE

	Freq	Level	Over	Limit	Read	LISN	Cable	Remark
	MHz	dBuV	Limit	Line	Level	Factor	Loss	
			dB	dBuV	dBuV	dB	dB	
18	1.27	33.46	-12.54	46.00	23.09	0.23	10.14	Average
19	1.48	43.25	-12.75	56.00	32.90	0.21	10.14	QP
20	1.48	34.95	-11.05	46.00	24.60	0.21	10.14	Average
21	1.79	44.23	-11.77	56.00	33.90	0.19	10.14	QP
22	1.79	35.83	-10.17	46.00	25.50	0.19	10.14	Average
23	2.07	45.22	-10.78	56.00	34.90	0.18	10.14	QP
24	2.07	37.72	-8.28	46.00	27.40	0.18	10.14	Average
25	2.31	44.93	-11.07	56.00	34.60	0.18	10.15	QP
26	2.31	37.13	-8.87	46.00	26.80	0.18	10.15	Average
27	2.59	45.43	-10.57	56.00	35.10	0.18	10.15	QP
28	2.59	37.73	-8.27	46.00	27.40	0.18	10.15	Average
29	2.92	45.24	-10.76	56.00	34.91	0.18	10.15	QP
30	2.92	37.74	-8.26	46.00	27.41	0.18	10.15	Average
31	3.70	46.15	-9.85	56.00	35.80	0.19	10.16	QP
32	3.70	38.25	-7.75	46.00	27.90	0.19	10.16	Average
33	4.36	47.06	-8.94	56.00	36.70	0.19	10.17	QP
34 *	4.36	38.66	-7.34	46.00	28.30	0.19	10.17	Average
35	4.90	44.87	-11.13	56.00	34.50	0.19	10.18	QP
36	4.90	37.47	-8.53	46.00	27.10	0.19	10.18	Average
37	5.77	42.30	-17.70	60.00	31.89	0.21	10.20	QP
38	5.77	34.60	-15.40	50.00	24.19	0.21	10.20	Average



Test Mode :	Mode 1	Temperature :	22~24°C
Test Engineer :	Amos Zhang	Relative Humidity :	43~45%
Test Voltage :	120Vac / 60Hz	Phase :	Neutral
Function Type :	GSM850 Idle + Bluetooth Link + WLAN Link + Earphone + USB Cable (Charging from Adapter)		

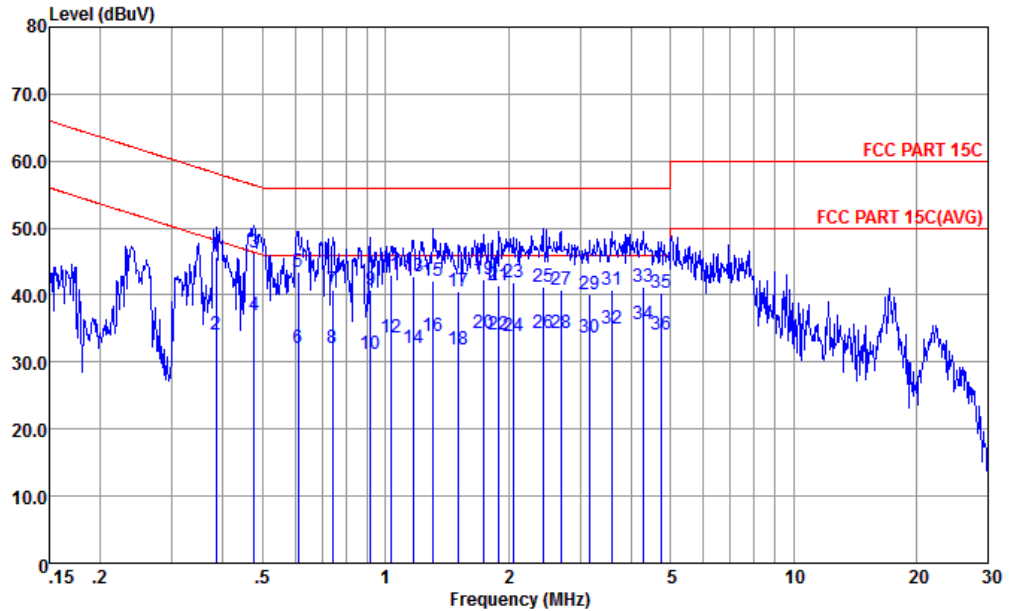

Site : CO01-kS
 Condition : FCC PART 15C LISN-N-20151024 NEUTRAL

	Freq	Level	Over Limit	Limit Line	Read Level	LISN Factor	Cable Loss	Remark
	MHz	dBuV	dB	dBuV	dBuV	dB	dB	
1	0.39	45.69	-12.48	58.17	35.20	0.32	10.17	QP
2	0.39	34.09	-14.08	48.17	23.60	0.32	10.17	Average
3	0.48	46.38	-10.03	56.41	35.90	0.32	10.16	QP
4 *	0.48	36.98	-9.43	46.41	26.50	0.32	10.16	Average
5	0.61	43.39	-12.61	56.00	32.90	0.33	10.16	QP
6	0.61	32.09	-13.91	46.00	21.60	0.33	10.16	Average
7	0.74	40.79	-15.21	56.00	30.30	0.34	10.15	QP
8	0.74	32.09	-13.91	46.00	21.60	0.34	10.15	Average
9	0.92	40.80	-15.20	56.00	30.30	0.36	10.14	QP
10	0.92	31.30	-14.70	46.00	20.80	0.36	10.14	Average
11	1.03	43.01	-12.99	56.00	32.50	0.37	10.14	QP
12	1.03	33.61	-12.39	46.00	23.10	0.37	10.14	Average
13	1.17	42.81	-13.19	56.00	32.30	0.37	10.14	QP
14	1.17	32.11	-13.89	46.00	21.60	0.37	10.14	Average
15	1.31	42.11	-13.89	56.00	31.60	0.37	10.14	QP
16	1.31	33.81	-12.19	46.00	23.30	0.37	10.14	Average
17	1.51	40.62	-15.38	56.00	30.10	0.38	10.14	QP



Test Mode :	Mode 1	Temperature :	22~24°C
Test Engineer :	Amos Zhang	Relative Humidity :	43~45%
Test Voltage :	120Vac / 60Hz	Phase :	Neutral
Function Type :	GSM850 Idle + Bluetooth Link + WLAN Link + Earphone + USB Cable (Charging from Adapter)		

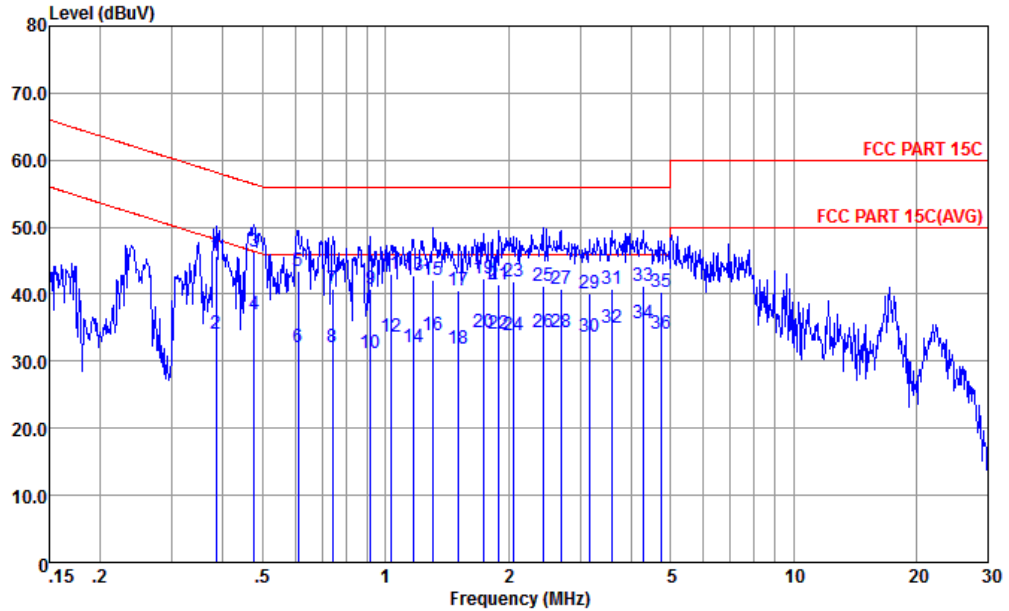

Site : CO01-kS
 Condition : FCC PART 15C LISN-N-20151024 NEUTRAL

	Freq	Level	Over Limit	Limit Line	Read Level	LISN Factor	Cable Loss	Remark
	MHz	dBuV	dB	dBuV	dBuV	dB	dB	
18	1.51	31.92	-14.08	46.00	21.40	0.38	10.14	Average
19	1.73	42.42	-13.58	56.00	31.90	0.38	10.14	QP
20	1.73	34.32	-11.68	46.00	23.80	0.38	10.14	Average
21	1.90	41.42	-14.58	56.00	30.90	0.38	10.14	QP
22	1.90	34.12	-11.88	46.00	23.60	0.38	10.14	Average
23	2.05	41.82	-14.18	56.00	31.30	0.38	10.14	QP
24	2.05	33.82	-12.18	46.00	23.30	0.38	10.14	Average
25	2.43	41.12	-14.88	56.00	30.59	0.38	10.15	QP
26	2.43	34.42	-11.58	46.00	23.89	0.38	10.15	Average
27	2.69	40.82	-15.18	56.00	30.30	0.37	10.15	QP
28	2.69	34.22	-11.78	46.00	23.70	0.37	10.15	Average
29	3.16	40.13	-15.87	56.00	29.60	0.37	10.16	QP
30	3.16	33.73	-12.27	46.00	23.20	0.37	10.16	Average
31	3.58	40.83	-15.17	56.00	30.30	0.37	10.16	QP
32	3.58	35.03	-10.97	46.00	24.50	0.37	10.16	Average
33	4.27	41.13	-14.87	56.00	30.60	0.36	10.17	QP
34	4.27	35.63	-10.37	46.00	25.10	0.36	10.17	Average
35	4.75	40.34	-15.66	56.00	29.80	0.36	10.18	QP
36	4.75	34.14	-11.86	46.00	23.60	0.36	10.18	Average



3.7 Antenna Requirements

3.7.1 Standard Applicable

If directional gain of transmitting antennas is greater than 6dBi, the power shall be reduced by the same level in dB comparing to gain minus 6dBi. For the fixed point-to-point operation, the power shall be reduced by one dB for every 3 dB that the directional gain of the antenna exceeds 6 dBi. The use of a permanently attached antenna or of an antenna that uses a unique coupling to the intentional radiator shall be considered sufficient to comply with the FCC rule.

3.7.2 Antenna Anti-Replacement Construction

An embedded-in antenna design is used.

3.7.3 Antenna Gain

The antenna peak gain of EUT is less than 6 dBi. Therefore, it is not necessary to reduce maximum peak output power limit.



4 List of Measuring Equipment

Instrument	Manufacturer	Model No.	Serial No.	Characteristics	Calibration Date	Test Date	Due Date	Remark
Spectrum Analyzer	R&S	FSV30	101338	9kHz~30GHz	May 04, 2015	Dec. 08, 2015~ Jan. 19, 2016	May 03, 2016	Conducted (TH01-KS)
Pulse Power Senor	Anritsu	MA2411B	0917070	30MHz~40GHz	Jan. 23, 2015	Dec. 08, 2015~ Jan. 19, 2016	Jan. 22, 2016	Conducted (TH01-KS)
Power Meter	Anritsu	ML2495A	1005002	50MHz Bandwidth	Jan. 23, 2015	Dec. 08, 2015~ Jan. 19, 2016	Jan. 22, 2016	Conducted (TH01-KS)
EMI Test Receiver	R&S	ESR7	101403	9kHz~7GHz;Ma x 30dBm	Sep. 10, 2015	Dec. 05, 2015~ Dec. 23, 2015	Sep. 09, 2016	Radiation (03CH03-KS)
EXA Spectrum Analyzer	Keysight	N9010A	MY551502 44	10Hz-44GHz	Jun. 05, 2015	Dec. 05, 2015~ Dec. 23, 2015	Jun. 04, 2016	Radiation (03CH03-KS)
Loop Antenna	R&S	HFH2-Z2	100321	9kHz~30MHz	Nov. 10, 2015	Dec. 05, 2015~ Dec. 23, 2015	Nov. 09, 2016	Radiation (03CH03-KS)
Bilog Antenna	TeseQ	CBL6112D	35406	25MHz-2GHz	Jun. 25, 2015	Dec. 05, 2015~ Dec. 23, 2015	Jun. 24, 2016	Radiation (03CH03-KS)
Horn Antenna	Schwarzbeck	BBHA9120D	9120D-135 6	1GHz~18GHz	Jun. 25, 2015	Dec. 05, 2015~ Dec. 23, 2015	Jun. 24, 2016	Radiation (03CH03-KS)
SHF-EHF Horn	Schwarzbeck	BBHA 9170	BBHA1702 49	15GHz ~40GHz	Mar. 03, 2015	Dec. 05, 2015~ Dec. 23, 2015	Mar. 02, 2016	Radiation (03CH03-KS)
Amplifier	Burgeon	BPA-530	102212	0.01MHz-3000M Hz	Aug. 10, 2015	Dec. 05, 2015~ Dec. 23, 2015	Aug. 09, 2016	Radiation (03CH03-KS)
Amplifier	Agilent	8449B	3008A023 70	1GHz~26.5GHz	Oct. 24, 2015	Dec. 05, 2015~ Dec. 23, 2015	Oct. 23, 2016	Radiation (03CH03-KS)
AC Power Source	Chroma	61601	F1040900 04	N/A	NCR	Dec. 05, 2015~ Dec. 23, 2015	NCR	Radiation (03CH03-KS)
Turn Table	ChamPro	EM 1000-T	060762-T	0~360 degree	NCR	Dec. 05, 2015~ Dec. 23, 2015	NCR	Radiation (03CH03-KS)
Antenna Mast	ChamPro	EM 1000-A	060762-A	1 m~4 m	NCR	Dec. 05, 2015~ Dec. 23, 2015	NCR	Radiation (03CH03-KS)
EMI Test Receiver	R&S	ESR7	101403	9kHz~7GHz;Ma x 30dBm	Sep. 10, 2015	Dec. 08, 2015	Sep. 09, 2016	Conduction (CO01-KS)
AC LISN	MessTec	AN3016	060103	9kHz~30MHz	Oct. 24, 2015	Dec. 08, 2015	Oct. 23, 2016	Conduction (CO01-KS)
AC LISN (for auxiliary equipment)	MessTec	AN3016	060105	9kHz~30MHz	Oct. 24, 2015	Dec. 08, 2015	Oct. 23, 2016	Conduction (CO01-KS)
AC Power Source	Chroma	61602	ABP00000 0811	AC 0V~300V, 45Hz~1000Hz	Oct. 24, 2015	Dec. 08, 2015	Oct. 23, 2016	Conduction (CO01-KS)



5 Uncertainty of Evaluation

Uncertainty of Conducted Emission Measurement (150kHz ~ 30MHz)

Measuring Uncertainty for a Level of Confidence of 95% ($U = 2Uc(y)$)	2.3dB
---	-------

Uncertainty of Radiated Emission Measurement (30 MHz ~ 1000 MHz)

Measuring Uncertainty for a Level of Confidence of 95% ($U = 2Uc(y)$)	4.5dB
---	-------



Appendix A. Conducted Test Results

A1 - DTS Part

Test Engineer:	Issac Song	Temperature:	24~25	°C
Test Date:	2015/12/8 ~ 2016/1/19	Relative Humidity:	49~51	%

TEST RESULTS DATA
6dB and 99% Occupied Bandwidth

2.4GHz Band								
Mod.	Data Rate	N _{TX}	CH.	Freq. (MHz)	99% Occupied BW (MHz)	6dB BW (MHz)	6dB BW Limit (MHz)	Pass/Fail
11b	1Mbps	1	1	2412	12.54	9.55	0.50	Pass
11b	1Mbps	1	6	2437	12.64	10.01	0.50	Pass
11b	1Mbps	1	11	2462	12.54	10.01	0.50	Pass
11g	54Mbps	1	1	2412	18.03	16.34	0.50	Pass
11g	54Mbps	1	2	2417	17.68	16.38	0.50	Pass
11g	54Mbps	1	6	2437	17.38	16.40	0.50	Pass
11g	54Mbps	1	10	2457	17.43	16.34	0.50	Pass
11g	54Mbps	1	11	2462	17.88	16.34	0.50	Pass
HT20	MCS7	1	1	2412	18.38	17.72	0.50	Pass
HT20	MCS7	1	6	2437	18.38	17.72	0.50	Pass
HT20	MCS7	1	11	2462	18.38	17.74	0.50	Pass
HT40	MCS7	1	3	2422	36.46	36.40	0.50	Pass
HT40	MCS7	1	6	2437	36.36	36.36	0.50	Pass
HT40	MCS7	1	9	2452	36.46	36.36	0.50	Pass

TEST RESULTS DATA
Peak Power Table

2.4GHz Band										
Mod.	Data Rate	N _{TX}	CH.	Freq. (MHz)	Peak Conducted Power (dBm)	Conducted Power Limit (dBm)	DG (dBi)	EIRP Power (dBm)	EIRP Power Limit (dBm)	Pass /Fail
11b	1Mbps	1	1	2412	18.26	30.00	0.05	18.31	36.00	Pass
11b	1Mbps	1	6	2437	18.82	30.00	0.05	18.87	36.00	Pass
11b	1Mbps	1	11	2462	18.18	30.00	0.05	18.23	36.00	Pass
11g	54Mbps	1	1	2412	19.81	30.00	0.05	19.86	36.00	Pass
11g	54Mbps	1	2	2417	22.59	30.00	0.05	22.64	36.00	Pass
11g	54Mbps	1	6	2437	22.18	30.00	0.05	22.23	36.00	Pass
11g	54Mbps	1	10	2457	22.54	30.00	0.05	22.59	36.00	Pass
11g	54Mbps	1	11	2462	20.04	30.00	0.05	20.09	36.00	Pass
HT20	MCS7	1	1	2412	21.46	30.00	0.05	21.51	36.00	Pass
HT20	MCS7	1	6	2437	21.12	30.00	0.05	21.17	36.00	Pass
HT20	MCS7	1	11	2462	21.38	30.00	0.05	21.43	36.00	Pass
HT40	MCS7	1	3	2422	21.77	30.00	0.05	21.82	36.00	Pass
HT40	MCS7	1	6	2437	21.34	30.00	0.05	21.39	36.00	Pass
HT40	MCS7	1	9	2452	21.52	30.00	0.05	21.57	36.00	Pass

TEST RESULTS DATA
Average Power Table
(Reporting Only)

2.4GHz Band						
Mod.	Data Rate	N _{TX}	CH.	Freq. (MHz)	Duty Factor (dB)	Average Conducted Power (dBm)
11b	1Mbps	1	1	2412	0.04	15.33
11b	1Mbps	1	6	2437	0.04	16.05
11b	1Mbps	1	11	2462	0.04	15.19
11g	54Mbps	1	1	2412	0.12	9.72
11g	54Mbps	1	2	2417	0.12	12.88
11g	54Mbps	1	6	2437	0.12	12.08
11g	54Mbps	1	10	2457	0.12	12.66
11g	54Mbps	1	11	2462	0.12	9.85
HT20	MCS7	1	1	2412	0.12	10.76
HT20	MCS7	1	6	2437	0.12	10.35
HT20	MCS7	1	11	2462	0.12	10.56
HT40	MCS7	1	3	2422	0.23	10.77
HT40	MCS7	1	6	2437	0.23	10.13
HT40	MCS7	1	9	2452	0.23	10.44

TEST RESULTS DATA
Peak Power Density

2.4GHz Band								
Mod.	Data Rate	N _{TX}	CH.	Freq. (MHz)	Peak PSD (dBm /3kHz)	DG (dBi)	Peak PSD Limit (dBm /3kHz)	Pass/Fail
11b	1Mbps	1	1	2412	-7.91	0.05	8.00	Pass
11b	1Mbps	1	6	2437	-7.76	0.05	8.00	Pass
11b	1Mbps	1	11	2462	-7.89	0.05	8.00	Pass
11g	54Mbps	1	1	2412	-15.10	0.05	8.00	Pass
11g	54Mbps	1	2	2417	-12.70	0.05	8.00	Pass
11g	54Mbps	1	6	2437	-12.40	0.05	8.00	Pass
11g	54Mbps	1	10	2457	-12.76	0.05	8.00	Pass
11g	54Mbps	1	11	2462	-14.08	0.05	8.00	Pass
HT20	MCS7	1	1	2412	-14.29	0.05	8.00	Pass
HT20	MCS7	1	6	2437	-14.84	0.05	8.00	Pass
HT20	MCS7	1	11	2462	-13.85	0.05	8.00	Pass
HT40	MCS7	1	3	2422	-15.64	0.05	8.00	Pass
HT40	MCS7	1	6	2437	-17.30	0.05	8.00	Pass
HT40	MCS7	1	9	2452	-17.51	0.05	8.00	Pass



Appendix B. Radiated Spurious Emission

WIFI	2.4GHz 2400~2483.5MHz WIFI 802.11b (Band Edge @ 3m)	
ANT	CH01 2412MHz	
1	Horizontal	Vertical
Peak		
Average		

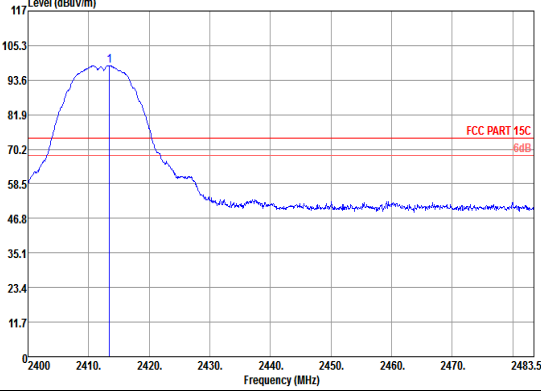
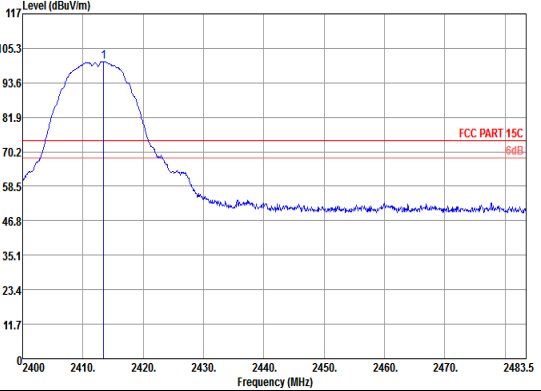
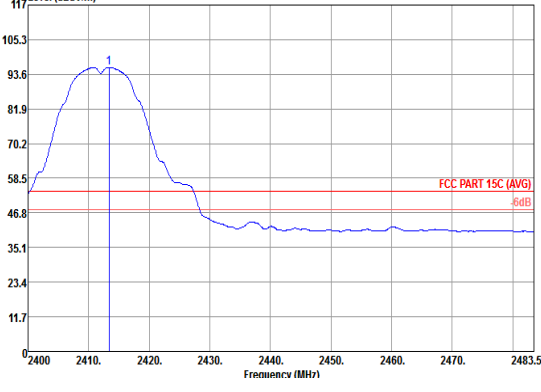
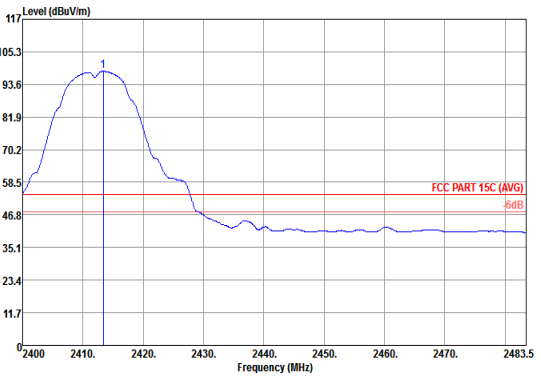

WIFI	2.4GHz 2400~2483.5MHz WIFI 802.11b (Fundamental Emission @ 3m)	
ANT	CH01 2412MHz	
1	Horizontal	Vertical
Peak		
Average		

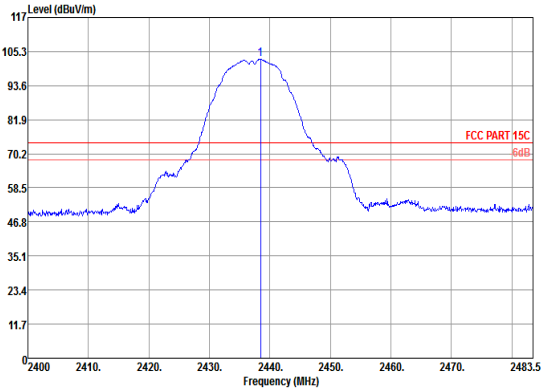
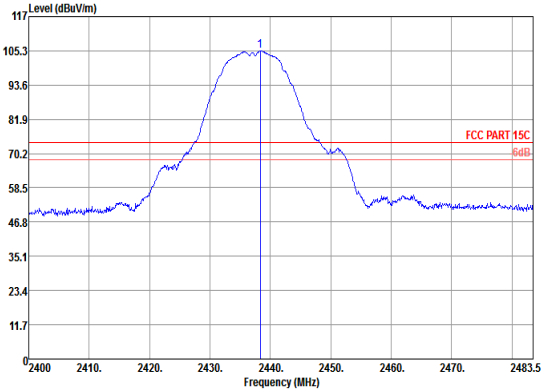
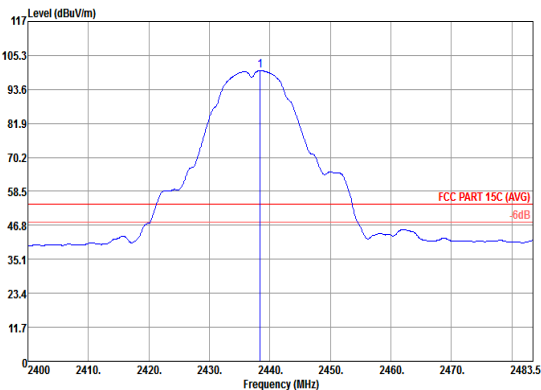
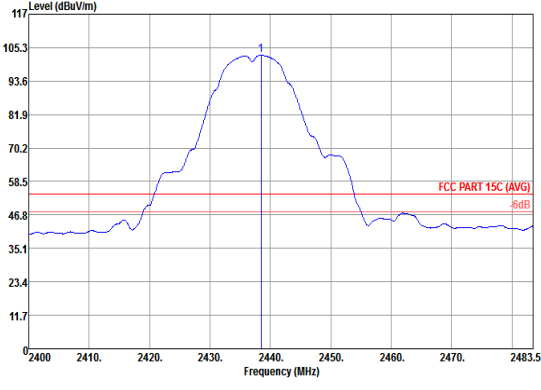

WIFI	2.4GHz 2400~2483.5MHz WIFI 802.11b (Fundamental Emission @ 3m)	
ANT	CH06 2437MHz	
1	Horizontal	Vertical
Peak		
Average		

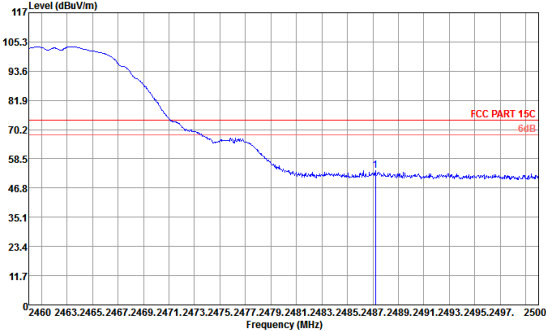
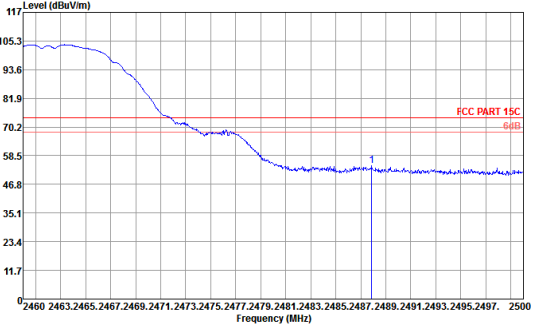
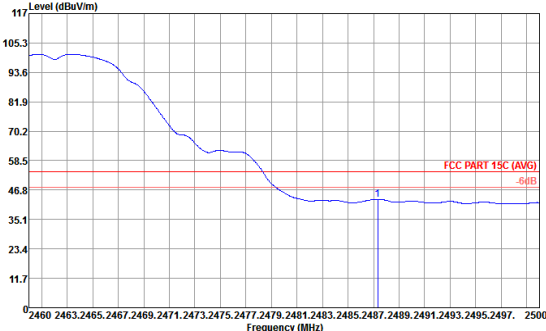
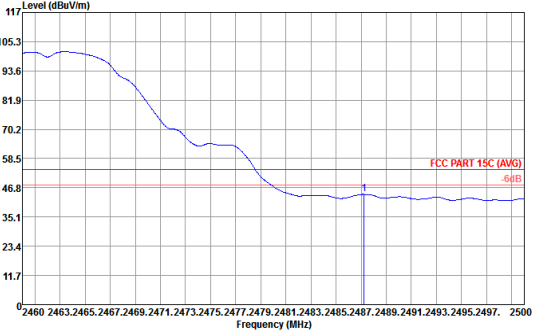

WIFI	2.4GHz 2400~2483.5MHz WIFI 802.11b (Band Edge @ 3m)	
ANT	CH11 2462MHz	
1	Horizontal	Vertical
Peak		
Average		

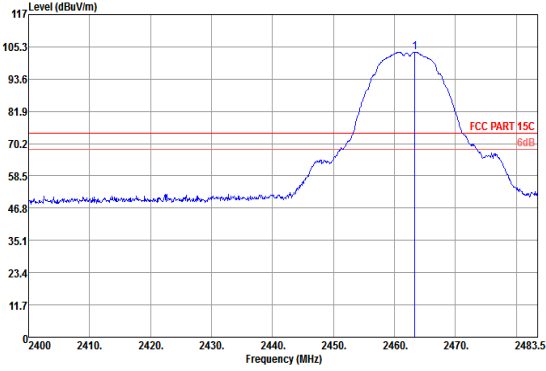
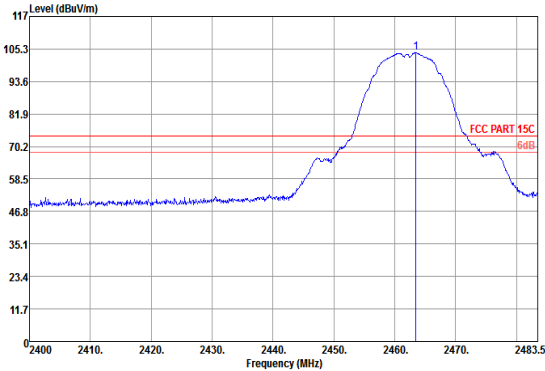
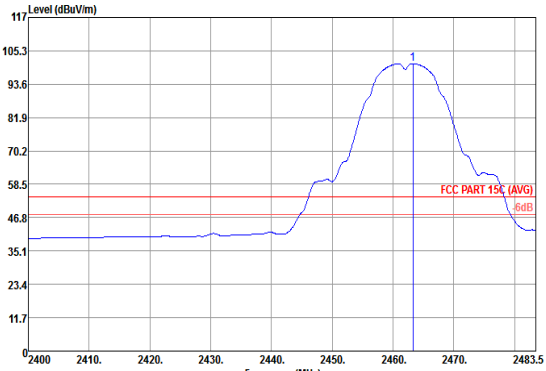
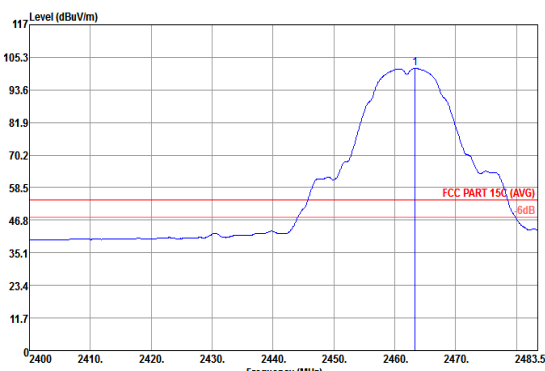

WIFI	2.4GHz 2400~2483.5MHz WIFI 802.11b (Fundamental Emission @ 3m)	
ANT	CH11 2462MHz	
1	Horizontal	Vertical
Peak		
Average		

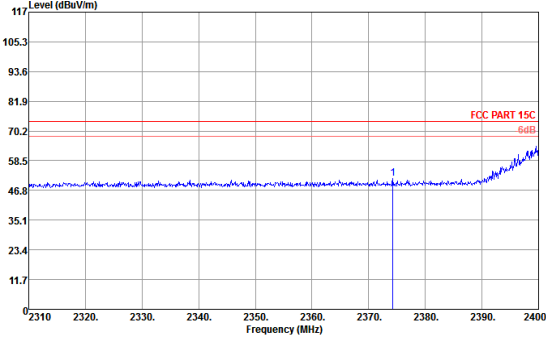
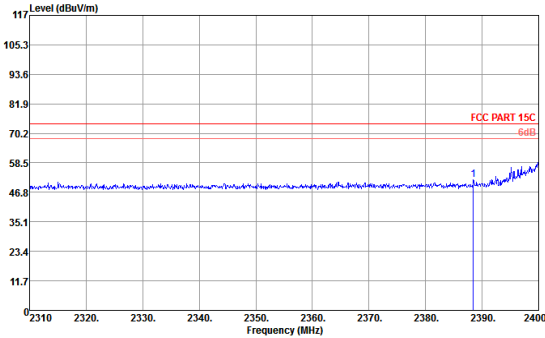
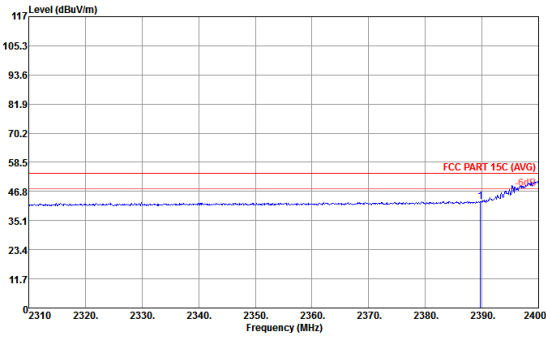
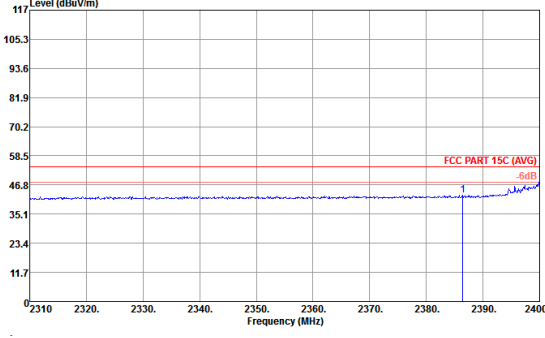

WIFI	2.4GHz 2400~2483.5MHz WIFI 802.11g (Band Edge @ 3m)	
ANT	CH01 2412MHz	
1	Horizontal	Vertical
Peak		
Average		

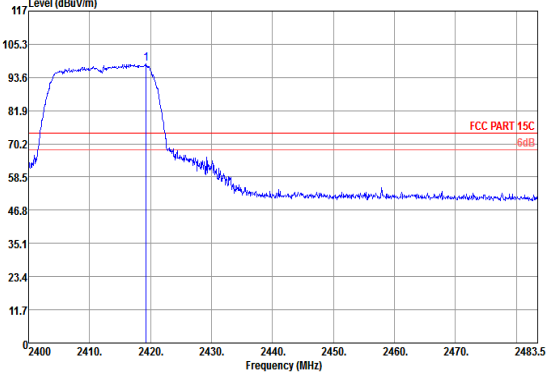
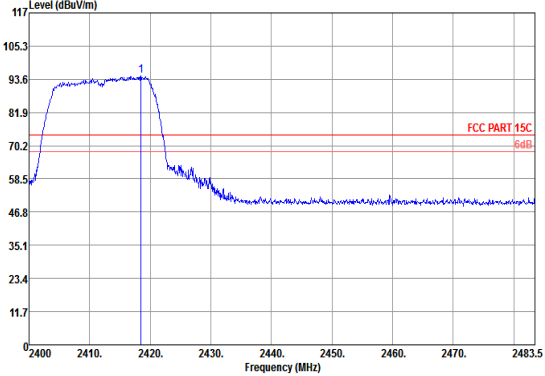
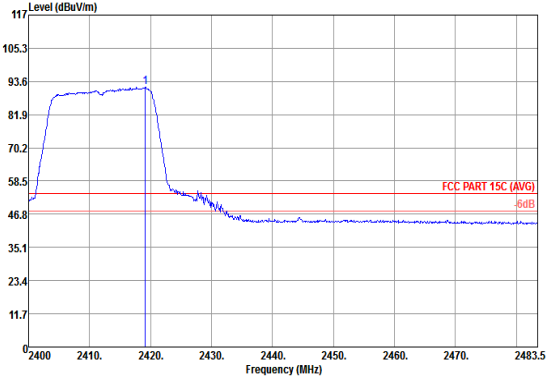
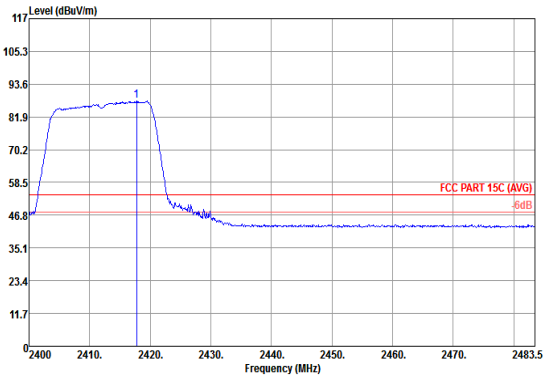

WIFI	2.4GHz 2400~2483.5MHz WIFI 802.11g (Fundamental Emission @ 3m)	
ANT	CH01 2412MHz	
1	Horizontal	Vertical
Peak		
Average		

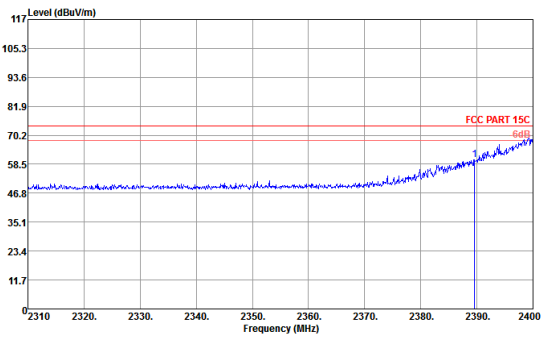
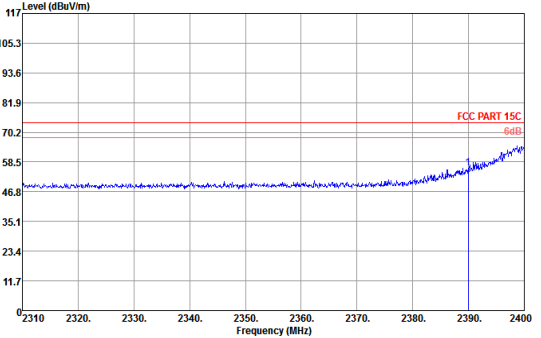
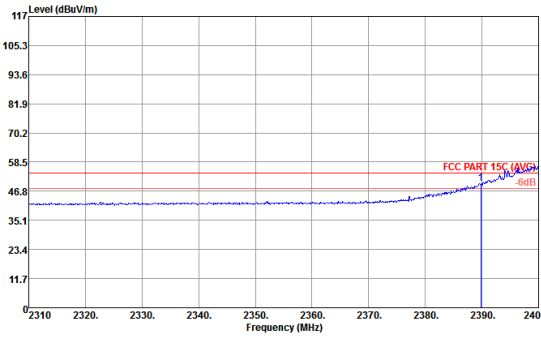
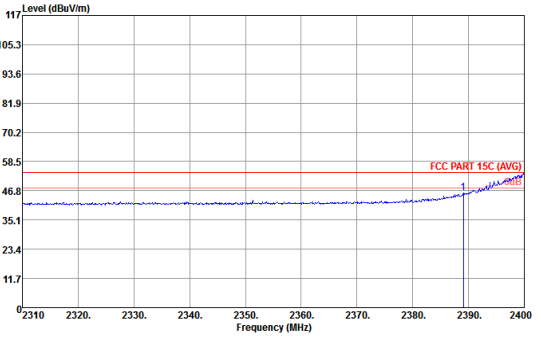

WIFI	2.4GHz 2400~2483.5MHz WIFI 802.11g (Band Edge @ 3m)	
ANT	CH02 2417MHz	
1	Horizontal	Vertical
Peak		
Average		

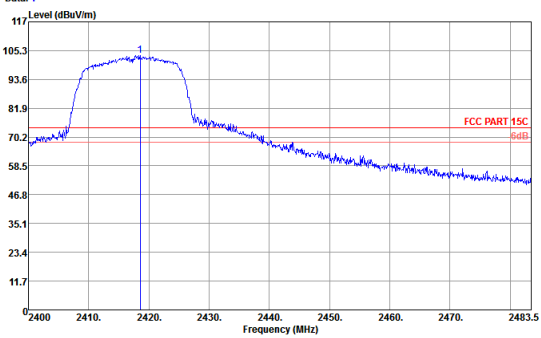
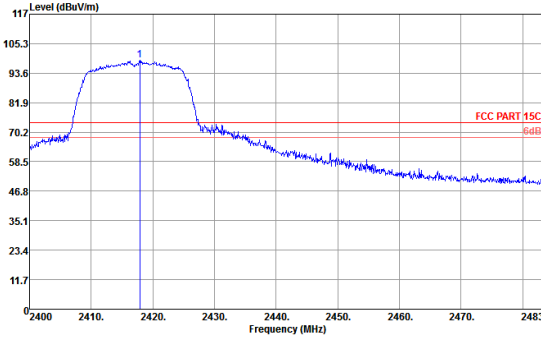
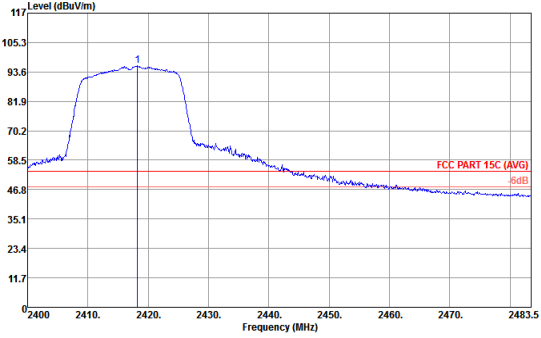
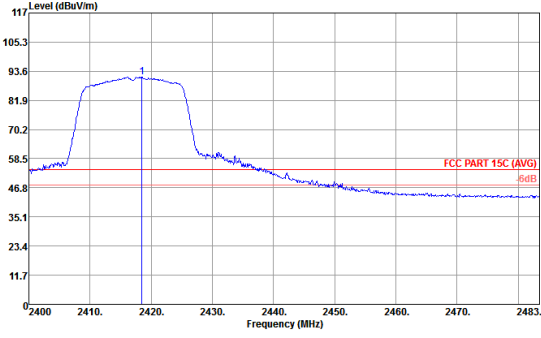

WIFI	2.4GHz 2400~2483.5MHz WIFI 802.11g (Fundamental Emission @ 3m)	
ANT	CH02 2417MHz	
1	Horizontal	Vertical
Peak		
Average		

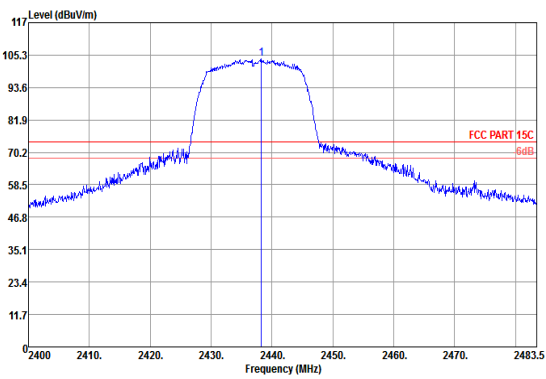
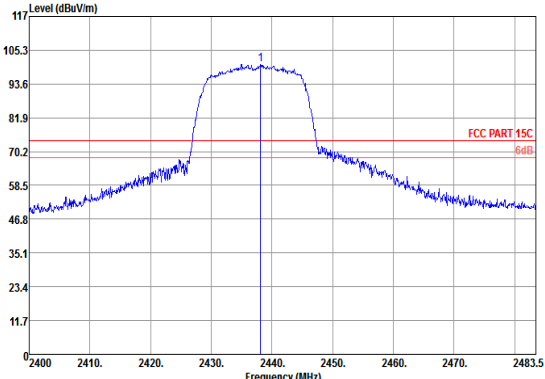
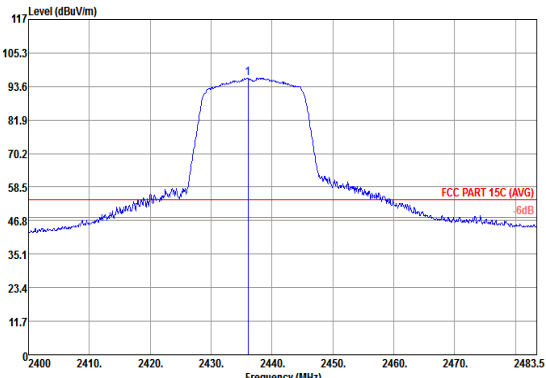
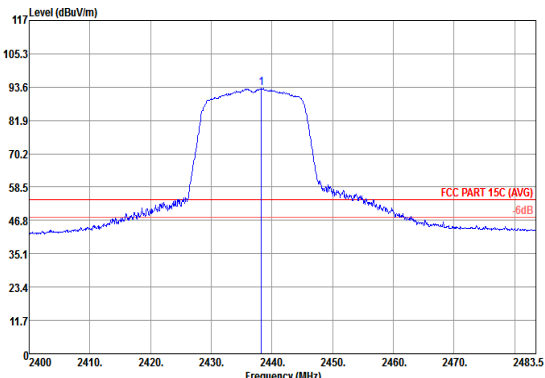

WIFI	2.4GHz 2400~2483.5MHz WIFI 802.11g (Fundamental Emission @ 3m)	
ANT	CH06 2437MHz	
1	Horizontal	Vertical
Peak		
Average		

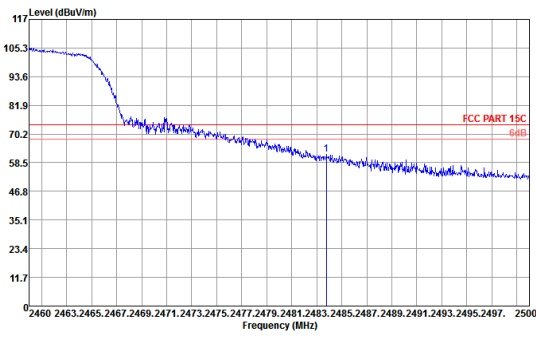
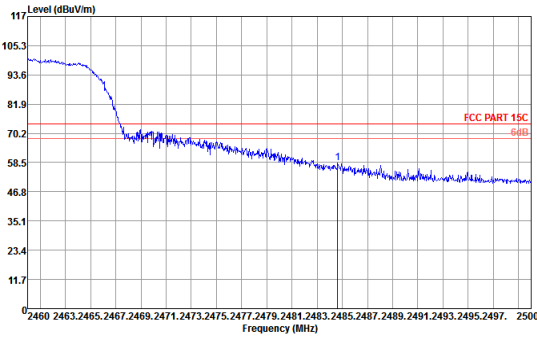
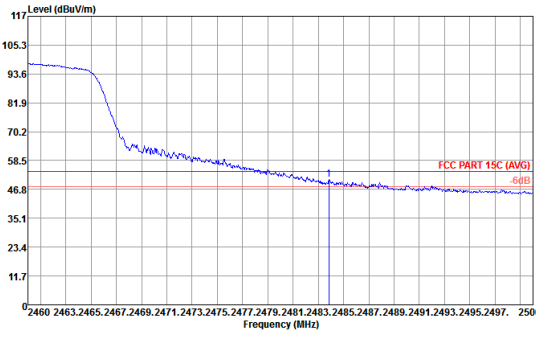
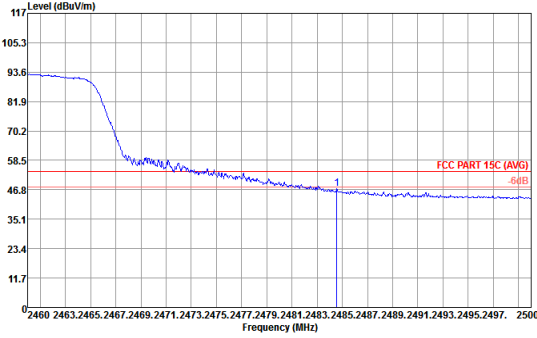

WIFI	2.4GHz 2400~2483.5MHz WIFI 802.11g (Band Edge @ 3m)	
ANT	CH10 2457MHz	
1	Horizontal	Vertical
Peak		
Average		

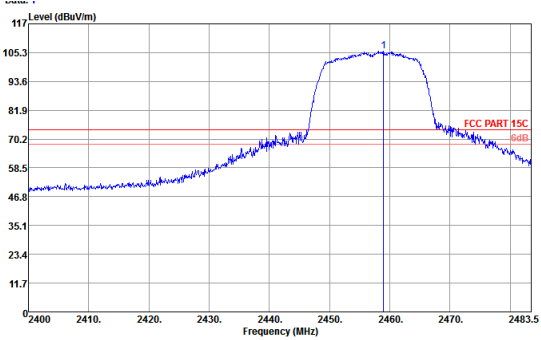
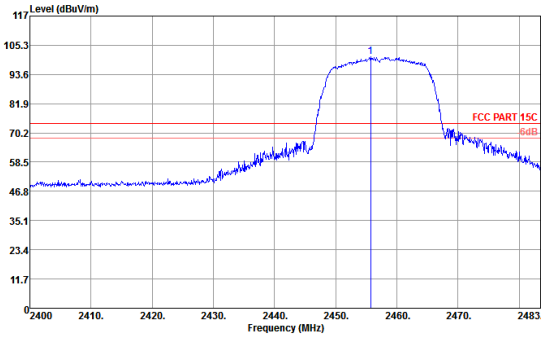
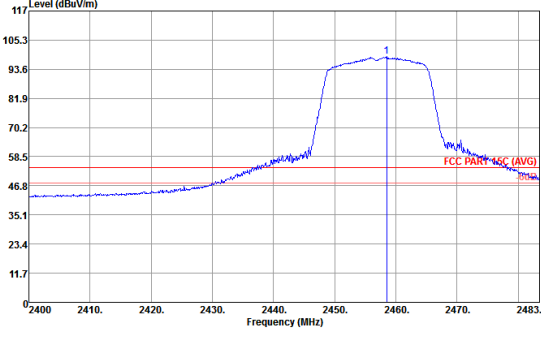
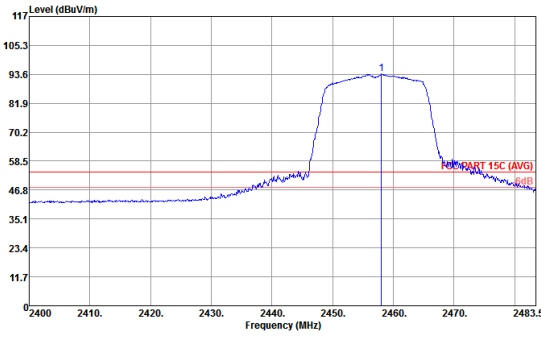

WIFI	2.4GHz 2400~2483.5MHz WIFI 802.11g (Fundamental Emission @ 3m)	
ANT	CH10 2457MHz	
1	Horizontal	Vertical
Peak		
Average		

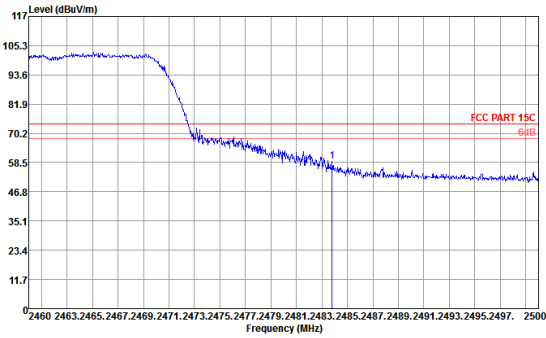
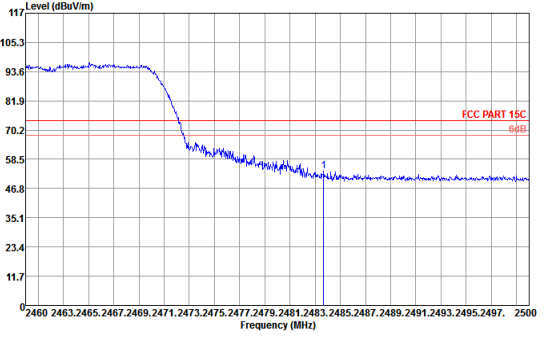
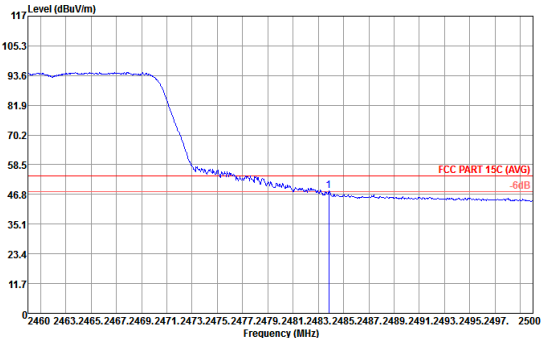
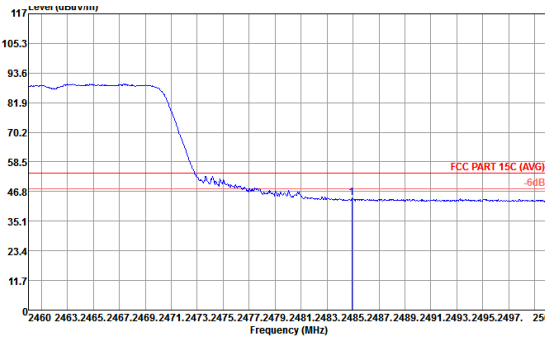

WIFI	2.4GHz 2400~2483.5MHz WIFI 802.11g (Band Edge @ 3m)	
ANT	CH11 2462MHz	
1	Horizontal	Vertical
Peak	 <p>Level (dBuV/m) vs Frequency (MHz) for Horizontal orientation. The plot shows a signal level starting at approximately 105.3 dBuV/m at 2460 MHz, dropping to about 70.2 dBuV/m by 2475 MHz, and then fluctuating around 58.5 dBuV/m. A red horizontal line indicates the FCC PART 15C limit at 60 dB. A vertical blue line marks the test frequency at 2462 MHz.</p>	 <p>Level (dBuV/m) vs Frequency (MHz) for Vertical orientation. The plot shows a signal level starting at approximately 105.3 dBuV/m at 2460 MHz, dropping to about 70.2 dBuV/m by 2475 MHz, and then fluctuating around 58.5 dBuV/m. A red horizontal line indicates the FCC PART 15C limit at 60 dB. A vertical blue line marks the test frequency at 2462 MHz.</p>
Average	 <p>Level (dBuV/m) vs Frequency (MHz) for Horizontal orientation (Average). The plot shows a smoothed signal level starting at approximately 93.6 dBuV/m at 2460 MHz, dropping to about 58.5 dBuV/m by 2475 MHz, and then fluctuating around 46.8 dBuV/m. A red horizontal line indicates the FCC PART 15C (AVG) limit at 50 dB. A vertical blue line marks the test frequency at 2462 MHz.</p>	 <p>Level (dBuV/m) vs Frequency (MHz) for Vertical orientation (Average). The plot shows a smoothed signal level starting at approximately 93.6 dBuV/m at 2460 MHz, dropping to about 58.5 dBuV/m by 2475 MHz, and then fluctuating around 46.8 dBuV/m. A red horizontal line indicates the FCC PART 15C (AVG) limit at 50 dB. A vertical blue line marks the test frequency at 2462 MHz.</p>

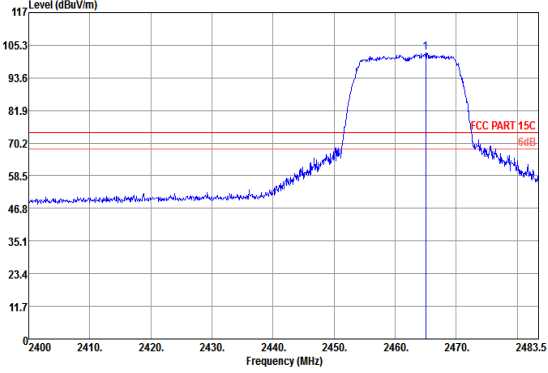
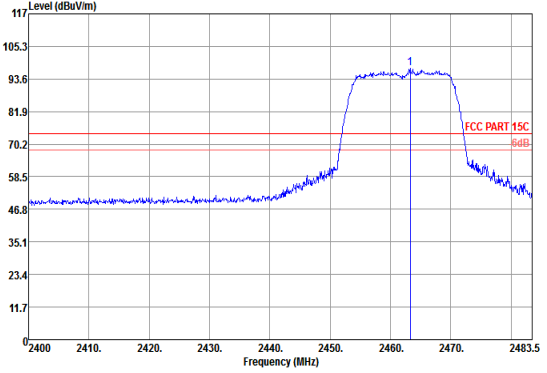
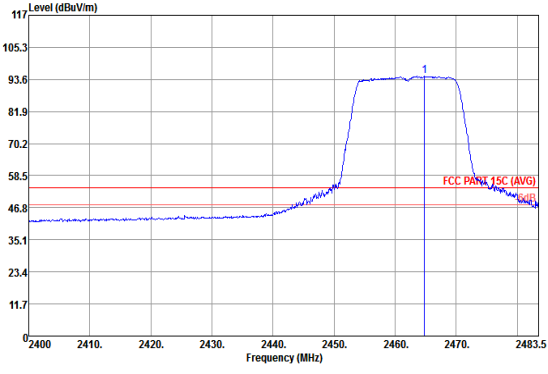
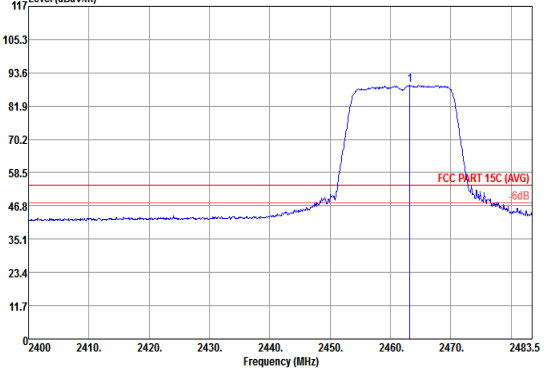

WIFI	2.4GHz 2400~2483.5MHz WIFI 802.11g (Fundamental Emission @ 3m)	
ANT	CH11 2462MHz	
1	Horizontal	Vertical
Peak		
Average		

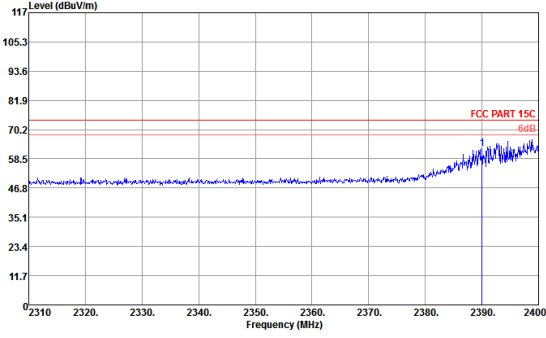
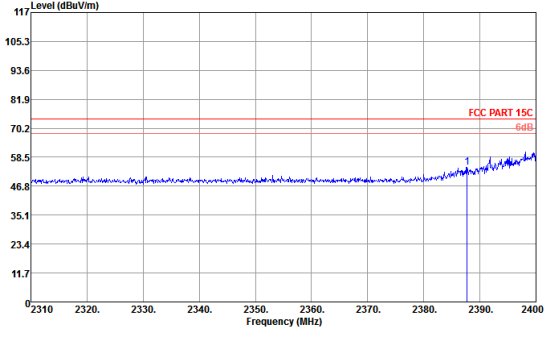
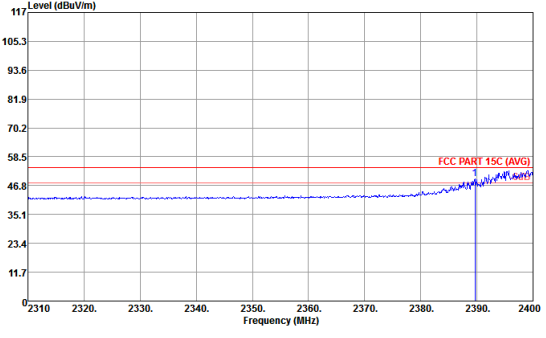
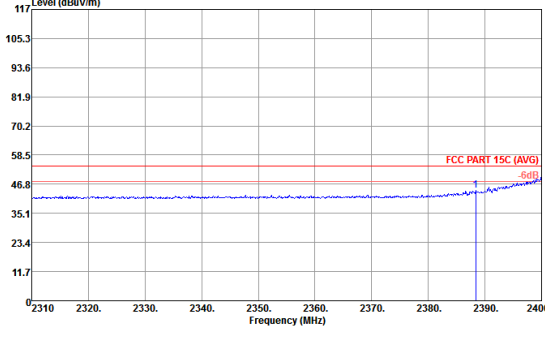

WIFI	2.4GHz 2400~2483.5MHz WIFI 802.11n HT20 (Band Edge @ 3m)	
ANT	CH01 2412MHz	
1	Horizontal	Vertical
Peak		
Average		

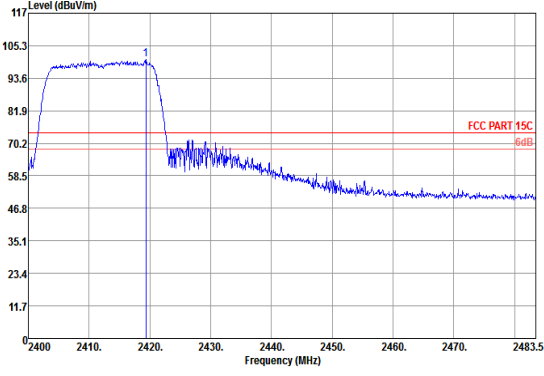
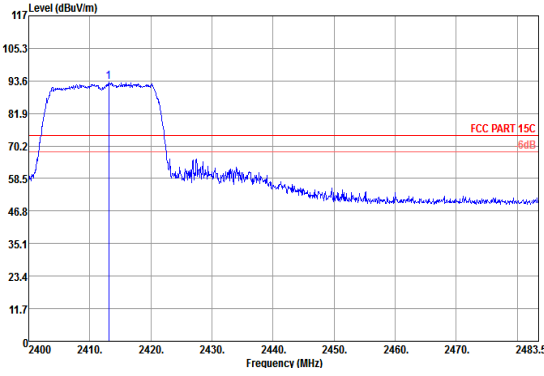
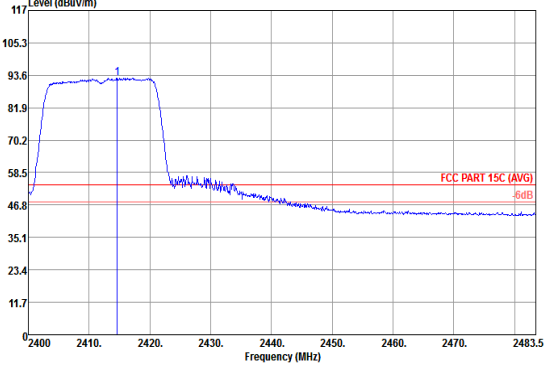
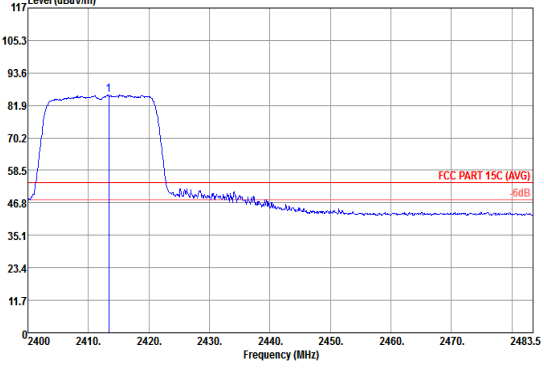

WIFI	2.4GHz 2400~2483.5MHz WIFI 802.11n HT20 (Fundamental Emission @ 3m)	
ANT	CH01 2412MHz	
1	Horizontal	Vertical
Peak		
Average		



WIFI	2.4GHz 2400~2483.5MHz WIFI 802.11n HT20 (Fundamental Emission @ 3m)	
ANT	CH06 2437MHz	
1	Horizontal	Vertical
Peak	<p>Horizontal Peak Plot: The y-axis represents Level (dBuV/m) from 0 to 117, and the x-axis represents Frequency (MHz) from 2400 to 2483.5. A blue signal trace shows a peak at approximately 2440 MHz. A red horizontal line indicates the FCC PART 15C limit at 8dB. The signal level at the peak is significantly above the limit.</p>	<p>Vertical Peak Plot: The y-axis represents Level (dBuV/m) from 0 to 117, and the x-axis represents Frequency (MHz) from 2400 to 2483.5. A blue signal trace shows a peak at approximately 2440 MHz. A red horizontal line indicates the FCC PART 15C limit at 8dB. The signal level at the peak is significantly above the limit.</p>
Average	<p>Horizontal Average Plot: The y-axis represents Level (dBuV/m) from 0 to 117, and the x-axis represents Frequency (MHz) from 2400 to 2483.5. A blue signal trace shows a peak at approximately 2440 MHz. A red horizontal line indicates the FCC PART 15C (AVG) limit at 8dB. The signal level at the peak is significantly above the limit.</p>	<p>Vertical Average Plot: The y-axis represents Level (dBuV/m) from 0 to 117, and the x-axis represents Frequency (MHz) from 2400 to 2483.5. A blue signal trace shows a peak at approximately 2440 MHz. A red horizontal line indicates the FCC PART 15C (AVG) limit at 8dB. The signal level at the peak is significantly above the limit.</p>

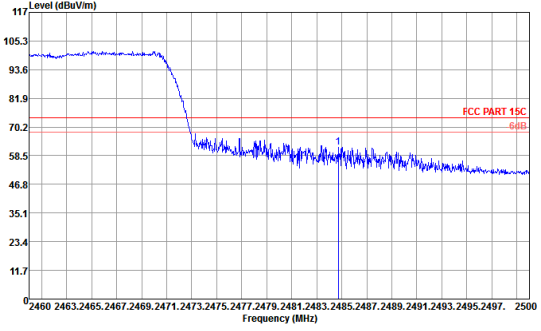
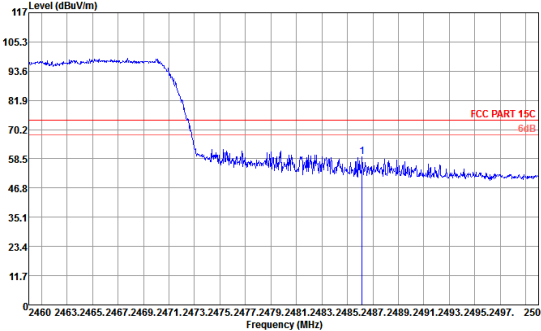
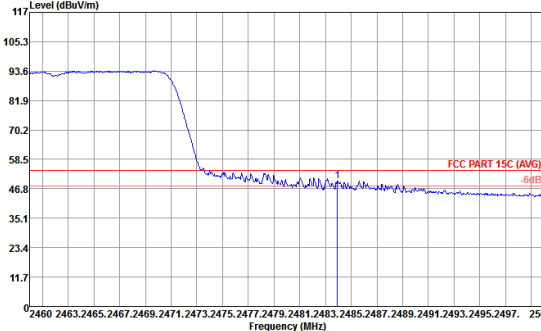
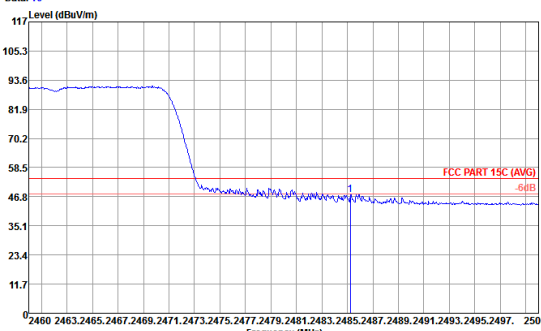

WIFI	2.4GHz 2400~2483.5MHz WIFI 802.11n HT20 (Band Edge @ 3m)	
ANT	CH11 2462MHz	
1	Horizontal	Vertical
Peak	 <p>Level (dBuV/m) vs Frequency (MHz) for Peak Horizontal. The plot shows a signal level starting at approximately 105.3 dBuV/m at 2460 MHz, dropping to about 58.5 dBuV/m by 2475 MHz, and then fluctuating between 58.5 and 60 dBuV/m up to 2500 MHz. A red horizontal line indicates the FCC PART 15C limit at 60 dBuV/m.</p>	 <p>Level (dBuV/m) vs Frequency (MHz) for Peak Vertical. The plot shows a signal level starting at approximately 105.3 dBuV/m at 2460 MHz, dropping to about 58.5 dBuV/m by 2475 MHz, and then fluctuating between 58.5 and 60 dBuV/m up to 2500 MHz. A red horizontal line indicates the FCC PART 15C limit at 60 dBuV/m.</p>
Average	 <p>Level (dBuV/m) vs Frequency (MHz) for Average Horizontal. The plot shows a signal level starting at approximately 93.6 dBuV/m at 2460 MHz, dropping to about 46.8 dBuV/m by 2475 MHz, and then fluctuating between 46.8 and 50 dBuV/m up to 2500 MHz. A red horizontal line indicates the FCC PART 15C (AVG) limit at 46.8 dBuV/m.</p>	 <p>Level (dBuV/m) vs Frequency (MHz) for Average Vertical. The plot shows a signal level starting at approximately 93.6 dBuV/m at 2460 MHz, dropping to about 46.8 dBuV/m by 2475 MHz, and then fluctuating between 46.8 and 50 dBuV/m up to 2500 MHz. A red horizontal line indicates the FCC PART 15C (AVG) limit at 46.8 dBuV/m.</p>

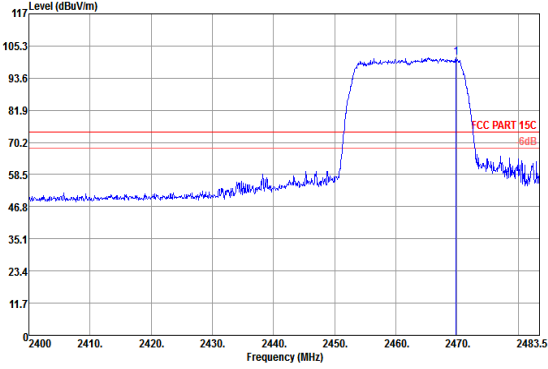
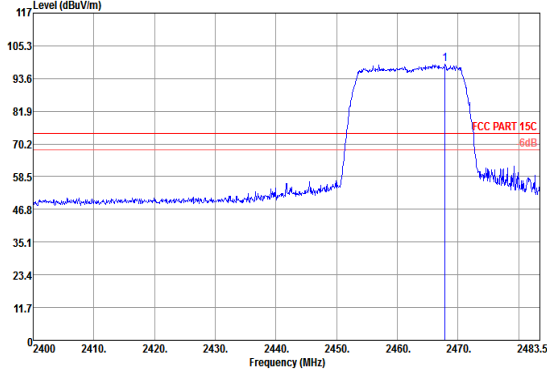
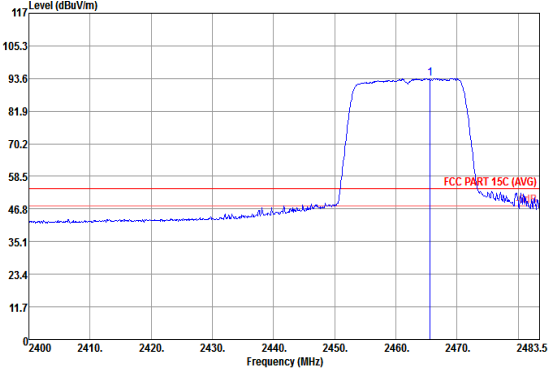
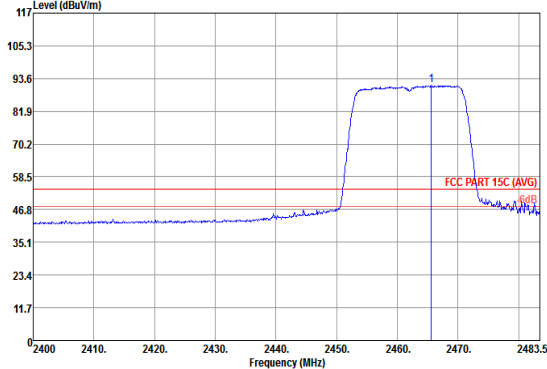

WIFI	2.4GHz 2400~2483.5MHz WIFI 802.11n HT20 (Fundamental Emission @ 3m)	
ANT	CH11 2462MHz	
1	Horizontal	Vertical
Peak		
Average		



WIFI	2.4GHz 2400~2483.5MHz WIFI 802.11n HT40 (Band Edge @ 3m)	
ANT	CH03 2422MHz	
1	Horizontal	Horizontal
Peak		
Average		
1	Vertical	Vertical
Peak		

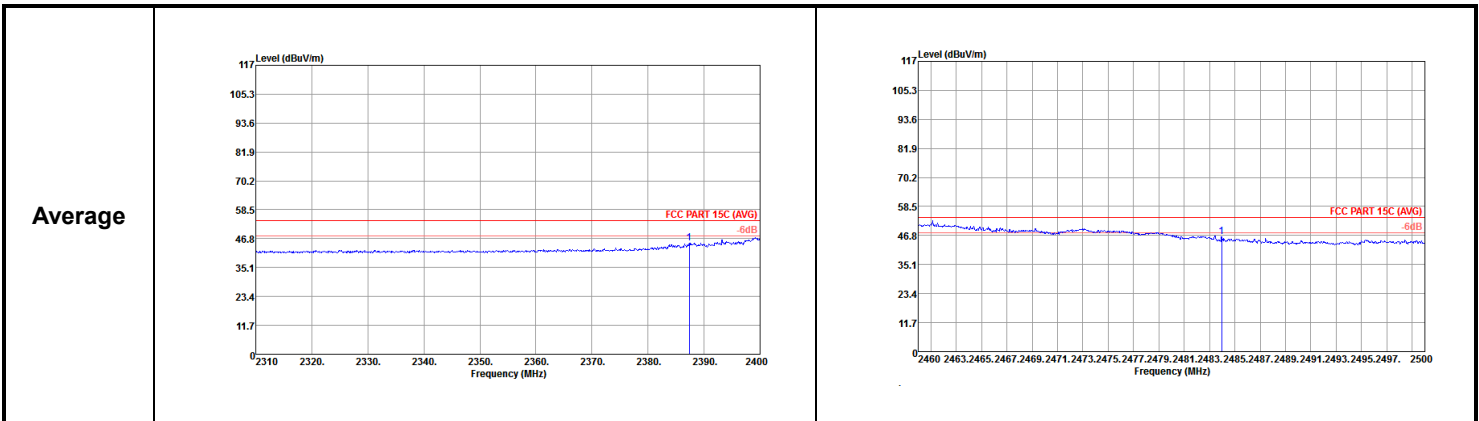

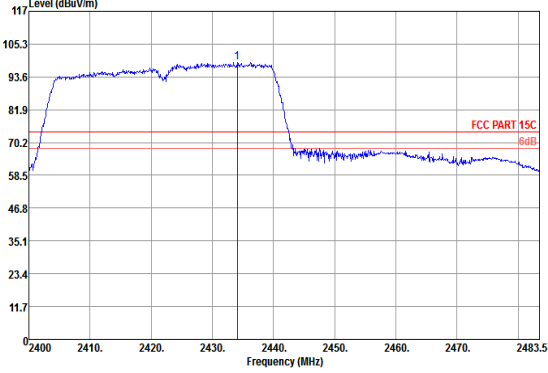
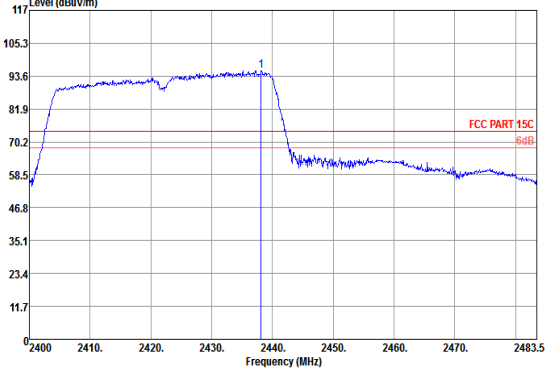
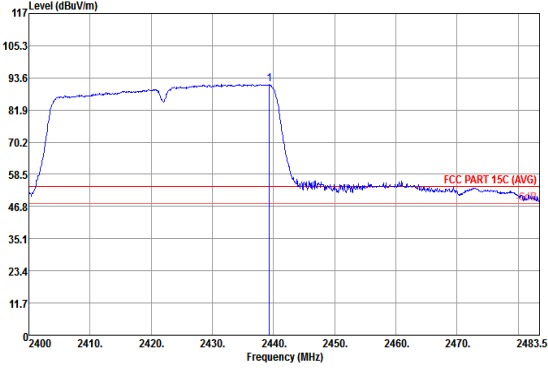
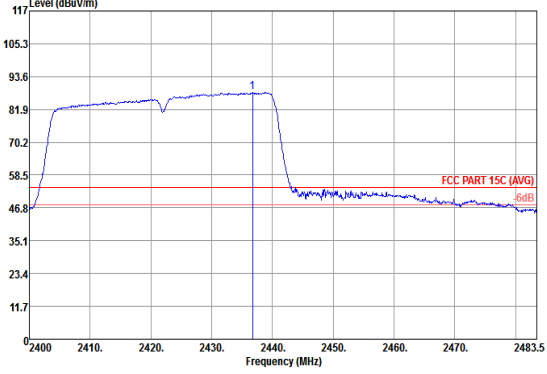

WIFI	2.4GHz 2400~2483.5MHz WIFI 802.11n HT40 (Fundamental Emission @ 3m)	
ANT	CH03 2422MHz	
1	Horizontal	Vertical
Peak		
Average		



WIFI	2.4GHz 2400~2483.5MHz WIFI 802.11 n HT40 (Band Edge @ 3m)	
ANT	CH06 2437MHz	
1	Horizontal	Horizontal
Peak		
Average		
1	Vertical	Vertical
Peak		

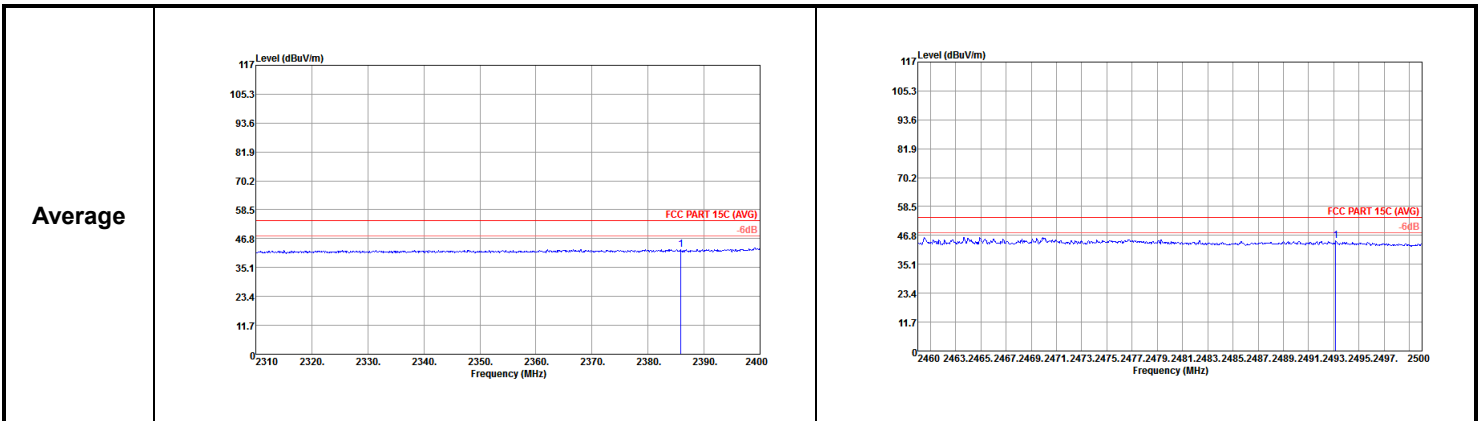

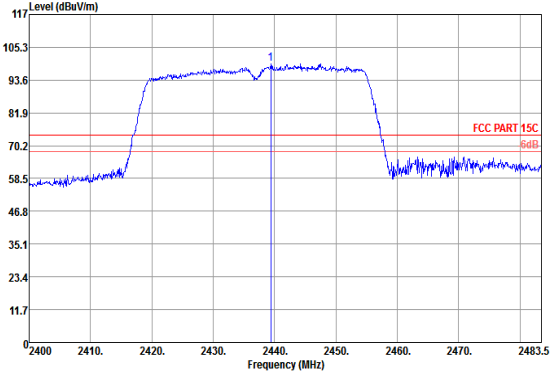
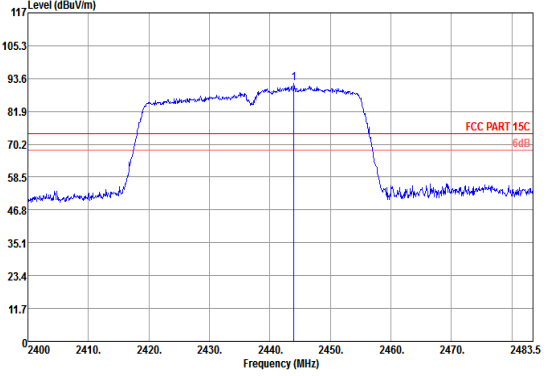
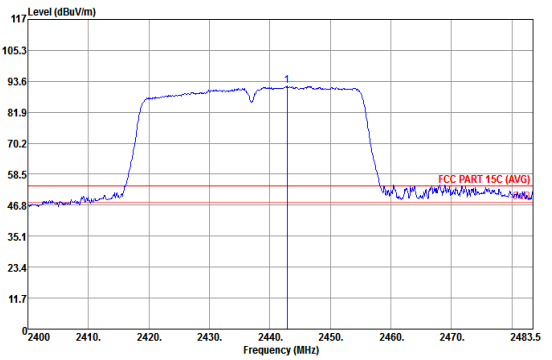
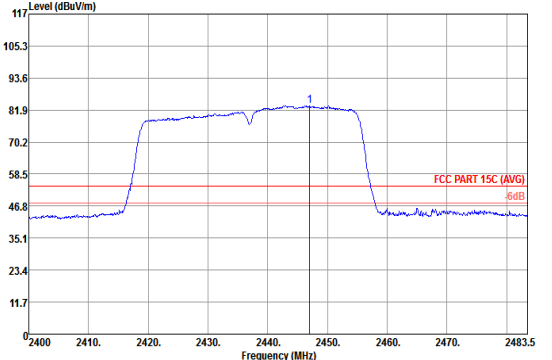

WIFI	2.4GHz 2400~2483.5MHz WIFI 802.11n HT40 (Fundamental Emission @ 3m)	
ANT	CH06 2437MHz	
1	Horizontal	Vertical
Peak		
Average		



WIFI	2.4GHz 2400~2483.5MHz WIFI 802.11 n HT40 (Band Edge @ 3m)	
ANT	CH09 2452MHz	
1	Horizontal	Horizontal
Peak		
Average		
1	Vertical	Vertical
Peak		

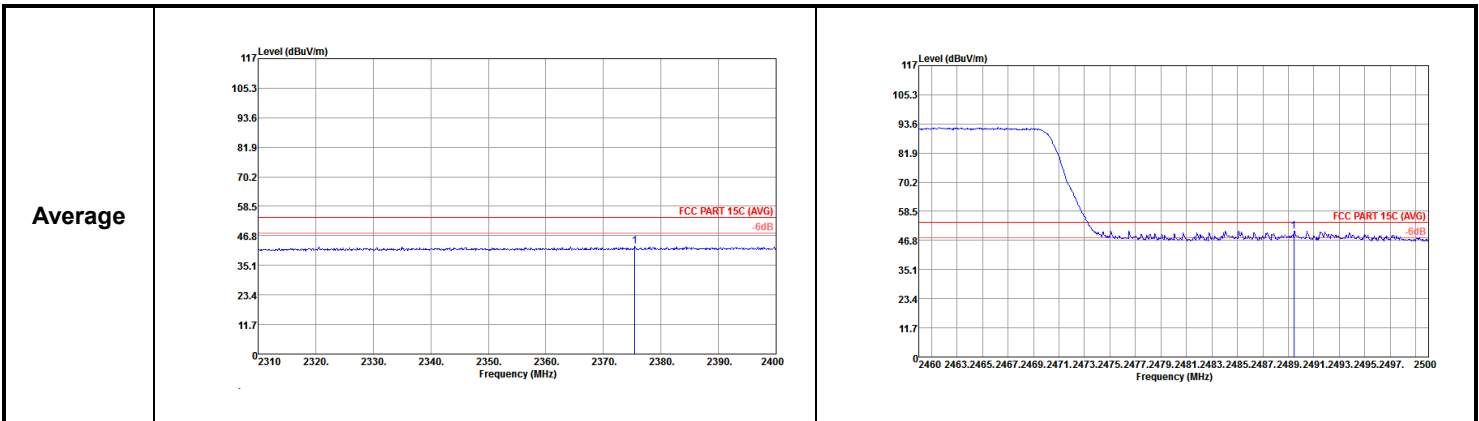

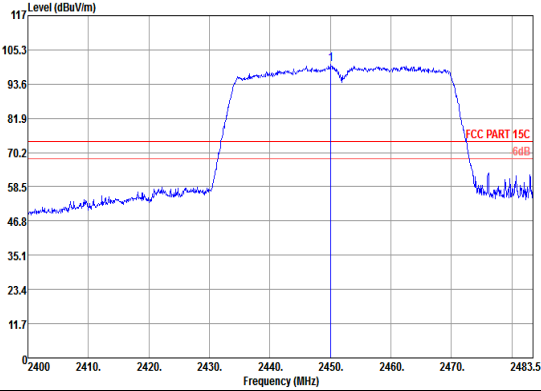
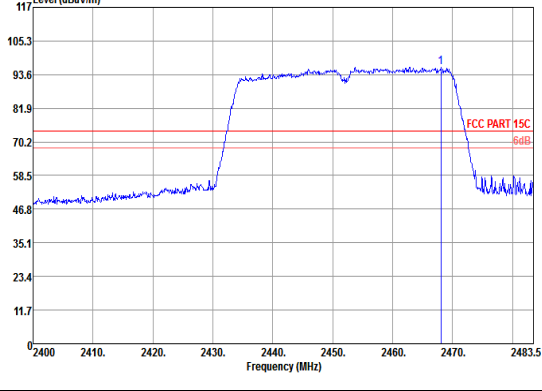
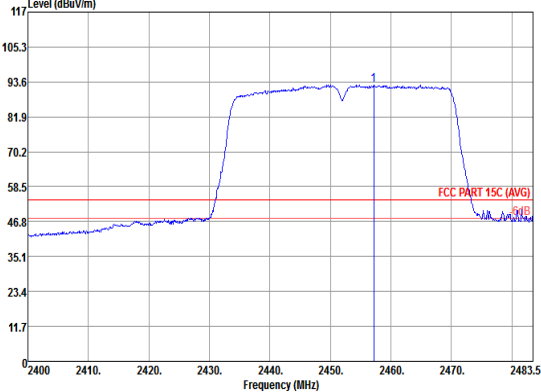
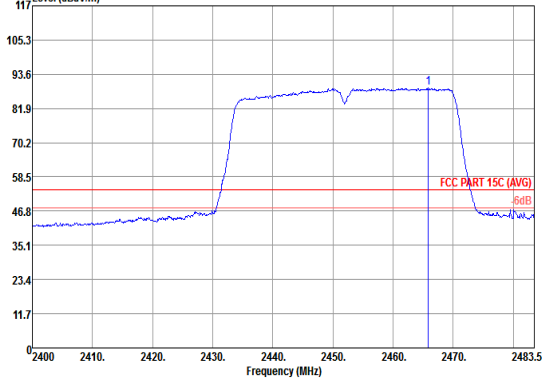

WIFI	2.4GHz 2400~2483.5MHz WIFI 802.11 n HT40 (Fundamental Emission @ 3m)	
ANT	CH09 2452MHz	
1	Horizontal	Vertical
Peak		
Average		



WIFI	2.4GHz 2400~2483.5MHz WIFI 802.11b (Harmonic @ 3m)	
ANT	CH01 2412MHz	
1	Horizontal	Vertical
Peak		
WIFI	2.4GHz 2400~2483.5MHz WIFI 802.11b (Harmonic @ 3m)	
ANT	CH06 2437MHz	
1	Horizontal	Vertical
Peak		
WIFI	2.4GHz 2400~2483.5MHz WIFI 802.11b (Harmonic @ 3m)	
ANT	CH11 2462MHz	
1	Horizontal	Vertical
Peak		



WIFI	2.4GHz 2400~2483.5MHz WIFI 802.11g (Harmonic @ 3m)	
ANT	CH01 2412MHz	
1	Horizontal	Vertical
Peak		
WIFI	2.4GHz 2400~2483.5MHz WIFI 802.11g (Harmonic @ 3m)	
ANT	CH02 2417MHz	
1	Horizontal	Vertical
Peak		
WIFI	2.4GHz 2400~2483.5MHz WIFI 802.11g (Harmonic @ 3m)	
ANT	CH06 2437MHz	
1	Horizontal	Vertical
Peak		



WIFI	2.4GHz 2400~2483.5MHz WIFI 802.11g (Harmonic @ 3m)	
ANT	CH10 2457MHz	
1	Horizontal	Vertical
Peak		
WIFI	2.4GHz 2400~2483.5MHz WIFI 802.11g (Harmonic @ 3m)	
ANT	CH11 2462MHz	
1	Horizontal	Vertical
Peak		



WIFI	2.4GHz 2400~2483.5MHz WIFI 802.11n HT20 (Harmonic @ 3m)	
ANT	CH01 2412MHz	
1	Horizontal	Vertical
Peak		
WIFI	2.4GHz 2400~2483.5MHz WIFI 802.11n HT20 (Harmonic @ 3m)	
ANT	CH06 2437MHz	
1	Horizontal	Vertical
Peak		
WIFI	2.4GHz 2400~2483.5MHz WIFI 802.11n HT20 (Harmonic @ 3m)	
ANT	CH11 2462MHz	
1	Horizontal	Vertical
Peak		



WIFI	2.4GHz 2400~2483.5MHz WIFI 802.11n HT40 (Harmonic @ 3m)	
ANT	CH03 2422MHz	
1	Horizontal	Vertical
Peak		
WIFI	2.4GHz 2400~2483.5MHz WIFI 802.11n HT40 (Harmonic @ 3m)	
ANT	CH06 2437MHz	
1	Horizontal	Vertical
Peak		
WIFI	2.4GHz 2400~2483.5MHz WIFI 802.11n HT40 (Harmonic @ 3m)	
ANT	CH09 2452MHz	
1	Horizontal	Vertical
Peak		

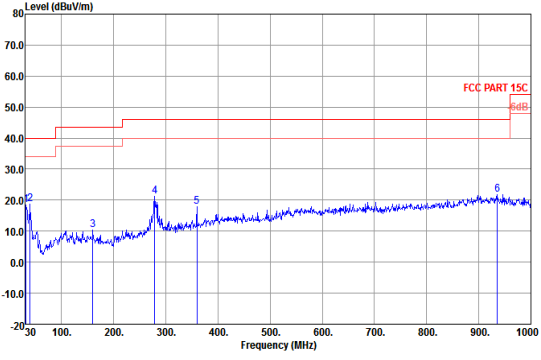
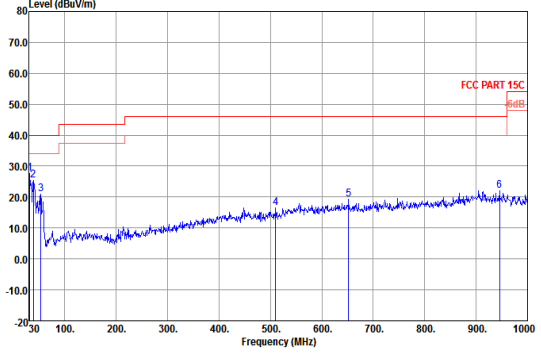

WIFI	Emission below 1GHz	
ANT	2.4GHz WIFI 802.11n HT40 (LF)	
1	Horizontal	Vertical
Peak		



2.4GHz 2400~2483.5MHz

WIFI 802.11b (Band Edge @ 3m)

WIFI	Note	Frequency	Level	Over	Limit	Read	Antenna	Cable	Preamp	Ant	Table	Peak	Pol.
Ant.				Limit	Line	Level	Factor	Loss	Factor	Pos	Pos	Avg.	
1		(MHz)	(dBμV/m)	(dB)	(dBμV/m)	(dBμV)	(dB/m)	(dB)	(dB)	(cm)	(deg)	(P/A)	(H/V)
802.11b CH 01 2412MHz		2339.25	51.38	-22.62	74	56.01	26.86	5.52	37.01	300	24	P	H
		2389.47	40.83	-13.17	54	45.26	27	5.59	37.02	300	24	A	H
	*	2413.444	98.44	-	-	102.7	27.13	5.61	37	300	24	P	H
	*	2413.36	95.95	-	-	100.21	27.13	5.61	37	300	24	A	H
		2389.02	52.04	-21.96	74	56.47	27	5.59	37.02	171	128	P	V
		2389.38	42	-12	54	46.43	27	5.59	37.02	171	128	A	V
	*	2413.444	100.86	-	-	105.12	27.13	5.61	37	171	128	P	V
	*	2413.36	98.3	-	-	102.56	27.13	5.61	37	171	128	A	V
802.11b CH 06 2437MHz	*	2438.493	102.6	-	-	106.53	27.39	5.65	36.97	296	38	P	H
	*	2438.41	100.05	-	-	103.98	27.39	5.65	36.97	296	38	A	H
	*	2438.326	105.19	-	-	109.12	27.39	5.65	36.97	100	185	P	V
	*	2438.493	102.62	-	-	106.55	27.39	5.65	36.97	100	185	A	V
802.11b CH 11 2462MHz	*	2463.376	103.4	-	-	107.18	27.51	5.67	36.96	202	31	P	H
	*	2463.293	100.82	-	-	104.6	27.51	5.67	36.96	202	31	A	H
		2487.2	53.87	-20.13	74	57.48	27.64	5.69	36.94	202	31	P	H
		2487.32	43.1	-10.9	54	46.71	27.64	5.69	36.94	202	31	A	H
	*	2463.46	103.85	-	-	107.63	27.51	5.67	36.96	100	188	P	V
	*	2463.376	101.29	-	-	105.07	27.51	5.67	36.96	100	188	A	V
		2487.88	54.43	-19.57	74	57.88	27.77	5.71	36.93	100	188	P	V
		2487.24	44.16	-9.84	54	47.77	27.64	5.69	36.94	100	188	A	V
Remark	<ol style="list-style-type: none"> No other spurious found. All results are PASS against Peak and Average limit line. 												



2.4GHz 2400~2483.5MHz
WIFI 802.11b (Harmonic @ 3m)

Table with 14 columns: WIFI Ant. 1, Note, Frequency (MHz), Level (dBµV/m), Over Limit (dB), Limit Line (dBµV/m), Read Level (dBµV), Antenna Factor (dB/m), Cable Loss (dB), Preamp Factor (dB), Ant Pos (cm), Table Pos (deg), Peak Avg. (P/A), Pol. (H/V). Rows include data for 802.11b CH 01 (2412MHz), CH 06 (2437MHz), and CH 11 (2462MHz).



2.4GHz 2400~2483.5MHz
WIFI 802.11g (Band Edge @ 3m)

Table with 14 columns: WIFI Ant. 1, Note, Frequency (MHz), Level (dBµV/m), Over Limit (dB), Limit Line (dBµV/m), Read Level (dBµV), Antenna Factor (dB/m), Cable Loss (dB), Preamp Factor (dB), Ant Pos (cm), Table Pos (deg), Peak Avg. (P/A), Pol. (H/V). Rows include data for 802.11g CH 01 (2412MHz) and CH 02 (2417MHz).



**2.4GHz 2400~2483.5MHz
WIFI 802.11g (Band Edge @ 3m)**

WIFI Ant. 1	Note	Frequency (MHz)	Level (dBμV/m)	Over Limit (dB)	Limit Line (dBμV/m)	Read Level (dBμV)	Antenna Factor (dB/m)	Cable Loss (dB)	Preamp Factor (dB)	Ant Pos (cm)	Table Pos (deg)	Peak Avg. (P/A)	Pol. (H/V)
802.11g CH 06 2437MHz	*	2438.243	103.89	-	-	107.82	27.39	5.65	36.97	165	235	P	H
	*	2436.072	96.51	-	-	100.61	27.26	5.63	36.99	165	235	A	H
	*	2438.159	100.51	-	-	104.44	27.39	5.65	36.97	364	97	P	V
	*	2438.243	93.14	-	-	97.07	27.39	5.65	36.97	364	97	A	V
802.11g CH 10 2457MHz	*	2458.951	105.87	-	-	109.65	27.51	5.67	36.96	163	231	P	H
	*	2458.533	98.72	-	-	102.5	27.51	5.67	36.96	163	231	A	H
		2483.76	61.8	-12.2	74	65.41	27.64	5.69	36.94	163	231	P	H
	!	2483.84	50.8	-3.2	54	54.41	27.64	5.69	36.94	163	231	A	H
	*	2455.695	100.7	-	-	104.48	27.51	5.67	36.96	397	93	P	V
	*	2458.032	93.71	-	-	97.49	27.51	5.67	36.96	397	93	A	V
		2484.64	58.32	-15.68	74	61.93	27.64	5.69	36.94	397	93	P	V
		2484.56	47.13	-6.87	54	50.74	27.64	5.69	36.94	397	93	A	V
802.11g CH 11 2462MHz	*	2465.046	102.62	-	-	106.4	27.51	5.67	36.96	107	31	P	H
	*	2464.796	94.73	-	-	98.51	27.51	5.67	36.96	107	31	A	H
		2483.8	59.08	-14.92	74	62.69	27.64	5.69	36.94	107	31	P	H
	!	2483.84	48.35	-5.65	54	51.96	27.64	5.69	36.94	107	31	A	H
	*	2463.293	97.49	-	-	101.27	27.51	5.67	36.96	100	28	P	V
	*	2463.209	89.19	-	-	92.97	27.51	5.67	36.96	100	28	A	V
		2483.68	53.71	-20.29	74	57.32	27.64	5.69	36.94	100	28	P	V
		2484.92	44.21	-9.79	54	47.82	27.64	5.69	36.94	100	28	A	V
Remark	1. No other spurious found. 2. All results are PASS against Peak and Average limit line.												



2.4GHz 2400~2483.5MHz
WIFI 802.11g (Harmonic @ 3m)

Table with 14 columns: WIFI Ant. 1, Note, Frequency (MHz), Level (dBµV/m), Over Limit (dB), Limit Line (dBµV/m), Read Level (dBµV), Antenna Factor (dB/m), Cable Loss (dB), Preamp Factor (dB), Ant Pos (cm), Table Pos (deg), Peak Avg. (P/A), Pol. (H/V). Rows include channels 01, 02, 06, 10, 11 with various frequency and level data.

Remark

- 1. No other spurious found.
2. All results are PASS against Peak and Average limit line.



**2.4GHz 2400~2483.5MHz
WIFI 802.11n HT20 (Band Edge @ 3m)**

WIFI Ant. 1	Note	Frequency (MHz)	Level (dBμV/m)	Over Limit (dB)	Limit Line (dBμV/m)	Read Level (dBμV)	Antenna Factor (dB/m)	Cable Loss (dB)	Preamp Factor (dB)	Ant Pos (cm)	Table Pos (deg)	Peak Avg. (P/A)	Pol. (H/V)
802.11n HT20 CH 01 2412MHz		2390	62.61	-11.39	74	67.04	27	5.59	37.02	326	198	P	H
	!	2389.65	49.53	-4.47	54	53.96	27	5.59	37.02	326	198	A	H
	*	2419.372	100.25	-	-	104.51	27.13	5.61	37	326	198	P	H
	*	2414.613	92.52	-	-	96.78	27.13	5.61	37	326	198	A	H
		2387.76	54.59	-19.41	74	59.02	27	5.59	37.02	100	22	P	V
		2388.39	44.4	-9.6	54	48.83	27	5.59	37.02	100	22	A	V
	*	2413.11	93.13	-	-	97.39	27.13	5.61	37	100	22	P	V
	*	2413.36	85.63	-	-	89.89	27.13	5.61	37	100	22	A	V
802.11n HT20 CH 06 2437MHz	*	2442.585	101.73	-	-	105.66	27.39	5.65	36.97	163	217	P	H
	*	2442.668	94.67	-	-	98.6	27.39	5.65	36.97	163	217	A	H
	*	2443.503	97.13	-	-	101.06	27.39	5.65	36.97	249	46	P	V
	*	2442.167	90.33	-	-	94.26	27.39	5.65	36.97	249	46	A	V
802.11n HT20 CH 11 2462MHz	*	2469.889	101.13	-	-	104.91	27.51	5.67	36.96	307	221	P	H
	*	2465.631	93.7	-	-	97.48	27.51	5.67	36.96	307	221	A	H
		2484.72	62	-12	74	65.61	27.64	5.69	36.94	307	221	P	H
	!	2483.92	50.01	-3.99	54	53.62	27.64	5.69	36.94	307	221	A	H
	*	2467.885	98.9	-	-	102.68	27.51	5.67	36.96	100	73	P	V
	*	2465.631	91.31	-	-	95.09	27.51	5.67	36.96	100	73	A	V
		2486.16	59.18	-14.82	74	62.79	27.64	5.69	36.94	100	73	P	V
	2485.24	47.67	-6.33	54	51.28	27.64	5.69	36.94	100	73	A	V	
Remark	1. No other spurious found. 2. All results are PASS against Peak and Average limit line.												



**2.4GHz 2400~2483.5MHz
WIFI 802.11n HT20 (Harmonic @ 3m)**

WIFI Ant. 1	Note	Frequency (MHz)	Level (dBμV/m)	Over Limit (dB)	Limit Line (dBμV/m)	Read Level (dBμV)	Antenna Factor (dB/m)	Cable Loss (dB)	Preamp Factor (dB)	Ant Pos (cm)	Table Pos (deg)	Peak Avg. (P/A)	Pol. (H/V)
802.11n HT20 CH 01 2412MHz		4824	42.97	-31.03	74	40.29	31.51	7.85	36.68	128	317	P	H
		4824	44.17	-29.83	74	41.49	31.51	7.85	36.68	162	219	P	V
802.11n HT20 CH 06 2437MHz		4875	42.31	-31.69	74	39.49	31.59	7.89	36.66	100	360	P	H
		7311	45.91	-28.09	74	38.99	34.03	9.58	36.69	100	0	P	H
		4875	42.08	-31.92	74	39.26	31.59	7.89	36.66	100	360	P	V
		7311	45.45	-28.55	74	38.53	34.03	9.58	36.69	100	0	P	V
802.11n HT20 CH 11 2462MHz		4924	42.54	-31.46	74	39.6	31.67	7.92	36.65	164	81	P	H
		7386	44.51	-29.49	74	37.24	34.29	9.76	36.78	259	133	P	H
		4923	43.58	-30.42	74	40.64	31.67	7.92	36.65	138	274	P	V
		7386	45.07	-28.93	74	37.8	34.29	9.76	36.78	128	197	P	V
Remark	1. No other spurious found. 2. All results are PASS against Peak and Average limit line.												



**2.4GHz 2400~2483.5MHz
WIFI 802.11n HT40 (Band Edge @ 3m)**

WIFI Ant. 1	Note	Frequency (MHz)	Level (dBμV/m)	Over Limit (dB)	Limit Line (dBμV/m)	Read Level (dBμV)	Antenna Factor (dB/m)	Cable Loss (dB)	Preamp Factor (dB)	Ant Pos (cm)	Table Pos (deg)	Peak Avg. (P/A)	Pol. (H/V)
802.11n HT40 CH 03 2422MHz		2388.66	61.53	-12.47	74	65.96	27	5.59	37.02	100	235	P	H
	!	2388.75	49.49	-4.51	54	53.92	27	5.59	37.02	100	235	A	H
	*	2434.068	98.84	-	-	102.94	27.26	5.63	36.99	100	235	P	H
	*	2439.329	91.24	-	-	95.17	27.39	5.65	36.97	100	235	A	H
		2483.72	62.09	-11.91	74	65.7	27.64	5.69	36.94	100	235	P	H
	!	2484.2	50.01	-3.99	54	53.62	27.64	5.69	36.94	100	235	A	H
		2388.66	56.03	-17.97	74	60.46	27	5.59	37.02	371	84	P	V
		2387.4	44.97	-9.03	54	49.4	27	5.59	37.02	371	84	A	V
	*	2438.159	95.63	-	-	99.56	27.39	5.65	36.97	371	84	P	V
	*	2436.74	87.92	-	-	91.85	27.39	5.65	36.97	371	84	A	V
		2483.64	57.31	-16.69	74	60.92	27.64	5.69	36.94	371	84	P	V
		2483.96	46.31	-7.69	54	49.92	27.64	5.69	36.94	371	84	A	V
802.11n HT40 CH 06 2437MHz		2390	53.51	-20.49	74	57.94	27	5.59	37.02	100	235	P	H
		2390	43.22	-10.78	54	47.65	27	5.59	37.02	100	235	A	H
	*	2439.412	99.54	-	-	103.47	27.39	5.65	36.97	100	235	P	H
	*	2442.835	91.79	-	-	95.72	27.39	5.65	36.97	100	235	A	H
		2484.2	63.09	-10.91	74	66.7	27.64	5.69	36.94	100	235	P	H
	!	2483.76	51.82	-2.18	54	55.43	27.64	5.69	36.94	100	235	A	H
		2355.81	51.21	-22.79	74	55.78	26.91	5.54	37.02	100	156	P	V
		2385.87	42.49	-11.51	54	46.92	27	5.59	37.02	100	156	A	V
	*	2444.004	91.85	-	-	95.78	27.39	5.65	36.97	100	156	P	V
	*	2447.01	83.52	-	-	87.45	27.39	5.65	36.97	100	156	A	V
	2489.8	55.54	-18.46	74	58.99	27.77	5.71	36.93	100	156	P	V	
	2493.16	44.56	-9.44	54	48.01	27.77	5.71	36.93	100	156	A	V	



802.11n HT40 CH 09 2452MHz		2364.99	51.08	-22.92	74	55.65	26.91	5.54	37.02	114	56	P	H
		2377.5	42.55	-11.45	54	47.05	26.95	5.57	37.02	114	56	A	H
	*	2450.1	100.24	-	-	104.17	27.39	5.65	36.97	114	56	P	H
	*	2457.198	92.52	-	-	96.3	27.51	5.67	36.96	114	56	A	H
		2484.12	63.64	-10.36	74	67.25	27.64	5.69	36.94	114	56	P	H
	!	2489.44	50.63	-3.37	54	54.08	27.77	5.71	36.93	114	56	A	H
		2344.92	51	-23	74	55.63	26.86	5.52	37.01	368	94	P	V
		2375.43	42.67	-11.33	54	47.17	26.95	5.57	37.02	368	94	A	V
	*	2468.052	96.11	-	-	99.89	27.51	5.67	36.96	368	94	P	V
	*	2465.882	88.91	-	-	92.69	27.51	5.67	36.96	368	94	A	V
		2490.04	58.68	-15.32	74	62.13	27.77	5.71	36.93	368	94	P	V
		2483.96	46.33	-7.67	54	49.94	27.64	5.69	36.94	368	94	A	V
Remark	1. No other spurious found. 2. All results are PASS against Peak and Average limit line.												



2.4GHz 2400~2483.5MHz
WIFI 802.11n HT40 (Harmonic @ 3m)

Table with 14 columns: WIFI Ant. 1, Note, Frequency (MHz), Level (dBµV/m), Over Limit (dB), Limit Line (dBµV/m), Read Level (dBµV), Antenna Factor (dB/m), Cable Loss (dB), Preamp Factor (dB), Ant Pos (cm), Table Pos (deg), Peak Avg. (P/A), Pol. (H/V). Rows include data for 802.11n HT40 CH 03 (2422MHz) and CH 06 (2437MHz), and 802.11n HT40 CH 09 (2452MHz).

Remark

- 1. No other spurious found.
2. All results are PASS against Peak and Average limit line.



Emission below 1GHz

2.4GHz WIFI 802.11n HT40 (LF)

WIFI	Note	Frequency	Level	Over	Limit	Read	Antenna	Cable	Preamp	Ant	Table	Peak	Pol.
Ant.				Limit	Line	Level	Factor	Loss	Factor	Pos	Pos	Avg.	
1		(MHz)	(dBμV/m)	(dB)	(dBμV/m)	(dBμV)	(dB/m)	(dB)	(dB)	(cm)	(deg)	(P/A)	(H/V)
2.4GHz 802.11n HT40 LF		31.94	18.4	-21.6	40	31.94	18.22	0.79	32.55	-	-	P	H
		39.7	18.65	-21.35	40	36.12	14.3	0.79	32.56	100	214	P	H
		159.98	10.49	-33.01	43.5	30.13	11.33	1.44	32.41	-	-	P	H
		278.32	21.29	-24.71	46	38.89	12.61	1.9	32.11	-	-	P	H
		359.8	17.83	-28.17	46	32.67	15.29	2.15	32.28	-	-	P	H
		935.98	21.88	-24.12	46	27.84	21.9	3.57	31.43	-	-	P	H
		31.94	27.58	-12.42	40	41.12	18.22	0.79	32.55	100	219	P	V
		38.73	25.43	-14.57	40	42.39	14.79	0.79	32.54	-	-	P	V
		53.28	21.08	-18.92	40	44.92	7.92	0.79	32.55	-	-	P	V
		510.15	16.41	-29.59	46	28.42	17.45	2.64	32.1	-	-	P	V
		651.77	19.39	-26.61	46	28.69	19.42	2.92	31.64	-	-	P	V
	945.68	22.06	-23.94	46	28.07	21.69	3.68	31.38	-	-	P	V	
Remark	1. No other spurious found. 2. All results are PASS against limit line.												



Note symbol

*	Fundamental Frequency which can be ignored. However, the level of any unwanted emissions shall not exceed the level of the fundamental frequency.
!	Test result is over limit line.
P/A	Peak or Average
H/V	Horizontal or Vertical



A calculation example for radiated spurious emission is shown as below:

WIFI	Note	Frequency	Level	Over	Limit	Read	Antenna	Cable	Preamp	Ant	Table	Peak	Pol.
Ant.				Limit	Line	Level	Factor	Loss	Factor	Pos	Pos	Avg.	
1		(MHz)	(dBμV/m)	(dB)	(dBμV/m)	(dBμV)	(dB/m)	(dB)	(dB)	(cm)	(deg)	(P/A)	(H/V)
802.11b		2390	55.45	-18.55	74	54.51	32.22	4.58	35.86	103	308	P	H
CH 01													
2412MHz		2390	43.54	-10.46	54	42.6	32.22	4.58	35.86	103	308	A	H

- Level(dBμV/m) =
Antenna Factor(dB/m) + Cable Loss(dB) + Read Level(dBμV) - Preamp Factor(dB)
- Over Limit(dB) = Level(dBμV/m) – Limit Line(dBμV/m)

For Peak Limit @ 2390MHz:

- Level(dBμV/m)
= Antenna Factor(dB/m) + Cable Loss(dB) + Read Level(dBμV) - Preamp Factor(dB)
= 32.22(dB/m) + 4.58(dB) + 54.51(dBμV) – 35.86 (dB)
= 55.45 (dBμV/m)
- Over Limit(dB)
= Level(dBμV/m) – Limit Line(dBμV/m)
= 55.45(dBμV/m) – 74(dBμV/m)
= -18.55(dB)

For Average Limit @ 2390MHz:

- Level(dBμV/m)
= Antenna Factor(dB/m) + Cable Loss(dB) + Read Level(dBμV) - Preamp Factor(dB)
= 32.22(dB/m) + 4.58(dB) + 42.6(dBμV) – 35.86 (dB)
= 43.54 (dBμV/m)
- Over Limit(dB)
= Level(dBμV/m) – Limit Line(dBμV/m)
= 43.54(dBμV/m) – 54(dBμV/m)
= -10.46(dB)

Both peak and average measured complies with the limit line, so test result is “PASS”.