



# FCC Test Report

**APPLICANT** : LG Electronics Mobile Comm USA  
**EQUIPMENT** : Smart phone  
**BRAND NAME** : LG  
**MODEL NAME** : LG-X220g  
**FCC ID** : ZNFX220G  
**STANDARD** : FCC 47 CFR FCC Part 15 Subpart B  
**CLASSIFICATION** : Certification

The product was received on Dec. 03, 2015 and testing was completed on Dec. 09, 2015. We, SPORTON INTERNATIONAL (KUNSHAN) INC., would like to declare that the tested sample has been evaluated in accordance with the test procedures given in ANSI C63.4-2009 and has been in compliance with the applicable technical standards.

The test results in this report apply exclusively to the tested model / sample. Without written approval of SPORTON INTERNATIONAL (KUNSHAN) INC., the test report shall not be reproduced except in full.

Prepared by: James Huang / Manager

Approved by: Jones Tsai / Manager



**SPORTON INTERNATIONAL (KUNSHAN) INC.**  
No. 3-2, PingXiang Road, Kunshan, Jiangsu Province, P. R. China



## TABLE OF CONTENTS

REVISION HISTORY.....	3
SUMMARY OF TEST RESULT .....	4
1. GENERAL DESCRIPTION .....	5
1.1. Applicant.....	5
1.2. Manufacturer .....	5
1.3. Product Feature of Equipment Under Test .....	5
1.4. Product Specification of Equipment Under Test .....	6
1.5. Modification of EUT .....	6
1.6. Test Location .....	7
1.7. Applicable Standards .....	7
2. TEST CONFIGURATION OF EQUIPMENT UNDER TEST.....	8
2.1. Test Mode .....	8
2.2. Connection Diagram of Test System .....	10
2.3. Support Unit used in test configuration and system.....	11
2.4. EUT Operation Test Setup .....	11
3. TEST RESULT.....	12
3.1. Test of AC Conducted Emission Measurement .....	12
3.2. Test of Radiated Emission Measurement .....	20
4. LIST OF MEASURING EQUIPMENT .....	26
5. UNCERTAINTY OF EVALUATION .....	27





### SUMMARY OF TEST RESULT

Report Section	FCC Rule	Description	Limit	Result	Remark
3.1	15.107	AC Conducted Emission	< 15.107 limits	PASS	Under limit 7.15 dB at 3.940 MHz
3.2	15.109	Radiated Emission	< 15.109 limits	PASS	Under limit 6.97 dB at 42.960 MHz for Quasi-Peak



# 1. General Description

## 1.1. Applicant

**LG Electronics Mobile Comm USA**  
1000 Sylvan Avenue Englewood Cliffs, NJ 07632

## 1.2. Manufacturer

**Arima Communications Corp.**  
6F, No.866,Jhongjheng Rd., Jhonghe Dist., New Taipei City 23586, Taiwan

## 1.3. Product Feature of Equipment Under Test

Product Feature	
<b>Equipment</b>	Smart phone
<b>Brand Name</b>	LG
<b>Model Name</b>	LG-X220g
<b>FCC ID</b>	ZNFX220G
<b>EUT supports Radios application</b>	GSM/GPRS/EGPRS(Downlink Only)/WCDMA/HSPA/ HSPA+(16QAM uplink is not supported)/ WLAN 2.4GHz 802.11b/g/n HT20/HT40/ Bluetooth v3.0 + EDR/Bluetooth v4.0 LE
<b>IMEI Code</b>	Conduction: 353468062997145 Radiation: 353468062997137
<b>HW Version</b>	5542MB-003
<b>SW Version</b>	LGX220g-00-V08a-334-20-NOV-11-2015+0
<b>EUT Stage</b>	Production Unit

**Remark:** The above EUT's information was declared by manufacturer. Please refer to the specifications or user's manual for more detailed description.



### 1.4. Product Specification of Equipment Under Test

Standards-related Product Specification	
<b>Tx Frequency</b>	GSM850 : 824.2 MHz ~ 848.8 MHz GSM1900 : 1850.2 MHz ~ 1909.8MHz WCDMA Band V : 826.4 MHz ~ 846.6 MHz WCDMA Band II : 1852.4 MHz ~ 1907.6 MHz 802.11b/g/n: 2412 MHz ~ 2462 MHz Bluetooth: 2402 MHz ~ 2480 MHz
<b>Rx Frequency</b>	GSM850 : 869.2 MHz ~ 893.8 MHz GSM1900 : 1930.2 MHz ~ 1989.8 MHz WCDMA Band V : 871.4 MHz ~ 891.6 MHz WCDMA Band II : 1932.4 MHz ~ 1987.6 MHz 802.11b/g/n: 2412 MHz ~ 2462 MHz Bluetooth: 2402 MHz ~ 2480 MHz GPS : 1.57542 GHz
<b>Antenna Type</b>	WWAN : IFA Antenna WLAN : IFA Antenna Bluetooth : IFA Antenna GPS: IFA Antenna
<b>Type of Modulation</b>	GSM: GMSK GPRS: GMSK EDGE(MCS 0-4): GMSK/(MCS 5-9): 8PSK(Downlink Only) WCDMA: QPSK (Uplink) HSDPA: QPSK (Uplink) HSUPA: QPSK (Uplink) HSPA+: 16QAM (16QAM uplink is not supported) 802.11b : DSSS (DBPSK / DQPSK / CCK) 802.11g/n : OFDM (BPSK / QPSK / 16QAM / 64QAM) Bluetooth LE : GFSK Bluetooth (1Mbps) : GFSK Bluetooth (2Mbps) : $\pi/4$ -DQPSK Bluetooth (3Mbps) : 8-DPSK GPS : BPSK

### 1.5. Modification of EUT

No modifications are made to the EUT during all test items.



### 1.6. Test Location

Test Site	SPORTON INTERNATIONAL (KUNSHAN) INC.		
Test Site Location	No. 3-2, PingXiang Road, Kunshan, Jiangsu Province, P. R. China TEL: +86-0512-5790-0158 FAX: +86-0512-5790-0958		
Test Site No.	Sporton Site No.		FCC Registration No.
	CO01-KS	03CH02-KS	418269

### 1.7. Applicable Standards

According to the specifications of the manufacturer, the EUT must comply with the requirements of the following standards:

- ♦ FCC 47 CFR FCC Part 15 Subpart B
- ♦ ANSI C63.4-2009

**Remark:** All test items were verified and recorded according to the standards and without any deviation during the test.



## 2. Test Configuration of Equipment Under Test

### 2.1. Test Mode

The EUT has been associated with peripherals pursuant to ANSI C63.4-2009 and configuration operated in a manner tended to maximize its emission characteristics in a typical application.

Frequency range investigated: conduction (150 kHz to 30 MHz), radiation (30MHz to the 5th harmonic of the highest fundamental frequency or to 40 GHz, whichever is lower).

The following tables are showing the test modes as the worst cases and recorded in this report.

Item	EUT Configuration	Test Condition		
		EMI AC	EMI RE<1G	EMI RE≥1G
1.	Charging Mode (EUT with adapter)	☒	☒	☒
2.	Data application transferred mode (EUT connected with notebook)	☒	☒	☒

**Abbreviations:**

- EMI AC: AC conducted emissions
- EMI RE ≥ 1G: EUT radiated emissions ≥ 1GHz
- EMI RE < 1G: EUT radiated emissions < 1GHz





Test Items	EUT Configure Mode	Function Type
AC Conducted Emission	1/2	Mode 1: GSM850 Idle + Bluetooth Idle + WLAN Idle + USB Cable (Charging from Adapter) + Earphone + Camera(Rear) <Fig. 1> Mode 2: GSM1900 Idle + Bluetooth Idle + WLAN Idle + USB Cable (Charging from Adapter) + Earphone + Camera(Front) <Fig. 1> Mode 3: WCDMA Band V Idle + Bluetooth Idle + WLAN Idle + USB Cable (Charging from Adapter) + Earphone + MPEG4 <Fig. 1> Mode 4: WCDMA Band II Idle + Bluetooth Idle + WLAN Idle + USB Cable (Data Link with Notebook) + Earphone + GPS Rx<Fig. 2>
Radiated Emissions < 1GHz	1/2	Mode 1: GSM850 Idle + Bluetooth Idle + WLAN Idle + USB Cable (Charging from Adapter) + Earphone + Camera(Rear) <Fig. 1> Mode 2: GSM1900 Idle + Bluetooth Idle + WLAN Idle + USB Cable (Charging from Adapter) + Earphone + Camera(Front) <Fig. 1> Mode 3: WCDMA Band V Idle + Bluetooth Idle + WLAN Idle + USB Cable (Charging from Adapter) + Earphone + MPEG4<Fig. 1> Mode 4: WCDMA Band II Idle + Bluetooth Idle + WLAN Idle + USB Cable (Data Link with Notebook) + Earphone + GPS Rx<Fig. 2>
Radiated Emissions ≥ 1GHz	1/2	Mode 1: WCDMA Band V Idle + Bluetooth Idle + WLAN Idle + USB Cable (Charging from Adapter) + Earphone + MPEG4 <Fig. 1> Mode 2: WCDMA Band II Idle + Bluetooth Idle + WLAN Idle + USB Cable (Data Link with Notebook) + Earphone + GPS Rx<Fig. 2>
<b>Remark:</b> <ol style="list-style-type: none"> <li>The worst case of AC is mode 2; and the USB Link mode of AC is mode 4, the test data of these modes were reported.</li> <li>The worst case of RE &lt; 1G is mode 3; and the USB Link mode of RE is mode 4, the test data of these modes were reported.</li> <li>Data Link with Notebook means data application transferred mode between EUT and Notebook.</li> </ol>		

## 2.2. Connection Diagram of Test System

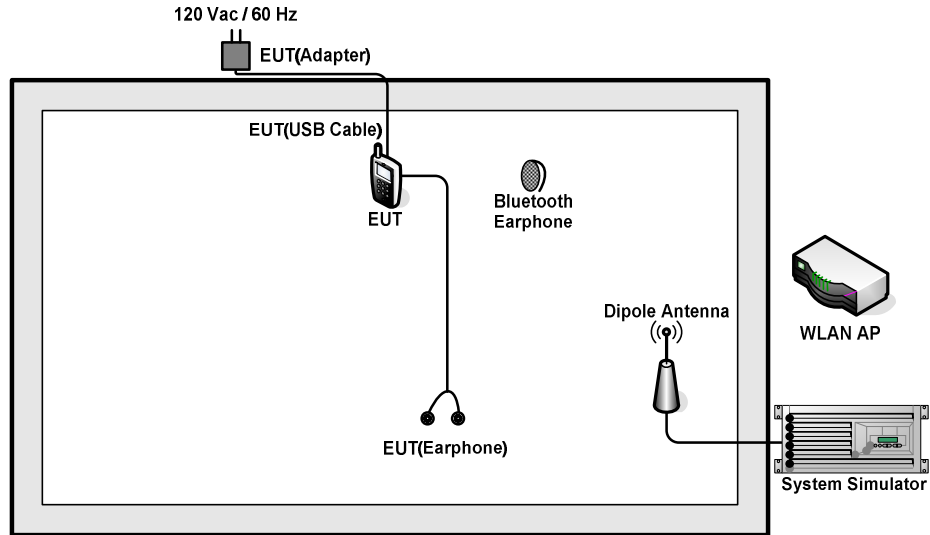

<Fig.1>

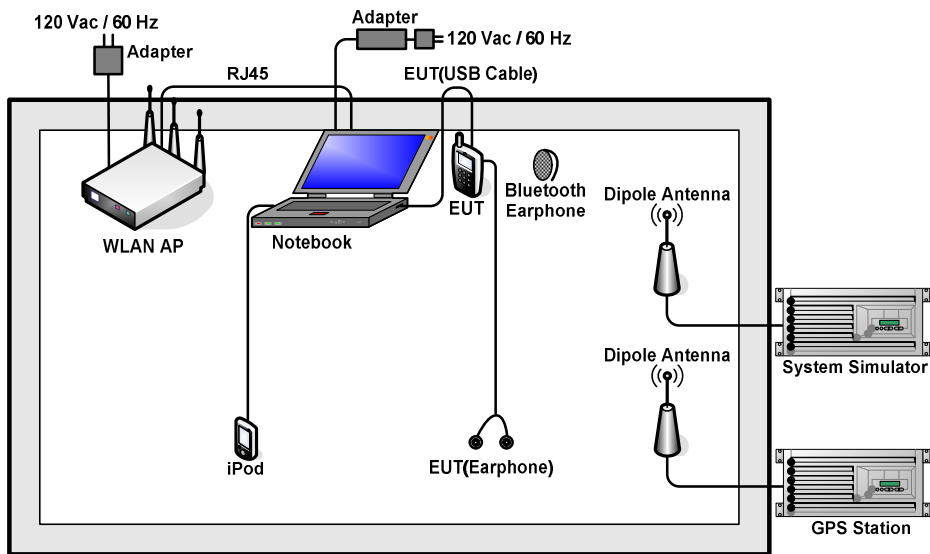

<Fig.2>

### 2.3. Support Unit used in test configuration and system

Item	Equipment	Trade Name	Model Name	FCC ID	Data Cable	Power Cord
1.	System Simulator	R&S	CMU200	N/A	N/A	Unshielded, 1.8 m
2.	GPS Station	ADIVIC	MP9000	N/A	N/A	Unshielded, 1.8 m
3.	Notebook	Lenovo	G480	N/A	N/A	AC I/P: Unshielded, 1.8 m DC O/P: Shielded, 1.8 m
4.	Bluetooth Earphone	Nokia	BH-102	PYAHS-107W	N/A	N/A
5.	WLAN AP	D-Link	DIR-855	KA2DIR855A2	N/A	Unshielded, 1.8 m
6.	WLAN AP	LINKSYS	WRT600N	Q87-WRT600NV11	N/A	Unshielded, 1.8 m
7.	iPod	Apple	A1199	FCC DoC	Shielded, 1.2 m	N/A
8.	SD Card	Kingston	4GB	N/A	N/A	N/A

### 2.4. EUT Operation Test Setup

The EUT was in GSM or WCDMA idle mode during the testing. The EUT was synchronized to the BCCH, and was in continuous receiving mode by setting system simulator's paging reorganization.

At the same time, the EUT was attached to the Bluetooth earphone or WLAN AP, and the following programs installed in the EUT were programmed during the test.

1. Data application is transferred between Notebook and EUT via USB cable.
2. Execute "Video Player" to play MPEG4 files.
3. Turn on camera to capture images.
4. Turn on GPS function to make the EUT receive continuous signals from GPS station.

### 3. Test Result

#### 3.1. Test of AC Conducted Emission Measurement

##### 3.1.1 Limits of AC Conducted Emission

For equipment that is designed to be connected to the public utility (AC) power line, the radio frequency voltage that is conducted back onto the AC power line on any frequency or frequencies within the band 150 kHz to 30 MHz shall not exceed the limits in the following table.

Frequency of emission (MHz)	Conducted limit (dBuV)	
	Quasi-peak	Average
0.15-0.5	66 to 56*	56 to 46*
0.5-5	56	46
5-30	60	50

\*Decreases with the logarithm of the frequency.

##### 3.1.2 Measuring Instruments

The measuring equipment is listed in the section 4 of this test report.

##### 3.1.3 Test Procedure

1. The EUT was placed 0.4 meter from the conducting wall of the shielding room was kept at least 80 centimeters from any other grounded conducting surface.
2. Connect EUT to the power mains through a line impedance stabilization network (LISN).
3. All the support units are connecting to the other LISN.
4. The LISN provides 50 ohm coupling impedance for the measuring instrument.
5. The FCC states that a 50 ohm, 50 microhenry LISN should be used.
6. Both sides of AC line were checked for maximum conducted interference.
7. The frequency range from 150 kHz to 30 MHz was searched.
8. Set the test-receiver system to Peak Detect Function and specified bandwidth (IF Bandwidth = 9kHz) with Maximum Hold Mode. Then measurement is also conducted by Average Detector and Quasi-Peak Detector Function respectively.

### 3.1.4 Test Setup

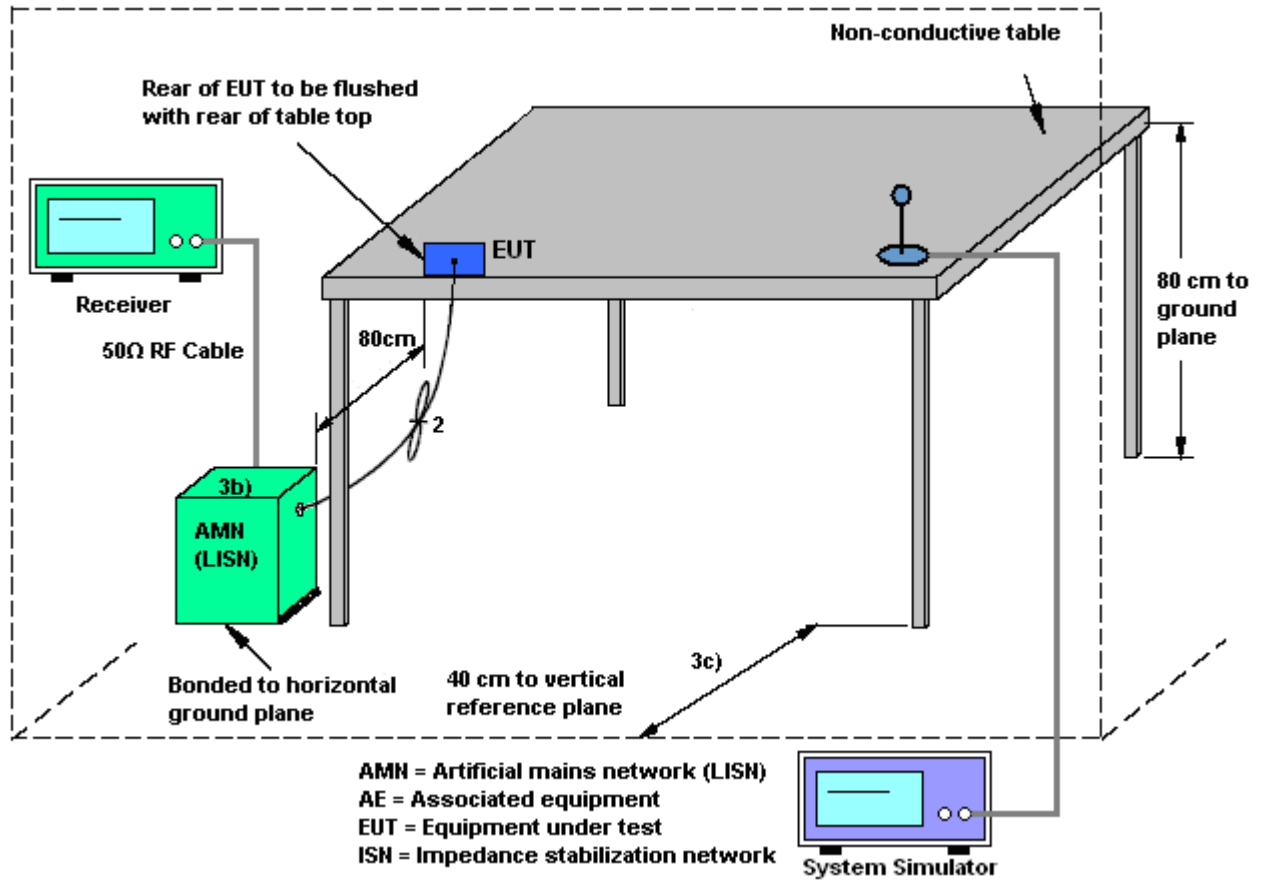



3.1.5 Test Result of AC Conducted Emission

Test Mode :	Mode 2	Temperature :	22~24°C
Test Engineer :	Amos Zhang	Relative Humidity :	43~45%
Test Voltage :	120Vac / 60Hz	Phase :	Line
Function Type :	GSM1900 Idle + Bluetooth Idle + WLAN Idle + USB Cable (Charging from Adapter) + Earphone + Camera(Front)		

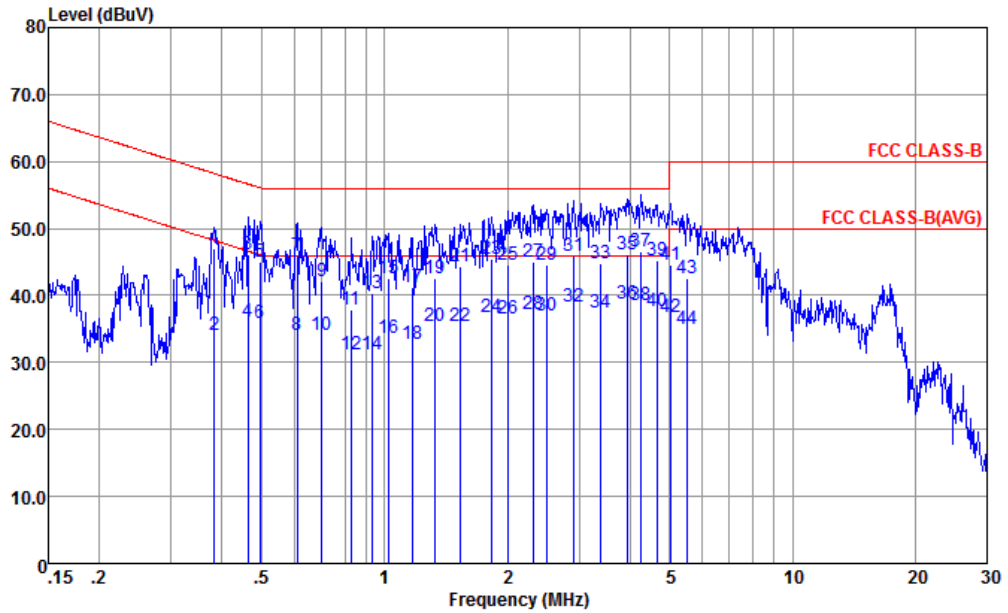

Site : CO01-kS  
 Condition : FCC CLASS-B LISN-L-20151024 LINE  
 mode : Mode 2

	Freq	Level	Over Limit	Limit Line	Read Level	LISN Factor	Cable Loss	Remark
	MHz	dBuV	dB	dBuV	dBuV	dB	dB	
1	0.38	47.00	-11.21	58.21	36.60	0.23	10.17	QP
2	0.38	34.00	-14.21	48.21	23.60	0.23	10.17	Average
3	0.46	46.09	-10.54	56.63	35.70	0.23	10.16	QP
4	0.46	35.99	-10.64	46.63	25.60	0.23	10.16	Average
5	0.49	44.99	-11.11	56.10	34.60	0.23	10.16	QP
6	0.49	35.89	-10.21	46.10	25.50	0.23	10.16	Average
7	0.61	45.99	-10.01	56.00	35.59	0.24	10.16	QP
8	0.61	33.99	-12.01	46.00	23.59	0.24	10.16	Average
9	0.70	42.19	-13.81	56.00	31.80	0.24	10.15	QP
10	0.70	33.99	-12.01	46.00	23.60	0.24	10.15	Average
11	0.83	37.99	-18.01	56.00	27.61	0.24	10.14	QP
12	0.83	31.19	-14.81	46.00	20.81	0.24	10.14	Average
13	0.93	40.29	-15.71	56.00	29.90	0.25	10.14	QP
14	0.93	31.29	-14.71	46.00	20.90	0.25	10.14	Average
15	1.02	42.48	-13.52	56.00	32.09	0.25	10.14	QP
16	1.02	33.68	-12.32	46.00	23.29	0.25	10.14	Average
17	1.17	41.27	-14.73	56.00	30.90	0.23	10.14	QP



Test Mode :	Mode 2	Temperature :	22~24°C
Test Engineer :	Amos Zhang	Relative Humidity :	43~45%
Test Voltage :	120Vac / 60Hz	Phase :	Line
Function Type :	GSM1900 Idle + Bluetooth Idle + WLAN Idle + USB Cable (Charging from Adapter) + Earphone + Camera(Front)		

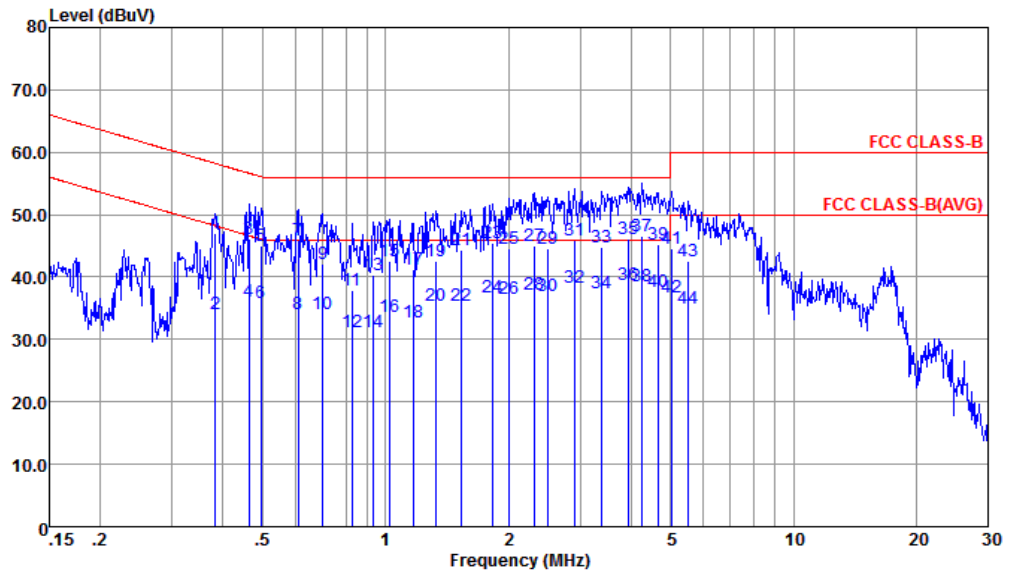

Site : CO01-kS  
 Condition : FCC CLASS-B LISN-L-20151024 LINE  
 mode : Mode 2

	Freq	Level	Over Limit	Limit Line	Read Level	LISN Factor	Cable Loss	Remark
	MHz	dBuV	dB	dBuV	dBuV	dB	dB	
18	1.17	32.67	-13.33	46.00	22.30	0.23	10.14	Average
19	1.32	42.56	-13.44	56.00	32.20	0.22	10.14	QP
20	1.32	35.46	-10.54	46.00	25.10	0.22	10.14	Average
21	1.53	44.45	-11.55	56.00	34.10	0.21	10.14	QP
22	1.53	35.45	-10.55	46.00	25.10	0.21	10.14	Average
23	1.83	45.53	-10.47	56.00	35.20	0.19	10.14	QP
24	1.83	36.83	-9.17	46.00	26.50	0.19	10.14	Average
25	2.00	44.52	-11.48	56.00	34.20	0.18	10.14	QP
26	2.00	36.52	-9.48	46.00	26.20	0.18	10.14	Average
27	2.31	44.93	-11.07	56.00	34.60	0.18	10.15	QP
28	2.31	37.13	-8.87	46.00	26.80	0.18	10.15	Average
29	2.50	44.53	-11.47	56.00	34.20	0.18	10.15	QP
30	2.50	36.93	-9.07	46.00	26.60	0.18	10.15	Average
31	2.90	45.84	-10.16	56.00	35.51	0.18	10.15	QP
32	2.90	38.44	-7.56	46.00	28.11	0.18	10.15	Average
33	3.38	44.84	-11.16	56.00	34.49	0.19	10.16	QP
34	3.38	37.44	-8.56	46.00	27.09	0.19	10.16	Average
35	3.94	46.15	-9.85	56.00	35.79	0.19	10.17	QP
36 *	3.94	38.85	-7.15	46.00	28.49	0.19	10.17	Average
37	4.25	46.56	-9.44	56.00	36.20	0.19	10.17	QP
38	4.25	38.66	-7.34	46.00	28.30	0.19	10.17	Average
39	4.67	45.17	-10.83	56.00	34.80	0.19	10.18	QP
40	4.67	37.67	-8.33	46.00	27.30	0.19	10.18	Average
41	5.03	44.57	-15.43	60.00	34.20	0.19	10.18	QP
42	5.03	36.87	-13.13	50.00	26.50	0.19	10.18	Average
43	5.51	42.59	-17.41	60.00	32.20	0.20	10.19	QP
44	5.51	34.99	-15.01	50.00	24.60	0.20	10.19	Average



Test Mode :	Mode 2	Temperature :	22~24°C
Test Engineer :	Amos Zhang	Relative Humidity :	43~45%
Test Voltage :	120Vac / 60Hz	Phase :	Neutral
Function Type :	GSM1900 Idle + Bluetooth Idle + WLAN Idle + USB Cable (Charging from Adapter) + Earphone + Camera(Front)		

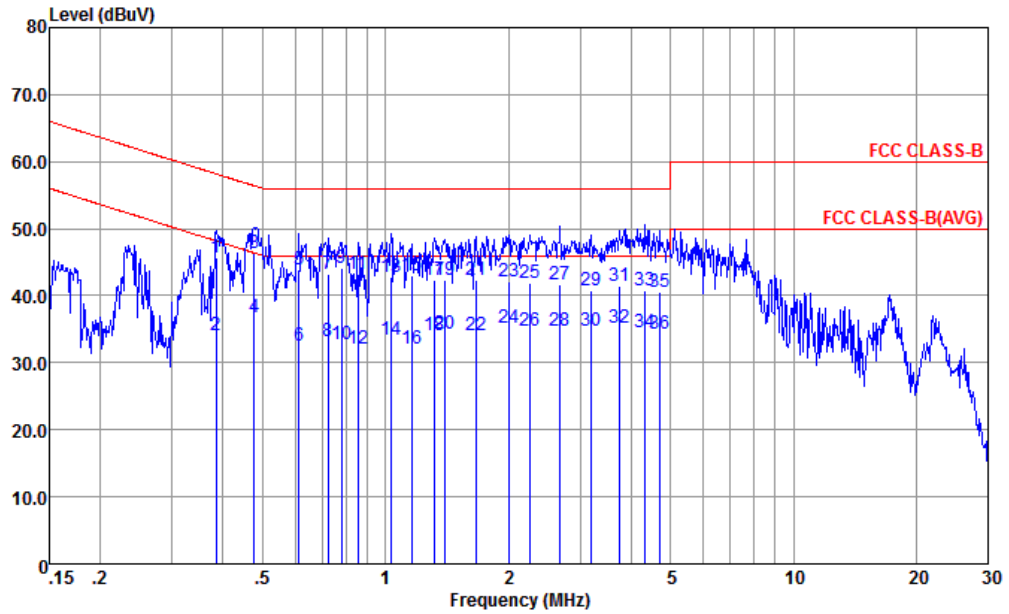

Site : CO01-KS  
 Condition : FCC CLASS-B LISN-N-20151024 NEUTRAL  
 mode : Mode 2

	Freq	Level	Over Limit	Limit Line	Read Level	LISN Factor	Cable Loss	Remark
	MHz	dBuV	dB	dBuV	dBuV	dB	dB	
1	0.39	45.59	-12.58	58.17	35.10	0.32	10.17	QP
2	0.39	34.09	-14.08	48.17	23.60	0.32	10.17	Average
3	0.48	46.38	-10.03	56.41	35.90	0.32	10.16	QP
4 *	0.48	36.68	-9.73	46.41	26.20	0.32	10.16	Average
5	0.61	43.79	-12.21	56.00	33.30	0.33	10.16	QP
6	0.61	32.59	-13.41	46.00	22.10	0.33	10.16	Average
7	0.72	43.29	-12.71	56.00	32.80	0.34	10.15	QP
8	0.72	33.29	-12.71	46.00	22.80	0.34	10.15	Average
9	0.78	44.10	-11.90	56.00	33.60	0.35	10.15	QP
10	0.78	32.80	-13.20	46.00	22.30	0.35	10.15	Average
11	0.86	43.30	-12.70	56.00	32.80	0.36	10.14	QP
12	0.86	32.10	-13.90	46.00	21.60	0.36	10.14	Average
13	1.03	42.71	-13.29	56.00	32.20	0.37	10.14	QP
14	1.03	33.41	-12.59	46.00	22.90	0.37	10.14	Average
15	1.17	43.11	-12.89	56.00	32.60	0.37	10.14	QP
16	1.17	32.11	-13.89	46.00	21.60	0.37	10.14	Average
17	1.32	42.31	-13.69	56.00	31.80	0.37	10.14	QP





Test Mode :	Mode 2	Temperature :	22~24°C
Test Engineer :	Amos Zhang	Relative Humidity :	43~45%
Test Voltage :	120Vac / 60Hz	Phase :	Neutral
Function Type :	GSM1900 Idle + Bluetooth Idle + WLAN Idle + USB Cable (Charging from Adapter) + Earphone + Camera(Front)		

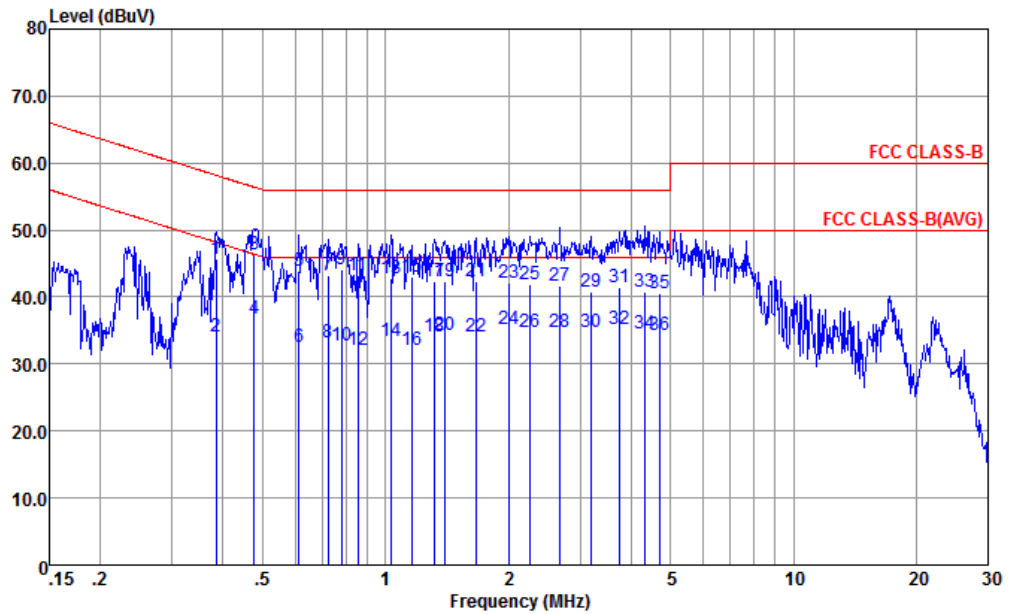

Site : CO01-KS  
 Condition : FCC CLASS-B LISN-N-20151024 NEUTRAL  
 mode : Mode 2

	Freq	Level	Over Limit	Limit Line	Read Level	LISN Factor	Cable Loss	Remark
	MHz	dBuV	dB	dBuV	dBuV	dB	dB	
18	1.32	34.11	-11.89	46.00	23.60	0.37	10.14	Average
19	1.40	42.41	-13.59	56.00	31.90	0.37	10.14	QP
20	1.40	34.31	-11.69	46.00	23.80	0.37	10.14	Average
21	1.66	42.32	-13.68	56.00	31.80	0.38	10.14	QP
22	1.66	34.12	-11.88	46.00	23.60	0.38	10.14	Average
23	2.00	42.12	-13.88	56.00	31.60	0.38	10.14	QP
24	2.00	35.12	-10.88	46.00	24.60	0.38	10.14	Average
25	2.26	41.92	-14.08	56.00	31.39	0.38	10.15	QP
26	2.26	34.72	-11.28	46.00	24.19	0.38	10.15	Average
27	2.68	41.62	-14.38	56.00	31.10	0.37	10.15	QP
28	2.68	34.72	-11.28	46.00	24.20	0.37	10.15	Average
29	3.19	40.83	-15.17	56.00	30.30	0.37	10.16	QP
30	3.19	34.73	-11.27	46.00	24.20	0.37	10.16	Average
31	3.74	41.43	-14.57	56.00	30.90	0.37	10.16	QP
32	3.74	35.13	-10.87	46.00	24.60	0.37	10.16	Average
33	4.31	40.83	-15.17	56.00	30.30	0.36	10.17	QP
34	4.31	34.63	-11.37	46.00	24.10	0.36	10.17	Average
35	4.70	40.64	-15.36	56.00	30.10	0.36	10.18	QP
36	4.70	34.34	-11.66	46.00	23.80	0.36	10.18	Average



Test Mode :	Mode 4	Temperature :	22~24°C
Test Engineer :	Amos Zhang	Relative Humidity :	43~45%
Test Voltage :	120Vac / 60Hz	Phase :	Line
Function Type :	WCDMA Band II Idle + Bluetooth Idle + WLAN Idle + USB Cable (Data Link with Notebook) + Earphone + GPS Rx		

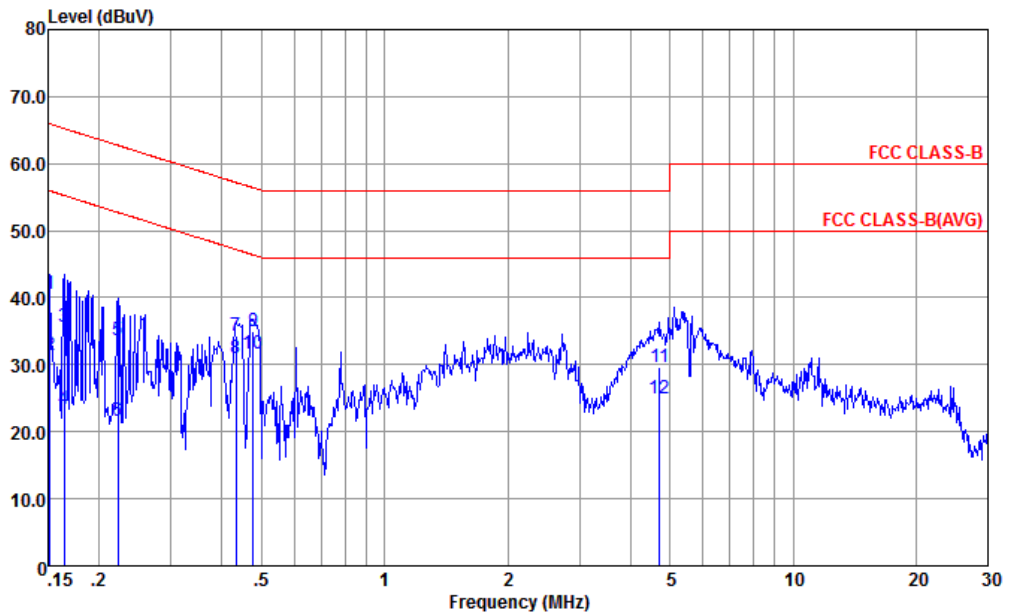

Site : CO01-kS  
 Condition : FCC CLASS-B LISN-L-20151024 LINE  
 mode : Mode 4

	Freq	Level	Over Limit	Limit Line	Read Level	LISN Factor	Cable Loss	Remark
	MHz	dBuV	dB	dBuV	dBuV	dB	dB	
1	0.15	40.53	-25.38	65.91	29.90	0.52	10.11	QP
2	0.15	31.43	-24.48	55.91	20.80	0.52	10.11	Average
3	0.16	35.64	-29.61	65.25	25.10	0.43	10.11	QP
4	0.16	23.34	-31.91	55.25	12.80	0.43	10.11	Average
5	0.22	33.75	-28.99	62.74	23.40	0.22	10.13	QP
6	0.22	21.55	-31.19	52.74	11.20	0.22	10.13	Average
7	0.43	34.30	-22.90	57.20	23.90	0.23	10.17	QP
8	0.43	30.90	-16.30	47.20	20.50	0.23	10.17	Average
9	0.48	34.99	-21.42	56.41	24.60	0.23	10.16	QP
10 *	0.48	31.69	-14.72	46.41	21.30	0.23	10.16	Average
11	4.72	29.57	-26.43	56.00	19.20	0.19	10.18	QP
12	4.72	24.97	-21.03	46.00	14.60	0.19	10.18	Average



Test Mode :	Mode 4	Temperature :	22~24°C
Test Engineer :	Amos Zhang	Relative Humidity :	43~45%
Test Voltage :	120Vac / 60Hz	Phase :	Neutral
Function Type :	WCDMA Band II Idle + Bluetooth Idle + WLAN Idle + USB Cable (Data Link with Notebook) + Earphone + GPS Rx		

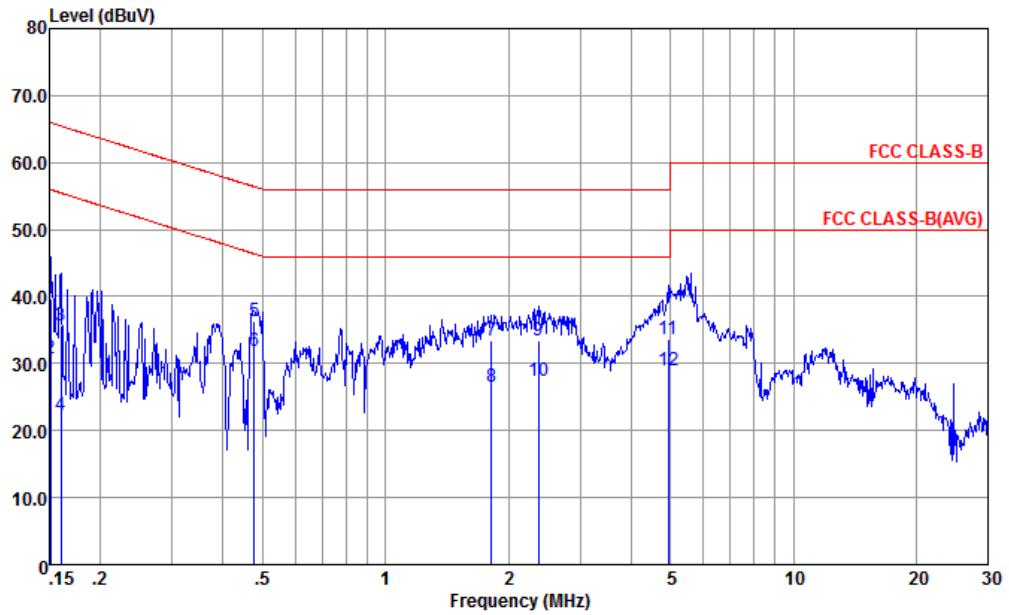

Site : CO01-kS  
 Condition : FCC CLASS-B LISN-N-20151024 NEUTRAL  
 mode : Mode 4

	Freq	Level	Over Limit	Limit Line	Read Level	LISN Factor	Cable Loss	Remark
	MHz	dBuV	dB	dBuV	dBuV	dB	dB	
1	0.15	39.71	-26.25	65.96	29.30	0.30	10.11	QP
2	0.15	30.71	-25.25	55.96	20.30	0.30	10.11	Average
3	0.16	35.71	-29.76	65.47	25.30	0.30	10.11	QP
4	0.16	22.21	-33.26	55.47	11.80	0.30	10.11	Average
5	0.48	36.38	-20.03	56.41	25.90	0.32	10.16	QP
6 *	0.48	31.78	-14.63	46.41	21.30	0.32	10.16	Average
7	1.82	33.42	-22.58	56.00	22.90	0.38	10.14	QP
8	1.82	26.62	-19.38	46.00	16.10	0.38	10.14	Average
9	2.37	33.42	-22.58	56.00	22.89	0.38	10.15	QP
10	2.37	27.32	-18.68	46.00	16.79	0.38	10.15	Average
11	4.93	33.64	-22.36	56.00	23.10	0.36	10.18	QP
12	4.93	29.04	-16.96	46.00	18.50	0.36	10.18	Average



### 3.2. Test of Radiated Emission Measurement

#### 3.2.1. Limit of Radiated Emission

The emissions from an unintentional radiator shall not exceed the field strength levels specified in the following table:

Frequency (MHz)	Field Strength (microvolts/meter)	Measurement Distance (meters)
30 – 88	100	3
88 – 216	150	3
216 - 960	200	3
Above 960	500	3

#### 3.2.2. Measuring Instruments

The measuring equipment is listed in the section 4 of this test report.

#### 3.2.3. Test Procedures

1. The EUT was placed on a turntable with 0.8 meter above ground.
2. The EUT was set 3 meters from the interference receiving antenna, which was mounted on the top of a variable height antenna tower.
3. The table was rotated 360 degrees to determine the position of the highest radiation.
4. The antenna is a Bi-Log antenna and its height is adjusted between one to four meters above ground to find the maximum value of the field strength for both horizontal polarization and vertical polarization of the antenna.
5. For each suspected emission, the EUT was arranged to its worst case and then tune the antenna tower (from 1 m to 4 m) and turntable (from 0 degree to 360 degrees) to find the maximum reading.
6. Set the test-receiver system to Peak Detect Function and specified bandwidth with Maximum Hold Mode (RBW=120kHz/VBW=300kHz for frequency below 1GHz; RBW=1MHz VBW=3MHz (Peak), RBW=1MHz/VBW=10Hz (Average) for frequency above 1GHz).
7. If the emission level of the EUT in peak mode was 3 dB lower than the limit specified, peak values of EUT will be reported. Otherwise, the emission will be repeated by using the quasi-peak method and reported.
8. Emission level (dBµV/m) = 20 log Emission level (µV/m)
9. Corrected Reading: Antenna Factor + Cable Loss + Read Level - Preamp Factor = Level

### 3.2.4. Test Setup of Radiated Emission

For radiated emissions from 30MHz to 1GHz

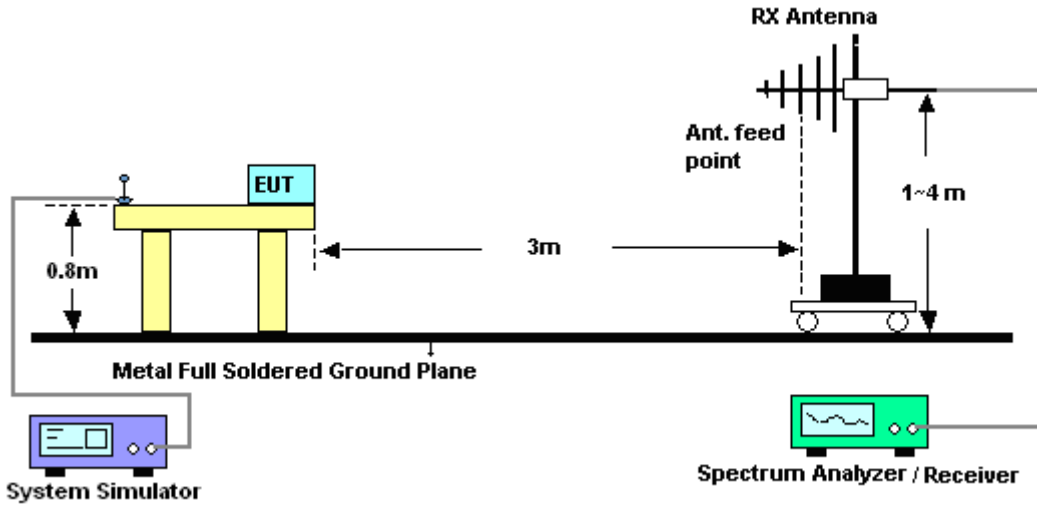

For radiated emissions above 1GHz

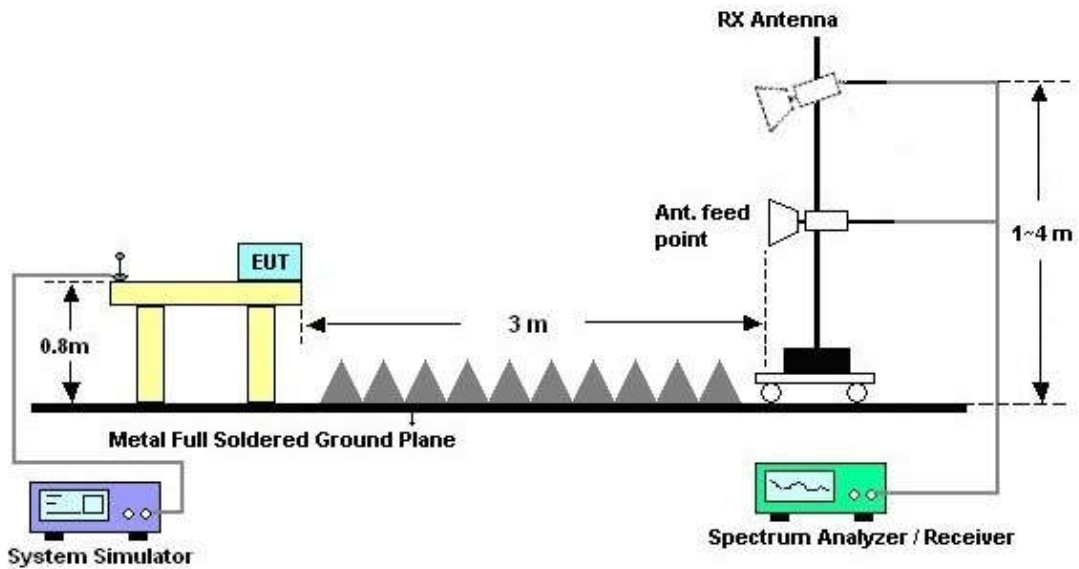



3.2.5. Test Result of Radiated Emission

Test Mode :	Mode 3	Temperature :	21~22°C
Test Engineer :	Jack Wang	Relative Humidity :	41~42%
Test Distance :	3m	Polarization :	Horizontal
Function Type :	WCDMA Band V Idle + Bluetooth Idle + WLAN Idle + USB Cable (Charging from Adapter) + Earphone + MPEG4		
Remark :	#6 is system simulator signal which can be ignored.		

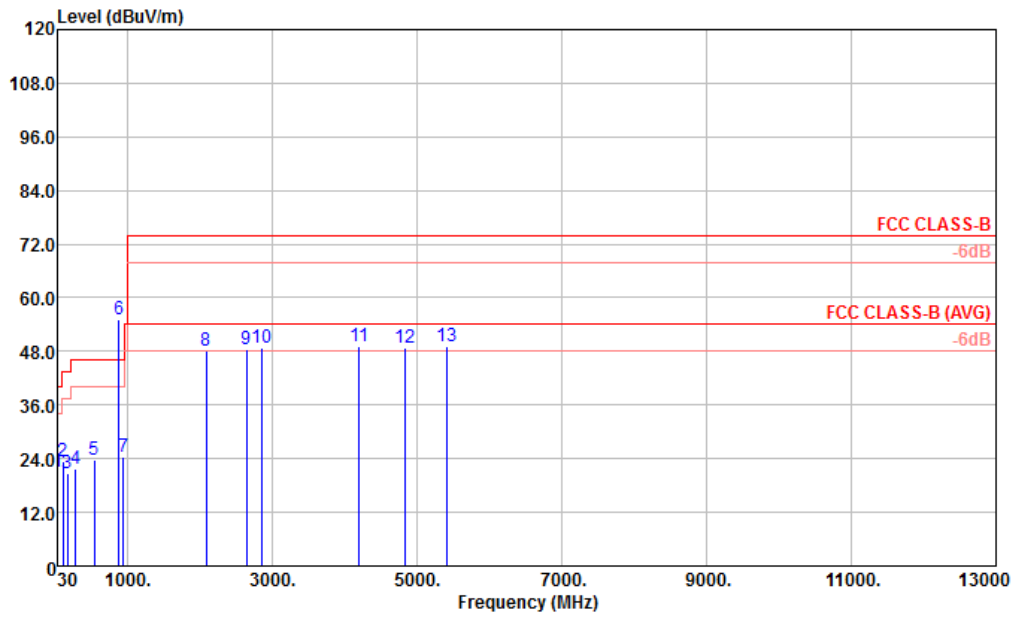

Site : 03CH02-KS  
 Condition : FCC CLASS-B 3m LF\_ANT\_37879 HORIZONTAL  
 Project : (FC)5D0302  
 Mode : 3

	Freq	Level	Over	Limit	ReadAntenna	Cable	Preamp	A/Pos	T/Pos	Remark	Pol/Phas
	MHz	dBuV/m	dB	dBuV/m	dBuV	dB/m	dB	dB	cm	deg	
1	38.91	21.14	-18.86	40.00	36.18	14.79	1.07	30.90	164	325	Peak HORIZONTAL
2	108.57	23.46	-20.04	43.50	40.80	11.37	1.69	30.40	---	---	Peak HORIZONTAL
3	173.10	20.62	-22.88	43.50	38.03	10.81	2.18	30.40	---	---	Peak HORIZONTAL
4	280.02	21.82	-24.18	46.00	36.90	12.65	2.77	30.50	---	---	Peak HORIZONTAL
5	540.10	23.74	-22.26	46.00	31.63	18.55	3.88	30.32	---	---	Peak HORIZONTAL
6 *	883.10	55.02			58.39	22.11	5.05	30.53	---	---	Peak HORIZONTAL
7	940.50	24.50	-21.50	46.00	27.97	21.79	5.26	30.52	---	---	Peak HORIZONTAL
8	2090.00	48.29	-25.71	74.00	44.00	30.92	5.80	32.43	---	---	Peak HORIZONTAL
9	2646.00	48.57	-25.43	74.00	40.45	31.87	6.52	30.27	---	---	Peak HORIZONTAL
10	2862.00	48.85	-25.15	74.00	39.15	32.53	6.77	29.60	---	---	Peak HORIZONTAL
11	4197.00	49.28	-24.72	74.00	36.04	34.79	8.52	30.07	---	---	Peak HORIZONTAL
12	4836.00	48.85	-25.15	74.00	37.88	34.90	8.73	32.66	---	---	Peak HORIZONTAL
13	5406.00	49.27	-24.73	74.00	40.64	35.12	9.31	35.80	---	---	Peak HORIZONTAL



Test Mode :	Mode 3	Temperature :	21~22°C
Test Engineer :	Jack Wang	Relative Humidity :	41~42%
Test Distance :	3m	Polarization :	Vertical
Function Type :	WCDMA Band V Idle + Bluetooth Idle + WLAN Idle + USB Cable (Charging from Adapter) + Earphone + MPEG4		
Remark :	#6 is system simulator signal which can be ignored.		

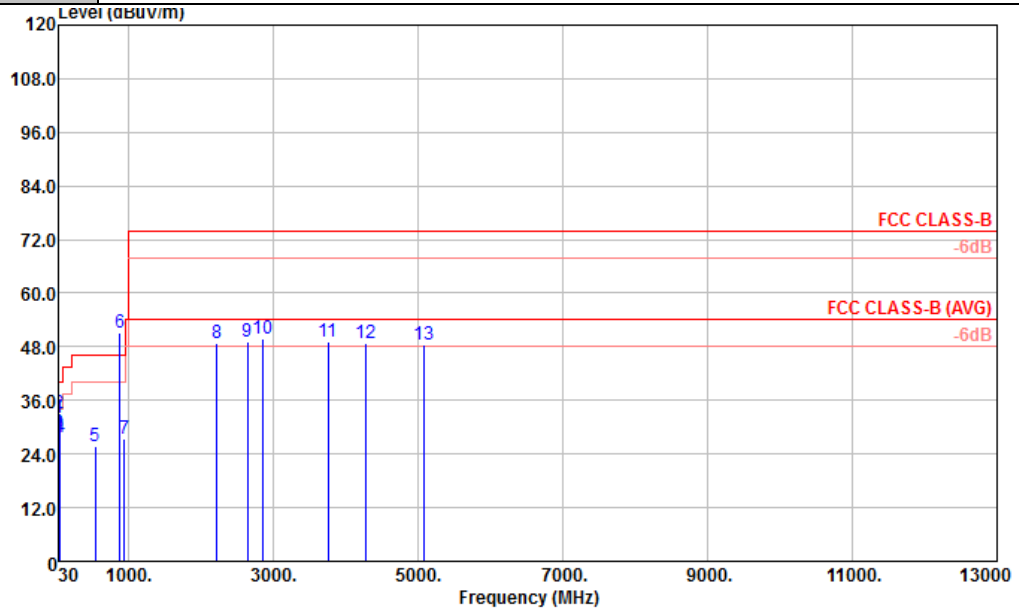

Site : 03CH02-KS  
 Condition : FCC CLASS-B 3m LF\_ANT\_37879 VERTICAL  
 Project : (FC)5D0302  
 Mode : 3

	Freq	Level	Over	Limit	ReadAntenna	Cable	Preamp	A/Pos	T/Pos	Remark	Pol/Phas	
	MHz	dBuV/m	dB	dBuV/m	dBuV	dB/m	dB	dB	cm	deg		
1	33.24	31.94	-8.06	40.00	44.20	17.73	0.99	30.98	---	---	Peak	VERTICAL
2	42.96	33.03	-6.97	40.00	50.00	12.77	1.10	30.84	105	358	QP	VERTICAL
3	47.82	28.71	-11.29	40.00	48.17	10.23	1.11	30.80	---	---	Peak	VERTICAL
4	54.30	27.81	-12.19	40.00	49.66	7.66	1.19	30.70	---	---	Peak	VERTICAL
5	540.10	25.60	-20.40	46.00	33.49	18.55	3.88	30.32	---	---	Peak	VERTICAL
6 *	882.40	51.14			54.51	22.11	5.05	30.53	---	---	Peak	VERTICAL
7	940.50	27.52	-18.48	46.00	30.99	21.79	5.26	30.52	---	---	Peak	VERTICAL
8	2218.00	48.89	-25.11	74.00	43.40	31.12	5.96	31.59	---	---	Peak	VERTICAL
9	2644.00	48.99	-25.01	74.00	40.87	31.87	6.52	30.27	---	---	Peak	VERTICAL
10	2860.00	49.69	-24.31	74.00	39.99	32.50	6.77	29.57	---	---	Peak	VERTICAL
11	3753.00	49.11	-24.89	74.00	36.28	34.20	8.06	29.43	---	---	Peak	VERTICAL
12	4272.00	48.97	-25.03	74.00	36.15	34.77	8.52	30.47	---	---	Peak	VERTICAL
13	5082.00	48.51	-25.49	74.00	38.20	35.02	8.93	33.64	---	---	Peak	VERTICAL



Test Mode :	Mode 4	Temperature :	21~22°C
Test Engineer :	Jack Wang	Relative Humidity :	41~42%
Test Distance :	3m	Polarization :	Horizontal
Function Type :	WCDMA Band II Idle + Bluetooth Idle + WLAN Idle + USB Cable (Data Link with Notebook) + Earphone + GPS Rx		

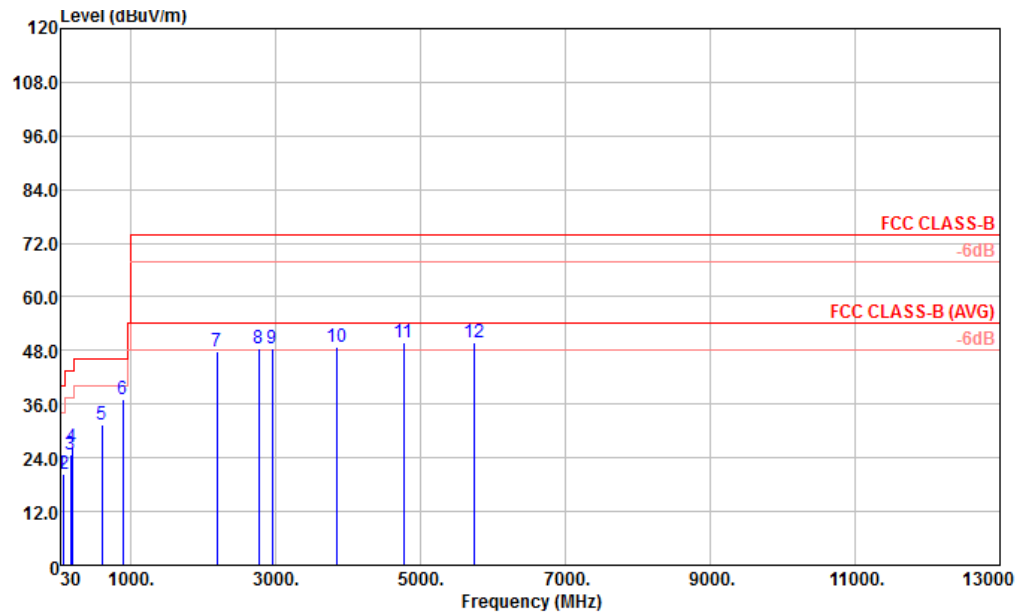

Site : 03CH02-KS  
 Condition : FCC CLASS-B 3m LF\_ANT\_37879 HORIZONTAL  
 Project : (FC)5D0302  
 Mode : 4

	Freq	Level	Over	Limit	ReadAntenna	Cable	Preamp	A/Pos	T/Pos	Remark	Pol/Phas
	MHz	dBuV/m	dB	dBuV/m	dBuV	dB/m	dB	dB	cm	deg	
1	31.62	20.38	-19.62	40.00	32.21	18.22	0.97	31.02	---	---	Peak HORIZONTAL
2	77.25	20.36	-19.64	40.00	40.50	8.85	1.51	30.50	---	---	Peak HORIZONTAL
3	165.81	24.61	-18.89	43.50	41.78	11.10	2.13	30.40	---	---	Peak HORIZONTAL
4	187.41	26.45	-17.05	43.50	44.31	10.28	2.26	30.40	---	---	Peak HORIZONTAL
5	597.50	31.49	-14.51	46.00	38.71	18.81	4.18	30.21	---	---	Peak HORIZONTAL
6	895.00	37.10	-8.90	46.00	40.06	22.54	5.08	30.58	128	326	Peak HORIZONTAL
7	2192.00	47.65	-26.35	74.00	42.39	31.08	5.91	31.73	---	---	Peak HORIZONTAL
8	2768.00	48.42	-25.58	74.00	39.12	32.28	6.67	29.65	---	---	Peak HORIZONTAL
9	2948.00	48.58	-25.42	74.00	38.78	32.70	6.86	29.76	---	---	Peak HORIZONTAL
10	3840.00	48.88	-25.12	74.00	35.83	34.32	8.22	29.49	---	---	Peak HORIZONTAL
11	4770.00	49.88	-24.12	74.00	38.62	34.86	8.71	32.31	---	---	Peak HORIZONTAL
12	5739.00	49.66	-24.34	74.00	40.29	35.29	9.63	35.55	---	---	Peak HORIZONTAL





Test Mode :	Mode 4	Temperature :	21~22°C
Test Engineer :	Jack Wang	Relative Humidity :	41~42%
Test Distance :	3m	Polarization :	Vertical
Function Type :	WCDMA Band II Idle + Bluetooth Idle + WLAN Idle + USB Cable (Data Link with Notebook) + Earphone + GPS Rx		

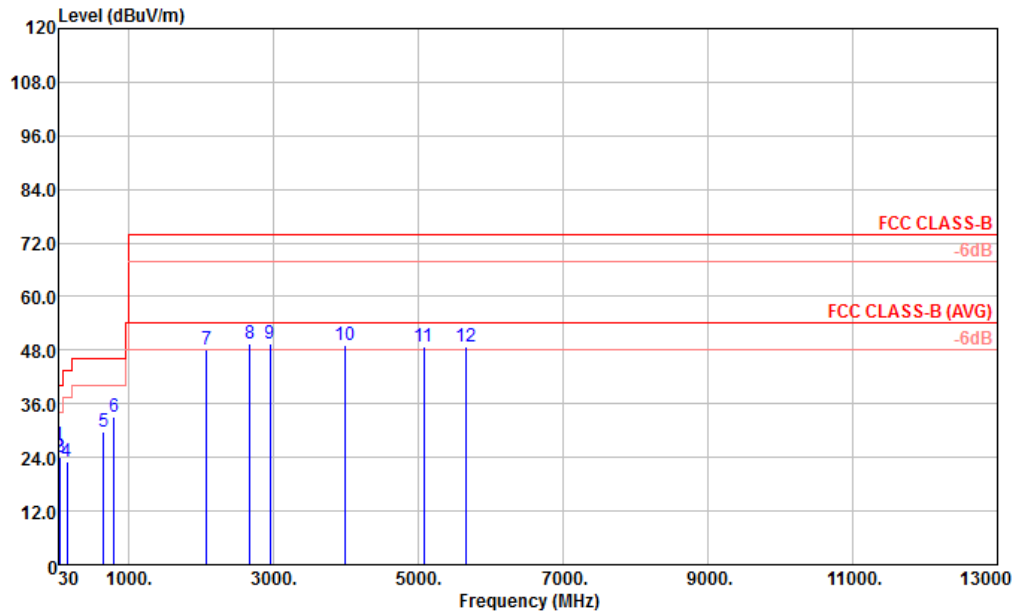

Site : 03CH02-KS  
 Condition : FCC CLASS-B 3m LF\_ANT\_37879 VERTICAL  
 Project : (FC)5D0302  
 Mode : 4

	Freq	Level	Over	Limit	ReadAntenna	Cable	Preamp	A/Pos	T/Pos	Remark	Po1/Phas
	MHz	dBuV/m	dB	dBuV/m	dBuV	dB/m	dB	dB	cm	deg	
1	37.02	26.69	-13.31	40.00	40.78	15.77	1.04	30.90	---	---	Peak VERTICAL
2	48.09	24.17	-15.83	40.00	44.14	9.72	1.11	30.80	---	---	Peak VERTICAL
3	54.30	23.95	-16.05	40.00	45.80	7.66	1.19	30.70	---	---	Peak VERTICAL
4	153.12	23.12	-20.38	43.50	39.88	11.59	2.05	30.40	---	---	Peak VERTICAL
5	649.30	29.89	-16.11	46.00	36.52	19.39	4.28	30.30	---	---	Peak VERTICAL
6	796.30	32.93	-13.07	46.00	38.32	20.29	4.82	30.50	168	321	Peak VERTICAL
7	2074.00	48.16	-25.84	74.00	44.06	30.90	5.75	32.55	---	---	Peak VERTICAL
8	2676.00	49.32	-24.68	74.00	40.85	31.99	6.57	30.09	---	---	Peak VERTICAL
9	2950.00	49.47	-24.53	74.00	39.67	32.70	6.86	29.76	---	---	Peak VERTICAL
10	3984.00	49.26	-24.74	74.00	36.21	34.54	8.52	30.01	---	---	Peak VERTICAL
11	5073.00	48.77	-25.23	74.00	38.46	35.02	8.93	33.64	---	---	Peak VERTICAL
12	5661.00	48.74	-25.26	74.00	39.33	35.22	9.55	35.36	---	---	Peak VERTICAL



### 4. List of Measuring Equipment

Instrument	Manufacturer	Model No.	Serial No.	Characteristics	Calibration Date	Test Date	Due Date	Remark
EMI Test Receiver	R&S	ESR7	101403	9kHz~7GHz;Max x 30dBm	Sep. 10, 2015	Dec. 09, 2015	Sep. 09, 2016	Radiation (03CH02-KS)
Spectrum Analyzer	R&S	FSV40	101040	10kHz~40GHz; Max 30dBm	Sep. 10, 2015	Dec. 09, 2015	Sep. 09, 2016	Radiation (03CH02-KS)
Bilog Antenna	TeseQ	CBL6112D	37879	30MHz-2GHz	Sep. 12, 2015	Dec. 09, 2015	Sep. 11, 2016	Radiation (03CH02-KS)
Double Ridge Horn Antenna	ETS-Lindgren	3117	75957	1GHz~18GHz	Nov. 07, 2015	Dec. 09, 2015	Nov. 06, 2016	Radiation (03CH02-KS)
Amplifier	com-power	PA-103A	161069	1kHz~1000MHz / 32 dB	May 04, 2015	Dec. 09, 2015	May 03, 2016	Radiation (03CH02-KS)
Amplifier	Agilent	8449B	3008A02384	1-26.5GHz Gain 30dB	Oct. 24, 2015	Dec. 09, 2015	Oct. 23, 2016	Radiation (03CH02-KS)
AC Power Source	Chroma	61601	61601000247 3	N/A	NCR	Dec. 09, 2015	NCR	Radiation (03CH02-KS)
Turn Table	MF	MF7802	N/A	0~360 degree	NCR	Dec. 09, 2015	NCR	Radiation (03CH02-KS)
Antenna Mast	MF	MF7802	N/A	1 m~4 m	NCR	Dec. 09, 2015	NCR	Radiation (03CH02-KS)
EMI Test Receiver	R&S	ESR7	101403	9kHz~7GHz;Max x 30dBm	Sep. 10, 2015	Dec. 08, 2015	Sep. 09, 2016	Conduction (CO01-KS)
AC LISN	MessTec	AN3016	060103	9kHz~30MHz	Oct. 24, 2015	Dec. 08, 2015	Oct. 23, 2016	Conduction (CO01-KS)
AC LISN (for auxiliary equipment)	MessTec	AN3016	060105	9kHz~30MHz	Oct. 24, 2015	Dec. 08, 2015	Oct. 23, 2016	Conduction (CO01-KS)
AC Power Source	Chroma	61602	ABP0000008 11	AC 0V~300V, 45Hz~1000Hz	Oct. 24, 2015	Dec. 08, 2015	Oct. 23, 2016	Conduction (CO01-KS)



## 5. Uncertainty of Evaluation

### Uncertainty of Conducted Emission Measurement (150 kHz ~ 30 MHz)

Measuring Uncertainty for a Level of Confidence of 95% ( $U = 2Uc(y)$ )	2.3dB
---	-------

### Uncertainty of Radiated Emission Measurement (30 MHz ~ 1000 MHz)

Measuring Uncertainty for a Level of Confidence of 95% ( $U = 2Uc(y)$ )	5.1dB
---	-------