

## HEARING AID COMPATIBILITY

**Applicant Name:**  
LG Electronics MobileComm U.S.A. Inc.  
1000 Sylvan Avenue  
Englewood Cliffs, NJ 07632  
United States

**Date of Testing:**  
10/03/2017  
**Test Site/Location:**  
PCTEST Lab, Columbia, MD, USA  
**Test Report Serial No.:**  
1M1710020259-11.ZNF

**FCC ID:** ZNFX210MA

**APPLICANT:** LG ELECTRONICS MOBILECOMM U.S.A. INC.

**Scope of Test:** Audio Band Magnetic Testing (T-Coil)  
**Application Type:** Class II Permissive Change  
**FCC Rule Part(s):** CFR §20.19(b)  
**HAC Standard:** ANSI C63.19-2011  
285076 D01 HAC Guidance v05  
285076 D02 T-Coil testing for CMRS IP v03  
**DUT Type:** Portable Handset  
**Model:** LM-X210MA  
**Additional Model(s):** LMX210MA, X210MA, LM-X210TA, LMX210TA, X210TA, LM-X210TAT, LMX210TAT, X210TAT  
**Test Device Serial No.:** Pre-Production Sample [S/N: 71462]  
**Class II Permissive Change(s):** See FCC Change Document



**C63.19-2011 HAC Category:** T3 (SIGNAL TO NOISE CATEGORY)

This wireless portable device has been shown to be hearing-aid compatible under the above rated category, specified in ANSI/IEEE Std. C63.19-2011 and has been tested in accordance with the specified measurement procedures. Test results reported herein relate only to the item(s) tested. Hearing-Aid Compatibility is based on the assumption that all production units will be designed electrically identical to the device tested in this report. North American Bands only.

I attest to the accuracy of data. All measurements reported herein were performed by me or were made under my supervision and are correct to the best of my knowledge and belief. I assume full responsibility for the completeness of these measurements and vouch for the qualifications of all persons taking them.

  
Randy Ortanez  
President





FCC ID: ZNFX210MA		HAC (T-COIL) TEST REPORT		Approved by: Quality Manager
Filename: 1M1710020259-11.ZNF	Test Dates: 10/03/2017	DUT Type: Portable Handset	Page 1 of 50	

# TABLE OF CONTENTS

---

1.	INTRODUCTION .....	3
2.	DUT DESCRIPTION.....	4
3.	ANSI C63.19-2011 PERFORMANCE CATEGORIES .....	5
4.	METHOD OF MEASUREMENT .....	7
5.	FCC 3G MEASUREMENTS .....	17
6.	TEST SUMMARY .....	18
7.	MEASUREMENT UNCERTAINTY .....	23
8.	EQUIPMENT LIST.....	24
9.	TEST DATA.....	25
10.	CALIBRATION CERTIFICATES.....	38
11.	CONCLUSION.....	45
12.	REFERENCES .....	46
13.	TEST SETUP PHOTOGRAPHS .....	48

<b>FCC ID:</b> ZNFX210MA		<b>HAC (T-COIL) TEST REPORT</b>		<b>Approved by:</b> Quality Manager
<b>Filename:</b> 1M1710020259-11.ZNF	<b>Test Dates:</b> 10/03/2017	<b>DUT Type:</b> Portable Handset	Page 2 of 50	

# 1. INTRODUCTION

On July 10, 2003, the Federal Communications Commission (FCC) adopted new rules requiring wireless manufacturers and service providers to provide digital wireless phones that are compatible with hearing aids. The FCC has modified the exemption for wireless phones under the Hearing Aid Compatibility Act of 1998 (HAC Act) in WT Docket 01-309 RM-8658<sup>1</sup> to extend the benefits of wireless telecommunications to individuals with hearing disabilities. These benefits encompass business, social and emergency communications, which increase the value of the wireless network for everyone. An estimated more than 10% of the population in the United States show signs of hearing impairment and of that fraction, almost 80% use hearing aids. Approximately 500 million people worldwide and 30 million people in the United States suffer from hearing loss.

## Compatibility Tests Involved:

The standard calls for wireless communications devices to be measured for:

- RF Electric-field emissions
- T-coil mode, magnetic-signal strength in the audio band
- T-coil mode, magnetic-signal frequency response through the audio band
- T-coil mode, magnetic-signal and noise articulation index

The hearing aid must be measured for:

- RF immunity in microphone mode
- RF immunity in T-coil mode

In the following tests and results, this report includes the evaluation for a wireless communications device.

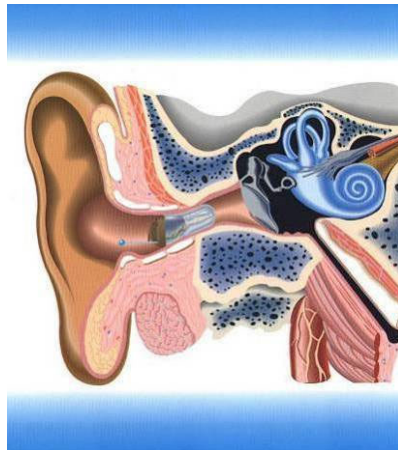



Figure 1-1 Hearing Aid *in-vitu*

<sup>1</sup> FCC Rule & Order, WT Docket 01-309 RM-8658

FCC ID: ZNFX210MA		HAC (T-COIL) TEST REPORT		Approved by: Quality Manager
Filename: 1M1710020259-11.ZNF	Test Dates: 10/03/2017	DUT Type: Portable Handset		Page 3 of 50

## 2. DUT DESCRIPTION



**FCC ID:** ZNFX210MA  
**Applicant:** LG Electronics MobileComm U.S.A. Inc.  
 1000 Sylvan Avenue  
 Englewood Cliffs, NJ 07632  
 United States  
**Model:** LM-X210MA  
**Additional Model(s):** LMX210MA, X210MA, LM-X210TA, LMX210TA, X210TA, LM-X210TAT, LMX210TAT, X210TAT  
**Serial Number:** 71462  
**HW Version:** Rev.1.0  
**SW Version:** X210\_LAMPNMR2R170919  
**Antenna:** Internal Antenna  
**HAC Test Configurations:** GSM 850, 128, 190, 251, BT Off, WLAN Off, LTE Off  
 GSM 1900, 512, 661, 810, BT Off, WLAN Off, LTE Off  
 UMTS V, 4132, 4183, 4233, BT Off, WLAN Off, LTE Off  
 UMTS IV, 1312, 1412, 1513, BT Off, WLAN Off, LTE Off  
 UMTS II, 9262, 9400, 9538, BT Off, WLAN Off, LTE Off  
**DUT Type:** Portable Handset

Table 2-1: ZNFX210MA HAC Air Interfaces

Air-Interface	Band (MHz)	Type Transport	HAC Tested	Simultaneous But Not Tested	Voice over Digital Transport OTT Capability	Additional GSM Power Reduction
GSM	850	VO	Yes	Yes: WIFI or BT	N/A	No
	1900	VO	Yes	Yes: WIFI or BT	N/A	No
	GPRS/EDGE	DT	No	Yes: WIFI or BT	Yes	No
UMTS	850	VD	Yes	Yes: WIFI or BT	N/A	N/A
	1700	VD	Yes	Yes: WIFI or BT	N/A	N/A
	1900	VD	Yes	Yes: WIFI or BT	N/A	N/A
	HSPA	DT	No	Yes: WIFI or BT	Yes	N/A
LTE (FDD)	700 (B12)	VD	No <sup>1</sup>	Yes: WIFI or BT	Yes	N/A
	850 (B5)	VD	No <sup>1</sup>	Yes: WIFI or BT	Yes	N/A
	1700 (B66)	VD	No <sup>1</sup>	Yes: WIFI or BT	Yes	N/A
	1900 (B2)	VD	No <sup>1</sup>	Yes: WIFI or BT	Yes	N/A
WIFI	2450	VD	No <sup>1</sup>	Yes: GSM, UMTS, or LTE	Yes	N/A
	5200	VD	No <sup>1</sup>	Yes: GSM, UMTS, or LTE	Yes	N/A
	5300	VD	No <sup>1</sup>	Yes: GSM, UMTS, or LTE	Yes	N/A
	5500	VD	No <sup>1</sup>	Yes: GSM, UMTS, or LTE	Yes	N/A
	5800	VD	No <sup>1</sup>	Yes: GSM, UMTS, or LTE	Yes	N/A
BT	2450	DT	No	Yes: GSM, UMTS, or LTE	N/A	N/A
Type Transport VO = Voice Only DT = Digital Data - Not intended for CMRS Service VD = CMRS and Data Transport			Notes: 1. Not tested in accordance with the guidance issued by OET in KDB publication 285076 D02 T-Coil testing for CMRS IP.			

<b>FCC ID:</b> ZNFX210MA	PCTEST ENGINEERING LABORATORY, INC.	<b>HAC (T-COIL) TEST REPORT</b>		<b>Approved by:</b> Quality Manager
<b>Filename:</b> 1M1710020259-11.ZNF	<b>Test Dates:</b> 10/03/2017	<b>DUT Type:</b> Portable Handset		Page 4 of 50

### 3. ANSI C63.19-2011 PERFORMANCE CATEGORIES

#### I. MAGNETIC COUPLING

##### Axial and Radial Field Intensity

All orientations of the magnetic field, in the axial and radial position along the measurement plane shall be  $\geq -18$  dB(A/m) at 1 kHz in a 1/3 octave band filter per §8.3.1.

##### Frequency Response

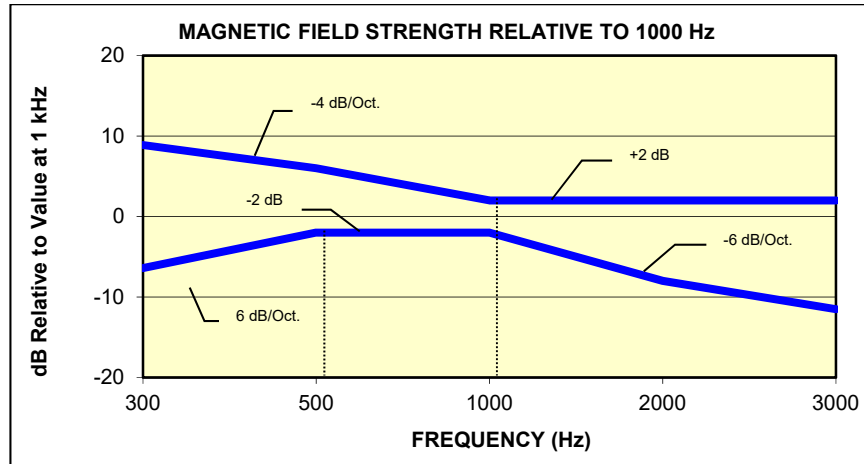

The frequency response of the axial component of the magnetic field shall follow the response curve specified in EIA RS-504-1983, over the frequency range 300 Hz – 3000 Hz per §8.3.2.

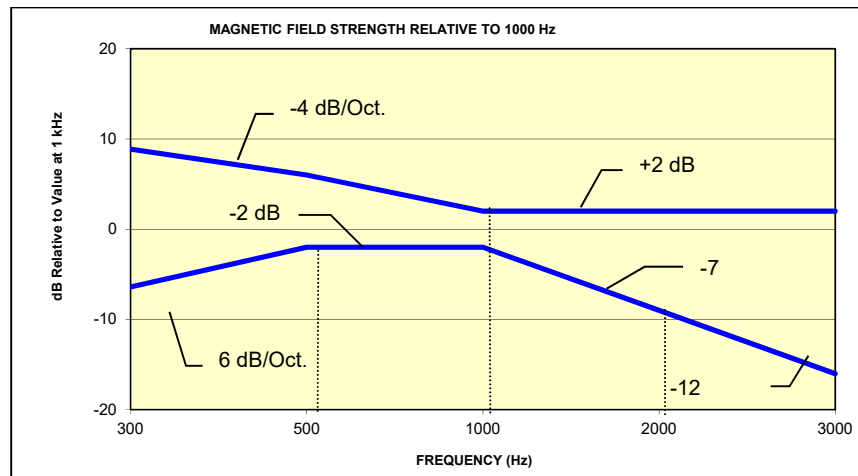

**Figure 3-1**  
Magnetic field frequency response for Wireless Devices with an axial field  $\leq -15$  dB(A/m) at 1 kHz



**Figure 3-2**  
Magnetic Field frequency response for wireless devices with an axial field that exceeds  $-15$  dB(A/m) at 1 kHz

FCC ID: ZNFX210MA		HAC (T-COIL) TEST REPORT		Approved by: Quality Manager
Filename: 1M1710020259-11.ZNF	Test Dates: 10/03/2017	DUT Type: Portable Handset		Page 5 of 50



## Signal Quality

The table below provides the signal quality requirement for the intended audio magnetic signal from a wireless device. Only the RF immunity of the hearing aid is measured in T-coil mode. It is assumed that a hearing aid can have no immunity to an interference signal in the audio band, which is the intended reception band for this mode. The only criterion that can be measured is the RF immunity in T-coil mode. This is measured using the same procedure as the audio coupling mode at the same levels.

The signal quality of the axial and radial components of the magnetic field was used to determine the T-coil mode category.

Category	Telephone RF Parameters
	Wireless Device Signal Quality [(Signal + Noise)-to-noise ratio in dB]
T1	0 to 10 dB
T2	10 to 20 dB
T3	20 to 30 dB
T4	> 30 dB

Table 3-1  
**Magnetic Coupling Parameters**

FCC ID: ZNFX210MA	 PCTEST ENGINEERING LABORATORY, INC.	HAC (T-COIL) TEST REPORT		Approved by: Quality Manager
Filename: 1M1710020259-11.ZNF	Test Dates: 10/03/2017	DUT Type: Portable Handset		Page 6 of 50

## 4. METHOD OF MEASUREMENT

### I. Test Setup

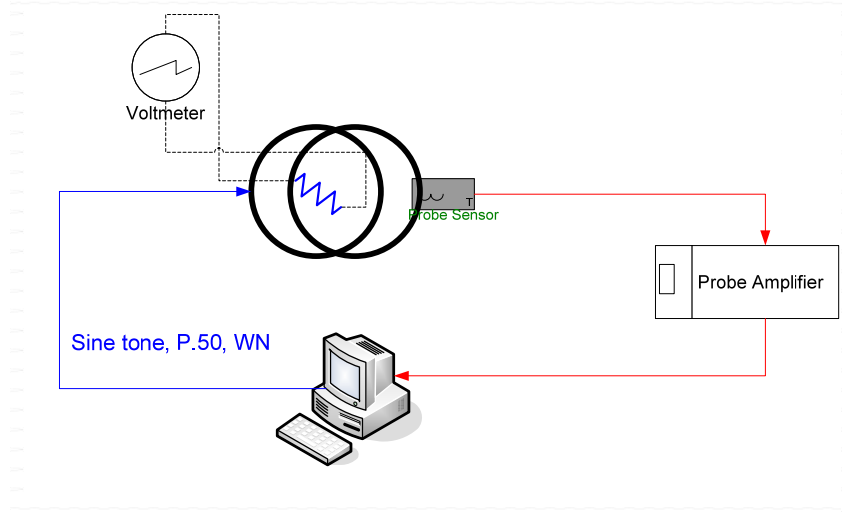

The equipment was connected as shown in an acoustic/RF hemi-anechoic chamber:

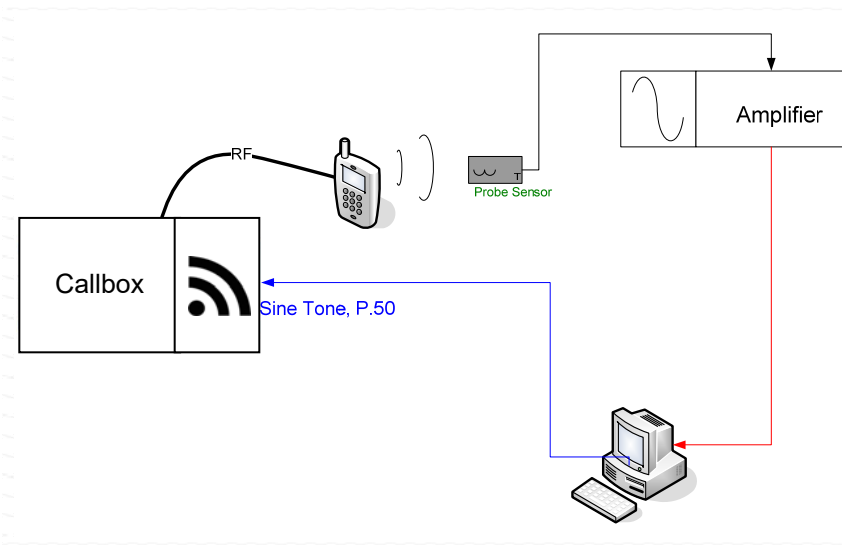

**Figure 4-1**  
**Validation Setup with Helmholtz Coil**



**Figure 4-2**  
**T-Coil Test Setup**

FCC ID: ZNFX210MA		HAC (T-COIL) TEST REPORT		Approved by: Quality Manager
Filename: 1M1710020259-11.ZNF	Test Dates: 10/03/2017	DUT Type: Portable Handset		Page 7 of 50

© 2017 PCTEST Engineering Laboratory, Inc.

REV 3.1.M

09/14/2017

© 2017 PCTEST Engineering Laboratory, Inc. All rights reserved. Unless otherwise specified, no part of this report may be reproduced or utilized in any part, form or by any means, electronic or mechanical, including photocopying and microfilm, without permission in writing from PCTEST Engineering Laboratory, Inc. If you have any questions about this international copyright or have an enquiry about obtaining additional rights to this report or assembly of contents thereof, please contact [INFO@PCTESTLAB.COM](mailto:INFO@PCTESTLAB.COM).

## II. Scanning Mechanism

Manufacturer: TEM  
 Accuracy:  $\pm 0.83$  cm/meter  
 Minimum Step Size: 0.1 mm  
 Maximum speed: 6.1 cm/sec  
 Line Voltage: 115 VAC  
 Line Frequency: 60 Hz  
 Material Composite: Delrin (Acetal)  
 Data Control: Parallel Port  
 Dynamic Range (X-Y-Z): 45 x 31.75 x 47 cm  
 Dimensions: 36" x 25" x 38"  
 Operating Area: 36" x 49" x 55"  
 Reflections: < -20 dB (in anechoic chamber)

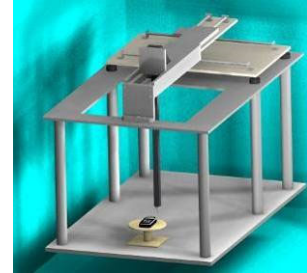

**Figure 4-3**  
RF Near-Field Scanner

## III. ITU-T P.50 Artificial Voice

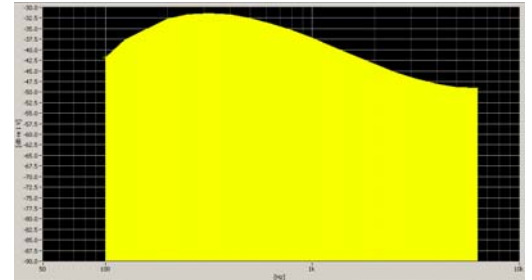

Manufacturer: ITU-T  
 Active Frequency Range: 100 Hz – 8 kHz  
 Stimulus Type: Male and Female, no spaces  
 Single Sample Duration: 20.96 seconds  
 Activity Level: 100%

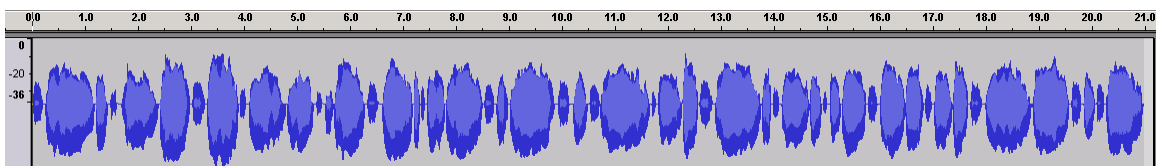

**Figure 4-4**  
Spectral Characteristic of full P.50



**Figure 4-5**  
Temporal Characteristic of full P.50

FCC ID: ZNFX210MA		HAC (T-COIL) TEST REPORT		Approved by: Quality Manager
Filename: 1M1710020259-11.ZNF	Test Dates: 10/03/2017	DUT Type: Portable Handset		Page 8 of 50

© 2017 PCTEST Engineering Laboratory, Inc.

REV 3.1.M  
09/14/2017

© 2017 PCTEST Engineering Laboratory, Inc. All rights reserved. Unless otherwise specified, no part of this report may be reproduced or utilized in any part, form or by any means, electronic or mechanical, including photocopying and microfilm, without permission in writing from PCTEST Engineering Laboratory, Inc. If you have any questions about this international copyright or have an enquiry about obtaining additional rights to this report or assembly of contents thereof, please contact [INFO@PCTESTLAB.COM](mailto:INFO@PCTESTLAB.COM).



ABM1 Measurement Block Diagram:

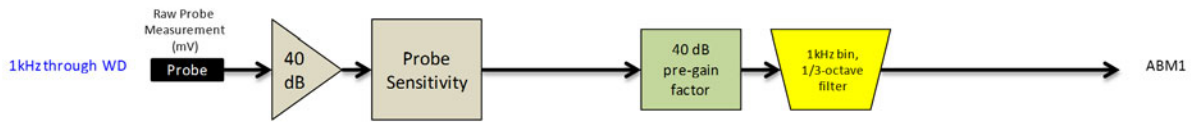

ABM2 Measurement Block Diagram:

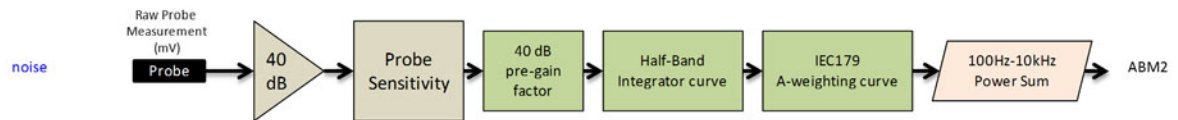

Figure 4-6 Magnetic Measurement Processing Steps

## IV. Test Procedure

1. Ambient Noise Check per C63.19 §7.3.1
  - a. Ambient interference was monitored using a Real-Time Analyzer between 100-10,000 Hz with 1/3 octave filtering.
  - b. “A-weighting” and Half-Band Integration was applied to the measurements.
  - c. Since this measurement was measured in the same method as ABM2 measurements, this level was verified to be more than 10 dB below the lowest measurement signal (which is the highest ABM2 measurement for a T4 WD). Therefore the maximum noise level for a T4 WD with an ABM1 = -18 dBA/m is:  

$$-18 - 30 - 10 = -58 \text{ dBA/m}$$
2. Measurement System Validation(See Figure 4-1)
  - a. The measurement system including the probe, pre-amplifier and acquisition system were validated as an entire system to ensure the reliability of test measurements.
  - b. ABM1 Validation  
 The magnetic field at the center of the Helmholtz coil is given by the equation (per C63.19 Annex D.10.1):



$$H_c = \frac{NI}{r\sqrt{1.25^3}} = \frac{N\left(\frac{V}{R}\right)}{r\sqrt{1.25^3}}$$

Where  $H_c$  = magnetic field strength in amperes per meter  
 N = number of turns per coil

For the Helmholtz Coil,  $N=20$ ;  $r=0.08\text{m}$ ;  $R=10.2\Omega$  and using  $V=18\text{mV}$ :

$$H_c = \frac{20 \cdot \left(\frac{0.018}{10.2}\right)}{0.08 \cdot \sqrt{1.25^3}} = 0.316 \text{ A/m} \approx -10 \text{ dB(A/m)}$$

Therefore a pure tone of 1kHz was applied into the coils such that 18mV was observed across the resistor. The voltmeter used for measurement was verified to be capable of measurements in the audio band range. This theoretically generates an expected field of -10 dB(A/m) in the center of the Helmholtz coil which was used to validate the probe

FCC ID: ZNFX210MA		HAC (T-COIL) TEST REPORT		Approved by: Quality Manager
Filename: 1M1710020259-11.ZNF	Test Dates: 10/03/2017	DUT Type: Portable Handset		Page 9 of 50

measurement at -10dB(A/m). This was verified to be within  $\pm 0.5$  dB of the -10dB(A/m) value (see Page 21).

c. Frequency Response Validation

The frequency response through the Helmholtz Coil was verified to be within 0.5 dB relative to 1kHz, between 300 – 3000 Hz using the P.50 signal as shown below:



Figure 4-7 Frequency Response Validation

d. ABM2 Measurement Validation

WD noise measurements are filtered with A-weighting and Half-Band Integration over a frequency range of 100Hz – 10kHz to process ABM2 measurements. Below is the verification of the system processing A-weighting and Half-Band integration between system input to output within 0.5 dB of the theoretical result:

Table 4-1  
ABM2 Frequency Response Validation

f (Hz)	HBI, A - Measured (dB re 1kHz)	HBI, A - Theoretical (dB re 1kHz)	dB Var.
100	-16.180	-16.170	-0.010
125	-13.257	-13.250	-0.007
160	-10.347	-10.340	-0.007
200	-8.017	-8.010	-0.007
250	-5.925	-5.920	-0.005
315	-4.045	-4.040	-0.005
400	-2.405	-2.400	-0.005
500	-1.212	-1.210	-0.002
630	-0.349	-0.350	0.001
800	0.071	0.070	0.001
1000	0.000	0.000	0.000
1250	-0.503	-0.500	-0.003
1600	-1.513	-1.510	-0.003
2000	-2.778	-2.780	0.002
2500	-4.316	-4.320	0.004
3150	-6.166	-6.170	0.004
4000	-8.322	-8.330	0.008
5000	-10.573	-10.590	0.017
6300	-13.178	-13.200	0.022
8000	-16.241	-16.270	0.029
10000	-19.495	-19.520	0.025

FCC ID: ZNFX210MA		HAC (T-COIL) TEST REPORT		Approved by: Quality Manager
Filename: 1M1710020259-11.ZNF	Test Dates: 10/03/2017	DUT Type: Portable Handset		Page 10 of 50

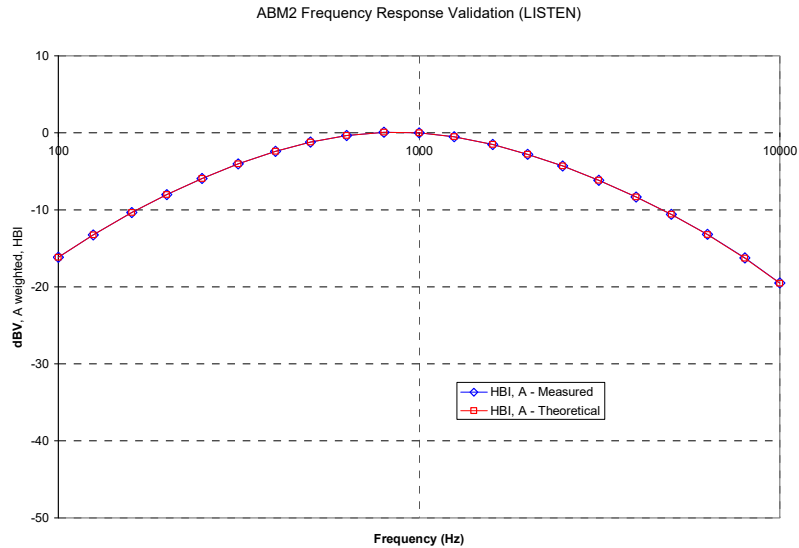

**Figure 4-8**  
**ABM2 Frequency Response Validation**

The ABM2 result is a power sum from 100Hz to 10kHz with half-band integration and A-weighting. To verify the power sum measurement, a power sum over the full band was measured and verified to track with the source level (See Figure 4-9). Therefore the setup in this step was used to verify the power sum post-processing for ABM2 measurements. See below block diagram:

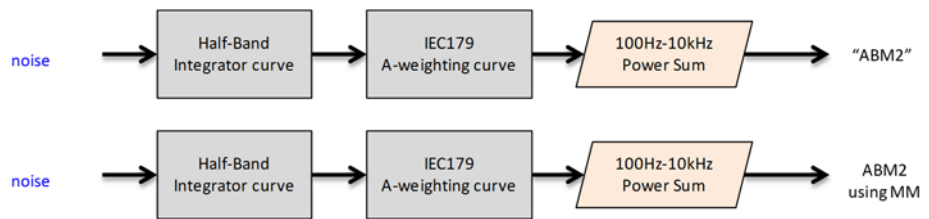

**Figure 4-9**  
**ABM2 Validation Block Diagram**

The power summed output results for a known input were compared to the multi-meter results to verify any deviation in the post-processing implemented with the power-sum.

**Table 4-2**  
**ABM2 Power Sum Validation**

WN Input (dBV)	Power Sum (dBV)	Multimeter-Full (dBV)	Dev (dB)
-60	-60.36	-60.2	0.16
-50	-50.19	-50.13	0.06
-40	-40.14	-40.03	0.11
-30	-30.13	-30.01	0.12
-20	-20.12	-20	0.12
-10	-10.14	-10	0.14

FCC ID: ZNFX210MA	PCTEST ENGINEERING LABORATORY, INC.	HAC (T-COIL) TEST REPORT	LG	Approved by: Quality Manager
Filename: 1M1710020259-11.ZNF	Test Dates: 10/03/2017	DUT Type: Portable Handset		Page 11 of 50

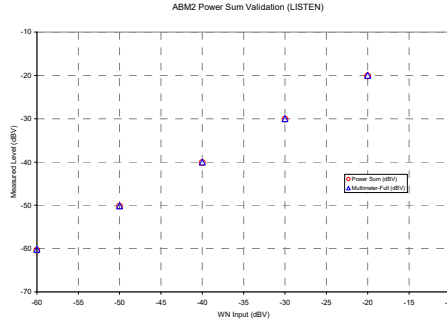
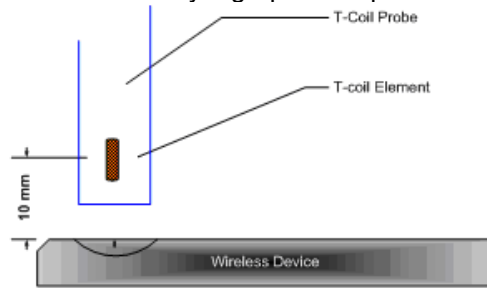

**Figure 4-10**  
**ABM2 Power Sum Validation**

3. Measurement Test Setup

a. Fine scan above the WD (TEM)

- i. A multitone signal was applied to the handset such that the phone acoustic output was stable within 1dB over the probe settling time and with the acoustic output level at the C63.19 specified levels (below). The measurement step size was in 2 mm increments at a distance of 10 mm between the surface of the wireless device as shown below (note that in Figure 4-12, the grid is not to scale but merely a graphical representation of the coordinate system in use):



**Figure 4-11**  
**Measurement Distance**

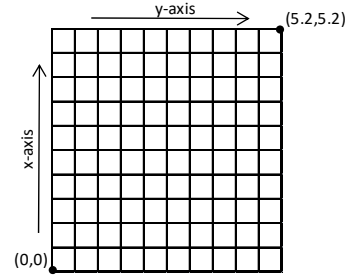

**Figure 4-12**  
**Measurement Grid**

- ii. After scanning, the planar field maximum point was determined. The position of the probe was moved to this location to setup the test using the SoundCheck system.
  - iii. These steps were repeated for all T-coil orientations (axial and radial) per Figure 4-16 after a T-coil orientation was fully measured with the SoundCheck system.
- b. Speech Signal Setup to Base Station Simulator
- i. C63.19 Table 7-1 states audio reference input levels for various technologies:

Standard	Technology	Input Level (dBm0)
TIA/EIA/IS-2000	CDMA	-18
J-STD-007	GSM (217)	-16
T1/T1P1/3GPP	UMTS (WCDMA)	-16
iDEN™	TDMA (22 and 11 Hz)	-18

The CMU200 audio levels were determined using base station simulator manufacturer calibration procedures resulting in the below corresponding voltages relative to handset test point level (in dBm0):

FCC ID: ZNFX210MA		HAC (T-COIL) TEST REPORT		Approved by: Quality Manager
Filename: 1M1710020259-11.ZNF	Test Dates: 10/03/2017	DUT Type: Portable Handset		Page 12 of 50

**Table 4-3  
CMU200 Voltage Input Levels for Audio**

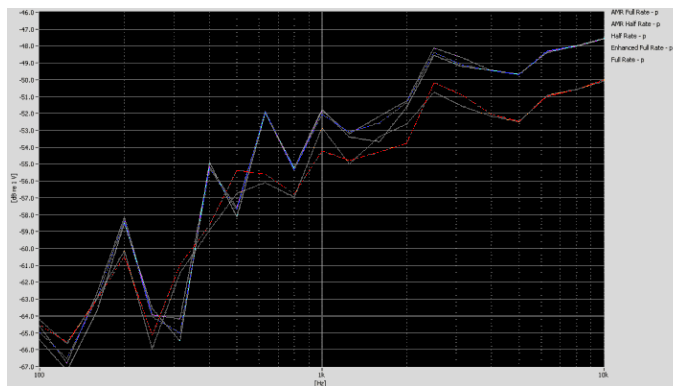

dBm0 Ref.	Voltage		Notes
3.14 dBm0	990.5 mV	-0.08 dBV	From GSM "DECODER CAL". (What is needed through Encoder for FS)
-16 dBm0	109.4 mV	-19.2 dBV	For Speechcod/Handset Low
dBm0 Ref.	Voltage		Notes
3.14 dBm0	1068.5 mV	0.58 dBV	From UMTS "DECODER CAL". (What is needed through Encoder for FS)
-16 dBm0	118.0 mV	-18.6 dBV	For Handset Low

- c. Real-Time Analyzer (RTA)
  - i. The Real-Time Analyzer was configured to analyze measurements using 1/3 Octave band weighted filtering.
- d. WD Radio Configuration Selection
  - i. The device was chosen to be tested in the worst-case ABM2 condition (see below for GSM, see Section 5 for more information regarding worst-case configurations for UMTS.):



**Figure 4-13  
Vocoder Analysis for ABM Noise for GSM**

- 4. Signal Quality Data Analysis
  - a. Narrow-band Magnetic Intensity
    - i. The standard specifies a 1kHz 1/3 octave band minimum field intensity for a sine tone. The ABM1 measurements were evaluated at 1kHz with 1/3 octave band filtering over an averaged period of 10 seconds.
  - b. Frequency Response
    - i. The appropriate frequency response curve was measured to curves in Figure 3-1 or Figure 3-2 between 300 – 3000 Hz using digital linear averaging (limit lines chosen according to measurement found in step 4a). A linear average over 3x the length of the artificial voice signal (3x sampling) was performed. A 10 second delay was configured in the measurement process of the stimulus to ensure handset vocoder latency effects and echo cancellation devices (if any) were appropriately stabilized during measurements.

FCC ID: ZNFX210MA		HAC (T-COIL) TEST REPORT		Approved by: Quality Manager
Filename: 1M1710020259-11.ZNF	Test Dates: 10/03/2017	DUT Type: Portable Handset		Page 13 of 50

- ii. The appropriate post-processing was applied according to the system processing chain illustrated in Figure 4-7. All R10 frequencies were plotted with respect to 0dB at 1kHz value and aligned with respect to the EIA-504 mask.
  - iii. The margin is represented by the closest measured data point on the curve to the EIA-504 limit lines, in dB.
- c. Signal Quality Index
- i. Ensuring the WD was at maximum RF power, maximum volume, backlight off, display on, maximum contrast setting, keypad lights on (when possible) with no audio signal through the vocoder, the WD was measured over at least 100 Hz – 10,000 Hz, maximized over 5 seconds with a 50ms sample time for the ABM2 measurement (5 second time period is used in noise measurements under standards such as IEEE 269, etc.).
  - ii. After applying half-band integration and A-weighting to the result, a power sum was applied over each 1/3 octave bandwidth frequency for an ABM2 value.
  - iii. This result was subtracted from the ABM1 result in step a, to obtain the Signal Quality.

## V. Test Setup

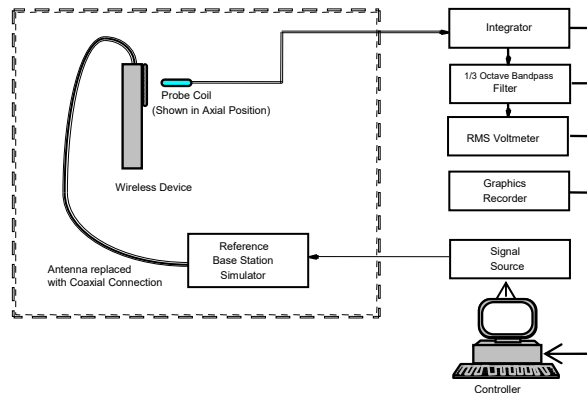

**Figure 4-14**  
**Audio Magnetic Field Test Setup**

## VI. Deviation from C63.19 Test Procedure



Non-conducted RF connection due to shielding effects of battery cover.

## VII. Air Interface Technologies Tested

All air interfaces which support voice capabilities over a managed CMRS were tested for T-coil unless otherwise noted. See Table 2-1 for more details regarding which modes were tested.

According to the April 2013 TCB workshop slides, OTT data services are outside the current definition of a managed CMRS service and are currently not required to be evaluated.

VoLTE and VoIP over WIFI CMRS air interfaces were not tested in accordance with the guidance issued by OET in KDB publication 285076 D02 T-Coil testing for CMRS IP.

FCC ID: ZNFX210MA		HAC (T-COIL) TEST REPORT		Approved by: Quality Manager
Filename: 1M1710020259-11.ZNF	Test Dates: 10/03/2017	DUT Type: Portable Handset		Page 14 of 50

## VIII. Wireless Device Channels and Frequencies

The frequencies listed in the table below are those that lie in the center of the bands used for cellular telephony. Low, middle and high channels were tested in each band for FCC compliance evaluation to ensure the maximum emission is captured across the entire band.

**Table 4-4  
Center Channels and Frequencies**

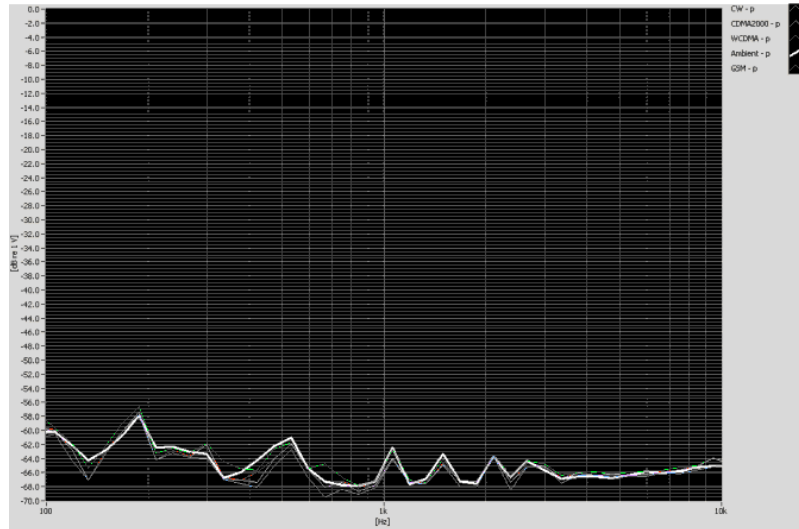

Test frequencies & associated channels	
Channel	Frequency (MHz)
<b>Cellular 850</b>	
190 (GSM)	836.60
4183 (UMTS)	836.60
<b>AWS 1750</b>	
1412 (UMTS)	1730.40
<b>PCS 1900</b>	
661 (GSM)	1880
9400 (UMTS)	1880

## IX. RF Emission Effect on T-coil Measurements



**Figure 4-15**

**High power RF Emissions Effect with HAC Dipole on the T-coil Probe System 10mm between dipole maximum and magnetic probe**

FCC ID: ZNFX210MA		HAC (T-COIL) TEST REPORT		Approved by: Quality Manager
Filename: 1M1710020259-11.ZNF	Test Dates: 10/03/2017	DUT Type: Portable Handset		Page 15 of 50

© 2017 PCTEST Engineering Laboratory, Inc.

REV 3.1.M  
09/14/2017



© 2017 PCTEST Engineering Laboratory, Inc. All rights reserved. Unless otherwise specified, no part of this report may be reproduced or utilized in any part, form or by any means, electronic or mechanical, including photocopying and microfilm, without permission in writing from PCTEST Engineering Laboratory, Inc. If you have any questions about this international copyright or have an enquiry about obtaining additional rights to this report or assembly of contents thereof, please contact [INFO@PCTESTLAB.COM](mailto:INFO@PCTESTLAB.COM).

## X. Test Flow

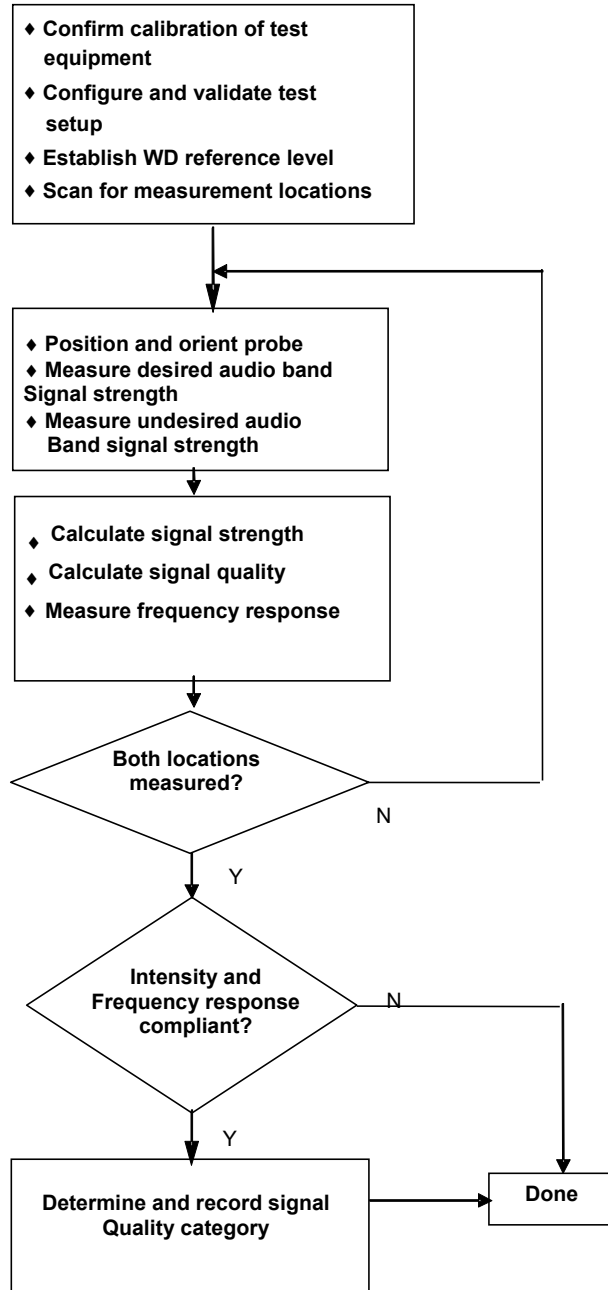
The flow diagram below was followed (From C63.19):



**Figure 4-16**  
**C63.19 T-Coil Signal Test Process**

FCC ID: ZNFX210MA		HAC (T-COIL) TEST REPORT		Approved by: Quality Manager
Filename: 1M1710020259-11.ZNF	Test Dates: 10/03/2017	DUT Type: Portable Handset	Page 16 of 50	

© 2017 PCTEST Engineering Laboratory, Inc.

REV 3.1.M

09/14/2017

© 2017 PCTEST Engineering Laboratory, Inc. All rights reserved. Unless otherwise specified, no part of this report may be reproduced or utilized in any part, form or by any means, electronic or mechanical, including photocopying and microfilm, without permission in writing from PCTEST Engineering Laboratory, Inc. If you have any questions about this international copyright or have an enquiry about obtaining additional rights to this report or assembly of contents thereof, please contact [INFO@PCTESTLAB.COM](mailto:INFO@PCTESTLAB.COM).



## 5. FCC 3G MEASUREMENTS

### I. UMTS Test Configurations

AMR at 12.2kbps, 13.6kbps SRB was used for the testing as the worst-case configuration for the handset. See below plot for ABM noise comparison between vocoder rates:

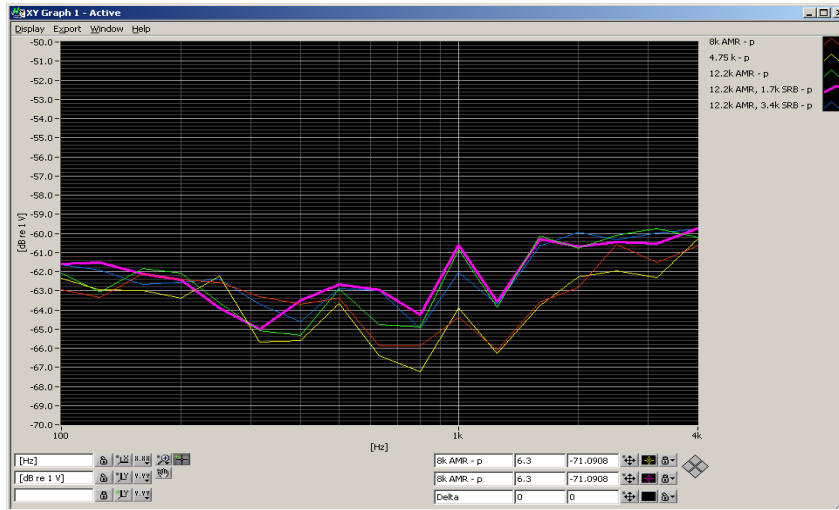

Figure 5-1  
UMTS Audio Band Magnetic Noise

Table 5-1  
FCC 3G ABM Measurements for ZNFX210MA (UMTS)

Codec Setting:	AMR 12.2kbps	AMR 7.95kbps	AMR 4.75kbps	Orientation	Channel
ABM1 Pre-test (dBA/m)	-6.00	-5.97	-6.14	Radial	9538
ABM2 Pre-test (dBA/m) (A-weight, Half-Band Int.)	-43.63	-44.05	-43.97		
S+N/N (dB)	37.63	38.08	37.83		

- Mute on; Backlight off; Max Volume; Max Contrast
- TPC="All 1s"

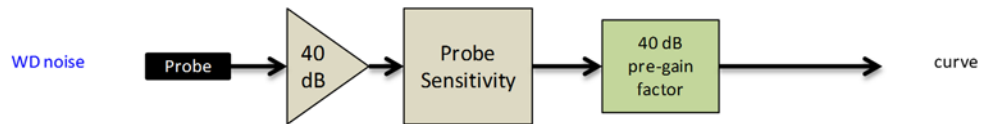

Figure 5-2  
Audio Band Magnetic Curve Measurement Block Diagram

FCC ID: ZNFX210MA		HAC (T-COIL) TEST REPORT		Approved by: Quality Manager
Filename: 1M1710020259-11.ZNF	Test Dates: 10/03/2017	DUT Type: Portable Handset		Page 17 of 50

## 6. TEST SUMMARY

### I. T-Coil Test Summary

**Table 6-1**  
**Table of Results for GSM**



C63.19 Sec.	Mode	Band	Test Description	Minimum Limit*	Measured	Verdict
				<i>dBA/m</i>	<i>dBA/m</i>	<i>PASS/FAIL</i>
8.3.1	GSM	Cellular	Intensity, Axial	-18	7.3	PASS
8.3.1			Intensity, Radial	-18	-2.2	PASS
8.3.4			Signal-to-Noise/Noise, Axial	20	28.0	PASS
8.3.4			Signal-to-Noise/Noise, Radial	20	24.6	PASS
8.3.2			Frequency Response, Axial	0	1.6	PASS
8.3.1	GSM	PCS	Intensity, Axial	-18	7.3	PASS
8.3.1			Intensity, Radial	-18	-2.3	PASS
8.3.4			Signal-to-Noise/Noise, Axial	20	33.5	PASS
8.3.4			Signal-to-Noise/Noise, Radial	20	30.5	PASS
8.3.2			Frequency Response, Axial	0	1.6	PASS

Note: The above summary table represents the worst-case numerical values according to configurations in Table 6-4.

**Table 6-2**  
**Table of Results for UMTS**

C63.19 Sec.	Mode	Band	Test Description	Minimum Limit*	Measured	Verdict
				<i>dBA/m</i>	<i>dBA/m</i>	<i>PASS/FAIL</i>
8.3.1	UMTS	Band 5	Intensity, Axial	-18	3.7	PASS
8.3.1			Intensity, Radial	-18	-5.9	PASS
8.3.4			Signal-to-Noise/Noise, Axial	20	39.5	PASS
8.3.4			Signal-to-Noise/Noise, Radial	20	38.1	PASS
8.3.2			Frequency Response, Axial	0	1.7	PASS
8.3.1	UMTS	Band 4	Intensity, Axial	-18	3.7	PASS
8.3.1			Intensity, Radial	-18	-6.0	PASS
8.3.4			Signal-to-Noise/Noise, Axial	20	39.4	PASS
8.3.4			Signal-to-Noise/Noise, Radial	20	38.1	PASS
8.3.2			Frequency Response, Axial	0	1.7	PASS
8.3.1	UMTS	Band 2	Intensity, Axial	-18	3.8	PASS
8.3.1			Intensity, Radial	-18	-6.0	PASS
8.3.4			Signal-to-Noise/Noise, Axial	20	39.2	PASS
8.3.4			Signal-to-Noise/Noise, Radial	20	37.8	PASS
8.3.2			Frequency Response, Axial	0	1.8	PASS



Note: The above summary table represents the worst-case numerical values according to configurations in Table 6-5.

FCC ID: ZNFX210MA		HAC (T-COIL) TEST REPORT		Approved by: Quality Manager
Filename: 1M1710020259-11.ZNF	Test Dates: 10/03/2017	DUT Type: Portable Handset		Page 18 of 50

**Table 6-3  
Consolidated Tabled Results**

		Freq. Response Margin		Magnetic Intensity Verdict		FCC SNNR Verdict		FCC Margin (dB)	C63.19-2011 Rating
		Axial	Radial	Axial	Radial	Axial	Radial		
<b>GSM</b>	Cellular	PASS	NA	PASS	PASS	PASS	PASS	<b>-4.57</b>	<b>T3</b>
	PCS	PASS	NA	PASS	PASS	PASS	PASS		
<b>UMTS</b>	Cellular	PASS	NA	PASS	PASS	PASS	PASS	<b>-17.81</b>	<b>T4</b>
	AWS	PASS	NA	PASS	PASS	PASS	PASS		
	PCS	PASS	NA	PASS	PASS	PASS	PASS		

Note: Result shown is for T-coil category only.

<b>FCC ID:</b> ZNFX210MA		<b>HAC (T-COIL) TEST REPORT</b>		<b>Approved by:</b> Quality Manager
<b>Filename:</b> 1M1710020259-11.ZNF	<b>Test Dates:</b> 10/03/2017	<b>DUT Type:</b> Portable Handset		Page 19 of 50

## II. Raw Handset Data

**Table 6-4**  
**Raw Data Results for GSM**

Mode	Orientation	Channel	ABM1 [dB(A/m)]	ABM2 [dB(A/m)]	Ambient Noise [dB(A/m)]	Frequency Response Margin (dB)	S+N/N (dB)	FCC Limit (dB)	FCC Margin (dB)	C63.19-2011 Rating	Test Coordinates
GSM850	Axial	128	7.28	-20.71	-58.41	1.62	27.99	20.00	-7.99	T3	3.0, 2.6
		190	7.27	-20.82		1.62	28.09	20.00	-8.09	T3	
		251	7.27	-20.85		1.62	28.12	20.00	-8.12	T3	
	Radial	128	-2.13	-27.15	-58.12	N/A	25.02	20.00	-5.02	T3	3.0, 3.2
		190	-2.15	-26.72		N/A	24.57	20.00	-4.57	T3	
		251	-2.22	-27.03		N/A	24.81	20.00	-4.81	T3	
GSM1900	Axial	512	7.25	-26.25	-58.41	1.64	33.50	20.00	-13.50	T4	3.0, 2.6
		661	7.30	-26.73		1.66	34.03	20.00	-14.03	T4	
		810	7.29	-26.67		1.60	33.96	20.00	-13.96	T4	
	Radial	512	-2.27	-32.75	-58.12	N/A	30.48	20.00	-10.48	T4	3.0, 3.2
		661	-2.30	-33.42		N/A	31.12	20.00	-11.12	T4	
		810	-2.24	-33.21		N/A	30.97	20.00	-10.97	T4	



**Table 6-5**  
**Raw Data Results for UMTS**

Mode	Orientation	Channel	ABM1 [dB(A/m)]	ABM2 [dB(A/m)]	Ambient Noise [dB(A/m)]	Frequency Response Margin (dB)	S+N/N (dB)	FCC Limit (dB)	FCC Margin (dB)	C63.19-2011 Rating	Test Coordinates
UMTS V	Axial	4132	3.85	-36.16	-58.41	1.66	40.01	20.00	-20.01	T4	3.0, 2.6
		4183	3.78	-35.76		1.69	39.54	20.00	-19.54	T4	
		4233	3.74	-35.89		1.70	39.63	20.00	-19.63	T4	
	Radial	4132	-5.78	-44.22	-58.12	N/A	38.44	20.00	-18.44	T4	3.0, 3.2
		4183	-5.84	-43.98		N/A	38.14	20.00	-18.14	T4	
		4233	-5.87	-44.00		N/A	38.13	20.00	-18.13	T4	
UMTS IV	Axial	1312	3.72	-35.63	-58.41	1.72	39.35	20.00	-19.35	T4	3.0, 2.6
		1412	3.85	-35.55		1.75	39.40	20.00	-19.40	T4	
		1513	3.83	-35.87		1.78	39.70	20.00	-19.70	T4	
	Radial	1312	-5.92	-44.20	-58.12	N/A	38.28	20.00	-18.28	T4	3.0, 3.2
		1412	-5.93	-44.06		N/A	38.13	20.00	-18.13	T4	
		1513	-5.95	-44.13		N/A	38.18	20.00	-18.18	T4	
UMTS II	Axial	9262	3.81	-35.46	-58.41	1.76	39.27	20.00	-19.27	T4	3.0, 2.6
		9400	3.83	-35.67		1.78	39.50	20.00	-19.50	T4	
		9538	3.85	-35.36		1.76	39.21	20.00	-19.21	T4	
	Radial	9262	-5.95	-44.19	-58.12	N/A	38.24	20.00	-18.24	T4	3.0, 3.2
		9400	-5.99	-43.85		N/A	37.86	20.00	-17.86	T4	
		9538	-5.97	-43.78		N/A	37.81	20.00	-17.81	T4	

## III. Test Notes

### A. General

1. Phone Condition: Mute on; Backlight off; Max Volume; Max Contrast
2. 'Radial' orientation refers to radial transverse.
3. Hearing Aid Mode (**Phone→Call Settings→More→Hearing aids**) as well as Noise Suppression Mode (**Phone→Call Settings→More→Noise Suppression**) was set to ON for Frequency Response compliance.

FCC ID: ZNFX210MA		HAC (T-COIL) TEST REPORT		Approved by: Quality Manager
Filename: 1M1710020259-11.ZNF	Test Dates: 10/03/2017	DUT Type: Portable Handset	Page 20 of 50	

B. GSM

1. Power Configuration: GSM850: PCL=5, GSM1900: PCL=0;
2. Vocoder Configuration: EFR (GSM);
3. Speech Signal: ITU-T P.50 Artificial Voice

C. UMTS

1. Power Configuration: TPC="All 1s";
2. Vocoder Configuration: AMR 12.2 kbps (UMTS);
3. Speech Signal: ITU-T P.50 Artificial Voice

IV. 1 kHz Vocoder Application Check

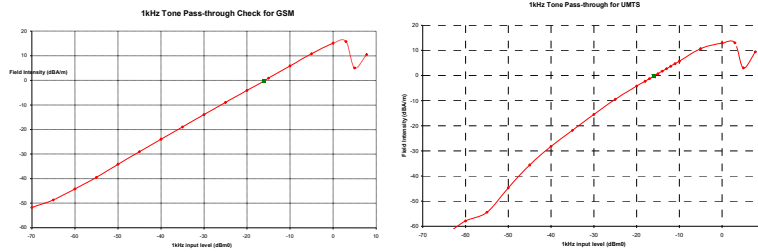



This model was verified to be within the linear region for ABM1 measurements at -16 dBm0 for GSM, and UMTS. This measurement was taken in the axial configuration above the maximum location.

V. T-Coil Validation Test Results

Table 6-6  
Helmholtz Coil Validation Table of Results

Item	Target	Result	Verdict
<b>Axial</b>			
Magnetic Intensity, -10 dBA/m	-10 ± 0.5 dB	-10.200	PASS
Environmental Noise	< -58 dBA/m	-58.41	PASS
Frequency Response, from limits	> 0 dB	0.80	PASS
<b>Radial</b>			
Magnetic Intensity, -10 dBA/m	-10 ± 0.5 dB	-10.358	PASS
Environmental Noise	< -58 dBA/m	-58.12	PASS
Frequency Response, from limits	> 0 dB	0.80	PASS

FCC ID: ZNFX210MA		HAC (T-COIL) TEST REPORT		Approved by: Quality Manager
Filename: 1M1710020259-11.ZNF	Test Dates: 10/03/2017	DUT Type: Portable Handset		Page 21 of 50

## VI. ABM1 Magnetic Field Distribution Scan Overlays

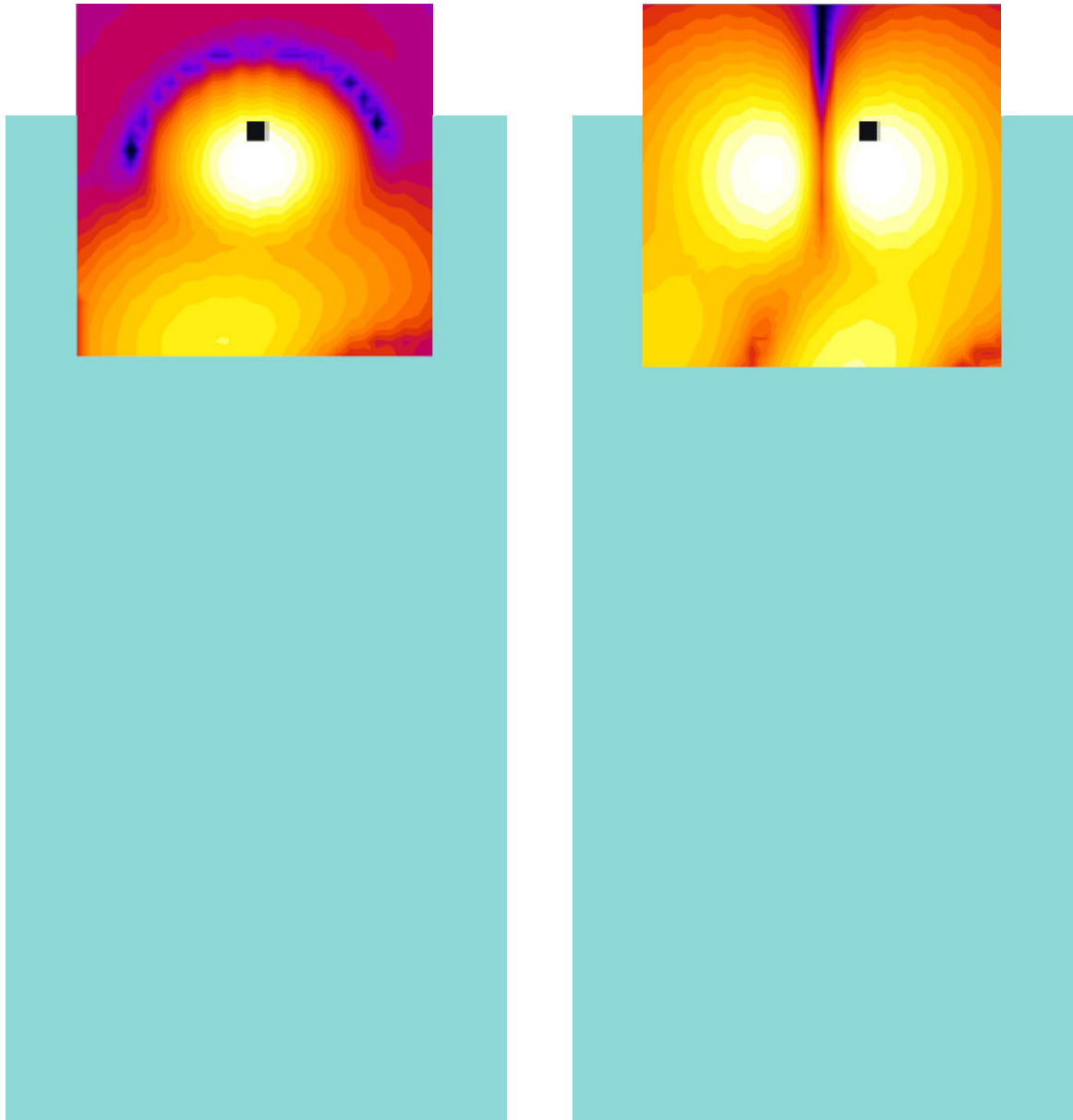



Axial

Radial (Transverse)

**Figure 6-1**  
**T-Coil Scan Overlay Magnetic Field Distributions**

**Notes:**

1. Final measurement locations are indicated by a cursor on the contour plots.
2. See Test Setup Photographs for actual WD overlay.

FCC ID: ZNFX210MA	 <b>PCTEST</b> ENGINEERING LABORATORY, INC.	HAC (T-COIL) TEST REPORT	 <b>Approved by:</b> Quality Manager
<b>Filename:</b> 1M1710020259-11.ZNF	<b>Test Dates:</b> 10/03/2017	<b>DUT Type:</b> Portable Handset	Page 22 of 50

© 2017 PCTEST Engineering Laboratory, Inc.

REV 3.1.M  
09/14/2017

© 2017 PCTEST Engineering Laboratory, Inc. All rights reserved. Unless otherwise specified, no part of this report may be reproduced or utilized in any part, form or by any means, electronic or mechanical, including photocopying and microfilm, without permission in writing from PCTEST Engineering Laboratory, Inc. If you have any questions about this international copyright or have an enquiry about obtaining additional rights to this report or assembly of contents thereof, please contact [INFO@PCTESTLAB.COM](mailto:INFO@PCTESTLAB.COM).

## 7. MEASUREMENT UNCERTAINTY



**Table 7-1  
Uncertainty Estimation Table**

Contribution	Data +/- %	Data +/- dB	Data Type	Probability distribution	Divisor	Standard uncertainty	Standard Uncertainty (dB)
ABM Noise	7.0%	0.29	Std. Dev.	Normal k=1	1.00	7.0%	
RF Reflections	4.7%	0.20	Specification	Rectangular	1.73	2.7%	
Reference Signal Level	12.2%	0.50	Specification	Rectangular	1.73	7.0%	
Positioning Accuracy	10.0%	0.41	Uncertainty	Rectangular	1.73	5.8%	
Probe Coil Sensitivity	12.2%	0.50	Specification	Rectangular	1.73	7.0%	
Probe Linearity	2.4%	0.10	Std. Dev.	Normal k=1	1.00	2.4%	
Cable Loss	2.8%	0.12	Specification	Rectangular	1.73	1.6%	
Frequency Analyzer	5.0%	0.21	Specification	Rectangular	1.73	2.9%	
System Repeatability	5.0%	0.21	Std. Dev.	Normal k=1	1.00	5.0%	
WD Repeatability	9.0%	0.37	Std. Dev.	Normal k=1	1.00	9.0%	
Positioner Accuracy	1.0%	0.04	Specification	Rectangular	1.73	0.6%	
Combined standard uncertainty, uc (k=1)						17.7%	0.71
Expanded uncertainty (k=2), 95% confidence level						35.3%	1.31

**Notes:**

1. Test equipments are calibrated according to techniques outlined in NIS81, NIS3003 and NIST Tech Note 1297.
2. All equipments have traceability according to NIST. Measurement Uncertainties are defined in further detail in NIS 81 and NIST Tech Note 1297 and UKAS M3003.



Measurement uncertainty reflects the quality and accuracy of a measured result as compared to the true value. Such statements are generally required when stating results of measurements so that it is clear to the intended audience that the results may differ when reproduced by different facilities. Measurement results vary due to the measurement uncertainty of the instrumentation, measurement technique, and test engineer. Most uncertainties are calculated using the tolerances of the instrumentation used in the measurement, the measurement setup variability, and the technique used in performing the test. While not generally included, the variability of the equipment under test also figures into the overall measurement uncertainty. Another component of the overall uncertainty is based on the variability of repeated measurements (so-called Type A uncertainty). This may mean that the Hearing Aid compatibility tests may have to be repeated by taking down the test setup and resetting it up so that there are a statistically significant number of repeat measurements to identify the measurement uncertainty. By combining the repeat measurement results with that of the instrumentation chain using the technique contained in NIS 81 and NIS 3003, the overall measurement uncertainty was estimated.

<b>FCC ID:</b> ZNFX210MA		<b>HAC (T-COIL) TEST REPORT</b>		<b>Approved by:</b> Quality Manager
<b>Filename:</b> 1M1710020259-11.ZNF	<b>Test Dates:</b> 10/03/2017	<b>DUT Type:</b> Portable Handset	Page 23 of 50	

## 8. EQUIPMENT LIST

**Table 8-1  
Equipment List**

Manufacturer	Model	Description	Cal Date	Cal Interval	Cal Due	Serial Number
Dell	Latitude E6540	SoundCheck Acoustic Analyzer Laptop	4/11/2017	Annual	4/11/2018	7BFNM32
Listen	SoundConnect	Microphone Power Supply	12/2/2016	Annual	12/2/2017	PS2612
RME	Fireface UC	SoundCheck Acoustic Analyzer External Audio Interface	4/11/2017	Annual	4/11/2018	23528889
Rohde & Schwarz	CMU200	Radio Communication Tester	N/A	N/A	N/A	107826
TEM	Radial T-Coil Probe	Radial T-Coil Probe	12/7/2016	Annual	12/7/2017	TEM-1130
TEM	Axial T-Coil Probe	Axial T-Coil Probe	12/7/2016	Annual	12/7/2017	TEM-1124
TEM	Helmholtz Coil	Helmholtz Coil	12/7/2016	Annual	12/7/2017	925
TEM		HAC System Controller with Software	N/A	N/A	N/A	N/A
TEM		HAC Positioner	N/A	N/A	N/A	N/A

FCC ID: ZNFX210MA		HAC (T-COIL) TEST REPORT		Approved by: Quality Manager
Filename: 1M1710020259-11.ZNF	Test Dates: 10/03/2017	DUT Type: Portable Handset		Page 24 of 50



© 2017 PCTEST Engineering Laboratory, Inc.

REV 3.1.M  
09/14/2017

© 2017 PCTEST Engineering Laboratory, Inc. All rights reserved. Unless otherwise specified, no part of this report may be reproduced or utilized in any part, form or by any means, electronic or mechanical, including photocopying and microfilm, without permission in writing from PCTEST Engineering Laboratory, Inc. If you have any questions about this international copyright or have an enquiry about obtaining additional rights to this report or assembly of contents thereof, please contact [INFO@PCTESTLAB.COM](mailto:INFO@PCTESTLAB.COM).



# 9. TEST DATA

<b>FCC ID:</b> ZNFX210MA		<b>HAC (T-COIL) TEST REPORT</b>		<b>Approved by:</b> Quality Manager
<b>Filename:</b> 1M1710020259-11.ZNF	<b>Test Dates:</b> 10/03/2017	<b>DUT Type:</b> Portable Handset	Page 25 of 50	

  
**PCTEST Hearing-Aid Compatibility Facility**

**DUT: HH Coil – SN: 925**

Type: HH Coil  
Serial: 925

**Measurement Standard:** ANSI C63.19-2011

**Equipment:**

- Probe: Axial T-Coil Probe – SN: TEM-1124; Calibrated: 12/07/2016
- Helmholtz Coil – SN: 925; Calibrated: 12/07/2016

**Noise Spectrum**

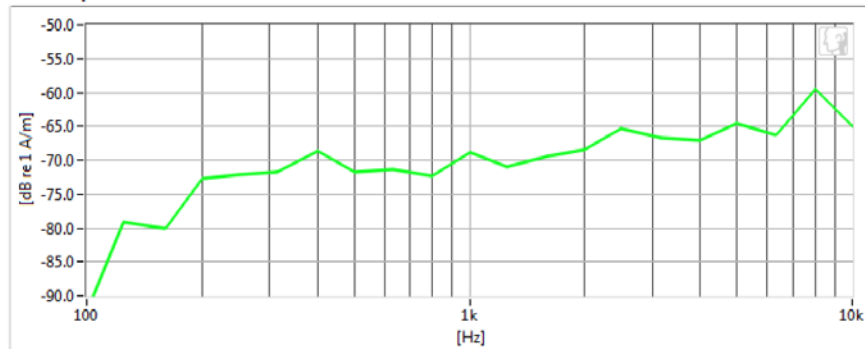

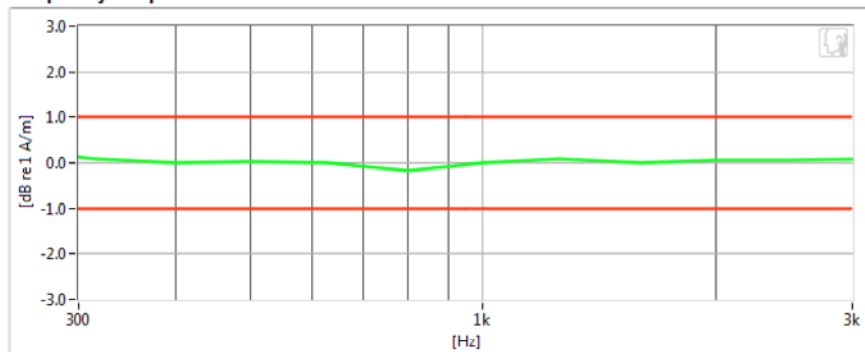

**Frequency Response**



**Results**

Verification 1kHz Intensity	-10.2 dB	✓	Max/Min	-9.5/-10.5
Verification ABM2	-58.41 dB	✓	Maximum	-58.0
Frequency Response Margin	800m dB	✓	Tolerance curves	Aligned Data

PCTEST 2017

FCC ID: ZNFX210MA		HAC (T-COIL) TEST REPORT		Approved by: Quality Manager
Filename: 1M1710020259-11.ZNF	Test Dates: 10/03/2017	DUT Type: Portable Handset		Page 26 of 50

© 2017 PCTEST Engineering Laboratory, Inc.

REV 3.1.M  
09/14/2017

© 2017 PCTEST Engineering Laboratory, Inc. All rights reserved. Unless otherwise specified, no part of this report may be reproduced or utilized in any part, form or by any means, electronic or mechanical, including photocopying and microfilm, without permission in writing from PCTEST Engineering Laboratory, Inc. If you have any questions about this international copyright or have an enquiry about obtaining additional rights to this report or assembly of contents thereof, please contact [INFO@PCTESTLAB.COM](mailto:INFO@PCTESTLAB.COM).



**PCTEST Hearing-Aid Compatibility Facility**

**DUT: HH Coil – SN: 925**

Type: HH Coil  
Serial: 925

**Measurement Standard:** ANSI C63.19-2011

**Equipment:**

- Probe: Radial T-Coil Probe – SN: TEM-1130; Calibrated: 12/07/2016
- Helmholtz Coil – SN: 925; Calibrated: 12/07/2016

**Noise Spectrum**

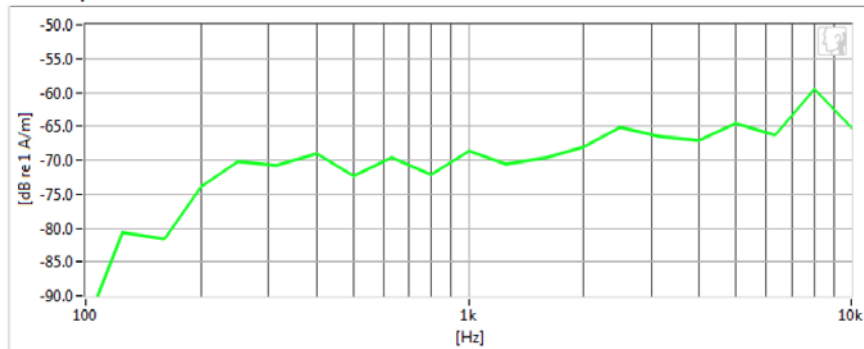

**Frequency Response**

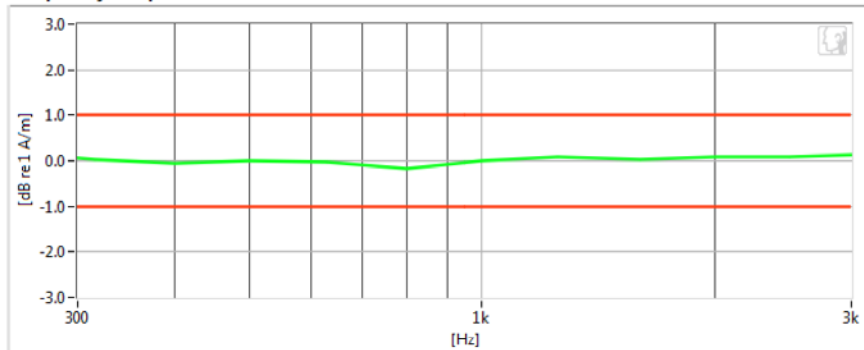

**Results**

Verification 1kHz Intensity	-10.358 dB	✓	Max/Min	-9.5/-10.5
Verification ABM2	-58.12 dB	✓	Maximum	-58.0
Frequency Response Margin	800m dB	✓	Tolerance curves	Aligned Data

PCTEST 2017

FCC ID: ZNFX210MA	PCTEST ENGINEERING LABORATORY, INC.	HAC (T-COIL) TEST REPORT	LG	Approved by: Quality Manager
Filename: 1M1710020259-11.ZNF	Test Dates: 10/03/2017	DUT Type: Portable Handset		Page 27 of 50

© 2017 PCTEST Engineering Laboratory, Inc.

REV 3.1.M  
09/14/2017

© 2017 PCTEST Engineering Laboratory, Inc. All rights reserved. Unless otherwise specified, no part of this report may be reproduced or utilized in any part, form or by any means, electronic or mechanical, including photocopying and microfilm, without permission in writing from PCTEST Engineering Laboratory, Inc. If you have any questions about this international copyright or have an enquiry about obtaining additional rights to this report or assembly of contents thereof, please contact [INFO@PCTESTLAB.COM](mailto:INFO@PCTESTLAB.COM).

  
**PCTEST Hearing-Aid Compatibility Facility**

**DUT: ZNFX210MA**

Type: Portable Handset  
Serial: 71462

**Measurement Standard:** ANSI C63.19-2011

**Equipment:**

- Probe: Axial T-Coil Probe – SN: TEM-1124; Calibrated: 12/07/2016

**Test Configuration:**

- Mode: GSM 850
- Channel: 128
- Speech Signal: ITU-T P.50 Artificial Voice

**Noise Spectrum**

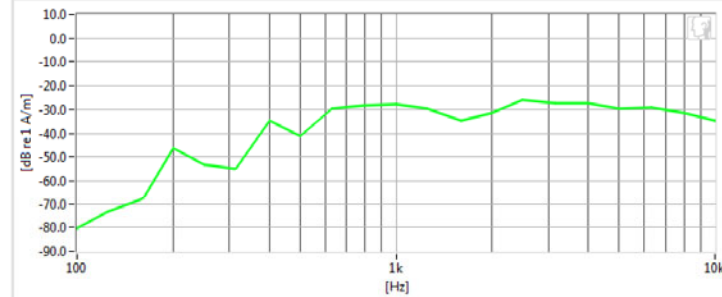

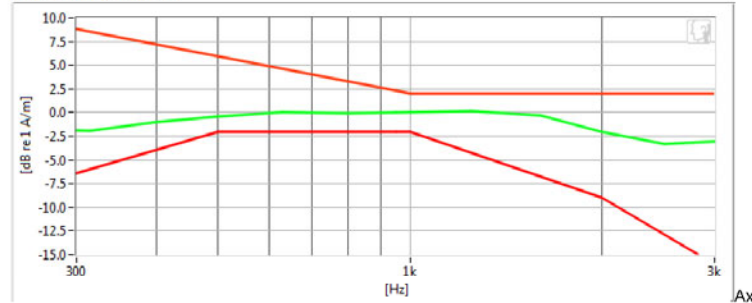

**Frequency Response**



**Results**

ABM1	7.28 dB	✓	Minimum	-18.0
ABM2	-20.71 dB	✓	Maximum	0
SNNR	27.99 dB	✓	Minimum	20
Aligned Response - P.50	1.62 dB	✓	Tolerance curves	Aligned Data

PCTEST 2017

FCC ID: ZNFX210MA		<b>HAC (T-COIL) TEST REPORT</b>		<b>Approved by:</b> Quality Manager
<b>Filename:</b> 1M1710020259-11.ZNF	<b>Test Dates:</b> 10/03/2017	<b>DUT Type:</b> Portable Handset	Page 28 of 50	

© 2017 PCTEST Engineering Laboratory, Inc.

REV 3.1.M  
09/14/2017

© 2017 PCTEST Engineering Laboratory, Inc. All rights reserved. Unless otherwise specified, no part of this report may be reproduced or utilized in any part, form or by any means, electronic or mechanical, including photocopying and microfilm, without permission in writing from PCTEST Engineering Laboratory, Inc. If you have any questions about this international copyright or have an enquiry about obtaining additional rights to this report or assembly of contents thereof, please contact [INFO@PCTESTLAB.COM](mailto:INFO@PCTESTLAB.COM).

  
**PCTEST Hearing-Aid Compatibility Facility**

**DUT: ZNFX210MA**

Type: Portable Handset  
Serial: 71462

**Measurement Standard:** ANSI C63.19-2011

**Equipment:**

- Probe: Axial T-Coil Probe – SN: TEM-1124; Calibrated: 12/07/2016

**Test Configuration:**

- Mode: GSM 1900
- Channel: 512
- Speech Signal: ITU-T P.50 Artificial Voice

**Noise Spectrum**

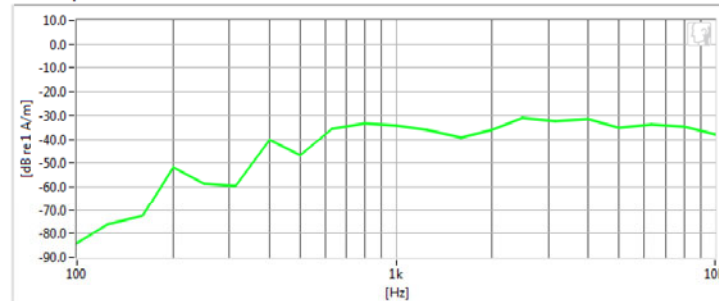

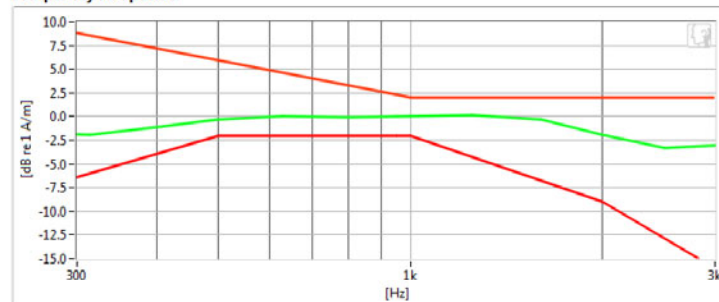

**Frequency Response**



**Results**

ABM1	7.25 dB	✓	Minimum	-18.0
ABM2	-26.26 dB	✓	Maximum	0.0
SNNR	33.5 dB	✓	Minimum	20.0
Aligned Response - P.50	1.64 dB	✓	Tolerance curves	Aligned Data

PCTEST 2017

<b>FCC ID:</b> ZNFX210MA		<b>HAC (T-COIL) TEST REPORT</b>		<b>Approved by:</b> Quality Manager
<b>Filename:</b> 1M1710020259-11.ZNF	<b>Test Dates:</b> 10/03/2017	<b>DUT Type:</b> Portable Handset		Page 29 of 50

© 2017 PCTEST Engineering Laboratory, Inc.

REV 3.1.M

09/14/2017

© 2017 PCTEST Engineering Laboratory, Inc. All rights reserved. Unless otherwise specified, no part of this report may be reproduced or utilized in any part, form or by any means, electronic or mechanical, including photocopying and microfilm, without permission in writing from PCTEST Engineering Laboratory, Inc. If you have any questions about this international copyright or have an enquiry about obtaining additional rights to this report or assembly of contents thereof, please contact [INFO@PCTESTLAB.COM](mailto:INFO@PCTESTLAB.COM).

  
**PCTEST Hearing-Aid Compatibility Facility**

**DUT: ZNFX210MA**

Type: Portable Handset  
Serial: 71462

**Measurement Standard:** ANSI C63.19-2011

**Equipment:**

- Probe: Axial T-Coil Probe – SN: TEM-1124; Calibrated: 12/07/2016

**Test Configuration:**

- Mode: UMTS Band V
- Channel: 4183
- Speech Signal: ITU-T P.50 Artificial Voice

**Noise Spectrum**

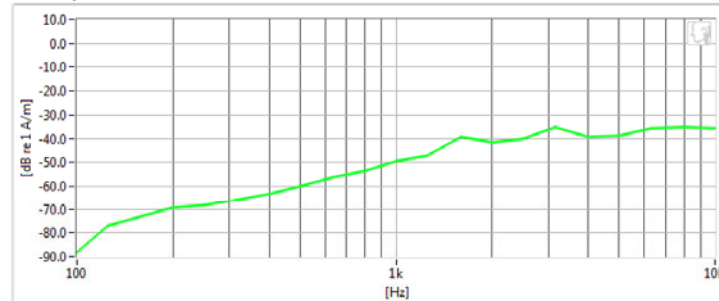

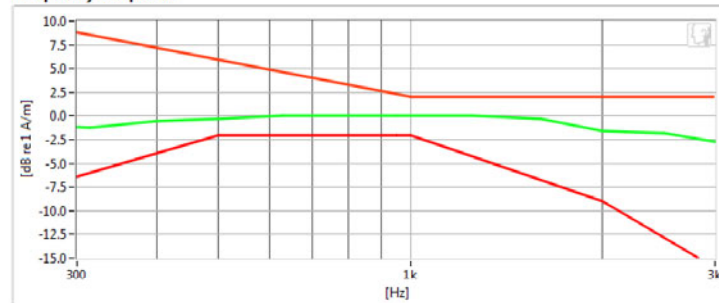

**Frequency Response**



**Results**

ABM1	3.78 dB	✓	Minimum	-18.0
ABM2	-35.76 dB	✓	Maximum	0.0
SNNR	39.54 dB	✓	Minimum	20.0
Aligned Response - P.50	1.69 dB	✓	Tolerance curves	Aligned Data

PCTEST 2017

FCC ID: ZNFX210MA		<b>HAC (T-COIL) TEST REPORT</b>		<b>Approved by:</b> Quality Manager
<b>Filename:</b> 1M1710020259-11.ZNF	<b>Test Dates:</b> 10/03/2017	<b>DUT Type:</b> Portable Handset	Page 30 of 50	

© 2017 PCTEST Engineering Laboratory, Inc.

REV 3.1.M  
09/14/2017

© 2017 PCTEST Engineering Laboratory, Inc. All rights reserved. Unless otherwise specified, no part of this report may be reproduced or utilized in any part, form or by any means, electronic or mechanical, including photocopying and microfilm, without permission in writing from PCTEST Engineering Laboratory, Inc. If you have any questions about this international copyright or have an enquiry about obtaining additional rights to this report or assembly of contents thereof, please contact [INFO@PCTESTLAB.COM](mailto:INFO@PCTESTLAB.COM).

  
**PCTEST Hearing-Aid Compatibility Facility**

**DUT: ZNFX210MA**

Type: Portable Handset  
Serial: 71462

**Measurement Standard:** ANSI C63.19-2011

**Equipment:**

- Probe: Axial T-Coil Probe – SN: TEM-1124; Calibrated: 12/07/2016

**Test Configuration:**

- Mode: UMTS Band IV
- Channel: 1312
- Speech Signal: ITU-T P.50 Artificial Voice

**Noise Spectrum**

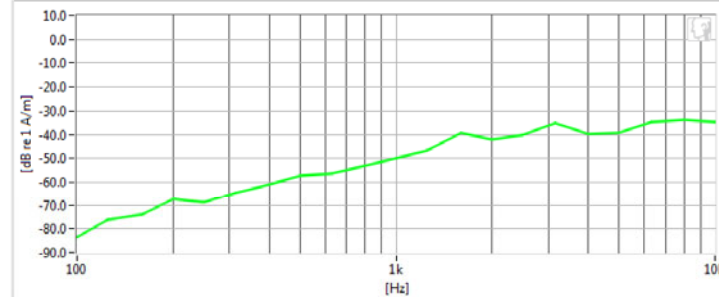

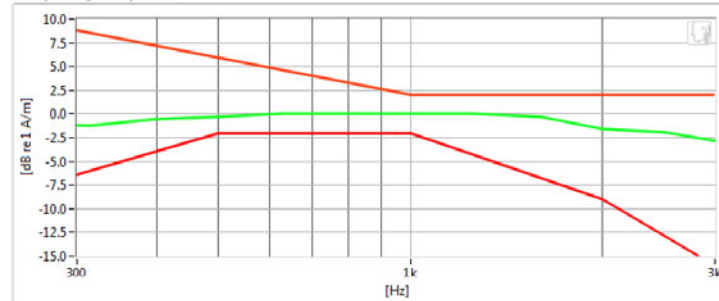

**Frequency Response**



**Results**

ABM1	3.72 dB	✓	Minimum	-18.0
ABM2	-35.63 dB	✓	Maximum	0
SNNR	39.35 dB	✓	Minimum	20
Aligned Response - P.50	1.72 dB	✓	Tolerance curves	Aligned Data

PCTEST 2017

<b>FCC ID:</b> ZNFX210MA		<b>HAC (T-COIL) TEST REPORT</b>		<b>Approved by:</b> Quality Manager
<b>Filename:</b> 1M1710020259-11.ZNF	<b>Test Dates:</b> 10/03/2017	<b>DUT Type:</b> Portable Handset	Page 31 of 50	

© 2017 PCTEST Engineering Laboratory, Inc.

REV 3.1.M

09/14/2017

© 2017 PCTEST Engineering Laboratory, Inc. All rights reserved. Unless otherwise specified, no part of this report may be reproduced or utilized in any part, form or by any means, electronic or mechanical, including photocopying and microfilm, without permission in writing from PCTEST Engineering Laboratory, Inc. If you have any questions about this international copyright or have an enquiry about obtaining additional rights to this report or assembly of contents thereof, please contact [INFO@PCTESTLAB.COM](mailto:INFO@PCTESTLAB.COM).

  
**PCTEST Hearing-Aid Compatibility Facility**

**DUT: ZNFX210MA**

Type: Portable Handset  
Serial: 71462

**Measurement Standard:** ANSI C63.19-2011

**Equipment:**

- Probe: Axial T-Coil Probe – SN: TEM-1124; Calibrated: 12/07/2016

**Test Configuration:**

- Mode: UMTS Band II
- Channel: 9538
- Speech Signal: ITU-T P.50 Artificial Voice

**Noise Spectrum**

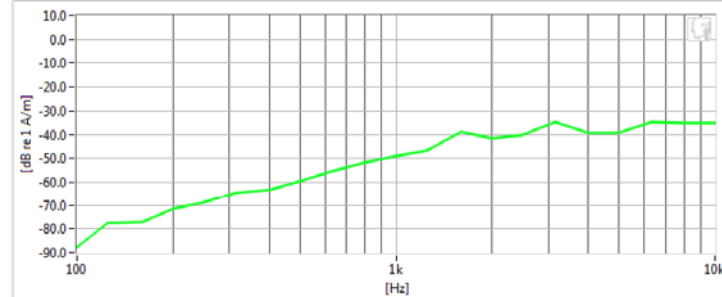

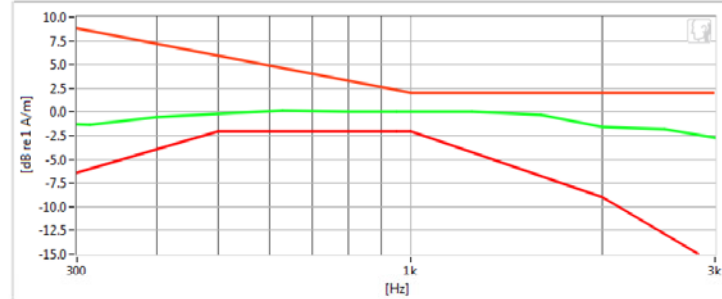

**Frequency Response**



**Results**

ABM1	3.85 dB	✓	Minimum	-18.0
ABM2	-35.36 dB	✓	Maximum	0
SNNR	39.21 dB	✓	Minimum	20
Aligned Response - P.50	1.76 dB	✓	Tolerance curves	Aligned Data

PCTEST 2017

<b>FCC ID:</b> ZNFX210MA		<b>HAC (T-COIL) TEST REPORT</b>		<b>Approved by:</b> Quality Manager
<b>Filename:</b> 1M1710020259-11.ZNF	<b>Test Dates:</b> 10/03/2017	<b>DUT Type:</b> Portable Handset		Page 32 of 50

© 2017 PCTEST Engineering Laboratory, Inc.

REV 3.1.M  
09/14/2017

© 2017 PCTEST Engineering Laboratory, Inc. All rights reserved. Unless otherwise specified, no part of this report may be reproduced or utilized in any part, form or by any means, electronic or mechanical, including photocopying and microfilm, without permission in writing from PCTEST Engineering Laboratory, Inc. If you have any questions about this international copyright or have an enquiry about obtaining additional rights to this report or assembly of contents thereof, please contact [INFO@PCTESTLAB.COM](mailto:INFO@PCTESTLAB.COM).



  
**PCTEST Hearing-Aid Compatibility Facility**

**DUT: ZNFX210MA**

Type: Portable Handset  
Serial: 71462

**Measurement Standard:** ANSI C63.19-2011

**Equipment:**

- Probe: Radial T-Coil Probe – SN: TEM-1130; Calibrated: 12/07/2016

**Test Configuration:**

- Mode: GSM 850
- Channel: 190

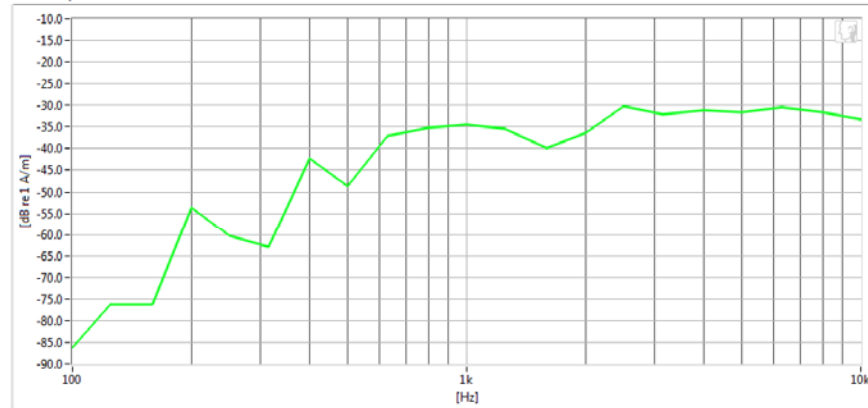

**Noise Spectrum**



**Results**

ABM1	-2.15 dB	✓	Minimum	-18.0
ABM2	-26.72 dB	✓	Maximum	0.0
SNNR	24.57 dB	✓	Minimum	20.0

PCTEST 2017

<b>FCC ID:</b> ZNFX210MA		<b>HAC (T-COIL) TEST REPORT</b>		<b>Approved by:</b> Quality Manager
<b>Filename:</b> 1M1710020259-11.ZNF	<b>Test Dates:</b> 10/03/2017	<b>DUT Type:</b> Portable Handset	Page 33 of 50	

© 2017 PCTEST Engineering Laboratory, Inc.

REV 3.1.M  
09/14/2017

© 2017 PCTEST Engineering Laboratory, Inc. All rights reserved. Unless otherwise specified, no part of this report may be reproduced or utilized in any part, form or by any means, electronic or mechanical, including photocopying and microfilm, without permission in writing from PCTEST Engineering Laboratory, Inc. If you have any questions about this international copyright or have an enquiry about obtaining additional rights to this report or assembly of contents thereof, please contact [INFO@PCTESTLAB.COM](mailto:INFO@PCTESTLAB.COM).

  
**PCTEST Hearing-Aid Compatibility Facility**

**DUT: ZNFX210MA**

Type: Portable Handset  
Serial: 71462

**Measurement Standard:** ANSI C63.19-2011

**Equipment:**

- Probe: Radial T-Coil Probe – SN: TEM-1130; Calibrated: 12/07/2016

**Test Configuration:**

- Mode: GSM 1900
- Channel: 512

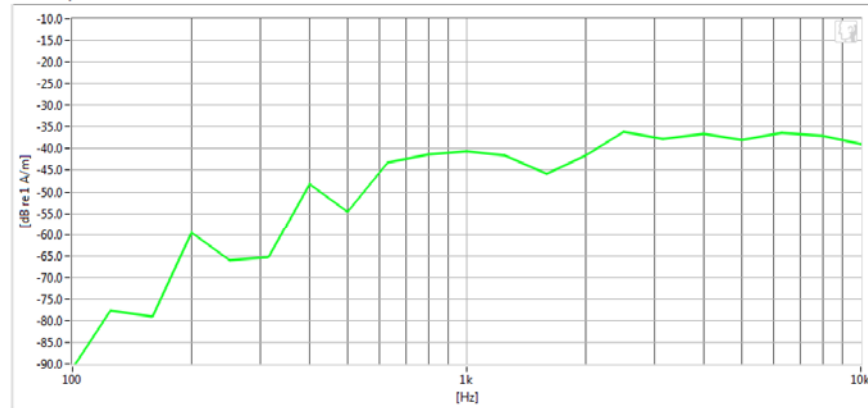

**Noise Spectrum**



**Results**

ABM1	-2.27 dB	✓	Minimum	-18.0
ABM2	-32.75 dB	✓	Maximum	0.0
SNNR	30.48 dB	✓	Minimum	20.0

PCTEST 2017

<b>FCC ID:</b> ZNFX210MA		<b>HAC (T-COIL) TEST REPORT</b>		<b>Approved by:</b> Quality Manager
<b>Filename:</b> 1M1710020259-11.ZNF	<b>Test Dates:</b> 10/03/2017	<b>DUT Type:</b> Portable Handset	Page 34 of 50	

© 2017 PCTEST Engineering Laboratory, Inc.

REV 3.1.M  
09/14/2017

© 2017 PCTEST Engineering Laboratory, Inc. All rights reserved. Unless otherwise specified, no part of this report may be reproduced or utilized in any part, form or by any means, electronic or mechanical, including photocopying and microfilm, without permission in writing from PCTEST Engineering Laboratory, Inc. If you have any questions about this international copyright or have an enquiry about obtaining additional rights to this report or assembly of contents thereof, please contact [INFO@PCTESTLAB.COM](mailto:INFO@PCTESTLAB.COM).

  
**PCTEST Hearing-Aid Compatibility Facility**

**DUT: ZNFX210MA**

Type: Portable Handset  
Serial: 71462

**Measurement Standard:** ANSI C63.19-2011

**Equipment:**

- Probe: Radial T-Coil Probe – SN: TEM-1130; Calibrated: 12/07/2016

**Test Configuration:**

- Mode: UMTS Band V
- Channel: 4233

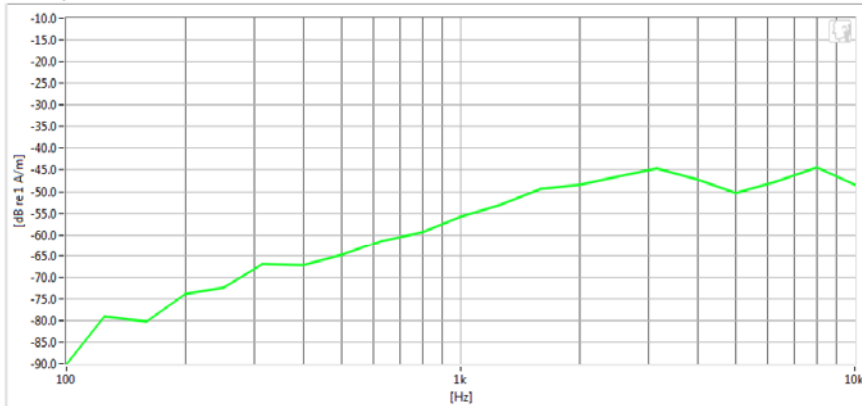

**Noise Spectrum**



**Results**

ABM1	-5.87 dB	✓	Minimum	-18.0
ABM2	-44 dB	✓	Maximum	0.0
SNNR	38.13 dB	✓	Minimum	20.0

PCTEST 2017

FCC ID: ZNFX210MA		HAC (T-COIL) TEST REPORT		Approved by: Quality Manager
Filename: 1M1710020259-11.ZNF	Test Dates: 10/03/2017	DUT Type: Portable Handset		Page 35 of 50

© 2017 PCTEST Engineering Laboratory, Inc.

REV 3.1.M  
09/14/2017

© 2017 PCTEST Engineering Laboratory, Inc. All rights reserved. Unless otherwise specified, no part of this report may be reproduced or utilized in any part, form or by any means, electronic or mechanical, including photocopying and microfilm, without permission in writing from PCTEST Engineering Laboratory, Inc. If you have any questions about this international copyright or have an enquiry about obtaining additional rights to this report or assembly of contents thereof, please contact [INFO@PCTESTLAB.COM](mailto:INFO@PCTESTLAB.COM).

  
**PCTEST Hearing-Aid Compatibility Facility**

**DUT: ZNFX210MA**

Type: Portable Handset  
Serial: 71462

**Measurement Standard:** ANSI C63.19-2011

**Equipment:**

- Probe: Radial T-Coil Probe – SN: TEM-1130; Calibrated: 12/07/2016

**Test Configuration:**

- Mode: UMTS Band IV
- Channel: 1412

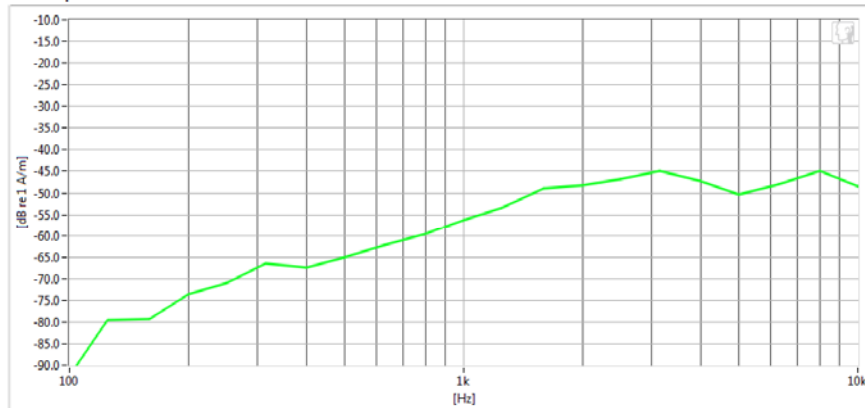

**Noise Spectrum**



**Results**

ABM1	-5.93 dB	✓	Minimum	-18.0
ABM2	-44.06 dB	✓	Maximum	0.0
SNNR	38.13 dB	✓	Minimum	20.0

PCTEST 2017

FCC ID: ZNFX210MA		HAC (T-COIL) TEST REPORT		Approved by: Quality Manager
Filename: 1M1710020259-11.ZNF	Test Dates: 10/03/2017	DUT Type: Portable Handset		Page 36 of 50

© 2017 PCTEST Engineering Laboratory, Inc.

REV 3.1.M  
09/14/2017

© 2017 PCTEST Engineering Laboratory, Inc. All rights reserved. Unless otherwise specified, no part of this report may be reproduced or utilized in any part, form or by any means, electronic or mechanical, including photocopying and microfilm, without permission in writing from PCTEST Engineering Laboratory, Inc. If you have any questions about this international copyright or have an enquiry about obtaining additional rights to this report or assembly of contents thereof, please contact [INFO@PCTESTLAB.COM](mailto:INFO@PCTESTLAB.COM).

  
**PCTEST Hearing-Aid Compatibility Facility**

**DUT: ZNFX210MA**

Type: Portable Handset  
Serial: 71462

**Measurement Standard:** ANSI C63.19-2011

**Equipment:**

- Probe: Radial T-Coil Probe – SN: TEM-1130; Calibrated: 12/07/2016

**Test Configuration:**

- Mode: UMTS Band II
- Channel: 9538

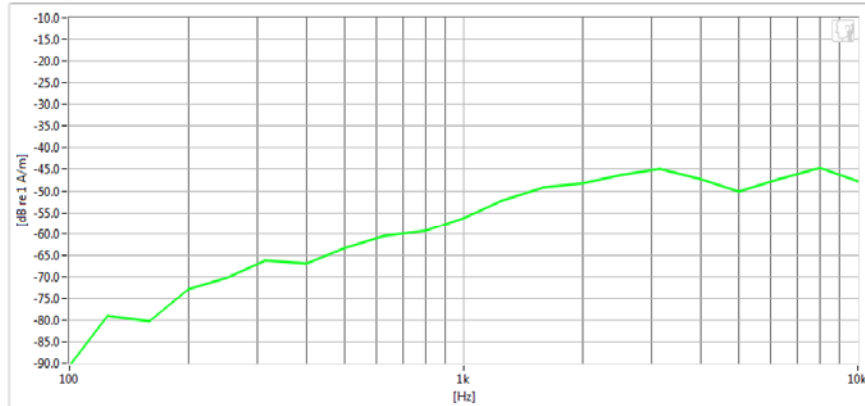

**Noise Spectrum**



**Results**

ABM1	-5.97 dB	✓	Minimum	-18.0
ABM2	-43.77 dB	✓	Maximum	0.0
SNNR	37.81 dB	✓	Minimum	20.0

PCTEST 2017



<b>FCC ID:</b> ZNFX210MA		<b>HAC (T-COIL) TEST REPORT</b>		<b>Approved by:</b> Quality Manager
<b>Filename:</b> 1M1710020259-11.ZNF	<b>Test Dates:</b> 10/03/2017	<b>DUT Type:</b> Portable Handset	Page 37 of 50	

© 2017 PCTEST Engineering Laboratory, Inc.

REV 3.1.M  
09/14/2017

© 2017 PCTEST Engineering Laboratory, Inc. All rights reserved. Unless otherwise specified, no part of this report may be reproduced or utilized in any part, form or by any means, electronic or mechanical, including photocopying and microfilm, without permission in writing from PCTEST Engineering Laboratory, Inc. If you have any questions about this international copyright or have an enquiry about obtaining additional rights to this report or assembly of contents thereof, please contact [INFO@PCTESTLAB.COM](mailto:INFO@PCTESTLAB.COM).

# 10. CALIBRATION CERTIFICATES

FCC ID: ZNFX210MA		HAC (T-COIL) TEST REPORT		<b>Approved by:</b> Quality Manager
<b>Filename:</b> 1M1710020259-11.ZNF	<b>Test Dates:</b> 10/03/2017	<b>DUT Type:</b> Portable Handset	Page 38 of 50	

© 2017 PCTEST Engineering Laboratory, Inc.

REV 3.1.M  
09/14/2017

© 2017 PCTEST Engineering Laboratory, Inc. All rights reserved. Unless otherwise specified, no part of this report may be reproduced or utilized in any part, form or by any means, electronic or mechanical, including photocopying and microfilm, without permission in writing from PCTEST Engineering Laboratory, Inc. If you have any questions about this international copyright or have an enquiry about obtaining additional rights to this report or assembly of contents thereof, please contact [INFO@PCTESTLAB.COM](mailto:INFO@PCTESTLAB.COM).

West Caldwell Calibration Laboratories Inc.

# Certificate of Calibration

for

AXIAL T COIL PROBE

Manufactured by: TEM CONSULTING  
Model No: AXIAL T COIL PROBE  
Serial No: TEM-1124  
Calibration Recall No: 27068

Submitted By:

Customer: ANDREW HARWELL  
Company: PCTEST ENGINEERING LAB  
Address: 6660-B DOBBIN ROAD  
COLUMBIA MD 21045

The subject instrument was calibrated to the indicated specification using standards traceable to the National Institute of Standards and Technology or to accepted values of natural physical constants. This document certifies that the instrument met the following specification upon its return to the submitter.

West Caldwell Calibration Laboratories Procedure No. AXIAL T C TEM C

Upon receipt for Calibration, the instrument was found to be:

Within ( X )

tolerance of the indicated specification. See attached Report of Calibration.

West Caldwell Calibration Laboratories' calibration control system meets the following requirements, ISO 10012-1 MIL STD 45662A, ANSI/NCSL Z540-1, IEC Guide 25, ISO 9001:2008 and ISO 17025

Note: With this Certificate, Report of Calibration is included.

Approved by:

Calibration Date: 07-Dec-16

Certificate No: 27068 -3

QA Doc. #1051 Rev. 2.0 10/1/01

Certificate Page 1 of 1

FC

Felix Christopher (QA Mgr.)

ISO/IEC 17025:2005

**West Caldwell Calibration Laboratories, Inc.**  
uncompromised calibration  
1575 State Route 96, Victor, NY 14564, U.S.A.



Calibration Lab. Cert. # 1533.01

FCC ID: ZNFX210MA	PCTEST ENGINEERING LABORATORY, INC.	HAC (T-COIL) TEST REPORT	LG	Approved by: Quality Manager
Filename: 1M1710020259-11.ZNF	Test Dates: 10/03/2017	DUT Type: Portable Handset		Page 39 of 50

© 2017 PCTEST Engineering Laboratory, Inc.

REV 3.1.M

09/14/2017

© 2017 PCTEST Engineering Laboratory, Inc. All rights reserved. Unless otherwise specified, no part of this report may be reproduced or utilized in any part, form or by any means, electronic or mechanical, including photocopying and microfilm, without permission in writing from PCTEST Engineering Laboratory, Inc. If you have any questions about this international copyright or have an enquiry about obtaining additional rights to this report or assembly of contents thereof, please contact [INFO@PCTESTLAB.COM](mailto:INFO@PCTESTLAB.COM).



## REPORT OF CALIBRATION

TEM Consulting LP Axial T Coil Probe

for Model No.: Axial T Coil Probe

Serial No.: TEM 1124

Company : PCTEST Engineering Lab.

I. D. No: 80578

Calibration results:			Before & after data same: ...X.....		
<b>Probe Sensitivity measured with Helmholtz Coil</b>					
<i>Helmholtz Coil;</i>					
the number of turns on each coil;	10	No.			
the radius of each coil, in meters;	0.204	m			
the current in the coils, in amperes.;	0.09	A			
<i>Helmholtz Coil Constant;</i>	7.09	A/m/V			
<i>Helmholtz Coil magnetic field;</i>	5.98	A/m			
Laboratory Environment:					
Probe Sensitivity at		1000	Hz.	Ambient Temperature: 20.2 °C	
was		-60.23	dBV/A/m	Ambient Humidity: 31.4 % RH	
		0.974	mV/A/m	Ambient Pressure: 99.1 kPa	
Probe resistance		904	Ohms	Calibration Date: 7-Dec-16	
				Re-calibration Due: 7-Dec-17	
				Report Number: 27068 -3	
				Control Number: 27068	

The above listed instrument meets or exceeds the tested manufacturer's specifications.

This Calibration is traceable through NIST test numbers: 683/284413-14  
 The expanded uncertainty of calibration: 0.30dB at 95% confidence level with a coverage factor of k=2.  
 Graph represents Probes Frequency Response.

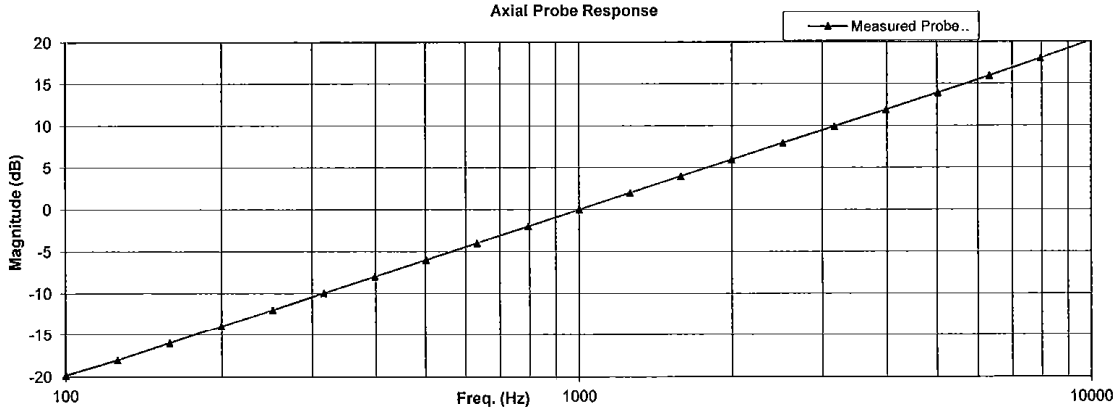

The above listed instrument was checked using calibration procedure documented in West Caldwell Calibration Laboratories Inc. procedure : **Rev. 7.0 Jan. 24, 2014 Doc. # 1038 HCATEMC**  
 Calibration was performed by West Caldwell Calibration Laboratories Inc. under Operating Procedures intended to implement the requirements of ISO10012-1, IEC Guide 25, ANSI/NCSL Z540-1, (MIL-STD-45662A) and ISO 9001:2008, ISO 17025

Cal. Date: 7-Dec-2016  
 Calibrated on WCCL system type 9700  
 Measurements performed by: *[Signature]*  
**Felix Christopher**  
 This document shall not be reproduced, except in full, without the written approval from West Caldwell Cal. Labs. Inc. **Rev. 7.0 Jan. 24, 2014 Doc. # 1038 HCATEMC**

FCC ID: ZNFX210MA		HAC (T-COIL) TEST REPORT		Approved by: Quality Manager
Filename: 1M1710020259-11.ZNF	Test Dates: 10/03/2017	DUT Type: Portable Handset		Page 40 of 50



HCATEMC\_TEM 1124\_Dec-07-2016

West Caldwell Calibration Laboratories Inc.

1575 State Route 96, Victor NY 14564  
Tel. (585) 586-3900 FAX (585) 586-4327



**Calibration Data Record**

TEM Consulting LP Axial T Coil Probe      for      Model No.: Axial T Coil Probe      Serial No.: TEM 1124  
Company : PCTEST Engineering Lab.

Test	Function	Tolerance	Measured values		
			Before	Out	Remarks
1.0	Probe Sensitivity at	1000 Hz.      dBV/A/m	-60.23		
2.0	Probe Level Linearity	dB			
		6	6.03		
		0	0.00		
		-6	-6.03		
		-12	-12.05		
3.0	Probe Frequency Response	Hz			
		100	-19.8		
		126	-18.0		
		158	-16.0		
		200	-13.9		
		251	-12.0		
		316	-9.9		
		398	-8.0		
		501	-6.0		
		631	-4.0		
		794	-2.0		
		1000	0.0		
		1259	2.0		
		1585	4.0		
		1995	6.0		
		2512	7.9		
		3162	9.9		
3981	11.9				
5012	13.9				
6310	15.9				
7943	18.0				
10000	20.2				

Instruments used for calibration:			Date of Cal.	Traceability No.	Due Date
HP	34401A	S/N 36064102	1-Oct-2016	,287708	1-Oct-2017
HP	34401A	S/N 36102471	1-Oct-2016	,287708	1-Oct-2017
HP	33120A	S/N 36043716	1-Oct-2016	,287708	1-Oct-2017
B&K	2133	S/N 1583254	1-Oct-2016	683/284413-14	1-Oct-2017

Cal. Date: 7-Dec-2016      Tested by: Felix Christopher  
Calibrated on WCCL system type 9700  
This document shall not be reproduced, except in full, without the written approval from West Caldwell Cal. Labs. Inc.      Rev. 7.0 Jan. 24, 2014 Doc. # 1038 HCATEMC

FCC ID: ZNFX210MA		HAC (T-COIL) TEST REPORT		Approved by: Quality Manager
Filename: 1M1710020259-11.ZNF	Test Dates: 10/03/2017	DUT Type: Portable Handset		Page 41 of 50

West Caldwell Calibration Laboratories Inc.

# Certificate of Calibration

for

## RADIAL T COIL PROBE

Manufactured by: TEM CONSULTING  
Model No: RADIAL T COIL PROBE  
Serial No: TEM-1130  
Calibration Recall No: 27068

### Submitted By:

Customer: ANDREW HARWELL  
Company: PCTEST ENGINEERING LAB  
Address: 6660-B DOBBIN ROAD  
COLUMBIA MD 21045

The subject instrument was calibrated to the indicated specification using standards traceable to the National Institute of Standards and Technology or to accepted values of natural physical constants. This document certifies that the instrument met the following specification upon its return to the submitter.

West Caldwell Calibration Laboratories Procedure No. RADIAL T TEM C

Upon receipt for Calibration, the instrument was found to be:

Within ( X )

tolerance of the indicated specification. See attached Report of Calibration.

West Caldwell Calibration Laboratories' calibration control system meets the following requirements, ISO 10012-1 MIL STD 45662A, ANSI/NCSL Z540-1, IEC Guide 25, ISO 9001:2008 and ISO 17025

Note: With this Certificate, Report of Calibration is included.

Approved by:

Calibration Date: 07-Dec-16

Certificate No: 27068 -2

QA Doc. #1061 Rev. 2.0 10/1/01

Certificate Page 1 of 1

*FC*  
Felix Christopher (QA Mgr.)  
ISO/IEC 17025:2005

**West Caldwell Calibration Laboratories, Inc.**  
uncompromised calibration  
1575 State Route 96, Victor, NY 14564, U.S.A.



Calibration Lab. Cert. # 1533.01

FCC ID: ZNFX210MA		HAC (T-COIL) TEST REPORT		Approved by: Quality Manager
Filename: 1M1710020259-11.ZNF	Test Dates: 10/03/2017	DUT Type: Portable Handset		Page 42 of 50

© 2017 PCTEST Engineering Laboratory, Inc.

REV 3.1.M  
09/14/2017

© 2017 PCTEST Engineering Laboratory, Inc. All rights reserved. Unless otherwise specified, no part of this report may be reproduced or utilized in any part, form or by any means, electronic or mechanical, including photocopying and microfilm, without permission in writing from PCTEST Engineering Laboratory, Inc. If you have any questions about this international copyright or have an enquiry about obtaining additional rights to this report or assembly of contents thereof, please contact [INFO@PCTESTLAB.COM](mailto:INFO@PCTESTLAB.COM).



1575 State Route 96, Victor NY 14564

ISO/IEC 17025: 2005



Calibration Lab. Cert. # 1533.01

## REPORT OF CALIBRATION

TEM Consulting LP Radial T Coil Probe

for  
Model No.: Radial T Coil Probe

Serial No.: TEM-1130

Company : PCTEST Engineering Lab.

I. D. No: 80579

Calibration results:			
<b>Probe Sensitivity measured with Helmholtz Coil</b>			
<i>Helmholtz Coil;</i>			
the number of turns on each coil;	10	No.	
the radius of each coil, in meters;	0.204	m	
the current in the coils, in amperes.;	0.09	A	
<i>Helmholtz Coil Constant;</i>			
	7.09	A/m/V	
<i>Helmholtz Coil magnetic field;</i>			
	5.98	A/m	
Before & after data same: ...X.....			
Laboratory Environment:			
Ambient Temperature:	20.2	°C	
Ambient Humidity:	31.4	% RH	
Ambient Pressure:	99.1	kPa	
Calibration Date:	7-Dec-16		
Re-calibration Due:	7-Dec-17		
Report Number:	27068	-2	
Control Number:	27068		
Probe Sensitivity at	1000	Hz.	
was	-60.27	dBV/A/m	
	0.969	mV/A/m	
Probe resistance	902	Ohms	

The above listed instrument meets or exceeds the tested manufacturer's specifications.

This Calibration is traceable through NIST test numbers: 683/284413-14

The expanded uncertainty of calibration: 0.30dB at 95% confidence level with a coverage factor of k=2.

Graph represents Probes Frequency Response.

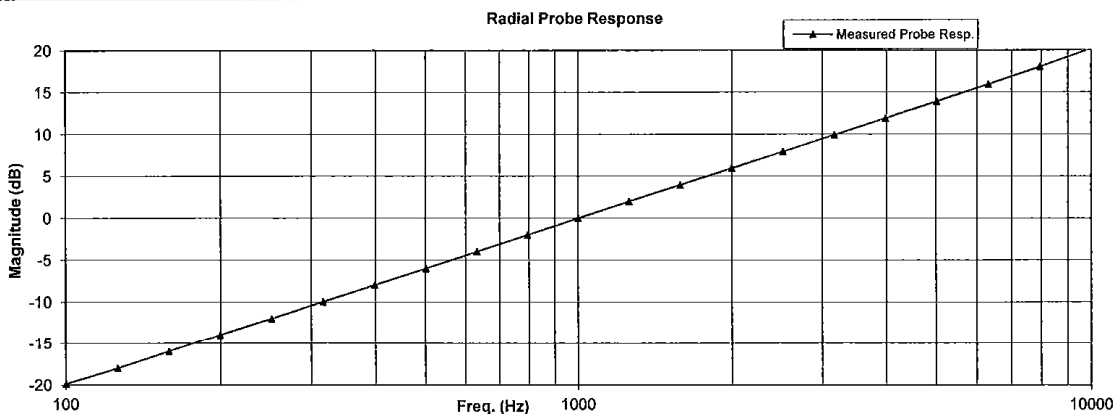

The above listed instrument was checked using calibration procedure documented in West Caldwell Calibration Laboratories Inc. procedure : **Rev. 7.0 Jan. 24, 2014 Doc. # 1038 HCRTEMC**  
 Calibration was performed by West Caldwell Calibration Laboratories Inc. under Operating Procedures intended to implement the requirements of ISO10012-1, IEC Guide 25, ANSI/NCSL Z540-1, (MIL-STD-45662A) and ISO 9001:2008, ISO 17025

Cal. Date: 7-Dec-2016

Measurements performed by: *[Signature]*

Calibrated on WCCL system type 9700

**Felix Christopher**

This document shall not be reproduced, except in full, without the written approval from West Caldwell Cal. Labs. Inc.

Rev. 7.0 Jan. 24, 2014 Doc. # 1038 HCRTEMC

FCC ID: ZNFX210MA		HAC (T-COIL) TEST REPORT		Approved by: Quality Manager
Filename: 1M1710020259-11.ZNF	Test Dates: 10/03/2017	DUT Type: Portable Handset		Page 43 of 50

HCRTEMC\_TEM-1130\_Dec-07-2016

**West Caldwell Calibration Laboratories Inc.**

1575 State Route 96, Victor NY 14564  
Tel. (585) 586-3900 FAX (585) 586-4327



**Calibration Data Record**

TEM Consulting LP Radial T Coil Probe      for      Model No.: Radial T Coil Probe      Serial No.: TEM-1130  
Company : PCTEST Engineering Lab.

Test	Function	Tolerance		Measured values		
				Before	Out	Remarks
1.0	Probe Sensitivity at	1000 Hz.	dBV/A/m	-60.27		
2.0	Probe Level Linearity	Ref. (0 dB)	dB			
			6	6.03		
			0	0.00		
			-6	-6.03		
			-12	-12.06		
3.0	Probe Frequency Response	Ref. (0 dB)	Hz			
			100	-19.9		
			126	-18.0		
			158	-16.0		
			200	-13.9		
			251	-12.0		
			316	-10.0		
			398	-8.0		
			501	-6.0		
			631	-4.0		
			794	-2.0		
			1000	0.0		
			1259	2.0		
			1585	4.0		
			1995	6.0		
			2512	7.9		
			3162	9.9		
3981	11.9					
5012	13.9					
6310	15.9					
7943	18.0					
10000	20.2					

Instruments used for calibration:			Date of Cal.	Traceability No.	Due Date
HP	34401A	S/N 36064102	1-Oct-2016	,287708	1-Oct-2017
HP	34401A	S/N 36102471	1-Oct-2016	,287708	1-Oct-2017
HP	33120A	S/N 36043716	1-Oct-2016	,287708	1-Oct-2017
B&K	2133	S/N 1583254	1-Oct-2016	683/284413-14	1-Oct-2017



Cal. Date: 7-Dec-2016      Tested by: Felix Christopher  
Calibrated on WCCL system type 9700  
This document shall not be reproduced, except in full, without the written approval from West Caldwell Cal. Labs. Inc.      Rev. 7.0 Jan. 24, 2014 Doc. # 1038 HCRTEMC

FCC ID: ZNFX210MA		HAC (T-COIL) TEST REPORT		Approved by: Quality Manager
Filename: 1M1710020259-11.ZNF	Test Dates: 10/03/2017	DUT Type: Portable Handset		Page 44 of 50

## 11. CONCLUSION

The measurements indicate that the wireless communications device complies with the HAC limits specified in accordance with the ANSI C63.19 Standard and FCC WT Docket No. 01-309 RM-8658. Precise laboratory measures were taken to assure repeatability of the tests. The tested device complies with the requirements in respect to all parameters specific to the test. The test results and statements relate only to the item(s) tested.

The measurement system and techniques presented in this evaluation are proposed in the ANSI standard as a means of best approximating wireless device compatibility with a hearing-aid. The literature is under continual re-construction.

<b>FCC ID:</b> ZNFX210MA		<b>HAC (T-COIL) TEST REPORT</b>		<b>Approved by:</b> Quality Manager
<b>Filename:</b> 1M1710020259-11.ZNF	<b>Test Dates:</b> 10/03/2017	<b>DUT Type:</b> Portable Handset	Page 45 of 50	



© 2017 PCTEST Engineering Laboratory, Inc.

REV 3.1.M  
09/14/2017

© 2017 PCTEST Engineering Laboratory, Inc. All rights reserved. Unless otherwise specified, no part of this report may be reproduced or utilized in any part, form or by any means, electronic or mechanical, including photocopying and microfilm, without permission in writing from PCTEST Engineering Laboratory, Inc. If you have any questions about this international copyright or have an enquiry about obtaining additional rights to this report or assembly of contents thereof, please contact [INFO@PCTESTLAB.COM](mailto:INFO@PCTESTLAB.COM).

## 12. REFERENCES

1. ANSI C63.19-2011, American National Standard for Methods of Measurement of Compatibility between Wireless communication devices and Hearing Aids., New York, NY, IEEE, May 2011
2. FCC Office of Engineering and Technology KDB, "285076 D01 HAC Guidance v05," September 13, 2017
3. FCC Office of Engineering and Technology KDB, "285076 D02 T-Coil Testing for CMRS IP v03," September 13, 2017
4. FCC Public Notice DA 06-1215, *Wireless Telecommunications Bureau and Office of Engineering and Technology Clarify Use of Revised Wireless Phone Hearing Aid Compatibility Standard*, June 6, 2006
5. FCC 3G Review Guidance, Laboratory Division OET FCC, May/June 2006
6. Berger, H. S., "Compatibility Between Hearing Aids and Wireless Devices," Electronic Industries Forum, Boston, MA, May, 1997
7. Berger, H. S., "Hearing Aid and Cellular Phone Compatibility: Working Toward Solutions," Wireless Telephones and Hearing Aids: New Challenges for Audiology, Gallaudet University, Washington, D.C., May, 1997 (To be reprinted in the American Journal of Audiology).
8. Berger, H. S., "Hearing Aid Compatibility with Wireless Communications Devices," IEEE International Symposium on Electromagnetic Compatibility, Austin, TX, August, 1997.
9. Bronaugh, E. L., "Simplifying EMI Immunity (Susceptibility) Tests in TEM Cells," in the 1990 IEEE International Symposium on Electromagnetic Compatibility Symposium Record, Washington, D.C., August 1990, pp. 488-491
10. Byrne, D. and Dillon, H., The National Acoustics Laboratory (NAL) New Procedure for Selecting the Gain and Frequency Response of a Hearing Aid, Ear and Hearing 7:257-265, 1986.
11. Crawford, M. L., "Measurement of Electromagnetic Radiation from Electronic Equipment using TEM Transmission Cells," U.S. Department of Commerce, National Bureau of Standards, NBSIR 73-306, Feb. 1973.
12. Crawford, M. L., and Workman, J. L., "Using a TEM Cell for EMC Measurements of Electronic Equipment," U.S. Department of Commerce, National Bureau of Standards. Technical Note 1013, July 1981.
13. EHIMA GSM Project, Development phase, Project Report (1<sup>st</sup> part) Revision A. Technical-Audiological Laboratory and Telecom Denmark, October 1993.
14. EHIMA GSM Project, Development phase, Part II Project Report. Technical-Audiological Laboratory and Telecom Denmark, June 1994.
15. EHIMA GSM Project Final Report, Hearing Aids and GSM Mobile Telephones: Interference Problems, Methods of Measurement and Levels of Immunity. Technical-Audiological Laboratory and Telecom Denmark, 1995.
16. HAMPIS Report, Comparison of Mobile phone electromagnetic near field with an upscaled electromagnetic far field, using hearing aid as reference, 21 October 1999.
17. Hearing Aids/GSM, Report from OTWIDAM, Technical-Audiological Laboratory and Telecom Denmark, April 1993.
18. IEEE 100, The Authoritative Dictionary of IEEE Standards Terms, Seventh Edition.
19. Joyner, K. H, et. al., Interference to Hearing Aids by the New Digital Mobile Telephone System, Global System for Mobile (GSM) Communication Standard, National Acoustic Laboratory, Australian Hearing Series, Sydney 1993.
20. Joyner, K. H., et. al., Interference to Hearing Aids by the Digital Mobile Telephone System, Global System for Mobile Communications (GSM), NAL Report #131, National Acoustic Laboratory, Australian Hearing Series, Sydney, 1995.
21. Kecker, W. T., Crawford, M. L., and Wilson, W. A., "Construction of a Transverse Electromagnetic Cell", U.S. Department of Commerce, National Bureau of Standards, Technical Note 1011, Nov. 1978.



FCC ID: ZNFX210MA		HAC (T-COIL) TEST REPORT		Approved by: Quality Manager
Filename: 1M1710020259-11.ZNF	Test Dates: 10/03/2017	DUT Type: Portable Handset	Page 46 of 50	

© 2017 PCTEST Engineering Laboratory, Inc.

REV 3.1.M  
09/14/2017

© 2017 PCTEST Engineering Laboratory, Inc. All rights reserved. Unless otherwise specified, no part of this report may be reproduced or utilized in any part, form or by any means, electronic or mechanical, including photocopying and microfilm, without permission in writing from PCTEST Engineering Laboratory, Inc. If you have any questions about this international copyright or have an enquiry about obtaining additional rights to this report or assembly of contents thereof, please contact [INFO@PCTESTLAB.COM](mailto:INFO@PCTESTLAB.COM).

22. Konigstein, D., and Hansen, D., "A New Family of TEM Cells with enlarged bandwidth and Optimized working Volume," in the Proceedings of the 7<sup>th</sup> International Symposium on EMC, Zurich, Switzerland, March 1987; 50:9, pp. 127-132.
23. Kuk, F., and Hjordgaard, N. K., "Factors affecting interference from digital cellular telephones," Hearing Journal, 1997; 50:9, pp 32-34.
24. Ma, M. A., and Kanda, M., "Electromagnetic Compatibility and Interference Metrology," U.S. Department of Commerce, National Bureau of Standards, Technical Note 1099, July 1986, pp. 17-43.
25. Ma, M. A., Sreenivashiah, I. , and Chang, D. C., "A Method of Determining the Emission and Susceptibility Levels of Electrically Small Objects Using a TEM Cell," U.S. Department of Commerce, National Bureau of Standards, Technical Note 1040, July 1981.
26. McCandless, G. A., and Lyregaard, P. E., Prescription of Gain/Output (POGO) for Hearing Aids, Hearing Instruments 1:16-21, 1983
27. Skopec, M., "Hearing Aid Electromagnetic Interference from Digital Wireless Telephones, "IEEE Transactions on Rehabilitation Engineering, vol. 6, no. 2, pp. 235-239, June 1998.
28. Technical Report, GSM 05.90, GSM EMC Considerations, European Telecommunications Standards Institute, January 1993.
29. Victorian, T. A., "Digital Cellular Telephone Interference and Hearing Aid Compatibility—an Update," Hearing Journal 1998; 51:10, pp. 53-60
30. Wong, G. S. K., and Embleton, T. F. W., eds., AIP Handbook of Condenser Microphones: Theory, Calibration and Measurements, AIP Press.

<b>FCC ID:</b> ZNFX210MA		<b>HAC (T-COIL) TEST REPORT</b>		<b>Approved by:</b> Quality Manager
<b>Filename:</b> 1M1710020259-11.ZNF	<b>Test Dates:</b> 10/03/2017	<b>DUT Type:</b> Portable Handset	Page 47 of 50	

© 2017 PCTEST Engineering Laboratory, Inc.

REV 3.1.M  
09/14/2017

© 2017 PCTEST Engineering Laboratory, Inc. All rights reserved. Unless otherwise specified, no part of this report may be reproduced or utilized in any part, form or by any means, electronic or mechanical, including photocopying and microfilm, without permission in writing from PCTEST Engineering Laboratory, Inc. If you have any questions about this international copyright or have an enquiry about obtaining additional rights to this report or assembly of contents thereof, please contact [INFO@PCTESTLAB.COM](mailto:INFO@PCTESTLAB.COM).