



TEST REPORT FCC Part 27

Report Reference No.....: HK2002110161-2E

FCC ID.....: ZNFX210LMW

Compiled by
(position+printedname+signature)....: File administrators Gary Qian

Supervised by
(position+printedname+signature)....: Technique principal Eden Hu

Approved by
(position+printedname+signature)....: Manager Jason Zhou

Date of issue.....: Feb. 21, 2020

Testing Laboratory Name: Shenzhen HUAKE Testing Technology Co., Ltd.

Address: 1F, B2 Building, Junfeng Zhongcheng Zhizao Innovation Park,
Heping Community, Fuhai Street, Bao' an District, Shenzhen,China

Applicant's name.....: LG Electronics USA, Inc.

Address: 1000 Sylvan Ave., Englewood Cliffs, New Jersey 07632, United States

Test specification

Standard: FCC CFR Title 47 Part 2, Part 27

TRF Originator.....: Shenzhen HUAKE Testing Technology Co., Ltd.

Shenzhen HUAKE Testing Technology Co., Ltd.All rights reserved.

This publication may be reproduced in whole or in part for non-commercial purposes as long as the Shenzhen HUAKE Testing Technology Co., Ltd.as copyright owner and source of the material. Shenzhen HUAKE Testing Technology Co., Ltd.takes no responsibility for and will not assume liability for damages resulting from the reader's interpretation of the reproduced material due to its placement and context.

Test item description: 4G Mobile phone

Trade Mark: LG

Manufacturer.....: OPTIEMUS ELECTRONICS LIMITED

Model/Type reference.....: LM-X210LMW

Listed Models: N/A

Modulation Type: QPSK, 16QAM

Rating: DC 3.85V From Battery

Hardware version: V2.0

Software version.....: V2.0

Result.....: **PASS**

**TEST REPORT**

Test Report No. :	HK2002110161-2E	Feb. 21, 2020
		Date of issue

Equipment under Test : 4G Mobile phone

Model /Type : LM-X210LMW

Listed Models : N/A

Applicant : **LG Electronics USA, Inc.**

Address : 1000 Sylvan Ave., Englewood Cliffs, New Jersey 07632,
United States

Manufacturer : OPTIEMUS ELECTRONICS LIMITED

Address : D-348, Sector-63, Noida, Uttar Pradesh, Pin Code-
201307

Test Result:	PASS
---------------------	-------------

The test report merely corresponds to the test sample.

It is not permitted to copy extracts of these test result without the written permission of the test laboratory.



Revision History

Revision	Issue Date	Revisions	Revised By
V1.0	2020-02-21	Initial Issue	James Zhou



Contents

<u>1</u>	<u>TEST STANDARDS</u>	<u>5</u>
<u>2</u>	<u>SUMMARY</u>	<u>6</u>
2.1	General Remarks	6
2.2	Product Description	6
2.3	Equipment under Test	6
2.4	Short description of the Equipment under Test (EUT)	6
2.5	Normal Accessory setting	7
2.6	EUT configuration	7
2.7	Related Submittal(s) / Grant (s)	7
2.8	Modifications	7
2.9	GeneralTest Conditions/Configurations	7
<u>3</u>	<u>TEST ENVIRONMENT</u>	<u>8</u>
3.1	Address of the test laboratory	8
3.2	Test Description	8
3.3	Equipments Used during the Test	9
<u>4</u>	<u>TEST CONDITIONS AND RESULTS</u>	<u>10</u>
4.1	Output Power	10
4.2	Peak-to-Average Ratio (PAR)	16
4.3	Occupied Bandwidth and Emission Bandwidth	21
4.4	Band Edge compliance	26
4.5	Spurious Emssion on Antenna Port	31
4.6	Radiated Spurious Emssion	44
4.7	Frequency Stability	50
<u>5</u>	<u>TEST SETUP PHOTOS OF THE EUT</u>	<u>52</u>
<u>6</u>	<u>EXTERNAL AND INTERNAL PHOTOS OF THE EUT</u>	<u>53</u>



1 TEST STANDARDS

The tests were performed according to following standards:

[FCC Part 2](#): FREQUENCY ALLOCATIONS AND RADIO TREATY MATTERS; GENERAL RULES AND REGULATIONS

[FCC Part 27](#): MISCELLANEOUS WIRELESS COMMUNICATIONS SERVICES

[ANSI/TIA-603-E-2016](#): Land Mobile FM or PM Communications Equipment Measurement and Performance Standards.

[ANSI C63.26-2015](#): IEEE/ANSI Standard for Compliance Testing of Transmitters Used in Licensed Radio Services

[FCKDB971168D01](#) Power Meas License Digital Systems



2 SUMMARY

2.1 General Remarks

Date of receipt of test sample	:	Jun. 24, 2019
Testing commenced on	:	Jun. 25, 2019
Testing concluded on	:	Feb. 21, 2020

2.2 Product Description

The LG Electronics USA, Inc.'s Model: LM-X210LMW or the "EUT" as referred to in this report; more general information as follows, for more details, refer to the user's manual of the EUT.

Name of EUT	4G Mobile phone
Model/Type reference:	LM-X210LMW
List Model:	/
Power supply:	DC 3.85V From Battery
Adapter Information	N/A
Modulation Type	QPSK, 16QAM
Antenna Type	Internal Antenna
Antenna Gain	1.3dBi
Operation Frequency Band	LTE Band 41
Operation frequency	LTE Band 41: 2555~2655 MHz
LTE Release	R8
Extreme temp. Tolerance	-30°C to +50°C
Extreme vol. Limits	3.465VDC to 4.235VDC (nominal: 3.85VDC)

2.3 Equipment under Test

Power supply system utilised

Power supply voltage	:	<input type="radio"/> 120V/ 60 Hz	<input type="radio"/> 115V/60Hz
		<input type="radio"/> 12 V DC	<input type="radio"/> 24 V DC
		<input checked="" type="radio"/> Other (specified in blank below)	

DC 3.85V From Battery

2.4 Short description of the Equipment under Test (EUT)

2.4.1 General Description

LM-X210LMW is subscriber equipment in the LTE system. LTE frequency band is band 41; The 4G Mobile phone implements such functions as RF signal receiving/transmitting, LTE protocol processing, voice, video MMS service, etc. Externally it provides microSD card interface, earphone port (to provide voice service) and SIM card interface.



2.5 Normal Accessory setting

Fully charged battery was used during the test.

2.6 EUT configuration

The following peripheral devices and interface cables were connected during the measurement:

● - supplied by the manufacturer

○ - supplied by the lab

<input type="radio"/>	Power Cable	Length (m) :	/
		Shield :	/
		Detachable :	/
<input type="radio"/>	Multimeter	Manufacturer :	/
		Model No. :	/

2.7 Related Submittal(s) / Grant (s)

This submittal(s) (test report) is intended for **FCC ID: ZNFX210LMW** filing to comply with FCC Part 27, Rules.

2.8 Modifications

No modifications were implemented to meet testing criteria.

2.9 General Test Conditions/Configurations

2.9.1 Test Environment

Environment Parameter	Selected Values During Tests	
Relative Humidity	Ambient	
Temperature	TN	Ambient
Voltage	VL	3.465V
	VN	3.85V
	VH	4.235V

NOTE: VL=lower extreme test voltage VN=nominal voltage
VH=upper extreme test voltage TN=normal temperature



3 TEST ENVIRONMENT

3.1 Address of the test laboratory

Test Firm : Shenzhen HUAKE Testing Technology Co., Ltd.

Address : 1F, B2 Building, Junfeng Zhongcheng Zhizao Innovation Park, Fuhai Street, Bao'an District, Shenzhen City, China

FCC designation number : CN1229

test firm registration number : 616276

3.2 Test Description

Test Item	FCCRuleNo.	Verdict
Effective(Isotropic)RadiatedOutputPower	Part 2.1046 27.50(h)(2)	Pass
Peak-AverageRatio	Part 2.1046	Pass
ModulationCharacteristics	§2.1047	N/A
Bandwidth	Part 2.1049	Pass
BandEdgesCompliance	Part 2.1051 27.53(m)	Pass
SpuriousEmissionatAntennaTerminals	Part 2.1051 27.53(m)	Pass
Field Strengthof Spurious Radiation	Part 2.1053 27.53(m)	Pass
Frequency Stability	Part 2.1055 27.54	Pass

NOTE 1:For the verdict,the“N/A”denotes“not applicable”,the“N/T”denotes “nottested”.

Remark:

1. The measurement uncertainty is not included in the test result.



3.3 Equipments Used during the Test

Test Equipment	Manufacturer	Model No.	Serial No.	Calibration Date	Calibration Due Date
LISN	R&S	ENV216	HKE-059	2019/12/26	2020/12/25
LISN	R&S	ENV216	HKE-002	2019/12/26	2020/12/25
Receiver	R&S	ESCI 7	HKE-010	2019/12/26	2020/12/25
Spectrum analyzer	R&S	FSP40	HKE-025	2019/12/26	2020/12/25
Spectrum analyzer	Agilent	N9020A	HKE-048	2019/12/26	2020/12/25
RF automatic control unit	Tonscend	JS0806-1	HKE-060	2019/12/26	2020/12/25
Loop antenna	Schwarzbeck	FMZB 1519 B	HKE-014	2019/12/26	2020/12/25
Bilog Broadband Antenna	Schwarzbeck	VULB9163	HKE-012	2019/12/26	2020/12/25
Horn antenna	Schwarzbeck	9120D	HKE-013	2019/12/26	2020/12/25
High gain antenna	Schwarzbeck	LB-180400KF	HKE-054	2019/12/26	2020/12/25
Preamplifier	EMCI	EMC051845SE	HKE-015	2019/12/26	2020/12/25
Preamplifier	Agilent	83051A	HKE-016	2019/12/26	2020/12/25
Preamplifier	Schwarzbeck	BBV 9743	HKE-006	2019/12/26	2020/12/25
Temperature and humidity meter	Boyang	HTC-1	HKE-075	2019/12/26	2020/12/25
High-low temperature chamber	Guangke	HT-80L	HKE-118	2019/12/26	2020/12/25
High pass filter unit	Tonscend	JS0806-F	HKE-055	2019/12/26	2020/12/25
RF Cable(below1GHz)	Times	9kHz-1GHz	HKE-117	2019/12/26	2020/12/25
RF Cable(above 1GHz)	Times	1-40G	HKE-034	2019/12/26	2020/12/25
Power meter	Agilent	E4419B	HKE-085	2019/12/26	2020/12/25
Power Sensor	Agilent	E9300A	HKE-086	2019/12/26	2020/12/25
Conducted test software	Tonscend	TS+ Rev 2.5.0.0	HKE-081	N/A	N/A
Radiated test software	Tonscend	TS+ Rev 2.5.0.0	HKE-082	N/A	N/A
RF test software	Tonscend	JS1120-B Version 2.6	HKE-083	N/A	N/A
RF test software	Tonscend	JS1120-4	HKE-113	N/A	N/A
RF test software	Tonscend	JS1120-3	HKE-114	N/A	N/A
RF test software	Tonscend	JS1120-1	HKE-115	N/A	N/A
Wireless Communication Test Set	R&S	CMW500	HKE-026	2019/12/26	2020/12/25
Wireless Communication Test Set	R&S	CMU200	HKE-029	2019/12/26	2020/12/25

4 TEST CONDITIONS AND RESULTS

4.1 Output Power

4.1.1 Conducted Output Power

TEST APPLICABLE

Part 27.50(h)(2) , during the process of testing, the EUT was controlled via R&S Digital Radio Communication tester (CMW500) to ensure max power transmission and proper modulation. This result contains output power measurements for the EUT. In all cases, output power is within the specified limits.

TEST CONFIGURATION

Conducted Power Measurement:

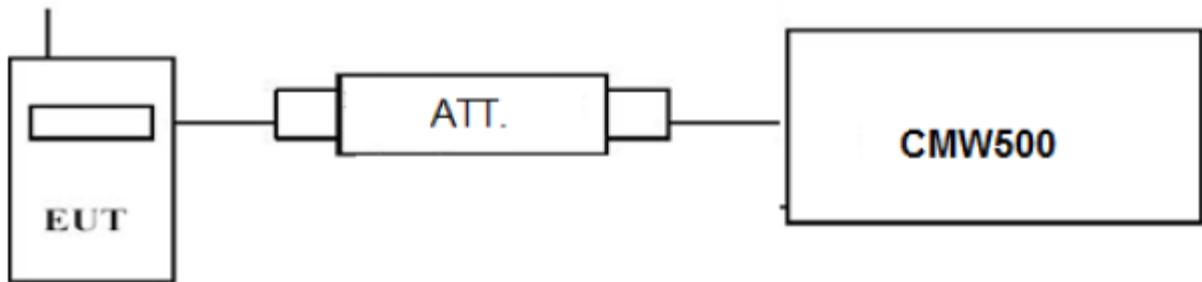

TEST PROCEDURE

Conducted Power Measurement:

- a) Place the EUT on a bench and set it in transmitting mode.
- b) Connect a low loss RF cable from the antenna port to a CMW500 by an Att.
- c) EUT Communicate with CMW500 then selects a channel for testing.
- d) Add a correction factor to the display CMW500, and then test.

TEST RESULTS



EUT:	4G Mobile phone	Test Date:	Oct. 21, 2019
Temperature:	25 ⁰ C	Tested by:	Gary Qian
Humidity:	55 % RH	Test Voltage	Normal Voltage
Operation Mode:	Normal Voltage- Tx Mode		

Remark:

1. We measured all RB Configuration refer 3GPP TS136 521 for each Channel Bandwidth of LTE Band 41;

LTE Band 41				
TX Channel Bandwidth	Frequency (MHz)	RB Size/Offset	Burst Average Power [dBm]	
			QPSK	16QAM
5 MHz	2557.5	1 RB low	23.81	23.39
		1 RB mid	23.87	23.38
		1 RB high	23.94	23.40
		50% RB low	23.36	23.36
		50% RB mid	23.42	23.43
		50% RB high	23.37	23.43
		100% RB	22.93	21.95
	2600.0	1 RB low	23.53	23.31
		1 RB mid	23.58	23.30
		1 RB high	23.61	23.35
		50% RB low	23.30	23.28
		50% RB mid	23.29	23.30
		50% RB high	23.25	23.26
		100% RB	22.82	22.05
	2652.5	1 RB low	23.42	22.29
		1 RB mid	23.43	22.24
		1 RB high	23.48	22.17
		50% RB low	22.24	22.31
		50% RB mid	22.18	22.27
		50% RB high	22.23	22.23
		100% RB	22.55	21.76
10 MHz	2560.0	1 RB low	23.65	22.52
		1 RB mid	23.64	22.50
		1 RB high	23.74	22.57
		50% RB low	22.71	22.71
		50% RB mid	22.71	22.71
		50% RB high	22.77	22.77
		100% RB	22.73	21.78
	2600.0	1 RB low	24.00	23.06
		1 RB mid	23.98	23.19
		1 RB high	23.96	23.35
		50% RB low	22.88	22.88
		50% RB mid	22.87	22.87
		50% RB high	22.79	22.79
		100% RB	22.76	22.06
	2650.0	1 RB low	23.48	22.70
		1 RB mid	23.57	22.62
		1 RB high	23.52	22.62
		50% RB low	22.48	22.49
		50% RB mid	22.50	22.50
		50% RB high	22.41	22.41
		100% RB	22.40	21.44
15 MHz	2562.5	1 RB low	23.84	22.26
		1 RB mid	23.79	21.93
		1 RB high	23.80	21.94
		50% RB low	22.30	22.21
		50% RB mid	21.88	22.10



		50% RB high	21.94	21.91	
		100% RB	22.87	22.05	
	2600.0	1 RB low	23.89	22.25	
		1 RB mid	23.88	22.36	
		1 RB high	23.97	23.35	
		50% RB low	23.07	23.07	
		50% RB mid	23.19	23.19	
		50% RB high	23.38	23.38	
		100% RB	22.81	21.97	
	2647.5	1 RB low	23.61	22.73	
		1 RB mid	23.63	22.64	
		1 RB high	23.47	22.56	
		50% RB low	22.77	22.79	
		50% RB mid	22.66	22.70	
		50% RB high	22.58	22.56	
	20 MHz	2570.0	1 RB low	24.13	23.71
			1 RB mid	24.18	23.62
			1 RB high	24.01	23.64
50% RB low			22.98	22.11	
50% RB mid			23.02	22.07	
50% RB high			22.89	21.99	
100% RB			22.97	22.05	
2600.0		1 RB low	23.84	23.54	
		1 RB mid	23.96	23.57	
		1 RB high	23.97	23.53	
		50% RB low	22.86	21.97	
		50% RB mid	22.85	21.96	
		50% RB high	22.88	21.99	
2640.0		100% RB	22.87	21.86	
		1 RB low	23.67	23.30	
		1 RB mid	23.51	23.28	
		1 RB high	23.52	23.29	
		50% RB low	22.66	21.91	
	50% RB mid	22.66	21.92		
	50% RB high	22.65	21.81		
100% RB	22.60	21.76			

4.1.2. Radiated Output Power

LIMIT

This is the test for the maximum radiated power from the EUT.

TEST CONFIGURATION

RadiatedPowerMeasurement:

remark : 0.8m for below 1GHz, 1.5m for above 1GHz

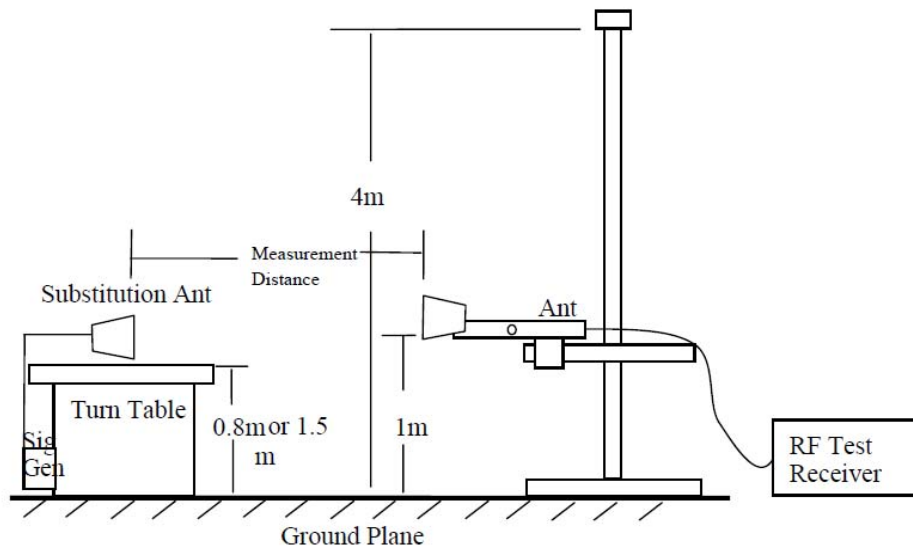

TEST PROCEDURE

The EUT was setup according to EIA/TIA 603D

- The EUT shall be placed at the specified height on a support, and in the position closest to normal use as declared by provider.
- The test antenna shall be oriented initially for vertical polarization and shall be chosen to correspond to the frequency of the transmitter.
- The output of the test antenna shall be connected to the measuring receiver.
- The transmitter shall be switched on and the measuring receiver shall be tuned to the frequency of the transmitter under test.
- The test antenna shall be raised and lowered through the specified range of height until a maximum signal level is detected by the measuring receiver.
- The transmitter shall then be rotated through 360° in the horizontal plane, until the maximum signal level is detected by the measuring receiver.
- The test antenna shall be raised and lowered again through the specified range of height until a maximum signal level is detected by the measuring receiver.
- The maximum signal level detected by the measuring receiver shall be noted.
- The transmitter shall be replaced by a substitution antenna.
- The substitution antenna shall be orientated for vertical polarization and the length of the substitution antenna shall be adjusted to correspond to the frequency of the transmitter.
- The substitution antenna shall be connected to a calibrated signal generator.
- If necessary, the input attenuator setting of the measuring receiver shall be adjusted in order to increase the sensitivity of the measuring receiver.
- The test antenna shall be raised and lowered through the specified range of height to ensure that the maximum signal is received.
- The input signal to the substitution antenna shall be adjusted to the level that produces a level detected by the measuring receiver, that is equal to the level noted while the transmitter radiated power was measured, corrected for the change of input attenuator setting of the measuring receiver.
- The measurement shall be repeated with the test antenna and the substitution antenna orientated for horizontal polarization.
- The measure of the effective radiated power is the larger of the two levels recorded at the input to the substitution antenna, corrected for gain of the substitution antenna if necessary.
- Test site anechoic chamber refer to ANSI C63.4.

**TEST RESULTS**

EUT:	4G Mobile phone	Test Date:	Oct. 21, 2019
Temperature:	25 ⁰ C	Tested by:	Gary Qian
Humidity:	55 % RH	Test Voltage	Normal Voltage
Operation Mode:	Normal Voltage- Tx Mode		

Radiated Measurement:

Remark:

1. We measured all RB Configuration refer 3GPP TS136 521 for each Channel Bandwidth of LTE Band 41; recorded worst case for each Channel Bandwidth of LTE Band 41.
2. $EIRP = P_s(dBm) - P_{cl}(dB) + G_a(dBi)$
3. We measured both Horizontal and Vertical direction, recorded worst case direction.

LTE Band 41_Channel Bandwidth 5MHz_QPSK_1RB#0

Frequency (MHz)	P _s (dBm)	P _{cl} (dB)	G _a Antenna Gain(dB)	Burst Average EIRP (dBm)	Limit (dBm)	Margin (dB)	Polarization
2557.5	7.29	3.41	15.12	19.25	33.01	13.76	V
2600.0	7.62	3.49	15.12	19.34	33.01	13.67	V
2652.5	6.95	3.55	15.12	19.00	33.01	14.01	V

LTE Band 41_Channel Bandwidth 10MHz_QPSK_1RB#0

Frequency (MHz)	P _s (dBm)	P _{cl} (dB)	G _a Antenna Gain(dB)	Burst Average EIRP (dBm)	Limit (dBm)	Margin (dB)	Polarization
2560.0	7.51	3.41	15.12	19.50	33.01	13.51	V
2600.0	7.69	3.49	15.12	19.46	33.01	13.55	V
2650.0	7.30	3.55	15.12	18.71	33.01	14.30	V

LTE Band 41_Channel Bandwidth 15MHz_QPSK_1RB#0

Frequency (MHz)	P _s (dBm)	P _{cl} (dB)	G _a Antenna Gain(dB)	Burst Average EIRP (dBm)	Limit (dBm)	Margin (dB)	Polarization
2562.5	7.47	3.41	15.12	19.22	33.01	13.79	V
2600.0	7.58	3.49	15.12	19.36	33.01	13.65	V
2647.5	7.10	3.55	15.12	19.06	33.01	13.95	V

LTE Band 41_Channel Bandwidth 20MHz_QPSK_1RB#0

Frequency (MHz)	P _s (dBm)	P _{cl} (dB)	G _a Antenna Gain(dB)	Burst Average EIRP (dBm)	Limit (dBm)	Margin (dB)	Polarization
2570.0	7.31	3.41	15.12	19.49	33.01	13.52	V
2600.0	7.69	3.49	15.12	19.55	33.01	13.46	V
2640.0	7.16	3.55	15.12	18.89	33.01	14.12	V

*LTE Band 41_Channel Bandwidth 5MHz_16QAM_1RB#0*

Frequency (MHz)	P _s (dBm)	P _{cl} (dB)	G _a Antenna Gain(dB)	Burst Average EIRP (dBm)	Limit (dBm)	Margin (dB)	Polarization
2557.5	7.48	3.41	15.12	19.31	33.01	13.70	V
2600.0	7.74	3.49	15.12	19.46	33.01	13.55	V
2652.5	7.16	3.55	15.12	18.70	33.01	14.31	V

LTE Band 41_Channel Bandwidth 10MHz_16QAM_1RB#0

Frequency (MHz)	P _s (dBm)	P _{cl} (dB)	G _a Antenna Gain(dB)	Burst Average EIRP (dBm)	Limit (dBm)	Margin (dB)	Polarization
2560.0	7.57	3.41	15.12	19.41	33.01	13.6	V
2600.0	7.36	3.49	15.12	19.21	33.01	13.8	V
2650.0	7.29	3.55	15.12	18.9	33.01	14.11	V

LTE Band 41_Channel Bandwidth 15MHz_16QAM_1RB#0

Frequency (MHz)	P _s (dBm)	P _{cl} (dB)	G _a Antenna Gain(dB)	Burst Average EIRP (dBm)	Limit (dBm)	Margin (dB)	Polarization
2562.5	7.58	3.41	15.12	19.29	33.01	13.72	V
2600.0	7.43	3.49	15.12	19.41	33.01	13.6	V
2647.5	7.29	3.55	15.12	18.67	33.01	14.34	V

LTE Band 41_Channel Bandwidth 20MHz_16QAM_1RB#0

Frequency (MHz)	P _s (dBm)	P _{cl} (dB)	G _a Antenna Gain(dB)	Burst Average EIRP (dBm)	Limit (dBm)	Margin (dB)	Polarization
2570.0	7.53	3.41	15.12	19.24	33.01	13.77	V
2600.0	7.58	3.49	15.12	19.19	33.01	13.82	V
2640.0	7.16	3.55	15.12	18.87	33.01	14.14	V



4.2 Peak-to-Average Ratio (PAR)

LIMIT

The Peak-to-Average Ratio (PAR) of the transmission may not exceed 13 dB.

TEST CONFIGURATION

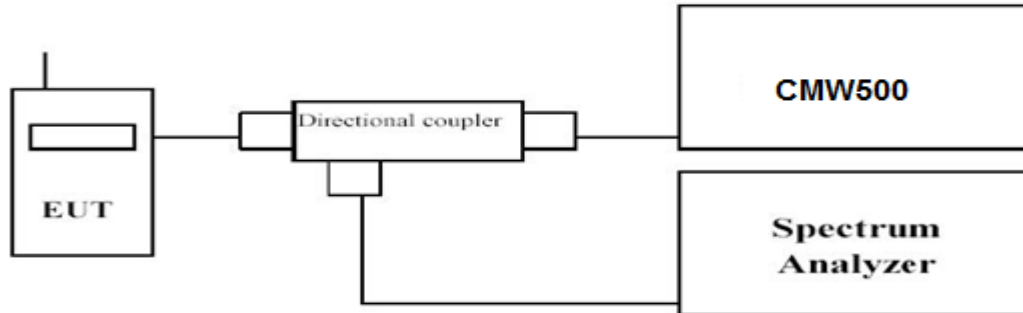

TEST PROCEDURE

1. Refer to instrument's analyzer instruction manual for details on how to use the power statistics/CCDF function;
2. Set resolution/measurement bandwidth \geq signal's occupied bandwidth;
3. Set the number of counts to a value that stabilizes the measured CCDF curve;
4. Set the measurement interval as follows:
 - 1). for continuous transmissions, set to 1 ms,
 - 2). for burst transmissions, employ an external trigger that is synchronized with the EUT burst timing sequence, or use the internal burst trigger with a trigger level that allows the burst to stabilize and set the measurement interval to a time that is less than or equal to the burst duration.
5. Record the maximum PAPR level associated with a probability of 0.1%.

TEST RESULTS

EUT:	4G Mobile phone	Test Date:	Oct. 21, 2019
Temperature:	25 ⁰ C	Tested by:	Gary Qian
Humidity:	55 % RH	Test Voltage	Normal Voltage
Operation Mode:	Normal Voltage- Tx Mode		

Remark:

1. We measured all RB Configuration refer 3GPP TS136 521 for each Channel Bandwidth of LTE Band 41; recorded worst case for each Channel Bandwidth of LTE Band 41.

LTE Band 41				
TX Channel Bandwidth	Frequency (MHz)	RB Size/Offset	PAPR(dB)	
			QPSK	16QAM
5 MHz	2557.5	1RB#0	6.33	7.10
	2600.0		6.45	6.34
	2652.5		5.29	5.98
10 MHz	2560.0	1RB#0	6.52	7.13
	2600.0		6.54	6.87
	2650.0		5.72	6.90
15 MHz	2562.5	1RB#0	6.65	7.61
	2600.0		6.42	7.30
	2647.5		5.90	7.04
20 MHz	2570.0	1RB#0	6.12	6.62
	2600.0		5.63	6.29
	2640.0		6.03	6.25



LTE Band 41-5MHz Channel Bandwidth PAPP

QPSK

16QAM

Low Channel

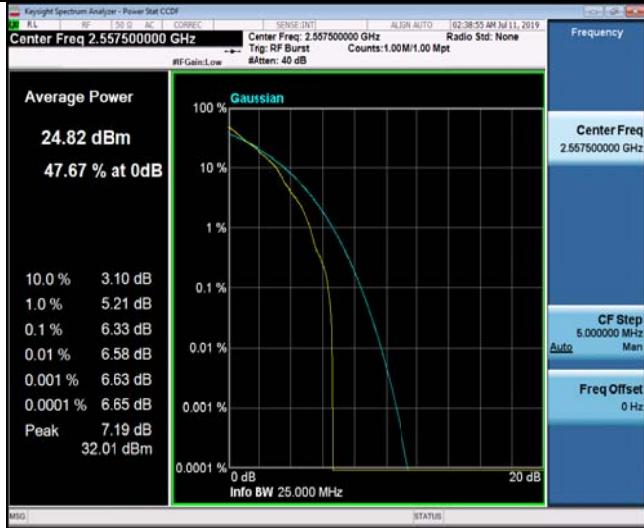

1RB#0

1RB#0

Middle Channel

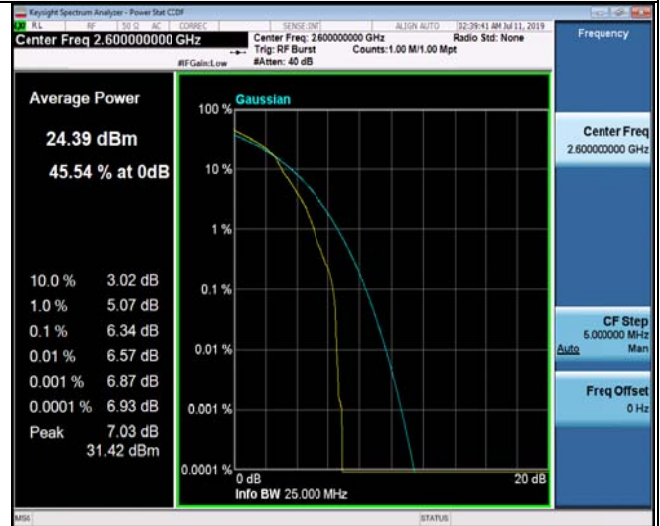
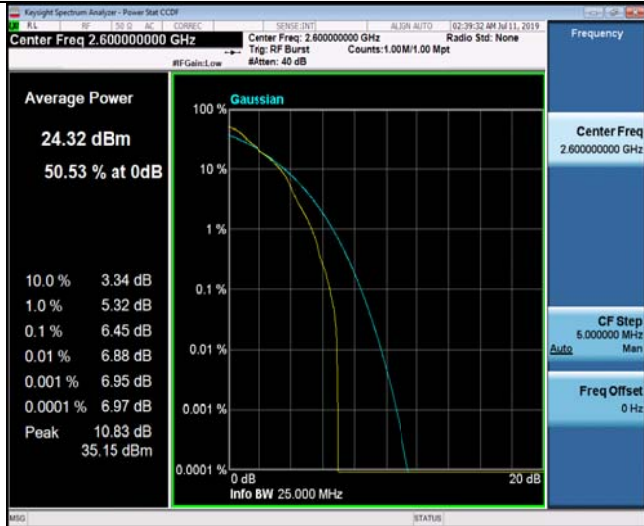

1RB#0

1RB#0

High Channel

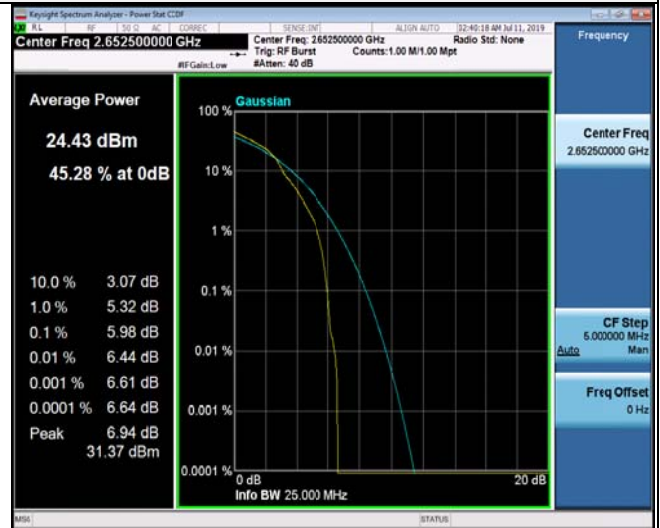
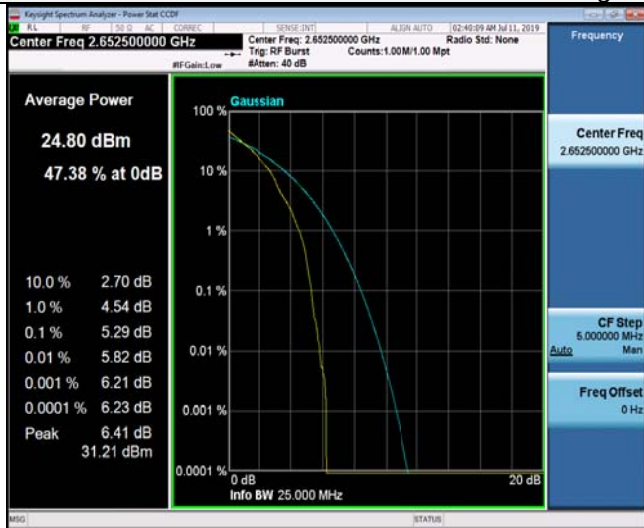

1RB#0

1RB#0



LTE Band 41-10MHz Channel BandwidthPAPR

QPSK

16QAM

Low Channel

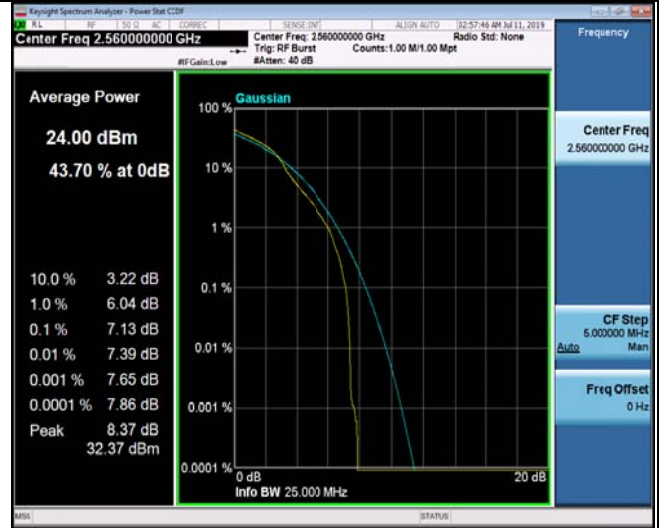

1RB#0

1RB#0

Middle Channel

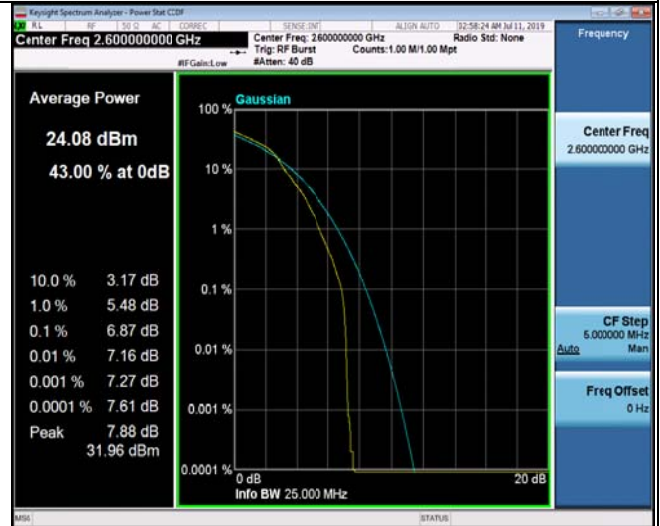
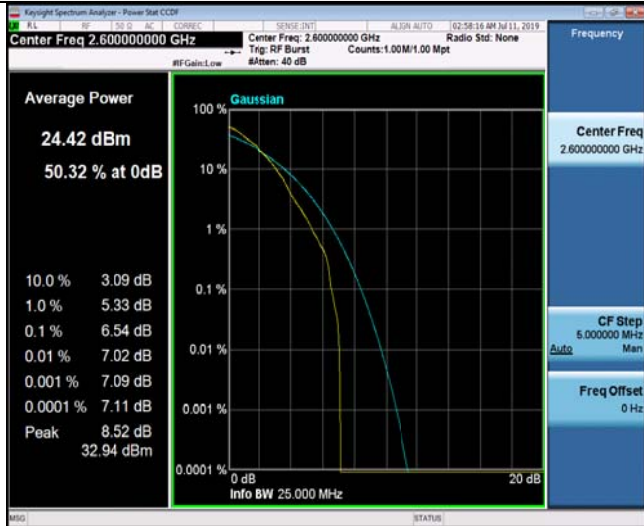

1RB#0

1RB#0

High Channel



1RB#0

1RB#0



LTE Band 41– 15 MHz Channel Bandwidth PAPR

QPSK

16QAM

Low Channel

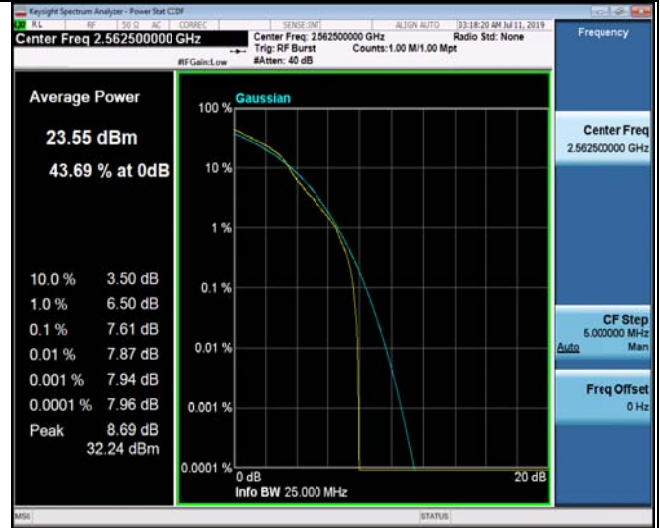

1RB#0

1RB#0

Middle Channel

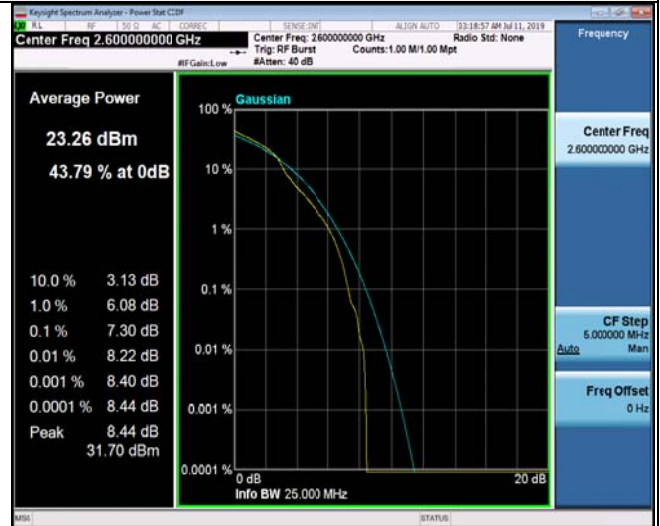
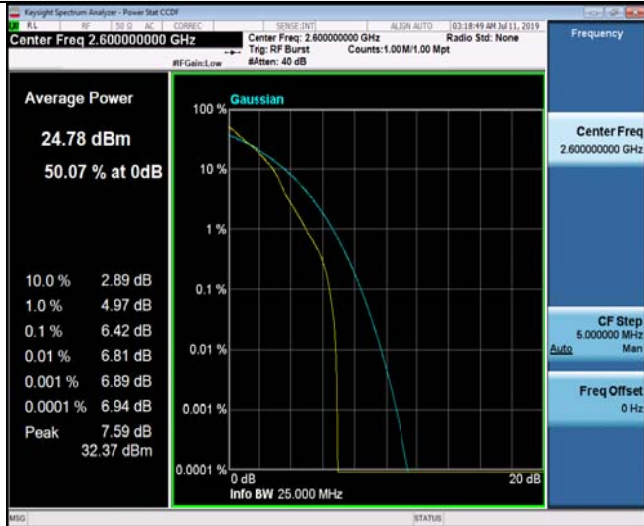

1RB#0

1RB#0

High Channel



1RB#0

1RB#0



LTE Band 41-20MHz Channel BandwidthPAPR

QPSK

16QAM

Low Channel



1RB#0

1RB#0

Middle Channel

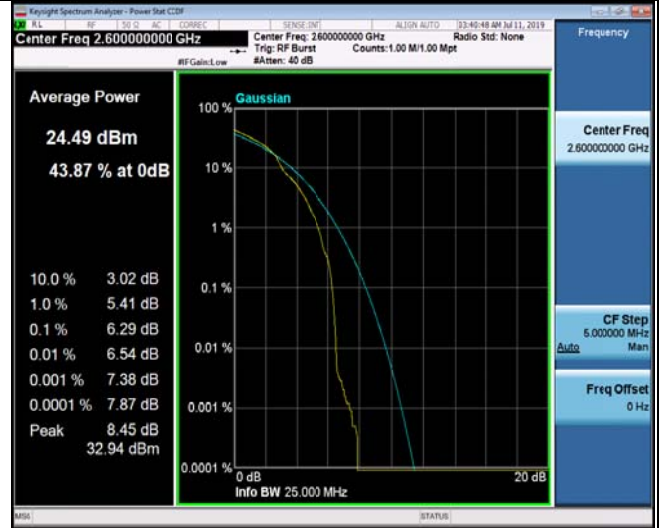

1RB#0

1RB#0

High Channel

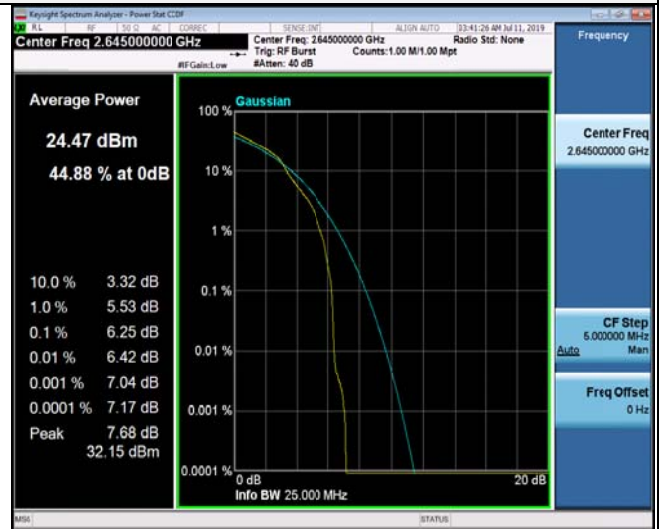
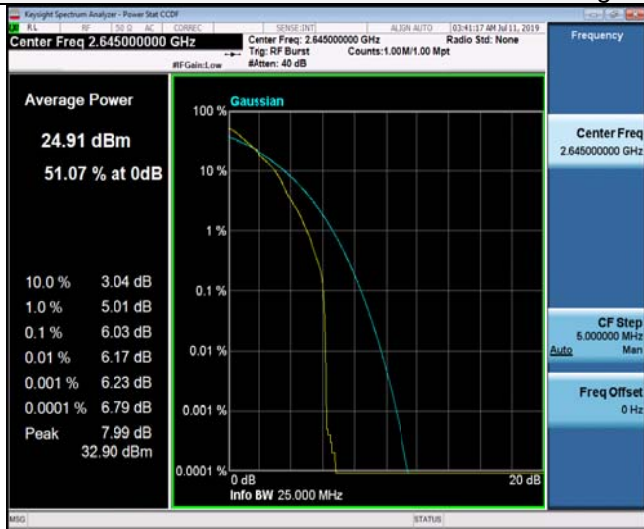

1RB#0

1RB#0



4.3 Occupied Bandwidth and Emission Bandwidth

LIMIT

N/A

TEST CONFIGURATION

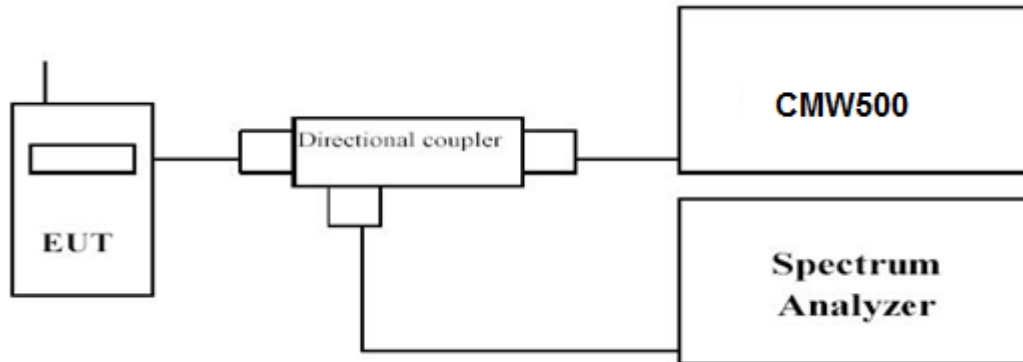

TEST PROCEDURE

The transmitter output was connected to a calibrated coaxial cable and coupler, the other end of which was connected to a spectrum analyzer. The occupied bandwidth was measured with the spectrum analyzer at low, middle and high channel in each band. The -26dBc Emission bandwidth was also measured and recorded. Set RBW was set to about 1% of emission BW, VBW ≥ 3 times RBW.

-26dBc display line was placed on the screen (or 99% bandwidth), the occupied bandwidth is the delta frequency between the two points where the display line intersects the signal trace.

TEST RESULTS

EUT:	4G Mobile phone	Test Date:	Oct. 21, 2019
Temperature:	25 ⁰ C	Tested by:	Gary Qian
Humidity:	55 % RH	Test Voltage	Normal Voltage
Operation Mode:	Normal Voltage- Tx Mode		

Remark:

1. We were tested all RB Configuration refer 3GPP TS136 521 for each Channel Bandwidth of LTE Band 41; recorded worst case for each Channel Bandwidth of LTE Band 41.

LTE Band 41						
TX Channel Bandwidth	RB Size/Offset	Frequency (MHz)	99% Occupied bandwidth (MHz)		-26dBc Emission bandwidth (MHz)	
			QPSK	16QAM	QPSK	16QAM
5 MHz	25RB#0	2557.5	4.4929	4.4954	4.874	4.854
		2600.0	4.5057	4.4871	4.817	4.845
		2652.5	4.4954	4.4916	4.904	4.839
10 MHz	50RB#0	2560.0	8.9846	8.9770	9.517	9.558
		2600.0	8.9823	8.9690	9.522	9.545
		2650.0	8.9681	8.9762	9.532	9.581
15 MHz	75RB#0	2562.5	13.424	13.447	14.23	14.29
		2600.0	13.468	13.477	14.25	14.31
		2647.5	13.469	13.443	14.28	14.26
20 MHz	100RB#0	2570.0	17.956	17.952	18.99	18.96
		2600.0	17.982	17.965	18.96	18.99
		2640.0	17.950	17.932	18.96	19.04



LTE Band 41-5MHz Channel Bandwidth Occupied Bandwidth and Emission Bandwidth

QPSK

16QAM

Low Channel

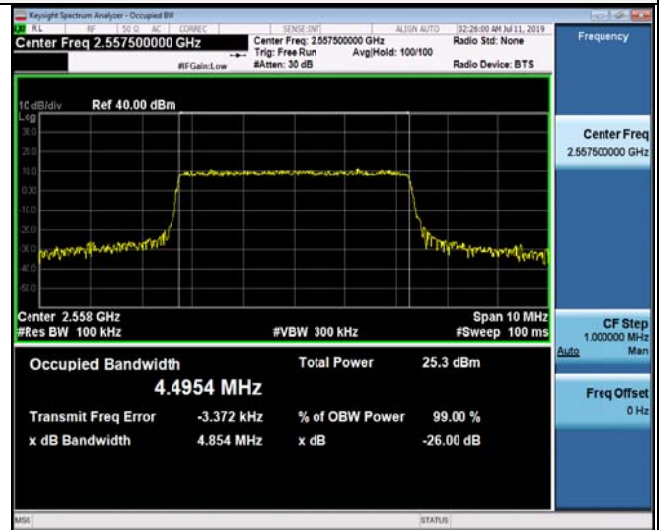

25RB#0

25RB#0

Middle Channel

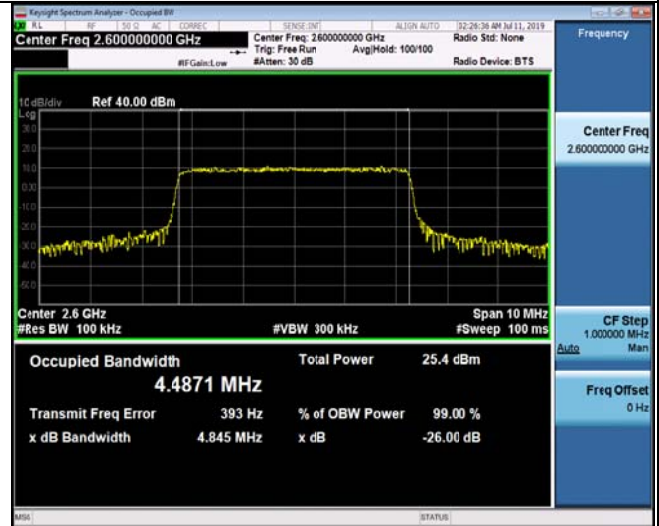
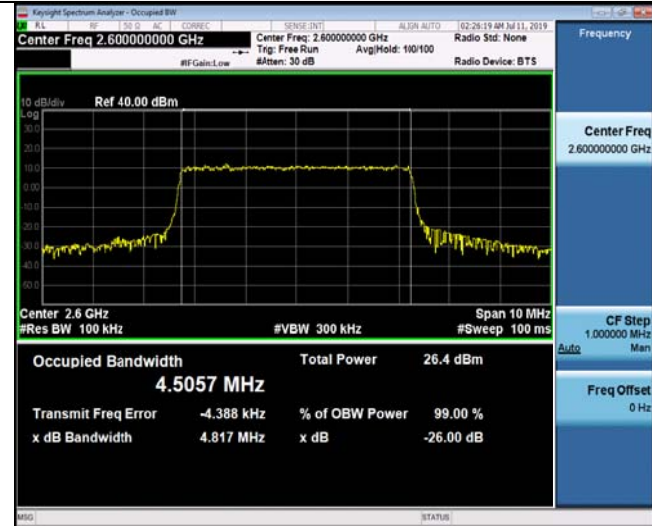

25RB#0

25RB#0

High Channel

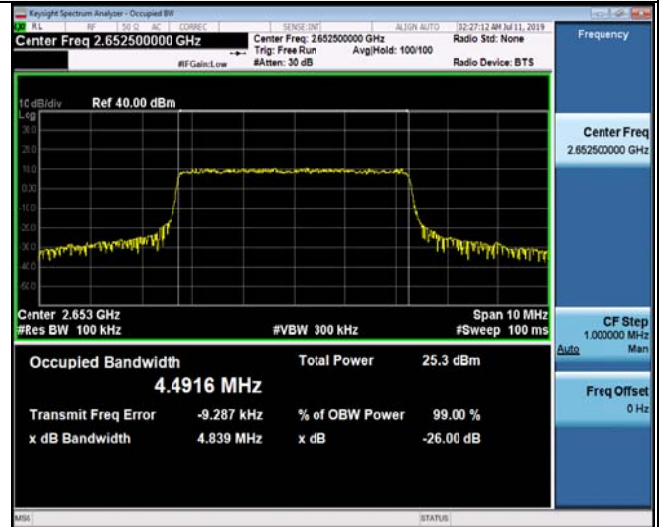
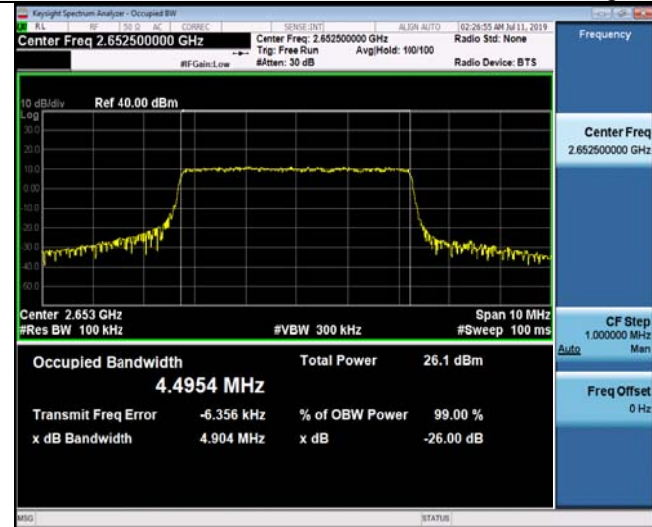

25RB#0

25RB#0



LTE Band 41-10MHz Channel Bandwidth Occupied Bandwidth and Emission Bandwidth

QPSK

16QAM

Low Channel

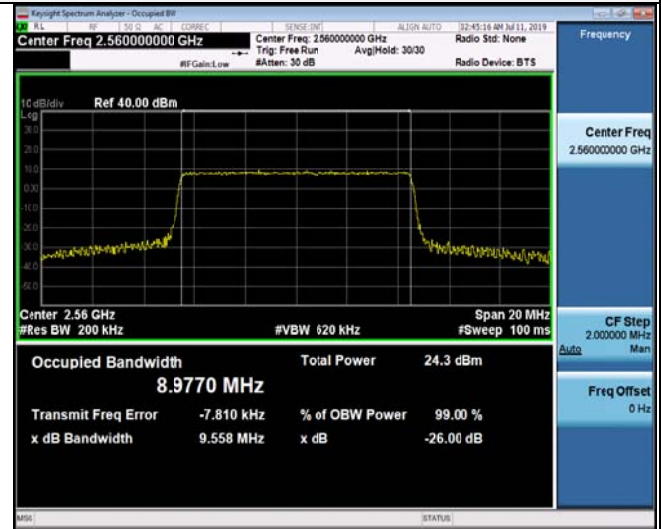
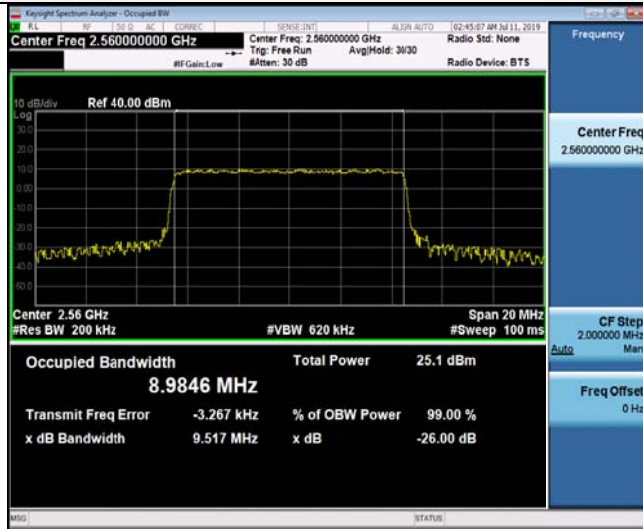

50RB#0

50RB#0

Middle Channel

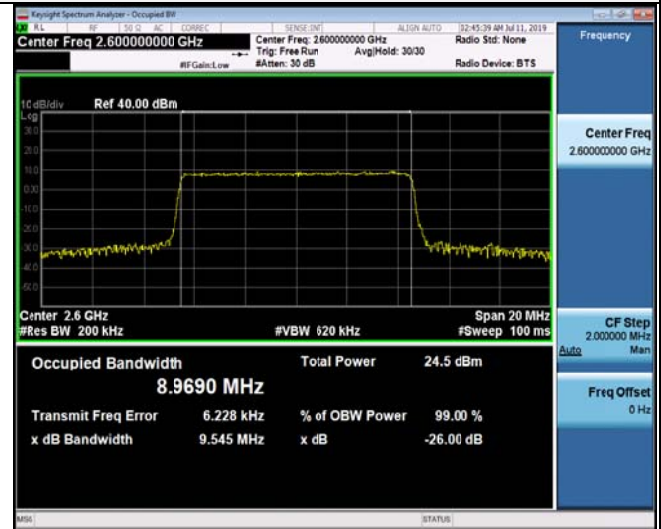
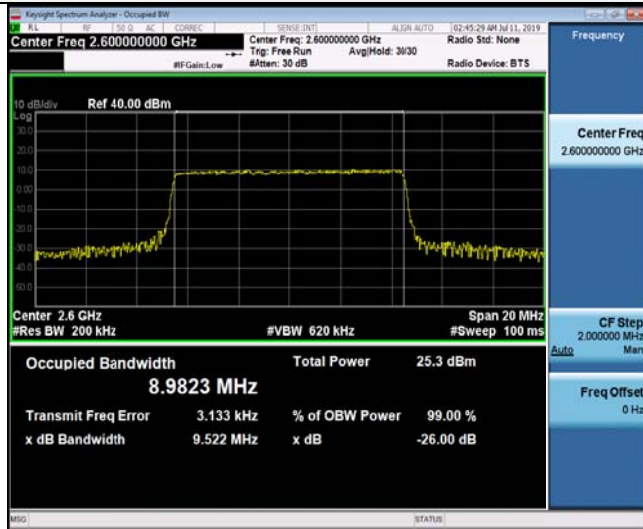

50RB#0

50RB#0

High Channel

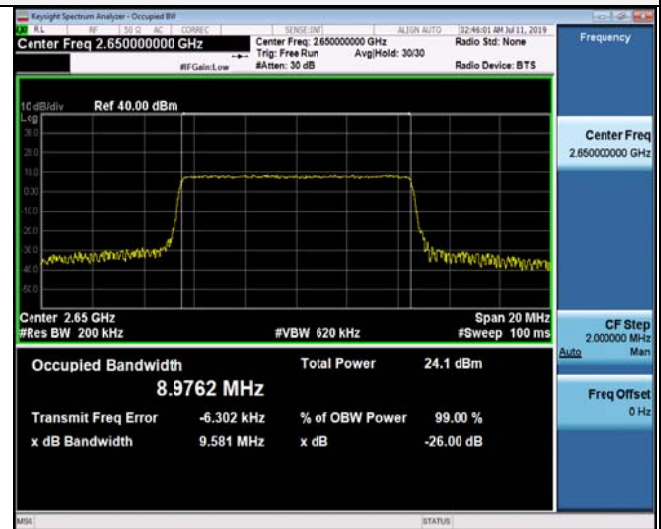
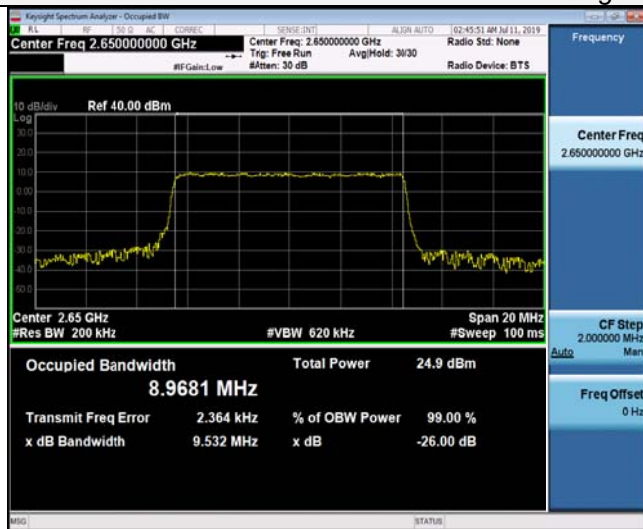

50RB#0

50RB#0



LTE Band 41-15MHz Channel Bandwidth Occupied Bandwidth and Emission Bandwidth

QPSK

16QAM

Low Channel

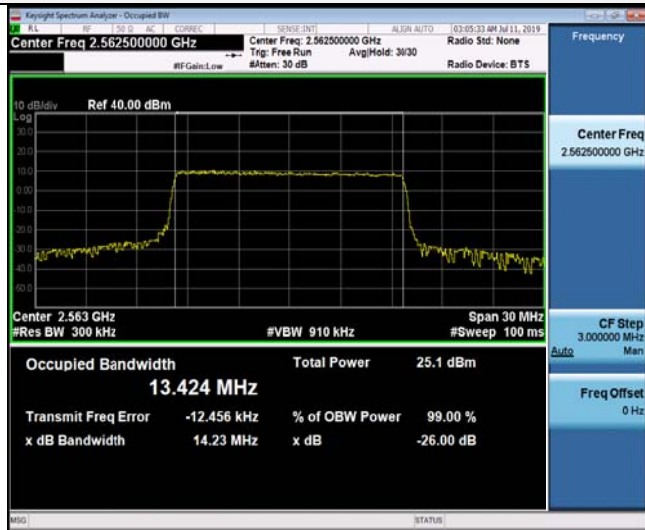

75RB#0

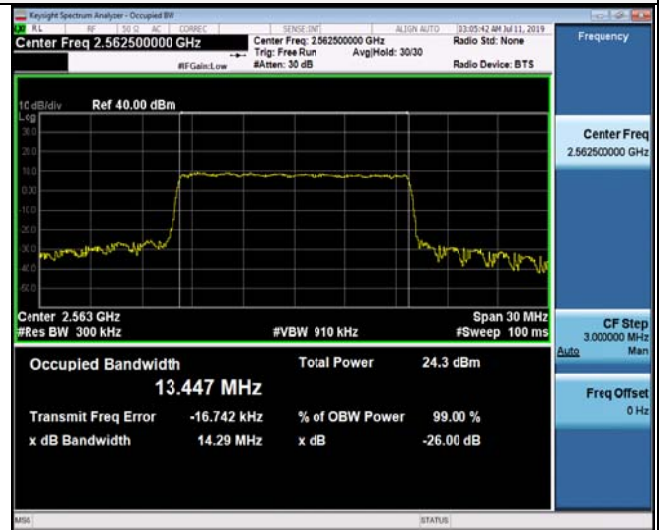

75RB#0

Middle Channel

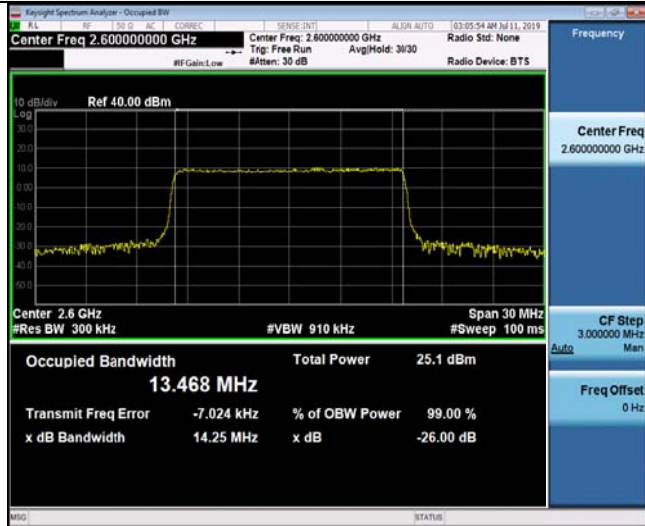

75RB#0

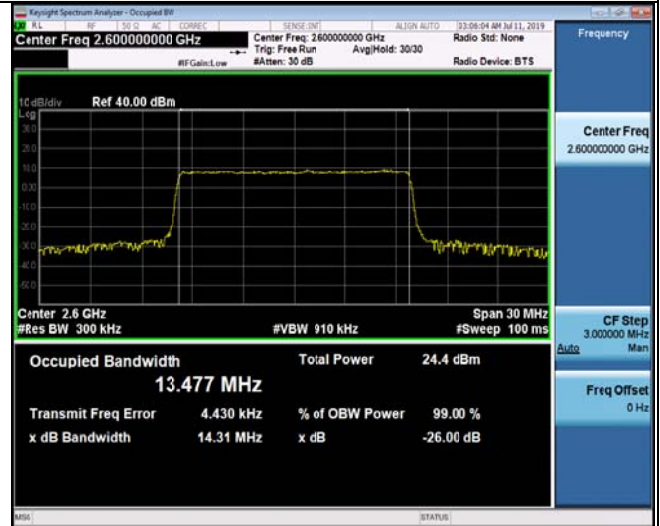

75RB#0

High Channel

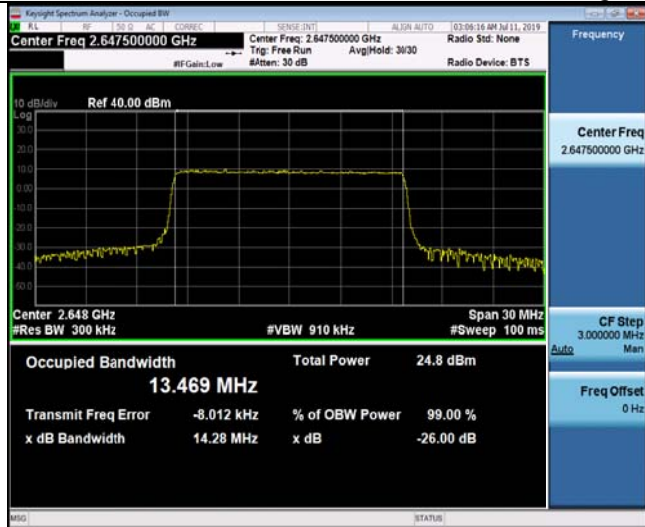

75RB#0

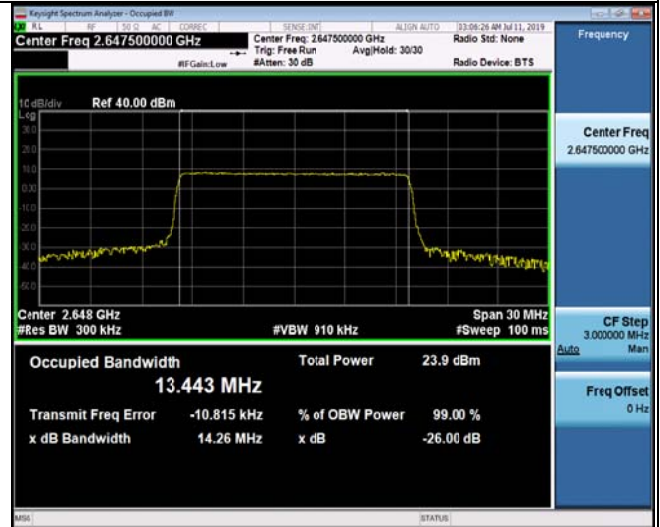

75RB#0



LTE Band 41-20MHz Channel Bandwidth Occupied Bandwidth and Emission Bandwidth

QPSK

16QAM

Low Channel

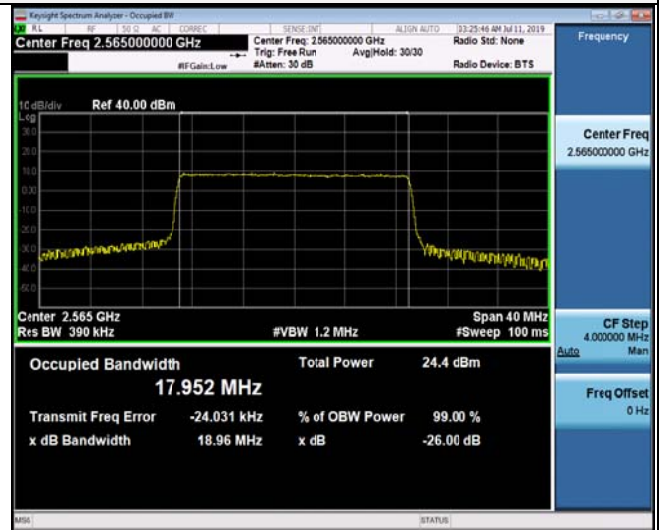
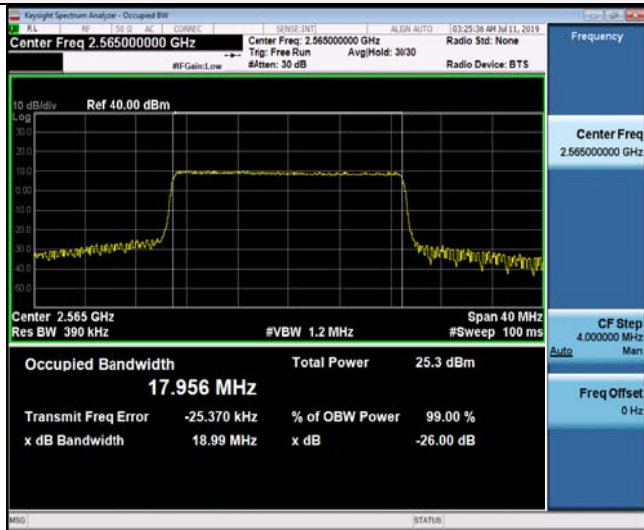

100RB#0

100RB#0

Middle Channel

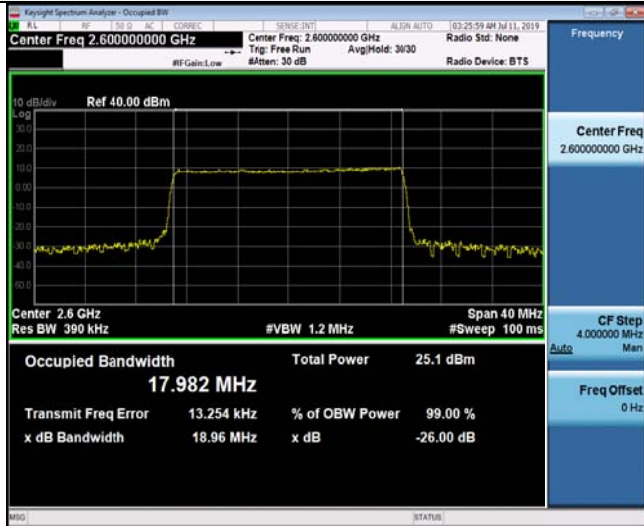

100RB#0

100RB#0

High Channel

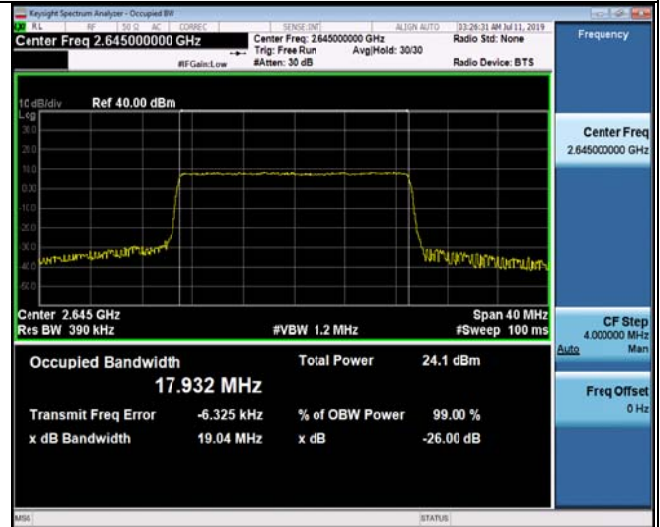
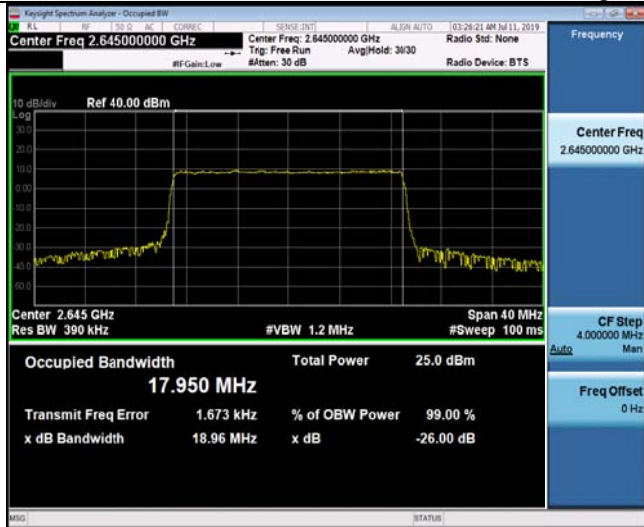

100RB#0

100RB#0



4.4 Band Edge compliance

LIMIT

the power of any emission outside of the authorized operating frequency ranges must be attenuated below the transmitting power (P) by a factor of at least $40 + 10 \log P$ dB (-10 dBm, 100 nW) on all frequencies between the channel edge and 5 MHz from the channel edge, $43 + 10 \log P$ dB (-13 dBm, 50 nW) on all frequencies between 5 MHz and X MHz from the channel edge, and $55 + 10 \log P$ dB (-25 dBm, 3 nW) on all frequencies more than 20 MHz from the channel edge, where XMHz is the greater of 6 MHz or the actual emission bandwidth (26 dB).

TEST CONFIGURATION

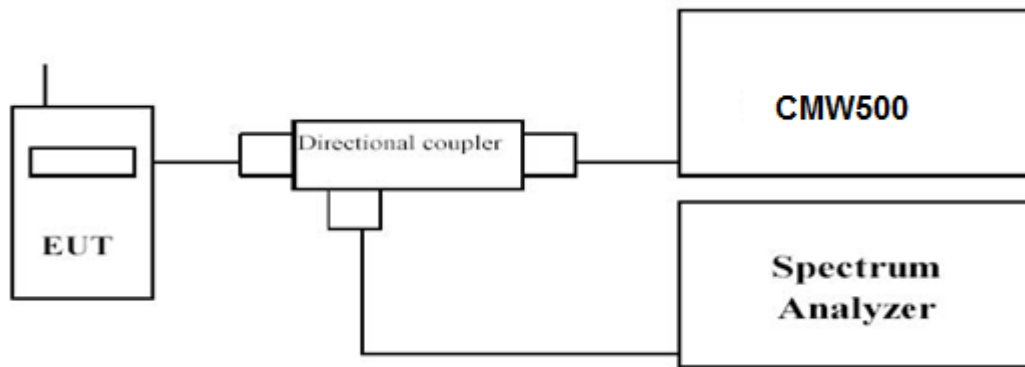

TEST PROCEDURE

1. The transmitter output port was connected to base station.
2. The RF output of EUT was connected to the power meter by RF cable and attenuator, the path loss was compensated to the results for each measurement.
3. Set EUT at maximum power through base station.
4. Select lowest and highest channels for each band and different modulation.
5. Measure Band edge using RMS (Average) detector by spectrum
6. Set RBW = 100 kHz, VBW=300 kHz, Span=50MHz Peak Detector.

TEST RESULTS

EUT:	4G Mobile phone	Test Date:	July. 11, 2019
Temperature:	25°C	Tested by:	Gary Qian
Humidity:	55 % RH	Test Voltage	Normal Voltage
Operation Mode:	Normal Voltage- Tx Mode		

Remark:

1. We were tested all RB Configuration refer 3GPP TS136 521 for each Channel Bandwidth of LTE Band 41; recorded worst case for each Channel Bandwidth of LTE Band 41.



LTE Band 41-5MHz Channel Bandwidth Band Edge Compliance

QPSK

16QAM

Low Channel

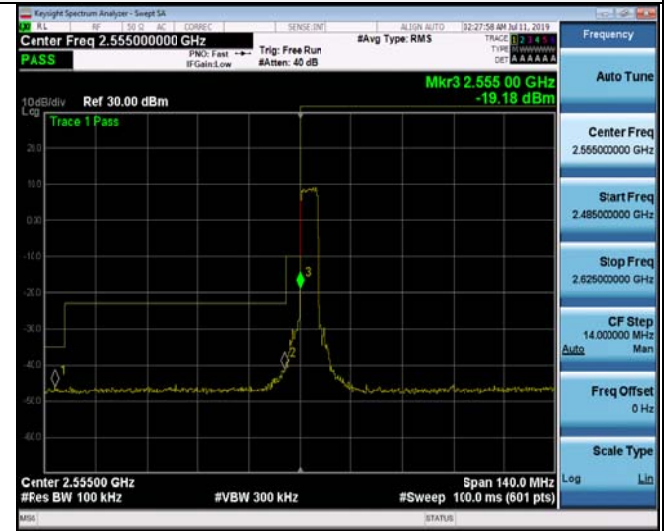
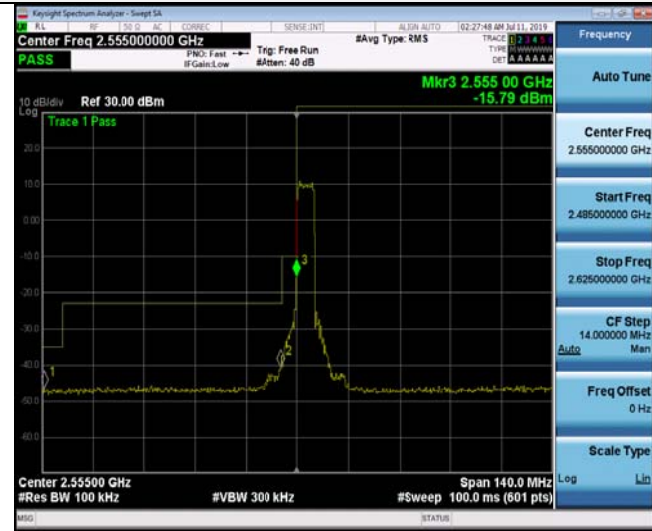

25RB#0

25RB#0

High Channel

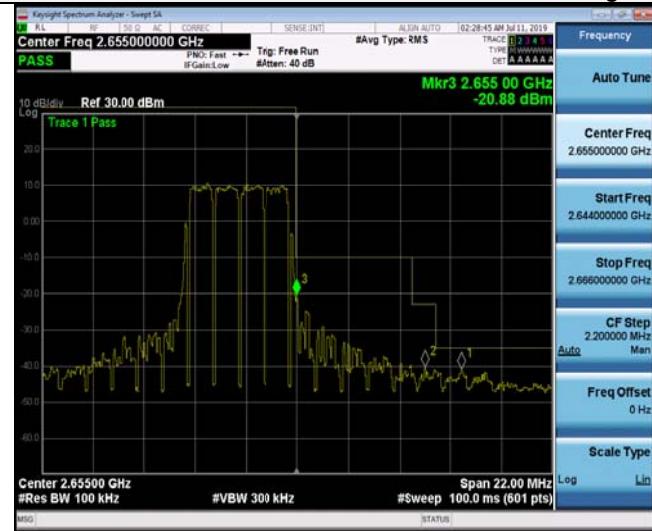

25RB#0

25RB#0



LTE Band 41- 10 MHz Channel Bandwidth Band Edge Compliance

QPSK

16QAM

Low Channel

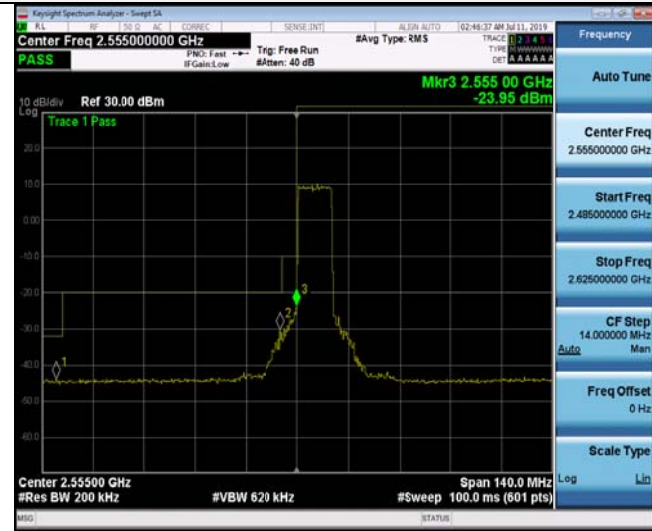

50RB#0

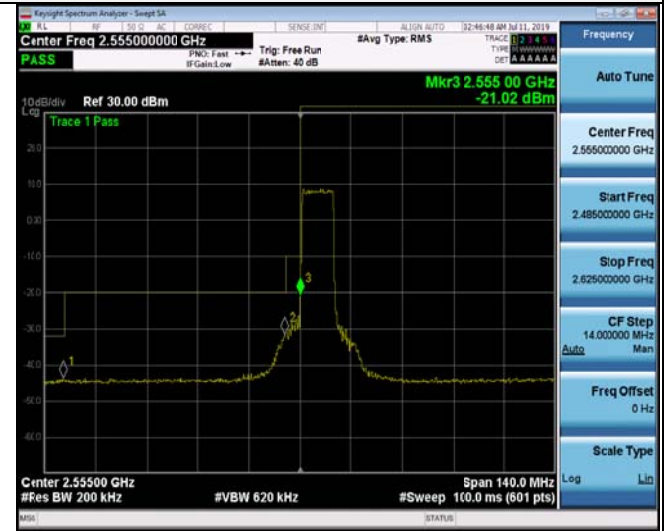

50RB#0

High Channel

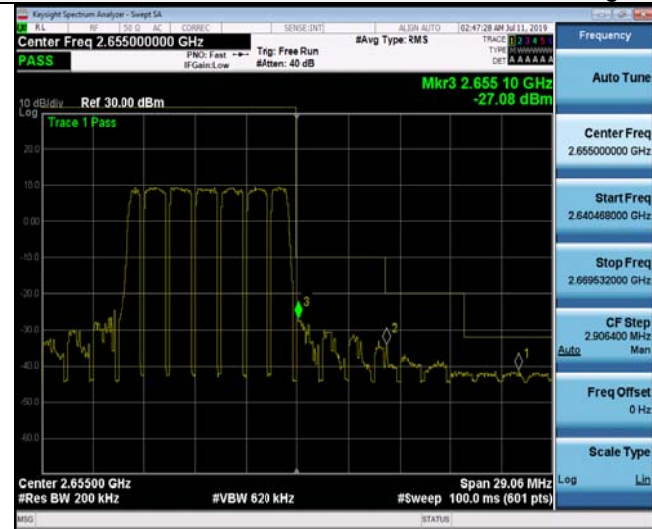

50RB#0



50RB#0



LTE Band 41-15MHz Channel Bandwidth Band Edge Compliance

QPSK

16QAM

Low Channel

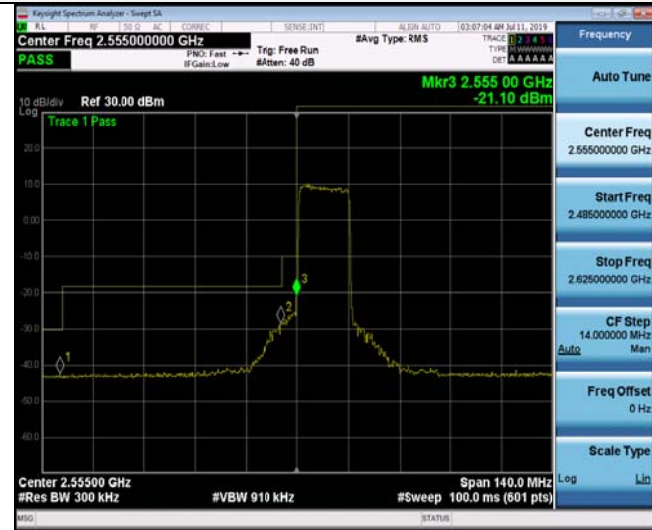

75RB#0



75RB#0

High Channel



75RB#0



75RB#0



LTE Band 41-20MHz Channel Bandwidth Band Edge Compliance

QPSK

16QAM

Low Channel



100RB#0



100RB#0

High Channel



100RB#0



100RB#0



4.5 Spurious Emission on Antenna Port

LIMIT

The power of any emission outside of the authorized operating frequency ranges must be attenuated below the transmitting power (P) by a factor of at least $40 + 10 \log P$ dB (-10 dBm, 100 nW) on all frequencies between the channel edge and 5 MHz from the channel edge, $43 + 10 \log P$ dB (-13 dBm, 50 nW) on all frequencies between 5 MHz and X MHz from the channel edge, and $55 + 10 \log P$ dB (-25 dBm, 3 nW) on all frequencies more than 20 MHz from the channel edge, where X MHz is the greater of 6 MHz or the actual emission bandwidth (26 dB).

TEST CONFIGURATION

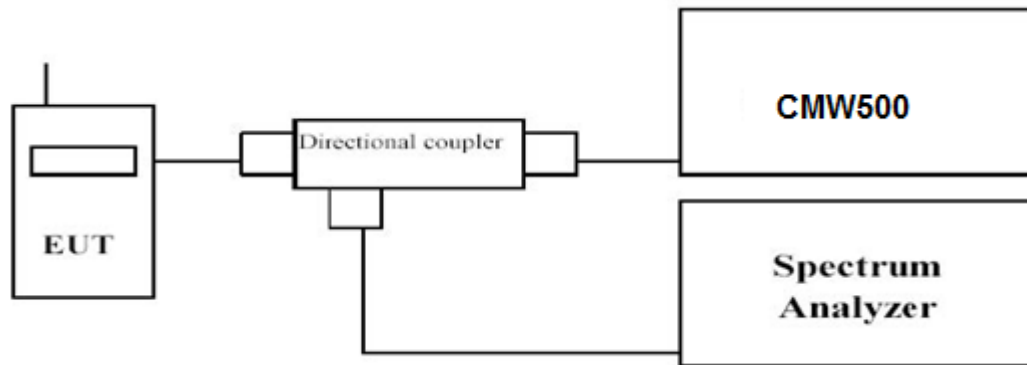

TEST PROCEDURE

The EUT was setup according to EIA/TIA 603D

- Place the EUT on a bench and set it in transmitting mode.
- Connect a low loss RF cable from the antenna port to a spectrum analyzer and CMW500 by a Directional Coupler.
- EUT Communicate with CMW500, then select a channel for testing.
- Add a correction factor to the display of spectrum, and then test.
- The resolution bandwidth of the spectrum analyzer was set sufficient scans were taken to show the out of band Emission if any up to 10th harmonic.
- Please refer to following tables for test antenna conducted emissions.

Working Frequency	Sub range (GHz)	RBW	VBW	Sweep time (s)
LTE Band 41	0.03~26.5	1 MHz	3 MHz	Auto

TEST RESULTS

EUT:	4G Mobile phone	Test Date:	Oct. 21, 2019
Temperature:	25 ⁰ C	Tested by:	Gary Qian
Humidity:	55 % RH	Test Voltage	Normal Voltage
Operation Mode:	Normal Voltage- Tx Mode		

Remark:

- We were tested all RB Configuration refer 3GPP TS136 521 for each Channel Bandwidth of LTE Band 41; recorded worst case at the QPSK Mode for each Channel Bandwidth of LTE Band 41



LTE Band 41-5 MHz Channel Bandwidth

Low Channel

QPSK



10MHz~3GHz

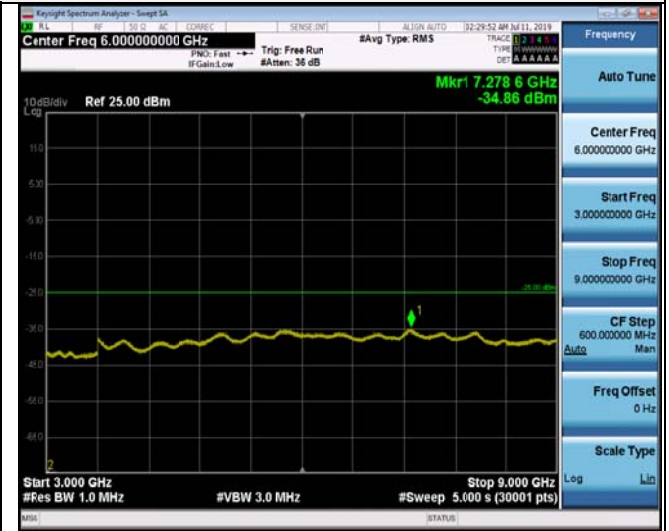

3GHz~9GHz

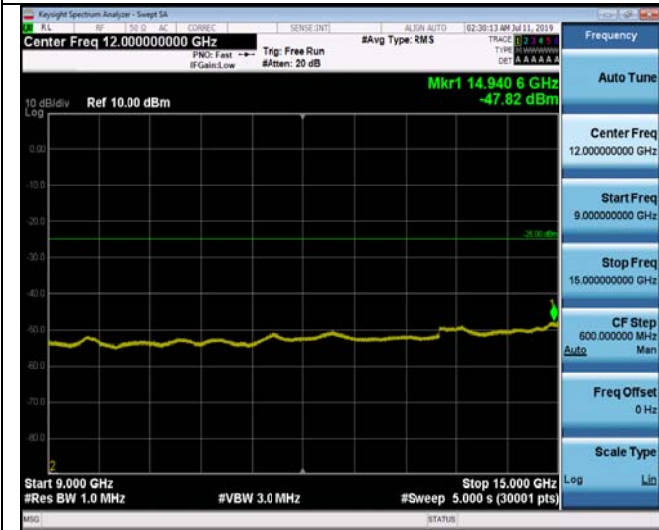

9 GHz~15 GHz



15 GHz~26.5GHz



LTE Band 41-5 MHz Channel Bandwidth

Middle Channel

QPSK



10MHz~3GHz

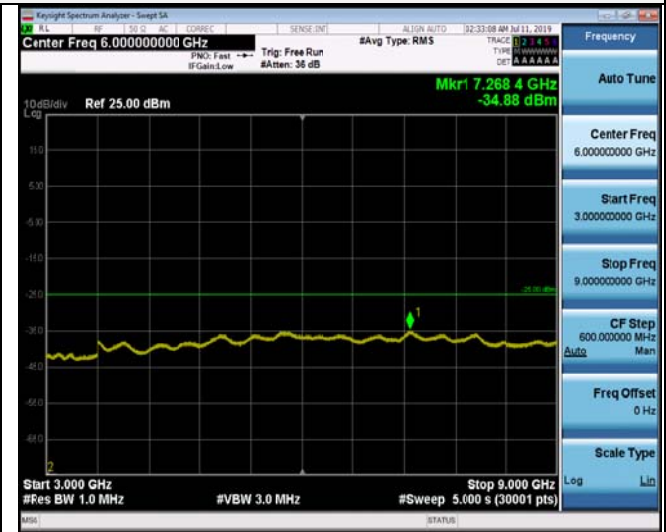

3GHz ~9GHz



9 GHz ~15 GHz



15 GHz ~26.5GHz



LTE Band 41-5 MHz Channel Bandwidth

High Channel

QPSK

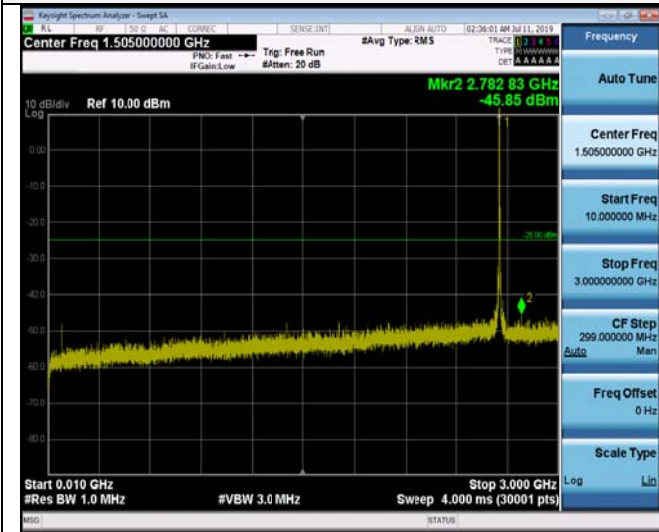

10MHz~3GHz

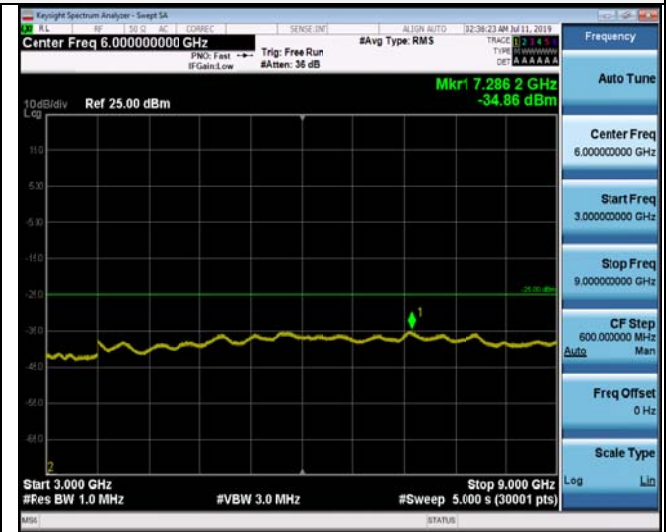

3GHz ~9GHz



9 GHz ~15 GHz

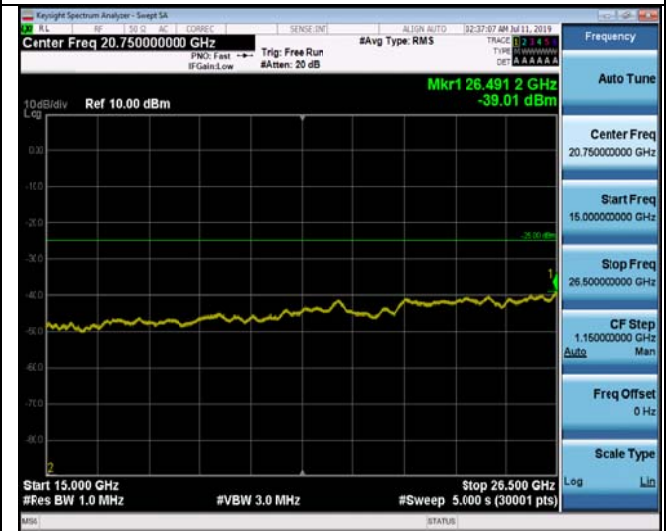

15 GHz ~26.5GHz



LTE Band 41-10 MHz Channel Bandwidth

Low Channel

QPSK



10MHz~3GHz

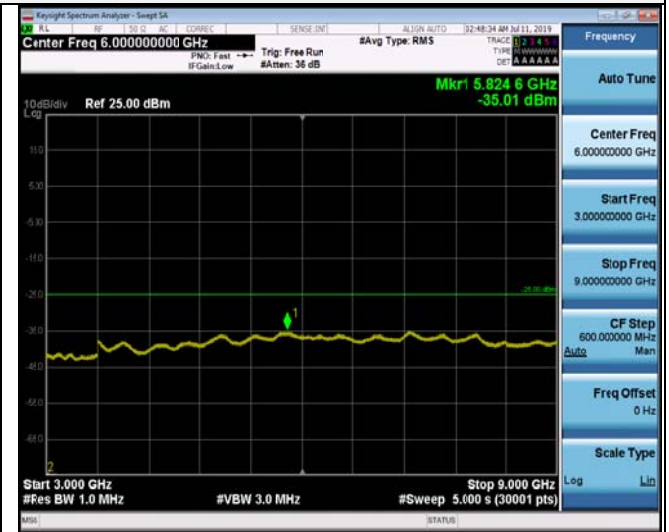

3GHz ~9GHz



9 GHz ~15 GHz



15 GHz ~26.5GHz



LTE Band 41-10 MHz Channel Bandwidth

Middle Channel

QPSK



10MHz~3GHz

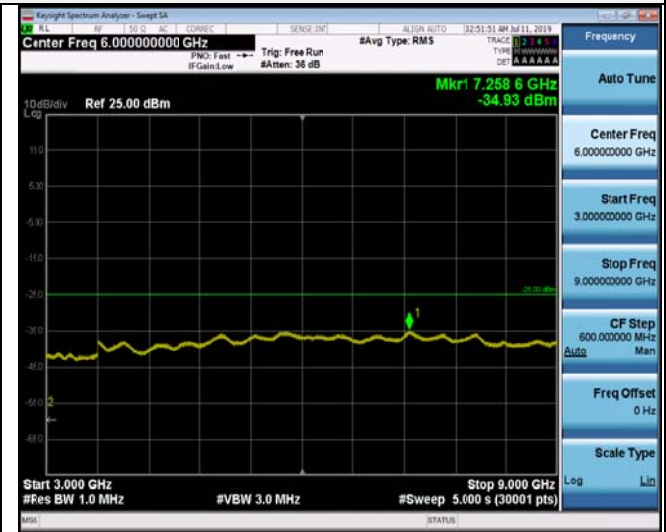

3GHz ~9GHz



9 GHz ~15 GHz



15 GHz ~26.5GHz



LTE Band 41-10 MHz Channel Bandwidth

High Channel

QPSK



10MHz~3GHz

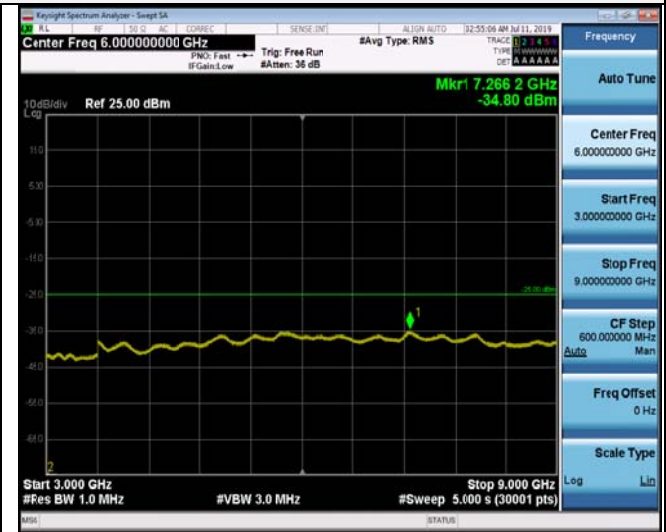

3GHz ~9GHz



9 GHz ~15 GHz



15 GHz ~26.5GHz



LTE Band 41-15 MHz Channel Bandwidth

Low Channel

QPSK

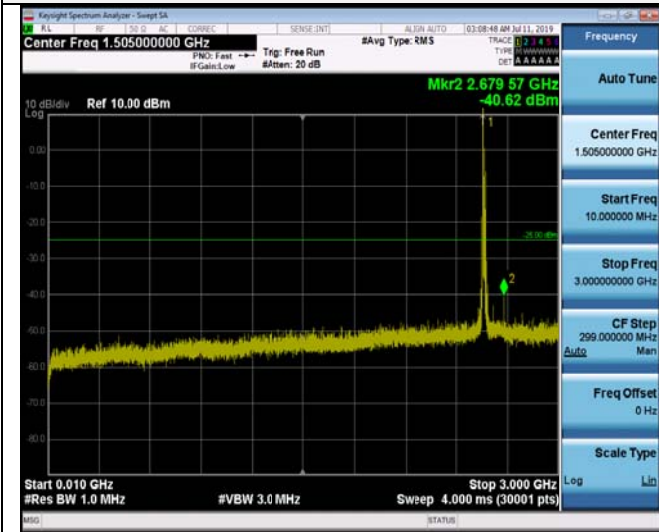

10MHz~3GHz

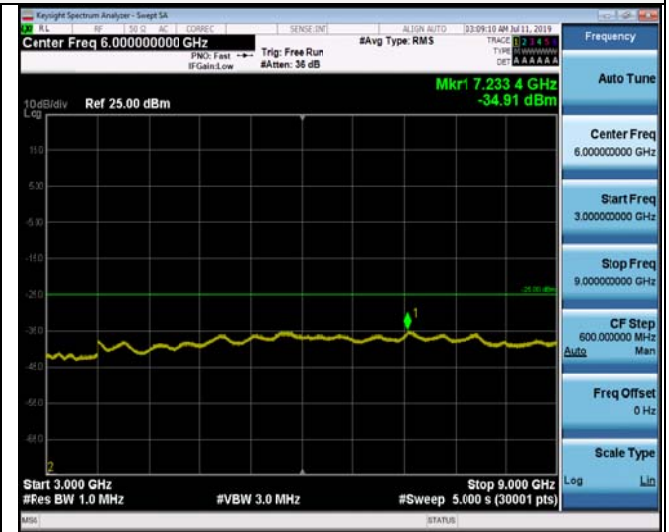

3GHz ~9GHz



9 GHz ~15 GHz



15 GHz ~26.5GHz



LTE Band 41-15 MHz Channel Bandwidth

Middle Channel

QPSK

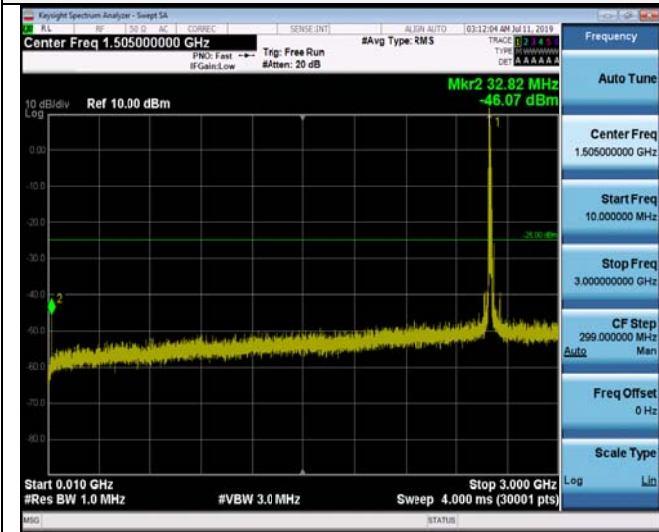

10MHz~3GHz

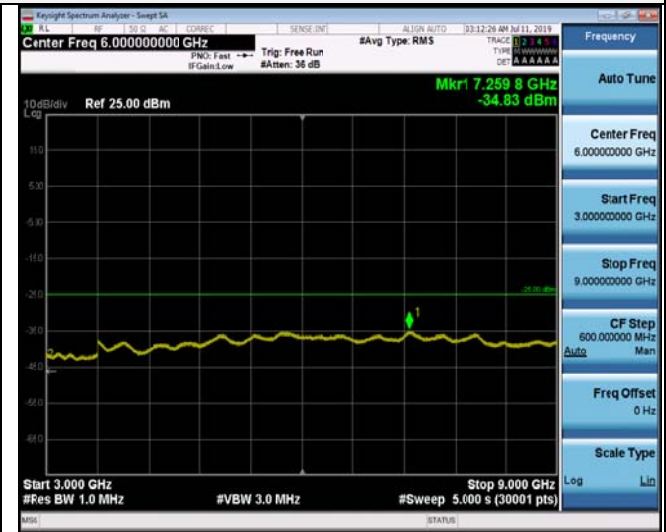

3GHz ~9GHz



9 GHz ~15 GHz



15 GHz ~26.5GHz



LTE Band 41-15 MHz Channel Bandwidth

High Channel

QPSK

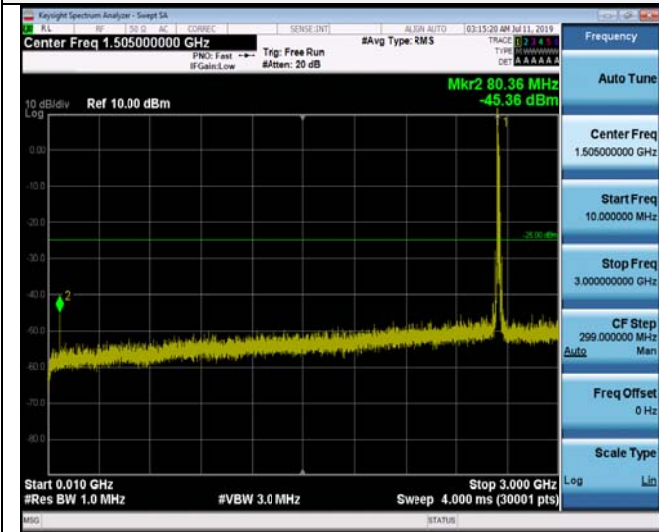

10MHz~3GHz

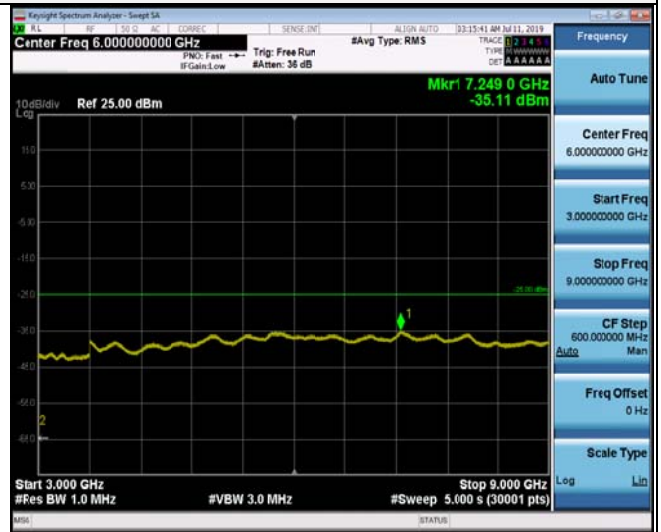

3GHz ~9GHz



9 GHz ~15 GHz



15 GHz ~26.5GHz



LTE Band 41-20 MHz Channel Bandwidth

Low Channel

QPSK

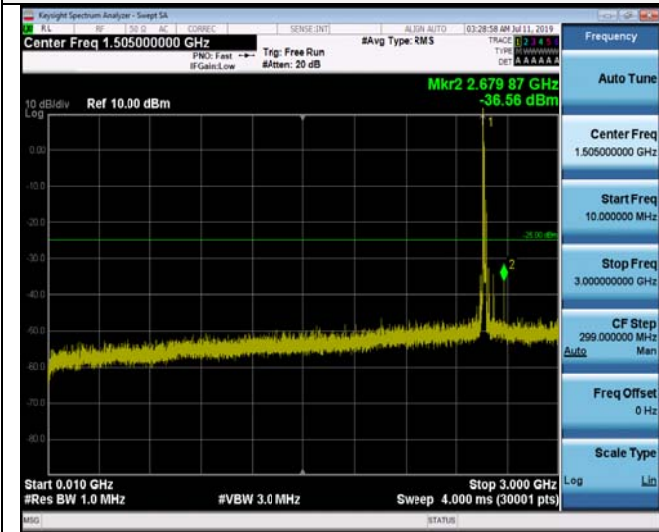

10MHz~3GHz

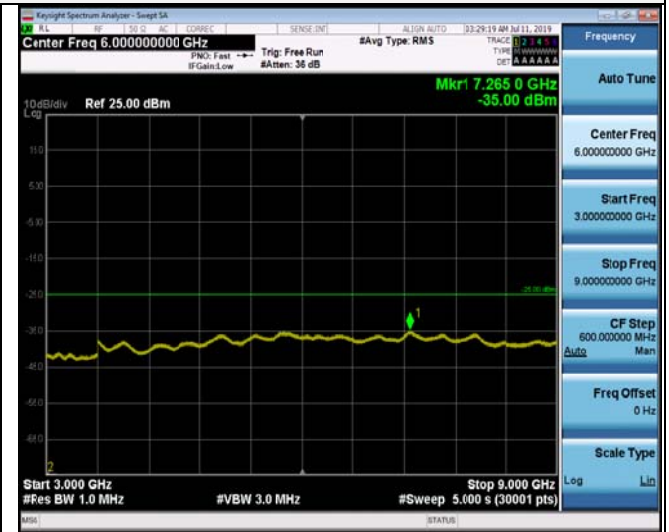

3GHz~9GHz



9 GHz~15 GHz



15 GHz~26.5GHz



LTE Band 41-20 MHz Channel Bandwidth

Middle Channel

QPSK



10MHz~3GHz

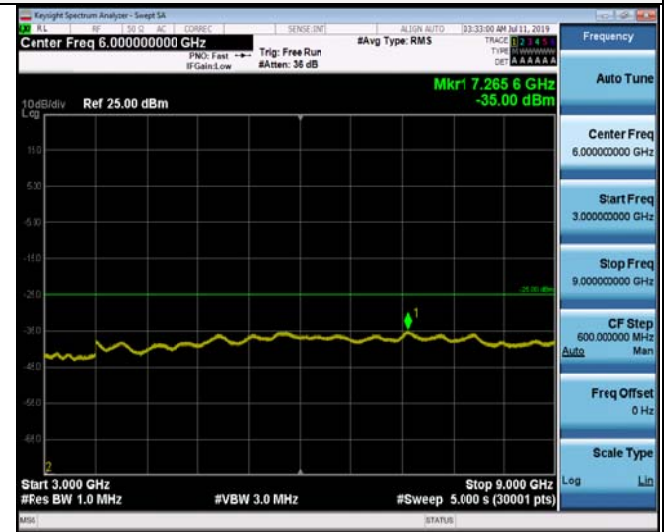

3GHz ~9GHz



9 GHz ~15 GHz

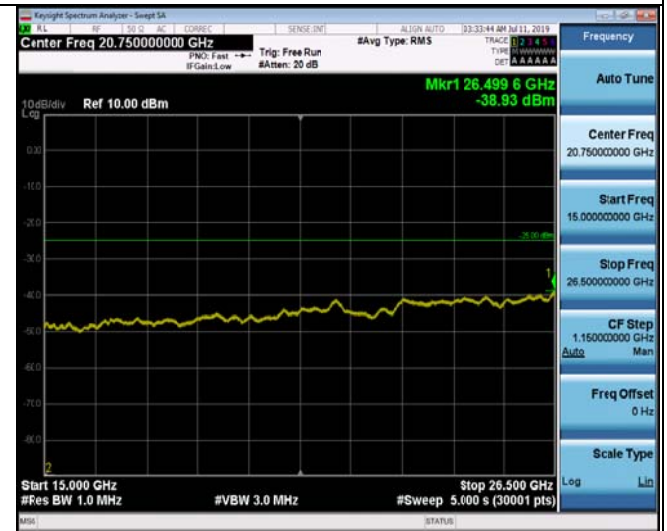

15 GHz ~26.5GHz



LTE Band 41-20 MHz Channel Bandwidth

High Channel

QPSK

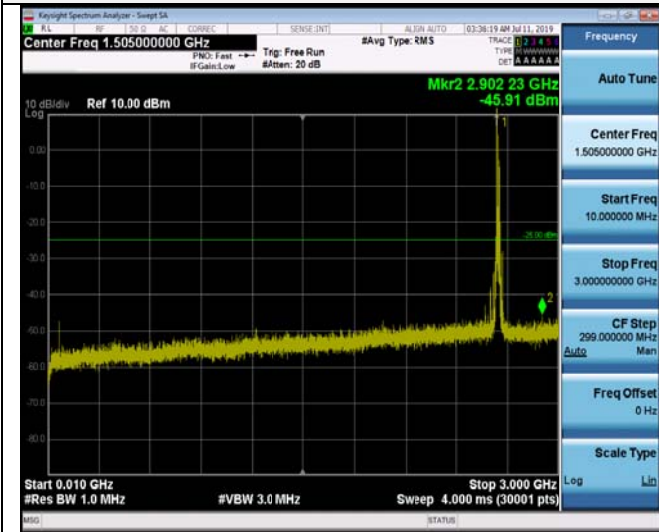

10MHz~3GHz

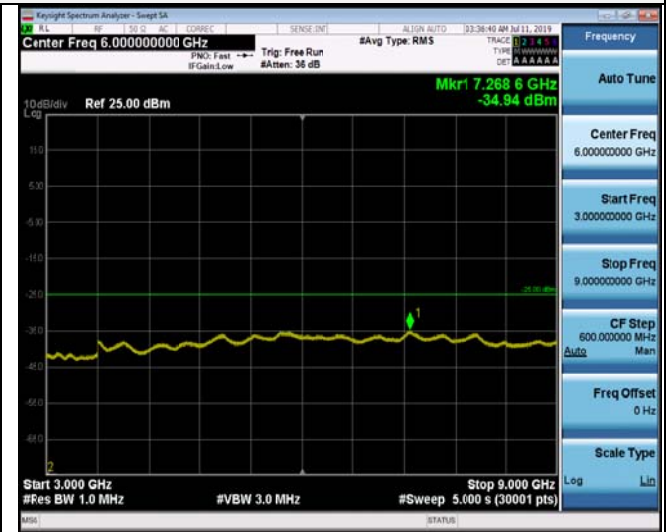

3GHz~9GHz



9 GHz~15 GHz



15 GHz~26.5GHz

4.6 Radiated Spurious Emission

TEST APPLICABLE

The power of any emission outside of the authorized operating frequency ranges must be attenuated below the transmitting power (P) by a factor of at least $40 + 10 \log P$ dB (-10 dBm, 100 nW) on all frequencies between the channel edge and 5 MHz from the channel edge, $43 + 10 \log P$ dB (-13 dBm, 50 nW) on all frequencies between 5 MHz and X MHz from the channel edge, and $55 + 10 \log P$ dB (-25 dBm, 3 nW) on all frequencies more than 20 MHz from the channel edge, where X MHz is the greater of 6 MHz or the actual emission bandwidth (26 dB).

TEST CONFIGURATION

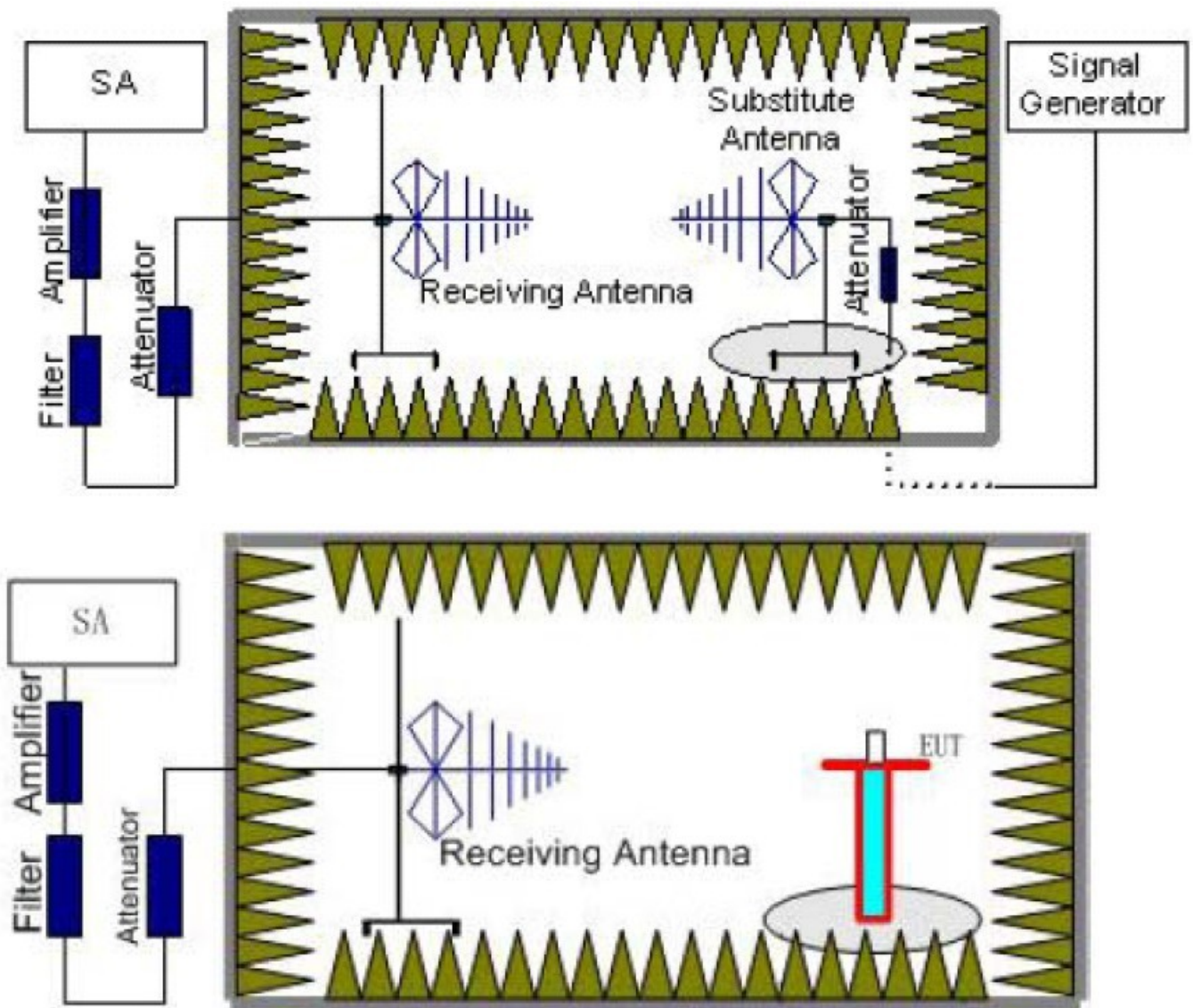

TEST PROCEDURE

The EUT was setup according to EIA/TIA 603D

- The EUT shall be placed at the specified height on a support, and in the position closest to normal use as declared by provider.
- The test antenna shall be oriented initially for vertical polarization and shall be chosen to correspond to the frequency of the transmitter
- The output of the test antenna shall be connected to the measuring receiver.
- The transmitter shall be switched on and the measuring receiver shall be tuned to the frequency of the transmitter under test.



- e. The test antenna shall be raised and lowered through the specified range of height until a maximum signal level is detected by the measuring receiver.
- f. The transmitter shall then be rotated through 360° in the horizontal plane, until the maximum signal level is detected by the measuring receiver.
- g. The test antenna shall be raised and lowered again through the specified range of height until a maximum signal level is detected by the measuring receiver.
- h. The maximum signal level detected by the measuring receiver shall be noted.
- i. The transmitter shall be replaced by a substitution antenna.
- j. The substitution antenna shall be orientated for vertical polarization and the length of the substitution antenna shall be adjusted to correspond to the frequency of the transmitter.
- k. The substitution antenna shall be connected to a calibrated signal generator.
- l. If necessary, the input attenuator setting of the measuring receiver shall be adjusted in order to increase the sensitivity of the measuring receiver.
- m. The test antenna shall be raised and lowered through the specified range of height to ensure that the maximum signal is received.
- n. The input signal to the substitution antenna shall be adjusted to the level that produces a level detected by the measuring receiver, that is equal to the level noted while the transmitter radiated power was measured, corrected for the change of input attenuator setting of the measuring receiver.
- o. The measurement shall be repeated with the test antenna and the substitution antenna orientated for horizontal polarization.
- p. The measure of the effective radiated power is the larger of the two levels recorded at the input to the substitution antenna, corrected for gain of the substitution antenna if necessary.
- q. Test site anechoic chamber refer to ANSI C63.4:2014.

Frequency	Channel	Frequency Range	Verdict
LTE Band 41	Low	30MHz -26.5GHz	PASS
	Middle	30MHz -26.5GHz	PASS
	High	30MHz -26.5GHz	PASS

Radiated Measurement:

EUT:	4G Mobile phone	Test Date:	Oct. 21, 2019
Temperature:	25°C	Tested by:	Gary Qian
Humidity:	55 % RH	Test Voltage	Normal Voltage
Operation Mode:	Normal Voltage- Tx Mode		

Remark:

1. We measured all RB Configuration refer 3GPP TS136 521 for each Channel Bandwidth of LTE Band 41; recorded worst case for each Channel Bandwidth of LTE Band 41.
2. $EIRP = P_s(dBm) - P_{cl}(dB) + G_a(dBi)$
3. Not recorded other points means the reading of emissions are attenuated more than 20dB below the permissible limits or the field strength is too small to be measured.
4. $Margin = Limit - EIRP$

LTE Band 41_Channel Bandwidth 5MHz_QPSK_1RB#0

Frequency (MHz)	P _s (dBm)	P _{cl} (dB)	Distance	G _a Antenna Gain (dB)	Peak EIRP (dBm)	Limit (dBm)	Margin (dB)	Polarization
5115.0	-41.93	4.39	3.00	12.34	-33.98	-25.00	8.98	H
7672.5	-51.26	5.31	3.00	13.52	-43.05	-25.00	18.05	H
5115.0	-43.35	4.39	3.00	12.34	-35.4	-25.00	10.4	V
7672.5	-53.83	5.31	3.00	13.52	-45.62	-25.00	20.62	V

*LTE Band 41_Channel Bandwidth 5MHz_QPSK_1RB#0*

Frequency (MHz)	P _s (dBm)	P _{cl} (dB)	Diatance	G _a Antenna Gain(dB)	Peak EIRP (dBm)	Limit (dBm)	Margin (dB)	Polarization
5200.0	-42.01	4.41	3.00	12.34	-34.08	-25.00	9.08	H
7800.0	-49.59	5.38	3.00	13.58	-41.39	-25.00	16.39	H
5200.0	-44.48	4.41	3.00	12.34	-36.55	-25.00	11.55	V
7800.0	-51.57	5.38	3.00	13.58	-43.37	-25.00	18.37	V

LTE Band 41_Channel Bandwidth 5MHz_QPSK_1RB#0

Frequency (MHz)	P _s (dBm)	P _{cl} (dB)	Diatance	G _a Antenna Gain(dB)	Peak EIRP (dBm)	Limit (dBm)	Margin (dB)	Polarization
5305.0	-45.42	4.45	3.00	12.45	-41.14	-25.00	16.14	H
7957.5	-49.28	5.47	3.00	13.66	-45.17	-25.00	20.17	H
5305.0	-43.26	4.45	3.00	12.45	-44.74	-25.00	19.74	V
7957.5	-51.93	5.48	3.00	13.66	-50.45	-25.00	25.45	V

LTE Band 41_Channel Bandwidth 10MHz_QPSK_1RB#0

Frequency (MHz)	P _s (dBm)	P _{cl} (dB)	Diatance	G _a Antenna Gain(dB)	Peak EIRP (dBm)	Limit (dBm)	Margin (dB)	Polarization
5120.0	-41.95	4.39	3.00	12.34	-34	-25.00	9	H
7680.0	-51.49	5.31	3.00	13.52	-43.28	-25.00	18.28	H
5120.0	-43.73	4.39	3.00	12.34	-35.78	-25.00	10.78	V
7680.0	-54.08	5.31	3.00	13.52	-45.87	-25.00	20.87	V

LTE Band 41_Channel Bandwidth 10MHz_QPSK_1RB#0

Frequency (MHz)	P _s (dBm)	P _{cl} (dB)	Diatance	G _a Antenna Gain(dB)	Peak EIRP (dBm)	Limit (dBm)	Margin (dB)	Polarization
5200.0	-41.34	4.41	3.00	12.34	-33.41	-25.00	8.41	H
7800.0	-49.17	5.38	3.00	13.58	-40.97	-25.00	15.97	H
5200.0	-43.79	4.41	3.00	12.34	-35.86	-25.00	10.86	V
7800.0	-51.24	5.38	3.00	13.58	-43.04	-25.00	18.04	V

LTE Band 41_Channel Bandwidth 10MHz_QPSK_1RB#0

Frequency (MHz)	P _s (dBm)	P _{cl} (dB)	Diatance	G _a Antenna Gain(dB)	Peak EIRP (dBm)	Limit (dBm)	Margin (dB)	Polarization
5300.0	-45.57	4.45	3.00	12.45	-41.14	-25.00	16.14	H
7950.0	-48.91	5.47	3.00	13.66	-45.17	-25.00	20.17	H
5300.0	-43.68	4.45	3.00	12.45	-44.74	-25.00	19.74	V
7950.0	-52.02	5.48	3.00	13.66	-50.45	-25.00	25.45	V

LTE Band 41_Channel Bandwidth 15MHz_QPSK_1RB#0

Frequency (MHz)	P _s (dBm)	P _{cl} (dB)	Diatance	G _a Antenna Gain(dB)	Peak EIRP (dBm)	Limit (dBm)	Margin (dB)	Polarization
5125.0	-41.64	4.39	3.00	12.34	-33.69	-25.00	8.69	H
7687.5	-50.93	5.31	3.00	13.52	-42.72	-25.00	17.72	H
5125.0	-43.49	4.39	3.00	12.34	-35.54	-25.00	10.54	V
7687.5	-53.08	5.31	3.00	13.52	-44.87	-25.00	19.87	V

LTE Band 41_Channel Bandwidth 15MHz_QPSK_1RB#0

Frequency (MHz)	P _s (dBm)	P _{cl} (dB)	Diatance	G _a Antenna Gain(dB)	Peak EIRP (dBm)	Limit (dBm)	Margin (dB)	Polarization
5200.0	-42.09	4.41	3.00	12.34	-34.16	-25.00	9.16	H
7800.0	-49.95	5.38	3.00	13.58	-41.75	-25.00	16.75	H
5200.0	-44.14	4.41	3.00	12.34	-36.21	-25.00	11.21	V
7800.0	-50.75	5.38	3.00	13.58	-42.55	-25.00	17.55	V

*LTE Band 41_Channel Bandwidth 15MHz_QPSK_1RB#0*

Frequency (MHz)	Ps (dBm)	P _{cl} (dB)	Diatance	G _a Antenna Gain(dB)	Peak EIRP (dBm)	Limit (dBm)	Margin (dB)	Polarization
5295.0	-44.68	4.45	3.00	12.45	-41.14	-25.00	16.14	H
7942.5	-48.76	5.47	3.00	13.66	-45.17	-25.00	20.17	H
5295.0	-43.18	4.45	3.00	12.45	-44.74	-25.00	19.74	V
7942.5	-51.37	5.48	3.00	13.66	-50.45	-25.00	25.45	V

LTE Band 41_Channel Bandwidth 20MHz_QPSK_1RB#0

Frequency (MHz)	Ps (dBm)	P _{cl} (dB)	Diatance	G _a Antenna Gain(dB)	Peak EIRP (dBm)	Limit (dBm)	Margin (dB)	Polarization
5140.0	-41.79	4.39	3.00	12.34	-33.84	-25.00	8.84	H
7710.0	-51.65	5.31	3.00	13.52	-43.44	-25.00	18.44	H
5140.0	-43.79	4.39	3.00	12.34	-35.84	-25.00	10.84	V
7710.0	-3.89	5.31	3.00	13.52	4.32	-25.00	-29.32	V

LTE Band 41_Channel Bandwidth 20MHz_QPSK_1RB#0

Frequency (MHz)	Ps (dBm)	P _{cl} (dB)	Diatance	G _a Antenna Gain(dB)	Peak EIRP (dBm)	Limit (dBm)	Margin (dB)	Polarization
5200.0	-42.08	4.41	3.00	12.34	-34.15	-25.00	9.15	H
7800.0	-49.72	5.38	3.00	13.58	-41.52	-25.00	16.52	H
5200.0	-44.06	4.41	3.00	12.34	-36.13	-25.00	11.13	V
7800.0	-51.27	5.38	3.00	13.58	-43.07	-25.00	18.07	V

LTE Band 41_Channel Bandwidth 20MHz_QPSK_1RB#0

Frequency (MHz)	Ps (dBm)	P _{cl} (dB)	Diatance	G _a Antenna Gain(dB)	Peak EIRP (dBm)	Limit (dBm)	Margin (dB)	Polarization
5280.0	-44.86	4.45	3.00	12.45	-41.14	-25.00	16.14	H
7920.0	-48.79	5.47	3.00	13.66	-45.17	-25.00	20.17	H
5280.0	-43.46	4.45	3.00	12.45	-44.74	-25.00	19.74	V
7920.0	-51.24	5.48	3.00	13.66	-50.45	-25.00	25.45	V

LTE Band 41_Channel Bandwidth 5MHz_16QAM_1RB#0

Frequency (MHz)	Ps (dBm)	P _{cl} (dB)	Diatance	G _a Antenna Gain(dB)	Peak EIRP (dBm)	Limit (dBm)	Margin (dB)	Polarization
5115.0	-41.75	4.39	3.00	12.34	-33.8	-25.00	8.8	H
7672.5	-50.86	5.31	3.00	13.52	-42.65	-25.00	17.65	H
5115.0	-43.35	4.39	3.00	12.34	-35.4	-25.00	10.4	V
7672.5	-53.47	5.31	3.00	13.52	-45.26	-25.00	20.26	V

LTE Band 41_Channel Bandwidth 5MHz_16QAM_1RB#0

Frequency (MHz)	Ps (dBm)	P _{cl} (dB)	Diatance	G _a Antenna Gain(dB)	Peak EIRP (dBm)	Limit (dBm)	Margin (dB)	Polarization
5200.0	-41.64	4.41	3.00	12.34	-33.71	-25.00	8.71	H
7800.0	-49.39	5.38	3.00	13.58	-41.19	-25.00	16.19	H
5200.0	-44.33	4.41	3.00	12.34	-36.4	-25.00	11.4	V
7800.0	-51.27	5.38	3.00	13.58	-43.07	-25.00	18.07	V

LTE Band 41_Channel Bandwidth 5MHz_16QAM_1RB#0

Frequency (MHz)	Ps (dBm)	P _{cl} (dB)	Diatance	G _a Antenna Gain(dB)	Peak EIRP (dBm)	Limit (dBm)	Margin (dB)	Polarization
5305.0	-45.33	4.45	3.00	12.45	-41.14	-25.00	16.14	H
7957.5	-49.53	5.47	3.00	13.66	-45.17	-25.00	20.17	H
5305.0	-43.69	4.45	3.00	12.45	-44.74	-25.00	19.74	V
7957.5	-51.76	5.48	3.00	13.66	-50.45	-25.00	25.45	V

*LTE Band 41_Channel Bandwidth 10MHz_16QAM_1RB#0*

Frequency (MHz)	Ps (dBm)	P _{cl} (dB)	Diatance	G _a Antenna Gain(dB)	Peak EIRP (dBm)	Limit (dBm)	Margin (dB)	Polarization
5120.0	-41.76	4.39	3.00	12.34	-33.81	-25.00	8.81	H
7680.0	-51.65	5.31	3.00	13.52	-43.44	-25.00	18.44	H
5120.0	-43.62	4.39	3.00	12.34	-35.67	-25.00	10.67	V
7680.0	-53.57	5.31	3.00	13.52	-45.36	-25.00	20.36	V

LTE Band 41_Channel Bandwidth 10MHz_16QAM_1RB#0

Frequency (MHz)	Ps (dBm)	P _{cl} (dB)	Diatance	G _a Antenna Gain(dB)	Peak EIRP (dBm)	Limit (dBm)	Margin (dB)	Polarization
5200.0	-41.91	4.41	3.00	12.34	-33.98	-25.00	8.98	H
7800.0	-49.24	5.38	3.00	13.58	-41.04	-25.00	16.04	H
5200.0	-44.09	4.41	3.00	12.34	-36.16	-25.00	11.16	V
7800.0	-50.91	5.38	3.00	13.58	-42.71	-25.00	17.71	V

LTE Band 41_Channel Bandwidth 10MHz_16QAM_1RB#0

Frequency (MHz)	Ps (dBm)	P _{cl} (dB)	Diatance	G _a Antenna Gain(dB)	Peak EIRP (dBm)	Limit (dBm)	Margin (dB)	Polarization
5300.0	-45.32	4.45	3.00	12.45	-41.14	-25.00	16.14	H
7950.0	-49.67	5.47	3.00	13.66	-45.17	-25.00	20.17	H
5300.0	-43.56	4.45	3.00	12.45	-44.74	-25.00	19.74	V
7950.0	-51.39	5.48	3.00	13.66	-50.45	-25.00	25.45	V

LTE Band 41_Channel Bandwidth 15MHz_16QAM_1RB#0

Frequency (MHz)	Ps (dBm)	P _{cl} (dB)	Diatance	G _a Antenna Gain(dB)	Peak EIRP (dBm)	Limit (dBm)	Margin (dB)	Polarization
5125.0	-42.01	4.39	3.00	12.34	-34.06	-25.00	9.06	H
7687.5	-51.70	5.31	3.00	13.52	-43.49	-25.00	18.49	H
5125.0	-43.62	4.39	3.00	12.34	-35.67	-25.00	10.67	V
7687.5	-53.92	5.31	3.00	13.52	-45.71	-25.00	20.71	V

LTE Band 41_Channel Bandwidth 15MHz_16QAM_1RB#0

Frequency (MHz)	Ps (dBm)	P _{cl} (dB)	Diatance	G _a Antenna Gain(dB)	Peak EIRP (dBm)	Limit (dBm)	Margin (dB)	Polarization
5200.0	-42.09	4.41	3.00	12.34	-34.16	-25.00	9.16	H
7800.0	-49.96	5.38	3.00	13.58	-41.76	-25.00	16.76	H
5200.0	-44.29	4.41	3.00	12.34	-36.36	-25.00	11.36	V
7800.0	-50.92	5.38	3.00	13.58	-42.72	-25.00	17.72	V

LTE Band 41_Channel Bandwidth 15MHz_16QAM_1RB#0

Frequency (MHz)	Ps (dBm)	P _{cl} (dB)	Diatance	G _a Antenna Gain(dB)	Peak EIRP (dBm)	Limit (dBm)	Margin (dB)	Polarization
5295.0	-44.52	4.45	3.00	12.45	-36.52	-25.00	11.52	H
7942.5	-49.09	5.47	3.00	13.66	-40.9	-25.00	15.9	H
5295.0	-43.56	4.45	3.00	12.45	-35.56	-25.00	10.56	V
7942.5	-51.73	5.48	3.00	13.66	-43.55	-25.00	18.55	V

LTE Band 41_Channel Bandwidth 20MHz_16QAM_1RB#0

Frequency (MHz)	Ps (dBm)	P _{cl} (dB)	Diatance	G _a Antenna Gain(dB)	Peak EIRP (dBm)	Limit (dBm)	Margin (dB)	Polarization
5140.0	-41.48	4.39	3.00	12.34	-33.53	-25.00	8.53	H
7710.0	-51.56	5.31	3.00	13.52	-43.35	-25.00	18.35	H
5140.0	-43.44	4.39	3.00	12.34	-35.49	-25.00	10.49	V
7710.0	-53.95	5.31	3.00	13.52	-45.74	-25.00	20.74	V

*LTE Band 41_Channel Bandwidth 20MHz_16QAM_1RB#0*

Frequency (MHz)	Ps (dBm)	P _{cl} (dB)	Diatance	G _a Antenna Gain(dB)	Peak EIRP (dBm)	Limit (dBm)	Margin (dB)	Polarization
5200.0	-41.57	4.41	3.00	12.34	-33.64	-25.00	8.64	H
7800.0	-49.14	5.38	3.00	13.58	-40.94	-25.00	15.94	H
5200.0	-44.42	4.41	3.00	12.34	-36.49	-25.00	11.49	V
7800.0	-50.94	5.38	3.00	13.58	-42.74	-25.00	17.74	V

LTE Band 41_Channel Bandwidth 20MHz_16QAM_1RB#0

Frequency (MHz)	Ps (dBm)	P _{cl} (dB)	Diatance	G _a Antenna Gain(dB)	Peak EIRP (dBm)	Limit (dBm)	Margin (dB)	Polarization
5280.0	-44.97	4.45	3.00	12.45	-36.97	-25.00	11.97	H
7920.0	-49.55	5.47	3.00	13.66	-41.36	-25.00	16.36	H
5280.0	-43.75	4.45	3.00	12.45	-35.75	-25.00	10.75	V
7920.0	-51.66	5.48	3.00	13.66	-43.48	-25.00	18.48	V

4.7 Frequency Stability

LIMIT

According to §2.1055 requirement, the frequency stability shall be sufficient to ensure that the fundamental emissions stay within the authorized bands of operation and should not exceed 2.5ppm.

TEST CONFIGURATION

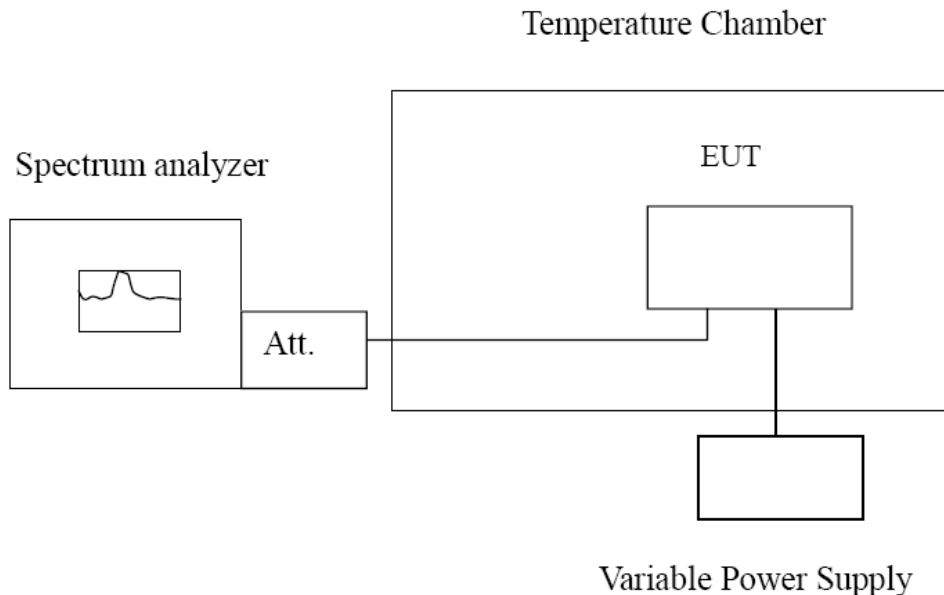

TEST PROCEDURE

The EUT was setup according to EIA/TIA 603D

Frequency Stability Under Temperature Variations:

In order to measure the carrier frequency under the condition of AFC lock, it is necessary to make measurements with the EUT in a "call mode". This is accomplished with the use of R&S CMW500 DIGITAL RADIO COMMUNICATION TESTER.

1. Measure the carrier frequency at room temperature.
2. Subject the EUT to overnight soak at -30°C.
3. With the EUT, powered via nominal voltage, connected to the CMW500 and in a simulated call on middle channel for LTE band 41, measure the carrier frequency. These measurements should be made within 2 minutes of Powering up the EUT, to prevent significant self-warming.
4. Repeat the above measurements at 10°C increments from -30°C to +50°C. Allow at least 1.5 hours at each temperature, unpowered, before making measurements.
5. Re-measure carrier frequency at room temperature with nominal voltage. Vary supply voltage from minimum voltage to maximum voltage, in 0.1Volt increments re-measuring carrier frequency at each voltage. Pause at nominal voltage for 1.5 hours unpowered, to allow any self-heating to stabilize, before continuing.
6. Subject the EUT to overnight soak at +50°C.
7. With the EUT, powered via nominal voltage, connected to the CMW500 and in a simulated call on the centre channel, measure the carrier frequency. These measurements should be made within 2 minutes of Powering up the EUT, to prevent significant self-warming.
8. Repeat the above measurements at 10 °C increments from +50°C to -30°C. Allow at least 1.5 hours at each temperature, unpowered, before making measurements
9. At all temperature levels hold the temperature to +/- 0.5°C during the measurement procedure.

Frequency Stability Under Voltage Variations:

Set chamber temperature to 20°C. Use a variable AC power supply / DC power source to power the EUT and set the voltage to rated voltage. Set the spectrum analyzer RBW low enough to obtain the desired frequency resolution and recorded the frequency.

Reduce the input voltage to specify extreme voltage variation ($\pm 15\%$) and endpoint, record the maximum frequency change.

**TEST RESULTS**

EUT:	4G Mobile phone	Test Date:	Oct. 21, 2019
Temperature:	25 ⁰ C	Tested by:	Gary Qian
Humidity:	55 % RH	Test Voltage	Normal Voltage
Operation Mode:	Normal Voltage- Tx Mode		

Remark:

1. We tested all RB Configuration refer 3GPP TS136 521 for each Channel Bandwidth of LTE Band 41; recorded worst case.

LTE Band 41_5MHz bandwidth_QPSK_1RB#0 (worst case of all bandwidths)

LTE Band 41					
DC Power	Temperature (°C)	Frequency error(Hz)	Frequency error(ppm)	Limit (ppm)	Verdict
3.40	20	28	-0.006134	2.50	PASS
3.70	20	32	-0.006412	2.50	PASS
4.20	20	18	-0.006816	2.50	PASS
3.70	-30	27	-0.005726	2.50	PASS
3.70	-20	19	0.013318	2.50	PASS
3.70	-10	15	-0.013524	2.50	PASS
3.70	0	32	-0.005652	2.50	PASS
3.70	10	19	0.011701	2.50	PASS
3.70	20	25	-0.014541	2.50	PASS
3.70	30	29	-0.013084	2.50	PASS
3.70	40	15	-0.006623	2.50	PASS
3.70	50	21	-0.006367	2.50	PASS

LTE Band 41_5MHz bandwidth_16QAM_1RB#0 (worst case of all bandwidths)

LTE Band 41					
DC Power	Temperature (°C)	Frequency error(Hz)	Frequency error(ppm)	Limit (ppm)	Verdict
3.40	20	34	-0.006748	2.50	PASS
3.70	20	42	0.009158	2.50	PASS
4.20	20	57	0.005364	2.50	PASS
3.70	-30	62	0.005924	2.50	PASS
3.70	-20	32	0.010887	2.50	PASS
3.70	-10	41	0.007008	2.50	PASS
3.70	0	32	-0.005887	2.50	PASS
3.70	10	27	0.011289	2.50	PASS
3.70	20	23	-0.006738	2.50	PASS
3.70	30	32	-0.005935	2.50	PASS
3.70	40	23	0.007421	2.50	PASS
3.70	50	17	0.006037	2.50	PASS

5 Test Setup Photos of the EUT

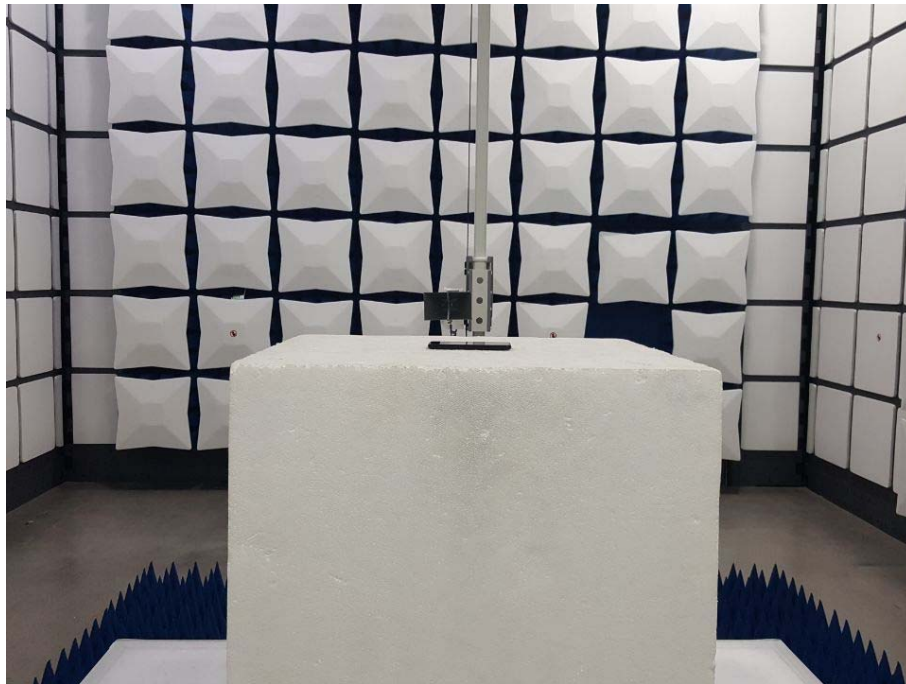
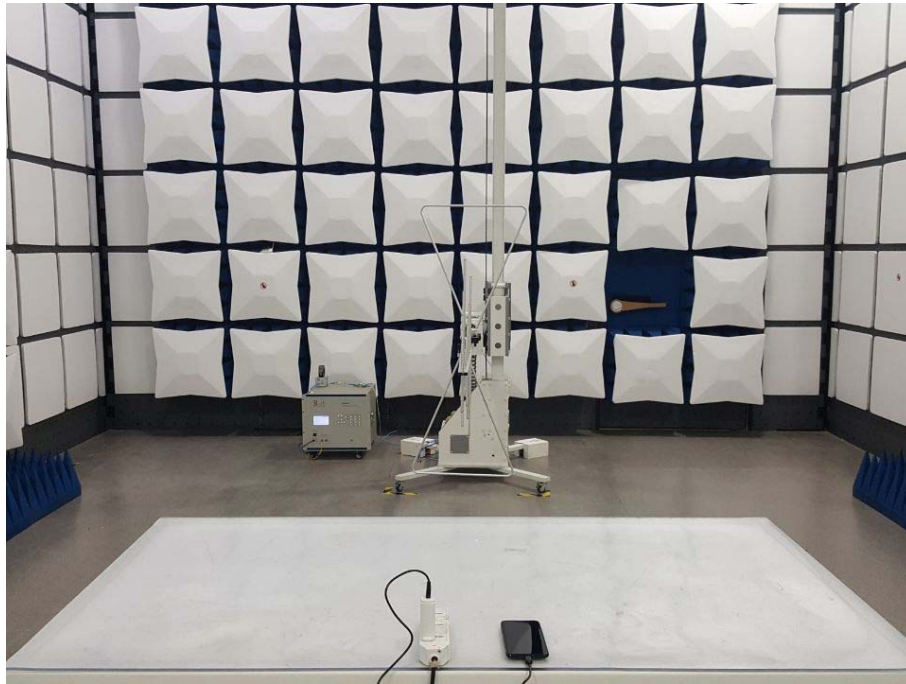



6 External and Internal Photos of the EUT

Reference to the report :ANNEX A of external photos and ANNEX B of internal photos

*******End of Report*******