



FCC PART 24 TEST REPORT
Part 22H Subpart E

Report Reference No......: HK1907111626-3E

FCC ID.....: ZNFX210LMW

Compiled by
(position+printed name+signature)..: File administrators Gary Qian

Supervised by
(position+printed name+signature)..: Technique principal Eden Hu

Approved by
(position+printed name+signature)..: Manager Jason Zhou

Date of issue.....: July. 12,2019

Testing Laboratory Name: **Shenzhen HUAKE Testing Technology Co., Ltd.**
Address.....: 1F, B2 Building, Junfeng Zhongcheng Zhizao Innovation Park,
Heping Community, Fuhai Street, Bao' an District, Shenzhen,China

Applicant's name: **LG Electronics USA, Inc.**
Address: 1000 Sylvan Ave., Englewood Cliffs, New Jersey 07632, United States

Test specification:
Standard: **FCC CFR Title 47 Part 2, Part 22H**
TRF Originator.....: Shenzhen HUAKE Testing Technology Co., Ltd.

Shenzhen HUAKE Testing Technology Co., Ltd.All rights reserved.
This publication may be reproduced in whole or in part for non-commercial purposes as long as the Shenzhen HUAKE Testing Technology Co., Ltd.as copyright owner and source of the material. Shenzhen HUAKE Testing Technology Co., Ltd.takes no responsibility for and will not assume liability for damages resulting from the reader's interpretation of the reproduced material due to its placement and context.

Test item description: 4G Mobile phone
Trade Mark: LG
Manufacturer.....: OPTIEMUS ELECTRONICS LIMITED
Model/Type reference.....: LM-X210LMW
Listed Models: /
Modulation Type: QPSK, 16QAM
Rating: DC 3.85V From Battery
Hardware version: V2.0
Software version.....: V2.0
Result.....: **PASS**

**TEST REPORT**

Test Report No. :	HK1907111626-3E	July. 12,2019
		Date of issue

Equipment under Test : 4G Mobile phone

Model /Type : LM-X210LMW

Listed Models : /

Applicant : **LG Electronics USA, Inc.**

Address : 1000 Sylvan Ave., Englewood Cliffs, New Jersey 07632,
United States

Manufacturer : OPTIEMUS ELECTRONICS LIMITED

Address : D-348, Sector-63, Noida, Uttar Pradesh, Pin Code-
201307

Test Result:	PASS
---------------------	-------------

The test report merely corresponds to the test sample.

It is not permitted to copy extracts of these test result without the written permission of the test laboratory.



Revision History

Revision	Issue Date	Revisions	Revised By
V1.0	2019-07-12	Initial Issue	James Zhou



Contents

<u>1</u>	<u>TEST STANDARDS</u>	<u>5</u>
<u>2</u>	<u>SUMMARY</u>	<u>6</u>
2.1	General Remarks	6
2.2	Product Description	6
2.3	Equipment under Test	6
2.4	Normal Accessory setting	6
2.5	EUT configuration	6
2.6	Related Submittal(s) / Grant (s)	7
2.7	Modifications	7
2.8	GeneralTest Conditions/Configurations	7
<u>3</u>	<u>TEST ENVIRONMENT</u>	<u>8</u>
3.1	Address of the test laboratory	8
3.2	Environmental conditions	8
3.3	Test Description	8
3.4	Equipments Used during the Test	9
<u>4</u>	<u>TEST CONDITIONS AND RESULTS.....</u>	<u>10</u>
4.1	Output Power	10
4.2	Peak-to-Average Ratio (PAR)	15
4.3	Occupied Bandwidth and Emission Bandwidth	20
4.4	Band Edge compliance	25
4.5	Spurious Emssion on Antenna Port	30
4.6	Radiated Spurious Emssion	43
4.7	Frequency Stability	49
<u>5</u>	<u>TEST SETUP PHOTOS OF THE EUT</u>	<u>52</u>



1 TEST STANDARDS

The tests were performed according to following standards:

[FCC Part 2](#): FREQUENCY ALLOCATIONS AND RADIO TREATY MATTERS; GENERAL RULES AND REGULATIONS

[FCC Part 22 Subpart H](#): PRIVATE LAND MOBILE RADIO SERVICES.

[ANSI/TIA-603-E-2016](#): Land Mobile FM or PM Communications Equipment Measurement and Performance Standards.

[ANSI C63.26-2015](#): IEEE/ANSI Standard for Compliance Testing of Transmitters Used in Licensed Radio Services

[FCKDB971168D01](#) Power Meas License Digital Systems



2 SUMMARY

2.1 General Remarks

Date of receipt of test sample	:	Jun. 24, 2019
Testing commenced on	:	Jun. 25, 2019
Testing concluded on	:	July. 12, 2019

2.2 Product Description

Name of EUT	4G Mobile phone
Model/Type reference:	LM-X210LMW
List Model:	/
Power supply:	DC 3.85V From Battery
Adapter Information	N/A
Modulation Type	QPSK, 16QAM
Antenna Type	Internal Antenna
Operation Frequency Band	LTE BAND 5
Operation frequency	LTE BAND 5: 824~849 MHz
LTE Release	R8
Extreme temp. Tolerance	-30°C to +50°C
Extreme vol. Limits	3.465VDC to 4.235VDC (nominal: 3.85VDC)

2.3 Equipment under Test

Power supply system utilised

Power supply voltage	:	<input type="radio"/> 120V/ 60 Hz	<input type="radio"/> 115V/60Hz
		<input type="radio"/> 12 V DC	<input type="radio"/> 24 V DC
		<input checked="" type="radio"/> Other (specified in blank below)	

DC 3.85V From Battery

2.4 Normal Accessory setting

Fully charged battery was used during the test.

2.5 EUT configuration

The following peripheral devices and interface cables were connected during the measurement:

● - supplied by the manufacturer

○ - supplied by the lab

<input type="radio"/> Power Cable	Length (m) :	/
	Shield :	/
	Detachable :	/
<input type="radio"/> Multimeter	Manufacturer :	/
	Model No. :	/



2.6 Related Submittal(s) / Grant (s)

This submittal(s) (test report) is intended for **FCC ID: ZNFX210LMW** filing to comply with FCC Part 22H, Rules.

2.7 Modifications

No modifications were implemented to meet testing criteria.

2.8 General Test Conditions/Configurations

2.10.1 Test Environment

Environment Parameter	Selected Values During Tests	
Relative Humidity	Ambient	
Temperature	TN	Ambient
Voltage	VL	3.465V
	VN	3.85V
	VH	4.235V

NOTE: VL=lower extreme test voltage VN=nominal voltage
VH=upper extreme test voltage TN=normal temperature



3 TEST ENVIRONMENT

3.1 Address of the test laboratory

Shenzhen HUAKE Testing Technology Co., Ltd.
Add.:1F, B2 Building, Junfeng Zhongcheng Zhizao Innovation Park,Heping Community, Fuhai Street,
Bao'an District, Shenzhen, China

3.2 Environmental conditions

During the measurement the environmental conditions were within the listed ranges:

Temperature:	15-35 ° C
Humidity:	30-60 %
Atmospheric pressure:	950-1050mbar

3.3 Test Description

Band 5 (824~849 MHz)

Test Item	FCCRuleNo.	Requirements	Verdict
Effective(Isotropic) Radiated Output Power	§2.1046, §2.913(a)(2)	EIRP ≤ 2W	Pass
Peak-AverageRatio	§24.232(d)	FCC:Limit≤13dB	Pass
Modulation Characteristics	§2.1047	Digitalmodulation	Pass
Bandwidth	§2.1049	OBW: Nolimit. EBW: Nolimit.	Pass
Band Edges Compliance	§2.1051, §24.238	≤ -13dBm/1%*EBW, In1MHz band simmediately outside and adjacent to The frequency block.	Pass
Spurious Emissionat AntennaTerminals	§2.1051, §24.238	≤-13dBm/1MHz, from 9kHz to10th harmonicsbut outside authorized Operating frequency ranges.	Pass
Field Strength of Spurious Radiation	Clause 7of KDB971168 D01 v02r02	≤ -13dBm/1MHz.	Pass
Frequency Stability	§2.1055, §22.355, §24.235	FCC:with in authorized frequency block.	Pass

NOTE 1:For the verdict,the“N/A”denotes“not applicable”,the“N/T”denotes “nottested”.

Remark:

1. The measurement uncertainty is not included in the test result.



3.4 Equipments Used during the Test

Test Equipment	Manufacturer	Model No.	Serial No.	Calibration Date	Calibration Due Date
LISN	R&S	ENV216	HKE-059	2018/12/27	2019/12/26
LISN	R&S	ENV216	HKE-002	2018/12/27	2019/12/26
Receiver	R&S	ESCI 7	HKE-010	2018/12/27	2019/12/26
Spectrum analyzer	R&S	FSP40	HKE-025	2018/12/27	2019/12/26
Spectrum analyzer	Agilent	N9020A	HKE-048	2018/12/27	2019/12/26
RF automatic control unit	Tonscend	JS0806-1	HKE-060	2018/12/27	2019/12/26
Loop antenna	Schwarzbeck	FMZB 1519 B	HKE-014	2018/12/27	2019/12/26
Bilog Broadband Antenna	Schwarzbeck	VULB9163	HKE-012	2018/12/27	2019/12/26
Horn antenna	Schwarzbeck	9120D	HKE-013	2018/12/27	2019/12/26
High gain antenna	Schwarzbeck	LB-180400KF	HKE-054	2018/12/27	2019/12/26
Preamplifier	EMCI	EMC051845SE	HKE-015	2018/12/27	2019/12/26
Preamplifier	Agilent	83051A	HKE-016	2018/12/27	2019/12/26
Preamplifier	Schwarzbeck	BBV 9743	HKE-006	2018/12/27	2019/12/26
Temperature and humidity meter	Boyang	HTC-1	HKE-075	2018/12/27	2019/12/26
High-low temperature chamber	Guangke	HT-80L	HKE-118	2018/12/27	2019/12/26
High pass filter unit	Tonscend	JS0806-F	HKE-055	2018/12/27	2019/12/26
RF Cable(below1GHz)	Times	9kHz-1GHz	HKE-117	2018/12/27	2019/12/26
RF Cable(above 1GHz)	Times	1-40G	HKE-034	2018/12/27	2019/12/26
Power meter	Agilent	E4419B	HKE-085	2018/12/27	2019/12/26
Power Sensor	Agilent	E9300A	HKE-086	2018/12/27	2019/12/26
Conducted test software	Tonscend	TS+ Rev 2.5.0.0	HKE-081	N/A	N/A
Radiated test software	Tonscend	TS+ Rev 2.5.0.0	HKE-082	N/A	N/A
RF test software	Tonscend	JS1120-B Version 2.6	HKE-083	N/A	N/A
RF test software	Tonscend	JS1120-4	HKE-113	N/A	N/A
RF test software	Tonscend	JS1120-3	HKE-114	N/A	N/A
RF test software	Tonscend	JS1120-1	HKE-115	N/A	N/A
Wireless Communication Test Set	R&S	CMW500	HKE-026	2018/12/27	2019/12/26
Wireless Communication Test Set	R&S	CMU200	HKE-029	2018/12/27	2019/12/26

4 TEST CONDITIONS AND RESULTS

4.1 Output Power

4.1.1 Conducted Output Power

TEST APPLICABLE

During the process of testing, the EUT was controlled via R&S Digital Radio Communication tester (CMW500) to ensure max power transmission and proper modulation. This result contains output power and EIRP measurements for the EUT. In all cases, output power is within the specified limits.

TEST CONFIGURATION



TEST PROCEDURE

Conducted Power Measurement:

- Place the EUT on a bench and set it in transmitting mode.
- Connect a low loss RF cable from the antenna port to a CMW500 by an Att.
- EUT Communicate with CMW500 then selects a channel for testing.
- Add a correction factor to the display CMW500, and then test.

TEST RESULTS

compliance *

Remark:

- We measured all RB Configuration refer 3GPP TS136 521 for each Channel Bandwidth of LTE FDD Band 5;

LTE FDD Band 5				
TX Channel Bandwidth	Frequency (MHz)	RB Size/Offset	Burst Average Power [dBm]	
			QPSK	16QAM
1.4 MHz	824.7	1 RB low	23.13	22.69
		1 RB high	23.05	22.59
		50% RB mid	23.07	22.41
		100% RB	23.13	23.09
	836.5	1 RB low	23.22	22.37
		1 RB high	23.23	22.33
		50% RB mid	23.16	22.25
		100% RB	23.13	23.10
	848.3	1 RB low	23.37	22.26
		1 RB high	23.73	23.31
		50% RB mid	23.72	23.28
		100% RB	23.20	23.56
3 MHz	825.5	1 RB low	23.26	21.99
		1 RB high	23.15	21.87
		50% RB mid	23.31	21.82
		100% RB	21.98	21.99
	836.5	1 RB low	23.21	22.00
		50% RB mid	23.23	22.06



	847.5	100% RB	22.00	22.03
		1 RB low	23.38	22.38
		1 RB high	23.66	22.42
		50% RB mid	22.43	22.43
		100% RB	22.41	22.21
5 MHz	826.5	1 RB low	23.19	22.04
		1 RB high	23.12	22.13
		50% RB mid	23.13	22.15
		100% RB	22.16	21.66
	836.5	1 RB low	23.02	21.61
		1 RB high	23.19	21.75
		50% RB mid	22.07	22.08
		100% RB	22.09	22.09
	846.5	1 RB low	23.34	22.64
		1 RB high	23.21	22.80
		50% RB mid	23.61	22.79
		100% RB	22.58	22.56
10 MHz	829.0	1 RB low	23.03	22.02
		1 RB high	22.92	21.91
		50% RB mid	23.17	21.99
		100% RB	22.14	22.10
	836.5	1 RB low	23.10	22.59
		1 RB high	23.25	22.51
		50% RB mid	23.31	22.78
		100% RB	22.14	22.14
	844.0	1 RB low	23.31	22.14
		1 RB high	23.74	22.21
		50% RB mid	23.65	22.54
		100% RB	22.28	22.27

4.1.2. Radiated Output Power

LIMIT

This is the test for the maximum radiated power from the EUT.

Rule Part 22H.232(b) specifies, "Mobile/portable stations are limited to 7 watts e.i.r.p.

TEST CONFIGURATION

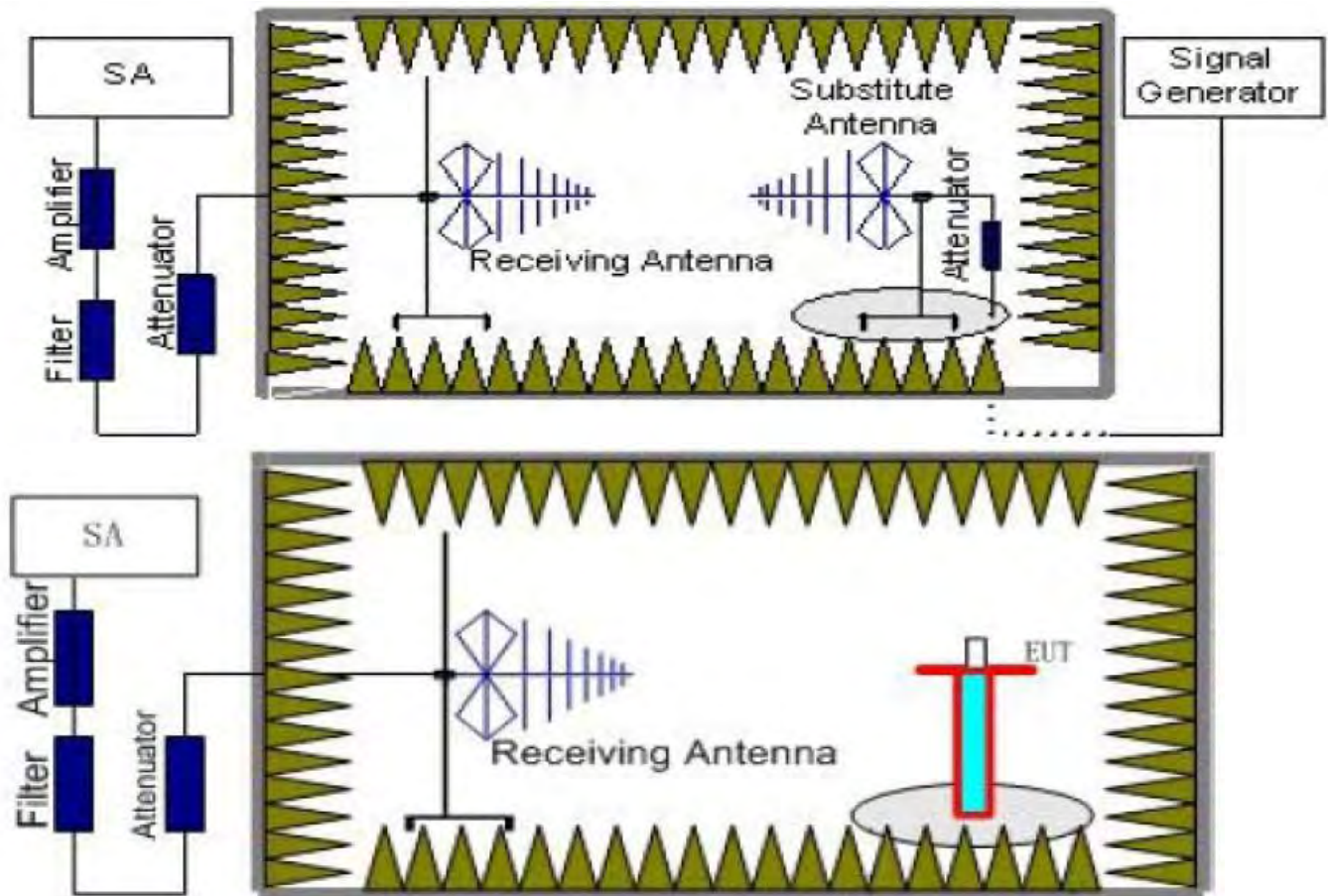

TEST PROCEDURE

1. EUT was placed on a 1.50 meter high non-conductive stand at a 3 meter test distance from the receive antenna. A receiving antenna was placed on the antenna mast 3 meters from the EUT for emission measurements. The height of receiving antenna is 1.50m. Detected emissions were maximized at each frequency by rotating the EUT through 360° and adjusting the receiving antenna polarization. The radiated emission measurements of all transmit frequencies in three channels (High, Middle, Low) were measured with peak detector.
2. A log-periodic antenna or double-ridged waveguide horn antenna shall be substituted in place of the EUT. The log-periodic antenna will be driven by a signal generator and the level will be adjusted till the same power value on the spectrum analyzer or receiver. The level of the spurious emissions can be calculated through the level of the signal generator, cable loss, the gain of the substitution antenna and the reading of the spectrum analyzer or receiver.
3. The EUT is then put into continuously transmitting mode at its maximum power level during the test. Set Test Receiver or Spectrum RBW=1MHz, VBW=3MHz, And the maximum value of the receiver should be recorded as (P_r).
4. The EUT shall be replaced by a substitution antenna. In the chamber, an substitution antenna for the frequency band of interest is placed at the reference point of the chamber. An RF Signal source for the frequency band of interest is connected to the substitution antenna with a cable that has been constructed to not interfere with the radiation pattern of the antenna. A power (P_{Mea}) is applied to the input of the substitution antenna, and adjust the level of the signal generator output until the value of the receiver reach the previously recorded (P_r). The power of signal source (P_{Mea}) is recorded. The test should be performed by rotating the test item and adjusting the receiving antenna polarization.



5. An amplifier should be connected to the Signal Source output port. And the cable should be connect between the Amplifier and the Substitution Antenna. The cable loss (P_{cl}), the Substitution Antenna Gain (G_a) and the Amplifier Gain (P_{Ag}) should be recorded after test.

The measurement results are obtained as described below: $\text{Power(EIRP)} = P_{\text{Mea}} - P_{\text{Ag}} - P_{\text{cl}} + G_a$

We used SMF100A microwave signal generator which signal level can up to 33dBm, so we not used power Amplifier for substitution test; The measurement results are amend as described below:

$\text{Power(EIRP)} = P_{\text{Mea}} - P_{\text{cl}} + G_a$

6. This value is EIRP since the measurement is calibrated using an antenna of known gain (2.15 dBi) and known input power.
7. ERP can be calculated from EIRP by subtracting the gain of the dipole, $\text{ERP} = \text{EIRP} - 2.15\text{dBi}$.

TEST RESULTS

Radiated Measurement:

Remark:

- We measured all RB Configuration refer 3GPP TS136 521 for each Channel Bandwidth of LTE FDD Band 5; recorded worst case for each Channel Bandwidth of LTE FDD Band 5.
- $\text{EIRP} = P_{\text{Mea}}(\text{dBm}) - P_{\text{cl}}(\text{dB}) + P_{\text{Ag}}(\text{dB}) + G_a(\text{dBi})$
- We measured both Horizontal and Vertical direction, recorded worst case direction.

LTE FDD Band 5_Channel Bandwidth 1.4MHz_QPSK

Frequency (MHz)	P_{Mea} (dBm)	P_{cl} (dB)	G_a Antenna Gain(dB)	P_{Ag} (dB)	ERP (dBm)	Limit (dBm)	Margin (dB)	Polarization
824.7	-20.71	3.41	10.24	33.60	19.72	38.45	18.73	V
836.5	-21.8	3.49	10.24	33.60	18.55	38.45	19.9	V
848.3	-21.17	3.55	10.23	33.60	19.11	38.45	19.34	V

LTE FDD Band 5_Channel Bandwidth 3MHz_QPSK

Frequency (MHz)	P_{Mea} (dBm)	P_{cl} (dB)	G_a Antenna Gain(dB)	P_{Ag} (dB)	ERP (dBm)	Limit (dBm)	Margin (dB)	Polarization
825.5	-21.33	3.41	10.24	33.60	19.1	38.45	19.35	V
836.5	-21.69	3.49	10.24	33.60	18.66	38.45	19.79	V
847.5	-21.42	3.55	10.23	33.60	18.86	38.45	19.59	V

LTE FDD Band 5_Channel Bandwidth 5MHz_QPSK

Frequency (MHz)	P_{Mea} (dBm)	P_{cl} (dB)	G_a Antenna Gain(dB)	P_{Ag} (dB)	ERP (dBm)	Limit (dBm)	Margin (dB)	Polarization
826.5	-20.96	3.41	10.24	33.60	19.47	38.45	18.98	V
836.5	-21.73	3.49	10.24	33.60	18.62	38.45	19.83	V
846.5	-21.06	3.55	10.23	33.60	19.22	38.45	19.23	V

LTE FDD Band 5_Channel Bandwidth 10MHz_QPSK

Frequency (MHz)	P_{Mea} (dBm)	P_{cl} (dB)	G_a Antenna Gain(dB)	P_{Ag} (dB)	ERP (dBm)	Limit (dBm)	Margin (dB)	Polarization
829.0	-20.51	3.41	10.24	33.60	19.92	38.45	18.53	V
836.5	-21.95	3.49	10.24	33.60	18.4	38.45	20.05	V
844.0	-21.56	3.55	10.23	33.60	18.72	38.45	19.73	V

*LTE FDD Band 5_Channel Bandwidth 1.4MHz_16QAM*

Frequency (MHz)	P _{Mea} (dBm)	P _{cl} (dB)	G _a Antenna Gain(dB)	Correction (dB)	P _{Ag} (dB)	ERP (dBm)	Limit (dBm)	Margin (dB)	Polarization
824.7	-20.11	3.41	10.24	33.6	20.32	18.13	38.45	20.32	V
836.5	-21.14	3.49	10.24	33.6	19.21	19.24	38.45	19.21	V
848.3	-21.96	3.55	10.23	33.6	18.32	20.13	38.45	18.32	V

LTE FDD Band 5_Channel Bandwidth 3MHz_16QAM

Frequency (MHz)	P _{Mea} (dBm)	P _{cl} (dB)	G _a Antenna Gain(dB)	Correction (dB)	P _{Ag} (dB)	ERP (dBm)	Limit (dBm)	Margin (dB)	Polarization
825.5	-20.89	3.41	10.24	33.6	19.54	18.91	38.45	19.54	V
836.5	-22.56	3.49	10.24	33.6	17.79	20.66	38.45	17.79	V
847.5	-21	3.55	10.23	33.6	19.28	19.17	38.45	19.28	V

LTE FDD Band 5_Channel Bandwidth 5MHz_16QAM

Frequency (MHz)	P _{Mea} (dBm)	P _{cl} (dB)	G _a Antenna Gain(dB)	Correction (dB)	P _{Ag} (dB)	ERP (dBm)	Limit (dBm)	Margin (dB)	Polarization
826.5	-21.3	3.41	10.24	33.6	19.13	19.32	38.45	19.13	V
836.5	-21.56	3.49	10.24	33.6	18.79	19.66	38.45	18.79	V
846.5	-21.04	3.55	10.23	33.6	19.24	19.21	38.45	19.24	V

LTE FDD Band 5_Channel Bandwidth 10MHz_16QAM

Frequency (MHz)	P _{Mea} (dBm)	P _{cl} (dB)	G _a Antenna Gain(dB)	Correction (dB)	P _{Ag} (dB)	ERP (dBm)	Limit (dBm)	Margin (dB)	Polarization
829.0	-20.92	3.41	10.24	33.6	19.51	18.94	38.45	19.51	V
836.5	-21.56	3.49	10.24	33.6	18.79	19.66	38.45	18.79	V
844.0	-21.58	3.55	10.23	33.6	18.7	19.75	38.45	18.7	V



4.2 Peak-to-Average Ratio (PAR)

LIMIT

The Peak-to-Average Ratio (PAR) of the transmission may not exceed 13 dB.

TEST CONFIGURATION

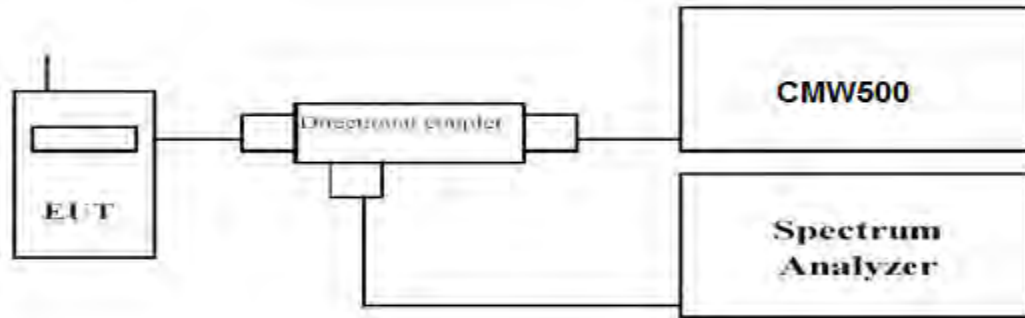

TEST PROCEDURE

1. Refer to instrument's analyzer instruction manual for details on how to use the power statistics/CCDF function;
2. Set resolution/measurement bandwidth \geq signal's occupied bandwidth;
3. Set the number of counts to a value that stabilizes the measured CCDF curve;
4. Set the measurement interval as follows:
 - 1). for continuous transmissions, set to 1 ms,
 - 2). for burst transmissions, employ an external trigger that is synchronized with the EUT burst timing sequence, or use the internal burst trigger with a trigger level that allows the burst to stabilize and set the measurement interval to a time that is less than or equal to the burst duration.
5. Record the maximum PAPR level associated with a probability of 0.1%.

TEST RESULTS

Remark:

1. We measured all RB Configuration refer 3GPP TS136 521 for each Channel Bandwidth of LTE FDD Band 5; recorded worst case for each Channel Bandwidth of LTE FDD Band 5.

LTE FDD Band 5				
TX Channel Bandwidth	Frequency (MHz)	RB Size/Offset	PAPR(dB)	
			QPSK	16QAM
1.4 MHz	824.7	1RB#0	5.74	6.36
	836.5		5.19	5.84
	848.3		5.17	5.82
3 MHz	825.5	1RB#0	5.64	6.69
	836.5		5.07	6.18
	847.5		5.12	5.86
5 MHz	826.5	1RB#0	5.85	6.30
	836.5		5.00	5.82
	846.5		5.38	5.99
10 MHz	829.0	1RB#0	5.53	6.57
	836.5		4.75	5.57
	844.0		5.49	6.30



LTE FDD Band 5 – 1.4 MHz Channel Bandwidth PAPR

QPSK

16QAM

Low Channel

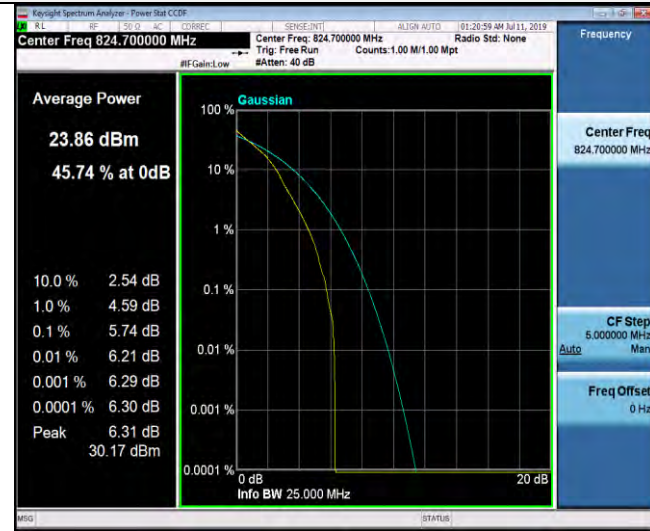

1RB#0

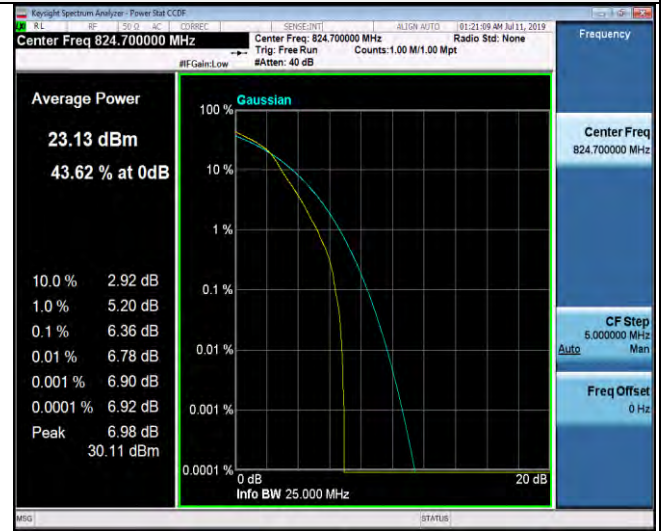

1RB#0

Middle Channel

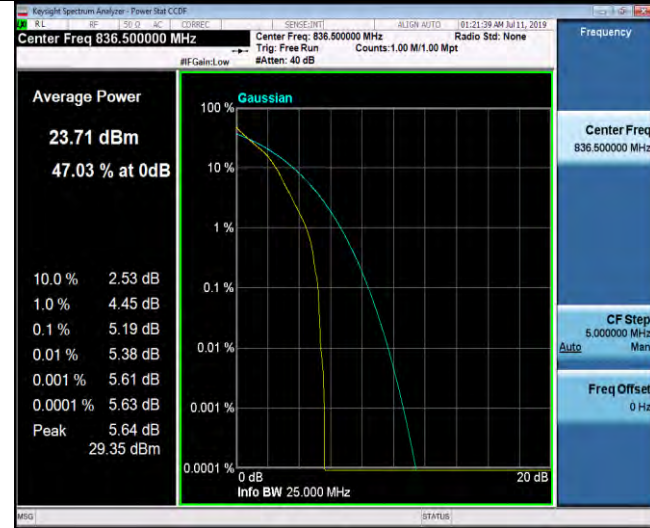

1RB#0

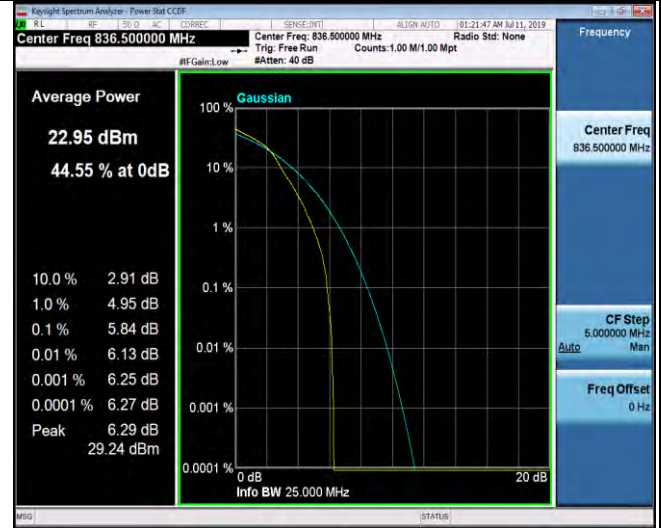

1RB#0

High Channel



1RB#0

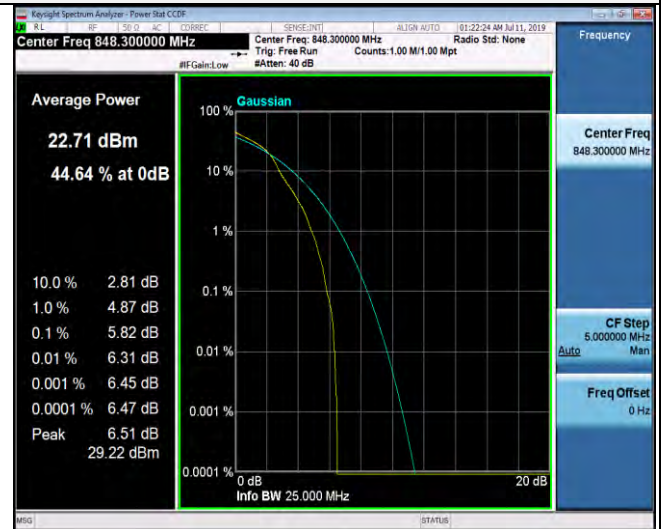

1RB#0



LTE FDD Band 5-3MHz Channel Bandwidth PPR

QPSK

16QAM

Low Channel

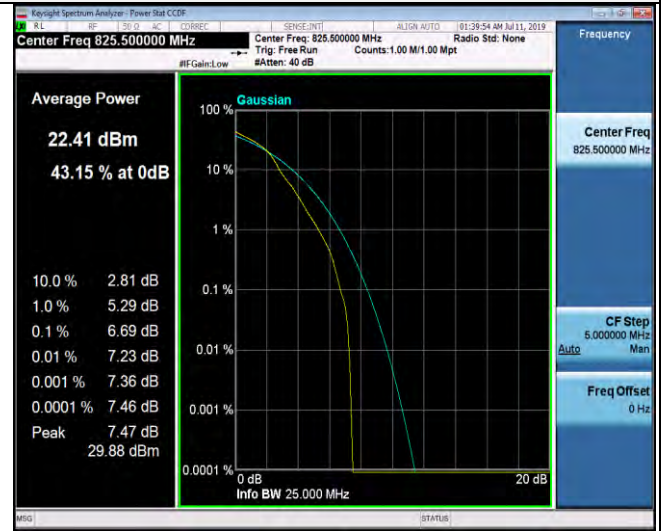
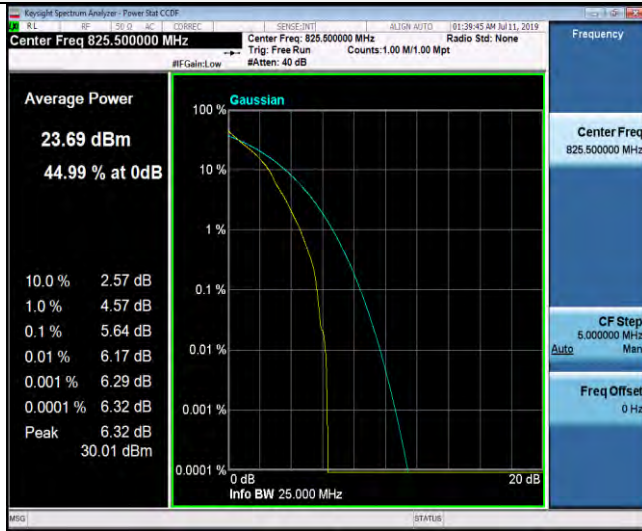

1RB#0

1RB#0

Middle Channel

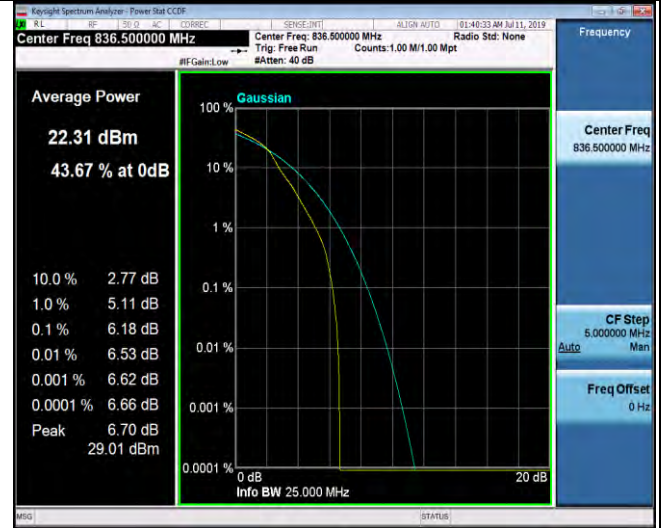

1RB#0

1RB#0

High Channel

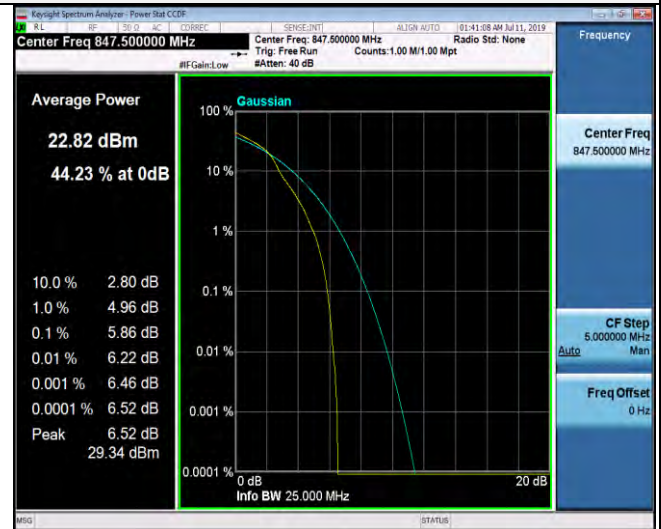
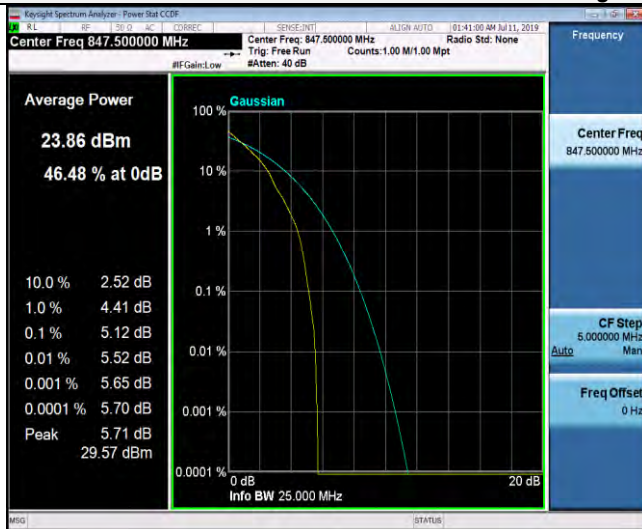

1RB#0

1RB#0



LTE FDD Band 5-5MHz Channel Bandwidth PPR

QPSK

16QAM

Low Channel

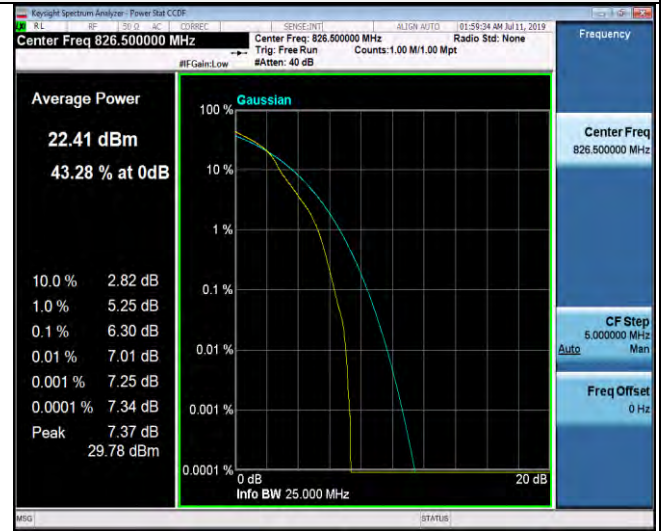

1RB#0

1RB#0

Middle Channel

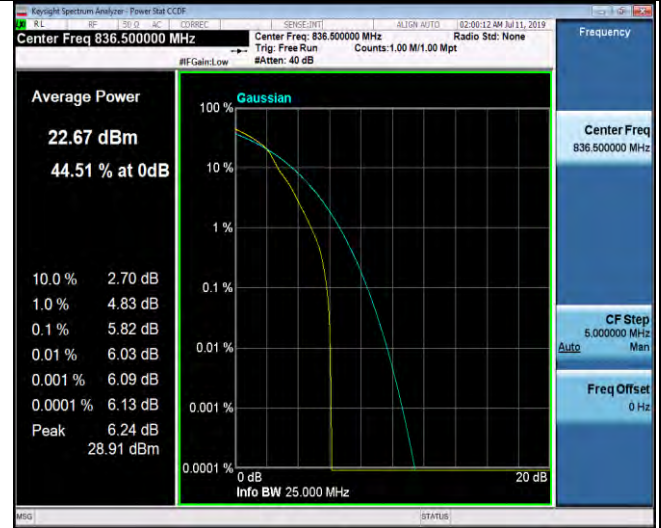

1RB#0

1RB#0

High Channel

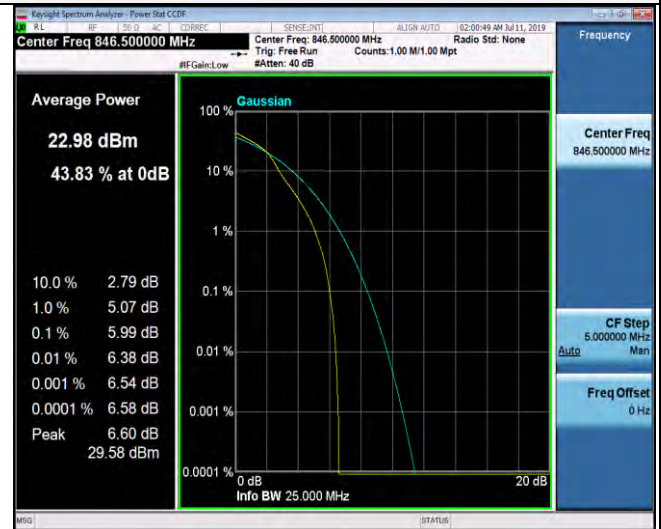
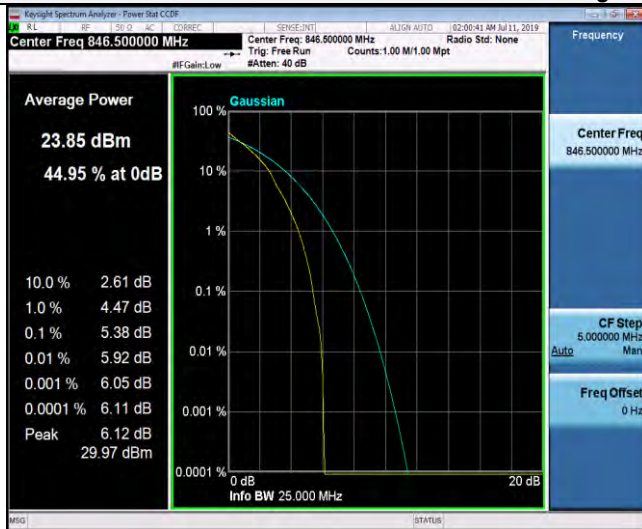

1RB#0

1RB#0



LTE FDD Band 5-10MHz Channel Bandwidth PAPR

QPSK

16QAM

Low Channel

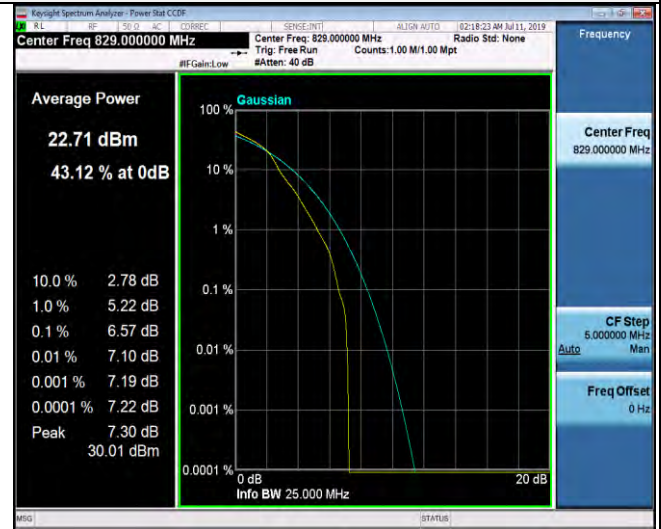

1RB#0

1RB#0

Middle Channel

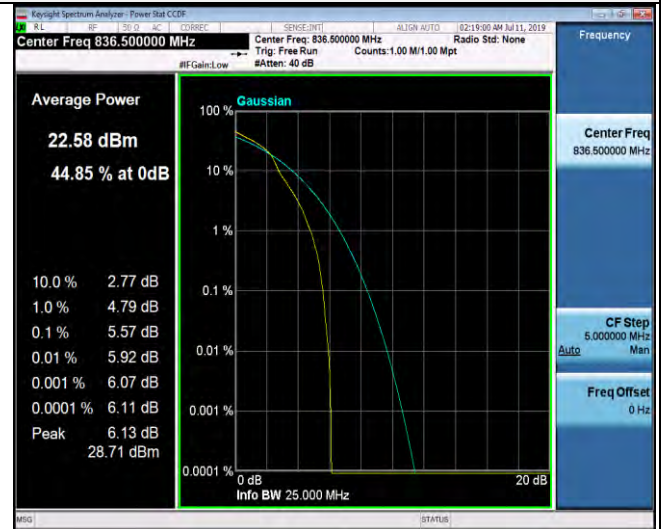
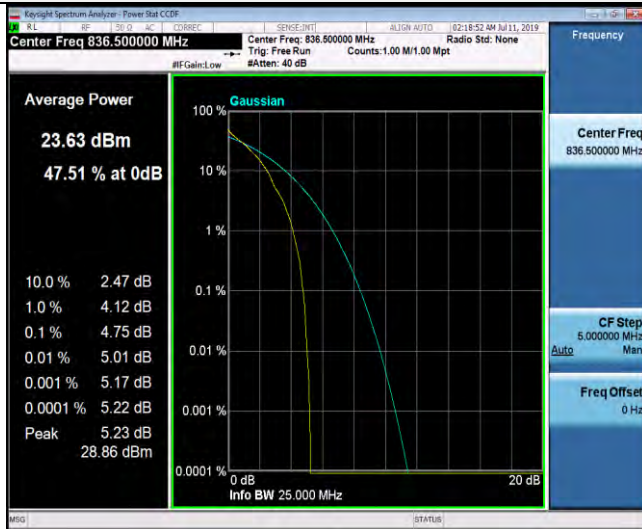

1RB#0

1RB#0

High Channel

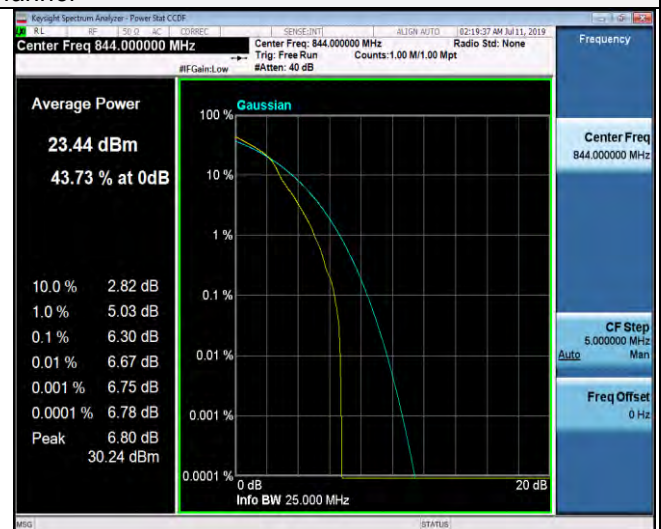
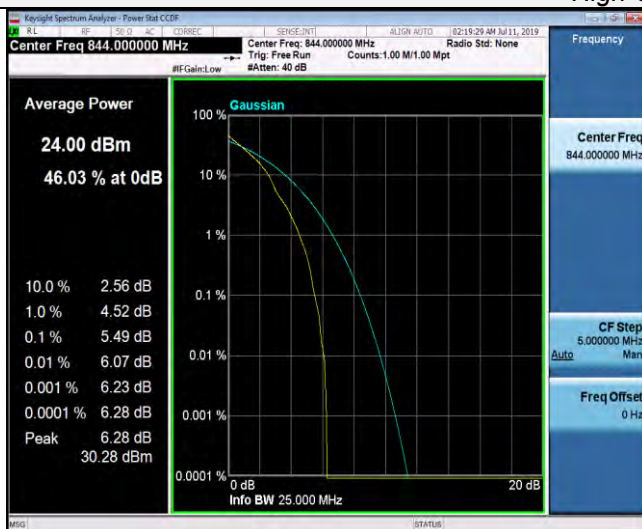

1RB#0

1RB#0

4.3 Occupied Bandwidth and Emission Bandwidth

LIMIT

N/A

TEST CONFIGURATION

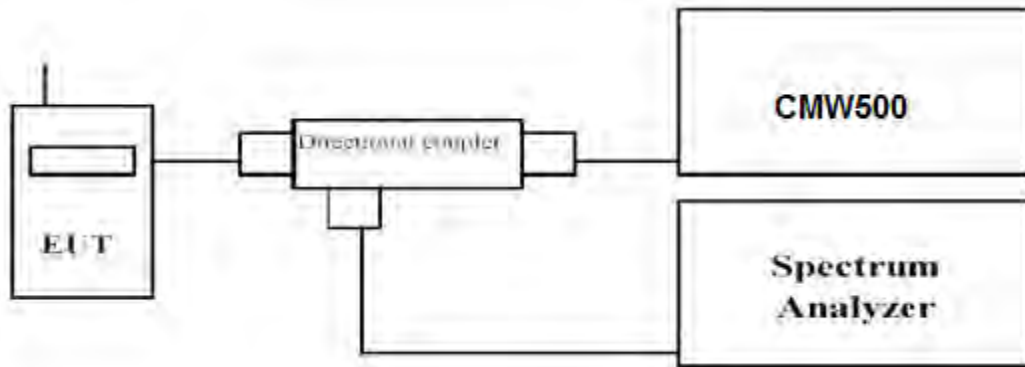

TEST PROCEDURE

The transmitter output was connected to a calibrated coaxial cable and coupler, the other end of which was connected to a spectrum analyzer. The occupied bandwidth was measured with the spectrum analyzer at low, middle and high channel in each band. The -26dBc Emission bandwidth was also measured and recorded. Set RBW was set to about 1% of emission BW, VBW ≥ 3 times RBW. -26dBc display line was placed on the screen (or 99% bandwidth), the occupied bandwidth is the delta frequency between the two points where the display line intersects the signal trace.

TEST RESULTS

Remark:

1. We were tested all RB Configuration refer 3GPP TS136 521 for each Channel Bandwidth of LTE FDD Band 5; recorded worst case for each Channel Bandwidth of LTE FDD Band 5.

LTE FDD Band 5						
TX Channel Bandwidth	RB Size/Offset	Frequency (MHz)	-26dBc Emission bandwidth (MHz)		99% Occupied bandwidth (MHz)	
			QPSK	16QAM	QPSK	16QAM
1.4 MHz	6RB#0	824.7	1.241	1.241	1.0890	1.0919
		836.5	1.242	1.251	1.0882	1.0901
		848.3	1.248	1.268	1.0951	1.0921
3 MHz	15RB#0	825.5	2.994	2.998	2.7013	2.6970
		836.5	2.953	2.978	2.6941	2.6967
		847.5	2.996	3.024	2.7000	2.7002
5 MHz	25RB#0	826.5	4.956	4.968	4.5032	4.4990
		836.5	4.926	4.997	4.4977	4.4936
		846.5	4.887	4.906	4.5029	4.4990
10 MHz	50RB#0	829.0	9.559	9.621	8.9796	8.9862
		836.5	9.530	9.556	8.9715	8.9753
		844.0	9.591	9.584	9.0004	8.9759



LTE FDD Band 5 – 1.4 MHz Channel Bandwidth Occupied Bandwidth and Emission Bandwidth

QPSK

16QAM

Low Channel

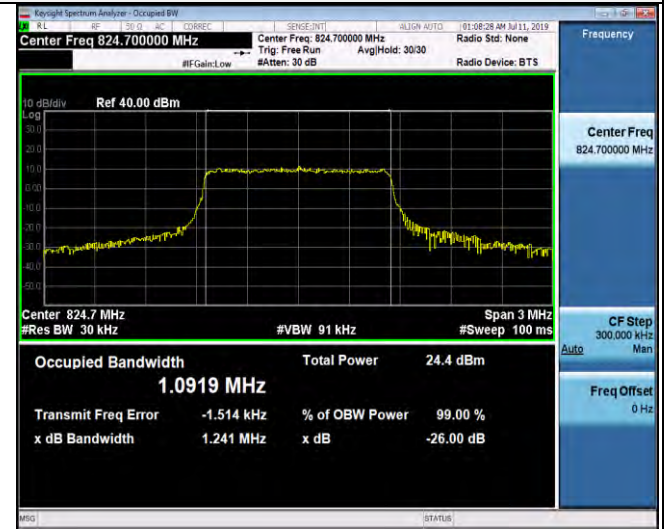

6RB#0

6RB#0

Middle Channel



6RB#0

6RB#0

High Channel

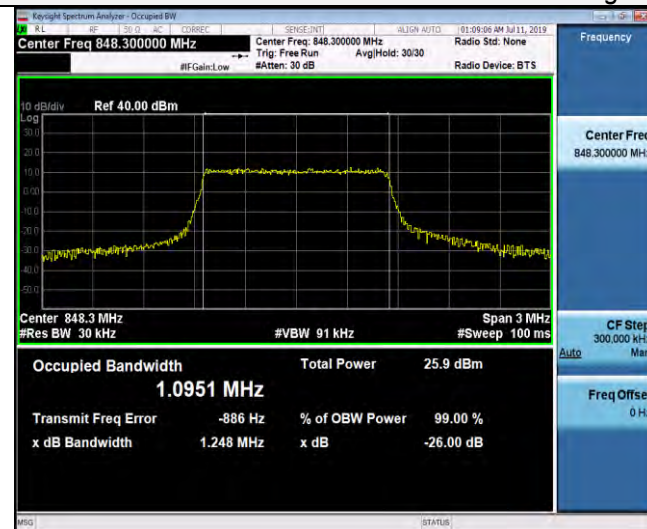

6RB#0

6RB#0



LTE FDD Band 5-3MHz Channel Bandwidth Occupied Bandwidth and Emission Bandwidth

QPSK

16QAM

Low Channel

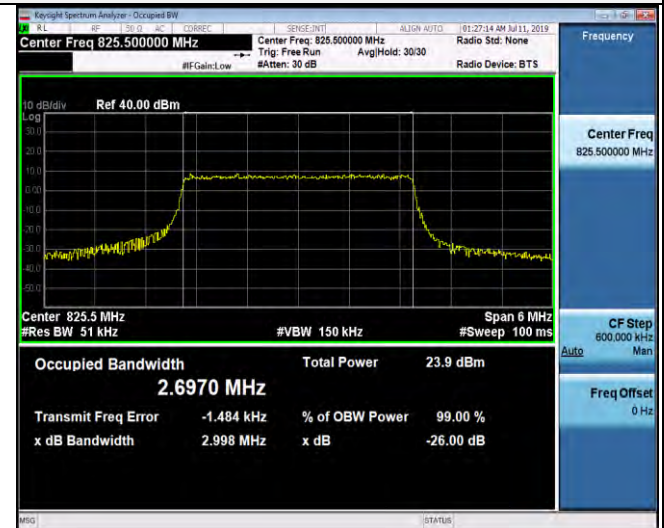
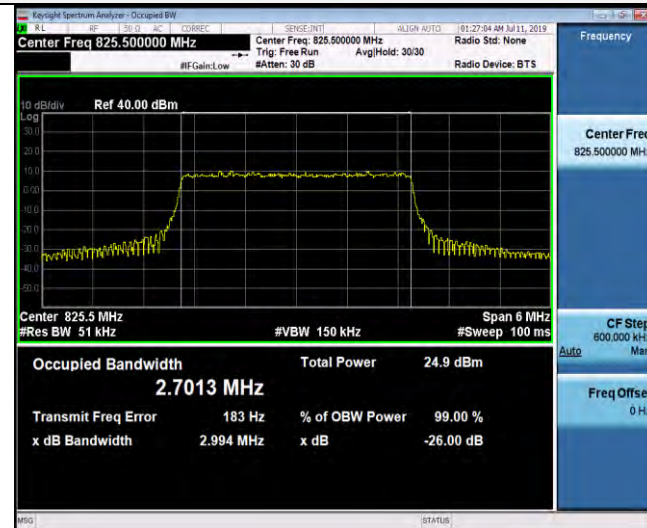

15RB#0

15RB#0

Middle Channel

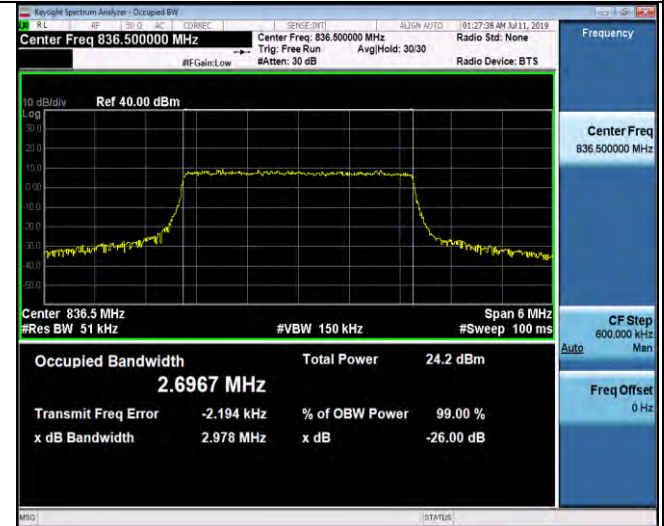
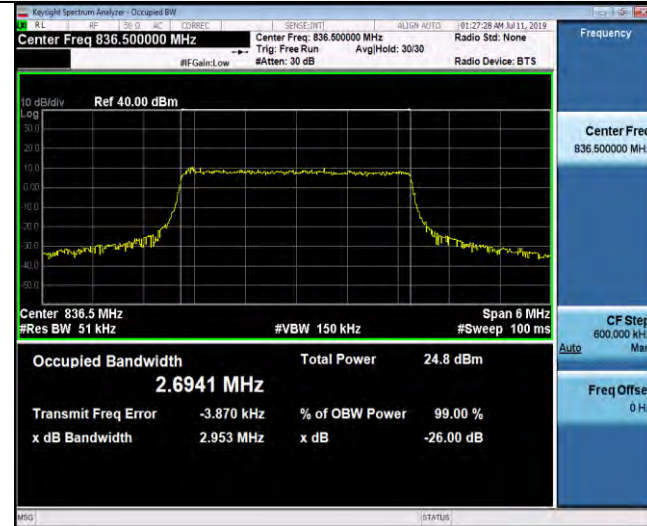

15RB#0

15RB#0

High Channel

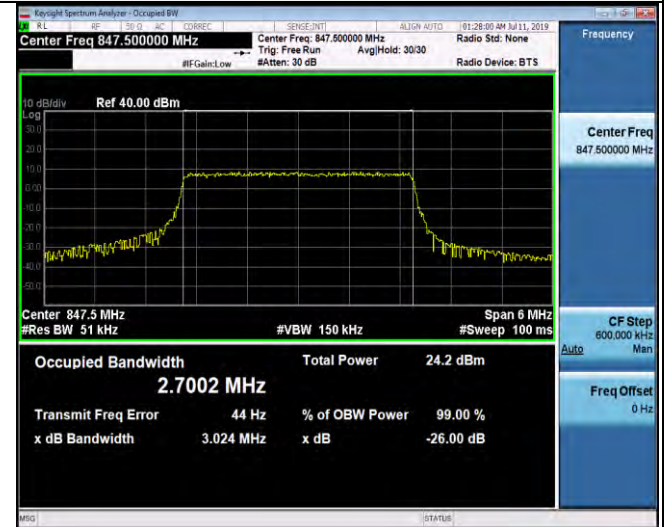
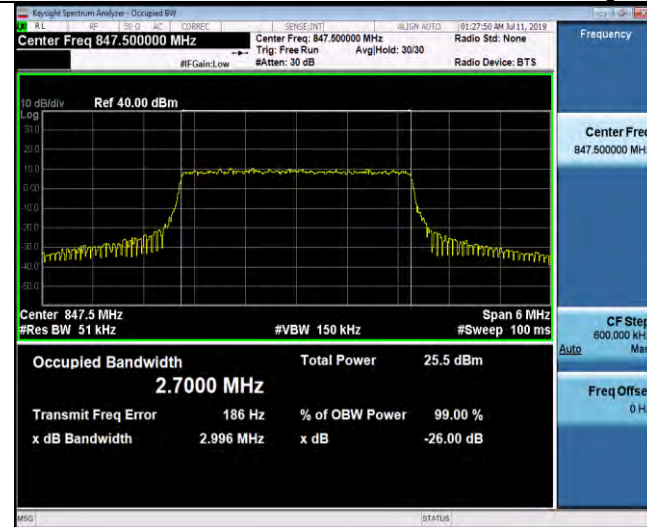

15RB#0

15RB#0



LTE FDD Band 5-5MHz Channel Bandwidth Occupied Bandwidth and Emission Bandwidth

QPSK

16QAM

Low Channel



25RB#0

25RB#0

Middle Channel

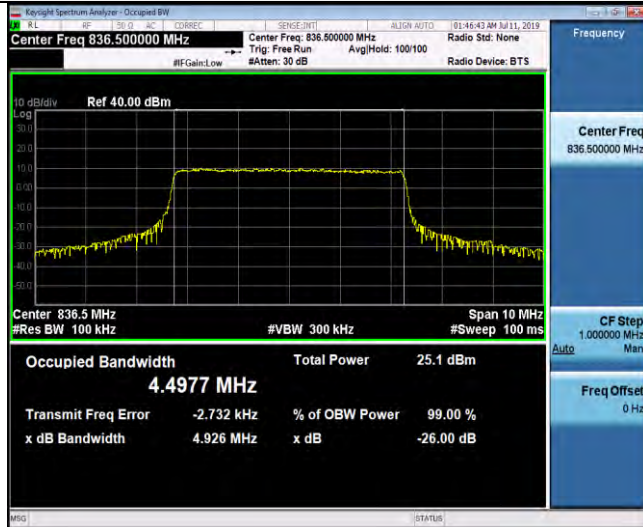

25RB#0

25RB#0

High Channel

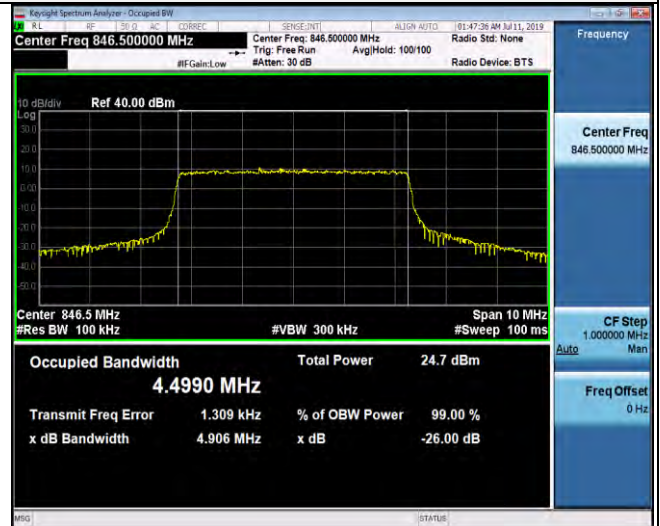
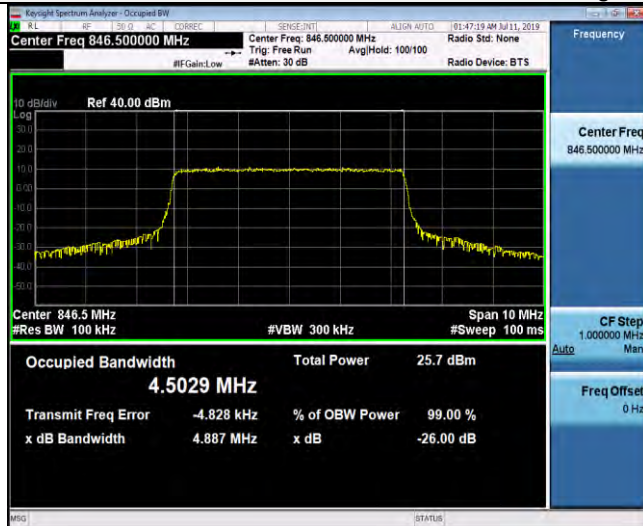

25RB#0

25RB#0



LTE FDD Band 5-10MHz Channel Bandwidth Occupied Bandwidth and Emission Bandwidth

QPSK

16QAM

Low Channel



50RB#0

50RB#0

Middle Channel

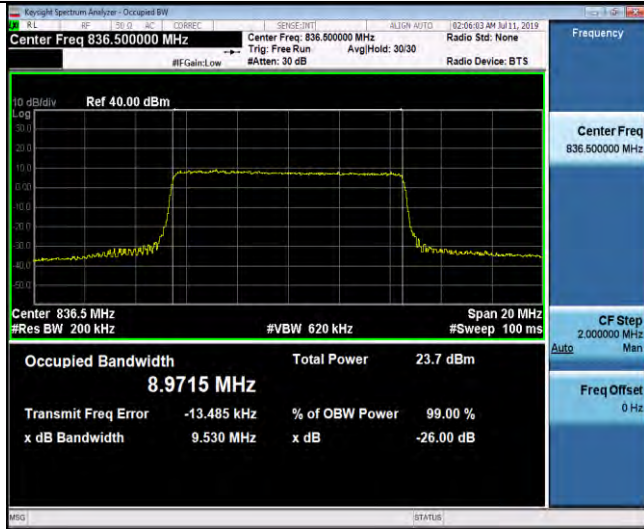

50RB#0

50RB#0

High Channel



50RB#0

50RB#0



4.4 Band Edge compliance

LIMIT

Per FCC §24.238 the power of any emission outside of the authorized operating frequency ranges must be attenuated below the transmitting power (P) by a factor of at least $43 + 10\log(P)$ dB.

TEST CONFIGURATION

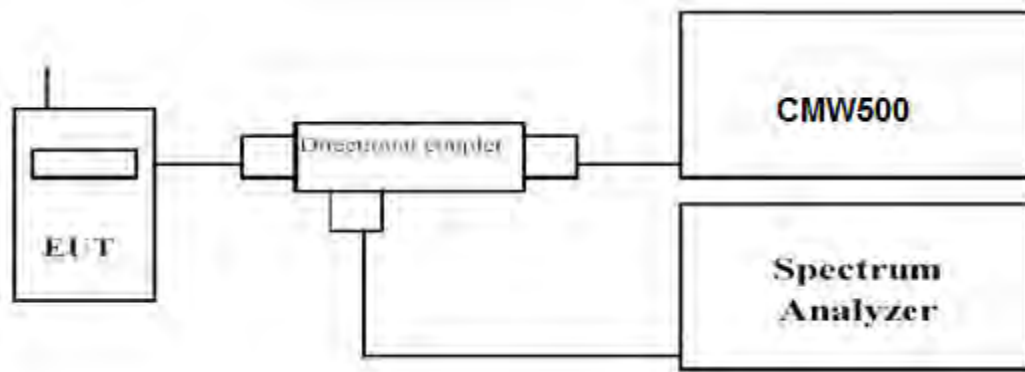

TEST PROCEDURE

1. The transmitter output port was connected to base station.
2. The RF output of EUT was connected to the power meter by RF cable and attenuator, the path loss was compensated to the results for each measurement.
3. Set EUT at maximum power through base station.
4. Select lowest and highest channels for each band and different modulation.
5. Measure Band edge using RMS (Average) detector by spectrum

TEST RESULTS

Remark:

1. We were tested all RB Configuration refer 3GPP TS136 521 for each Channel Bandwidth of LTE FDD Band 5; recorded worst case for each Channel Bandwidth of LTE FDD Band 5.



LTE FDD Band 5 – 1.4 MHz Channel Bandwidth Band Edge Compliance

QPSK

16QAM

Low Channel

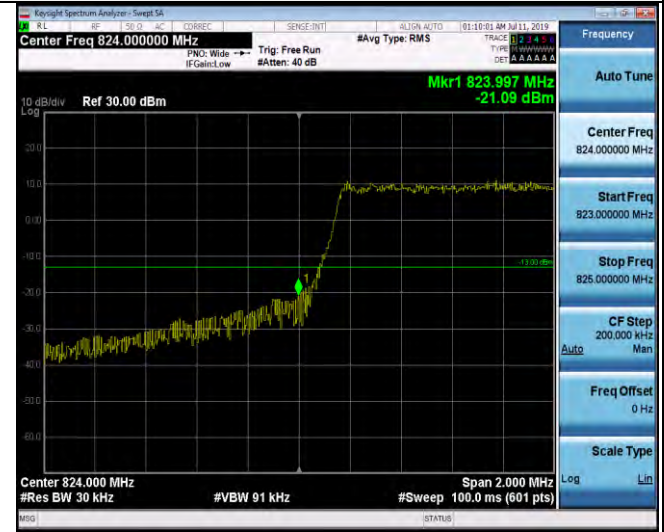

6RB#0

6RB#0

High Channel



6RB#0

6RB#0



LTE FDD Band 5-3MHz Channel Bandwidth Band Edge Compliance

QPSK

16QAM

Low Channel



15RB#0

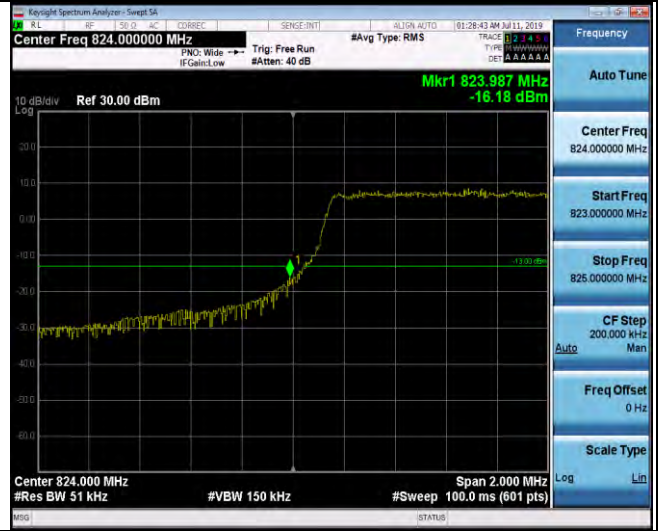

15RB#0

High Channel



15RB#0



15RB#0



LTE FDD Band 5-5MHz Channel Bandwidth Band Edge Compliance

QPSK

16QAM

Low Channel

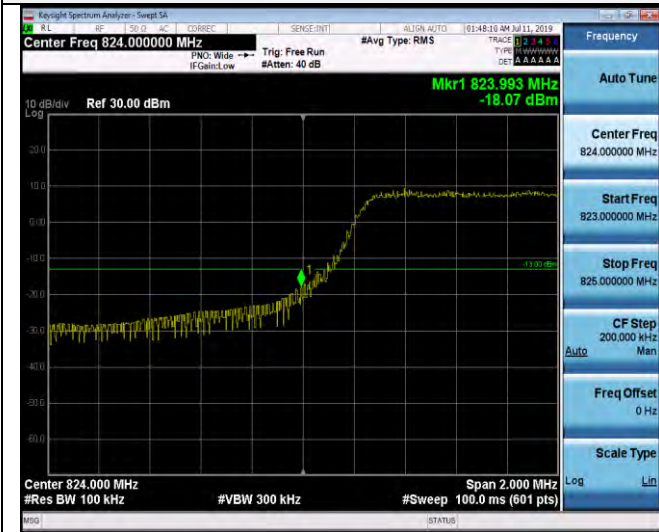

25RB#0



25RB#0

High Channel



25RB#0



25RB#0



LTE FDD Band 5 – 10 MHz Channel Bandwidth Band Edge Compliance

QPSK

16QAM

Low Channel

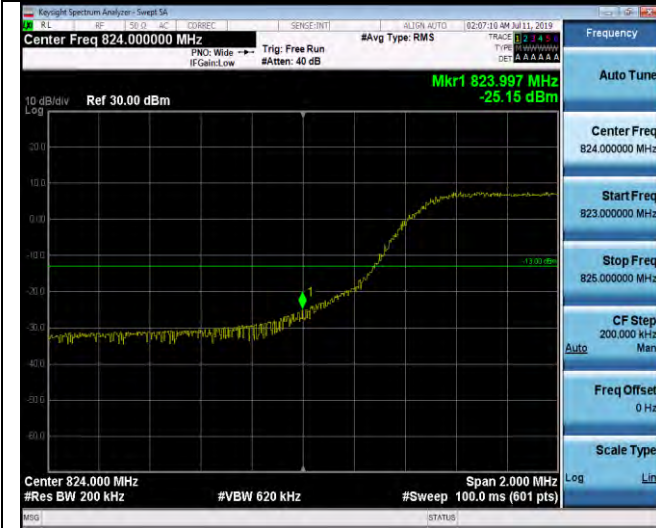

50RB#0

50RB#0

High Channel

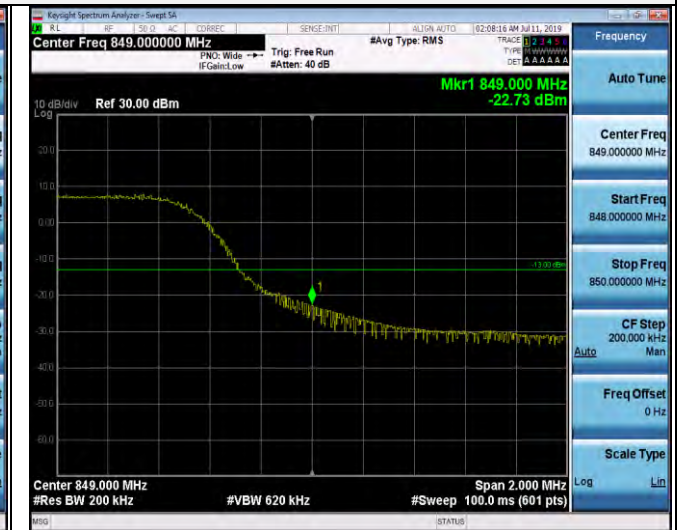
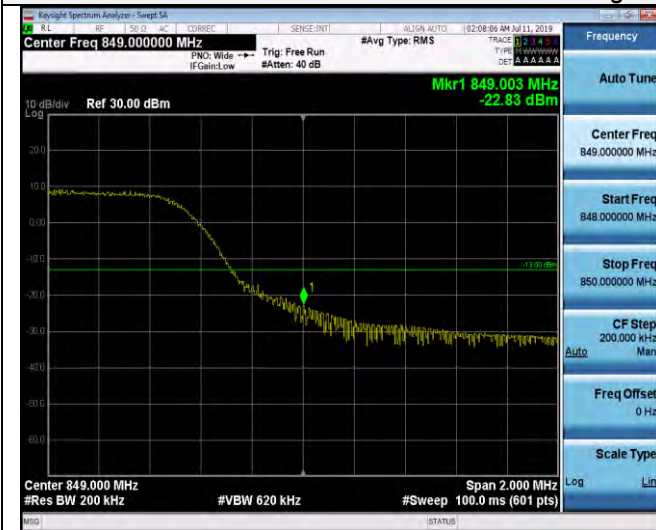

50RB#0

50RB#0

4.5 Spurious Emission on Antenna Port

LIMIT

Per FCC §24.238, the power of any emission outside of the authorized operating frequency ranges must be attenuated below the transmitting power (P) by a factor of at least $43 + 10\log(P)$ dB.

TEST CONFIGURATION

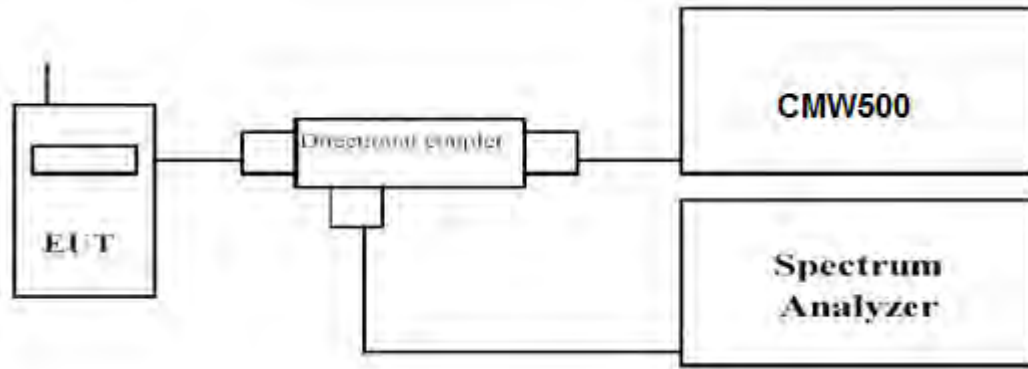

TEST PROCEDURE

The EUT was setup according to EIA/TIA 603D

- a. Place the EUT on a bench and set it in transmitting mode.
- b. Connect a low loss RF cable from the antenna port to a spectrum analyzer and CMW500 by a Directional Couple.
- c. EUT Communicate with CMW500, then select a channel for testing.
- d. Add a correction factor to the display of spectrum, and then test.
- e. The resolution bandwidth of the spectrum analyzer was set sufficient scans were taken to show the out of band Emission if any up to 10th harmonic.
- f. Please refer to following tables for test antenna conducted emissions.

Working Frequency	Sub range (GHz)	RBW	VBW	Sweep time (s)
LTE FDD Band 5	0.01~20	1 MHz	3 MHz	Auto

TEST RESULTS

Remark:

1. We were tested all RB Configuration refer 3GPP TS136 521 for each Channel Bandwidth of LTE FDD Band 5; recorded worst case at the QPSK Mode for each Channel Bandwidth of LTE FDD Band 5



LTE FDD Band 5-1.4MHz Channel Bandwidth

Low Channel

QPSK

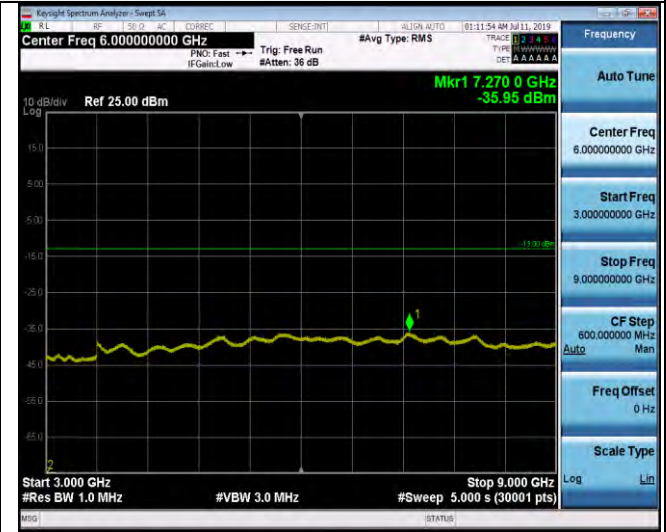

10MHz~3GHz

3GHz ~9GHz

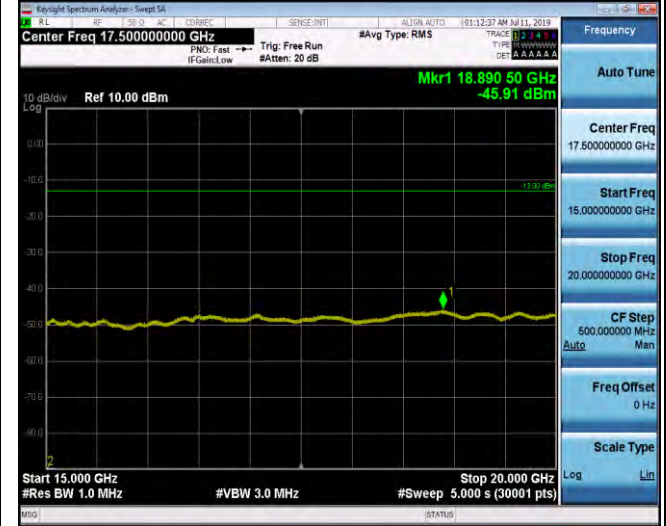

9 GHz ~15 GHz

15 GHz ~20GHz



LTE FDD Band 5-1.4MHz Channel Bandwidth

Middle Channel

QPSK

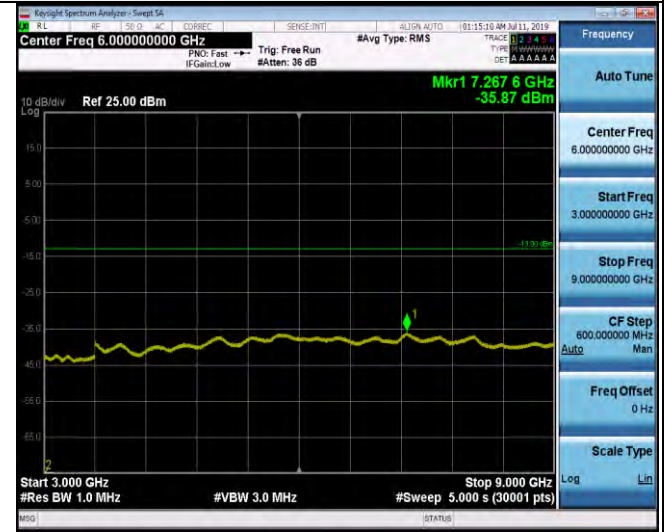
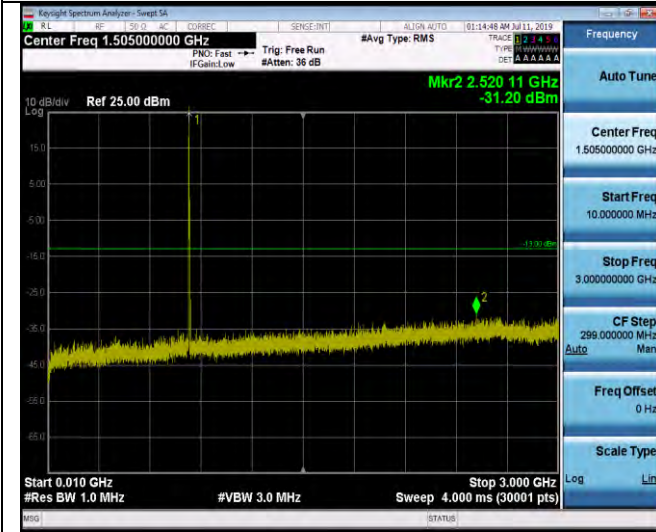

10MHz~3GHz

3GHz ~9GHz

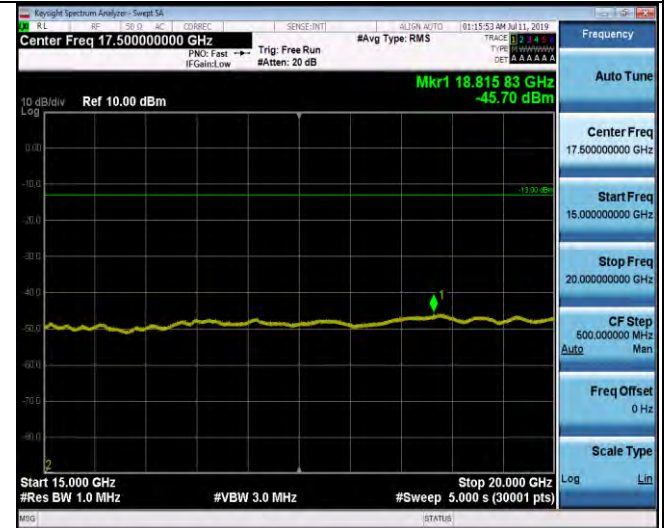

9 GHz ~15 GHz

15 GHz ~20GHz



LTE FDD Band 5-1.4MHz Channel Bandwidth

High Channel

QPSK

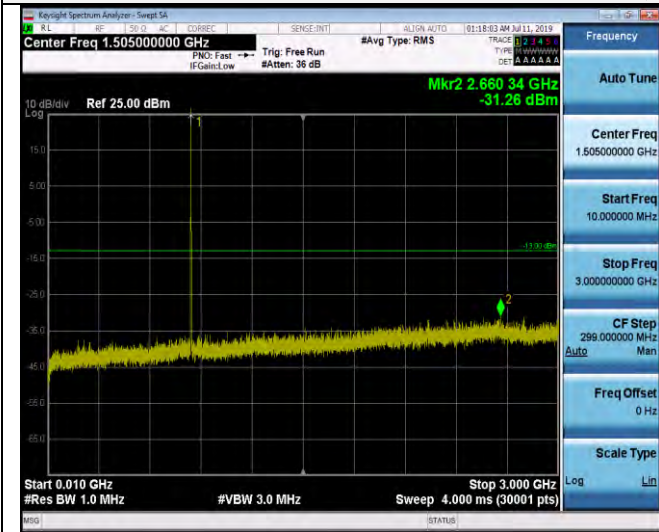

10MHz~3GHz

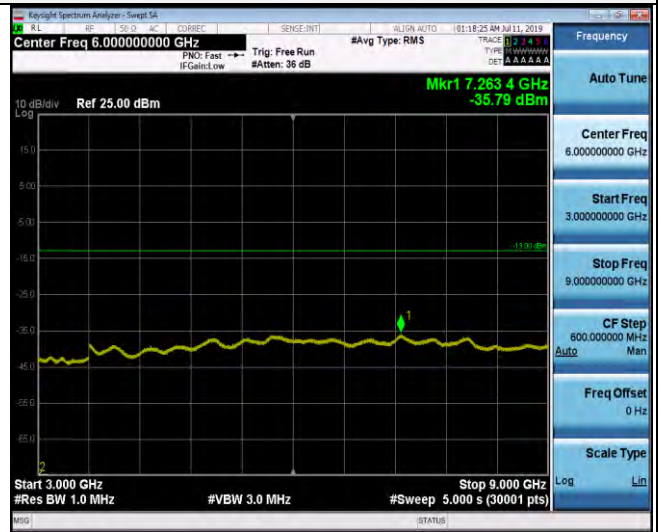

3GHz~9GHz



9 GHz~15 GHz

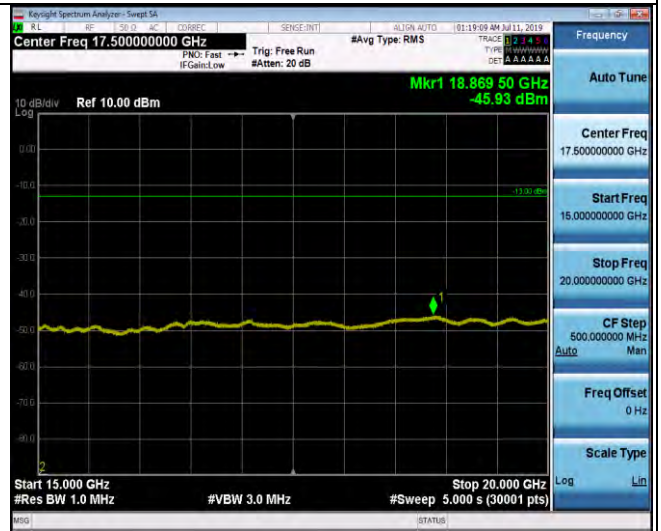

15 GHz~20GHz



LTE FDD Band 5-3MHz Channel Bandwidth

Low Channel

QPSK



10MHz~3GHz

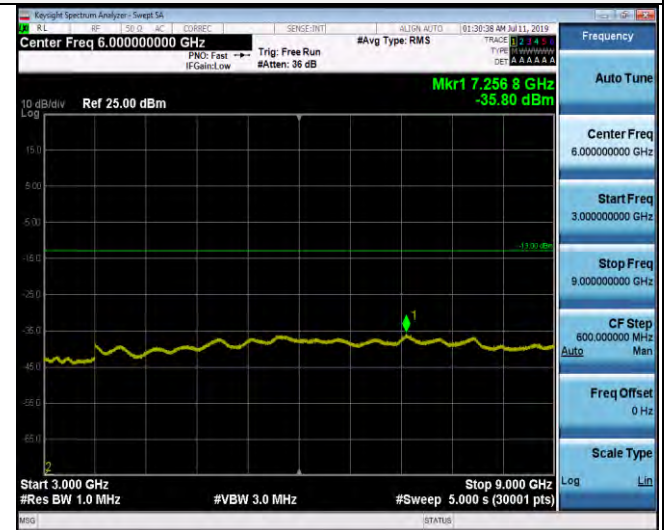

3GHz ~9GHz

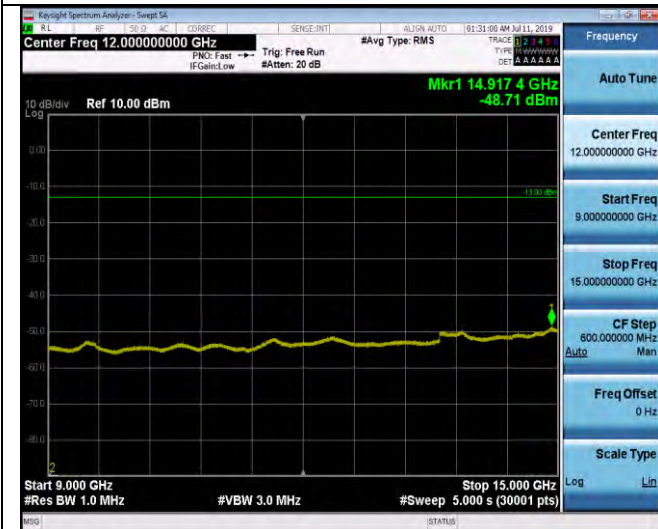

9 GHz ~15 GHz

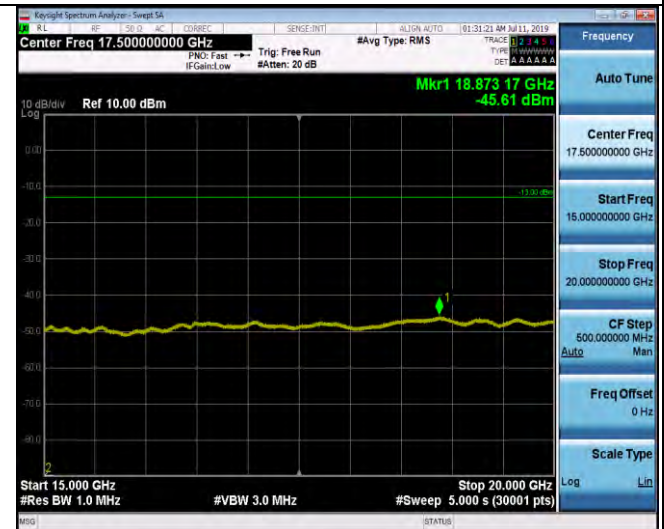

15 GHz ~20GHz



LTE FDD Band 5-3MHz Channel Bandwidth

Middle Channel

QPSK

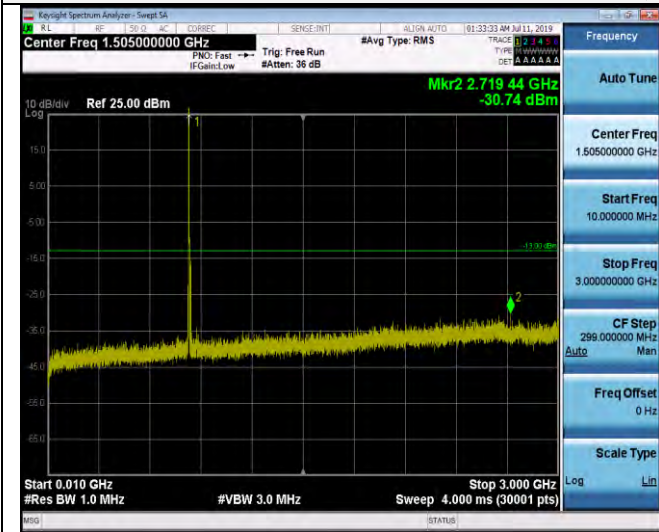

10MHz~3GHz

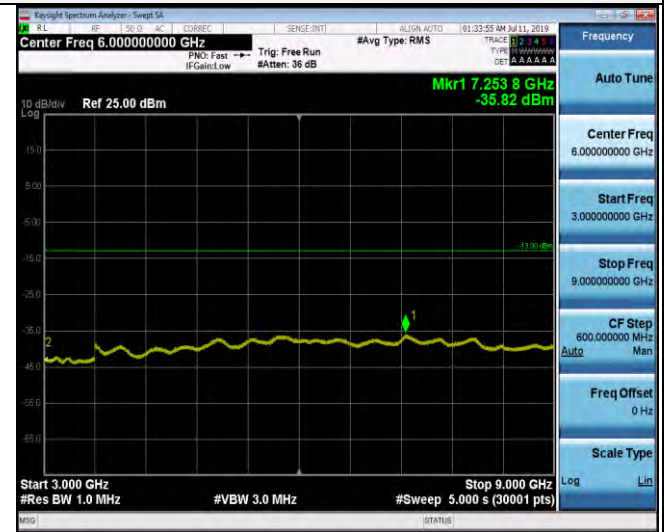

3GHz~9GHz

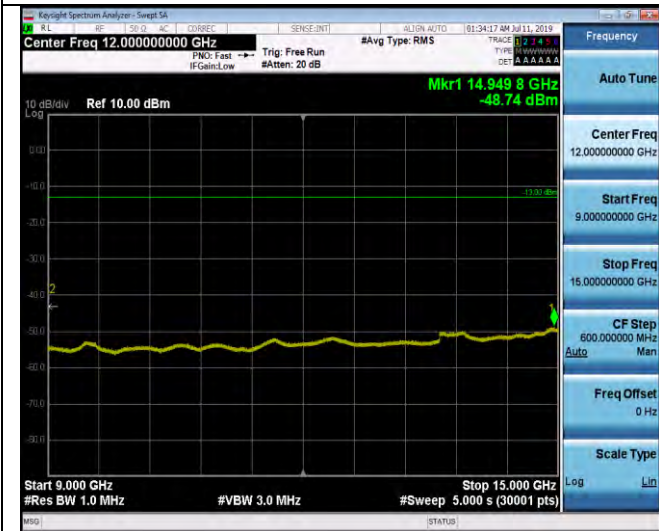

9 GHz~15 GHz



15 GHz~20GHz



LTE FDD Band 5-3MHz Channel Bandwidth

High Channel

QPSK



10MHz~3GHz

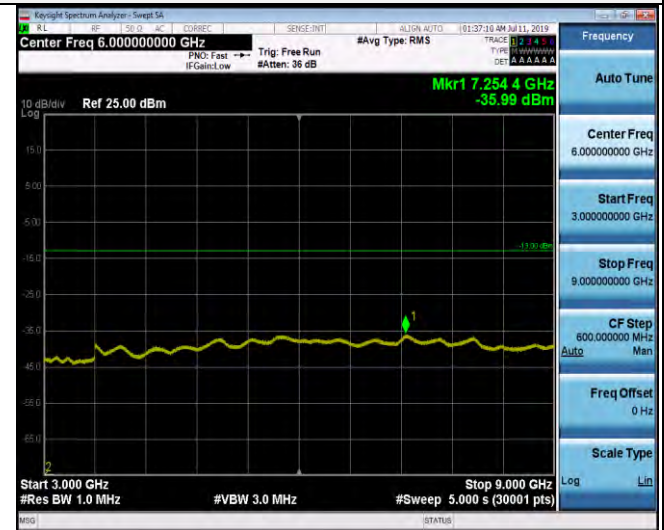

3GHz~9GHz



9 GHz~15 GHz



15 GHz~20GHz



LTE FDD Band 5-5 MHz Channel Bandwidth

Low Channel

QPSK

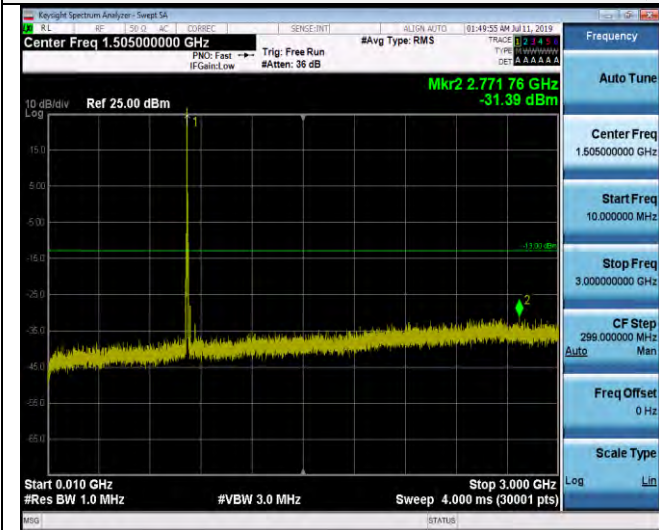

10MHz~3GHz

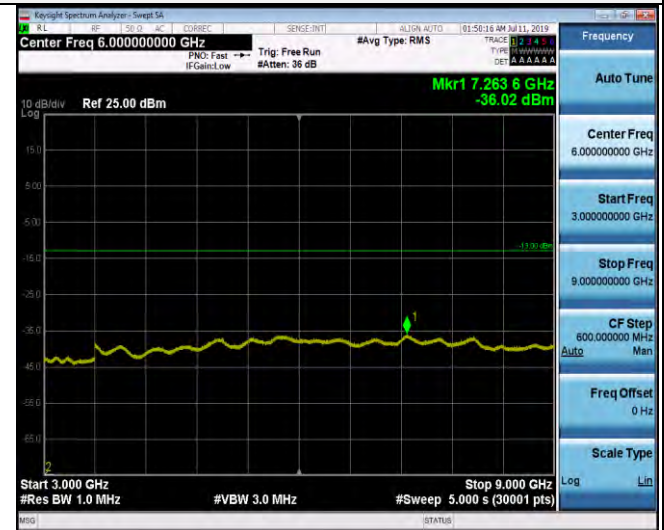

3GHz~9GHz



9 GHz~15 GHz



15 GHz~20GHz



LTE FDD Band 5-5 MHz Channel Bandwidth

Middle Channel

QPSK

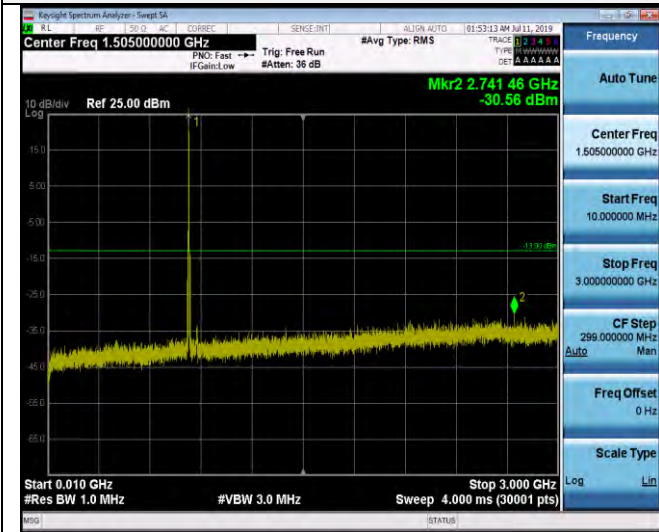

10MHz~3GHz



3GHz~9GHz

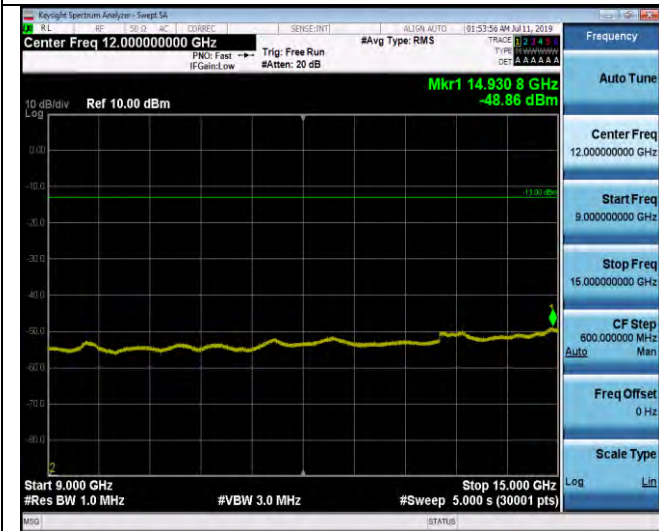

9 GHz~15 GHz



15 GHz~20GHz



LTE FDD Band 5-5 MHz Channel Bandwidth

High Channel

QPSK

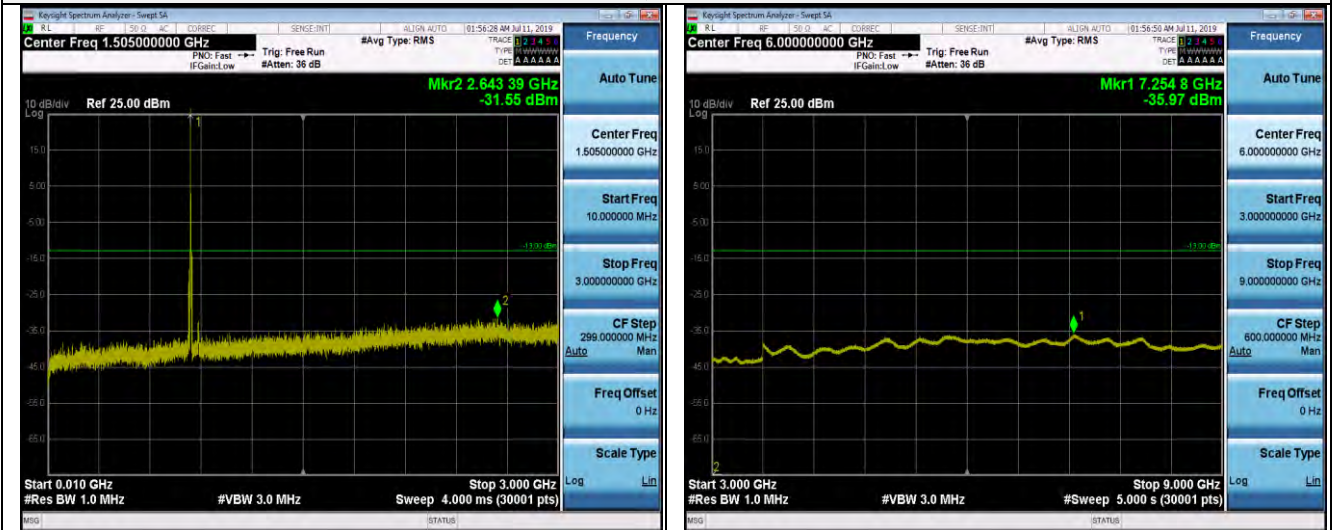

10MHz~3GHz

3GHz ~9GHz



9 GHz ~15 GHz

15 GHz ~20GHz



LTE FDD Band 5-10 MHz Channel Bandwidth

Low Channel

QPSK

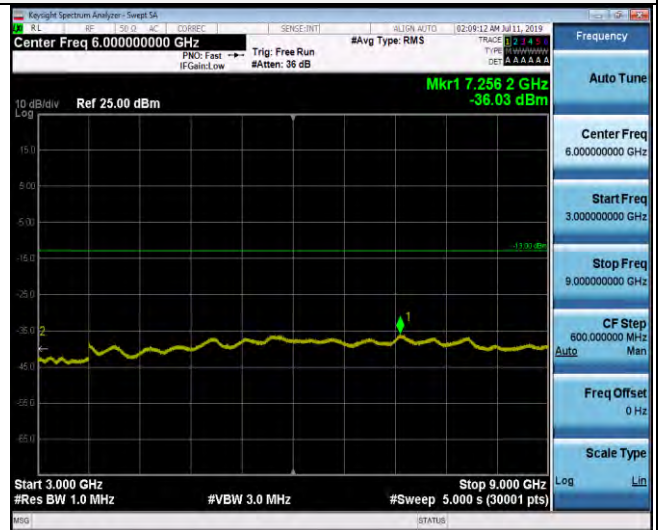
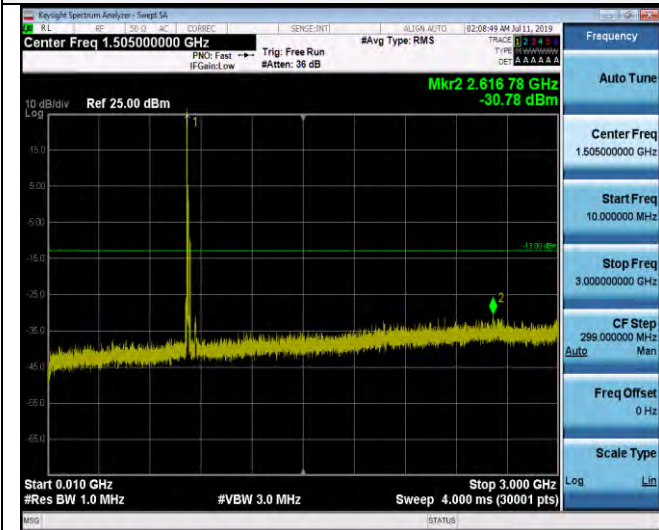

10MHz~3GHz

3GHz~9GHz

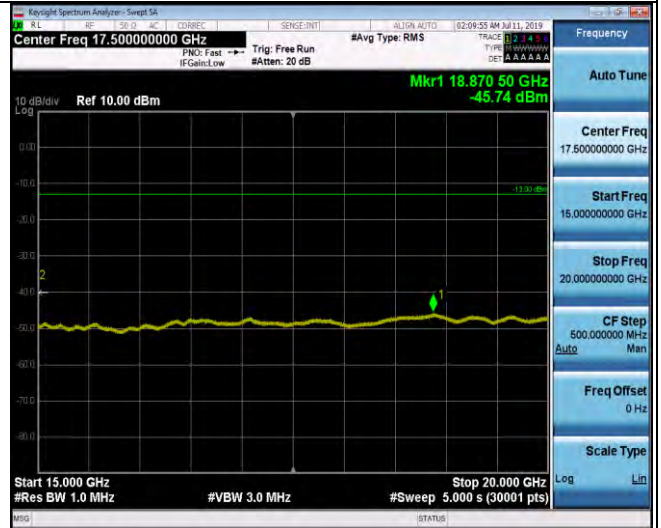

9 GHz ~15 GHz

15 GHz ~20GHz



LTE FDD Band 5-10 MHz Channel Bandwidth

Middle Channel

QPSK

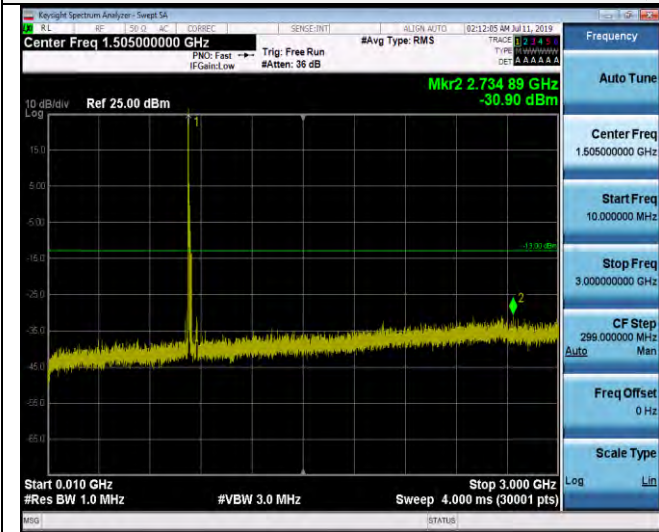

10MHz~3GHz

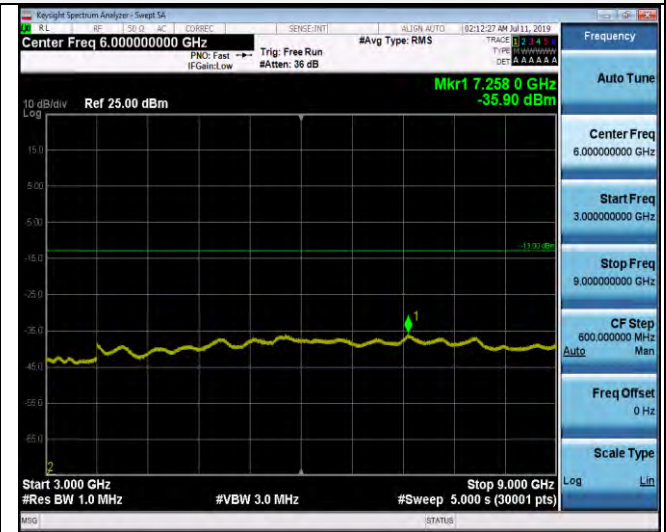

3GHz ~9GHz

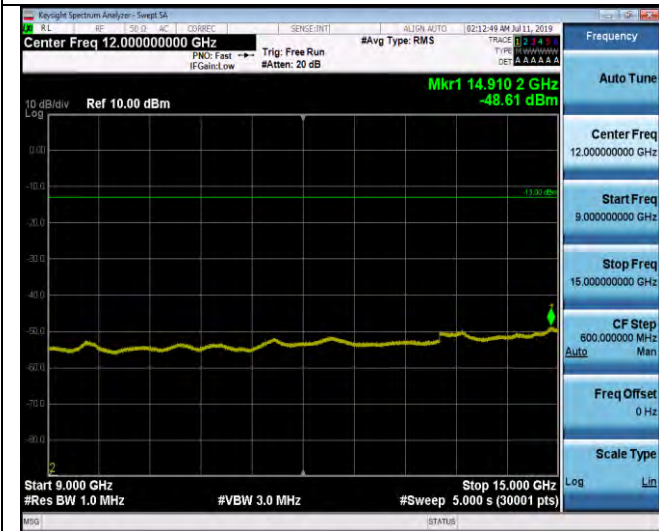

9 GHz ~15 GHz



15 GHz ~20GHz



LTE FDD Band 5-10 MHz Channel Bandwidth

High Channel

QPSK

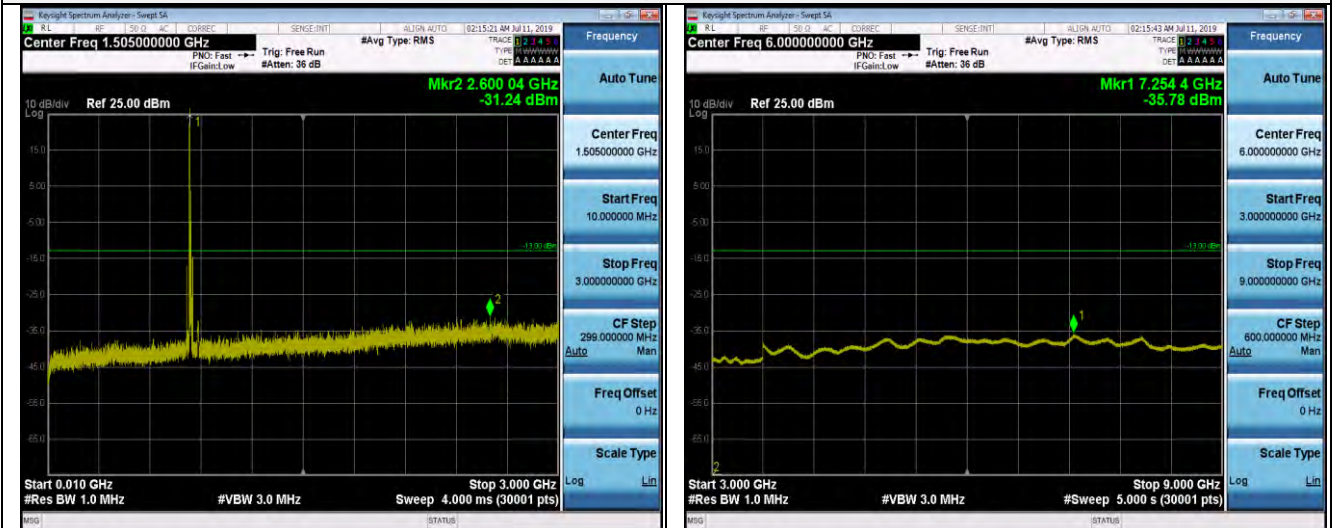

10MHz~3GHz

3GHz~9GHz

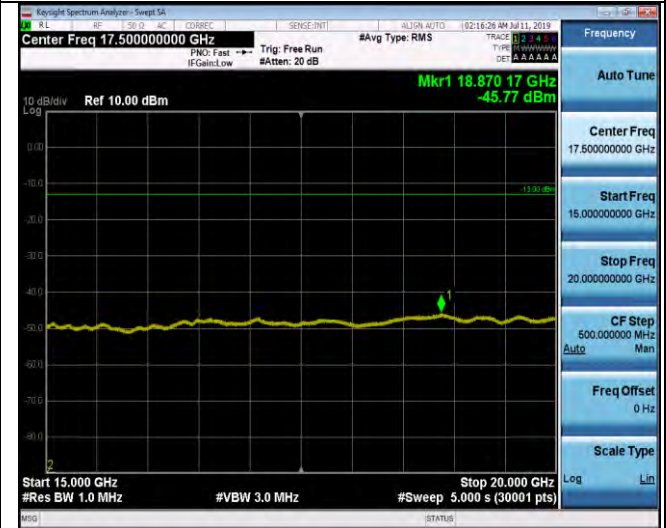

9 GHz~15 GHz

15 GHz~20GHz

4.6 Radiated Spurious Emission

TEST APPLICABLE

Per FCC §24.238, the power of any emission outside of the authorized operating frequency ranges must be attenuated below the transmitting power (P) by a factor of at least $43 + 10\log(P)$ dB.

TEST CONFIGURATION

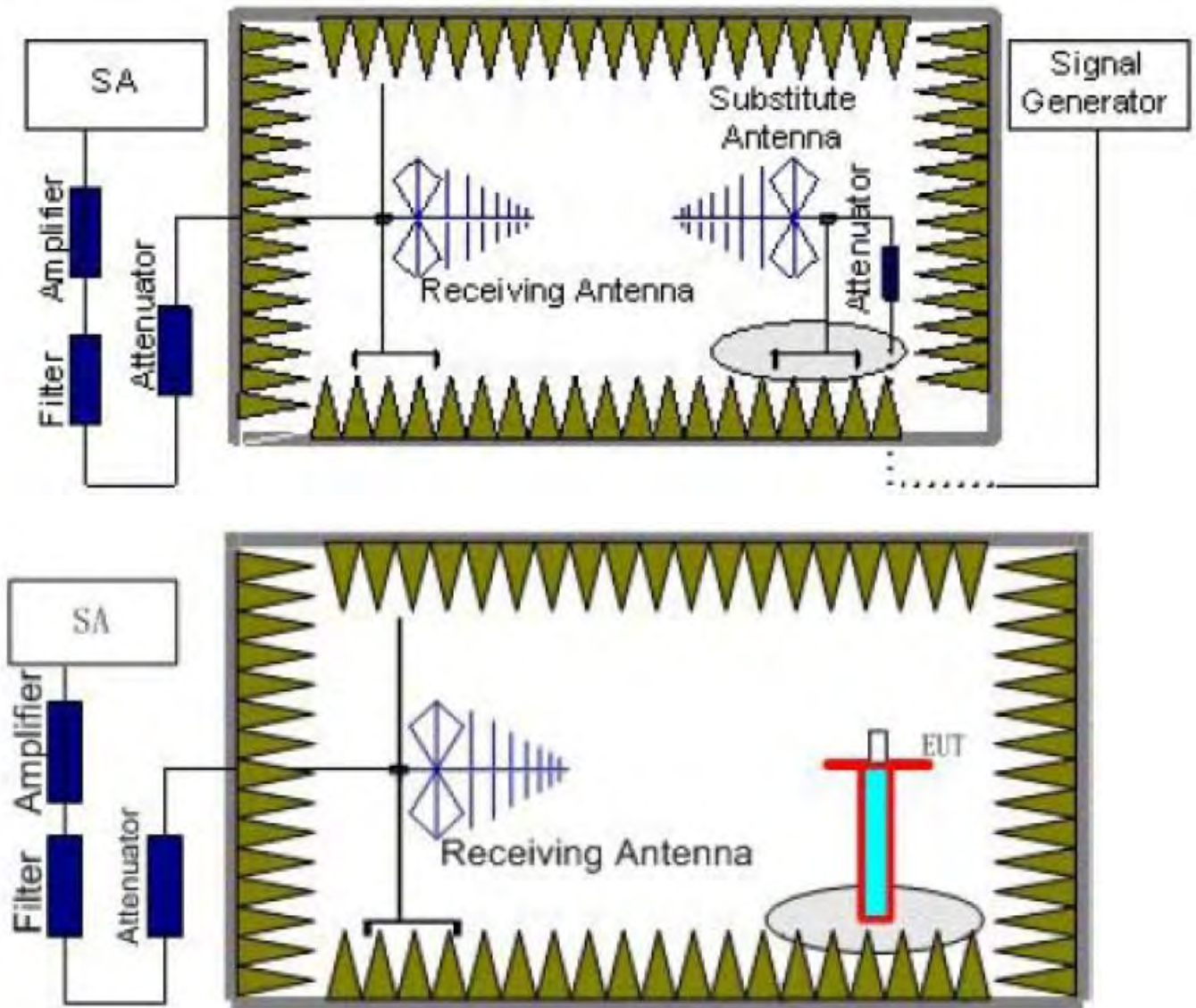

TEST PROCEDURE

1. EUT was placed on a 1.50 meter high non-conductive stand at a 3 meter test distance from the receive antenna. A receiving antenna was placed on the antenna mast 3 meters from the EUT for emission measurements. The height of receiving antenna is 1.50m. Detected emissions were maximized at each frequency by rotating the EUT through 360° and adjusting the receiving antenna polarization. The radiated emission measurements of all transmit frequencies in three channels (High, Middle, Low) were measured with peak detector.
2. A log-periodic antenna or double-ridged waveguide horn antenna shall be substituted in place of the EUT. The log-periodic antenna will be driven by a signal generator and the level will be adjusted till the same power value on the spectrum analyzer or receiver. The level of the spurious emissions can be calculated through the level of the signal generator, cable loss, the gain of the substitution antenna and the reading of the spectrum analyzer or receiver.



3. The EUT is then put into continuously transmitting mode at its maximum power level during the test. Set Test Receiver or Spectrum RBW=1MHz, VBW=3MHz, And the maximum value of the receiver should be recorded as (P_r).
4. The EUT shall be replaced by a substitution antenna. In the chamber, an substitution antenna for the frequency band of interest is placed at the reference point of the chamber. An RF Signal source for the frequency band of interest is connected to the substitution antenna with a cable that has been constructed to not interfere with the radiation pattern of the antenna. A power (P_{Mea}) is applied to the input of the substitution antenna, and adjust the level of the signal generator output until the value of the receiver reach the previously recorded (P_r). The power of signal source (P_{Mea}) is recorded. The test should be performed by rotating the test item and adjusting the receiving antenna polarization.
5. A amplifier should be connected to the Signal Source output port. And the cable should be connect between the Amplifier and the Substitution Antenna. The cable loss (P_{cl}), the Substitution Antenna Gain (G_a) and the Amplifier Gain (P_{Ag}) should be recorded after test.
The measurement results are obtained as described below:
 $Power(EIRP) = P_{Mea} - P_{Ag} - P_{cl} + G_a$
6. This value is EIRP since the measurement is calibrated using an antenna of known gain (2.15 dBi) and known input power.
7. ERP can be calculated from EIRP by subtracting the gain of the dipole, $ERP = EIRP - 2.15dBi$.
8. In order to make sure test results more clearly, we set frequency range and sweep time for difference frequency range as follows table:

Working Frequency	Subrange (GHz)	RBW	VBW	Sweep time (s)
LTE BAND 5	0.03~1	100KHz	300KHz	10
	1~20	1 MHz	3 MHz	2

TEST LIMITS

According to 24.238 specify that the power of any emission outside of the authorized operating frequency ranges must be attenuated below the transmitting power (P) by a factor of at least $43 + 10 \log(P)$ dB. The specification that emissions shall be attenuated below the transmitter power (P) by at least $43 + 10 \log(P)$ dB, translates in the relevant power range (1 to 0.001 W) to -13 dBm. At 1 W the specified minimum attenuation becomes 43 dB and relative to a 30 dBm (1 W) carrier becomes a limit of -13 dBm. At 0.001 W (0 dBm) the minimum attenuation is 13 dB, which again yields a limit of -13 dBm. In this way a translation of the specification from relative to absolute terms is carried out.

Frequency	Channel	Frequency Range	Verdict
LTE BAND 5	Low	30MHz -20GHz	PASS
	Middle	30MHz -20GHz	PASS
	High	30MHz -20GHz	PASS

Radiated Measurement:

Remark:

1. We measured all RB Configuration refer 3GPP TS136 521 for each Channel Bandwidth of LTE BAND 5; recorded worst case for each Channel Bandwidth of LTE BAND 5.
2. $EIRP = P_{Mea}(dBm) - P_{cl}(dB) + G_a(dBi)$
3. Not recorded other points as values lower than limits.
4. $Margin = Limit - EIRP$

Remark:

1. We measured all RB Configuration refer 3GPP TS136 521 for each Channel Bandwidth of LTE FDD Band 5; recorded worst case for each Channel Bandwidth of LTE FDD Band 5.
2. $EIRP = P_{Mea}(dBm) - P_{cl}(dB) + G_a(dBi)$
3. Not recorded other points as values lower than limits.
4. $Margin = Limit - EIRP$

*LTE FDD Band 5_Channel Bandwidth 1.4MHz_QPSK_Low Channel*

Frequency (MHz)	P _{Mea} (dBm)	P _{cl} (dB)	Diatance	G _a Antenna Gain(dB)	Peak EIRP (dBm)	Limit (dBm)	Margin (dB)	Polarization
1649.4	-30.94	3.00	3.00	9.58	-24.36	-13.00	11.36	H
2474.1	-36.72	3.03	3.00	10.72	-29.03	-13.00	16.03	H
1649.4	-30.06	3.00	3.00	9.68	-23.38	-13.00	10.38	V
2474.1	-39.93	3.03	3.00	10.72	-32.24	-13.00	19.24	V

LTE FDD Band 5_Channel Bandwidth 1.4MHz_QPSK_Middle Channel

Frequency (MHz)	P _{Mea} (dBm)	P _{cl} (dB)	Diatance	G _a Antenna Gain(dB)	Peak EIRP (dBm)	Limit (dBm)	Margin (dB)	Polarization
1673.0	-28.14	3.00	3.00	9.58	-21.56	-13.00	8.56	H
2509.5	-39.53	3.03	3.00	10.72	-31.84	-13.00	18.84	H
1673.0	-30.65	3.00	3.00	9.68	-23.97	-13.00	10.97	V
2509.5	-38.7	3.03	3.00	10.72	-31.01	-13.00	18.01	V

LTE FDD Band 5_Channel Bandwidth 1.4MHz_QPSK_High Channel

Frequency (MHz)	P _{Mea} (dBm)	P _{cl} (dB)	Diatance	G _a Antenna Gain(dB)	Peak EIRP (dBm)	Limit (dBm)	Margin (dB)	Polarization
1696.6	-32.61	3.00	3.00	9.58	-26.03	-13.00	13.03	H
2544.9	-37.76	3.03	3.00	10.72	-30.07	-13.00	17.07	H
1696.6	-29.84	3.00	3.00	9.68	-23.16	-13.00	10.16	V
2544.9	-35.99	3.03	3.00	10.72	-28.3	-13.00	15.3	V

LTE FDD Band 5_Channel Bandwidth 3MHz_QPSK_Low Channel

Frequency (MHz)	P _{Mea} (dBm)	P _{cl} (dB)	Diatance	G _a Antenna Gain(dB)	Peak EIRP (dBm)	Limit (dBm)	Margin (dB)	Polarization
1651.0	-30.84	3.00	3.00	9.58	-24.26	-13.00	11.26	H
2476.5	-36.93	3.03	3.00	10.72	-29.24	-13.00	16.24	H
1651.0	-30.1	3.00	3.00	9.68	-23.42	-13.00	10.42	V
2476.5	-39.21	3.03	3.00	10.72	-31.52	-13.00	18.52	V

LTE FDD Band 5_Channel Bandwidth 3MHz_QPSK_Middle Channel

Frequency (MHz)	P _{Mea} (dBm)	P _{cl} (dB)	Diatance	G _a Antenna Gain(dB)	Peak EIRP (dBm)	Limit (dBm)	Margin (dB)	Polarization
1673.0	-28.86	3.00	3.00	9.58	-22.28	-13.00	9.28	H
2509.5	-38.97	3.03	3.00	10.72	-31.28	-13.00	18.28	H
1673.0	-31.17	3.00	3.00	9.68	-24.49	-13.00	11.49	V
2509.5	-38.84	3.03	3.00	10.72	-31.15	-13.00	18.15	V

LTE FDD Band 5_Channel Bandwidth 3MHz_QPSK_High Channel

Frequency (MHz)	P _{Mea} (dBm)	P _{cl} (dB)	Diatance	G _a Antenna Gain(dB)	Peak EIRP (dBm)	Limit (dBm)	Margin (dB)	Polarization
1695.0	-33	3.00	3.00	9.58	-26.42	-13.00	13.42	H
2542.5	-37.83	3.03	3.00	10.72	-30.14	-13.00	17.14	H
1695.0	-30.37	3.00	3.00	9.68	-23.69	-13.00	10.69	V
2542.5	-35.56	3.03	3.00	10.72	-27.87	-13.00	14.87	V

LTE FDD Band 5_Channel Bandwidth 5MHz_QPSK_Low Channel

Frequency (MHz)	P _{Mea} (dBm)	P _{cl} (dB)	Diatance	G _a Antenna Gain(dB)	Peak EIRP (dBm)	Limit (dBm)	Margin (dB)	Polarization
1653.0	-30.39	3.00	3.00	9.58	-23.81	-13.00	10.81	H
2479.5	-37.24	3.03	3.00	10.72	-29.55	-13.00	16.55	H
1653.0	-30.72	3.00	3.00	9.68	-24.04	-13.00	11.04	V
2479.5	-39.19	3.03	3.00	10.72	-31.5	-13.00	18.5	V

*LTE FDD Band 5_Channel Bandwidth 5MHz_QPSK_Middle Channel*

Frequency (MHz)	P _{Mea} (dBm)	P _{cl} (dB)	Diatance	G _a Antenna Gain(dB)	Peak EIRP (dBm)	Limit (dBm)	Margin (dB)	Polarization
1673.0	-28.96	3.00	3.00	9.58	-22.38	-13.00	9.38	H
2509.5	-39.02	3.03	3.00	10.72	-31.33	-13.00	18.33	H
1673.0	-30.85	3.00	3.00	9.68	-24.17	-13.00	11.17	V
2509.5	-38.46	3.03	3.00	10.72	-30.77	-13.00	17.77	V

LTE FDD Band 5_Channel Bandwidth 5MHz_QPSK_High Channel

Frequency (MHz)	P _{Mea} (dBm)	P _{cl} (dB)	Diatance	G _a Antenna Gain(dB)	Peak EIRP (dBm)	Limit (dBm)	Margin (dB)	Polarization
1693.0	-32.23	3.00	3.00	9.58	-25.65	-13.00	12.65	H
2539.5	-37.38	3.03	3.00	10.72	-29.69	-13.00	16.69	H
1693.0	-30.32	3.00	3.00	9.68	-23.64	-13.00	10.64	V
2539.5	-36.1	3.03	3.00	10.72	-28.41	-13.00	15.41	V

LTE FDD Band 5_Channel Bandwidth 10MHz_QPSK_Low Channel

Frequency (MHz)	P _{Mea} (dBm)	P _{cl} (dB)	Diatance	G _a Antenna Gain(dB)	Peak EIRP (dBm)	Limit (dBm)	Margin (dB)	Polarization
1658.0	-30.5	3.00	3.00	9.58	-23.92	-13.00	10.92	H
2487.0	-37.26	3.03	3.00	10.72	-29.57	-13.00	16.57	H
1658.0	-29.8	3.00	3.00	9.68	-23.12	-13.00	10.12	V
2487.0	-39.46	3.03	3.00	10.72	-31.77	-13.00	18.77	V

LTE FDD Band 5_Channel Bandwidth 10MHz_QPSK_Middle Channel

Frequency (MHz)	P _{Mea} (dBm)	P _{cl} (dB)	Diatance	G _a Antenna Gain(dB)	Peak EIRP (dBm)	Limit (dBm)	Margin (dB)	Polarization
1673.0	-28.82	3.00	3.00	9.58	-22.24	-13.00	9.24	H
2509.5	-38.96	3.03	3.00	10.72	-31.27	-13.00	18.27	H
1673.0	-31	3.00	3.00	9.68	-24.32	-13.00	11.32	V
2509.5	-38.37	3.03	3.00	10.72	-30.68	-13.00	17.68	V

LTE FDD Band 5_Channel Bandwidth 10MHz_QPSK_High Channel

Frequency (MHz)	P _{Mea} (dBm)	P _{cl} (dB)	Diatance	G _a Antenna Gain(dB)	Peak EIRP (dBm)	Limit (dBm)	Margin (dB)	Polarization
1688.0	-32.21	3.00	3.00	9.58	-25.63	-13.00	12.63	H
2532.0	-38.18	3.03	3.00	10.72	-30.49	-13.00	17.49	H
1688.0	-30.7	3.00	3.00	9.68	-24.02	-13.00	11.02	V
2532.0	-35.35	3.03	3.00	10.72	-27.66	-13.00	14.66	V

LTE FDD Band 5_Channel Bandwidth 1.4MHz_16QAM_Low Channel

Frequency (MHz)	P _{Mea} (dBm)	P _{cl} (dB)	Diatance	G _a Antenna Gain(dB)	Peak EIRP (dBm)	Limit (dBm)	Margin (dB)	Polarization
1649.4	-30.76	3.00	3.00	9.58	-24.18	-13.00	11.18	H
2474.1	-37.55	3.03	3.00	10.72	-29.86	-13.00	16.86	H
1649.4	-29.77	3.00	3.00	9.68	-23.09	-13.00	10.09	V
2474.1	-39.45	3.03	3.00	10.72	-31.76	-13.00	18.76	V

LTE FDD Band 5_Channel Bandwidth 1.4MHz_16QAM_Middle Channel

Frequency (MHz)	P _{Mea} (dBm)	P _{cl} (dB)	Diatance	G _a Antenna Gain(dB)	Peak EIRP (dBm)	Limit (dBm)	Margin (dB)	Polarization
1673.0	-28.64	3.00	3.00	9.58	-22.06	-13.00	9.06	H
2509.5	-39.9	3.03	3.00	10.72	-32.21	-13.00	19.21	H
1673.0	-30.38	3.00	3.00	9.68	-23.7	-13.00	10.7	V
2509.5	-38.44	3.03	3.00	10.72	-30.75	-13.00	17.75	V

*LTE FDD Band 5_Channel Bandwidth 1.4MHz_16QAM_High Channel*

Frequency (MHz)	P _{Mea} (dBm)	P _{cl} (dB)	Diatance	G _a Antenna Gain(dB)	Peak EIRP (dBm)	Limit (dBm)	Margin (dB)	Polarization
1696.6	-32.77	3.00	3.00	9.58	-26.19	-13.00	13.19	H
2544.9	-37.94	3.03	3.00	10.72	-30.25	-13.00	17.25	H
1696.6	-30.02	3.00	3.00	9.68	-23.34	-13.00	10.34	V
2544.9	-36.08	3.03	3.00	10.72	-28.39	-13.00	15.39	V

LTE FDD Band 5_Channel Bandwidth 3MHz_16QAM_Low Channel

Frequency (MHz)	P _{Mea} (dBm)	P _{cl} (dB)	Diatance	G _a Antenna Gain(dB)	Peak EIRP (dBm)	Limit (dBm)	Margin (dB)	Polarization
1651.0	-30.42	3.00	3.00	9.58	-23.84	-13.00	10.84	H
2476.5	-36.95	3.03	3.00	10.72	-29.26	-13.00	16.26	H
1651.0	-29.81	3.00	3.00	9.68	-23.13	-13.00	10.13	V
2476.5	-39.56	3.03	3.00	10.72	-31.87	-13.00	18.87	V

LTE FDD Band 5_Channel Bandwidth 3MHz_16QAM_Middle Channel

Frequency (MHz)	P _{Mea} (dBm)	P _{cl} (dB)	Diatance	G _a Antenna Gain(dB)	Peak EIRP (dBm)	Limit (dBm)	Margin (dB)	Polarization
1673.0	-28.46	3.00	3.00	9.58	-21.88	-13.00	8.88	H
2509.5	-39.34	3.03	3.00	10.72	-31.65	-13.00	18.65	H
1673.0	-30.55	3.00	3.00	9.68	-23.87	-13.00	10.87	V
2509.5	-38.36	3.03	3.00	10.72	-30.67	-13.00	17.67	V

LTE FDD Band 5_Channel Bandwidth 3MHz_16QAM_High Channel

Frequency (MHz)	P _{Mea} (dBm)	P _{cl} (dB)	Diatance	G _a Antenna Gain(dB)	Peak EIRP (dBm)	Limit (dBm)	Margin (dB)	Polarization
1695.0	-32.68	3.00	3.00	9.58	-26.1	-13.00	13.1	H
2542.5	-38.25	3.03	3.00	10.72	-30.56	-13.00	17.56	H
1695.0	-29.99	3.00	3.00	9.68	-23.31	-13.00	10.31	V
2542.5	-35.34	3.03	3.00	10.72	-27.65	-13.00	14.65	V

LTE FDD Band 5_Channel Bandwidth 5MHz_16QAM_Low Channel

Frequency (MHz)	P _{Mea} (dBm)	P _{cl} (dB)	Diatance	G _a Antenna Gain(dB)	Peak EIRP (dBm)	Limit (dBm)	Margin (dB)	Polarization
1653.0	-30.08	3.00	3.00	9.58	-23.5	-13.00	10.5	H
2479.5	-36.59	3.03	3.00	10.72	-28.9	-13.00	15.9	H
1653.0	-30.28	3.00	3.00	9.68	-23.6	-13.00	10.6	V
2479.5	-39.36	3.03	3.00	10.72	-31.67	-13.00	18.67	V

LTE FDD Band 5_Channel Bandwidth 5MHz_16QAM_Middle Channel

Frequency (MHz)	P _{Mea} (dBm)	P _{cl} (dB)	Diatance	G _a Antenna Gain(dB)	Peak EIRP (dBm)	Limit (dBm)	Margin (dB)	Polarization
1673.0	-28.31	3.00	3.00	9.58	-21.73	-13.00	8.73	H
2509.5	-38.99	3.03	3.00	10.72	-31.3	-13.00	18.3	H
1673.0	-30.89	3.00	3.00	9.68	-24.21	-13.00	11.21	V
2509.5	-38.32	3.03	3.00	10.72	-30.63	-13.00	17.63	V

LTE FDD Band 5_Channel Bandwidth 5MHz_16QAM_High Channel

Frequency (MHz)	P _{Mea} (dBm)	P _{cl} (dB)	Diatance	G _a Antenna Gain(dB)	Peak EIRP (dBm)	Limit (dBm)	Margin (dB)	Polarization
1693.0	-32.49	3.00	3.00	9.58	-25.91	-13.00	12.91	H
2539.5	-37.37	3.03	3.00	10.72	-29.68	-13.00	16.68	H
1693.0	-30.23	3.00	3.00	9.68	-23.55	-13.00	10.55	V
2539.5	-35.86	3.03	3.00	10.72	-28.17	-13.00	15.17	V

*LTE FDD Band 5_Channel Bandwidth 10MHz_16QAM_Low Channel*

Frequency (MHz)	P _{Mea} (dBm)	P _{cl} (dB)	Diatance	G _a Antenna Gain(dB)	Peak EIRP (dBm)	Limit (dBm)	Margin (dB)	Polarization
1658.0	-30.45	3.00	3.00	9.58	-23.87	-13.00	10.87	H
2487.0	-37.27	3.03	3.00	10.72	-29.58	-13.00	16.58	H
1658.0	-29.9	3.00	3.00	9.68	-23.22	-13.00	10.22	V
2487.0	-39.18	3.03	3.00	10.72	-31.49	-13.00	18.49	V

LTE FDD Band 5_Channel Bandwidth 10MHz_16QAM_Middle Channel

Frequency (MHz)	P _{Mea} (dBm)	P _{cl} (dB)	Diatance	G _a Antenna Gain(dB)	Peak EIRP (dBm)	Limit (dBm)	Margin (dB)	Polarization
1673.0	-28.4	3.00	3.00	9.58	-21.82	-13.00	8.82	H
2509.5	-39.62	3.03	3.00	10.72	-31.93	-13.00	18.93	H
1673.0	-30.65	3.00	3.00	9.68	-23.97	-13.00	10.97	V
2509.5	-38.74	3.03	3.00	10.72	-31.05	-13.00	18.05	V

LTE FDD Band 5_Channel Bandwidth 10MHz_16QAM_High Channel

Frequency (MHz)	P _{Mea} (dBm)	P _{cl} (dB)	Diatance	G _a Antenna Gain(dB)	Peak EIRP (dBm)	Limit (dBm)	Margin (dB)	Polarization
1688.0	-32.43	3.00	3.00	9.58	-25.85	-13.00	12.85	H
2532.0	-37.7	3.03	3.00	10.72	-30.01	-13.00	17.01	H
1688.0	-29.83	3.00	3.00	9.68	-23.15	-13.00	10.15	V
2532.0	-36.23	3.03	3.00	10.72	-28.54	-13.00	15.54	V



4.7 Frequency Stability

LIMIT

According to §24.235, §2.1055 requirement, the frequency stability shall be sufficient to ensure that the fundamental emissions stay within the authorized bands of operation and should not exceed 2.5ppm.

TEST CONFIGURATION

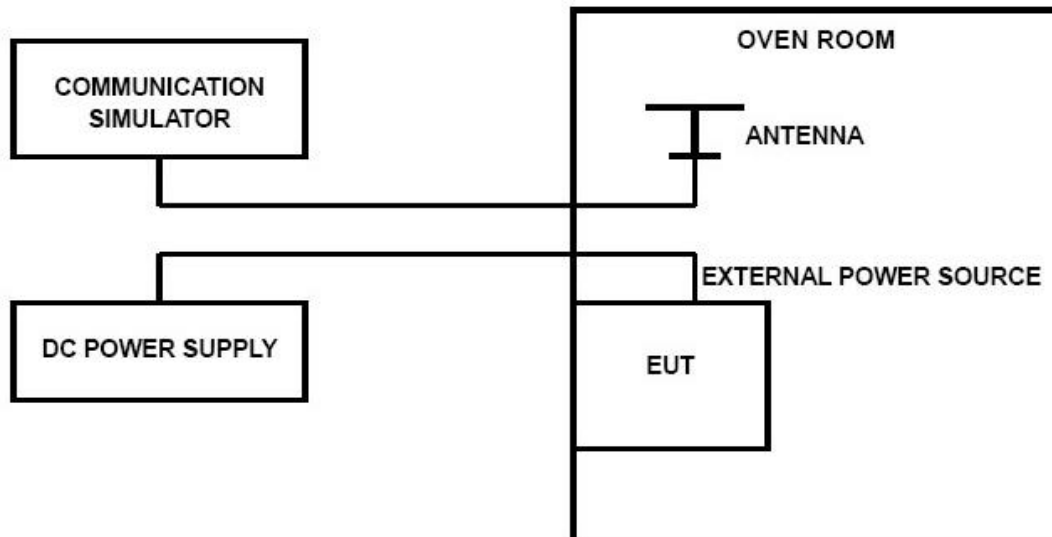

TEST PROCEDURE

The EUT was setup according to EIA/TIA 603D

Frequency Stability Under Temperature Variations:

In order to measure the carrier frequency under the condition of AFC lock, it is necessary to make measurements with the EUT in a “call mode”. This is accomplished with the use of R&S CMW500 DIGITAL RADIO COMMUNICATION TESTER.

1. Measure the carrier frequency at room temperature.
2. Subject the EUT to overnight soak at -30°C.
3. With the EUT, powered via nominal voltage, connected to the CMW500 and in a simulated call on middle channel for LTE Band 5, measure the carrier frequency. These measurements should be made within 2 minutes of Powering up the EUT, to prevent significant self-warming.
4. Repeat the above measurements at 10°C increments from -30°C to +50°C. Allow at least 1.5 hours at each temperature, unpowered, before making measurements.
5. Re-measure carrier frequency at room temperature with nominal voltage. Vary supply voltage from minimum voltage to maximum voltage, in 0.1Volt increments re-measuring carrier frequency at each voltage. Pause at nominal voltage for 1.5 hours unpowered, to allow any self-heating to stabilize, before continuing.
6. Subject the EUT to overnight soak at +50°C.
7. With the EUT, powered via nominal voltage, connected to the CMW500 and in a simulated call on the centre channel, measure the carrier frequency. These measurements should be made within 2 minutes of Powering up the EUT, to prevent significant self-warming.
8. Repeat the above measurements at 10 °C increments from +50°C to -30°C. Allow at least 1.5 hours at each temperature, unpowered, before making measurements
9. At all temperature levels hold the temperature to +/- 0.5°C during the measurement procedure.

Frequency Stability Under Voltage Variations:

Set chamber temperature to 20°C. Use a variable AC power supply / DC power source to power the EUT and set the voltage to rated voltage. Set the spectrum analyzer RBW low enough to obtain the desired frequency resolution and recorded the frequency.

Reduce the input voltage to specify extreme voltage variation ($\pm 15\%$) and endpoint, record the maximum frequency change.

TEST RESULTS

Remark:



1. We tested all RB Configuration refer 3GPP TS136 521 for each Channel Bandwidth of LTE FDD Band 5; recorded worst case.

LTE Band 5, 1.4MHz bandwidth , QPSK (worst case of all bandwidths)

LTE FDD Band 5					
DC Power	Temperature (°C)	Frequency error(Hz)	Frequency error(ppm)	Limit (ppm)	Verdict
3.40	20	28	0.0156	2.50	PASS
3.60	20	35	0.0177	2.50	PASS
4.20	20	17	0.0089	2.50	PASS
3.60	-30	26	0.0179	2.50	PASS
3.60	-20	17	0.0095	2.50	PASS
3.60	-10	20	0.0187	2.50	PASS
3.60	0	28	0.0190	2.50	PASS
3.60	10	21	0.0122	2.50	PASS
3.60	20	18	0.0078	2.50	PASS
3.60	30	27	0.0135	2.50	PASS
3.60	40	19	0.0177	2.50	PASS
3.60	50	25	0.0156	2.50	PASS



LTE Band 5, 1.4MHz bandwidth , 16QAM (worst case of all bandwidths)

LTE FDD Band 5					
DC Power	Temperature (°C)	Frequency error(Hz)	Frequency error(ppm)	Limit (ppm)	Verdict
3.40	20	38	0.0236	2.50	PASS
3.60	20	47	0.0235	2.50	PASS
4.20	20	52	0.0245	2.50	PASS
3.60	-30	61	0.0355	2.50	PASS
3.60	-20	37	0.0149	2.50	PASS
3.60	-10	42	0.0224	2.50	PASS
3.60	0	39	0.0212	2.50	PASS
3.60	10	25	0.0158	2.50	PASS
3.60	20	29	0.0145	2.50	PASS
3.60	30	35	0.0175	2.50	PASS
3.60	40	27	0.0145	2.50	PASS
3.60	50	22	0.0127	2.50	PASS

5 Test Setup Photos of the EUT

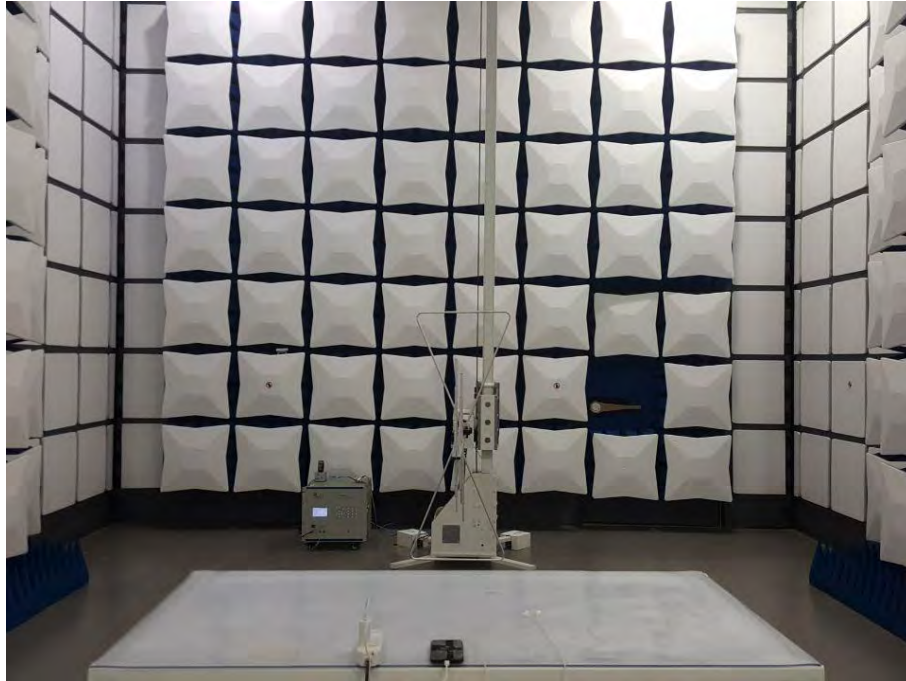

*****End of Report*****