



**TEST REPORT  
FCC Part 22 /Part 24**

Report Reference No.: HK1907111626-6E  
FCC ID : **ZNFX210LMW**  
Compiled by  
( position+printed name+signature)..: File administrators Gary Qian

Supervised by  
( position+printed name+signature)..: Technique principal Eden Hu

Approved by  
( position+printed name+signature)..: Manager Jason Zhou

Date of issue.....: July 15, 2019

**Testing Laboratory Name** .....: **Shenzhen HUAKE Testing Technology Co., Ltd.**  
Address.....: 1F, B2 Building, Junfeng Zhongcheng Zhizao Innovation Park,Heping Community, Fuhai Street, Bao'an District, Shenzhen, China

**Applicant's name** .....: **LG Electronics USA, Inc.**  
Address .....: 1000 Sylvan Ave., Englewood Cliffs, New Jersey 07632, United States

**Test specification** .....:  
**Standard** .....: **FCC Part 22: PUBLIC MOBILE SERVICES**  
**FCC Part 24: PERSONAL COMMUNICATIONS SERVICES**

**Shenzhen HUAKE Testing Technology Co., Ltd.All rights reserved.**  
This publication may be reproduced in whole or in part for non-commercial purposes as long as the Shenzhen HUAKE Testing Technology Co., Ltd.as copyright owner and source of the material. Shenzhen HUAKE Testing Technology Co., Ltd.takes no responsibility for and will not assume liability for damages resulting from the reader's interpretation of the reproduced material due to its placement and context.

**Test item description** .....: 4G Mobile phone  
Trade Mark .....: LG  
**Manufacturer** .....: **Optimus Electronics Ltd.**  
Model/Type reference.....: LM-X210LMW  
Listed Models .....: /  
Ratings .....: DC 3.85V From Battery  
Modulation .....: QPSK  
Hardware version .....: V2.0  
Software version .....: V2.0  
Frequency..... UMTS Band II, UMTS Band V  
Result.....: **PASS**

**TEST REPORT**

<b>Test Report No. :</b>	HK1907111626-6E	July 15, 2019
		Date of issue

Equipment under Test : 4G Mobile phone

Model /Type : LM-X210LMW

Listed Models : /

**Applicant** : **LG Electronics USA, Inc.**

Address : 1000 Sylvan Ave., Englewood Cliffs, New Jersey 07632,  
United States

**Manufacturer** : OPTIEMUS ELECTRONICS LIMITED

Address : D-348, Sector-63, Noida, Uttar Pradesh, Pin Code-  
201307

<b>Test Result:</b>	<b>PASS</b>
---------------------	-------------

The test report merely corresponds to the test sample.

It is not permitted to copy extracts of these test result without the written permission of the test laboratory.



## Revision History

Revision	Issue Date	Revisions	Revised By
V1.0	2019-07-15	Initial Issue	James Zhou



## Contents

<b>1</b>	<b><u>TEST STANDARDS .....</u></b>	<b><u>5</u></b>
<b>2</b>	<b><u>SUMMARY .....</u></b>	<b><u>6</u></b>
2.1	General Remarks	6
2.2	Product Description	6
2.3	Equipment under Test	6
2.4	Short description of the Equipment under Test (EUT)	7
2.5	EUT configuration	7
2.6	Related Submittal(s) / Grant (s)	7
2.7	General Test Conditions/Configurations	7
2.8	Modifications	7
<b>3</b>	<b><u>TEST ENVIRONMENT .....</u></b>	<b><u>8</u></b>
3.1	Address of the test laboratory	8
3.2	Environmental conditions	8
3.3	Test Description	8
3.4	Equipments Used during the Test	10
<b>4</b>	<b><u>TEST CONDITIONS AND RESULTS.....</u></b>	<b><u>11</u></b>
4.1	Output Power	11
4.2	Radiated Spurious Emission	15
4.3	Occupied Bandwidth and Emission Bandwidth	18
4.4	Band Edge Compliance	20
4.5	Spurious Emission on Antenna Port	22
4.6	Frequency Stability Test	27
4.7	Peak-to-Average Ratio (PAR)	29
<b>5</b>	<b><u>TEST SETUP PHOTOS OF THE EUT .....</u></b>	<b><u>31</u></b>



## **1 TEST STANDARDS**

The tests were performed according to following standards:

[FCC Part 2](#): FREQUENCY ALLOCATIONS AND RADIO TREATY MATTERS; GENERAL RULES AND REGULATIONS

[FCC Part 22 Subpart H](#): PRIVATE LAND MOBILE RADIO SERVICES.

[FCC Part 24 Subpart E](#): PUBLIC MOBILE SERVICES

[ANSI/TIA-603-E-2016](#): Land Mobile FM or PM Communications Equipment Measurement and Performance Standards.

[ANSI C63.26-2015](#): IEEE/ANSI Standard for Compliance Testing of Transmitters Used in Licensed Radio Services

[FCC KDB971168D01](#) Power Meas License Digital Systems



## 2 SUMMARY

### 2.1 General Remarks

Date of receipt of test sample	:	Jun 24, 2019
Testing commenced on	:	Jun 25, 2019
Testing concluded on	:	July 15, 2019

### 2.2 Product Description

The **MOVEON TECHNOLOGY LIMITED**'s Model: LM-X210LMW or the "EUT" as referred to in this report; more general information as follows, for more details, refer to the user's manual of the EUT.

Name of EUT	4G Mobile phone
Model Number	LM-X210LMW
Modulation Type	QPSK for UMTS,
Antenna Type	Internal Antenna
UMTS Operation Frequency Band	Device supported UMTS FDD Band II, FDD Band V
HSDPA Release Version	Release 10
HSUPA Release Version	Release 6
DC-HSUPA Release Version	Not Supported
WCDMA Release Version	R99
Extreme temp. Tolerance	-30°C to +50°C
Extreme vol. Limits	3.40VDC to 4.20VDC (nominal: 3.85VDC)

### 2.3 Equipment under Test

#### Power supply system utilised

Power supply voltage	:	<input type="radio"/> 120V / 60 Hz	<input type="radio"/> 115V / 60Hz
		<input type="radio"/> 12 V DC	<input type="radio"/> 24 V DC
		<input checked="" type="radio"/> Other (specified in blank below)	

DC 3.85V From Battery

Test Mode	TX/RX	RF Channel		
		Low(L)	Middle (M)	High (H)
WCDMA850	TX	Channel 4132	Channel 4182	Channel 4233
		826.4 MHz	836.4 MHz	846.6 MHz
	RX	Channel 4357	Channel 4407	Channel 4458
		871.4 MHz	881.4 MHz	891.6 MHz
Test Mode	TX/RX	RF Channel		
		Low(L)	Middle (M)	High (H)
WCDMA1900	TX	Channel 9262	Channel 9400	Channel 9538
		1852.4 MHz	1880.0 MHz	1907.6 MHz
	RX	Channel 9662	Channel 9800	Channel 9938
		1932.4 MHz	1960.0 MHz	1987.6 MHz



## 2.4 Short description of the Equipment under Test (EUT)

### 2.4.1 General Description

This is a 4G Mobile phone .

For more details, refer to the user's manual of the EUT

### 2.5 EUT configuration

The following peripheral devices and interface cables were connected during the measurement:

● - supplied by the manufacturer

○ - supplied by the lab

○ /	M/N : /
	Manufacturer: /

### 2.6 Related Submittal(s) / Grant (s)

This submittal(s) (test report) is intended for **FCC ID: ZNFX210LMW** filing to comply with FCC Part 22 and Part 24 Rules.

## 2.7 General Test Conditions/Configurations

### 2.7.1 Test Modes

NOTE: The test mode(s) are selected according to relevant radio technology specifications.

Test Mode	Test Modes Description
UMTS/TM1	WCDMA system, QPSK modulation
UMTS/TM2	HSDPA system, QPSK modulation
UMTS/TM3	HSUPA system, QPSK modulation

Note:

- As WCDMA, HSDPA and HSUPA with the same emission designator, test result recorded in this report at the worst case UMTS/TM1 only after exploratory scan.

### 2.7.2 Test Environment

Environment Parameter	Selected Values During Tests	
Relative Humidity	Ambient	
Temperature	TN	Ambient
Voltage	VL	3.465V
	VN	3.85V
	VH	4.235V

NOTE: VL=lower extreme test voltage VN=nominal voltage  
VH=upper extreme test voltage TN=normal temperature

## 2.8 Modifications

No modifications were implemented to meet testing criteria.



### 3 TEST ENVIRONMENT

#### 3.1 Address of the test laboratory

Shenzhen HUAKE Testing Technology Co., Ltd.  
 Add.:1F, B2 Building, Junfeng Zhongcheng Zhizao Innovation Park,Heping Community, Fuhai Street,  
 Bao' an District, Shenzhen, China

#### 3.2 Environmental conditions

During the measurement the environmental conditions were within the listed ranges:

Temperature:	15-35 ° C
Humidity:	30-60 %
Atmospheric pressure:	950-1050mbar

(1) expressed at approximately the 95% confidence level using a coverage factor of k=1.96.

#### 3.3 Test Description

##### 3.3.1 Cellular Band (824-849MHz paired with 869-894MHz)

Test Item	FCC Rule No.	Requirements	Verdict
Effective(Isotropic) Radiated Output Power	Part§2.1046, Part§22.913	FCC: ERP ≤ 7W. IC≤11.5W.	Pass
Bandwidth	Part§2.1049	OBW: No limit. EBW: No limit.	Pass
Band Edges Compliance	Part§2.1051, Part§22.917	≤-13dBm/1%*EBW, in 1MHz bands immediately outside and adjacent to The frequency block.	Pass
Spurious Emission at Antenna Terminals	Part§2.1051, Part§22.917	FCC/IC: ≤ -13dBm/100kHz, from 9kHz to 10th harmonics but outside authorized operating frequency ranges.	Pass
Field Strength of Spurious Radiation	Part§2.1053, Part§22.917	FCC/IC: ≤ -13dBm/100kHz.	Pass
Frequency Stability	Part§2.1055, Part§22.355	FCC/IC:≤ ±2.5ppm.	Pass

NOTE 1: For the verdict, the "N/A" denotes "not applicable", the "N/T" de notes "not tested".





### 3.3.2 PCS Band (1850-1915MHz paired with 1930-1995MHz)

Test Item	FCC/IC Rule No.	Requirements	Verdict
Effective(Isotropic) Radiated Output Power	Part§2.1046, Part§24.232	EIRP ≤ 2W	Pass
Peak-Average Ratio	Part§2.1046, Part§24.232	FCC:Limit≤13dB	Pass
Bandwidth	Part§2.1049	OBW: No limit. EBW: No limit.	Pass
Band Edges Compliance	Part§2.1051, Part§24.238	≤ -13dBm/1%*EBW, In 1MHz bands immediately outside and adjacent to The frequency block.	Pass
Spurious Emission at Antenna Terminals	Part§2.1051, Part§24.238	≤-13dBm/1MHz, from 9kHz to10th harmonics but outside authorized Operating frequency ranges.	Pass
Field Strength of Spurious Radiation	Part§2.1053, Part§24.238	≤ -13dBm/1MHz.	Pass
Frequency Stability	Part§2.1055, Part§24.235	FCC: within authorized frequency block.	Pass

NOTE 1: For the verdict, the "N/A" denotes "not applicable", the "N/T" de notes "not tested".



### 3.4 Equipments Used during the Test

Test Equipment	Manufacturer	Model No.	Serial No.	Calibration Date	Calibration Due Date
LISN	R&S	ENV216	HKE-059	2018/12/27	2019/12/26
LISN	R&S	ENV216	HKE-002	2018/12/27	2019/12/26
Receiver	R&S	ESCI 7	HKE-010	2018/12/27	2019/12/26
Spectrum analyzer	R&S	FSP40	HKE-025	2018/12/27	2019/12/26
Spectrum analyzer	Agilent	N9020A	HKE-048	2018/12/27	2019/12/26
RF automatic control unit	Tonscend	JS0806-1	HKE-060	2018/12/27	2019/12/26
Loop antenna	Schwarzbeck	FMZB 1519 B	HKE-014	2018/12/27	2019/12/26
Bilog Broadband Antenna	Schwarzbeck	VULB9163	HKE-012	2018/12/27	2019/12/26
Horn antenna	Schwarzbeck	9120D	HKE-013	2018/12/27	2019/12/26
High gain antenna	Schwarzbeck	LB-180400KF	HKE-054	2018/12/27	2019/12/26
Preamplifier	EMCI	EMC051845SE	HKE-015	2018/12/27	2019/12/26
Preamplifier	Agilent	83051A	HKE-016	2018/12/27	2019/12/26
Preamplifier	Schwarzbeck	BBV 9743	HKE-006	2018/12/27	2019/12/26
Temperature and humidity meter	Boyang	HTC-1	HKE-075	2018/12/27	2019/12/26
High-low temperature chamber	Guangke	HT-80L	HKE-118	2018/12/27	2019/12/26
High pass filter unit	Tonscend	JS0806-F	HKE-055	2018/12/27	2019/12/26
RF Cable(below1GHz)	Times	9kHz-1GHz	HKE-117	2018/12/27	2019/12/26
RF Cable(above 1GHz)	Times	1-40G	HKE-034	2018/12/27	2019/12/26
Power meter	Agilent	E4419B	HKE-085	2018/12/27	2019/12/26
Power Sensor	Agilent	E9300A	HKE-086	2018/12/27	2019/12/26
Conducted test software	Tonscend	TS+ Rev 2.5.0.0	HKE-081	N/A	N/A
Radiated test software	Tonscend	TS+ Rev 2.5.0.0	HKE-082	N/A	N/A
RF test software	Tonscend	JS1120-B Version 2.6	HKE-083	N/A	N/A
RF test software	Tonscend	JS1120-4	HKE-113	N/A	N/A
RF test software	Tonscend	JS1120-3	HKE-114	N/A	N/A
RF test software	Tonscend	JS1120-1	HKE-115	N/A	N/A
Wireless Communication Test Set	R&S	CMW500	HKE-026	2018/12/27	2019/12/26
Wireless Communication Test Set	R&S	CMU200	HKE-029	2018/12/27	2019/12/26

Note: 1. The Cal.Interval was one year.



## **4 TEST CONDITIONS AND RESULTS**

### **4.1 Output Power**

#### **TEST APPLICABLE**

During the process of testing, the EUT was controlled via R&S Digital Radio Communication tester (CMU200) to ensure max power transmission and proper modulation. This result contains output power and EIRP measurements for the EUT. In all cases, output power is within the specified limits.

#### **4.1.1 Conducted Output Power**

##### **TEST CONFIGURATION**

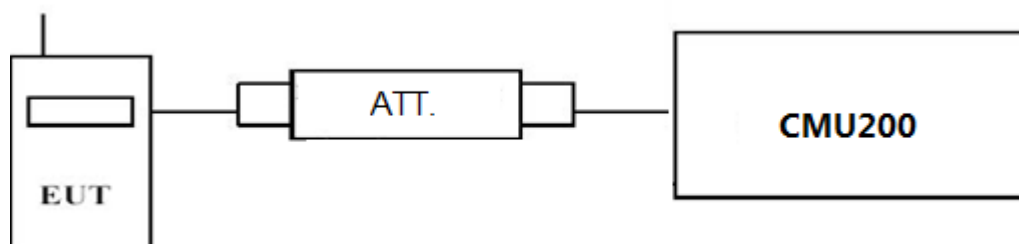

##### **TEST PROCEDURE**

###### **Conducted Power Measurement:**

- a) Place the EUT on a bench and set it in transmitting mode.
- b) Connect a low loss RF cable from the antenna port to a CMU200 by an Att.
- c) EUT Communicate with CMU200 then selects a channel for testing.
- d) Add a correction factor to the display CMU200, and then test.

##### **TEST RESULTS**



Test Mode	Test Channel	Burst Average Conducted power (dBm)	
		UMTS Band V	UMTS Band II
UMTS/TM1	LCH	22.50	22.30
	MCH	22.32	22.68
	HCH	22.62	22.34
UMTS/TM2	LCH_SubTest-1	22.13	22.06
	LCH_SubTest-2	22.18	21.94
	LCH_SubTest-3	22.06	22.23
	LCH_SubTest-4	20.93	21.28
	MCH_SubTest-1	22.24	22.38
	MCH_SubTest-2	21.41	21.66
	MCH_SubTest-3	21.49	21.53
	MCH_SubTest-4	21.63	21.76
	HCH_SubTest-1	22.42	22.07
	HCH_SubTest-2	22.33	21.94
	HCH_SubTest-3	22.37	22.45
	HCH_SubTest-4	21.49	21.17
UMTS/TM3	LCH_SubTest-1	20.75	20.04
	LCH_SubTest-2	20.36	20.25
	LCH_SubTest-3	21.19	20.99
	LCH_SubTest-4	20.30	19.99
	LCH_SubTest-5	19.81	20.20
	MCH_SubTest-1	21.23	21.55
	MCH_SubTest-2	20.21	20.33
	MCH_SubTest-3	21.14	21.37
	MCH_SubTest-4	19.89	20.42
	MCH_SubTest-5	21.25	21.66
	HCH_SubTest-1	20.18	20.39
	HCH_SubTest-2	20.46	20.36
	HCH_SubTest-3	20.73	20.21
	HCH_SubTest-4	20.16	20.14
	HCH_SubTest-5	21.22	21.04

### 4.1.2 Radiated Output Power

#### TEST DESCRIPTION

This is the test for the maximum radiated power from the EUT.

"Mobile/portable stations are limited to 2 watts e.i.r.p. Peak power" and specifies that "Peak transmit power must be measured over any interval of continuous transmission using instrumentation calibrated in terms of an rms-equivalent voltage. The ERP of mobile transmitters and auxiliary test transmitters must not exceed 7 Watts."

#### TEST CONFIGURATION

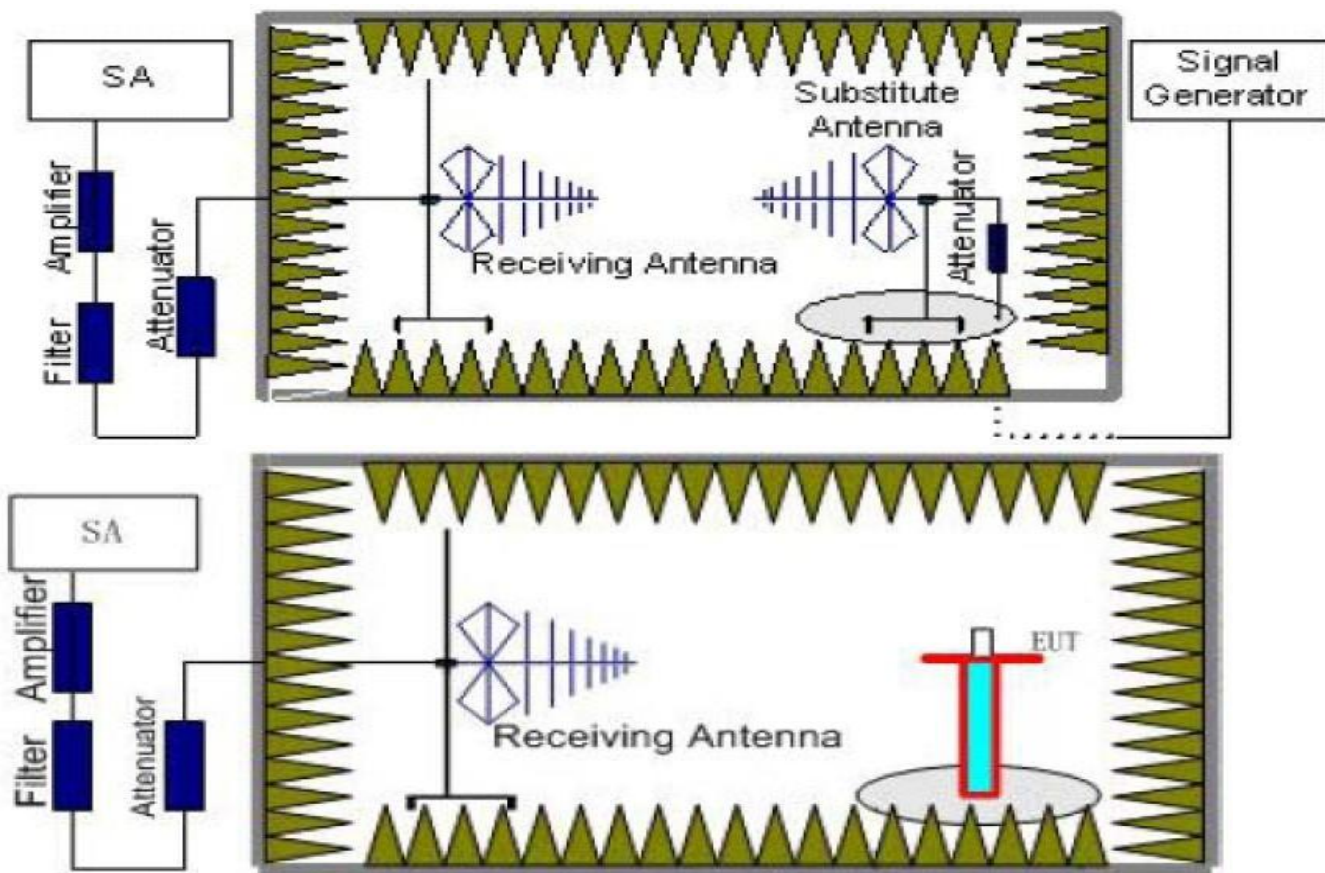

#### TEST PROCEDURE

1. EUT was placed on a 0.8 meter high non-conductive stand at a 3 meter test distance from the receive antenna. A receiving antenna was placed on the antenna mast 3 meters from the EUT for emission measurements. The height of receiving antenna is 1.50m. Detected emissions were maximized at each frequency by rotating the EUT through 360° and adjusting the receiving antenna polarization. The radiated emission measurements of all transmit frequencies in three channels (High, Middle, Low) were measured with peak detector.
2. A log-periodic antenna or double-ridged waveguide horn antenna shall be substituted in place of the EUT. The log-periodic antenna will be driven by a signal generator and the level will be adjusted till the same power value on the spectrum analyzer or receiver. The level of the spurious emissions can be calculated through the level of the signal generator, cable loss, the gain of the substitution antenna and the reading of the spectrum analyzer or receiver.
3. The EUT is then put into continuously transmitting mode at its maximum power level during the test. Set Test Receiver or Spectrum RBW=10MHz, VBW=10MHz, And the maximum value of the receiver should be recorded as ( $P_r$ ).
4. The EUT shall be replaced by a substitution antenna. In the chamber, an substitution antenna for the frequency band of interest is placed at the reference point of the chamber. An RF Signal source for the frequency band of interest is connected to the substitution antenna with a cable that has been constructed to not interfere with the radiation pattern of the antenna. A power ( $P_{Mea}$ ) is applied to the input of the substitution antenna, and adjust the level of the signal generator output until the value of the receiver



reach the previously recorded ( $P_r$ ). The power of signal source ( $P_{Mea}$ ) is recorded. The test should be performed by rotating the test item and adjusting the receiving antenna polarization.

5. A amplifier should be connected to the Signal Source output port. And the cable should be connect between the Amplifier and the Substitution Antenna. The cable loss ( $P_{cl}$ ), the Substitution Antenna Gain ( $G_a$ ) and the Amplifier Gain ( $P_{Ag}$ ) should be recorded after test.

The measurement results are obtained as described below:

$$\text{Power(EIRP)} = P_{Mea} - P_{Ag} - P_{cl} + G_a$$

We used SMF100A microwave signal generator which signal level can up to 33dBm, so we not used power Amplifier for substitution test; The measurement results are amend as described below:

$$\text{Power(EIRP)} = P_{Mea} - P_{cl} + G_a$$

6. This value is EIRP since the measurement is calibrated using an antenna of known gain (2.15 dBi) and known input power.
7. ERP can be calculated from EIRP by subtracting the gain of the dipole,  $ERP = EIRP - 2.15\text{dBi}$ .

**TEST LIMIT**

According to 22.913(a), 24.232(c) the ERP(EIRP) should be not exceeding following table limits:

UMTS Band V	<b>Burst Average ERP</b> 38.45dBm (7W)
UMTS Band IV	<b>Burst Average ERP</b> 30dBm (1W)
UMTS Band II	<b>Burst Average ERP</b> 33dBm (2W)

**TEST RESULTS**

Remark:

1. We were tested all Configuration refer 3GPP TS134 121.
2.  $EIRP = P_{Mea}(\text{dBm}) - P_{cl}(\text{dB}) + P_{Ag}(\text{dB}) + G_a(\text{dBi})$
3.  $ERP = EIRP - 2.15\text{dBi}$  as EIRP by subtracting the gain of the dipole.
4. Note: We test the H direction and V direction, V direction is worse.

*UMTS/TM1/UMTS Band II*

Frequency (MHz)	$P_{Mea}$ (dBm)	$P_{cl}$ (dB)	$G_a$ Antenna Gain (dB)	$P_{Ag}$ (dB)	EIRP (dBm)	Limit (dBm)	Margin (dB)	Polarization
1852.4	-19.45	3.41	10.24	33.6	20.98	33.01	12.03	V
1880.0	-19.45	3.49	10.24	33.6	20.9	33.01	12.11	V
1907.6	-19.93	3.55	10.23	33.6	20.35	33.01	12.66	V

*UMTS/TM1/UMTS Band V*

Frequency (MHz)	$P_{Mea}$ (dBm)	$P_{cl}$ (dB)	$G_a$ Antenna Gain (dB)	Correction (dB)	$P_{Ag}$ (dB)	ERP (dBm)	Limit (dBm)	Margin (dB)	Polarization
826.40	-14.17	2.42	8.45	2.15	36.82	26.53	38.45	11.92	V
836.60	-15.33	2.46	8.45	2.15	36.82	25.33	38.45	13.12	V
846.60	-12.9	2.53	8.36	2.15	36.82	27.6	38.45	10.85	V

## 4.2 Radiated Spurious Emission

### TEST APPLICABLE

According to the TIA/EIA 603D:2010 test method, The Receiver or Spectrum was scanned from 9 KHz to the 10<sup>th</sup> harmonic of the highest frequency generated within the equipment, which is the transmitted carrier that can be as high as 1910 MHz The resolution bandwidth is set as outlined in TIA/EIA 603D:2010. The spectrum is scanned with the mobile station transmitting at carrier frequencies that pertain to low, mid and high channels of WCDMA Band II , WCDMA Band V., WCDMA Band IV

### TEST CONFIGURATION

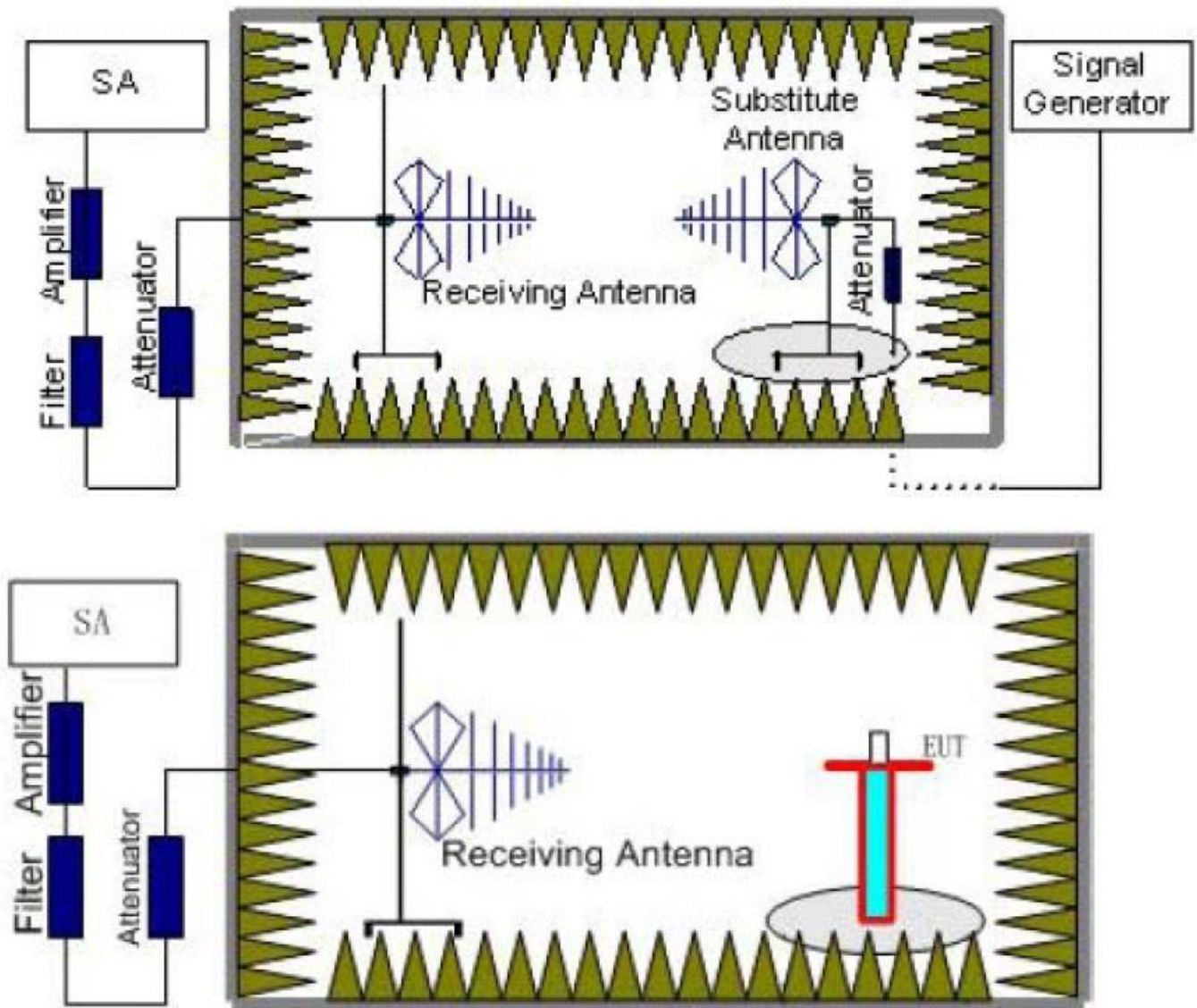

### TEST PROCEDURE

1. EUT was placed on a 1.50 meter high non-conductive stand at a 3 meter test distance from the receive antenna. A receiving antenna was placed on the antenna mast 3 meters from the EUT for emission measurements. The height of receiving antenna is 1.50m. Detected emissions were maximized at each frequency by rotating the EUT through 360° and adjusting the receiving antenna polarization. The radiated emission measurements of all transmit frequencies in three channels (High, Middle, Low) were measured with peak detector.
2. A log-periodic antenna or double-ridged waveguide horn antenna shall be substituted in place of the EUT. The log-periodic antenna will be driven by a signal generator and the level will be adjusted till the same power value on the spectrum analyzer or receiver. The level of the spurious emissions can be calculated through the level of the signal generator, cable loss, the gain of the substitution antenna and the reading of the spectrum analyzer or receiver.



3. The EUT is then put into continuously transmitting mode at its maximum power level during the test. Set Test Receiver or Spectrum RBW=1MHz, VBW=3MHz, And the maximum value of the receiver should be recorded as (P<sub>r</sub>).
4. The EUT shall be replaced by a substitution antenna. In the chamber, an substitution antenna for the frequency band of interest is placed at the reference point of the chamber. An RF Signal source for the frequency band of interest is connected to the substitution antenna with a cable that has been constructed to not interfere with the radiation pattern of the antenna. A power (P<sub>Mea</sub>) is applied to the input of the substitution antenna, and adjust the level of the signal generator output until the value of the receiver reach the previously recorded (P<sub>r</sub>). The power of signal source (P<sub>Mea</sub>) is recorded. The test should be performed by rotating the test item and adjusting the receiving antenna polarization.
5. A amplifier should be connected to the Signal Source output port. And the cable should be connect between the Amplifier and the Substitution Antenna. The cable loss (P<sub>cl</sub>), the Substitution Antenna Gain (G<sub>a</sub>) and the Amplifier Gain (P<sub>Ag</sub>) should be recorded after test.  
The measurement results are obtained as described below:  
Power(EIRP)=P<sub>Mea</sub>- P<sub>Ag</sub> - P<sub>cl</sub> + G<sub>a</sub>
6. This value is EIRP since the measurement is calibrated using an antenna of known gain (2.15 dBi) and known input power.
7. ERP can be calculated from EIRP by subtracting the gain of the dipole, ERP = EIRP -2.15dBi.
8. In order to make sure test results more clearly, we set frequency range and sweep time for difference frequency range as follows table:

Working Frequency	Subrange (GHz)	RBW	VBW	Sweep time (s)
UMTS/TM1/ WCDMA Band V	0.00009~0.15	1KHz	3KHz	30
	0.00015~0.03	10KHz	30KHz	10
	0.03~1	100KHz	300KHz	10
	1~2	1 MHz	3 MHz	2
	2~5	1 MHz	3 MHz	3
	5~8	1 MHz	3 MHz	3
	8~10	1 MHz	3 MHz	3
UMTS/TM1/ WCDMA Band II	0.00009~0.15	1KHz	3KHz	30
	0.00015~0.03	10KHz	30KHz	10
	0.03~1	100KHz	300KHz	10
	1~2	1 MHz	3 MHz	2
	2~5	1 MHz	3 MHz	3
	5~8	1 MHz	3 MHz	3
	8~11	1 MHz	3 MHz	3
	11~14	1 MHz	3 MHz	3
	14~18	1 MHz	3 MHz	3
	18~20	1 MHz	3 MHz	2

**TEST LIMITS**

that the power of any emission outside of the authorized operating frequency ranges must be attenuated below the transmitting power (P) by a factor of at least 43 + 10 log(P) dB.

The specification that emissions shall be attenuated below the transmitter power (P) by at least 43 + 10 log (P) dB, translates in the relevant power range (1 to 0.001 W) to -13 dBm. At 1 W the specified minimum attenuation becomes 43 dB and relative to a 30 dBm (1 W) carrier becomes a limit of -13 dBm. At 0.001 W (0 dBm) the minimum attenuation is 13 dB, which again yields a limit of -13 dBm. In this way a translation of the specification from relative to absolute terms is carried out.

Frequency	Channel	Frequency Range	Verdict
UMTS/TM1/ WCDMA Band V	Low	9KHz-10GHz	PASS
	Middle	9KHz -10GHz	PASS
	High	9KHz -10GHz	PASS
UMTS/TM1/ WCDMA Band II	Low	9KHz -20GHz	PASS
	Middle	9KHz -20GHz	PASS
	High	9KHz -20GHz	PASS



**TEST RESULTS**

Remark:

1. We were tested all Configuration refer 3GPP TS134 121.
2.  $EIRP = P_{Mea}(dBm) - P_{cl}(dB) + P_{Ag}(dB) + G_a(dBi)$
3.  $ERP = EIRP - 2.15dBi$  as EIRP by subtracting the gain of the dipole.
5. Margin = Limit – Emission Level
6. We test both H direction and V direction, recorded worst case direction.

*UMTS/TM1/ WCDMA Band II \_ Low Channel*

Frequency (MHz)	P <sub>Mea</sub> (dBm)	P <sub>cl</sub> (dB)	Diatance	G <sub>a</sub> Antenna Gain(dB)	Peak EIRP (dBm)	Limit (dBm)	Margin (dB)	Polarization
3704.8	-41.91	4.39	3.00	12.34	-33.96	-13.00	20.96	H
5557.2	-44.8	5.31	3.00	13.52	-36.59	-13.00	23.59	H
3704.8	-39.17	4.39	3.00	12.34	-31.22	-13.00	18.22	V
5557.2	-46.08	5.31	3.00	13.52	-37.87	-13.00	24.87	V

*UMTS/TM1/ WCDMA Band II \_ Middle Channel*

Frequency (MHz)	P <sub>Mea</sub> (dBm)	P <sub>cl</sub> (dB)	Diatance	G <sub>a</sub> Antenna Gain(dB)	Peak EIRP (dBm)	Limit (dBm)	Margin (dB)	Polarization
3760.0	-40.73	4.41	3.00	12.34	-32.8	-13.00	19.8	H
5640.0	-46.32	5.38	3.00	13.58	-38.12	-13.00	25.12	H
3760.0	-39.49	4.41	3.00	12.34	-31.56	-13.00	18.56	V
5640.0	-45.58	5.38	3.00	13.58	-37.38	-13.00	24.38	V

*UMTS/TM1/ WCDMA Band II \_ High Channel*

Frequency (MHz)	P <sub>Mea</sub> (dBm)	P <sub>cl</sub> (dB)	Diatance	G <sub>a</sub> Antenna Gain(dB)	Peak EIRP (dBm)	Limit (dBm)	Margin (dB)	Polarization
3815.2	-39.62	4.45	3.00	12.45	-31.62	-13.00	18.62	H
5722.8	-46.89	5.47	3.00	13.66	-38.7	-13.00	25.7	H
3815.2	-39.84	4.45	3.00	12.45	-31.84	-13.00	18.84	V
5722.8	-45.58	5.48	3.00	13.66	-37.4	-13.00	24.4	V

*UMTS/TM1/ WCDMA Band V \_ Low Channel*

Frequency (MHz)	P <sub>Mea</sub> (dBm)	P <sub>cl</sub> (dB)	Diatance	G <sub>a</sub> Antenna Gain(dB)	Peak EIRP (dBm)	Limit (dBm)	Margin (dB)	Polarization
1652.8	-30.56	3.00	3.00	9.58	-23.98	-13.00	10.98	H
2479.2	-36.61	3.03	3.00	10.72	-28.92	-13.00	15.92	H
1652.8	-30.62	3.00	3.00	9.68	-23.94	-13.00	10.94	V
2479.2	-39.61	3.03	3.00	10.72	-31.92	-13.00	18.92	V

*UMTS/TM1/ WCDMA Band V \_ Middle Channel*

Frequency (MHz)	P <sub>Mea</sub> (dBm)	P <sub>cl</sub> (dB)	Diatance	G <sub>a</sub> Antenna Gain(dB)	Peak EIRP (dBm)	Limit (dBm)	Margin (dB)	Polarization
1672.8	-28.4	3.00	3.00	9.58	-21.82	-13.00	8.82	H
2509.2	-39.83	3.03	3.00	10.72	-32.14	-13.00	19.14	H
1672.8	-31.06	3.00	3.00	9.68	-24.38	-13.00	11.38	V
2509.2	-38.05	3.03	3.00	10.72	-30.36	-13.00	17.36	V

*UMTS/TM1/ WCDMA Band V \_ High Channel*

Frequency (MHz)	P <sub>Mea</sub> (dBm)	P <sub>cl</sub> (dB)	Diatance	G <sub>a</sub> Antenna Gain(dB)	Peak EIRP (dBm)	Limit (dBm)	Margin (dB)	Polarization
1693.2	-32.66	3.00	3.00	9.58	-26.08	-13.00	13.08	H
2539.8	-37.39	3.03	3.00	10.72	-29.7	-13.00	16.7	H
1693.2	-30.77	3.00	3.00	9.68	-24.09	-13.00	11.09	V
2539.8	-36.04	3.03	3.00	10.72	-28.35	-13.00	15.35	V



### 4.3 Occupied Bandwidth and Emission Bandwidth

#### TEST APPLICABLE

Similar to conducted emissions; occupied bandwidth measurements are only provided for selected frequencies in order to reduce the amount of submitted data. Data were taken at the extreme and mid frequencies of WCDMA Band II, WCDMA band V, WCDMA band IV. The table below lists the measured 99% Bandwidth and -26dBc Bandwidth.

#### TEST CONFIGURATION

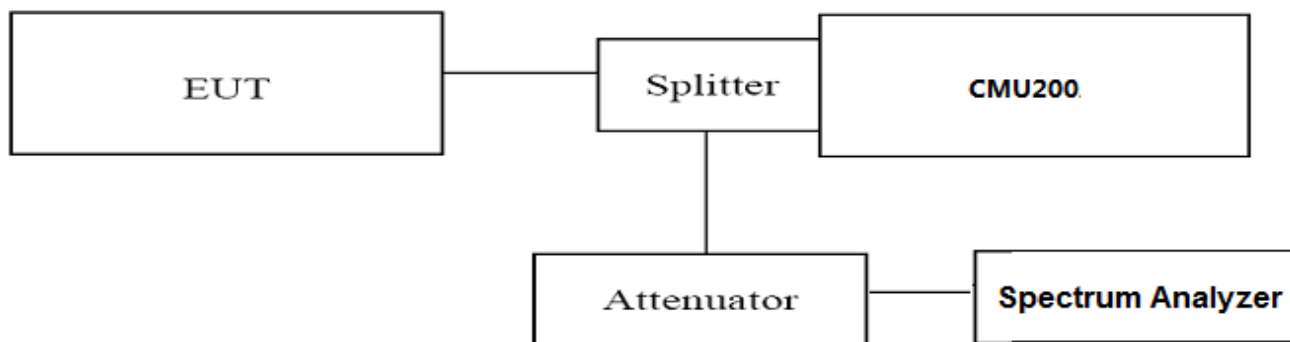

#### TEST PROCEDURE

1. The EUT was set up for the max output power with pseudo random data modulation;
2. Set RBW=100KHz, VBW=300KHz, Span=10MHz, SWT=Auto;
3. Set SPA Max hold and View, Set 99% Occupied Bandwidth/ Set -26dBc Occupied Bandwidth
4. These measurements were done at 3 frequencies for WCDMA band II /V. (low, middle and high of operational frequency range).

#### TEST RESULTS

Test Mode	Channel	Frequency (MHz)	Occupied Bandwidth (99% BW) (MHz)	Emission Bandwidth (-26 dBc BW) (MHz)	Verdict
UMTS/TM1/ WCDMA Band V	4132	826.40	4.1665	4.682	PASS
	4183	836.40	4.1385	4.675	PASS
	4233	846.60	4.1464	4.676	PASS
UMTS/TM1/ WCDMA Band II	9262	1852.4	4.1535	4.684	PASS
	9400	1880.0	4.1621	4.681	PASS
	9538	1907.6	4.1539	4.698	PASS

Remark:

1. Test results including cable loss;
2. please refer to following plots;



Occupied Bandwidth and Emission Bandwidth

UMTS/TM1/ WCDMA Band V

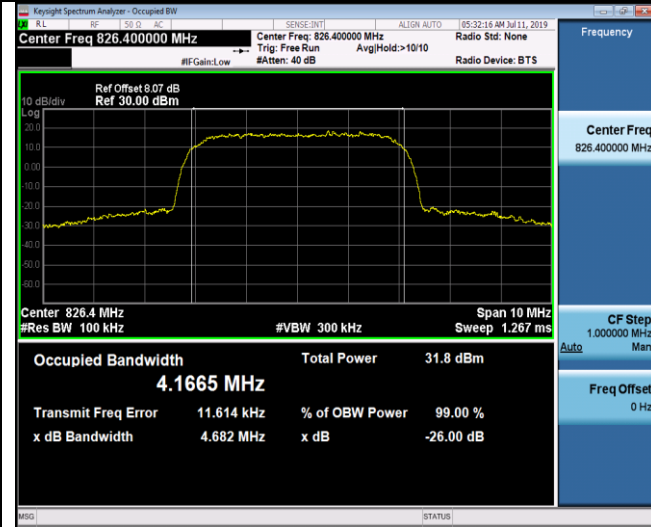

UMTS/TM1/ WCDMA Band II

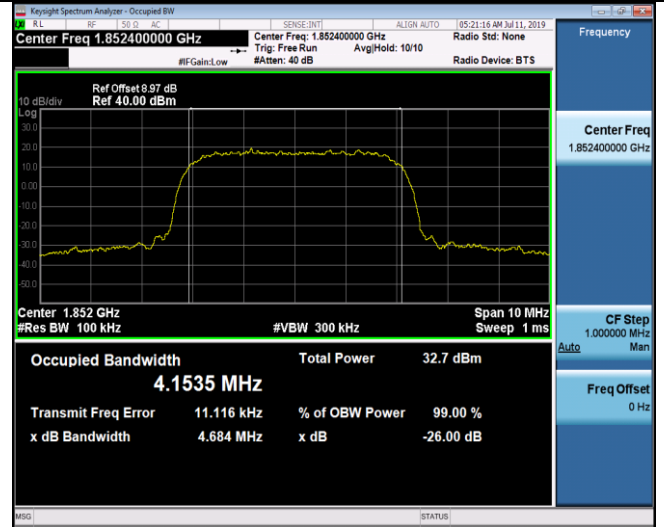

Channel 4132 / 826.4 MHz

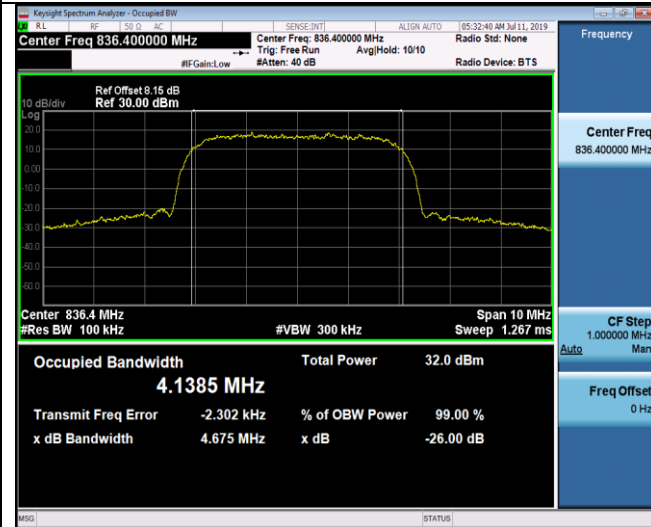

Channel 9262 / 1852.4 MHz

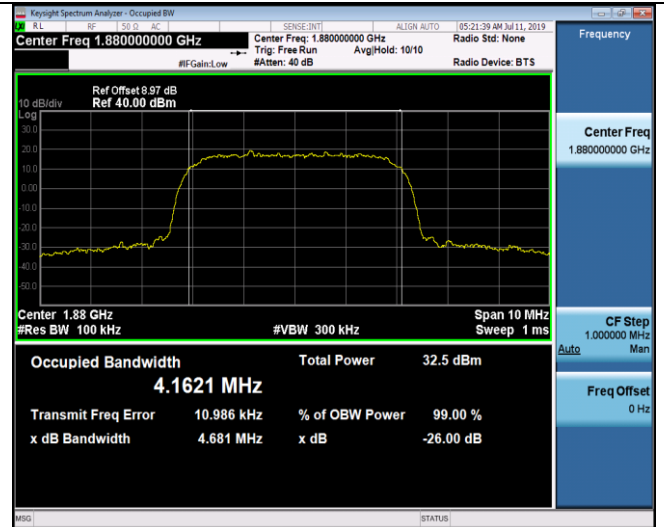

Channel 4183 / 836.4 MHz

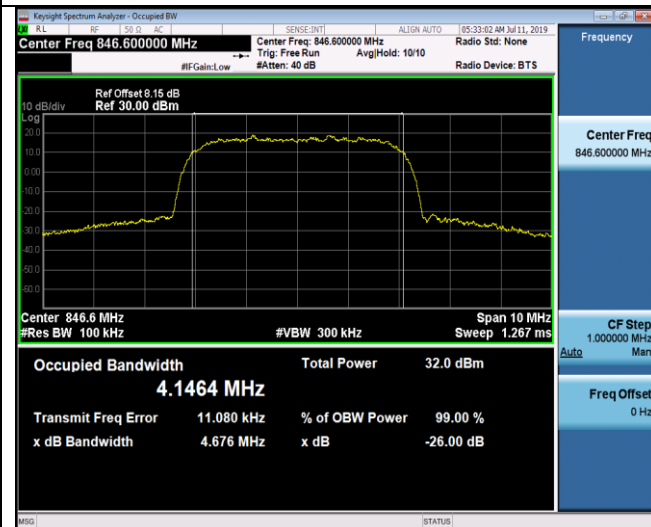

Channel 9400 / 1880.0 MHz

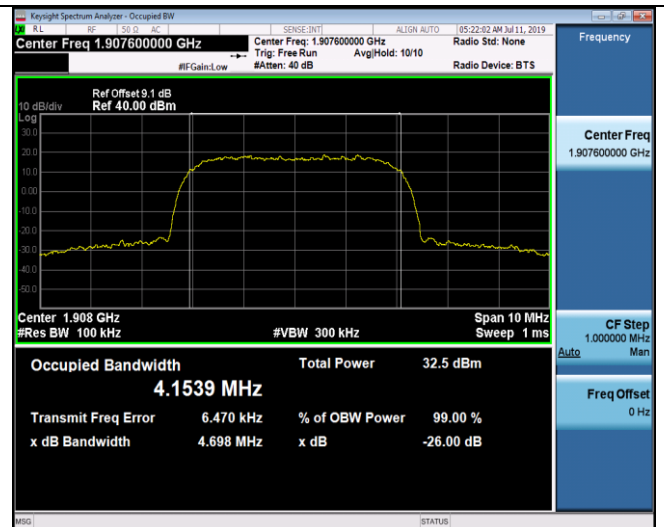

Channel 4233 / 846.6 MHz

Channel 9538 / 1907.6 MHz



### 4.4 Band Edge Compliance

#### TEST APPLICABLE

During the process of testing, the EUT was controlled via Aglient Digital Radio Communication tester (CMU200) to ensure max power transmission and proper modulation.

#### TEST CONFIGURATION

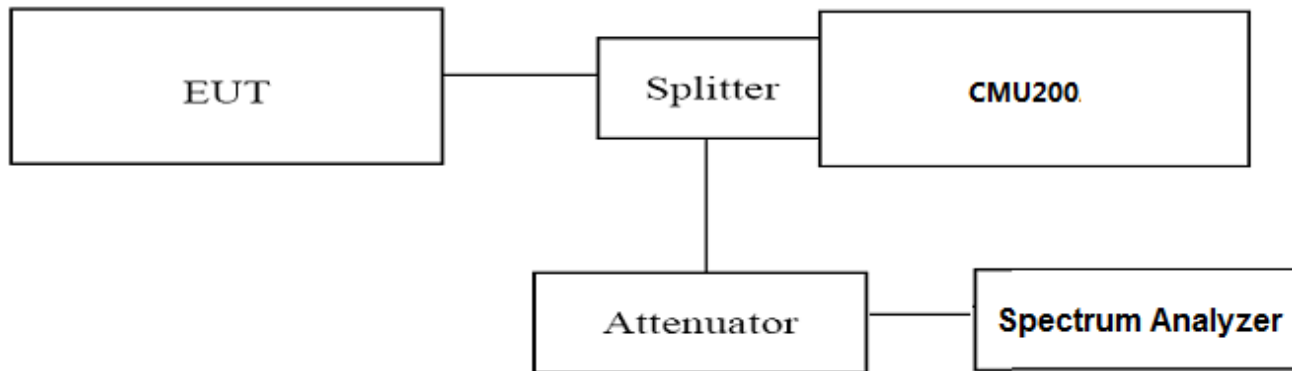

#### TEST PROCEDURE

1. The EUT was set up for the max output power with pseudo random data modulation;
2. Set RBW=51KHz,VBW=200KHz,Span=2MHz ,Dector: RMS;
3. These measurements were done at 2 frequencies (low and high of operational frequency range).

#### TEST RESULTS

UMTS/TM1/WCDMA Band V					
Test Mode	Channel	Frequency (MHz)	Band Edg Compliance (dBm)	Limits (dBm)	Verdict
UMTS/TM1/WCDMA Band V	4132	826.4	<-13dBm	-13dBm	PASS
	4233	846.6	<-13dBm	-13dBm	
UMTS/TM1/WCDMA Band II					
Test Mode	Channel	Frequency (MHz)	Band Edg Compliance (dBm)	Limits (dBm)	Verdict
UMTS/TM1/WCDMA Band II	9262	1852.4	<-13dBm	-13dBm	PASS
	9538	1907.6	<-13dBm	-13dBm	

Remark:

1. Test results including cable loss;
2. please refer to following plots;



### Band-edge Compliance

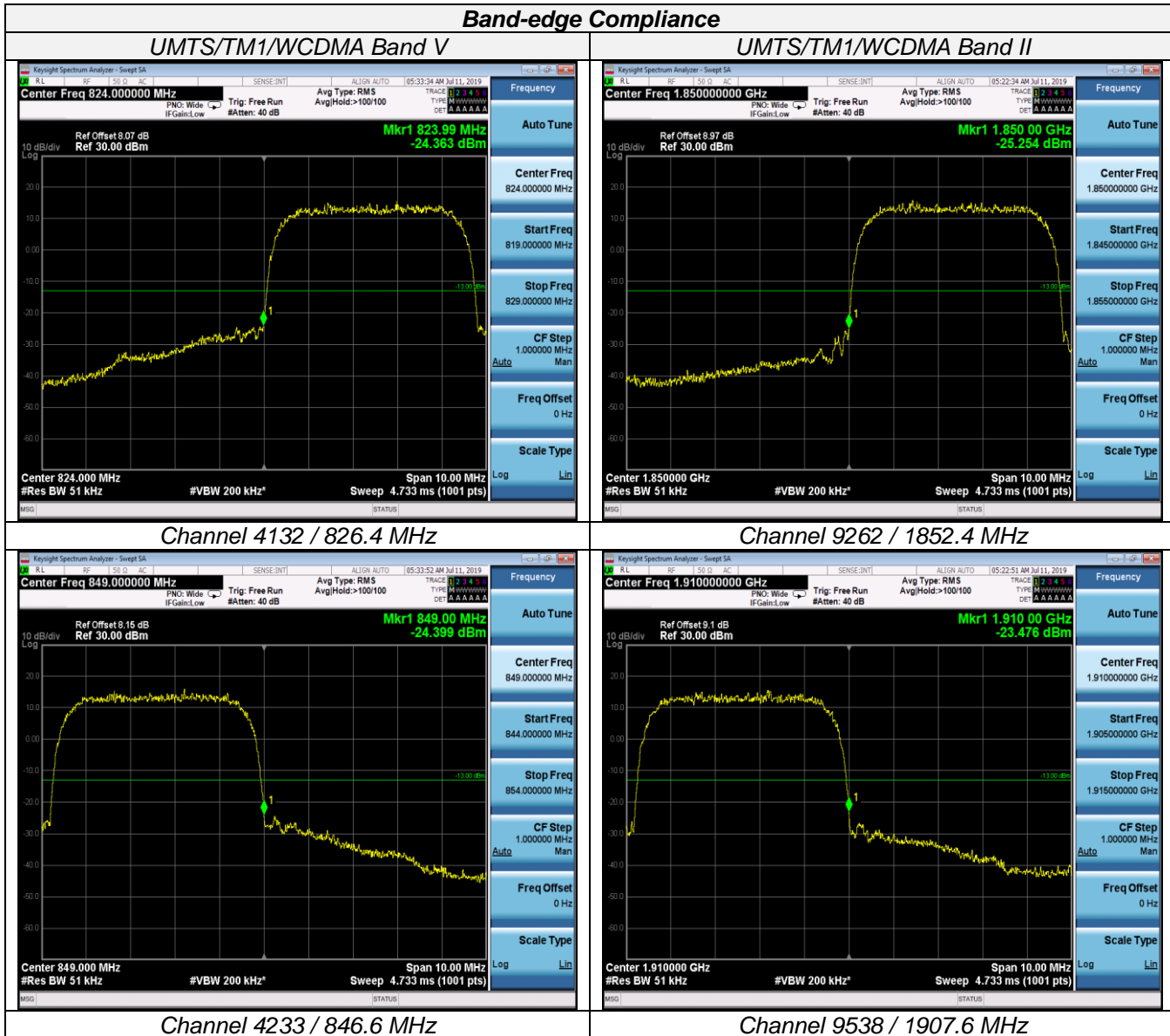

Channel 4233 / 846.6 MHz

Channel 9538 / 1907.6 MHz



## 4.5 Spurious Emission on Antenna Port

### TEST APPLICABLE

The following steps outline the procedure used to measure the conducted emissions from the EUT.

1. Determine frequency range for measurements: the spectrum should be investigated from the lowest radio frequency generated in the equipment up to at least the 10<sup>th</sup> harmonic of the carrier frequency. For the equipment of WCDMA band II data taken from 9 KHz to 20 GHz. For WCDMA Band V, data taken from 9 KHz to 9 GHz. WCDMA band I V data taken from 9 KHz to 20 GHz.
2. The sweep time is set automatically by instrument itself. That should be the optimal sweep time for the span and the RBW. If the sweep time is too short, that is sweep is too fast, the sweep result is not accurate; if the sweep time is too long, that is sweep is too low, some frequency components may be lost. The instrument will give an optimal sweep time according the selected span and RBW.
3. The procedure to get the conducted spurious emission is as follows:  
The trace mode is set to MaxHold to get the highest signal at each frequency;  
Wait 25 seconds; Get the result.
4. Determine EUT transmit frequencies: below outlines the band edge frequencies pertinent to conducted emissions testing.

### TEST CONFIGURATION

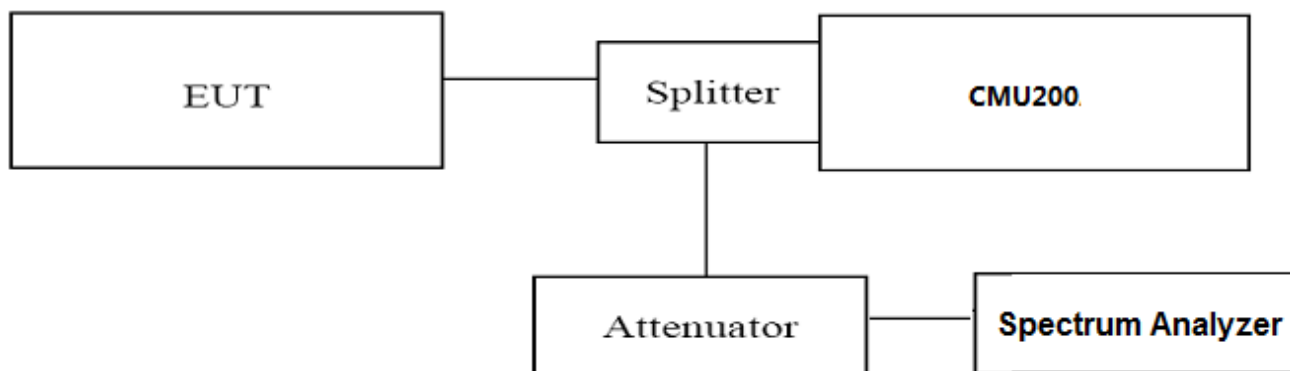

### TEST PROCEDURE

1. The EUT was set up for the max output power with pseudo random data modulation;
2. These measurements were done at 3 frequencies (low, middle and high of operational frequency range) of each band.

### TEST LIMIT

the power of any emission outside of the authorized operating frequency ranges must be attenuated below the transmitting power (P) by a factor of at least  $43 + 10 \log(P)$  dB.

The specification that emissions shall be attenuated below the transmitter power (P) by at least  $43 + 10 \log(P)$  dB, translates in the relevant power range (1 to 0.001 W) to -13 dBm. At 1 W the specified minimum attenuation becomes 43 dB and relative to a 30 dBm (1 W) carrier becomes a limit of -13 dBm. At 0.001 W (0 dBm) the minimum attenuation is 13 dB, which again yields a limit of -13 dBm. In this way a translation of the specification from relative to absolute terms is carried out.

### TEST RESULTS

Test Mode	Channel	Frequency (MHz)	Spurious RF Conducted Emission (dBm)	Limits (dBm)	Verdict
UMTS/TM1/WCDMA Band V	4132	826.40	<-13dBm	-13dBm	PASS
	4183	836.40	<-13dBm	-13dBm	
	4233	846.60	<-13dBm	-13dBm	
UMTS/TM1/WCDMA Band II	9262	1852.40	<-13dBm	-13dBm	PASS
	9400	1880.00	<-13dBm	-13dBm	
	9538	1907.60	<-13dBm	-13dBm	



### Spurious Emission on Antenna Port UMTS/TM1/WCDMA Band V

Channel 4132 / 826.4 MHz

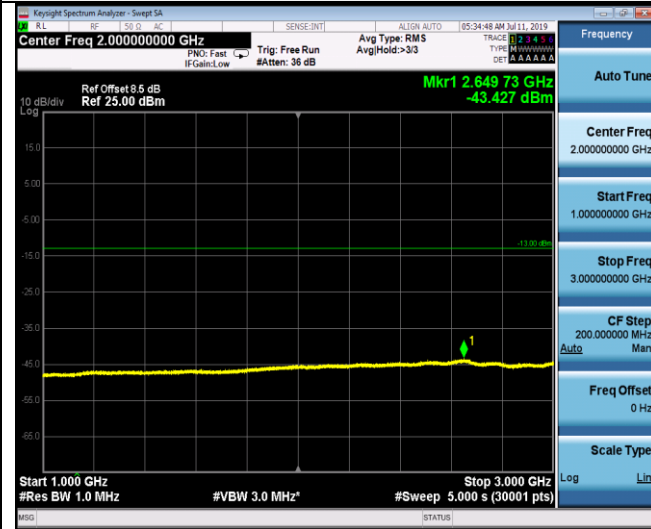

Channel 4183 / 836.6 MHz



1GHz-3GHz

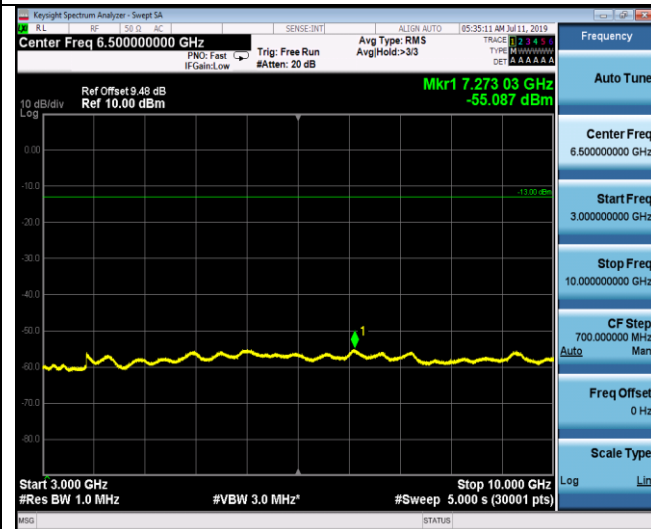

1GHz-3GHz

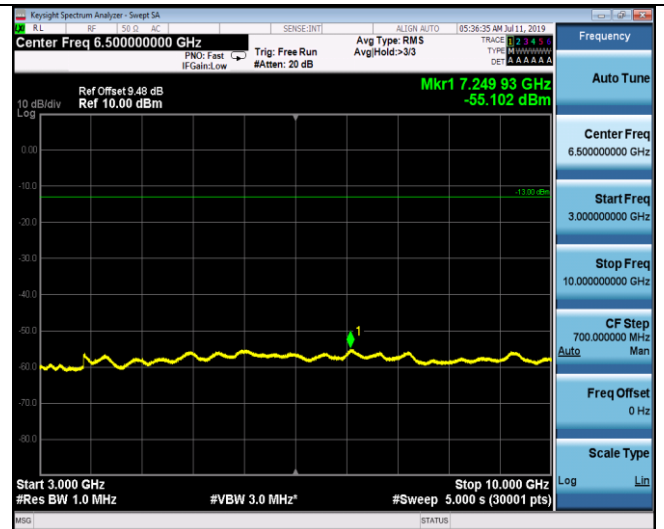

3GHz-10GHz



3GHz-10GHz



10GHz-18GHz



10GHz-18GHz

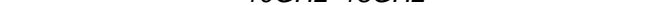



UMTS/TM1/WCDMA Band V

Channel 4233 / 846.6 MHz



1GHz-3GHz

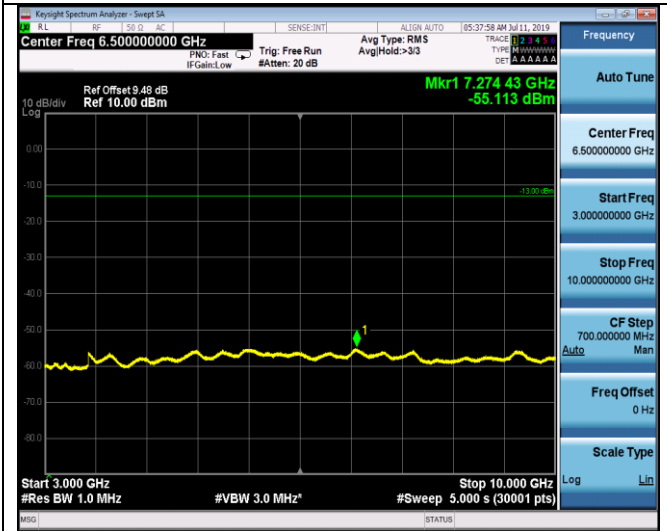

3GHz-10GHz



10GHz-18GHz





### Spurious Emission on Antenna Port UMTS/TM1/WCDMA Band II

Channel 9262 / 1852.4 MHz

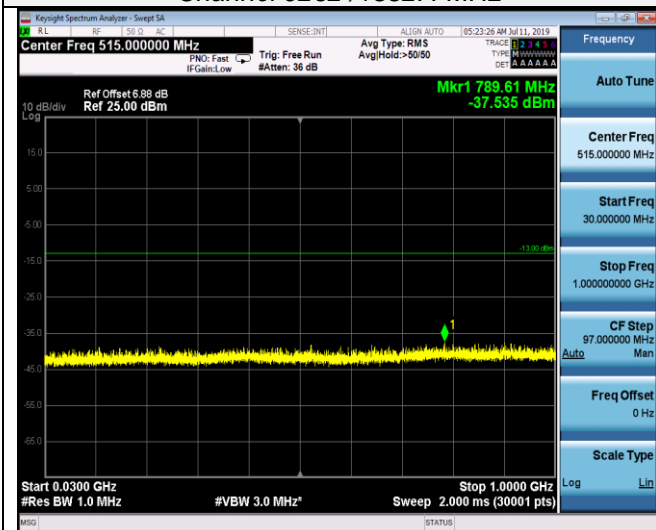

Channel 9400 / 1880.0 MHz

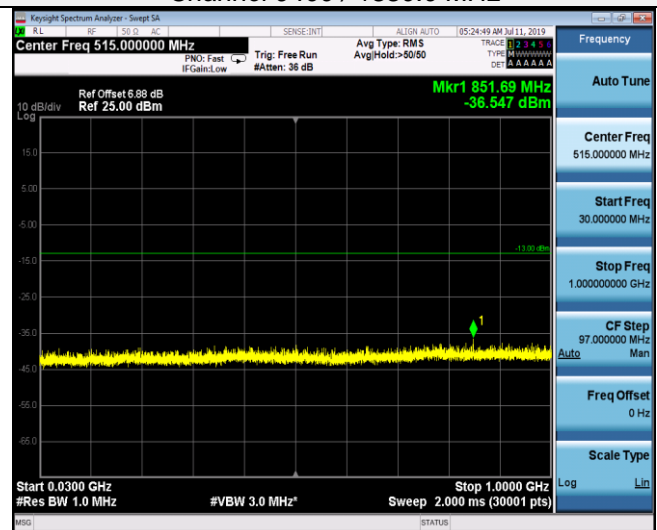

30 MHz-1GHz



30 MHz-1GHz



3GHz-10GHz

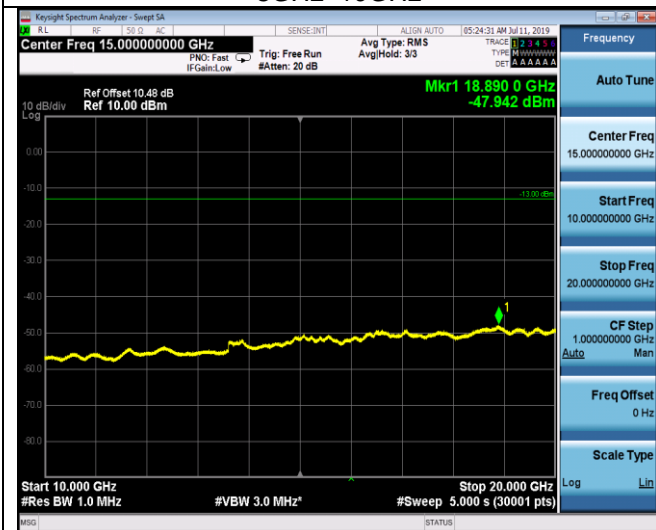

3GHz-10GHz



10GHz-20GHz

10GHz-20GHz



UMTS/TM1/WCDMA Band II

Channel 9538 / 1907.6 MHz

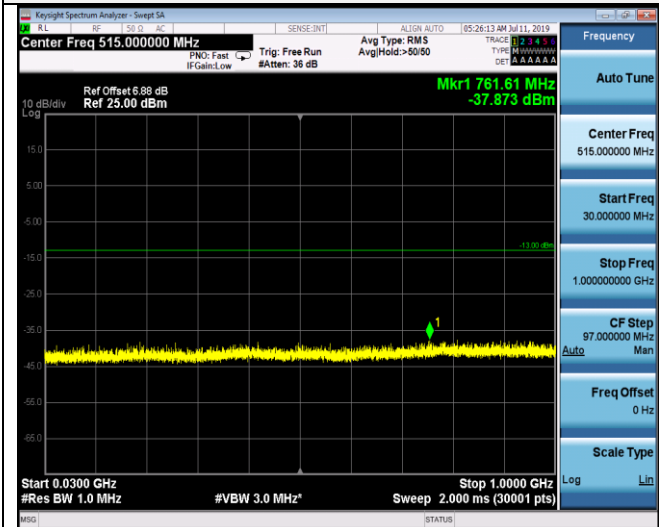

30 MHz-1GHz



3GHz-10GHz

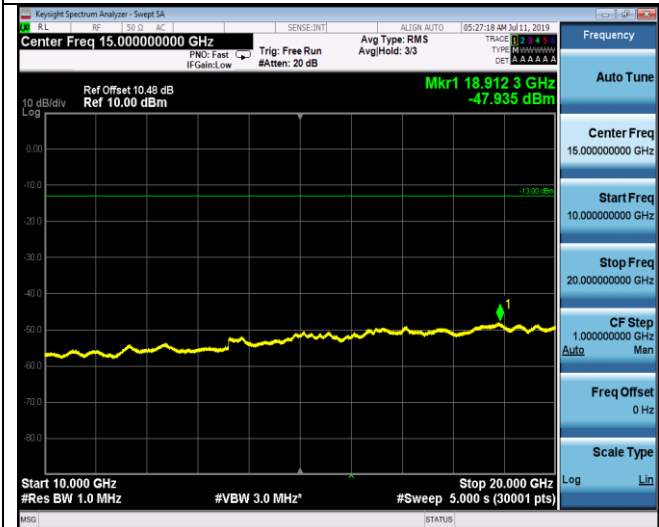

10GHz-20GHz



## 4.6 Frequency Stability Test

### TEST APPLICABLE

1. According to FCC Part 2 Section 2.1055 (a)(1), the frequency stability shall be measured with variation of ambient temperature from  $-30^{\circ}\text{C}$  to  $+50^{\circ}\text{C}$  centigrade.
2. According to FCC Part 2 Section 2.1055 (E) (2), for battery powered equipment, the frequency stability shall be measured with reducing primary supply voltage to the battery operating end point, which is specified by the manufacture.
3. Vary primary supply voltage from 85 to 115 percent of the nominal value for other than hand carried voltage equipment and the end voltage point was 3.40V.

### TEST PROCEDURE

In order to measure the carrier frequency under the condition of AFC lock, it is necessary to make measurements with the EUT in a "call mode". This is accomplished with the use of R&S CMU200 DIGITAL RADIO COMMUNICATION TESTER.

1. Measure the carrier frequency at room temperature;
2. Subject the EUT to overnight soak at  $-30^{\circ}\text{C}$ ;
3. With the EUT, powered via nominal voltage, connected to the CMU200 and in a simulated call on middle channel of WCDMA Band V, measure the carrier frequency. These measurements should be made within 2 minutes of Powering up the EUT, to prevent significant self-warming;
4. Repeat the above measurements at  $10^{\circ}\text{C}$  increments from  $-30^{\circ}\text{C}$  to  $+50^{\circ}\text{C}$ . Allow at least 0.5 hours at each temperature, unpowered, before making measurements;
5. Remeasure carrier frequency at room temperature with nominal voltage. Vary supply voltage from minimum voltage to maximum voltage, in 0.1Volt increments remeasuring carrier frequency at each voltage. Pause at nominal voltage for 0.5 hours unpowered, to allow any self-heating to stabilize, before continuing;
6. Subject the EUT to overnight soak at  $+50^{\circ}\text{C}$ ;
7. With the EUT, powered via nominal voltage, connected to the CMU200 and in a simulated call on the centre channel, measure the carrier frequency. These measurements should be made within 2 minutes of Powering up the EUT, to prevent significant self-warming;
8. Repeat the above measurements at  $10^{\circ}\text{C}$  increments from  $+50^{\circ}\text{C}$  to  $-30^{\circ}\text{C}$ . Allow at least 0.5 hours at each temperature, unpowered, before making measurements;
9. At all temperature levels hold the temperature to  $\pm 0.5^{\circ}\text{C}$  during the measurement procedure;

### TEST CONFIGURATION

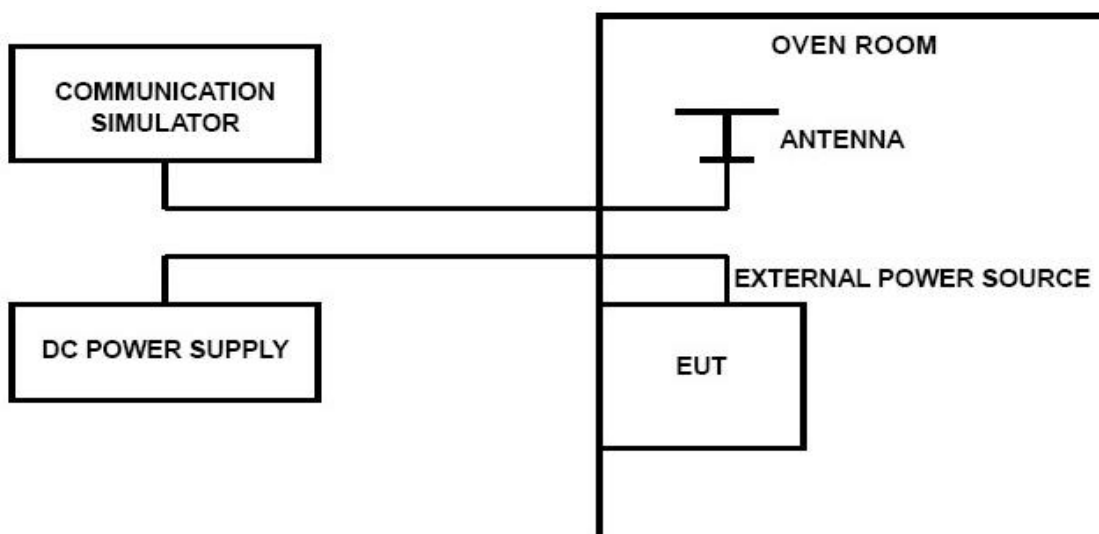

### TEST LIMITS

#### ***For Hand carried battery powered equipment***

According to the JTC standard the frequency stability of the carrier shall be accurate to within 0.1 ppm of the received frequency from the base station. This accuracy is sufficient to meet Sec. 24.235, Frequency Stability. The frequency stability shall be sufficient to ensure that the fundamental emission stays within the authorized



frequency block. As this transceiver is considered "Hand carried, battery powered equipment" Section 2.1055(d)(2) applies. This requires that the lower voltage for frequency stability testing be specified by the manufacturer. This transceiver is specified to operate with an input voltage of between 3.40VDC and 4.20VDC, with a nominal voltage of 3.80DC. Operation above or below these voltage limits is prohibited by transceiver software in order to prevent improper operation as well as to protect components from overstress. These voltages represent a tolerance of -10 % and +12.5 %. For the purposes of measuring frequency stability these voltage limits are to be used.

***For equipment powered by primary supply voltage***

According to the JTC standard the frequency stability of the carrier shall be accurate to within 0.1 ppm of the received frequency from the base station. This accuracy is sufficient to meet Sec. 24.235, Frequency Stability. The frequency stability shall be sufficient to ensure that the fundamental emission stays within the authorized frequency block. For this EUT section 2.1055(d)(1) applies. This requires varying primary supply voltage from 85 to 115 percent of the nominal value for other than hand carried battery equipment.

**TEST RESULTS**

UMTS/TM1/WCDMA Band II					
DC Power	Temperature (°C)	Frequency error(Hz)	Frequency error(ppm)	Limit (ppm)	Verdict
3.40	20	37	0.000807	2.50	PASS
3.60	20	31	-0.003188	2.50	PASS
4.20	20	42	-0.003583	2.50	PASS
3.60	-30	37	-0.004919	2.50	PASS
3.60	-20	42	-0.002971	2.50	PASS
3.60	-10	26	-0.003068	2.50	PASS
3.60	0	32	-0.003823	2.50	PASS
3.60	10	38	0.004837	2.50	PASS
3.60	20	37	0.004602	2.50	PASS
3.60	30	21	0.004188	2.50	PASS
3.60	40	27	-0.002922	2.50	PASS
3.60	50	21	0.000438	2.50	PASS

UMTS/TM1/WCDMA Band V					
DC Power	Temperature (°C)	Frequency error(Hz)	Frequency error(ppm)	Limit (ppm)	Verdict
3.40	20	29	0.000132	2.50	PASS
3.60	20	27	-0.002023	2.50	PASS
4.20	20	32	0.000332	2.50	PASS
3.60	-30	25	-0.002741	2.50	PASS
3.60	-20	15	0.000979	2.50	PASS
3.60	-10	21	-0.005235	2.50	PASS
3.60	0	19	-0.000690	2.50	PASS
3.60	10	23	-0.009721	2.50	PASS
3.60	20	18	-0.001660	2.50	PASS
3.60	30	29	0.002808	2.50	PASS
3.60	40	27	-0.004903	2.50	PASS
3.60	50	17	-0.006785	2.50	PASS



## 4.7 Peak-to-Average Ratio (PAR)

### LIMIT

The Peak-to-Average Ratio (PAR) of the transmission may not exceed 13 dB.

### TEST CONFIGURATION

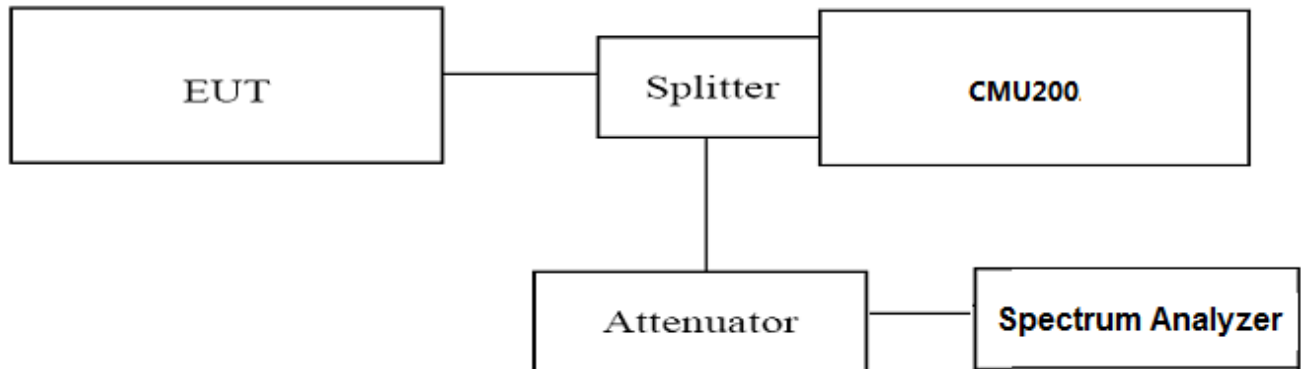

### TEST PROCEDURE

1. Refer to instrument's analyzer instruction manual for details on how to use the power statistics/CCDF function;
2. Set resolution/measurement bandwidth  $\geq$  signal's occupied bandwidth;
3. Set the number of counts to a value that stabilizes the measured CCDF curve;
4. Set the measurement interval as follows:
  - 1). for continuous transmissions, set to 1 ms,
  - 2). for burst transmissions, employ an external trigger that is synchronized with the EUT burst timing sequence, or use the internal burst trigger with a trigger level that allows the burst to stabilize and set the measurement interval to a time that is less than or equal to the burst duration.
5. Record the maximum PAPR level associated with a probability of 0.1%.

### TEST RESULTS

Test Mode	Channel	Frequency (MHz)	PAPR Value (dB)	Limits (dB)	Verdict
UMTS/TM1/WCDMA Band II	9262	1852.40	3.34	13.0	PASS
	9400	1880.00	3.31	13.0	PASS
	9538	1907.60	3.26	13.0	PASS
UMTS/TM1/WCDMA Band V	4132	826.40	3.55	13.0	PASS
	4183	836.60	3.49	13.0	PASS
	4233	846.60	3.57	13.0	PASS

Remark:

1. Test results including cable loss;
2. please refer to following plots;



### Peak-to-Average Ratio (PAR)

#### UMTS/TM1/ WCDMA Band V

#### UMTS/TM1/ WCDMA Band II

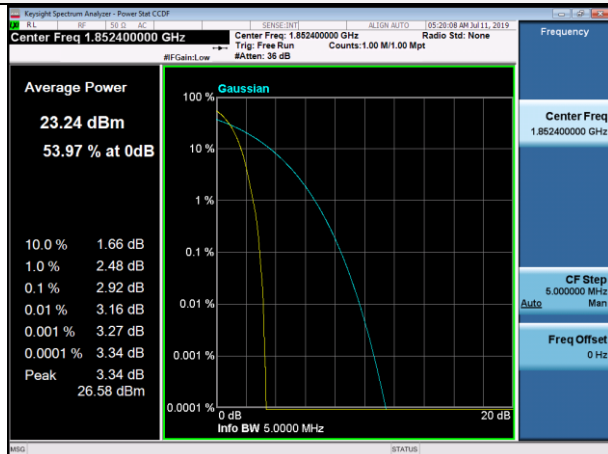
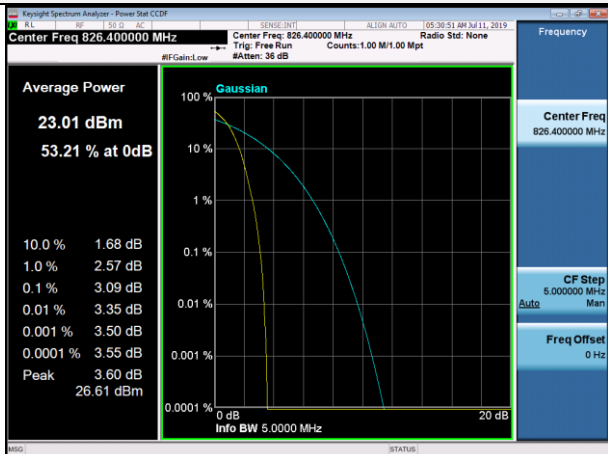

Channel 4132 / 826.4 MHz

Channel 9262 / 1852.4 MHz

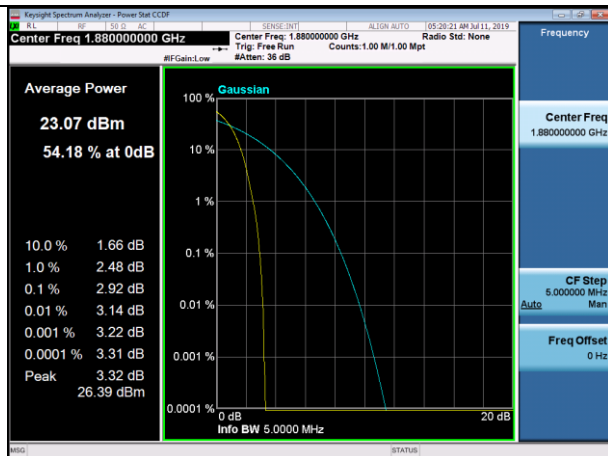
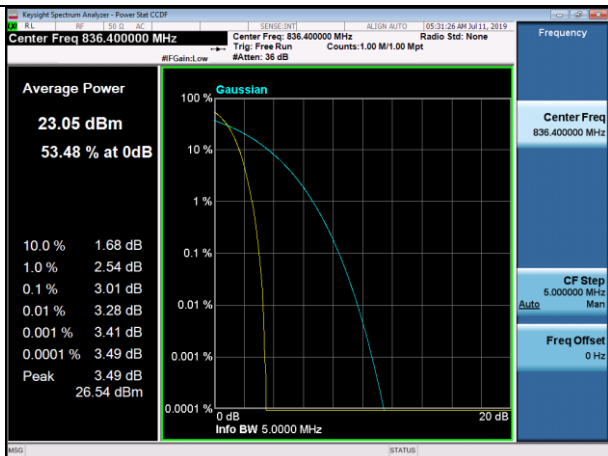

Channel 4183 / 836.4 MHz

Channel 9400 / 1880.0 MHz

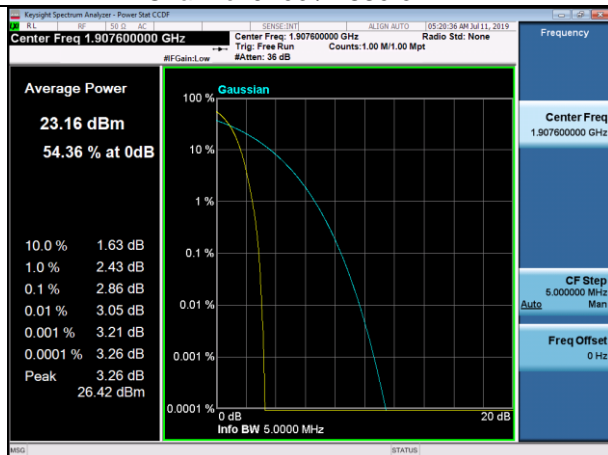
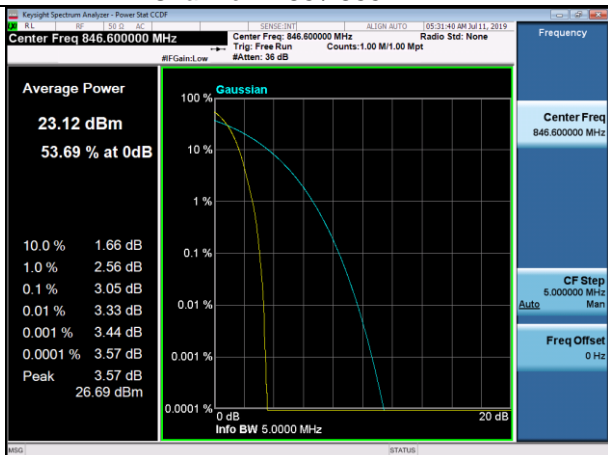

Channel 4233 / 846.6 MHz

Channel 9538 / 1907.6 MHz



## 5 Test Setup Photos of the EUT

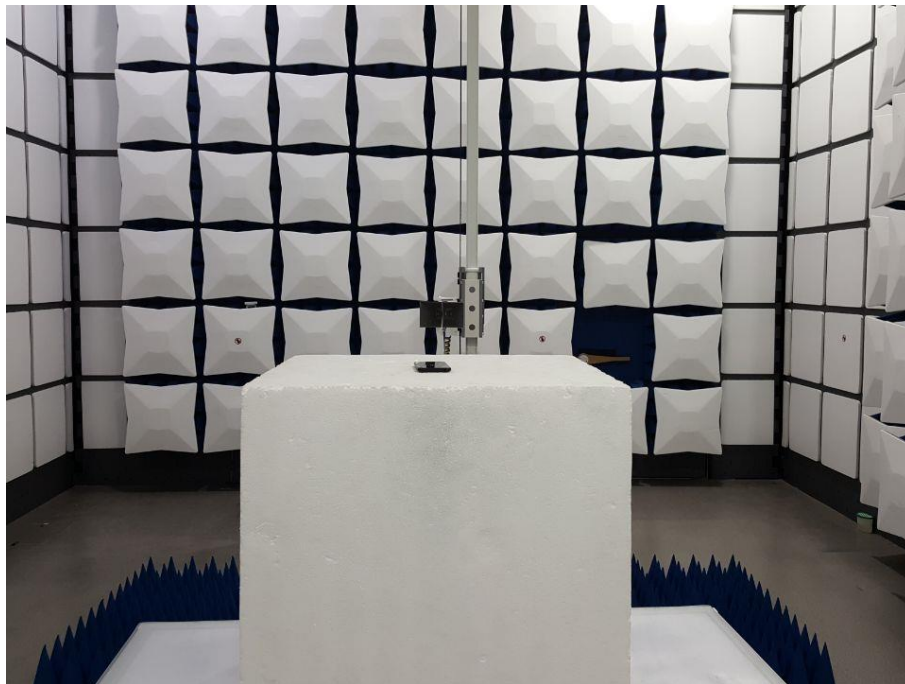
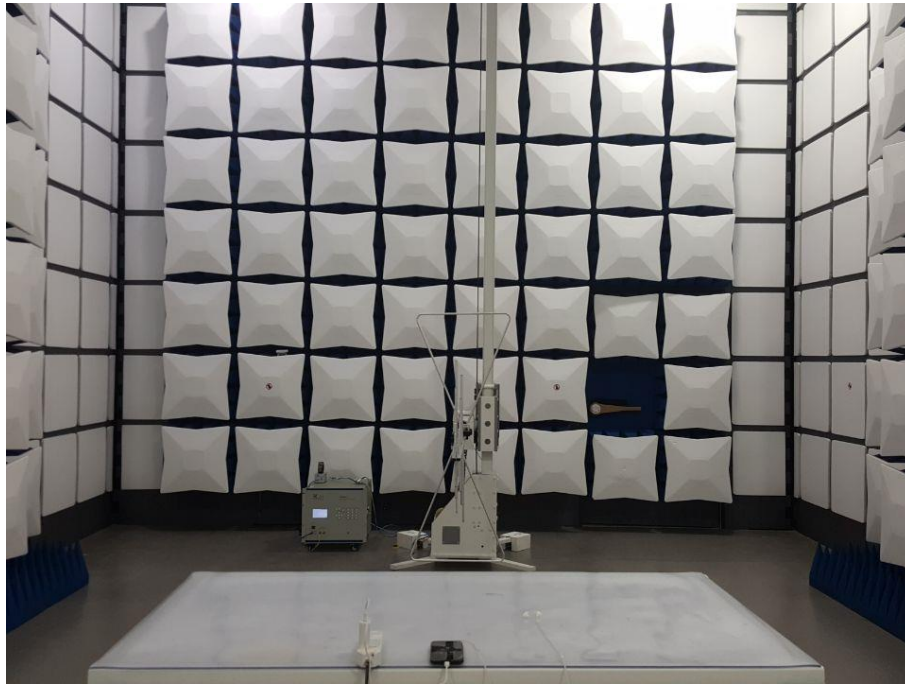

.....End of Report.....