



FCC RF Test Report

APPLICANT : LG Electronics Mobile Comm USA
EQUIPMENT : Smart phone
BRAND NAME : LG
MODEL NAME : LG-X210g, LGX210g, X210g, LG-X210G,
LGX210G, X210G
FCC ID : ZNFX210G
STANDARD : FCC Part 15 Subpart C §15.247
CLASSIFICATION : (DSS) Spread Spectrum Transmitter

The product was received on Nov. 20, 2015 and testing was completed on Dec. 19, 2015 . We, SPORTON INTERNATIONAL (KUNSHAN) INC., would like to declare that the tested sample has been evaluated in accordance with the test procedures and has been in compliance with the applicable technical standards.

The test results in this report apply exclusively to the tested model / sample. Without written approval of SPORTON INTERNATIONAL (KUNSHAN) INC., the test report shall not be reproduced except in full.

Prepared by: James Huang / Manager

Approved by: Jones Tsai / Manager



SPORTON INTERNATIONAL (KUNSHAN) INC.
No. 3-2, PingXiang Road, Kunshan, Jiangsu Province, P. R. China



TABLE OF CONTENTS

REVISION HISTORY..... 3

SUMMARY OF TEST RESULT 4

1 GENERAL DESCRIPTION..... 5

 1.1 Applicant..... 5

 1.2 Manufacturer..... 5

 1.3 Product Feature of Equipment Under Test..... 5

 1.4 Product Specification subjective to this standard 6

 1.5 Modification of EUT 6

 1.6 Testing Location 6

 1.7 Applicable Standards..... 7

2 TEST CONFIGURATION OF EQUIPMENT UNDER TEST..... 8

 2.1 Descriptions of Test Mode 8

 2.2 Test Mode..... 9

 2.3 Connection Diagram of Test System..... 10

 2.4 Support Unit used in test configuration and system 11

 2.5 EUT Operation Test Setup 11

 2.6 Measurement Results Explanation Example..... 12

3 TEST RESULT 13

 3.1 Number of Channel Measurement 13

 3.2 Hopping Channel Separation Measurement 15

 3.3 Dwell Time Measurement..... 22

 3.4 20dB Bandwidth Measurement 25

 3.5 Peak Output Power Measurement 32

 3.6 Conducted Band Edges Measurement 34

 3.7 Conducted Spurious Emission Measurement 41

 3.8 Radiated Band Edges and Spurious Emission Measurement 51

 3.9 AC Conducted Emission Measurement..... 57

 3.10 Antenna Requirements..... 63

4 LIST OF MEASURING EQUIPMENT..... 64

5 UNCERTAINTY OF EVALUATION..... 65

APPENDIX A. RADIATED TEST RESULTS



SUMMARY OF TEST RESULT

| Report Section | FCC Rule | Description | Limit | Result | Remark |
|----------------|--------------------|--|----------------------------|--------|---|
| 3.1 | 15.247(a)(1) | Number of Channels | ≥ 15Chs | Pass | - |
| 3.2 | 15.247(a)(1) | Hopping Channel Separation | ≥ 2/3 of 20dB BW | Pass | - |
| 3.3 | 15.247(a)(1) | Dwell Time of Each Channel | ≤ 0.4sec in 31.6sec period | Pass | - |
| 3.4 | 15.247(a)(1) | 20dB Bandwidth | NA | Pass | - |
| 3.5 | 15.247(b)(1) | Peak Output Power | ≤ 125 mW | Pass | - |
| 3.6 | 15.247(d) | Conducted Band Edges | ≤ 20dBc | Pass | - |
| 3.7 | 15.247(d) | Conducted Spurious Emission | ≤ 20dBc | Pass | - |
| 3.8 | 15.247(d) | Radiated Band Edges and Radiated Spurious Emission | 15.209(a) & 15.247(d) | Pass | Under limit 7.85 dB at 35.820 MHz |
| 3.9 | 15.207 | AC Conducted Emission | 15.207(a) | Pass | Under limit 9.35 dB at 3.800 MHz |
| 3.10 | 15.203 & 15.247(b) | Antenna Requirement | N/A | Pass | - |



1 General Description

1.1 Applicant

LG Electronics Mobile Comm USA
1000 Sylvan Avenue Englewood Cliffs, NJ 07632

1.2 Manufacturer

Arima Communications Corp.
6F, No.866, Jhongjheng Rd., Jhonghe Dist., New Taipei City 23586, Taiwan

1.3 Product Feature of Equipment Under Test

| Product Feature | |
|---------------------------------|---|
| Equipment | Smart phone |
| Brand Name | LG |
| Model Name | LG-X210g, LGX210g, X210g, LG-X210G, LGX210G, X210G |
| FCC ID | ZNFX210G |
| EUT supports Radios application | GSM/GPRS/EGPRS(Downlink Only)/WCDMA/HSPA/HSPA+(16QAM uplink is not supported) WLAN 2.4GHz 802.11b/g/n HT20/HT40/ Bluetooth v3.0+EDR/Bluetooth v4.0 LE |
| IMEI Code | Conducted: 356238070005703 Radiation: 356238070006248 Conduction: 356238070006446 |
| HW Version | 5541MB-002 |
| SW Version | LGX210g-00-V08a-334-20-OCT-27-2015+0 |
| EUT Stage | Production Unit |

Remark: The above EUT's information was declared by manufacturer. Please refer to the specifications or user's manual for more detailed description.



1.4 Product Specification subjective to this standard

| Product Specification subjective to this standard | |
|---|--|
| Tx/Rx Frequency Range | 2402 MHz ~ 2480 MHz |
| Number of Channels | 79 |
| Carrier Frequency of Each Channel | 2402+n*1 MHz; n=0~78 |
| Maximum Output Power to Antenna | Bluetooth BR(1Mbps) : 7.28 dBm (0.00535 W) Bluetooth EDR (2Mbps) : 7.09 dBm (0.00512 W) Bluetooth EDR (3Mbps) : 7.22 dBm (0.00527 W) |
| Antenna Type/Gain | IFA Antenna with gain 0.11 dBi |
| Type of Modulation | Bluetooth BR (1Mbps) : GFSK Bluetooth EDR (2Mbps) : $\pi/4$ -DQPSK Bluetooth EDR (3Mbps) : 8-DPSK |

1.5 Modification of EUT

No modifications are made to the EUT during all test items.

1.6 Testing Location

| | | | | |
|---------------------------|---|-----------|---------|-----------------------------|
| Test Site | SPORTON INTERNATIONAL (KUNSHAN) INC. | | | |
| Test Site Location | No. 3-2, PingXiang Road, Kunshan, Jiangsu Province, P. R. China TEL: +86-0512-5790-0158 FAX: +86-0512-5790-0958 | | | |
| Test Site No. | Sporton Site No. | | | FCC Registration No. |
| | TH01-KS | 03CH03-KS | CO01-KS | 306251 |

Note: The test site complies with ANSI C63.4 2014 requirement.



1.7 Applicable Standards

According to the specifications of the manufacturer, the EUT must comply with the requirements of the following standards:

- ♦ FCC Part 15 Subpart C §15.247
- ♦ FCC Public Notice DA 00-705
- ♦ ANSI C63.10-2013

Remark:

1. All test items were verified and recorded according to the standards and without any deviation during the test.
2. This EUT has also been tested and complied with the requirements of FCC Part 15, Subpart B, recorded in a separate test report.



2 Test Configuration of Equipment Under Test

2.1 Descriptions of Test Mode

Preliminary tests were performed in different data rates and recorded the RF output power in the following table:

| Channel | Frequency | Bluetooth RF Output Power | | |
|---------|-----------|---------------------------|----------------|----------|
| | | Data Rate / Modulation | | |
| | | GFSK | $\pi/4$ -DQPSK | 8-DPSK |
| | | 1Mbps | 2Mbps | 3Mbps |
| Ch00 | 2402MHz | 7.09 dBm | 6.94 dBm | 7.02 dBm |
| Ch39 | 2441MHz | 7.28 dBm | 7.09 dBm | 7.22 dBm |
| Ch78 | 2480MHz | 7.17 dBm | 7.00 dBm | 7.16 dBm |

Remark:

1. All the test data for each data rate were verified, but only the worst case was reported.
 2. The data rate was set in 1Mbps for all the test items due to the highest RF output power.
-
- a. The EUT has been associated with peripherals and configuration operated in a manner tended to maximize its emission characteristics in a typical application. Frequency range investigated: conduction (150 kHz to 30 MHz), radiation (9 kHz to the 10th harmonic of the highest fundamental frequency or to 40 GHz, whichever is lower). Pre-scanned tests, X, Y, Z in three orthogonal panels, and different data rates were conducted to determine the final configuration (X plane as worst plane) from all possible combinations, and the worst mode of radiated spurious emissions is Bluetooth 1Mbps mode, and recorded in this report.
 - b. AC power line Conducted Emission was tested under maximum output power.



2.2 Test Mode

The following summary table is showing all test modes to demonstrate in compliance with the standard.

| Summary table of Test Cases | | | |
|--|--|---|---|
| Test Item | Data Rate / Modulation | | |
| | Bluetooth BR 1Mbps GFSK | Bluetooth EDR 2Mbps $\pi/4$ -DQPSK | Bluetooth EDR 3Mbps 8-DPSK |
| Conducted Test Cases | Mode 1: CH00_2402 MHz Mode 2: CH39_2441 MHz Mode 3: CH78_2480 MHz | Mode 4: CH00_2402 MHz Mode 5: CH39_2441 MHz Mode 6: CH78_2480 MHz | Mode 7: CH00_2402 MHz Mode 8: CH39_2441 MHz Mode 9: CH78_2480 MHz |
| Radiated Test Cases | Bluetooth BR 1Mbps GFSK | | |
| | Mode 1: CH00_2402 MHz Mode 2: CH39_2441 MHz Mode 3: CH78_2480 MHz | | |
| AC Conducted Emission | Mode 1 :GSM850 Idle + Bluetooth Link + WLAN Link + Earphone + USB Cable (Charging from Adapter) | | |
| Remark: | | | |
| <ol style="list-style-type: none"> For radiated test cases, the worst mode data rate 1Mbps was reported only, because this data rate has the highest RF output power at preliminary tests, and no other significantly frequencies found in conducted spurious emission. For Radiated Test Cases, The tests were performance with Adapter, Earphone, and USB Cable. | | | |

2.3 Connection Diagram of Test System

<Bluetooth Tx Mode>

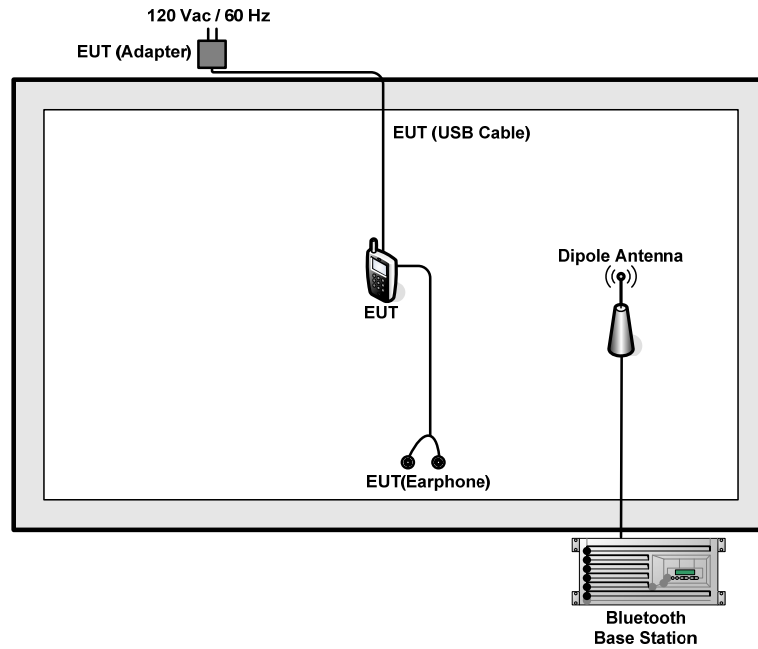

<AC Conducted Emission Mode>

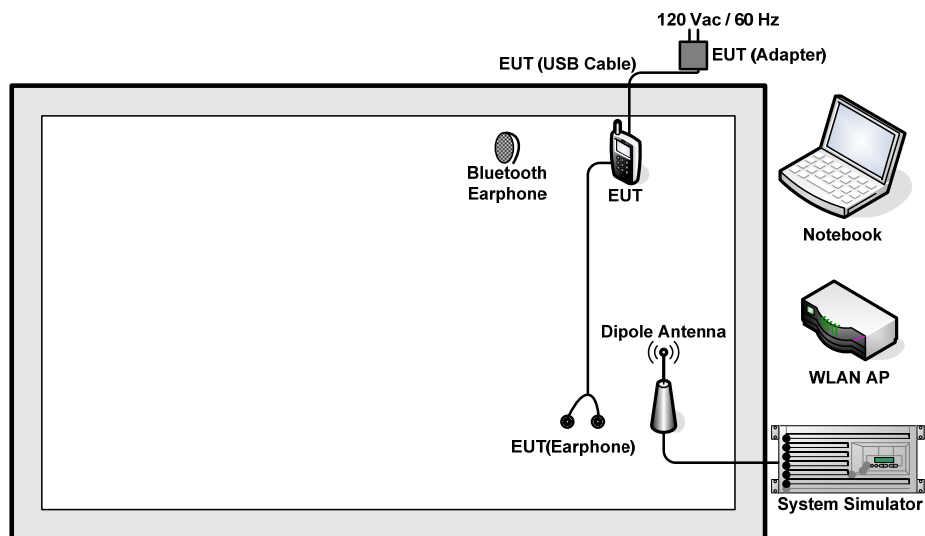



2.4 Support Unit used in test configuration and system

| Item | Equipment | Trade Name | Model Name | FCC ID | Data Cable | Power Cord |
|------|------------------------|------------|------------|----------------|-----------------|--|
| 1. | System Simulator | Anritsu | MT8820C | FCC DoC | Shielded, 1.5 m | N/A |
| 2. | Bluetooth Base Station | R&S | CBT | N/A | N/A | Unshielded, 1.8 m |
| 3. | Bluetooth Earphone | Nokia | BH-102 | PYAHS-107W | N/A | N/A |
| 4. | WLAN AP | LINKSYS | WRT600N | Q87-WRT600NV11 | N/A | Shielded, 1.8 m |
| 5. | Notebook | Lenovo | G480 | N/A | N/A | AC I/P: Unshielded, 1.8 m DC O/P: Shielded, 1.8 m |

2.5 EUT Operation Test Setup

For Bluetooth function, the engineering test program was provided and enabled to make EUT connect with Bluetooth base station to continuous transmit/receive.

For AC power line conducted emissions, the EUT was set to connect with the WLAN AP under large package sizes transmission.



2.6 Measurement Results Explanation Example

For all conducted test items:

The offset level is set in the spectrum analyzer to compensate the RF cable loss and attenuator factor between EUT conducted output port and spectrum analyzer. With the offset compensation, the spectrum analyzer reading level is exactly the EUT RF output level.

Example:

The spectrum analyzer offset is derived from RF cable loss.

Offset = RF cable loss.

Following shows an offset computation example with cable loss 5.5 dB.

Offset(dB) = RF cable loss(dB) = 5.5 (dB)

3 Test Result

3.1 Number of Channel Measurement

3.1.1 Limits of Number of Hopping Frequency

Frequency hopping systems in the 2400-2483.5 MHz band shall use at least 15 channels.

3.1.2 Measuring Instruments

The measuring equipment is listed in the section 4 of this test report.

3.1.3 Test Procedure

1. The testing follows FCC Public Notice DA 00-705 Measurement Guidelines.
2. The RF output of EUT was connected to the spectrum analyzer by RF cable and attenuator. The path loss was compensated to the results for each measurement.
3. Set to the maximum power setting and enable the EUT transmit continuously.
4. Enable the EUT hopping function.
5. Use the following spectrum analyzer settings: Span = the frequency band of operation; RBW \geq 1% of the span; VBW \geq RBW; Sweep = auto; Detector function = peak; Trace = max hold.
6. The number of hopping frequency used is defined as the number of total channel.
7. Record the measurement data derived from spectrum analyzer.

3.1.4 Test Setup

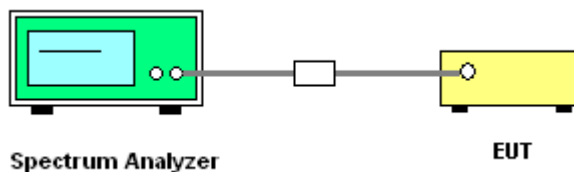

3.1.5 Test Result of Number of Hopping Frequency

| Test Mode : | 1Mbps | Temperature : | 24~25°C |
|-----------------------------|--------------------------------------|---------------------|-----------|
| Test Engineer : | Issac Song | Relative Humidity : | 49~51% |
| Number of Hopping (Channel) | Adaptive Frequency Hopping (Channel) | Limits (Channel) | Pass/Fail |
| 79 | 20 | > 15 | Pass |



Number of Hopping Channel Plot on Channel 00 - 78

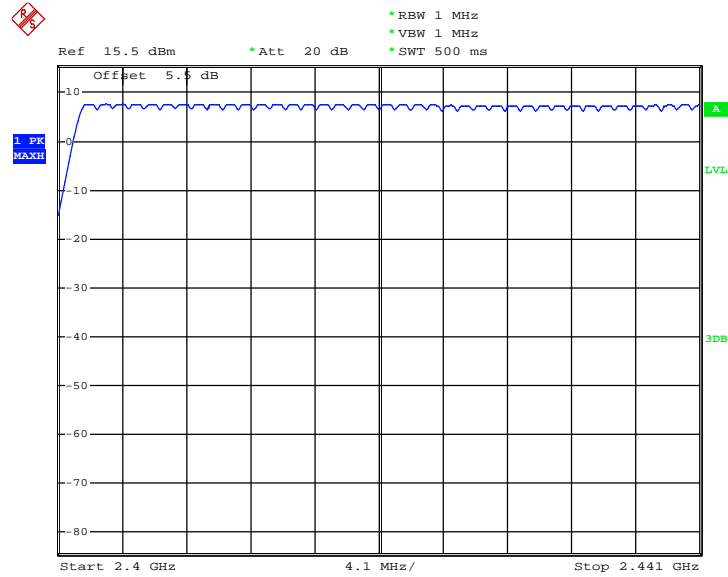

Date: 4.DEC.2015 21:45:45

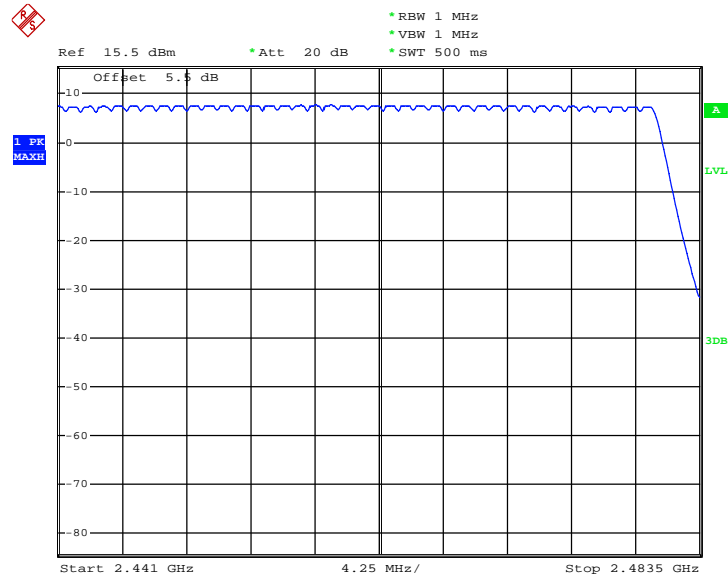

Date: 4.DEC.2015 21:51:18

3.2 Hopping Channel Separation Measurement

3.2.1 Limit of Hopping Channel Separation

Frequency hopping systems operating in the 2400-2483.5 MHz band may have hopping channel carrier frequencies that are separated by 25 kHz or two-thirds of the 20 dB bandwidth of the hopping channel, whichever is greater.

3.2.2 Measuring Instruments

The measuring equipment is listed in the section 4 of this test report.

3.2.3 Test Procedures

1. The testing follows FCC Public Notice DA 00-705 Measurement Guidelines.
2. The RF output of EUT was connected to the spectrum analyzer by RF cable and attenuator. The path loss was compensated to the results for each measurement.
3. Set to the maximum power setting and enable the EUT transmit continuously.
4. Enable the EUT hopping function.
5. Use the following spectrum analyzer settings:
Span = wide enough to capture the peaks of two adjacent channels; RBW \geq 1% of the span;
VBW \geq RBW; Sweep = auto; Detector function = peak; Trace = max hold.
6. Measure and record the results in the test report.

3.2.4 Test Setup

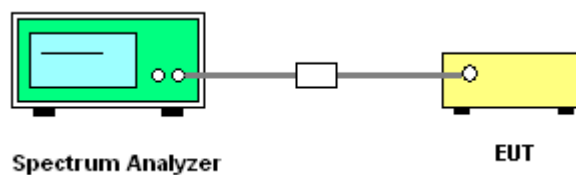



3.2.5 Test Result of Hopping Channel Separation

| | | | |
|-----------------|------------|---------------------|---------|
| Test Mode : | 1Mbps | Temperature : | 24~25°C |
| Test Engineer : | Issac Song | Relative Humidity : | 49~51% |

| Channel | Frequency (MHz) | Frequency Separation (MHz) | (2/3 of 20dB BW) Limits (MHz) | Pass/Fail |
|---------|-----------------|----------------------------|-------------------------------|-----------|
| 00 | 2402 | 1.002 | 0.6507 | Pass |
| 39 | 2441 | 1.002 | 0.6453 | Pass |
| 78 | 2480 | 1.002 | 0.6320 | Pass |

Channel Separation Plot on Channel 00 - 01

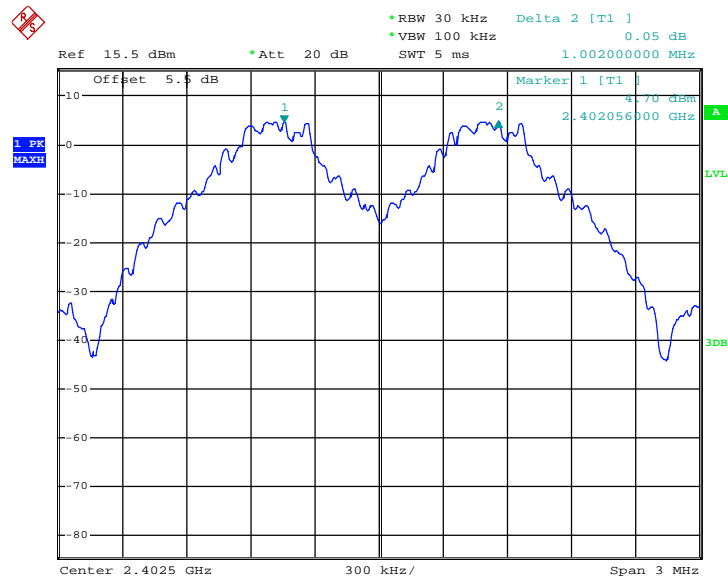

Date: 4.DEC.2015 21:21:03



Channel Separation Plot on Channel 39 - 40

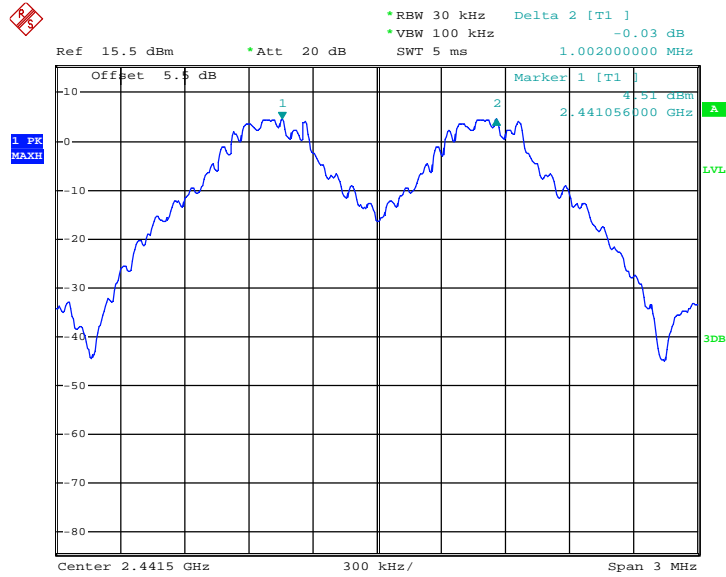

Date: 4.DEC.2015 21:21:49

Channel Separation Plot on Channel 77 - 78

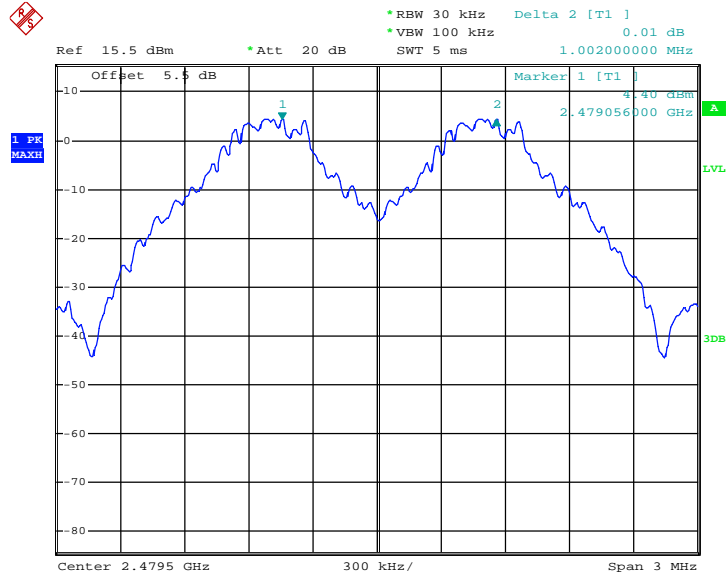

Date: 4.DEC.2015 21:22:37



| | | | |
|-----------------|------------|---------------------|---------|
| Test Mode : | 2Mbps | Temperature : | 24~25°C |
| Test Engineer : | Issac Song | Relative Humidity : | 49~51% |

| Channel | Frequency (MHz) | Frequency Separation (MHz) | (2/3 of 20dB BW) Limits (MHz) | Pass/Fail |
|---------|-----------------|----------------------------|-------------------------------|-----------|
| 00 | 2402 | 1.008 | 0.8400 | Pass |
| 39 | 2441 | 1.002 | 0.8480 | Pass |
| 78 | 2480 | 1.002 | 0.8160 | Pass |

Channel Separation Plot on Channel 00 - 01

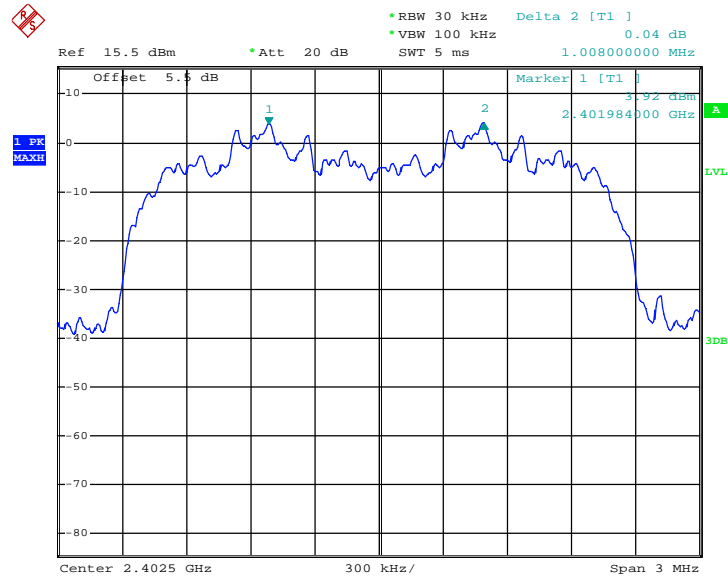

Date: 4.DEC.2015 21:24:10



Channel Separation Plot on Channel 39 - 40

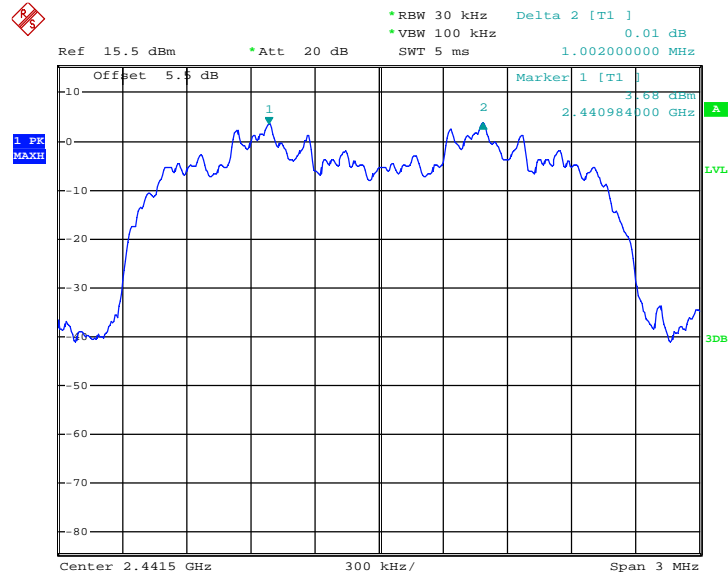

Date: 4.DEC.2015 21:25:31

Channel Separation Plot on Channel 77 - 78

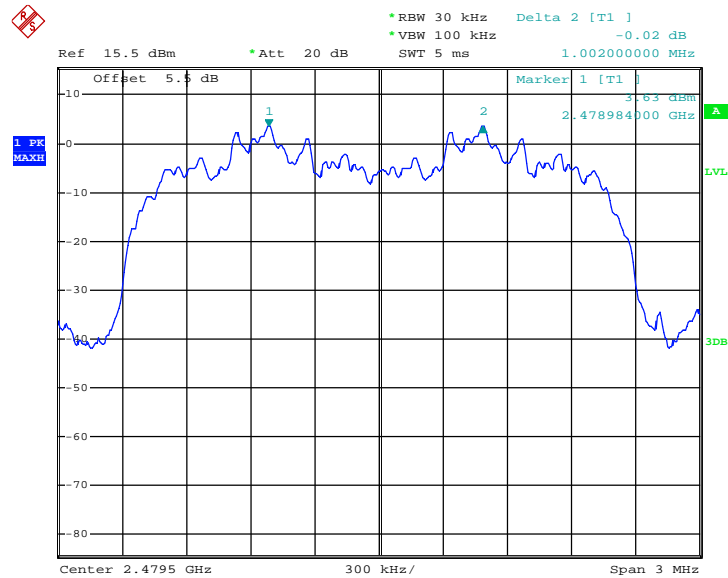

Date: 4.DEC.2015 21:26:14



| | | | |
|-----------------|------------|---------------------|---------|
| Test Mode : | 3Mbps | Temperature : | 24~25°C |
| Test Engineer : | Issac Song | Relative Humidity : | 49~51% |

| Channel | Frequency (MHz) | Frequency Separation (MHz) | (2/3 of 20dB BW) Limits (MHz) | Pass/Fail |
|---------|-----------------|----------------------------|-------------------------------|-----------|
| 00 | 2402 | 1.002 | 0.8280 | Pass |
| 39 | 2441 | 1.002 | 0.8200 | Pass |
| 78 | 2480 | 1.002 | 0.8240 | Pass |

Channel Separation Plot on Channel 00 - 01

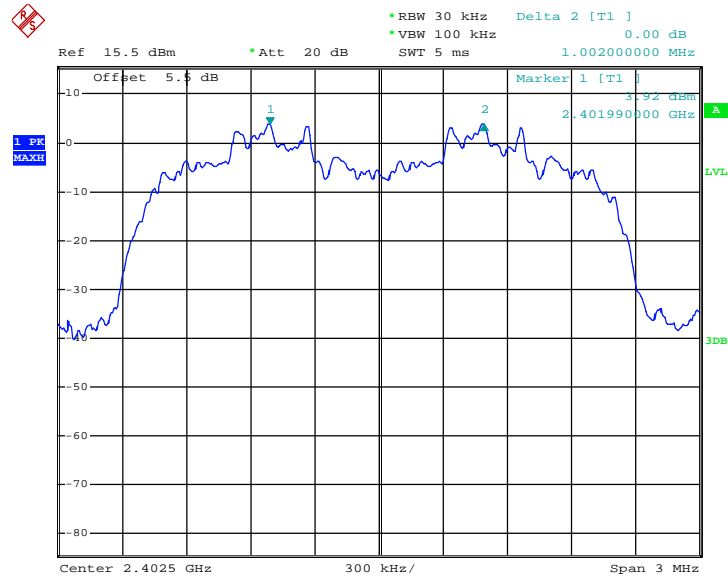

Date: 4.DEC.2015 21:26:55



Channel Separation Plot on Channel 39 - 40

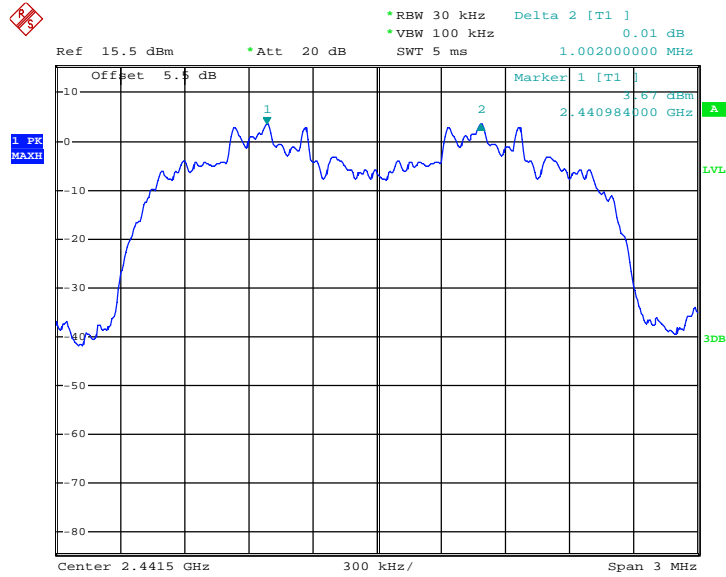

Date: 4.DEC.2015 21:27:38

Channel Separation Plot on Channel 77 - 78

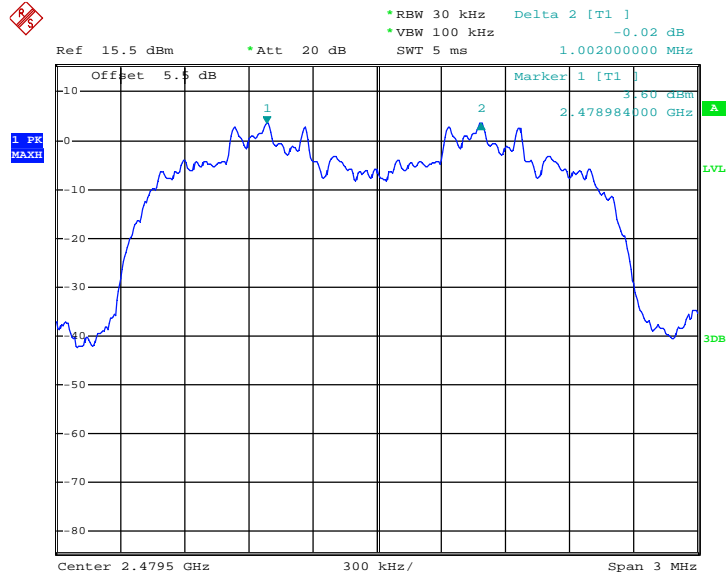

Date: 4.DEC.2015 21:28:20

3.3 Dwell Time Measurement

3.3.1 Limit of Dwell Time

The average time of occupancy on any channel shall not be greater than 0.4 seconds within a period of 0.4 seconds multiplied by the number of hopping channels employed.

3.3.2 Measuring Instruments

The measuring equipment is listed in the section 4 of this test report.

3.3.3 Test Procedures

1. The testing follows FCC Public Notice DA 00-705 Measurement Guidelines.
2. The RF output of EUT was connected to the spectrum analyzer by RF cable and attenuator. The path loss was compensated to the results for each measurement.
3. Set to the maximum power setting and enable the EUT transmit continuously.
4. Enable the EUT hopping function.
5. Use the following spectrum analyzer settings: Span = zero span, centered on a hopping channel; RBW = 1 MHz; VBW \geq RBW; Sweep = as necessary to capture the entire dwell time per hopping channel; Detector function = peak; Trace = max hold.
6. Measure and record the results in the test report.

3.3.4 Test Setup

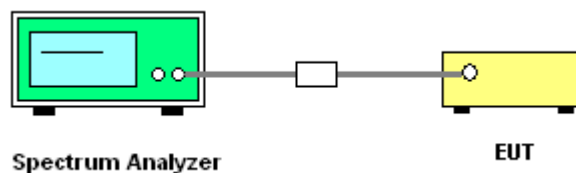



3.3.5 Test Result of Dwell Time

| | | | |
|-----------------|------------|---------------------|---------|
| Test Mode : | DH5 | Temperature : | 24~25°C |
| Test Engineer : | Issac Song | Relative Humidity : | 49~51% |

| Mode | Hopping Channel Number | Hops Over Occupancy Time(hops) | Package Transfer Time (msec) | Dwell Time (sec) | Limits (sec) | Pass/Fail |
|--------|------------------------|--------------------------------|------------------------------|------------------|--------------|-----------|
| Normal | 79 | 106.67 | 2.882 | 0.31 | 0.4 | Pass |
| AFH | 20 | 53.33 | 2.882 | 0.15 | 0.4 | Pass |

Remark:

1. In normal mode, hopping rate is 1600 hops/s with 6 slots in 79 hopping channels.
With channel hopping rate $(1600 / 6 / 79)$ in Occupancy Time Limit (0.4×79) (s),
Hops Over Occupancy Time comes to $(1600 / 6 / 79) \times (0.4 \times 79) = 106.67$ hops.
2. In AFH mode, hopping rate is 800 hops/s with 6 slots in 20 hopping channels.
With channel hopping rate $(800 / 6 / 20)$ in Occupancy Time Limit (0.4×20) (s),
Hops Over Occupancy Time comes to $(800 / 6 / 20) \times (0.4 \times 20) = 53.33$ hops.
3. Dwell Time(s) = Hops Over Occupancy Time (hops) x Package Transfer Time



Package Transfer Time Plot

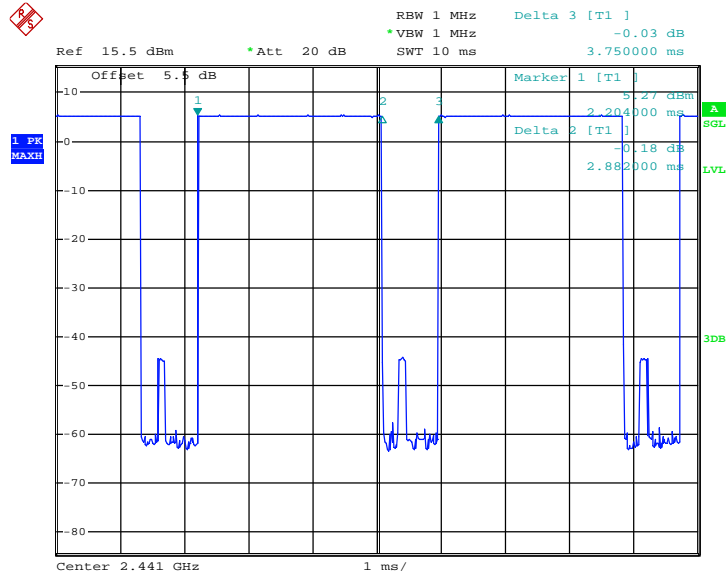

Date: 26.NOV.2015 00:30:24

3.4 20dB Bandwidth Measurement

3.4.1 Limit of 20dB Bandwidth

Reporting only

3.4.2 Measuring Instruments

The measuring equipment is listed in the section 4 of this test report.

3.4.3 Test Procedures

1. The testing follows FCC Public Notice DA 00-705 Measurement Guidelines.
2. The RF output of EUT was connected to the spectrum analyzer by RF cable and attenuator. The path loss was compensated to the results for each measurement.
3. Set to the maximum power setting and enable the EUT transmit continuously.
4. Use the following spectrum analyzer settings for 20dB Bandwidth measurement.
Span = approximately 2 to 3 times the 20 dB bandwidth, centered on a hopping channel;
RBW \geq 1% of the 20 dB bandwidth; VBW \geq RBW; Sweep = auto; Detector function = peak;
Trace = max hold.
5. Measure and record the results in the test report.

3.4.4 Test Setup

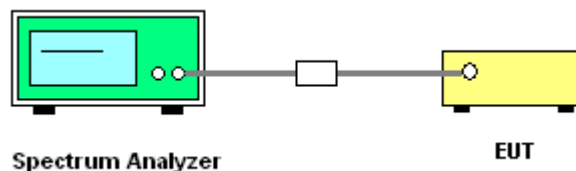



3.4.5 Test Result of 20dB Bandwidth

| | | | |
|-----------------|------------|---------------------|---------|
| Test Mode : | 1Mbps | Temperature : | 24~25°C |
| Test Engineer : | Issac Song | Relative Humidity : | 49~51% |

| Channel | Frequency (MHz) | 20dB Bandwidth (MHz) |
|---------|-----------------|----------------------|
| 00 | 2402 | 0.976 |
| 39 | 2441 | 0.968 |
| 78 | 2480 | 0.948 |

20 dB Bandwidth Plot on Channel 00

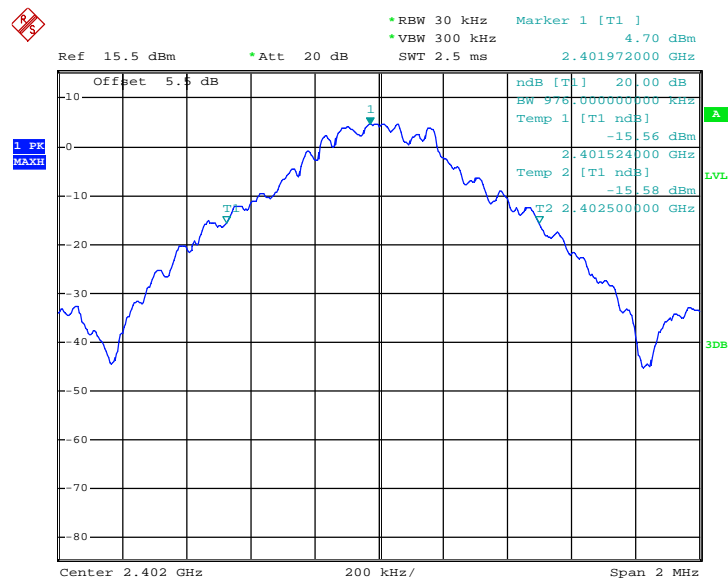

Date: 4.DEC.2015 21:28:41



20 dB Bandwidth Plot on Channel 39

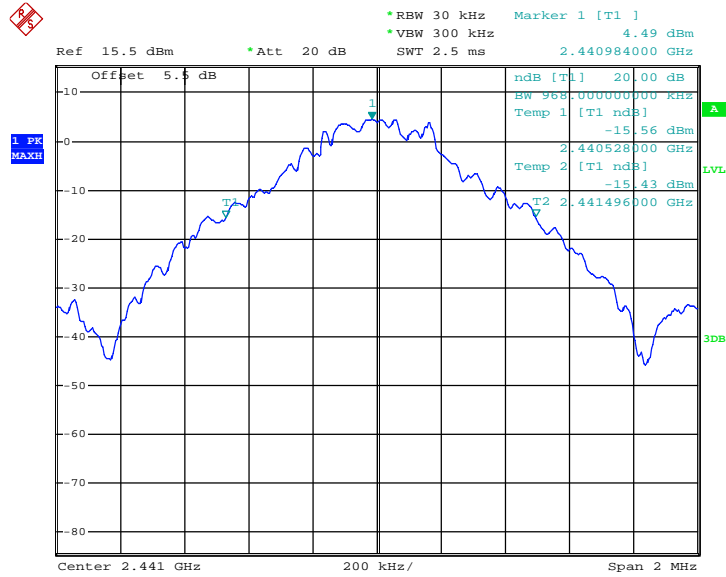

Date: 4.DEC.2015 21:28:52

20 dB Bandwidth Plot on Channel 78

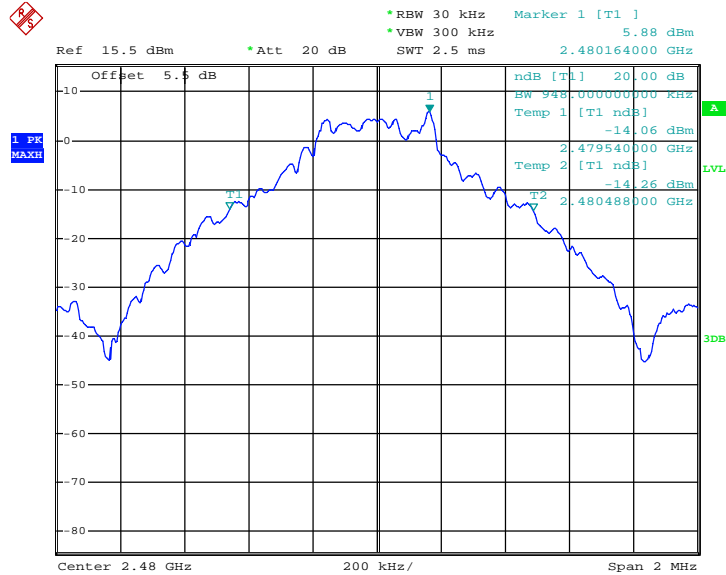

Date: 4.DEC.2015 21:29:03



| | | | |
|-----------------|------------|---------------------|---------|
| Test Mode : | 2Mbps | Temperature : | 24~25°C |
| Test Engineer : | Issac Song | Relative Humidity : | 49~51% |

| Channel | Frequency (MHz) | 20dB Bandwidth (MHz) |
|---------|-----------------|----------------------|
| 00 | 2402 | 1.260 |
| 39 | 2441 | 1.272 |
| 78 | 2480 | 1.224 |

20 dB Bandwidth Plot on Channel 00

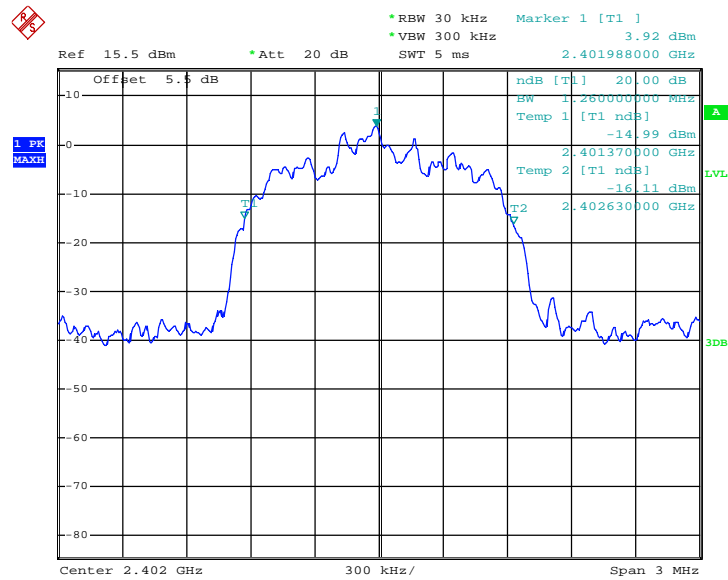

Date: 4.DEC.2015 21:29:15



20 dB Bandwidth Plot on Channel 39

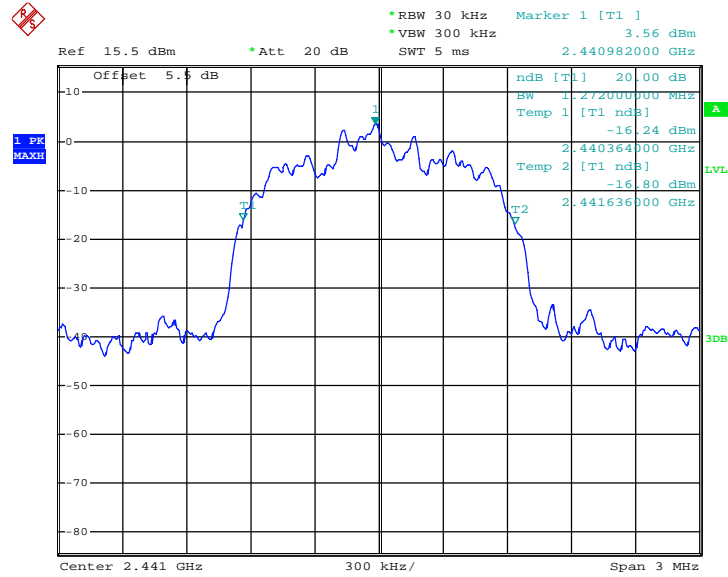

Date: 4.DEC.2015 21:29:29

20 dB Bandwidth Plot on Channel 78

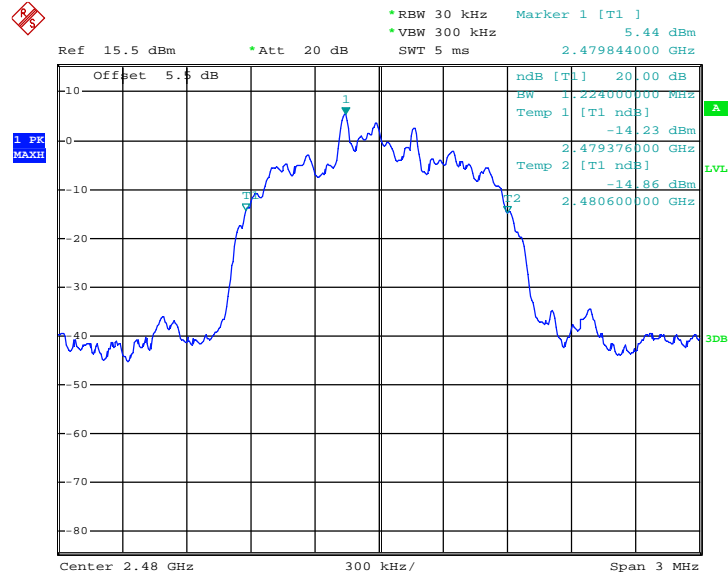

Date: 4.DEC.2015 21:29:39



| | | | |
|-----------------|------------|---------------------|---------|
| Test Mode : | 3Mbps | Temperature : | 24~25°C |
| Test Engineer : | Issac Song | Relative Humidity : | 49~51% |

| Channel | Frequency (MHz) | 20dB Bandwidth (MHz) |
|---------|-----------------|----------------------|
| 00 | 2402 | 1.242 |
| 39 | 2441 | 1.230 |
| 78 | 2480 | 1.236 |

20 dB Bandwidth Plot on Channel 00

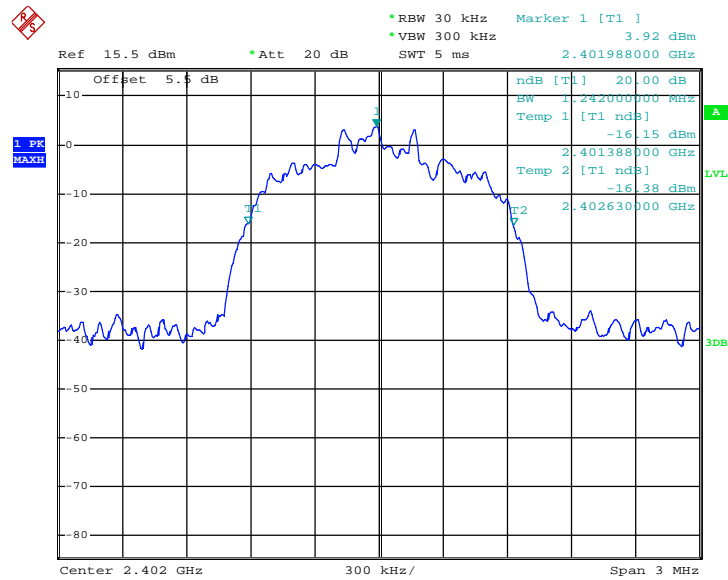

Date: 4.DEC.2015 21:29:55



20 dB Bandwidth Plot on Channel 39

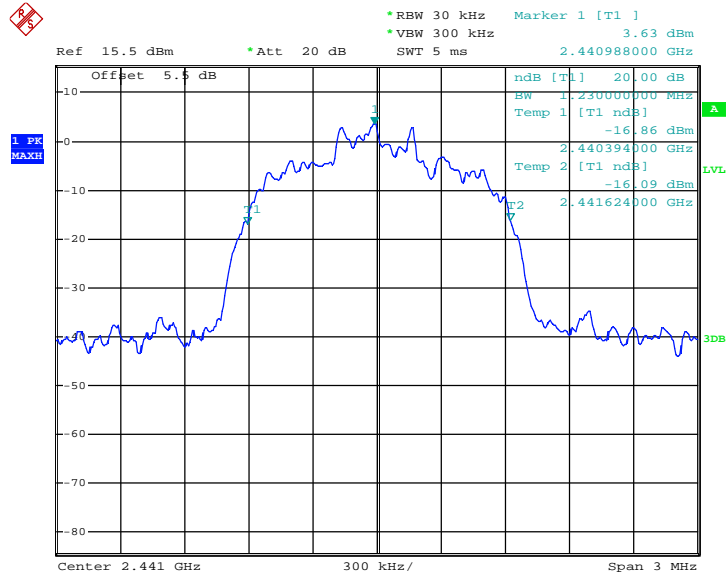

Date: 4.DEC.2015 21:30:06

20 dB Bandwidth Plot on Channel 78

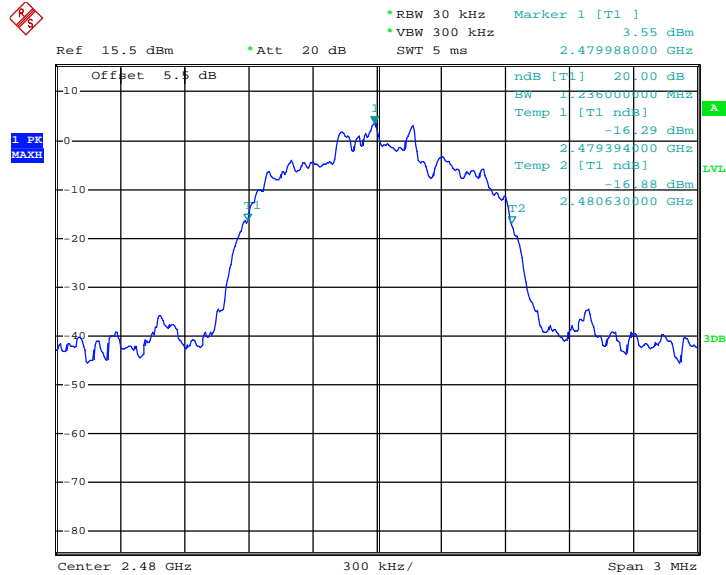

Date: 4.DEC.2015 21:30:15

3.5 Peak Output Power Measurement

3.5.1 Limit of Peak Output Power

Section 15.247 (b) The maximum peak conducted output power of the intentional radiator shall not exceed the following: (1) For frequency hopping systems operating in the 2400-2483.5 MHz band employing at least 75 non-overlapping hopping channels, and all frequency hopping systems in the 5725-5850 MHz band: 1 watt. For all other frequency hopping systems in the 2400-2483.5 MHz band 0.125 watts.

3.5.2 Measuring Instruments

The measuring equipment is listed in the section 4 of this test report.

3.5.3 Test Procedures

1. The testing follows FCC Public Notice DA 00-705 Measurement Guidelines.
2. The RF output of EUT was connected to the power meter by RF cable and attenuator. The path loss was compensated to the results for each measurement.
3. Set to the maximum power setting and enable the EUT transmit continuously.
4. Measure the conducted output power with cable loss and record the results in the test report.
5. Measure and record the results in the test report.

3.5.4 Test Setup

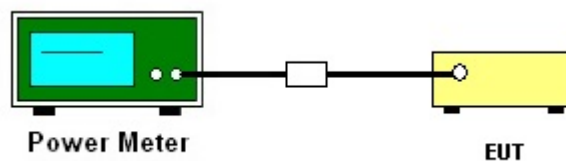



3.5.5 Test Result of Peak Output Power

| | | | |
|-----------------|------------|---------------------|---------|
| Test Mode : | 1Mbps | Temperature : | 24~25°C |
| Test Engineer : | Issac Song | Relative Humidity : | 49~51% |

| Channel | Frequency (MHz) | RF Power (dBm) | | |
|---------|-----------------|----------------|-------------------|-----------|
| | | GFSK | Max. Limits (dBm) | Pass/Fail |
| | | 1 Mbps | | |
| 00 | 2402 | 7.09 | 20.97 | Pass |
| 39 | 2441 | 7.28 | 20.97 | Pass |
| 78 | 2480 | 7.17 | 20.97 | Pass |

| | | | |
|-----------------|------------|---------------------|---------|
| Test Mode : | 2Mbps | Temperature : | 24~25°C |
| Test Engineer : | Issac Song | Relative Humidity : | 49~51% |

| Channel | Frequency (MHz) | RF Power (dBm) | | |
|---------|-----------------|----------------|-------------------|-----------|
| | | $\pi/4$ -DQPSK | Max. Limits (dBm) | Pass/Fail |
| | | 2 Mbps | | |
| 00 | 2402 | 6.94 | 20.97 | Pass |
| 39 | 2441 | 7.09 | 20.97 | Pass |
| 78 | 2480 | 7.00 | 20.97 | Pass |

| | | | |
|-----------------|------------|---------------------|---------|
| Test Mode : | 3Mbps | Temperature : | 24~25°C |
| Test Engineer : | Issac Song | Relative Humidity : | 49~51% |

| Channel | Frequency (MHz) | RF Power (dBm) | | |
|---------|-----------------|----------------|-------------------|-----------|
| | | 8-DPSK | Max. Limits (dBm) | Pass/Fail |
| | | 3 Mbps | | |
| 00 | 2402 | 7.02 | 20.97 | Pass |
| 39 | 2441 | 7.22 | 20.97 | Pass |
| 78 | 2480 | 7.16 | 20.97 | Pass |

3.6 Conducted Band Edges Measurement

3.6.1 Limit of Band Edges

In any 100 kHz bandwidth outside the intentional radiation frequency band, the radio frequency power shall be at least 20 dB below the highest level of the radiated power. In addition, radiated emissions which fall in the restricted bands must also comply with the radiated emission limits.

3.6.2 Measuring Instruments

The measuring equipment is listed in the section 4 of this test report.

3.6.3 Test Procedures

1. The testing follows the guidelines in Band-edge Compliance of RF Conducted Emissions of FCC Public Notice DA 00-705 Measurement Guidelines.
2. Set to the maximum power setting and enable the EUT transmit continuously.
3. Set RBW = 100kHz ($\geq 1\%$ span=10MHz), VBW = 300kHz (\geq RBW). Band edge emissions must be at least 20 dB down from the highest emission level within the authorized band as measured with a 100kHz RBW. The attenuation shall be 30 dB instead of 20 dB when RMS conducted output power procedure is used.
4. Enable hopping function of the EUT and then repeat step 2. and 3.
5. Measure and record the results in the test report.

3.6.4 Test Setup

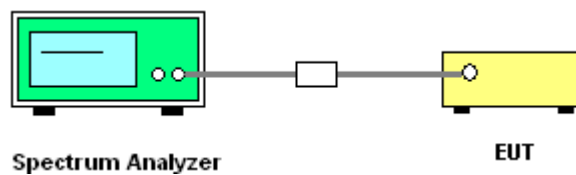



3.6.5 Test Result of Conducted Band Edges

| | | | |
|----------------|-----------|---------------------|------------|
| Test Mode : | 1Mbps | Temperature : | 24~25°C |
| Test Channel : | 00 and 78 | Relative Humidity : | 49~51% |
| | | Test Engineer : | Issac Song |

Low Band Edge Plot on Channel 00

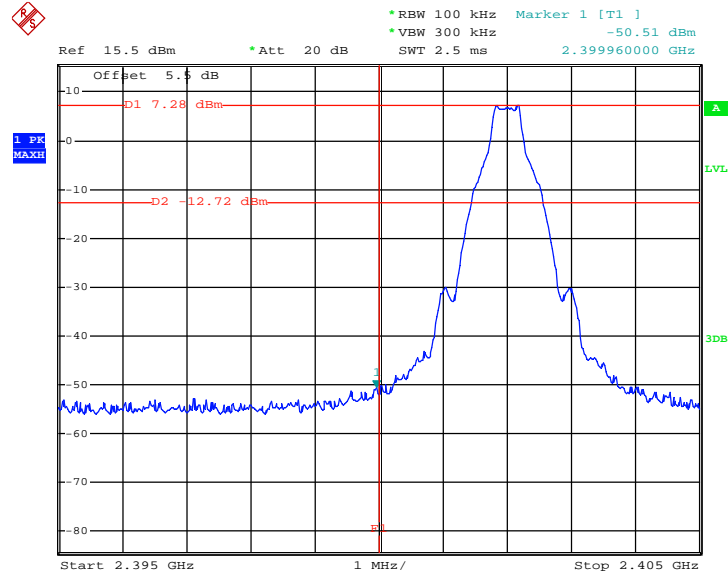

Date: 4.DEC.2015 22:01:36

High Band Edge Plot on Channel 78

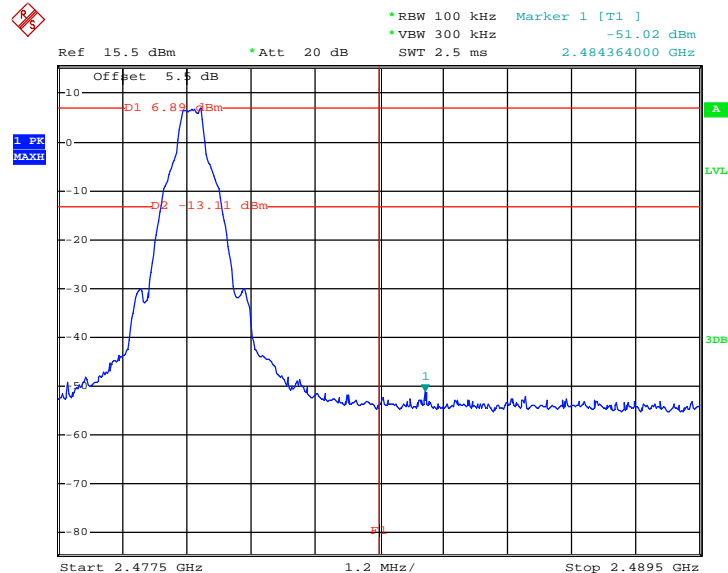

Date: 4.DEC.2015 21:32:01



| | | | |
|----------------|-----------|---------------------|------------|
| Test Mode : | 2Mbps | Temperature : | 24~25°C |
| Test Channel : | 00 and 78 | Relative Humidity : | 49~51% |
| | | Test Engineer : | Issac Song |

Low Band Edge Plot on Channel 00

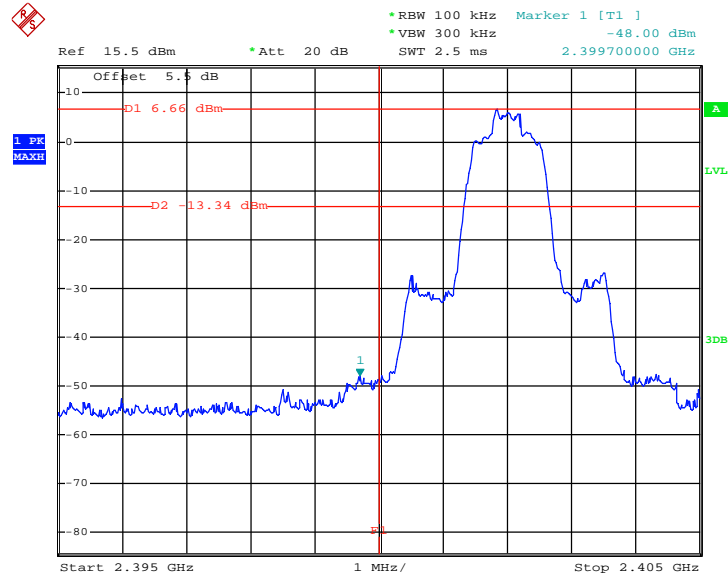

Date: 4.DEC.2015 21:52:55

High Band Edge Plot on Channel 78

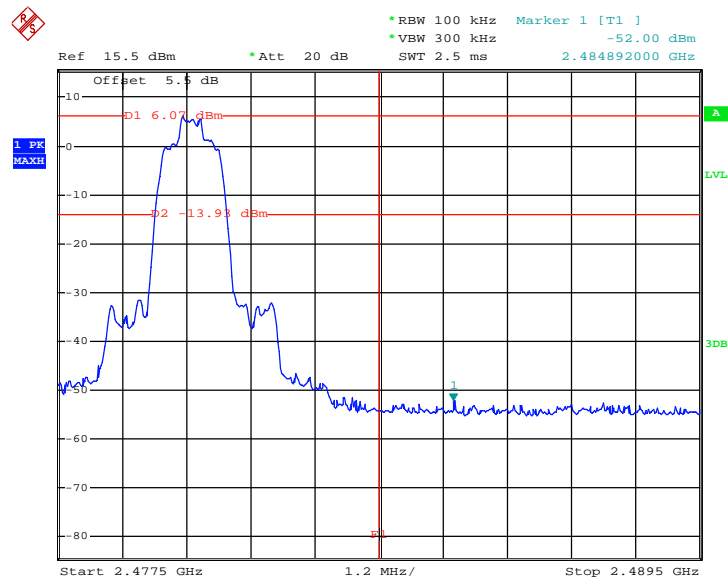

Date: 4.DEC.2015 21:33:44



| | | | |
|----------------|-----------|---------------------|------------|
| Test Mode : | 3Mbps | Temperature : | 24~25°C |
| Test Channel : | 00 and 78 | Relative Humidity : | 49~51% |
| | | Test Engineer : | Issac Song |

Low Band Edge Plot on Channel 00

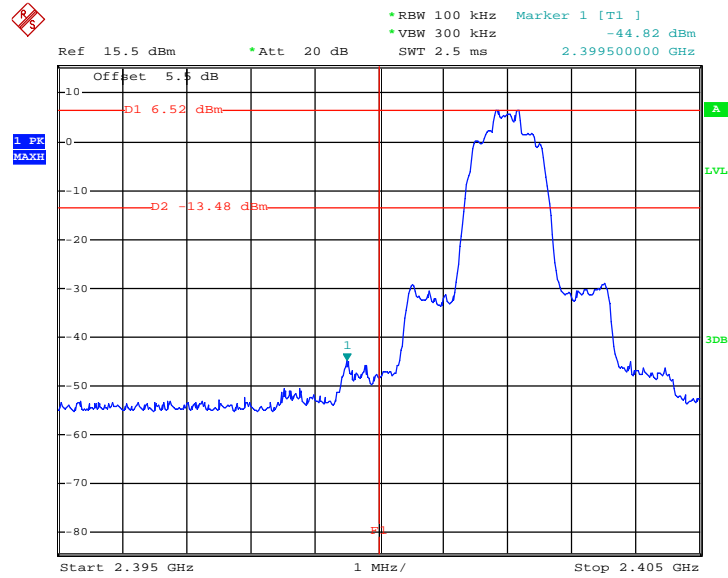

Date: 4.DEC.2015 21:34:36

High Band Edge Plot on Channel 78

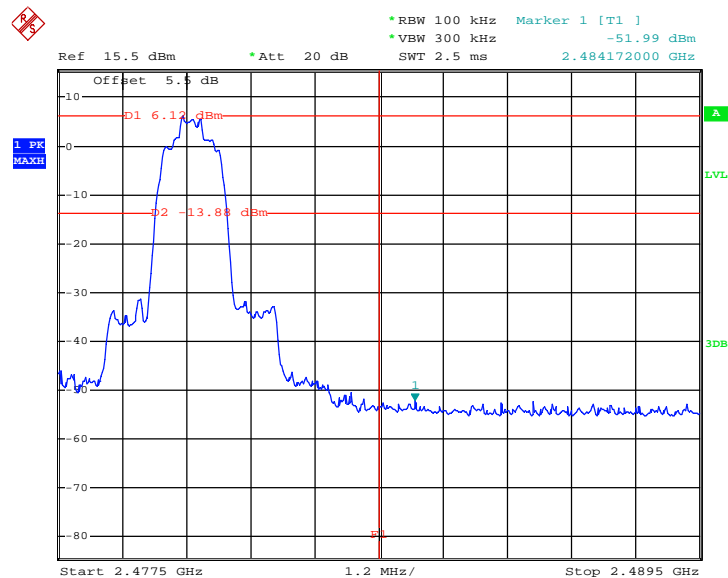

Date: 4.DEC.2015 21:35:27



3.6.6 Test Result of Conducted Hopping Mode Band Edges

| | | | |
|-----------------|------------|---------------------|---------|
| Test Mode : | 1Mbps | Temperature : | 24~25°C |
| Test Engineer : | Issac Song | Relative Humidity : | 49~51% |

1Mbps Hopping Mode Low Band Edge Plot

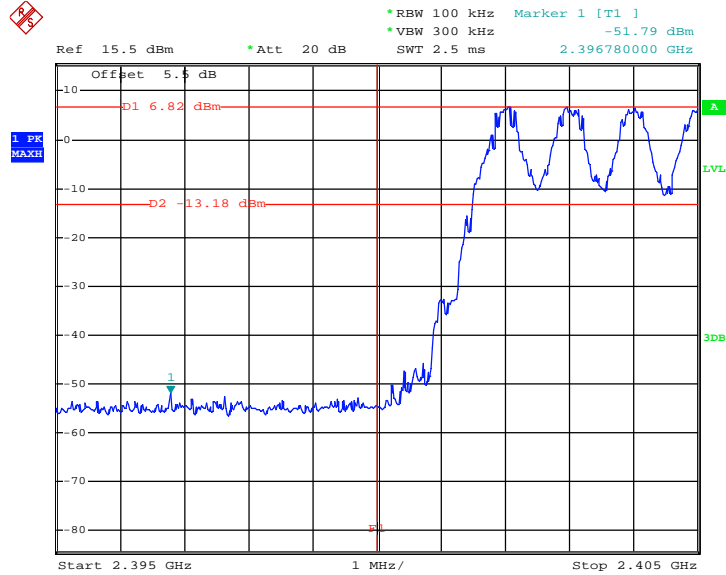

Date: 4.DEC.2015 22:06:24

1Mbps Hopping Mode High Band Edge Plot

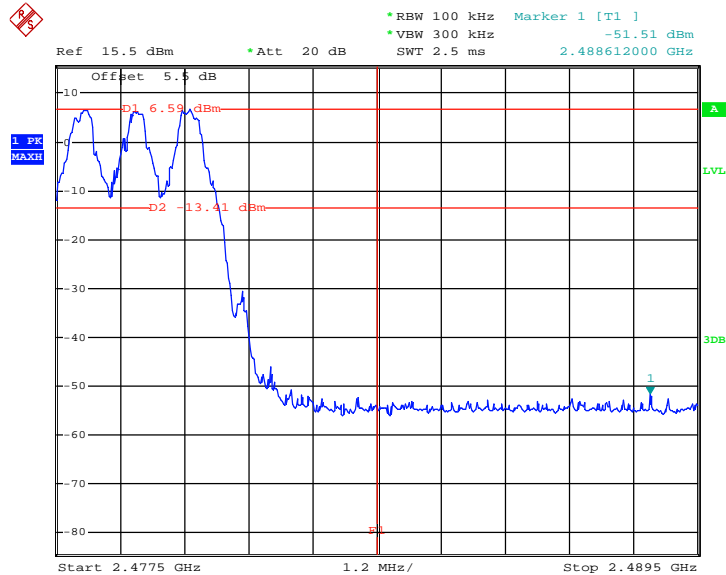

Date: 4.DEC.2015 22:14:04



| | | | |
|-----------------|------------|---------------------|---------|
| Test Mode : | 2Mbps | Temperature : | 24~25°C |
| Test Engineer : | Issac Song | Relative Humidity : | 49~51% |

2Mbps Hopping Mode Low Band Edge Plot

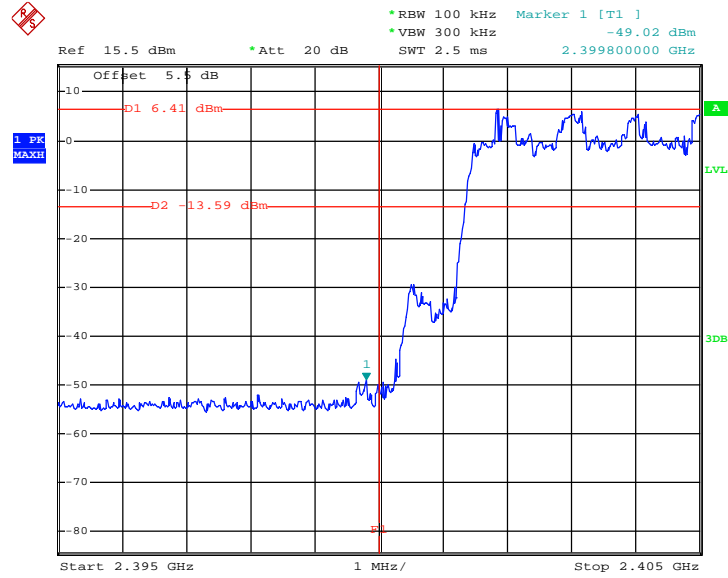

Date: 4.DEC.2015 22:08:21

2Mbps Hopping Mode High Band Edge Plot

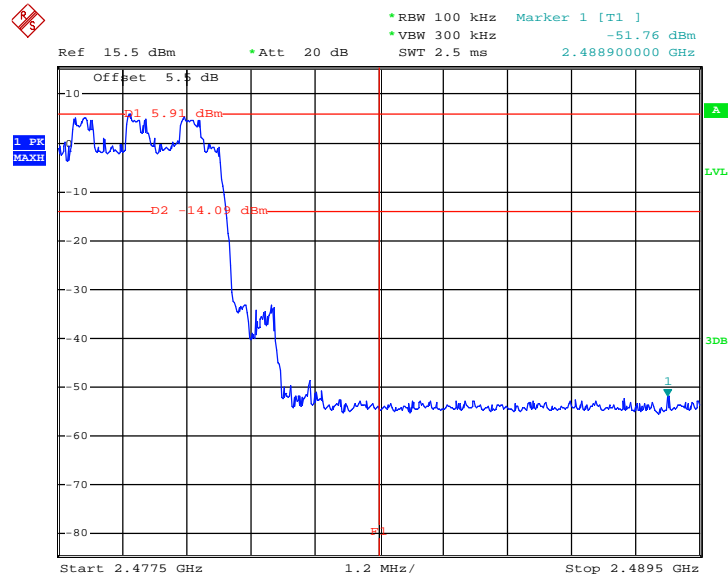

Date: 4.DEC.2015 22:13:25



| | | | |
|-----------------|------------|---------------------|---------|
| Test Mode : | 3Mbps | Temperature : | 24~25°C |
| Test Engineer : | Issac Song | Relative Humidity : | 49~51% |

3Mbps Hopping Mode Low Band Edge Plot

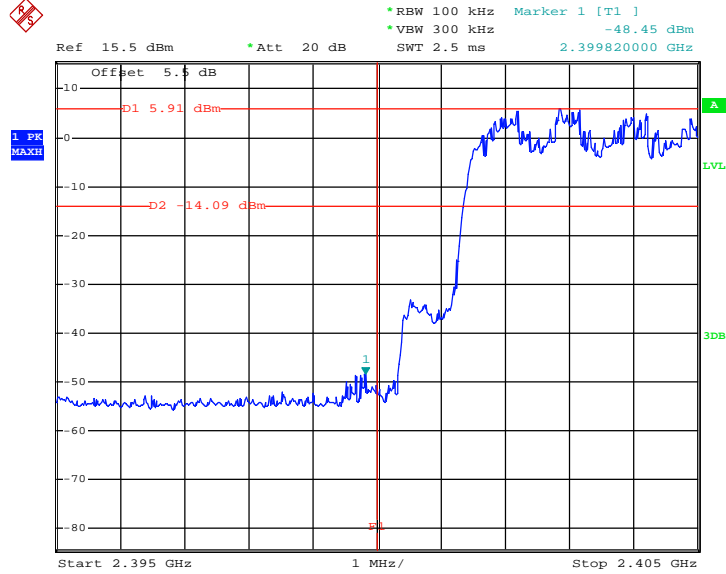

Date: 4.DEC.2015 22:09:44

3Mbps Hopping Mode High Band Edge Plot

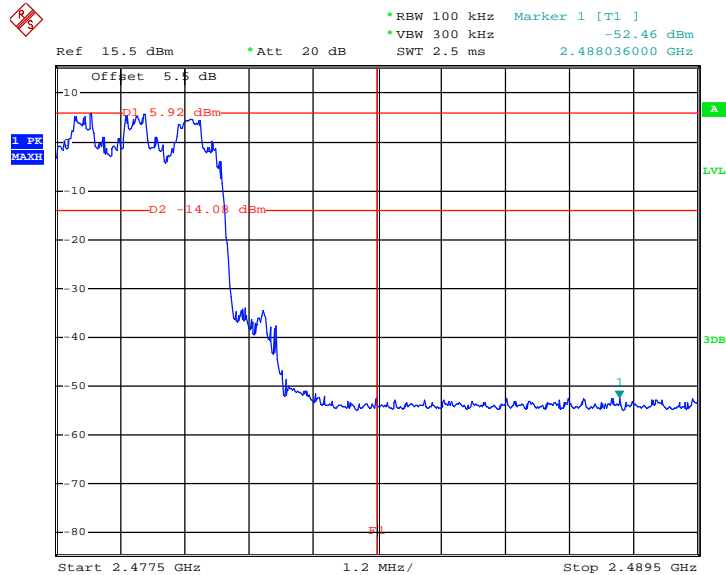

Date: 4.DEC.2015 22:11:55

3.7 Conducted Spurious Emission Measurement

3.7.1 Limit of Spurious Emission Measurement

In any 100 kHz bandwidth outside the intentional radiation frequency band, the radio frequency power shall be at least 20 dB below the highest level of the radiated power. In addition, radiated emissions which fall in the restricted bands must also comply with the radiated emission limits.

3.7.2 Measuring Instruments

The measuring equipment is listed in the section 4 of this test report.

3.7.3 Test Procedure

1. The testing follows the guidelines in Spurious RF Conducted Emissions of FCC Public Notice DA 00-705 Measurement Guidelines
2. The RF output of EUT was connected to the spectrum analyzer by RF cable and attenuator. The path loss was compensated to the results for each measurement.
3. Set to the maximum power setting and enable the EUT transmit continuously.
4. Set RBW = 100 kHz, VBW = 300kHz, scan up through 10th harmonic. All harmonics / spurs must be at least 20 dB down from the highest emission level within the authorized band as measured with a 100 kHz RBW.
5. Measure and record the results in the test report.
6. The RF fundamental frequency should be excluded against the limit line in the operating frequency band.

3.7.4 Test Setup

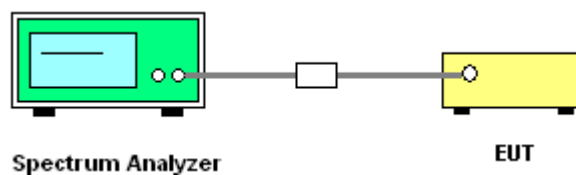



3.7.5 Test Result of Conducted Spurious Emission

| | | | |
|----------------|-------|---------------------|------------|
| Test Mode : | 1Mbps | Temperature : | 24~25°C |
| Test Channel : | 00 | Relative Humidity : | 49~51% |
| | | Test Engineer : | Issac Song |

1Mbps CSE Plot on Ch 00 between 30MHz ~ 3 GHz

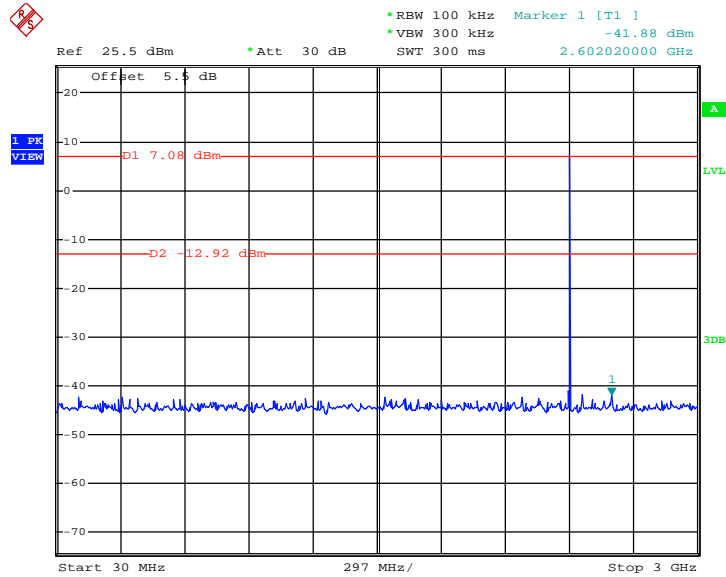

Date: 4.DEC.2015 22:14:48

1Mbps CSE Plot on Ch 00 between 2 GHz ~ 25 GHz

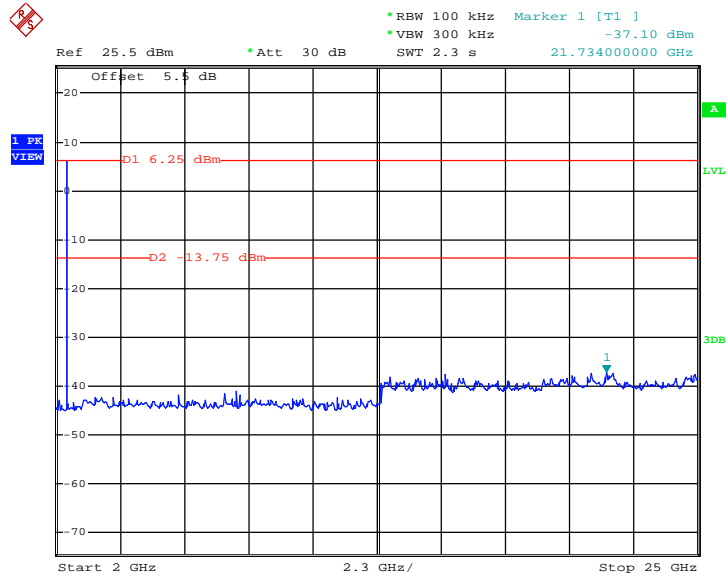

Date: 4.DEC.2015 22:15:10



| | | | |
|----------------|-------|---------------------|------------|
| Test Mode : | 1Mbps | Temperature : | 24~25°C |
| Test Channel : | 39 | Relative Humidity : | 49~51% |
| | | Test Engineer : | Issac Song |

1Mbps CSE Plot on Ch 39 between 30MHz ~ 3 GHz

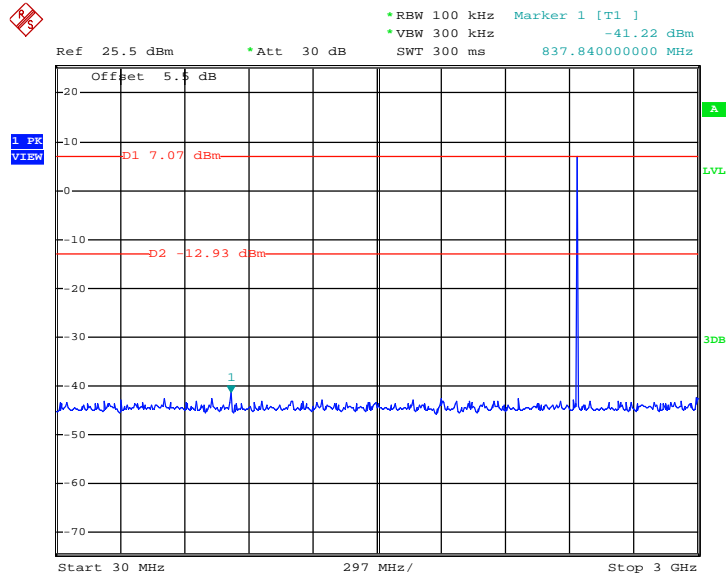

Date: 4.DEC.2015 22:36:40

1Mbps CSE Plot on Ch 39 between 2 GHz ~ 25 GHz

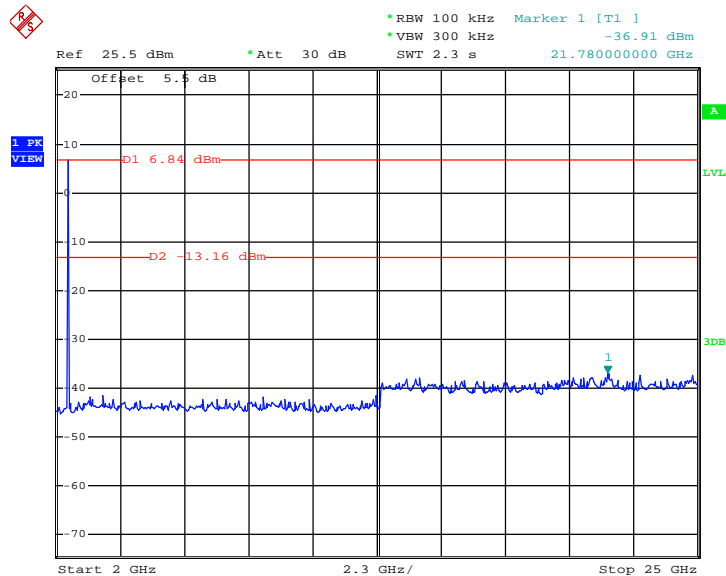

Date: 4.DEC.2015 22:37:02



| | | | |
|----------------|-------|---------------------|------------|
| Test Mode : | 1Mbps | Temperature : | 24~25°C |
| Test Channel : | 78 | Relative Humidity : | 49~51% |
| | | Test Engineer : | Issac Song |

1Mbps CSE Plot on Ch 78 between 30MHz ~ 3 GHz

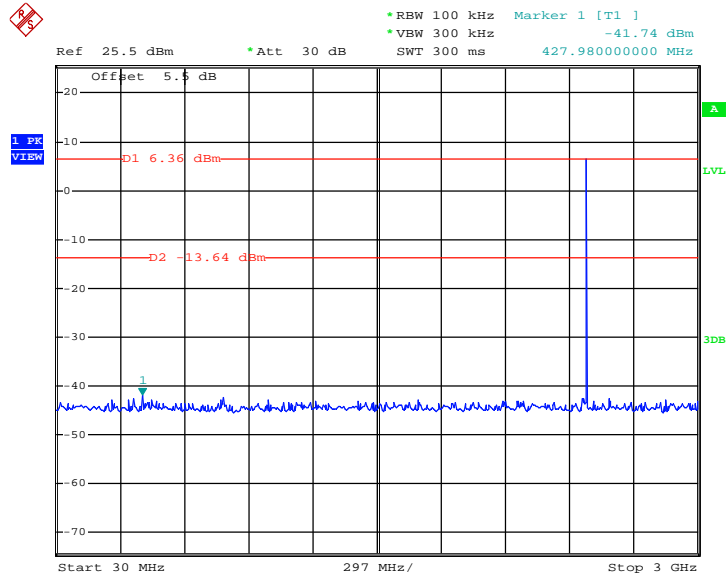

Date: 4.DEC.2015 22:57:30

1Mbps CSE Plot on Ch 78 between 2 GHz ~ 25 GHz

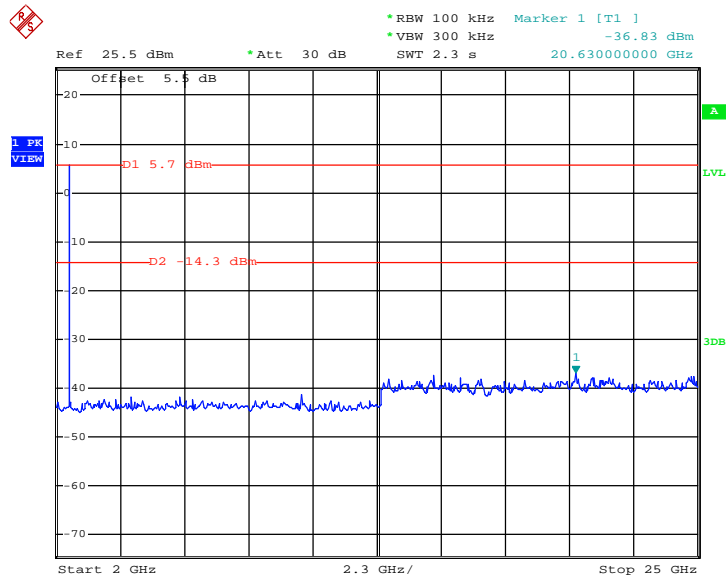

Date: 4.DEC.2015 22:57:52



| | | | |
|----------------|-------|---------------------|------------|
| Test Mode : | 2Mbps | Temperature : | 24~25°C |
| Test Channel : | 00 | Relative Humidity : | 49~51% |
| | | Test Engineer : | Issac Song |

2Mbps CSE Plot on Ch 00 between 30MHz ~ 3 GHz

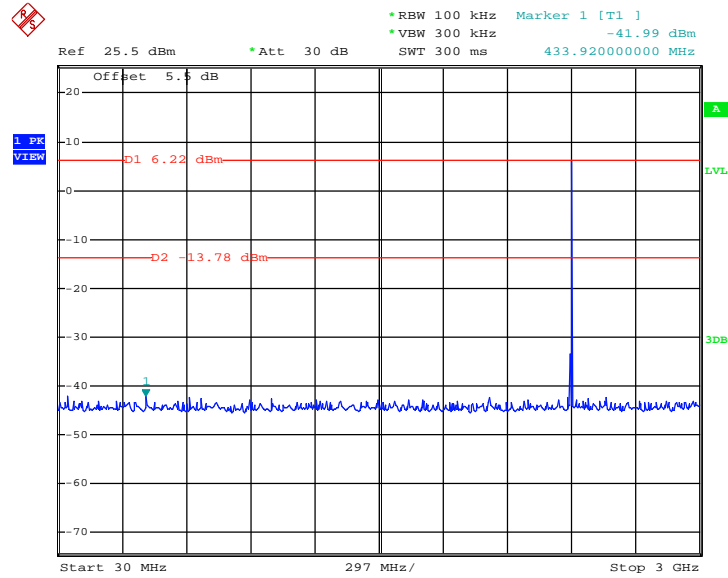

Date: 4.DEC.2015 22:21:12

2Mbps CSE Plot on Ch 00 between 2 GHz ~ 25 GHz

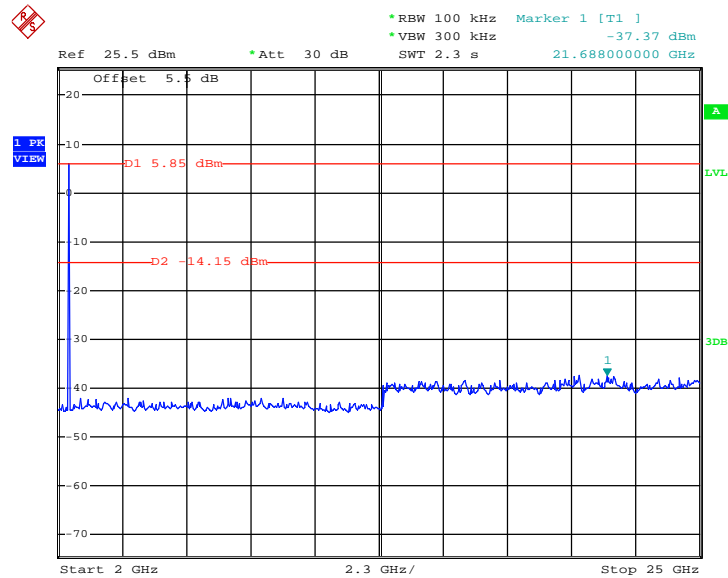

Date: 4.DEC.2015 22:21:34



| | | | |
|----------------|-------|---------------------|------------|
| Test Mode : | 2Mbps | Temperature : | 24~25°C |
| Test Channel : | 39 | Relative Humidity : | 49~51% |
| | | Test Engineer : | Issac Song |

2Mbps CSE Plot on Ch 39 between 30MHz ~ 3 GHz

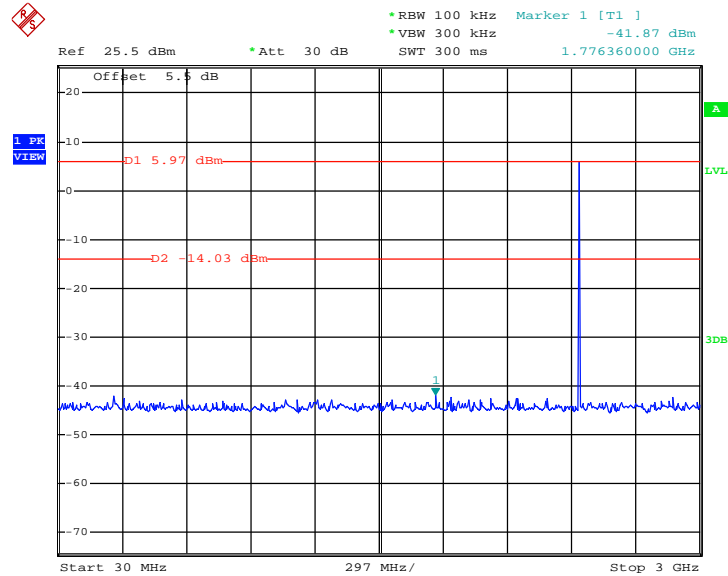

Date: 4.DEC.2015 22:41:56

2Mbps CSE Plot on Ch 39 between 2 GHz ~ 25 GHz

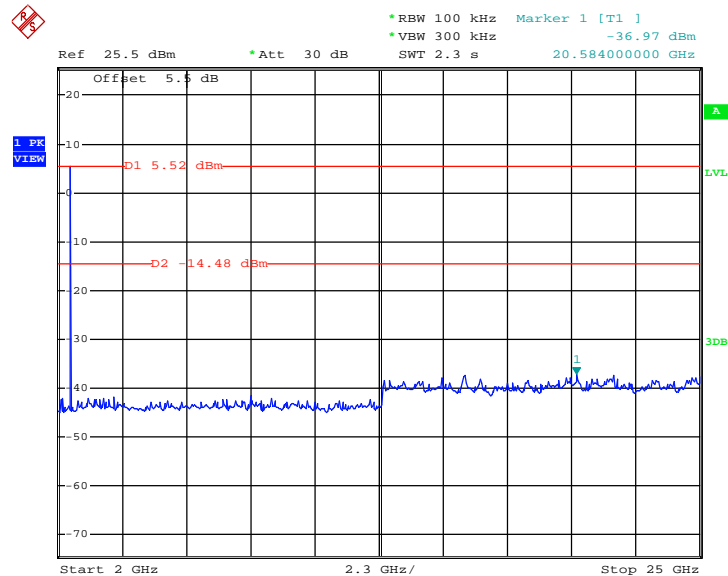

Date: 4.DEC.2015 22:42:18



| | | | |
|----------------|-------|---------------------|------------|
| Test Mode : | 2Mbps | Temperature : | 24~25°C |
| Test Channel : | 78 | Relative Humidity : | 49~51% |
| | | Test Engineer : | Issac Song |

2Mbps CSE Plot on Ch 78 between 30MHz ~ 3 GHz

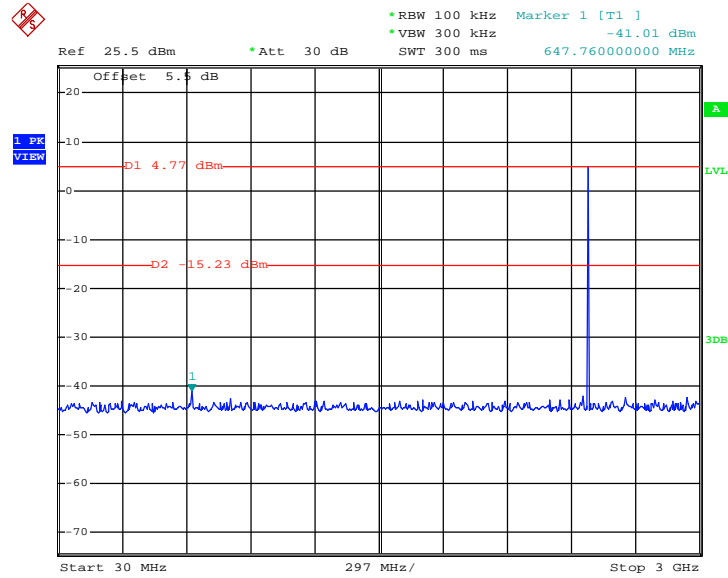

Date: 4.DEC.2015 23:00:39

2Mbps CSE Plot on Ch 78 between 2 GHz ~ 25 GHz

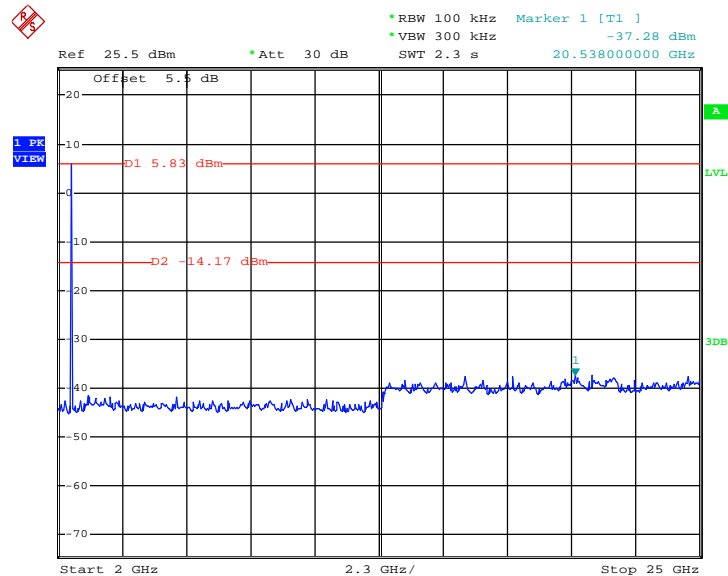

Date: 4.DEC.2015 23:01:01



| | | | |
|----------------|-------|---------------------|------------|
| Test Mode : | 3Mbps | Temperature : | 24~25°C |
| Test Channel : | 00 | Relative Humidity : | 49~51% |
| | | Test Engineer : | Issac Song |

3Mbps CSE Plot on Ch 00 between 30MHz ~ 3 GHz

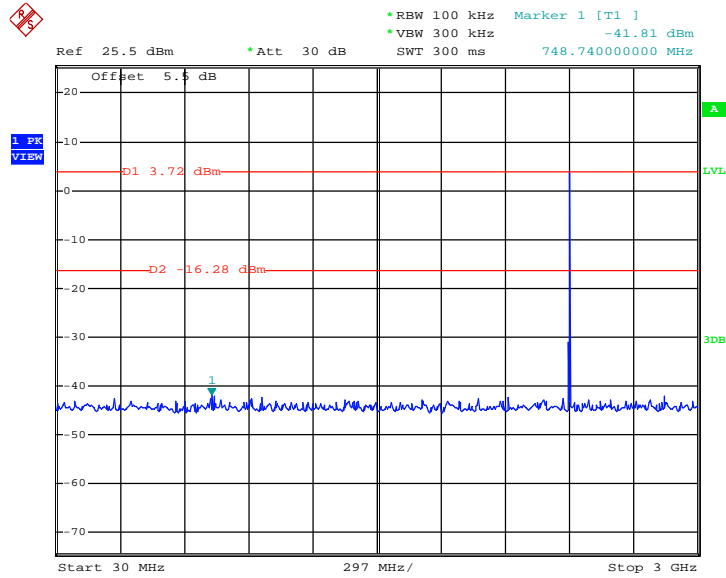

Date: 4.DEC.2015 23:13:22

3Mbps CSE Plot on Ch 00 between 2 GHz ~ 25 GHz

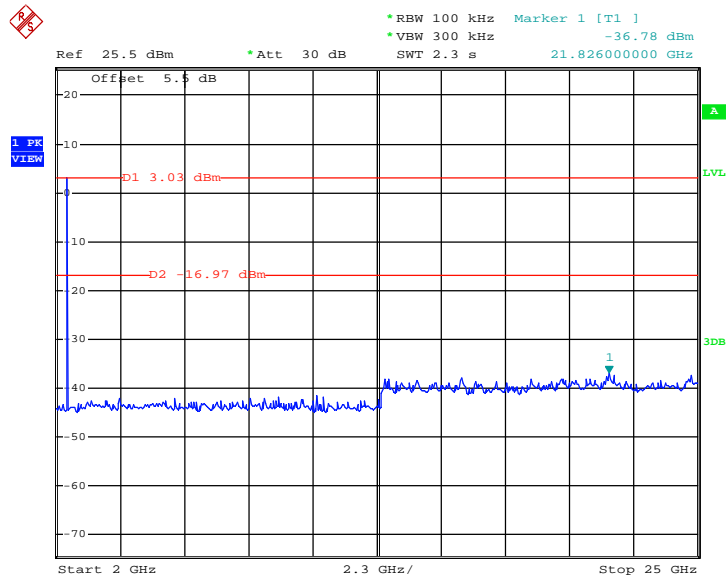

Date: 4.DEC.2015 23:13:44



| | | | |
|----------------|-------|---------------------|------------|
| Test Mode : | 3Mbps | Temperature : | 24~25°C |
| Test Channel : | 39 | Relative Humidity : | 49~51% |
| | | Test Engineer : | Issac Song |

3Mbps CSE Plot on Ch 39 between 30MHz ~ 3 GHz

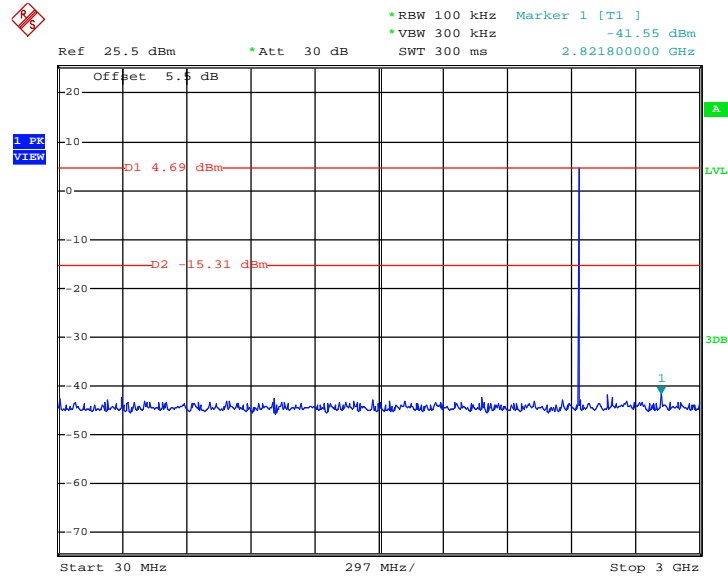

Date: 4.DEC.2015 22:56:37

3Mbps CSE Plot on Ch 39 between 2 GHz ~ 25 GHz

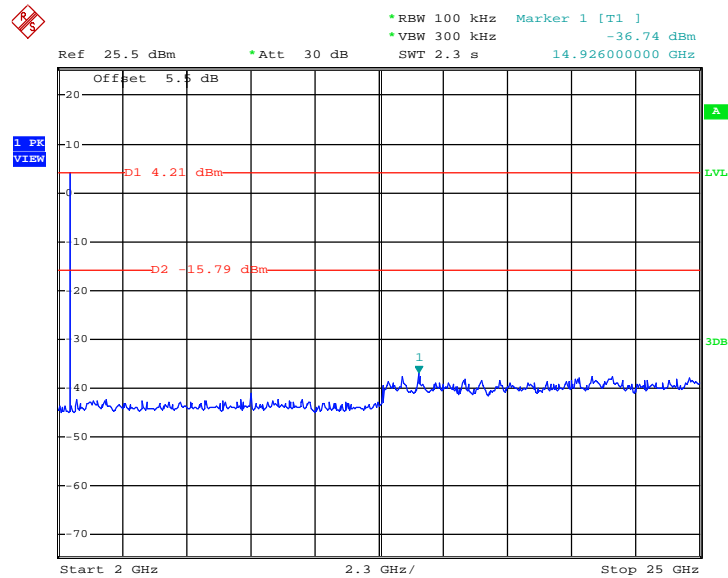

Date: 4.DEC.2015 22:56:59



| | | | |
|----------------|-------|---------------------|------------|
| Test Mode : | 3Mbps | Temperature : | 24~25°C |
| Test Channel : | 78 | Relative Humidity : | 49~51% |
| | | Test Engineer : | Issac Song |

3Mbps CSE Plot on Ch 78 between 30MHz ~ 3 GHz

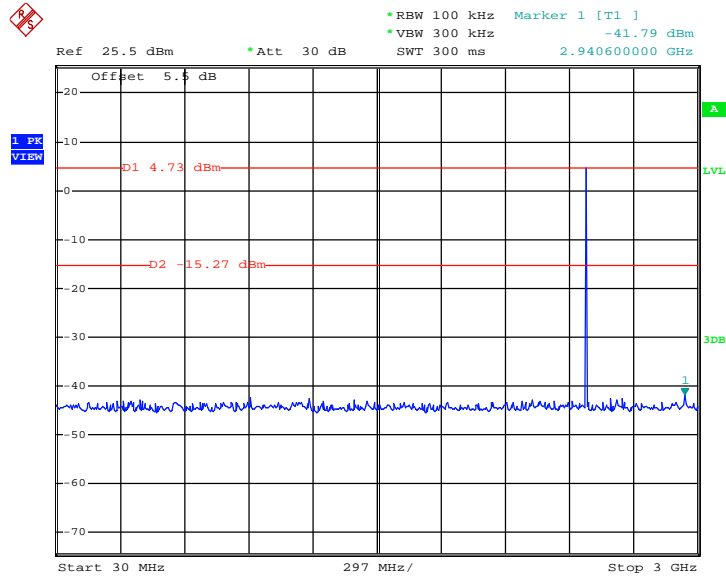

Date: 4.DEC.2015 23:09:42

3Mbps CSE Plot on Ch 78 between 2 GHz ~ 25 GHz

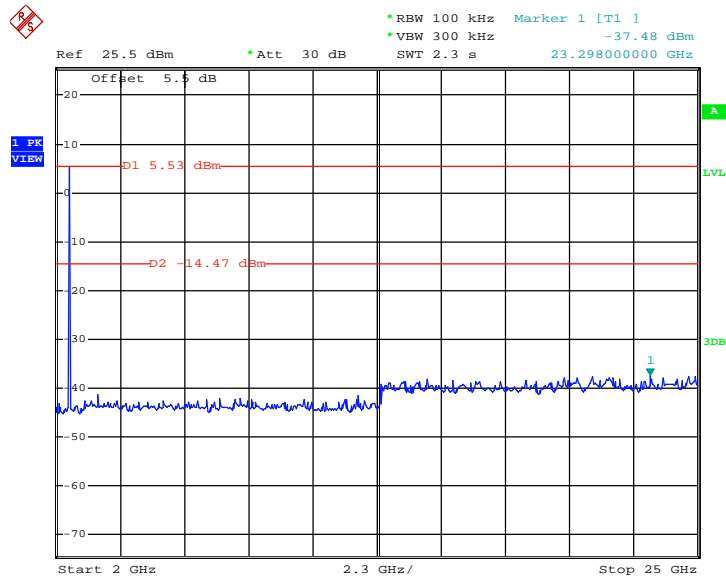

Date: 4.DEC.2015 23:10:04



3.8 Radiated Band Edges and Spurious Emission Measurement

3.8.1 Limit of Radiated Band Edges and Spurious Emission

In any 100 kHz bandwidth outside the intentional radiator frequency band, all harmonics/spurious must be at least 20 dB below the highest emission level within the authorized band. In addition, radiated emissions which fall in the restricted bands must also comply with the FCC section 15.209 limits as below.

| Frequency (MHz) | Field Strength (microvolts/meter) | Measurement Distance (meters) |
|-----------------|-----------------------------------|-------------------------------|
| 0.009 – 0.490 | 2400/F(kHz) | 300 |
| 0.490 – 1.705 | 24000/F(kHz) | 30 |
| 1.705 – 30.0 | 30 | 30 |
| 30 – 88 | 100 | 3 |
| 88 – 216 | 150 | 3 |
| 216 - 960 | 200 | 3 |
| Above 960 | 500 | 3 |

3.8.2 Measuring Instruments

The measuring equipment is listed in the section 4 of this test report.



3.8.3 Test Procedures

1. The EUT was placed on a turntable with 0.8 meter for frequency below 1GHz and 1.5 meter for frequency above 1GHz respectively above ground.
2. The EUT was set 3 meters from the interference receiving antenna, which was mounted on the top of a variable height antenna tower.
3. For each suspected emission, the EUT was arranged to its worst case and then tune the Antenna tower (from 1 m to 4 m) and turntable (from 0 degree to 360 degrees) to find the maximum reading. A pre-amp and a high pass filter are used for the test in order to get better signal level to comply with the guidelines.
4. Set to the maximum power setting and enable the EUT transmit continuously.
5. Use the following spectrum analyzer settings:
 - (1) Span shall wide enough to fully capture the emission being measured;
 - (2) Set RBW=100 kHz for $f < 1$ GHz, RBW=1MHz for $f > 1$ GHz ; VBW \geq RBW; Sweep = auto; Detector function = peak; Trace = max hold for peak
 - (3) For average measurement: use duty cycle correction factor method per 15.35(c).
Duty cycle = On time/100 milliseconds
On time = $N_1 * L_1 + N_2 * L_2 + \dots + N_{n-1} * L_{n-1} + N_n * L_n$
Where N_1 is number of type 1 pulses, L_1 is length of type 1 pulses, etc.
Average Emission Level = Peak Emission Level + $20 * \log(\text{Duty cycle})$
6. Corrected Reading: Antenna Factor + Cable Loss + Read Level - Preamp Factor = Level

Note: The average levels were calculated from the peak level corrected with duty cycle correction factor (-24.82dB) derived from $20 \log(\text{dwell time}/100\text{ms})$. This correction is only for signals that hop with the fundamental signal, such as band-edge and harmonic. Other spurious signals that are independent of the hopping signal would not use this correction.

3.8.4 Test Setup

For radiated emissions below 30MHz

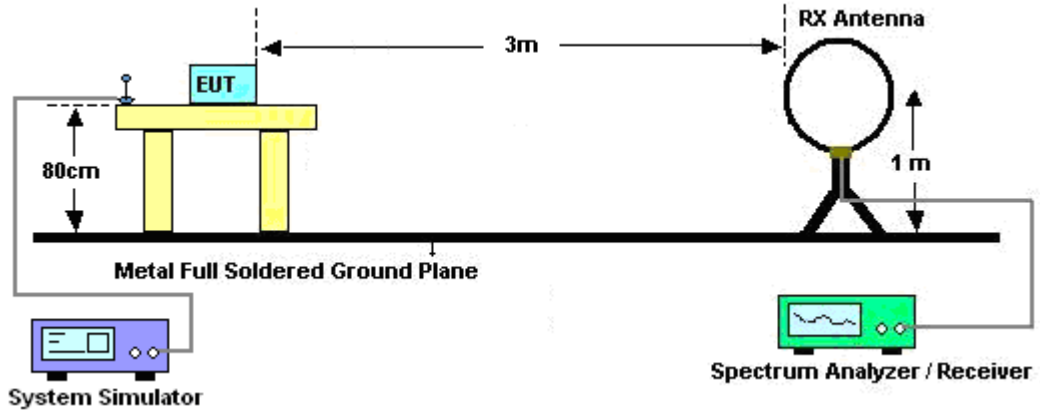

For radiated emissions from 30MHz to 1GHz

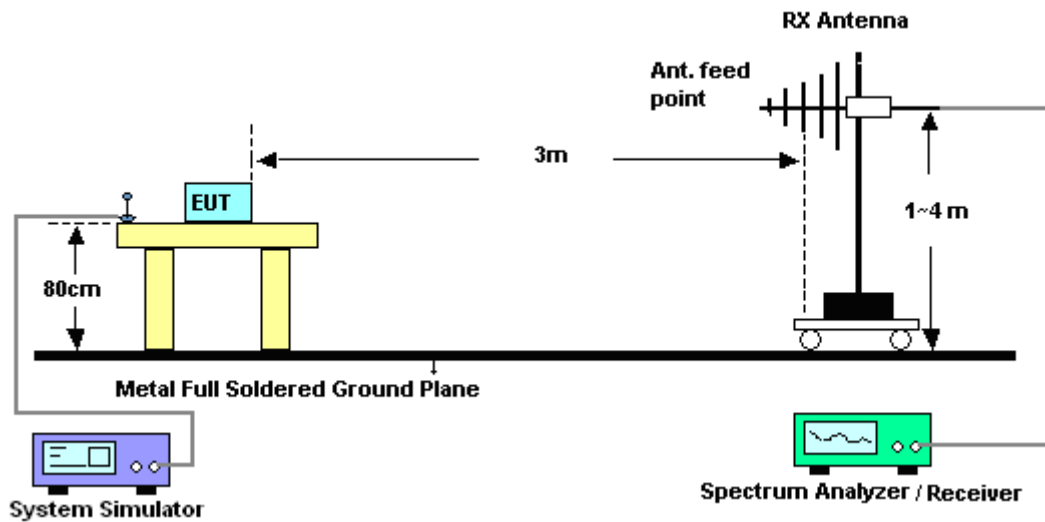

For radiated emissions above 1GHz

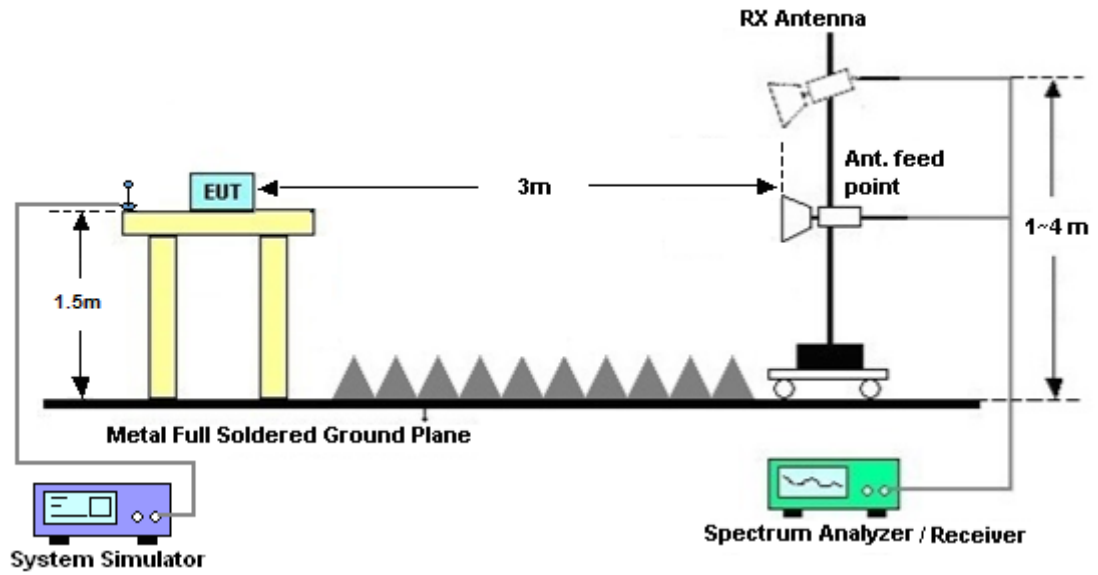

3.8.5 Test Results of Radiated Spurious Emissions (9 kHz ~ 30 MHz)

The low frequency, which started from 9 kHz to 30MHz, was pre-scanned and the result which was 20dB lower than the limit line per 15.31(o) was not reported.

3.8.6 Duty cycle correction factor for average measurement

DH5 on time (One Pulse) Plot on Channel 39

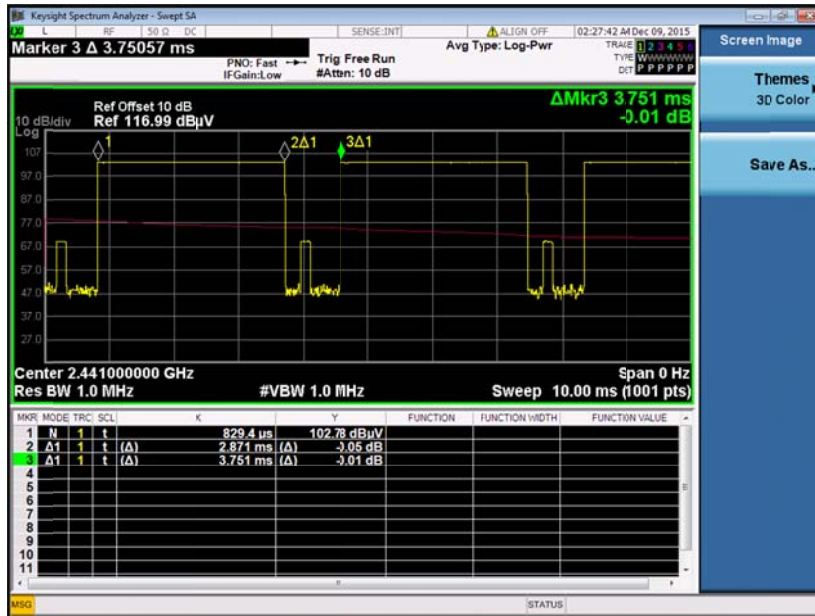

DH5 on time (Count Pulses) Plot on Channel 39



Note:

1. Worst case Duty cycle = on time/100 milliseconds = $2 * 2.87 / 100 = 5.74 \%$
2. Worst case Duty cycle correction factor = $20 * \log(\text{Duty cycle}) = -24.82 \text{ dB}$
3. DH5 has the highest duty cycle worst case and is reported.



Duty Cycle Correction Factor Consideration for AFH mode:

Bluetooth normal hopping rate is 1600Hz and reduced to 800Hz in AFH mode; due to the reduced number of hopping frequencies, with the same packet configuration the dwell time in each channel frequency within 100msec period is longer in AFH mode than normal mode.

In AFH mode, the minimum hopping frequencies are 20, to get the longest dwell time DH5 packet is observed; the period to have DH5 packet completing one hopping sequence is

$$2.87 \text{ ms} \times 20 \text{ channels} = 57.4 \text{ ms}$$

There cannot be 2 complete hopping sequences within 100ms period, considering the random hopping behavior, maximum 2 hops can be possibly observed within the period. $[100\text{ms} / 57.4\text{ms}] = 2$ hops

Thus, the maximum possible ON time:

$$2.87 \text{ ms} \times 2 = 5.74 \text{ ms}$$

Worst case Duty Cycle Correction factor, which is derived from the maximum possible ON time,

$$20 \times \log(5.74 \text{ ms}/100\text{ms}) = -24.82 \text{ dB}$$

3.8.7 Test Result of Radiated Spurious at Band Edges

Please refer to Appendix A.

3.8.8 Test Result of Radiated Spurious Emission (30MHz ~ 10th Harmonic)

Please refer to Appendix A.

3.9 AC Conducted Emission Measurement

3.9.1 Limit of AC Conducted Emission

For equipment that is designed to be connected to the public utility (AC) power line, the radio frequency voltage that is conducted back onto the AC power line on any frequency or frequencies within the band 150 kHz to 30 MHz shall not exceed the limits in the following table.

| Frequency of emission (MHz) | Conducted limit (dB μ V) | |
|-----------------------------|------------------------------|-----------|
| | Quasi-peak | Average |
| 0.15-0.5 | 66 to 56* | 56 to 46* |
| 0.5-5 | 56 | 46 |
| 5-30 | 60 | 50 |

*Decreases with the logarithm of the frequency.

3.9.2 Measuring Instruments

The measuring equipment is listed in the section 4 of this test report.

3.9.3 Test Procedures

1. The EUT was placed 0.4 meter from the conducting wall of the shielding room was kept at least 80 centimeters from any other grounded conducting surface.
2. Connect EUT to the power mains through a line impedance stabilization network (LISN).
3. All the support units are connecting to the other LISN.
4. The LISN provides 50 ohm coupling impedance for the measuring instrument.
5. The FCC states that a 50 ohm, 50 microhenry LISN should be used.
6. Both sides of AC line were checked for maximum conducted interference.
7. The frequency range from 150 kHz to 30 MHz was searched.
8. Set the test-receiver system to Peak Detect Function and specified bandwidth (IF Bandwidth = 9kHz) with Maximum Hold Mode. Then measurement is also conducted by Average Detector and Quasi-Peak Detector Function respectively.

3.9.4 Test Setup

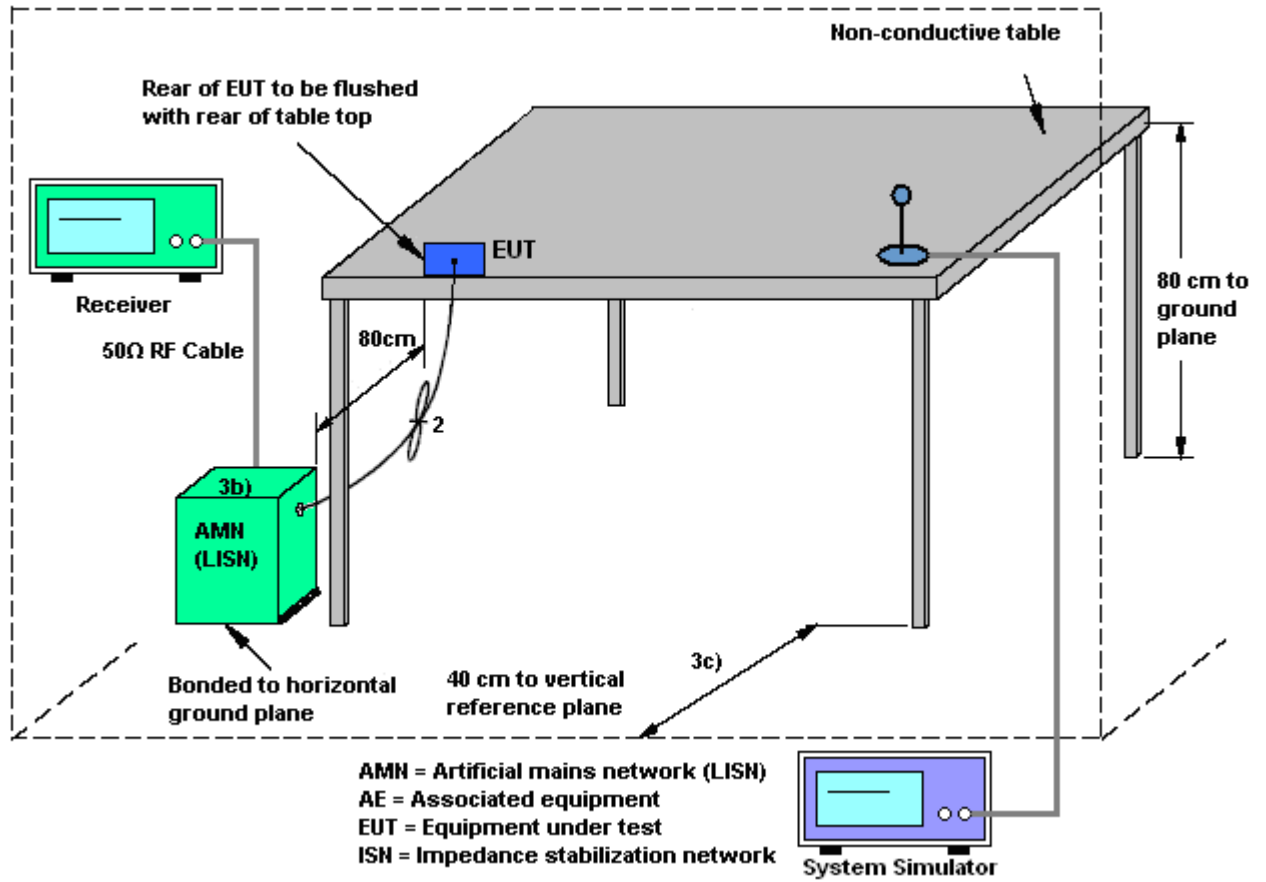



3.9.5 Test Result of AC Conducted Emission

| | | | |
|-----------------|---|---------------------|---------|
| Test Mode : | Mode 1 | Temperature : | 22~24°C |
| Test Engineer : | Amos Zhang | Relative Humidity : | 44~46% |
| Test Voltage : | 120Vac / 60Hz | Phase : | Line |
| Function Type : | GSM850 Idle + Bluetooth Link + WLAN Link + Earphone + USB Cable (Charging from Adapter) | | |

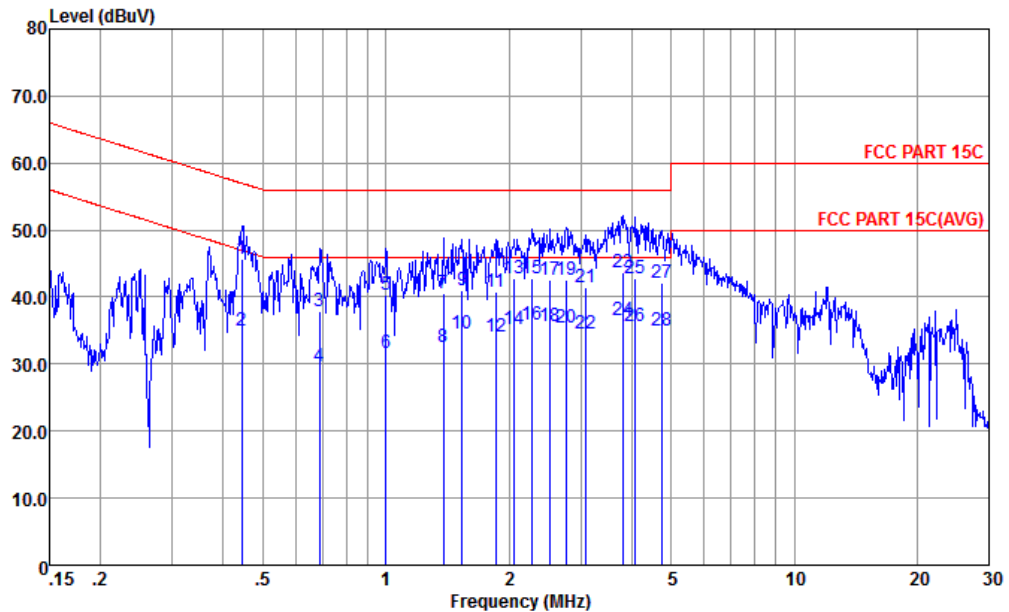

Site : CO01-KS
 Condition : FCC PART 15C LISN-L-20151024 LINE

| | Freq | Level | Over Limit | Limit Line | Read Level | LISN Factor | Cable Loss | Remark |
|----|------|-------|------------|------------|------------|-------------|------------|---------|
| | MHz | dBuV | dB | dBuV | dBuV | dB | dB | |
| 1 | 0.44 | 45.60 | -11.38 | 56.98 | 35.20 | 0.23 | 10.17 | QP |
| 2 | 0.44 | 35.00 | -11.98 | 46.98 | 24.60 | 0.23 | 10.17 | Average |
| 3 | 0.69 | 37.89 | -18.11 | 56.00 | 27.50 | 0.24 | 10.15 | QP |
| 4 | 0.69 | 29.59 | -16.41 | 46.00 | 19.20 | 0.24 | 10.15 | Average |
| 5 | 1.00 | 40.29 | -15.71 | 56.00 | 29.90 | 0.25 | 10.14 | QP |
| 6 | 1.00 | 31.69 | -14.31 | 46.00 | 21.30 | 0.25 | 10.14 | Average |
| 7 | 1.38 | 40.46 | -15.54 | 56.00 | 30.10 | 0.22 | 10.14 | QP |
| 8 | 1.38 | 32.46 | -13.54 | 46.00 | 22.10 | 0.22 | 10.14 | Average |
| 9 | 1.54 | 40.95 | -15.05 | 56.00 | 30.60 | 0.21 | 10.14 | QP |
| 10 | 1.54 | 34.65 | -11.35 | 46.00 | 24.30 | 0.21 | 10.14 | Average |
| 11 | 1.86 | 40.83 | -15.17 | 56.00 | 30.50 | 0.19 | 10.14 | QP |
| 12 | 1.86 | 34.13 | -11.87 | 46.00 | 23.80 | 0.19 | 10.14 | Average |
| 13 | 2.07 | 42.82 | -13.18 | 56.00 | 32.50 | 0.18 | 10.14 | QP |
| 14 | 2.07 | 35.12 | -10.88 | 46.00 | 24.80 | 0.18 | 10.14 | Average |
| 15 | 2.28 | 42.83 | -13.17 | 56.00 | 32.50 | 0.18 | 10.15 | QP |
| 16 | 2.28 | 35.93 | -10.07 | 46.00 | 25.60 | 0.18 | 10.15 | Average |
| 17 | 2.53 | 42.53 | -13.47 | 56.00 | 32.20 | 0.18 | 10.15 | QP |



| | | | |
|-----------------|---|---------------------|---------|
| Test Mode : | Mode 1 | Temperature : | 22~24°C |
| Test Engineer : | Amos Zhang | Relative Humidity : | 44~46% |
| Test Voltage : | 120Vac / 60Hz | Phase : | Line |
| Function Type : | GSM850 Idle + Bluetooth Link + WLAN Link + Earphone + USB Cable (Charging from Adapter) | | |

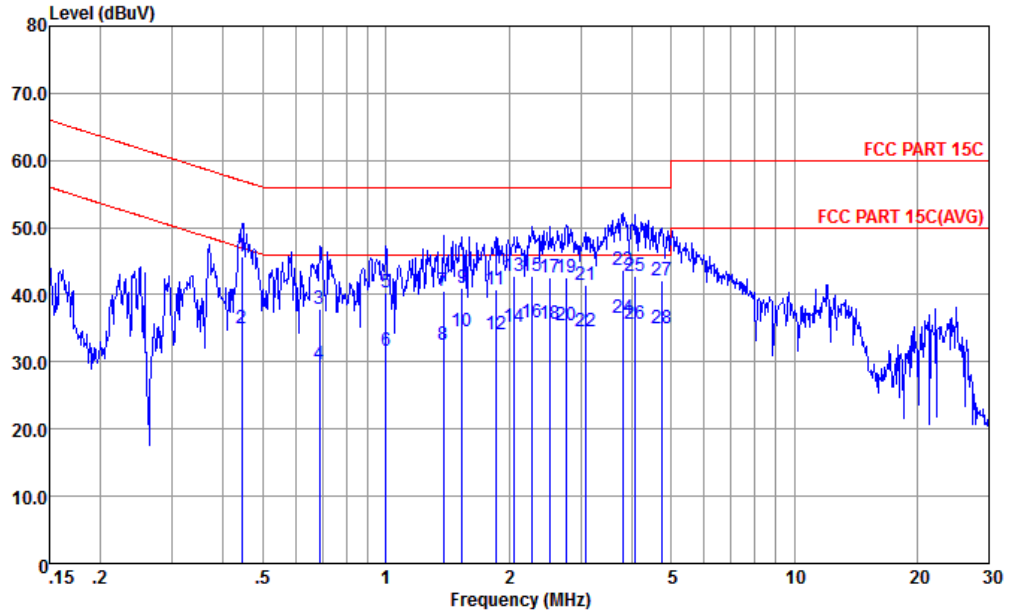

Site : CO01-KS
 Condition : FCC PART 15C LISN-L-20151024 LINE

| | Freq | Level | Over Limit | Limit Line | Read Level | LISN Factor | Cable Loss | Remark |
|------|------|-------|------------|------------|------------|-------------|------------|---------|
| | MHz | dBuV | dB | dBuV | dBuV | dB | dB | |
| 18 | 2.53 | 35.63 | -10.37 | 46.00 | 25.30 | 0.18 | 10.15 | Average |
| 19 | 2.76 | 42.63 | -13.37 | 56.00 | 32.30 | 0.18 | 10.15 | QP |
| 20 | 2.76 | 35.53 | -10.47 | 46.00 | 25.20 | 0.18 | 10.15 | Average |
| 21 | 3.07 | 41.54 | -14.46 | 56.00 | 31.21 | 0.18 | 10.15 | QP |
| 22 | 3.07 | 34.54 | -11.46 | 46.00 | 24.21 | 0.18 | 10.15 | Average |
| 23 | 3.80 | 43.65 | -12.35 | 56.00 | 33.30 | 0.19 | 10.16 | QP |
| 24 * | 3.80 | 36.65 | -9.35 | 46.00 | 26.30 | 0.19 | 10.16 | Average |
| 25 | 4.09 | 42.86 | -13.14 | 56.00 | 32.50 | 0.19 | 10.17 | QP |
| 26 | 4.09 | 35.66 | -10.34 | 46.00 | 25.30 | 0.19 | 10.17 | Average |
| 27 | 4.75 | 42.17 | -13.83 | 56.00 | 31.80 | 0.19 | 10.18 | QP |
| 28 | 4.75 | 34.97 | -11.03 | 46.00 | 24.60 | 0.19 | 10.18 | Average |



| | | | |
|-----------------|---|---------------------|---------|
| Test Mode : | Mode 1 | Temperature : | 22~24°C |
| Test Engineer : | Amos Zhang | Relative Humidity : | 44~46% |
| Test Voltage : | 120Vac / 60Hz | Phase : | Neutral |
| Function Type : | GSM850 Idle + Bluetooth Link + WLAN Link + Earphone + USB Cable (Charging from Adapter) | | |

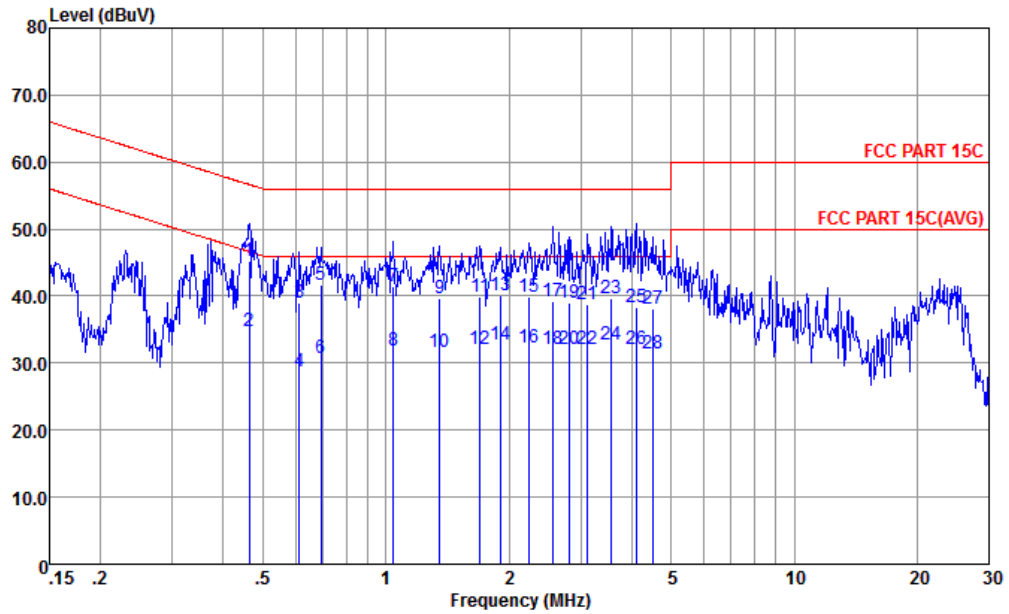

Site : CO01-KS
 Condition : FCC PART 15C LISN-N-20151024 NEUTRAL

| | Freq | Level | Over Limit | Limit Line | Read Level | LISN Factor | Cable Loss | Remark |
|-----|------|-------|------------|------------|------------|-------------|------------|---------|
| | MHz | dBuV | dB | dBuV | dBuV | dB | dB | |
| 1 * | 0.46 | 45.18 | -11.45 | 56.63 | 34.70 | 0.32 | 10.16 | QP |
| 2 | 0.46 | 34.68 | -11.95 | 46.63 | 24.20 | 0.32 | 10.16 | Average |
| 3 | 0.61 | 39.09 | -16.91 | 56.00 | 28.60 | 0.33 | 10.16 | QP |
| 4 | 0.61 | 28.69 | -17.31 | 46.00 | 18.20 | 0.33 | 10.16 | Average |
| 5 | 0.69 | 41.69 | -14.31 | 56.00 | 31.20 | 0.34 | 10.15 | QP |
| 6 | 0.69 | 30.79 | -15.21 | 46.00 | 20.30 | 0.34 | 10.15 | Average |
| 7 | 1.04 | 41.41 | -14.59 | 56.00 | 30.90 | 0.37 | 10.14 | QP |
| 8 | 1.04 | 31.81 | -14.19 | 46.00 | 21.30 | 0.37 | 10.14 | Average |
| 9 | 1.35 | 39.71 | -16.29 | 56.00 | 29.20 | 0.37 | 10.14 | QP |
| 10 | 1.35 | 31.71 | -14.29 | 46.00 | 21.20 | 0.37 | 10.14 | Average |
| 11 | 1.70 | 39.82 | -16.18 | 56.00 | 29.30 | 0.38 | 10.14 | QP |
| 12 | 1.70 | 32.02 | -13.98 | 46.00 | 21.50 | 0.38 | 10.14 | Average |
| 13 | 1.91 | 40.22 | -15.78 | 56.00 | 29.70 | 0.38 | 10.14 | QP |
| 14 | 1.91 | 32.72 | -13.28 | 46.00 | 22.20 | 0.38 | 10.14 | Average |
| 15 | 2.25 | 39.82 | -16.18 | 56.00 | 29.30 | 0.38 | 10.14 | QP |
| 16 | 2.25 | 32.42 | -13.58 | 46.00 | 21.90 | 0.38 | 10.14 | Average |
| 17 | 2.57 | 39.32 | -16.68 | 56.00 | 28.80 | 0.37 | 10.15 | QP |



| | | | |
|-----------------|---|---------------------|---------|
| Test Mode : | Mode 1 | Temperature : | 22~24°C |
| Test Engineer : | Amos Zhang | Relative Humidity : | 44~46% |
| Test Voltage : | 120Vac / 60Hz | Phase : | Neutral |
| Function Type : | GSM850 Idle + Bluetooth Link + WLAN Link + Earphone + USB Cable (Charging from Adapter) | | |

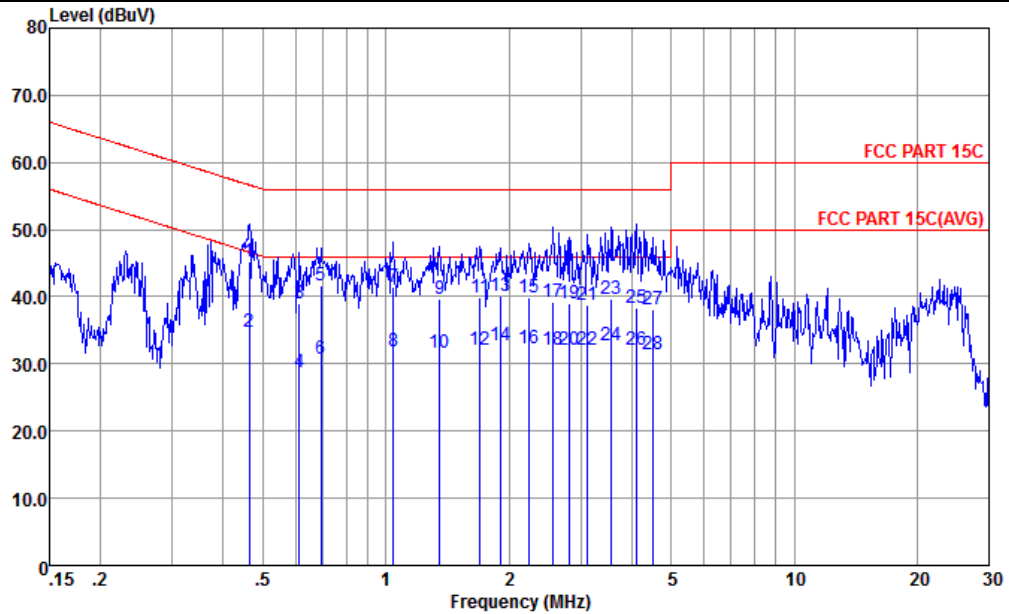

Site : CO01-KS
 Condition : FCC PART 15C LISN-N-20151024 NEUTRAL

| | Freq | Level | Over Limit | Limit Line | Read Level | LISN Factor | Cable Loss | Remark |
|----|------|-------|------------|------------|------------|-------------|------------|---------|
| | MHz | dBuV | dB | dBuV | dBuV | dB | dB | |
| 18 | 2.57 | 32.12 | -13.88 | 46.00 | 21.60 | 0.37 | 10.15 | Average |
| 19 | 2.81 | 39.02 | -16.98 | 56.00 | 28.50 | 0.37 | 10.15 | QP |
| 20 | 2.81 | 32.12 | -13.88 | 46.00 | 21.60 | 0.37 | 10.15 | Average |
| 21 | 3.11 | 38.83 | -17.17 | 56.00 | 28.30 | 0.37 | 10.16 | QP |
| 22 | 3.11 | 32.03 | -13.97 | 46.00 | 21.50 | 0.37 | 10.16 | Average |
| 23 | 3.57 | 39.63 | -16.37 | 56.00 | 29.10 | 0.37 | 10.16 | QP |
| 24 | 3.57 | 32.83 | -13.17 | 46.00 | 22.30 | 0.37 | 10.16 | Average |
| 25 | 4.11 | 38.43 | -17.57 | 56.00 | 27.90 | 0.36 | 10.17 | QP |
| 26 | 4.11 | 32.13 | -13.87 | 46.00 | 21.60 | 0.36 | 10.17 | Average |
| 27 | 4.50 | 38.04 | -17.96 | 56.00 | 27.51 | 0.36 | 10.17 | QP |
| 28 | 4.50 | 31.44 | -14.56 | 46.00 | 20.91 | 0.36 | 10.17 | Average |



3.10 Antenna Requirements

3.10.1 Standard Applicable

If directional gain of transmitting antennas is greater than 6dBi, the power shall be reduced by the same level in dB comparing to gain minus 6dBi. The use of a permanently attached antenna or of an antenna that uses a unique coupling to the intentional radiator shall be considered sufficient to comply with the FCC rule.

3.10.2 Antenna Anti-Replacement Construction

An embedded-in antenna design is used.

3.10.3 Antenna Gain

The antenna peak gain of EUT is less than 6 dBi. Therefore, it is not necessary to reduce maximum peak output power limit.



4 List of Measuring Equipment

| Instrument | Manufacturer | Model No. | Serial No. | Characteristics | Calibration Date | Test Date | Due Date | Remark |
|---|--------------|-----------|------------------|----------------------------|------------------|---------------------------------|---------------|--------------------------|
| Spectrum Analyzer | R&S | FSP40 | 100319 | 9kHz~40GHz | Oct. 24, 2015 | Nov. 26, 2015~ Dec. 19, 2015 | Oct. 23, 2016 | Conducted (TH01-KS) |
| Spectrum Analyzer | R&S | FSV30 | 101338 | 9kHz~30GHz | May 04, 2015 | Nov. 26, 2015~ Dec. 19, 2015 | May 03, 2016 | Conducted (TH01-KS) |
| Pulse Power Sensor | Anritsu | MA2411B | 0917070 | 30MHz~40GHz | Jan. 23, 2015 | Nov. 26, 2015~ Dec. 19, 2015 | Jan. 22, 2016 | Conducted (TH01-KS) |
| Power Meter | Anritsu | ML2495A | 1005002 | 50MHz Bandwidth | Jan. 23, 2015 | Nov. 26, 2015~ Dec. 19, 2015 | Jan. 22, 2016 | Conducted (TH01-KS) |
| EMI Test Receiver | R&S | ESR7 | 101403 | 9kHz~7GHz;Ma x 30dBm | Sep. 10, 2015 | Dec. 09, 2015~ Dec. 19, 2015 | Sep. 09, 2016 | Radiation (03CH03-KS) |
| EXA Spectrum Analyzer | Keysight | N9010A | MY551502 44 | 10Hz-44GHz | Jun. 05, 2015 | Dec. 09, 2015~ Dec. 19, 2015 | Jun. 04, 2016 | Radiation (03CH03-KS) |
| Loop Antenna | R&S | HFH2-Z2 | 100321 | 9kHz~30MHz | Nov. 10, 2015 | Dec. 09, 2015~ Dec. 19, 2015 | Nov. 09, 2016 | Radiation (03CH03-KS) |
| Bilog Antenna | TeseQ | CBL6112D | 35406 | 25MHz-2GHz | Jun. 25, 2015 | Dec. 09, 2015~ Dec. 19, 2015 | Jun. 24, 2016 | Radiation (03CH03-KS) |
| Horn Antenna | Schwarzbeck | BBHA9120D | 9120D-135 6 | 1GHz~18GHz | Jun. 25, 2015 | Dec. 09, 2015~ Dec. 19, 2015 | Jun. 24, 2016 | Radiation (03CH03-KS) |
| SHF-EHF Horn | Schwarzbeck | BBHA 9170 | BBHA1702 49 | 15GHz ~40GHz | Mar. 03, 2015 | Dec. 09, 2015~ Dec. 19, 2015 | Mar. 02, 2016 | Radiation (03CH03-KS) |
| Amplifier | Burgeon | BPA-530 | 102212 | 0.01MHz-3000M Hz | Aug. 10, 2015 | Dec. 09, 2015~ Dec. 19, 2015 | Aug. 09, 2016 | Radiation (03CH03-KS) |
| Amplifier | Agilent | 8449B | 3008A023 70 | 1GHz~26.5GHz | Oct. 24, 2015 | Dec. 09, 2015~ Dec. 19, 2015 | Oct. 23, 2016 | Radiation (03CH03-KS) |
| AC Power Source | Chroma | 61601 | F1040900 04 | N/A | NCR | Dec. 09, 2015~ Dec. 19, 2015 | NCR | Radiation (03CH03-KS) |
| Turn Table | ChamPro | EM 1000-T | 060762-T | 0~360 degree | NCR | Dec. 09, 2015~ Dec. 19, 2015 | NCR | Radiation (03CH03-KS) |
| Antenna Mast | ChamPro | EM 1000-A | 060762-A | 1 m~4 m | NCR | Dec. 09, 2015~ Dec. 19, 2015 | NCR | Radiation (03CH03-KS) |
| EMI Test Receiver | R&S | ESR7 | 101403 | 9kHz~7GHz;Ma x 30dBm | Sep. 10, 2015 | Dec. 02, 2015 | Sep. 09, 2016 | Conduction (CO01-KS) |
| AC LISN | MessTec | AN3016 | 060103 | 9kHz~30MHz | Oct. 24, 2015 | Dec. 02, 2015 | Oct. 23, 2016 | Conduction (CO01-KS) |
| AC LISN (for auxiliary equipment) | MessTec | AN3016 | 060105 | 9kHz~30MHz | Oct. 24, 2015 | Dec. 02, 2015 | Oct. 23, 2016 | Conduction (CO01-KS) |
| AC Power Source | Chroma | 61602 | ABP00000 0811 | AC 0V~300V, 45Hz~1000Hz | Oct. 24, 2015 | Dec. 02, 2015 | Oct. 23, 2016 | Conduction (CO01-KS) |



5 Uncertainty of Evaluation

Uncertainty of Conducted Emission Measurement (150 kHz ~ 30 MHz)

| | |
|---|--------|
| Measuring Uncertainty for a Level of Confidence of 95% ($U = 2Uc(y)$) | 2.3 dB |
|---|--------|

Uncertainty of Radiated Emission Measurement (30 MHz ~ 1000 MHz)

| | |
|---|--------|
| Measuring Uncertainty for a Level of Confidence of 95% ($U = 2Uc(y)$) | 4.5 dB |
|---|--------|



Appendix A. Radiated Spurious Emission

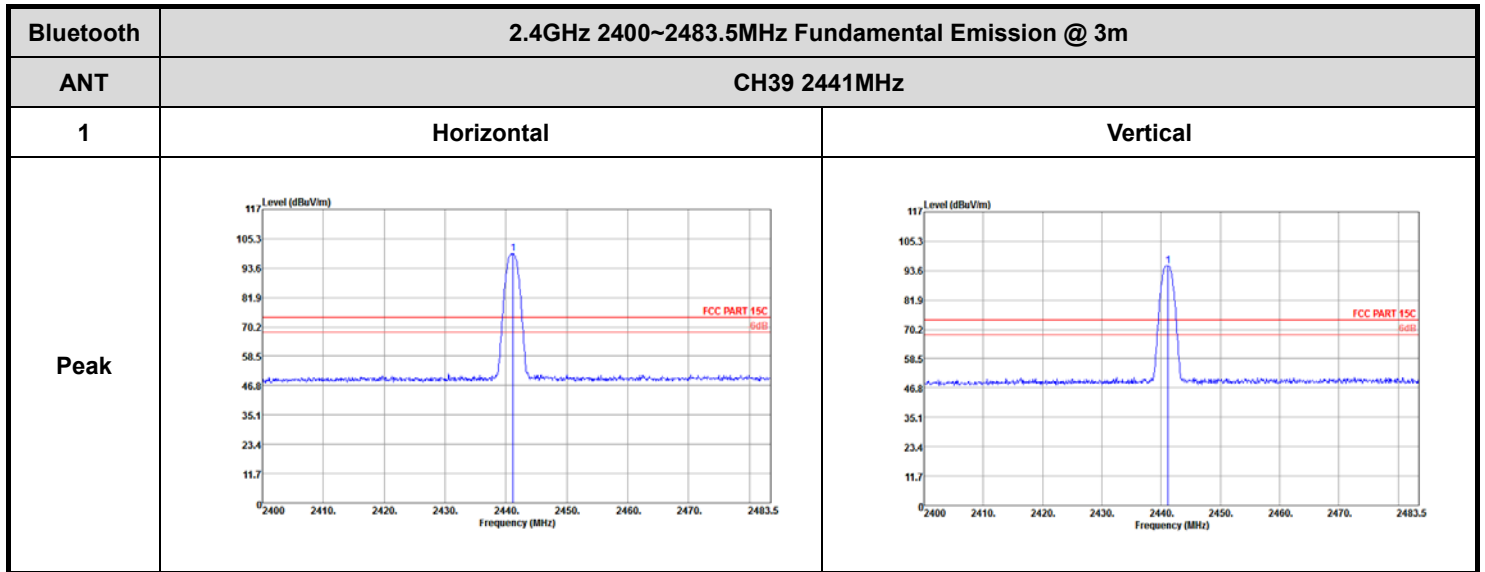
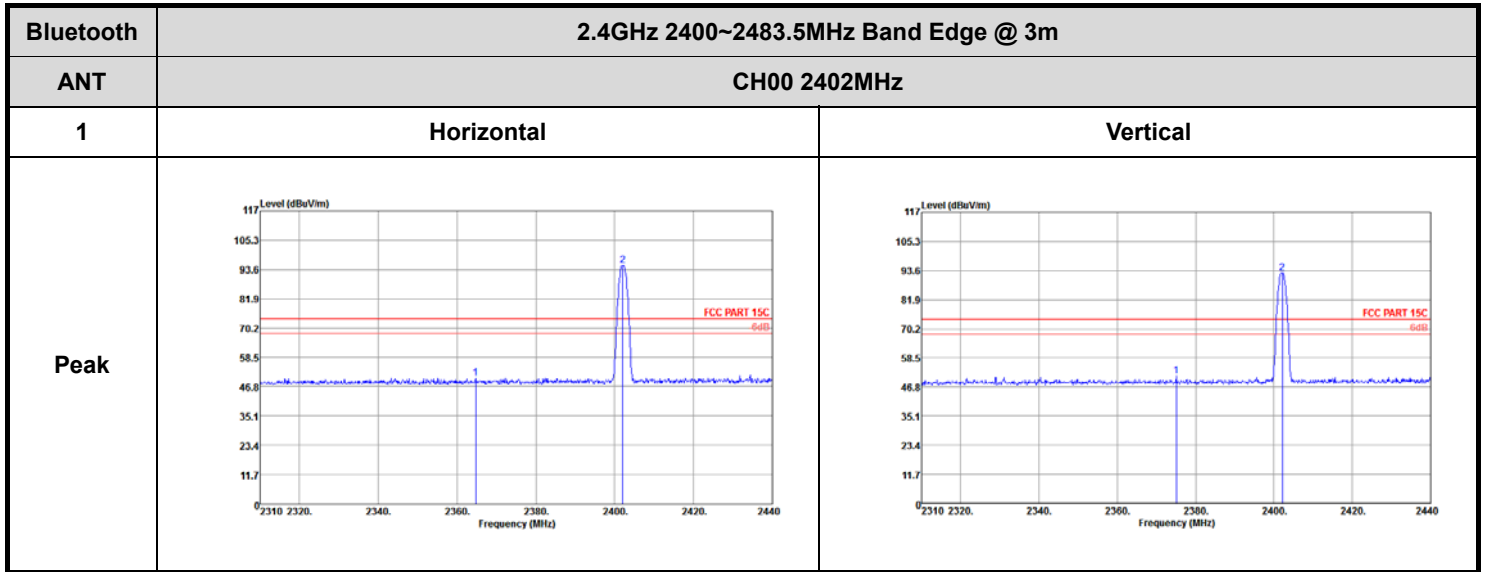



| | | |
|-----------|--------------------------------------|----------|
| Bluetooth | 2.4GHz 2400~2483.5MHz Band Edge @ 3m | |
| ANT | CH78 2480MHz | |
| 1 | Horizontal | Vertical |
| Peak | | |

| | | |
|-----------|---------------------------------------|----------|
| Bluetooth | 2.4GHz 2400~2483.5MHz (Harmonic @ 3m) | |
| ANT | CH00 2402MHz | |
| 1 | Horizontal | Vertical |
| Peak | | |

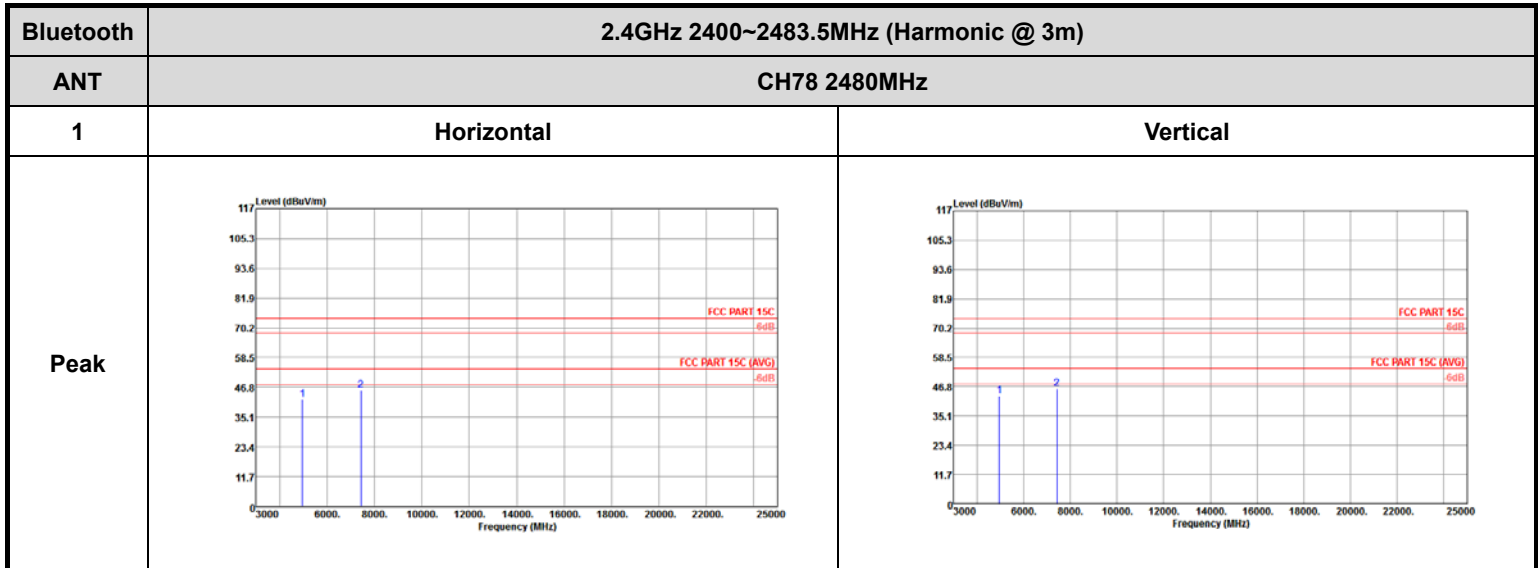
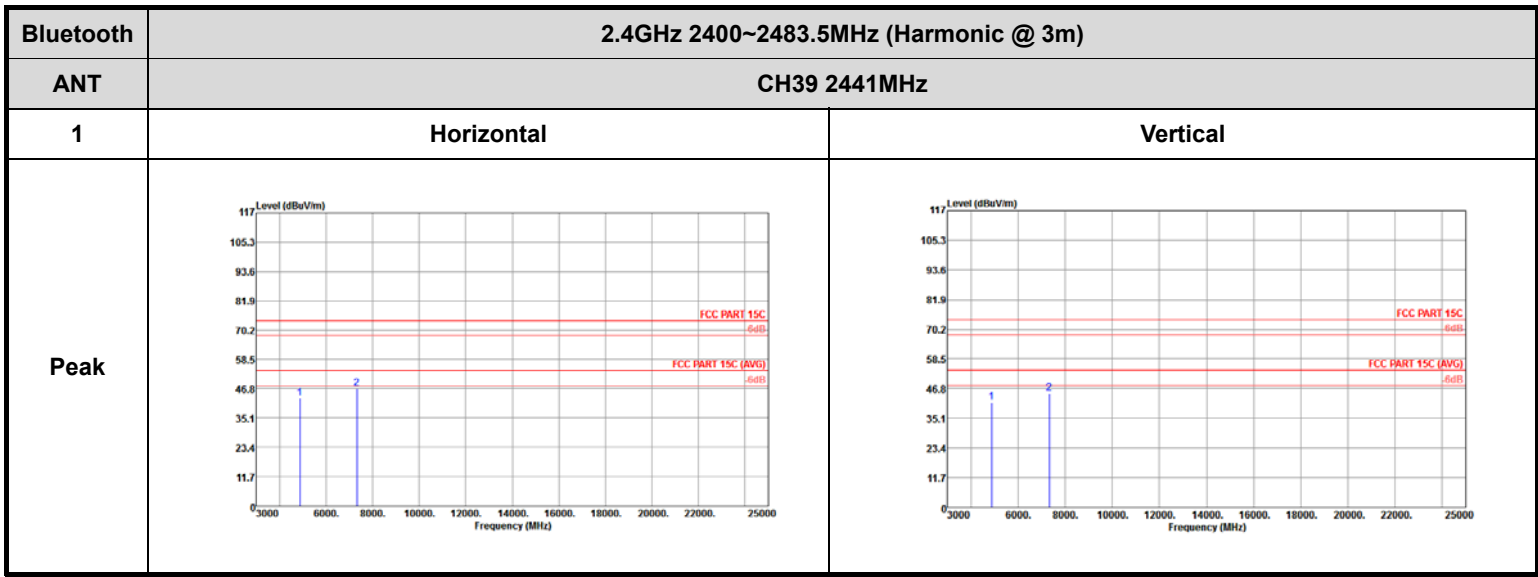

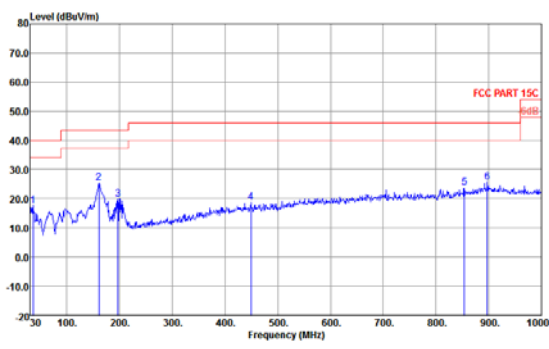
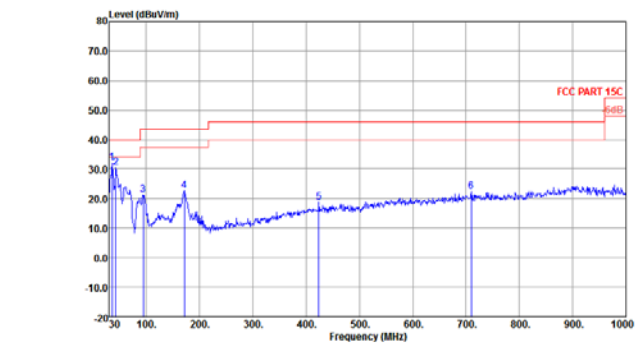

| Bluetooth | Emission below 1GHz | |
|-----------|---|--|
| ANT | 2.4GHz BT (LF) | |
| 1 | Horizontal | Vertical |
| Peak |  |  |



2.4GHz 2400~2483.5MHz

BT (Band Edge @ 3m)

| BT | Note | Frequency | Level | Over | Limit | Read | Antenna | Cable | Preamp | Ant | Table | Peak | Pol. |
|------------------------|---|-----------|------------|--------|------------|----------|----------|--------|--------|--------|---------|---------|---------|
| | | (MHz) | (dBμV/m) | (dB) | (dBμV/m) | (dBμV) | (dB/m) | (dB) | (dB) | (cm) | (deg) | (P/A) | (H/V) |
| BT CH00 2402MHz | | 2364.73 | 50.25 | -23.75 | 74 | 54.82 | 26.91 | 5.54 | 37.02 | 100 | 275 | P | H |
| | | 2364.73 | 25.43 | -28.57 | 54 | - | - | - | - | - | - | A | H |
| | * | 2402.04 | 95.32 | - | - | 99.75 | 27 | 5.59 | 37.02 | 100 | 275 | P | H |
| | * | 2402.04 | 70.5 | - | - | - | - | - | - | - | - | A | H |
| | | 2375 | 51.09 | -22.91 | 74 | 55.59 | 26.95 | 5.57 | 37.02 | 295 | 222 | P | V |
| | | 2375 | 26.27 | -27.73 | 54 | - | - | - | - | - | - | A | V |
| | * | 2402.17 | 92.71 | - | - | 97.14 | 27 | 5.59 | 37.02 | 295 | 222 | P | V |
| | * | 2402.17 | 67.89 | - | - | - | - | - | - | - | - | A | V |
| BT CH 39 2441MHz | * | 2441.166 | 99.26 | - | - | 103.19 | 27.39 | 5.65 | 36.97 | 124 | 274 | P | H |
| | * | 2441.166 | 74.44 | - | - | - | - | - | - | - | - | A | H |
| | * | 2441.166 | 95.6 | - | - | 99.53 | 27.39 | 5.65 | 36.97 | 139 | 235 | P | V |
| | * | 2441.166 | 70.78 | - | - | - | - | - | - | - | - | A | V |
| BT CH 78 2480MHz | * | 2479.91 | 96.63 | - | - | 100.24 | 27.64 | 5.69 | 36.94 | 100 | 281 | P | H |
| | * | 2479.91 | 71.81 | - | - | - | - | - | - | - | - | A | H |
| | | 2484.25 | 51.1 | -22.9 | 74 | 54.71 | 27.64 | 5.69 | 36.94 | 100 | 281 | P | H |
| | | 2484.25 | 26.28 | -27.72 | 54 | - | - | - | - | - | - | A | H |
| | * | 2480.12 | 92.48 | - | - | 96.09 | 27.64 | 5.69 | 36.94 | 100 | 163 | P | V |
| | * | 2480.12 | 67.66 | - | - | - | - | - | - | - | - | A | V |
| | | 2485.86 | 51.22 | -22.78 | 74 | 54.83 | 27.64 | 5.69 | 36.94 | 100 | 163 | P | V |
| | | 2485.86 | 26.4 | -27.6 | 54 | - | - | - | - | - | - | A | V |
| Remark | 1. No other spurious found. 2. All results are PASS against Peak and Average limit line. | | | | | | | | | | | | |



2.4GHz 2400~2483.5MHz

BT (Harmonic @ 3m)

| BT | Note | Frequency (MHz) | Level (dBμV/m) | Over Limit (dB) | Limit Line (dBμV/m) | Read Level (dBμV) | Antenna Factor (dB/m) | Cable Loss (dB) | Preamp Factor (dB) | Ant Pos (cm) | Table Pos (deg) | Peak Avg. (P/A) | Pol. (H/V) |
|------------------------|---|----------------------|---------------------|-------------------------|-----------------------------|---------------------------|-------------------------------|-------------------------|----------------------------|----------------------|-------------------------|-------------------------|-----------------|
| BT CH 00 2402MHz | | 4803 | 42.26 | -31.74 | 74 | 39.63 | 31.48 | 7.84 | 36.69 | 100 | 360 | P | H |
| | | 4803 | 41.58 | -32.42 | 74 | 38.95 | 31.48 | 7.84 | 36.69 | 100 | 360 | P | V |
| BT CH 39 2441MHz | | 4881 | 42.95 | -31.05 | 74 | 40.13 | 31.59 | 7.89 | 36.66 | 124 | 34 | P | H |
| | | 7323 | 46.9 | -27.1 | 74 | 39.91 | 34.08 | 9.62 | 36.71 | 168 | 284 | P | H |
| | | 4881 | 41.38 | -32.62 | 74 | 38.56 | 31.59 | 7.89 | 36.66 | 129 | 81 | P | V |
| | | 7323 | 45.01 | -28.99 | 74 | 38.02 | 34.08 | 9.62 | 36.71 | 281 | 354 | P | V |
| BT CH 78 2480MHz | | 4959 | 41.95 | -32.05 | 74 | 38.91 | 31.72 | 7.95 | 36.63 | 100 | 360 | P | H |
| | | 7440 | 45.66 | -28.34 | 74 | 38.22 | 34.44 | 9.77 | 36.77 | 100 | 0 | P | H |
| | | 4959 | 42.96 | -31.04 | 74 | 39.92 | 31.72 | 7.95 | 36.63 | 100 | 360 | P | V |
| | | 7440 | 45.96 | -28.04 | 74 | 38.52 | 34.44 | 9.77 | 36.77 | 100 | 0 | P | V |
| Remark | 1. No other spurious found. 2. All results are PASS against Peak and Average limit line. | | | | | | | | | | | | |



Emission below 1GHz

2.4GHz BT(LF)

| BT | Note | Frequency | Level | Over | Limit | Read | Antenna | Cable | Preamp | Ant | Table | Peak | Pol. |
|--------------------|--|-----------|------------|--------|------------|----------|----------|--------|--------|--------|---------|---------|---------|
| | | (MHz) | (dBμV/m) | (dB) | (dBμV/m) | (dBμV) | (dB/m) | (dB) | (dB) | (cm) | (deg) | (P/A) | (H/V) |
| 2.4GHz BT LF | | 35.82 | 17.63 | -22.37 | 40 | 31.24 | 16.26 | 1.03 | 30.9 | - | - | P | H |
| | | 160.95 | 25.46 | -18.04 | 43.5 | 42.49 | 11.29 | 2.08 | 30.4 | 100 | 216 | P | H |
| | | 196.84 | 19.8 | -23.7 | 43.5 | 38.01 | 9.91 | 2.28 | 30.4 | - | - | P | H |
| | | 449.04 | 18.71 | -27.29 | 46 | 28.4 | 17.28 | 3.53 | 30.5 | - | - | P | H |
| | | 853.53 | 23.82 | -22.18 | 46 | 28.13 | 21.13 | 4.98 | 30.42 | - | - | P | H |
| | | 897.18 | 25.72 | -20.28 | 46 | 28.62 | 22.6 | 5.09 | 30.59 | - | - | P | H |
| | | 35.82 | 32.15 | -7.85 | 40 | 45.76 | 16.26 | 1.03 | 30.9 | 100 | 154 | P | V |
| | | 42.61 | 30.47 | -9.53 | 40 | 47.44 | 12.77 | 1.1 | 30.84 | - | - | P | V |
| | | 94.02 | 21.34 | -22.16 | 43.5 | 39.55 | 10.64 | 1.57 | 30.42 | - | - | P | V |
| | | 171.62 | 22.74 | -20.76 | 43.5 | 40.08 | 10.88 | 2.18 | 30.4 | - | - | P | V |
| | | 423.82 | 18.79 | -27.21 | 46 | 29.04 | 16.88 | 3.47 | 30.6 | - | - | P | V |
| | | 709.97 | 22.24 | -23.76 | 46 | 27.93 | 20.04 | 4.69 | 30.42 | - | - | P | V |
| Remark | 1. No other spurious found. 2. All results are PASS against limit line. | | | | | | | | | | | | |



Note symbol

| | |
|-----|--|
| * | Fundamental Frequency which can be ignored. However, the level of any unwanted emissions shall not exceed the level of the fundamental frequency. |
| ! | Test result is over limit line. |
| P/A | Peak or Average |
| H/V | Horizontal or Vertical |



A calculation example for radiated spurious emission is shown as below:

| WIFI | Note | Frequency | Level | Over | Limit | Read | Antenna | Cable | Preamp | Ant | Table | Peak | Pol. |
|---------|------|-----------|------------|--------|------------|----------|----------|--------|--------|--------|---------|---------|---------|
| Ant. | | | | Limit | Line | Level | Factor | Loss | Factor | Pos | Pos | Avg. | |
| 1+2 | | (MHz) | (dBμV/m) | (dB) | (dBμV/m) | (dBμV) | (dB/m) | (dB) | (dB) | (cm) | (deg) | (P/A) | (H/V) |
| 802.11b | | 2390 | 55.45 | -18.55 | 74 | 54.51 | 32.22 | 4.58 | 35.86 | 103 | 308 | P | H |
| CH 01 | | | | | | | | | | | | | |
| 2412MHz | | 2390 | 43.54 | -10.46 | 54 | 42.6 | 32.22 | 4.58 | 35.86 | 103 | 308 | A | H |

- Level(dBμV/m) =
Antenna Factor(dB/m) + Cable Loss(dB) + Read Level(dBμV) - Preamp Factor(dB)
- Over Limit(dB) = Level(dBμV/m) – Limit Line(dBμV/m)

For Peak Limit @ 2390MHz:

- Level(dBμV/m)
= Antenna Factor(dB/m) + Cable Loss(dB) + Read Level(dBμV) - Preamp Factor(dB)
= 32.22(dB/m) + 4.58(dB) + 54.51(dBμV) – 35.86 (dB)
= 55.45 (dBμV/m)
- Over Limit(dB)
= Level(dBμV/m) – Limit Line(dBμV/m)
= 55.45(dBμV/m)– 74(dBμV/m)
= -18.55(dB)

For Average Limit @ 2390MHz:

- Level(dBμV/m)
= Antenna Factor(dB/m) + Cable Loss(dB) + Read Level(dBμV) - Preamp Factor(dB)
= 32.22(dB/m) + 4.58(dB) + 42.6(dBμV) – 35.86 (dB)
= 43.54 (dBμV/m)
- Over Limit(dB)
= Level(dBμV/m) – Limit Line(dBμV/m)
= 43.54(dBμV/m)– 54(dBμV/m)
= -10.46(dB)

Both peak and average measured complies with the limit line, so test result is “PASS”.