



SAR EVALUATION REPORT

Applicant Name:
 LG Electronics MobileComm U.S.A., Inc.
 1000 Sylvan Avenue
 Englewood Cliffs, NJ 07632
 United States

Date of Testing:
 06/11/13 - 06/18/13
Test Site/Location:
 PCTEST Lab, Columbia, MD, USA
Document Serial No.:
 OY1306100965.ZNF

FCC ID: ZNFVS890

APPLICANT: LG ELECTRONICS MOBILECOMM U.S.A., INC.

DUT Type: Portable Handset
Application Type: Class II Permissive Change
FCC Rule Part(s): CFR §2.1093
Model(s): LG-VS890; VS890; LGVS890
Permissive Change(s): See FCC Change Document
Date of Original Certification: 06/14/2013

Equipment Class	Band & Mode	Tx Frequency	Measured Conducted Power [dBm]	SAR		
				1 gm Head (W/kg)	1 gm Body-Worn (W/kg)	1 gm Hotspot (W/kg)
PCE	Cell. CDMA/EVDO	824.70 - 848.31 MHz	25.19	0.41	1.03	1.03
PCE	PCS CDMA/EVDO	1851.25 - 1908.75 MHz	24.42	0.79	1.03	1.03
PCE	LTE Band 13	782 MHz	23.69	0.29	0.63	0.63
DTS	2.4 GHz WLAN	2412 - 2462 MHz	15.09	< 0.1	< 0.1	< 0.1
DSS/DTS	Bluetooth	2402 - 2480 MHz	11.82	N/A		
Simultaneous SAR per KDB 690783 D01v01r02:				0.83	1.55	1.31



Note: Powers in the above table represent output powers for the SAR test configurations and may not represent the highest output powers for all configurations for each mode.

This wireless portable device has been shown to be capable of compliance for localized specific absorption rate (SAR) for uncontrolled environment/general population exposure limits specified in ANSI/IEEE C95.1-1992 and has been tested in accordance with the measurement procedures specified in Section 1.7 of this report; for North American frequency bands only.

I attest to the accuracy of data. All measurements reported herein were performed by me or were made under my supervision and are correct to the best of my knowledge and belief. I assume full responsibility for the completeness of these measurements and vouch for the qualifications of all persons taking them. Test results reported herein relate only to the item(s) tested.



 Randy Ortanez
 President



FCC ID: ZNFVS890		SAR EVALUATION REPORT		Reviewed by: Quality Manager
Document S/N: OY1306100965.ZNF	Test Dates: 06/11/13 - 06/18/13	DUT Type: Portable Handset		Page 1 of 44

T A B L E O F C O N T E N T S

1	DEVICE UNDER TEST	3
2	LTE INFORMATION	7
3	INTRODUCTION	8
4	DOSIMETRIC ASSESSMENT	9
5	DEFINITION OF REFERENCE POINTS	10
6	TEST CONFIGURATION POSITIONS FOR HANDSETS	11
7	RF EXPOSURE LIMITS	14
8	FCC MEASUREMENT PROCEDURES	15
9	RF CONDUCTED POWERS	19
10	LTE POWER REDUCTION	22
11	SYSTEM VERIFICATION	25
12	SAR DATA SUMMARY	27
13	FCC MULTI-TX AND ANTENNA SAR CONSIDERATIONS	33
14	SAR MEASUREMENT VARIABILITY	39
15	EQUIPMENT LIST	40
16	MEASUREMENT UNCERTAINTIES	41
17	CONCLUSION	42
18	REFERENCES	43
APPENDIX A: SAR TEST PLOTS		
APPENDIX B: SAR DIPOLE VERIFICATION PLOTS		
APPENDIX C: PROBE AND DIPOLE CALIBRATION CERTIFICATES		
APPENDIX D: SAR TISSUE SPECIFICATIONS		
APPENDIX E: SAR SYSTEM VALIDATION		
APPENDIX F: SAR TEST SETUP PHOTOGRAPHS		

FCC ID: ZNFVS890	 PCTEST <small>ENGINEERING LABORATORY, INC.</small>	SAR EVALUATION REPORT	 LG	Reviewed by: Quality Manager
Document S/N: 0Y1306100965.ZNF	Test Dates: 06/11/13 - 06/18/13	DUT Type: Portable Handset		Page 2 of 44

1 DEVICE UNDER TEST

1.1 Device Overview

Band & Mode	Operating Modes	Tx Frequency
Cell. CDMA/EVDO	Voice/Data	824.70 - 848.31 MHz
PCS CDMA/EVDO	Voice/Data	1851.25 - 1908.75 MHz
LTE Band 13	Data	782 MHz
2.4 GHz WLAN	Data	2412 - 2462 MHz
Bluetooth	Data	2402 - 2480 MHz

1.2 Nominal and Maximum Output Power Specifications



This device operates using the following maximum and nominal output power specifications. SAR values were scaled to the maximum allowed power to determine compliance per KDB Publication 447498 D01v05.

Mode / Band		Modulated Average (dBm)	
Cell. CDMA/EVDO	Maximum	25.2	
	Nominal	24.7	
PCS CDMA/EVDO	Maximum	24.5	
	Nominal	24.0	

Mode / Band			Modulated Average (dBm)
Cell. CDMA	SVLTE LTE is not reducing	Maximum	19.2
		Nominal	18.7
PCS CDMA	SVLTE LTE is not reducing	Maximum	19.2
		Nominal	18.7

Mode / Band		Modulated Average (dBm)	
LTE Band 13	Maximum	23.7	
	Nominal	23.2	

Mode / Band			Modulated Average (dBm)
LTE Band 13	Reduced CDMA Power \geq Threshold	Maximum	19.7
		Nominal	19.2

FCC ID: ZNFVS890	 PCTEST ENGINEERING LABORATORY, INC.	SAR EVALUATION REPORT	 LG	Reviewed by: Quality Manager
Document S/N: 0Y1306100965.ZNF	Test Dates: 06/11/13 - 06/18/13	DUT Type: Portable Handset		Page 3 of 44

Mode / Band		Modulated Average (dBm)
IEEE 802.11b (2.4 GHz)	Maximum	15.2
	Nominal	14.5
IEEE 802.11g (2.4 GHz)	Maximum	12.5
	Nominal	11.8
IEEE 802.11n (2.4 GHz)	Maximum	11.3
	Nominal	10.6
Bluetooth	Maximum	11.9
	Nominal	11.2
Bluetooth LE	Maximum	7.7
	Nominal	7.0

1.3 DUT Antenna Locations

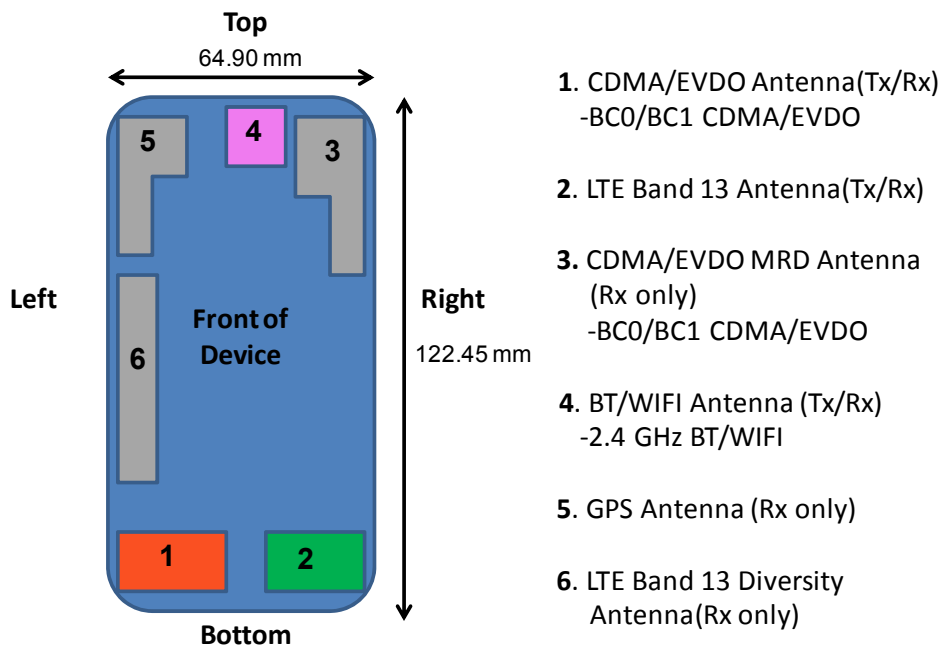

Note: Exact antenna dimensions and separation distances are shown in the Technical Descriptions in the FCC Filing.

Figure 1-1
DUT Antenna Locations

Table 1-1
Mobile Hotspot Sides for SAR Testing

Mobile Hotspot Sides for SAR Testing						
Mode	Back	Front	Top	Bottom	Right	Left
Cell TDSO/EVDO	Yes	Yes	No	Yes	No	Yes
PCS TDSO/EVDO	Yes	Yes	No	Yes	No	Yes
LTE Band 13	Yes	Yes	No	Yes	Yes	No
2.4 GHz WLAN	Yes	Yes	Yes	No	Yes	No

Note: Particular DUT edges were not required to be evaluated for Wireless Router SAR if the edges were greater than 2.5 cm from the transmitting antenna according to FCC KDB Publication 941225 D06v01 guidance, page 2.

FCC ID: ZNFVS890	PCTEST ENGINEERING LABORATORY, INC.	SAR EVALUATION REPORT	LG	Reviewed by: Quality Manager
Document S/N: 0Y1306100965.ZNF	Test Dates: 06/11/13 - 06/18/13	DUT Type: Portable Handset		Page 4 of 44

1.4 Simultaneous Transmission Capabilities

According to FCC KDB Publication 447498 D05v01, transmitters are considered to be transmitting simultaneously when there is overlapping transmission, with the exception of transmissions during network hand-offs with maximum hand-off duration less than 30 seconds. Possible transmission paths for the DUT are shown in Figure 1-2 and are color-coded to indicate communication modes which share the same path. Modes which share the same transmission path cannot transmit simultaneously with one another.



Figure 1-2
Simultaneous Transmission Paths

This device contains multiple transmitters that may operate simultaneously, and therefore requires a simultaneous transmission analysis according to FCC KDB Publication 447498 D01v05 3) procedures.

Table 1-2
Simultaneous Transmission Scenarios

No.	Capable Transmit Configurations	Head	Body-Worn Accessory	Hotspot	Note
		IEEE 1528, Supplement C	Supplement C	FCC KDB 941225 D06 Edges/Sides	
1	CDMA BC0 Voice + WiFi 2.4GHz Data	Yes	Yes	N/A	
2	CDMA BC1 Voice + WiFi 2.4GHz Data	Yes	Yes	N/A	
3	CDMA BC0 1x Data/EVDO + WIFI 2.4 GHz Data	Yes*	Yes*	Yes	CDMA Hotspot; VOIP
4	CDMA BC1 1x Data/EVDO + WIFI 2.4 GHz Data	Yes*	Yes*	Yes	CDMA Hotspot; VOIP
5	LTE B13 Data + WIFI 2.4 GHz Data	Yes*	Yes*	Yes	LTE Hotspot; VOIP
6	CDMA BC0 Voice + LTE B13 Data	Yes	Yes	N/A	SVLTE
7	CDMA BC1 Voice + LTE B13 Data	Yes	Yes	N/A	SVLTE
8	CDMA BC0 Voice+ LTE B13 Data + WIFI 2.4 GHz Data	Yes	Yes	Yes	WIFI Hotspot (SVLTE)
9	CDMA BC1 Voice+ LTE B13 Data + WIFI 2.4 GHz Data	Yes	Yes	Yes	WIFI Hotspot (SVLTE)
10	CDMA BC0 Voice + Bluetooth 2.4GHz	N/A	Yes	N/A	
11	CDMA BC1 Voice + Bluetooth 2.4GHz	N/A	Yes	N/A	
12	LTE B13 Data + Bluetooth 2.4 GHz	N/A	Yes*	N/A	
13	CDMA BC0 Voice + LTE B13 Data + Bluetooth 2.4 GHz	N/A	Yes	N/A	SVLTE
14	CDMA BC1 Voice + LTE B13 Data + Bluetooth 2.4 GHz	N/A	Yes	N/A	SVLTE

Notes:
 1. Simultaneous transmission between WIFI 2.4 GHz and Bluetooth 2.4 GHz is not supported
 2. Simultaneous transmission between CDMA EVDO and LTE is not supported

Notes:

- (*) = for VOIP 3rd party applications possibly installed and used by the end-user
- Per the manufacturer, WIFI Direct Group Owner capabilities are available in the 2.4 GHz Band.

FCC ID: ZNFVS890	PCTEST ENGINEERING LABORATORY, INC.	SAR EVALUATION REPORT	LG	Reviewed by: Quality Manager
Document S/N: OY1306100965.ZNF	Test Dates: 06/11/13 - 06/18/13	DUT Type: Portable Handset		Page 5 of 44

1.5 SAR Test Exclusions Applied

(A) WIFI/BT

Per FCC KDB 447498 D01v05, the SAR exclusion threshold for distances <50mm is defined by the following equation:

$$\frac{\text{Max Power of Channel (mW)}}{\text{Test Separation Dist (mm)}} * \sqrt{\text{Frequency(GHz)}} \leq 3.0$$

Based on the maximum average conducted power of Bluetooth (rounded to the nearest mW) and the antenna to user separation distance, Bluetooth SAR was not required; $[(15/10) * \sqrt{2.441}] = 2.3 < 3.0$. Per KDB Publication 447498 D01v05, the maximum power of the channel was rounded to the nearest mW before calculation.

(B) Licensed Transmitter(s)

LTE SAR for the higher modulations were not tested since the maximum average output power of all configurations was not more than 0.5 dB higher than the required tested configurations according to FCC KDB 941225 D05v02.

1.6 Power Reduction for SAR

This device uses power reduction mechanisms for LTE during SVLTE operation (1x-RTT CDMA voice + LTE data) for SAR compliance. See Section 10 for more details.



1.7 Guidance Applied

- FCC OET Bulletin 65 Supplement C [June 2001]
- IEEE 1528-2003
- FCC KDB Publication 941225 D01-D06 (3G/4G and Hotspot)
- FCC KDB Publication 248227 D01v01r02 (SAR Considerations for 802.11 Devices)
- FCC KDB Publication 447498 D01v05 (General SAR Guidance)
- FCC KDB Publication 865664 D01-D02 (SAR Measurements up to 6 GHz)

1.8 Device Serial Numbers

Several samples with identical hardware were used to support SAR testing. The manufacturer has confirmed that the device(s) tested have the same physical, mechanical and thermal characteristics and are within operational tolerances expected for production units.



	Head Serial Number	Body-Worn Serial Number	Hotspot Serial Number
Cell. CDMA/EVDO	001	001	001
PCS CDMA/EVDO	001	001	001
LTE Band 13	003	003	003
2.4 GHz WLAN	002	002	002

FCC ID: ZNFVS890	 PCTEST ENGINEERING LABORATORY, INC.	SAR EVALUATION REPORT	 LG	Reviewed by: Quality Manager
Document S/N: 0Y1306100965.ZNF	Test Dates: 06/11/13 - 06/18/13	DUT Type: Portable Handset		Page 6 of 44

2

LTE INFORMATION

LTE Information			
FCC ID	ZNFVS890		
Form Factor	Portable Handset		
Frequency Range of each LTE transmission band	LTE Band 13 (782 MHz)		
Channel Bandwidths	LTE Band 13: 10 MHz		
Channel Numbers and Frequencies (MHz)	Low	Mid	High
LTE Band 13: 10 MHz	782 (23230)	782 (23230)	782 (23230)
UE Category	3		
Modulations Supported in UL	QPSK, 16QAM		
LTE Transmitter and Antenna Implementation	This device uses 1 Tx/Rx and 1 Rx antenna for LTE		
Description of LTE Tx and Ant. Implementation	CDMA/LTE operate on separate transmission paths		
Hotspot with LTE+WIFI	YES		
Hotspot with LTE+WIFI active with 1Xvoice sessions?	YES		
LTE MPR Permanently implemented per 3GPP TS 36.101 section 6.2.3~6.2.5? (manufacturer attestation to be provided)	See Section 9 and Section 10		
A-MPR (Additional MPR) disabled for SAR Testing?	YES		
Conducted power Table provided for 1RB (low, mid and high offset), 50% RB (low, mid, and high offset), and 100% RB	YES		

FCC ID: ZNFVS890	 PCTEST ENGINEERING LABORATORY, INC.	SAR EVALUATION REPORT		Reviewed by: Quality Manager
Document S/N: 0Y1306100965.ZNF	Test Dates: 06/11/13 - 06/18/13	DUT Type: Portable Handset	Page 7 of 44	

3 INTRODUCTION

The FCC and Industry Canada have adopted the guidelines for evaluating the environmental effects of radio frequency (RF) radiation in ET Docket 93-62 on Aug. 6, 1996 and Health Canada Safety Code 6 to protect the public and workers from the potential hazards of RF emissions due to FCC-regulated portable devices. [1]

The safety limits used for the environmental evaluation measurements are based on the criteria published by the American National Standards Institute (ANSI) for localized specific absorption rate (SAR) in IEEE/ANSI C95.1-1992 Standard for Safety Levels with Respect to Human Exposure to Radio Frequency Electromagnetic Fields, 3 kHz to 300 GHz [3] and Health Canada RF Exposure Guidelines Safety Code 6 [24]. The measurement procedure described in IEEE/ANSI C95.3-2002 Recommended Practice for the Measurement of Potentially Hazardous Electromagnetic Fields - RF and Microwave [4] is used for guidance in measuring the Specific Absorption Rate (SAR) due to the RF radiation exposure from the Equipment Under Test (EUT). These criteria for SAR evaluation are similar to those recommended by the International Committee for Non-Ionizing Radiation Protection (ICNIRP) in Biological Effects and Exposure Criteria for Radiofrequency Electromagnetic Fields," Report No. Vol 74. SAR is a measure of the rate of energy absorption due to exposure to an RF transmitting source. SAR values have been related to threshold levels for potential biological hazards.

3.1 SAR Definition

Specific Absorption Rate is defined as the time derivative (rate) of the incremental energy (dU) absorbed by (dissipated in) an incremental mass (dm) contained in a volume element (dV) of a given density (ρ). It is also defined as the rate of RF energy absorption per unit mass at a point in an absorbing body (see Equation 3-1).

Equation 3-1
SAR Mathematical Equation

$$SAR = \frac{d}{dt} \left(\frac{dU}{dm} \right) = \frac{d}{dt} \left(\frac{dU}{\rho dv} \right)$$



SAR is expressed in units of Watts per Kilogram (W/kg).

$$SAR = \frac{\sigma \cdot E^2}{\rho}$$

where:

- σ = conductivity of the tissue-simulating material (S/m)
- ρ = mass density of the tissue-simulating material (kg/m³)
- E = Total RMS electric field strength (V/m)

NOTE: The primary factors that control rate of energy absorption were found to be the wavelength of the incident field in relation to the dimensions and geometry of the irradiated organism, the orientation of the organism in relation to the polarity of field vectors, the presence of reflecting surfaces, and whether conductive contact is made by the organism with a ground plane.[6]

FCC ID: ZNFVS890	 PCTEST ENGINEERING LABORATORY, INC.	SAR EVALUATION REPORT		Reviewed by: Quality Manager
Document S/N: 0Y1306100965.ZNF	Test Dates: 06/11/13 - 06/18/13	DUT Type: Portable Handset		Page 8 of 44

4 DOSIMETRIC ASSESSMENT

4.1 Measurement Procedure

The evaluation was performed using the following procedure:

1. The SAR distribution at the exposed side of the head or body was measured at a distance no greater than 5.0 mm from the inner surface of the shell. The area covered the entire dimension of the device-head and body interface and the horizontal grid resolution was determined per FCC KDB Publication 865664 D01v01 (See Table 4-1).
2. The point SAR measurement was taken at the maximum SAR region determined from Step 1 to enable the monitoring of SAR fluctuations/drifts during the 1g/10g cube evaluation. SAR at this fixed point was measured and used as a reference value.
3. Based on the area scan data, the peak of the region with maximum SAR was determined by spline interpolation. Around this point, a volume was assessed according to the measurement resolution and volume size requirements of FCC KDB Publication 865664 D01v01 (See Table 4-1). On the basis of this data set, the spatial peak SAR value was evaluated with the following procedure (see references or the DASYS manual online for more details):
 - a. The data was extrapolated to the surface of the outer-shell of the phantom. The combined distance extrapolated was the combined distance from the center of the dipoles 2.7mm away from the tip of the probe housing plus the 1.2 mm distance between the surface and the lowest measuring point. The extrapolation was based on a least-squares algorithm. A polynomial of the fourth order was calculated through the points in the z-axis (normal to the phantom shell).
 - b. After the maximum interpolated values were calculated between the points in the cube, the SAR was averaged over the spatial volume (1g or 10g) using a 3D-Spline interpolation algorithm. The 3D-spline is composed of three one-dimensional splines with the “Not a knot” condition (in x, y, and z directions). The volume was then integrated with the trapezoidal algorithm. One thousand points (10 x 10 x 10) were obtained through interpolation, in order to calculate the averaged SAR.
 - c. All neighboring volumes were evaluated until no neighboring volume with a higher average value was found.
4. The SAR reference value, at the same location as step 2, was re-measured after the zoom scan was complete to calculate the SAR drift. If the drift deviated by more than 5%, the SAR test and drift measurements were repeated.

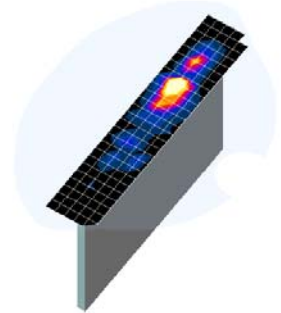

Figure 4-1
Sample SAR Area Scan

Table 4-1
Area and Zoom Scan Resolutions per FCC KDB Publication 865664 D01v01

Frequency	Maximum Area Scan Resolution (mm) ($\Delta x_{area}, \Delta y_{area}$)	Maximum Zoom Scan Resolution (mm) ($\Delta x_{zoom}, \Delta y_{zoom}$)	Maximum Zoom Scan Spatial Resolution (mm)			Minimum Zoom Scan Volume (mm) (x, y, z)
			Uniform Grid	Graded Grid		
				$\Delta z_{zoom}(n)$	$\Delta z_{zoom}(1)^*$	
≤ 2 GHz	≤ 15	≤ 8	≤ 5	≤ 4	≤ 1.5* $\Delta z_{zoom}(n-1)$	≥ 30
2-3 GHz	≤ 12	≤ 5	≤ 5	≤ 4	≤ 1.5* $\Delta z_{zoom}(n-1)$	≥ 30
3-4 GHz	≤ 12	≤ 5	≤ 4	≤ 3	≤ 1.5* $\Delta z_{zoom}(n-1)$	≥ 28
4-5 GHz	≤ 10	≤ 4	≤ 3	≤ 2.5	≤ 1.5* $\Delta z_{zoom}(n-1)$	≥ 25
5-6 GHz	≤ 10	≤ 4	≤ 2	≤ 2	≤ 1.5* $\Delta z_{zoom}(n-1)$	≥ 22

FCC ID: ZNFVS890	PCTEST ENGINEERING LABORATORY, INC.	SAR EVALUATION REPORT		LG	Reviewed by: Quality Manager
Document S/N: OY1306100965.ZNF	Test Dates: 06/11/13 - 06/18/13	DUT Type: Portable Handset			Page 9 of 44

5

DEFINITION OF REFERENCE POINTS

5.1 EAR REFERENCE POINT

Figure 5-2 shows the front, back and side views of the SAM Twin Phantom. The point “M” is the reference point for the center of the mouth, “LE” is the left ear reference point (ERP), and “RE” is the right ERP. The ERP is 15mm posterior to the entrance to the ear canal (EEC) along the B-M line (Back-Mouth), as shown in Figure 5-1. The plane passing through the two ear canals and M is defined as the Reference Plane. The line N-F (Neck-Front) is perpendicular to the reference plane and passing through the RE (or LE) is called the Reference Pivoting Line (see Figure 5-1). Line B-M is perpendicular to the N-F line. Both N-F and B-M lines are marked on the external phantom shell to facilitate handset positioning [5].

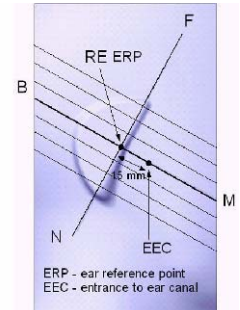

Figure 5-1
Close-Up Side view of ERP

5.2 HANDSET REFERENCE POINTS

Two imaginary lines on the handset were established: the vertical centerline and the horizontal line. The test device was placed in a normal operating position with the “test device reference point” located along the “vertical centerline” on the front of the device aligned to the “ear reference point” (See Figure 5-3). The “test device reference point” was then located at the same level as the center of the ear reference point. The test device was positioned so that the “vertical centerline” was bisecting the front surface of the handset at its top and bottom edges, positioning the “ear reference point” on the outer surface of the both the left and right head phantoms on the ear reference point.



Figure 5-2
Front, back and side view of SAM Twin Phantom

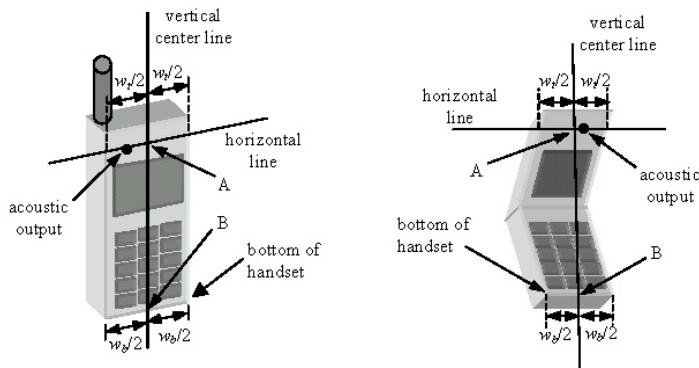



Figure 5-3
Handset Vertical Center & Horizontal Line Reference Points

FCC ID: ZNFVS890	 PCTEST ENGINEERING LABORATORY, INC.	SAR EVALUATION REPORT	 LG	Reviewed by: Quality Manager
Document S/N: 0Y1306100965.ZNF	Test Dates: 06/11/13 - 06/18/13	DUT Type: Portable Handset		Page 10 of 44

6 TEST CONFIGURATION POSITIONS FOR HANDSETS

6.1 Device Holder

The device holder is made out of low-loss POM material having the following dielectric parameters: relative permittivity $\epsilon = 3$ and loss tangent $\delta = 0.02$.

6.2 Positioning for Cheek

1. The test device was positioned with the device close to the surface of the phantom such that point A is on the (virtual) extension of the line passing through points RE and LE on the phantom (see Figure 6-1), such that the plane defined by the vertical center line and the horizontal line of the phone is approximately parallel to the sagittal plane of the phantom.

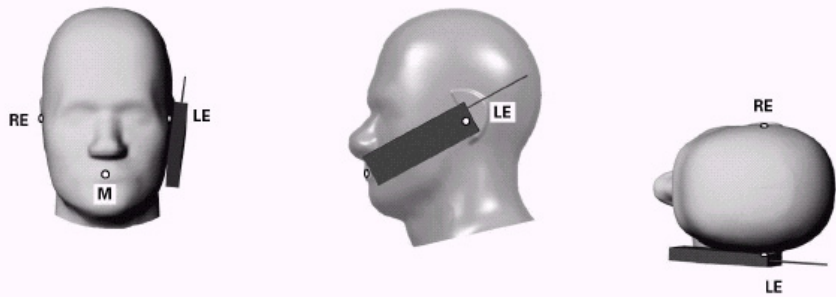



Figure 6-1 Front, Side and Top View of Cheek Position

2. The handset was translated towards the phantom along the line passing through RE & LE until the handset touches the ear.
3. While maintaining the handset in this plane, the handset was rotated around the LE-RE line until the vertical centerline was in the plane normal to MB-NF including the line MB (reference plane).
4. The phone was then rotated around the vertical centerline until the phone (horizontal line) was symmetrical with respect to the line NF.
5. While maintaining the vertical centerline in the reference plane, keeping point A on the line passing through RE and LE, and maintaining the device contact with the ear, the device was rotated about the NF line until any point on the handset made contact with a phantom point below the ear (cheek) (See Figure 6-2).

6.3 Positioning for Ear / 15° Tilt

With the test device aligned in the “Cheek Position”:

1. While maintaining the orientation of the phone, the phone was retracted parallel to the reference plane far enough to enable a rotation of the phone by 15 degrees.
2. The phone was then rotated around the horizontal line by 15 degrees.
3. While maintaining the orientation of the phone, the phone was moved parallel to the reference plane until any part of the handset touched the head. (In this position, point A was located on the line RE-LE). The tilted position is obtained when the contact is on the pinna. If the contact was at any location other than the pinna, the angle of the phone would then be reduced. The tilted position was obtained when any part of the phone was in contact of the ear as well as a second part of the phone was in contact with the head (see Figure 6-2).

FCC ID: ZNFVS890	 PCTEST ENGINEERING LABORATORY, INC.	SAR EVALUATION REPORT	 LG	Reviewed by: Quality Manager
Document S/N: 0Y1306100965.ZNF	Test Dates: 06/11/13 - 06/18/13	DUT Type: Portable Handset		Page 11 of 44

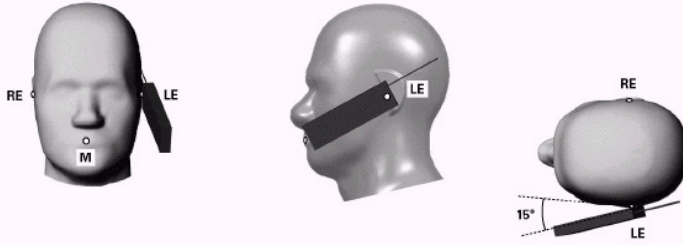

Figure 6-2 Front, Side and Top View of Ear/15° Tilt Position

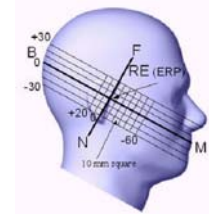

Figure 6-3 Side view w/ relevant markings

6.4 SAR Evaluations near the Mouth/Jaw Regions of the SAM Phantom

Antennas located near the bottom of a phone may require SAR measurements around the mouth and jaw regions of the SAM head phantom. This typically applies to clam-shell style phones that are generally longer in the unfolded normal use positions or to certain older style long rectangular phones.

Under these circumstances, the following procedures apply, adopted from the FCC guidance on SAR handsets document FCC KDB Publication 648474 D04_v01. The SAR required in these regions of SAM should be measured using a flat phantom. The phone should be positioned with a separation distance of 4 mm between the ear reference point (ERP) and the outer surface of the flat phantom shell. While maintaining this distance at the ERP location, the low (bottom) edge of the phone should be lowered from the phantom to establish the same separation distance between the peak SAR location identified by the truncated partial SAR distribution measured with the SAM phantom. The distance from the peak SAR location to the phone is determined by the straight line passing perpendicularly through the phantom surface. When it is not feasible to maintain 4 mm separation at the ERP while also establishing the required separation at the peak SAR location, the top edge of the phone will be allowed to touch the phantom with a separation < 4 mm at the ERP. The phone should not be tilted to the left or right while placed in this inclined position to the flat phantom.

The latest IEEE 1528 committee developments propose the usage of a tilted phantom when the antenna of the phone is mounted at the bottom or in all cases the peak absorption is in the chin region. Both SAM heads of the TwinSAM-Chin20 are rotated 20 degrees around the NF line. Each head can be removed individually from the table for emptying and cleaning.

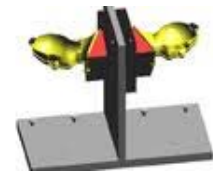



Figure 6-4 Twin SAM Chin20

FCC ID: ZNFVS890	 PCTEST ENGINEERING LABORATORY, INC.	SAR EVALUATION REPORT	 LG	Reviewed by: Quality Manager
Document S/N: 0Y1306100965.ZNF	Test Dates: 06/11/13 - 06/18/13	DUT Type: Portable Handset		Page 12 of 44

6.5 Body-Worn Accessory Configurations

Body-worn operating configurations are tested with the belt-clips and holsters attached to the device and positioned against a flat phantom in a normal use configuration (see Figure 6-5). Per FCC KDB Publication 648474 D04v01, Body-worn accessory exposure is typically related to voice mode operations when handsets are carried in body-worn accessories. The body-worn accessory procedures in FCC KDB Publication 447498 D01v05 should be used to test for body-worn accessory SAR compliance, without a headset connected to it. This enables the test results for such configuration to be compatible with that required for hotspot mode when the body-worn accessory test separation distance is greater than or equal to that required for hotspot mode, when applicable. When the reported SAR for a body-worn accessory, measured without a headset connected to the handset, is $> 1.2 \text{ W/kg}$, the highest reported SAR configuration for that wireless mode and frequency band should be repeated for that body-worn accessory with a headset attached to the handset.

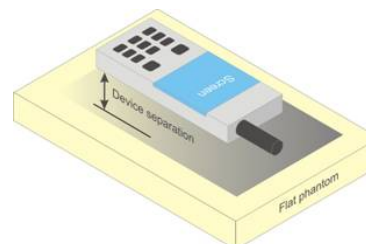

Figure 6-5
Sample Body-Worn Diagram

Accessories for Body-worn operation configurations are divided into two categories: those that do not contain metallic components and those that do contain metallic components. When multiple accessories that do not contain metallic components are supplied with the device, the device is tested with only the accessory that dictates the closest spacing to the body. Then multiple accessories that contain metallic components are tested with the device with each accessory. If multiple accessories share an identical metallic component (i.e. the same metallic belt-clip used with different holsters with no other metallic components) only the accessory that dictates the closest spacing to the body is tested.



Body-worn accessories may not always be supplied or available as options for some devices intended to be authorized for body-worn use. In this case, a test configuration with a separation distance between the back of the device and the flat phantom is used. Test position spacing was documented.

Transmitters that are designed to operate in front of a person's face, as in push-to-talk configurations, are tested for SAR compliance with the front of the device positioned to face the flat phantom in head fluid. For devices that are carried next to the body such as a shoulder, waist or chest-worn transmitters, SAR compliance is tested with the accessories, including headsets and microphones, attached to the device and positioned against a flat phantom in a normal use configuration.

6.6 Wireless Router Configurations

Some battery-operated handsets have the capability to transmit and receive user data through simultaneous transmission of WIFI simultaneously with a separate licensed transmitter. The FCC has provided guidance in FCC KDB Publication 941225 D06 v01 where SAR test considerations for handsets ($L \times W \geq 9 \text{ cm} \times 5 \text{ cm}$) are based on a composite test separation distance of 10 mm from the front, back and edges of the device containing transmitting antennas within 2.5 cm of their edges, determined from general mixed use conditions for this type of devices. Since the hotspot SAR results may overlap with the body-worn accessory SAR requirements, the more conservative configurations can be considered, thus excluding some body-worn accessory SAR tests.

When the user enables the personal wireless router functions for the handset, actual operations include simultaneous transmission of both the WIFI transmitter and another licensed transmitter. Both transmitters often do not transmit at the same transmitting frequency and thus cannot be evaluated for SAR under actual use conditions due to the limitations of the SAR assessment probes. Therefore, SAR must be evaluated for each frequency transmission and mode separately and spatially summed with the WIFI transmitter according to FCC KDB Publication 447498 D01v05 publication procedures. The "Portable Hotspot" feature on the handset was NOT activated during SAR assessments, to ensure the SAR measurements were evaluated for a single transmission frequency RF signal at a time.

FCC ID: ZNFVS890	 PCTEST ENGINEERING LABORATORY, INC.	SAR EVALUATION REPORT	 LG	Reviewed by: Quality Manager
Document S/N: 0Y1306100965.ZNF	Test Dates: 06/11/13 - 06/18/13	DUT Type: Portable Handset		Page 13 of 44

7 RF EXPOSURE LIMITS

7.1 Uncontrolled Environment

UNCONTROLLED ENVIRONMENTS are defined as locations where there is the exposure of individuals who have no knowledge or control of their exposure. The general population/uncontrolled exposure limits are applicable to situations in which the general public may be exposed or in which persons who are exposed as a consequence of their employment may not be made fully aware of the potential for exposure or cannot exercise control over their exposure. Members of the general public would come under this category when exposure is not employment-related; for example, in the case of a wireless transmitter that exposes persons in its vicinity.



7.2 Controlled Environment

CONTROLLED ENVIRONMENTS are defined as locations where there is exposure that may be incurred by persons who are aware of the potential for exposure, (i.e. as a result of employment or occupation). In general, occupational/controlled exposure limits are applicable to situations in which persons are exposed as a consequence of their employment, who have been made fully aware of the potential for exposure and can exercise control over their exposure. This exposure category is also applicable when the exposure is of a transient nature due to incidental passage through a location where the exposure levels may be higher than the general population/uncontrolled limits, but the exposed person is fully aware of the potential for exposure and can exercise control over his or her exposure by leaving the area or by some other appropriate means.

**Table 7-1
SAR Human Exposure Specified in ANSI/IEEE C95.1-1992 and Health Canada Safety Code 6**

HUMAN EXPOSURE LIMITS		
	UNCONTROLLED ENVIRONMENT <i>General Population</i> (W/kg) or (mW/g)	CONTROLLED ENVIRONMENT <i>Occupational</i> (W/kg) or (mW/g)
Peak Spatial Average SAR Head	1.6	8.0
Whole Body SAR	0.08	0.4
Peak Spatial Average SAR Hands, Feet, Ankle, Wrists, etc.	4.0	20

1. The Spatial Peak value of the SAR averaged over any 1 gram of tissue (defined as a tissue volume in the shape of a cube) and over the appropriate averaging time.
2. The Spatial Average value of the SAR averaged over the whole body.
3. The Spatial Peak value of the SAR averaged over any 10 grams of tissue (defined as a tissue volume in the shape of a cube) and over the appropriate averaging time.

FCC ID: ZNFVS890	 PCTEST ENGINEERING LABORATORY, INC.	SAR EVALUATION REPORT	 LG	Reviewed by: Quality Manager
Document S/N: 0Y1306100965.ZNF	Test Dates: 06/11/13 - 06/18/13	DUT Type: Portable Handset		Page 14 of 44

Power measurements were performed using a base station simulator under digital average power.

8.1 Measured and Reported SAR

Per FCC KDB Publication 447498 D01v05, When SAR is not measured at the maximum power level allowed for production units, the results must be scaled to the maximum tune-up tolerance limit according to the power applied to the individual channels tested to determine compliance. For simultaneous transmission, the measured aggregate SAR must be scaled according to the sum of the differences between the maximum tune-up tolerance and actual power used to test each transmitter. When SAR is measured at or scaled to the maximum tune-up tolerance limit, the results are referred to as *reported* SAR. The highest *reported* SAR results are identified on the grant of equipment authorization according to procedures in KDB 690783 D01v01r02.

8.2 Procedures Used to Establish RF Signal for SAR

The following procedures are according to FCC KDB Publication 941225 D01 "SAR Measurement Procedures for 3G Devices" v02, October 2007.

The device was placed into a simulated call using a base station simulator in a RF shielded chamber. Establishing connections in this manner ensure a consistent means for testing SAR and are recommended for evaluating SAR [4]. Devices under test were evaluated prior to testing, with a fully charged battery and were configured to operate at maximum output power. In order to verify that the device was tested throughout the SAR test at maximum output power, the SAR measurement system measures a "point SAR" at an arbitrary reference point at the start and end of the 1 gram SAR evaluation, to assess for any power drifts during the evaluation. If the power drift deviated by more than 5%, the SAR test and drift measurements were repeated.



8.3 SAR Measurement Conditions for CDMA2000

The following procedures were performed according to FCC KDB Publication 941225 D01 "SAR Measurement Procedures for 3G Devices" v02, October 2007.

8.3.1 Output Power Verification

See 3GPP2 C.S0011/TIA-98-E as recommended by "SAR Measurement Procedures for 3G Devices" v02, October 2007. Maximum output power is verified on the High, Middle and Low channels according to procedures in section 4.4.5.2 of 3GPP2 C.S0011/TIA-98-E. SO55 tests were measured with power control bits in the "All Up" condition.

1. If the mobile station (MS) supports Reverse TCH RC 1 and Forward TCH RC 1, set up a call using Fundamental Channel Test Mode 1 (RC=1/1) with 9600 bps data rate only.
2. Under RC1, C.S0011 Table 4.4.5.2-1, Table 8-1 parameters were applied.
3. If the MS supports the RC 3 Reverse FCH, RC3 Reverse SCH₀ and demodulation of RC 3,4, or 5, set up a call using Supplemental Channel Test Mode 3 (RC 3/3) with 9600 bps Fundamental Channel and 9600 bps SCH₀ data rate.
4. Under RC3, C.S0011 Table 4.4.5.2-2, Table 8-2 was applied.

FCC ID: ZNFVS890	 PCTEST ENGINEERING LABORATORY, INC.	SAR EVALUATION REPORT	 LG	Reviewed by: Quality Manager
Document S/N: 0Y1306100965.ZNF	Test Dates: 06/11/13 - 06/18/13	DUT Type: Portable Handset		Page 15 of 44

**Table 8-1
Parameters for Max. Power for RC1**

Parameter	Units	Value
I_{or}	dBm/1.23 MHz	-104
$\frac{Pilot E_c}{I_{or}}$	dB	-7
$\frac{Traffic E_c}{I_{or}}$	dB	-7.4

**Table 8-2
Parameters for Max. Power for RC3**

Parameter	Units	Value
I_{or}	dBm/1.23 MHz	-86
$\frac{Pilot E_c}{I_{or}}$	dB	-7
$\frac{Traffic E_c}{I_{or}}$	dB	-7.4

5. FCHs were configured at full rate for maximum SAR with “All Up” power control bits.

8.3.2 Head SAR Measurements

SAR for head exposure configurations is measured in RC3 with the DUT configured to transmit at full rate using Loopback Service Option SO55. SAR for RC1 is not required when the maximum average output of each channel is less than ¼ dB higher than that measured in RC3. Otherwise, SAR is measured on the maximum output channel in RC1 using the exposure configuration that results in the highest SAR for that channel in RC3.

Head SAR was additionally evaluated using EVDO Rev. A to support compliance for VoIP operations. See Section 8.3.4 for EVDO Rev. A configuration parameters.



8.3.3 Body SAR Measurements

SAR for body exposure configurations is measured in RC3 with the DUT configured to transmit at full rate on FCH with all other code channels disabled using TDSO / SO32. SAR for multiple code channels (FCH + SCH_n) is not required when the maximum average output of each RF channel is less than ¼ dB higher than that measured with FCH only. Otherwise, SAR is measured on the maximum output channel (FCH + SCH_n) with FCH at full rate and SCH₀ enabled at 9600 bps using the exposure configuration that results in the highest SAR for that channel with FCH only. When multiple code channels are enabled, the DUT output may shift by more than 0.5 dB and lead to higher SAR drifts and SCH dropouts. Body SAR was measured using TDSO / SO32 with power control bits in the “All Up”

Body SAR in RC1 is not required when the maximum average output of each channel is less than ¼ dB higher than that measured in RC3. Otherwise, SAR is measured on the maximum output channel in RC1; with Loopback Service Option SO55, at full rate, using the body exposure configuration that results in the highest SAR for that channel in RC3.

8.3.4 Handsets with EVDO

For handsets with Ev-Do capabilities, when the maximum average output of each channel in Rev. 0 is less than ¼ dB higher than that measured in RC3 (1x RTT), body SAR for EV-DO is not required. Otherwise, SAR for Rev. 0 is measured on the maximum output channel at 153.6 kbps using the body exposure configuration that results in the highest SAR for that channel in RC3. SAR for Rev. A is not required when the maximum average output of each channel is less than that measured in Rev. 0 or less than ¼ dB higher than that measured in RC3. Otherwise, SAR is measured on the maximum output channel for Rev. A using a Reverse Data Channel payload size of 4096 bits and a Termination Target of 16 slots defined for Subtype 2 Physical Layer configurations. A Forward Traffic Channel data rate corresponding to the 2-slot version of 307.2 kbps with the ACK Channel transmitting in all slots would be configured in the downlink for both Rev. 0 and Rev. A.

FCC ID: ZNFVS890	 PCTEST ENGINEERING LABORATORY, INC.	SAR EVALUATION REPORT		Reviewed by: Quality Manager
Document S/N: OY1306100965.ZNF	Test Dates: 06/11/13 - 06/18/13	DUT Type: Portable Handset		Page 16 of 44

8.3.5 Body SAR Measurements for EVDO Hotspot

Hotspot Body SAR is measured using Subtype 0/1 Physical Layer configurations for Rev. 0 per KDB Publication 941225 D01 procedures for “1x Ev-Do data Devices”. SAR for Subtype 2 Physical layer configurations is not required for Rev. A when the maximum average output of each RF channels is less than that measured in Subtype 0/1 Physical layer configurations. Otherwise, SAR is measured on the maximum output channel for Rev. A using the exposure configuration that results in the highest SAR for the RF channels in Rev. 0. The AT is tested with a Reverse Data Channel rate of 153.6 kbps in Subtype 0/1 Physical Layer configurations; and a Reverse Data Channel payload size of 4096 bits and Termination Target of 16 slots in Subtype 2 Physical Layer configurations.

SAR is not required for 1x RTT for Ev-Do devices that also support 1x RTT voice and/or data operations, when the maximum average output of each channel is less than 1/4 dB higher than that measured in Subtype 0/1 Physical Layer configurations for Rev. 0. Otherwise, CDMA “Body-SAR Measurement” procedures for “CDMA 2000 1x Handsets” were applied.

8.4 SAR Measurement Conditions for LTE

LTE modes were tested according to FCC KDB 941225 D05v02 publication. Please see notes after the tabulated SAR data for required test configurations. Establishing connections with base station simulators ensure a consistent means for testing SAR and are recommended for evaluating SAR [4]. The R&S CMW500 was used for LTE output power measurements and SAR testing. Closed loop power control was used so the UE transmits with maximum output power during SAR testing.

8.4.1 Spectrum Plots for RB Configurations

A properly configured base station simulator was used for SAR tests and power measurements. Therefore, spectrum plots for RB configurations were not required to be included in this report.

8.4.2 MPR

MPR is permanently implemented for maximum power in this device by the manufacturer. The specific manufacturer target MPR is indicated alongside the SAR results. MPR is enabled for this device, according to 3GPP TS36.101 Section 6.2.3 – 6.2.5 under Table 6.2.3-1. MPR is not applied for reduced power configurations.



8.4.3 A-MPR

A-MPR (Additional MPR) has been disabled for all SAR tests by setting NS=01 on the base station simulator.

8.4.4 Required RB Size and RB Offsets for SAR Testing

According to FCC KDB 941225 D05v02r01:

- a. Per Section 5.2.1, SAR is required for QPSK 1 RB Allocation for the largest bandwidth
 - i. The required channel and offset combination with the highest maximum output power is required for SAR.
 - ii. When the reported SAR is ≤ 0.8 W/kg, testing of the remaining RB offset configurations and required test channels is not required. Otherwise, SAR is required for the remaining required test channels using the RB offset configuration with highest output power for that channel.
 - iii. When the reported SAR for a required test channel is > 1.45 W/kg, SAR is required for all RB offset configurations for that channel.

FCC ID: ZNFVS890	 PCTEST ENGINEERING LABORATORY, INC.	SAR EVALUATION REPORT	 LG	Reviewed by: Quality Manager
Document S/N: OY1306100965.ZNF	Test Dates: 06/11/13 - 06/18/13	DUT Type: Portable Handset		Page 17 of 44

- b. Per Section 5.2.2, SAR is required for 50% RB allocation using the largest bandwidth following the same procedures outlined in Section 5.2.1.
- c. Per Section 5.2.3, QPSK SAR is not required for the 100% allocation when the highest maximum output power for the 100% allocation is less than the highest maximum output power of the 1 RB and 50% RB allocations and the reported SAR for the 1 RB and 50% RB allocations is < 0.8 W/kg.
- d. Per Section 5.2.4 and 5.3, SAR tests for higher order modulation configurations are not required when the conducted power of the required test configurations determined by Sections 5.2.1 through 5.2.3 is less than or equal to ½ dB higher than the equivalent configuration using QPSK modulation and when the QPSK SAR for those configurations is <1.45 W/kg.

8.5 SAR Testing with 802.11 Transmitters

Normal network operating configurations are not suitable for measuring the SAR of 802.11 b/g/n transmitters. Unpredictable fluctuations in network traffic and antenna diversity conditions can introduce undesirable variations in SAR results. The SAR for these devices should be measured using chipset based test mode software to ensure the results are consistent and reliable. See KDB Publication 248227 D01v01r02 for more details.



8.5.1 General Device Setup

Chipset based test mode software is hardware dependent and generally varies among manufacturers. The device operating parameters established in test mode for SAR measurements must be identical to those programmed in production units, including output power levels, amplifier gain settings and other RF performance tuning parameters. The test frequencies should correspond to actual channel frequencies defined for domestic use. SAR for devices with switched diversity should be measured with only one antenna transmitting at a time during each SAR measurement, according to a fixed modulation and data rate. The same data pattern should be used for all measurements.

8.5.2 Frequency Channel Configurations [27]

For 2.4 GHz, the highest average RF output power channel between the low, mid and high channel at the lowest data rate was selected for SAR evaluation in 802.11b mode. 802.11g/n modes and higher data rates for 802.11b were additionally evaluated for SAR if the output power of the respective mode was 0.25 dB or higher than the powers of the SAR configurations tested in the 802.11b mode.

If the maximum extrapolated peak SAR of the zoom scan for the highest output channel was less than 1.6 W/kg and if the 1g averaged SAR was less than 0.8 W/kg, SAR testing was not required for the other test channels in the band.

FCC ID: ZNFVS890	 PCTEST ENGINEERING LABORATORY, INC.	SAR EVALUATION REPORT	 LG	Reviewed by: Quality Manager
Document S/N: 0Y1306100965.ZNF	Test Dates: 06/11/13 - 06/18/13	DUT Type: Portable Handset	Page 18 of 44	

9 RF CONDUCTED POWERS

9.1 CDMA Conducted Powers

Band	Channel	Frequency	SO55 [dBm]	SO55 [dBm]	TDSO SO32 [dBm]	TDSO SO32 [dBm]	1x EvDO Rev. 0 [dBm]	1x EvDO Rev. A [dBm]
	F-RC	MHz	RC1	RC3	FCH+SCH	FCH	(RTAP)	(RETAP)
Cellular	1013	824.7	25.19	25.14	25.14	25.16	25.10	25.06
	384	836.52	25.07	25.05	25.05	25.04	25.01	25.00
	777	848.31	25.18	25.16	25.19	25.19	25.17	25.16
PCS	25	1851.25	24.14	24.16	24.36	24.23	24.32	24.20
	600	1880	24.21	24.33	24.31	24.31	24.42	24.24
	1175	1908.75	24.28	24.31	24.39	24.39	24.29	24.28

Note: RC1 is only applicable for IS-95 compatibility.

Per KDB Publication 941225 D01v02:

1. Head SAR was tested with SO55 RC3. SO55 RC1 was not required since the average output power was not more than 0.25 dB than the SO55 RC3 powers.
2. Body-Worn SAR was tested with 1x RTT with TDSO / SO32 FCH Only. Ev-Do and TDSO / SO32 FCH+SCH SAR tests were not required since the average output power was not more than 0.25 dB higher than the TDSO / SO32 FCH only powers.
3. Hotspot SAR is measured using Subtype 0/1 Physical Layer configurations for Rev. 0. If the average output power of Subtype 2 for Rev. A is less than the Rev. 0 power levels, then Rev. A SAR is not required. Otherwise, SAR is measured on the maximum output channel for Rev. A using the exposure configuration that results in the highest SAR for that RF channel in Rev. 0. SAR is not required for 1x RTT for Ev-Do hotspot devices when the maximum average output of each channel is less than 1/4 dB higher than that measured in Subtype 0/1 Physical Layer configurations for Rev. 0
4. CDMA 1x-RTT SAR was additionally required to be evaluated for Hotspot exposure conditions to support simultaneous transmission capabilities.
5. Head SAR was additionally evaluated with EVDO Rev. A to determine compliance for held-to-ear VoIP operations.



Figure 9-1
Power Measurement Setup

FCC ID: ZNFVS890	PCTEST ENGINEERING LABORATORY, INC.	SAR EVALUATION REPORT	LG	Reviewed by: Quality Manager
Document S/N: 0Y1306100965.ZNF	Test Dates: 06/11/13 - 06/18/13	DUT Type: Portable Handset		Page 19 of 44



9.2 LTE Conducted Powers

9.2.1 LTE Band 13

Table 9-1
LTE Band 13 Conducted Powers - 10 MHz Bandwidth

Frequency [MHz]	Channel	Bandwidth [MHz]	Modulation	RB Size	RB Offset	Conducted Power [dBm]	Target MPR [dB]	MPR Allowed per 3GPP [dB]
782.0	23230	10	QPSK	1	0	23.59	0	0
782.0	23230	10	QPSK	1	25	23.69	0	0
782.0	23230	10	QPSK	1	49	23.68	0	0
782.0	23230	10	QPSK	25	0	22.64	1	0-1
782.0	23230	10	QPSK	25	12	22.67	1	0-1
782.0	23230	10	QPSK	25	25	22.58	1	0-1
782.0	23230	10	QPSK	50	0	22.55	1	0-1
782.0	23230	10	16QAM	1	0	22.61	1	0-1
782.0	23230	10	16QAM	1	25	22.66	1	0-1
782.0	23230	10	16QAM	1	49	22.59	1	0-1
782.0	23230	10	16QAM	25	0	21.58	2	0-2
782.0	23230	10	16QAM	25	12	21.55	2	0-2
782.0	23230	10	16QAM	25	25	21.49	2	0-2
782.0	23230	10	16QAM	50	0	21.45	2	0-2

Note: LTE Band 13 at 10 MHz bandwidth does not support three non-overlapping channels. Per KDB Publication 941225 D05v02, when a device supports overlapping channel assignment in a channel bandwidth configuration, the middle channel of the group of overlapping channels should be selected for testing.

FCC ID: ZNFVS890	 PCTEST ENGINEERING LABORATORY, INC.	SAR EVALUATION REPORT	 LG	Reviewed by: Quality Manager
Document S/N: 0Y1306100965.ZNF	Test Dates: 06/11/13 - 06/18/13	DUT Type: Portable Handset		Page 20 of 44

9.3 WLAN Conducted Powers

Per the FCC change document for this device, the 2.4 GHz WLAN/Bluetooth chipset remains the same as the original certified device. Therefore, conducted powers IEEE 802.11 b/g/n and Bluetooth remain the same as the original certification.

Table 9-2
IEEE 802.11b Average RF Power

Mode	Freq [MHz]	Channel	802.11b Conducted Power [dBm]			
			Data Rate [Mbps]			
			1	2	5.5	11
802.11b	2412	1	14.25	14.32	14.32	14.34
802.11b	2437	6	15.09	15.05	15.09	15.08
802.11b	2462	11	14.88	14.86	14.92	14.94

Table 9-3
IEEE 802.11g Average RF Power

Mode	Freq [MHz]	Channel	802.11g Conducted Power [dBm]							
			Data Rate [Mbps]							
			6	9	12	18	24	36	48	54
802.11g	2412	1	11.63	11.67	11.75	11.62	11.68	11.62	11.64	11.65
802.11g	2437	6	12.44	12.46	12.31	12.30	12.37	12.30	12.39	12.35
802.11g	2462	11	12.16	12.13	12.17	12.18	12.25	12.23	12.18	12.19

Table 9-4
IEEE 802.11n Average RF Power

Mode	Freq [MHz]	Channel	802.11n (2.4GHz) Conducted Power [dBm]							
			Data Rate [Mbps]							
			6.5	13	20	26	39	52	58.5	65
802.11n	2412	1	10.61	10.58	10.61	10.50	10.57	10.63	10.62	10.67
802.11n	2437	6	11.29	11.28	11.31	11.22	11.22	11.18	11.26	11.25
802.11n	2462	11	11.07	10.96	10.99	11.00	11.01	11.07	11.04	11.06

Justification for reduced test configurations for WIFI channels per KDB Publication 248227 D01v01r02 and October 2012/April 2013 FCC/TCB Meeting Notes:

- For 2.4 GHz, highest average RF output power channel for the lowest data rate for IEEE 802.11b were selected for SAR evaluation. Other IEEE 802.11 modes (including 802.11g/n) were not investigated since the average output powers over all channels and data rates were not more than 0.25 dB higher than the tested channel in the lowest data rate of IEEE 802.11b mode.
- When the maximum extrapolated peak SAR of the zoom scan for the maximum output channel is <1.6 W/kg and the reported 1g averaged SAR is <0.8 W/kg, SAR testing on other channels is not required. Otherwise, the other default (or corresponding required) test channels were additionally tested using the lowest data rate.
- The bolded data rate and channel above were tested for SAR.



Figure 9-2
Power Measurement Setup

FCC ID: ZNFVS890	PCTEST ENGINEERING LABORATORY, INC.	SAR EVALUATION REPORT	LG	Reviewed by: Quality Manager
Document S/N: 0Y1306100965.ZNF	Test Dates: 06/11/13 - 06/18/13	DUT Type: Portable Handset		Page 21 of 44

10 LTE POWER REDUCTION

10.1 Introduction to LTE Power Reduction

This device is capable of Simultaneous Voice and LTE (SVLTE) calls, with the voice call supported by a CDMA 1x-RTT transmitter and the data connection supported by a separate LTE transmitter. A LTE power reduction scheme is applied during a LTE connection operating simultaneously with 1x-RTT voice calls. The maximum transmit power of LTE is limited depending on the CDMA 1x voice transmit power level. When CDMA 1x Voice is operating at a certain range of high power levels, the maximum LTE transmit power is limited. When CDMA 1x Voice transmit power is below a certain threshold transmit power level, LTE can transmit at the maximum power. Target levels of power reduction and CDMA voice threshold levels are provided in Table 10-1.

**Table 10-1
SVLTE Power Reduction Scheme**



Mode	Voice Average Power (P) 1x 850/1900 MHz (dBm)	Max B13 LTE Data Avg Power (dBm)
SVLTE	$P \geq 18.7$	19.2
	$P < 18.7$	23.2

10.2 Output Power Verification

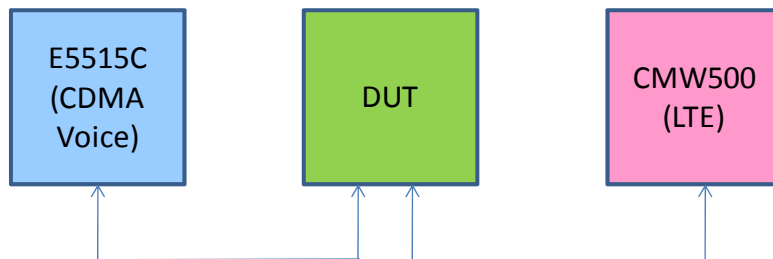
Per KDB Publication 941225 D05v02 Section 4.4, output powers were measured in SVLTE mode to determine that the power reduction mechanism was operating reliably and consistently. The power reduction was investigated by simultaneously connecting the device to both LTE and CDMA base station simulators. LTE output powers were measured through conducted RF connections by first connecting the device in a LTE data call and subsequently a CDMA 1x-RTT call. CDMA powers were controlled by configuring the CDMA base station simulator to active bits. The LTE output power was monitored while changing the cell output power level. The power reduction targets and threshold level described in Table 10-1 were confirmed. Please see results in Table 10-2. Per the FCC change document for this device, the SVLTE power reduction mechanism remains the same as the original certified device. Therefore, SVLTE power reduction verification remains the same as the original device.



**Figure 10-1
SVLTE Conducted Power Measurement Setup**

FCC ID: ZNFVS890	 PCTEST ENGINEERING LABORATORY, INC.	SAR EVALUATION REPORT	 LG	Reviewed by: Quality Manager
Document S/N: 0Y1306100965.ZNF	Test Dates: 06/11/13 - 06/18/13	DUT Type: Portable Handset		Page 22 of 44

**Table 10-2
SVLTE Power Reduction Verification Results**

BC0 1x-RTT CDMA Voice Channel	BC0 1x-RTT CDMA Voice Tx (dBm)	LTE Band 13 Conducted Power (dBm)															
		QPSK 1 RB 0 RB Offset	QPSK 1 RB 25 RB Offset	QPSK 1 RB 49 RB Offset	QPSK 25 RB 0 RB Offset	QPSK 25 RB 12 RB Offset	QPSK 25 RB 25 RB Offset	QPSK 50 RB 0 RB Offset	16QAM 1 RB 0 RB Offset	16QAM 1 RB 25 RB Offset	16QAM 1 RB 49 RB Offset	16QAM 25 RB 0 RB Offset	16QAM 25 RB 12 RB Offset	16QAM 25 RB 25 RB Offset	16QAM 50 RB 0 RB Offset	16QAM 50 RB 25 RB Offset	
1013 (Low)	25	19.62	19.65	19.58	19.54	19.55	19.56	19.57	19.54	19.57	19.54	19.57	19.56	19.55	19.56	19.55	
	23	19.61	19.62	19.57	19.57	19.56	19.55	19.56	19.57	19.61	19.55	19.55	19.56	19.57	19.57	19.55	
	20	19.57	19.57	19.51	19.56	19.61	19.59	19.54	19.58	19.54	19.56	19.55	19.57	19.56	19.58	19.58	
	18	23.54	23.61	23.61	22.57	22.61	22.61	22.61	22.65	22.67	22.65	21.61	21.66	21.58	21.62	21.56	
	15	23.55	23.51	23.52	22.55	22.51	22.57	22.51	22.53	22.54	22.55	21.54	21.53	21.56	21.56	21.56	
384 (Mid)	25	19.57	19.61	19.58	19.57	19.58	19.57	19.57	19.56	19.58	19.53	19.54	19.58	19.55	19.54	19.56	
	23	19.57	19.55	19.54	19.56	19.57	19.56	19.58	19.55	19.56	19.58	19.56	19.56	19.56	19.56	19.56	
	20	19.61	19.56	19.54	19.57	19.57	19.56	19.58	19.57	19.56	19.58	19.57	19.54	19.58	19.58	19.61	
	18	23.61	23.62	23.61	22.56	22.57	22.54	22.58	22.61	22.64	22.65	21.58	21.59	21.57	21.57	21.57	
	15	23.51	23.53	23.54	22.51	22.54	22.56	22.56	22.54	22.53	22.54	21.57	21.55	21.56	21.56	21.53	
777 (High)	25	19.54	19.56	19.58	19.54	19.54	19.54	19.54	19.55	19.55	19.56	19.57	19.56	19.58	19.58	19.54	
	23	19.61	19.55	19.54	19.55	19.54	19.57	19.55	19.55	19.55	19.56	19.57	19.56	19.58	19.58	19.54	
	20	19.56	19.57	19.56	19.58	19.54	19.58	19.56	19.53	19.57	19.58	19.57	19.56	19.56	19.61	19.61	
	18	23.57	23.58	23.56	22.57	22.56	22.56	22.57	22.58	22.61	22.65	21.57	21.56	21.59	21.57	21.57	
	15	23.56	23.55	23.57	22.56	22.57	22.57	22.55	22.57	22.61	22.54	21.57	21.55	21.57	21.55	21.57	

10.3 SVLTE SAR Testing Procedures



Per KDB 941225 D05v02 Section 4.4 B), SAR testing was additionally performed at the reduced CDMA and LTE power levels with respect to the simultaneous transmission scenarios. Device samples were configured to fixed reduced power levels to represent the SVLTE condition in a standalone environment. While the power reduction mechanism is activated at the CDMA Voice power level of 18.7 dBm, simultaneous SAR summations of maximum power LTE were evaluated at this reduced fixed CDMA voice power level. SAR was additionally evaluated at reduced power LTE levels to perform simultaneous SAR analysis when CDMA voice is at maximum power.

10.3.1 Reduced LTE B13 Conducted Powers

**Table 10-2
Reduced LTE Band 13 Conducted Power – 10MHz Bandwidths**

Frequency [MHz]	Channel	Bandwidth [MHz]	Modulation	RB Size	RB Offset	Conducted Power [dBm]	Target MPR [dB]	MPR Allowed per 3GPP [dB]
Mid	782.0	23230	10	QPSK	1	0	19.60	0
	782.0	23230	10	QPSK	1	25	19.69	0
	782.0	23230	10	QPSK	1	49	19.65	0
	782.0	23230	10	QPSK	25	0	19.69	0
	782.0	23230	10	QPSK	25	12	19.68	0
	782.0	23230	10	QPSK	25	25	19.67	0
	782.0	23230	10	QPSK	50	0	19.65	0
	782.0	23230	10	16QAM	1	0	19.25	0
	782.0	23230	10	16QAM	1	25	19.35	0
	782.0	23230	10	16QAM	1	49	19.21	0
	782.0	23230	10	16QAM	25	0	19.68	0
	782.0	23230	10	16QAM	25	12	19.64	0
	782.0	23230	10	16QAM	25	25	19.62	0
	782.0	23230	10	16QAM	50	0	19.60	0

Note: LTE Band 13 at 10 MHz Bandwidth does not support three non-overlapping channels. Per KDB 941225 D05v02, when a device supports overlapping channel assignment in a channel bandwidth configuration, the middle channel of the group of overlapping channels should be selected for testing.

FCC ID: ZNFV890	 PCTEST ENGINEERING LABORATORY, INC.	SAR EVALUATION REPORT		Reviewed by: Quality Manager
Document S/N: OY1306100965.ZNF	Test Dates: 06/11/13 - 06/18/13	DUT Type: Portable Handset		Page 23 of 44

10.3.2 Threshold CDMA Powers

**Table 10-4
Threshold CDMA powers**

Band	Channel	Frequency	Loopback		Data	
			SO55 [dBm]	SO55 [dBm]	TDSO SO32 [dBm]	TDSO SO32 [dBm]
	F-RC	MHz	RC1	RC3	FCH+SCH	FCH
Cellular	1013	824.7	19.17	19.20	19.14	19.20
	384	836.52	19.12	19.13	19.11	19.08
	777	848.31	19.18	19.15	19.18	19.15
PCS	25	1851.25	18.96	18.99	19.02	19.00
	600	1880	19.00	18.97	18.97	19.02
	1175	1908.75	19.10	19.16	19.07	19.20

Notes:

1. RC1 is only applicable for IS-95 compatibility.
2. There is no power reduction applied to the CDMA Voice modes, however the device with output powers represented in the table above was tuned down (for SAR Test purposes only) to analyze simultaneous SAR scenarios in the SVLTE condition where LTE is operating at maximum output power in conjunction with a lower CDMA voice level (see Table 10-1).

Per KDB Publication 941225 D01v02:

1. Head SAR was tested with SO55 RC3. SO55 RC1 was not required since the average output power was not more than 0.25 dB than the SO55 RC3 powers.
2. Body-Worn SAR was tested with 1x RTT with TDSO / SO32 FCH Only. TDSO / SO32 FCH+SCH SAR tests were not required since the average output power was not more than 0.25 dB higher than the TDSO / SO32 FCH only powers.
3. CDMA 1x-RTT SAR was required to be evaluated for Hotspot exposure conditions to support simultaneous transmission capabilities.

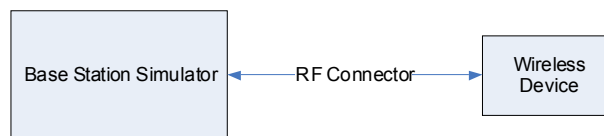

**Figure 10-2
Power Measurement Setup**

FCC ID: ZNFVS890	PCTEST ENGINEERING LABORATORY, INC.	SAR EVALUATION REPORT	LG	Reviewed by: Quality Manager
Document S/N: 0Y1306100965.ZNF	Test Dates: 06/11/13 - 06/18/13	DUT Type: Portable Handset		Page 24 of 44



11 SYSTEM VERIFICATION

11.1 Tissue Verification

**Table 11-1
Measured Tissue Properties**

Calibrated for Tests Performed on:	Tissue Type	Tissue Temp During Calibration (C°)	Measured Frequency (MHz)	Measured Conductivity, σ (S/m)	Measured Dielectric Constant, ϵ	TARGET Conductivity, σ (S/m)	TARGET Dielectric Constant, ϵ	% dev σ	% dev ϵ
06/13/2013	750H	23.0	740	0.893	41.348	0.889	41.953	0.45%	-1.44%
			755	0.904	41.384	0.891	41.876	1.46%	-1.17%
			770	0.924	41.138	0.892	41.806	3.59%	-1.60%
			785	0.932	40.769	0.894	41.735	4.25%	-2.31%
06/13/2013	835H	23.2	820	0.920	42.211	0.898	41.571	2.45%	1.54%
			835	0.935	42.022	0.900	41.500	3.89%	1.26%
			850	0.950	41.836	0.916	41.500	3.71%	0.81%
06/11/2013	1900H	23.1	1850	1.381	38.851	1.400	40.000	-1.36%	-2.87%
			1880	1.415	38.732	1.400	40.000	1.07%	-3.17%
			1910	1.431	38.656	1.400	40.000	2.21%	-3.36%
06/12/2013	2450H	23.8	2401	1.824	39.002	1.758	39.298	3.75%	-0.75%
			2450	1.878	38.782	1.800	39.200	4.33%	-1.07%
			2499	1.937	38.591	1.852	39.135	4.59%	-1.39%
06/13/2013	750B	22.7	740	0.965	55.623	0.963	55.570	0.21%	0.10%
			755	0.981	55.542	0.964	55.512	1.76%	0.05%
			770	0.997	55.354	0.965	55.453	3.32%	-0.18%
			785	1.009	55.183	0.966	55.395	4.45%	-0.38%
06/18/2013	835B	22.9	820	0.993	56.088	0.969	55.258	2.48%	1.50%
			835	1.005	55.891	0.970	55.200	3.61%	1.25%
			850	1.023	55.734	0.988	55.154	3.54%	1.05%
06/11/2013	1900B	23.6	1850	1.493	51.566	1.520	53.300	-1.78%	-3.25%
			1880	1.527	51.466	1.520	53.300	0.46%	-3.44%
			1910	1.559	51.347	1.520	53.300	2.57%	-3.66%
06/11/2013	2450B	23.9	2401	1.937	51.139	1.903	52.765	1.79%	-3.08%
			2450	2.001	50.950	1.950	52.700	2.62%	-3.32%
			2499	2.064	50.776	2.019	52.638	2.23%	-3.54%

The above measured tissue parameters were used in the DASY software. The DASY software was used to perform interpolation to determine the dielectric parameters at the SAR test device frequencies (per IEEE 1528 6.6.1.2). The tissue parameters listed in the SAR test plots may slightly differ from the table above due to significant digit rounding in the software.

FCC ID: ZNFVS890	 PCTEST ENGINEERING LABORATORY, INC.	SAR EVALUATION REPORT	 LG	Reviewed by: Quality Manager
Document S/N: 0Y1306100965.ZNF	Test Dates: 06/11/13 - 06/18/13	DUT Type: Portable Handset		Page 25 of 44

11.2 Test System Verification

Prior to SAR assessment, the system is verified to $\pm 10\%$ of the SAR measurement on the reference dipole at the time of calibration by the calibration facility. Full system validation status and result summary can be found in Appendix E.

Table 11-2
System Verification Results

System Verification TARGET & MEASURED												
SAR System #	Tissue Frequency (MHz)	Tissue Type	Date:	Amb. Temp (°C)	Liquid Temp (°C)	Input Power (W)	Dipole SN	Probe SN	Measured SAR _{1g} (W/kg)	1 W Target SAR _{1g} (W/kg)	1 W Normalized SAR _{1g} (W/kg)	Deviation _{1g} (%)
C	750	HEAD	06/13/2013	23.8	22.5	0.100	1054	3022	0.785	8.500	7.850	-7.65%
D	835	HEAD	06/13/2013	23.1	23.2	0.100	4d132	3288	0.970	9.660	9.700	0.41%
B	1900	HEAD	06/11/2013	22.0	22.2	0.100	5d080	3287	4.150	39.400	41.500	5.33%
C	2450	HEAD	06/12/2013	23.5	23.8	0.100	719	3022	5.410	52.700	54.100	2.66%
C	750	BODY	06/13/2013	23.3	22.7	0.100	1054	3022	0.853	8.720	8.530	-2.18%
G	835	BODY	06/18/2013	24.6	22.9	0.100	4d132	3209	0.994	9.360	9.940	6.20%
E	1900	BODY	06/11/2013	24.4	23.5	0.100	5d148	3920	4.240	40.800	42.400	3.92%
C	2450	BODY	06/11/2013	23.7	23.5	0.040	719	3022	2.170	51.600	54.250	5.14%

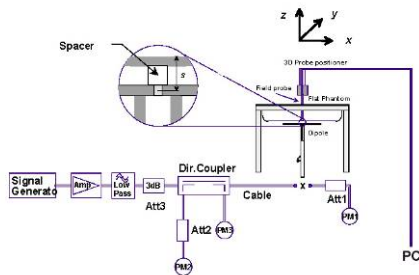



Figure 11-1
System Verification Setup Diagram



Figure 11-2
System Verification Setup Photo

FCC ID: ZNFVS890	 PCTEST ENGINEERING LABORATORY, INC.	SAR EVALUATION REPORT	 LG	Reviewed by: Quality Manager
Document S/N: 0Y1306100965.ZNF	Test Dates: 06/11/13 - 06/18/13	DUT Type: Portable Handset		Page 26 of 44

12 SAR DATA SUMMARY



12.1 Standalone Head SAR Data

**Table 12-1
Cell. CDMA Head SAR**

MEASUREMENT RESULTS														
FREQUENCY		Mode/Band	Service	Maximum Allowed Power [dBm]	Conducted Power [dBm]	Power Drift [dB]	Side	Test Position	Device Serial Number	Duty Cycle	SAR (1g)	Scaling Factor	Scaled SAR (1g)	Plot #
MHz	Ch.										(W/kg)		(W/kg)	
836.52	384	Cell. CDMA	RC3 / SO55	25.2	25.05	-0.02	Right	Cheek	001	1:1	0.295	1.035	0.305	
836.52	384	Cell. CDMA	RC3 / SO55	25.2	25.05	0.02	Right	Tilt	001	1:1	0.290	1.035	0.300	
836.52	384	Cell. CDMA	RC3 / SO55	25.2	25.05	0.00	Left	Cheek	001	1:1	0.380	1.035	0.393	
836.52	384	Cell. CDMA	RC3 / SO55	25.2	25.05	-0.01	Left	Tilt	001	1:1	0.283	1.035	0.293	
836.52	384	Cell. CDMA	RC3 / SO55	19.2	19.13	0.09	Right	Cheek	001	1:1	0.064	1.016	0.065	
836.52	384	Cell. CDMA	RC3 / SO55	19.2	19.13	0.01	Right	Tilt	001	1:1	0.069	1.016	0.070	
836.52	384	Cell. CDMA	RC3 / SO55	19.2	19.13	0.02	Left	Cheek	001	1:1	0.089	1.016	0.090	
836.52	384	Cell. CDMA	RC3 / SO55	19.2	19.13	0.16	Left	Tilt	001	1:1	0.070	1.016	0.071	
836.52	384	Cell. CDMA	EVDO Rev. A	25.2	25.00	0.01	Right	Cheek	001	1:1	0.309	1.047	0.324	
836.52	384	Cell. CDMA	EVDO Rev. A	25.2	25.00	0.01	Right	Tilt	001	1:1	0.291	1.047	0.305	
836.52	384	Cell. CDMA	EVDO Rev. A	25.2	25.00	0.00	Left	Cheek	001	1:1	0.390	1.047	0.408	A1
836.52	384	Cell. CDMA	EVDO Rev. A	25.2	25.00	0.18	Left	Tilt	001	1:1	0.311	1.047	0.326	
ANSI / IEEE C95.1 1992 - SAFETY LIMIT Spatial Peak Uncontrolled Exposure/General Population								Head 1.6 W/kg (mW/g) averaged over 1 gram						

**Table 12-2
PCS CDMA Head SAR**

MEASUREMENT RESULTS														
FREQUENCY		Mode/Band	Service	Maximum Allowed Power [dBm]	Conducted Power [dBm]	Power Drift [dB]	Side	Test Position	Device Serial Number	Duty Cycle	SAR (1g)	Scaling Factor	Scaled SAR (1g)	Plot #
MHz	Ch.										(W/kg)		(W/kg)	
1880.00	600	PCS CDMA	RC3 / SO55	24.5	24.33	0.10	Right	Cheek	001	1:1	0.447	1.040	0.465	
1880.00	600	PCS CDMA	RC3 / SO55	24.5	24.33	0.03	Right	Tilt	001	1:1	0.497	1.040	0.517	
1880.00	600	PCS CDMA	RC3 / SO55	24.5	24.33	0.02	Left	Cheek	001	1:1	0.666	1.040	0.693	
1880.00	600	PCS CDMA	RC3 / SO55	24.5	24.33	0.07	Left	Tilt	001	1:1	0.322	1.040	0.335	
1880.00	600	PCS CDMA	RC3 / SO55	19.2	18.97	-0.02	Right	Cheek	001	1:1	0.108	1.054	0.114	
1880.00	600	PCS CDMA	RC3 / SO55	19.2	18.97	-0.12	Right	Tilt	001	1:1	0.138	1.054	0.145	
1880.00	600	PCS CDMA	RC3 / SO55	19.2	18.97	-0.18	Left	Cheek	001	1:1	0.174	1.054	0.183	
1880.00	600	PCS CDMA	RC3 / SO55	19.2	18.97	0.07	Left	Tilt	001	1:1	0.087	1.054	0.092	
1880.00	600	PCS CDMA	EVDO Rev. A	24.5	24.24	-0.01	Right	Cheek	001	1:1	0.469	1.062	0.498	
1880.00	600	PCS CDMA	EVDO Rev. A	24.5	24.24	0.02	Right	Tilt	001	1:1	0.415	1.062	0.441	
1880.00	600	PCS CDMA	EVDO Rev. A	24.5	24.24	0.09	Left	Cheek	001	1:1	0.747	1.062	0.793	A2
1880.00	600	PCS CDMA	EVDO Rev. A	24.5	24.24	0.08	Left	Tilt	001	1:1	0.288	1.062	0.306	
ANSI / IEEE C95.1 1992 - SAFETY LIMIT Spatial Peak Uncontrolled Exposure/General Population								Head 1.6 W/kg (mW/g) averaged over 1 gram						

FCC ID: ZNFVS890	 PCTEST ENGINEERING LABORATORY, INC.	SAR EVALUATION REPORT		Reviewed by: Quality Manager
Document S/N: OY1306100965.ZNF	Test Dates: 06/11/13 - 06/18/13	DUT Type: Portable Handset		Page 27 of 44

**Table 12-3
LTE Band 13 Head SAR**

MEASUREMENT RESULTS																			
FREQUENCY		Mode	Bandwidth [MHz]	Maximum Allowed Power [dBm]	Conducted Power [dBm]	Power Drift [dB]	MPR [dB]	Side	Test Position	Modulation	RB Size	RB Offset	Device Serial Number	Duty Cycle	SAR (1g) (W/kg)	Scaling Factor	Scaled SAR (1g) (W/kg)	Plot #	
MHz	Ch.																		
782.00	23230	Mid	LTE Band 13	10	23.7	23.69	0.01	0	Right	Cheek	QPSK	1	25	003	1:1	0.287	1.002	0.288	A3
782.00	23230	Mid	LTE Band 13	10	22.7	22.67	0.06	1	Right	Cheek	QPSK	25	12	003	1:1	0.215	1.007	0.217	
782.00	23230	Mid	LTE Band 13	10	23.7	23.69	0.04	0	Right	Tilt	QPSK	1	25	003	1:1	0.216	1.002	0.216	
782.00	23230	Mid	LTE Band 13	10	22.7	22.67	0.05	1	Right	Tilt	QPSK	25	12	003	1:1	0.168	1.007	0.169	
782.00	23230	Mid	LTE Band 13	10	23.7	23.69	0.01	0	Left	Cheek	QPSK	1	25	003	1:1	0.195	1.002	0.195	
782.00	23230	Mid	LTE Band 13	10	22.7	22.67	-0.05	1	Left	Cheek	QPSK	25	12	003	1:1	0.149	1.007	0.150	
782.00	23230	Mid	LTE Band 13	10	23.7	23.69	-0.04	0	Left	Tilt	QPSK	1	25	003	1:1	0.179	1.002	0.179	
782.00	23230	Mid	LTE Band 13	10	22.7	22.67	0.04	1	Left	Tilt	QPSK	25	12	003	1:1	0.136	1.007	0.137	
782.00	23230	Mid	LTE Band 13	10	19.7	19.69	0.05	0	Right	Cheek	QPSK	1	25	003	1:1	0.118	1.002	0.118	
782.00	23230	Mid	LTE Band 13	10	19.7	19.69	0.04	0	Right	Cheek	QPSK	25	0	003	1:1	0.118	1.002	0.118	
782.00	23230	Mid	LTE Band 13	10	19.7	19.69	0.08	0	Right	Tilt	QPSK	1	25	003	1:1	0.087	1.002	0.087	
782.00	23230	Mid	LTE Band 13	10	19.7	19.69	0.10	0	Right	Tilt	QPSK	25	0	003	1:1	0.086	1.002	0.086	
782.00	23230	Mid	LTE Band 13	10	19.7	19.69	0.08	0	Left	Cheek	QPSK	1	25	003	1:1	0.076	1.002	0.076	
782.00	23230	Mid	LTE Band 13	10	19.7	19.69	0.11	0	Left	Cheek	QPSK	25	0	003	1:1	0.079	1.002	0.079	
782.00	23230	Mid	LTE Band 13	10	19.7	19.69	0.04	0	Left	Tilt	QPSK	1	25	003	1:1	0.067	1.002	0.067	
782.00	23230	Mid	LTE Band 13	10	19.7	19.69	0.01	0	Left	Tilt	QPSK	25	0	003	1:1	0.068	1.002	0.068	
ANSI / IEEE C95.1 1992 - SAFETY LIMIT Spatial Peak Uncontrolled Exposure/General Population										Head 1.6 W/kg (mW/g) averaged over 1 gram									

**Table 12-4
DTS Head SAR**



MEASUREMENT RESULTS															
FREQUENCY		Mode	Service	Maximum Allowed Power [dBm]	Conducted Power [dBm]	Power Drift [dB]	Side	Test Position	Device Serial Number	Data Rate (Mbps)	Duty Cycle	SAR (1g) (W/kg)	Scaling Factor	Scaled SAR (1g) (W/kg)	Plot #
MHz	Ch.														
2437	6	IEEE 802.11b	DSSS	15.2	15.09	-0.13	Right	Cheek	002	1	1:1	0.030	1.026	0.031	
2437	6	IEEE 802.11b	DSSS	15.2	15.09	0.03	Right	Tilt	002	1	1:1	0.043	1.026	0.044	
2437	6	IEEE 802.11b	DSSS	15.2	15.09	-0.07	Left	Cheek	002	1	1:1	0.037	1.026	0.038	
2437	6	IEEE 802.11b	DSSS	15.2	15.09	0.15	Left	Tilt	002	1	1:1	0.046	1.026	0.047	A4
ANSI / IEEE C95.1 1992 - SAFETY LIMIT Spatial Peak Uncontrolled Exposure/General Population										Head 1.6 W/kg (mW/g) averaged over 1 gram					

12.2 Standalone Body-Worn SAR Data

**Table 12-5
CDMA Body-Worn SAR Data**

MEASUREMENT RESULTS															
FREQUENCY		Mode	Service	Maximum Allowed Power [dBm]	Conducted Power [dBm]	Power Drift [dB]	Spacing	Device Serial Number	Duty Cycle	Side	SAR (1g) (W/kg)	Scaling Factor	Scaled SAR (1g) (W/kg)	Plot #	
MHz	Ch.														
824.70	1013	Cell. CDMA	TDSO / SO32	25.2	25.16	-0.07	10 mm	001	1:1	back	0.914	1.009	0.922		
836.52	384	Cell. CDMA	TDSO / SO32	25.2	25.04	0.00	10 mm	001	1:1	back	0.956	1.038	0.992		
848.31	777	Cell. CDMA	TDSO / SO32	25.2	25.19	0.03	10 mm	001	1:1	back	1.020	1.002	1.022		
836.52	384	Cell. CDMA	TDSO / SO32	19.2	19.08	0.02	10 mm	001	1:1	back	0.240	1.028	0.247		
848.31	777	Cell. CDMA	TDSO / SO32	25.2	25.19	0.00	10 mm	001	1:1	back	1.030	1.002	1.032	A5	
1851.25	25	PCS CDMA	TDSO / SO32	24.5	24.23	-0.07	10 mm	001	1:1	back	0.964	1.064	1.026	A6	
1880.00	600	PCS CDMA	TDSO / SO32	24.5	24.31	0.00	10 mm	001	1:1	back	0.898	1.045	0.938		
1908.75	1175	PCS CDMA	TDSO / SO32	24.5	24.39	0.03	10 mm	001	1:1	back	0.878	1.026	0.901		
1880.00	600	PCS CDMA	TDSO / SO32	19.2	19.02	0.04	10 mm	001	1:1	back	0.258	1.042	0.269		
ANSI / IEEE C95.1 1992 - SAFETY LIMIT Spatial Peak Uncontrolled Exposure/General Population										Body 1.6 W/kg (mW/g) averaged over 1 gram					

Note: Blue highlighted entry in the table above represents repeatability measurement.



FCC ID: ZNFV890	 PCTEST ENGINEERING LABORATORY, INC.	SAR EVALUATION REPORT		Reviewed by: Quality Manager
Document S/N: OY1306100965.ZNF	Test Dates: 06/11/13 - 06/18/13	DUT Type: Portable Handset		Page 28 of 44

**Table 12-6
LTE Body-Worn SAR**

MEASUREMENT RESULTS																			
FREQUENCY		Mode	Bandwidth [MHz]	Maximum Allowed Power [dBm]	Conducted Power [dBm]	Power Drift [dB]	MPR [dB]	Device Serial Number	Modulation	RB Size	RB Offset	Spacing	Side	Duty Cycle	SAR (1g)	Scaling Factor	Scaled SAR (1g)	Plot #	
MHz	Ch.														(W/kg)		(W/kg)		
782.00	23230	Mid	LTE Band 13	10	23.7	23.69	0.04	0	003	QPSK	1	25	10 mm	back	1:1	0.632	1.002	0.633	A8
782.00	23230	Mid	LTE Band 13	10	22.7	22.67	0.02	1	003	QPSK	25	12	10 mm	back	1:1	0.491	1.007	0.494	
782.00	23230	Mid	LTE Band 13	10	19.7	19.69	0.07	0	003	QPSK	1	25	10 mm	back	1:1	0.197	1.002	0.197	
782.00	23230	Mid	LTE Band 13	10	19.7	19.69	0.05	0	003	QPSK	25	0	10 mm	back	1:1	0.203	1.002	0.203	
ANSI / IEEE C95.1 1992 - SAFETY LIMIT Spatial Peak Uncontrolled Exposure/General Population								Body 1.6 W/kg (mW/g) averaged over 1 gram											

**Table 12-7
DTS Body-Worn SAR**

MEASUREMENT RESULTS															
FREQUENCY		Mode	Service	Maximum Allowed Power [dBm]	Conducted Power [dBm]	Power Drift [dB]	Spacing	Device Serial Number	Data Rate (Mbps)	Side	Duty Cycle	SAR (1g)	Scaling Factor	Scaled SAR (1g)	Plot #
MHz	Ch.											(W/kg)		(W/kg)	
2437	6	IEEE 802.11b	DSSS	15.2	15.09	0.08	10 mm	002	1	back	1:1	0.071	1.026	0.073	A9
ANSI / IEEE C95.1 1992 - SAFETY LIMIT Spatial Peak Uncontrolled Exposure/General Population								Body 1.6 W/kg (mW/g) averaged over 1 gram							



FCC ID: ZNFVS890	 PCTEST ENGINEERING LABORATORY, INC.	SAR EVALUATION REPORT	 LG	Reviewed by: Quality Manager
Document S/N: OY1306100965.ZNF	Test Dates: 06/11/13 - 06/18/13	DUT Type: Portable Handset		Page 29 of 44

12.3 Standalone Wireless Router SAR Data

Table 12-8
CDMA Hotspot SAR Data

MEASUREMENT RESULTS														
FREQUENCY		Mode	Service	Maximum Allowed Power [dBm]	Conducted Power [dBm]	Power Drift [dB]	Spacing	Device Serial Number	Duty Cycle	Side	SAR (1g)	Scaling Factor	Scaled SAR (1g)	Plot #
MHz	Ch.										(W/kg)		(W/kg)	
824.70	1013	Cell. CDMA	TDSO / SO32	25.2	25.16	-0.07	10 mm	001	1:1	back	0.914	1.009	0.922	
836.52	384	Cell. CDMA	TDSO / SO32	25.2	25.04	0.00	10 mm	001	1:1	back	0.956	1.038	0.992	
848.31	777	Cell. CDMA	TDSO / SO32	25.2	25.19	0.03	10 mm	001	1:1	back	1.020	1.002	1.022	
836.52	384	Cell. CDMA	TDSO / SO32	25.2	25.04	0.07	10 mm	001	1:1	front	0.451	1.038	0.468	
836.52	384	Cell. CDMA	TDSO / SO32	25.2	25.04	0.09	10 mm	001	1:1	bottom	0.191	1.038	0.198	
824.70	1013	Cell. CDMA	TDSO / SO32	25.2	25.16	0.07	10 mm	001	1:1	left	0.723	1.009	0.730	
836.52	384	Cell. CDMA	TDSO / SO32	25.2	25.04	-0.03	10 mm	001	1:1	left	0.850	1.038	0.882	
848.31	777	Cell. CDMA	TDSO / SO32	25.2	25.19	0.01	10 mm	001	1:1	left	0.884	1.002	0.886	
836.52	384	Cell. CDMA	TDSO / SO32	19.2	19.08	0.02	10 mm	001	1:1	back	0.240	1.028	0.247	
836.52	384	Cell. CDMA	TDSO / SO32	19.2	19.08	-0.03	10 mm	001	1:1	front	0.125	1.028	0.129	
836.52	384	Cell. CDMA	TDSO / SO32	19.2	19.08	-0.09	10 mm	001	1:1	bottom	0.052	1.028	0.053	
836.52	384	Cell. CDMA	TDSO / SO32	19.2	19.08	0.04	10 mm	001	1:1	left	0.237	1.028	0.244	
824.70	1013	Cell. CDMA	EVDO Rev. 0	25.2	25.10	-0.02	10 mm	001	1:1	back	0.956	1.023	0.978	
836.52	384	Cell. CDMA	EVDO Rev. 0	25.2	25.01	0.03	10 mm	001	1:1	back	0.960	1.045	1.003	
848.31	777	Cell. CDMA	EVDO Rev. 0	25.2	25.17	-0.03	10 mm	001	1:1	back	1.010	1.007	1.017	
836.52	384	Cell. CDMA	EVDO Rev. 0	25.2	25.01	-0.07	10 mm	001	1:1	front	0.535	1.045	0.559	
836.52	384	Cell. CDMA	EVDO Rev. 0	25.2	25.01	0.02	10 mm	001	1:1	bottom	0.203	1.045	0.212	
824.70	1013	Cell. CDMA	EVDO Rev. 0	25.2	25.10	0.02	10 mm	001	1:1	left	0.778	1.023	0.796	
836.52	384	Cell. CDMA	EVDO Rev. 0	25.2	25.01	0.01	10 mm	001	1:1	left	0.855	1.045	0.893	
848.31	777	Cell. CDMA	EVDO Rev. 0	25.2	25.17	-0.07	10 mm	001	1:1	left	0.918	1.007	0.924	
848.31	777	Cell. CDMA	TDSO / SO32	25.2	25.19	0.00	10 mm	001	1:1	back	1.030	1.002	1.032	A5
1851.25	25	PCS CDMA	TDSO / SO32	24.5	24.23	-0.07	10 mm	001	1:1	back	0.964	1.064	1.026	
1880.00	600	PCS CDMA	TDSO / SO32	24.5	24.31	0.00	10 mm	001	1:1	back	0.898	1.045	0.938	
1908.75	1175	PCS CDMA	TDSO / SO32	24.5	24.39	0.03	10 mm	001	1:1	back	0.878	1.026	0.901	
1880.00	600	PCS CDMA	TDSO / SO32	24.5	24.31	-0.01	10 mm	001	1:1	front	0.513	1.045	0.536	
1880.00	600	PCS CDMA	TDSO / SO32	24.5	24.31	0.05	10 mm	001	1:1	bottom	0.400	1.045	0.418	
1880.00	600	PCS CDMA	TDSO / SO32	24.5	24.31	0.04	10 mm	001	1:1	left	0.527	1.045	0.551	
1880.00	600	PCS CDMA	TDSO / SO32	19.2	19.02	0.04	10 mm	001	1:1	back	0.258	1.042	0.269	
1880.00	600	PCS CDMA	TDSO / SO32	19.2	19.02	-0.01	10 mm	001	1:1	front	0.158	1.042	0.165	
1880.00	600	PCS CDMA	TDSO / SO32	19.2	19.02	0.05	10 mm	001	1:1	bottom	0.087	1.042	0.091	
1880.00	600	PCS CDMA	TDSO / SO32	19.2	19.02	0.05	10 mm	001	1:1	left	0.147	1.042	0.153	
1851.25	25	PCS CDMA	EVDO Rev. 0	24.5	24.32	-0.05	10 mm	001	1:1	back	0.975	1.042	1.016	A7
1880.00	600	PCS CDMA	EVDO Rev. 0	24.5	24.42	-0.06	10 mm	001	1:1	back	0.890	1.019	0.907	
1908.75	1175	PCS CDMA	EVDO Rev. 0	24.5	24.29	0.02	10 mm	001	1:1	back	0.900	1.050	0.945	
1880.00	600	PCS CDMA	EVDO Rev. 0	24.5	24.42	0.01	10 mm	001	1:1	front	0.518	1.019	0.528	
1880.00	600	PCS CDMA	EVDO Rev. 0	24.5	24.42	-0.03	10 mm	001	1:1	bottom	0.407	1.019	0.415	
1880.00	600	PCS CDMA	EVDO Rev. 0	24.5	24.42	-0.01	10 mm	001	1:1	left	0.521	1.019	0.531	
1851.25	25	PCS CDMA	EVDO Rev. 0	24.5	24.32	-0.04	10 mm	001	1:1	back	0.919	1.042	0.958	
ANSI / IEEE C95.1 1992 - SAFETY LIMIT Spatial Peak Uncontrolled Exposure/General Population							Body 1.6 W/kg (mW/g) averaged over 1 gram							

Note: Blue highlighted entries in the table above represent repeatability measurements.

FCC ID: ZNFVS890	 PCTEST ENGINEERING LABORATORY, INC.	SAR EVALUATION REPORT		Reviewed by: Quality Manager
Document S/N: OY1306100965.ZNF	Test Dates: 06/11/13 - 06/18/13	DUT Type: Portable Handset		Page 30 of 44

**Table 12-9
LTE Band 13 Hotspot SAR**

MEASUREMENT RESULTS																			
FREQUENCY		Mode	Bandwidth [MHz]	Maximum Allowed Power [dBm]	Conducted Power [dBm]	Power Drift [dB]	MPR [dB]	Device Serial Number	Modulation	RB Size	RB Offset	Spacing	Side	Duty Cycle	SAR (1g)	Scaling Factor	Scaled SAR (1g)	Plot #	
MHz	Ch.														(W/kg)		(W/kg)		
782.00	23230	Mid	LTE Band 13	10	23.7	23.69	0.04	0	003	QPSK	1	25	10 mm	back	1:1	0.632	1.002	0.633	A8
782.00	23230	Mid	LTE Band 13	10	22.7	22.67	0.02	1	003	QPSK	25	12	10 mm	back	1:1	0.491	1.007	0.494	
782.00	23230	Mid	LTE Band 13	10	23.7	23.69	-0.04	0	003	QPSK	1	25	10 mm	front	1:1	0.317	1.002	0.318	
782.00	23230	Mid	LTE Band 13	10	22.7	22.67	-0.03	1	003	QPSK	25	12	10 mm	front	1:1	0.235	1.007	0.237	
782.00	23230	Mid	LTE Band 13	10	23.7	23.69	-0.02	0	003	QPSK	1	25	10 mm	bottom	1:1	0.155	1.002	0.155	
782.00	23230	Mid	LTE Band 13	10	22.7	22.67	0.00	1	003	QPSK	25	12	10 mm	bottom	1:1	0.120	1.007	0.121	
782.00	23230	Mid	LTE Band 13	10	23.7	23.69	0.01	0	003	QPSK	1	25	10 mm	right	1:1	0.459	1.002	0.460	
782.00	23230	Mid	LTE Band 13	10	22.7	22.67	-0.06	1	003	QPSK	25	12	10 mm	right	1:1	0.355	1.007	0.357	
782.00	23230	Mid	LTE Band 13	10	19.7	19.69	0.07	0	003	QPSK	1	25	10 mm	back	1:1	0.197	1.002	0.197	
782.00	23230	Mid	LTE Band 13	10	19.7	19.69	0.05	0	003	QPSK	25	0	10 mm	back	1:1	0.203	1.002	0.203	
782.00	23230	Mid	LTE Band 13	10	19.7	19.69	0.13	0	003	QPSK	1	25	10 mm	front	1:1	0.088	1.002	0.088	
782.00	23230	Mid	LTE Band 13	10	19.7	19.69	0.11	0	003	QPSK	25	0	10 mm	front	1:1	0.080	1.002	0.080	
782.00	23230	Mid	LTE Band 13	10	19.7	19.69	0.02	0	003	QPSK	1	25	10 mm	bottom	1:1	0.061	1.002	0.061	
782.00	23230	Mid	LTE Band 13	10	19.7	19.69	0.03	0	003	QPSK	25	0	10 mm	bottom	1:1	0.056	1.002	0.056	
782.00	23230	Mid	LTE Band 13	10	19.7	19.69	-0.05	0	003	QPSK	1	25	10 mm	right	1:1	0.106	1.002	0.106	
782.00	23230	Mid	LTE Band 13	10	19.7	19.69	-0.06	0	003	QPSK	25	0	10 mm	right	1:1	0.110	1.002	0.110	
ANSI / IEEE C95.1 1992 - SAFETY LIMIT Spatial Peak Uncontrolled Exposure/General Population							Body 1.6 W/kg (mW/g) averaged over 1 gram												



**Table 12-10
WLAN Hotspot SAR**

MEASUREMENT RESULTS															
FREQUENCY		Mode	Service	Maximum Allowed Power [dBm]	Conducted Power [dBm]	Power Drift [dB]	Spacing	Device Serial Number	Data Rate (Mbps)	Side	Duty Cycle	SAR (1g)	Scaling Factor	Scaled SAR (1g)	Plot #
MHz	Ch.											(W/kg)		(W/kg)	
2437	6	IEEE 802.11b	DSSS	15.2	15.09	0.08	10 mm	002	1	back	1:1	0.071	1.026	0.073	A9
2437	6	IEEE 802.11b	DSSS	15.2	15.09	0.11	10 mm	002	1	front	1:1	0.010	1.026	0.010	
2437	6	IEEE 802.11b	DSSS	15.2	15.09	-0.03	10 mm	002	1	top	1:1	0.062	1.026	0.064	
2437	6	IEEE 802.11b	DSSS	15.2	15.09	0.09	10 mm	002	1	right	1:1	0.013	1.026	0.013	
ANSI / IEEE C95.1 1992 - SAFETY LIMIT Spatial Peak Uncontrolled Exposure/General Population							Body 1.6 W/kg (mW/g) averaged over 1 gram								

12.4 SAR Test Notes

General Notes:

- The test data reported are the worst-case SAR values according to test procedures specified in IEEE 1528-2003, FCC/OET Bulletin 65, Supplement C [June 2001] and FCC KDB Publication 447498 D01v05.
- Batteries are fully charged at the beginning of the SAR measurements. A standard battery was used for all SAR measurements.
- Liquid tissue depth was at least 15.0 cm for all frequencies.
- The manufacturer has confirmed that the device(s) tested have the same physical, mechanical and thermal characteristics and are within operational tolerances expected for production units.
- SAR results were scaled to the maximum allowed power to demonstrate compliance per FCC KDB Publication 447498 D01v05.
- Device was tested using a fixed spacing for body-worn accessory testing. A separation distance of 10 mm was considered because the manufacturer has determined that there will be body-worn accessories available in the marketplace for users to support this separation distance.
- Per FCC KDB Publication 648474 D04v01, Body-Worn Accessory SAR was evaluated without a headset connected to the device. Since the standalone reported Body-Worn Accessory SAR was ≤ 1.2 W/kg, no additional SAR evaluations using a headset cable were required.

FCC ID: ZNFV8890	 PCTEST ENGINEERING LABORATORY, INC.	SAR EVALUATION REPORT		Reviewed by: Quality Manager
Document S/N: OY1306100965.ZNF	Test Dates: 06/11/13 - 06/18/13	DUT Type: Portable Handset		Page 31 of 44

8. Per FCC KDB 865664 D01 v01, variability SAR tests were performed when the measured SAR results for a frequency band were greater than 0.8 W/kg. Repeated SAR measurements are highlighted in the tables above for clarity. Please see Section 14 for variability analysis.
9. During SAR Testing for the Wireless Router conditions per FCC KDB Publication 941225 D06v01, the actual Portable Hotspot operation (with actual simultaneous transmission of a transmitter with WIFI) was not activated (See Section 6.6 for more details).

CDMA Notes:



1. Head SAR for CDMA2000 mode was tested under RC3/SO55 per FCC KDB Publication 941225 D01v02.
2. Body-Worn SAR was tested with 1x RTT with TDSO / SO32 FCH Only. EVDO and TDSO / SO32 FCH+SCH SAR tests were not required since the average output power was not more than 0.25 dB higher than the TDSO / SO32 FCH only powers, per FCC KDB Publication 941225 D01v02.
3. CDMA Wireless Router SAR is measured using Subtype 0/1 Physical Layer configurations for Rev. 0 according to KDB 941225 D01 procedures for data devices. Since the average output power of Subtype 2 for Rev. A is less than the Rev. 0 power levels, EVDO Rev. A SAR is not required. SAR is not required for 1x RTT for Ev-Do hotspot devices when the maximum average output of each channel is less than 1/4 dB higher than that measured in Subtype 0/1 Physical Layer configurations for Rev. 0.
4. CDMA 1x-RTT Hotspot SAR was additionally evaluated for Hotspot exposure to support simultaneous transmission capabilities.
5. Head SAR was additionally evaluated using EVDO Rev. A to determine compliance for VoIP operations.
6. Per FCC KDB Publication 447498 D01v05, when the reported (scaled) SAR measured at the middle channel or highest output power channel for a given test configuration is > 0.8 W/kg, testing at the other channels is required for such test configuration(s). Since the maximum output power variation across the required test channels is $\leq \frac{1}{2}$ dB, middle channel was the default power channel was used.

LTE Notes:

1. LTE Considerations: LTE test configurations are determined according to SAR Evaluation Considerations for LTE Devices in FCC KDB Publication 941225 D05v02r01. The general test procedures used for testing can be found in Section 8.4.4.
2. MPR is permanently implemented for maximum power in this device by the manufacturer. The specific manufacturer target MPR is indicated alongside the SAR results. MPR is enabled for this device, according to 3GPP TS36.101 Section 6.2.3 – 6.2.5 under Table 6.2.3-1. MPR is not applied for reduced power configurations.
3. A-MPR was disabled for all SAR tests by setting NS=01 on the base station simulator.

WLAN Notes:

1. Justification for reduced test configurations for WIFI channels per KDB Publication 248227 D01v01r02 and October 2012 FCC/TCB Meeting Notes for 2.4 GHz WIFI: Highest average RF output power channel for the lowest data rate was selected for SAR evaluation in 802.11b. Other IEEE 802.11 modes (including 802.11g/n) were not investigated since the average output powers over all channels and data rates were not more than 0.25 dB higher than the tested channel in the lowest data rate of IEEE 802.11b mode.
2. WIFI transmission was verified using an uncalibrated spectrum analyzer.
3. Since the maximum extrapolated peak SAR of the zoom scan for the maximum output channel is <1.6 W/kg and the reported 1g averaged SAR is <0.8 W/kg, SAR testing on other default channels was not required.

FCC ID: ZNFVS890	 PCTEST ENGINEERING LABORATORY, INC.	SAR EVALUATION REPORT		Reviewed by: Quality Manager
Document S/N: OY1306100965.ZNF	Test Dates: 06/11/13 - 06/18/13	DUT Type: Portable Handset	Page 32 of 44	

13 FCC MULTI-TX AND ANTENNA SAR CONSIDERATIONS

13.1 Introduction

The following procedures adopted from FCC KDB Publication 447498 D01v05 are applicable to handsets with built-in unlicensed transmitters such as 802.11b/g/n and Bluetooth devices which may simultaneously transmit with the licensed transmitter.

13.2 Simultaneous Transmission Procedures



This device contains transmitters that may operate simultaneously. Therefore simultaneous transmission analysis is required. Per FCC KDB 447498 D01v05 IV.C.1.iii, simultaneous transmission SAR test exclusion may be applied when the sum of the 1-g SAR for all the simultaneous transmitting antennas in a specific a physical test configuration is ≤ 1.6 W/kg. When standalone SAR is not required to be measured, per FCC KDB 447498 D01v05 4.3.2 2), the following equation must be used to estimate the standalone 1g SAR for simultaneous transmission assessment involving that transmitter.

$$\text{Estimated SAR} = \frac{\sqrt{f(\text{GHz})}}{7.5} * \frac{(\text{Max Power of channel, mW})}{\text{Min. Separation Distance, mm}}$$

**Table 13-1
Estimated SAR**

Mode	Frequency	Maximum Allowed Power	Separation Distance (Body)	Estimated SAR (Body)
	[MHz]	[dBm]	[mm]	[W/kg]
Bluetooth	2441	11.90	10	0.312

Note: Held-to ear configurations are not applicable to Bluetooth operations and therefore were not considered for simultaneous transmission. Per KDB Publication 447498 D01v05, the maximum power of the channel was rounded to the nearest mW before calculation.

FCC ID: ZNFVS890	 PCTEST ENGINEERING LABORATORY, INC.	SAR EVALUATION REPORT		Reviewed by: Quality Manager
Document S/N: 0Y1306100965.ZNF	Test Dates: 06/11/13 - 06/18/13	DUT Type: Portable Handset		Page 33 of 44

13.3 Head SAR Simultaneous Transmission Analysis

Table 13-2
Simultaneous Transmission Scenario with 2.4 GHz WLAN (Held to Ear)

Simult Tx	Configuration	Cell. CDMA SAR (W/kg)	2.4 GHz WLAN SAR (W/kg)	Σ SAR (W/kg)	Simult Tx	Configuration	Cell. EVDO SAR (W/kg)	2.4 GHz WLAN SAR (W/kg)	Σ SAR (W/kg)
Head SAR	Right Cheek	0.305	0.031	0.336	Head SAR	Right Cheek	0.324	0.031	0.355
	Right Tilt	0.300	0.044	0.344		Right Tilt	0.305	0.044	0.349
	Left Cheek	0.393	0.038	0.431		Left Cheek	0.408	0.038	0.446
	Left Tilt	0.293	0.047	0.340		Left Tilt	0.326	0.047	0.373
Simult Tx	Configuration	PCS CDMA SAR (W/kg)	2.4 GHz WLAN SAR (W/kg)	Σ SAR (W/kg)	Simult Tx	Configuration	PCS EVDO SAR (W/kg)	2.4 GHz WLAN SAR (W/kg)	Σ SAR (W/kg)
Head SAR	Right Cheek	0.465	0.031	0.496	Head SAR	Right Cheek	0.498	0.031	0.529
	Right Tilt	0.517	0.044	0.561		Right Tilt	0.441	0.044	0.485
	Left Cheek	0.693	0.038	0.731		Left Cheek	0.793	0.038	0.831
	Left Tilt	0.335	0.047	0.382		Left Tilt	0.306	0.047	0.353
Simult Tx	Configuration	LTE Band 13 SAR (W/kg)	2.4 GHz WLAN SAR (W/kg)	Σ SAR (W/kg)					
Head SAR	Right Cheek	0.288	0.031	0.319					
	Right Tilt	0.216	0.044	0.260					
	Left Cheek	0.195	0.038	0.233					
	Left Tilt	0.179	0.047	0.226					

13.4 Body-Worn Simultaneous Transmission Analysis



Table 13-3
Simultaneous Transmission Scenario with 2.4 GHz WLAN (Body-Worn at 10 mm)

Configuration	Mode	CDMA/LTE SAR (W/kg)	2.4 GHz WLAN SAR (W/kg)	Σ SAR (W/kg)
Back Side	Cell. CDMA	1.032	0.073	1.105
Back Side	PCS CDMA	1.026	0.073	1.099
Back Side	LTE Band 13	0.633	0.073	0.706

Table 13-4
Simultaneous Transmission Scenario with Bluetooth (Body-Worn at 10 mm)

Configuration	Mode	CDMA/LTE SAR (W/kg)	Bluetooth SAR (W/kg)	Σ SAR (W/kg)
Back Side	Cell. CDMA	1.032	0.312	1.344
Back Side	PCS CDMA	1.026	0.312	1.338
Back Side	LTE Band 13	0.633	0.312	0.945

Note: Bluetooth SAR was not required to be measured per FCC KDB 447498. Estimated SAR results were used in the above table to determine simultaneous transmission SAR test exclusion.

FCC ID: ZNFVS890	 PCTEST ENGINEERING LABORATORY, INC.	SAR EVALUATION REPORT		Reviewed by: Quality Manager
Document S/N: OY1306100965.ZNF	Test Dates: 06/11/13 - 06/18/13	DUT Type: Portable Handset		Page 34 of 44

13.5 Hotspot SAR Simultaneous Transmission Analysis

Per FCC KDB Publication 941225 D06v01, the devices edges with antennas more than 2.5 cm from edge are not required to be evaluated for SAR (“-”).



Table 13-5
Simultaneous Transmission Scenario (2.4 GHz Hotspot at 1.0 cm)

Simult Tx	Configuration	Cell. EVDO SAR (W/kg)	2.4 GHz WLAN SAR (W/kg)	Σ SAR (W/kg)
Body SAR	Back	1.017	0.073	1.090
	Front	0.559	0.010	0.569
	Top	-	0.064	0.064
	Bottom	0.212	-	0.212
	Right	-	0.013	0.013
	Left	0.924	-	0.924
Simult Tx	Configuration	PCS EVDO SAR (W/kg)	2.4 GHz WLAN SAR (W/kg)	Σ SAR (W/kg)
Body SAR	Back	1.016	0.073	1.089
	Front	0.528	0.010	0.538
	Top	-	0.064	0.064
	Bottom	0.415	-	0.415
	Right	-	0.013	0.013
	Left	0.531	-	0.531
Simult Tx	Configuration	LTE Band 13 SAR (W/kg)	2.4 GHz WLAN SAR (W/kg)	Σ SAR (W/kg)
Body SAR	Back	0.633	0.073	0.706
	Front	0.318	0.010	0.328
	Top	-	0.064	0.064
	Bottom	0.155	-	0.155
	Right	0.460	0.013	0.473
	Left	-	-	0.000

13.6 SVLTE Simultaneous Transmission Analysis

Table 13-6
Simultaneous Transmission Scenario with 2.4 GHz WLAN (Held to Ear)

Simult Tx	CDMA Power Level (dBm)	Configuration	Cell. CDMA SAR (W/kg)	LTE Band 13 SAR (W/kg)	2.4 GHz WLAN SAR (W/kg)	Σ SAR (W/kg)	
			1	2	3	1+2	1+2+3
			Maximum Allowed Power (dBm)	25.2	19.7	15.2	
Head SAR	P ≥ 18.7	Right Cheek	0.305	0.118	0.031	0.423	0.454
		Right Tilt	0.300	0.087	0.044	0.387	0.431
		Left Cheek	0.393	0.079	0.038	0.472	0.510
		Left Tilt	0.293	0.068	0.047	0.361	0.408
		Maximum Allowed Power (dBm)	19.2	23.7	15.2		
	P < 18.7	Right Cheek	0.065	0.288	0.031	0.353	0.384
		Right Tilt	0.070	0.216	0.044	0.286	0.330
		Left Cheek	0.090	0.195	0.038	0.285	0.323
Left Tilt		0.071	0.179	0.047	0.250	0.297	

FCC ID: ZNFVS890	 PCTEST ENGINEERING LABORATORY, INC.	SAR EVALUATION REPORT		Reviewed by: Quality Manager
Document S/N: OY1306100965.ZNF	Test Dates: 06/11/13 - 06/18/13	DUT Type: Portable Handset		Page 35 of 44

Simult Tx	CDMA Power Level (dBm)	Configuration	PCS CDMA SAR (W/kg)	LTE Band 13 SAR (W/kg)	2.4 GHz WLAN SAR (W/kg)	Σ SAR (W/kg)	
		Tx Antenna	1	2	3	1+2	1+2+3
		Maximum Allowed Power (dBm)	24.5	19.7	15.2		
Head SAR	P ≥ 18.7	Right Cheek	0.465	0.118	0.031	0.583	0.614
		Right Tilt	0.517	0.087	0.044	0.604	0.648
		Left Cheek	0.693	0.079	0.038	0.772	0.810
		Left Tilt	0.335	0.068	0.047	0.403	0.450
	Maximum Allowed Power (dBm)		19.2	23.7	15.2		
	P < 18.7	Right Cheek	0.114	0.288	0.031	0.402	0.433
		Right Tilt	0.145	0.216	0.044	0.361	0.405
		Left Cheek	0.183	0.195	0.038	0.378	0.416
Left Tilt		0.092	0.179	0.047	0.271	0.318	

Table 13-7
Simultaneous Transmission Scenario with 2.4 GHz WLAN (Body-worn at 10 mm)

Configuration	CDMA Power Level (dBm)	Mode	CDMA SAR (W/kg)	LTE Band 13 SAR (W/kg)	2.4 GHz WLAN SAR (W/kg)	Σ SAR (W/kg)	
		Tx Antenna	1	2	3	1+2	1+2+3
		Maximum Allowed Power (dBm)	25.2	19.7	15.2		
Back Side	P ≥ 18.7	Cell. CDMA	1.032	0.203	0.073	1.235	1.308
Maximum Allowed Power (dBm)			19.2	23.7	15.2		
Back Side	P < 18.7	Cell. CDMA	0.247	0.633	0.073	0.880	0.953
Configuration	CDMA Power Level (dBm)	Mode	CDMA SAR (W/kg)	LTE Band 13 SAR (W/kg)	2.4 GHz WLAN SAR (W/kg)	Σ SAR (W/kg)	
		Tx Antenna	1	2	3	1+2	1+2+3
		Maximum Allowed Power (dBm)	24.5	19.7	15.2		
Back Side	P ≥ 18.7	PCS CDMA	1.026	0.203	0.073	1.229	1.302
Maximum Allowed Power (dBm)			19.2	23.7	15.2		
Back Side	P < 18.7	PCS CDMA	0.269	0.633	0.073	0.902	0.975



Table 13-8
Simultaneous Transmission Scenario with Bluetooth (Body-worn at 10 mm)

Configuration	CDMA Power Level (dBm)	Mode	CDMA SAR (W/kg)	LTE Band 13 SAR (W/kg)	Bluetooth SAR (W/kg)	Σ SAR (W/kg)	
		Tx Antenna	1	2	3		
		Maximum Allowed Power (dBm)	25.2	19.7	11.9	1+2	1+2+3
Back Side	P ≥ 18.7	Cell. CDMA	1.032	0.203	0.312	1.235	1.547
		Maximum Allowed Power (dBm)	19.2	23.7	11.9		
Back Side	P < 18.7	Cell. CDMA	0.247	0.633	0.312	0.880	1.192
Configuration	CDMA Power Level (dBm)	Mode	CDMA SAR (W/kg)	LTE Band 13 SAR (W/kg)	Bluetooth SAR (W/kg)	Σ SAR (W/kg)	
		Tx Antenna	1	2	3		
		Maximum Allowed Power (dBm)	24.5	19.7	11.9	1+2	1+2+3
Back Side	P ≥ 18.7	PCS CDMA	1.026	0.203	0.312	1.229	1.541
		Maximum Allowed Power (dBm)	19.2	23.7	11.9		
Back Side	P < 18.7	PCS CDMA	0.269	0.633	0.312	0.902	1.214

Note: Bluetooth SAR was not required to be measured per FCC KDB 447498. Estimated SAR results were used in the above table to determine simultaneous transmission SAR test exclusion.

Table 13-9
Simultaneous Transmission Scenario with 2.4 GHz WLAN (Hotspot at 10 mm)



Simult Tx	CDMA Power Level (dBm)	Configuration	Cell. CDMA SAR (W/kg)	LTE Band 13 SAR (W/kg)	2.4 GHz WLAN SAR (W/kg)	Σ SAR (W/kg)
		Tx Antenna	1	2	3	1+2+3
		Maximum Allowed Power (dBm)	25.2	19.7	15.2	
Body SAR	P ≥ 18.7	Back	1.032	0.203	0.073	1.308
		Front	0.468	0.088	0.010	0.566
		Top	-	-	0.064	0.064
		Bottom	0.198	0.061	-	0.259
		Right	-	0.110	0.013	0.123
		Left	0.886	-	-	0.886
		Maximum Allowed Power (dBm)	19.2	23.7	15.2	
	P < 18.7	Back	0.247	0.633	0.073	0.953
		Front	0.129	0.318	0.010	0.457
		Top	-	-	0.064	0.064
		Bottom	0.053	0.155	-	0.208
		Right	-	0.460	0.013	0.473
		Left	0.244	-	-	0.244
				Maximum Allowed Power (dBm)	19.2	23.7

FCC ID: ZNFVS890	 PCTEST ENGINEERING LABORATORY, INC.	SAR EVALUATION REPORT	 LG	Reviewed by: Quality Manager
Document S/N: OY1306100965.ZNF	Test Dates: 06/11/13 - 06/18/13	DUT Type: Portable Handset		Page 37 of 44

Simult Tx	CDMA Power Level (dBm)	Configuration	PCS CDMA SAR (W/kg)	LTE Band 13 SAR (W/kg)	2.4 GHz WLAN SAR (W/kg)	Σ SAR (W/kg)	
		Tx Antenna	1	2	3	1+2+3	
		Maximum Allowed Power (dBm)	24.5	19.7	15.2		
Body SAR	P ≥ 18.7	Back	1.026	0.203	0.073	1.302	
		Front	0.536	0.088	0.010	0.634	
		Top	-	-	0.064	0.064	
		Bottom	0.418	0.061	-	0.479	
		Right	-	0.110	0.013	0.123	
		Left	0.551	-	-	0.551	
			Maximum Allowed Power (dBm)	19.2	23.7	15.2	
	P < 18.7	Back	0.269	0.633	0.073	0.975	
		Front	0.165	0.318	0.010	0.493	
		Top	-	-	0.064	0.064	
		Bottom	0.091	0.155	-	0.246	
		Right	-	0.460	0.013	0.473	
Left		0.153	-	-	0.153		

13.7 Simultaneous Transmission Conclusion

The above numerical summed SAR results for all the worst-case simultaneous transmission conditions were below the SAR limit. Therefore, the above analysis is sufficient to determine that simultaneous transmission cases will not exceed the SAR limit and therefore no measured volumetric simultaneous SAR summation is required per FCC KDB Publication 447498 D01v05.

FCC ID: ZNFVS890	 PCTEST ENGINEERING LABORATORY, INC.	SAR EVALUATION REPORT	 LG	Reviewed by: Quality Manager
Document S/N: 0Y1306100965.ZNF	Test Dates: 06/11/13 - 06/18/13	DUT Type: Portable Handset		Page 38 of 44

14 SAR MEASUREMENT VARIABILITY

14.1 Measurement Variability

Per FCC KDB Publication 865664 D01v01, SAR measurement variability was assessed for each frequency band, which was determined by the SAR probe calibration point and tissue-equivalent medium used for the device measurements. When both head and body tissue-equivalent media were required for SAR measurements in a frequency band, the variability measurement procedures were applied to the tissue medium with the highest measured SAR, using the highest measured SAR configuration for that tissue-equivalent medium. These additional measurements were repeated after the completion of all measurements requiring the same head or body tissue-equivalent medium in a frequency band. The test device was returned to ambient conditions (normal room temperature) with the battery fully charged before it was re-mounted on the device holder for the repeated measurement(s) to minimize any unexpected variations in the repeated results.

SAR Measurement Variability was assessed using the following procedures for each frequency band:



- 1) When the original highest measured SAR is ≥ 0.80 W/kg, the measurement was repeated once.
- 2) A second repeated measurement was preformed only if the ratio of largest to smallest SAR for the original and first repeated measurements was > 1.20 or when the original or repeated measurement was ≥ 1.45 W/kg (~ 10% from the 1-g SAR limit).
- 3) A third repeated measurement was performed only if the original, first or second repeated measurement was ≥ 1.5 W/kg and the ratio of largest to smallest SAR for the original, first and second repeated measurements is > 1.20 .
- 4) Repeated measurements are not required when the original highest measured SAR is < 0.80 W/kg

**Table 14-1
Body SAR Measurement Variability Results**

BODY VARIABILITY RESULTS													
Band	FREQUENCY		Mode	Service	Side	Spacing	Measured SAR (1g)	1st Repeated SAR (1g)	Ratio	2nd Repeated SAR (1g)	Ratio	3rd Repeated SAR (1g)	Ratio
	MHz	Ch.					(W/kg)	(W/kg)		(W/kg)		(W/kg)	
835	848.31	777	Cell. CDMA	TDSO / SO32	back	10 mm	1.020	1.030	1.01	N/A	N/A	N/A	N/A
1900	1851.25	25	PCS CDMA	EVDO Rev. 0	back	10 mm	0.975	0.919	1.06	N/A	N/A	N/A	N/A
ANSI / IEEE C95.1 1992 - SAFETY LIMIT Spatial Peak Uncontrolled Exposure/General Population							Body 1.6 W/kg (mW/g) averaged over 1 gram						

14.2 Measurement Uncertainty



The measured SAR was < 1.5 W/kg for all frequency bands. Therefore, per KDB Publication 865664 D01v01, the extended measurement uncertainty analysis per IEEE 1528-2003 was not required.

FCC ID: ZNFVS890	 PCTEST ENGINEERING LABORATORY, INC.	SAR EVALUATION REPORT		Reviewed by: Quality Manager
Document S/N: 0Y1306100965.ZNF	Test Dates: 06/11/13 - 06/18/13	DUT Type: Portable Handset		Page 39 of 44

15 EQUIPMENT LIST

Manufacturer	Model	Description	Cal Date	Cal Interval	Cal Due	Serial Number
Agilent	8648D	(9kHz-4GHz) Signal Generator	4/17/2013	Annual	4/17/2014	3629U00687
Agilent	85070E	Dielectric Probe Kit	2/14/2013	Annual	2/14/2014	MY44300633
Agilent	E8257D	(250kHz-20GHz) Signal Generator	4/16/2013	Annual	4/16/2014	MY45470194
Agilent	8753E	(30kHz-6GHz) Network Analyzer	4/16/2013	Annual	4/16/2014	JP38020182
Agilent	E5515C	Wireless Communications Test Set	10/18/2012	Biennial	10/18/2014	GB43193563
Agilent	85047A	S-Parameter Test Set	N/A	N/A	N/A	2904A00579
Agilent	8594A	(9kHz-2.9GHz) Spectrum Analyzer	N/A	N/A	N/A	3051A00187
Amplifier Research	5S1G4	5W, 800MHz-4.2GHz	CBT	N/A	CBT	21910
Anritsu	ML2438A	Power Meter	2/14/2013	Annual	2/14/2014	1190013
Anritsu	MA24106A	USB Power Sensor	12/7/2012	Annual	12/7/2013	1244515
Anritsu	MA24106A	USB Power Sensor	12/7/2012	Annual	12/7/2013	1244512
Anritsu	MA2481A	Power Sensor	2/14/2013	Annual	2/14/2014	5318
Anritsu	ML2438A	Power Meter	2/14/2013	Annual	2/14/2014	98150041
Anritsu	MA2481A	Power Sensor	2/14/2013	Annual	2/14/2014	5821
Anritsu	MT8820C	Radio Communication Tester	11/6/2012	Annual	11/6/2013	6200901190
Anritsu	MA24106A	USB Power Sensor	8/22/2012	Annual	8/22/2013	1231538
Anritsu	MA24106A	USB Power Sensor	8/22/2012	Annual	8/22/2013	1231535
Anritsu	ML2495A	Power Meter	10/11/2012	Annual	10/11/2013	1039008
Anritsu	MA2411B	Pulse Power Sensor	12/5/2012	Annual	12/5/2013	1126066
Anritsu	MA2481D	Universal Sensor	12/17/2012	Annual	12/17/2013	1204419
Anritsu	MA2411B	Pulse Power Sensor	12/4/2012	Annual	12/4/2013	1207364
COMTECH	AR85729-5	Solid State Amplifier	CBT	N/A	CBT	M1S5A00-009
COMTECH	AR85729-5/5759B	Solid State Amplifier	CBT	N/A	CBT	M3W1A00-1002
MCL	BW-N6W5+	6dB Attenuator	CBT	N/A	CBT	1139
MiniCircuits	SLP-2400+	Low Pass Filter	CBT	N/A	CBT	R8979500903
Mini-Circuits	NLP-1200+	Low Pass Filter DC to 1000 MHz	CBT	N/A	CBT	N/A
Mini-Circuits	BW-N20W5	Power Attenuator	CBT	N/A	CBT	1226
Mini-Circuits	NLP-2950+	Low Pass Filter DC to 2700 MHz	CBT	N/A	CBT	N/A
Mini-Circuits	BW-N20W5+	DC to 18 GHz Precision Fixed 20 dB Attenuator	CBT	N/A	CBT	N/A
Narda	BW-S3W2	Attenuator (3dB)	CBT	N/A	CBT	120
Narda	4772-3	Attenuator (3dB)	CBT	N/A	CBT	9406
Narda	4014C-6	4 - 8 GHz SMA 6 dB Directional Coupler	CBT	N/A	CBT	N/A
Pasternack	PE2209-10	Bidirectional Coupler	CBT	N/A	CBT	N/A
Pasternack	PE2208-6	Bidirectional Coupler	CBT	N/A	CBT	N/A
Rohde & Schwarz	CMW500	LTE Radio Communication Tester	2/8/2013	Annual	2/8/2014	101699
Rohde & Schwarz	ZVC	Vector Network Analyzer	4/25/2013	Biennial	4/25/2015	100056
Rohde & Schwarz	CMW500	LTE Radio Communication Tester	10/7/2011	Biennial	10/7/2013	103962
Seekonk	NC-100	Torque Wrench (8" lb)	3/5/2012	Triennial	3/5/2015	N/A
SPEAG	D1900V2	1900 MHz SAR Dipole	2/6/2013	Annual	2/6/2014	5d148
SPEAG	D1900V2	1900 MHz SAR Dipole	7/20/2012	Annual	7/20/2013	5d080
SPEAG	D2450V2	2450 MHz SAR Dipole	8/23/2012	Annual	8/23/2013	719
SPEAG	D750V3	750 MHz Dipole	3/18/2013	Annual	3/18/2014	1054
SPEAG	D835V2	835 MHz SAR Dipole	1/7/2013	Annual	1/7/2014	4d132
SPEAG	DAE4	Dasy Data Acquisition Electronics	8/24/2012	Annual	8/24/2013	1322
SPEAG	DAE4	Dasy Data Acquisition Electronics	9/19/2012	Annual	9/19/2013	1323
SPEAG	DAE4	Dasy Data Acquisition Electronics	3/8/2013	Annual	3/8/2014	1334
SPEAG	DAE4	Dasy Data Acquisition Electronics	2/6/2013	Annual	2/6/2014	649
SPEAG	DAE4	Dasy Data Acquisition Electronics	11/13/2012	Annual	11/13/2013	1333
SPEAG	DAK-3.5	Dielectric Assessment Kit	5/14/2013	Annual	5/14/2014	1070
SPEAG	DAK-3.5	Dielectric Assessment Kit	12/11/2012	Annual	12/11/2013	1091
SPEAG	ES3DV2	SAR Probe	8/28/2012	Annual	8/28/2013	3022
SPEAG	ES3DV3	SAR Probe	11/15/2012	Annual	11/15/2013	3287
SPEAG	ES3DV3	SAR Probe	9/20/2012	Annual	9/20/2013	3288
SPEAG	ES3DV3	SAR Probe	3/15/2013	Annual	3/15/2014	3209
SPEAG	EX3DV4	SAR Probe	2/27/2013	Annual	2/27/2014	3920
VWR	36934-158	Wall-Mounted Thermometer	9/30/2011	Biennial	9/30/2013	111859332
VWR	36934-158	Wall-Mounted Thermometer	9/30/2011	Biennial	9/30/2013	111859323
VWR	23226-658	Long Stem Thermometer	6/27/2012	Biennial	6/27/2014	122363923
VWR	23226-658	Long Stem Thermometer	7/11/2012	Biennial	7/11/2014	122389334



Note: CBT (Calibrated Before Testing). Prior to testing, the measurement paths containing a cable, amplifier, attenuator, coupler or filter were connected to a calibrated source (i.e. a signal generator) to determine the losses of the measurement path. The power meter offset was then adjusted to compensate for the measurement system losses. This level offset is stored within the power meter before measurements are made. This calibration verification procedure applies to the system verification and output power measurements. The calibrated reading is then taken directly from the power meter after compensation of the losses for all final power measurements.

FCC ID: ZNFVS890	 PCTEST ENGINEERING LABORATORY, INC.	SAR EVALUATION REPORT		Reviewed by: Quality Manager
Document S/N: OY1306100965.ZNF	Test Dates: 06/11/13 - 06/18/13	DUT Type: Portable Handset	Page 40 of 44	

16 MEASUREMENT UNCERTAINTIES

a	b	c	d	e= f(d,k)	f	g	h = c x f/e	i = c x g/e	k	
Uncertainty Component	IEEE 1528 Sec.	Tol. (± %)	Prob. Dist.	Div.	c _i 1gm	c _i 10 gms	1gm u _i (± %)	10gms u _i (± %)	v _i	
Measurement System										
Probe Calibration	E.2.1	6.0	N	1	1.0	1.0	6.0	6.0	∞	
Axial Isotropy	E.2.2	0.25	N	1	0.7	0.7	0.2	0.2	∞	
Hemishperical Isotropy	E.2.2	1.3	N	1	1.0	1.0	1.3	1.3	∞	
Boundary Effect	E.2.3	0.4	N	1	1.0	1.0	0.4	0.4	∞	
Linearity	E.2.4	0.3	N	1	1.0	1.0	0.3	0.3	∞	
System Detection Limits	E.2.5	5.1	N	1	1.0	1.0	5.1	5.1	∞	
Readout Electronics	E.2.6	1.0	N	1	1.0	1.0	1.0	1.0	∞	
Response Time	E.2.7	0.8	R	1.73	1.0	1.0	0.5	0.5	∞	
Integration Time	E.2.8	2.6	R	1.73	1.0	1.0	1.5	1.5	∞	
RF Ambient Conditions	E.6.1	3.0	R	1.73	1.0	1.0	1.7	1.7	∞	
Probe Positioner Mechanical Tolerance	E.6.2	0.4	R	1.73	1.0	1.0	0.2	0.2	∞	
Probe Positioning w/ respect to Phantom	E.6.3	2.9	R	1.73	1.0	1.0	1.7	1.7	∞	
Extrapolation, Interpolation & Integration algorithms for Max. SAR Evaluation	E.5	1.0	R	1.73	1.0	1.0	0.6	0.6	∞	
Test Sample Related										
Test Sample Positioning	E.4.2	6.0	N	1	1.0	1.0	6.0	6.0	287	
Device Holder Uncertainty	E.4.1	3.32	R	1.73	1.0	1.0	1.9	1.9	∞	
Output Power Variation - SAR drift measurement	6.6.2	5.0	R	1.73	1.0	1.0	2.9	2.9	∞	
Phantom & Tissue Parameters										
Phantom Uncertainty (Shape & Thickness tolerances)	E.3.1	4.0	R	1.73	1.0	1.0	2.3	2.3	∞	
Liquid Conductivity - deviation from target values	E.3.2	5.0	R	1.73	0.64	0.43	1.8	1.2	∞	
Liquid Conductivity - measurement uncertainty	E.3.3	3.8	N	1	0.64	0.43	2.4	1.6	6	
Liquid Permittivity - deviation from target values	E.3.2	5.0	R	1.73	0.60	0.49	1.7	1.4	∞	
Liquid Permittivity - measurement uncertainty	E.3.3	4.5	N	1	0.60	0.49	2.7	2.2	6	
Combined Standard Uncertainty (k=1)							RSS	12.1	11.7	299
Expanded Uncertainty (95% CONFIDENCE LEVEL)							k=2	24.2	23.5	

The above measurement uncertainties are according to IEEE Std. 1528-2003



FCC ID: ZNFVS890	 PCTEST ENGINEERING LABORATORY, INC.	SAR EVALUATION REPORT	 LG	Reviewed by: Quality Manager
Document S/N: OY1306100965.ZNF	Test Dates: 06/11/13 - 06/18/13	DUT Type: Portable Handset		Page 41 of 44

17 CONCLUSION

17.1 Measurement Conclusion



The SAR evaluation indicates that the EUT complies with the RF radiation exposure limits of the FCC and Industry Canada, with respect to all parameters subject to this test. These measurements were taken to simulate the RF effects of RF exposure under worst-case conditions. Precise laboratory measures were taken to assure repeatability of the tests. The results and statements relate only to the item(s) tested.

Please note that the absorption and distribution of electromagnetic energy in the body are very complex phenomena that depend on the mass, shape, and size of the body, the orientation of the body with respect to the field vectors, and the electrical properties of both the body and the environment. Other variables that may play a substantial role in possible biological effects are those that characterize the environment (e.g. ambient temperature, air velocity, relative humidity, and body insulation) and those that characterize the individual (e.g. age, gender, activity level, debilitation, or disease). Because various factors may interact with one another to vary the specific biological outcome of an exposure to electromagnetic fields, any protection guide should consider maximal amplification of biological effects as a result of field-body interactions, environmental conditions, and physiological variables. [3]



FCC ID: ZNFVS890	 PCTEST ENGINEERING LABORATORY, INC.	SAR EVALUATION REPORT		Reviewed by: Quality Manager
Document S/N: 0Y1306100965.ZNF	Test Dates: 06/11/13 - 06/18/13	DUT Type: Portable Handset		Page 42 of 44

18 REFERENCES

- [1] Federal Communications Commission, ET Docket 93-62, Guidelines for Evaluating the Environmental Effects of Radiofrequency Radiation, Aug. 1996.
- [2] ANSI/IEEE C95.1-2005, American National Standard safety levels with respect to human exposure to radio frequency electromagnetic fields, 3kHz to 300GHz, New York: IEEE, 2006.
- [3] ANSI/IEEE C95.1-1992, American National Standard safety levels with respect to human exposure to radio frequency electromagnetic fields, 3kHz to 300GHz, New York: IEEE, Sept. 1992.
- [4] ANSI/IEEE C95.3-2002, IEEE Recommended Practice for the Measurement of Potentially Hazardous Electromagnetic Fields - RF and Microwave, New York: IEEE, December 2002.
- [5] Federal Communications Commission, OET Bulletin 65 (Edition 97-01), Supplement C (Edition 01-01), Evaluating Compliance with FCC Guidelines for Human Exposure to Radiofrequency Electromagnetic Fields, June 2001.
- [6] IEEE Standards Coordinating Committee 34 – IEEE Std. 1528-2003, Recommended Practice for Determining the Peak Spatial-Average Specific Absorption Rate (SAR) in the Human Body Due to Wireless Communications Devices.
- [7] NCRP, National Council on Radiation Protection and Measurements, Biological Effects and Exposure Criteria for RadioFrequency Electromagnetic Fields, NCRP Report No. 86, 1986. Reprinted Feb. 1995.
- [8] T. Schmid, O. Egger, N. Kuster, Automated E-field scanning system for dosimetric assessments, IEEE Transaction on Microwave Theory and Techniques, vol. 44, Jan. 1996, pp. 105-113.
- [9] K. Pokovic, T. Schmid, N. Kuster, Robust setup for precise calibration of E-field probes in tissue simulating liquids at mobile communications frequencies, ICECOM97, Oct. 1997, pp. -124.
- [10] K. Pokovic, T. Schmid, and N. Kuster, E-field Probe with improved isotropy in brain simulating liquids, Proceedings of the ELMAR, Zadar, Croatia, June 23-25, 1996, pp. 172-175.
- [11] Schmid & Partner Engineering AG, Application Note: Data Storage and Evaluation, June 1998, p2.
- [12] V. Hombach, K. Meier, M. Burkhardt, E. Kuhn, N. Kuster, The Dependence of EM Energy Absorption upon Human Modeling at 900 MHz, IEEE Transaction on Microwave Theory and Techniques, vol. 44 no. 10, Oct. 1996, pp. 1865-1873.
- [13] N. Kuster and Q. Balzano, Energy absorption mechanism by biological bodies in the near field of dipole antennas above 300MHz, IEEE Transaction on Vehicular Technology, vol. 41, no. 1, Feb. 1992, pp. 17-23.
- [14] G. Hartsgrrove, A. Kraszewski, A. Surowiec, Simulated Biological Materials for Electromagnetic Radiation Absorption Studies, University of Ottawa, Bioelectromagnetics, Canada: 1987, pp. 29-36.
- [15] Q. Balzano, O. Garay, T. Manning Jr., Electromagnetic Energy Exposure of Simulated Users of Portable Cellular Telephones, IEEE Transactions on Vehicular Technology, vol. 44, no.3, Aug. 1995.
- [16] W. Gander, Computermathematik, Birkhaeuser, Basel, 1992.
- [17] W.H. Press, S.A. Teukolsky, W.T. Vetterling, and B.P. Flannery, Numerical Recipes in C, The Art of Scientific Computing, Second edition, Cambridge University Press, 1992.

FCC ID: ZNFVS890	 PCTEST ENGINEERING LABORATORY, INC.	SAR EVALUATION REPORT	 LG	Reviewed by: Quality Manager
Document S/N: 0Y1306100965.ZNF	Test Dates: 06/11/13 - 06/18/13	DUT Type: Portable Handset		Page 43 of 44

- [18] Federal Communications Commission, OET Bulletin 65, Evaluating Compliance with FCC Guidelines for Human Exposure to Radiofrequency Electromagnetic Fields. Supplement C, Dec. 1997.
- [19] N. Kuster, R. Kastle, T. Schmid, Dosimetric evaluation of mobile communications equipment with known precision, IEEE Transaction on Communications, vol. E80-B, no. 5, May 1997, pp. 645-652.
- [20] CENELEC CLC/SC111B, European Prestandard (prENV 50166-2), Human Exposure to Electromagnetic Fields High-frequency: 10kHz-300GHz, Jan. 1995.
- [21] Prof. Dr. Niels Kuster, ETH, Eidgenössische Technische Hochschule Zürich, Dosimetric Evaluation of the Cellular Phone.
- [22] IEC 62209-1, Human exposure to radio frequency fields from hand-held and body-mounted wireless communication devices - Human models, instrumentation, and procedures - Part 1: Procedure to determine the specific absorption rate (SAR) for hand-held devices used in close proximity to the ear (frequency range of 300 MHz to 3 GHz), Feb. 2005.
- [23] Industry Canada RSS-102 Radio Frequency Exposure Compliance of Radiocommunication Apparatus (All Frequency Bands) Issue 4, March 2010.
- [24] Health Canada Safety Code 6 Limits of Human Exposure to Radio Frequency Electromagnetic Fields in the Frequency Range from 3 kHz – 300 GHz, 2009
- [25] FCC Public Notice DA-02-1438. Office of Engineering and Technology Announces a Transition Period for the Phantom Requirements of Supplement C to OET Bulletin 65, June 19, 2002
- [26] FCC SAR Test Procedures for 2G-3G Devices, Mobile Hotspot and UMPC Devices KDB Publications 941225, D01-D07
- [27] SAR Measurement procedures for IEEE 802.11a/b/g KDB Publication 248227 D01v01r02
- [28] FCC SAR Considerations for Handsets with Multiple Transmitters and Antennas, KDB Publications 648474 D02-D04
- [29] FCC SAR Evaluation Considerations for Laptop, Notebook, Netbook and Tablet Computers, FCC KDB Publication 616217 D04
- [30] FCC SAR Measurement and Reporting Requirements for 100MHz – 6 GHz, KDB Publications 865664 D01-D02
- [31] FCC General RF Exposure Guidance and SAR Procedures for Dongles, KDB Publication 447498, D01-D02
- [32] Anexo à Resolução No. 533, de 10 de Setembro de 2009.
- [33] IEC 62209-2, Human exposure to radio frequency fields from hand-held and body-mounted wireless communication devices - Human models, instrumentation, and procedures - Part 2: Procedure to determine the specific absorption rate (SAR) for wireless communication devices used in close proximity to the human body (frequency range of 30 MHz to 6 GHz), Mar. 2010.

FCC ID: ZNFVS890	 PCTEST ENGINEERING LABORATORY, INC.	SAR EVALUATION REPORT		Reviewed by: Quality Manager
Document S/N: 0Y1306100965.ZNF	Test Dates: 06/11/13 - 06/18/13	DUT Type: Portable Handset		Page 44 of 44

APPENDIX A: SAR TEST DATA

PCTEST ENGINEERING LABORATORY, INC.

DUT: ZNFVS890; Type: Portable Handset; Serial: 001

Communication System: CDMA; Frequency: 836.52 MHz; Duty Cycle: 1:1

Medium: 835 Head Medium parameters used (interpolated):

$f = 836.52 \text{ MHz}$; $\sigma = 0.937 \text{ S/m}$; $\epsilon_r = 42.003$; $\rho = 1000 \text{ kg/m}^3$

Phantom section: Left Section

Test Date: 06-13-2013; Ambient Temp: 23.1°C; Tissue Temp: 23.2°C

Probe: ES3DV3 - SN3288; ConvF(6.41, 6.41, 6.41); Calibrated: 9/20/2012;

Sensor-Surface: 4mm (Mechanical Surface Detection)

Electronics: DAE4 Sn1323; Calibrated: 9/19/2012

Phantom: SAM v5.0 front; Type: QD000P40CD; Serial: TP-1646

Measurement SW: DASY52, Version 52.8 (7); SEMCAD X Version 14.6.10 (7164)

Mode: Cell. EVDO Rev. A, Left Head, Cheek, Mid.ch

Area Scan (8x13x1): Measurement grid: dx=15mm, dy=15mm

Zoom Scan (6x5x7)/Cube 0: Measurement grid: dx=8mm, dy=8mm, dz=5mm

Reference Value = 20.683 V/m; Power Drift = 0.00 dB

Peak SAR (extrapolated) = 0.500 W/kg

SAR(1 g) = 0.390 W/kg

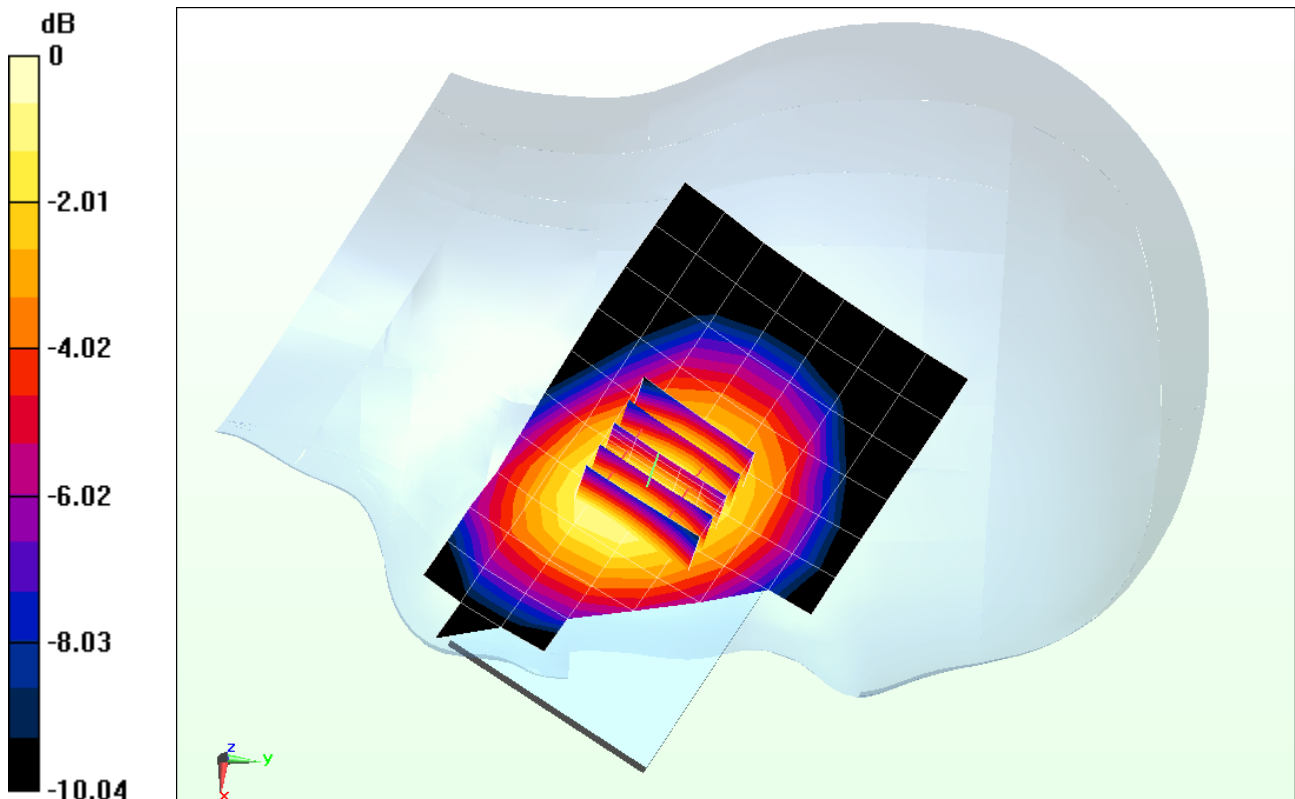

0 dB = 0.403 W/kg = -3.95 dBW/kg

PCTEST ENGINEERING LABORATORY, INC.

DUT: ZNFVS890; Type: Portable Handset; Serial: 001

Communication System: PCS CDMA; Frequency: 1880 MHz; Duty Cycle: 1:1

Medium: 1900 Head Medium parameters used:

$f = 1880 \text{ MHz}$; $\sigma = 1.415 \text{ S/m}$; $\epsilon_r = 38.732$; $\rho = 1000 \text{ kg/m}^3$

Phantom section: Left Section

Test Date: 06-11-2013; Ambient Temp: 22.0°C; Tissue Temp: 22.2°C

Probe: ES3DV3 - SN3287; ConvF(4.96, 4.96, 4.96); Calibrated: 11/15/2012;

Sensor-Surface: 4mm (Mechanical Surface Detection)

Electronics: DAE4 Sn1333; Calibrated: 11/13/2012

Phantom: SAM with CRP; Type: SAM 4.0; Serial: TP1375

Measurement SW: DASY4, Version 4.7 (80); SEMCAD X Version 14.6.10 (7164)

Mode: PCS EVDO Rev. A, Left Head, Cheek, Mid.ch

Area Scan (7x14x1): Measurement grid: dx=15mm, dy=15mm

Zoom Scan (5x5x7)/Cube 0: Measurement grid: dx=8mm, dy=8mm, dz=5mm

Reference Value = 25.264 V/m; Power Drift = 0.09 dB

Peak SAR (extrapolated) = 1.18 W/kg

SAR(1 g) = 0.747 W/kg

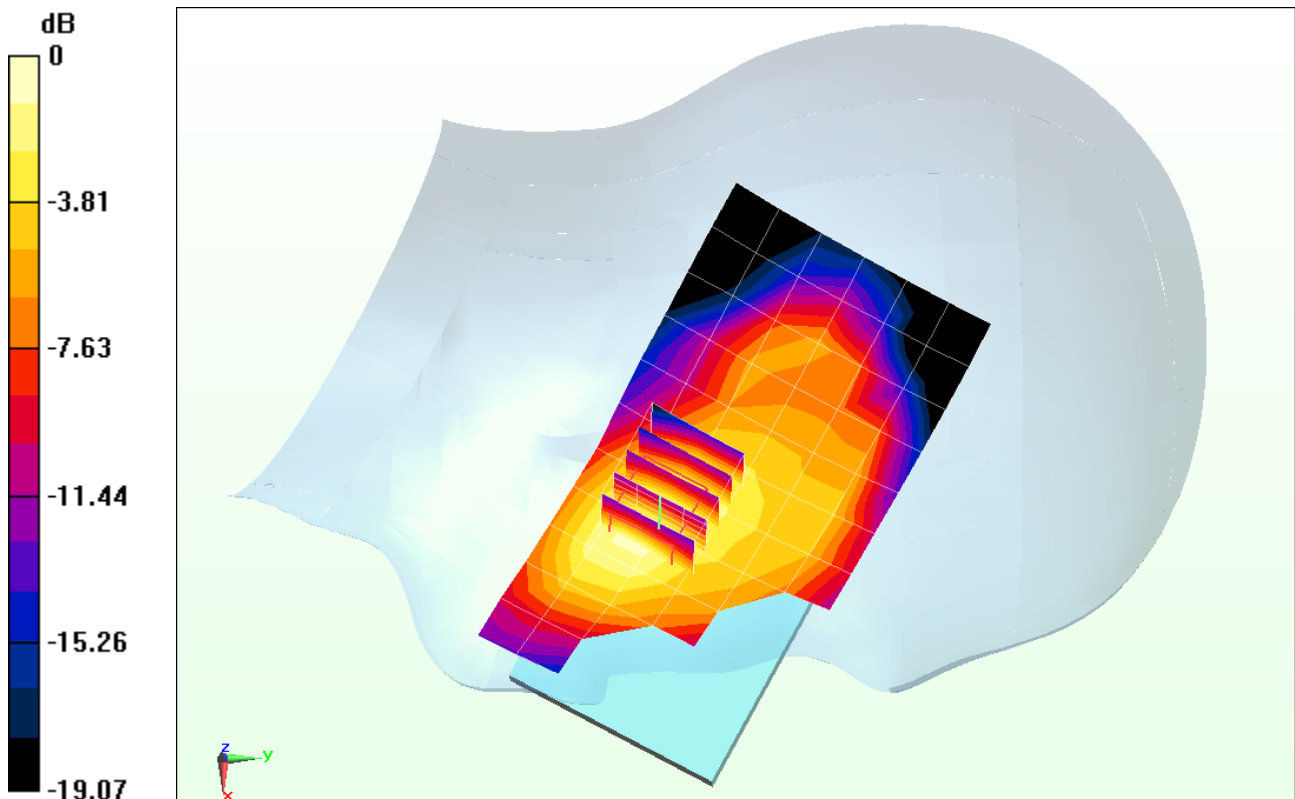

0 dB = 0.791 W/kg = -1.02 dBW/kg

PCTEST ENGINEERING LABORATORY, INC.

DUT: ZNFVS890; Type: Portable Handset; Serial: 003

Communication System: LTE RF; Frequency: 782 MHz; Duty Cycle: 1:1

Medium: 750 Head Medium parameters used (interpolated):

$f = 782 \text{ MHz}$; $\sigma = 0.93 \text{ S/m}$; $\epsilon_r = 40.843$; $\rho = 1000 \text{ kg/m}^3$

Phantom section: Right Section

Test Date: 06-13-2013; Ambient Temp: 23.8°C; Tissue Temp: 22.5°C

Probe: ES3DV2 - SN3022; ConvF(6.3, 6.3, 6.3); Calibrated: 8/28/2012;

Sensor-Surface: 4mm (Mechanical Surface Detection)

Electronics: DAE4 Sn1322; Calibrated: 8/24/2012

Phantom: SAM Main; Type: SAM 4.0; Serial: TP-1406

Measurement SW: DASY4, Version 4.7 (80); SEMCAD X Version 14.6.10 (7164)

Mode: LTE Band 13, Right Head, Cheek, Mid.ch, 10 MHz Bandwidth, QPSK, 1 RB, 25 RB Offset

Area Scan (7x14x1): Measurement grid: dx=15mm, dy=15mm

Zoom Scan (5x5x7)/Cube 0: Measurement grid: dx=8mm, dy=8mm, dz=5mm

Reference Value = 18.856 V/m; Power Drift = 0.01 dB

Peak SAR (extrapolated) = 0.355 W/kg

SAR(1 g) = 0.287 W/kg

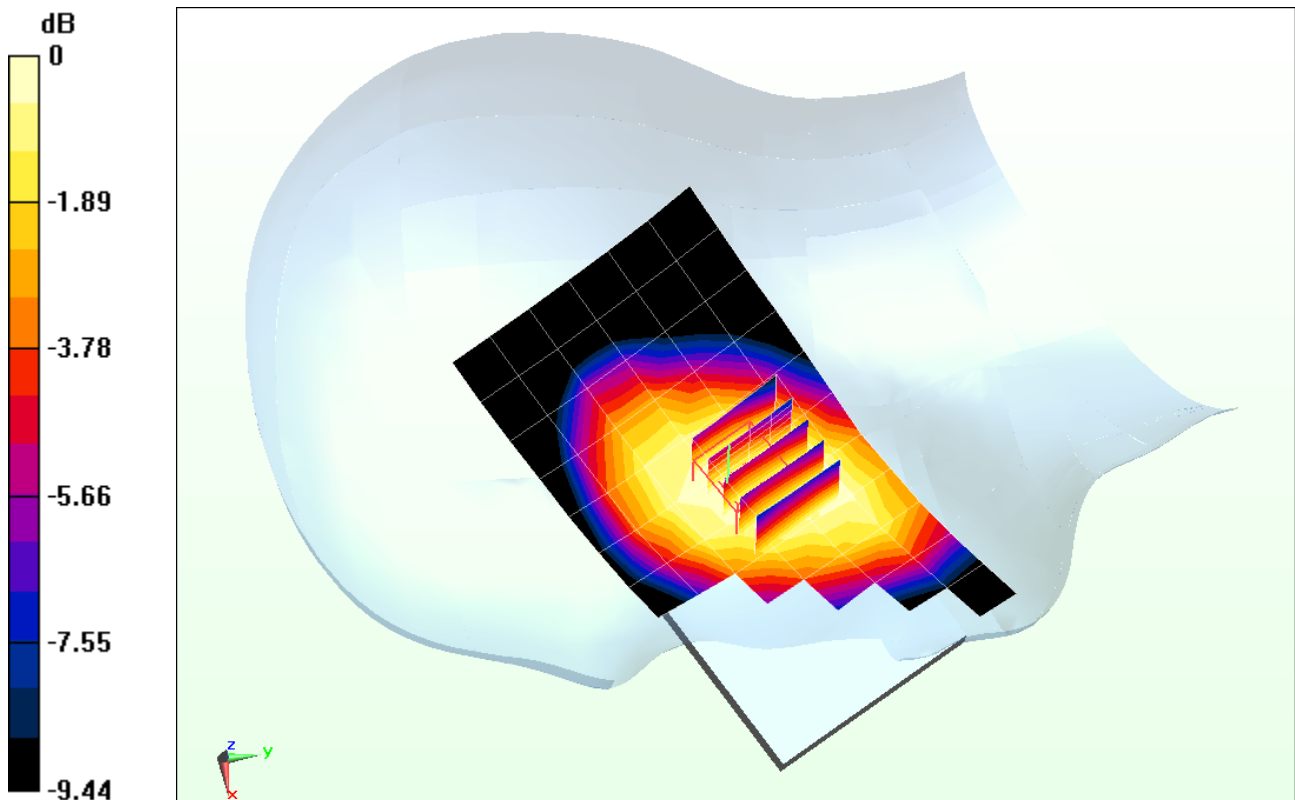

0 dB = 0.298 W/kg = -5.26 dBW/kg

PCTEST ENGINEERING LABORATORY, INC.

DUT: ZNFVS890; Type: Portable Handset; Serial: 002

Communication System: IEEE 802.11b; Frequency: 2437 MHz; Duty Cycle: 1:1

Medium: 2450 Head Medium parameters used (interpolated):

$f = 2437 \text{ MHz}$; $\sigma = 1.864 \text{ S/m}$; $\epsilon_r = 38.84$; $\rho = 1000 \text{ kg/m}^3$

Phantom section: Left Section

Test Date: 06-12-2013; Ambient Temp: 23.5°C; Tissue Temp: 23.8°C

Probe: ES3DV2 - SN3022; ConvF(4.23, 4.23, 4.23); Calibrated: 8/28/2012;

Sensor-Surface: 3mm (Mechanical Surface Detection)

Electronics: DAE4 Sn1322; Calibrated: 8/24/2012

Phantom: SAM Sub; Type: SAM 4.0; Serial: TP-1357

Measurement SW: DASY4, Version 4.7 (80); SEMCAD X Version 14.6.10 (7164)

Mode: IEEE 802.11b, Left Head, Tilt, Ch 06, 1 Mbps

Area Scan (10x15x1): Measurement grid: dx=12mm, dy=12mm

Zoom Scan (7x7x7)/Cube 0: Measurement grid: dx=5mm, dy=5mm, dz=5mm

Reference Value = 5.238 V/m; Power Drift = 0.15 dB

Peak SAR (extrapolated) = 0.0910 W/kg

SAR(1 g) = 0.046 W/kg

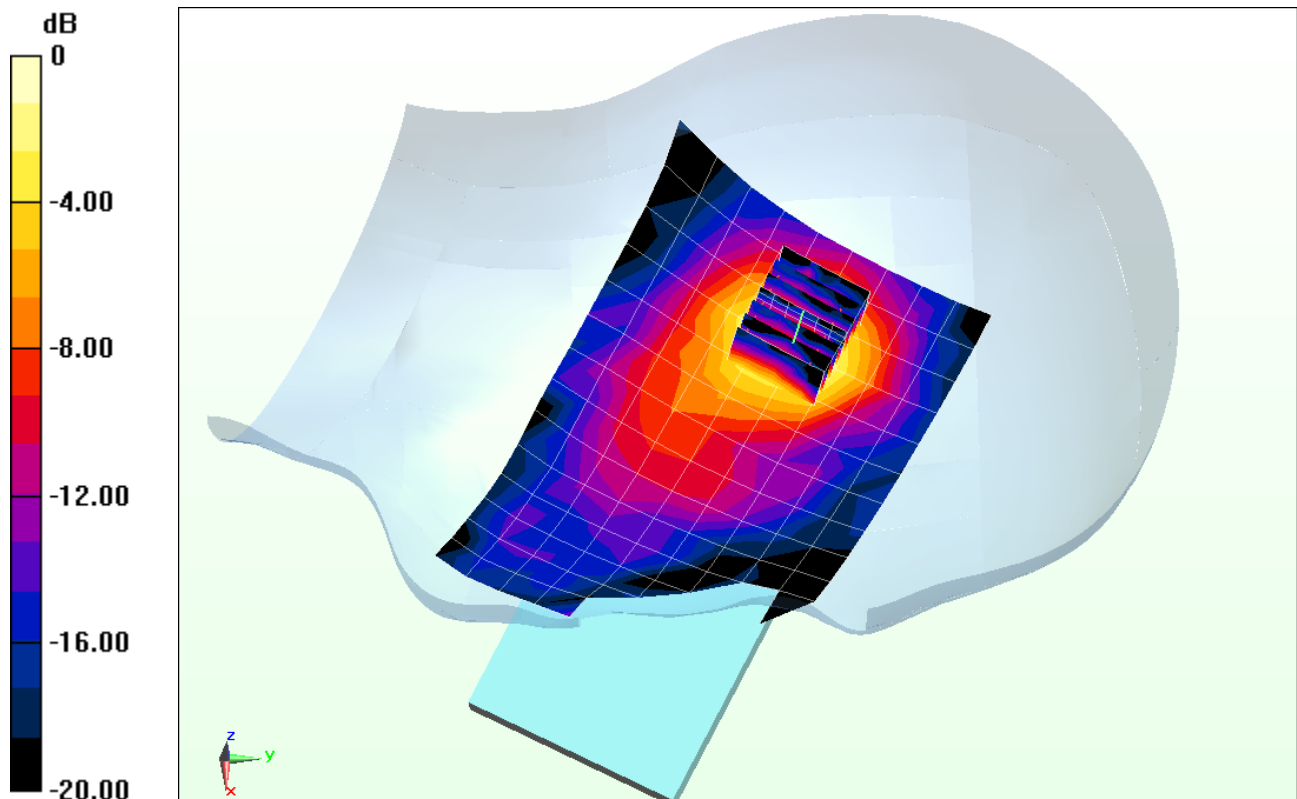

0 dB = 0.0589 W/kg = -12.30 dBW/kg

PCTEST ENGINEERING LABORATORY, INC.

DUT: ZNFVS890; Type: Portable Handset; Serial: 001

Communication System: CDMA; Frequency: 848.31 MHz; Duty Cycle: 1:1

Medium: 835 Body Medium parameters used (interpolated):

$f = 848.31 \text{ MHz}$; $\sigma = 1.021 \text{ S/m}$; $\epsilon_r = 55.752$; $\rho = 1000 \text{ kg/m}^3$

Phantom section: Flat Section; Space: 1.0 cm

Test Date: 06-18-2013; Ambient Temp: 24.6°C; Tissue Temp: 22.9°C

Probe: ES3DV3 - SN3209; ConvF(6.28, 6.28, 6.28); Calibrated: 3/15/2013;

Sensor-Surface: 4mm (Mechanical Surface Detection)

Electronics: DAE4 Sn1334; Calibrated: 3/8/2013

Phantom: ELI v5.0; Type: QDOVA002AA; Serial: TP-1158

Measurement SW: DASY52, Version 52.8 (7); SEMCAD X Version 14.6.10 (7164)

Mode: Cell. CDMA, Body SAR, Back side, High.ch

Area Scan (7x12x1): Measurement grid: $dx=15\text{mm}$, $dy=15\text{mm}$

Zoom Scan (6x5x7)/Cube 0: Measurement grid: $dx=8\text{mm}$, $dy=8\text{mm}$, $dz=5\text{mm}$

Reference Value = 32.431 V/m; Power Drift = 0.00 dB

Peak SAR (extrapolated) = 1.29 W/kg

SAR(1 g) = 1.03 W/kg

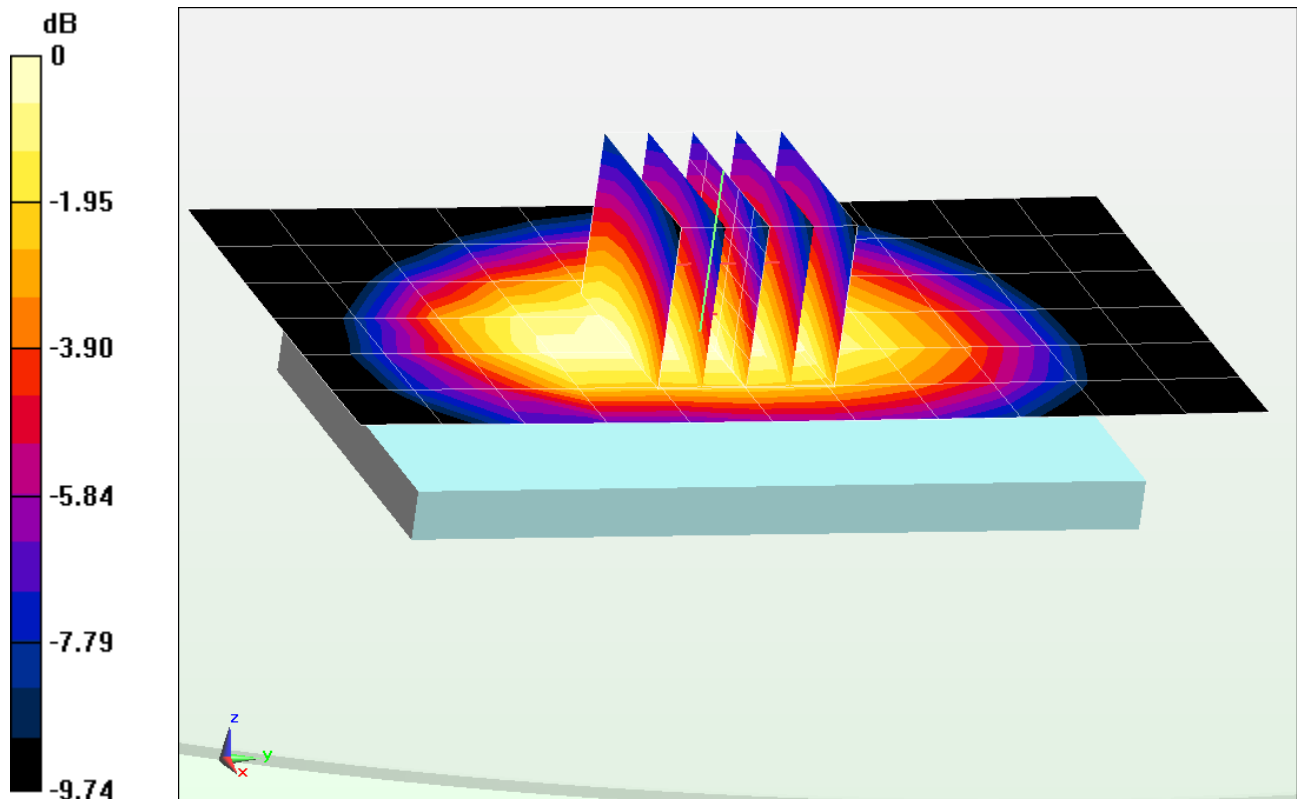

0 dB = 1.09 W/kg = 0.37 dBW/kg

PCTEST ENGINEERING LABORATORY, INC.

DUT: ZNFVS890; Type: Portable Handset; Serial: 001

Communication System: CDMA; Frequency: 1851.25 MHz; Duty Cycle: 1:1

Medium: 1900 Body Medium parameters used (interpolated):
 $f = 1851.25 \text{ MHz}$; $\sigma = 1.494 \text{ S/m}$; $\epsilon_r = 51.562$; $\rho = 1000 \text{ kg/m}^3$

Phantom section: Flat Section; Space: 1.0 cm

Test Date: 06-11-2013; Ambient Temp: 24.4°C; Tissue Temp: 23.5°C

Probe: EX3DV4 - SN3920; ConvF(7.38, 7.38, 7.38); Calibrated: 2/27/2013;

Sensor-Surface: 4mm (Mechanical Surface Detection)

Electronics: DAE4 Sn649; Calibrated: 2/6/2013

Phantom: SAM 5.0 front; Type: QD000P40CD; Serial: TP:-1648

Measurement SW: DASY52, Version 52.8 (7);SEMCAD X Version 14.6.10 (7164)

Mode: PCS CDMA, Body SAR, Back side, Low.ch

Area Scan (8x12x1): Measurement grid: dx=15mm, dy=15mm

Zoom Scan (6x6x7)/Cube 0: Measurement grid: dx=8mm, dy=8mm, dz=5mm

Reference Value = 24.971 V/m; Power Drift = -0.07 dB

Peak SAR (extrapolated) = 1.49 W/kg

SAR(1 g) = 0.964 W/kg

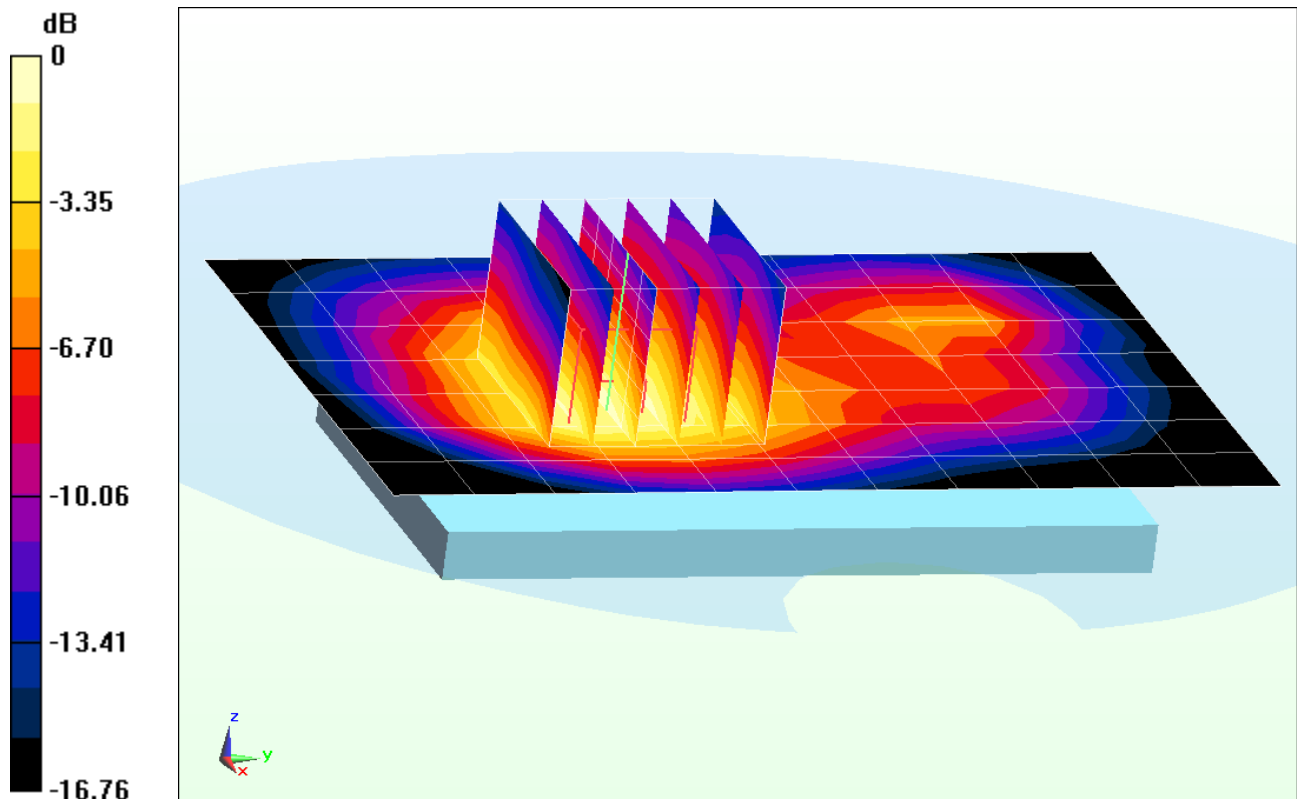

0 dB = 1.03 W/kg = 0.13 dBW/kg

PCTEST ENGINEERING LABORATORY, INC.

DUT: ZNFVS890; Type: Portable Handset; Serial: 001

Communication System: CDMA; Frequency: 1851.25 MHz; Duty Cycle: 1:1

Medium: 1900 Body Medium parameters used (interpolated):

$f = 1851.25 \text{ MHz}$; $\sigma = 1.494 \text{ S/m}$; $\epsilon_r = 51.562$; $\rho = 1000 \text{ kg/m}^3$

Phantom section: Flat Section; Space: 1.0 cm

Test Date: 06-11-2013; Ambient Temp: 24.4°C; Tissue Temp: 23.5°C

Probe: EX3DV4 - SN3920; ConvF(7.38, 7.38, 7.38); Calibrated: 2/27/2013;

Sensor-Surface: 4mm (Mechanical Surface Detection)

Electronics: DAE4 Sn649; Calibrated: 2/6/2013

Phantom: SAM 5.0 front; Type: QD000P40CD; Serial: TP:-1648

Measurement SW: DASY52, Version 52.8 (7);SEMCAD X Version 14.6.10 (7164)

Mode: PCS EVDO Rev. 0, Body SAR, Back side, Low.ch

Area Scan (8x12x1): Measurement grid: dx=15mm, dy=15mm

Zoom Scan (5x6x7)/Cube 0: Measurement grid: dx=8mm, dy=8mm, dz=5mm

Reference Value = 25.879 V/m; Power Drift = -0.05 dB

Peak SAR (extrapolated) = 1.49 W/kg

SAR(1 g) = 0.975 W/kg

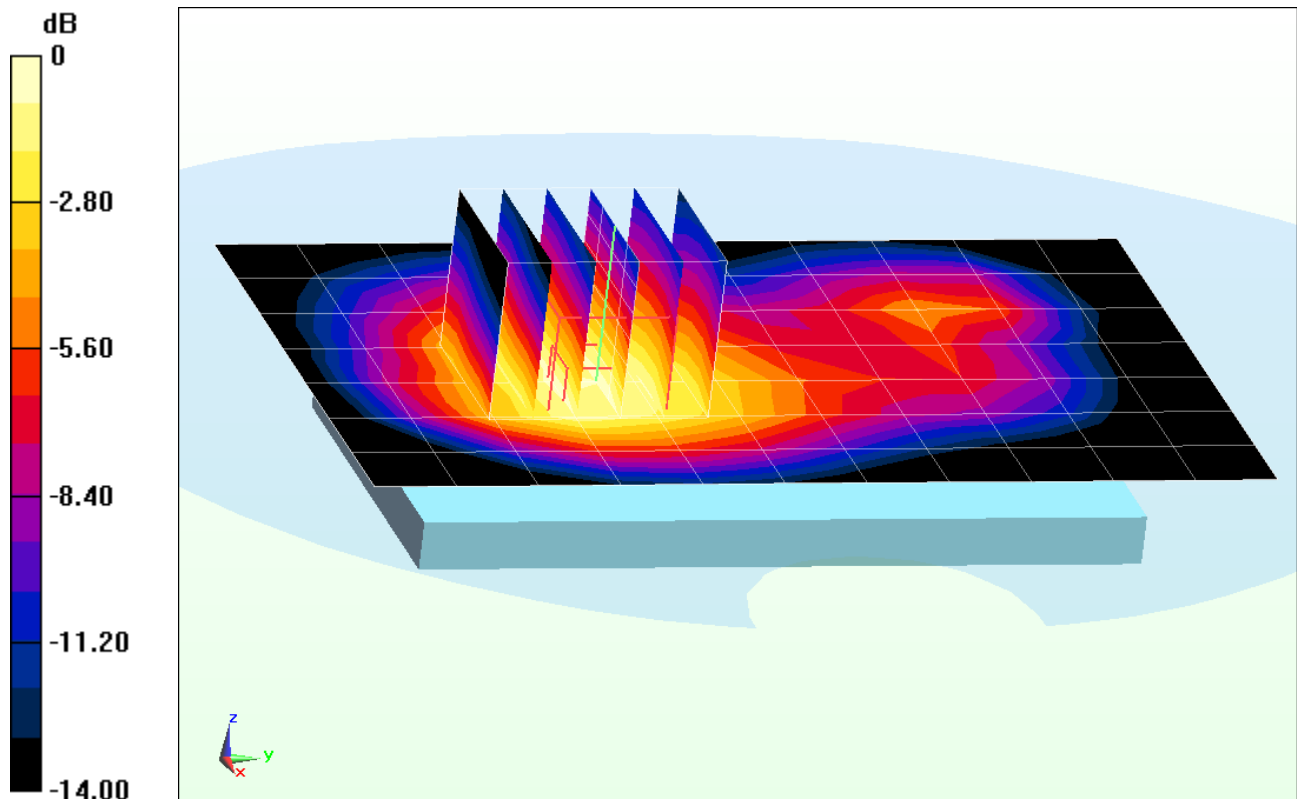

0 dB = 1.03 W/kg = 0.13 dBW/kg

PCTEST ENGINEERING LABORATORY, INC.

DUT: ZNFVS890; Type: Portable Handset; Serial: 003

Communication System: LTE RF; Frequency: 782 MHz; Duty Cycle: 1:1

Medium: 750 Body Medium parameters used (interpolated):

$f = 782 \text{ MHz}$; $\sigma = 1.007 \text{ S/m}$; $\epsilon_r = 55.217$; $\rho = 1000 \text{ kg/m}^3$

Phantom section: Flat Section; Space: 1.0 cm

Test Date: 06-13-2013; Ambient Temp: 23.3°C; Tissue Temp: 22.7°C

Probe: ES3DV2 - SN3022; ConvF(6.07, 6.07, 6.07); Calibrated: 8/28/2012;

Sensor-Surface: 4mm (Mechanical Surface Detection)

Electronics: DAE4 Sn1322; Calibrated: 8/24/2012

Phantom: SAM Main; Type: SAM 4.0; Serial: TP-1406

Measurement SW: DASY4, Version 4.7 (80); SEMCAD X Version 14.6.10 (7164)

Mode: LTE Band 13, Body SAR, Back side, Mid.ch, 10 MHz Bandwidth, QPSK, 1 RB, 25 RB Offset

Area Scan (8x12x1): Measurement grid: dx=15mm, dy=15mm

Zoom Scan (5x5x7)/Cube 0: Measurement grid: dx=8mm, dy=8mm, dz=5mm

Reference Value = 26.046 V/m; Power Drift = 0.04 dB

Peak SAR (extrapolated) = 0.948 W/kg

SAR(1 g) = 0.632 W/kg

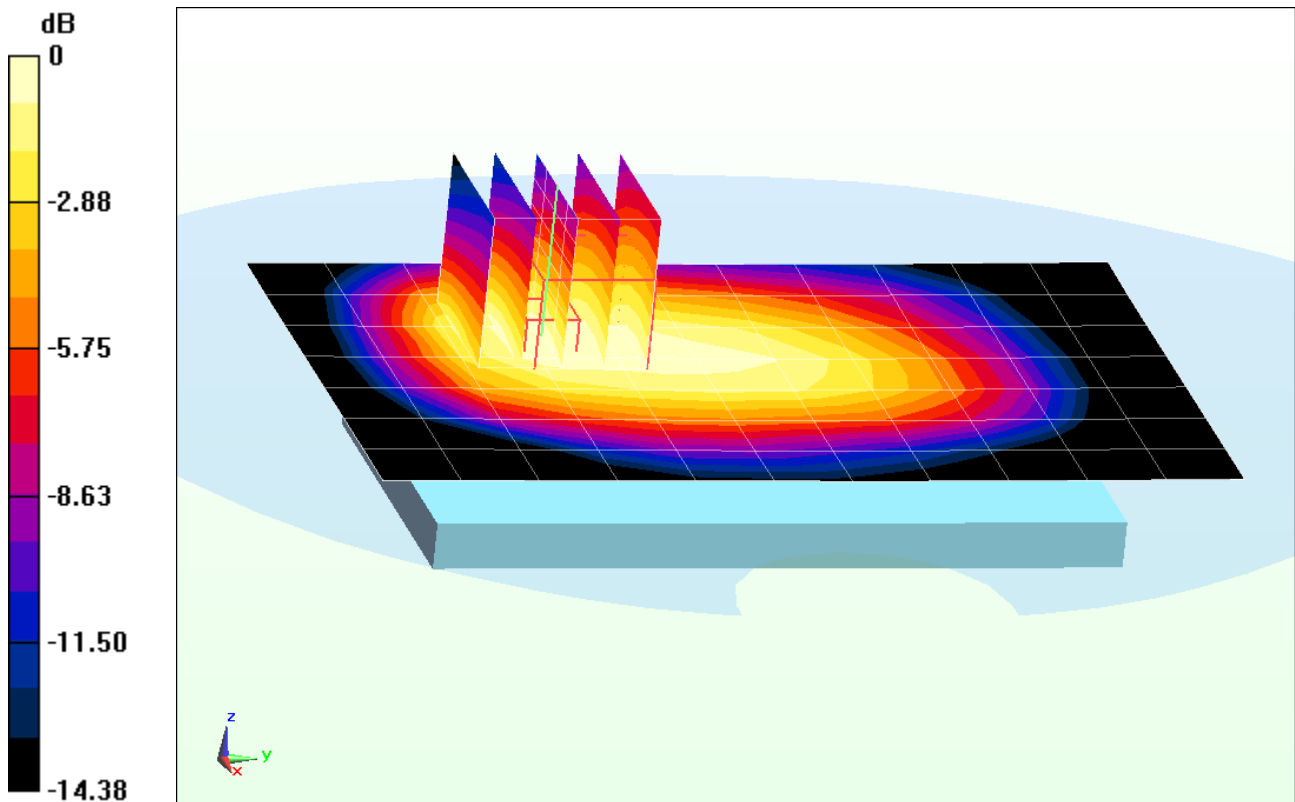

0 dB = 0.671 W/kg = -1.73 dBW/kg

PCTEST ENGINEERING LABORATORY, INC.

DUT: ZNFVS890; Type: Portable Handset; Serial: 002

Communication System: IEEE 802.11b; Frequency: 2437 MHz; Duty Cycle: 1:1
Medium: 2450 Body Medium parameters used (interpolated):

$$f = 2437 \text{ MHz}; \sigma = 1.984 \text{ S/m}; \epsilon_r = 51; \rho = 1000 \text{ kg/m}^3$$

Phantom section: Flat Section; Space: 1.0 cm

Test Date: 06-11-2013; Ambient Temp: 23.7°C; Tissue Temp: 23.5°C

Probe: ES3DV2 - SN3022; ConvF(3.97, 3.97, 3.97); Calibrated: 8/28/2012;

Sensor-Surface: 3mm (Mechanical Surface Detection)

Electronics: DAE4 Sn1322; Calibrated: 8/24/2012

Phantom: SAM Sub; Type: SAM 4.0; Serial: TP-1357

Measurement SW: DASY4, Version 4.7 (80); SEMCAD X Version 14.6.10 (7164)

Mode: IEEE 802.11b, Body SAR, Ch 06, 1 Mbps, Back Side

Area Scan (9x14x1): Measurement grid: dx=12mm, dy=12mm

Zoom Scan (7x7x7)/Cube 0: Measurement grid: dx=5mm, dy=5mm, dz=5mm

Reference Value = 6.165 V/m; Power Drift = 0.08 dB

Peak SAR (extrapolated) = 0.149 W/kg

SAR(1 g) = 0.0705 W/kg

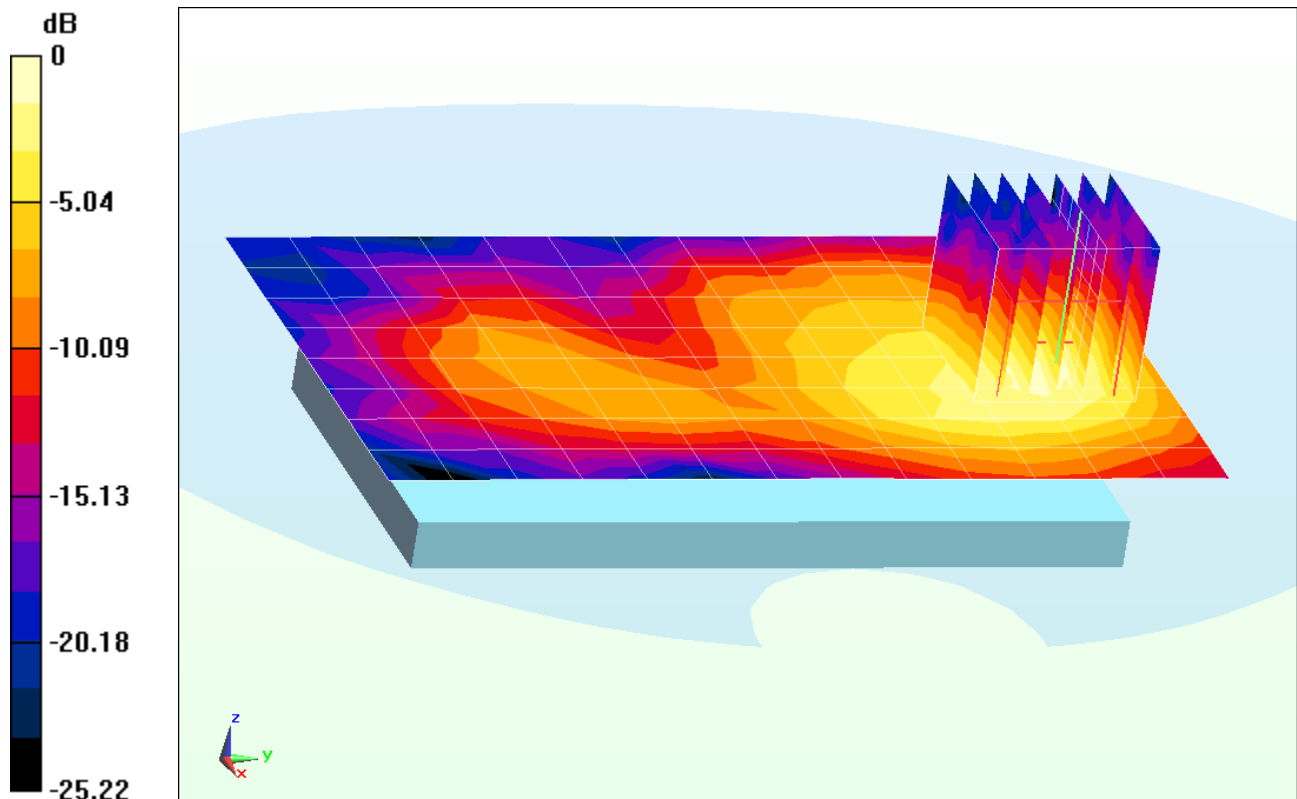

0 dB = 0.0896 W/kg = -10.48 dBW/kg

APPENDIX B: SYSTEM VERIFICATION

PCTEST ENGINEERING LABORATORY, INC.

DUT: Dipole 750 MHz; Type: D750V3; Serial: 1054

Communication System: CW; Frequency: 750 MHz; Duty Cycle: 1:1

Medium: 750 Head Medium parameters used (interpolated):

$$f = 750 \text{ MHz}; \sigma = 0.9 \text{ S/m}; \epsilon_r = 41.372; \rho = 1000 \text{ kg/m}^3$$

Phantom section: Flat Section; Space: 1.5 cm

Test Date: 06-13-2013; Ambient Temp: 23.8°C; Tissue Temp: 22.5°C

Probe: ES3DV2 - SN3022; ConvF(6.3, 6.3, 6.3); Calibrated: 8/28/2012;

Sensor-Surface: 4mm (Mechanical Surface Detection)

Electronics: DAE4 Sn1322; Calibrated: 8/24/2012

Phantom: SAM Main; Type: SAM 4.0; Serial: TP-1406

Measurement SW: DASY4, Version 4.7 (80); SEMCAD X Version 14.6.10 (7164)

750 MHz System Verification

Area Scan (7x13x1): Measurement grid: dx=15mm, dy=15mm

Zoom Scan (5x5x7)/Cube 0: Measurement grid: dx=8mm, dy=8mm, dz=5mm

Input Power = 20.0 dBm (100 mW)

Peak SAR (extrapolated) = 1.14 W/kg

SAR(1 g) = 0.785 W/kg

Deviation = -7.65%

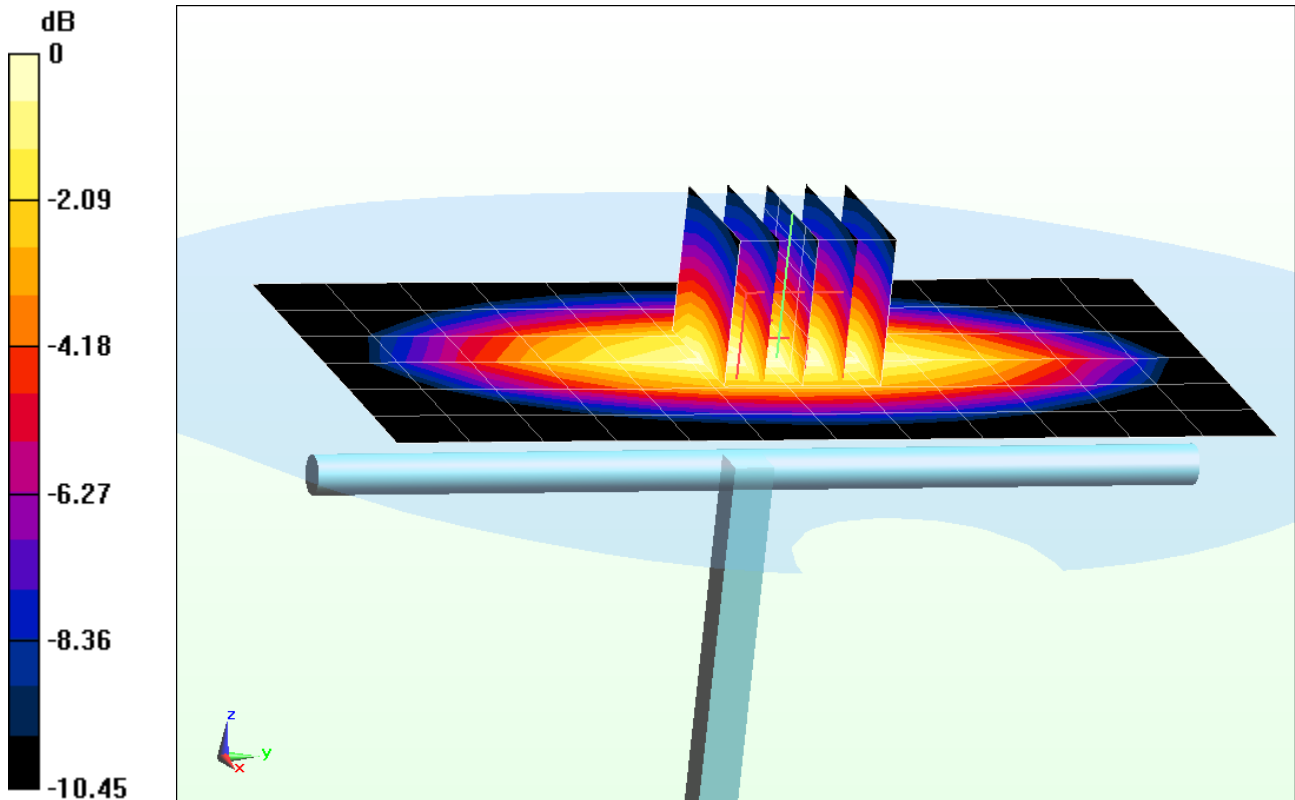

0 dB = 0.851 W/kg = -0.70 dBW/kg

PCTEST ENGINEERING LABORATORY, INC.

DUT: SAR Dipole 835 MHz; Type: D835V2; Serial: 4d132

Communication System: CW; Frequency: 835 MHz; Duty Cycle: 1:1

Medium: 835 Head Medium parameters used:

$f = 835 \text{ MHz}$; $\sigma = 0.935 \text{ S/m}$; $\epsilon_r = 42.022$; $\rho = 1000 \text{ kg/m}^3$

Phantom section: Flat Section; Space: 1.5 cm

Test Date: 06-13-2013; Ambient Temp: 23.1°C; Tissue Temp: 23.2°C

Probe: ES3DV3 - SN3288; ConvF(6.41, 6.41, 6.41); Calibrated: 9/20/2012;

Sensor-Surface: 4mm (Mechanical Surface Detection)

Electronics: DAE4 Sn1323; Calibrated: 9/19/2012

Phantom: SAM v5.0 front; Type: QD000P40CD; Serial: TP-1646

Measurement SW: DASYS2, Version 52.8 (7); SEMCAD X Version 14.6.10 (7164)

835 MHz System Verification

Area Scan (7x14x1): Measurement grid: dx=15mm, dy=15mm

'Zoom Scan (5x5x7)/Cube 0: Measurement grid: dx=8mm, dy=8mm, dz=5mm

Input Power = 20.0 dBm (100 mW)

Peak SAR (extrapolated) = 1.45 W/kg

..... SAR(1 g) = 0.970 W/kg

Deviation = 0.41 %

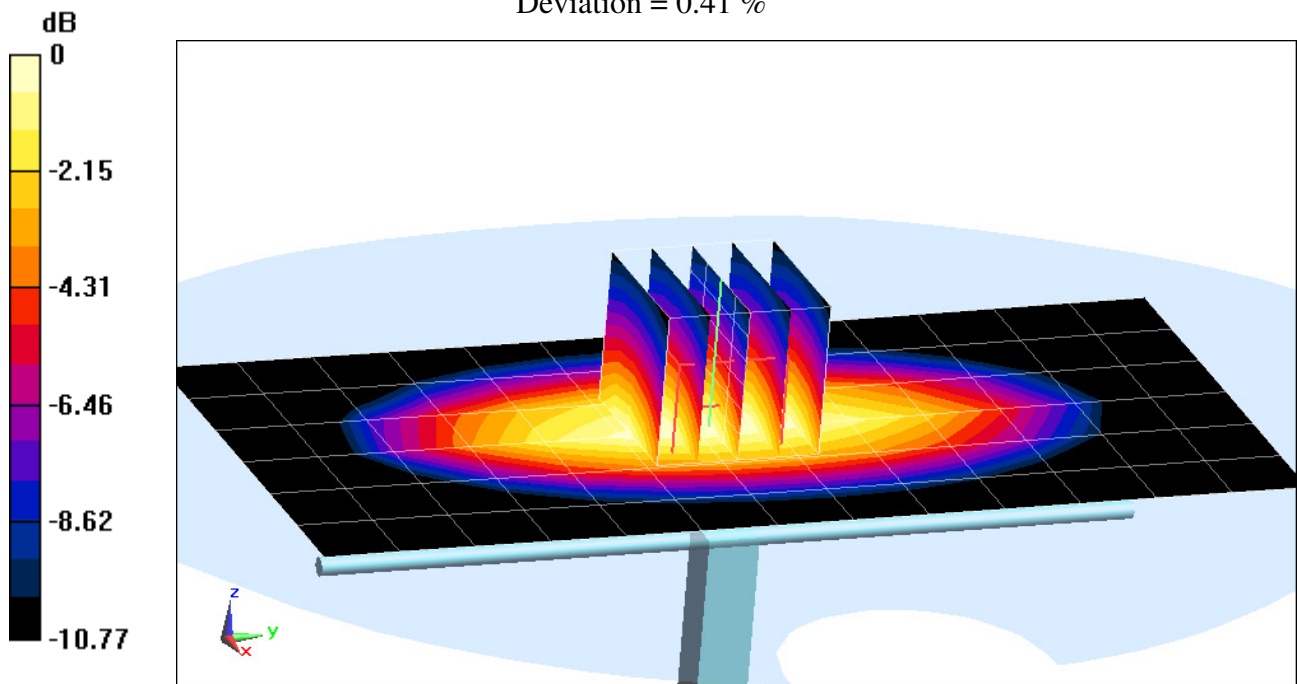

0 dB = 1.05 W/kg = 0.21 dBW/kg

PCTEST ENGINEERING LABORATORY, INC.

DUT: SAR Dipole 1900 MHz; Type: D1900V2; Serial: 5d080

Communication System: CW; Frequency: 1900 MHz; Duty Cycle: 1:1

Medium: 1900 Head Medium parameters used (interpolated):

$f = 1900 \text{ MHz}$; $\sigma = 1.426 \text{ S/m}$; $\epsilon_r = 38.681$; $\rho = 1000 \text{ kg/m}^3$

Phantom section: Flat Section; Space: 1.0 cm

Test Date: 06-11-2013; Ambient Temp: 22.0°C; Tissue Temp: 22.2°C

Probe: ES3DV3 - SN3287; ConvF(4.96, 4.96, 4.96); Calibrated: 11/15/2012;

Sensor-Surface: 4mm (Mechanical Surface Detection)

Electronics: DAE4 Sn1333; Calibrated: 11/13/2012

Phantom: SAM with CRP; Type: SAM 4.0; Serial: TP1375

Measurement SW: DASY4, Version 4.7 (80); SEMCAD X Version 14.6.10 (7164)

1900 MHz System Verification

Area Scan (5x7x1): Measurement grid: dx=15mm, dy=15mm

Zoom Scan (5x5x7)/Cube 0: Measurement grid: dx=8mm, dy=8mm, dz=5mm

Input Power = 20.0 dBm (100 mW)

Peak SAR (extrapolated) = 7.74 W/kg

*****SAR(1 g) = 4.15 W/kg

Deviation = 5.33%

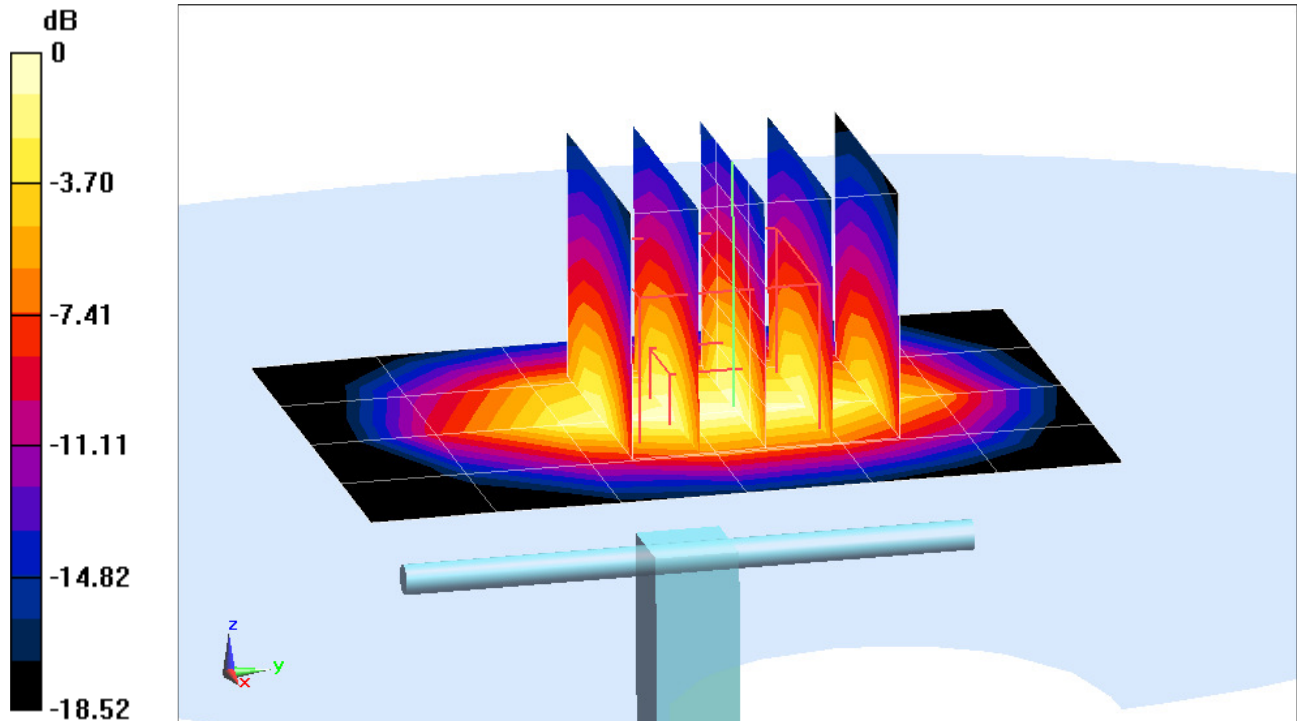

0 dB = 4.59 W/kg = 6.62 dBW/kg

PCTEST ENGINEERING LABORATORY, INC.

DUT: SAR Dipole 2450 MHz; Type: D2450V2; Serial: 719

Communication System: CW; Frequency: 2450 MHz; Duty Cycle: 1:1

Medium: 2450 Head Medium parameters used:

$f = 2450 \text{ MHz}$; $\sigma = 1.878 \text{ S/m}$; $\epsilon_r = 38.782$; $\rho = 1000 \text{ kg/m}^3$

Phantom section: Flat Section; Space: 1.0 cm

Test Date: 06-12-2013; Ambient Temp: 23.5°C; Tissue Temp: 23.8°C

Probe: ES3DV2 - SN3022; ConvF(4.23, 4.23, 4.23); Calibrated: 8/28/2012;

Sensor-Surface: 3mm (Mechanical Surface Detection)

Electronics: DAE4 Sn1322; Calibrated: 8/24/2012

Phantom: SAM Sub; Type: SAM 4.0; Serial: TP-1357

Measurement SW: DASY4, Version 4.7 (80); SEMCAD X Version 14.6.10 (7164)

2450MHz System Verification

Area Scan (6x9x1): Measurement grid: dx=12mm, dy=12mm

Zoom Scan (7x7x7)/Cube 0: Measurement grid: dx=5mm, dy=5mm, dz=5mm

Input Power = 20.0 dBm (100 mW)

Peak SAR (extrapolated) = 11.5 W/kg

SAR(1 g) = 5.41 W/kg

Deviation = 2.66%

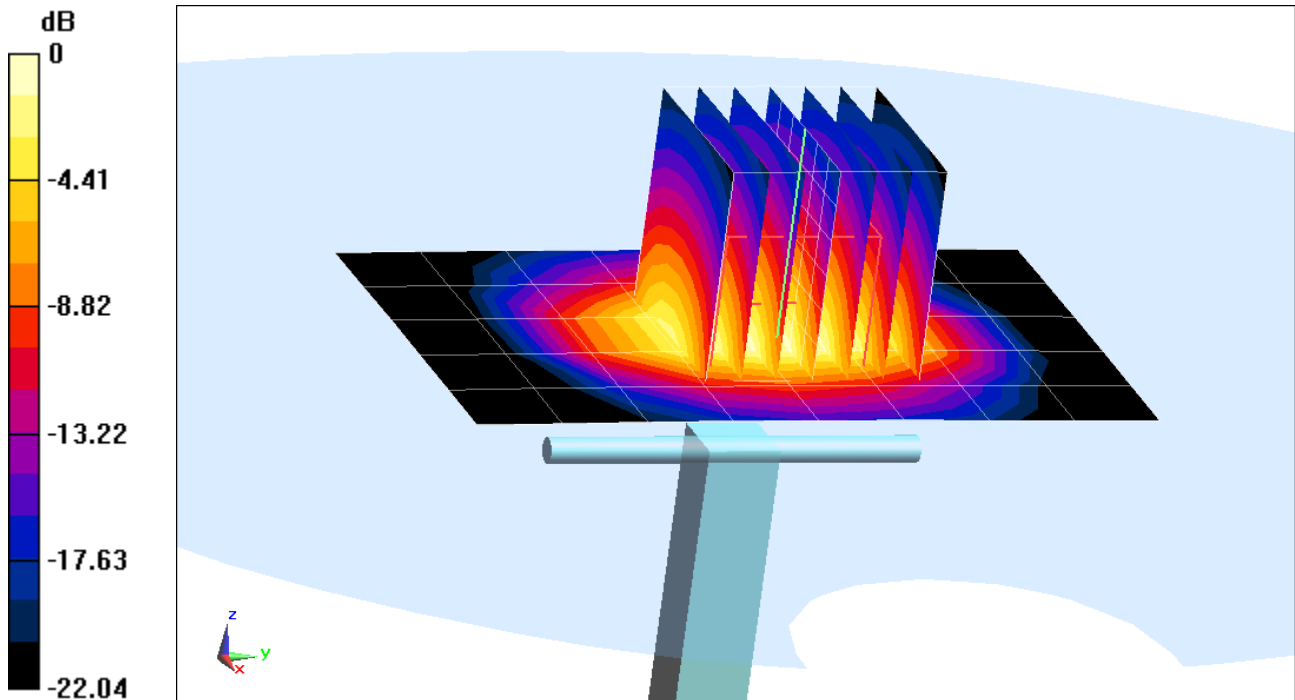

0 dB = 7.02 W/kg = 8.46 dBW/kg

PCTEST ENGINEERING LABORATORY, INC.

DUT: Dipole 750 MHz; Type: D750V3; Serial: 1054

Communication System: CW; Frequency: 750 MHz; Duty Cycle: 1:1

Medium: 750 Body Medium parameters used (interpolated):

$f = 750 \text{ MHz}$; $\sigma = 0.976 \text{ S/m}$; $\epsilon_r = 55.569$; $\rho = 1000 \text{ kg/m}^3$

Phantom section: Flat Section; Space: 1.5 cm

Test Date: 06-13-2013; Ambient Temp: 23.3°C; Tissue Temp: 22.7°C

Probe: ES3DV2 - SN3022; ConvF(6.07, 6.07, 6.07); Calibrated: 8/28/2012;

Sensor-Surface: 4mm (Mechanical Surface Detection)

Electronics: DAE4 Sn1322; Calibrated: 8/24/2012

Phantom: SAM Main; Type: SAM 4.0; Serial: TP-1406

Measurement SW: DASY4, Version 4.7 (80);SEMCAD X Version 14.6.10 (7164)

750 MHz System Verification

Area Scan (7x15x1): Measurement grid: dx=15mm, dy=15mm

Zoom Scan (5x5x7)/Cube 0: Measurement grid: dx=8mm, dy=8mm, dz=5mm

Input Power = 20.0 dBm (100 mW)

Peak SAR (extrapolated) = 1.23 W/kg

*****SAR(1 g) = 0.853 W/kg

Deviation = -2.18%

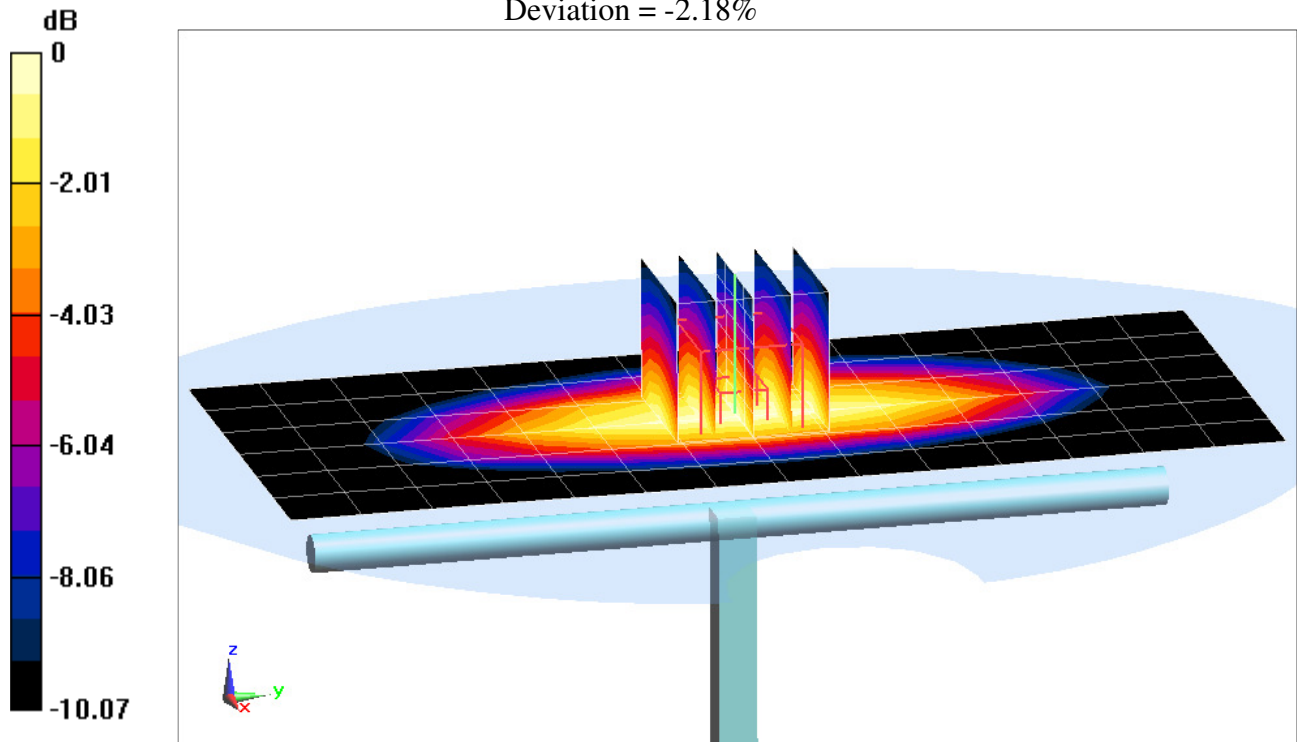

0 dB = 0.922 W/kg = -0.35 dBW/kg

PCTEST ENGINEERING LABORATORY, INC.

DUT: SAR Dipole 835 MHz; Type: D835V2; Serial: 4d132

Communication System: CW; Frequency: 835 MHz; Duty Cycle: 1:1
Medium: 835 Body Medium parameters used:

$$f = 835 \text{ MHz}; \sigma = 1.005 \text{ S/m}; \epsilon_r = 55.891; \rho = 1000 \text{ kg/m}^3$$

Phantom section: Flat Section; Space: 1.5 cm

Test Date: 06-18-2013; Ambient Temp: 24.6°C; Tissue Temp: 22.9°C

Probe: ES3DV3 - SN3209; ConvF(6.28, 6.28, 6.28); Calibrated: 3/15/2013;

Sensor-Surface: 4mm (Mechanical Surface Detection)

Electronics: DAE4 Sn1334; Calibrated: 3/8/2013

Phantom: ELI v5.0; Type: QDOVA002AA; Serial: TP-1158

Measurement SW: DASY52, Version 52.8 (7);SEMCAD X Version 14.6.10 (7164)

835 MHz System Verification

Area Scan (7x14x1): Measurement grid: dx=15mm, dy=15mm

Zoom Scan (5x5x7)/Cube 0: Measurement grid: dx=8mm, dy=8mm, dz=5mm

Input Power = 20.0 dBm (100 mW)

Peak SAR (extrapolated) = 1.44 W/kg

SAR(1 g) = 0.994 W/kg

Deviation = 6.20%

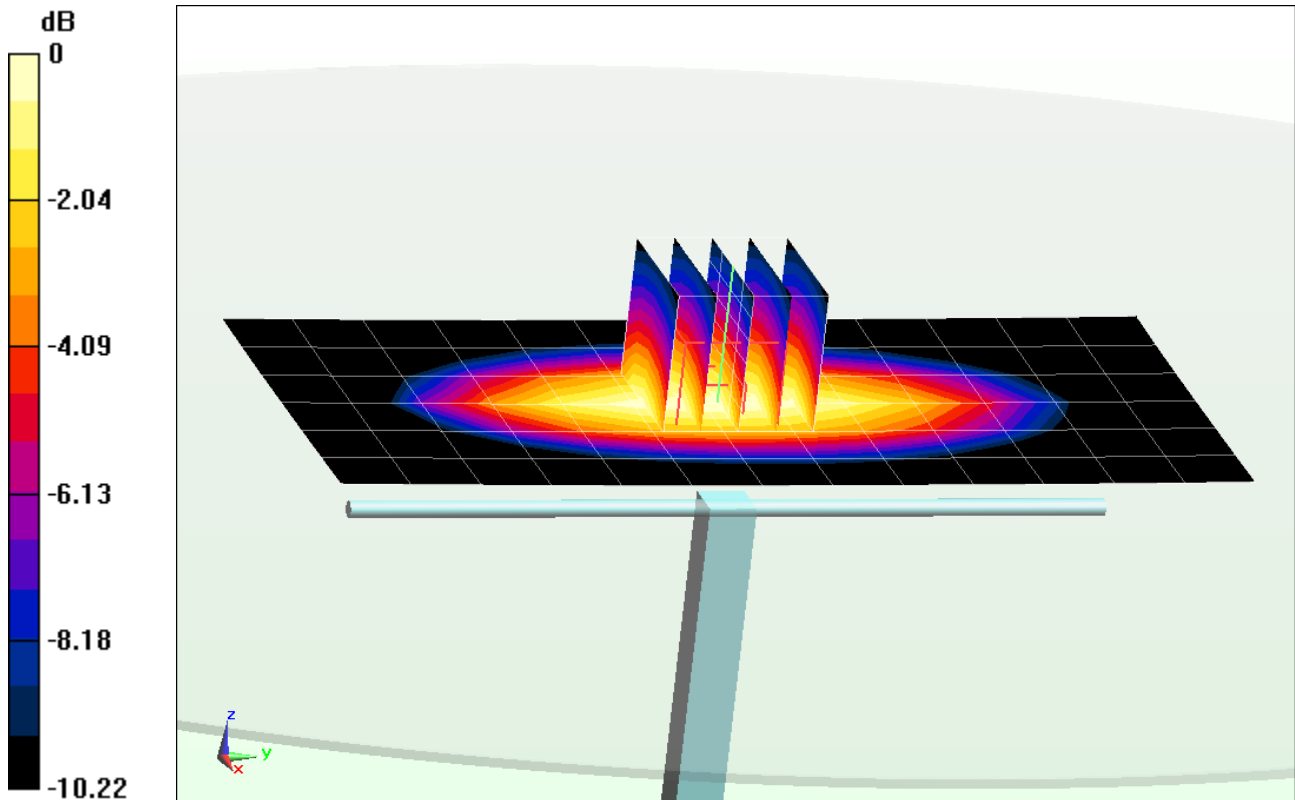

0 dB = 1.08 W/kg = 0.33 dBW/kg

PCTEST ENGINEERING LABORATORY, INC.

DUT: SAR Dipole 1900 MHz; Type: D1900V2; Serial: 5d148

Communication System: CW; Frequency: 1900 MHz; Duty Cycle: 1:1

Medium: 1900 Body Medium parameters used (interpolated):

$f = 1900 \text{ MHz}$; $\sigma = 1.548 \text{ S/m}$; $\epsilon_r = 51.387$; $\rho = 1000 \text{ kg/m}^3$

Phantom section: Flat Section; Space: 1.0 cm

Test Date: 06-11-2013; Ambient Temp: 24.4°C; Tissue Temp: 23.5°C

Probe: EX3DV4 - SN3920; ConvF(7.38, 7.38, 7.38); Calibrated: 2/27/2013;

Sensor-Surface: 4mm (Mechanical Surface Detection)

Electronics: DAE4 Sn649; Calibrated: 2/6/2013

Phantom: SAM 5.0 front; Type: QD000P40CD; Serial: TP:-1648

Measurement SW: DASY52, Version 52.8 (7);SEMCAD X Version 14.6.10 (7164)

1900 MHz System Verification

Area Scan (7x10x1): Measurement grid: $dx=15\text{mm}$, $dy=15\text{mm}$

Zoom Scan (5x5x7)/Cube 0: Measurement grid: $dx=8\text{mm}$, $dy=8\text{mm}$, $dz=5\text{mm}$

Input Power = 20.0 dBm (100 mW)

Peak SAR (extrapolated) = 7.58 W/kg

SAR(1 g) = 4.24 W/kg

Deviation = 3.92%

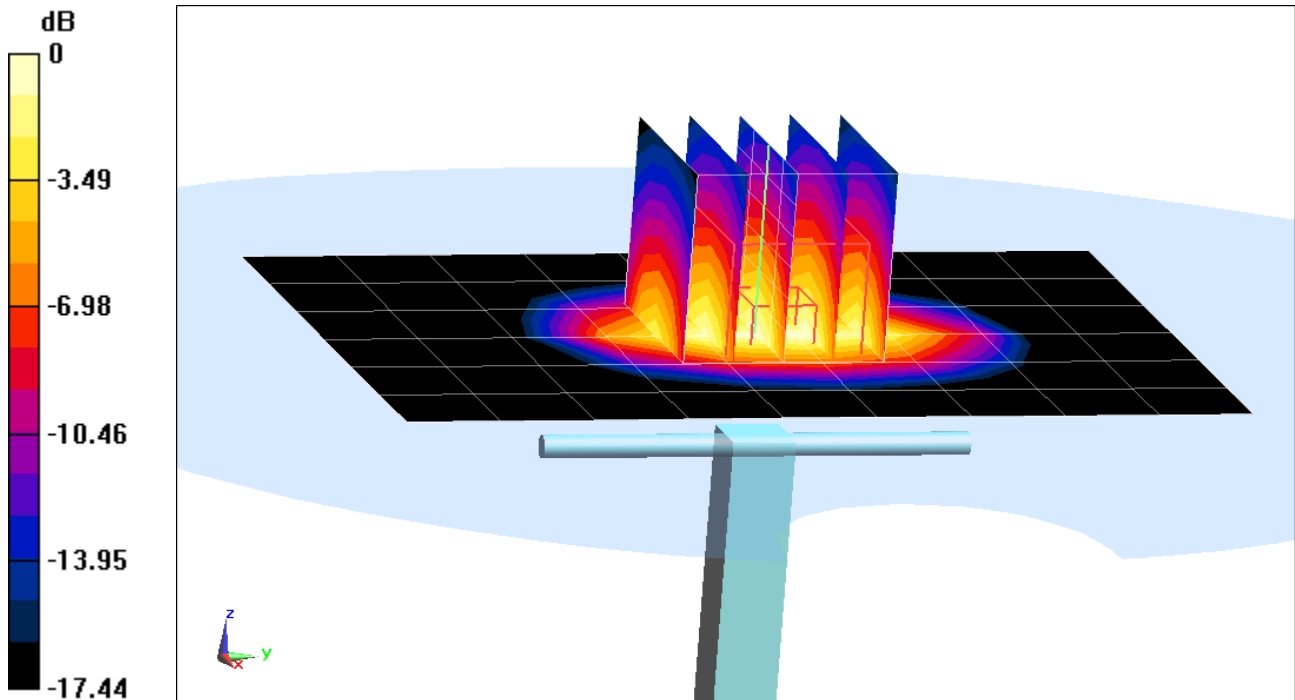

PCTEST ENGINEERING LABORATORY, INC.

DUT: SAR Dipole 2450 MHz; Type: D2450V2; Serial: 719

Communication System: CW; Frequency: 2450 MHz; Duty Cycle: 1:1
Medium: 2450 Body Medium parameters used:

$$f = 2450 \text{ MHz}; \sigma = 2.001 \text{ S/m}; \epsilon_r = 50.95; \rho = 1000 \text{ kg/m}^3$$

Phantom section: Flat Section; Space: 1.0 cm

Test Date: 06-11-2013; Ambient Temp: 23.7°C; Tissue Temp: 23.5°C

Probe: ES3DV2 - SN3022; ConvF(3.97, 3.97, 3.97); Calibrated: 8/28/2012;

Sensor-Surface: 3mm (Mechanical Surface Detection)

Electronics: DAE4 Sn1322; Calibrated: 8/24/2012

Phantom: SAM Sub; Type: SAM 4.0; Serial: TP-1357

Measurement SW: DASY4, Version 4.7 (80); SEMCAD X Version 14.6.10 (7164)

2450 MHz System Verification

Area Scan (6x8x1): Measurement grid: dx=12mm, dy=12mm

Zoom Scan (7x7x7)/Cube 0: Measurement grid: dx=5mm, dy=5mm, dz=5mm

Input Power = 16.0 dBm (40 mW)

Peak SAR (extrapolated) = 4.58 W/kg

SAR(1 g) = 2.17 W/kg

Deviation = 5.14%

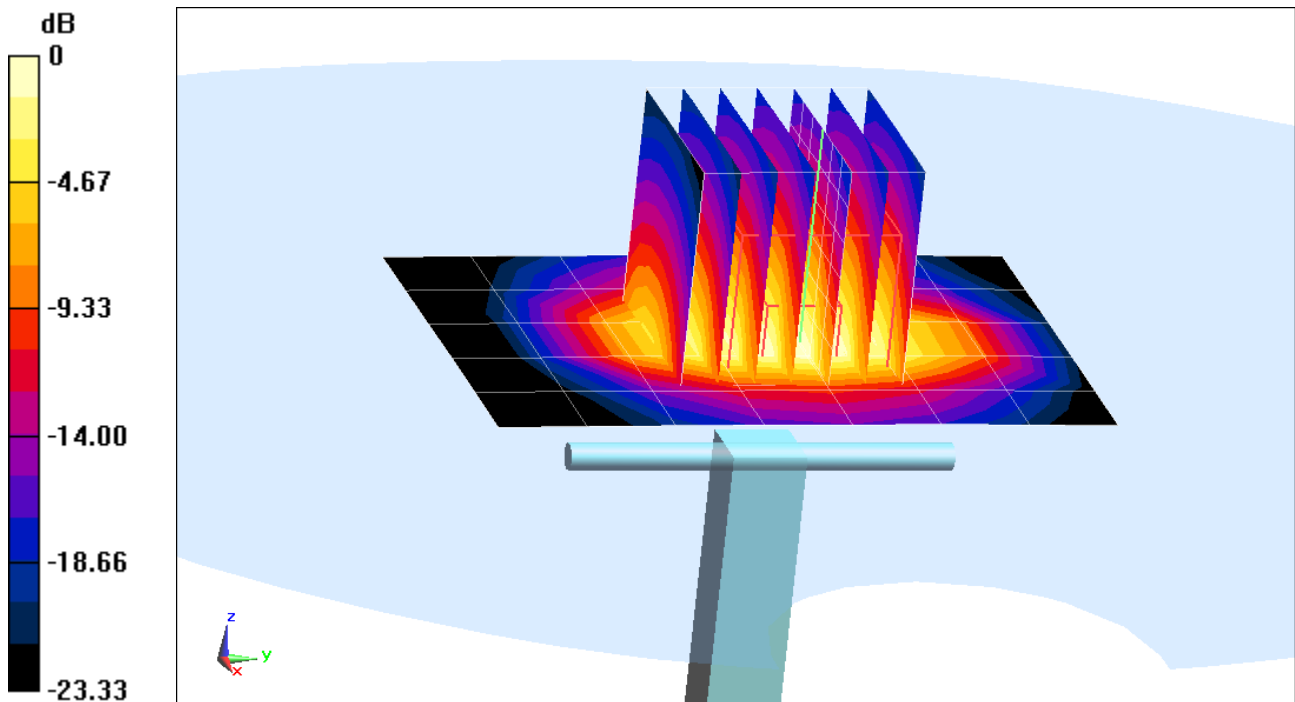

0 dB = 2.78 W/kg = 4.44 dBW/kg

APPENDIX C: PROBE CALIBRATION



Accredited by the Swiss Accreditation Service (SAS)
The Swiss Accreditation Service is one of the signatories to the EA
Multilateral Agreement for the recognition of calibration certificates

Accreditation No.: **SCS 108**

Client **PC Test**

Certificate No: **ES3-3022_Aug12**

CALIBRATION CERTIFICATE

Object **ES3DV2 - SN:3022**

Calibration procedure(s) **QA CAL-01.v8, QA CAL-23.v4, QA CAL-25.v4
Calibration procedure for dosimetric E-field probes**

Calibration date: **August 28, 2012**

This calibration certificate documents the traceability to national standards, which realize the physical units of measurements (SI).
The measurements and the uncertainties with confidence probability are given on the following pages and are part of the certificate.

All calibrations have been conducted in the closed laboratory facility: environment temperature (22 ± 3)°C and humidity < 70%.

Calibration Equipment used (M&TE critical for calibration)

Handwritten signature: KOK 9/10

Primary Standards	ID	Cal Date (Certificate No.)	Scheduled Calibration
Power meter E4419B	GB41293874	29-Mar-12 (No. 217-01508)	Apr-13
Power sensor E4412A	MY41498087	29-Mar-12 (No. 217-01508)	Apr-13
Reference 3 dB Attenuator	SN: S5054 (3c)	27-Mar-12 (No. 217-01531)	Apr-13
Reference 20 dB Attenuator	SN: S5086 (20b)	27-Mar-12 (No. 217-01529)	Apr-13
Reference 30 dB Attenuator	SN: S5129 (30b)	27-Mar-12 (No. 217-01532)	Apr-13
Reference Probe ES3DV2	SN: 3013	29-Dec-11 (No. ES3-3013_Dec11)	Dec-12
DAE4	SN: 660	20-Jun-12 (No. DAE4-660_Jun12)	Jun-13
Secondary Standards	ID	Check Date (in house)	Scheduled Check
RF generator HP 8648C	US3642U01700	4-Aug-99 (in house check Apr-11)	In house check: Apr-13
Network Analyzer HP 8753E	US37390585	18-Oct-01 (in house check Oct-11)	In house check: Oct-12

	Name	Function	Signature
Calibrated by:	Jeton Kastrati	Laboratory Technician	<i>[Signature]</i>
Approved by:	Katja Pokovic	Technical Manager	<i>[Signature]</i>

Issued: August 28, 2012

This calibration certificate shall not be reproduced except in full without written approval of the laboratory.



Accredited by the Swiss Accreditation Service (SAS)

Accreditation No.: **SCS 108**

The Swiss Accreditation Service is one of the signatories to the EA
Multilateral Agreement for the recognition of calibration certificates

Glossary:

TSL	tissue simulating liquid
NORM _{x,y,z}	sensitivity in free space
ConvF	sensitivity in TSL / NORM _{x,y,z}
DCP	diode compression point
CF	crest factor (1/duty_cycle) of the RF signal
A, B, C	modulation dependent linearization parameters
Polarization ϕ	ϕ rotation around probe axis
Polarization ϑ	ϑ rotation around an axis that is in the plane normal to probe axis (at measurement center), i.e., $\vartheta = 0$ is normal to probe axis

Calibration is Performed According to the Following Standards:

- IEEE Std 1528-2003, "IEEE Recommended Practice for Determining the Peak Spatial-Averaged Specific Absorption Rate (SAR) in the Human Head from Wireless Communications Devices: Measurement Techniques", December 2003
- IEC 62209-1, "Procedure to measure the Specific Absorption Rate (SAR) for hand-held devices used in close proximity to the ear (frequency range of 300 MHz to 3 GHz)", February 2005

Methods Applied and Interpretation of Parameters:

- NORM_{x,y,z}**: Assessed for E-field polarization $\vartheta = 0$ ($f \leq 900$ MHz in TEM-cell; $f > 1800$ MHz: R22 waveguide). NORM_{x,y,z} are only intermediate values, i.e., the uncertainties of NORM_{x,y,z} does not affect the E²-field uncertainty inside TSL (see below ConvF).
- NORM(f)_{x,y,z}** = NORM_{x,y,z} * frequency_response (see Frequency Response Chart). This linearization is implemented in DASY4 software versions later than 4.2. The uncertainty of the frequency response is included in the stated uncertainty of ConvF.
- DCP_{x,y,z}**: DCP are numerical linearization parameters assessed based on the data of power sweep with CW signal (no uncertainty required). DCP does not depend on frequency nor media.
- PAR**: PAR is the Peak to Average Ratio that is not calibrated but determined based on the signal characteristics
- A_{x,y,z}; B_{x,y,z}; C_{x,y,z}; VR_{x,y,z}**: A, B, C are numerical linearization parameters assessed based on the data of power sweep for specific modulation signal. The parameters do not depend on frequency nor media. VR is the maximum calibration range expressed in RMS voltage across the diode.
- ConvF and Boundary Effect Parameters**: Assessed in flat phantom using E-field (or Temperature Transfer Standard for $f \leq 800$ MHz) and inside waveguide using analytical field distributions based on power measurements for $f > 800$ MHz. The same setups are used for assessment of the parameters applied for boundary compensation (alpha, depth) of which typical uncertainty values are given. These parameters are used in DASY4 software to improve probe accuracy close to the boundary. The sensitivity in TSL corresponds to NORM_{x,y,z} * ConvF whereby the uncertainty corresponds to that given for ConvF. A frequency dependent ConvF is used in DASY version 4.4 and higher which allows extending the validity from ± 50 MHz to ± 100 MHz.
- Spherical isotropy (3D deviation from isotropy)**: in a field of low gradients realized using a flat phantom exposed by a patch antenna.
- Sensor Offset**: The sensor offset corresponds to the offset of virtual measurement center from the probe tip (on probe axis). No tolerance required.

Probe ES3DV2

SN:3022

Manufactured: April 15, 2003
Calibrated: August 28, 2012

Calibrated for DASY/EASY Systems
(Note: non-compatible with DASY2 system!)

DASY/EASY - Parameters of Probe: ES3DV2 - SN:3022

Basic Calibration Parameters

	Sensor X	Sensor Y	Sensor Z	Unc (k=2)
Norm ($\mu\text{V}/(\text{V}/\text{m})^2$) ^A	1.00	1.04	0.99	$\pm 10.1 \%$
DCP (mV) ^B	98.3	99.5	101.3	

Modulation Calibration Parameters

UID	Communication System Name	PAR		A dB	B dB	C dB	VR mV	Unc ^E (k=2)
0	CW	0.00	X	0.00	0.00	1.00	133.3	$\pm 2.7 \%$
			Y	0.00	0.00	1.00	140.3	
			Z	0.00	0.00	1.00	178.9	

The reported uncertainty of measurement is stated as the standard uncertainty of measurement multiplied by the coverage factor k=2, which for a normal distribution corresponds to a coverage probability of approximately 95%.

^A The uncertainties of NormX,Y,Z do not affect the E²-field uncertainty inside TSL (see Pages 5 and 6).

^B Numerical linearization parameter: uncertainty not required.

^E Uncertainty is determined using the max. deviation from linear response applying rectangular distribution and is expressed for the square of the field value.

DASY/EASY - Parameters of Probe: ES3DV2 - SN:3022

Calibration Parameter Determined in Head Tissue Simulating Media

f (MHz) ^C	Relative Permittivity ^F	Conductivity (S/m) ^F	ConvF X	ConvF Y	ConvF Z	Alpha	Depth (mm)	Unct. (k=2)
750	41.9	0.89	6.30	6.30	6.30	0.30	1.72	± 12.0 %
835	41.5	0.90	6.03	6.03	6.03	0.35	1.63	± 12.0 %
1750	40.1	1.37	5.07	5.07	5.07	0.32	1.89	± 12.0 %
1900	40.0	1.40	4.86	4.86	4.86	0.40	1.57	± 12.0 %
2450	39.2	1.80	4.23	4.23	4.23	0.59	1.44	± 12.0 %
2600	39.0	1.96	4.10	4.10	4.10	0.67	1.37	± 12.0 %

^C Frequency validity of ± 100 MHz only applies for DASY v4.4 and higher (see Page 2), else it is restricted to ± 50 MHz. The uncertainty is the RSS of the ConvF uncertainty at calibration frequency and the uncertainty for the indicated frequency band.

^F At frequencies below 3 GHz, the validity of tissue parameters (ϵ and σ) can be relaxed to ± 10% if liquid compensation formula is applied to measured SAR values. At frequencies above 3 GHz, the validity of tissue parameters (ϵ and σ) is restricted to ± 5%. The uncertainty is the RSS of the ConvF uncertainty for indicated target tissue parameters.

DASY/EASY - Parameters of Probe: ES3DV2 - SN:3022

Calibration Parameter Determined in Body Tissue Simulating Media

f (MHz) ^C	Relative Permittivity ^F	Conductivity (S/m) ^F	ConvF X	ConvF Y	ConvF Z	Alpha	Depth (mm)	Unct. (k=2)
750	55.5	0.96	6.07	6.07	6.07	0.23	2.09	± 12.0 %
835	55.2	0.97	6.02	6.02	6.02	0.47	1.44	± 12.0 %
1750	53.4	1.49	4.70	4.70	4.70	0.46	1.55	± 12.0 %
1900	53.3	1.52	4.43	4.43	4.43	0.36	1.87	± 12.0 %
2450	52.7	1.95	3.97	3.97	3.97	0.65	1.06	± 12.0 %
2600	52.5	2.16	3.80	3.80	3.80	0.54	0.75	± 12.0 %

^C Frequency validity of ± 100 MHz only applies for DASY v4.4 and higher (see Page 2), else it is restricted to ± 50 MHz. The uncertainty is the RSS of the ConvF uncertainty at calibration frequency and the uncertainty for the indicated frequency band.

^F At frequencies below 3 GHz, the validity of tissue parameters (ϵ and σ) can be relaxed to ± 10% if liquid compensation formula is applied to measured SAR values. At frequencies above 3 GHz, the validity of tissue parameters (ϵ and σ) is restricted to ± 5%. The uncertainty is the RSS of the ConvF uncertainty for indicated target tissue parameters.

Frequency Response of E-Field

(TEM-Cell:ifi110 EXX, Waveguide: R22)

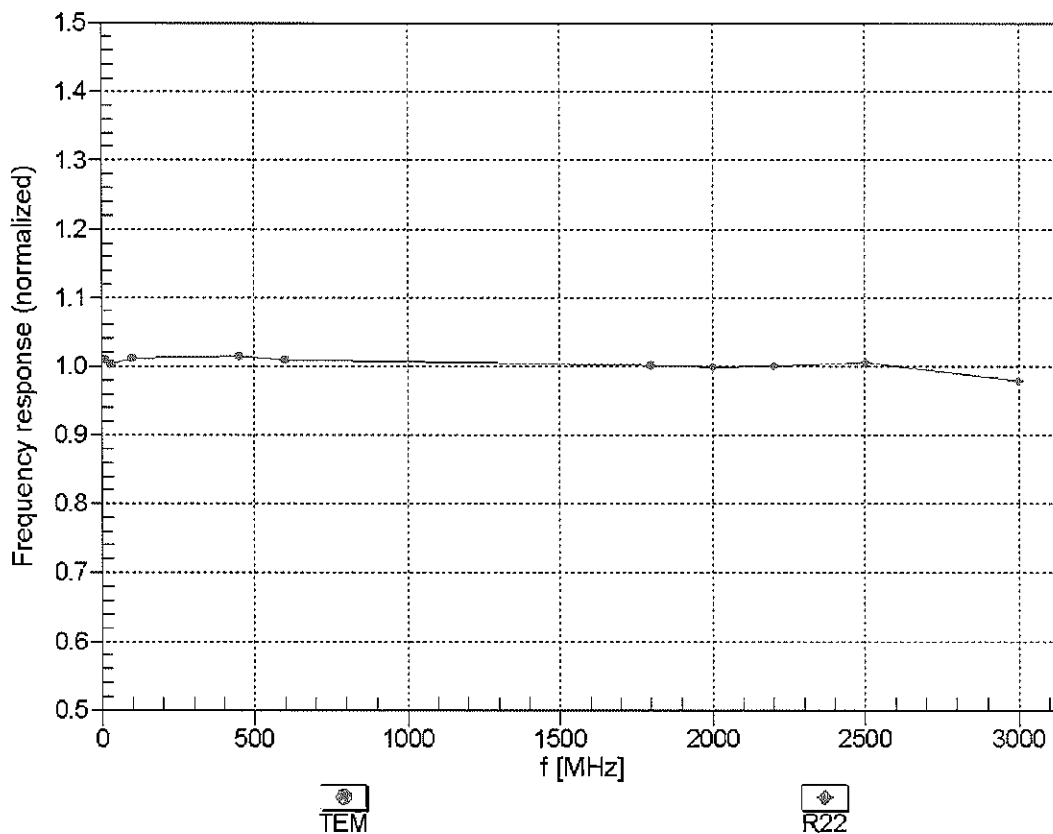

Uncertainty of Frequency Response of E-field: $\pm 6.3\%$ (k=2)

Receiving Pattern (ϕ), $\theta = 0^\circ$

f=600 MHz, TEM

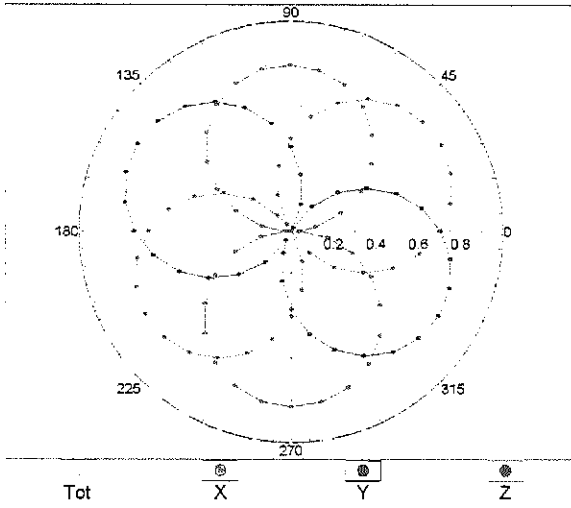

f=1800 MHz, R22

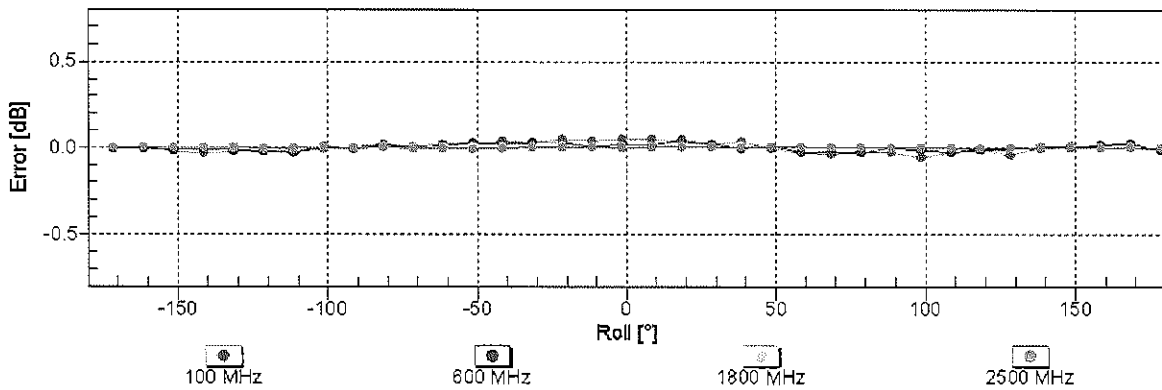
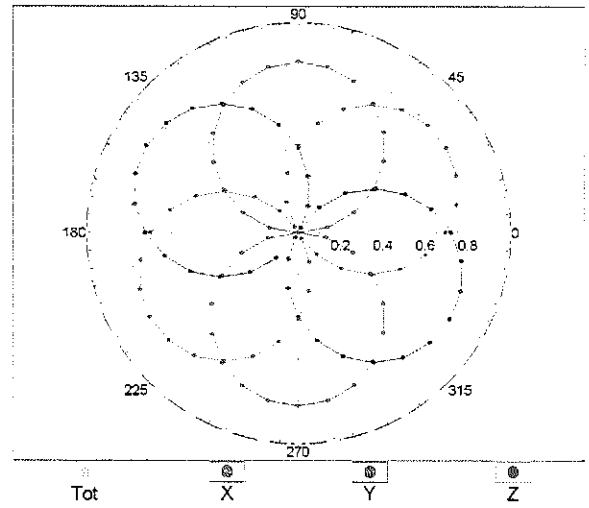

Uncertainty of Axial Isotropy Assessment: $\pm 0.5\%$ (k=2)

Dynamic Range $f(\text{SAR}_{\text{head}})$ (TEM cell , $f = 900 \text{ MHz}$)

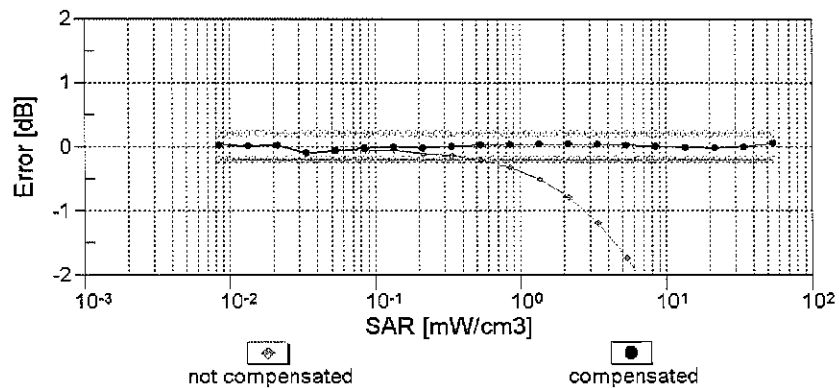
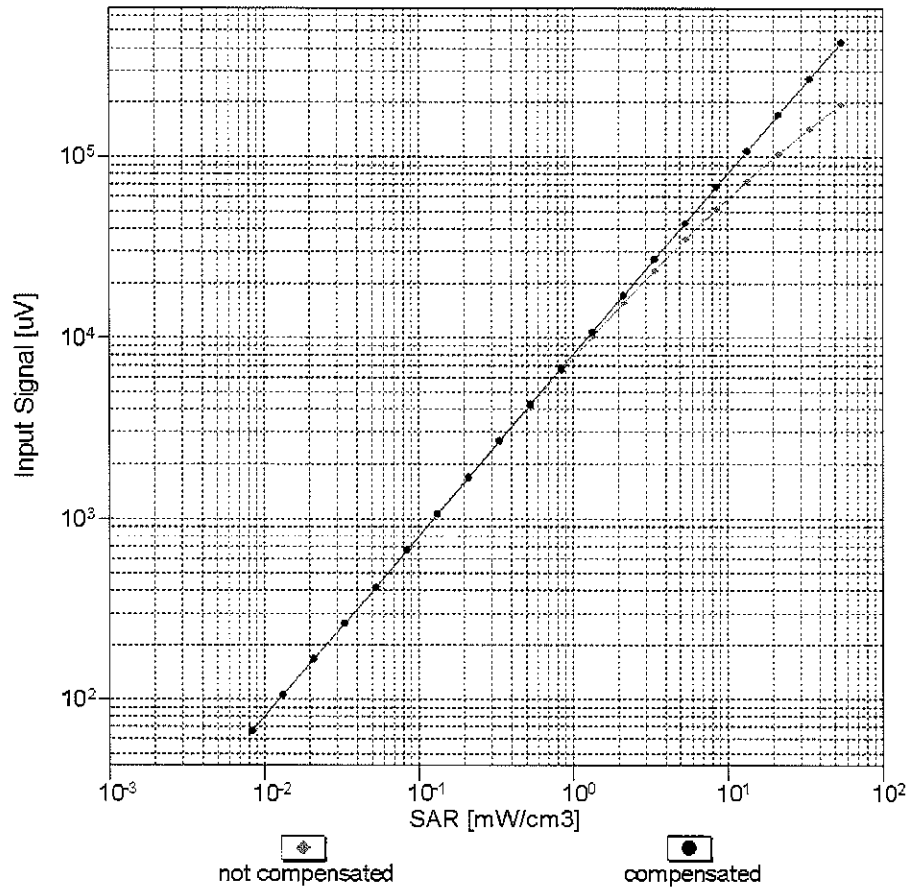

Uncertainty of Linearity Assessment: $\pm 0.6\%$ ($k=2$)

Conversion Factor Assessment

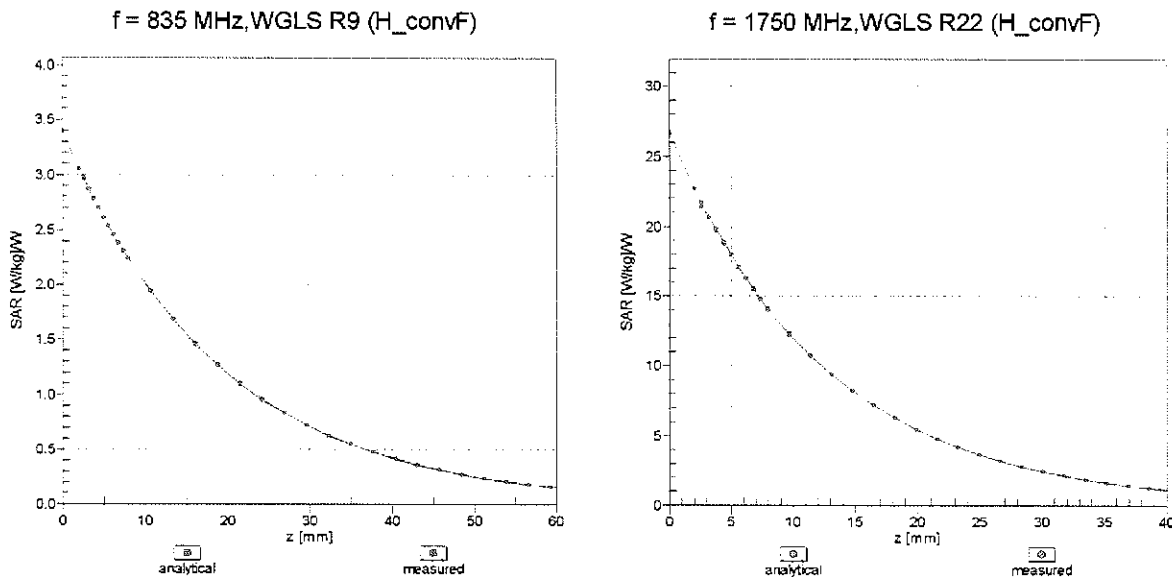

Deviation from Isotropy in Liquid

Error (ϕ, θ), f = 900 MHz

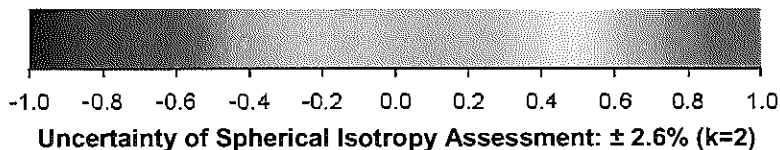
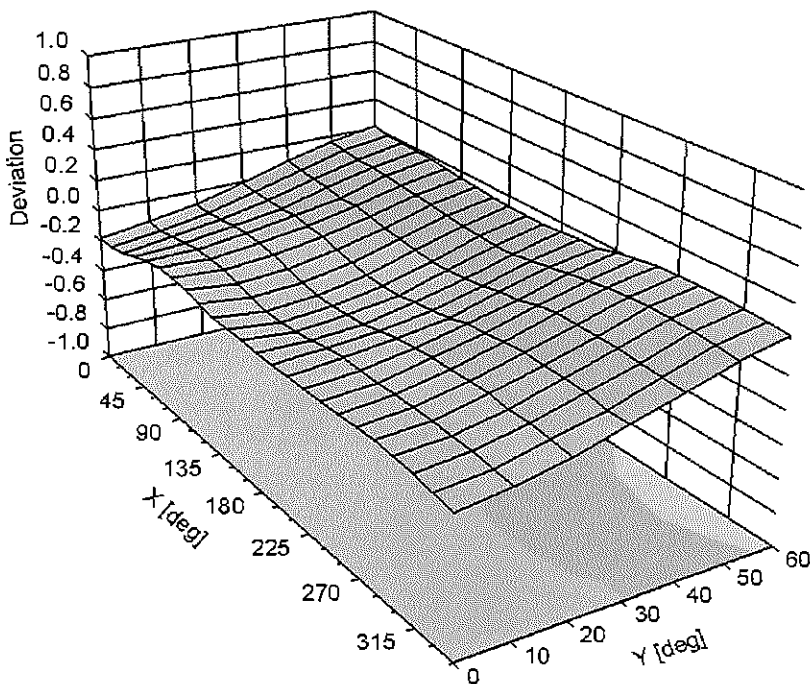

DASY/EASY - Parameters of Probe: ES3DV2 - SN:3022

Other Probe Parameters

Sensor Arrangement	Triangular
Connector Angle (°)	98.5
Mechanical Surface Detection Mode	enabled
Optical Surface Detection Mode	disabled
Probe Overall Length	337 mm
Probe Body Diameter	10 mm
Tip Length	10 mm
Tip Diameter	4 mm
Probe Tip to Sensor X Calibration Point	2 mm
Probe Tip to Sensor Y Calibration Point	2 mm
Probe Tip to Sensor Z Calibration Point	2 mm
Recommended Measurement Distance from Surface	3 mm

**Calibration Laboratory of
Schmid & Partner
Engineering AG**
Zeughausstrasse 43, 8004 Zurich, Switzerland



S Schweizerischer Kalibrierdienst
S Service suisse d'étalonnage
S Servizio svizzero di taratura
S Swiss Calibration Service

Accredited by the Swiss Accreditation Service (SAS)
The Swiss Accreditation Service is one of the signatories to the EA
Multilateral Agreement for the recognition of calibration certificates

Accreditation No.: **SCS 108**

Client **PC Test**

Certificate No: **ES3-3288_Sep12**

CALIBRATION CERTIFICATE

Object **ES3DV3 - SN:3288**

Calibration procedure(s) **QA CAL-01.v8, QA CAL-23.v4, QA CAL-25.v4
Calibration procedure for dosimetric E-field probes**

Calibration date: **September 20, 2012**

This calibration certificate documents the traceability to national standards, which realize the physical units of measurements (SI).
The measurements and the uncertainties with confidence probability are given on the following pages and are part of the certificate.

All calibrations have been conducted in the closed laboratory facility: environment temperature (22 ± 3)°C and humidity < 70%.

Calibration Equipment used (M&TE critical for calibration)

*KOK
10/2/12*

Primary Standards	ID	Cal Date (Certificate No.)	Scheduled Calibration
Power meter E4419B	GB41293874	29-Mar-12 (No. 217-01508)	Apr-13
Power sensor E4412A	MY41498087	29-Mar-12 (No. 217-01508)	Apr-13
Reference 3 dB Attenuator	SN: S5054 (3c)	27-Mar-12 (No. 217-01531)	Apr-13
Reference 20 dB Attenuator	SN: S5086 (20b)	27-Mar-12 (No. 217-01529)	Apr-13
Reference 30 dB Attenuator	SN: S5129 (30b)	27-Mar-12 (No. 217-01532)	Apr-13
Reference Probe ES3DV2	SN: 3013	29-Dec-11 (No. ES3-3013_Dec11)	Dec-12
DAE4	SN: 660	20-Jun-12 (No. DAE4-660_Jun12)	Jun-13
Secondary Standards	ID	Check Date (in house)	Scheduled Check
RF generator HP 8648C	US3642U01700	4-Aug-99 (in house check Apr-11)	In house check: Apr-13
Network Analyzer HP 8753E	US37390585	18-Oct-01 (in house check Oct-11)	In house check: Oct-12

Calibrated by: **Jeton Kastrati** Name: **Jeton Kastrati** Function: **Laboratory Technician** Signature: *[Signature]*

Approved by: **Katja Pokovic** Name: **Katja Pokovic** Function: **Technical Manager** Signature: *[Signature]*

Issued: September 20, 2012

This calibration certificate shall not be reproduced except in full without written approval of the laboratory.



Accredited by the Swiss Accreditation Service (SAS)

Accreditation No.: **SCS 108**

The Swiss Accreditation Service is one of the signatories to the EA
Multilateral Agreement for the recognition of calibration certificates

Glossary:

TSL	tissue simulating liquid
NORM _{x,y,z}	sensitivity in free space
ConvF	sensitivity in TSL / NORM _{x,y,z}
DCP	diode compression point
CF	crest factor (1/duty_cycle) of the RF signal
A, B, C	modulation dependent linearization parameters
Polarization ϕ	ϕ rotation around probe axis
Polarization ϑ	ϑ rotation around an axis that is in the plane normal to probe axis (at measurement center), i.e., $\vartheta = 0$ is normal to probe axis

Calibration is Performed According to the Following Standards:

- IEEE Std 1528-2003, "IEEE Recommended Practice for Determining the Peak Spatial-Averaged Specific Absorption Rate (SAR) in the Human Head from Wireless Communications Devices: Measurement Techniques", December 2003
- IEC 62209-1, "Procedure to measure the Specific Absorption Rate (SAR) for hand-held devices used in close proximity to the ear (frequency range of 300 MHz to 3 GHz)", February 2005

Methods Applied and Interpretation of Parameters:

- NORM_{x,y,z}**: Assessed for E-field polarization $\vartheta = 0$ ($f \leq 900$ MHz in TEM-cell; $f > 1800$ MHz: R22 waveguide). NORM_{x,y,z} are only intermediate values, i.e., the uncertainties of NORM_{x,y,z} does not affect the E²-field uncertainty inside TSL (see below ConvF).
- NORM(f)_{x,y,z}** = NORM_{x,y,z} * frequency_response (see Frequency Response Chart). This linearization is implemented in DASY4 software versions later than 4.2. The uncertainty of the frequency response is included in the stated uncertainty of ConvF.
- DCP_{x,y,z}**: DCP are numerical linearization parameters assessed based on the data of power sweep with CW signal (no uncertainty required). DCP does not depend on frequency nor media.
- PAR**: PAR is the Peak to Average Ratio that is not calibrated but determined based on the signal characteristics
- A_{x,y,z}; B_{x,y,z}; C_{x,y,z}; VR_{x,y,z}; A, B, C** are numerical linearization parameters assessed based on the data of power sweep for specific modulation signal. The parameters do not depend on frequency nor media. VR is the maximum calibration range expressed in RMS voltage across the diode.
- ConvF and Boundary Effect Parameters**: Assessed in flat phantom using E-field (or Temperature Transfer Standard for $f \leq 800$ MHz) and inside waveguide using analytical field distributions based on power measurements for $f > 800$ MHz. The same setups are used for assessment of the parameters applied for boundary compensation (alpha, depth) of which typical uncertainty values are given. These parameters are used in DASY4 software to improve probe accuracy close to the boundary. The sensitivity in TSL corresponds to NORM_{x,y,z} * ConvF whereby the uncertainty corresponds to that given for ConvF. A frequency dependent ConvF is used in DASY version 4.4 and higher which allows extending the validity from ± 50 MHz to ± 100 MHz.
- Spherical isotropy (3D deviation from isotropy)**: in a field of low gradients realized using a flat phantom exposed by a patch antenna.
- Sensor Offset**: The sensor offset corresponds to the offset of virtual measurement center from the probe tip (on probe axis). No tolerance required.

Probe ES3DV3

SN:3288

Manufactured: July 6, 2010
Calibrated: September 20, 2012

Calibrated for DASY/EASY Systems
(Note: non-compatible with DASY2 system!)

DASY/EASY - Parameters of Probe: ES3DV3 - SN:3288

Basic Calibration Parameters

	Sensor X	Sensor Y	Sensor Z	Unc (k=2)
Norm ($\mu\text{V}/(\text{V}/\text{m})^2$) ^A	0.87	0.97	0.75	$\pm 10.1 \%$
DCP (mV) ^B	101.3	102.4	103.9	

Modulation Calibration Parameters

UID	Communication System Name	PAR		A dB	B dB	C dB	VR mV	Unc ^E (k=2)
0	CW	0.00	X	0.00	0.00	1.00	168.6	$\pm 3.3 \%$
			Y	0.00	0.00	1.00	132.2	
			Z	0.00	0.00	1.00	156.8	

The reported uncertainty of measurement is stated as the standard uncertainty of measurement multiplied by the coverage factor $k=2$, which for a normal distribution corresponds to a coverage probability of approximately 95%.

^A The uncertainties of NormX,Y,Z do not affect the E^2 -field uncertainty inside TSL (see Pages 5 and 6).

^B Numerical linearization parameter: uncertainty not required.

^E Uncertainty is determined using the max. deviation from linear response applying rectangular distribution and is expressed for the square of the field value.

DASY/EASY - Parameters of Probe: ES3DV3 - SN:3288

Calibration Parameter Determined in Head Tissue Simulating Media

f (MHz) ^c	Relative Permittivity ^F	Conductivity (S/m) ^F	ConvF X	ConvF Y	ConvF Z	Alpha	Depth (mm)	Unct. (k=2)
750	41.9	0.89	6.67	6.67	6.67	0.80	1.14	± 12.0 %
835	41.5	0.90	6.41	6.41	6.41	0.76	1.18	± 12.0 %
1750	40.1	1.37	5.51	5.51	5.51	0.70	1.28	± 12.0 %
1900	40.0	1.40	5.28	5.28	5.28	0.80	1.22	± 12.0 %
2450	39.2	1.80	4.61	4.61	4.61	0.80	1.26	± 12.0 %
2600	39.0	1.96	4.45	4.45	4.45	0.80	1.31	± 12.0 %

^c Frequency validity of ± 100 MHz only applies for DASY v4.4 and higher (see Page 2), else it is restricted to ± 50 MHz. The uncertainty is the RSS of the ConvF uncertainty at calibration frequency and the uncertainty for the indicated frequency band.

^F At frequencies below 3 GHz, the validity of tissue parameters (ϵ and σ) can be relaxed to ± 10% if liquid compensation formula is applied to measured SAR values. At frequencies above 3 GHz, the validity of tissue parameters (ϵ and σ) is restricted to ± 5%. The uncertainty is the RSS of the ConvF uncertainty for indicated target tissue parameters.

DASY/EASY - Parameters of Probe: ES3DV3 - SN:3288

Calibration Parameter Determined in Body Tissue Simulating Media

f (MHz) ^C	Relative Permittivity ^F	Conductivity (S/m) ^F	ConvF X	ConvF Y	ConvF Z	Alpha	Depth (mm)	Unct. (k=2)
750	55.5	0.96	6.44	6.44	6.44	0.62	1.31	± 12.0 %
835	55.2	0.97	6.31	6.31	6.31	0.38	1.78	± 12.0 %
1750	53.4	1.49	5.18	5.18	5.18	0.64	1.43	± 12.0 %
1900	53.3	1.52	4.89	4.89	4.89	0.50	1.64	± 12.0 %
2450	52.7	1.95	4.35	4.35	4.35	0.74	1.23	± 12.0 %
2600	52.5	2.16	4.09	4.09	4.09	0.80	1.07	± 12.0 %

^C Frequency validity of ± 100 MHz only applies for DASY v4.4 and higher (see Page 2), else it is restricted to ± 50 MHz. The uncertainty is the RSS of the ConvF uncertainty at calibration frequency and the uncertainty for the indicated frequency band.

^F At frequencies below 3 GHz, the validity of tissue parameters (ϵ and σ) can be relaxed to ± 10% if liquid compensation formula is applied to measured SAR values. At frequencies above 3 GHz, the validity of tissue parameters (ϵ and σ) is restricted to ± 5%. The uncertainty is the RSS of the ConvF uncertainty for indicated target tissue parameters.

Frequency Response of E-Field (TEM-Cell:ifi110 EXX, Waveguide: R22)

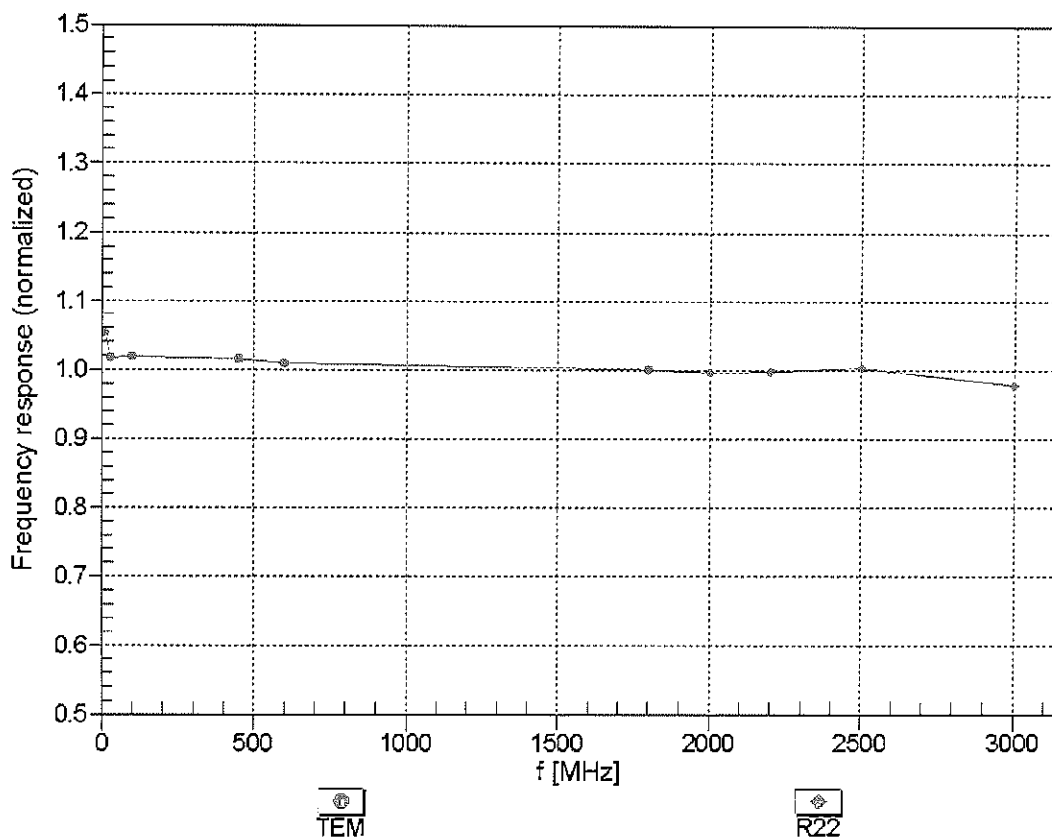

Uncertainty of Frequency Response of E-field: $\pm 6.3\%$ (k=2)

Receiving Pattern (ϕ), $\vartheta = 0^\circ$

f=600 MHz, TEM

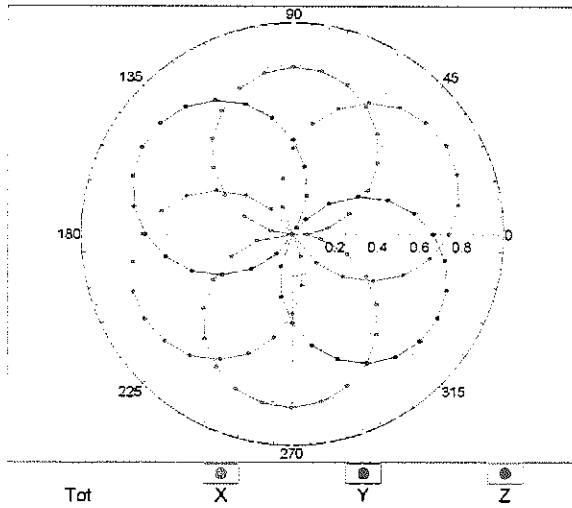

f=1800 MHz, R22

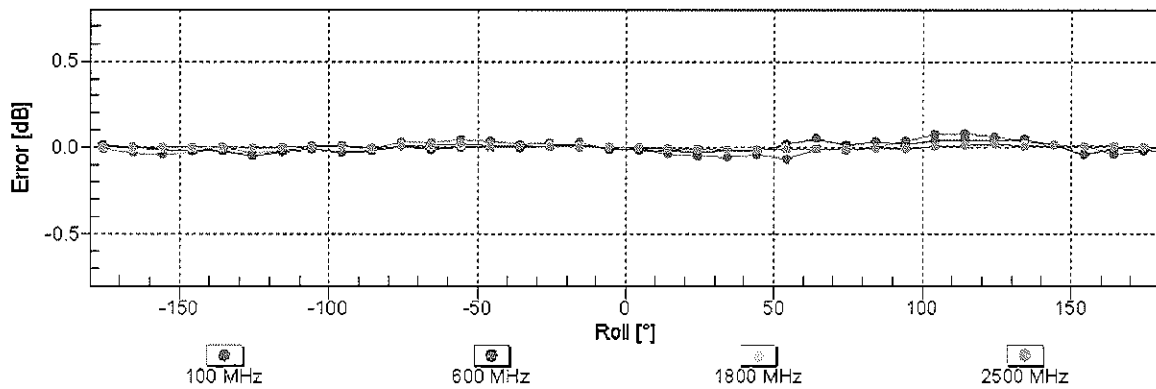
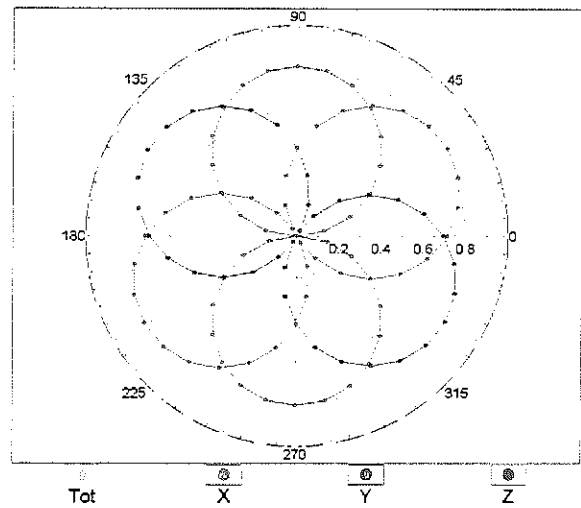

Uncertainty of Axial Isotropy Assessment: $\pm 0.5\%$ (k=2)

Dynamic Range $f(SAR_{head})$ (TEM cell , $f = 900$ MHz)

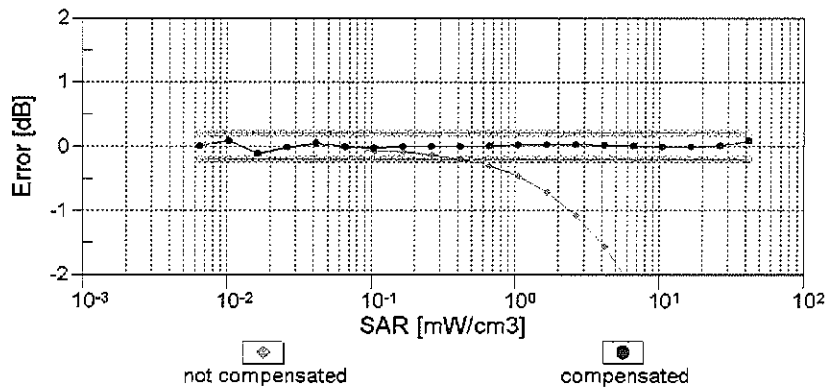
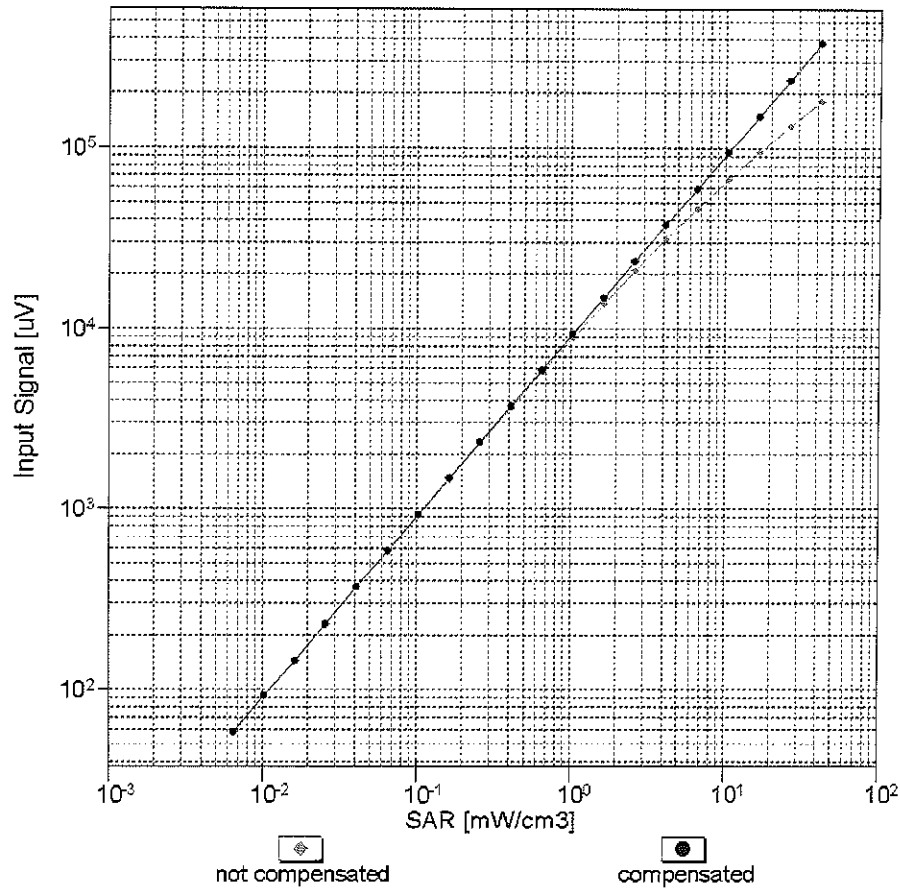

Uncertainty of Linearity Assessment: $\pm 0.6\%$ ($k=2$)

Conversion Factor Assessment

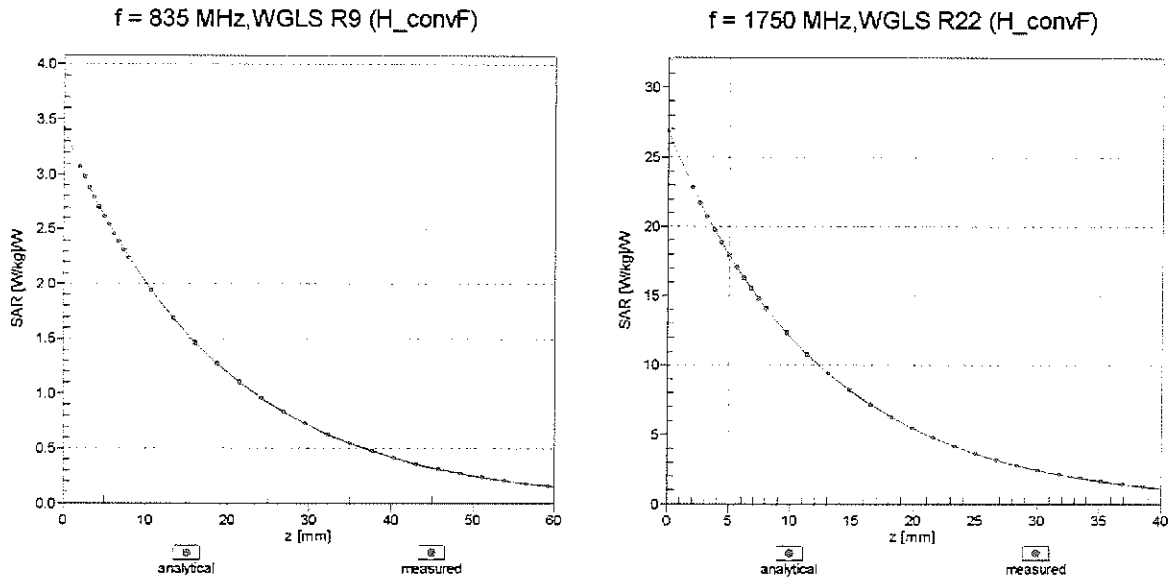

Deviation from Isotropy in Liquid

Error (ϕ, θ), f = 900 MHz

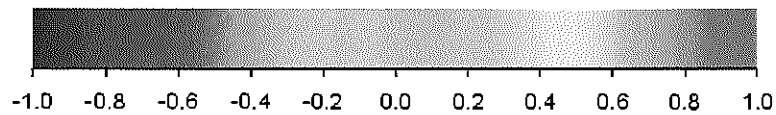
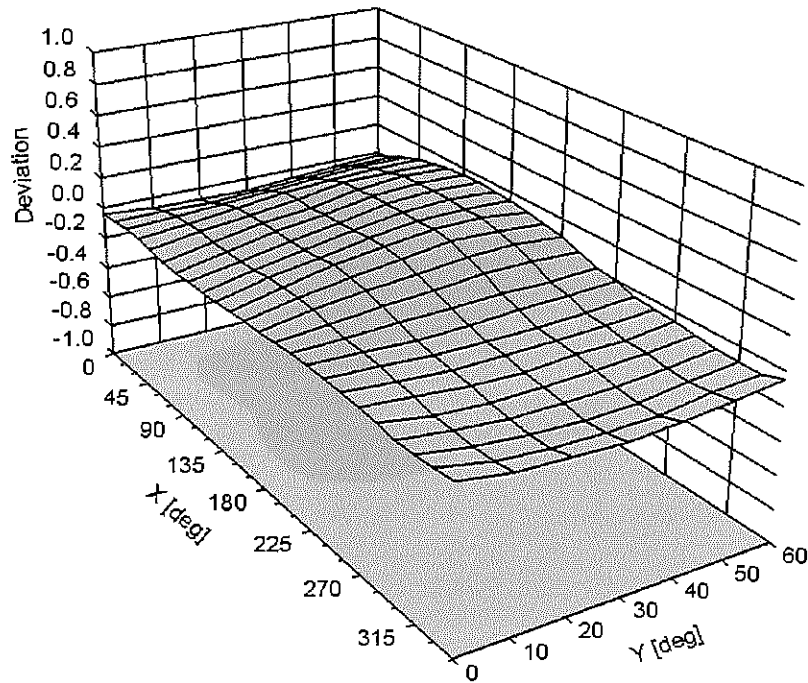

Uncertainty of Spherical Isotropy Assessment: $\pm 2.6\%$ (k=2)

DASY/EASY - Parameters of Probe: ES3DV3 - SN:3288**Other Probe Parameters**

Sensor Arrangement	Triangular
Connector Angle (°)	54.3
Mechanical Surface Detection Mode	enabled
Optical Surface Detection Mode	disabled
Probe Overall Length	337 mm
Probe Body Diameter	10 mm
Tip Length	10 mm
Tip Diameter	4 mm
Probe Tip to Sensor X Calibration Point	2 mm
Probe Tip to Sensor Y Calibration Point	2 mm
Probe Tip to Sensor Z Calibration Point	2 mm
Recommended Measurement Distance from Surface	3 mm

**Calibration Laboratory of
Schmid & Partner
Engineering AG**
Zeughausstrasse 43, 8004 Zurich, Switzerland



S Schweizerischer Kalibrierdienst
C Service suisse d'étalonnage
S Servizio svizzero di taratura
Swiss Calibration Service

Accredited by the Swiss Accreditation Service (SAS)
The Swiss Accreditation Service is one of the signatories to the EA
Multilateral Agreement for the recognition of calibration certificates

Accreditation No.: **SCS 108**

Client **PC Test**

Certificate No: **ES3-3287_Nov12**

CALIBRATION CERTIFICATE

Object **ES3DV3 - SN:3287**

Calibration procedure(s) **QA CAL-01.v8, QA CAL-23.v4, QA CAL-25.v4
Calibration procedure for dosimetric E-field probes**

Calibration date: **November 15, 2012**

*✓ KOK
11/2012*

This calibration certificate documents the traceability to national standards, which realize the physical units of measurements (SI).
The measurements and the uncertainties with confidence probability are given on the following pages and are part of the certificate.

All calibrations have been conducted in the closed laboratory facility: environment temperature (22 ± 3)°C and humidity < 70%.

Calibration Equipment used (M&TE critical for calibration)

Primary Standards	ID	Cal Date (Certificate No.)	Scheduled Calibration
Power meter E4419B	GB41293874	29-Mar-12 (No. 217-01508)	Apr-13
Power sensor E4412A	MY41498087	29-Mar-12 (No. 217-01508)	Apr-13
Reference 3 dB Attenuator	SN: S5054 (3c)	27-Mar-12 (No. 217-01531)	Apr-13
Reference 20 dB Attenuator	SN: S5086 (20b)	27-Mar-12 (No. 217-01529)	Apr-13
Reference 30 dB Attenuator	SN: S5129 (30b)	27-Mar-12 (No. 217-01532)	Apr-13
Reference Probe ES3DV2	SN: 3013	29-Dec-11 (No. ES3-3013_Dec11)	Dec-12
DAE4	SN: 660	20-Jun-12 (No. DAE4-660_Jun12)	Jun-13
Secondary Standards	ID	Check Date (in house)	Scheduled Check
RF generator HP 8648C	US3642U01700	4-Aug-99 (in house check Apr-11)	In house check: Apr-13
Network Analyzer HP 8753E	US37390585	18-Oct-01 (in house check Oct-12)	In house check: Oct-13

Calibrated by:	Name Claudio Leubler	Function Laboratory Technician	Signature
Approved by:	Name Katja Pokovic	Function Technical Manager	Signature

Issued: November 16, 2012

This calibration certificate shall not be reproduced except in full without written approval of the laboratory.



Accredited by the Swiss Accreditation Service (SAS)

Accreditation No.: **SCS 108**

The Swiss Accreditation Service is one of the signatories to the EA
Multilateral Agreement for the recognition of calibration certificates

Glossary:

TSL	tissue simulating liquid
NORM _{x,y,z}	sensitivity in free space
ConvF	sensitivity in TSL / NORM _{x,y,z}
DCP	diode compression point
CF	crest factor (1/duty_cycle) of the RF signal
A, B, C	modulation dependent linearization parameters
Polarization φ	φ rotation around probe axis
Polarization ϑ	ϑ rotation around an axis that is in the plane normal to probe axis (at measurement center), i.e., $\vartheta = 0$ is normal to probe axis

Calibration is Performed According to the Following Standards:

- IEEE Std 1528-2003, "IEEE Recommended Practice for Determining the Peak Spatial-Averaged Specific Absorption Rate (SAR) in the Human Head from Wireless Communications Devices: Measurement Techniques", December 2003
- IEC 62209-1, "Procedure to measure the Specific Absorption Rate (SAR) for hand-held devices used in close proximity to the ear (frequency range of 300 MHz to 3 GHz)", February 2005

Methods Applied and Interpretation of Parameters:

- NORM_{x,y,z}**: Assessed for E-field polarization $\vartheta = 0$ ($f \leq 900$ MHz in TEM-cell; $f > 1800$ MHz: R22 waveguide). NORM_{x,y,z} are only intermediate values, i.e., the uncertainties of NORM_{x,y,z} does not affect the E²-field uncertainty inside TSL (see below ConvF).
- NORM(f)_{x,y,z}** = NORM_{x,y,z} * frequency_response (see Frequency Response Chart). This linearization is implemented in DASY4 software versions later than 4.2. The uncertainty of the frequency response is included in the stated uncertainty of ConvF.
- DCP_{x,y,z}**: DCP are numerical linearization parameters assessed based on the data of power sweep with CW signal (no uncertainty required). DCP does not depend on frequency nor media.
- PAR**: PAR is the Peak to Average Ratio that is not calibrated but determined based on the signal characteristics
- A_{x,y,z}; B_{x,y,z}; C_{x,y,z}; VR_{x,y,z}**: A, B, C are numerical linearization parameters assessed based on the data of power sweep for specific modulation signal. The parameters do not depend on frequency nor media. VR is the maximum calibration range expressed in RMS voltage across the diode.
- ConvF and Boundary Effect Parameters**: Assessed in flat phantom using E-field (or Temperature Transfer Standard for $f \leq 800$ MHz) and inside waveguide using analytical field distributions based on power measurements for $f > 800$ MHz. The same setups are used for assessment of the parameters applied for boundary compensation (alpha, depth) of which typical uncertainty values are given. These parameters are used in DASY4 software to improve probe accuracy close to the boundary. The sensitivity in TSL corresponds to NORM_{x,y,z} * ConvF whereby the uncertainty corresponds to that given for ConvF. A frequency dependent ConvF is used in DASY version 4.4 and higher which allows extending the validity from ± 50 MHz to ± 100 MHz.
- Spherical isotropy (3D deviation from isotropy)**: in a field of low gradients realized using a flat phantom exposed by a patch antenna.
- Sensor Offset**: The sensor offset corresponds to the offset of virtual measurement center from the probe tip (on probe axis). No tolerance required.

Probe ES3DV3

SN:3287

Manufactured: June 7, 2010
Calibrated: November 15, 2012

Calibrated for DASY/EASY Systems
(Note: non-compatible with DASY2 system!)

DASY/EASY - Parameters of Probe: ES3DV3 - SN:3287

Basic Calibration Parameters

	Sensor X	Sensor Y	Sensor Z	Unc (k=2)
Norm ($\mu\text{V}/(\text{V}/\text{m})^2$) ^A	1.31	1.25	1.25	$\pm 10.1\%$
DCP (mV) ^B	102.9	103.6	101.6	

Modulation Calibration Parameters

UID	Communication System Name	PAR		A dB	B dB	C dB	VR mV	Unc ^E (k=2)
0	CW	0.00	X	0.0	0.0	1.0	116.8	$\pm 3.5\%$
			Y	0.0	0.0	1.0	118.5	
			Z	0.0	0.0	1.0	154.1	

The reported uncertainty of measurement is stated as the standard uncertainty of measurement multiplied by the coverage factor $k=2$, which for a normal distribution corresponds to a coverage probability of approximately 95%.

^A The uncertainties of NormX,Y,Z do not affect the E^2 -field uncertainty inside TSL (see Pages 5 and 6).

^B Numerical linearization parameter: uncertainty not required.

^E Uncertainty is determined using the max. deviation from linear response applying rectangular distribution and is expressed for the square of the field value.

DASY/EASY - Parameters of Probe: ES3DV3 - SN:3287

Calibration Parameter Determined in Head Tissue Simulating Media

f (MHz) ^C	Relative Permittivity ^F	Conductivity (S/m) ^F	ConvF X	ConvF Y	ConvF Z	Alpha	Depth (mm)	Unct. (k=2)
750	41.9	0.89	6.40	6.40	6.40	0.20	2.54	± 12.0 %
835	41.5	0.90	6.17	6.17	6.17	0.34	1.68	± 12.0 %
1750	40.1	1.37	5.16	5.16	5.16	0.63	1.30	± 12.0 %
1900	40.0	1.40	4.96	4.96	4.96	0.48	1.55	± 12.0 %
2450	39.2	1.80	4.30	4.30	4.30	0.79	1.31	± 12.0 %
2600	39.0	1.96	4.19	4.19	4.19	0.80	1.31	± 12.0 %

^C Frequency validity of ± 100 MHz only applies for DASY v4.4 and higher (see Page 2), else it is restricted to ± 50 MHz. The uncertainty is the RSS of the ConvF uncertainty at calibration frequency and the uncertainty for the indicated frequency band.

^F At frequencies below 3 GHz, the validity of tissue parameters (ϵ and σ) can be relaxed to ± 10% if liquid compensation formula is applied to measured SAR values. At frequencies above 3 GHz, the validity of tissue parameters (ϵ and σ) is restricted to ± 5%. The uncertainty is the RSS of the ConvF uncertainty for indicated target tissue parameters.

DASY/EASY - Parameters of Probe: ES3DV3 - SN:3287

Calibration Parameter Determined in Body Tissue Simulating Media

f (MHz) ^C	Relative Permittivity ^F	Conductivity (S/m) ^F	ConvF X	ConvF Y	ConvF Z	Alpha	Depth (mm)	Unct. (k=2)
750	55.5	0.96	6.14	6.14	6.14	0.28	2.06	± 12.0 %
835	55.2	0.97	6.06	6.06	6.06	0.42	1.63	± 12.0 %
1750	53.4	1.49	4.86	4.86	4.86	0.43	1.64	± 12.0 %
1900	53.3	1.52	4.69	4.69	4.69	0.56	1.54	± 12.0 %
2450	52.7	1.95	4.29	4.29	4.29	0.80	1.02	± 12.0 %
2600	52.5	2.16	4.12	4.12	4.12	0.64	0.92	± 12.0 %

^C Frequency validity of ± 100 MHz only applies for DASY v4.4 and higher (see Page 2), else it is restricted to ± 50 MHz. The uncertainty is the RSS of the ConvF uncertainty at calibration frequency and the uncertainty for the indicated frequency band.

^F At frequencies below 3 GHz, the validity of tissue parameters (ϵ and σ) can be relaxed to ± 10% if liquid compensation formula is applied to measured SAR values. At frequencies above 3 GHz, the validity of tissue parameters (ϵ and σ) is restricted to ± 5%. The uncertainty is the RSS of the ConvF uncertainty for indicated target tissue parameters.

Frequency Response of E-Field (TEM-Cell:ifi110 EXX, Waveguide: R22)

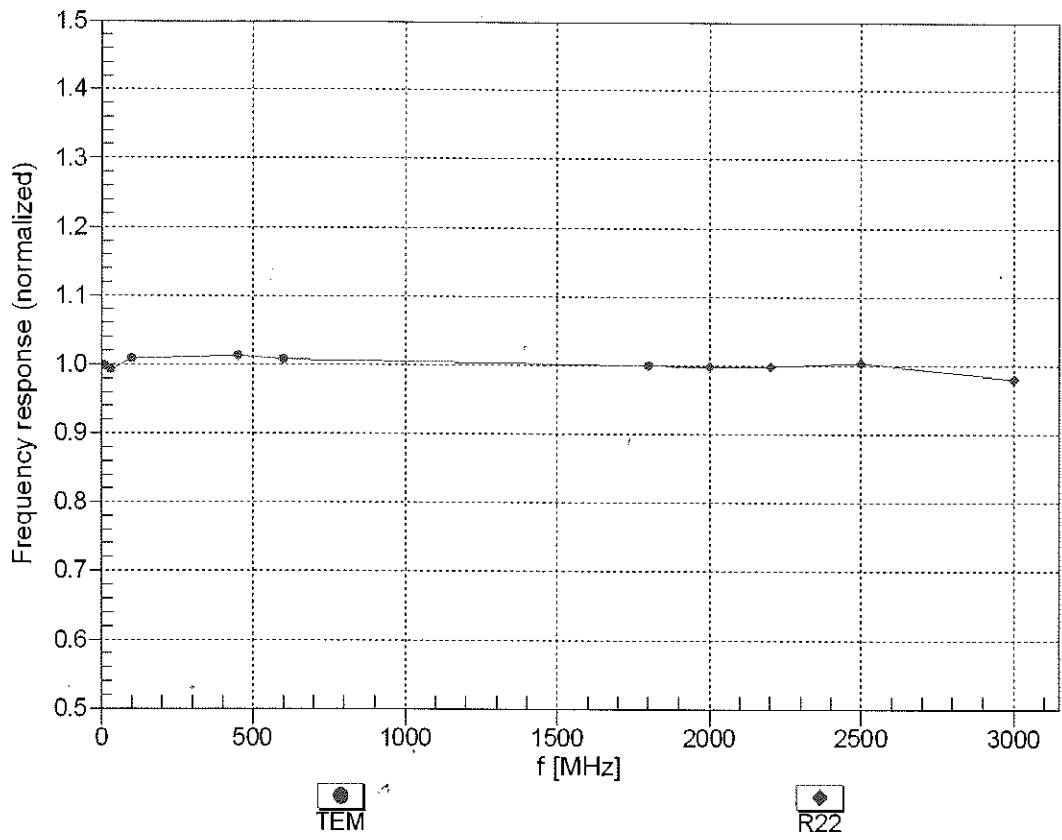

Uncertainty of Frequency Response of E-field: $\pm 6.3\%$ (k=2)

Receiving Pattern (ϕ), $\theta = 0^\circ$

f=600 MHz,TEM

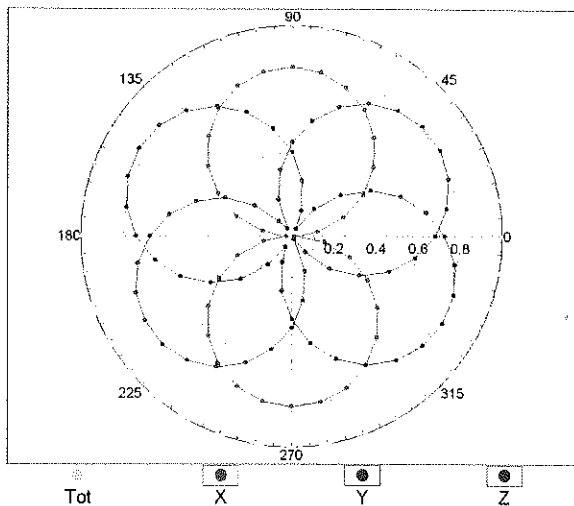

f=1800 MHz,R22

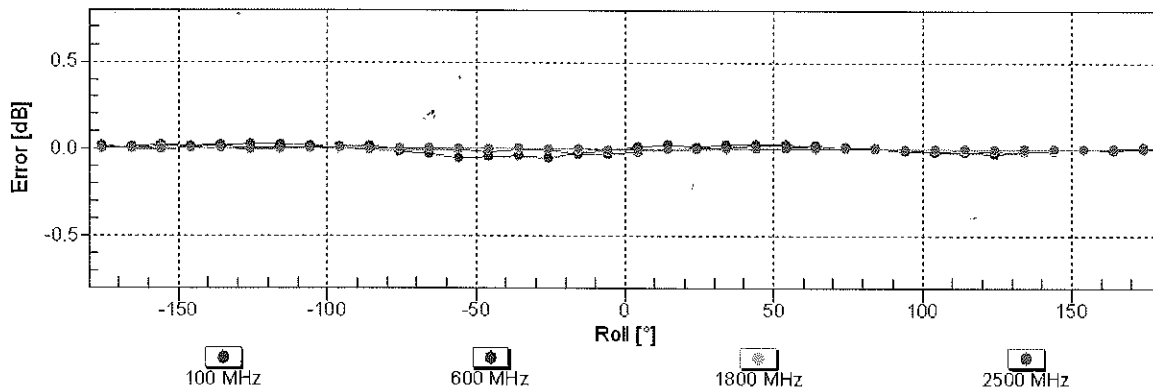
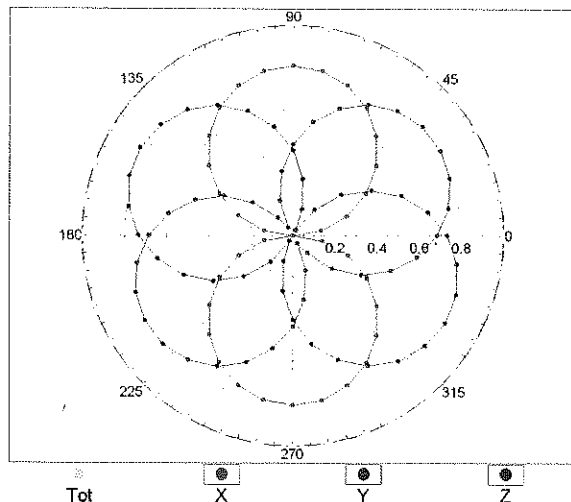

Uncertainty of Axial Isotropy Assessment: $\pm 0.5\%$ (k=2)

Dynamic Range f(SAR_{head}) (TEM cell , f = 900 MHz)

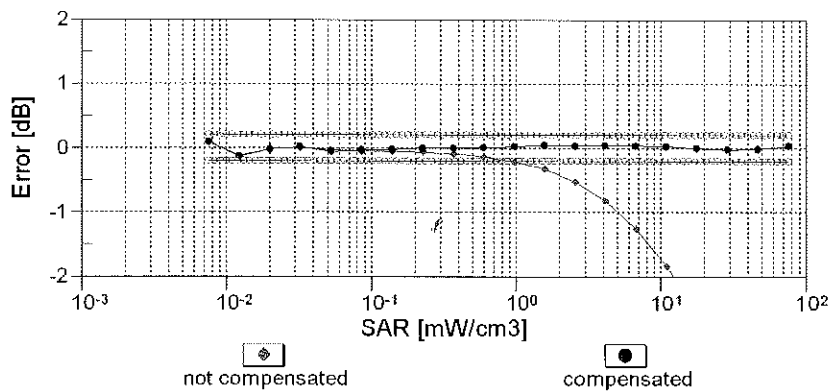
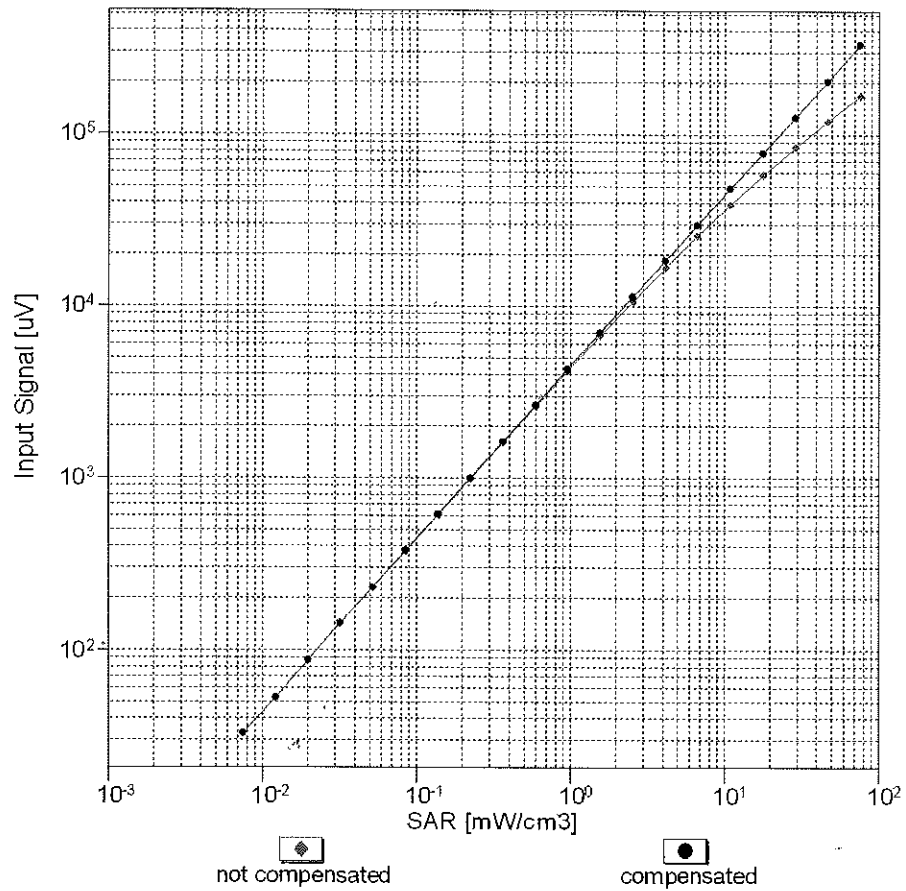

Uncertainty of Linearity Assessment: ± 0.6% (k=2)

Conversion Factor Assessment

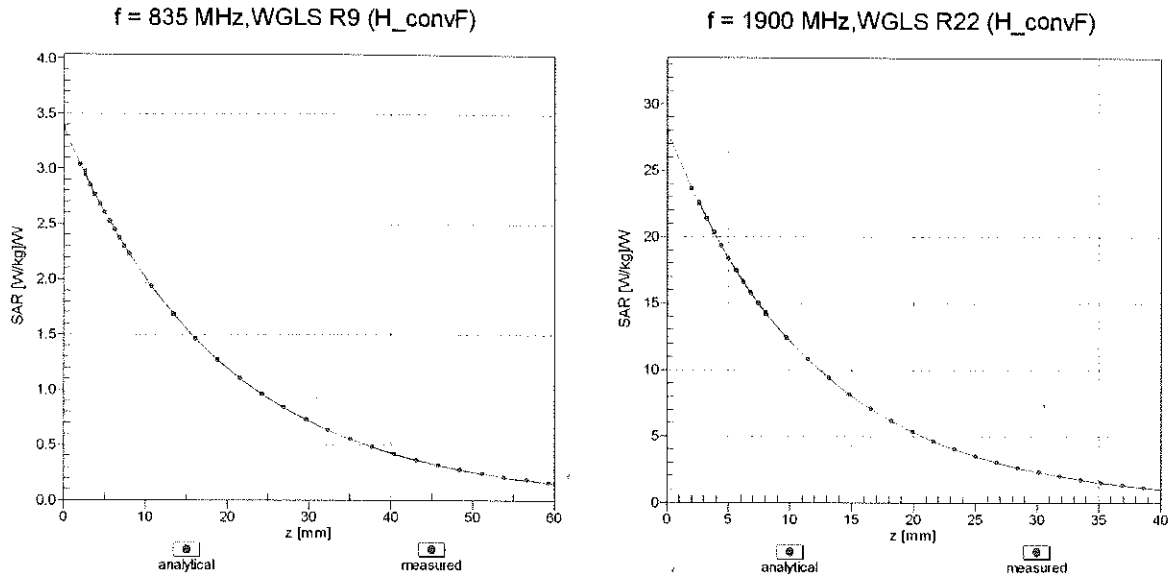

Deviation from Isotropy in Liquid Error (ϕ, θ), f = 900 MHz

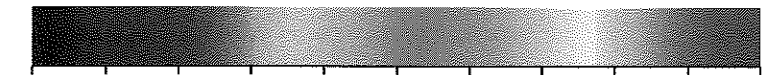
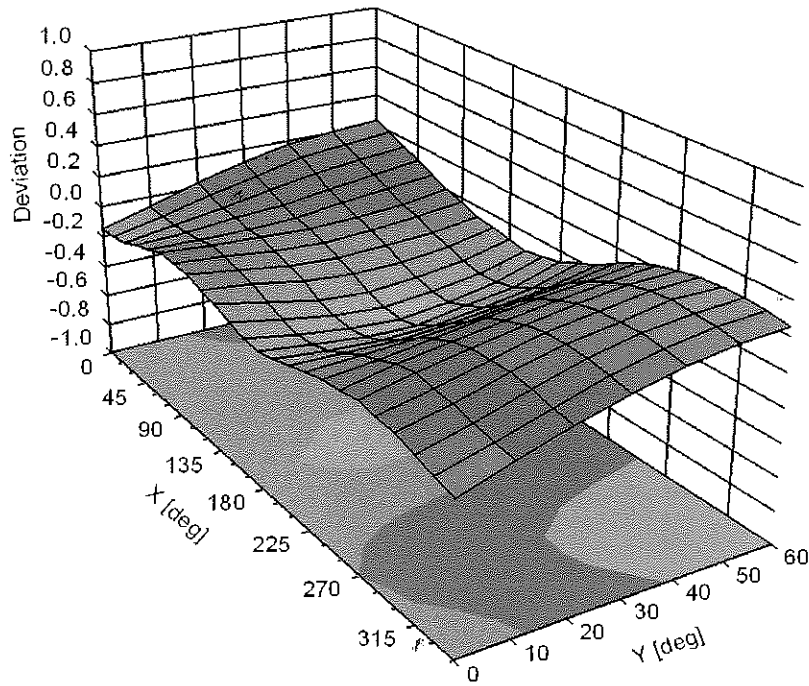

Uncertainty of Spherical Isotropy Assessment: $\pm 2.6\%$ (k=2)

DASY/EASY - Parameters of Probe: ES3DV3 - SN:3287

Other Probe Parameters

Sensor Arrangement	Triangular
Connector Angle (°)	-15.9
Mechanical Surface Detection Mode	enabled
Optical Surface Detection Mode	disabled
Probe Overall Length	337 mm
Probe Body Diameter	10 mm
Tip Length	10 mm
Tip Diameter	4 mm
Probe Tip to Sensor X Calibration Point	2 mm
Probe Tip to Sensor Y Calibration Point	2 mm
Probe Tip to Sensor Z Calibration Point	2 mm
Recommended Measurement Distance from Surface	3 mm



Accredited by the Swiss Accreditation Service (SAS)
The Swiss Accreditation Service is one of the signatories to the EA
Multilateral Agreement for the recognition of calibration certificates

Accreditation No.: **SCS 108**

Client **PC Test**

Certificate No: **ES3-3209_Mar13**

CALIBRATION CERTIFICATE

Object **ES3DV3 - SN:3209**

Calibration procedure(s) **QA CAL-01.v8, QA CAL-23.v4, QA CAL-25.v4
Calibration procedure for dosimetric E-field probes**

Calibration date: **March 15, 2013**

This calibration certificate documents the traceability to national standards, which realize the physical units of measurements (SI).
The measurements and the uncertainties with confidence probability are given on the following pages and are part of the certificate.

All calibrations have been conducted in the closed laboratory facility: environment temperature (22 ± 3)°C and humidity < 70%.

✓ KOK 3/22/13

Calibration Equipment used (M&TE critical for calibration)

Primary Standards	ID	Cal Date (Certificate No.)	Scheduled Calibration
Power meter E4419B	GB41293874	29-Mar-12 (No. 217-01508)	Apr-13
Power sensor E4412A	MY41498087	29-Mar-12 (No. 217-01508)	Apr-13
Reference 3 dB Attenuator	SN: S5054 (3c)	27-Mar-12 (No. 217-01531)	Apr-13
Reference 20 dB Attenuator	SN: S5086 (20b)	27-Mar-12 (No. 217-01529)	Apr-13
Reference 30 dB Attenuator	SN: S5129 (30b)	27-Mar-12 (No. 217-01532)	Apr-13
Reference Probe ES3DV2	SN: 3013	28-Dec-12 (No. ES3-3013_Dec12)	Dec-13
DAE4	SN: 660	31-Jan-13 (No. DAE4-660_Jan13)	Jan-14
Secondary Standards	ID	Check Date (in house)	Scheduled Check
RF generator HP 8648C	US3642U01700	4-Aug-99 (in house check Apr-11)	In house check: Apr-13
Network Analyzer HP 8753E	US37390585	18-Oct-01 (in house check Oct-12)	In house check: Oct-13

	Name	Function	Signature
Calibrated by:	Israe El-Naouq	Laboratory Technician	<i>Israe El-Naouq</i>
Approved by:	Katja Pokovic	Technical Manager	<i>Katja Pokovic</i>

Issued: March 15, 2013

This calibration certificate shall not be reproduced except in full without written approval of the laboratory.

80242



Accredited by the Swiss Accreditation Service (SAS)

Accreditation No.: **SCS 108**

The Swiss Accreditation Service is one of the signatories to the EA
 Multilateral Agreement for the recognition of calibration certificates

Glossary:

TSL	tissue simulating liquid
NORM _{x,y,z}	sensitivity in free space
ConvF	sensitivity in TSL / NORM _{x,y,z}
DCP	diode compression point
CF	crest factor (1/duty_cycle) of the RF signal
A, B, C, D	modulation dependent linearization parameters
Polarization φ	φ rotation around probe axis
Polarization θ	θ rotation around an axis that is in the plane normal to probe axis (at measurement center), i.e., θ = 0 is normal to probe axis

Calibration is Performed According to the Following Standards:

- a) IEEE Std 1528-2003, "IEEE Recommended Practice for Determining the Peak Spatial-Averaged Specific Absorption Rate (SAR) in the Human Head from Wireless Communications Devices: Measurement Techniques", December 2003
- b) IEC 62209-1, "Procedure to measure the Specific Absorption Rate (SAR) for hand-held devices used in close proximity to the ear (frequency range of 300 MHz to 3 GHz)", February 2005

Methods Applied and Interpretation of Parameters:

- NORM_{x,y,z}: Assessed for E-field polarization θ = 0 (f ≤ 900 MHz in TEM-cell; f > 1800 MHz: R22 waveguide). NORM_{x,y,z} are only intermediate values, i.e., the uncertainties of NORM_{x,y,z} does not affect the E²-field uncertainty inside TSL (see below ConvF).
- NORM(f)_{x,y,z} = NORM_{x,y,z} * frequency_response (see Frequency Response Chart). This linearization is implemented in DASY4 software versions later than 4.2. The uncertainty of the frequency response is included in the stated uncertainty of ConvF.
- DCP_{x,y,z}: DCP are numerical linearization parameters assessed based on the data of power sweep with CW signal (no uncertainty required). DCP does not depend on frequency nor media.
- PAR: PAR is the Peak to Average Ratio that is not calibrated but determined based on the signal characteristics
- Ax,y,z; Bx,y,z; Cx,y,z; Dx,y,z; VRx,y,z; A, B, C, D are numerical linearization parameters assessed based on the data of power sweep for specific modulation signal. The parameters do not depend on frequency nor media. VR is the maximum calibration range expressed in RMS voltage across the diode.
- ConvF and Boundary Effect Parameters: Assessed in flat phantom using E-field (or Temperature Transfer Standard for f ≤ 800 MHz) and inside waveguide using analytical field distributions based on power measurements for f > 800 MHz. The same setups are used for assessment of the parameters applied for boundary compensation (alpha, depth) of which typical uncertainty values are given. These parameters are used in DASY4 software to improve probe accuracy close to the boundary. The sensitivity in TSL corresponds to NORM_{x,y,z} * ConvF whereby the uncertainty corresponds to that given for ConvF. A frequency dependent ConvF is used in DASY version 4.4 and higher which allows extending the validity from ± 50 MHz to ± 100 MHz.
- Spherical isotropy (3D deviation from isotropy): in a field of low gradients realized using a flat phantom exposed by a patch antenna.
- Sensor Offset: The sensor offset corresponds to the offset of virtual measurement center from the probe tip (on probe axis). No tolerance required.

Probe ES3DV3

SN:3209

Manufactured: October 14, 2008
Calibrated: March 15, 2013

Calibrated for DASY/EASY Systems
(Note: non-compatible with DASY2 system!)

DASY/EASY - Parameters of Probe: ES3DV3 - SN:3209

Basic Calibration Parameters

	Sensor X	Sensor Y	Sensor Z	Unc (k=2)
Norm ($\mu\text{V}/(\text{V}/\text{m})^2$) ^A	1.35	1.33	1.14	$\pm 10.1 \%$
DCP (mV) ^B	99.2	97.8	98.3	

Modulation Calibration Parameters

UID	Communication System Name		A dB	B dB $\sqrt{\mu\text{V}}$	C	D dB	VR mV	Unc ^E (k=2)
0	CW	X	0.0	0.0	1.0	0.00	163.6	$\pm 3.5 \%$
		Y	0.0	0.0	1.0		170.3	
		Z	0.0	0.0	1.0		158.7	

The reported uncertainty of measurement is stated as the standard uncertainty of measurement multiplied by the coverage factor k=2, which for a normal distribution corresponds to a coverage probability of approximately 95%.

^A The uncertainties of NormX,Y,Z do not affect the E²-field uncertainty inside TSL (see Pages 5 and 6).

^B Numerical linearization parameter: uncertainty not required.

^E Uncertainty is determined using the max. deviation from linear response applying rectangular distribution and is expressed for the square of the field value.

DASY/EASY - Parameters of Probe: ES3DV3 - SN:3209

Calibration Parameter Determined in Head Tissue Simulating Media

f (MHz) ^C	Relative Permittivity ^F	Conductivity (S/m) ^F	ConvF X	ConvF Y	ConvF Z	Alpha	Depth (mm)	Unct. (k=2)
750	41.9	0.89	6.74	6.74	6.74	0.76	1.18	± 12.0 %
835	41.5	0.90	6.46	6.46	6.46	0.31	1.81	± 12.0 %
1750	40.1	1.37	5.39	5.39	5.39	0.80	1.21	± 12.0 %
1900	40.0	1.40	5.21	5.21	5.21	0.78	1.26	± 12.0 %
2450	39.2	1.80	4.57	4.57	4.57	0.65	1.43	± 12.0 %
2600	39.0	1.96	4.43	4.43	4.43	0.75	1.36	± 12.0 %

^C Frequency validity of ± 100 MHz only applies for DASY v4.4 and higher (see Page 2), else it is restricted to ± 50 MHz. The uncertainty is the RSS of the ConvF uncertainty at calibration frequency and the uncertainty for the indicated frequency band.

^F At frequencies below 3 GHz, the validity of tissue parameters (ϵ and σ) can be relaxed to ± 10% if liquid compensation formula is applied to measured SAR values. At frequencies above 3 GHz, the validity of tissue parameters (ϵ and σ) is restricted to ± 5%. The uncertainty is the RSS of the ConvF uncertainty for indicated target tissue parameters.

DASY/EASY - Parameters of Probe: ES3DV3 - SN:3209

Calibration Parameter Determined in Body Tissue Simulating Media

f (MHz) ^C	Relative Permittivity ^F	Conductivity (S/m) ^F	ConvF X	ConvF Y	ConvF Z	Alpha	Depth (mm)	Unct. (k=2)
750	55.5	0.96	6.38	6.38	6.38	0.80	1.16	± 12.0 %
835	55.2	0.97	6.28	6.28	6.28	0.52	1.45	± 12.0 %
1750	53.4	1.49	5.03	5.03	5.03	0.58	1.45	± 12.0 %
1900	53.3	1.52	4.77	4.77	4.77	0.70	1.36	± 12.0 %
2450	52.7	1.95	4.34	4.34	4.34	0.80	1.15	± 12.0 %
2600	52.5	2.16	4.11	4.11	4.11	0.80	1.00	± 12.0 %

^C Frequency validity of ± 100 MHz only applies for DASY v4.4 and higher (see Page 2), else it is restricted to ± 50 MHz. The uncertainty is the RSS of the ConvF uncertainty at calibration frequency and the uncertainty for the indicated frequency band.

^F At frequencies below 3 GHz, the validity of tissue parameters (ϵ and σ) can be relaxed to ± 10% if liquid compensation formula is applied to measured SAR values. At frequencies above 3 GHz, the validity of tissue parameters (ϵ and σ) is restricted to ± 5%. The uncertainty is the RSS of the ConvF uncertainty for indicated target tissue parameters.

Frequency Response of E-Field (TEM-Cell:ifi110 EXX, Waveguide: R22)

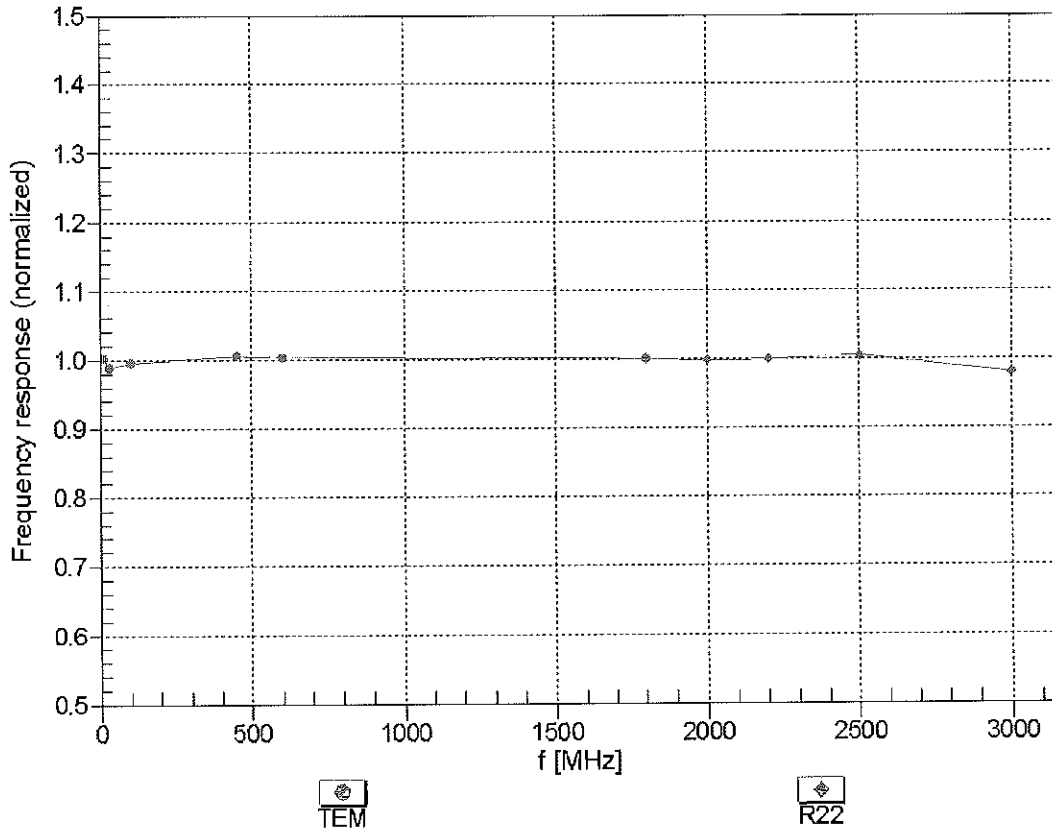

Uncertainty of Frequency Response of E-field: $\pm 6.3\%$ (k=2)

Receiving Pattern (ϕ), $\theta = 0^\circ$

f=600 MHz,TEM

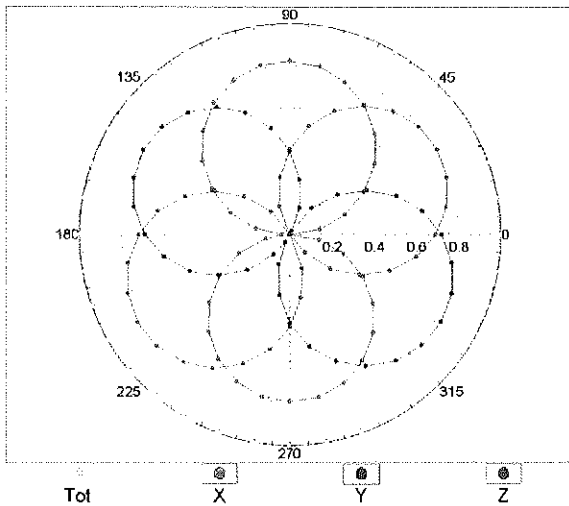

f=1800 MHz,R22

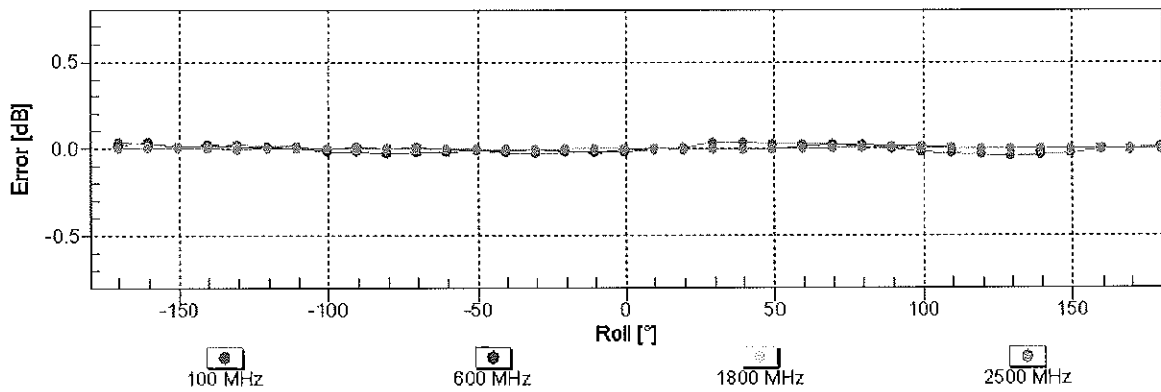
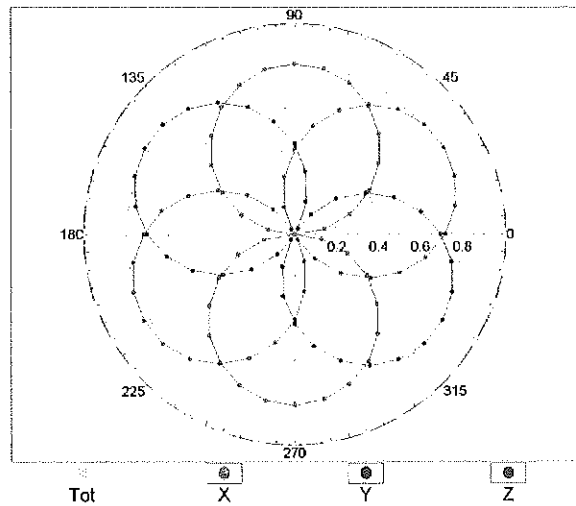

Uncertainty of Axial Isotropy Assessment: $\pm 0.5\%$ (k=2)

Dynamic Range f(SAR_{head}) (TEM cell , f = 900 MHz)

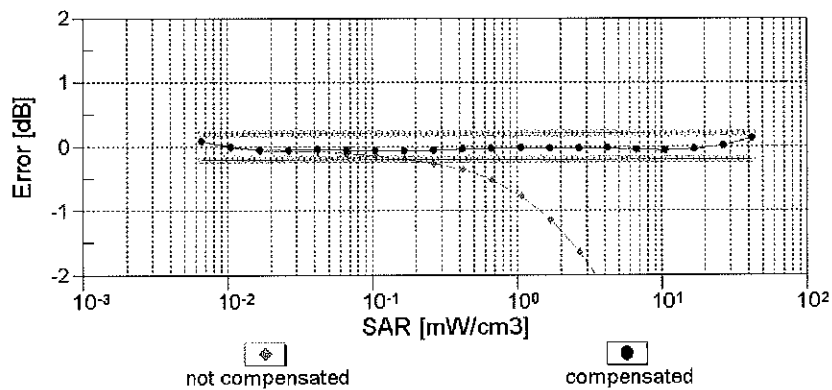
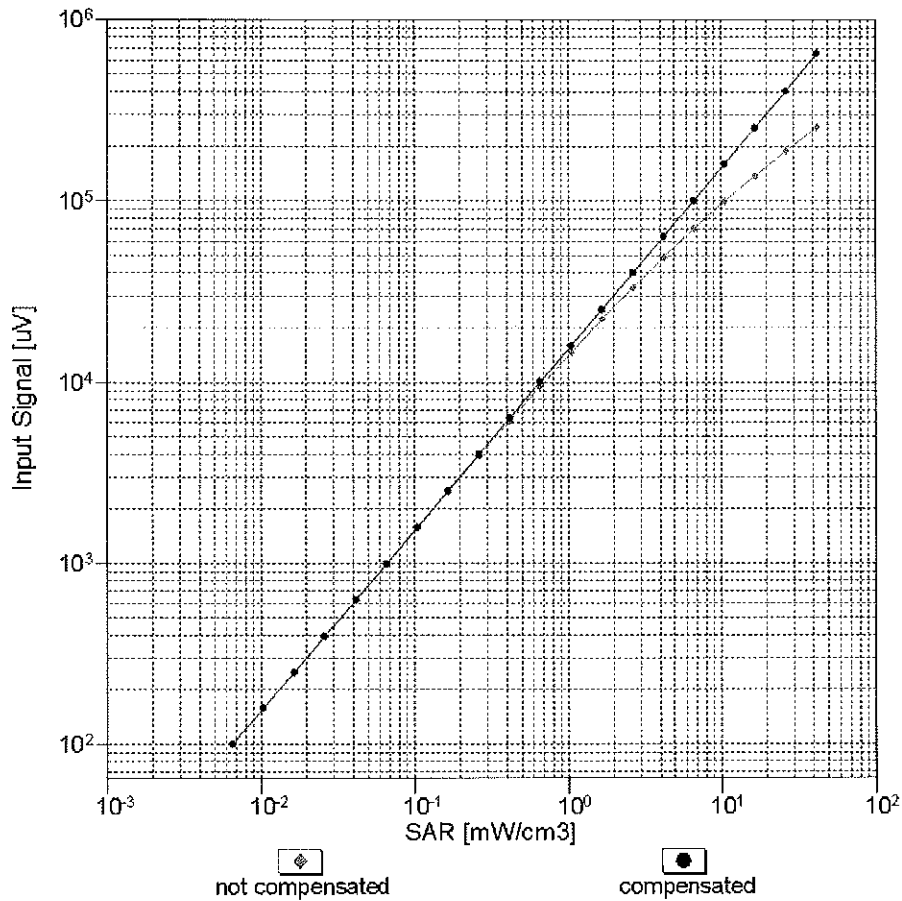

Uncertainty of Linearity Assessment: ± 0.6% (k=2)

Conversion Factor Assessment

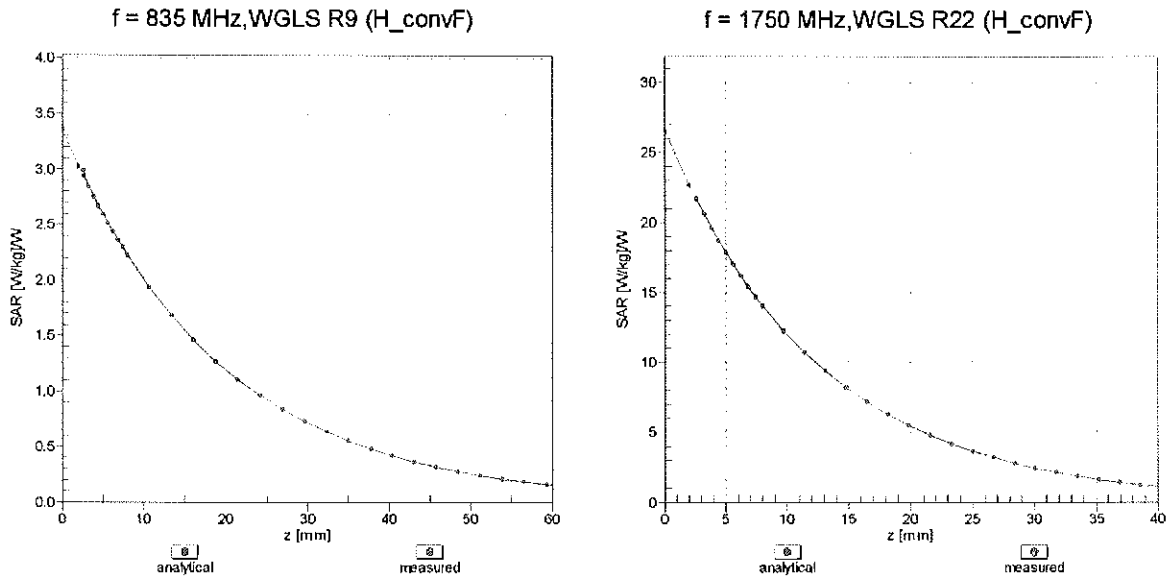

Deviation from Isotropy in Liquid Error (ϕ, θ), f = 900 MHz

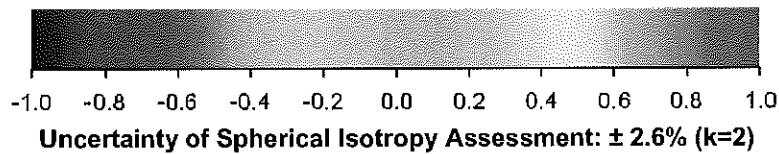
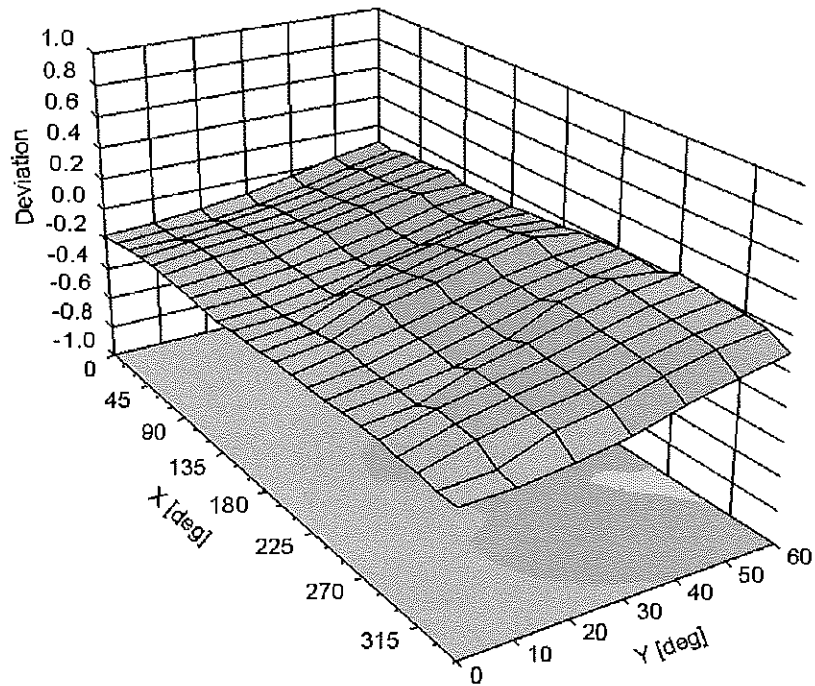

DASY/EASY - Parameters of Probe: ES3DV3 - SN:3209

Other Probe Parameters

Sensor Arrangement	Triangular
Connector Angle (°)	-40.6
Mechanical Surface Detection Mode	enabled
Optical Surface Detection Mode	disabled
Probe Overall Length	337 mm
Probe Body Diameter	10 mm
Tip Length	10 mm
Tip Diameter	4 mm
Probe Tip to Sensor X Calibration Point	2 mm
Probe Tip to Sensor Y Calibration Point	2 mm
Probe Tip to Sensor Z Calibration Point	2 mm
Recommended Measurement Distance from Surface	3 mm



Accredited by the Swiss Accreditation Service (SAS)
The Swiss Accreditation Service is one of the signatories to the EA
Multilateral Agreement for the recognition of calibration certificates

Accreditation No.: **SCS 108**

Client **PC Test**

Certificate No: **EX3-3920_Feb13/2**

CALIBRATION CERTIFICATE (Replacement of No: EX3-3920_Feb13)

Object: **EX3DV4 - SN:3920**

Calibration procedure(s): **QA CAL-01.v8, QA CAL-14.v3, QA CAL-23.v4, QA CAL-25.v4
Calibration procedure for dosimetric E-field probes**

Calibration date: **February 27, 2013**

This calibration certificate documents the traceability to national standards, which realize the physical units of measurements (SI).
The measurements and the uncertainties with confidence probability are given on the following pages and are part of the certificate.

All calibrations have been conducted in the closed laboratory facility: environment temperature (22 ± 3)°C and humidity < 70%.

✓ KOK 3/27/13

Calibration Equipment used (M&TE critical for calibration)

Primary Standards	ID	Cal Date (Certificate No.)	Scheduled Calibration
Power meter E4419B	GB41293874	29-Mar-12 (No. 217-01508)	Apr-13
Power sensor E4412A	MY41498087	29-Mar-12 (No. 217-01508)	Apr-13
Reference 3 dB Attenuator	SN: S5054 (3c)	27-Mar-12 (No. 217-01531)	Apr-13
Reference 20 dB Attenuator	SN: S5086 (20b)	27-Mar-12 (No. 217-01529)	Apr-13
Reference 30 dB Attenuator	SN: S5129 (30b)	27-Mar-12 (No. 217-01532)	Apr-13
Reference Probe ES3DV2	SN: 3013	28-Dec-12 (No. ES3-3013_Dec12)	Dec-13
DAE4	SN: 660	31-Jan-13 (No. DAE4-660_Jan13)	Jan-14
Secondary Standards	ID	Check Date (in house)	Scheduled Check
RF generator HP 8648C	US3642U01700	4-Aug-99 (in house check Apr-11)	In house check: Apr-13
Network Analyzer HP 8753E	US37390585	18-Oct-01 (in house check Oct-12)	In house check: Oct-13

Calibrated by:	Name Claudio Leubler	Function Laboratory Technician	Signature
Approved by:	Name Katja Pokovic	Function Technical Manager	Signature

Issued: March 5, 2013

This calibration certificate shall not be reproduced except in full without written approval of the laboratory.



Accredited by the Swiss Accreditation Service (SAS)

The Swiss Accreditation Service is one of the signatories to the EA
Multilateral Agreement for the recognition of calibration certificates

Accreditation No.: **SCS 108**

Glossary:

TSL	tissue simulating liquid
NORM _{x,y,z}	sensitivity in free space
ConvF	sensitivity in TSL / NORM _{x,y,z}
DCP	diode compression point
CF	crest factor (1/duty_cycle) of the RF signal
A, B, C, D	modulation dependent linearization parameters
Polarization φ	φ rotation around probe axis
Polarization ϑ	ϑ rotation around an axis that is in the plane normal to probe axis (at measurement center), i.e., $\vartheta = 0$ is normal to probe axis

Calibration is Performed According to the Following Standards:

- IEEE Std 1528-2003, "IEEE Recommended Practice for Determining the Peak Spatial-Averaged Specific Absorption Rate (SAR) in the Human Head from Wireless Communications Devices: Measurement Techniques", December 2003
- IEC 62209-1, "Procedure to measure the Specific Absorption Rate (SAR) for hand-held devices used in close proximity to the ear (frequency range of 300 MHz to 3 GHz)", February 2005

Methods Applied and Interpretation of Parameters:

- NORM_{x,y,z}**: Assessed for E-field polarization $\vartheta = 0$ ($f \leq 900$ MHz in TEM-cell; $f > 1800$ MHz: R22 waveguide). NORM_{x,y,z} are only intermediate values, i.e., the uncertainties of NORM_{x,y,z} does not affect the E²-field uncertainty inside TSL (see below ConvF).
- NORM(f)_{x,y,z}** = NORM_{x,y,z} * frequency_response (see Frequency Response Chart). This linearization is implemented in DASY4 software versions later than 4.2. The uncertainty of the frequency response is included in the stated uncertainty of ConvF.
- DCP_{x,y,z}**: DCP are numerical linearization parameters assessed based on the data of power sweep with CW signal (no uncertainty required). DCP does not depend on frequency nor media.
- PAR**: PAR is the Peak to Average Ratio that is not calibrated but determined based on the signal characteristics
- A_{x,y,z}; B_{x,y,z}; C_{x,y,z}; D_{x,y,z}; VR_{x,y,z}**: A, B, C, D are numerical linearization parameters assessed based on the data of power sweep for specific modulation signal. The parameters do not depend on frequency nor media. VR is the maximum calibration range expressed in RMS voltage across the diode.
- ConvF and Boundary Effect Parameters**: Assessed in flat phantom using E-field (or Temperature Transfer Standard for $f \leq 800$ MHz) and inside waveguide using analytical field distributions based on power measurements for $f > 800$ MHz. The same setups are used for assessment of the parameters applied for boundary compensation (alpha, depth) of which typical uncertainty values are given. These parameters are used in DASY4 software to improve probe accuracy close to the boundary. The sensitivity in TSL corresponds to NORM_{x,y,z} * ConvF whereby the uncertainty corresponds to that given for ConvF. A frequency dependent ConvF is used in DASY version 4.4 and higher which allows extending the validity from ± 50 MHz to ± 100 MHz.
- Spherical isotropy (3D deviation from isotropy)**: in a field of low gradients realized using a flat phantom exposed by a patch antenna.
- Sensor Offset**: The sensor offset corresponds to the offset of virtual measurement center from the probe tip (on probe axis). No tolerance required.

Probe EX3DV4

SN:3920

Manufactured: December 18, 2012
Calibrated: February 27, 2013

Calibrated for DASY/EASY Systems
(Note: non-compatible with DASY2 system!)

DASY/EASY - Parameters of Probe: EX3DV4 - SN:3920

Basic Calibration Parameters

	Sensor X	Sensor Y	Sensor Z	Unc (k=2)
Norm ($\mu\text{V}/(\text{V}/\text{m})^2$) ^A	0.34	0.50	0.50	$\pm 10.1\%$
DCP (mV) ^B	101.2	101.0	99.1	

Modulation Calibration Parameters

UID	Communication System Name		A dB	B dB $\sqrt{\mu\text{V}}$	C	D dB	VR mV	Unc ^E (k=2)
0	CW	X	0.0	0.0	1.0	0.00	134.3	$\pm 3.3\%$
		Y	0.0	0.0	1.0		164.7	
		Z	0.0	0.0	1.0		161.4	

The reported uncertainty of measurement is stated as the standard uncertainty of measurement multiplied by the coverage factor $k=2$, which for a normal distribution corresponds to a coverage probability of approximately 95%.

^A The uncertainties of NormX,Y,Z do not affect the E^2 -field uncertainty inside TSL (see Pages 5 and 6).

^B Numerical linearization parameter: uncertainty not required.

^E Uncertainty is determined using the max. deviation from linear response applying rectangular distribution and is expressed for the square of the field value.

DASY/EASY - Parameters of Probe: EX3DV4 - SN:3920

Calibration Parameter Determined in Head Tissue Simulating Media

f (MHz) ^C	Relative Permittivity ^F	Conductivity (S/m) ^F	ConvF X	ConvF Y	ConvF Z	Alpha	Depth (mm)	Unct. (k=2)
750	41.9	0.89	9.86	9.86	9.86	0.19	1.39	± 12.0 %
835	41.5	0.90	9.58	9.58	9.58	0.77	0.54	± 12.0 %
1750	40.1	1.37	7.97	7.97	7.97	0.57	0.69	± 12.0 %
1900	40.0	1.40	7.73	7.73	7.73	0.54	0.73	± 12.0 %
2450	39.2	1.80	7.04	7.04	7.04	0.40	0.82	± 12.0 %
2600	39.0	1.96	6.80	6.80	6.80	0.49	0.76	± 12.0 %
5200	36.0	4.66	4.87	4.87	4.87	0.35	1.80	± 13.1 %
5300	35.9	4.76	4.73	4.73	4.73	0.37	1.80	± 13.1 %
5500	35.6	4.96	4.52	4.52	4.52	0.39	1.80	± 13.1 %
5600	35.5	5.07	4.17	4.17	4.17	0.50	1.80	± 13.1 %
5800	35.3	5.27	4.02	4.02	4.02	0.45	1.80	± 13.1 %

^C Frequency validity of ± 100 MHz only applies for DASY v4.4 and higher (see Page 2), else it is restricted to ± 50 MHz. The uncertainty is the RSS of the ConvF uncertainty at calibration frequency and the uncertainty for the indicated frequency band.

^F At frequencies below 3 GHz, the validity of tissue parameters (ϵ and σ) can be relaxed to ± 10% if liquid compensation formula is applied to measured SAR values. At frequencies above 3 GHz, the validity of tissue parameters (ϵ and σ) is restricted to ± 5%. The uncertainty is the RSS of the ConvF uncertainty for indicated target tissue parameters.

DASY/EASY - Parameters of Probe: EX3DV4 - SN:3920

Calibration Parameter Determined in Body Tissue Simulating Media

f (MHz) ^C	Relative Permittivity ^F	Conductivity (S/m) ^F	ConvF X	ConvF Y	ConvF Z	Alpha	Depth (mm)	Unct. (k=2)
750	55.5	0.96	9.57	9.57	9.57	0.43	0.83	± 12.0 %
835	55.2	0.97	9.42	9.42	9.42	0.36	0.98	± 12.0 %
1750	53.4	1.49	7.59	7.59	7.59	0.43	0.78	± 12.0 %
1900	53.3	1.52	7.38	7.38	7.38	0.33	0.91	± 12.0 %
2450	52.7	1.95	7.07	7.07	7.07	0.80	0.55	± 12.0 %
2600	52.5	2.16	6.73	6.73	6.73	0.80	0.56	± 12.0 %
5200	49.0	5.30	4.23	4.23	4.23	0.51	1.90	± 13.1 %
5300	48.9	5.42	4.13	4.13	4.13	0.49	1.90	± 13.1 %
5500	48.6	5.65	3.63	3.63	3.63	0.52	1.90	± 13.1 %
5600	48.5	5.77	3.62	3.62	3.62	0.49	1.90	± 13.1 %
5800	48.2	6.00	3.91	3.91	3.91	0.54	1.90	± 13.1 %

^C Frequency validity of ± 100 MHz only applies for DASY v4.4 and higher (see Page 2), else it is restricted to ± 50 MHz. The uncertainty is the RSS of the ConvF uncertainty at calibration frequency and the uncertainty for the indicated frequency band.

^F At frequencies below 3 GHz, the validity of tissue parameters (ϵ and σ) can be relaxed to ± 10% if liquid compensation formula is applied to measured SAR values. At frequencies above 3 GHz, the validity of tissue parameters (ϵ and σ) is restricted to ± 5%. The uncertainty is the RSS of the ConvF uncertainty for indicated target tissue parameters.

Frequency Response of E-Field (TEM-Cell:ifi110 EXX, Waveguide: R22)

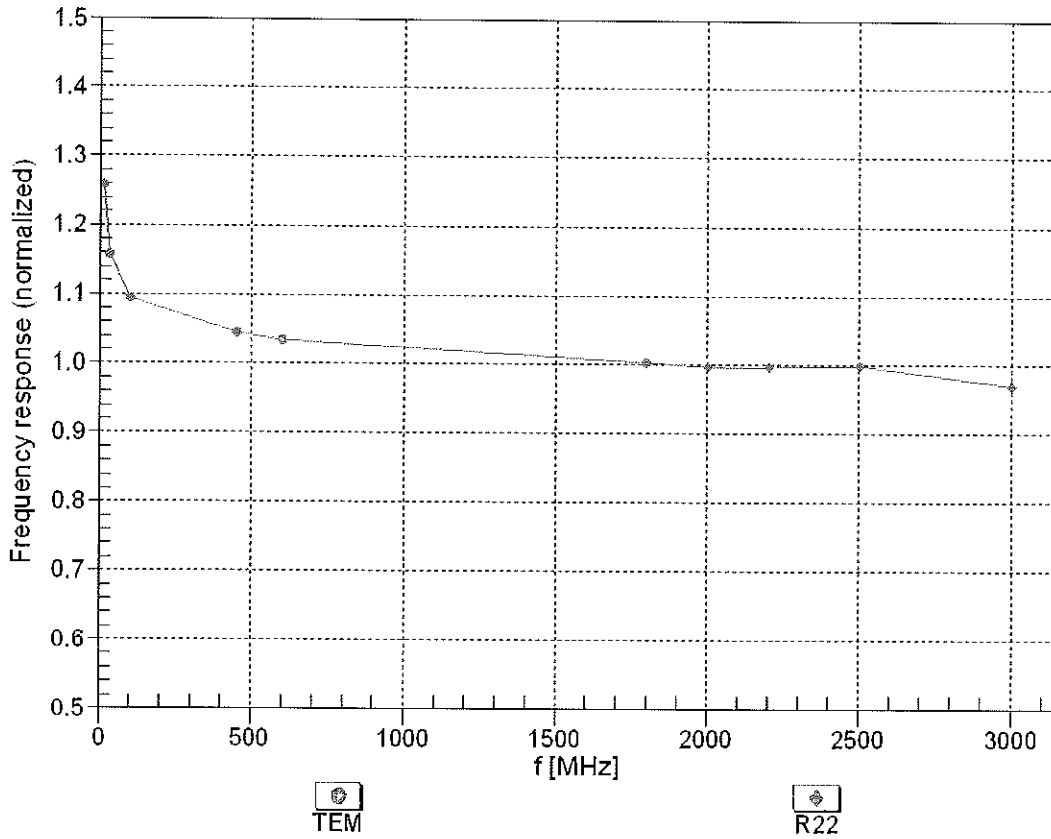

Uncertainty of Frequency Response of E-field: $\pm 6.3\%$ (k=2)

Receiving Pattern (ϕ), $\theta = 0^\circ$

f=600 MHz,TEM

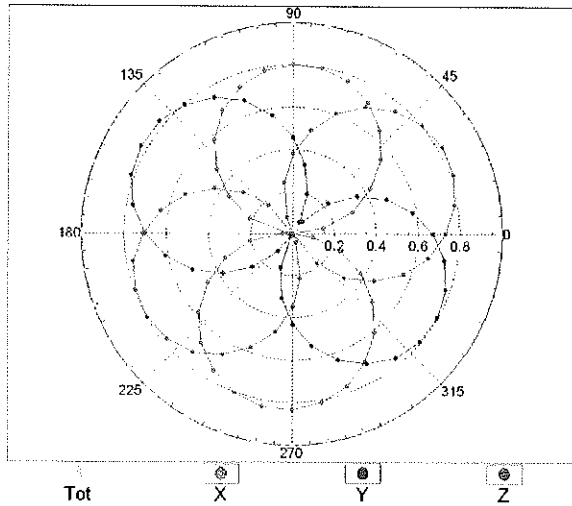

f=1800 MHz,R22

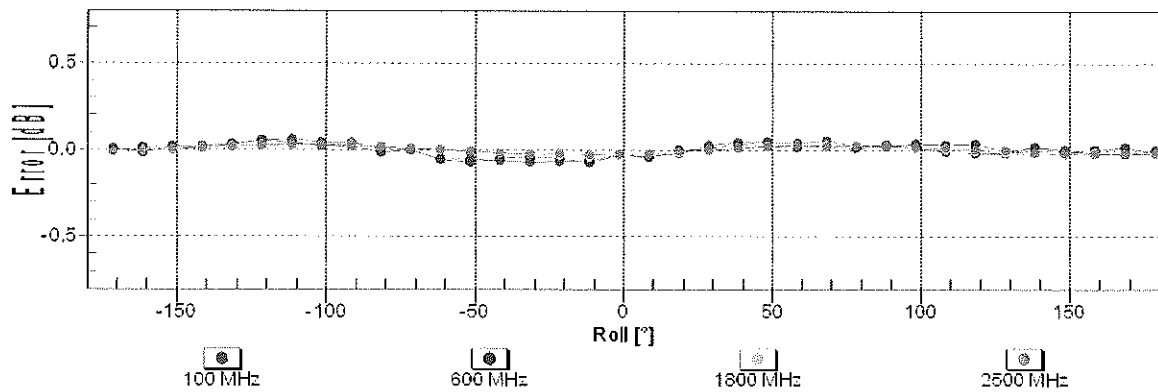
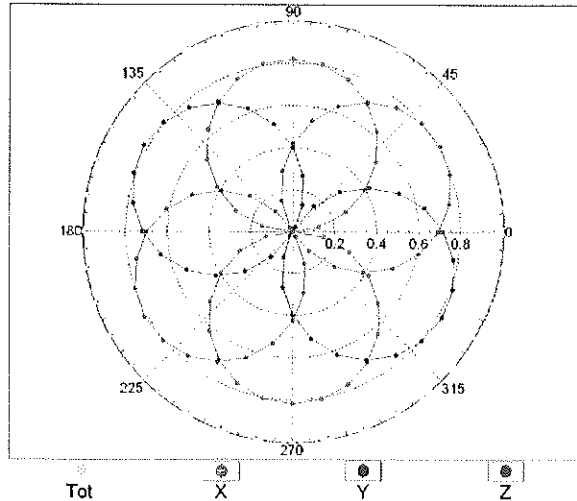

Uncertainty of Axial Isotropy Assessment: $\pm 0.5\%$ (k=2)

Dynamic Range f(SAR_{head}) (TEM cell , f = 900 MHz)

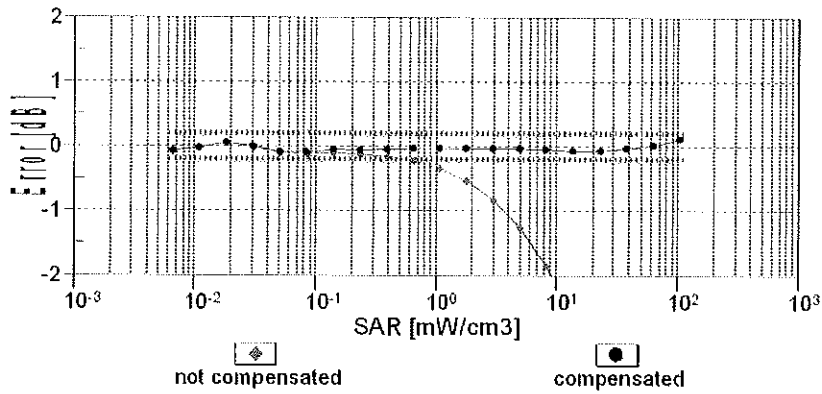
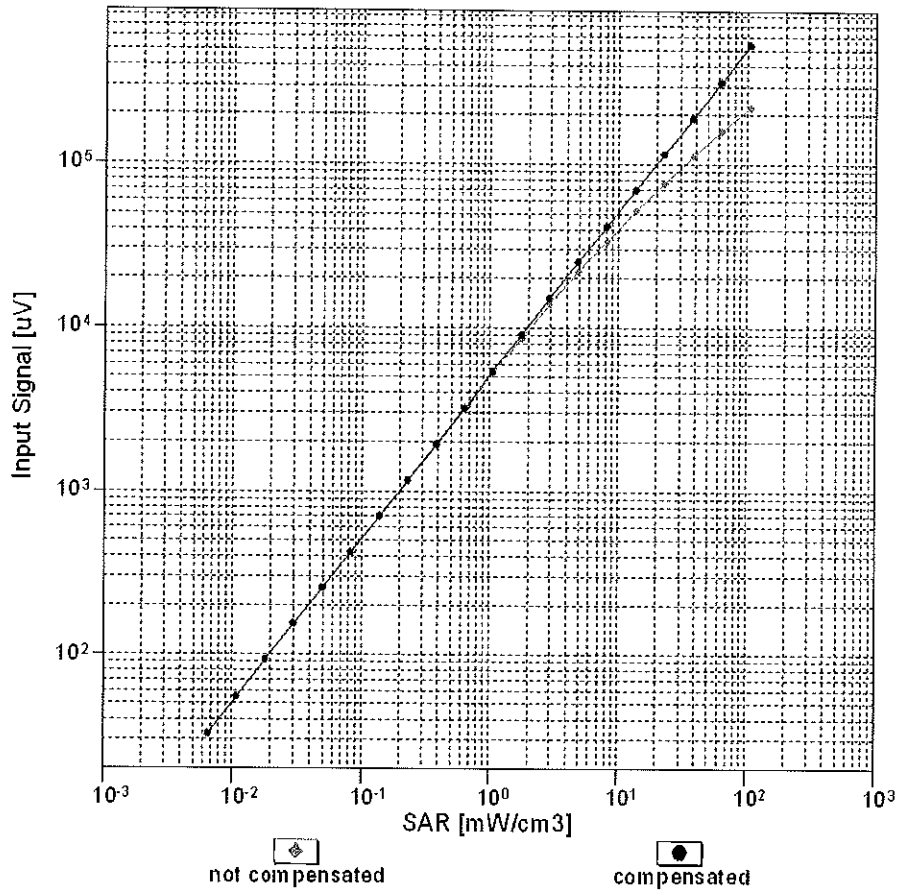

Uncertainty of Linearity Assessment: ± 0.6% (k=2)

Conversion Factor Assessment

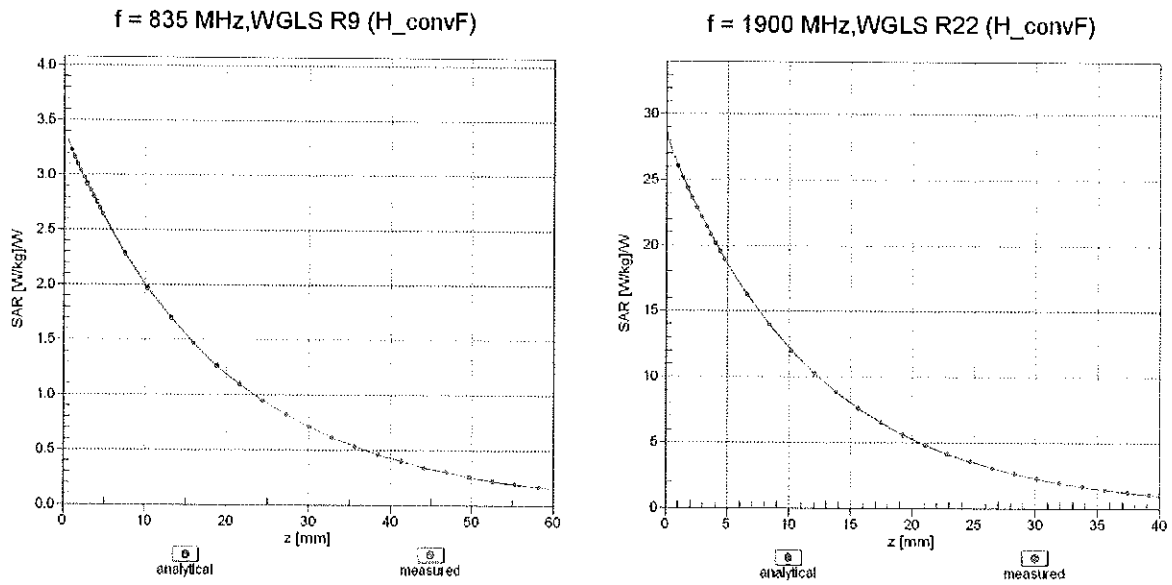

Deviation from Isotropy in Liquid Error (ϕ, θ), f = 900 MHz

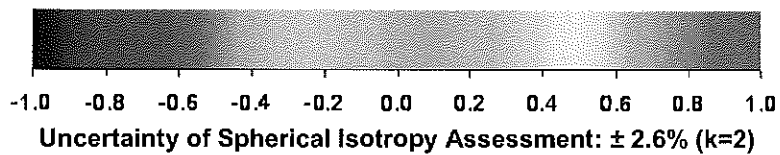
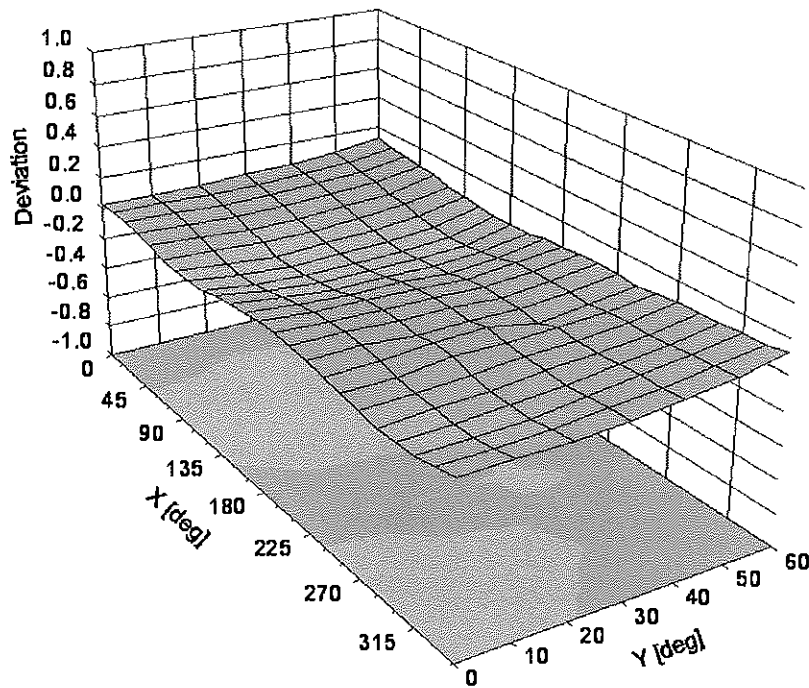

DASY/EASY - Parameters of Probe: EX3DV4 - SN:3920

Other Probe Parameters

Sensor Arrangement	Triangular
Connector Angle (°)	-21.6
Mechanical Surface Detection Mode	enabled
Optical Surface Detection Mode	disabled
Probe Overall Length	337 mm
Probe Body Diameter	10 mm
Tip Length	9 mm
Tip Diameter	2.5 mm
Probe Tip to Sensor X Calibration Point	1 mm
Probe Tip to Sensor Y Calibration Point	1 mm
Probe Tip to Sensor Z Calibration Point	1 mm
Recommended Measurement Distance from Surface	2 mm



Accredited by the Swiss Accreditation Service (SAS)
The Swiss Accreditation Service is one of the signatories to the EA
Multilateral Agreement for the recognition of calibration certificates

Accreditation No.: **SCS 108**

Client **PC Test**

Certificate No: **D750V3-1054_Mar13**

CALIBRATION CERTIFICATE

Object **D750V3 - SN: 1054**

Calibration procedure(s) **QA CAL-05.v9
Calibration procedure for dipole validation kits above 700 MHz**

Calibration date: **March 18, 2013**

*✓ KOK
3/22/13*

This calibration certificate documents the traceability to national standards, which realize the physical units of measurements (SI).
The measurements and the uncertainties with confidence probability are given on the following pages and are part of the certificate.

All calibrations have been conducted in the closed laboratory facility: environment temperature (22 ± 3)°C and humidity < 70%.

Calibration Equipment used (M&TE critical for calibration)

Primary Standards	ID #	Cal Date (Certificate No.)	Scheduled Calibration
Power meter EPM-442A	GB37480704	01-Nov-12 (No. 217-01640)	Oct-13
Power sensor HP 8481A	US37292783	01-Nov-12 (No. 217-01640)	Oct-13
Reference 20 dB Attenuator	SN: 5058 (20k)	27-Mar-12 (No. 217-01530)	Apr-13
Type-N mismatch combination	SN: 5047.3 / 06327	27-Mar-12 (No. 217-01533)	Apr-13
Reference Probe ES3DV3	SN: 3205	28-Dec-12 (No. ES3-3205_Dec12)	Dec-13
DAE4	SN: 601	27-Jun-12 (No. DAE4-601_Jun12)	Jun-13
Secondary Standards	ID #	Check Date (in house)	Scheduled Check
Power sensor HP 8481A	MY41092317	18-Oct-02 (in house check Oct-11)	In house check: Oct-13
RF generator R&S SMT-06	100005	04-Aug-99 (in house check Oct-11)	In house check: Oct-13
Network Analyzer HP 8753E	US37390585 S4206	18-Oct-01 (in house check Oct-12)	In house check: Oct-13

Calibrated by:	Name Israe El-Naouq	Function Laboratory Technician	Signature <i>Israe El-Naouq</i>
Approved by:	Name Katja Pokovic	Function Technical Manager	Signature <i>Katja Pokovic</i>

Issued: March 18, 2013

This calibration certificate shall not be reproduced except in full without written approval of the laboratory.



Accredited by the Swiss Accreditation Service (SAS)
The Swiss Accreditation Service is one of the signatories to the EA
Multilateral Agreement for the recognition of calibration certificates

Accreditation No.: **SCS 108**

Glossary:

TSL	tissue simulating liquid
ConvF	sensitivity in TSL / NORM x,y,z
N/A	not applicable or not measured

Calibration is Performed According to the Following Standards:

- a) IEEE Std 1528-2003, "IEEE Recommended Practice for Determining the Peak Spatial-Averaged Specific Absorption Rate (SAR) in the Human Head from Wireless Communications Devices: Measurement Techniques", December 2003
- b) IEC 62209-1, "Procedure to measure the Specific Absorption Rate (SAR) for hand-held devices used in close proximity to the ear (frequency range of 300 MHz to 3 GHz)", February 2005
- c) Federal Communications Commission Office of Engineering & Technology (FCC OET), "Evaluating Compliance with FCC Guidelines for Human Exposure to Radiofrequency Electromagnetic Fields; Additional Information for Evaluating Compliance of Mobile and Portable Devices with FCC Limits for Human Exposure to Radiofrequency Emissions", Supplement C (Edition 01-01) to Bulletin 65

Additional Documentation:

- d) DASY4/5 System Handbook

Methods Applied and Interpretation of Parameters:

- *Measurement Conditions:* Further details are available from the Validation Report at the end of the certificate. All figures stated in the certificate are valid at the frequency indicated.
- *Antenna Parameters with TSL:* The dipole is mounted with the spacer to position its feed point exactly below the center marking of the flat phantom section, with the arms oriented parallel to the body axis.
- *Feed Point Impedance and Return Loss:* These parameters are measured with the dipole positioned under the liquid filled phantom. The impedance stated is transformed from the measurement at the SMA connector to the feed point. The Return Loss ensures low reflected power. No uncertainty required.
- *Electrical Delay:* One-way delay between the SMA connector and the antenna feed point. No uncertainty required.
- *SAR measured:* SAR measured at the stated antenna input power.
- *SAR normalized:* SAR as measured, normalized to an input power of 1 W at the antenna connector.
- *SAR for nominal TSL parameters:* The measured TSL parameters are used to calculate the nominal SAR result.

The reported uncertainty of measurement is stated as the standard uncertainty of measurement multiplied by the coverage factor $k=2$, which for a normal distribution corresponds to a coverage probability of approximately 95%.

Measurement Conditions

DASY system configuration, as far as not given on page 1.

DASY Version	DASY5	V52.8.5
Extrapolation	Advanced Extrapolation	
Phantom	Modular Flat Phantom	
Distance Dipole Center - TSL	15 mm	with Spacer
Zoom Scan Resolution	dx, dy, dz = 5 mm	
Frequency	750 MHz \pm 1 MHz	

Head TSL parameters

The following parameters and calculations were applied.

	Temperature	Permittivity	Conductivity
Nominal Head TSL parameters	22.0 °C	41.9	0.89 mho/m
Measured Head TSL parameters	(22.0 \pm 0.2) °C	41.1 \pm 6 %	0.92 mho/m \pm 6 %
Head TSL temperature change during test	< 0.5 °C	----	----

SAR result with Head TSL

SAR averaged over 1 cm³ (1 g) of Head TSL	Condition	
SAR measured	250 mW input power	2.19 W/kg
SAR for nominal Head TSL parameters	normalized to 1W	8.50 W/kg \pm 17.0 % (k=2)

SAR averaged over 10 cm³ (10 g) of Head TSL	condition	
SAR measured	250 mW input power	1.42 W/kg
SAR for nominal Head TSL parameters	normalized to 1W	5.55 W/kg \pm 16.5 % (k=2)

Body TSL parameters

The following parameters and calculations were applied.

	Temperature	Permittivity	Conductivity
Nominal Body TSL parameters	22.0 °C	55.5	0.96 mho/m
Measured Body TSL parameters	(22.0 \pm 0.2) °C	54.2 \pm 6 %	1.00 mho/m \pm 6 %
Body TSL temperature change during test	< 0.5 °C	----	----

SAR result with Body TSL

SAR averaged over 1 cm³ (1 g) of Body TSL	Condition	
SAR measured	250 mW input power	2.26 W/kg
SAR for nominal Body TSL parameters	normalized to 1W	8.72 W/kg \pm 17.0 % (k=2)

SAR averaged over 10 cm³ (10 g) of Body TSL	condition	
SAR measured	250 mW input power	1.48 W/kg
SAR for nominal Body TSL parameters	normalized to 1W	5.75 W/kg \pm 16.5 % (k=2)

Appendix

Antenna Parameters with Head TSL

Impedance, transformed to feed point	54.4 Ω - 0.9 j Ω
Return Loss	- 27.2 dB

Antenna Parameters with Body TSL

Impedance, transformed to feed point	49.7 Ω - 2.7 j Ω
Return Loss	- 31.4 dB

General Antenna Parameters and Design

Electrical Delay (one direction)	1.034 ns
----------------------------------	----------

After long term use with 100W radiated power, only a slight warming of the dipole near the feedpoint can be measured.

The dipole is made of standard semirigid coaxial cable. The center conductor of the feeding line is directly connected to the second arm of the dipole. The antenna is therefore short-circuited for DC-signals. On some of the dipoles, small end caps are added to the dipole arms in order to improve matching when loaded according to the position as explained in the "Measurement Conditions" paragraph. The SAR data are not affected by this change. The overall dipole length is still according to the Standard.

No excessive force must be applied to the dipole arms, because they might bend or the soldered connections near the feedpoint may be damaged.

Additional EUT Data

Manufactured by	SPEAG
Manufactured on	November 08, 2011

DASY5 Validation Report for Head TSL

Date: 18.03.2013

Test Laboratory: SPEAG, Zurich, Switzerland

DUT: Dipole 750 MHz; Type: D750V3; Serial: D750V3 - SN: 1054

Communication System: CW; Frequency: 750 MHz

Medium parameters used: $f = 750$ MHz; $\sigma = 0.92$ S/m; $\epsilon_r = 41.1$; $\rho = 1000$ kg/m³

Phantom section: Flat Section

Measurement Standard: DASY5 (IEEE/IEC/ANSI C63.19-2007)

DASY52 Configuration:

- Probe: ES3DV3 - SN3205; ConvF(6.28, 6.28, 6.28); Calibrated: 28.12.2012;
- Sensor-Surface: 3mm (Mechanical Surface Detection)
- Electronics: DAE4 Sn601; Calibrated: 27.06.2012
- Phantom: Flat Phantom 4.9L; Type: QD000P49AA; Serial: 1001
- DASY52 52.8.5(1059); SEMCAD X 14.6.8(7028)

Dipole Calibration for Head Tissue/Pin=250 mW, d=15mm/Zoom Scan (7x7x7)/Cube 0:

Measurement grid: dx=5mm, dy=5mm, dz=5mm

Reference Value = 52.772 V/m; Power Drift = 0.03 dB

Peak SAR (extrapolated) = 3.33 W/kg

SAR(1 g) = 2.19 W/kg; SAR(10 g) = 1.42 W/kg

Maximum value of SAR (measured) = 2.55 W/kg

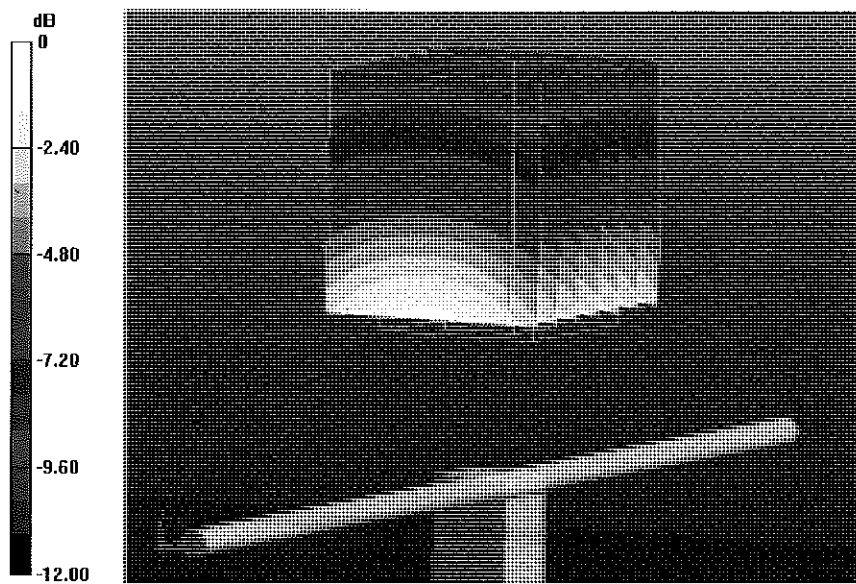

0 dB = 2.55 W/kg = 4.07 dBW/kg

Impedance Measurement Plot for Head TSL

18 Mar 2013 13:14:09

CH1 S11 1 U FS 1: 54.449 Δ -917.97 m Ω 231.17 pF 750.000 000 MHz

De1

Ca

Avg
16

H1 d

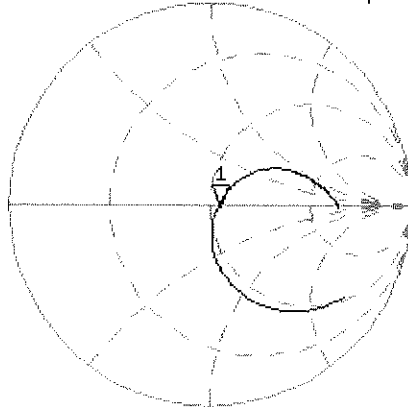

CH2 S11 LOG 5 dB/REF -20 dB 1:-27.227 dB 750.000 000 MHz

Ca

Avg
16

H1 d

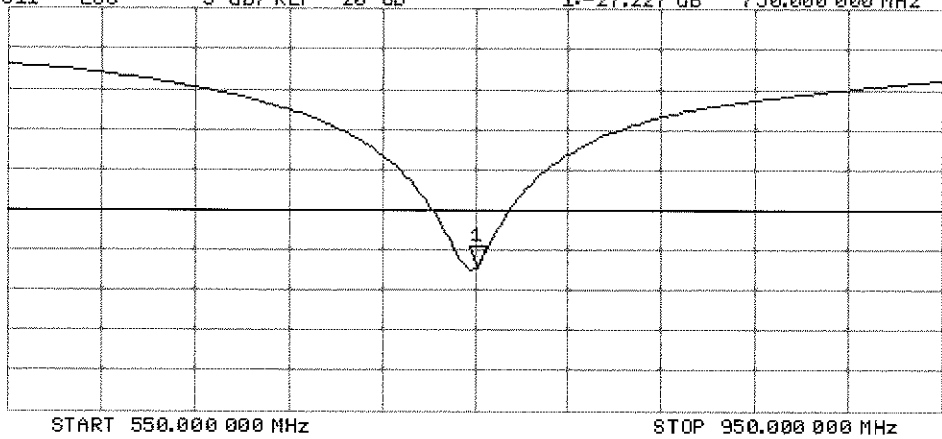

DASY5 Validation Report for Body TSL

Date: 18.03.2013

Test Laboratory: SPEAG, Zurich, Switzerland

DUT: Dipole 750 MHz; Type: D750V3; Serial: D750V3 - SN: 1054

Communication System: CW; Frequency: 750 MHz

Medium parameters used: $f = 750 \text{ MHz}$; $\sigma = 1 \text{ S/m}$; $\epsilon_r = 54.2$; $\rho = 1000 \text{ kg/m}^3$

Phantom section: Flat Section

Measurement Standard: DASY5 (IEEE/IEC/ANSI C63.19-2007)

DASY52 Configuration:

- Probe: ES3DV3 - SN3205; ConvF(6.11, 6.11, 6.11); Calibrated: 28.12.2012;
- Sensor-Surface: 3mm (Mechanical Surface Detection)
- Electronics: DAE4 Sn601; Calibrated: 27.06.2012
- Phantom: Flat Phantom 4.9L; Type: QD000P49AA; Serial: 1001
- DASY52 52.8.5(1059); SEMCAD X 14.6.8(7028)

Dipole Calibration for Body Tissue/Pin=250 mW, d=15mm/Zoom Scan (7x7x7)/Cube 0:

Measurement grid: dx=5mm, dy=5mm, dz=5mm

Reference Value = 52.772 V/m; Power Drift = 0.03 dB

Peak SAR (extrapolated) = 3.32 W/kg

SAR(1 g) = 2.26 W/kg; SAR(10 g) = 1.48 W/kg

Maximum value of SAR (measured) = 2.61 W/kg

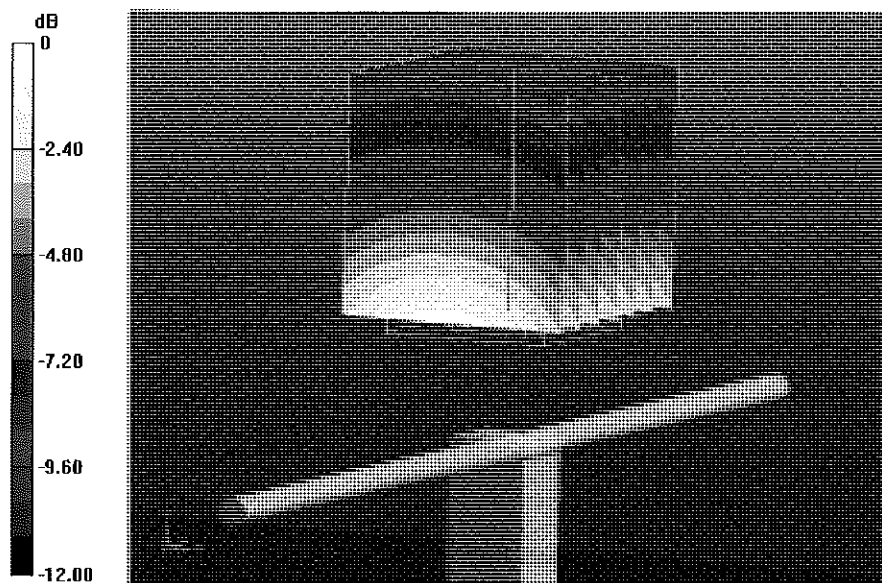

0 dB = 2.61 W/kg = 4.17 dBW/kg

Impedance Measurement Plot for Body TSL

18 Mar 2013 12:24:11

CH1 S11 1 U FS

1: 49.717 Ω -2.6553 Δ 79.890 pF

750.000 000 MHz

*
De1

CA

Avg
16

H1d

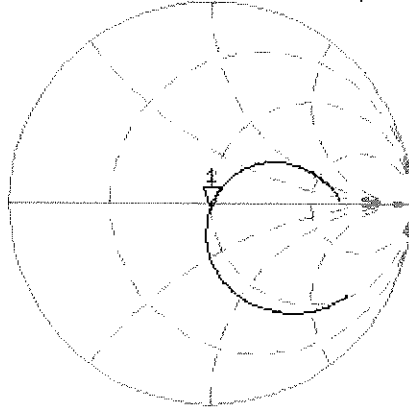

CH2 S11

LOG

5 dB/REF -20 dB

1: -31.444 dB

750.000 000 MHz

CA

Avg
16

H1d

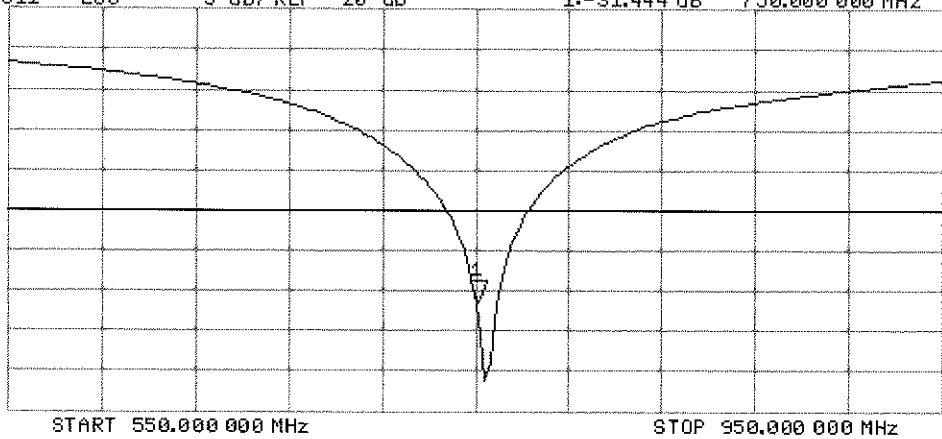



Accredited by the Swiss Accreditation Service (SAS)
The Swiss Accreditation Service is one of the signatories to the EA
Multilateral Agreement for the recognition of calibration certificates

Accreditation No.: **SCS 108**

Client **PC Test**

Certificate No: **D835V2-4d132_Jan13**

CALIBRATION CERTIFICATE

Object **D835V2 - SN: 4d132**

Calibration procedure(s) **QA CAL-05.v9
Calibration procedure for dipole validation kits above 700 MHz**

Calibration date: **January 07, 2013**

*✓ KOK
1/28/13*

This calibration certificate documents the traceability to national standards, which realize the physical units of measurements (SI).
The measurements and the uncertainties with confidence probability are given on the following pages and are part of the certificate.

All calibrations have been conducted in the closed laboratory facility: environment temperature (22 ± 3)°C and humidity < 70%.

Calibration Equipment used (M&TE critical for calibration)

Primary Standards	ID #	Cal Date (Certificate No.)	Scheduled Calibration
Power meter EPM-442A	GB37480704	01-Nov-12 (No. 217-01640)	Oct-13
Power sensor HP 8481A	US37292783	01-Nov-12 (No. 217-01640)	Oct-13
Reference 20 dB Attenuator	SN: 5058 (20k)	27-Mar-12 (No. 217-01530)	Apr-13
Type-N mismatch combination	SN: 5047.3 / 06327	27-Mar-12 (No. 217-01533)	Apr-13
Reference Probe ES3DV3	SN: 3205	28-Dec-12 (No. ES3-3205_Dec12)	Dec-13
DAE4	SN: 601	27-Jun-12 (No. DAE4-601_Jun12)	Jun-13
Secondary Standards	ID #	Check Date (in house)	Scheduled Check
Power sensor HP 8481A	MY41092317	18-Oct-02 (in house check Oct-11)	In house check: Oct-13
RF generator R&S SMT-06	100005	04-Aug-99 (in house check Oct-11)	In house check: Oct-13
Network Analyzer HP 8753E	US37390585 S4206	18-Oct-01 (in house check Oct-12)	In house check: Oct-13

	Name	Function	Signature
Calibrated by:	Leif Klysner	Laboratory Technician	
Approved by:	Katja Pokovic	Technical Manager	

Issued: January 8, 2013

This calibration certificate shall not be reproduced except in full without written approval of the laboratory.



Accredited by the Swiss Accreditation Service (SAS)
The Swiss Accreditation Service is one of the signatories to the EA
Multilateral Agreement for the recognition of calibration certificates

Accreditation No.: **SCS 108**

Glossary:

TSL	tissue simulating liquid
ConvF	sensitivity in TSL / NORM x,y,z
N/A	not applicable or not measured

Calibration is Performed According to the Following Standards:

- a) IEEE Std 1528-2003, "IEEE Recommended Practice for Determining the Peak Spatial-Averaged Specific Absorption Rate (SAR) in the Human Head from Wireless Communications Devices: Measurement Techniques", December 2003
- b) IEC 62209-1, "Procedure to measure the Specific Absorption Rate (SAR) for hand-held devices used in close proximity to the ear (frequency range of 300 MHz to 3 GHz)", February 2005
- c) Federal Communications Commission Office of Engineering & Technology (FCC OET), "Evaluating Compliance with FCC Guidelines for Human Exposure to Radiofrequency Electromagnetic Fields; Additional Information for Evaluating Compliance of Mobile and Portable Devices with FCC Limits for Human Exposure to Radiofrequency Emissions", Supplement C (Edition 01-01) to Bulletin 65

Additional Documentation:

- d) DASY4/5 System Handbook

Methods Applied and Interpretation of Parameters:

- *Measurement Conditions:* Further details are available from the Validation Report at the end of the certificate. All figures stated in the certificate are valid at the frequency indicated.
- *Antenna Parameters with TSL:* The dipole is mounted with the spacer to position its feed point exactly below the center marking of the flat phantom section, with the arms oriented parallel to the body axis.
- *Feed Point Impedance and Return Loss:* These parameters are measured with the dipole positioned under the liquid filled phantom. The impedance stated is transformed from the measurement at the SMA connector to the feed point. The Return Loss ensures low reflected power. No uncertainty required.
- *Electrical Delay:* One-way delay between the SMA connector and the antenna feed point. No uncertainty required.
- *SAR measured:* SAR measured at the stated antenna input power.
- *SAR normalized:* SAR as measured, normalized to an input power of 1 W at the antenna connector.
- *SAR for nominal TSL parameters:* The measured TSL parameters are used to calculate the nominal SAR result.

The reported uncertainty of measurement is stated as the standard uncertainty of measurement multiplied by the coverage factor $k=2$, which for a normal distribution corresponds to a coverage probability of approximately 95%.

Measurement Conditions

DASY system configuration, as far as not given on page 1.

DASY Version	DASY5	V52.8.4
Extrapolation	Advanced Extrapolation	
Phantom	Modular Flat Phantom	
Distance Dipole Center - TSL	15 mm	with Spacer
Zoom Scan Resolution	dx, dy, dz = 5 mm	
Frequency	835 MHz \pm 1 MHz	

Head TSL parameters

The following parameters and calculations were applied.

	Temperature	Permittivity	Conductivity
Nominal Head TSL parameters	22.0 °C	41.5	0.90 mho/m
Measured Head TSL parameters	(22.0 \pm 0.2) °C	42.0 \pm 6 %	0.92 mho/m \pm 6 %
Head TSL temperature change during test	< 0.5 °C	----	----

SAR result with Head TSL

SAR averaged over 1 cm³ (1 g) of Head TSL	Condition	
SAR measured	250 mW input power	2.45 W/kg
SAR for nominal Head TSL parameters	normalized to 1W	9.66 W/kg \pm 17.0 % (k=2)

SAR averaged over 10 cm³ (10 g) of Head TSL	condition	
SAR measured	250 mW input power	1.59 W/kg
SAR for nominal Head TSL parameters	normalized to 1W	6.29 W/kg \pm 16.5 % (k=2)

Body TSL parameters

The following parameters and calculations were applied.

	Temperature	Permittivity	Conductivity
Nominal Body TSL parameters	22.0 °C	55.2	0.97 mho/m
Measured Body TSL parameters	(22.0 \pm 0.2) °C	54.7 \pm 6 %	0.99 mho/m \pm 6 %
Body TSL temperature change during test	< 0.5 °C	----	----

SAR result with Body TSL

SAR averaged over 1 cm³ (1 g) of Body TSL	Condition	
SAR measured	250 mW input power	2.38 W/kg
SAR for nominal Body TSL parameters	normalized to 1W	9.36 W/kg \pm 17.0 % (k=2)

SAR averaged over 10 cm³ (10 g) of Body TSL	condition	
SAR measured	250 mW input power	1.57 W/kg
SAR for nominal Body TSL parameters	normalized to 1W	6.20 W/kg \pm 16.5 % (k=2)

Appendix

Antenna Parameters with Head TSL

Impedance, transformed to feed point	$54.2 \Omega + 1.3 j\Omega$
Return Loss	- 27.5 dB

Antenna Parameters with Body TSL

Impedance, transformed to feed point	$48.8 \Omega - 1.3 j\Omega$
Return Loss	- 34.9 dB

General Antenna Parameters and Design

Electrical Delay (one direction)	1.391 ns
----------------------------------	----------

After long term use with 100W radiated power, only a slight warming of the dipole near the feedpoint can be measured.

The dipole is made of standard semirigid coaxial cable. The center conductor of the feeding line is directly connected to the second arm of the dipole. The antenna is therefore short-circuited for DC-signals. On some of the dipoles, small end caps are added to the dipole arms in order to improve matching when loaded according to the position as explained in the "Measurement Conditions" paragraph. The SAR data are not affected by this change. The overall dipole length is still according to the Standard.

No excessive force must be applied to the dipole arms, because they might bend or the soldered connections near the feedpoint may be damaged.

Additional EUT Data

Manufactured by	SPEAG
Manufactured on	July 22, 2011

DASY5 Validation Report for Head TSL

Date: 07.01.2013

Test Laboratory: SPEAG, Zurich, Switzerland

DUT: Dipole 835 MHz; Type: D835V2; Serial: D835V2 - SN: 4d132

Communication System: CW; Frequency: 835 MHz

Medium parameters used: $f = 835$ MHz; $\sigma = 0.92$ S/m; $\epsilon_r = 42$; $\rho = 1000$ kg/m³

Phantom section: Flat Section

Measurement Standard: DASY5 (IEEE/IEC/ANSI C63.19-2007)

DASY52 Configuration:

- Probe: ES3DV3 - SN3205; ConvF(6.05, 6.05, 6.05); Calibrated: 28.12.2012;
- Sensor-Surface: 3mm (Mechanical Surface Detection)
- Electronics: DAE4 Sn601; Calibrated: 27.06.2012
- Phantom: Flat Phantom 4.9L; Type: QD000P49AA; Serial: 1001
- DASY52 52.8.4(1052); SEMCAD X 14.6.8(7028)

Dipole Calibration for Head Tissue/Pin=250 mW, d=15mm/Zoom Scan (7x7x7)/Cube 0:

Measurement grid: dx=5mm, dy=5mm, dz=5mm

Reference Value = 57.542 V/m; Power Drift = 0.07 dB

Peak SAR (extrapolated) = 3.71 W/kg

SAR(1 g) = 2.45 W/kg; SAR(10 g) = 1.59 W/kg

Maximum value of SAR (measured) = 2.88 W/kg

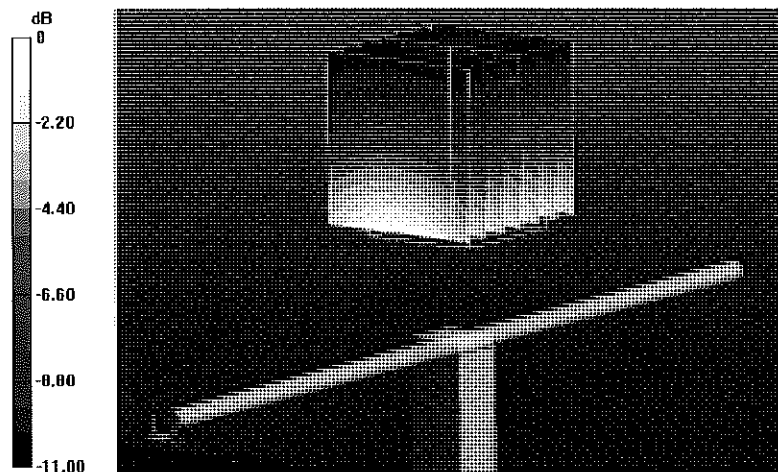

0 dB = 2.88 W/kg = 4.59 dBW/kg

Impedance Measurement Plot for Head TSL

7 Jan 2013 13:03:50

CH1 S11 1 U FS 2: 54.162 Ω 1.3398 Ω 255.38 μ H 835.000 000 MHz

*
Del
CA
Avg
16
Hid

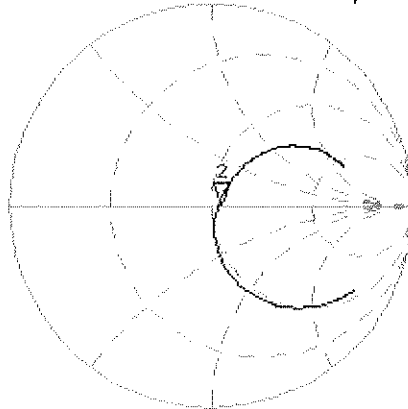

CH2 S11 LOG 5 dB/REF -20 dB 2:-27.537 dB 835.000 000 MHz

CA
Avg
16
Hid

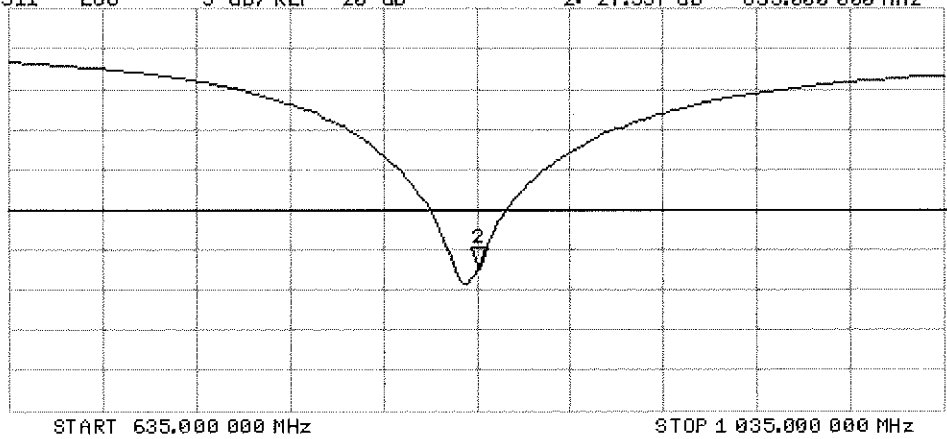

DASY5 Validation Report for Body TSL

Date: 07.01.2013

Test Laboratory: SPEAG, Zurich, Switzerland

DUT: Dipole 835 MHz; Type: D835V2; Serial: D835V2 - SN: 4d132

Communication System: CW; Frequency: 835 MHz

Medium parameters used: $f = 835$ MHz; $\sigma = 0.99$ S/m; $\epsilon_r = 54.7$; $\rho = 1000$ kg/m³

Phantom section: Flat Section

Measurement Standard: DASY5 (IEEE/IEC/ANSI C63.19-2007)

DASY52 Configuration:

- Probe: ES3DV3 - SN3205; ConvF(6.04, 6.04, 6.04); Calibrated: 28.12.2012;
- Sensor-Surface: 3mm (Mechanical Surface Detection)
- Electronics: DAE4 Sn601; Calibrated: 27.06.2012
- Phantom: Flat Phantom 4.9L; Type: QD000P49AA; Serial: 1001
- DASY52 52.8.4(1052); SEMCAD X 14.6.8(7028)

Dipole Calibration for Body Tissue/Pin=250 mW, d=15mm/Zoom Scan (7x7x7)/Cube 0:

Measurement grid: dx=5mm, dy=5mm, dz=5mm

Reference Value = 54.512 V/m; Power Drift = 0.07 dB

Peak SAR (extrapolated) = 3.47 W/kg

SAR(1 g) = 2.38 W/kg; SAR(10 g) = 1.57 W/kg

Maximum value of SAR (measured) = 2.77 W/kg

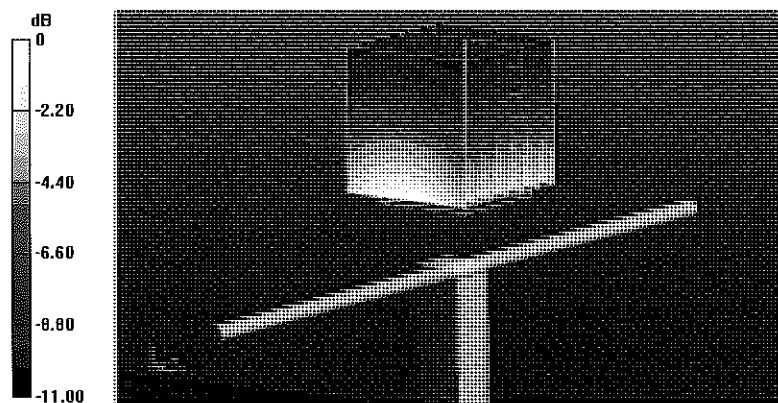

0 dB = 2.77 W/kg = 4.42 dBW/kg

Impedance Measurement Plot for Body TSL

7 Jan 2013 10:07:01

CH1 S11 1 U FS

2: 48.762 Ω -1.2773 Ω 149.22 pF

835.000 000 MHz

*
De1
CΔ
Avg
16
H1d

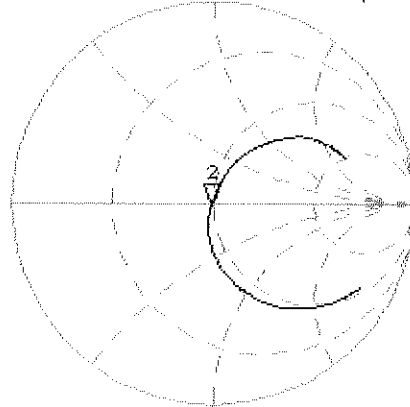

CH2 S11 LOG

5 dB/REF -20 dB

2:-34.896 dB

835.000 000 MHz

CΔ
Avg
16
H1d

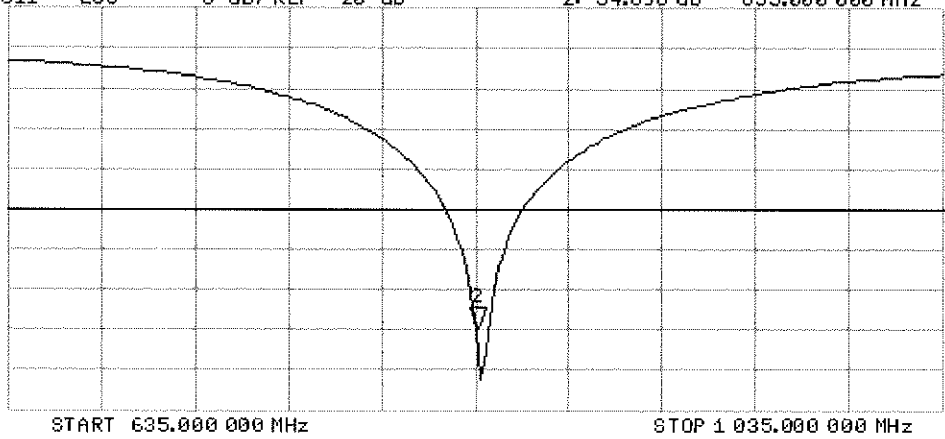



Accredited by the Swiss Accreditation Service (SAS)
The Swiss Accreditation Service is one of the signatories to the EA
Multilateral Agreement for the recognition of calibration certificates

Accreditation No.: **SCS 108**

Client **PC Test**

Certificate No: **D1900V2-5d080_Jul12**

CALIBRATION CERTIFICATE

Object **D1900V2 - SN: 5d080**

Calibration procedure(s) **QA CAL-05.v8
Calibration procedure for dipole validation kits above 700 MHz**

Calibration date: **July 20, 2012**

*KOK
8/13/12*

This calibration certificate documents the traceability to national standards, which realize the physical units of measurements (SI).
The measurements and the uncertainties with confidence probability are given on the following pages and are part of the certificate.

All calibrations have been conducted in the closed laboratory facility: environment temperature (22 ± 3)°C and humidity < 70%.

Calibration Equipment used (M&TE critical for calibration)

Primary Standards	ID #	Cal Date (Certificate No.)	Scheduled Calibration
Power meter EPM-442A	GB37480704	05-Oct-11 (No. 217-01451)	Oct-12
Power sensor HP 8481A	US37292783	05-Oct-11 (No. 217-01451)	Oct-12
Reference 20 dB Attenuator	SN: 5058 (20k)	27-Mar-12 (No. 217-01530)	Apr-13
Type-N mismatch combination	SN: 5047.2 / 06327	27-Mar-12 (No. 217-01533)	Apr-13
Reference Probe ES3DV3	SN: 3205	30-Dec-11 (No. ES3-3205_Dec11)	Dec-12
DAE4	SN: 601	27-Jun-12 (No. DAE4-601_Jun12)	Jun-13

Secondary Standards	ID #	Check Date (in house)	Scheduled Check
Power sensor HP 8481A	MY41092317	18-Oct-02 (in house check Oct-11)	In house check: Oct-13
RF generator R&S SMT-06	100005	04-Aug-99 (in house check Oct-11)	In house check: Oct-13
Network Analyzer HP 8753E	US37390585 S4206	18-Oct-01 (in house check Oct-11)	In house check: Oct-12

Calibrated by: **Dimce Iliev** Name: **Dimce Iliev** Function: **Laboratory Technician**

Signature: *Dimce Iliev*

Approved by: **Katja Pokovic** Name: **Katja Pokovic** Technical Manager

Signature: *Katja Pokovic*

Issued: July 20, 2012

This calibration certificate shall not be reproduced except in full without written approval of the laboratory.

Calibration Laboratory of
Schmid & Partner
Engineering AG
Zeughausstrasse 43, 8004 Zurich, Switzerland



S Schweizerischer Kalibrierdienst
C Service suisse d'étalonnage
S Servizio svizzero di taratura
S Swiss Calibration Service

Accredited by the Swiss Accreditation Service (SAS)
The Swiss Accreditation Service is one of the signatories to the EA
Multilateral Agreement for the recognition of calibration certificates

Accreditation No.: **SCS 108**

Glossary:

TSL	tissue simulating liquid
ConvF	sensitivity in TSL / NORM x,y,z
N/A	not applicable or not measured

Calibration is Performed According to the Following Standards:

- IEEE Std 1528-2003, "IEEE Recommended Practice for Determining the Peak Spatial-Averaged Specific Absorption Rate (SAR) in the Human Head from Wireless Communications Devices: Measurement Techniques", December 2003
- IEC 62209-1, "Procedure to measure the Specific Absorption Rate (SAR) for hand-held devices used in close proximity to the ear (frequency range of 300 MHz to 3 GHz)", February 2005
- Federal Communications Commission Office of Engineering & Technology (FCC OET), "Evaluating Compliance with FCC Guidelines for Human Exposure to Radiofrequency Electromagnetic Fields; Additional Information for Evaluating Compliance of Mobile and Portable Devices with FCC Limits for Human Exposure to Radiofrequency Emissions", Supplement C (Edition 01-01) to Bulletin 65

Additional Documentation:

- DASY4/5 System Handbook

Methods Applied and Interpretation of Parameters:

- Measurement Conditions:** Further details are available from the Validation Report at the end of the certificate. All figures stated in the certificate are valid at the frequency indicated.
- Antenna Parameters with TSL:** The dipole is mounted with the spacer to position its feed point exactly below the center marking of the flat phantom section, with the arms oriented parallel to the body axis.
- Feed Point Impedance and Return Loss:** These parameters are measured with the dipole positioned under the liquid filled phantom. The impedance stated is transformed from the measurement at the SMA connector to the feed point. The Return Loss ensures low reflected power. No uncertainty required.
- Electrical Delay:** One-way delay between the SMA connector and the antenna feed point. No uncertainty required.
- SAR measured:** SAR measured at the stated antenna input power.
- SAR normalized:** SAR as measured, normalized to an input power of 1 W at the antenna connector.
- SAR for nominal TSL parameters:** The measured TSL parameters are used to calculate the nominal SAR result.

The reported uncertainty of measurement is stated as the standard uncertainty of measurement multiplied by the coverage factor $k=2$, which for a normal distribution corresponds to a coverage probability of approximately 95%.

Measurement Conditions

DASY system configuration, as far as not given on page 1.

DASY Version	DASY5	V52.8.1
Extrapolation	Advanced Extrapolation	
Phantom	Modular Flat Phantom	
Distance Dipole Center - TSL	10 mm	with Spacer
Zoom Scan Resolution	dx, dy, dz = 5 mm	
Frequency	1900 MHz \pm 1 MHz	

Head TSL parameters

The following parameters and calculations were applied.

	Temperature	Permittivity	Conductivity
Nominal Head TSL parameters	22.0 °C	40.0	1.40 mho/m
Measured Head TSL parameters	(22.0 \pm 0.2) °C	39.9 \pm 6 %	1.38 mho/m \pm 6 %
Head TSL temperature change during test	< 0.5 °C	----	----

SAR result with Head TSL

SAR averaged over 1 cm ³ (1 g) of Head TSL	Condition	
SAR measured	250 mW input power	9.78 mW / g
SAR for nominal Head TSL parameters	normalized to 1W	39.4 mW / g \pm 17.0 % (k=2)

SAR averaged over 10 cm ³ (10 g) of Head TSL	condition	
SAR measured	250 mW input power	5.17 mW / g
SAR for nominal Head TSL parameters	normalized to 1W	20.8 mW / g \pm 16.5 % (k=2)

Body TSL parameters

The following parameters and calculations were applied.

	Temperature	Permittivity	Conductivity
Nominal Body TSL parameters	22.0 °C	53.3	1.52 mho/m
Measured Body TSL parameters	(22.0 \pm 0.2) °C	52.6 \pm 6 %	1.52 mho/m \pm 6 %
Body TSL temperature change during test	< 0.5 °C	----	----

SAR result with Body TSL

SAR averaged over 1 cm ³ (1 g) of Body TSL	Condition	
SAR measured	250 mW input power	10.1 mW / g
SAR for nominal Body TSL parameters	normalized to 1W	40.3 mW / g \pm 17.0 % (k=2)

SAR averaged over 10 cm ³ (10 g) of Body TSL	condition	
SAR measured	250 mW input power	5.35 mW / g
SAR for nominal Body TSL parameters	normalized to 1W	21.4 mW / g \pm 16.5 % (k=2)

Appendix

Antenna Parameters with Head TSL

Impedance, transformed to feed point	$50.9 \Omega + 5.7 j\Omega$
Return Loss	- 24.9 dB

Antenna Parameters with Body TSL

Impedance, transformed to feed point	$46.9 \Omega + 6.0 j\Omega$
Return Loss	- 23.1 dB

General Antenna Parameters and Design

Electrical Delay (one direction)	1.191 ns
----------------------------------	----------

After long term use with 100W radiated power, only a slight warming of the dipole near the feedpoint can be measured.

The dipole is made of standard semirigid coaxial cable. The center conductor of the feeding line is directly connected to the second arm of the dipole. The antenna is therefore short-circuited for DC-signals. On some of the dipoles, small end caps are added to the dipole arms in order to improve matching when loaded according to the position as explained in the "Measurement Conditions" paragraph. The SAR data are not affected by this change. The overall dipole length is still according to the Standard.

No excessive force must be applied to the dipole arms, because they might bend or the soldered connections near the feedpoint may be damaged.

Additional EUT Data

Manufactured by	SPEAG
Manufactured on	June 28, 2006

DASY5 Validation Report for Head TSL

Date: 20.07.2012

Test Laboratory: SPEAG, Zurich, Switzerland

DUT: Dipole 1900 MHz; Type: D1900V2; Serial: D1900V2 - SN: 5d080

Communication System: CW; Frequency: 1900 MHz

Medium parameters used: $f = 1900$ MHz; $\sigma = 1.38$ mho/m; $\epsilon_r = 39.9$; $\rho = 1000$ kg/m³

Phantom section: Flat Section

Measurement Standard: DASY5 (IEEE/IEC/ANSI C63.19-2007)

DASY52 Configuration:

- Probe: ES3DV3 - SN3205; ConvF(5.01, 5.01, 5.01); Calibrated: 30.12.2011;
- Sensor-Surface: 3mm (Mechanical Surface Detection)
- Electronics: DAE4 Sn601; Calibrated: 27.06.2012
- Phantom: Flat Phantom 5.0 (front); Type: QD000P50AA; Serial: 1001
- DASY52 52.8.1(838); SEMCAD X 14.6.5(6469)

Dipole Calibration for Head Tissue/Pin=250 mW, d=10mm/Zoom Scan (7x7x7)/Cube 0:

Measurement grid: dx=5mm, dy=5mm, dz=5mm

Reference Value = 97.586 V/m; Power Drift = 0.02 dB

Peak SAR (extrapolated) = 17.454 mW/g

SAR(1 g) = 9.78 mW/g; SAR(10 g) = 5.17 mW/g

Maximum value of SAR (measured) = 12.2 mW/g

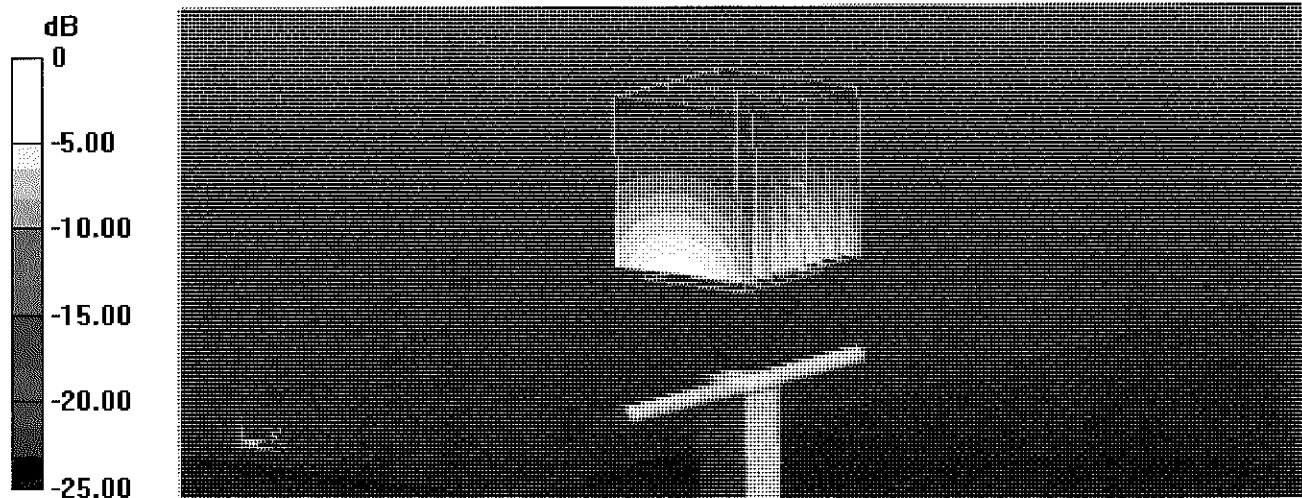

0 dB = 12.2 mW/g = 21.73 dB mW/g

Impedance Measurement Plot for Head TSL

18 Jul 2012 16:15:02

CH1 S11 1 U FS

1: 50.879 Ω 5.7270 Ω 478.05 pF

1 900.000 000 MHz

*
Del
Cor

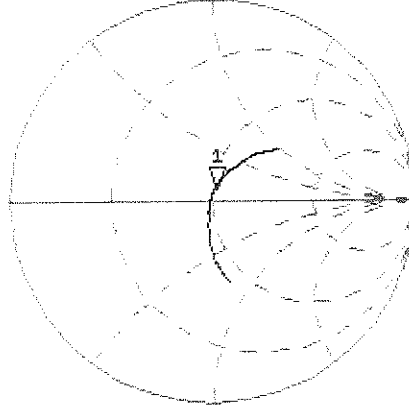

Avg
15

H1d

CH2 S11 LOG 5 dB/REF -20 dB 1: -24.851 dB 1 900.000 000 MHz

Del

Cor

Avg
15

H1d

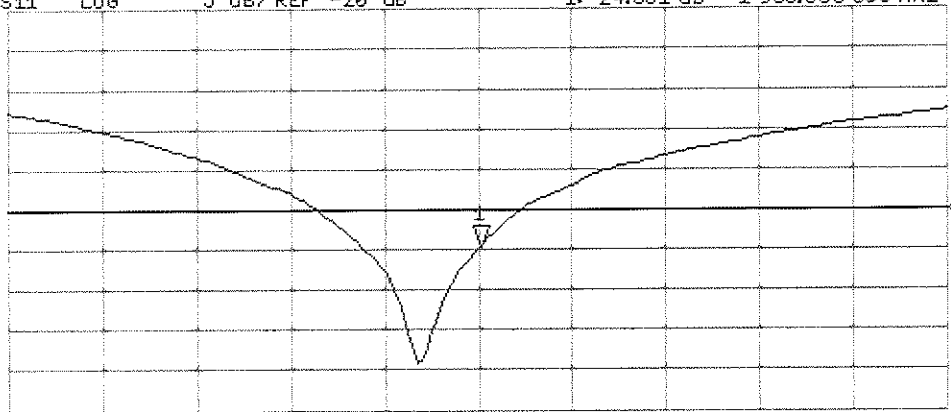

START 1 700.000 000 MHz

STOP 2 100.000 000 MHz

DASY5 Validation Report for Body TSL

Date: 20.07.2012

Test Laboratory: SPEAG, Zurich, Switzerland

DUT: Dipole 1900 MHz; Type: D1900V2; Serial: D1900V2 - SN: 5d080

Communication System: CW; Frequency: 1900 MHz

Medium parameters used: $f = 1900$ MHz; $\sigma = 1.52$ mho/m; $\epsilon_r = 52.6$; $\rho = 1000$ kg/m³

Phantom section: Flat Section

Measurement Standard: DASY5 (IEEE/IEC/ANSI C63.19-2007)

DASY52 Configuration:

- Probe: ES3DV3 - SN3205; ConvF(4.62, 4.62, 4.62); Calibrated: 30.12.2011;
- Sensor-Surface: 3mm (Mechanical Surface Detection)
- Electronics: DAE4 Sn601; Calibrated: 27.06.2012
- Phantom: Flat Phantom 5.0 (back); Type: QD000P50AA; Serial: 1002
- DASY52 52.8.1(838); SEMCAD X 14.6.5(6469)

Dipole Calibration for Body Tissue/Pin=250 mW, d=10mm/Zoom Scan (7x7x7)/Cube 0:

Measurement grid: dx=5mm, dy=5mm, dz=5mm

Reference Value = 95.688 V/m; Power Drift = -0.00 dB

Peak SAR (extrapolated) = 17.552 mW/g

SAR(1 g) = 10.1 mW/g; SAR(10 g) = 5.35 mW/g

Maximum value of SAR (measured) = 12.8 mW/g

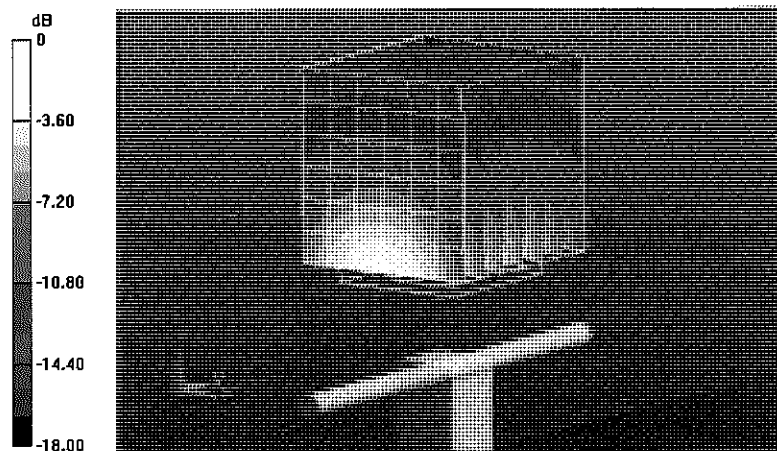

0 dB = 12.8 mW/g = 22.14 dB mW/g

Impedance Measurement Plot for Body TSL

18 Jul 2012 16:16:11

CH1 S11 1 U FS 1: 46.941 \angle 6.0313 \angle 505.21 pH 1 900.000 000 MHz

*
De1
Cor
Avg
16
H1d

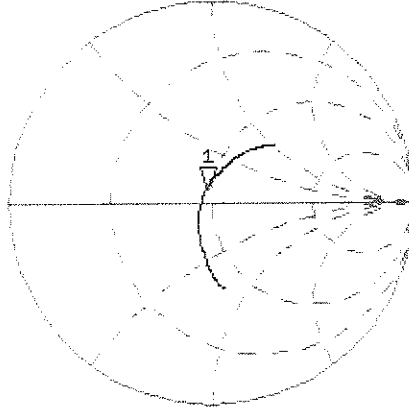

CH2 S11 LOG 5 dB/REF -20 dB 1:-23.145 dB 1 900.000 000 MHz

De1
Cor
Avg
16
H1d

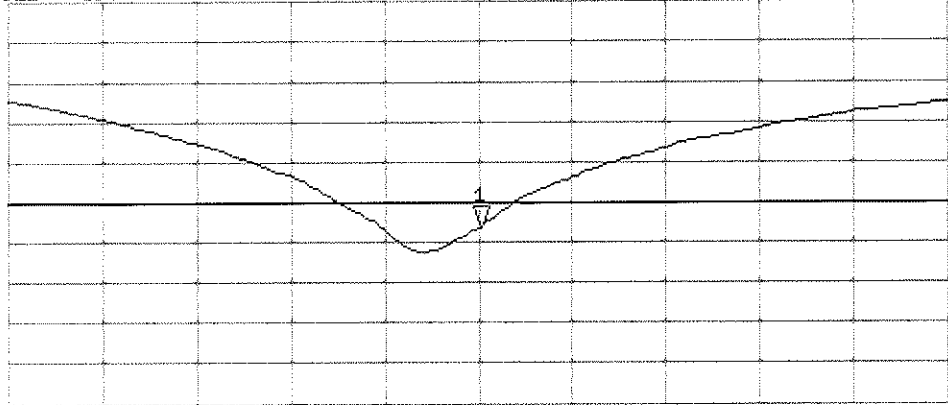

START 1 700.000 000 MHz

STOP 2 100.000 000 MHz

**Calibration Laboratory of
Schmid & Partner
Engineering AG**
Zeughausstrasse 43, 8004 Zurich, Switzerland



S Schweizerischer Kalibrierdienst
C Service suisse d'étalonnage
S Servizio svizzero di taratura
S Swiss Calibration Service

Accredited by the Swiss Accreditation Service (SAS)
The Swiss Accreditation Service is one of the signatories to the EA
Multilateral Agreement for the recognition of calibration certificates

Accreditation No.: **SCS 108**

Client **PC Test**

Certificate No: **D2450V2-719_Aug12**

CALIBRATION CERTIFICATE

Object **D2450V2 - SN: 719**

Calibration procedure(s) **QA CAL-05.v8
Calibration procedure for dipole validation kits above 700 MHz**

Calibration date: **August 23, 2012**

*✓ KOK
9/17/12*

This calibration certificate documents the traceability to national standards, which realize the physical units of measurements (SI).
The measurements and the uncertainties with confidence probability are given on the following pages and are part of the certificate.

All calibrations have been conducted in the closed laboratory facility: environment temperature (22 ± 3)°C and humidity < 70%.

Calibration Equipment used (M&TE critical for calibration)

Primary Standards	ID #	Cal Date (Certificate No.)	Scheduled Calibration
Power meter EPM-442A	GB37480704	05-Oct-11 (No. 217-01451)	Oct-12
Power sensor HP 8481A	US37292783	05-Oct-11 (No. 217-01451)	Oct-12
Reference 20 dB Attenuator	SN: 5058 (20k)	27-Mar-12 (No. 217-01530)	Apr-13
Type-N mismatch combination	SN: 5047.2 / 06327	27-Mar-12 (No. 217-01533)	Apr-13
Reference Probe ES3DV3	SN: 3205	30-Dec-11 (No. ES3-3205_Dec11)	Dec-12
DAE4	SN: 601	27-Jun-12 (No. DAE4-601_Jun12)	Jun-13

Secondary Standards	ID #	Check Date (in house)	Scheduled Check
Power sensor HP 8481A	MY41092317	18-Oct-02 (in house check Oct-11)	In house check: Oct-13
RF generator R&S SMT-06	100005	04-Aug-99 (in house check Oct-11)	In house check: Oct-13
Network Analyzer HP 8753E	US37390585 S4206	18-Oct-01 (in house check Oct-11)	In house check: Oct-12

Calibrated by: **Israe El-Naouq** Name: **Israe El-Naouq** Function: **Laboratory Technician**

Approved by: **Katja Pokovic** Name: **Katja Pokovic** Function: **Technical Manager**

Signature
Israe El-Naouq
Katja Pokovic

Issued: August 23, 2012

This calibration certificate shall not be reproduced except in full without written approval of the laboratory.



Accredited by the Swiss Accreditation Service (SAS)
The Swiss Accreditation Service is one of the signatories to the EA
Multilateral Agreement for the recognition of calibration certificates

Accreditation No.: **SCS 108**

Glossary:

TSL	tissue simulating liquid
ConvF	sensitivity in TSL / NORM x,y,z
N/A	not applicable or not measured

Calibration is Performed According to the Following Standards:

- a) IEEE Std 1528-2003, "IEEE Recommended Practice for Determining the Peak Spatial-Averaged Specific Absorption Rate (SAR) in the Human Head from Wireless Communications Devices: Measurement Techniques", December 2003
- b) IEC 62209-1, "Procedure to measure the Specific Absorption Rate (SAR) for hand-held devices used in close proximity to the ear (frequency range of 300 MHz to 3 GHz)", February 2005
- c) Federal Communications Commission Office of Engineering & Technology (FCC OET), "Evaluating Compliance with FCC Guidelines for Human Exposure to Radiofrequency Electromagnetic Fields; Additional Information for Evaluating Compliance of Mobile and Portable Devices with FCC Limits for Human Exposure to Radiofrequency Emissions", Supplement C (Edition 01-01) to Bulletin 65

Additional Documentation:

- d) DASY4/5 System Handbook

Methods Applied and Interpretation of Parameters:

- *Measurement Conditions:* Further details are available from the Validation Report at the end of the certificate. All figures stated in the certificate are valid at the frequency indicated.
- *Antenna Parameters with TSL:* The dipole is mounted with the spacer to position its feed point exactly below the center marking of the flat phantom section, with the arms oriented parallel to the body axis.
- *Feed Point Impedance and Return Loss:* These parameters are measured with the dipole positioned under the liquid filled phantom. The impedance stated is transformed from the measurement at the SMA connector to the feed point. The Return Loss ensures low reflected power. No uncertainty required.
- *Electrical Delay:* One-way delay between the SMA connector and the antenna feed point. No uncertainty required.
- *SAR measured:* SAR measured at the stated antenna input power.
- *SAR normalized:* SAR as measured, normalized to an input power of 1 W at the antenna connector.
- *SAR for nominal TSL parameters:* The measured TSL parameters are used to calculate the nominal SAR result.

The reported uncertainty of measurement is stated as the standard uncertainty of measurement multiplied by the coverage factor $k=2$, which for a normal distribution corresponds to a coverage probability of approximately 95%.

Measurement Conditions

DASY system configuration, as far as not given on page 1.

DASY Version	DASY5	V52.8.2
Extrapolation	Advanced Extrapolation	
Phantom	Modular Flat Phantom	
Distance Dipole Center - TSL	10 mm	with Spacer
Zoom Scan Resolution	dx, dy, dz = 5 mm	
Frequency	2450 MHz ± 1 MHz	

Head TSL parameters

The following parameters and calculations were applied.

	Temperature	Permittivity	Conductivity
Nominal Head TSL parameters	22.0 °C	39.2	1.80 mho/m
Measured Head TSL parameters	(22.0 ± 0.2) °C	39.2 ± 6 %	1.81 mho/m ± 6 %
Head TSL temperature change during test	< 0.5 °C	----	----

SAR result with Head TSL

SAR averaged over 1 cm ³ (1 g) of Head TSL	Condition	
SAR measured	250 mW input power	13.2 mW / g
SAR for nominal Head TSL parameters	normalized to 1W	52.7 mW / g ± 17.0 % (k=2)

SAR averaged over 10 cm ³ (10 g) of Head TSL	condition	
SAR measured	250 mW input power	6.19 mW / g
SAR for nominal Head TSL parameters	normalized to 1W	24.7 mW / g ± 16.5 % (k=2)

Body TSL parameters

The following parameters and calculations were applied.

	Temperature	Permittivity	Conductivity
Nominal Body TSL parameters	22.0 °C	52.7	1.95 mho/m
Measured Body TSL parameters	(22.0 ± 0.2) °C	51.3 ± 6 %	1.99 mho/m ± 6 %
Body TSL temperature change during test	< 0.5 °C	----	----

SAR result with Body TSL

SAR averaged over 1 cm ³ (1 g) of Body TSL	Condition	
SAR measured	250 mW input power	13.1 mW / g
SAR for nominal Body TSL parameters	normalized to 1W	51.6 mW / g ± 17.0 % (k=2)

SAR averaged over 10 cm ³ (10 g) of Body TSL	condition	
SAR measured	250 mW input power	6.16 mW / g
SAR for nominal Body TSL parameters	normalized to 1W	24.4 mW / g ± 16.5 % (k=2)

Appendix

Antenna Parameters with Head TSL

Impedance, transformed to feed point	54.4 Ω + 3.8 j Ω
Return Loss	- 25.1 dB

Antenna Parameters with Body TSL

Impedance, transformed to feed point	50.7 Ω + 5.9 j Ω
Return Loss	- 24.6 dB

General Antenna Parameters and Design

Electrical Delay (one direction)	1.150 ns
----------------------------------	----------

After long term use with 100W radiated power, only a slight warming of the dipole near the feedpoint can be measured.

The dipole is made of standard semirigid coaxial cable. The center conductor of the feeding line is directly connected to the second arm of the dipole. The antenna is therefore short-circuited for DC-signals. On some of the dipoles, small end caps are added to the dipole arms in order to improve matching when loaded according to the position as explained in the "Measurement Conditions" paragraph. The SAR data are not affected by this change. The overall dipole length is still according to the Standard.

No excessive force must be applied to the dipole arms, because they might bend or the soldered connections near the feedpoint may be damaged.

Additional EUT Data

Manufactured by	SPEAG
Manufactured on	September 10, 2002

DASY5 Validation Report for Head TSL

Date: 23.08.2012

Test Laboratory: SPEAG, Zurich, Switzerland

DUT: Dipole 2450 MHz; Type: D2450V2; Serial: D2450V2 - SN: 719

Communication System: CW; Frequency: 2450 MHz

Medium parameters used: $f = 2450$ MHz; $\sigma = 1.81$ mho/m; $\epsilon_r = 39.2$; $\rho = 1000$ kg/m³

Phantom section: Flat Section

Measurement Standard: DASY5 (IEEE/IEC/ANSI C63.19-2007)

DASY52 Configuration:

- Probe: ES3DV3 - SN3205; ConvF(4.45, 4.45, 4.45); Calibrated: 30.12.2011;
- Sensor-Surface: 3mm (Mechanical Surface Detection)
- Electronics: DAE4 Sn601; Calibrated: 27.06.2012
- Phantom: Flat Phantom 5.0 (front); Type: QD000P50AA; Serial: 1001
- DASY52 52.8.2(969); SEMCAD X 14.6.6(6824)

Dipole Calibration for Head Tissue/Pin=250 mW, d=10mm/Zoom Scan (7x7x7)/Cube 0:

Measurement grid: dx=5mm, dy=5mm, dz=5mm

Reference Value = 99.219 V/m; Power Drift = 0.03 dB

Peak SAR (extrapolated) = 26.633 mW/g

SAR(1 g) = 13.2 mW/g; SAR(10 g) = 6.19 mW/g

Maximum value of SAR (measured) = 16.5 W/kg

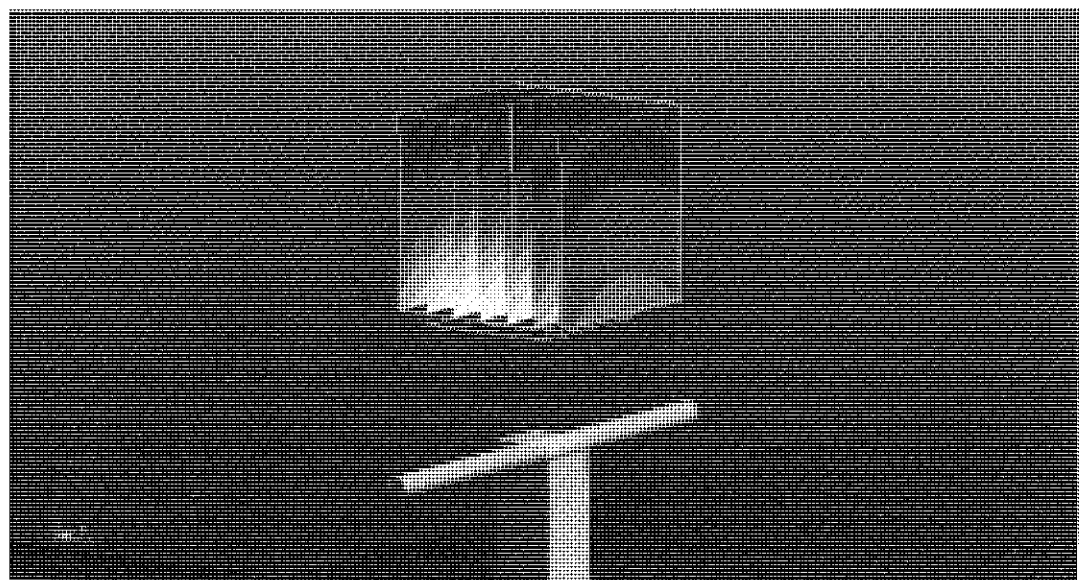
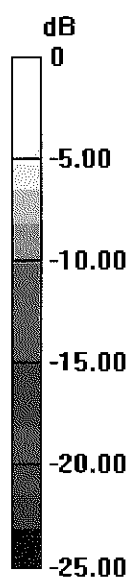

0 dB = 16.5 W/kg = 24.35 dB W/kg

Impedance Measurement Plot for Head TSL

22 Aug 2012 15:39:08

CH1 S11 1 U FS

3: 54.416 Ω 3.7656 Ω 244.62 pF

2 450.000 000 MHz

*
Del

CΔ

Avg
16

H1 d

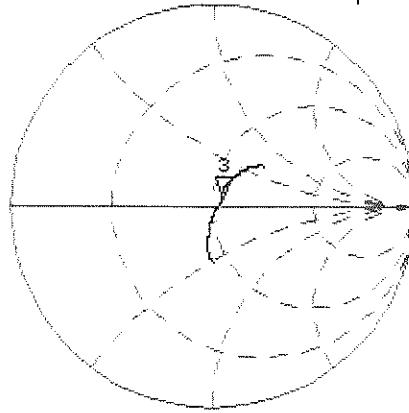

CH2 S11 LOG 5 dB/REF -20 dB 3: -25.109 dB 2 450.000 000 MHz

CΔ

Avg
16

H1 d

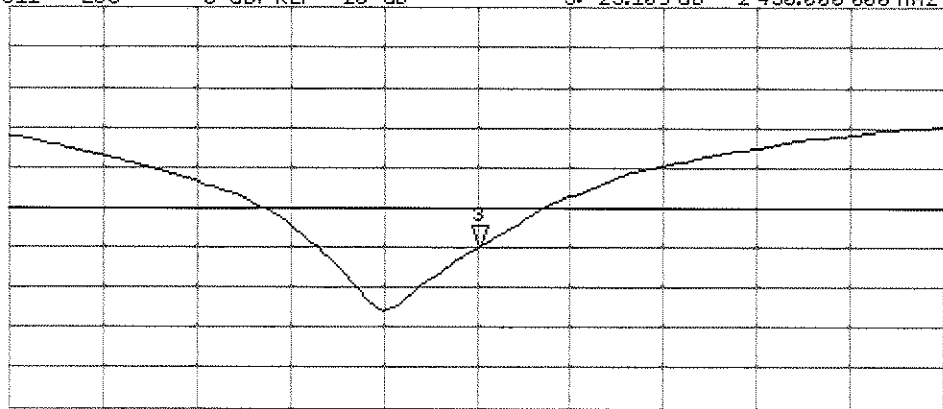

START 2 250.000 000 MHz

STOP 2 650.000 000 MHz

DASY5 Validation Report for Body TSL

Date: 22.08.2012

Test Laboratory: SPEAG, Zurich, Switzerland

DUT: Dipole 2450 MHz; Type: D2450V2; Serial: D2450V2 - SN: 719

Communication System: CW; Frequency: 2450 MHz

Medium parameters used: $f = 2450$ MHz; $\sigma = 1.99$ mho/m; $\epsilon_r = 51.3$; $\rho = 1000$ kg/m³

Phantom section: Flat Section

Measurement Standard: DASY5 (IEEE/IEC/ANSI C63.19-2007)

DASY52 Configuration:

- Probe: ES3DV3 - SN3205; ConvF(4.26, 4.26, 4.26); Calibrated: 30.12.2011;
- Sensor-Surface: 3mm (Mechanical Surface Detection)
- Electronics: DAE4 Sn601; Calibrated: 27.06.2012
- Phantom: Flat Phantom 5.0 (back); Type: QD000P50AA; Serial: 1002
- DASY52 52.8.2(969); SEMCAD X 14.6.6(6824)

Dipole Calibration for Body Tissue/Pin=250 mW, d=10mm/Zoom Scan (7x7x7)/Cube 0:

Measurement grid: dx=5mm, dy=5mm, dz=5mm

Reference Value = 95.970 V/m; Power Drift = 0.03 dB

Peak SAR (extrapolated) = 26.692 mW/g

SAR(1 g) = 13.1 mW/g; SAR(10 g) = 6.16 mW/g

Maximum value of SAR (measured) = 17.1 W/kg

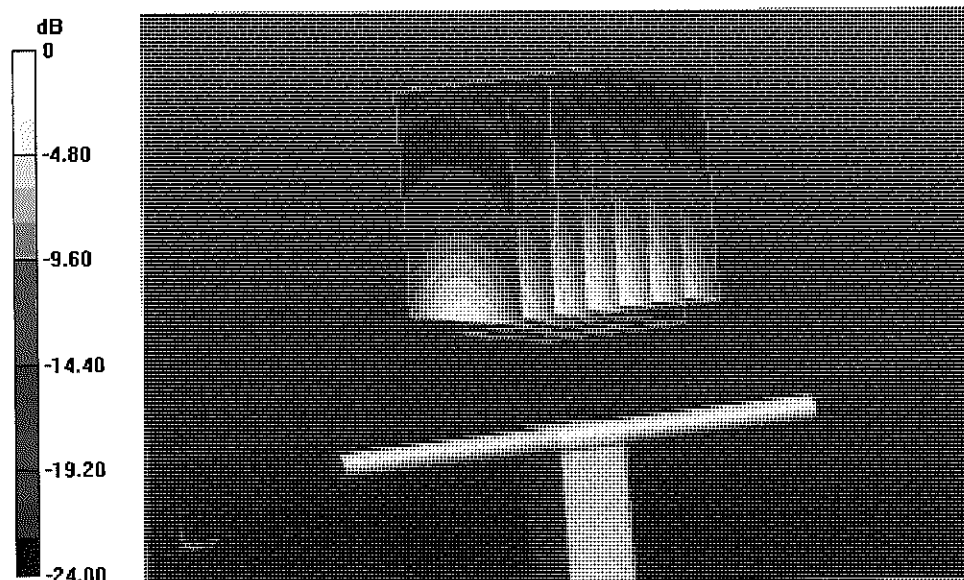

0 dB = 17.1 W/kg = 24.66 dB W/kg

Impedance Measurement Plot for Body TSL

22 Aug 2012 15:38:22

[CH1] S11 1 U FS

3: 50.709 Ω 5.8906 Ω 382.66 pF

2 450.000 000 MHz

*
Del
CA
Avg
16
H1d

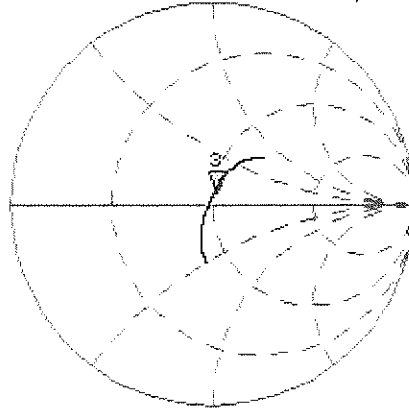

CH2 S11 LOG 5 dB/REF -20 dB 3: -24.605 dB 2 450.000 000 MHz

CA
Avg
16
H1d

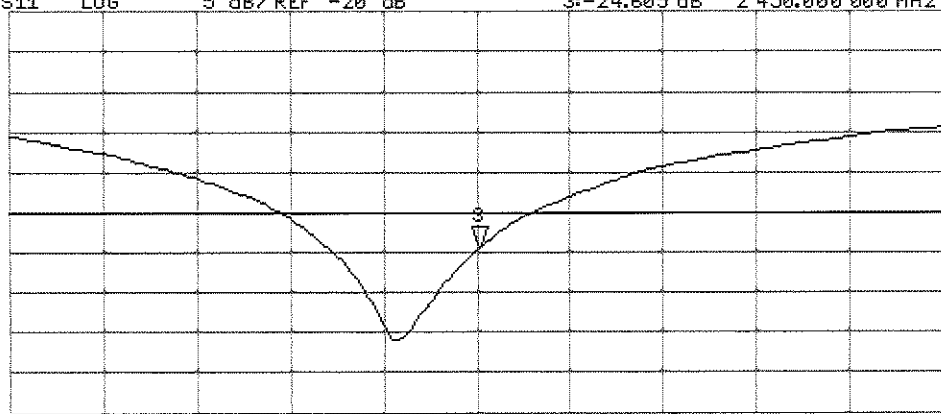

START 2 250.000 000 MHz

STOP 2 650.000 000 MHz



Accredited by the Swiss Accreditation Service (SAS)
The Swiss Accreditation Service is one of the signatories to the EA
Multilateral Agreement for the recognition of calibration certificates

Accreditation No.: **SCS 108**

Client **PC Test**

Certificate No: **D1900V2-5d148_Feb13**

CALIBRATION CERTIFICATE

Object **D1900V2 - SN: 5d148**

Calibration procedure(s) **QA CAL-05.v9
Calibration procedure for dipole validation kits above 700 MHz**

Calibration date: **February 06, 2013**

*KOK
2/21/13*

This calibration certificate documents the traceability to national standards, which realize the physical units of measurements (SI).
The measurements and the uncertainties with confidence probability are given on the following pages and are part of the certificate.

All calibrations have been conducted in the closed laboratory facility: environment temperature (22 ± 3)°C and humidity < 70%.

Calibration Equipment used (M&TE critical for calibration)

Primary Standards	ID #	Cal Date (Certificate No.)	Scheduled Calibration
Power meter EPM-442A	GB37480704	01-Nov-12 (No. 217-01640)	Oct-13
Power sensor HP 8481A	US37292783	01-Nov-12 (No. 217-01640)	Oct-13
Reference 20 dB Attenuator	SN: 5058 (20k)	27-Mar-12 (No. 217-01530)	Apr-13
Type-N mismatch combination	SN: 5047.3 / 06327	27-Mar-12 (No. 217-01533)	Apr-13
Reference Probe ES3DV3	SN: 3205	28-Dec-12 (No. ES3-3205_Dec12)	Dec-13
DAE4	SN: 601	27-Jun-12 (No. DAE4-601_Jun12)	Jun-13
Secondary Standards	ID #	Check Date (in house)	Scheduled Check
Power sensor HP 8481A	MY41092317	18-Oct-02 (in house check Oct-11)	In house check: Oct-13
RF generator R&S SMT-06	100005	04-Aug-99 (in house check Oct-11)	In house check: Oct-13
Network Analyzer HP 8753E	US37390585 S4206	18-Oct-01 (in house check Oct-12)	In house check: Oct-13

Calibrated by: **Leif Klysner** Name: **Leif Klysner** Function: **Laboratory Technician**

Signature: *Leif Klysner*

Approved by: **Katja Pokovic** Name: **Katja Pokovic** Technical Manager

Signature: *Katja Pokovic*

Issued: February 6, 2013

This calibration certificate shall not be reproduced except in full without written approval of the laboratory.



Accredited by the Swiss Accreditation Service (SAS)

The Swiss Accreditation Service is one of the signatories to the EA Multilateral Agreement for the recognition of calibration certificates

Accreditation No.: **SCS 108**

Glossary:

TSL	tissue simulating liquid
ConvF	sensitivity in TSL / NORM x,y,z
N/A	not applicable or not measured

Calibration is Performed According to the Following Standards:

- IEEE Std 1528-2003, "IEEE Recommended Practice for Determining the Peak Spatial-Averaged Specific Absorption Rate (SAR) in the Human Head from Wireless Communications Devices: Measurement Techniques", December 2003
- IEC 62209-1, "Procedure to measure the Specific Absorption Rate (SAR) for hand-held devices used in close proximity to the ear (frequency range of 300 MHz to 3 GHz)", February 2005
- Federal Communications Commission Office of Engineering & Technology (FCC OET), "Evaluating Compliance with FCC Guidelines for Human Exposure to Radiofrequency Electromagnetic Fields; Additional Information for Evaluating Compliance of Mobile and Portable Devices with FCC Limits for Human Exposure to Radiofrequency Emissions", Supplement C (Edition 01-01) to Bulletin 65

Additional Documentation:

- DASY4/5 System Handbook

Methods Applied and Interpretation of Parameters:

- Measurement Conditions:* Further details are available from the Validation Report at the end of the certificate. All figures stated in the certificate are valid at the frequency indicated.
- Antenna Parameters with TSL:* The dipole is mounted with the spacer to position its feed point exactly below the center marking of the flat phantom section, with the arms oriented parallel to the body axis.
- Feed Point Impedance and Return Loss:* These parameters are measured with the dipole positioned under the liquid filled phantom. The impedance stated is transformed from the measurement at the SMA connector to the feed point. The Return Loss ensures low reflected power. No uncertainty required.
- Electrical Delay:* One-way delay between the SMA connector and the antenna feed point. No uncertainty required.
- SAR measured:* SAR measured at the stated antenna input power.
- SAR normalized:* SAR as measured, normalized to an input power of 1 W at the antenna connector.
- SAR for nominal TSL parameters:* The measured TSL parameters are used to calculate the nominal SAR result.

The reported uncertainty of measurement is stated as the standard uncertainty of measurement multiplied by the coverage factor $k=2$, which for a normal distribution corresponds to a coverage probability of approximately 95%.

Measurement Conditions

DASY system configuration, as far as not given on page 1.

DASY Version	DASY5	V52.8.5
Extrapolation	Advanced Extrapolation	
Phantom	Modular Flat Phantom	
Distance Dipole Center - TSL	10 mm	with Spacer
Zoom Scan Resolution	dx, dy, dz = 5 mm	
Frequency	1900 MHz \pm 1 MHz	

Head TSL parameters

The following parameters and calculations were applied.

	Temperature	Permittivity	Conductivity
Nominal Head TSL parameters	22.0 °C	40.0	1.40 mho/m
Measured Head TSL parameters	(22.0 \pm 0.2) °C	39.4 \pm 6 %	1.38 mho/m \pm 6 %
Head TSL temperature change during test	< 0.5 °C	----	----

SAR result with Head TSL

SAR averaged over 1 cm³ (1 g) of Head TSL	Condition	
SAR measured	250 mW input power	9.87 W/kg
SAR for nominal Head TSL parameters	normalized to 1W	39.7 W/kg \pm 17.0 % (k=2)

SAR averaged over 10 cm³ (10 g) of Head TSL	condition	
SAR measured	250 mW input power	5.18 W/kg
SAR for nominal Head TSL parameters	normalized to 1W	20.8 W/kg \pm 16.5 % (k=2)

Body TSL parameters

The following parameters and calculations were applied.

	Temperature	Permittivity	Conductivity
Nominal Body TSL parameters	22.0 °C	53.3	1.52 mho/m
Measured Body TSL parameters	(22.0 \pm 0.2) °C	51.9 \pm 6 %	1.53 mho/m \pm 6 %
Body TSL temperature change during test	< 0.5 °C	----	----

SAR result with Body TSL

SAR averaged over 1 cm³ (1 g) of Body TSL	Condition	
SAR measured	250 mW input power	10.3 W/kg
SAR for nominal Body TSL parameters	normalized to 1W	40.8 W/kg \pm 17.0 % (k=2)

SAR averaged over 10 cm³ (10 g) of Body TSL	condition	
SAR measured	250 mW input power	5.45 W/kg
SAR for nominal Body TSL parameters	normalized to 1W	21.7 W/kg \pm 16.5 % (k=2)

Appendix

Antenna Parameters with Head TSL

Impedance, transformed to feed point	52.1 Ω + 5.9 j Ω
Return Loss	- 24.3 dB

Antenna Parameters with Body TSL

Impedance, transformed to feed point	48.3 Ω + 6.3 j Ω
Return Loss	- 23.6 dB

General Antenna Parameters and Design

Electrical Delay (one direction)	1.199 ns
----------------------------------	----------

After long term use with 100W radiated power, only a slight warming of the dipole near the feedpoint can be measured.

The dipole is made of standard semirigid coaxial cable. The center conductor of the feeding line is directly connected to the second arm of the dipole. The antenna is therefore short-circuited for DC-signals. On some of the dipoles, small end caps are added to the dipole arms in order to improve matching when loaded according to the position as explained in the "Measurement Conditions" paragraph. The SAR data are not affected by this change. The overall dipole length is still according to the Standard.

No excessive force must be applied to the dipole arms, because they might bend or the soldered connections near the feedpoint may be damaged.

Additional EUT Data

Manufactured by	SPEAG
Manufactured on	March 11, 2011

DASY5 Validation Report for Head TSL

Date: 06.02.2013

Test Laboratory: SPEAG, Zurich, Switzerland

DUT: Dipole 1900 MHz; Type: D1900V2; Serial: D1900V2 - SN: 5d148

Communication System: CW; Frequency: 1900 MHz

Medium parameters used: $f = 1900$ MHz; $\sigma = 1.38$ S/m; $\epsilon_r = 39.4$; $\rho = 1000$ kg/m³

Phantom section: Flat Section

Measurement Standard: DASY5 (IEEE/IEC/ANSI C63.19-2007)

DASY52 Configuration:

- Probe: ES3DV3 - SN3205; ConvF(4.98, 4.98, 4.98); Calibrated: 28.12.2012;
- Sensor-Surface: 3mm (Mechanical Surface Detection)
- Electronics: DAE4 Sn601; Calibrated: 27.06.2012
- Phantom: Flat Phantom 5.0 (front); Type: QD000P50AA; Serial: 1001
- DASY52 52.8.5(1059); SEMCAD X 14.6.8(7028)

Dipole Calibration for Head Tissue/Pin=250 mW, d=10mm/Zoom Scan (7x7x7)/Cube 0:

Measurement grid: dx=5mm, dy=5mm, dz=5mm

Reference Value = 96.534 V/m; Power Drift = 0.05 dB

Peak SAR (extrapolated) = 17.8 W/kg

SAR(1 g) = 9.87 W/kg; SAR(10 g) = 5.18 W/kg

Maximum value of SAR (measured) = 12.1 W/kg

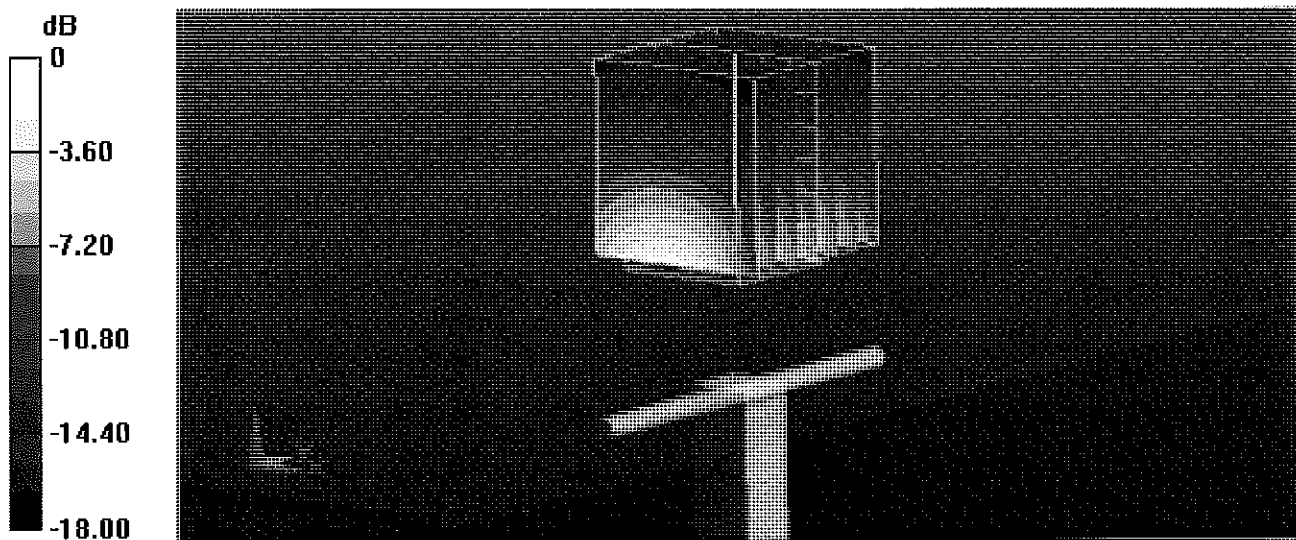

0 dB = 12.1 W/kg = 10.83 dBW/kg

Impedance Measurement Plot for Head TSL

6 Feb 2013 09:25:10

CH1 S11 1 U FS

1: 52.125 Ω 5.8711 Ω 491.80 μ H

1 900.000 000 MHz

*
Del
CA
Avg
16
H1d

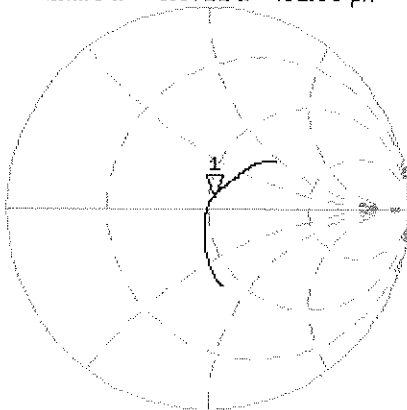

CH2 S11 LOG

5 dB/REF -20 dB

1: -24.287 dB 1 900.000 000 MHz

CA
Avg
16
H1d

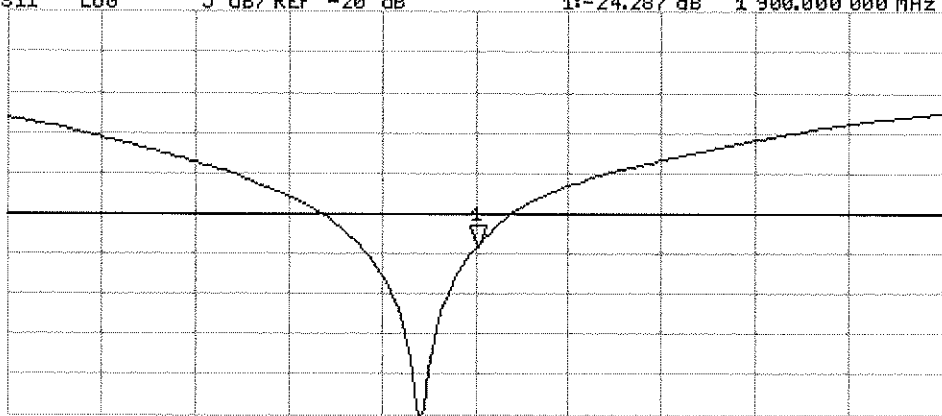

START 1 700.000 000 MHz

STOP 2 100.000 000 MHz

DASY5 Validation Report for Body TSL

Date: 06.02.2013

Test Laboratory: SPEAG, Zurich, Switzerland

DUT: Dipole 1900 MHz; Type: D1900V2; Serial: D1900V2 - SN: 5d148

Communication System: CW; Frequency: 1900 MHz

Medium parameters used: $f = 1900$ MHz; $\sigma = 1.53$ S/m; $\epsilon_r = 51.9$; $\rho = 1000$ kg/m³

Phantom section: Flat Section

Measurement Standard: DASY5 (IEEE/IEC/ANSI C63.19-2007)

DASY52 Configuration:

- Probe: ES3DV3 - SN3205; ConvF(4.6, 4.6, 4.6); Calibrated: 28.12.2012;
- Sensor-Surface: 3mm (Mechanical Surface Detection)
- Electronics: DAE4 Sn601; Calibrated: 27.06.2012
- Phantom: Flat Phantom 5.0 (back); Type: QD000P50AA; Serial: 1002
- DASY52 52.8.5(1059); SEMCAD X 14.6.8(7028)

Dipole Calibration for Body Tissue/Pin=250 mW, d=10mm/Zoom Scan (7x7x7)/Cube 0:

Measurement grid: dx=5mm, dy=5mm, dz=5mm

Reference Value = 96.534 V/m; Power Drift = -0.02 dB

Peak SAR (extrapolated) = 17.9 W/kg

SAR(1 g) = 10.3 W/kg; SAR(10 g) = 5.45 W/kg

Maximum value of SAR (measured) = 13.1 W/kg

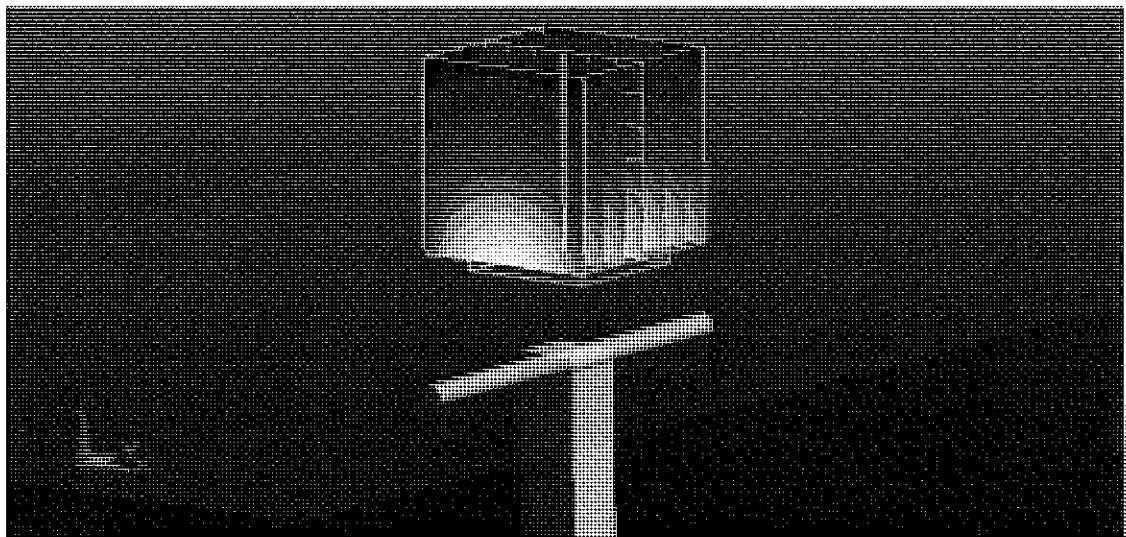
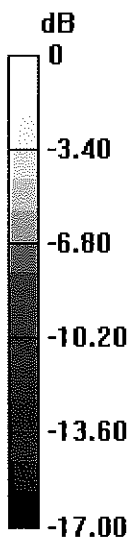

0 dB = 13.1 W/kg = 11.17 dBW/kg

Impedance Measurement Plot for Body TSL

6 Feb 2013 09:24:17

CH1 S11 1 U FS 1: 48.344 Ω 6.2715 Ω 525.34 μ H 1 900.000 000 MHz

*
De1

CA

Avg
16

H1d

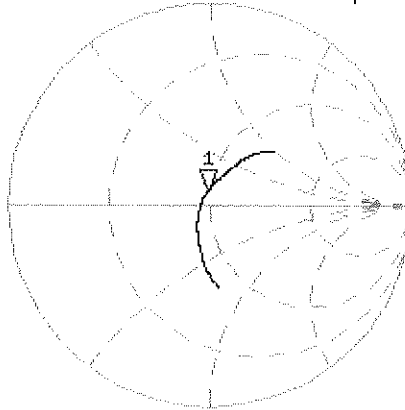

CH2 S11 LOG 5 dB/REF -20 dB 1:-23.628 dB 1 900.000 000 MHz

CA

Avg
16

H1d

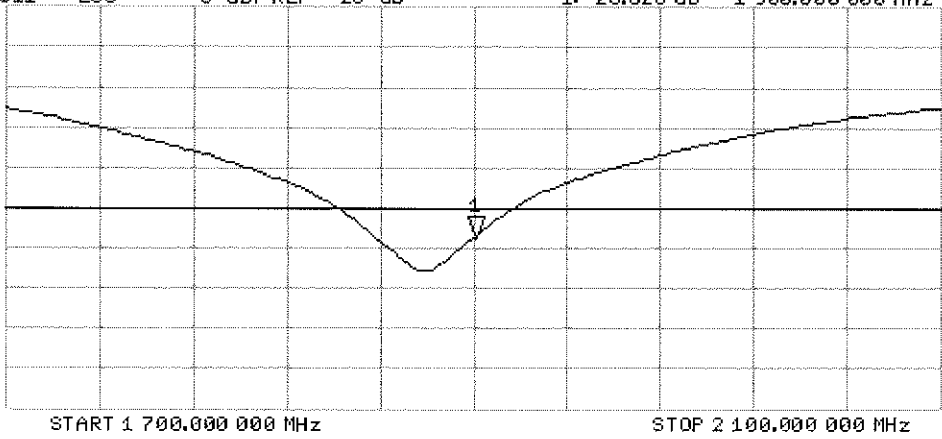

APPENDIX D: SAR TISSUE SPECIFICATIONS

Measurement Procedure for Tissue verification:



- 1) The network analyzer and probe system was configured and calibrated.
- 2) The probe was immersed in the tissue. The tissue was placed in a nonmetallic container. Trapped air bubbles beneath the flange were minimized by placing the probe at a slight angle.
- 3) The complex admittance with respect to the probe aperture was measured
- 4) The complex relative permittivity ϵ can be calculated from the below equation (Pournaropoulos and Misra):

$$Y = \frac{j2\omega\epsilon_r\epsilon_0}{[\ln(b/a)]^2} \int_a^b \int_a^b \int_0^\pi \cos\phi' \frac{\exp[-j\omega r(\mu_0\epsilon_r'\epsilon_0)^{1/2}]}{r} d\phi' d\rho' d\rho$$

where Y is the admittance of the probe in contact with the sample, the primed and unprimed coordinates refer to source and observation points, respectively, $r^2 = \rho^2 + \rho'^2 - 2\rho\rho'\cos\phi'$, ω is the angular frequency, and $j = \sqrt{-1}$.

**Table D-I
Composition of the Tissue Equivalent Matter**

Frequency (MHz)	750	750	835	835	1900	1900	2450	2450
Tissue	Head	Body	Head	Body	Head	Body	Head	Body
Ingredients (% by weight)								
Bactericide	See Page 2 and 3	See Page 2	0.1	0.1			See Page 4	
DGBE					44.92	29.44		26.7
HEC			1	1				
NaCl			1.45	0.94	0.18	0.39		0.1
Sucrose			57	44.9				
Water			40.45	53.06	54.9	70.17		73.2

FCC ID: ZNFVS890		SAR EVALUATION REPORT		Reviewed by: Quality Manager
Test Dates: 06/11/13 - 06/18/13	DUT Type: Portable Handset			APPENDIX D: Page 1 of 4

2 Composition / Information on ingredients

The Item is composed of the following ingredients:

H ₂ O	Water, 35 – 58%
Sucrose	Sugar, white, refined, 40 – 60%
NaCl	Sodium Chloride, 0 – 6%
Hydroxyethyl-cellulose	Medium Viscosity (CAS# 9004-62-0), <0.3%
Preventol-D7	Preservative: aqueous preparation, (CAS# 55965-84-9), containing 5-chloro-2-methyl-3(2H)-isothiazolone and 2-methyl-3(2H)-isothiazolone, 0.1 – 0.7%

Relevant for safety; Refer to the respective Safety Data Sheet*.

**Figure D-1
Composition of 750 MHz Head and Body Tissue Equivalent Matter**

Note: 750MHz liquid recipes are proprietary SPEAG. Since the composition is approximate to the actual liquids utilized, the manufacturer tissue-equivalent liquid data sheets are provided below.

Measurement Certificate / Material Test

Item Name	Body Tissue Simulating Liquid (MSL750)
Product No.	SL AAM 075 AA (Charge: 111130-3)
Manufacturer	SPEAG

Measurement Method

TSL dielectric parameters measured using calibrated OCP probe (type DAK).

Target Parameters

Target parameters as defined in the IEEE 1528 and IEC 62209 compliance standards.

Test Condition

Ambient Condition 22°C ; 30% humidity
TSL Temperature 22°C
Test Date 7-Dec-11

Additional Information



TSL Density 1.212 g/cm³
TSL Heat-capacity 3.006 kJ/(kg*K)

Results

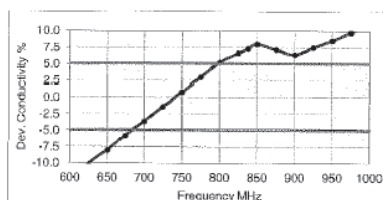
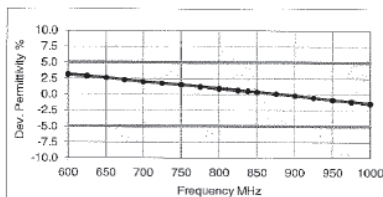
f [MHz]	Measured			Target		Diff. to Target (%)	
	HP-e'	HP-e''	sigma	eps	sigma	Δ-eps	Δ-sigma
600	57.9	25.01	0.83	56.1	0.95	3.1	-12.3
625	57.6	24.66	0.86	56.0	0.95	2.9	-10.1
650	57.4	24.31	0.88	55.9	0.96	2.6	-8.0
675	57.1	24.02	0.90	55.8	0.96	2.3	-5.8
700	56.8	23.74	0.92	55.7	0.96	2.0	-3.7
725	56.6	23.50	0.95	55.6	0.96	1.7	-1.5
750	56.4	23.26	0.97	55.5	0.96	1.5	0.8
775	56.1	23.06	0.99	55.4	0.97	1.2	3.0
800	55.8	22.86	1.02	55.3	0.97	0.9	5.2
825	55.6	22.72	1.04	55.2	0.98	0.6	6.6
838	55.5	22.64	1.05	55.2	0.98	0.5	7.3
850	55.4	22.57	1.07	55.2	0.99	0.4	8.0
875	55.1	22.44	1.09	55.1	1.02	0.1	7.2
900	54.9	22.31	1.12	55.0	1.05	-0.2	6.4
925	54.7	22.20	1.14	55.0	1.08	-0.5	7.5
950	54.5	22.09	1.17	54.9	1.08	-0.9	8.5
975	54.3	21.99	1.19	54.9	1.09	-1.2	9.7
1000	54.1	21.89	1.22	54.8	1.10	-1.4	10.9



**Figure D-2
750MHz Body Tissue Equivalent Matter**

FCC ID: ZNFVS890		SAR EVALUATION REPORT		Reviewed by: Quality Manager
Test Dates: 06/11/13 - 06/18/13	DUT Type: Portable Handset			APPENDIX D: Page 2 of 4

Measurement Certificate / Material Test

Item Name	Head Tissue Simulating Liquid (HSL 750)
Product No.	SL AAH 075 (Charge: 111208-2)
Manufacturer	SPEAG

Measurement Method

TSL dielectric parameters measured using calibrated OCP probe (type DAK).

Target Parameters

Target parameters as defined in the IEEE 1528 and IEC 62209 compliance standards.

Test Condition

Ambient Condition 22°C ; 30% humidity
 TSL Temperature 22°C
 Test Date 14-Dec-11

Additional Information

TSL Density 1.284 g/cm³
 TSL Heat-capacity 2.701 kJ/(kg*K)

Results

f [MHz]	Measured			Target		Diff.to Target [%]	
	HP-e'	HP-e''	sigma	eps	sigma	Δ-eps	Δ-sigma
600	44.5	22.77	0.76	42.7	0.88	4.2	-13.8
625	44.2	22.50	0.78	42.6	0.88	3.7	-11.5
650	43.8	22.24	0.80	42.5	0.89	3.1	-9.2
675	43.4	22.03	0.83	42.3	0.89	2.5	-6.8
700	43.0	21.82	0.85	42.2	0.89	1.9	-4.5
725	42.7	21.64	0.87	42.1	0.89	1.4	-2.1
750	42.3	21.45	0.89	41.9	0.89	1.0	0.2
775	42.0	21.28	0.92	41.8	0.90	0.5	2.4
800	41.7	21.11	0.94	41.7	0.90	0.0	4.7
825	41.4	20.97	0.96	41.6	0.91	-0.5	6.1
838	41.2	20.90	0.97	41.5	0.91	-0.7	6.8
850	41.1	20.83	0.98	41.5	0.92	-1.0	7.5
875	40.8	20.69	1.01	41.5	0.94	-1.7	6.8
900	40.5	20.55	1.03	41.5	0.97	-2.4	6.1
925	40.2	20.45	1.05	41.5	0.98	-3.0	7.1
950	39.9	20.34	1.08	41.4	0.99	-3.6	8.1
975	39.7	20.24	1.10	41.4	1.00	-4.2	9.3
1000	39.4	20.14	1.12	41.3	1.01	-4.7	10.4

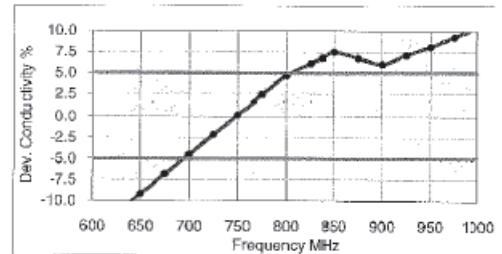
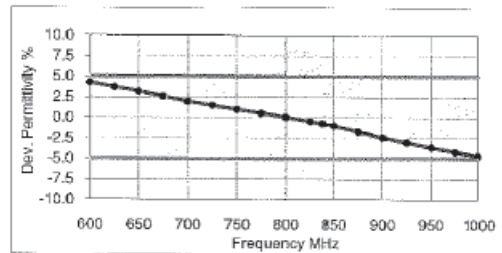

**Figure D-3
 750MHz Head Tissue Equivalent Matter**

FCC ID: ZNFVS890	PCTEST Engineering Laboratory, Inc.	SAR EVALUATION REPORT	LG	Reviewed by: Quality Manager
Test Dates: 06/11/13 - 06/18/13	DUT Type: Portable Handset			APPENDIX D: Page 3 of 4

2 Composition / Information on ingredients

The Item is composed of the following ingredients:

H2O	Water, 52 – 75%
C8H18O3	Diethylene glycol monobutyl ether (DGBE), 25 – 48% (CAS-No. 112-34-5, EC-No. 203-961-6, EC-index-No. 603-096-00-8) Relevant for safety; Refer to the respective Safety Data Sheet*.
NaCl	Sodium Chloride, <1.0%

Figure D-4
Composition of 2.4 GHz Head Tissue Equivalent Matter

Note: 2.4 GHz head liquid recipes are proprietary SPEAG. Since the composition is approximate to the actual liquids utilized, the manufacturer tissue-equivalent liquid data sheets are provided below.

Measurement Certificate / Material Test

Item Name	Head Tissue Simulating Liquid (HSL 2450)
Product No.	SL AAH 245 BA (Charge: 120112-4)
Manufacturer	SPEAG

Measurement Method

TSL dielectric parameters measured using calibrated OCP probe (type DAK).

Target Parameters

Target parameters as defined in the IEEE 1528 and IEC 62209 compliance standards.

Test Condition

Ambient Condition 22°C; 30% humidity
TSL Temperature 23°C
Test Date 18-Jan-12

Additional Information

TSL Density 0.988 g/cm³
TSL Heat-capacity 3.680 kJ/(kg*K)

Results

f [MHz]	Measured			Target		Diff.to Target [%]	
	HP-e'	HP-e''	sigma	eps	sigma	Δ-eps	Δ-sigma
1900	40.5	11.99	1.27	40.0	1.40	1.1	-9.5
1925	40.3	12.08	1.29	40.0	1.40	0.9	-7.6
1950	40.2	12.17	1.32	40.0	1.40	0.6	-5.7
1975	40.1	12.26	1.35	40.0	1.40	0.3	-3.8
2000	40.0	12.35	1.37	40.0	1.40	0.0	-1.9
2025	39.9	12.44	1.40	40.0	1.42	-0.1	-1.5
2050	39.9	12.53	1.43	39.9	1.44	-0.3	-1.1
2075	39.7	12.60	1.46	39.9	1.47	-0.4	-0.8
2100	39.6	12.68	1.48	39.8	1.49	-0.6	-0.5
2125	39.5	12.76	1.51	39.8	1.51	-0.7	-0.2
2150	39.4	12.84	1.54	39.7	1.53	-0.8	0.2
2175	39.3	12.93	1.56	39.7	1.56	-1.0	0.6
2200	39.2	13.02	1.59	39.6	1.58	-1.1	1.0
2225	39.1	13.09	1.62	39.6	1.60	-1.3	1.3
2250	39.0	13.17	1.65	39.6	1.62	-1.4	1.6
2275	38.9	13.25	1.68	39.5	1.64	-1.5	2.0
2300	38.8	13.33	1.71	39.5	1.67	-1.7	2.3
2325	38.7	13.40	1.73	39.4	1.69	-1.8	2.7
2350	38.6	13.48	1.76	39.4	1.71	-2.0	3.0
2375	38.5	13.56	1.79	39.3	1.73	-2.1	3.3
2400	38.4	13.63	1.82	39.3	1.76	-2.3	3.7
2425	38.3	13.71	1.85	39.2	1.78	-2.4	4.0
2450	38.2	13.78	1.88	39.2	1.80	-2.6	4.4
2475	38.1	13.85	1.91	39.2	1.83	-2.7	4.4
2500	38.0	13.93	1.94	39.1	1.85	-2.9	4.4
2525	37.9	13.99	1.97	39.1	1.88	-3.1	4.4
2550	37.8	14.06	1.99	39.1	1.91	-3.3	4.4
2575	37.7	14.13	2.02	39.0	1.94	-3.5	4.5
2600	37.6	14.20	2.05	39.0	1.96	-3.7	4.6
2625	37.5	14.28	2.08	39.0	1.99	-3.8	4.6
2650	37.4	14.32	2.11	38.9	2.02	-4.0	4.6
2675	37.3	14.39	2.14	38.9	2.05	-4.3	4.7
2700	37.1	14.46	2.17	38.9	2.07	-4.5	4.8

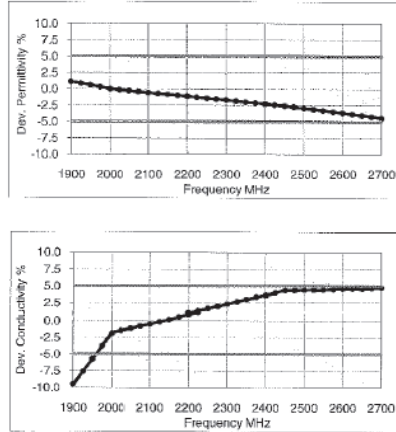

Figure D-5
2.4 GHz Head Tissue Equivalent Matter

FCC ID: ZNFVS890		SAR EVALUATION REPORT		Reviewed by: Quality Manager
Test Dates: 06/11/13 - 06/18/13	DUT Type: Portable Handset			APPENDIX D: Page 4 of 4

APPENDIX E: SAR SYSTEM VALIDATION



Per FCC KDB 865664 D02v01, SAR system validation status should be documented to confirm measurement accuracy. The SAR systems (including SAR probes, system components and software versions) used for this device were validated against its performance specifications prior to the SAR measurements. Reference dipoles were used with the required tissue- equivalent media for system validation, according to the procedures outlined in IEEE 1528-2003 and FCC KDB 865664 D01 v01. Since SAR probe calibrations are frequency dependent, each probe calibration point was validated at a frequency within the valid frequency range of the probe calibration point, using the system that normally operates with the probe for routine SAR measurements and according to the required tissue-equivalent media.

A tabulated summary of the system validation status including the validation date(s), measurement frequencies, SAR probes and tissue dielectric parameters has been included.

Table E-I
SAR System Validation Summary

SAR SYSTEM #	FREQ. [MHz]	DATE	PROBE SN	PROBE TYPE	PROBE CAL. POINT		COND.	PERM.	CW VALIDATION			MOD. VALIDATION		
							(σ)	(ϵ_r)	SENSI-TIVITY	PROBE LINEARITY	PROBE ISOTROPY	MOD. TYPE	DUTY FACTOR	PAR
C	750	10/24/2012	3022	ES3DV2	750	Head	0.865	40.53	PASS	PASS	PASS	N/A	N/A	N/A
D	835	10/17/2012	3288	ES3DV3	835	Head	0.899	42.07	PASS	PASS	PASS	GMSK	PASS	N/A
B	1900	1/29/2013	3287	ES3DV3	1900	Head	1.440	38.80	PASS	PASS	PASS	GMSK	PASS	N/A
C	2450	11/9/2012	3022	ES3DV2	2450	Head	1.874	38.23	PASS	PASS	PASS	OFDM	N/A	PASS
C	750	10/24/2012	3022	ES3DV2	750	Body	0.865	40.53	PASS	PASS	PASS	N/A	N/A	N/A
G	835	3/26/2013	3209	ES3DV3	835	Body	1.006	54.42	PASS	PASS	PASS	GMSK	PASS	N/A
E	1900	3/5/2013	3920	EX3DV4	1900	Body	1.574	52.42	PASS	PASS	PASS	GMSK	PASS	N/A
C	2450	11/8/2012	3022	ES3DV2	2450	Body	2.038	51.10	PASS	PASS	PASS	OFDM	N/A	PASS

NOTE: All measurements were performed using probes calibrated for CW signals only. Modulations in the table above represent test configurations for which the measurement system has been validated per FCC KDB Publication 865664 D01v01. SAR systems were validated for modulated signals with a periodic duty cycle, such as GMSK, or with a high peak to average ratio (>5 dB), such as OFDM according to KDB 865664.

FCC ID: ZNFVS890	 PCTEST ENGINEERING LABORATORY, INC.	SAR EVALUATION REPORT	 LG	Reviewed by: Quality Manager
Test Dates: 06/11/13 - 06/18/13	DUT Type: Portable Handset			APPENDIX E: Page 1 of 1