



17. TEST PHOTOGRAPHS

See following Attached Pages for setup photographs.

FCC ID: ZNFVS870	 PCTEST ENGINEERING LABORATORY, INC.	HAC (RF EMISSIONS) TEST REPORT	 LG	Reviewed by: Quality Manager
HAC Filename: 0Y1211261706.ZNF	Test Dates: December 3-4, 2012	EUT Type: Portable Handset	Page 79 of 81	

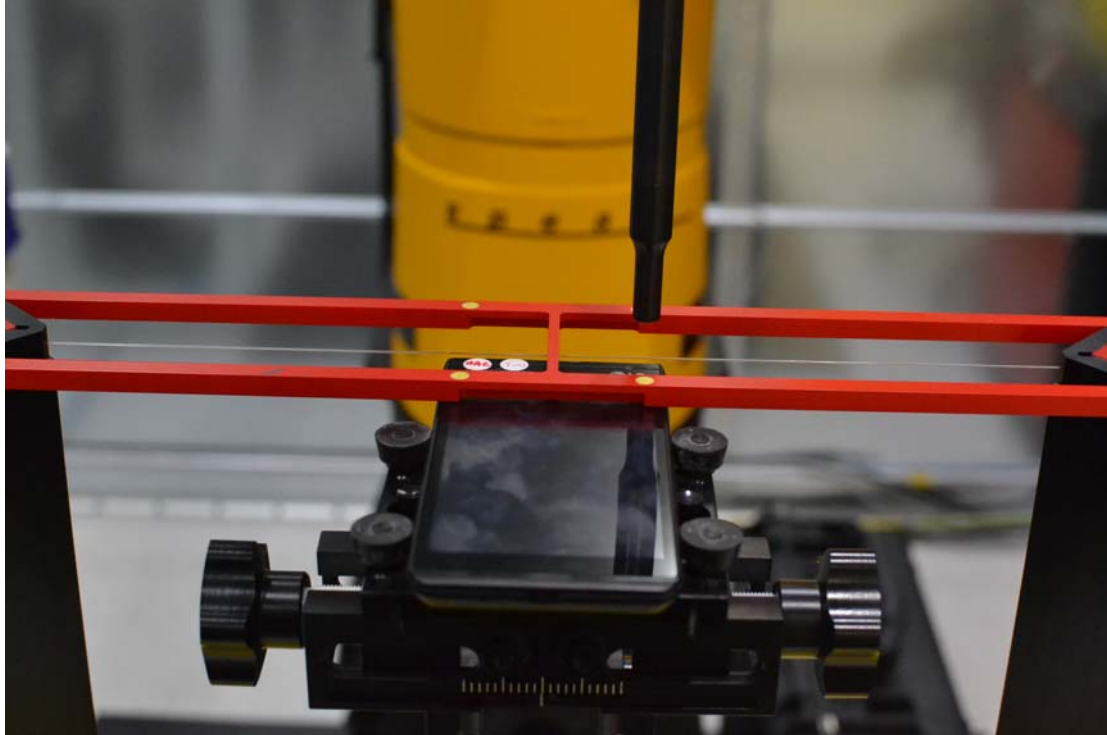

Figure 17-1
Ear Reference Point HAC Phantom Alignment

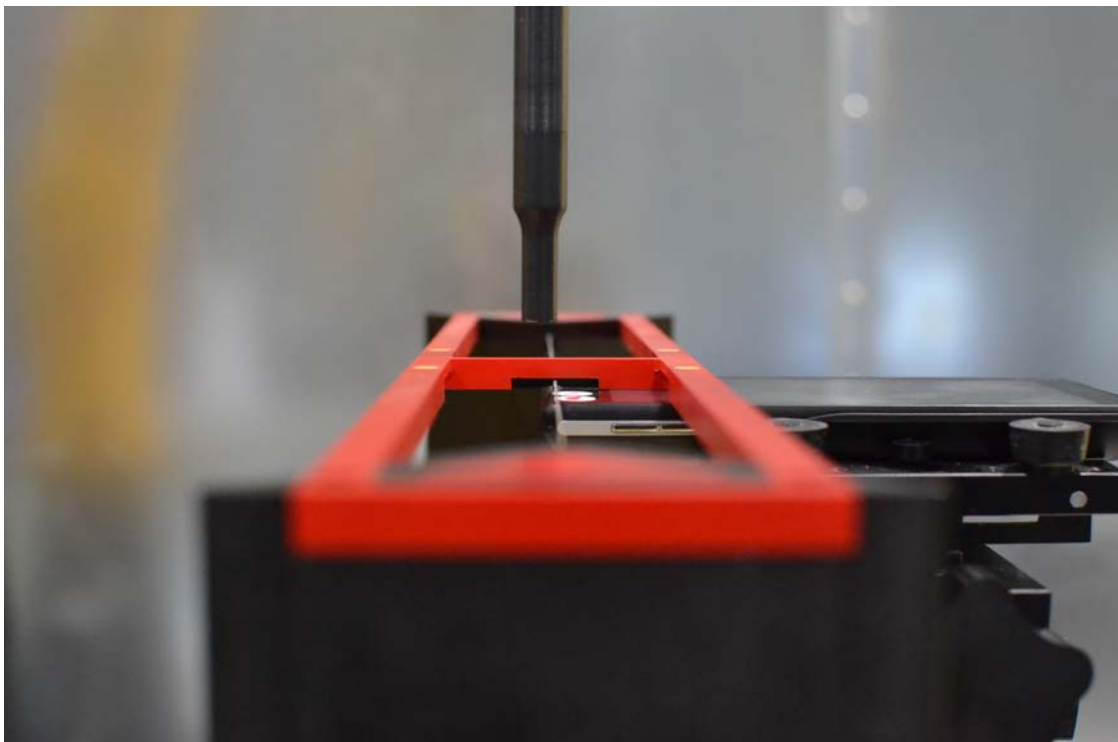



Figure 17-2
HAC Phantom Plane Alignment

FCC ID: ZNFVS870		HAC (RF EMISSIONS) TEST REPORT		Reviewed by: Quality Manager
HAC Filename: 0Y1211261706.ZNF	Test Dates: December 3-4, 2012	EUT Type: Portable Handset	Page 80 of 81	

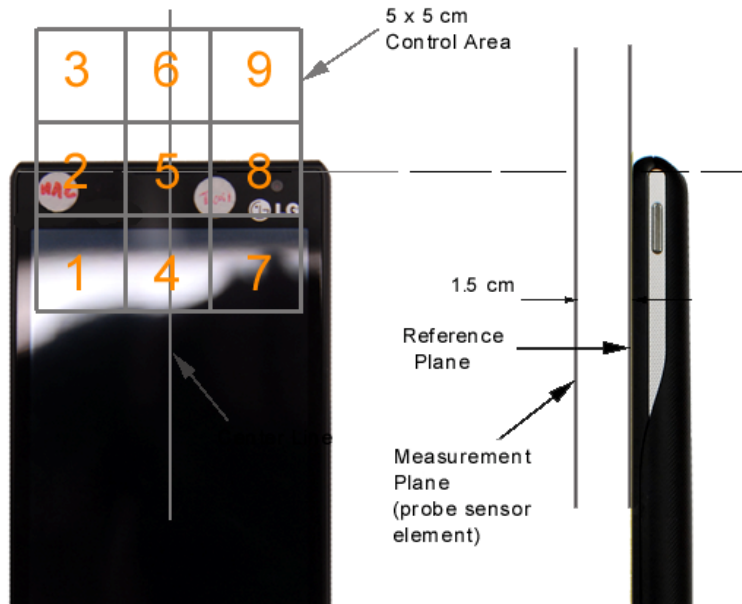

Figure 17-3
5x5 Scan grid above WD



Figure 17-4
E-Field WD Scan overlay



Figure 17-5
H-Field WD Scan overlay

FCC ID: ZNFVS870	PCTEST ENGINEERING LABORATORY, INC.	HAC (RF EMISSIONS) TEST REPORT	LG	Reviewed by: Quality Manager
HAC Filename: 0Y1211261706.ZNF	Test Dates: December 3-4, 2012	EUT Type: Portable Handset		Page 81 of 81