

## APPENDIX C: PROBE CALIBRATION



Accredited by the Swiss Accreditation Service (SAS)  
The Swiss Accreditation Service is one of the signatories to the EA  
Multilateral Agreement for the recognition of calibration certificates

Accreditation No.: **SCS 0108**

Client **PC Test**

Certificate No: **D750V3-1161\_Jul16**

## CALIBRATION CERTIFICATE

Object **D750V3 - SN:1161**

Calibration procedure(s) **QA CAL-05.v9**  
**Calibration procedure for dipole validation kits above 700 MHz**

✓PN  
8/9/16

Calibration date: **July 13, 2016**

This calibration certificate documents the traceability to national standards, which realize the physical units of measurements (SI).  
The measurements and the uncertainties with confidence probability are given on the following pages and are part of the certificate.

All calibrations have been conducted in the closed laboratory facility: environment temperature ( $22 \pm 3$ )°C and humidity < 70%.

Calibration Equipment used (M&TE critical for calibration)

Primary Standards	ID #	Cal Date (Certificate No.)	Scheduled Calibration
Power meter NRP	SN: 104778	06-Apr-16 (No. 217-02288/02289)	Apr-17
Power sensor NRP-Z91	SN: 103244	06-Apr-16 (No. 217-02288)	Apr-17
Power sensor NRP-Z91	SN: 103245	06-Apr-16 (No. 217-02289)	Apr-17
Reference 20 dB Attenuator	SN: 5058 (20k)	05-Apr-16 (No. 217-02292)	Apr-17
Type-N mismatch combination	SN: 5047.2 / 06327	05-Apr-16 (No. 217-02295)	Apr-17
Reference Probe EX3DV4	SN: 7349	15-Jun-16 (No. EX3-7349_Jun16)	Jun-17
DAE4	SN: 601	30-Dec-15 (No. DAE4-601_Dec15)	Dec-16

Secondary Standards	ID #	Check Date (in house)	Scheduled Check
Power meter EPM-442A	SN: GB37480704	07-Oct-15 (No. 217-02222)	In house check: Oct-16
Power sensor HP 8481A	SN: US37292783	07-Oct-15 (No. 217-02222)	In house check: Oct-16
Power sensor HP 8481A	SN: MY41092317	07-Oct-15 (No. 217-02223)	In house check: Oct-16
RF generator R&S SMT-06	SN: 100972	15-Jun-15 (in house check Jun-15)	In house check: Oct-16
Network Analyzer HP 8753E	SN: US37390585	18-Oct-01 (in house check Oct-15)	In house check: Oct-16

Calibrated by: **Claudio Leubler**      Name: Claudio Leubler      Function: Laboratory Technician

Approved by: **Katja Pokovic**      Name: Katja Pokovic      Function: Technical Manager

Signature

Issued: July 13, 2016

This calibration certificate shall not be reproduced except in full without written approval of the laboratory.



Accredited by the Swiss Accreditation Service (SAS)  
The Swiss Accreditation Service is one of the signatories to the EA  
Multilateral Agreement for the recognition of calibration certificates

**Glossary:**

TSL	tissue simulating liquid
ConvF	sensitivity in TSL / NORM x,y,z
N/A	not applicable or not measured

**Calibration is Performed According to the Following Standards:**

- a) IEEE Std 1528-2013, "IEEE Recommended Practice for Determining the Peak Spatial-Averaged Specific Absorption Rate (SAR) in the Human Head from Wireless Communications Devices: Measurement Techniques", June 2013
- b) IEC 62209-1, "Procedure to measure the Specific Absorption Rate (SAR) for hand-held devices used in close proximity to the ear (frequency range of 300 MHz to 3 GHz)", February 2005
- c) IEC 62209-2, "Procedure to determine the Specific Absorption Rate (SAR) for wireless communication devices used in close proximity to the human body (frequency range of 30 MHz to 6 GHz)", March 2010
- d) KDB 865664, "SAR Measurement Requirements for 100 MHz to 6 GHz"

**Additional Documentation:**

- e) DASY4/5 System Handbook

**Methods Applied and Interpretation of Parameters:**

- *Measurement Conditions:* Further details are available from the Validation Report at the end of the certificate. All figures stated in the certificate are valid at the frequency indicated.
- *Antenna Parameters with TSL:* The dipole is mounted with the spacer to position its feed point exactly below the center marking of the flat phantom section, with the arms oriented parallel to the body axis.
- *Feed Point Impedance and Return Loss:* These parameters are measured with the dipole positioned under the liquid filled phantom. The impedance stated is transformed from the measurement at the SMA connector to the feed point. The Return Loss ensures low reflected power. No uncertainty required.
- *Electrical Delay:* One-way delay between the SMA connector and the antenna feed point. No uncertainty required.
- *SAR measured:* SAR measured at the stated antenna input power.
- *SAR normalized:* SAR as measured, normalized to an input power of 1 W at the antenna connector.
- *SAR for nominal TSL parameters:* The measured TSL parameters are used to calculate the nominal SAR result.

The reported uncertainty of measurement is stated as the standard uncertainty of measurement multiplied by the coverage factor  $k=2$ , which for a normal distribution corresponds to a coverage probability of approximately 95%.

## Measurement Conditions

DASY system configuration, as far as not given on page 1.

DASY Version	DASY5	V52.8.8
Extrapolation	Advanced Extrapolation	
Phantom	Modular Flat Phantom	
Distance Dipole Center - TSL	15 mm	with Spacer
Zoom Scan Resolution	dx, dy, dz = 5 mm	
Frequency	750 MHz $\pm$ 1 MHz	

## Head TSL parameters

The following parameters and calculations were applied.

	Temperature	Permittivity	Conductivity
Nominal Head TSL parameters	22.0 °C	41.9	0.89 mho/m
Measured Head TSL parameters	(22.0 $\pm$ 0.2) °C	40.9 $\pm$ 6 %	0.91 mho/m $\pm$ 6 %
Head TSL temperature change during test	< 0.5 °C	----	----

## SAR result with Head TSL

SAR averaged over 1 cm <sup>3</sup> (1 g) of Head TSL	Condition	
SAR measured	250 mW input power	2.09 W/kg
SAR for nominal Head TSL parameters	normalized to 1W	<b>8.17 W/kg <math>\pm</math> 17.0 % (k=2)</b>

SAR averaged over 10 cm <sup>3</sup> (10 g) of Head TSL	condition	
SAR measured	250 mW input power	1.37 W/kg
SAR for nominal Head TSL parameters	normalized to 1W	<b>5.39 W/kg <math>\pm</math> 16.5 % (k=2)</b>

## Body TSL parameters

The following parameters and calculations were applied.

	Temperature	Permittivity	Conductivity
Nominal Body TSL parameters	22.0 °C	55.5	0.96 mho/m
Measured Body TSL parameters	(22.0 $\pm$ 0.2) °C	55.1 $\pm$ 6 %	0.99 mho/m $\pm$ 6 %
Body TSL temperature change during test	< 0.5 °C	----	----

## SAR result with Body TSL

SAR averaged over 1 cm <sup>3</sup> (1 g) of Body TSL	Condition	
SAR measured	250 mW input power	2.16 W/kg
SAR for nominal Body TSL parameters	normalized to 1W	<b>8.43 W/kg <math>\pm</math> 17.0 % (k=2)</b>

SAR averaged over 10 cm <sup>3</sup> (10 g) of Body TSL	condition	
SAR measured	250 mW input power	1.41 W/kg
SAR for nominal Body TSL parameters	normalized to 1W	<b>5.53 W/kg <math>\pm</math> 16.5 % (k=2)</b>

## Appendix (Additional assessments outside the scope of SCS 0108)

### Antenna Parameters with Head TSL

Impedance, transformed to feed point	55.6 $\Omega$ - 0.9 $j\Omega$
Return Loss	- 25.4 dB

### Antenna Parameters with Body TSL

Impedance, transformed to feed point	50.2 $\Omega$ - 4.0 $j\Omega$
Return Loss	- 28.0 dB

### General Antenna Parameters and Design

Electrical Delay (one direction)	1.033 ns
----------------------------------	----------

After long term use with 100W radiated power, only a slight warming of the dipole near the feedpoint can be measured.

The dipole is made of standard semirigid coaxial cable. The center conductor of the feeding line is directly connected to the second arm of the dipole. The antenna is therefore short-circuited for DC-signals. On some of the dipoles, small end caps are added to the dipole arms in order to improve matching when loaded according to the position as explained in the "Measurement Conditions" paragraph. The SAR data are not affected by this change. The overall dipole length is still according to the Standard.

No excessive force must be applied to the dipole arms, because they might bend or the soldered connections near the feedpoint may be damaged.

### Additional EUT Data

Manufactured by	SPEAG
Manufactured on	November 19, 2015

## DASY5 Validation Report for Head TSL

Date: 13.07.2016

Test Laboratory: SPEAG, Zurich, Switzerland

**DUT: Dipole 750 MHz; Type: D750V3; Serial: D750V3 - SN:1161**

Communication System: UID 0 - CW; Frequency: 750 MHz

Medium parameters used:  $f = 750$  MHz;  $\sigma = 0.91$  S/m;  $\epsilon_r = 40.9$ ;  $\rho = 1000$  kg/m<sup>3</sup>

Phantom section: Flat Section

Measurement Standard: DASY5 (IEEE/IEC/ANSI C63.19-2011)

DASY52 Configuration:

- Probe: EX3DV4 - SN7349; ConvF(10.07, 10.07, 10.07); Calibrated: 15.06.2016;
- Sensor-Surface: 1.4mm (Mechanical Surface Detection)
- Electronics: DAE4 Sn601; Calibrated: 30.12.2015
- Phantom: Flat Phantom 4.9L; Type: QD000P49AA; Serial: 1001
- DASY52 52.8.8(1258); SEMCAD X 14.6.10(7372)

### Dipole Calibration for Head Tissue/Pin=250 mW, d=15mm/Zoom Scan (7x7x7)/Cube 0:

Measurement grid: dx=5mm, dy=5mm, dz=5mm

Reference Value = 58.07 V/m; Power Drift = -0.00 dB

Peak SAR (extrapolated) = 3.13 W/kg

**SAR(1 g) = 2.09 W/kg; SAR(10 g) = 1.37 W/kg**

Maximum value of SAR (measured) = 2.80 W/kg



0 dB = 2.80 W/kg = 4.47 dBW/kg

# Impedance Measurement Plot for Head TSL

13 Jul 2016 09:55:53  
 [CH1] S11 1 U FS 1: 55.615  $\Omega$  -949.22 m $\Omega$  223.56 pF 750.000 000 MHz

\*  
 De1  
 CA

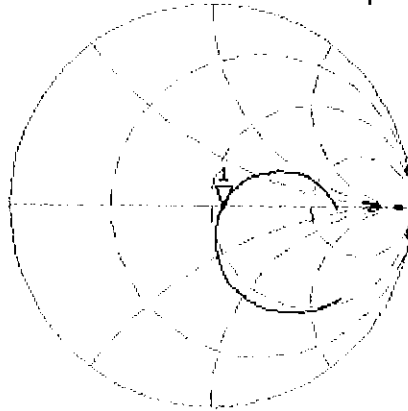

Avg  
 16

H1d

CH2 S11 LOG 5 dB/REF -20 dB 1:-25.361 dB 750.000 000 MHz

CA

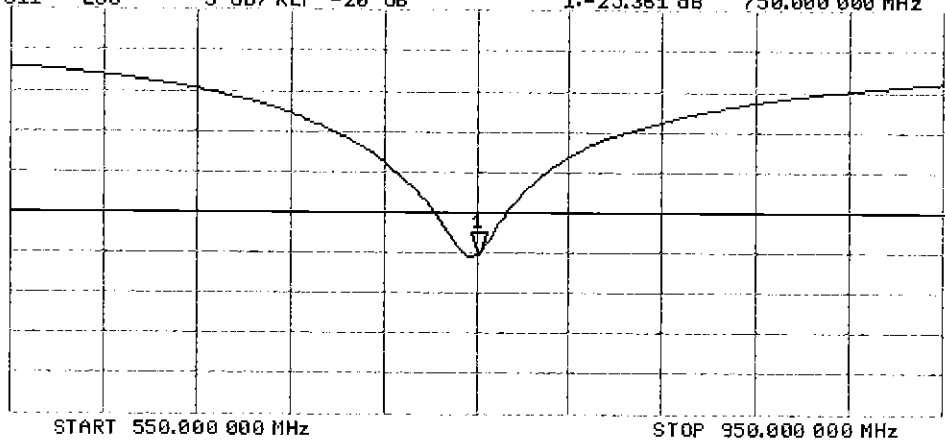

Avg  
 16

H1d

START 550.000 000 MHz

STOP 950.000 000 MHz

# DASY5 Validation Report for Body TSL

Date: 13.07.2016

Test Laboratory: SPEAG, Zurich, Switzerland

**DUT: Dipole 750 MHz; Type: D750V3; Serial: D750V3 - SN:1161**

Communication System: UID 0 - CW; Frequency: 750 MHz

Medium parameters used:  $f = 750$  MHz;  $\sigma = 0.99$  S/m;  $\epsilon_r = 55.1$ ;  $\rho = 1000$  kg/m<sup>3</sup>

Phantom section: Flat Section

Measurement Standard: DASY5 (IEEE/IEC/ANSI C63.19-2011)

DASY52 Configuration:

- Probe: EX3DV4 - SN7349; ConvF(9.99, 9.99, 9.99); Calibrated: 15.06.2016;
- Sensor-Surface: 1.4mm (Mechanical Surface Detection)
- Electronics: DAE4 Sn601; Calibrated: 30.12.2015
- Phantom: Flat Phantom 4.9L; Type: QD000P49AA; Serial: 1001
- DASY52 52.8.8(1258); SEMCAD X 14.6.10(7372)

## Dipole Calibration for Body Tissue/Pin=250 mW, d=15mm/Zoom Scan (7x7x7)/Cube 0:

Measurement grid: dx=5mm, dy=5mm, dz=5mm

Reference Value = 56.33 V/m; Power Drift = -0.00 dB

Peak SAR (extrapolated) = 3.22 W/kg

**SAR(1 g) = 2.16 W/kg; SAR(10 g) = 1.41 W/kg**

Maximum value of SAR (measured) = 2.87 W/kg



0 dB = 2.87 W/kg = 4.58 dBW/kg



# Impedance Measurement Plot for Body TSL

13 Jul 2016 13:16:34  
[CH1] S11 1 U FS 1: 50.244  $\Omega$  -3.9707  $\Omega$  53.443 pF 750.000 000 MHz

\*  
Del  
CA

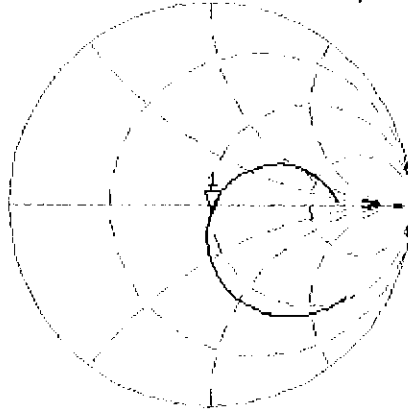

Avg  
16

H1d

CH2 S11 LOG 5 dB/REF -20 dB 1:-27.995 dB 750.000 000 MHz

CA

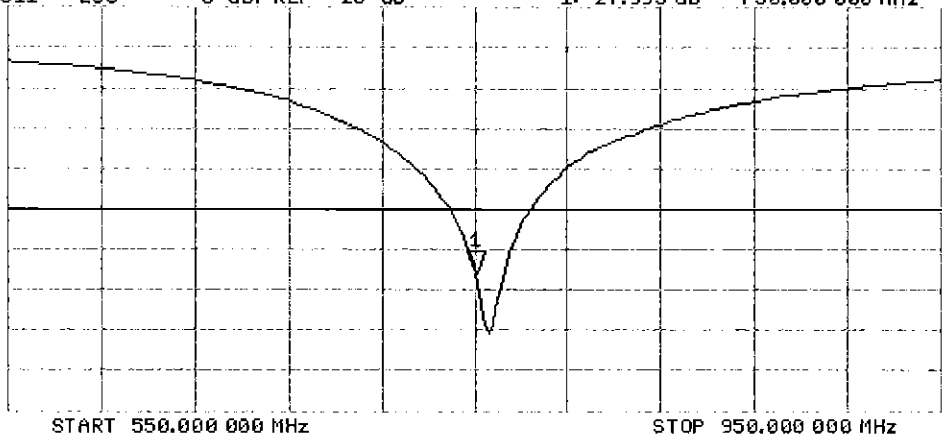

H1d



Accredited by the Swiss Accreditation Service (SAS)  
The Swiss Accreditation Service is one of the signatories to the EA  
Multilateral Agreement for the recognition of calibration certificates

Accreditation No.: **SCS 0108**

Client **PC Test**

Certificate No: **D835V2-4d047\_Jul16**

## CALIBRATION CERTIFICATE

Object **D835V2 - SN:4d047**

Calibration procedure(s) **QA CAL-05.v9**  
**Calibration procedure for dipole validation kits above 700 MHz**

Calibration date: **July 13, 2016**

*BNV*  
*7/16/2016*

This calibration certificate documents the traceability to national standards, which realize the physical units of measurements (SI).  
The measurements and the uncertainties with confidence probability are given on the following pages and are part of the certificate.

All calibrations have been conducted in the closed laboratory facility: environment temperature (22 ± 3)°C and humidity < 70%.

Calibration Equipment used (M&TE critical for calibration)

Primary Standards	ID #	Cal Date (Certificate No.)	Scheduled Calibration
Power meter NRP	SN: 104778	06-Apr-16 (No. 217-02288/02289)	Apr-17
Power sensor NRP-Z91	SN: 103244	06-Apr-16 (No. 217-02288)	Apr-17
Power sensor NRP-Z91	SN: 103245	06-Apr-16 (No. 217-02289)	Apr-17
Reference 20 dB Attenuator	SN: 5058 (20k)	05-Apr-16 (No. 217-02292)	Apr-17
Type-N mismatch combination	SN: 5047.2 / 06327	05-Apr-16 (No. 217-02295)	Apr-17
Reference Probe EX3DV4	SN: 7349	15-Jun-16 (No. EX3-7349_Jun16)	Jun-17
DAE4	SN: 601	30-Dec-15 (No. DAE4-601_Dec15)	Dec-16
Secondary Standards	ID #	Check Date (in house)	Scheduled Check
Power meter EPM-442A	SN: GB37480704	07-Oct-15 (No. 217-02222)	In house check: Oct-16
Power sensor HP 8481A	SN: US37292783	07-Oct-15 (No. 217-02222)	In house check: Oct-16
Power sensor HP 8481A	SN: MY41092317	07-Oct-15 (No. 217-02223)	In house check: Oct-16
RF generator R&S SMT-06	SN: 100972	15-Jun-15 (in house check Jun-15)	In house check: Oct-16
Network Analyzer HP 8753E	SN: US37390585	18-Oct-01 (in house check Oct-15)	in house check: Oct-16

Calibrated by: **Jeton Kastrali**      Name: **Jeton Kastrali**      Function: **Laboratory Technician**

Signature:

Approved by: **Katja Pokovic**      Name: **Katja Pokovic**      Function: **Technical Manager**

Signature:

Issued: July 13, 2016

This calibration certificate shall not be reproduced except in full without written approval of the laboratory.



Accredited by the Swiss Accreditation Service (SAS)

The Swiss Accreditation Service is one of the signatories to the EA  
Multilateral Agreement for the recognition of calibration certificates

Accreditation No.: **SCS 0108**

### Glossary:

TSL	tissue simulating liquid
ConvF	sensitivity in TSL / NORM x,y,z
N/A	not applicable or not measured

### Calibration is Performed According to the Following Standards:

- IEEE Std 1528-2013, "IEEE Recommended Practice for Determining the Peak Spatial-Averaged Specific Absorption Rate (SAR) in the Human Head from Wireless Communications Devices: Measurement Techniques", June 2013
- IEC 62209-1, "Procedure to measure the Specific Absorption Rate (SAR) for hand-held devices used in close proximity to the ear (frequency range of 300 MHz to 3 GHz)", February 2005
- IEC 62209-2, "Procedure to determine the Specific Absorption Rate (SAR) for wireless communication devices used in close proximity to the human body (frequency range of 30 MHz to 6 GHz)", March 2010
- KDB 865664, "SAR Measurement Requirements for 100 MHz to 6 GHz"

### Additional Documentation:

- DASY4/5 System Handbook

### Methods Applied and Interpretation of Parameters:

- Measurement Conditions:** Further details are available from the Validation Report at the end of the certificate. All figures stated in the certificate are valid at the frequency indicated.
- Antenna Parameters with TSL:** The dipole is mounted with the spacer to position its feed point exactly below the center marking of the flat phantom section, with the arms oriented parallel to the body axis.
- Feed Point Impedance and Return Loss:** These parameters are measured with the dipole positioned under the liquid filled phantom. The impedance stated is transformed from the measurement at the SMA connector to the feed point. The Return Loss ensures low reflected power. No uncertainty required.
- Electrical Delay:** One-way delay between the SMA connector and the antenna feed point. No uncertainty required.
- SAR measured:** SAR measured at the stated antenna input power.
- SAR normalized:** SAR as measured, normalized to an input power of 1 W at the antenna connector.
- SAR for nominal TSL parameters:** The measured TSL parameters are used to calculate the nominal SAR result.

The reported uncertainty of measurement is stated as the standard uncertainty of measurement multiplied by the coverage factor  $k=2$ , which for a normal distribution corresponds to a coverage probability of approximately 95%.

## Measurement Conditions

DASY system configuration, as far as not given on page 1.

DASY Version	DASY5	V52.8.8
Extrapolation	Advanced Extrapolation	
Phantom	Modular Flat Phantom	
Distance Dipole Center - TSL	15 mm	with Spacer
Zoom Scan Resolution	dx, dy, dz = 5 mm	
Frequency	835 MHz $\pm$ 1 MHz	

## Head TSL parameters

The following parameters and calculations were applied.

	Temperature	Permittivity	Conductivity
Nominal Head TSL parameters	22.0 °C	41.5	0.90 mho/m
Measured Head TSL parameters	(22.0 $\pm$ 0.2) °C	40.6 $\pm$ 6 %	0.94 mho/m $\pm$ 6 %
Head TSL temperature change during test	< 0.5 °C	----	----

## SAR result with Head TSL

SAR averaged over 1 cm <sup>3</sup> (1 g) of Head TSL	Condition	
SAR measured	250 mW input power	2.37 W/kg
SAR for nominal Head TSL parameters	normalized to 1W	9.13 W/kg $\pm$ 17.0 % (k=2)

SAR averaged over 10 cm <sup>3</sup> (10 g) of Head TSL	condition	
SAR measured	250 mW input power	1.53 W/kg
SAR for nominal Head TSL parameters	normalized to 1W	5.95 W/kg $\pm$ 16.5 % (k=2)

## Body TSL parameters

The following parameters and calculations were applied.

	Temperature	Permittivity	Conductivity
Nominal Body TSL parameters	22.0 °C	55.2	0.97 mho/m
Measured Body TSL parameters	(22.0 $\pm$ 0.2) °C	54.9 $\pm$ 6 %	1.01 mho/m $\pm$ 6 %
Body TSL temperature change during test	< 0.5 °C	----	----

## SAR result with Body TSL

SAR averaged over 1 cm <sup>3</sup> (1 g) of Body TSL	Condition	
SAR measured	250 mW input power	2.47 W/kg
SAR for nominal Body TSL parameters	normalized to 1W	9.57 W/kg $\pm$ 17.0 % (k=2)

SAR averaged over 10 cm <sup>3</sup> (10 g) of Body TSL	condition	
SAR measured	250 mW input power	1.60 W/kg
SAR for nominal Body TSL parameters	normalized to 1W	6.24 W/kg $\pm$ 16.5 % (k=2)

## Appendix (Additional assessments outside the scope of SCS 0108)

### Antenna Parameters with Head TSL

Impedance, transformed to feed point	49.8 $\Omega$ - 5.9 j $\Omega$
Return Loss	- 24.5 dB

### Antenna Parameters with Body TSL

Impedance, transformed to feed point	45.8 $\Omega$ - 8.2 j $\Omega$
Return Loss	- 20.3 dB

### General Antenna Parameters and Design

Electrical Delay (one direction)	None ns
----------------------------------	---------

After long term use with 100W radiated power, only a slight warming of the dipole near the feedpoint can be measured.

The dipole is made of standard semirigid coaxial cable. The center conductor of the feeding line is directly connected to the second arm of the dipole. The antenna is therefore short-circuited for DC-signals. On some of the dipoles, small end caps are added to the dipole arms in order to improve matching when loaded according to the position as explained in the "Measurement Conditions" paragraph. The SAR data are not affected by this change. The overall dipole length is still according to the Standard.

No excessive force must be applied to the dipole arms, because they might bend or the soldered connections near the feedpoint may be damaged.

### Additional EUT Data

Manufactured by	SPEAG
Manufactured on	August 16, 2006

## DASY5 Validation Report for Head TSL

Date: 13.07.2016

Test Laboratory: SPEAG, Zurich, Switzerland

**DUT: Dipole 835 MHz D835V2; Type: D835V2; Serial: D835V2 - SN:4d047**

Communication System: UID 0 - CW; Frequency: 835 MHz

Medium parameters used:  $f = 835$  MHz;  $\sigma = 0.94$  S/m;  $\epsilon_r = 40.6$ ;  $\rho = 1000$  kg/m<sup>3</sup>

Phantom section: Flat Section

Measurement Standard: DASY5 (IEEE/IEC/ANSI C63.19-2011)

DASY52 Configuration:

- Probe: EX3DV4 - SN7349; ConvF(9.72, 9.72, 9.72); Calibrated: 15.06.2016;
- Sensor-Surface: 1.4mm (Mechanical Surface Detection)
- Electronics: DAE4 Sn601; Calibrated: 30.12.2015
- Phantom: Flat Phantom 4.9L; Type: QD000P49AA; Serial: 1001
- DASY52 52.8.8(1258); SEMCAD X 14.6.10(7372)

### Dipole Calibration for Head Tissue/Pin=250 mW, d=15mm/Zoom Scan (7x7x7)/Cube 0:

Measurement grid: dx=5mm, dy=5mm, dz=5mm

Reference Value = 60.98 V/m; Power Drift = 0.01 dB

Peak SAR (extrapolated) = 3.56 W/kg

**SAR(1 g) = 2.37 W/kg; SAR(10 g) = 1.53 W/kg**

Maximum value of SAR (measured) = 3.17 W/kg



0 dB = 3.17 W/kg = 5.01 dBW/kg

# Impedance Measurement Plot for Head TSL

13 Jul 2016 12:00:27

CH1 S11 1 U FS

1: 49.820  $\Omega$  -5.9316  $\Omega$  32.134 pF

835.000 000 MHz

\*  
De1  
CA

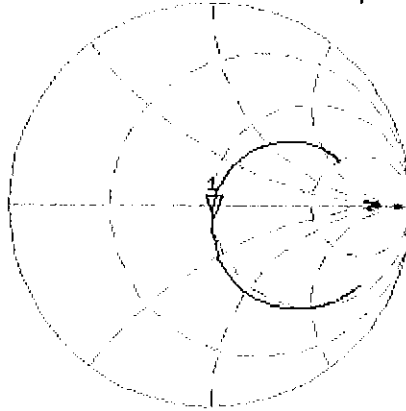

Avg  
16

H1d

CH2 S11 LOG

5 dB/REF -20 dB

1:-24.525 dB

835.000 000 MHz

CA

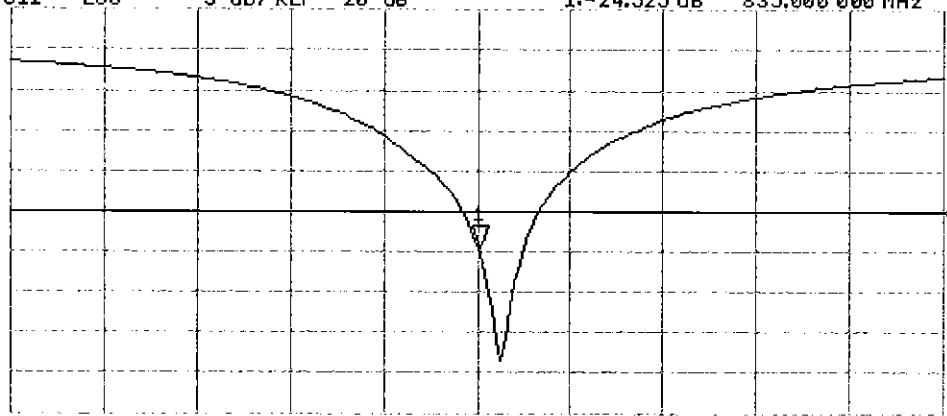

Avg  
16

H1d

START 635.000 000 MHz

STOP 1 035.000 000 MHz

## DASY5 Validation Report for Body TSL

Date: 13.07.2016

Test Laboratory: SPEAG, Zurich, Switzerland

**DUT: Dipole 835 MHz D835V2; Type: D835V2; Serial: D835V2 - SN:4d047**

Communication System: UID 0 - CW; Frequency: 835 MHz

Medium parameters used:  $f = 835$  MHz;  $\sigma = 1.01$  S/m;  $\epsilon_r = 54.9$ ;  $\rho = 1000$  kg/m<sup>3</sup>

Phantom section: Flat Section

Measurement Standard: DASY5 (IEEE/IEC/ANSI C63.19-2011)

DASY52 Configuration:

- Probe: EX3DV4 - SN7349; ConvF(9.73, 9.73, 9.73); Calibrated: 15.06.2016;
- Sensor-Surface: 1.4mm (Mechanical Surface Detection)
- Electronics: DAE4 Sn601; Calibrated: 30.12.2015
- Phantom: Flat Phantom 4.9L; Type: QD000P49AA; Serial: 1001
- DASY52 52.8.8(1258); SEMCAD X 14.6.10(7372)

### Dipole Calibration for Body Tissue/Pin=250 mW, d=15mm/Zoom Scan (7x7x7)/Cube 0:

Measurement grid: dx=5mm, dy=5mm, dz=5mm

Reference Value = 59.88 V/m; Power Drift = -0.01 dB

Peak SAR (extrapolated) = 3.67 W/kg

**SAR(1 g) = 2.47 W/kg; SAR(10 g) = 1.6 W/kg**

Maximum value of SAR (measured) = 3.27 W/kg

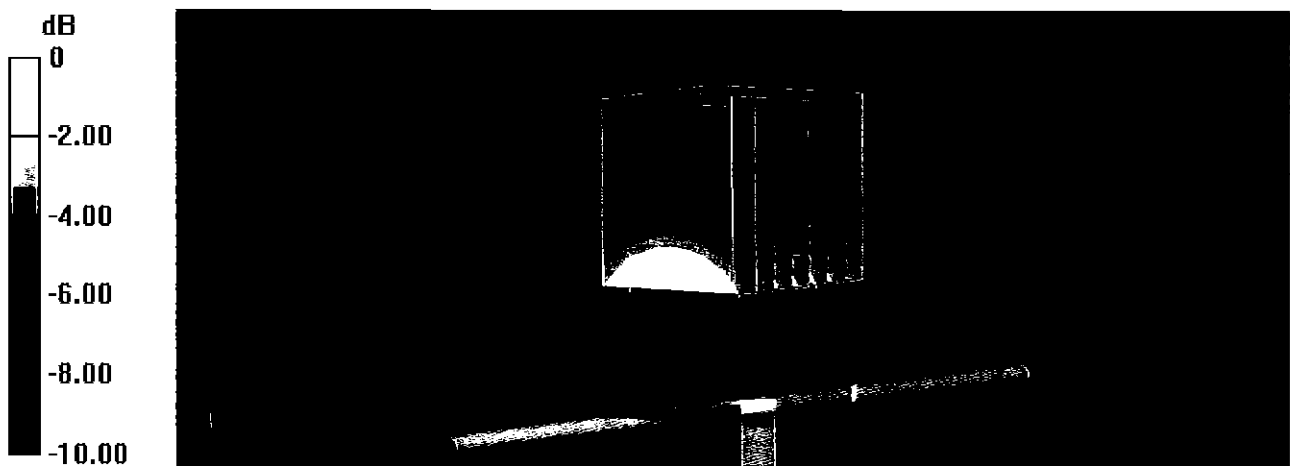

0 dB = 3.27 W/kg = 5.15 dBW/kg



# Impedance Measurement Plot for Body TSL

13 Jul 2016 13:35:41  
CH1 S11 1 U FS 1: 45.793  $\Omega$  -8.1777  $\Omega$  23.308 pF 835.000 000 MHz

\*  
Del

CA

Avg  
16

H1 d

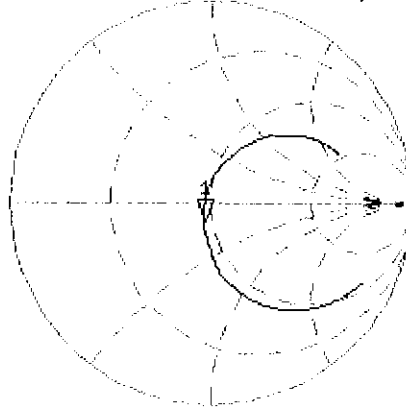

CH2 S11 LOG 5 dB/ REF -20 dB 1: -20.332 dB 835.000 000 MHz

CA

H1 d

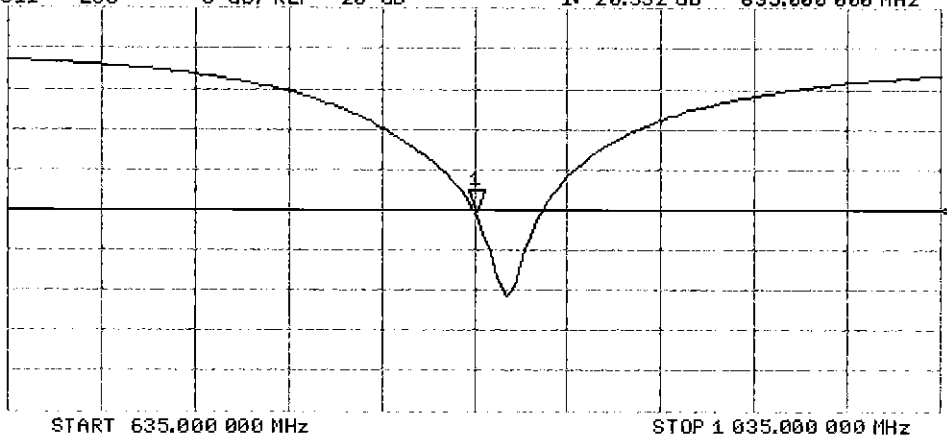



Accredited by the Swiss Accreditation Service (SAS)  
The Swiss Accreditation Service is one of the signatories to the EA  
Multilateral Agreement for the recognition of calibration certificates

Accreditation No.: **SCS 0108**

Client **PC Test**

Certificate No: **D1750V2-1148\_May16**

## CALIBRATION CERTIFICATE

Object **D1750V2 - SN: 1148**

Calibration procedure(s) **QA CAL-05.v9  
Calibration procedure for dipole validation kits above 700 MHz**

Calibration date: **May 09, 2016**

*BNV*  
*5/17/2016*

This calibration certificate documents the traceability to national standards, which realize the physical units of measurements (SI).  
The measurements and the uncertainties with confidence probability are given on the following pages and are part of the certificate.

All calibrations have been conducted in the closed laboratory facility: environment temperature (22 ± 3)°C and humidity < 70%.

Calibration Equipment used (M&TE critical for calibration)

Primary Standards	ID #	Cal Date (Certificate No.)	Scheduled Calibration
Power meter NRP	SN: 104778	06-Apr-16 (No. 217-02288/02289)	Apr-17
Power sensor NRP-Z91	SN: 103244	06-Apr-16 (No. 217-02288)	Apr-17
Power sensor NRP-Z91	SN: 103245	06-Apr-16 (No. 217-02289)	Apr-17
Reference 20 dB Attenuator	SN: 5058 (20k)	05-Apr-16 (No. 217-02292)	Apr-17
Type-N mismatch combination	SN: 5047.2 / 06327	05-Apr-16 (No. 217-02295)	Apr-17
Reference Probe EX3DV4	SN: 7349	31-Dec-15 (No. EX3-7349_Dec15)	Dec-16
DAE4	SN: 601	30-Dec-15 (No. DAE4-601_Dec15)	Dec-16
Secondary Standards	ID #	Check Date (in house)	Scheduled Check
Power meter EPM-442A	SN: GB37480704	07-Oct-15 (No. 217-02222)	In house check: Oct-16
Power sensor HP 8481A	SN: US37292783	07-Oct-15 (No. 217-02222)	In house check: Oct-16
Power sensor HP 8481A	SN: MY41092317	07-Oct-15 (No. 217-02223)	In house check: Oct-16
RF generator R&S SMT-06	SN: 100972	15-Jun-15 (in house check Jun-15)	In house check: Oct-16
Network Analyzer HP 8753E	SN: US37390585	18-Oct-01 (in house check Oct-15)	In house check: Oct-16

Calibrated by: **Michael Weber**      Function: **Laboratory Technician**

Signature  
*M. Weber*

Approved by: **Katja Pokovic**      Technical Manager

*Katja Pokovic*

Issued: May 11, 2016

This calibration certificate shall not be reproduced except in full without written approval of the laboratory.



Accredited by the Swiss Accreditation Service (SAS)  
The Swiss Accreditation Service is one of the signatories to the EA  
Multilateral Agreement for the recognition of calibration certificates

Accreditation No.: **SCS 0108**

**Glossary:**

TSL	tissue simulating liquid
ConvF	sensitivity in TSL / NORM x,y,z
N/A	not applicable or not measured

**Calibration is Performed According to the Following Standards:**

- a) IEEE Std 1528-2013, "IEEE Recommended Practice for Determining the Peak Spatial-Averaged Specific Absorption Rate (SAR) in the Human Head from Wireless Communications Devices: Measurement Techniques", June 2013
- b) IEC 62209-1, "Procedure to measure the Specific Absorption Rate (SAR) for hand-held devices used in close proximity to the ear (frequency range of 300 MHz to 3 GHz)", February 2005
- c) IEC 62209-2, "Procedure to determine the Specific Absorption Rate (SAR) for wireless communication devices used in close proximity to the human body (frequency range of 30 MHz to 6 GHz)", March 2010
- d) KDB 865664, "SAR Measurement Requirements for 100 MHz to 6 GHz"

**Additional Documentation:**

- e) DASY4/5 System Handbook

**Methods Applied and Interpretation of Parameters:**

- *Measurement Conditions:* Further details are available from the Validation Report at the end of the certificate. All figures stated in the certificate are valid at the frequency indicated.
- *Antenna Parameters with TSL:* The dipole is mounted with the spacer to position its feed point exactly below the center marking of the flat phantom section, with the arms oriented parallel to the body axis.
- *Feed Point Impedance and Return Loss:* These parameters are measured with the dipole positioned under the liquid filled phantom. The impedance stated is transformed from the measurement at the SMA connector to the feed point. The Return Loss ensures low reflected power. No uncertainty required.
- *Electrical Delay:* One-way delay between the SMA connector and the antenna feed point. No uncertainty required.
- *SAR measured:* SAR measured at the stated antenna input power.
- *SAR normalized:* SAR as measured, normalized to an input power of 1 W at the antenna connector.
- *SAR for nominal TSL parameters:* The measured TSL parameters are used to calculate the nominal SAR result.

The reported uncertainty of measurement is stated as the standard uncertainty of measurement multiplied by the coverage factor  $k=2$ , which for a normal distribution corresponds to a coverage probability of approximately 95%.

## Measurement Conditions

DASY system configuration, as far as not given on page 1.

DASY Version	DASY5	V52.8.8
Extrapolation	Advanced Extrapolation	
Phantom	Modular Flat Phantom	
Distance Dipole Center - TSL	10 mm	with Spacer
Zoom Scan Resolution	dx, dy, dz = 5 mm	
Frequency	1750 MHz $\pm$ 1 MHz	

## Head TSL parameters

The following parameters and calculations were applied.

	Temperature	Permittivity	Conductivity
Nominal Head TSL parameters	22.0 °C	40.1	1.37 mho/m
Measured Head TSL parameters	(22.0 $\pm$ 0.2) °C	39.7 $\pm$ 6 %	1.36 mho/m $\pm$ 6 %
Head TSL temperature change during test	< 0.5 °C	----	----

## SAR result with Head TSL

SAR averaged over 1 cm <sup>3</sup> (1 g) of Head TSL	Condition	
SAR measured	250 mW input power	9.03 W/kg
SAR for nominal Head TSL parameters	normalized to 1W	<b>36.2 W/kg <math>\pm</math> 17.0 % (k=2)</b>

SAR averaged over 10 cm <sup>3</sup> (10 g) of Head TSL	condition	
SAR measured	250 mW input power	4.78 W/kg
SAR for nominal Head TSL parameters	normalized to 1W	<b>19.1 W/kg <math>\pm</math> 16.5 % (k=2)</b>

## Body TSL parameters

The following parameters and calculations were applied.

	Temperature	Permittivity	Conductivity
Nominal Body TSL parameters	22.0 °C	53.4	1.49 mho/m
Measured Body TSL parameters	(22.0 $\pm$ 0.2) °C	53.8 $\pm$ 6 %	1.50 mho/m $\pm$ 6 %
Body TSL temperature change during test	< 0.5 °C	----	----

## SAR result with Body TSL

SAR averaged over 1 cm <sup>3</sup> (1 g) of Body TSL	Condition	
SAR measured	250 mW input power	9.30 W/kg
SAR for nominal Body TSL parameters	normalized to 1W	<b>37.1 W/kg <math>\pm</math> 17.0 % (k=2)</b>

SAR averaged over 10 cm <sup>3</sup> (10 g) of Body TSL	condition	
SAR measured	250 mW input power	4.93 W/kg
SAR for nominal Body TSL parameters	normalized to 1W	<b>19.7 W/kg <math>\pm</math> 16.5 % (k=2)</b>

## Appendix (Additional assessments outside the scope of SCS 0108)

### Antenna Parameters with Head TSL

Impedance, transformed to feed point	49.9 $\Omega$ - 0.7 j $\Omega$
Return Loss	- 43.3 dB

### Antenna Parameters with Body TSL

Impedance, transformed to feed point	46.2 $\Omega$ - 1.4 j $\Omega$
Return Loss	- 27.5 dB

### General Antenna Parameters and Design

Electrical Delay (one direction)	1.221 ns
----------------------------------	----------

After long term use with 100W radiated power, only a slight warming of the dipole near the feedpoint can be measured.

The dipole is made of standard semirigid coaxial cable. The center conductor of the feeding line is directly connected to the second arm of the dipole. The antenna is therefore short-circuited for DC-signals. On some of the dipoles, small end caps are added to the dipole arms in order to improve matching when loaded according to the position as explained in the "Measurement Conditions" paragraph. The SAR data are not affected by this change. The overall dipole length is still according to the Standard.

No excessive force must be applied to the dipole arms, because they might bend or the soldered connections near the feedpoint may be damaged.

### Additional EUT Data

Manufactured by	SPEAG
Manufactured on	September 30, 2014

# DASY5 Validation Report for Head TSL

Date: 09.05.2016

Test Laboratory: SPEAG, Zurich, Switzerland

**DUT: Dipole 1750 MHz; Type: D1750V2; Serial: D1750V2 - SN: 1148**

Communication System: UID 0 - CW; Frequency: 1750 MHz

Medium parameters used:  $f = 1750$  MHz;  $\sigma = 1.36$  S/m;  $\epsilon_r = 39.7$ ;  $\rho = 1000$  kg/m<sup>3</sup>

Phantom section: Flat Section

Measurement Standard: DASY5 (IEEE/IEC/ANSI C63.19-2011)

DASY52 Configuration:

- Probe: EX3DV4 - SN7349; ConvF(8.54, 8.54, 8.54); Calibrated: 31.12.2015;
- Sensor-Surface: 1.4mm (Mechanical Surface Detection)
- Electronics: DAE4 Sn601; Calibrated: 30.12.2015
- Phantom: Flat Phantom 5.0 (front); Type: QD000P50AA; Serial: 1001
- DASY52 52.8.8(1258); SEMCAD X 14.6.10(7372)

## Dipole Calibration for Head Tissue/Pin=250 mW, d=10mm/Zoom Scan (7x7x7)/Cube 0:

Measurement grid: dx=5mm, dy=5mm, dz=5mm

Reference Value = 103.5 V/m; Power Drift = 0.04 dB

Peak SAR (extrapolated) = 16.7 W/kg

**SAR(1 g) = 9.03 W/kg; SAR(10 g) = 4.78 W/kg**

Maximum value of SAR (measured) = 13.6 W/kg

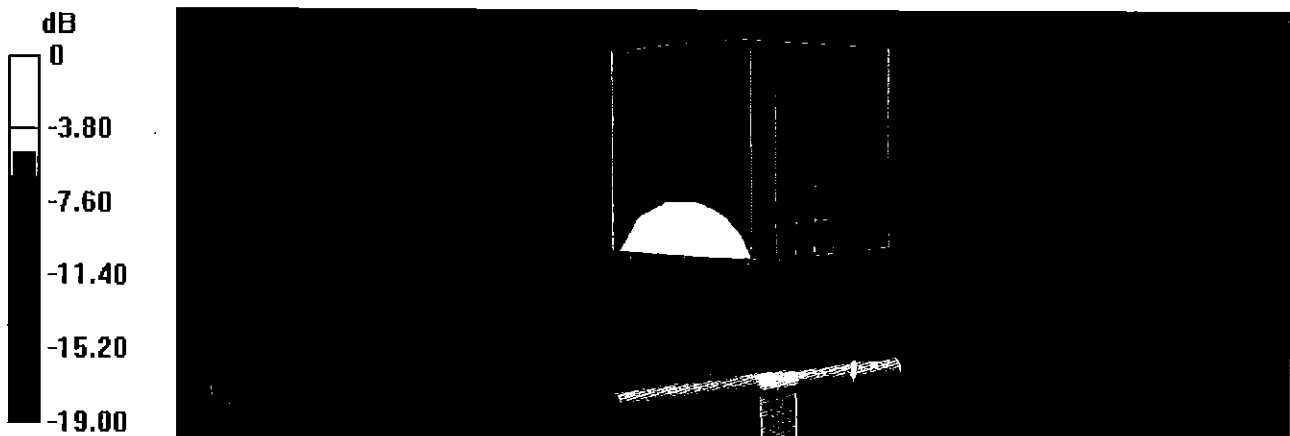

0 dB = 13.6 W/kg = 11.34 dBW/kg

# Impedance Measurement Plot for Head TSL

9 May 2016 11:49:12  
[CH1] S11 1 U FS 1: 49.912  $\Omega$  -679.69 m $\Omega$  133.81 pF 1 750.000 000 MHz

\*  
De1  
CA

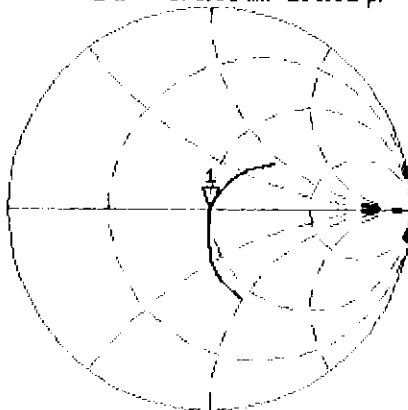

Avg  
16  
H1d

CH2 S11 LOG 5 dB/REF -20 dB 1: -43.269 dB 1 750.000 000 MHz

De1  
CA

Avg  
16  
H1d

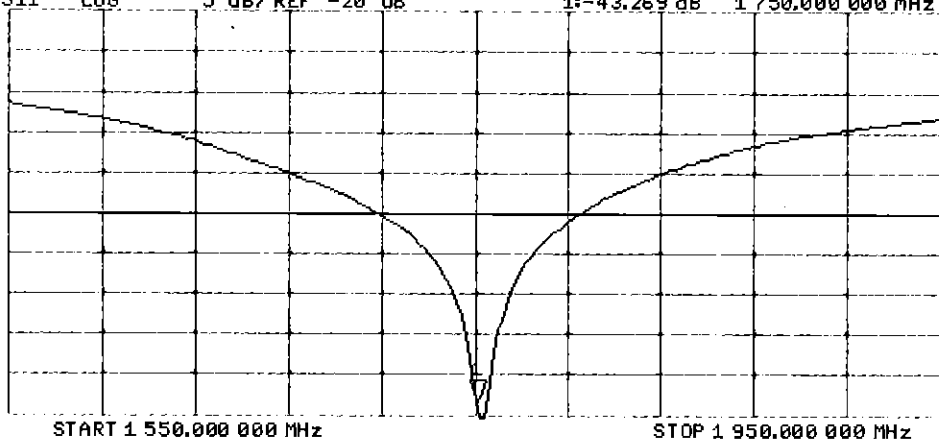

# DASY5 Validation Report for Body TSL

Date: 09.05.2016

Test Laboratory: SPEAG, Zurich, Switzerland

**DUT: Dipole 1750 MHz; Type: D1750V2; Serial: D1750V2 - SN: 1148**

Communication System: UID 0 - CW; Frequency: 1750 MHz

Medium parameters used:  $f = 1750$  MHz;  $\sigma = 1.5$  S/m;  $\epsilon_r = 53.8$ ;  $\rho = 1000$  kg/m<sup>3</sup>

Phantom section: Flat Section

Measurement Standard: DASY5 (IEEE/IEC/ANSI C63.19-2011)

DASY52 Configuration:

- Probe: EX3DV4 - SN7349; ConvF(8.25, 8.25, 8.25); Calibrated: 31.12.2015;
- Sensor-Surface: 1.4mm (Mechanical Surface Detection)
- Electronics: DAE4 Sn601; Calibrated: 30.12.2015
- Phantom: Flat Phantom 5.0 (back); Type: QD000P50AA; Serial: 1002
- DASY52 52.8.8(1258); SEMCAD X 14.6.10(7372)

## Dipole Calibration for Body Tissue/Pin=250 mW, d=10mm/Zoom Scan (7x7x7)/Cube 0:

Measurement grid: dx=5mm, dy=5mm, dz=5mm

Reference Value = 102.0 V/m; Power Drift = -0.08 dB

Peak SAR (extrapolated) = 16.6 W/kg

**SAR(1 g) = 9.3 W/kg; SAR(10 g) = 4.93 W/kg**

Maximum value of SAR (measured) = 14.1 W/kg

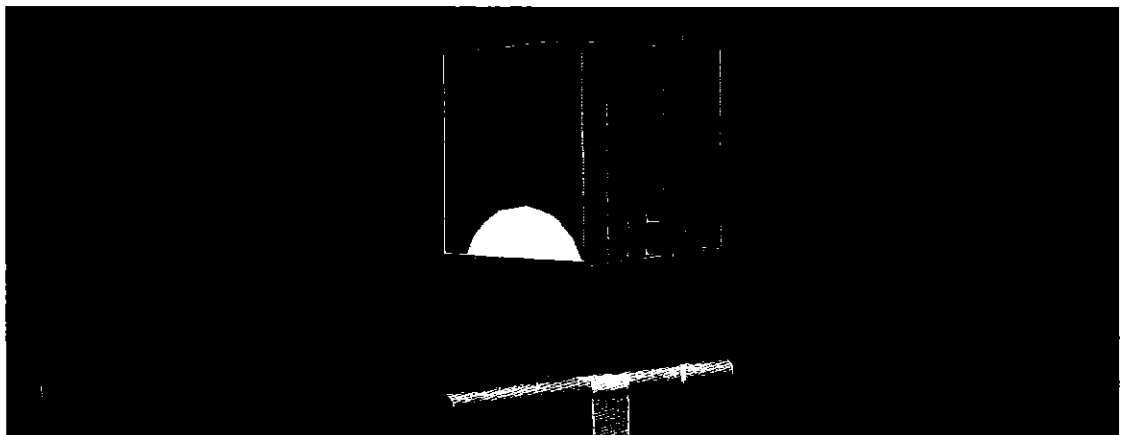
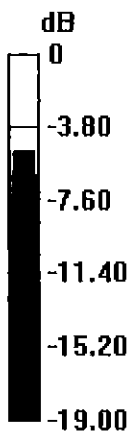

0 dB = 14.1 W/kg = 11.49 dBW/kg



# Impedance Measurement Plot for Body TSL

9 May 2016 11:48:41  
[CH1] S11 1 U FS 1: 46.205  $\Omega$  -1.4258  $\Omega$  63.787 pF 1 750.000 000 MHz

\*  
De1

CA

Avg  
16

H1d

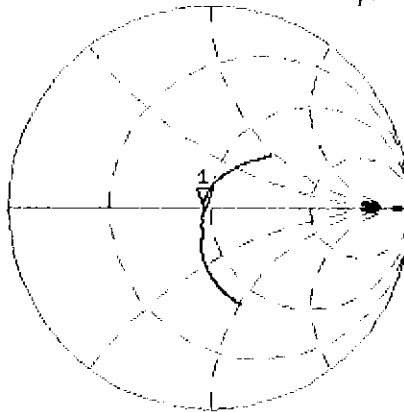

CH2 S11 LOG 5 dB/REF -20 dB 1:-27.503 dB 1 750.000 000 MHz

De1

CA

Avg  
16

H1d

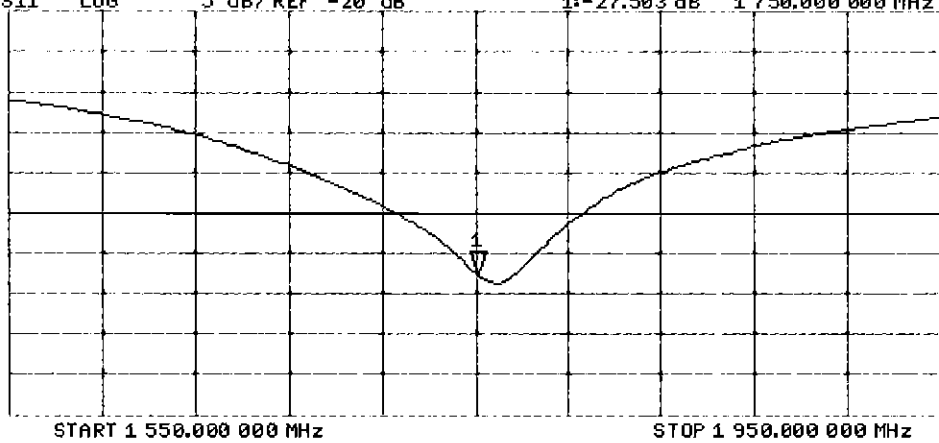



Accredited by the Swiss Accreditation Service (SAS)  
The Swiss Accreditation Service is one of the signatories to the EA  
Multilateral Agreement for the recognition of calibration certificates

Accreditation No.: **SCS 0108**

Client **PC Test**

Certificate No: **D1900V2-5d149\_Jul16**

## CALIBRATION CERTIFICATE

Object **D1900V2 - SN:5d149**

Calibration procedure(s) **QA CAL-05.v9**  
**Calibration procedure for dipole validation kits above 700 MHz**

Calibration date: **July 15, 2016**

*PNV*  
*07/27/2016*

This calibration certificate documents the traceability to national standards, which realize the physical units of measurements (SI).  
The measurements and the uncertainties with confidence probability are given on the following pages and are part of the certificate.

All calibrations have been conducted in the closed laboratory facility: environment temperature ( $22 \pm 3$ )°C and humidity < 70%.

Calibration Equipment used (M&TE critical for calibration)

Primary Standards	ID #	Cal Date (Certificate No.)	Scheduled Calibration
Power meter NRP	SN: 104778	06-Apr-16 (No. 217-02288/02289)	Apr-17
Power sensor NRP-Z91	SN: 103244	06-Apr-16 (No. 217-02288)	Apr-17
Power sensor NRP-Z91	SN: 103245	06-Apr-16 (No. 217-02289)	Apr-17
Reference 20 dB Attenuator	SN: 5058 (20k)	05-Apr-16 (No. 217-02292)	Apr-17
Type-N mismatch combination	SN: 5047.2 / 06327	05-Apr-16 (No. 217-02295)	Apr-17
Reference Probe EX3DV4	SN: 7349	15-Jun-16 (No. EX3-7349_Jun16)	Jun-17
DAE4	SN: 601	30-Dec-15 (No. DAE4-601_Dec15)	Dec-16

Secondary Standards	ID #	Check Date (in house)	Scheduled Check
Power meter EPM-442A	SN: GB37480704	07-Oct-15 (No. 217-02222)	In house check: Oct-16
Power sensor HP 8481A	SN: US37292783	07-Oct-15 (No. 217-02222)	In house check: Oct-16
Power sensor HP 8481A	SN: MY41092317	07-Oct-15 (No. 217-02223)	In house check: Oct-16
RF generator R&S SMT-06	SN: 100972	15-Jun-15 (in house check Jun-15)	In house check: Oct-16
Network Analyzer HP 8753E	SN: US37390585	18-Oct-01 (in house check Oct-15)	In house check: Oct-16

Calibrated by: **Claudio Leubler**      Name: Claudio Leubler      Function: Laboratory Technician

Approved by: **Katja Pokovic**      Name: Katja Pokovic      Function: Technical Manager

Signature  
*[Handwritten Signature]*

*[Handwritten Signature]*

Issued: July 19, 2016

This calibration certificate shall not be reproduced except in full without written approval of the laboratory.



Accredited by the Swiss Accreditation Service (SAS)  
The Swiss Accreditation Service is one of the signatories to the EA  
Multilateral Agreement for the recognition of calibration certificates

Accreditation No.: **SCS 0108**

### Glossary:

TSL	tissue simulating liquid
ConvF	sensitivity in TSL / NORM x,y,z
N/A	not applicable or not measured

### Calibration is Performed According to the Following Standards:

- IEEE Std 1528-2013, "IEEE Recommended Practice for Determining the Peak Spatial-Averaged Specific Absorption Rate (SAR) in the Human Head from Wireless Communications Devices: Measurement Techniques", June 2013
- IEC 62209-1, "Procedure to measure the Specific Absorption Rate (SAR) for hand-held devices used in close proximity to the ear (frequency range of 300 MHz to 3 GHz)", February 2005
- IEC 62209-2, "Procedure to determine the Specific Absorption Rate (SAR) for wireless communication devices used in close proximity to the human body (frequency range of 30 MHz to 6 GHz)", March 2010
- KDB 865664, "SAR Measurement Requirements for 100 MHz to 6 GHz"

### Additional Documentation:

- DASY4/5 System Handbook

### Methods Applied and Interpretation of Parameters:

- Measurement Conditions:** Further details are available from the Validation Report at the end of the certificate. All figures stated in the certificate are valid at the frequency indicated.
- Antenna Parameters with TSL:** The dipole is mounted with the spacer to position its feed point exactly below the center marking of the flat phantom section, with the arms oriented parallel to the body axis.
- Feed Point Impedance and Return Loss:** These parameters are measured with the dipole positioned under the liquid filled phantom. The impedance stated is transformed from the measurement at the SMA connector to the feed point. The Return Loss ensures low reflected power. No uncertainty required.
- Electrical Delay:** One-way delay between the SMA connector and the antenna feed point. No uncertainty required.
- SAR measured:** SAR measured at the stated antenna input power.
- SAR normalized:** SAR as measured, normalized to an input power of 1 W at the antenna connector.
- SAR for nominal TSL parameters:** The measured TSL parameters are used to calculate the nominal SAR result.

The reported uncertainty of measurement is stated as the standard uncertainty of measurement multiplied by the coverage factor  $k=2$ , which for a normal distribution corresponds to a coverage probability of approximately 95%.

## Measurement Conditions

DASY system configuration, as far as not given on page 1.

DASY Version	DASY5	V52.8.8
Extrapolation	Advanced Extrapolation	
Phantom	Modular Flat Phantom	
Distance Dipole Center - TSL	10 mm	with Spacer
Zoom Scan Resolution	dx, dy, dz = 5 mm	
Frequency	1900 MHz $\pm$ 1 MHz	

## Head TSL parameters

The following parameters and calculations were applied.

	Temperature	Permittivity	Conductivity
Nominal Head TSL parameters	22.0 °C	40.0	1.40 mho/m
Measured Head TSL parameters	(22.0 $\pm$ 0.2) °C	39.8 $\pm$ 6 %	1.38 mho/m $\pm$ 6 %
Head TSL temperature change during test	< 0.5 °C	----	----

## SAR result with Head TSL

SAR averaged over 1 cm <sup>3</sup> (1 g) of Head TSL	Condition	
SAR measured	250 mW input power	9.96 W/kg
SAR for nominal Head TSL parameters	normalized to 1W	40.1 W/kg $\pm$ 17.0 % (k=2)

SAR averaged over 10 cm <sup>3</sup> (10 g) of Head TSL	condition	
SAR measured	250 mW input power	5.23 W/kg
SAR for nominal Head TSL parameters	normalized to 1W	21.0 W/kg $\pm$ 16.5 % (k=2)

## Body TSL parameters

The following parameters and calculations were applied.

	Temperature	Permittivity	Conductivity
Nominal Body TSL parameters	22.0 °C	53.3	1.52 mho/m
Measured Body TSL parameters	(22.0 $\pm$ 0.2) °C	52.7 $\pm$ 6 %	1.51 mho/m $\pm$ 6 %
Body TSL temperature change during test	< 0.5 °C	----	----

## SAR result with Body TSL

SAR averaged over 1 cm <sup>3</sup> (1 g) of Body TSL	Condition	
SAR measured	250 mW input power	9.95 W/kg
SAR for nominal Body TSL parameters	normalized to 1W	39.9 W/kg $\pm$ 17.0 % (k=2)

SAR averaged over 10 cm <sup>3</sup> (10 g) of Body TSL	condition	
SAR measured	250 mW input power	5.28 W/kg
SAR for nominal Body TSL parameters	normalized to 1W	21.1 W/kg $\pm$ 16.5 % (k=2)

## Appendix (Additional assessments outside the scope of SCS 0108)

### Antenna Parameters with Head TSL

Impedance, transformed to feed point	52.4 $\Omega$ + 5.5 j $\Omega$
Return Loss	- 24.6 dB

### Antenna Parameters with Body TSL

Impedance, transformed to feed point	49.6 $\Omega$ + 7.0 j $\Omega$
Return Loss	- 23.1 dB

### General Antenna Parameters and Design

Electrical Delay (one direction)	1.197 ns
----------------------------------	----------

After long term use with 100W radiated power, only a slight warming of the dipole near the feedpoint can be measured.

The dipole is made of standard semirigid coaxial cable. The center conductor of the feeding line is directly connected to the second arm of the dipole. The antenna is therefore short-circuited for DC-signals. On some of the dipoles, small end caps are added to the dipole arms in order to improve matching when loaded according to the position as explained in the "Measurement Conditions" paragraph. The SAR data are not affected by this change. The overall dipole length is still according to the Standard.

No excessive force must be applied to the dipole arms, because they might bend or the soldered connections near the feedpoint may be damaged.

### Additional EUT Data

Manufactured by	SPEAG
Manufactured on	March 11, 2011

## DASY5 Validation Report for Head TSL

Date: 15.07.2016

Test Laboratory: SPEAG, Zurich, Switzerland

**DUT: Dipole 1900 MHz; Type: D1900V2; Serial: D1900V2 - SN:5d149**

Communication System: UID 0 - CW; Frequency: 1900 MHz

Medium parameters used:  $f = 1900$  MHz;  $\sigma = 1.38$  S/m;  $\epsilon_r = 39.8$ ;  $\rho = 1000$  kg/m<sup>3</sup>

Phantom section: Flat Section

Measurement Standard: DASY5 (IEEE/IEC/ANSI C63.19-2011)

DASY52 Configuration:

- Probe: EX3DV4 - SN7349; ConvF(7.99, 7.99, 7.99); Calibrated: 15.06.2016;
- Sensor-Surface: 1.4mm (Mechanical Surface Detection)
- Electronics: DAE4 Sn601; Calibrated: 30.12.2015
- Phantom: Flat Phantom 5.0 (front); Type: QD000P50AA; Serial: 1001
- DASY52 52.8.8(1258); SEMCAD X 14.6.10(7372)

**Dipole Calibration for Head Tissue/Pin=250 mW, d=10mm/Zoom Scan (7x7x7)/Cube 0:**

Measurement grid: dx=5mm, dy=5mm, dz=5mm

Reference Value = 107.5 V/m; Power Drift = -0.02 dB

Peak SAR (extrapolated) = 18.7 W/kg

**SAR(1 g) = 9.96 W/kg; SAR(10 g) = 5.23 W/kg**

Maximum value of SAR (measured) = 15.5 W/kg

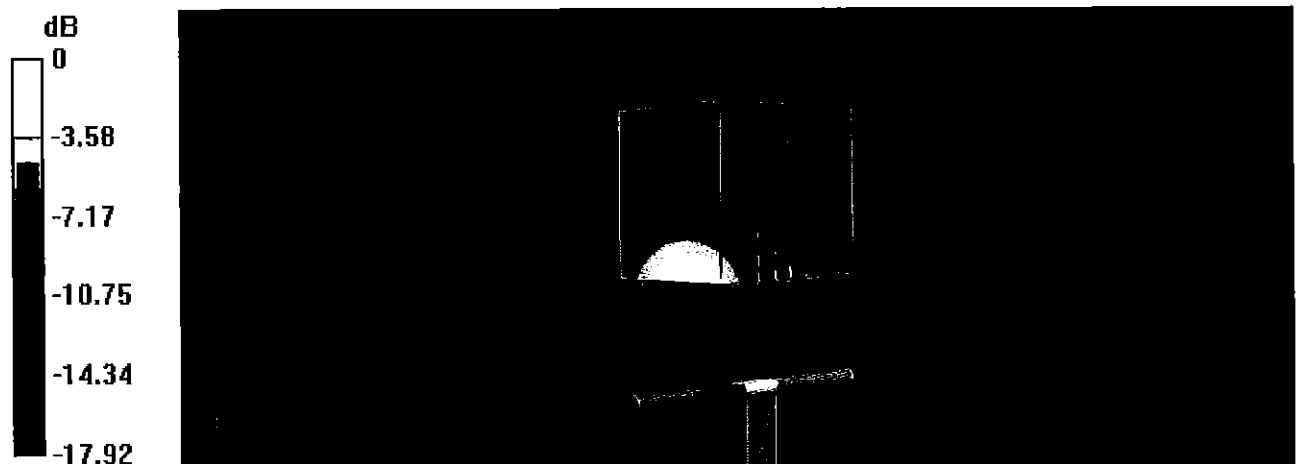

0 dB = 15.5 W/kg = 11.90 dBW/kg

# Impedance Measurement Plot for Head TSL

15 Jul 2016 14:30:53

[CH1] S11 1 U FS 1: 52.393  $\Omega$  5.5488  $\Omega$  454.80  $\mu$ H 1 900.000 000 MHz

\*  
De1  
CA  
Avg  
16  
H1d

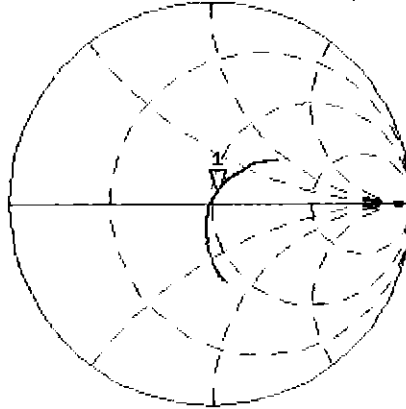

CH2 S11 LOG 5 dB/REF -20 dB 1:-24.579 dB 1 900.000 000 MHz

CA  
H1d

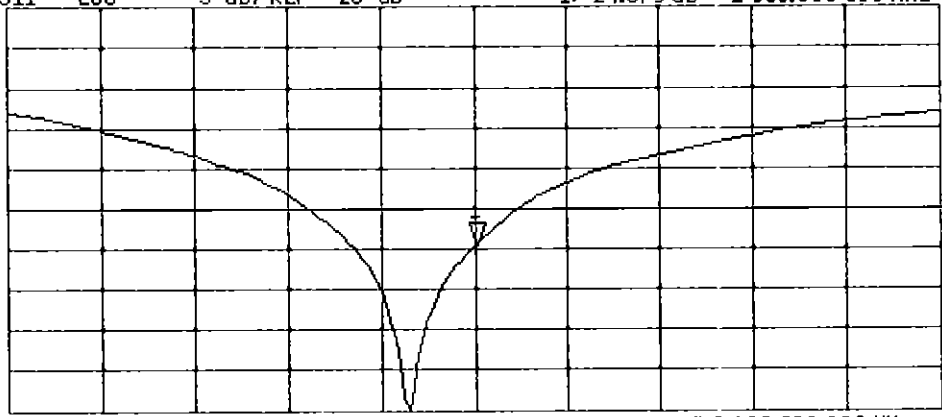

START 1 700.000 000 MHz

STOP 2 100.000 000 MHz

## DASY5 Validation Report for Body TSL

Date: 13.07.2016

Test Laboratory: SPEAG, Zurich, Switzerland

**DUT: Dipole 1900 MHz D1900V2; Type: D1900V2; Serial: D1900V2 - SN:5d149**

Communication System: UID 0 - CW; Frequency: 1900 MHz

Medium parameters used:  $f = 1900$  MHz;  $\sigma = 1.51$  S/m;  $\epsilon_r = 52.7$ ;  $\rho = 1000$  kg/m<sup>3</sup>

Phantom section: Flat Section

Measurement Standard: DASY5 (IEEE/IEC/ANSI C63.19-2011)

DASY52 Configuration:

- Probe: EX3DV4 - SN7349; ConvF(8.03, 8.03, 8.03); Calibrated: 15.06.2016;
- Sensor-Surface: 1.4mm (Mechanical Surface Detection)
- Electronics: DAE4 Sn601; Calibrated: 30.12.2015
- Phantom: Flat Phantom 5.0 (back); Type: QD000P50AA; Serial: 1002
- DASY52 52.8.8(1222); SEMCAD X 14.6.10(7372)

### Dipole Calibration for Body Tissue/Pin=250 mW, d=10mm/Zoom Scan (7x7x7)/Cube 0:

Measurement grid: dx=5mm, dy=5mm, dz=5mm

Reference Value = 103.9 V/m; Power Drift = 0.00 dB

Peak SAR (extrapolated) = 17.4 W/kg

**SAR(1 g) = 9.95 W/kg; SAR(10 g) = 5.28 W/kg**

Maximum value of SAR (measured) = 14.9 W/kg

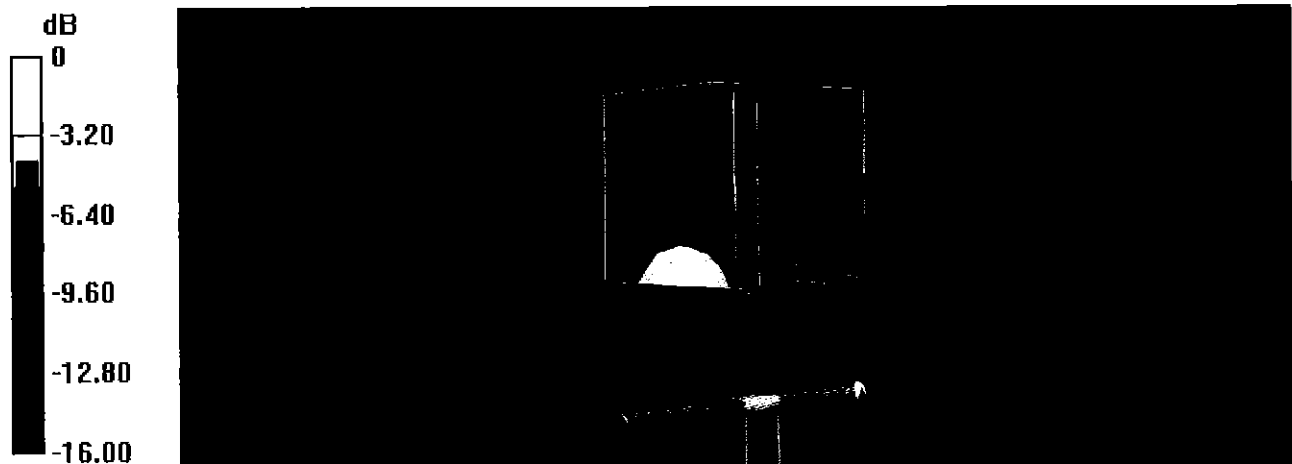

0 dB = 14.9 W/kg = 11.73 dBW/kg



# Impedance Measurement Plot for Body TSL

13 Jul 2016 16:29:36

CH1 S11 1 U FS 1: 49.625  $\Omega$  6.9922  $\Omega$  585.71 pF 1 900,000 000 MHz

\*  
De1  
Cor  
Avg  
16  
H1d

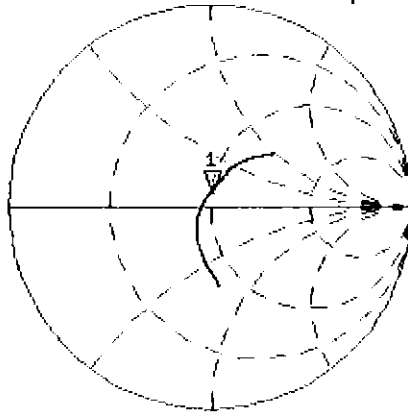

CH2 S11 LOG 5 dB/REF -20 dB 1:-23.087 dB 1 900,000 000 MHz

Cor  
Avg  
16  
H1d

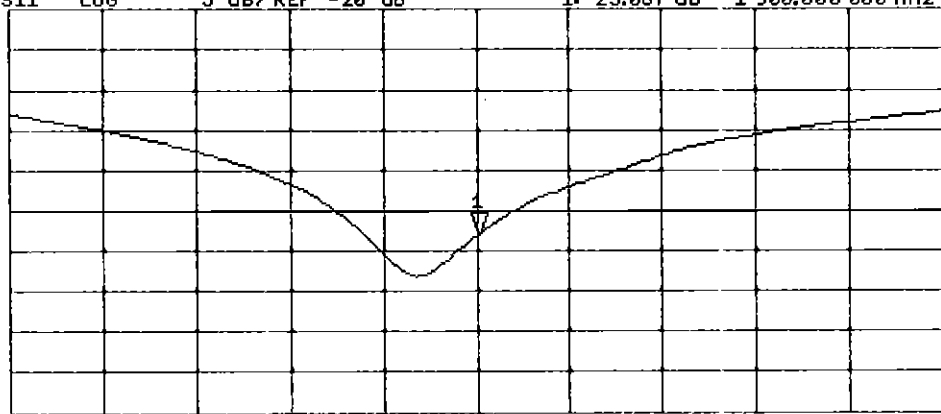

START 1 700,000 000 MHz

STOP 2 100,000 000 MHz



Accredited by the Swiss Accreditation Service (SAS)  
The Swiss Accreditation Service is one of the signatories to the EA  
Multilateral Agreement for the recognition of calibration certificates

Accreditation No.: **SCS 0108**

Client **PC Test**

Certificate No: **D2450V2-797\_Sep16**

## CALIBRATION CERTIFICATE

Object **D2450V2 - SN:797**

Calibration procedure(s) **QA CAL-05.v9**  
**Calibration procedure for dipole validation kits above 700 MHz**

*BNV*  
*09-28-2016*

Calibration date: **September 13, 2016**

This calibration certificate documents the traceability to national standards, which realize the physical units of measurements (SI).  
The measurements and the uncertainties with confidence probability are given on the following pages and are part of the certificate.

All calibrations have been conducted in the closed laboratory facility: environment temperature (22 ± 3)°C and humidity < 70%.

Calibration Equipment used (M&TE critical for calibration)

Primary Standards	ID #	Cal Date (Certificate No.)	Scheduled Calibration
Power meter NRP	SN: 104778	06-Apr-16 (No. 217-02288/02289)	Apr-17
Power sensor NRP-Z91	SN: 103244	06-Apr-16 (No. 217-02288)	Apr-17
Power sensor NRP-Z91	SN: 103245	06-Apr-16 (No. 217-02289)	Apr-17
Reference 20 dB Attenuator	SN: 5058 (20k)	05-Apr-16 (No. 217-02292)	Apr-17
Type-N mismatch combination	SN: 5047.2 / 06327	05-Apr-16 (No. 217-02295)	Apr-17
Reference Probe EX3DV4	SN: 7349	15-Jun-16 (No. EX3-7349_Jun16)	Jun-17
DAE4	SN: 601	30-Dec-15 (No. DAE4-601_Dec15)	Dec-16

Secondary Standards	ID #	Check Date (in house)	Scheduled Check
Power meter EPM-442A	SN: GB37480704	07-Oct-15 (No. 217-02222)	In house check: Oct-16
Power sensor HP 8481A	SN: US37292783	07-Oct-15 (No. 217-02222)	In house check: Oct-16
Power sensor HP 8481A	SN: MY41092317	07-Oct-15 (No. 217-02223)	In house check: Oct-16
RF generator R&S SMT-06	SN: 100972	15-Jun-15 (in house check Jun-15)	In house check: Oct-16
Network Analyzer HP 8753E	SN: US37390585	18-Oct-01 (in house check Oct-15)	In house check: Oct-16

Calibrated by: **Jeton Kastrati**      Function: **Laboratory Technician**

Approved by: **Katja Pokovic**      Technical Manager

Signature

Issued: September 13, 2016

This calibration certificate shall not be reproduced except in full without written approval of the laboratory.



Accredited by the Swiss Accreditation Service (SAS)  
The Swiss Accreditation Service is one of the signatories to the EA  
Multilateral Agreement for the recognition of calibration certificates

Accreditation No.: **SCS 0108**

**Glossary:**

TSL	tissue simulating liquid
ConvF	sensitivity in TSL / NORM x,y,z
N/A	not applicable or not measured

**Calibration is Performed According to the Following Standards:**

- IEEE Std 1528-2013, "IEEE Recommended Practice for Determining the Peak Spatial-Averaged Specific Absorption Rate (SAR) in the Human Head from Wireless Communications Devices: Measurement Techniques", June 2013
- IEC 62209-1, "Procedure to measure the Specific Absorption Rate (SAR) for hand-held devices used in close proximity to the ear (frequency range of 300 MHz to 3 GHz)", February 2005
- IEC 62209-2, "Procedure to determine the Specific Absorption Rate (SAR) for wireless communication devices used in close proximity to the human body (frequency range of 30 MHz to 6 GHz)", March 2010
- KDB 865664, "SAR Measurement Requirements for 100 MHz to 6 GHz"

**Additional Documentation:**

- DASY4/5 System Handbook

**Methods Applied and Interpretation of Parameters:**

- Measurement Conditions:* Further details are available from the Validation Report at the end of the certificate. All figures stated in the certificate are valid at the frequency indicated.
- Antenna Parameters with TSL:* The dipole is mounted with the spacer to position its feed point exactly below the center marking of the flat phantom section, with the arms oriented parallel to the body axis.
- Feed Point Impedance and Return Loss:* These parameters are measured with the dipole positioned under the liquid filled phantom. The impedance stated is transformed from the measurement at the SMA connector to the feed point. The Return Loss ensures low reflected power. No uncertainty required.
- Electrical Delay:* One-way delay between the SMA connector and the antenna feed point. No uncertainty required.
- SAR measured:* SAR measured at the stated antenna input power.
- SAR normalized:* SAR as measured, normalized to an input power of 1 W at the antenna connector.
- SAR for nominal TSL parameters:* The measured TSL parameters are used to calculate the nominal SAR result.

The reported uncertainty of measurement is stated as the standard uncertainty of measurement multiplied by the coverage factor  $k=2$ , which for a normal distribution corresponds to a coverage probability of approximately 95%.

## Measurement Conditions

DASY system configuration, as far as not given on page 1.

DASY Version	DASY5	V52.8.8
Extrapolation	Advanced Extrapolation	
Phantom	Modular Flat Phantom	
Distance Dipole Center - TSL	10 mm	with Spacer
Zoom Scan Resolution	dx, dy, dz = 5 mm	
Frequency	2450 MHz ± 1 MHz	

## Head TSL parameters

The following parameters and calculations were applied.

	Temperature	Permittivity	Conductivity
Nominal Head TSL parameters	22.0 °C	39.2	1.80 mho/m
Measured Head TSL parameters	(22.0 ± 0.2) °C	37.9 ± 6 %	1.88 mho/m ± 6 %
Head TSL temperature change during test	< 0.5 °C	----	----

## SAR result with Head TSL

SAR averaged over 1 cm <sup>3</sup> (1 g) of Head TSL	Condition	
SAR measured	250 mW input power	13.4 W/kg
SAR for nominal Head TSL parameters	normalized to 1W	52.1 W/kg ± 17.0 % (k=2)

SAR averaged over 10 cm <sup>3</sup> (10 g) of Head TSL	condition	
SAR measured	250 mW input power	6.26 W/kg
SAR for nominal Head TSL parameters	normalized to 1W	24.6 W/kg ± 16.5 % (k=2)

## Body TSL parameters

The following parameters and calculations were applied.

	Temperature	Permittivity	Conductivity
Nominal Body TSL parameters	22.0 °C	52.7	1.95 mho/m
Measured Body TSL parameters	(22.0 ± 0.2) °C	51.6 ± 6 %	2.04 mho/m ± 6 %
Body TSL temperature change during test	< 0.5 °C	----	----

## SAR result with Body TSL

SAR averaged over 1 cm <sup>3</sup> (1 g) of Body TSL	Condition	
SAR measured	250 mW input power	13.0 W/kg
SAR for nominal Body TSL parameters	normalized to 1W	50.7 W/kg ± 17.0 % (k=2)

SAR averaged over 10 cm <sup>3</sup> (10 g) of Body TSL	condition	
SAR measured	250 mW input power	6.13 W/kg
SAR for nominal Body TSL parameters	normalized to 1W	24.2 W/kg ± 16.5 % (k=2)

## Appendix (Additional assessments outside the scope of SCS 0108)

### Antenna Parameters with Head TSL

Impedance, transformed to feed point	53.8 $\Omega$ + 6.0 j $\Omega$
Return Loss	- 23.3 dB

### Antenna Parameters with Body TSL

Impedance, transformed to feed point	50.8 $\Omega$ + 8.0 j $\Omega$
Return Loss	- 22.0 dB

### General Antenna Parameters and Design

Electrical Delay (one direction)	1.160 ns
----------------------------------	----------

After long term use with 100W radiated power, only a slight warming of the dipole near the feedpoint can be measured.

The dipole is made of standard semirigid coaxial cable. The center conductor of the feeding line is directly connected to the second arm of the dipole. The antenna is therefore short-circuited for DC-signals. On some of the dipoles, small end caps are added to the dipole arms in order to improve matching when loaded according to the position as explained in the "Measurement Conditions" paragraph. The SAR data are not affected by this change. The overall dipole length is still according to the Standard.

No excessive force must be applied to the dipole arms, because they might bend or the soldered connections near the feedpoint may be damaged.

### Additional EUT Data

Manufactured by	SPEAG
Manufactured on	January 24, 2006

## DASY5 Validation Report for Head TSL

Date: 13.09.2016

Test Laboratory: SPEAG, Zurich, Switzerland

**DUT: Dipole 2450 MHz; Type: D2450V2; Serial: D2450V2 - SN:797**

Communication System: UID 0 - CW; Frequency: 2450 MHz

Medium parameters used:  $f = 2450$  MHz;  $\sigma = 1.88$  S/m;  $\epsilon_r = 37.9$ ;  $\rho = 1000$  kg/m<sup>3</sup>

Phantom section: Flat Section

Measurement Standard: DASY5 (IEEE/IEC/ANSI C63.19-2011)

DASY52 Configuration:

- Probe: EX3DV4 - SN7349; ConvF(7.72, 7.72, 7.72); Calibrated: 15.06.2016;
- Sensor-Surface: 1.4mm (Mechanical Surface Detection)
- Electronics: DAE4 Sn601; Calibrated: 30.12.2015
- Phantom: Flat Phantom 5.0 (front); Type: QD000P50AA; Serial: 1001
- DASY52 52.8.8(1258); SEMCAD X 14.6.10(7372)

### Dipole Calibration for Head Tissue/Pin=250 mW, d=10mm/Zoom Scan (7x7x7)/Cube 0:

Measurement grid: dx=5mm, dy=5mm, dz=5mm

Reference Value = 113.4 V/m; Power Drift = -0.02 dB

Peak SAR (extrapolated) = 26.9 W/kg

**SAR(1 g) = 13.4 W/kg; SAR(10 g) = 6.26 W/kg**

Maximum value of SAR (measured) = 21.9 W/kg

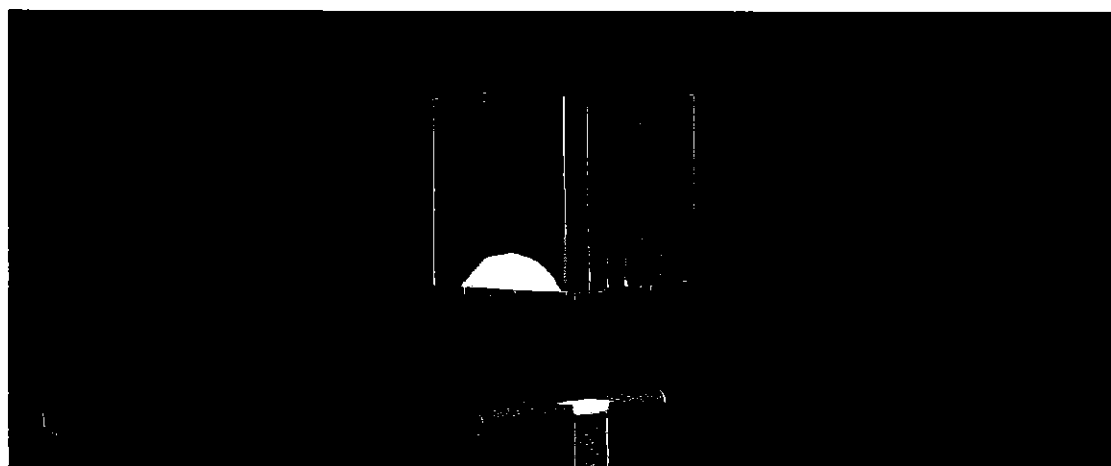
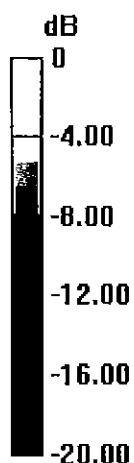

0 dB = 21.9 W/kg = 13.40 dBW/kg

# Impedance Measurement Plot for Head TSL

12 Sep 2016 12:42:03  
CH1 S11 1 U FS 2: 53.771  $\Omega$  6.0234  $\Omega$  391.29  $\mu$ H 2 450.000 000 MHz

\*  
De1  
CA

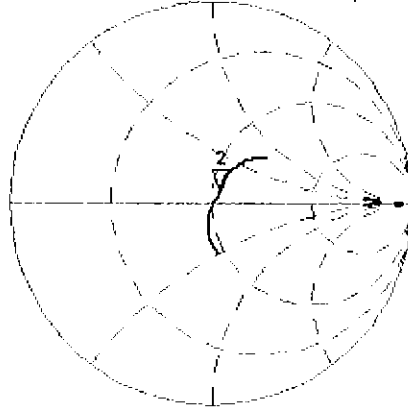

Avg  
16

H1d

CH2 S11 LOG 5 dB/REF -20 dB 2:-23.300 dB 2 450.000 000 MHz

CA

Avg  
16

H1d

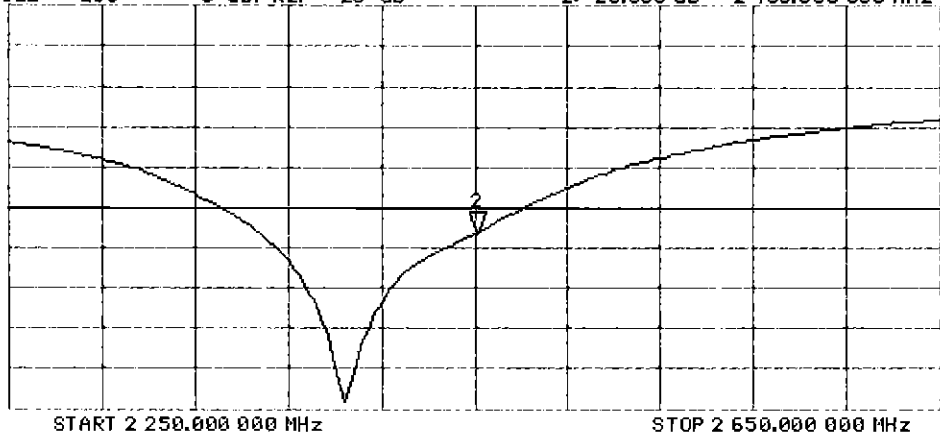

## DASY5 Validation Report for Body TSL

Date: 13.09.2016

Test Laboratory: SPEAG, Zurich, Switzerland

**DUT: Dipole 2450 MHz; Type: D2450V2; Serial: D2450V2 - SN:797**

Communication System: UID 0 - CW; Frequency: 2450 MHz

Medium parameters used:  $f = 2450$  MHz;  $\sigma = 2.04$  S/m;  $\epsilon_r = 51.6$ ;  $\rho = 1000$  kg/m<sup>3</sup>

Phantom section: Flat Section

Measurement Standard: DASY5 (IEEE/IEC/ANSI C63.19-2011)

DASY52 Configuration:

- Probe: EX3DV4 - SN7349; ConvF(7.79, 7.79, 7.79); Calibrated: 15.06.2016;
- Sensor-Surface: 1.4mm (Mechanical Surface Detection)
- Electronics: DAE4 Sn601; Calibrated: 30.12.2015
- Phantom: Flat Phantom 5.0 (back); Type: QD000P50AA; Serial: 1002
- DASY52 52.8.8(1258); SEMCAD X 14.6.10(7372)

### Dipole Calibration for Body Tissue/Pin=250 mW, d=10mm/Zoom Scan (7x7x7)/Cube 0:

Measurement grid: dx=5mm, dy=5mm, dz=5mm

Reference Value = 106.5 V/m; Power Drift = -0.04 dB

Peak SAR (extrapolated) = 25.6 W/kg

**SAR(1 g) = 13 W/kg; SAR(10 g) = 6.13 W/kg**

Maximum value of SAR (measured) = 21.2 W/kg

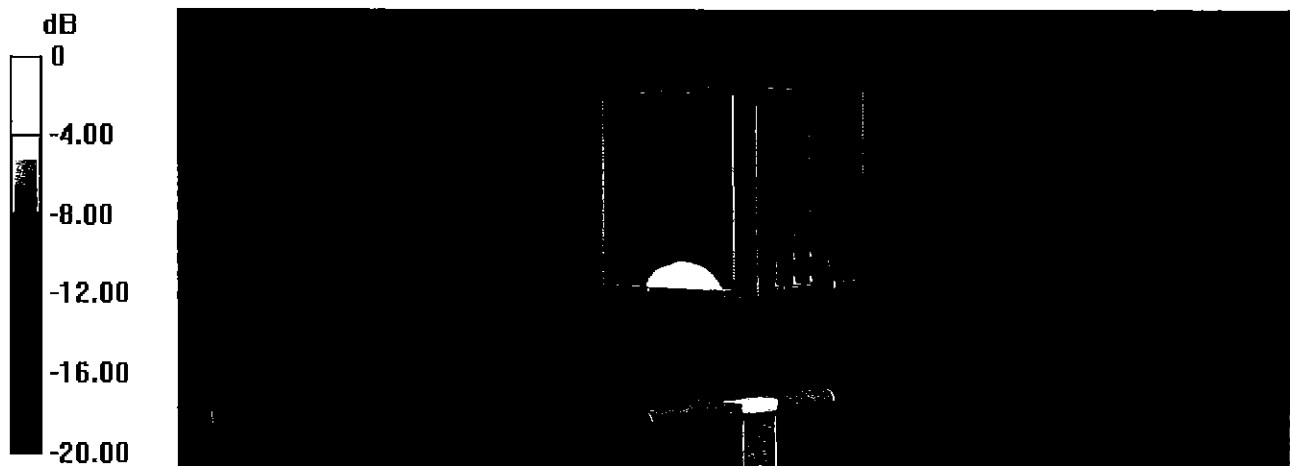

0 dB = 21.2 W/kg = 13.26 dBW/kg



# Impedance Measurement Plot for Body TSL

12 Sep 2016 12:40:39

CH1 S11 1 U FS 2: 50.842  $\Omega$  7.9531  $\Omega$  516.64  $\mu\text{H}$  2 450.000 000 MHz

\*  
De1  
CA  
Avg  
16  
H1d

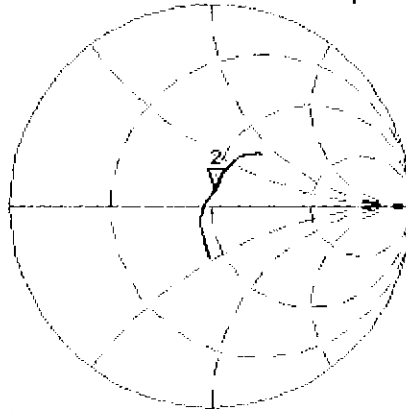

CH2 S11 LOG 5 dB/REF -20 dB 2:-22.037 dB 2 450.000 000 MHz

CA  
Avg  
16  
H1d

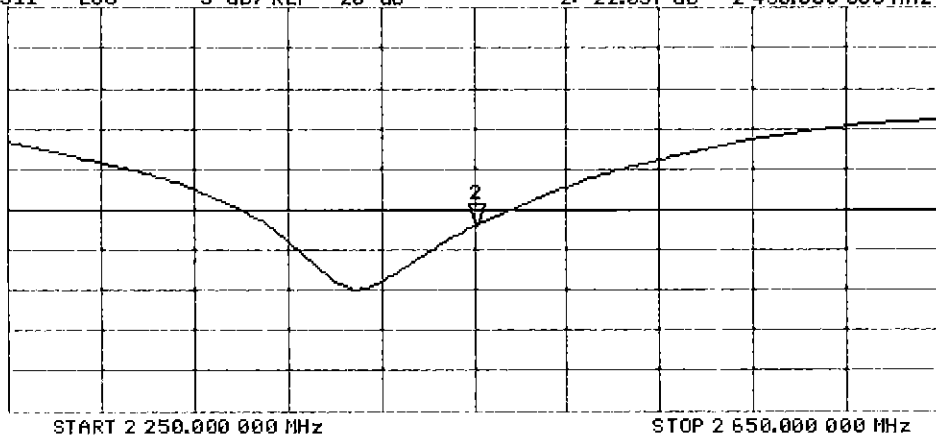



Accredited by the Swiss Accreditation Service (SAS)  
The Swiss Accreditation Service is one of the signatories to the EA  
Multilateral Agreement for the recognition of calibration certificates

Accreditation No.: **SCS 0108**

Client **PC Test**

Certificate No: **D5GHzV2-1191\_Sep16**

## CALIBRATION CERTIFICATE

Object **D5GHzV2 - SN:1191**

Calibration procedure(s) **QA CAL-22.v2**  
**Calibration procedure for dipole validation kits between 3-6 GHz**

*BNV*  
*09-28-2016*

Calibration date: **September 21, 2016**

This calibration certificate documents the traceability to national standards, which realize the physical units of measurements (SI).  
The measurements and the uncertainties with confidence probability are given on the following pages and are part of the certificate.

All calibrations have been conducted in the closed laboratory facility: environment temperature ( $22 \pm 3$ )°C and humidity < 70%.

Calibration Equipment used (M&TE critical for calibration)

Primary Standards	ID #	Cal Date (Certificate No.)	Scheduled Calibration
Power meter NRP	SN: 104778	06-Apr-16 (No. 217-02288/02289)	Apr-17
Power sensor NRP-Z91	SN: 103244	06-Apr-16 (No. 217-02288)	Apr-17
Power sensor NRP-Z91	SN: 103245	06-Apr-16 (No. 217-02289)	Apr-17
Reference 20 dB Attenuator	SN: 5058 (20k)	05-Apr-16 (No. 217-02292)	Apr-17
Type-N mismatch combination	SN: 5047.2 / 06327	05-Apr-16 (No. 217-02295)	Apr-17
Reference Probe EX3DV4	SN: 3503	30-Jun-16 (No. EX3-3503_Jun16)	Jun-17
DAE4	SN: 601	30-Dec-15 (No. DAE4-601_Dec15)	Dec-16
Secondary Standards	ID #	Check Date (in house)	Scheduled Check
Power meter EPM-442A	SN: GB37480704	07-Oct-15 (No. 217-02222)	In house check: Oct-16
Power sensor HP 8481A	SN: US37292783	07-Oct-15 (No. 217-02222)	In house check: Oct-16
Power sensor HP 8481A	SN: MY41092317	07-Oct-15 (No. 217-02223)	In house check: Oct-16
RF generator R&S SMT-06	SN: 100972	15-Jun-15 (in house check Jun-15)	In house check: Oct-16
Network Analyzer HP 8753E	SN: US37390585	18-Oct-01 (in house check Oct-15)	In house check: Oct-16

Calibrated by: **Leif Klysner**      Name: **Leif Klysner**      Function: **Laboratory Technician**

Approved by: **Katja Pokovic**      Name: **Katja Pokovic**      Function: **Technical Manager**

Signature  
*Leif Klysner*  
*Katja Pokovic*

Issued: September 22, 2016

This calibration certificate shall not be reproduced except in full without written approval of the laboratory.



Accredited by the Swiss Accreditation Service (SAS)

The Swiss Accreditation Service is one of the signatories to the EA Multilateral Agreement for the recognition of calibration certificates

Accreditation No.: **SCS 0108**

**Glossary:**

TSL	tissue simulating liquid
ConvF	sensitivity in TSL / NORM x,y,z
N/A	not applicable or not measured

**Calibration is Performed According to the Following Standards:**

- IEEE Std 1528-2013, "IEEE Recommended Practice for Determining the Peak Spatial-Averaged Specific Absorption Rate (SAR) in the Human Head from Wireless Communications Devices: Measurement Techniques", June 2013
- IEC 62209-2, "Procedure to determine the Specific Absorption Rate (SAR) for wireless communication devices used in close proximity to the human body (frequency range of 30 MHz to 6 GHz)", March 2010
- KDB 865664, "SAR Measurement Requirements for 100 MHz to 6 GHz"

**Additional Documentation:**

- DASY4/5 System Handbook

**Methods Applied and Interpretation of Parameters:**

- Measurement Conditions:** Further details are available from the Validation Report at the end of the certificate. All figures stated in the certificate are valid at the frequency indicated.
- Antenna Parameters with TSL:** The dipole is mounted with the spacer to position its feed point exactly below the center marking of the flat phantom section, with the arms oriented parallel to the body axis.
- Feed Point Impedance and Return Loss:** These parameters are measured with the dipole positioned under the liquid filled phantom. The impedance stated is transformed from the measurement at the SMA connector to the feed point. The Return Loss ensures low reflected power. No uncertainty required.
- Electrical Delay:** One-way delay between the SMA connector and the antenna feed point. No uncertainty required.
- SAR measured:** SAR measured at the stated antenna input power.
- SAR normalized:** SAR as measured, normalized to an input power of 1 W at the antenna connector.
- SAR for nominal TSL parameters:** The measured TSL parameters are used to calculate the nominal SAR result.

The reported uncertainty of measurement is stated as the standard uncertainty of measurement multiplied by the coverage factor  $k=2$ , which for a normal distribution corresponds to a coverage probability of approximately 95%.

## Measurement Conditions

DASY system configuration, as far as not given on page 1.

<b>DASY Version</b>	DASY5	V52.8.8
<b>Extrapolation</b>	Advanced Extrapolation	
<b>Phantom</b>	Modular Flat Phantom V5.0	
<b>Distance Dipole Center - TSL</b>	10 mm	with Spacer
<b>Zoom Scan Resolution</b>	dx, dy = 4.0 mm, dz = 1.4 mm	Graded Ratio = 1.4 (Z direction)
<b>Frequency</b>	5250 MHz ± 1 MHz 5600 MHz ± 1 MHz 5750 MHz ± 1 MHz	

## Head TSL parameters at 5250 MHz

The following parameters and calculations were applied.

	Temperature	Permittivity	Conductivity
<b>Nominal Head TSL parameters</b>	22.0 °C	35.9	4.71 mho/m
<b>Measured Head TSL parameters</b>	(22.0 ± 0.2) °C	34.5 ± 6 %	4.59 mho/m ± 6 %
<b>Head TSL temperature change during test</b>	< 0.5 °C	----	----

## SAR result with Head TSL at 5250 MHz

<b>SAR averaged over 1 cm<sup>3</sup> (1 g) of Head TSL</b>	Condition	
SAR measured	100 mW input power	7.96 W/kg
SAR for nominal Head TSL parameters	normalized to 1W	<b>78.9 W/kg ± 19.9 % (k=2)</b>

<b>SAR averaged over 10 cm<sup>3</sup> (10 g) of Head TSL</b>	condition	
SAR measured	100 mW input power	2.29 W/kg
SAR for nominal Head TSL parameters	normalized to 1W	<b>22.6 W/kg ± 19.5 % (k=2)</b>

### Head TSL parameters at 5600 MHz

The following parameters and calculations were applied.

	Temperature	Permittivity	Conductivity
Nominal Head TSL parameters	22.0 °C	35.5	5.07 mho/m
Measured Head TSL parameters	(22.0 ± 0.2) °C	34.0 ± 6 %	4.93 mho/m ± 6 %
Head TSL temperature change during test	< 0.5 °C	----	----

### SAR result with Head TSL at 5600 MHz

SAR averaged over 1 cm <sup>3</sup> (1 g) of Head TSL	Condition	
SAR measured	100 mW input power	8.45 W/kg
SAR for nominal Head TSL parameters	normalized to 1W	<b>83.6 W / kg ± 19.9 % (k=2)</b>

SAR averaged over 10 cm <sup>3</sup> (10 g) of Head TSL	condition	
SAR measured	100 mW input power	2.41 W/kg
SAR for nominal Head TSL parameters	normalized to 1W	<b>23.8 W/kg ± 19.5 % (k=2)</b>

### Head TSL parameters at 5750 MHz

The following parameters and calculations were applied.

	Temperature	Permittivity	Conductivity
Nominal Head TSL parameters	22.0 °C	35.4	5.22 mho/m
Measured Head TSL parameters	(22.0 ± 0.2) °C	33.8 ± 6 %	5.08 mho/m ± 6 %
Head TSL temperature change during test	< 0.5 °C	----	----

### SAR result with Head TSL at 5750 MHz

SAR averaged over 1 cm <sup>3</sup> (1 g) of Head TSL	Condition	
SAR measured	100 mW input power	7.99 W/kg
SAR for nominal Head TSL parameters	normalized to 1W	<b>79.1 W/kg ± 19.9 % (k=2)</b>

SAR averaged over 10 cm <sup>3</sup> (10 g) of Head TSL	condition	
SAR measured	100 mW input power	2.27 W/kg
SAR for nominal Head TSL parameters	normalized to 1W	<b>22.4 W/kg ± 19.5 % (k=2)</b>

### Body TSL parameters at 5250 MHz

The following parameters and calculations were applied.

	Temperature	Permittivity	Conductivity
Nominal Body TSL parameters	22.0 °C	48.9	5.36 mho/m
Measured Body TSL parameters	(22.0 ± 0.2) °C	47.4 ± 6 %	5.52 mho/m ± 6 %
Body TSL temperature change during test	< 0.5 °C	----	----

### SAR result with Body TSL at 5250 MHz

SAR averaged over 1 cm <sup>3</sup> (1 g) of Body TSL	Condition	
SAR measured	100 mW input power	7.74 W/kg
SAR for nominal Body TSL parameters	normalized to 1W	77.0 W/kg ± 19.9 % (k=2)

SAR averaged over 10 cm <sup>3</sup> (10 g) of Body TSL	condition	
SAR measured	100 mW input power	2.17 W/kg
SAR for nominal Body TSL parameters	normalized to 1W	21.6 W/kg ± 19.5 % (k=2)

### Body TSL parameters at 5600 MHz

The following parameters and calculations were applied.

	Temperature	Permittivity	Conductivity
Nominal Body TSL parameters	22.0 °C	48.5	5.77 mho/m
Measured Body TSL parameters	(22.0 ± 0.2) °C	46.8 ± 6 %	6.00 mho/m ± 6 %
Body TSL temperature change during test	< 0.5 °C	----	----

### SAR result with Body TSL at 5600 MHz

SAR averaged over 1 cm <sup>3</sup> (1 g) of Body TSL	Condition	
SAR measured	100 mW input power	7.96 W/kg
SAR for nominal Body TSL parameters	normalized to 1W	79.2 W/kg ± 19.9 % (k=2)

SAR averaged over 10 cm <sup>3</sup> (10 g) of Body TSL	condition	
SAR measured	100 mW input power	2.24 W/kg
SAR for nominal Body TSL parameters	normalized to 1W	22.2 W/kg ± 19.5 % (k=2)

### Body TSL parameters at 5750 MHz

The following parameters and calculations were applied.

	Temperature	Permittivity	Conductivity
Nominal Body TSL parameters	22.0 °C	48.3	5.94 mho/m
Measured Body TSL parameters	(22.0 ± 0.2) °C	46.5 ± 6 %	6.21 mho/m ± 6 %
Body TSL temperature change during test	< 0.5 °C	----	----

### SAR result with Body TSL at 5750 MHz

SAR averaged over 1 cm <sup>3</sup> (1 g) of Body TSL	Condition	
SAR measured	100 mW input power	7.65 W/kg
SAR for nominal Body TSL parameters	normalized to 1W	76.1 W/kg ± 19.9 % (k=2)

SAR averaged over 10 cm <sup>3</sup> (10 g) of Body TSL	condition	
SAR measured	100 mW input power	2.14 W/kg
SAR for nominal Body TSL parameters	normalized to 1W	21.2 W/kg ± 19.5 % (k=2)

## Appendix (Additional assessments outside the scope of SCS 0108)

### Antenna Parameters with Head TSL at 5250 MHz

Impedance, transformed to feed point	55.7 $\Omega$ - 4.3 j $\Omega$
Return Loss	- 23.4 dB

### Antenna Parameters with Head TSL at 5600 MHz

Impedance, transformed to feed point	58.3 $\Omega$ - 3.2 j $\Omega$
Return Loss	- 21.8 dB

### Antenna Parameters with Head TSL at 5750 MHz

Impedance, transformed to feed point	58.1 $\Omega$ + 4.8 j $\Omega$
Return Loss	- 21.2 dB

### Antenna Parameters with Body TSL at 5250 MHz

Impedance, transformed to feed point	56.1 $\Omega$ - 3.7 j $\Omega$
Return Loss	- 23.4 dB

### Antenna Parameters with Body TSL at 5600 MHz

Impedance, transformed to feed point	58.9 $\Omega$ - 1.7 j $\Omega$
Return Loss	- 21.7 dB

### Antenna Parameters with Body TSL at 5750 MHz

Impedance, transformed to feed point	59.5 $\Omega$ + 6.9 j $\Omega$
Return Loss	- 19.4 dB

### General Antenna Parameters and Design

Electrical Delay (one direction)	1.204 ns
----------------------------------	----------

After long term use with 100W radiated power, only a slight warming of the dipole near the feedpoint can be measured.

The dipole is made of standard semirigid coaxial cable. The center conductor of the feeding line is directly connected to the second arm of the dipole. The antenna is therefore short-circuited for DC-signals. On some of the dipoles, small end caps are added to the dipole arms in order to improve matching when loaded according to the position as explained in the "Measurement Conditions" paragraph. The SAR data are not affected by this change. The overall dipole length is still according to the Standard.

No excessive force must be applied to the dipole arms, because they might bend or the soldered connections near the feedpoint may be damaged.

### Additional EUT Data

Manufactured by	SPEAG
Manufactured on	August 28, 2003



## DASY5 Validation Report for Head TSL

Date: 21.09.2016

Test Laboratory: SPEAG, Zurich, Switzerland

**DUT: Dipole D5GHzV2; Type: D5GHzV2; Serial: D5GHzV2 - SN:1191**

Communication System: UID 0 - CW; Frequency: 5250 MHz, Frequency: 5600 MHz, Frequency: 5750 MHz  
Medium parameters used:  $f = 5250$  MHz;  $\sigma = 4.59$  S/m;  $\epsilon_r = 34.5$ ;  $\rho = 1000$  kg/m<sup>3</sup>, Medium parameters used:  $f = 5600$  MHz;  $\sigma = 4.93$  S/m;  $\epsilon_r = 34$ ;  $\rho = 1000$  kg/m<sup>3</sup>, Medium parameters used:  $f = 5750$  MHz;  $\sigma = 5.08$  S/m;  $\epsilon_r = 33.8$ ;  $\rho = 1000$  kg/m<sup>3</sup>

Phantom section: Flat Section

Measurement Standard: DASY5 (IEEE/IEC/ANSI C63.19-2011)

DASY52 Configuration:

- Probe: EX3DV4 - SN3503; ConvF(5.42, 5.42, 5.42); Calibrated: 30.06.2016, ConvF(4.89, 4.89, 4.89); Calibrated: 30.06.2016, ConvF(4.85, 4.85, 4.85); Calibrated: 30.06.2016;
- Sensor-Surface: 1.4mm (Mechanical Surface Detection)
- Electronics: DAE4 Sn601; Calibrated: 30.12.2015
- Phantom: Flat Phantom 5.0 (front); Type: QD000P50AA; Serial: 1001
- DASY52 52.8.8(1258); SEMCAD X 14.6.10(7372)

**Dipole Calibration for Head Tissue/Pin=100mW, dist=10mm, f=5250 MHz/Zoom Scan, dist=1.4mm (8x8x7)/Cube 0:** Measurement grid: dx=4mm, dy=4mm, dz=1.4mm

Reference Value = 68.49 V/m; Power Drift = 0.01 dB

Peak SAR (extrapolated) = 28.6 W/kg

**SAR(1 g) = 7.96 W/kg; SAR(10 g) = 2.29 W/kg**

Maximum value of SAR (measured) = 18.2 W/kg

**Dipole Calibration for Head Tissue/Pin=100mW, dist=10mm, f=5600 MHz/Zoom Scan, dist=1.4mm (8x8x7)/Cube 0:** Measurement grid: dx=4mm, dy=4mm, dz=1.4mm

Reference Value = 69.34 V/m; Power Drift = -0.00 dB

Peak SAR (extrapolated) = 32.9 W/kg

**SAR(1 g) = 8.45 W/kg; SAR(10 g) = 2.41 W/kg**

Maximum value of SAR (measured) = 20.0 W/kg

**Dipole Calibration for Head Tissue/Pin=100mW, dist=10mm, f=5750 MHz/Zoom Scan, dist=1.4mm (8x8x7)/Cube 0:** Measurement grid: dx=4mm, dy=4mm, dz=1.4mm

Reference Value = 67.15 V/m; Power Drift = 0.02 dB

Peak SAR (extrapolated) = 32.3 W/kg

**SAR(1 g) = 7.99 W/kg; SAR(10 g) = 2.27 W/kg**

Maximum value of SAR (measured) = 19.3 W/kg

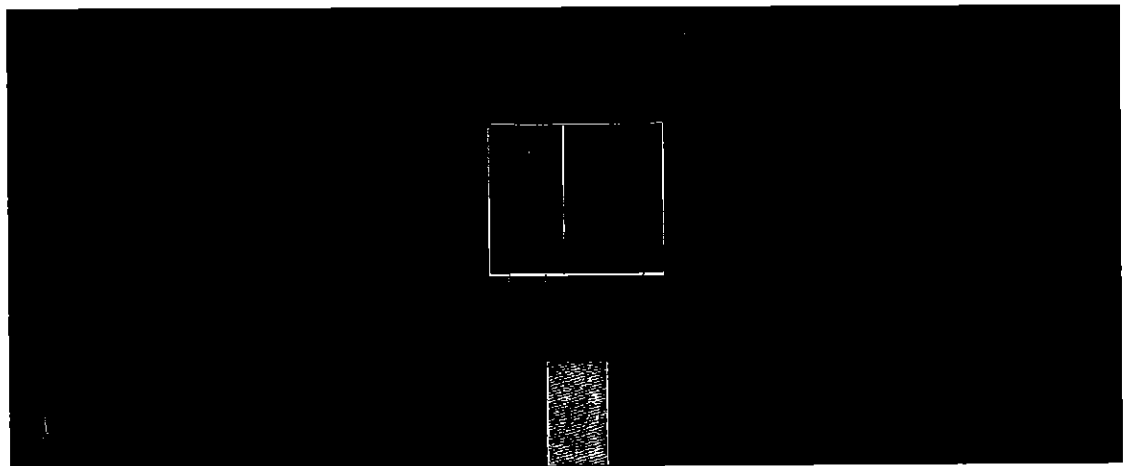
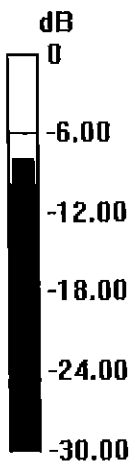

0 dB = 18.2 W/kg = 12.60 dBW/kg

# Impedance Measurement Plot for Head TSL

20 Sep 2016 13:20:17

CH1 S11 1 U FS 1: 55.695  $\Omega$  -4.2793  $\Omega$  7.0842 pF 5 250.000 000 MHz

\*  
Del  
Cor  
Avg  
16  
H1d

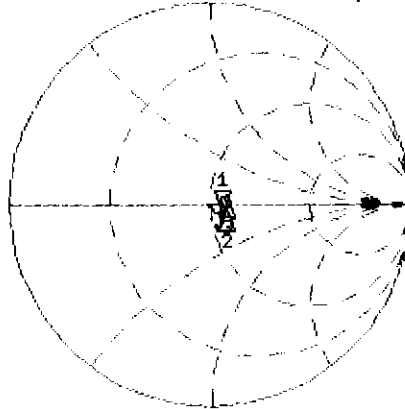

CH1 Markers  
2: 58.262  $\Omega$   
-3.1738  $\Omega$   
5.60000 GHz  
3: 58.078  $\Omega$   
4.7969  $\Omega$   
5.75000 GHz

CH2 S11 LOG 5 dB/REF -20 dB 1: -23.432 dB 5 250.000 000 MHz

Cor  
Avg  
16  
H1d

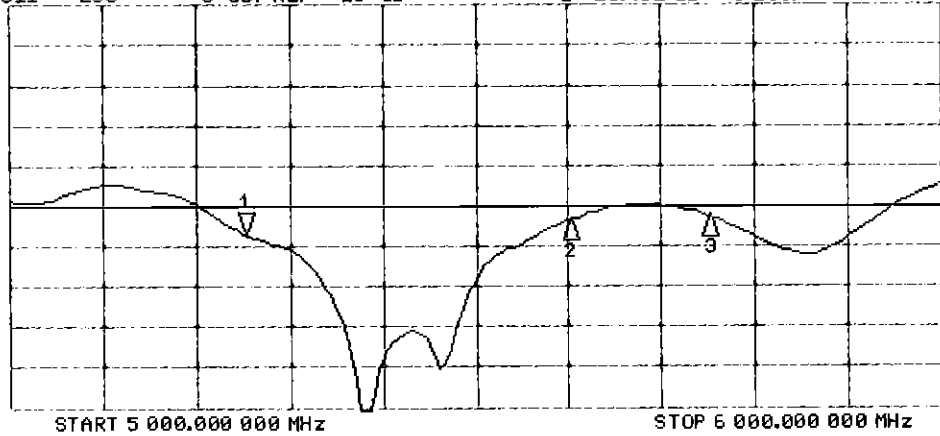

CH2 Markers  
2: -21.752 dB  
5.60000 GHz  
3: -21.228 dB  
5.75000 GHz

## DASY5 Validation Report for Body TSL

Date: 20.09.2016

Test Laboratory: SPEAG, Zurich, Switzerland

**DUT: Dipole D5GHzV2; Type: D5GHzV2; Serial: D5GHzV2 - SN:1191**

Communication System: UID 0 - CW; Frequency: 5250 MHz, Frequency: 5600 MHz, Frequency: 5750 MHz  
Medium parameters used:  $f = 5250$  MHz;  $\sigma = 5.52$  S/m;  $\epsilon_r = 47.4$ ;  $\rho = 1000$  kg/m<sup>3</sup>, Medium parameters used:  $f = 5600$  MHz;  $\sigma = 6$  S/m;  $\epsilon_r = 46.8$ ;  $\rho = 1000$  kg/m<sup>3</sup>, Medium parameters used:  $f = 5750$  MHz;  $\sigma = 6.21$  S/m;  $\epsilon_r = 46.5$ ;  $\rho = 1000$  kg/m<sup>3</sup>

Phantom section: Flat Section

Measurement Standard: DASY5 (IEEE/IEC/ANSI C63.19-2011)

DASY52 Configuration:

- Probe: EX3DV4 - SN3503; ConvF(4.85, 4.85, 4.85); Calibrated: 30.06.2016, ConvF(4.35, 4.35, 4.35); Calibrated: 30.06.2016, ConvF(4.3, 4.3, 4.3); Calibrated: 30.06.2016;
- Sensor-Surface: 1.4mm (Mechanical Surface Detection)
- Electronics: DAE4 Sn601; Calibrated: 30.12.2015
- Phantom: Flat Phantom 5.0 (back); Type: QD000P50AA; Serial: 1002
- DASY52 52.8.8(1258); SEMCAD X 14.6.10(7372)

### **Dipole Calibration for Body Tissue/Pin=100mW, dist=10mm, f=5250MHz/Zoom Scan,**

**dist=1.4mm (8x8x7)/Cube 0:** Measurement grid: dx=4mm, dy=4mm, dz=1.4mm

Reference Value = 66.49 V/m; Power Drift = -0.07 dB

Peak SAR (extrapolated) = 29.1 W/kg

**SAR(1 g) = 7.74 W/kg; SAR(10 g) = 2.17 W/kg**

Maximum value of SAR (measured) = 17.7 W/kg

### **Dipole Calibration for Body Tissue/Pin=100mW, dist=10mm, f=5600 MHz/Zoom Scan,**

**dist=1.4mm (8x8x7)/Cube 0:** Measurement grid: dx=4mm, dy=4mm, dz=1.4mm

Reference Value = 65.85 V/m; Power Drift = -0.09 dB

Peak SAR (extrapolated) = 32.5 W/kg

**SAR(1 g) = 7.96 W/kg; SAR(10 g) = 2.24 W/kg**

Maximum value of SAR (measured) = 18.8 W/kg

### **Dipole Calibration for Body Tissue/Pin=100mW, dist=10mm, f=5750 MHz/Zoom Scan,**

**dist=1.4mm (8x8x7)/Cube 0:** Measurement grid: dx=4mm, dy=4mm, dz=1.4mm

Reference Value = 64.21 V/m; Power Drift = -0.09 dB

Peak SAR (extrapolated) = 32.7 W/kg

**SAR(1 g) = 7.65 W/kg; SAR(10 g) = 2.14 W/kg**

Maximum value of SAR (measured) = 18.5 W/kg

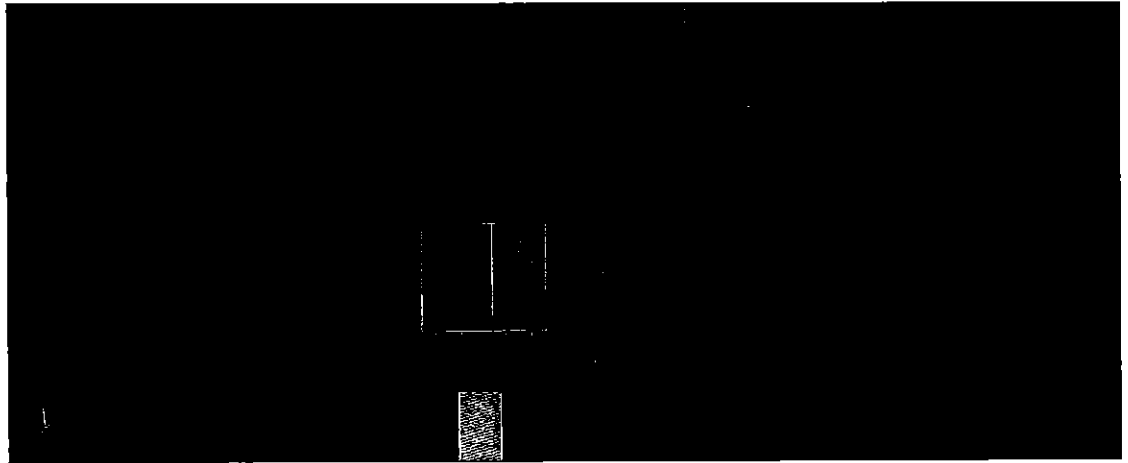
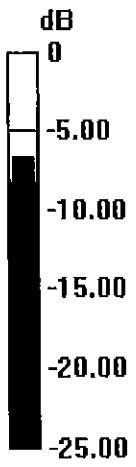

0 dB = 17.7 W/kg = 12.48 dBW/kg

# Impedance Measurement Plot for Body TSL

20 Sep 2016 13:19:13

CH1 S11 1 U FS 1: 56.143  $\Omega$  -3.6992  $\Omega$  8.1950 pF 5 250.000 000 MHz

\*  
De1  
Cor  
Avg  
16  
H1d

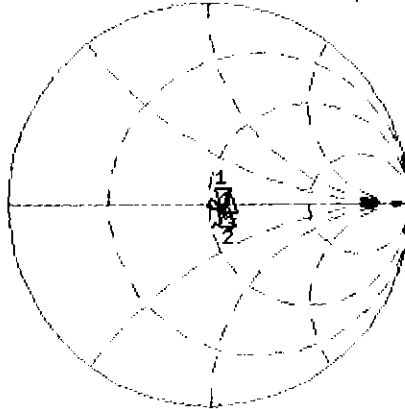

CH1 Markers  
2: 58.887  $\Omega$   
-1.6504  $\Omega$   
5.60000 GHz  
3: 59.510  $\Omega$   
6.9121  $\Omega$   
5.75000 GHz

CH2 S11 LOG 5 dB/REF -20 dB 1: -23.406 dB 5 250.000 000 MHz

Cor  
Avg  
16  
H1d

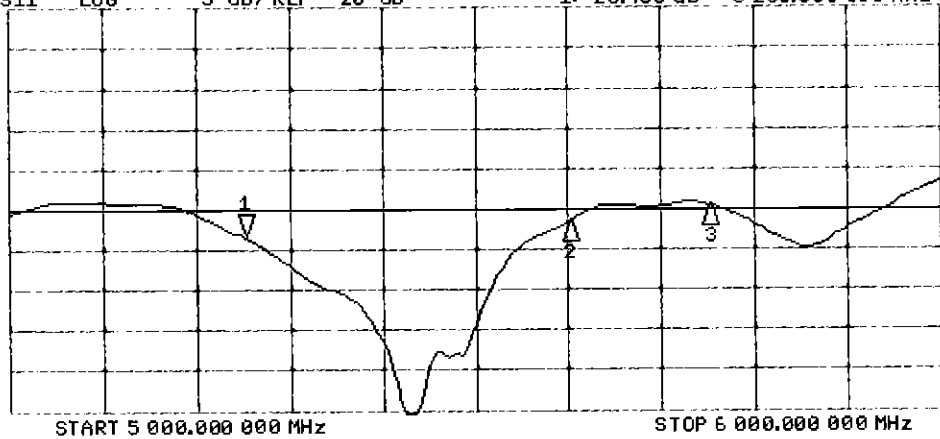

CH2 Markers  
2: -21.616 dB  
5.60000 GHz  
3: -19.400 dB  
5.75000 GHz



Accredited by the Swiss Accreditation Service (SAS)  
The Swiss Accreditation Service is one of the signatories to the EA  
Multilateral Agreement for the recognition of calibration certificates

Accreditation No.: **SCS 0108**

Client **PC Test**

Certificate No: **D1900V2-5d080\_Jul16**

## CALIBRATION CERTIFICATE

Object **D1900V2 - SN:5d080**

Calibration procedure(s) **QA CAL-05.v9  
Calibration procedure for dipole validation kits above 700 MHz**

Calibration date: **July 08, 2016**

*BNV  
7/16/2016*

This calibration certificate documents the traceability to national standards, which realize the physical units of measurements (SI).  
The measurements and the uncertainties with confidence probability are given on the following pages and are part of the certificate.

All calibrations have been conducted in the closed laboratory facility: environment temperature (22 ± 3)°C and humidity < 70%.

Calibration Equipment used (M&TE critical for calibration)

Primary Standards	ID #	Cal Date (Certificate No.)	Scheduled Calibration
Power meter NRP	SN: 104778	06-Apr-16 (No. 217-02288/02289)	Apr-17
Power sensor NRP-Z91	SN: 103244	06-Apr-16 (No. 217-02288)	Apr-17
Power sensor NRP-Z91	SN: 103245	06-Apr-16 (No. 217-02289)	Apr-17
Reference 20 dB Attenuator	SN: 5058 (20k)	05-Apr-16 (No. 217-02292)	Apr-17
Type-N mismatch combination	SN: 5047.2 / 06327	05-Apr-16 (No. 217-02295)	Apr-17
Reference Probe EX3DV4	SN: 7349	15-Jun-16 (No. EX3-7349_Jun16)	Jun-17
DAE4	SN: 601	30-Dec-15 (No. DAE4-601_Dec15)	Dec-16
Secondary Standards	ID #	Check Date (in house)	Scheduled Check
Power meter EPM-442A	SN: GB37480704	07-Oct-15 (No. 217-02222)	In house check: Oct-16
Power sensor HP 8481A	SN: US37292783	07-Oct-15 (No. 217-02222)	In house check: Oct-16
Power sensor HP 8481A	SN: MY41092317	07-Oct-15 (No. 217-02223)	In house check: Oct-16
RF generator R&S SMT-06	SN: 100972	15-Jun-15 (in house check Jun-15)	In house check: Oct-16
Network Analyzer HP 8753E	SN: US37390585	18-Oct-01 (in house check Oct-15)	In house check: Oct-16

Calibrated by: **Jeton Kastrati**      Name: **Jeton Kastrati**      Function: **Laboratory Technician**

Approved by: **Katja Pokovic**      Name: **Katja Pokovic**      Function: **Technical Manager**

Signature  
*[Handwritten signatures]*

Issued: July 13, 2016

This calibration certificate shall not be reproduced except in full without written approval of the laboratory.



Accredited by the Swiss Accreditation Service (SAS)  
The Swiss Accreditation Service is one of the signatories to the EA  
Multilateral Agreement for the recognition of calibration certificates

Accreditation No.: **SCS 0108**

**Glossary:**

TSL	tissue simulating liquid
ConvF	sensitivity in TSL / NORM x,y,z
N/A	not applicable or not measured

**Calibration is Performed According to the Following Standards:**

- a) IEEE Std 1528-2013, "IEEE Recommended Practice for Determining the Peak Spatial-Averaged Specific Absorption Rate (SAR) in the Human Head from Wireless Communications Devices: Measurement Techniques", June 2013
- b) IEC 62209-1, "Procedure to measure the Specific Absorption Rate (SAR) for hand-held devices used in close proximity to the ear (frequency range of 300 MHz to 3 GHz)", February 2005
- c) IEC 62209-2, "Procedure to determine the Specific Absorption Rate (SAR) for wireless communication devices used in close proximity to the human body (frequency range of 30 MHz to 6 GHz)", March 2010
- d) KDB 865664, "SAR Measurement Requirements for 100 MHz to 6 GHz"

**Additional Documentation:**

- e) DASY4/5 System Handbook

**Methods Applied and Interpretation of Parameters:**

- *Measurement Conditions:* Further details are available from the Validation Report at the end of the certificate. All figures stated in the certificate are valid at the frequency indicated.
- *Antenna Parameters with TSL:* The dipole is mounted with the spacer to position its feed point exactly below the center marking of the flat phantom section, with the arms oriented parallel to the body axis.
- *Feed Point Impedance and Return Loss:* These parameters are measured with the dipole positioned under the liquid filled phantom. The impedance stated is transformed from the measurement at the SMA connector to the feed point. The Return Loss ensures low reflected power. No uncertainty required.
- *Electrical Delay:* One-way delay between the SMA connector and the antenna feed point. No uncertainty required.
- *SAR measured:* SAR measured at the stated antenna input power.
- *SAR normalized:* SAR as measured, normalized to an input power of 1 W at the antenna connector.
- *SAR for nominal TSL parameters:* The measured TSL parameters are used to calculate the nominal SAR result.

The reported uncertainty of measurement is stated as the standard uncertainty of measurement multiplied by the coverage factor  $k=2$ , which for a normal distribution corresponds to a coverage probability of approximately 95%.



## Measurement Conditions

DASY system configuration, as far as not given on page 1.

DASY Version	DASY5	V52.8.8
Extrapolation	Advanced Extrapolation	
Phantom	Modular Flat Phantom	
Distance Dipole Center - TSL	10 mm	with Spacer
Zoom Scan Resolution	dx, dy, dz = 5 mm	
Frequency	1900 MHz $\pm$ 1 MHz	

## Head TSL parameters

The following parameters and calculations were applied.

	Temperature	Permittivity	Conductivity
Nominal Head TSL parameters	22.0 °C	40.0	1.40 mho/m
Measured Head TSL parameters	(22.0 $\pm$ 0.2) °C	39.8 $\pm$ 6 %	1.38 mho/m $\pm$ 6 %
Head TSL temperature change during test	< 0.5 °C	----	----

## SAR result with Head TSL

SAR averaged over 1 cm <sup>3</sup> (1 g) of Head TSL	Condition	
SAR measured	250 mW input power	9.76 W/kg
SAR for nominal Head TSL parameters	normalized to 1W	39.3 W/kg $\pm$ 17.0 % (k=2)

SAR averaged over 10 cm <sup>3</sup> (10 g) of Head TSL	condition	
SAR measured	250 mW input power	5.10 W/kg
SAR for nominal Head TSL parameters	normalized to 1W	20.5 W/kg $\pm$ 16.5 % (k=2)

## Body TSL parameters

The following parameters and calculations were applied.

	Temperature	Permittivity	Conductivity
Nominal Body TSL parameters	22.0 °C	53.3	1.52 mho/m
Measured Body TSL parameters	(22.0 $\pm$ 0.2) °C	52.7 $\pm$ 6 %	1.51 mho/m $\pm$ 6 %
Body TSL temperature change during test	< 0.5 °C	----	----

## SAR result with Body TSL

SAR averaged over 1 cm <sup>3</sup> (1 g) of Body TSL	Condition	
SAR measured	250 mW input power	9.75 W/kg
SAR for nominal Body TSL parameters	normalized to 1W	39.1 W/kg $\pm$ 17.0 % (k=2)

SAR averaged over 10 cm <sup>3</sup> (10 g) of Body TSL	condition	
SAR measured	250 mW input power	5.17 W/kg
SAR for nominal Body TSL parameters	normalized to 1W	20.7 W/kg $\pm$ 16.5 % (k=2)

## Appendix (Additional assessments outside the scope of SCS 0108)

### Antenna Parameters with Head TSL

Impedance, transformed to feed point	52.1 $\Omega$ + 5.3 j $\Omega$
Return Loss	- 25.1 dB

### Antenna Parameters with Body TSL

Impedance, transformed to feed point	47.4 $\Omega$ + 6.8 j $\Omega$
Return Loss	- 22.6 dB

### General Antenna Parameters and Design

Electrical Delay (one direction)	1.192 ns
----------------------------------	----------

After long term use with 100W radiated power, only a slight warming of the dipole near the feedpoint can be measured.

The dipole is made of standard semirigid coaxial cable. The center conductor of the feeding line is directly connected to the second arm of the dipole. The antenna is therefore short-circuited for DC-signals. On some of the dipoles, small end caps are added to the dipole arms in order to improve matching when loaded according to the position as explained in the "Measurement Conditions" paragraph. The SAR data are not affected by this change. The overall dipole length is still according to the Standard.

No excessive force must be applied to the dipole arms, because they might bend or the soldered connections near the feedpoint may be damaged.

### Additional EUT Data

Manufactured by	SPEAG
Manufactured on	June 28, 2006

## DASY5 Validation Report for Head TSL

Date: 08.07.2016

Test Laboratory: SPEAG, Zurich, Switzerland

**DUT: Dipole 1900 MHz; Type: D1900V2; Serial: D1900V2 - SN:5d080**

Communication System: UID 0 - CW; Frequency: 1900 MHz

Medium parameters used:  $f = 1900$  MHz;  $\sigma = 1.38$  S/m;  $\epsilon_r = 39.8$ ;  $\rho = 1000$  kg/m<sup>3</sup>

Phantom section: Flat Section

Measurement Standard: DASY5 (IEEE/IEC/ANSI C63.19-2011)

DASY52 Configuration:

- Probe: EX3DV4 - SN7349; ConvF(7.99, 7.99, 7.99); Calibrated: 15.06.2016;
- Sensor-Surface: 1.4mm (Mechanical Surface Detection)
- Electronics: DAE4 Sn601; Calibrated: 30.12.2015
- Phantom: Flat Phantom 5.0 (front); Type: QD000P50AA; Serial: 1001
- DASY52 52.8.8(1258); SEMCAD X 14.6.10(7372)

### Dipole Calibration for Head Tissue/Pin=250 mW, d=10mm/Zoom Scan (7x7x7)/Cube 0:

Measurement grid: dx=5mm, dy=5mm, dz=5mm

Reference Value = 106.6 V/m; Power Drift = -0.04 dB

Peak SAR (extrapolated) = 18.4 W/kg

**SAR(1 g) = 9.76 W/kg; SAR(10 g) = 5.1 W/kg**

Maximum value of SAR (measured) = 15.0 W/kg

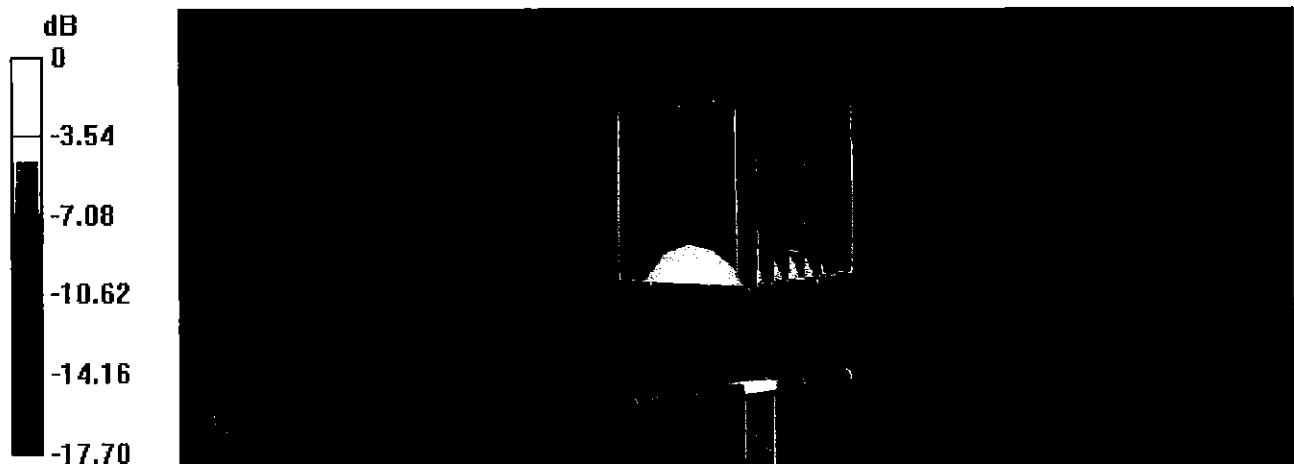

0 dB = 15.0 W/kg = 11.76 dBW/kg

# Impedance Measurement Plot for Head TSL

8 Jul 2016 16:18:04

CH1 S11 1 U FS

1: 52.143  $\Omega$  5.2500  $\Omega$  439.78 pF

1 900.000 000 MHz

\*  
Del  
Cor

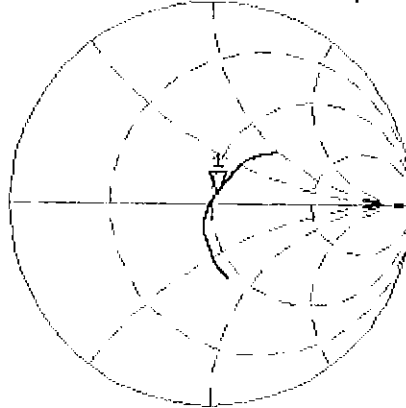

Avg  
16

H1d

CH2 S11 LOG

5 dB/REF -20 dB

1:-25.118 dB

1 900.000 000 MHz

Cor

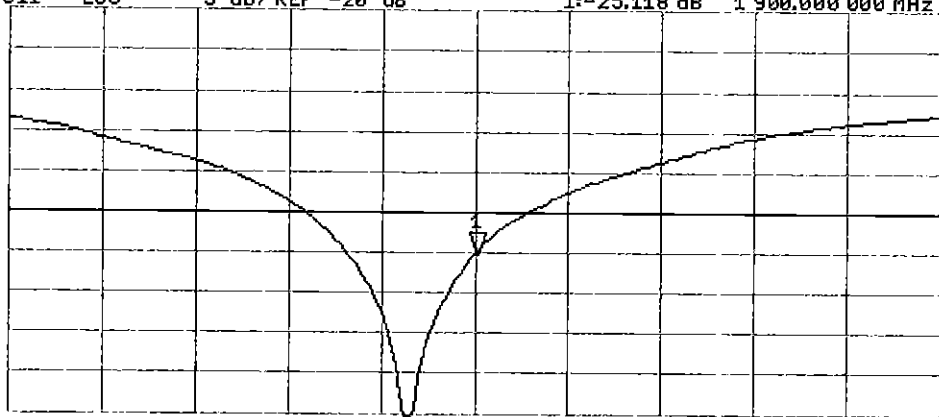

Avg  
16

H1d

START 1 700.000 000 MHz

STOP 2 100.000 000 MHz

# DASY5 Validation Report for Body TSL

Date: 08.07.2016

Test Laboratory: SPEAG, Zurich, Switzerland

**DUT: Dipole 1900 MHz; Type: D1900V2; Serial: D1900V2 - SN:5d080**

Communication System: UID 0 - CW; Frequency: 1900 MHz

Medium parameters used:  $f = 1900$  MHz;  $\sigma = 1.51$  S/m;  $\epsilon_r = 52.7$ ;  $\rho = 1000$  kg/m<sup>3</sup>

Phantom section: Flat Section

Measurement Standard: DASY5 (IEEE/IEC/ANSI C63.19-2011)

DASY52 Configuration:

- Probe: EX3DV4 - SN7349; ConvF(8.03, 8.03, 8.03); Calibrated: 15.06.2016;
- Sensor-Surface: 1.4mm (Mechanical Surface Detection)
- Electronics: DAE4 Sn601; Calibrated: 30.12.2015
- Phantom: Flat Phantom 5.0 (back); Type: QD000P50AA; Serial: 1002
- DASY52 52.8.8(1258); SEMCAD X 14.6.10(7372)

## Dipole Calibration for Body Tissue/Pin=250 mW, d=10mm/Zoom Scan (7x7x7)/Cube 0:

Measurement grid: dx=5mm, dy=5mm, dz=5mm

Reference Value = 103.1 V/m; Power Drift = -0.02 dB

Peak SAR (extrapolated) = 17.1 W/kg

**SAR(1 g) = 9.75 W/kg; SAR(10 g) = 5.17 W/kg**

Maximum value of SAR (measured) = 14.7 W/kg

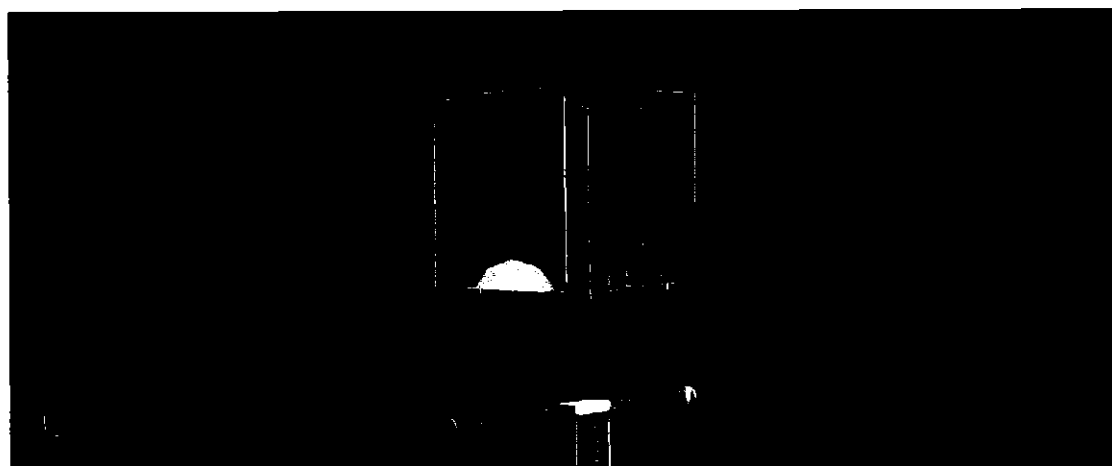
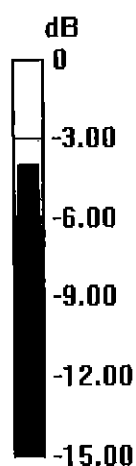

0 dB = 14.7 W/kg = 11.67 dBW/kg

# Impedance Measurement Plot for Body TSL

8 Jul 2016 16:16:56

CH1 S11 1 U FS

1: 47.412  $\Omega$  6.7422  $\Omega$  564.78 pF

1 900.000 000 MHz

\*  
De1  
Cor

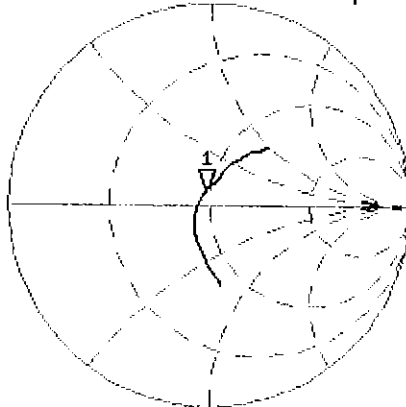

Avg  
16

H1d

CH2 S11 LOG

5 dB/REF -20 dB

1:-22.620 dB

1 900.000 000 MHz

Cor

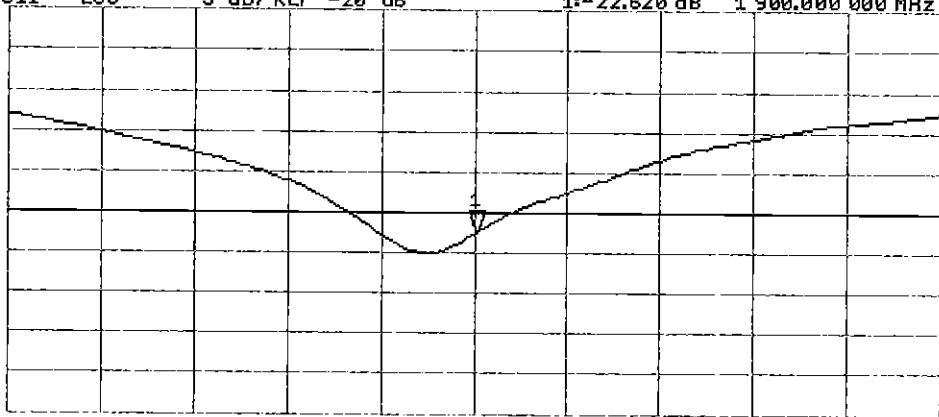

Avg  
16

H1d

START 1 700.000 000 MHz

STOP 2 100.000 000 MHz



Accredited by the Swiss Accreditation Service (SAS)  
The Swiss Accreditation Service is one of the signatories to the EA  
Multilateral Agreement for the recognition of calibration certificates

Accreditation No.: **SCS 0108**

Client **PC Test**

Certificate No: **D2450V2-981\_Jul16**

**CALIBRATION CERTIFICATE**

Object **D2450V2 - SN:981**

Calibration procedure(s) **QA CAL-05.v9  
Calibration procedure for dipole validation kits above 700 MHz**

*✓ PM  
8/9/16*

Calibration date: **July 25, 2016**

This calibration certificate documents the traceability to national standards, which realize the physical units of measurements (SI).  
The measurements and the uncertainties with confidence probability are given on the following pages and are part of the certificate.

All calibrations have been conducted in the closed laboratory facility: environment temperature (22 ± 3)°C and humidity < 70%.

Calibration Equipment used (M&TE critical for calibration)

Primary Standards	ID #	Cal Date (Certificate No.)	Scheduled Calibration
Power meter NRP	SN: 104778	06-Apr-16 (No. 217-02288/02289)	Apr-17
Power sensor NRP-Z91	SN: 103244	06-Apr-16 (No. 217-02288)	Apr-17
Power sensor NRP-Z91	SN: 103245	06-Apr-16 (No. 217-02289)	Apr-17
Reference 20 dB Attenuator	SN: 5058 (20k)	05-Apr-16 (No. 217-02292)	Apr-17
Type-N mismatch combination	SN: 5047.2 / 06327	05-Apr-16 (No. 217-02295)	Apr-17
Reference Probe EX3DV4	SN: 7349	15-Jun-16 (No. EX3-7349_Jun16)	Jun-17
DAE4	SN: 601	30-Dec-15 (No. DAE4-601_Dec15)	Dec-16

Secondary Standards	ID #	Check Date (in house)	Scheduled Check
Power meter EPM-442A	SN: GB37480704	07-Oct-15 (No. 217-02222)	In house check: Oct-16
Power sensor HP 8481A	SN: US37292783	07-Oct-15 (No. 217-02222)	In house check: Oct-16
Power sensor HP 8481A	SN: MY41092317	07-Oct-15 (No. 217-02223)	In house check: Oct-16
RF generator R&S SMT-06	SN: 100972	15-Jun-15 (in house check Jun-15)	In house check: Oct-16
Network Analyzer HP 8753E	SN: US37390585	18-Oct-01 (in house check Oct-15)	In house check: Oct-16

Calibrated by: **Michael Weber**      Name: **Michael Weber**      Function: **Laboratory Technician**

Signature: *M. Weber*

Approved by: **Katja Pokovic**      Name: **Katja Pokovic**      Technical Manager

Signature: *Katja Pokovic*

Issued: July 27, 2016

This calibration certificate shall not be reproduced except in full without written approval of the laboratory.



Accredited by the Swiss Accreditation Service (SAS)  
The Swiss Accreditation Service is one of the signatories to the EA  
Multilateral Agreement for the recognition of calibration certificates

Accreditation No.: **SCS 0108**

**Glossary:**

TSL	tissue simulating liquid
ConvF	sensitivity in TSL / NORM x,y,z
N/A	not applicable or not measured

**Calibration is Performed According to the Following Standards:**

- a) IEEE Std 1528-2013, "IEEE Recommended Practice for Determining the Peak Spatial-Averaged Specific Absorption Rate (SAR) in the Human Head from Wireless Communications Devices: Measurement Techniques", June 2013
- b) IEC 62209-1, "Procedure to measure the Specific Absorption Rate (SAR) for hand-held devices used in close proximity to the ear (frequency range of 300 MHz to 3 GHz)", February 2005
- c) IEC 62209-2, "Procedure to determine the Specific Absorption Rate (SAR) for wireless communication devices used in close proximity to the human body (frequency range of 30 MHz to 6 GHz)", March 2010
- d) KDB 865664, "SAR Measurement Requirements for 100 MHz to 6 GHz"

**Additional Documentation:**

- e) DASY4/5 System Handbook

**Methods Applied and Interpretation of Parameters:**

- *Measurement Conditions:* Further details are available from the Validation Report at the end of the certificate. All figures stated in the certificate are valid at the frequency indicated.
- *Antenna Parameters with TSL:* The dipole is mounted with the spacer to position its feed point exactly below the center marking of the flat phantom section, with the arms oriented parallel to the body axis.
- *Feed Point Impedance and Return Loss:* These parameters are measured with the dipole positioned under the liquid filled phantom. The impedance stated is transformed from the measurement at the SMA connector to the feed point. The Return Loss ensures low reflected power. No uncertainty required.
- *Electrical Delay:* One-way delay between the SMA connector and the antenna feed point. No uncertainty required.
- *SAR measured:* SAR measured at the stated antenna input power.
- *SAR normalized:* SAR as measured, normalized to an input power of 1 W at the antenna connector.
- *SAR for nominal TSL parameters:* The measured TSL parameters are used to calculate the nominal SAR result.

The reported uncertainty of measurement is stated as the standard uncertainty of measurement multiplied by the coverage factor  $k=2$ , which for a normal distribution corresponds to a coverage probability of approximately 95%.



## Measurement Conditions

DASY system configuration, as far as not given on page 1.

DASY Version	DASY5	V52.8.8
Extrapolation	Advanced Extrapolation	
Phantom	Modular Flat Phantom	
Distance Dipole Center - TSL	10 mm	with Spacer
Zoom Scan Resolution	dx, dy, dz = 5 mm	
Frequency	2450 MHz $\pm$ 1 MHz	

## Head TSL parameters

The following parameters and calculations were applied.

	Temperature	Permittivity	Conductivity
Nominal Head TSL parameters	22.0 °C	39.2	1.80 mho/m
Measured Head TSL parameters	(22.0 $\pm$ 0.2) °C	38.0 $\pm$ 6 %	1.86 mho/m $\pm$ 6 %
Head TSL temperature change during test	< 0.5 °C	----	----

## SAR result with Head TSL

SAR averaged over 1 cm <sup>3</sup> (1 g) of Head TSL	Condition	
SAR measured	250 mW input power	13.5 W/kg
SAR for nominal Head TSL parameters	normalized to 1W	52.8 W/kg $\pm$ 17.0 % (k=2)

SAR averaged over 10 cm <sup>3</sup> (10 g) of Head TSL	condition	
SAR measured	250 mW input power	6.26 W/kg
SAR for nominal Head TSL parameters	normalized to 1W	24.7 W/kg $\pm$ 16.5 % (k=2)

## Body TSL parameters

The following parameters and calculations were applied.

	Temperature	Permittivity	Conductivity
Nominal Body TSL parameters	22.0 °C	52.7	1.95 mho/m
Measured Body TSL parameters	(22.0 $\pm$ 0.2) °C	51.8 $\pm$ 6 %	2.03 mho/m $\pm$ 6 %
Body TSL temperature change during test	< 0.5 °C	----	----

## SAR result with Body TSL

SAR averaged over 1 cm <sup>3</sup> (1 g) of Body TSL	Condition	
SAR measured	250 mW input power	13.0 W/kg
SAR for nominal Body TSL parameters	normalized to 1W	50.8 W/kg $\pm$ 17.0 % (k=2)

SAR averaged over 10 cm <sup>3</sup> (10 g) of Body TSL	condition	
SAR measured	250 mW input power	6.04 W/kg
SAR for nominal Body TSL parameters	normalized to 1W	23.8 W/kg $\pm$ 16.5 % (k=2)

## Appendix (Additional assessments outside the scope of SCS 0108)

### Antenna Parameters with Head TSL

Impedance, transformed to feed point	53.2 $\Omega$ + 3.4 j $\Omega$
Return Loss	- 26.9 dB

### Antenna Parameters with Body TSL

Impedance, transformed to feed point	50.2 $\Omega$ + 4.5 j $\Omega$
Return Loss	- 27.0 dB

### General Antenna Parameters and Design

Electrical Delay (one direction)	1.162 ns
----------------------------------	----------

After long term use with 100W radiated power, only a slight warming of the dipole near the feedpoint can be measured.

The dipole is made of standard semirigid coaxial cable. The center conductor of the feeding line is directly connected to the second arm of the dipole. The antenna is therefore short-circuited for DC-signals. On some of the dipoles, small end caps are added to the dipole arms in order to improve matching when loaded according to the position as explained in the "Measurement Conditions" paragraph. The SAR data are not affected by this change. The overall dipole length is still according to the Standard.

No excessive force must be applied to the dipole arms, because they might bend or the soldered connections near the feedpoint may be damaged.

### Additional EUT Data

Manufactured by	SPEAG
Manufactured on	December 30, 2014

# DASY5 Validation Report for Head TSL

Date: 13.07.2016

Test Laboratory: SPEAG, Zurich, Switzerland

**DUT: Dipole 2450 MHz D2450V2; Type: D2450V2; Serial: D2450V2 - SN:981**

Communication System: UID 0 - CW; Frequency: 2450 MHz

Medium parameters used:  $f = 2450$  MHz;  $\sigma = 1.86$  S/m;  $\epsilon_r = 38$ ;  $\rho = 1000$  kg/m<sup>3</sup>

Phantom section: Flat Section

Measurement Standard: DASY5 (IEEE/IEC/ANSI C63.19-2011)

DASY52 Configuration:

- Probe: EX3DV4 - SN7349; ConvF(7.72, 7.72, 7.72); Calibrated: 15.06.2016;
- Sensor-Surface: 1.4mm (Mechanical Surface Detection)
- Electronics: DAE4 Sn601; Calibrated: 30.12.2015
- Phantom: Flat Phantom 5.0 (front); Type: QD000P50AA; Serial: 1001
- DASY52 52.8.8(1258); SEMCAD X 14.6.10(7372)

## Dipole Calibration for Head Tissue/Pin=250 mW, d=10mm/Zoom Scan (7x7x7)/Cube 0:

Measurement grid: dx=5mm, dy=5mm, dz=5mm

Reference Value = 115.8 V/m; Power Drift = 0.02 dB

Peak SAR (extrapolated) = 27.4 W/kg

**SAR(1 g) = 13.5 W/kg; SAR(10 g) = 6.26 W/kg**

Maximum value of SAR (measured) = 22.5 W/kg

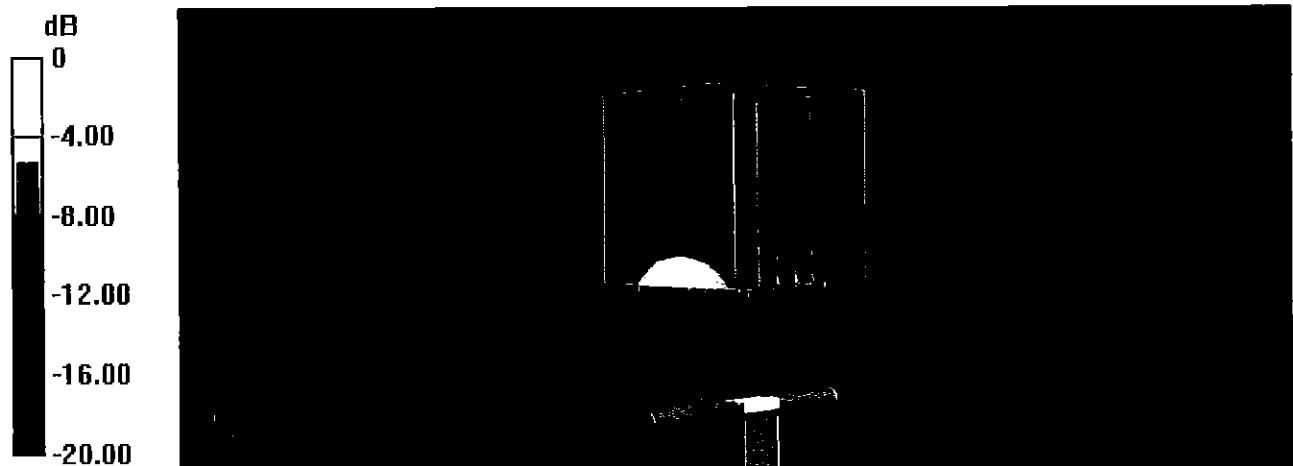

0 dB = 22.5 W/kg = 13.52 dBW/kg

# Impedance Measurement Plot for Head TSL

13 Jul 2016 12:53:29

CH1 S11 1 U FS 3: 53.234  $\Omega$  3.3633  $\Omega$  218.48  $\mu\text{H}$  2 450.000 000 MHz

\*  
De l  
CA  
Avg  
16  
H1 d

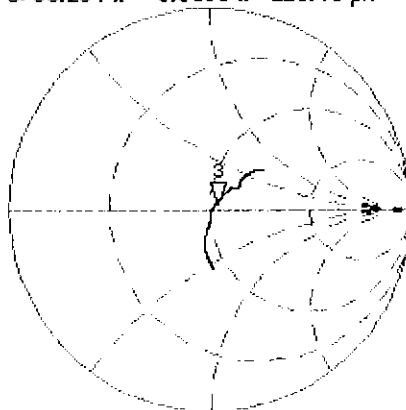

CH2 S11 LOG 5 dB/REF -20 dB 3:-26.900 dB 2 450.000 000 MHz

CA  
Avg  
16  
H1 d

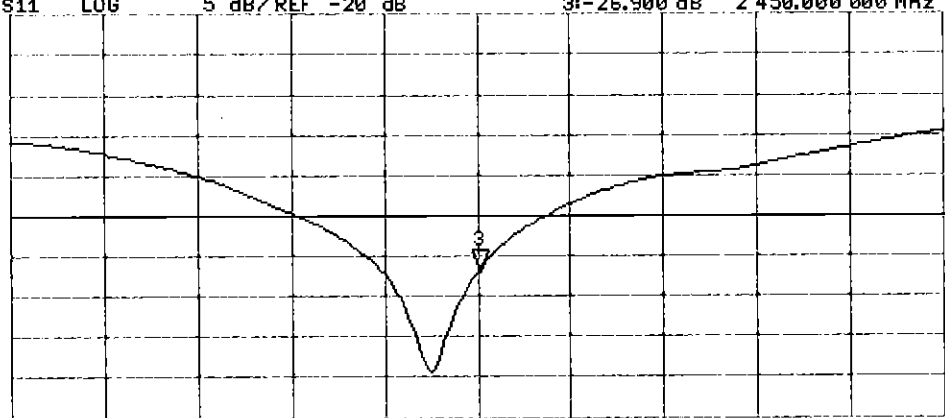

START 2 250.000 000 MHz

STOP 2 650.000 000 MHz

## DASY5 Validation Report for Body TSL

Date: 25.07.2016

Test Laboratory: SPEAG, Zurich, Switzerland

**DUT: Dipole 2450 MHz D2450V2; Type: D2450V2; Serial: D2450V2 - SN:981**

Communication System: UID 0 - CW; Frequency: 2450 MHz

Medium parameters used:  $f = 2450$  MHz;  $\sigma = 2.03$  S/m;  $\epsilon_r = 51.8$ ;  $\rho = 1000$  kg/m<sup>3</sup>

Phantom section: Flat Section

Measurement Standard: DASY5 (IEEE/IEC/ANSI C63.19-2011)

DASY52 Configuration:

- Probe: EX3DV4 - SN7349; ConvF(7.79, 7.79, 7.79); Calibrated: 15.06.2016;
- Sensor-Surface: 1.4mm (Mechanical Surface Detection)
- Electronics: DAE4 Sn601; Calibrated: 30.12.2015
- Phantom: Flat Phantom 5.0 (back); Type: QD000P50AA; Serial: 1002
- DASY52 52.8.8(1258); SEMCAD X 14.6.10(7372)

### Dipole Calibration for Body Tissue/Pin=250 mW, d=10mm/Zoom Scan (7x7x7)/Cube 0:

Measurement grid: dx=5mm, dy=5mm, dz=5mm

Reference Value = 107.1 V/m; Power Drift = -0.02 dB

Peak SAR (extrapolated) = 26.0 W/kg

**SAR(1 g) = 13 W/kg; SAR(10 g) = 6.04 W/kg**

Maximum value of SAR (measured) = 21.4 W/kg



0 dB = 21.4 W/kg = 13.30 dBW/kg

# Impedance Measurement Plot for Body TSL

25 Jul 2016 10:03:11

CH1 S11 1 U FS

1: 50.184  $\Omega$  4.4980  $\Omega$  292.20 pF

2 450.000 000 MHz

\*  
De1  
Ca

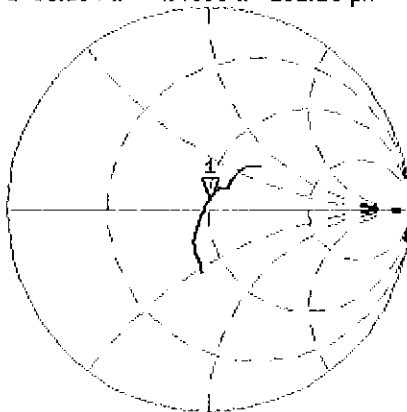

Avg  
16

H1 d

CH2 S11 LOG

5 dB/ REF -20 dB

1: -26.957 dB

2 450.000 000 MHz

Ca

H1 d

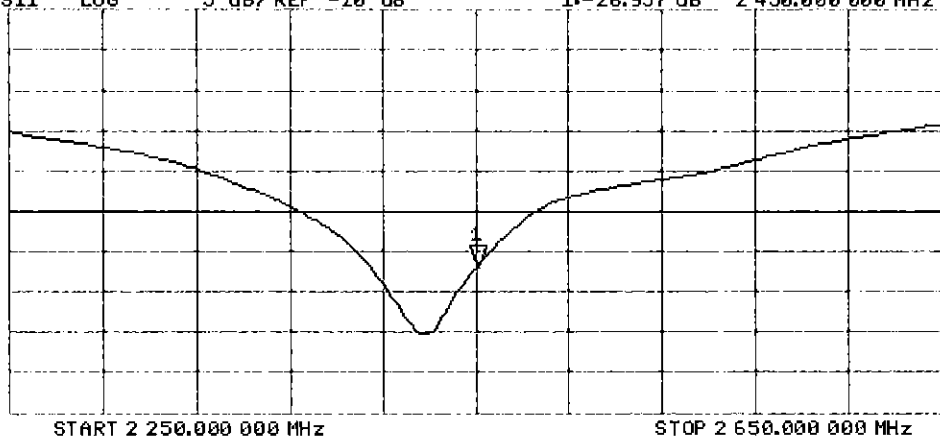



Accreditation No.: **SCS 0108**

Accredited by the Swiss Accreditation Service (SAS)  
The Swiss Accreditation Service is one of the signatories to the EA  
Multilateral Agreement for the recognition of calibration certificates

Client **PC Test**

Certificate No: **D5GHzV2-1237\_Aug16**

## CALIBRATION CERTIFICATE

Object **D5GHzV2 - SN:1237**

Calibration procedure(s) **QA CAL-22.v2  
Calibration procedure for dipole validation kits between 3-6 GHz**

✓PT  
8/9/16

Calibration date: **August 02, 2016**

This calibration certificate documents the traceability to national standards, which realize the physical units of measurements (SI).  
The measurements and the uncertainties with confidence probability are given on the following pages and are part of the certificate.

All calibrations have been conducted in the closed laboratory facility: environment temperature ( $22 \pm 3$ )°C and humidity < 70%.

Calibration Equipment used (M&TE critical for calibration)

Primary Standards	ID #	Cal Date (Certificate No.)	Scheduled Calibration
Power meter NRP	SN: 104778	06-Apr-16 (No. 217-02288/02289)	Apr-17
Power sensor NRP-Z91	SN: 103244	06-Apr-16 (No. 217-02288)	Apr-17
Power sensor NRP-Z91	SN: 103245	06-Apr-16 (No. 217-02289)	Apr-17
Reference 20 dB Attenuator	SN: 5058 (20k)	05-Apr-16 (No. 217-02292)	Apr-17
Type-N mismatch combination	SN: 5047.2 / 06327	05-Apr-16 (No. 217-02295)	Apr-17
Reference Probe EX3DV4	SN: 3503	30-Jun-16 (No. EX3-3503_Jun16)	Jun-17
DAE4	SN: 601	30-Dec-15 (No. DAE4-601_Dec15)	Dec-16
Secondary Standards	ID #	Check Date (in house)	Scheduled Check
Power meter EPM-442A	SN: GB37480704	07-Oct-15 (No. 217-02222)	In house check: Oct-16
Power sensor HP 8481A	SN: US37292783	07-Oct-15 (No. 217-02222)	In house check: Oct-16
Power sensor HP 8481A	SN: MY41092317	07-Oct-15 (No. 217-02223)	In house check: Oct-16
RF generator R&S SMT-06	SN: 100972	15-Jun-15 (in house check Jun-15)	In house check: Oct-16
Network Analyzer HP 8753E	SN: US37390585	18-Oct-01 (in house check Oct-15)	In house check: Oct-16

Calibrated by: **Claudio Leubler**      Name: Claudio Leubler      Function: Laboratory Technician

Approved by: **Katja Pokovic**      Name: Katja Pokovic      Function: Technical Manager

Signature

Issued: August 4, 2016

This calibration certificate shall not be reproduced except in full without written approval of the laboratory.



Accredited by the Swiss Accreditation Service (SAS)

The Swiss Accreditation Service is one of the signatories to the EA  
Multilateral Agreement for the recognition of calibration certificates

**Glossary:**

TSL	tissue simulating liquid
ConvF	sensitivity in TSL / NORM x,y,z
N/A	not applicable or not measured

**Calibration is Performed According to the Following Standards:**

- IEEE Std 1528-2013, "IEEE Recommended Practice for Determining the Peak Spatial-Averaged Specific Absorption Rate (SAR) in the Human Head from Wireless Communications Devices: Measurement Techniques", June 2013
- IEC 62209-2, "Procedure to determine the Specific Absorption Rate (SAR) for wireless communication devices used in close proximity to the human body (frequency range of 30 MHz to 6 GHz)", March 2010
- KDB 865664, "SAR Measurement Requirements for 100 MHz to 6 GHz"

**Additional Documentation:**

- DASY4/5 System Handbook

**Methods Applied and Interpretation of Parameters:**

- Measurement Conditions:* Further details are available from the Validation Report at the end of the certificate. All figures stated in the certificate are valid at the frequency indicated.
- Antenna Parameters with TSL:* The dipole is mounted with the spacer to position its feed point exactly below the center marking of the flat phantom section, with the arms oriented parallel to the body axis.
- Feed Point Impedance and Return Loss:* These parameters are measured with the dipole positioned under the liquid filled phantom. The impedance stated is transformed from the measurement at the SMA connector to the feed point. The Return Loss ensures low reflected power. No uncertainty required.
- Electrical Delay:* One-way delay between the SMA connector and the antenna feed point. No uncertainty required.
- SAR measured:* SAR measured at the stated antenna input power.
- SAR normalized:* SAR as measured, normalized to an input power of 1 W at the antenna connector.
- SAR for nominal TSL parameters:* The measured TSL parameters are used to calculate the nominal SAR result.

The reported uncertainty of measurement is stated as the standard uncertainty of measurement multiplied by the coverage factor  $k=2$ , which for a normal distribution corresponds to a coverage probability of approximately 95%.



## Measurement Conditions

DASY system configuration, as far as not given on page 1.

DASY Version	DASY5	V52.8.8
Extrapolation	Advanced Extrapolation	
Phantom	Modular Flat Phantom V5.0	
Distance Dipole Center - TSL	10 mm	with Spacer
Zoom Scan Resolution	dx, dy = 4.0 mm, dz = 1.4 mm	Graded Ratio = 1.4 (Z direction)
Frequency	5250 MHz ± 1 MHz 5600 MHz ± 1 MHz 5750 MHz ± 1 MHz	

## Head TSL parameters at 5250 MHz

The following parameters and calculations were applied.

	Temperature	Permittivity	Conductivity
Nominal Head TSL parameters	22.0 °C	35.9	4.71 mho/m
Measured Head TSL parameters	(22.0 ± 0.2) °C	34.4 ± 6 %	4.52 mho/m ± 6 %
Head TSL temperature change during test	< 0.5 °C	----	----

## SAR result with Head TSL at 5250 MHz

SAR averaged over 1 cm <sup>3</sup> (1 g) of Head TSL	Condition	
SAR measured	100 mW input power	8.00 W/kg
SAR for nominal Head TSL parameters	normalized to 1W	<b>79.2 W/kg ± 19.9 % (k=2)</b>

SAR averaged over 10 cm <sup>3</sup> (10 g) of Head TSL	condition	
SAR measured	100 mW input power	2.30 W/kg
SAR for nominal Head TSL parameters	normalized to 1W	<b>22.7 W/kg ± 19.5 % (k=2)</b>

### Head TSL parameters at 5600 MHz

The following parameters and calculations were applied.

	Temperature	Permittivity	Conductivity
Nominal Head TSL parameters	22.0 °C	35.5	5.07 mho/m
Measured Head TSL parameters	(22.0 ± 0.2) °C	33.9 ± 6 %	4.86 mho/m ± 6 %
Head TSL temperature change during test	< 0.5 °C	----	----

### SAR result with Head TSL at 5600 MHz

SAR averaged over 1 cm <sup>3</sup> (1 g) of Head TSL	Condition	
SAR measured	100 mW input power	8.43 W/kg
SAR for nominal Head TSL parameters	normalized to 1W	<b>83.3 W / kg ± 19.9 % (k=2)</b>

SAR averaged over 10 cm <sup>3</sup> (10 g) of Head TSL	condition	
SAR measured	100 mW input power	2.42 W/kg
SAR for nominal Head TSL parameters	normalized to 1W	<b>23.9 W/kg ± 19.5 % (k=2)</b>

### Head TSL parameters at 5750 MHz

The following parameters and calculations were applied.

	Temperature	Permittivity	Conductivity
Nominal Head TSL parameters	22.0 °C	35.4	5.22 mho/m
Measured Head TSL parameters	(22.0 ± 0.2) °C	33.7 ± 6 %	5.02 mho/m ± 6 %
Head TSL temperature change during test	< 0.5 °C	----	----

### SAR result with Head TSL at 5750 MHz

SAR averaged over 1 cm <sup>3</sup> (1 g) of Head TSL	Condition	
SAR measured	100 mW input power	8.25 W/kg
SAR for nominal Head TSL parameters	normalized to 1W	<b>81.5 W/kg ± 19.9 % (k=2)</b>

SAR averaged over 10 cm <sup>3</sup> (10 g) of Head TSL	condition	
SAR measured	100 mW input power	2.35 W/kg
SAR for nominal Head TSL parameters	normalized to 1W	<b>23.2 W/kg ± 19.5 % (k=2)</b>

### Body TSL parameters at 5250 MHz

The following parameters and calculations were applied.

	Temperature	Permittivity	Conductivity
Nominal Body TSL parameters	22.0 °C	48.9	5.36 mho/m
Measured Body TSL parameters	(22.0 ± 0.2) °C	47.1 ± 6 %	5.42 mho/m ± 6 %
Body TSL temperature change during test	< 0.5 °C	----	----

### SAR result with Body TSL at 5250 MHz

SAR averaged over 1 cm <sup>3</sup> (1 g) of Body TSL	Condition	
SAR measured	100 mW input power	7.54 W/kg
SAR for nominal Body TSL parameters	normalized to 1W	74.8 W/kg ± 19.9 % (k=2)

SAR averaged over 10 cm <sup>3</sup> (10 g) of Body TSL	condition	
SAR measured	100 mW input power	2.12 W/kg
SAR for nominal Body TSL parameters	normalized to 1W	21.0 W/kg ± 19.5 % (k=2)

### Body TSL parameters at 5600 MHz

The following parameters and calculations were applied.

	Temperature	Permittivity	Conductivity
Nominal Body TSL parameters	22.0 °C	48.5	5.77 mho/m
Measured Body TSL parameters	(22.0 ± 0.2) °C	46.5 ± 6 %	5.88 mho/m ± 6 %
Body TSL temperature change during test	< 0.5 °C	----	----

### SAR result with Body TSL at 5600 MHz

SAR averaged over 1 cm <sup>3</sup> (1 g) of Body TSL	Condition	
SAR measured	100 mW input power	7.76 W/kg
SAR for nominal Body TSL parameters	normalized to 1W	77.0 W/kg ± 19.9 % (k=2)

SAR averaged over 10 cm <sup>3</sup> (10 g) of Body TSL	condition	
SAR measured	100 mW input power	2.17 W/kg
SAR for nominal Body TSL parameters	normalized to 1W	21.5 W/kg ± 19.5 % (k=2)

### Body TSL parameters at 5750 MHz

The following parameters and calculations were applied.

	Temperature	Permittivity	Conductivity
Nominal Body TSL parameters	22.0 °C	48.3	5.94 mho/m
Measured Body TSL parameters	(22.0 ± 0.2) °C	46.2 ± 6 %	6.11 mho/m ± 6 %
Body TSL temperature change during test	< 0.5 °C	----	----

### SAR result with Body TSL at 5750 MHz

SAR averaged over 1 cm <sup>3</sup> (1 g) of Body TSL	Condition	
SAR measured	100 mW input power	7.60 W/kg
SAR for nominal Body TSL parameters	normalized to 1W	75.4 W/kg ± 19.9 % (k=2)

SAR averaged over 10 cm <sup>3</sup> (10 g) of Body TSL	condition	
SAR measured	100 mW input power	2.11 W/kg
SAR for nominal Body TSL parameters	normalized to 1W	20.9 W/kg ± 19.5 % (k=2)

## Appendix (Additional assessments outside the scope of SCS 0108)

### Antenna Parameters with Head TSL at 5250 MHz

Impedance, transformed to feed point	48.6 $\Omega$ - 2.5 j $\Omega$
Return Loss	- 30.7 dB

### Antenna Parameters with Head TSL at 5600 MHz

Impedance, transformed to feed point	50.9 $\Omega$ + 1.5 j $\Omega$
Return Loss	- 35.3 dB

### Antenna Parameters with Head TSL at 5750 MHz

Impedance, transformed to feed point	53.8 $\Omega$ + 5.8 j $\Omega$
Return Loss	- 23.5 dB

### Antenna Parameters with Body TSL at 5250 MHz

Impedance, transformed to feed point	47.0 $\Omega$ - 3.9 j $\Omega$
Return Loss	- 25.9 dB

### Antenna Parameters with Body TSL at 5600 MHz

Impedance, transformed to feed point	51.5 $\Omega$ + 3.9 j $\Omega$
Return Loss	- 27.7 dB

### Antenna Parameters with Body TSL at 5750 MHz

Impedance, transformed to feed point	53.8 $\Omega$ + 0.3 j $\Omega$
Return Loss	- 28.6 dB

### General Antenna Parameters and Design

Electrical Delay (one direction)	1.193 ns
----------------------------------	----------

After long term use with 100W radiated power, only a slight warming of the dipole near the feedpoint can be measured.

The dipole is made of standard semirigid coaxial cable. The center conductor of the feeding line is directly connected to the second arm of the dipole. The antenna is therefore short-circuited for DC-signals. On some of the dipoles, small end caps are added to the dipole arms in order to improve matching when loaded according to the position as explained in the "Measurement Conditions" paragraph. The SAR data are not affected by this change. The overall dipole length is still according to the Standard.

No excessive force must be applied to the dipole arms, because they might bend or the soldered connections near the feedpoint may be damaged.

### Additional EUT Data

Manufactured by	SPEAG
Manufactured on	May 04, 2015

## DASY5 Validation Report for Head TSL

Date: 02.08.2016

Test Laboratory: SPEAG, Zurich, Switzerland

**DUT: Dipole D5GHzV2; Type: D5GHzV2; Serial: D5GHzV2 - SN:1237**

Communication System: UID 0 - CW; Frequency: 5250 MHz, Frequency: 5600 MHz, Frequency: 5750 MHz  
Medium parameters used:  $f = 5250$  MHz;  $\sigma = 4.52$  S/m;  $\epsilon_r = 34.4$ ;  $\rho = 1000$  kg/m<sup>3</sup>  
Medium parameters used:  $f = 5600$  MHz;  $\sigma = 4.86$  S/m;  $\epsilon_r = 33.9$ ;  $\rho = 1000$  kg/m<sup>3</sup>  
Medium parameters used:  $f = 5750$  MHz;  $\sigma = 5.02$  S/m;  $\epsilon_r = 33.7$ ;  $\rho = 1000$  kg/m<sup>3</sup>  
Phantom section: Flat Section  
Measurement Standard: DASY5 (IEEE/IEC/ANSI C63.19-2011)

DASY52 Configuration:

- Probe: EX3DV4 - SN3503; ConvF(5.42, 5.42, 5.42); Calibrated: 30.06.2016; ConvF(4.89, 4.89, 4.89); Calibrated: 30.06.2016, ConvF(4.85, 4.85, 4.85); Calibrated: 30.06.2016,
- Sensor-Surface: 1.4mm (Mechanical Surface Detection)
- Electronics: DAE4 Sn601; Calibrated: 30.12.2015
- Phantom: Flat Phantom 5.0 (front); Type: QD000P50AA; Serial: 1001
- DASY52 52.8.8(1258); SEMCAD X 14.6.10(7372)

**Dipole Calibration for Head Tissue/Pin=100mW, dist=10mm, f=5250 MHz/Zoom Scan, dist=1.4mm (8x8x7)/Cube 0:** Measurement grid: dx=4mm, dy=4mm, dz=1.4mm  
Reference Value = 74.10 V/m; Power Drift = -0.03 dB  
Peak SAR (extrapolated) = 29.5 W/kg  
**SAR(1 g) = 8 W/kg; SAR(10 g) = 2.3 W/kg**  
Maximum value of SAR (measured) = 18.3 W/kg

**Dipole Calibration for Head Tissue/Pin=100mW, dist=10mm, f=5600 MHz/Zoom Scan, dist=1.4mm (8x8x7)/Cube 0:** Measurement grid: dx=4mm, dy=4mm, dz=1.4mm  
Reference Value = 73.55 V/m; Power Drift = -0.01 dB  
Peak SAR (extrapolated) = 32.9 W/kg  
**SAR(1 g) = 8.43 W/kg; SAR(10 g) = 2.42 W/kg**  
Maximum value of SAR (measured) = 19.7 W/kg

**Dipole Calibration for Head Tissue/Pin=100mW, dist=10mm, f=5750 MHz/Zoom Scan, dist=1.4mm (8x8x7)/Cube 0:** Measurement grid: dx=4mm, dy=4mm, dz=1.4mm  
Reference Value = 72.23 V/m; Power Drift = -0.01 dB  
Peak SAR (extrapolated) = 33.6 W/kg  
**SAR(1 g) = 8.25 W/kg; SAR(10 g) = 2.35 W/kg**  
Maximum value of SAR (measured) = 18.3 W/kg

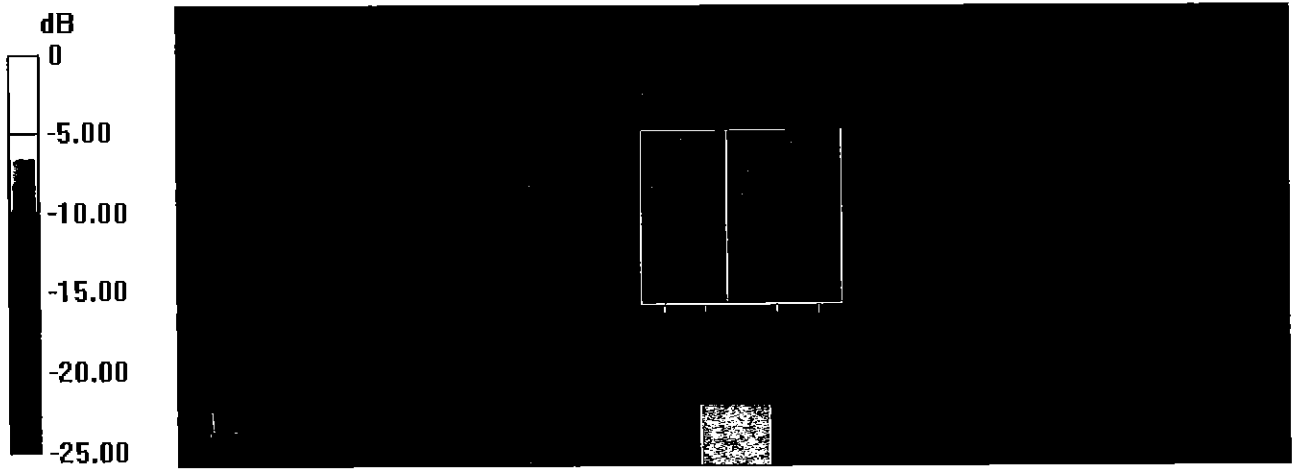

0 dB = 18.3 W/kg = 12.62 dBW/kg

# Impedance Measurement Plot for Head TSL

2 Aug 2016 08:52:20

CH1 S11 1 U FS

1: 48.623  $\Omega$  -2.5332  $\Omega$  11.967 pF

5 250.000 000 MHz

\*  
De1  
Cor  
Avg  
16  
H1d

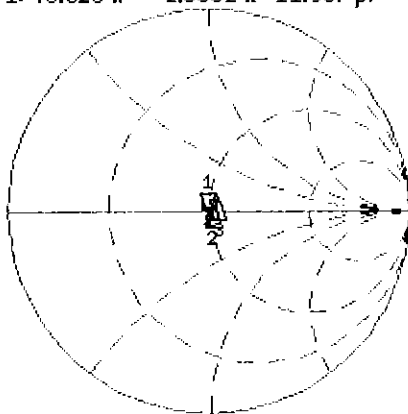

CH1 Markers  
2: 50.867  $\Omega$   
1.4961  $\Omega$   
5.60000 GHz  
3: 53.785  $\Omega$   
5.8164  $\Omega$   
5.75000 GHz

CH2 S11 LOG 5 dB/REF -20 dB 1:-30.691 dB 5 250.000 000 MHz

Cor  
Avg  
16  
H1d

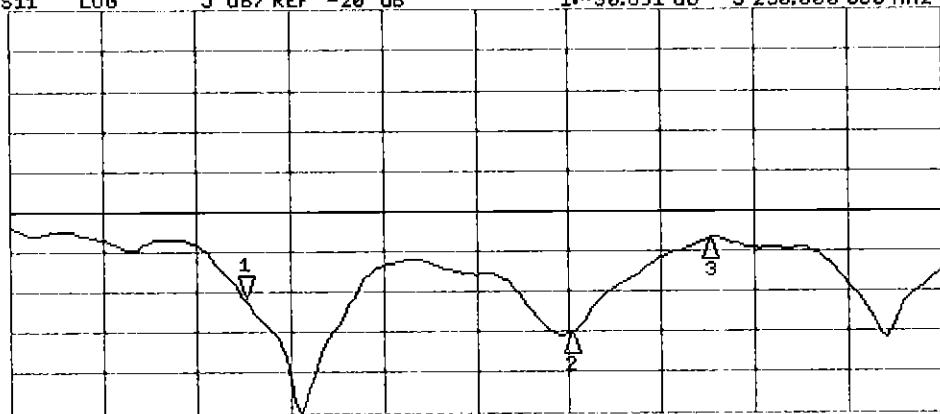

CH2 Markers  
2:-35.297 dB  
5.60000 GHz  
3:-23.501 dB  
5.75000 GHz

START 5 000.000 000 MHz

STOP 6 000.000 000 MHz



## DASY5 Validation Report for Body TSL

Date: 02.08.2016

Test Laboratory: SPEAG, Zurich, Switzerland

**DUT: Dipole D5GHzV2; Type: D5GHzV2; Serial: D5GHzV2 - SN:1237**

Communication System: UID 0 - CW; Frequency: 5250 MHz, Frequency: 5600 MHz, Frequency: 5750 MHz

Medium parameters used:  $f = 5250$  MHz;  $\sigma = 5.42$  S/m;  $\epsilon_r = 47.1$ ;  $\rho = 1000$  kg/m<sup>3</sup>

Medium parameters used:  $f = 5600$  MHz;  $\sigma = 5.88$  S/m;  $\epsilon_r = 46.5$ ;  $\rho = 1000$  kg/m<sup>3</sup>

Medium parameters used:  $f = 5750$  MHz;  $\sigma = 6.11$  S/m;  $\epsilon_r = 46.2$ ;  $\rho = 1000$  kg/m<sup>3</sup>

Phantom section: Flat Section

Measurement Standard: DASY5 (IEEE/IEC/ANSI C63.19-2011)

DASY52 Configuration:

- Probe: EX3DV4 - SN3503; ConvF(4.85, 4.85, 4.85); Calibrated: 30.06.2016, ConvF(4.35, 4.35, 4.35); Calibrated: 30.06.2016, ConvF(4.3, 4.3, 4.3); Calibrated: 30.06.2016;
- Sensor-Surface: 1.4mm (Mechanical Surface Detection)
- Electronics: DAB4 Sn601; Calibrated: 30.12.2015
- Phantom: Flat Phantom 5.0 (back); Type: QD000P50AA; Serial: 1002
- DASY52 52.8.8(1222); SEMCAD X 14.6.10(7372)

**Dipole Calibration for Body Tissue/Pin=100mW, dist=10mm, f=5250 MHz/Zoom Scan, dist=1.4mm (8x8x7)/Cube 0:** Measurement grid: dx=4mm, dy=4mm, dz=1.4mm

Reference Value = 67.19 V/m; Power Drift = -0.04 dB

Peak SAR (extrapolated) = 28.4 W/kg

**SAR(1 g) = 7.54 W/kg; SAR(10 g) = 2.12 W/kg**

Maximum value of SAR (measured) = 17.3 W/kg

**Dipole Calibration for Body Tissue/Pin=100mW, dist=10mm, f=5600 MHz/Zoom Scan, dist=1.4mm (8x8x7)/Cube 0:** Measurement grid: dx=4mm, dy=4mm, dz=1.4mm

Reference Value = 66.80 V/m; Power Drift = -0.06 dB

Peak SAR (extrapolated) = 31.9 W/kg

**SAR(1 g) = 7.76 W/kg; SAR(10 g) = 2.17 W/kg**

Maximum value of SAR (measured) = 18.3 W/kg

**Dipole Calibration for Body Tissue/Pin=100mW, dist=10mm, f=5750 MHz/Zoom Scan, dist=1.4mm (8x8x7)/Cube 0:** Measurement grid: dx=4mm, dy=4mm, dz=1.4mm

Reference Value = 65.31 V/m; Power Drift = -0.09 dB

Peak SAR (extrapolated) = 32.6 W/kg

**SAR(1 g) = 7.6 W/kg; SAR(10 g) = 2.11 W/kg**

Maximum value of SAR (measured) = 18.4 W/kg

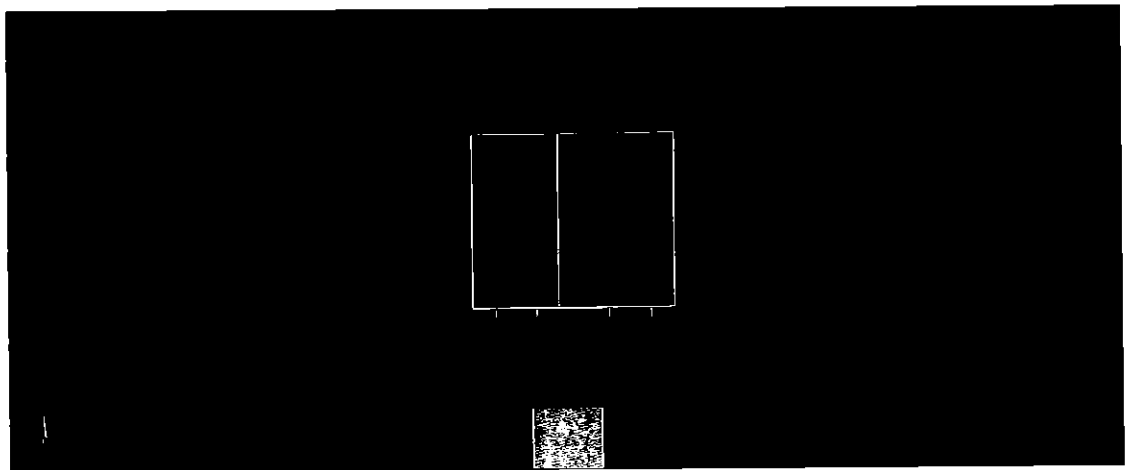
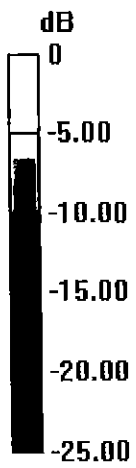

0 dB = 17.3 W/kg = 12.38 dBW/kg

# Impedance Measurement Plot for Body TSL

2 Aug 2016 08:49:13

CH1 S11 1 U FS

1: 46.998  $\Omega$  -3.8984  $\Omega$  7.7763 pF

5 250.000 000 MHz

\*  
Del  
Cor  
Avg  
16  
H1d

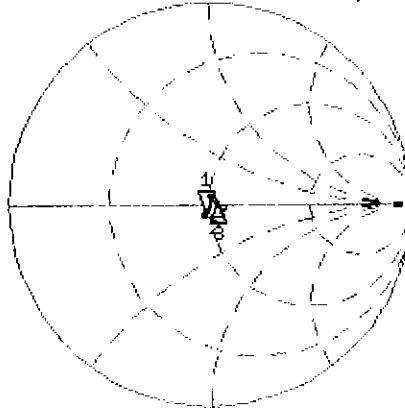

CH1 Markers  
2: 51.525  $\Omega$   
3.8945  $\Omega$   
5.60000 GHz  
3: 53.848  $\Omega$   
0.2930  $\Omega$   
5.75000 GHz

CH2 S11 LOG 5 dB/REF -20 dB 1:-25.900 dB 5 250.000 000 MHz

Cor  
Avg  
16  
H1d

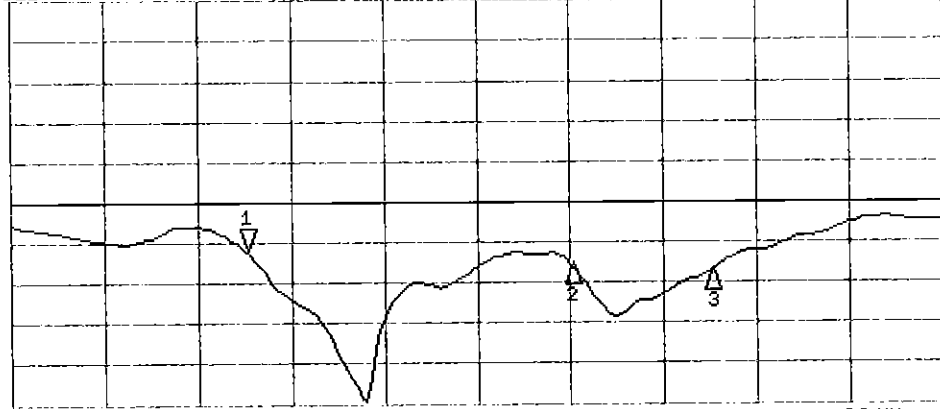

CH2 Markers  
2:-27.699 dB  
5.60000 GHz  
3:-28.596 dB  
5.75000 GHz

START 5 000.000 000 MHz

STOP 6 000.000 000 MHz



Accredited by the Swiss Accreditation Service (SAS)  
The Swiss Accreditation Service is one of the signatories to the EA  
Multilateral Agreement for the recognition of calibration certificates

Accreditation No.: **SCS 0108**

Client **PC Test**

Certificate No: **ES3-3209\_Mar16**

**CALIBRATION CERTIFICATE**

Object **ES3DV3 - SN:3209**

Calibration procedure(s) **QA CAL-01.v9, QA CAL-23.v5, QA CAL-25.v6  
Calibration procedure for dosimetric E-field probes**

Calibration date: **March 18, 2016**

*BN  
3/30/2016*

This calibration certificate documents the traceability to national standards, which realize the physical units of measurements (SI).  
The measurements and the uncertainties with confidence probability are given on the following pages and are part of the certificate.

All calibrations have been conducted in the closed laboratory facility: environment temperature (22 ± 3)°C and humidity < 70%.

Calibration Equipment used (M&TE critical for calibration)

Primary Standards	ID	Cal Date (Certificate No.)	Scheduled Calibration
Power meter E4419B	GB41293874	01-Apr-15 (No. 217-02128)	Mar-16
Power sensor E4412A	MY41498087	01-Apr-15 (No. 217-02128)	Mar-16
Reference 3 dB Attenuator	SN: S5054 (3c)	01-Apr-15 (No. 217-02129)	Mar-16
Reference 20 dB Attenuator	SN: S5277 (20x)	01-Apr-15 (No. 217-02132)	Mar-16
Reference 30 dB Attenuator	SN: S5129 (30b)	01-Apr-15 (No. 217-02133)	Mar-16
Reference Probe ES3DV2	SN: 3013	31-Dec-15 (No. ES3-3013_Dec15)	Dec-16
DAE4	SN: 660	23-Dec-15 (No. DAE4-660_Dec15)	Dec-16
Secondary Standards	ID	Check Date (in house)	Scheduled Check
RF generator HP 8648C	US3642U01700	4-Aug-99 (in house check Apr-13)	In house check: Apr-16
Network Analyzer HP 8753E	US37390585	18-Oct-01 (in house check Oct-15)	In house check: Oct-16

	Name	Function	Signature
Calibrated by:	Leif Klysner	Laboratory Technician	<i>Leif Klysner</i>
Approved by:	Katja Pokovic	Technical Manager	<i>Katja Pokovic</i>

Issued: March 22, 2016

This calibration certificate shall not be reproduced except in full without written approval of the laboratory.



Accredited by the Swiss Accreditation Service (SAS)

Accreditation No.: **SCS 0108**

The Swiss Accreditation Service is one of the signatories to the EA  
Multilateral Agreement for the recognition of calibration certificates

### Glossary:

TSL	tissue simulating liquid
NORM <sub>x,y,z</sub>	sensitivity in free space
ConvF	sensitivity in TSL / NORM <sub>x,y,z</sub>
DCP	diode compression point
CF	crest factor (1/duty_cycle) of the RF signal
A, B, C, D	modulation dependent linearization parameters
Polarization $\varphi$	$\varphi$ rotation around probe axis
Polarization $\vartheta$	$\vartheta$ rotation around an axis that is in the plane normal to probe axis (at measurement center), i.e., $\vartheta = 0$ is normal to probe axis
Connector Angle	information used in DASY system to align probe sensor X to the robot coordinate system

### Calibration is Performed According to the Following Standards:

- IEEE Std 1528-2013, "IEEE Recommended Practice for Determining the Peak Spatial-Averaged Specific Absorption Rate (SAR) in the Human Head from Wireless Communications Devices: Measurement Techniques", June 2013
- IEC 62209-1, "Procedure to measure the Specific Absorption Rate (SAR) for hand-held devices used in close proximity to the ear (frequency range of 300 MHz to 3 GHz)", February 2005
- IEC 62209-2, "Procedure to determine the Specific Absorption Rate (SAR) for wireless communication devices used in close proximity to the human body (frequency range of 30 MHz to 6 GHz)", March 2010
- KDB 865664, "SAR Measurement Requirements for 100 MHz to 6 GHz"

### Methods Applied and Interpretation of Parameters:

- NORM<sub>x,y,z</sub>**: Assessed for E-field polarization  $\vartheta = 0$  ( $f \leq 900$  MHz in TEM-cell;  $f > 1800$  MHz: R22 waveguide). NORM<sub>x,y,z</sub> are only intermediate values, i.e., the uncertainties of NORM<sub>x,y,z</sub> does not affect the  $E^2$ -field uncertainty inside TSL (see below ConvF).
- NORM(f)<sub>x,y,z</sub>** = NORM<sub>x,y,z</sub> \* frequency\_response (see Frequency Response Chart). This linearization is implemented in DASY4 software versions later than 4.2. The uncertainty of the frequency response is included in the stated uncertainty of ConvF.
- DCP<sub>x,y,z</sub>**: DCP are numerical linearization parameters assessed based on the data of power sweep with CW signal (no uncertainty required). DCP does not depend on frequency nor media.
- PAR**: PAR is the Peak to Average Ratio that is not calibrated but determined based on the signal characteristics
- A<sub>x,y,z</sub>; B<sub>x,y,z</sub>; C<sub>x,y,z</sub>; D<sub>x,y,z</sub>; VR<sub>x,y,z</sub>**: A, B, C, D are numerical linearization parameters assessed based on the data of power sweep for specific modulation signal. The parameters do not depend on frequency nor media. VR is the maximum calibration range expressed in RMS voltage across the diode.
- ConvF and Boundary Effect Parameters**: Assessed in flat phantom using E-field (or Temperature Transfer Standard for  $f \leq 800$  MHz) and inside waveguide using analytical field distributions based on power measurements for  $f > 800$  MHz. The same setups are used for assessment of the parameters applied for boundary compensation (alpha, depth) of which typical uncertainty values are given. These parameters are used in DASY4 software to improve probe accuracy close to the boundary. The sensitivity in TSL corresponds to NORM<sub>x,y,z</sub> \* ConvF whereby the uncertainty corresponds to that given for ConvF. A frequency dependent ConvF is used in DASY version 4.4 and higher which allows extending the validity from  $\pm 50$  MHz to  $\pm 100$  MHz.
- Spherical isotropy (3D deviation from isotropy)**: in a field of low gradients realized using a flat phantom exposed by a patch antenna.
- Sensor Offset**: The sensor offset corresponds to the offset of virtual measurement center from the probe tip (on probe axis). No tolerance required.
- Connector Angle**: The angle is assessed using the information gained by determining the NORM<sub>x</sub> (no uncertainty required).

# Probe ES3DV3

## SN:3209

Manufactured: October 14, 2008  
Calibrated: March 18, 2016

Calibrated for DASYS/EASY Systems  
(Note: non-compatible with DASYS2 system!)

# DASY/EASY - Parameters of Probe: ES3DV3 - SN:3209

## Basic Calibration Parameters

	Sensor X	Sensor Y	Sensor Z	Unc (k=2)
Norm ( $\mu V / (V/m)^2$ ) <sup>A</sup>	1.33	1.31	1.12	± 10.1 %
DCP (mV) <sup>B</sup>	101.7	103.5	101.2	

## Modulation Calibration Parameters

UID	Communication System Name		A dB	B dB $\sqrt{\mu V}$	C	D dB	VR mV	Unc <sup>E</sup> (k=2)
0	CW	X	0.0	0.0	1.0	0.00	220.0	±3.8 %
		Y	0.0	0.0	1.0		213.1	
		Z	0.0	0.0	1.0		195.4	
10010-CAA	SAR Validation (Square, 100ms, 10ms)	X	2.09	61.8	11.1	10.00	43.7	±0.9 %
		Y	2.54	63.7	12.3		42.4	
		Z	9.74	76.2	16.0		38.8	
10012-CAB	IEEE 802.11b WiFi 2.4 GHz (DSSS, 1 Mbps)	X	2.73	68.3	18.8	1.87	133.3	±0.7 %
		Y	3.26	72.2	21.0		127.7	
		Z	2.80	68.4	18.6		116.7	
10100-CAB	LTE-FDD (SC-FDMA, 100% RB, 20 MHz, QPSK)	X	6.61	68.5	20.5	5.67	147.6	±1.4 %
		Y	6.48	68.0	20.1		139.5	
		Z	6.30	67.2	19.6		127.7	
10103-CAB	LTE-TDD (SC-FDMA, 100% RB, 20 MHz, QPSK)	X	9.09	74.0	25.9	9.29	124.5	±2.2 %
		Y	9.05	73.2	25.1		120.6	
		Z	8.51	71.7	24.5		107.7	
10108-CAC	LTE-FDD (SC-FDMA, 100% RB, 10 MHz, QPSK)	X	6.45	68.0	20.4	5.80	144.1	±1.4 %
		Y	6.35	67.6	20.0		137.6	
		Z	6.17	66.8	19.5		124.8	
10151-CAB	LTE-TDD (SC-FDMA, 50% RB, 20 MHz, QPSK)	X	8.52	73.1	25.6	9.28	119.2	±2.5 %
		Y	8.47	72.2	24.7		116.3	
		Z	9.20	75.3	26.7		148.4	
10154-CAC	LTE-FDD (SC-FDMA, 50% RB, 10 MHz, QPSK)	X	6.14	67.6	20.2	5.75	140.1	±1.4 %
		Y	6.03	67.1	19.8		134.4	
		Z	5.89	66.4	19.4		121.9	
10160-CAB	LTE-FDD (SC-FDMA, 50% RB, 15 MHz, QPSK)	X	6.57	68.0	20.3	5.82	145.9	±1.4 %
		Y	6.48	67.6	20.0		139.5	
		Z	6.32	67.0	19.6		126.7	
10169-CAB	LTE-FDD (SC-FDMA, 1 RB, 20 MHz, QPSK)	X	4.84	66.7	19.9	5.73	121.1	±1.2 %
		Y	4.86	66.6	19.8		117.0	
		Z	5.16	67.8	20.4		148.7	
10172-CAB	LTE-TDD (SC-FDMA, 1 RB, 20 MHz, QPSK)	X	7.43	77.3	28.3	9.21	131.4	±1.9 %
		Y	7.40	75.8	27.0		129.7	
		Z	6.83	73.7	26.0		116.1	
10175-CAC	LTE-FDD (SC-FDMA, 1 RB, 10 MHz, QPSK)	X	4.75	66.3	19.7	5.72	114.6	±0.9 %
		Y	4.82	66.4	19.7		110.3	
		Z	5.16	67.8	20.4		147.4	

10181-CAB	LTE-FDD (SC-FDMA, 1 RB, 15 MHz, QPSK)	X	4.82	66.6	19.9	5.72	119.3	±0.9 %
		Y	4.79	66.2	19.6		110.0	
		Z	5.15	67.8	20.3		147.0	
10237-CAB	LTE-TDD (SC-FDMA, 1 RB, 10 MHz, QPSK)	X	7.37	76.9	28.1	9.21	130.4	±1.9 %
		Y	7.02	74.1	26.0		122.0	
		Z	6.83	73.6	25.9		115.6	
10252-CAB	LTE-TDD (SC-FDMA, 50% RB, 10 MHz, QPSK)	X	7.85	72.0	25.2	9.24	112.3	±2.5 %
		Y	7.74	70.8	24.1		104.5	
		Z	8.42	73.9	26.1		138.6	
10267-CAB	LTE-TDD (SC-FDMA, 100% RB, 10 MHz, QPSK)	X	8.43	72.7	25.4	9.30	116.9	±2.5 %
		Y	8.28	71.5	24.3		109.4	
		Z	9.17	75.2	26.7		147.6	
10297-AAA	LTE-FDD (SC-FDMA, 50% RB, 20 MHz, QPSK)	X	6.48	68.1	20.5	5.81	141.5	±1.4 %
		Y	6.32	67.4	20.0		136.8	
		Z	6.17	66.8	19.6		123.8	
10311-AAA	LTE-FDD (SC-FDMA, 100% RB, 15 MHz, QPSK)	X	7.07	68.8	20.8	6.06	146.9	±1.7 %
		Y	6.98	68.3	20.5		142.2	
		Z	6.77	67.5	20.0		128.8	

The reported uncertainty of measurement is stated as the standard uncertainty of measurement multiplied by the coverage factor  $k=2$ , which for a normal distribution corresponds to a coverage probability of approximately 95%.

<sup>A</sup> The uncertainties of Norm X,Y,Z do not affect the  $E^2$ -field uncertainty inside TSL (see Pages 6 and 7).

<sup>B</sup> Numerical linearization parameter: uncertainty not required.

<sup>E</sup> Uncertainty is determined using the max. deviation from linear response applying rectangular distribution and is expressed for the square of the field value.



## DASY/EASY - Parameters of Probe: ES3DV3 - SN:3209

### Calibration Parameter Determined in Head Tissue Simulating Media

f (MHz) <sup>C</sup>	Relative Permittivity <sup>F</sup>	Conductivity (S/m) <sup>F</sup>	ConvF X	ConvF Y	ConvF Z	Alpha <sup>G</sup>	Depth <sup>G</sup> (mm)	Unc (k=2)
750	41.9	0.89	6.60	6.60	6.60	0.47	1.59	± 12.0 %
835	41.5	0.90	6.20	6.20	6.20	0.80	1.19	± 12.0 %
1750	40.1	1.37	5.28	5.28	5.28	0.54	1.35	± 12.0 %
1900	40.0	1.40	5.14	5.14	5.14	0.71	1.21	± 12.0 %
2300	39.5	1.67	4.82	4.82	4.82	0.74	1.26	± 12.0 %
2450	39.2	1.80	4.63	4.63	4.63	0.55	1.50	± 12.0 %
2600	39.0	1.96	4.48	4.48	4.48	0.78	1.25	± 12.0 %

<sup>C</sup> Frequency validity above 300 MHz of ± 100 MHz only applies for DASY v4.4 and higher (see Page 2), else it is restricted to ± 50 MHz. The uncertainty is the RSS of the ConvF uncertainty at calibration frequency and the uncertainty for the indicated frequency band. Frequency validity below 300 MHz is ± 10, 25, 40, 50 and 70 MHz for ConvF assessments at 30, 64, 128, 150 and 220 MHz respectively. Above 5 GHz frequency validity can be extended to ± 110 MHz.

<sup>F</sup> At frequencies below 3 GHz, the validity of tissue parameters ( $\epsilon$  and  $\sigma$ ) can be relaxed to ± 10% if liquid compensation formula is applied to measured SAR values. At frequencies above 3 GHz, the validity of tissue parameters ( $\epsilon$  and  $\sigma$ ) is restricted to ± 5%. The uncertainty is the RSS of the ConvF uncertainty for indicated target tissue parameters.

<sup>G</sup> Alpha/Depth are determined during calibration. SPEAG warrants that the remaining deviation due to the boundary effect after compensation is always less than ± 1% for frequencies below 3 GHz and below ± 2% for frequencies between 3-6 GHz at any distance larger than half the probe tip diameter from the boundary.

## DASY/EASY - Parameters of Probe: ES3DV3 - SN:3209

### Calibration Parameter Determined in Body Tissue Simulating Media

f (MHz) <sup>C</sup>	Relative Permittivity <sup>F</sup>	Conductivity (S/m) <sup>F</sup>	ConvF X	ConvF Y	ConvF Z	Alpha <sup>G</sup>	Depth (mm) <sup>G</sup>	Unc (k=2)
750	55.5	0.96	6.19	6.19	6.19	0.53	1.42	± 12.0 %
835	55.2	0.97	6.19	6.19	6.19	0.62	1.30	± 12.0 %
1750	53.4	1.49	4.99	4.99	4.99	0.51	1.54	± 12.0 %
1900	53.3	1.52	4.77	4.77	4.77	0.56	1.52	± 12.0 %
2300	52.9	1.81	4.44	4.44	4.44	0.75	1.26	± 12.0 %
2450	52.7	1.95	4.31	4.31	4.31	0.74	1.26	± 12.0 %
2600	52.5	2.16	4.11	4.11	4.11	0.80	1.20	± 12.0 %

<sup>C</sup> Frequency validity above 300 MHz of ± 100 MHz only applies for DASY v4.4 and higher (see Page 2), else it is restricted to ± 50 MHz. The uncertainty is the RSS of the ConvF uncertainty at calibration frequency and the uncertainty for the indicated frequency band. Frequency validity below 300 MHz is ± 10, 25, 40, 50 and 70 MHz for ConvF assessments at 30, 64, 128, 150 and 220 MHz respectively. Above 5 GHz frequency validity can be extended to ± 110 MHz.

<sup>F</sup> At frequencies below 3 GHz, the validity of tissue parameters ( $\epsilon$  and  $\sigma$ ) can be relaxed to ± 10% if liquid compensation formula is applied to measured SAR values. At frequencies above 3 GHz, the validity of tissue parameters ( $\epsilon$  and  $\sigma$ ) is restricted to ± 5%. The uncertainty is the RSS of the ConvF uncertainty for indicated target tissue parameters.

<sup>G</sup> Alpha/Depth are determined during calibration. SPEAG warrants that the remaining deviation due to the boundary effect after compensation is always less than ± 1% for frequencies below 3 GHz and below ± 2% for frequencies between 3-6 GHz at any distance larger than half the probe tip diameter from the boundary.

# Frequency Response of E-Field

(TEM-Cell:ifi110 EXX, Waveguide: R22)

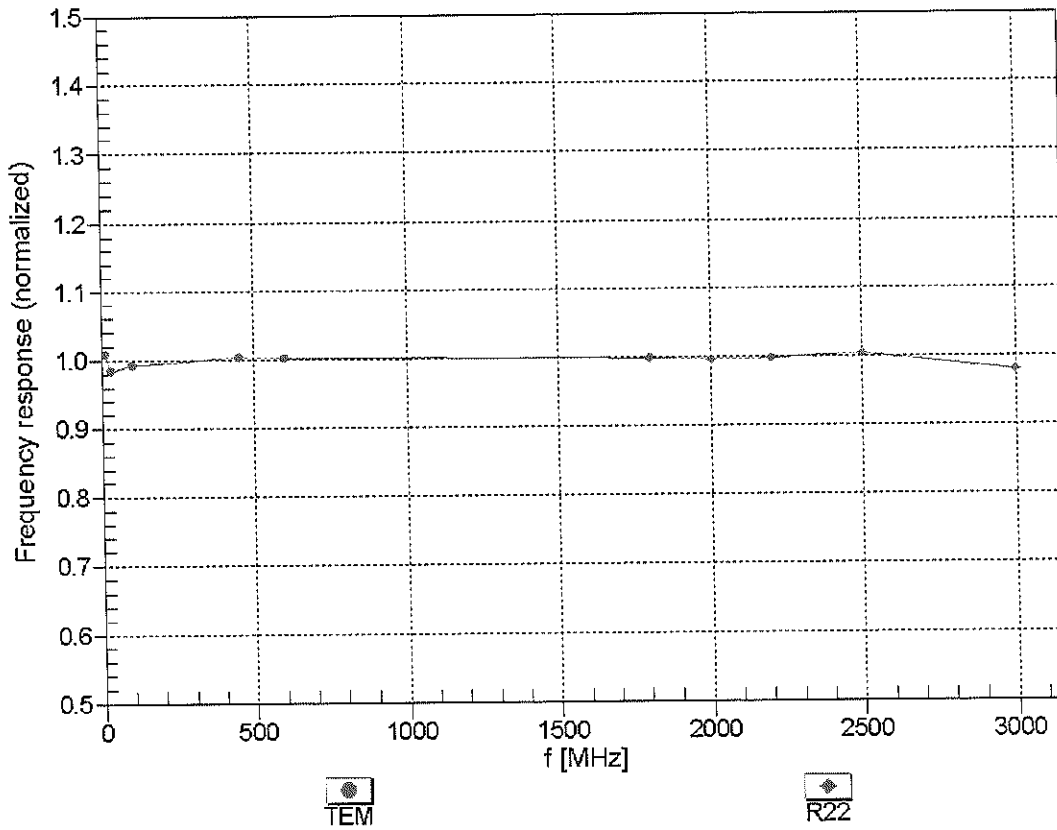

Uncertainty of Frequency Response of E-field:  $\pm 6.3\%$  (k=2)

### Receiving Pattern ( $\phi$ ), $\theta = 0^\circ$

f=600 MHz,TEM

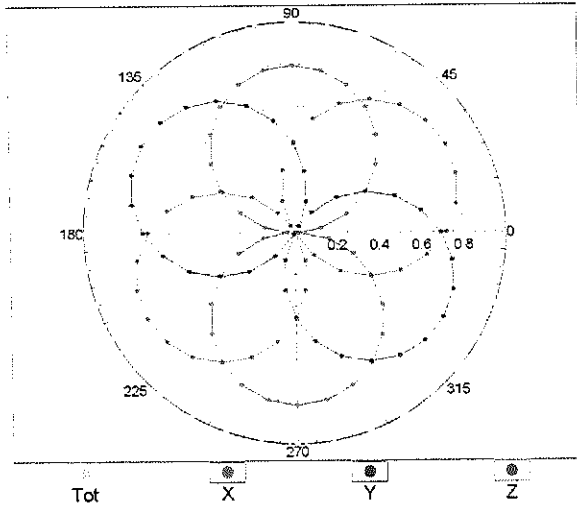

f=1800 MHz,R22

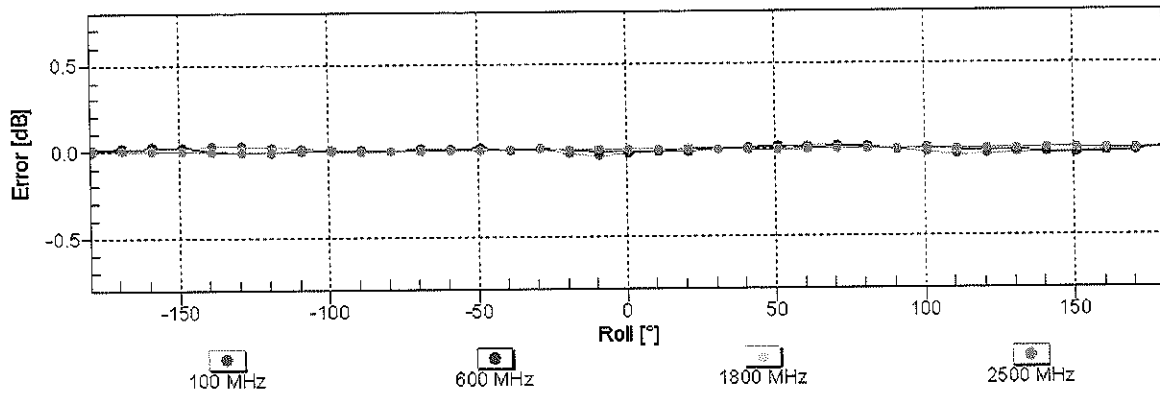
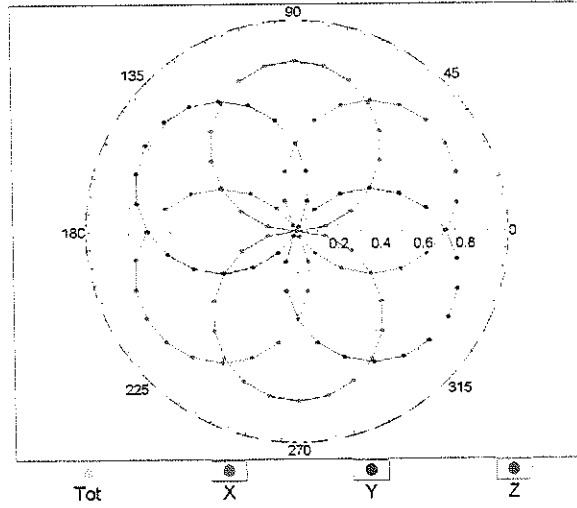

Uncertainty of Axial Isotropy Assessment:  $\pm 0.5\%$  (k=2)

### Dynamic Range f(SAR<sub>head</sub>) (TEM cell , f<sub>eval</sub>= 1900 MHz)

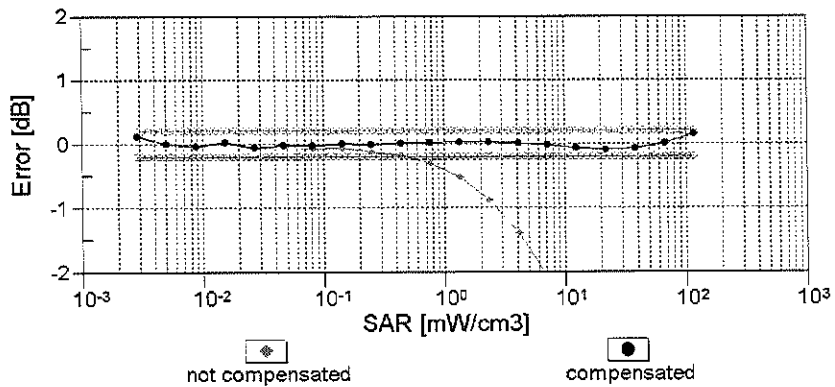
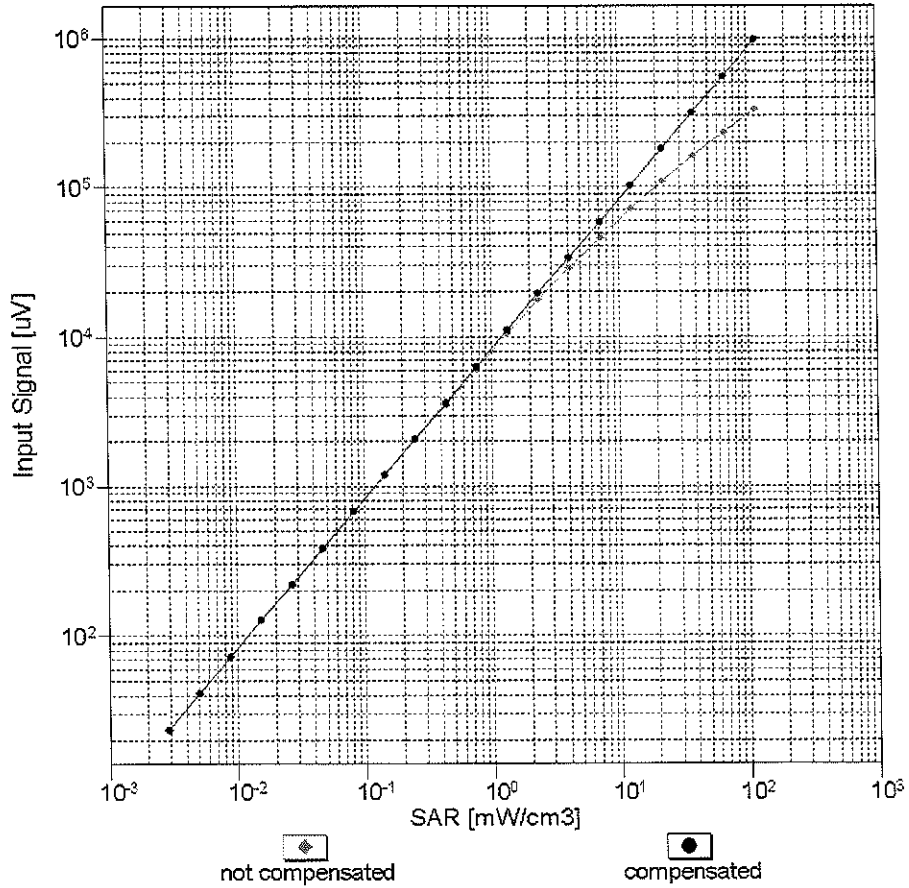

Uncertainty of Linearity Assessment: ± 0.6% (k=2)

# Conversion Factor Assessment

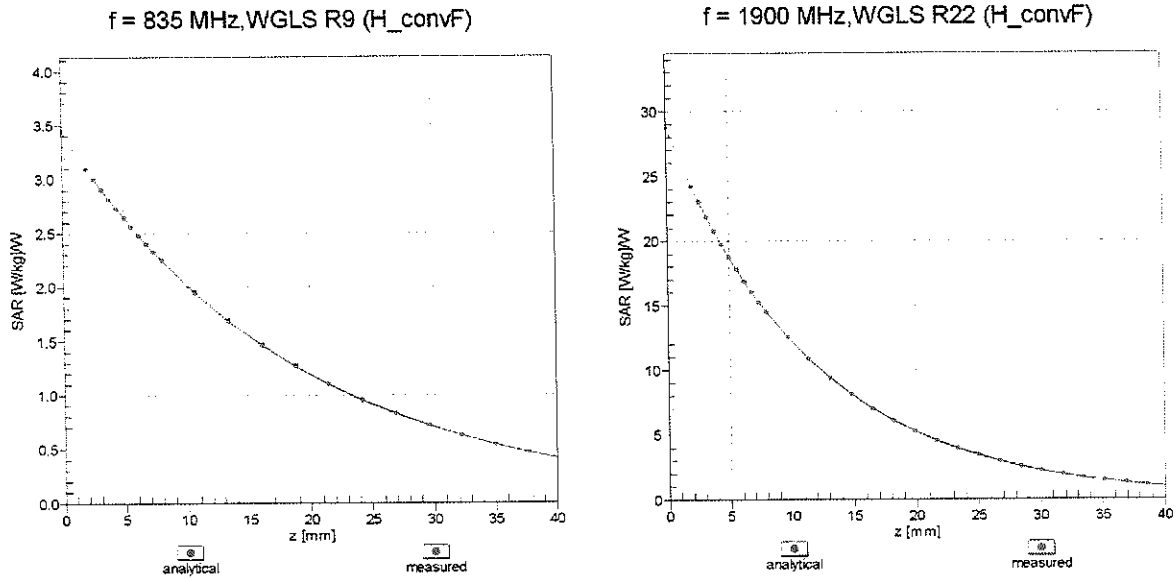

## Deviation from Isotropy in Liquid Error ( $\phi, \theta$ ), f = 900 MHz

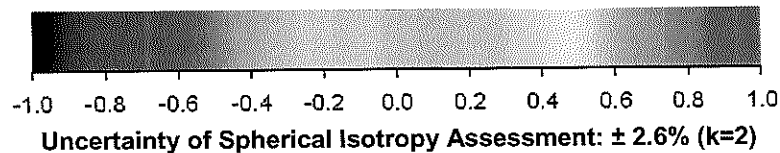
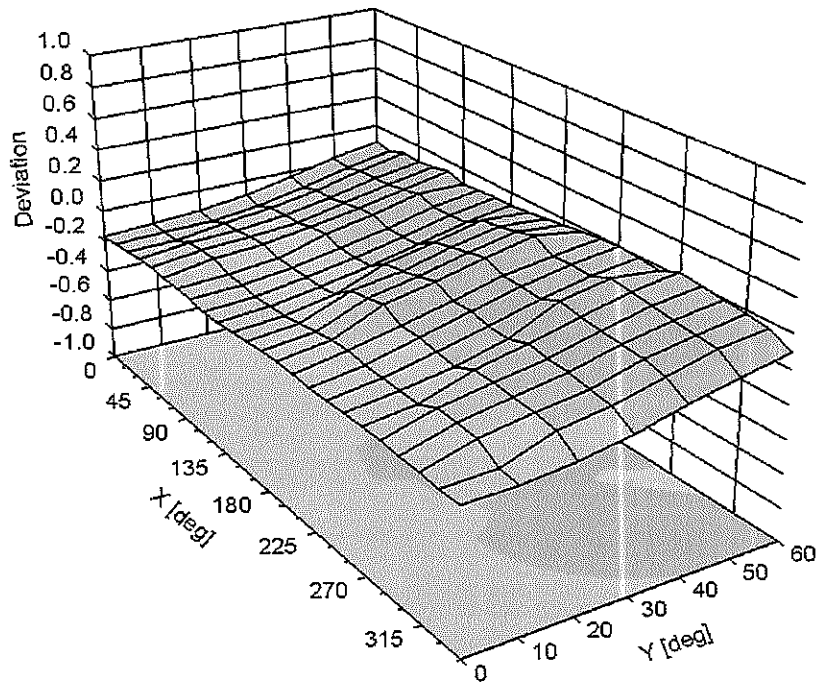

## DASY/EASY - Parameters of Probe: ES3DV3 - SN:3209

### Other Probe Parameters

Sensor Arrangement	Triangular
Connector Angle (°)	141
Mechanical Surface Detection Mode	enabled
Optical Surface Detection Mode	disabled
Probe Overall Length	337 mm
Probe Body Diameter	10 mm
Tip Length	10 mm
Tip Diameter	4 mm
Probe Tip to Sensor X Calibration Point	2 mm
Probe Tip to Sensor Y Calibration Point	2 mm
Probe Tip to Sensor Z Calibration Point	2 mm
Recommended Measurement Distance from Surface	3 mm

**Calibration Laboratory of  
Schmid & Partner  
Engineering AG**  
Zeughausstrasse 43, 8004 Zurich, Switzerland



**S** Schweizerischer Kalibrierdienst  
**C** Service suisse d'étalonnage  
**S** Servizio svizzero di taratura  
Swiss Calibration Service

Accredited by the Swiss Accreditation Service (SAS)  
The Swiss Accreditation Service is one of the signatories to the EA  
Multilateral Agreement for the recognition of calibration certificates

Accreditation No.: **SCS 0108**

Client **PC Test**

Certificate No: **ES3-3287\_Sep16**

## CALIBRATION CERTIFICATE

Object: **ES3DV3 - SN:3287**

Calibration procedure(s): **QA CAL-01.v9, QA CAL-23.v5, QA CAL-25.v6**  
**Calibration procedure for dosimetric E-field probes**

Calibration date: **September 19, 2016**

*BNV*  
*09-28-2016*

This calibration certificate documents the traceability to national standards, which realize the physical units of measurements (SI).  
The measurements and the uncertainties with confidence probability are given on the following pages and are part of the certificate.

All calibrations have been conducted in the closed laboratory facility: environment temperature (22 ± 3)°C and humidity < 70%.

Calibration Equipment used (M&TE critical for calibration)

Primary Standards	ID	Cal Date (Certificate No.)	Scheduled Calibration
Power meter NRP	SN: 104778	06-Apr-16 (No. 217-02288/02289)	Apr-17
Power sensor NRP-Z91	SN: 103244	06-Apr-16 (No. 217-02288)	Apr-17
Power sensor NRP-Z91	SN: 103245	06-Apr-16 (No. 217-02289)	Apr-17
Reference 20 dB Attenuator	SN: S5277 (20x)	05-Apr-16 (No. 217-02293)	Apr-17
Reference Probe ES3DV2	SN: 3013	31-Dec-15 (No. ES3-3013_Dec15)	Dec-16
DAE4	SN: 660	23-Dec-15 (No. DAE4-660_Dec15)	Dec-16
Secondary Standards	ID	Check Date (in house)	Scheduled Check
Power meter E4419B	SN: GB41293874	06-Apr-16 (in house check Jun-16)	In house check: Jun-18
Power sensor E4412A	SN: MY41498087	06-Apr-16 (in house check Jun-16)	In house check: Jun-18
Power sensor E4412A	SN: 000110210	06-Apr-16 (in house check Jun-16)	In house check: Jun-18
RF generator HP 8648C	SN: US3642U01700	04-Aug-99 (in house check Jun-16)	In house check: Jun-18
Network Analyzer HP 8753E	SN: US37390585	18-Oct-01 (in house check Oct-15)	In house check: Oct-16

Calibrated by:	Name <b>Leif Klysner</b>	Function <b>Laboratory Technician</b>	Signature <i>Leif Klysner</i>
Approved by:	Name <b>Katja Pokovic</b>	Function <b>Technical Manager</b>	Signature <i>Katja Pokovic</i>

Issued: September 20, 2016

This calibration certificate shall not be reproduced except in full without written approval of the laboratory.





Accredited by the Swiss Accreditation Service (SAS)

Accreditation No.: **SCS 0108**

The Swiss Accreditation Service is one of the signatories to the EA  
Multilateral Agreement for the recognition of calibration certificates

**Glossary:**

TSL	tissue simulating liquid
NORM <sub>x,y,z</sub>	sensitivity in free space
ConvF	sensitivity in TSL / NORM <sub>x,y,z</sub>
DCP	diode compression point
CF	crest factor (1/duty_cycle) of the RF signal
A, B, C, D	modulation dependent linearization parameters
Polarization $\varphi$	$\varphi$ rotation around probe axis
Polarization $\vartheta$	$\vartheta$ rotation around an axis that is in the plane normal to probe axis (at measurement center), i.e., $\vartheta = 0$ is normal to probe axis
Connector Angle	information used in DASY system to align probe sensor X to the robot coordinate system

**Calibration is Performed According to the Following Standards:**

- a) IEEE Std 1528-2013, "IEEE Recommended Practice for Determining the Peak Spatial-Averaged Specific Absorption Rate (SAR) in the Human Head from Wireless Communications Devices: Measurement Techniques", June 2013
- b) IEC 62209-1, "Procedure to measure the Specific Absorption Rate (SAR) for hand-held devices used in close proximity to the ear (frequency range of 300 MHz to 3 GHz)", February 2005
- c) IEC 62209-2, "Procedure to determine the Specific Absorption Rate (SAR) for wireless communication devices used in close proximity to the human body (frequency range of 30 MHz to 6 GHz)", March 2010
- d) KDB 865664, "SAR Measurement Requirements for 100 MHz to 6 GHz"

**Methods Applied and Interpretation of Parameters:**

- **NORM<sub>x,y,z</sub>:** Assessed for E-field polarization  $\vartheta = 0$  ( $f \leq 900$  MHz in TEM-cell;  $f > 1800$  MHz: R22 waveguide). NORM<sub>x,y,z</sub> are only intermediate values, i.e., the uncertainties of NORM<sub>x,y,z</sub> does not affect the  $E^2$ -field uncertainty inside TSL (see below ConvF).
- **NORM(f)<sub>x,y,z</sub> = NORM<sub>x,y,z</sub> \* frequency\_response** (see Frequency Response Chart). This linearization is implemented in DASY4 software versions later than 4.2. The uncertainty of the frequency response is included in the stated uncertainty of ConvF.
- **DCP<sub>x,y,z</sub>:** DCP are numerical linearization parameters assessed based on the data of power sweep with CW signal (no uncertainty required). DCP does not depend on frequency nor media.
- **PAR:** PAR is the Peak to Average Ratio that is not calibrated but determined based on the signal characteristics
- **A<sub>x,y,z</sub>; B<sub>x,y,z</sub>; C<sub>x,y,z</sub>; D<sub>x,y,z</sub>; VR<sub>x,y,z</sub>:** A, B, C, D are numerical linearization parameters assessed based on the data of power sweep for specific modulation signal. The parameters do not depend on frequency nor media. VR is the maximum calibration range expressed in RMS voltage across the diode.
- **ConvF and Boundary Effect Parameters:** Assessed in flat phantom using E-field (or Temperature Transfer Standard for  $f \leq 800$  MHz) and inside waveguide using analytical field distributions based on power measurements for  $f > 800$  MHz. The same setups are used for assessment of the parameters applied for boundary compensation (alpha, depth) of which typical uncertainty values are given. These parameters are used in DASY4 software to improve probe accuracy close to the boundary. The sensitivity in TSL corresponds to NORM<sub>x,y,z</sub> \* ConvF whereby the uncertainty corresponds to that given for ConvF. A frequency dependent ConvF is used in DASY version 4.4 and higher which allows extending the validity from  $\pm 50$  MHz to  $\pm 100$  MHz.
- **Spherical isotropy (3D deviation from isotropy):** in a field of low gradients realized using a flat phantom exposed by a patch antenna.
- **Sensor Offset:** The sensor offset corresponds to the offset of virtual measurement center from the probe tip (on probe axis). No tolerance required.
- **Connector Angle:** The angle is assessed using the information gained by determining the NORM<sub>x</sub> (no uncertainty required).

# Probe ES3DV3

## SN:3287

Manufactured: June 7, 2010  
Calibrated: September 19, 2016

Calibrated for DASY/EASY Systems  
(Note: non-compatible with DASY2 system!)

# DASY/EASY - Parameters of Probe: ES3DV3 - SN:3287

## Basic Calibration Parameters

	Sensor X	Sensor Y	Sensor Z	Unc (k=2)
Norm ( $\mu\text{V}/(\text{V}/\text{m})^2$ ) <sup>A</sup>	0.87	0.98	1.00	$\pm 10.1\%$
DCP (mV) <sup>B</sup>	101.9	101.4	106.1	

## Modulation Calibration Parameters

UID	Communication System Name		A dB	B dB $\sqrt{\mu\text{V}}$	C	D dB	VR mV	Unc <sup>E</sup> (k=2)
0	CW	X	0.0	0.0	1.0	0.00	198.4	$\pm 3.5\%$
		Y	0.0	0.0	1.0		189.6	
		Z	0.0	0.0	1.0		184.8	

Note: For details on UID parameters see Appendix.

## Sensor Model Parameters

	C1 fF	C2 fF	$\alpha$ V <sup>-1</sup>	T1 ms.V <sup>-2</sup>	T2 ms.V <sup>-1</sup>	T3 ms	T4 V <sup>-2</sup>	T5 V <sup>-1</sup>	T6
X	65.67	459.4	34.07	29.08	2.68	5.077	2	0.308	1.009
Y	71.46	511.8	35.31	29.86	3.707	5.1	0.748	0.607	1.009
Z	50.48	357.3	34.55	27.84	2.262	5.1	1.583	0.279	1.01

The reported uncertainty of measurement is stated as the standard uncertainty of measurement multiplied by the coverage factor k=2, which for a normal distribution corresponds to a coverage probability of approximately 95%.

<sup>A</sup> The uncertainties of Norm X,Y,Z do not affect the E<sup>2</sup>-field uncertainty inside TSL (see Pages 5 and 6).

<sup>B</sup> Numerical linearization parameter: uncertainty not required.

<sup>E</sup> Uncertainty is determined using the max. deviation from linear response applying rectangular distribution and is expressed for the square of the field value.

## DASY/EASY - Parameters of Probe: ES3DV3 - SN:3287

### Calibration Parameter Determined in Head Tissue Simulating Media

f (MHz) <sup>C</sup>	Relative Permittivity <sup>F</sup>	Conductivity (S/m) <sup>F</sup>	ConvF X	ConvF Y	ConvF Z	Alpha <sup>G</sup>	Depth <sup>G</sup> (mm)	Unc (k=2)
750	41.9	0.89	6.96	6.96	6.96	0.44	1.36	± 12.0 %
835	41.5	0.90	6.67	6.67	6.67	0.29	1.69	± 12.0 %
1750	40.1	1.37	5.49	5.49	5.49	0.43	1.42	± 12.0 %
1900	40.0	1.40	5.27	5.27	5.27	0.41	1.45	± 12.0 %
2300	39.5	1.67	4.86	4.86	4.86	0.61	1.28	± 12.0 %
2450	39.2	1.80	4.54	4.54	4.54	0.47	1.51	± 12.0 %
2600	39.0	1.96	4.41	4.41	4.41	0.77	1.18	± 12.0 %

<sup>C</sup> Frequency validity above 300 MHz of ± 100 MHz only applies for DASY v4.4 and higher (see Page 2), else it is restricted to ± 50 MHz. The uncertainty is the RSS of the ConvF uncertainty at calibration frequency and the uncertainty for the indicated frequency band. Frequency validity below 300 MHz is ± 10, 25, 40, 50 and 70 MHz for ConvF assessments at 30, 64, 128, 150 and 220 MHz respectively. Above 5 GHz frequency validity can be extended to ± 110 MHz.

<sup>F</sup> At frequencies below 3 GHz, the validity of tissue parameters ( $\epsilon$  and  $\sigma$ ) can be relaxed to ± 10% if liquid compensation formula is applied to measured SAR values. At frequencies above 3 GHz, the validity of tissue parameters ( $\epsilon$  and  $\sigma$ ) is restricted to ± 5%. The uncertainty is the RSS of the ConvF uncertainty for indicated target tissue parameters.

<sup>G</sup> Alpha/Depth are determined during calibration. SPEAG warrants that the remaining deviation due to the boundary effect after compensation is always less than ± 1% for frequencies below 3 GHz and below ± 2% for frequencies between 3-6 GHz at any distance larger than half the probe tip diameter from the boundary.

## DASY/EASY - Parameters of Probe: ES3DV3 - SN:3287

### Calibration Parameter Determined in Body Tissue Simulating Media

f (MHz) <sup>C</sup>	Relative Permittivity <sup>F</sup>	Conductivity (S/m) <sup>F</sup>	ConvF X	ConvF Y	ConvF Z	Alpha <sup>G</sup>	Depth <sup>G</sup> (mm)	Unc (k=2)
750	55.5	0.96	6.64	6.64	6.64	0.27	1.86	± 12.0 %
835	55.2	0.97	6.55	6.55	6.55	0.50	1.37	± 12.0 %
1750	53.4	1.49	5.11	5.11	5.11	0.33	1.85	± 12.0 %
1900	53.3	1.52	4.94	4.94	4.94	0.42	1.59	± 12.0 %
2300	52.9	1.81	4.55	4.55	4.55	0.55	1.42	± 12.0 %
2450	52.7	1.95	4.35	4.35	4.35	0.80	1.09	± 12.0 %
2600	52.5	2.16	4.12	4.12	4.12	0.80	1.10	± 12.0 %

<sup>C</sup> Frequency validity above 300 MHz of ± 100 MHz only applies for DASY v4.4 and higher (see Page 2), else it is restricted to ± 50 MHz. The uncertainty is the RSS of the ConvF uncertainty at calibration frequency and the uncertainty for the indicated frequency band. Frequency validity below 300 MHz is ± 10, 25, 40, 50 and 70 MHz for ConvF assessments at 30, 64, 128, 150 and 220 MHz respectively. Above 5 GHz frequency validity can be extended to ± 110 MHz.

<sup>F</sup> At frequencies below 3 GHz, the validity of tissue parameters ( $\epsilon$  and  $\sigma$ ) can be relaxed to ± 10% if liquid compensation formula is applied to measured SAR values. At frequencies above 3 GHz, the validity of tissue parameters ( $\epsilon$  and  $\sigma$ ) is restricted to ± 5%. The uncertainty is the RSS of the ConvF uncertainty for indicated target tissue parameters.

<sup>G</sup> Alpha/Depth are determined during calibration. SPEAG warrants that the remaining deviation due to the boundary effect after compensation is always less than ± 1% for frequencies below 3 GHz and below ± 2% for frequencies between 3-6 GHz at any distance larger than half the probe tip diameter from the boundary.

### Frequency Response of E-Field (TEM-Cell:ifi110 EXX, Waveguide: R22)

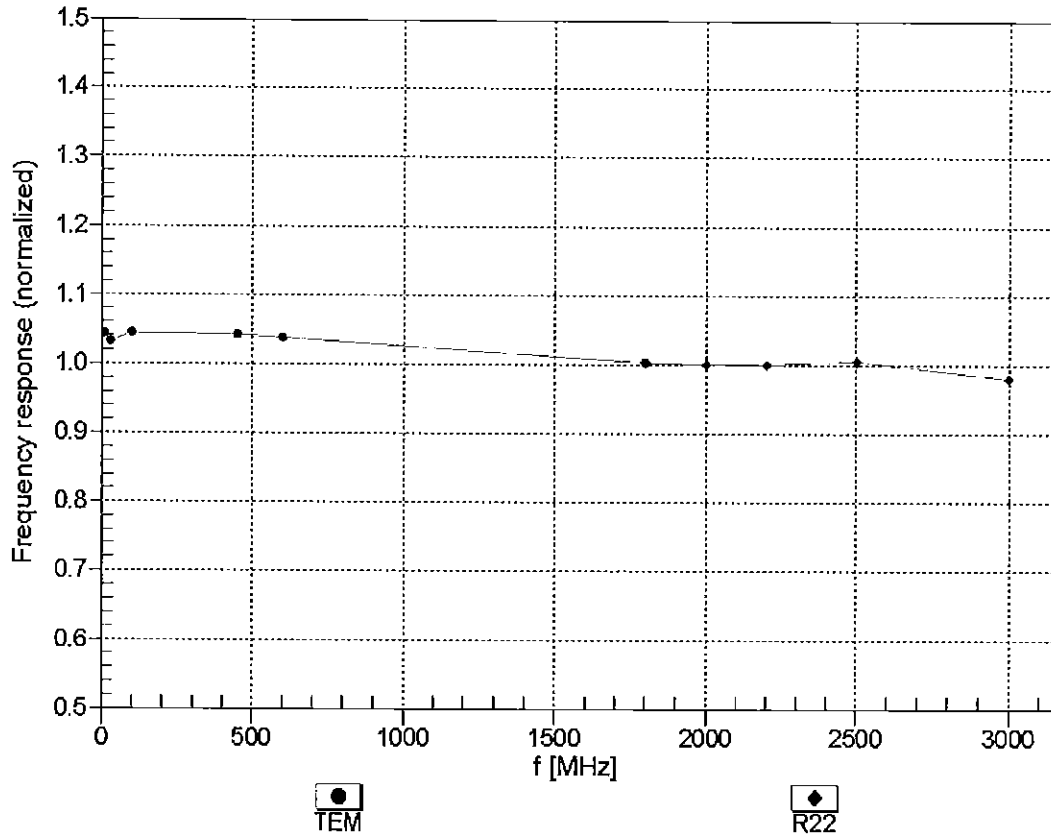

Uncertainty of Frequency Response of E-field:  $\pm 6.3\%$  (k=2)

### Receiving Pattern ( $\phi$ ), $\vartheta = 0^\circ$

f=600 MHz, TEM

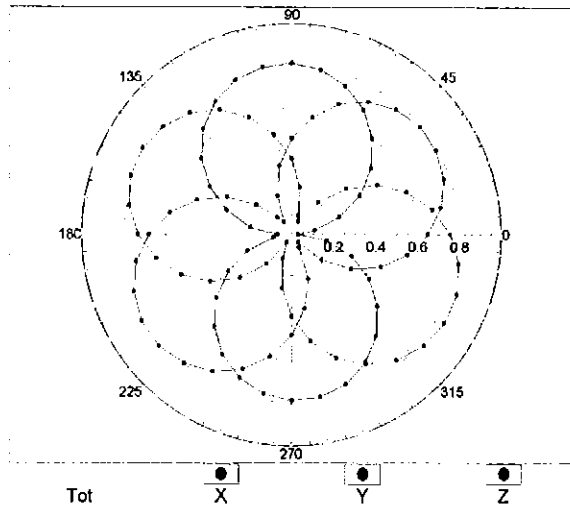

f=1800 MHz, R22

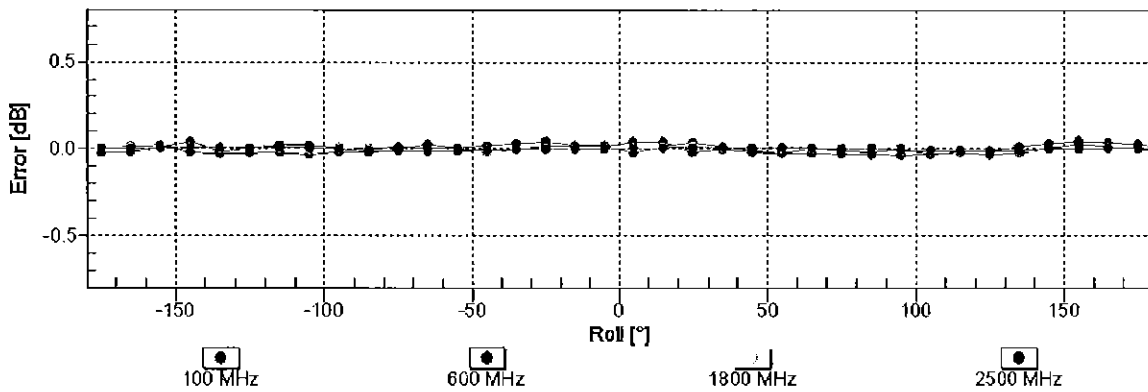
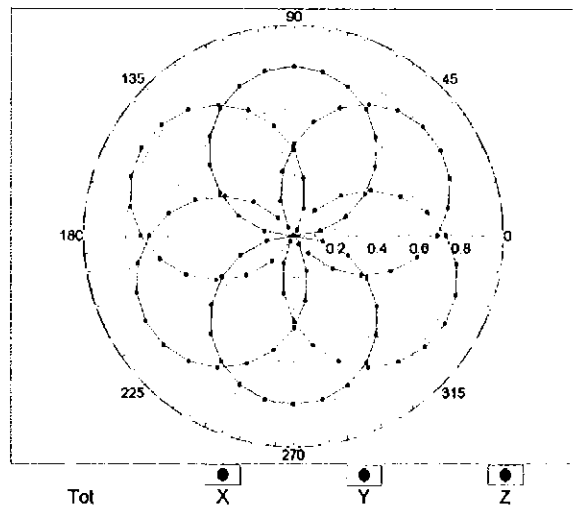

Uncertainty of Axial Isotropy Assessment:  $\pm 0.5\%$  (k=2)

### Dynamic Range $f(SAR_{head})$ (TEM cell , $f_{eval}= 1900$ MHz)

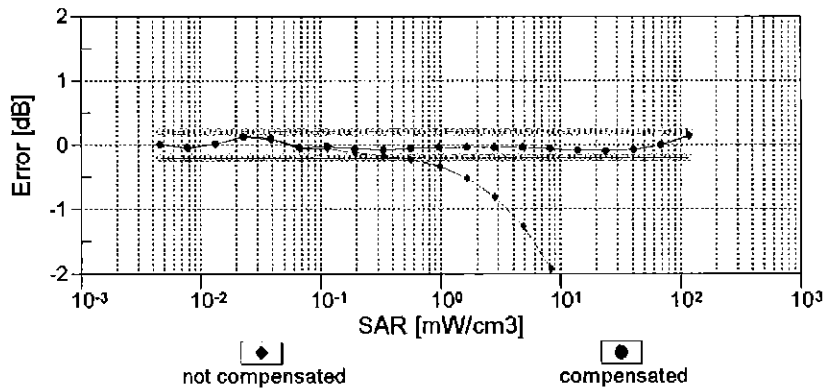
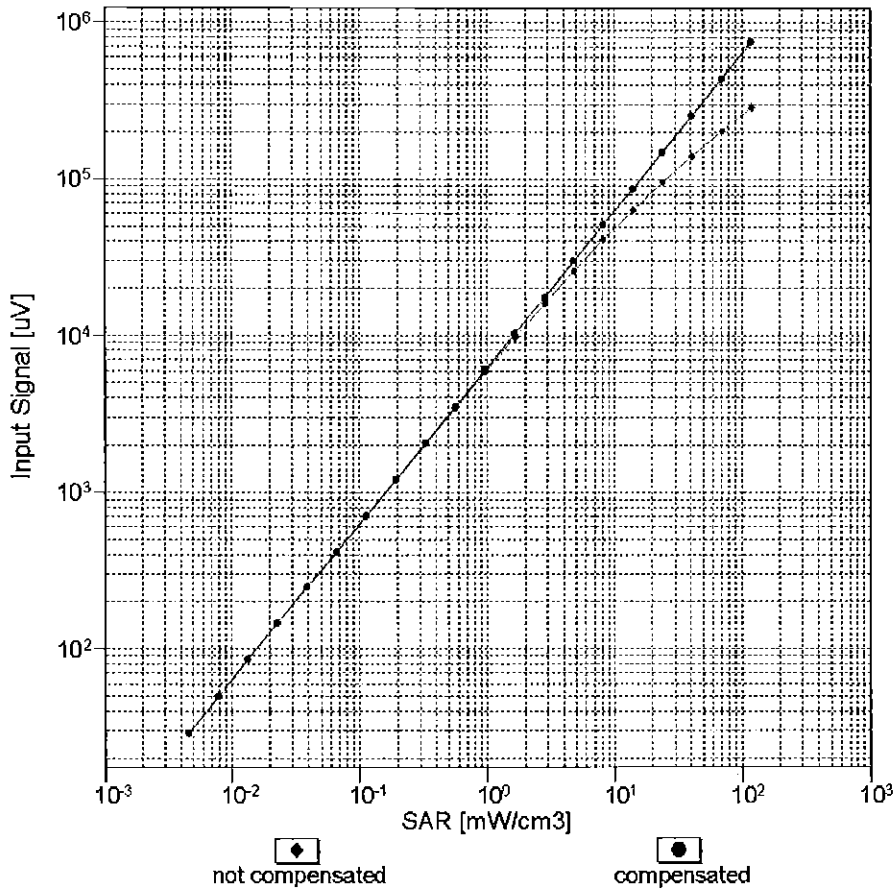

Uncertainty of Linearity Assessment: ± 0.6% (k=2)



# Conversion Factor Assessment

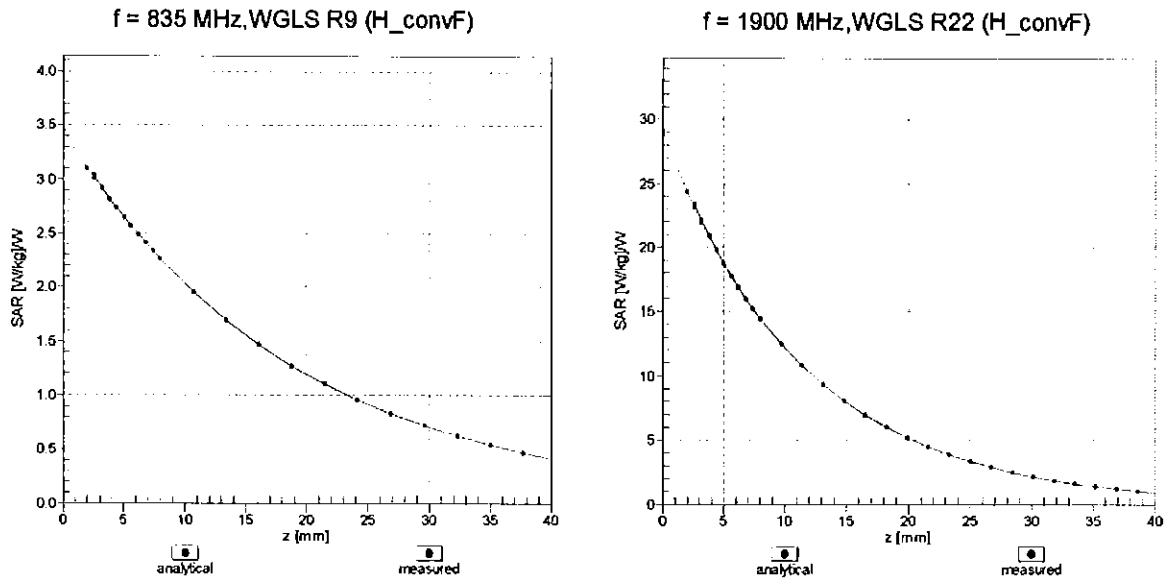

## Deviation from Isotropy in Liquid Error ( $\phi, \vartheta$ ), f = 900 MHz

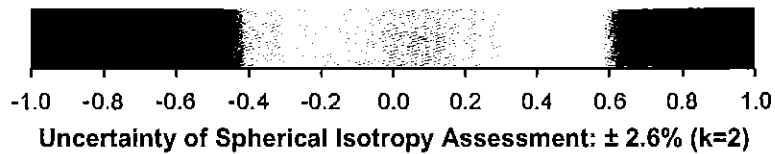
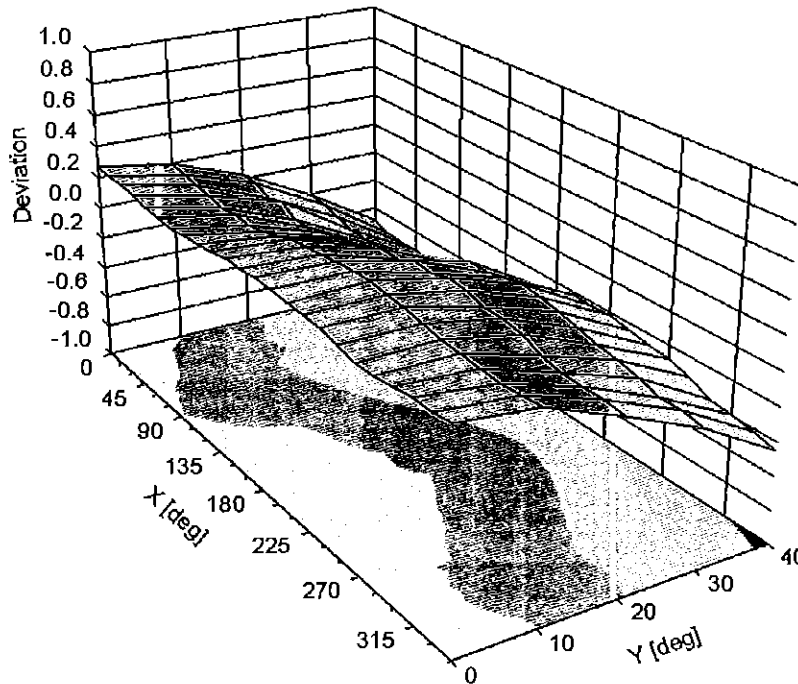

## DASY/EASY - Parameters of Probe: ES3DV3 - SN:3287

### Other Probe Parameters

Sensor Arrangement	Triangular
Connector Angle (°)	84.9
Mechanical Surface Detection Mode	enabled
Optical Surface Detection Mode	disabled
Probe Overall Length	337 mm
Probe Body Diameter	10 mm
Tip Length	10 mm
Tip Diameter	4 mm
Probe Tip to Sensor X Calibration Point	2 mm
Probe Tip to Sensor Y Calibration Point	2 mm
Probe Tip to Sensor Z Calibration Point	2 mm
Recommended Measurement Distance from Surface	3 mm

**Appendix: Modulation Calibration Parameters**

UID	Communication System Name		A dB	B dB $\mu$ V	C	D dB	VR mV	Max Unc <sup>E</sup> (k=2)
0	CW	X	0.00	0.00	1.00	0.00	198.4	$\pm 3.5\%$
		Y	0.00	0.00	1.00		189.6	
		Z	0.00	0.00	1.00		184.8	
10010- CAA	SAR Validation (Square, 100ms, 10ms)	X	9.57	81.27	19.66	10.00	25.0	$\pm 9.6\%$
		Y	9.48	81.17	20.59		25.0	
		Z	11.44	84.72	20.81		25.0	
10011- CAB	UMTS-FDD (WCDMA)	X	1.41	73.12	18.60	0.00	150.0	$\pm 9.6\%$
		Y	1.09	67.36	15.29		150.0	
		Z	1.04	67.24	15.12		150.0	
10012- CAB	IEEE 802.11b WiFi 2.4 GHz (DSSS, 1 Mbps)	X	1.39	66.79	17.15	0.41	150.0	$\pm 9.6\%$
		Y	1.33	64.98	15.75		150.0	
		Z	1.31	64.97	15.66		150.0	
10013- CAB	IEEE 802.11g WiFi 2.4 GHz (DSSS-OFDM, 6 Mbps)	X	5.20	67.40	17.54	1.46	150.0	$\pm 9.6\%$
		Y	5.27	67.18	17.41		150.0	
		Z	5.09	67.33	17.40		150.0	
10021- DAB	GSM-FDD (TDMA, GMSK)	X	25.12	98.64	27.15	9.39	50.0	$\pm 9.6\%$
		Y	16.05	91.61	25.96		50.0	
		Z	54.58	112.47	31.02		50.0	
10023- DAB	GPRS-FDD (TDMA, GMSK, TN 0)	X	21.90	96.28	26.48	9.57	50.0	$\pm 9.6\%$
		Y	15.04	90.31	25.57		50.0	
		Z	40.95	107.64	29.77		50.0	
10024- DAB	GPRS-FDD (TDMA, GMSK, TN 0-1)	X	100.00	118.44	30.60	6.56	60.0	$\pm 9.6\%$
		Y	56.85	112.42	30.28		60.0	
		Z	100.00	119.26	30.80		60.0	
10025- DAB	EDGE-FDD (TDMA, 8PSK, TN 0)	X	15.98	100.03	37.68	12.57	50.0	$\pm 9.6\%$
		Y	12.36	89.89	33.32		50.0	
		Z	14.92	100.13	38.33		50.0	
10026- DAB	EDGE-FDD (TDMA, 8PSK, TN 0-1)	X	19.89	102.72	35.15	9.56	60.0	$\pm 9.6\%$
		Y	15.11	94.49	32.22		60.0	
		Z	21.16	106.39	36.94		60.0	
10027- DAB	GPRS-FDD (TDMA, GMSK, TN 0-1-2)	X	100.00	117.46	29.21	4.80	80.0	$\pm 9.6\%$
		Y	100.00	119.97	30.83		80.0	
		Z	100.00	118.35	29.47		80.0	
10028- DAB	GPRS-FDD (TDMA, GMSK, TN 0-1-2-3)	X	100.00	117.97	28.63	3.55	100.0	$\pm 9.6\%$
		Y	100.00	119.91	29.91		100.0	
		Z	100.00	118.74	28.84		100.0	
10029- DAB	EDGE-FDD (TDMA, 8PSK, TN 0-1-2)	X	14.03	95.19	31.54	7.80	80.0	$\pm 9.6\%$
		Y	11.54	89.32	29.33		80.0	
		Z	13.09	95.17	31.96		80.0	
10030- CAA	IEEE 802.15.1 Bluetooth (GFSK, DH1)	X	100.00	117.04	29.36	5.30	70.0	$\pm 9.6\%$
		Y	100.00	119.78	31.12		70.0	
		Z	100.00	117.69	29.49		70.0	
10031- CAA	IEEE 802.15.1 Bluetooth (GFSK, DH3)	X	100.00	120.90	28.34	1.88	100.0	$\pm 9.6\%$
		Y	100.00	121.14	28.78		100.0	
		Z	100.00	119.84	27.78		100.0	

10032-CAA	IEEE 802.15.1 Bluetooth (GFSK, DH5)	X	100.00	128.75	30.50	1.17	100.0	± 9.6 %
		Y	100.00	125.19	29.33		100.0	
		Z	100.00	124.54	28.68		100.0	
10033-CAA	IEEE 802.15.1 Bluetooth (PI/4-DQPSK, DH1)	X	24.47	102.44	28.62	5.30	70.0	± 9.6 %
		Y	12.93	91.34	25.64		70.0	
		Z	20.22	99.06	27.27		70.0	
10034-CAA	IEEE 802.15.1 Bluetooth (PI/4-DQPSK, DH3)	X	15.75	99.73	26.60	1.88	100.0	± 9.6 %
		Y	6.06	84.29	21.90		100.0	
		Z	7.41	86.87	21.79		100.0	
10035-CAA	IEEE 802.15.1 Bluetooth (PI/4-DQPSK, DH5)	X	8.06	91.60	24.06	1.17	100.0	± 9.6 %
		Y	3.71	78.74	19.66		100.0	
		Z	4.06	80.00	19.16		100.0	
10036-CAA	IEEE 802.15.1 Bluetooth (8-DPSK, DH1)	X	31.59	106.91	29.95	5.30	70.0	± 9.6 %
		Y	14.71	93.73	26.48		70.0	
		Z	25.49	103.04	28.49		70.0	
10037-CAA	IEEE 802.15.1 Bluetooth (8-DPSK, DH3)	X	15.02	99.00	26.34	1.88	100.0	± 9.6 %
		Y	5.91	83.93	21.74		100.0	
		Z	6.95	86.01	21.48		100.0	
10038-CAA	IEEE 802.15.1 Bluetooth (8-DPSK, DH5)	X	8.64	92.97	24.58	1.17	100.0	± 9.6 %
		Y	3.82	79.37	19.97		100.0	
		Z	4.16	80.58	19.47		100.0	
10039-CAB	CDMA2000 (1xRTT, RC1)	X	3.32	80.83	20.52	0.00	150.0	± 9.6 %
		Y	1.99	71.59	16.56		150.0	
		Z	1.78	71.38	15.53		150.0	
10042-CAB	IS-54 / IS-136 FDD (TDMA/FDM, PI/4-DQPSK, Halfrate)	X	93.96	116.51	30.17	7.78	50.0	± 9.6 %
		Y	28.36	100.31	27.04		50.0	
		Z	100.00	118.01	30.46		50.0	
10044-CAA	IS-91/EIA/TIA-553 FDD (FDMA, FM)	X	0.00	110.81	0.68	0.00	150.0	± 9.6 %
		Y	0.00	94.68	0.92		150.0	
		Z	0.01	95.27	0.89		150.0	
10048-CAA	DECT (TDD, TDMA/FDM, GFSK, Full Slot, 24)	X	12.13	84.40	24.33	13.80	25.0	± 9.6 %
		Y	11.03	81.88	24.36		25.0	
		Z	15.47	90.17	26.32		25.0	
10049-CAA	DECT (TDD, TDMA/FDM, GFSK, Double Slot, 12)	X	14.56	88.92	24.53	10.79	40.0	± 9.6 %
		Y	12.34	85.94	24.48		40.0	
		Z	20.46	95.78	26.73		40.0	
10056-CAA	UMTS-TDD (TD-SCDMA, 1.28 Mcps)	X	13.90	88.80	25.15	9.03	50.0	± 9.6 %
		Y	11.60	84.93	24.34		50.0	
		Z	15.96	92.01	26.12		50.0	
10058-DAB	EDGE-FDD (TDMA, 8PSK, TN 0-1-2-3)	X	10.54	89.79	28.95	6.55	100.0	± 9.6 %
		Y	9.17	85.43	27.21		100.0	
		Z	9.28	88.15	28.66		100.0	
10059-CAB	IEEE 802.11b WiFi 2.4 GHz (DSSS, 2 Mbps)	X	1.62	69.54	18.42	0.61	110.0	± 9.6 %
		Y	1.52	67.09	16.78		110.0	
		Z	1.47	67.00	16.67		110.0	
10060-CAB	IEEE 802.11b WiFi 2.4 GHz (DSSS, 5.5 Mbps)	X	100.00	133.57	34.76	1.30	110.0	± 9.6 %
		Y	47.37	119.92	31.34		110.0	
		Z	100.00	131.70	33.88		110.0	

10061-CAB	IEEE 802.11b WiFi 2.4 GHz (DSSS, 11 Mbps)	X	24.29	111.37	31.49	2.04	110.0	± 9.6 %
		Y	7.57	90.21	25.12		110.0	
		Z	8.96	94.42	26.47		110.0	
10062-CAB	IEEE 802.11a/h WiFi 5 GHz (OFDM, 6 Mbps)	X	4.94	67.26	16.92	0.49	100.0	± 9.6 %
		Y	4.99	66.94	16.70		100.0	
		Z	4.80	67.06	16.67		100.0	
10063-CAB	IEEE 802.11a/h WiFi 5 GHz (OFDM, 9 Mbps)	X	4.98	67.42	17.05	0.72	100.0	± 9.6 %
		Y	5.03	67.12	16.85		100.0	
		Z	4.84	67.22	16.80		100.0	
10064-CAB	IEEE 802.11a/h WiFi 5 GHz (OFDM, 12 Mbps)	X	5.33	67.75	17.30	0.86	100.0	± 9.6 %
		Y	5.40	67.50	17.13		100.0	
		Z	5.14	67.52	17.06		100.0	
10065-CAB	IEEE 802.11a/h WiFi 5 GHz (OFDM, 18 Mbps)	X	5.22	67.77	17.45	1.21	100.0	± 9.6 %
		Y	5.30	67.55	17.30		100.0	
		Z	5.05	67.55	17.23		100.0	
10066-CAB	IEEE 802.11a/h WiFi 5 GHz (OFDM, 24 Mbps)	X	5.28	67.89	17.67	1.46	100.0	± 9.6 %
		Y	5.37	67.69	17.54		100.0	
		Z	5.11	67.69	17.47		100.0	
10067-CAB	IEEE 802.11a/h WiFi 5 GHz (OFDM, 36 Mbps)	X	5.58	67.96	18.07	2.04	100.0	± 9.6 %
		Y	5.70	67.83	17.99		100.0	
		Z	5.44	67.94	17.97		100.0	
10068-CAB	IEEE 802.11a/h WiFi 5 GHz (OFDM, 48 Mbps)	X	5.73	68.36	18.44	2.55	100.0	± 9.6 %
		Y	5.86	68.26	18.38		100.0	
		Z	5.56	68.20	18.31		100.0	
10069-CAB	IEEE 802.11a/h WiFi 5 GHz (OFDM, 54 Mbps)	X	5.80	68.22	18.58	2.67	100.0	± 9.6 %
		Y	5.93	68.12	18.53		100.0	
		Z	5.64	68.21	18.51		100.0	
10071-CAB	IEEE 802.11g WiFi 2.4 GHz (DSSS/OFDM, 9 Mbps)	X	5.34	67.61	17.91	1.99	100.0	± 9.6 %
		Y	5.43	67.44	17.80		100.0	
		Z	5.23	67.57	17.79		100.0	
10072-CAB	IEEE 802.11g WiFi 2.4 GHz (DSSS/OFDM, 12 Mbps)	X	5.41	68.20	18.23	2.30	100.0	± 9.6 %
		Y	5.52	68.04	18.13		100.0	
		Z	5.28	68.10	18.11		100.0	
10073-CAB	IEEE 802.11g WiFi 2.4 GHz (DSSS/OFDM, 18 Mbps)	X	5.54	68.52	18.63	2.83	100.0	± 9.6 %
		Y	5.67	68.41	18.56		100.0	
		Z	5.42	68.46	18.55		100.0	
10074-CAB	IEEE 802.11g WiFi 2.4 GHz (DSSS/OFDM, 24 Mbps)	X	5.57	68.60	18.89	3.30	100.0	± 9.6 %
		Y	5.71	68.53	18.84		100.0	
		Z	5.46	68.55	18.80		100.0	
10075-CAB	IEEE 802.11g WiFi 2.4 GHz (DSSS/OFDM, 36 Mbps)	X	5.74	69.13	19.40	3.82	90.0	± 9.6 %
		Y	5.91	69.12	19.39		90.0	
		Z	5.60	68.97	19.28		90.0	
10076-CAB	IEEE 802.11g WiFi 2.4 GHz (DSSS/OFDM, 48 Mbps)	X	5.73	68.87	19.48	4.15	90.0	± 9.6 %
		Y	5.91	68.89	19.48		90.0	
		Z	5.64	68.84	19.44		90.0	
10077-CAB	IEEE 802.11g WiFi 2.4 GHz (DSSS/OFDM, 54 Mbps)	X	5.76	68.96	19.58	4.30	90.0	± 9.6 %
		Y	5.95	68.98	19.59		90.0	
		Z	5.68	68.95	19.55		90.0	

10081-CAB	CDMA2000 (1xRTT, RC3)	X	1.45	73.74	17.54	0.00	150.0	± 9.6 %
		Y	1.01	66.70	13.93		150.0	
		Z	0.86	65.95	12.65		150.0	
10082-CAB	IS-54 / IS-136 FDD (TDMA/FDM, PI/4-DQPSK, Fullrate)	X	2.22	64.23	9.03	4.77	80.0	± 9.6 %
		Y	2.60	65.39	10.25		80.0	
		Z	2.07	64.06	8.86		80.0	
10090-DAB	GPRS-FDD (TDMA, GMSK, TN 0-4)	X	100.00	118.52	30.65	6.56	60.0	± 9.6 %
		Y	54.54	111.83	30.17		60.0	
		Z	100.00	119.33	30.85		60.0	
10097-CAB	UMTS-FDD (HSDPA)	X	2.07	69.87	17.29	0.00	150.0	± 9.6 %
		Y	1.87	67.25	15.70		150.0	
		Z	1.83	67.53	15.55		150.0	
10098-CAB	UMTS-FDD (HSUPA, Subtest 2)	X	2.03	69.88	17.28	0.00	150.0	± 9.6 %
		Y	1.83	67.20	15.65		150.0	
		Z	1.80	67.49	15.52		150.0	
10099-DAB	EDGE-FDD (TDMA, 8PSK, TN 0-4)	X	19.79	102.55	35.10	9.56	60.0	± 9.6 %
		Y	15.06	94.38	32.19		60.0	
		Z	21.07	106.24	36.89		60.0	
10100-CAB	LTE-FDD (SC-FDMA, 100% RB, 20 MHz, QPSK)	X	3.71	73.15	18.05	0.00	150.0	± 9.6 %
		Y	3.34	70.68	16.71		150.0	
		Z	3.15	70.31	16.60		150.0	
10101-CAB	LTE-FDD (SC-FDMA, 100% RB, 20 MHz, 16-QAM)	X	3.53	68.94	16.73	0.00	150.0	± 9.6 %
		Y	3.44	67.88	16.03		150.0	
		Z	3.28	67.66	15.91		150.0	
10102-CAB	LTE-FDD (SC-FDMA, 100% RB, 20 MHz, 64-QAM)	X	3.62	68.78	16.77	0.00	150.0	± 9.6 %
		Y	3.55	67.81	16.12		150.0	
		Z	3.38	67.61	16.00		150.0	
10103-CAB	LTE-TDD (SC-FDMA, 100% RB, 20 MHz, QPSK)	X	9.03	78.84	21.45	3.98	65.0	± 9.6 %
		Y	8.52	77.08	20.81		65.0	
		Z	8.79	79.04	21.64		65.0	
10104-CAB	LTE-TDD (SC-FDMA, 100% RB, 20 MHz, 16-QAM)	X	8.83	77.31	21.70	3.98	65.0	± 9.6 %
		Y	8.68	76.21	21.28		65.0	
		Z	8.45	77.10	21.68		65.0	
10105-CAB	LTE-TDD (SC-FDMA, 100% RB, 20 MHz, 64-QAM)	X	8.12	75.63	21.27	3.98	65.0	± 9.6 %
		Y	7.58	73.53	20.37		65.0	
		Z	7.68	75.16	21.11		65.0	
10108-CAC	LTE-FDD (SC-FDMA, 100% RB, 10 MHz, QPSK)	X	3.26	72.24	17.88	0.00	150.0	± 9.6 %
		Y	2.97	69.86	16.52		150.0	
		Z	2.76	69.54	16.43		150.0	
10109-CAC	LTE-FDD (SC-FDMA, 100% RB, 10 MHz, 16-QAM)	X	3.21	68.83	16.74	0.00	150.0	± 9.6 %
		Y	3.12	67.65	15.97		150.0	
		Z	2.93	67.47	15.80		150.0	
10110-CAC	LTE-FDD (SC-FDMA, 100% RB, 5 MHz, QPSK)	X	2.68	71.31	17.65	0.00	150.0	± 9.6 %
		Y	2.45	68.82	16.19		150.0	
		Z	2.25	68.65	16.05		150.0	
10111-CAC	LTE-FDD (SC-FDMA, 100% RB, 5 MHz, 16-QAM)	X	2.94	69.70	17.25	0.00	150.0	± 9.6 %
		Y	2.81	68.04	16.25		150.0	
		Z	2.63	68.09	16.01		150.0	

10112-CAC	LTE-FDD (SC-FDMA, 100% RB, 10 MHz, 64-QAM)	X	3.32	68.66	16.72	0.00	150.0	± 9.6 %
		Y	3.24	67.56	16.01		150.0	
		Z	3.06	67.45	15.85		150.0	
10113-CAC	LTE-FDD (SC-FDMA, 100% RB, 5 MHz, 64-QAM)	X	3.09	69.65	17.28	0.00	150.0	± 9.6 %
		Y	2.97	68.11	16.35		150.0	
		Z	2.78	68.22	16.13		150.0	
10114-CAB	IEEE 802.11n (HT Greenfield, 13.5 Mbps, BPSK)	X	5.30	67.67	16.69	0.00	150.0	± 9.6 %
		Y	5.32	67.34	16.45		150.0	
		Z	5.18	67.41	16.46		150.0	
10115-CAB	IEEE 802.11n (HT Greenfield, 81 Mbps, 16-QAM)	X	5.68	67.95	16.83	0.00	150.0	± 9.6 %
		Y	5.74	67.75	16.66		150.0	
		Z	5.49	67.60	16.57		150.0	
10116-CAB	IEEE 802.11n (HT Greenfield, 135 Mbps, 64-QAM)	X	5.43	67.93	16.74	0.00	150.0	± 9.6 %
		Y	5.45	67.58	16.50		150.0	
		Z	5.29	67.63	16.50		150.0	
10117-CAB	IEEE 802.11n (HT Mixed, 13.5 Mbps, BPSK)	X	5.31	67.69	16.73	0.00	150.0	± 9.6 %
		Y	5.33	67.35	16.48		150.0	
		Z	5.15	67.28	16.42		150.0	
10118-CAB	IEEE 802.11n (HT Mixed, 81 Mbps, 16-QAM)	X	5.73	68.05	16.89	0.00	150.0	± 9.6 %
		Y	5.76	67.71	16.65		150.0	
		Z	5.58	67.82	16.69		150.0	
10119-CAB	IEEE 802.11n (HT Mixed, 135 Mbps, 64-QAM)	X	5.40	67.88	16.73	0.00	150.0	± 9.6 %
		Y	5.42	67.54	16.49		150.0	
		Z	5.26	67.56	16.48		150.0	
10140-CAB	LTE-FDD (SC-FDMA, 100% RB, 15 MHz, 16-QAM)	X	3.67	68.77	16.68	0.00	150.0	± 9.6 %
		Y	3.60	67.81	16.05		150.0	
		Z	3.42	67.62	15.92		150.0	
10141-CAB	LTE-FDD (SC-FDMA, 100% RB, 15 MHz, 64-QAM)	X	3.79	68.75	16.79	0.00	150.0	± 9.6 %
		Y	3.72	67.84	16.19		150.0	
		Z	3.54	67.70	16.08		150.0	
10142-CAC	LTE-FDD (SC-FDMA, 100% RB, 3 MHz, QPSK)	X	2.48	71.58	17.67	0.00	150.0	± 9.6 %
		Y	2.22	68.66	16.03		150.0	
		Z	2.02	68.57	15.71		150.0	
10143-CAC	LTE-FDD (SC-FDMA, 100% RB, 3 MHz, 16-QAM)	X	2.90	70.86	17.43	0.00	150.0	± 9.6 %
		Y	2.68	68.61	16.20		150.0	
		Z	2.48	68.71	15.71		150.0	
10144-CAC	LTE-FDD (SC-FDMA, 100% RB, 3 MHz, 64-QAM)	X	2.65	68.53	15.87	0.00	150.0	± 9.6 %
		Y	2.53	66.90	14.94		150.0	
		Z	2.29	66.75	14.27		150.0	
10145-CAC	LTE-FDD (SC-FDMA, 100% RB, 1.4 MHz, QPSK)	X	2.00	71.65	16.48	0.00	150.0	± 9.6 %
		Y	1.64	67.49	14.42		150.0	
		Z	1.28	65.53	12.17		150.0	
10146-CAC	LTE-FDD (SC-FDMA, 100% RB, 1.4 MHz, 16-QAM)	X	6.65	82.42	19.81	0.00	150.0	± 9.6 %
		Y	3.51	73.00	16.51		150.0	
		Z	2.73	70.16	13.72		150.0	
10147-CAC	LTE-FDD (SC-FDMA, 100% RB, 1.4 MHz, 64-QAM)	X	11.62	90.60	22.70	0.00	150.0	± 9.6 %
		Y	4.34	76.22	18.03		150.0	
		Z	3.53	73.44	15.25		150.0	

10149-CAB	LTE-FDD (SC-FDMA, 50% RB, 20 MHz, 16-QAM)	X	3.22	68.90	16.79	0.00	150.0	± 9.6 %
		Y	3.13	67.70	16.01		150.0	
		Z	2.94	67.52	15.84		150.0	
10150-CAB	LTE-FDD (SC-FDMA, 50% RB, 20 MHz, 64-QAM)	X	3.33	68.71	16.76	0.00	150.0	± 9.6 %
		Y	3.25	67.61	16.05		150.0	
		Z	3.06	67.50	15.89		150.0	
10151-CAB	LTE-TDD (SC-FDMA, 50% RB, 20 MHz, QPSK)	X	9.59	81.08	22.43	3.98	65.0	± 9.6 %
		Y	8.87	78.87	21.64		65.0	
		Z	9.33	81.38	22.62		65.0	
10152-CAB	LTE-TDD (SC-FDMA, 50% RB, 20 MHz, 16-QAM)	X	8.50	77.58	21.63	3.98	65.0	± 9.6 %
		Y	8.30	76.31	21.16		65.0	
		Z	8.08	77.33	21.50		65.0	
10153-CAB	LTE-TDD (SC-FDMA, 50% RB, 20 MHz, 64-QAM)	X	8.85	78.28	22.25	3.98	65.0	± 9.6 %
		Y	8.62	76.95	21.75		65.0	
		Z	8.48	78.15	22.17		65.0	
10154-CAC	LTE-FDD (SC-FDMA, 50% RB, 10 MHz, QPSK)	X	2.77	71.95	18.01	0.00	150.0	± 9.6 %
		Y	2.51	69.32	16.50		150.0	
		Z	2.29	69.01	16.28		150.0	
10155-CAC	LTE-FDD (SC-FDMA, 50% RB, 10 MHz, 16-QAM)	X	2.94	69.69	17.25	0.00	150.0	± 9.6 %
		Y	2.80	68.03	16.25		150.0	
		Z	2.63	68.10	16.02		150.0	
10156-CAC	LTE-FDD (SC-FDMA, 50% RB, 5 MHz, QPSK)	X	2.40	72.31	17.91	0.00	150.0	± 9.6 %
		Y	2.09	68.89	16.05		150.0	
		Z	1.86	68.62	15.51		150.0	
10157-CAC	LTE-FDD (SC-FDMA, 50% RB, 5 MHz, 16-QAM)	X	2.55	69.65	16.30	0.00	150.0	± 9.6 %
		Y	2.36	67.46	15.11		150.0	
		Z	2.12	67.25	14.30		150.0	
10158-CAC	LTE-FDD (SC-FDMA, 50% RB, 10 MHz, 64-QAM)	X	3.10	69.70	17.32	0.00	150.0	± 9.6 %
		Y	2.97	68.15	16.39		150.0	
		Z	2.78	68.27	16.17		150.0	
10159-CAC	LTE-FDD (SC-FDMA, 50% RB, 5 MHz, 64-QAM)	X	2.69	70.18	16.62	0.00	150.0	± 9.6 %
		Y	2.48	67.89	15.40		150.0	
		Z	2.22	67.66	14.56		150.0	
10160-CAB	LTE-FDD (SC-FDMA, 50% RB, 15 MHz, QPSK)	X	3.10	70.43	17.35	0.00	150.0	± 9.6 %
		Y	2.94	68.69	16.29		150.0	
		Z	2.78	68.69	16.25		150.0	
10161-CAB	LTE-FDD (SC-FDMA, 50% RB, 15 MHz, 16-QAM)	X	3.22	68.62	16.74	0.00	150.0	± 9.6 %
		Y	3.14	67.48	16.00		150.0	
		Z	2.96	67.42	15.82		150.0	
10162-CAB	LTE-FDD (SC-FDMA, 50% RB, 15 MHz, 64-QAM)	X	3.32	68.61	16.76	0.00	150.0	± 9.6 %
		Y	3.24	67.49	16.04		150.0	
		Z	3.07	67.56	15.92		150.0	
10166-CAC	LTE-FDD (SC-FDMA, 50% RB, 1.4 MHz, QPSK)	X	4.32	72.20	20.50	3.01	150.0	± 9.6 %
		Y	4.09	70.13	19.37		150.0	
		Z	3.89	71.03	19.86		150.0	
10167-CAC	LTE-FDD (SC-FDMA, 50% RB, 1.4 MHz, 16-QAM)	X	6.13	77.20	21.71	3.01	150.0	± 9.6 %
		Y	5.31	73.40	20.02		150.0	
		Z	5.17	75.28	20.82		150.0	



10168-CAC	LTE-FDD (SC-FDMA, 50% RB, 1.4 MHz, 64-QAM)	X	6.94	79.87	23.11	3.01	150.0	± 9.6 %
		Y	5.79	75.28	21.14		150.0	
		Z	5.82	77.80	22.20		150.0	
10169-CAB	LTE-FDD (SC-FDMA, 1 RB, 20 MHz, QPSK)	X	4.47	76.31	22.20	3.01	150.0	± 9.6 %
		Y	3.93	72.42	20.26		150.0	
		Z	3.45	71.87	20.27		150.0	
10170-CAB	LTE-FDD (SC-FDMA, 1 RB, 20 MHz, 16-QAM)	X	9.97	90.37	26.89	3.01	150.0	± 9.6 %
		Y	6.08	79.64	22.84		150.0	
		Z	5.69	81.07	23.66		150.0	
10171-AAB	LTE-FDD (SC-FDMA, 1 RB, 20 MHz, 64-QAM)	X	6.58	81.51	22.72	3.01	150.0	± 9.6 %
		Y	4.82	74.69	19.94		150.0	
		Z	4.39	75.54	20.48		150.0	
10172-CAB	LTE-TDD (SC-FDMA, 1 RB, 20 MHz, QPSK)	X	73.64	126.23	37.77	6.02	65.0	± 9.6 %
		Y	18.65	98.22	29.94		65.0	
		Z	50.70	122.38	37.42		65.0	
10173-CAB	LTE-TDD (SC-FDMA, 1 RB, 20 MHz, 16-QAM)	X	94.74	123.96	35.21	6.02	65.0	± 9.6 %
		Y	22.61	98.04	28.47		65.0	
		Z	96.90	127.66	36.64		65.0	
10174-CAB	LTE-TDD (SC-FDMA, 1 RB, 20 MHz, 64-QAM)	X	56.11	113.11	31.91	6.02	65.0	± 9.6 %
		Y	18.59	93.53	26.66		65.0	
		Z	65.46	118.77	33.84		65.0	
10175-CAC	LTE-FDD (SC-FDMA, 1 RB, 10 MHz, QPSK)	X	4.37	75.74	21.85	3.01	150.0	± 9.6 %
		Y	3.86	71.99	19.97		150.0	
		Z	3.41	71.52	20.02		150.0	
10176-CAC	LTE-FDD (SC-FDMA, 1 RB, 10 MHz, 16-QAM)	X	9.99	90.41	26.90	3.01	150.0	± 9.6 %
		Y	6.09	79.66	22.85		150.0	
		Z	5.70	81.10	23.67		150.0	
10177-CAE	LTE-FDD (SC-FDMA, 1 RB, 5 MHz, QPSK)	X	4.43	76.02	22.00	3.01	150.0	± 9.6 %
		Y	3.90	72.21	20.10		150.0	
		Z	3.44	71.69	20.11		150.0	
10178-CAC	LTE-FDD (SC-FDMA, 1 RB, 5 MHz, 16-QAM)	X	9.65	89.71	26.63	3.01	150.0	± 9.6 %
		Y	5.97	79.26	22.66		150.0	
		Z	5.62	80.80	23.53		150.0	
10179-CAC	LTE-FDD (SC-FDMA, 1 RB, 10 MHz, 64-QAM)	X	7.97	85.43	24.54	3.01	150.0	± 9.6 %
		Y	5.36	76.88	21.19		150.0	
		Z	4.98	78.13	21.92		150.0	
10180-CAC	LTE-FDD (SC-FDMA, 1 RB, 5 MHz, 64-QAM)	X	6.51	81.29	22.61	3.01	150.0	± 9.6 %
		Y	4.79	74.55	19.86		150.0	
		Z	4.38	75.44	20.42		150.0	
10181-CAB	LTE-FDD (SC-FDMA, 1 RB, 15 MHz, QPSK)	X	4.42	75.99	21.99	3.01	150.0	± 9.6 %
		Y	3.90	72.19	20.09		150.0	
		Z	3.43	71.67	20.11		150.0	
10182-CAB	LTE-FDD (SC-FDMA, 1 RB, 15 MHz, 16-QAM)	X	9.63	89.67	26.62	3.01	150.0	± 9.6 %
		Y	5.96	79.23	22.65		150.0	
		Z	5.61	80.77	23.51		150.0	
10183-AAA	LTE-FDD (SC-FDMA, 1 RB, 15 MHz, 64-QAM)	X	6.50	81.25	22.60	3.01	150.0	± 9.6 %
		Y	4.78	74.53	19.85		150.0	
		Z	4.37	75.41	20.41		150.0	

10184-CAC	LTE-FDD (SC-FDMA, 1 RB, 3 MHz, QPSK)	X	4.44	76.05	22.02	3.01	150.0	± 9.6 %
		Y	3.91	72.24	20.12		150.0	
		Z	3.45	71.72	20.13		150.0	
10185-CAC	LTE-FDD (SC-FDMA, 1 RB, 3 MHz, 16-QAM)	X	9.70	89.80	26.67	3.01	150.0	± 9.6 %
		Y	5.99	79.32	22.68		150.0	
		Z	5.64	80.86	23.56		150.0	
10186-AAC	LTE-FDD (SC-FDMA, 1 RB, 3 MHz, 64-QAM)	X	6.54	81.37	22.64	3.01	150.0	± 9.6 %
		Y	4.81	74.60	19.88		150.0	
		Z	4.39	75.50	20.45		150.0	
10187-CAC	LTE-FDD (SC-FDMA, 1 RB, 1.4 MHz, QPSK)	X	4.45	76.10	22.07	3.01	150.0	± 9.6 %
		Y	3.92	72.26	20.15		150.0	
		Z	3.46	71.78	20.19		150.0	
10188-CAC	LTE-FDD (SC-FDMA, 1 RB, 1.4 MHz, 16-QAM)	X	10.51	91.45	27.34	3.01	150.0	± 9.6 %
		Y	6.26	80.23	23.14		150.0	
		Z	5.89	81.76	24.00		150.0	
10189-AAC	LTE-FDD (SC-FDMA, 1 RB, 1.4 MHz, 64-QAM)	X	6.85	82.27	23.07	3.01	150.0	± 9.6 %
		Y	4.94	75.14	20.19		150.0	
		Z	4.52	76.06	20.77		150.0	
10193-CAB	IEEE 802.11n (HT Greenfield, 6.5 Mbps, BPSK)	X	4.73	67.10	16.51	0.00	150.0	± 9.6 %
		Y	4.75	66.68	16.23		150.0	
		Z	4.57	66.79	16.16		150.0	
10194-CAB	IEEE 802.11n (HT Greenfield, 39 Mbps, 16-QAM)	X	4.94	67.48	16.62	0.00	150.0	± 9.6 %
		Y	4.96	67.08	16.34		150.0	
		Z	4.75	67.11	16.28		150.0	
10195-CAB	IEEE 802.11n (HT Greenfield, 65 Mbps, 64-QAM)	X	4.98	67.48	16.62	0.00	150.0	± 9.6 %
		Y	5.00	67.07	16.34		150.0	
		Z	4.79	67.14	16.30		150.0	
10196-CAB	IEEE 802.11n (HT Mixed, 6.5 Mbps, BPSK)	X	4.76	67.21	16.55	0.00	150.0	± 9.6 %
		Y	4.78	66.80	16.27		150.0	
		Z	4.58	66.86	16.18		150.0	
10197-CAB	IEEE 802.11n (HT Mixed, 39 Mbps, 16-QAM)	X	4.96	67.50	16.63	0.00	150.0	± 9.6 %
		Y	4.98	67.09	16.35		150.0	
		Z	4.76	67.14	16.30		150.0	
10198-CAB	IEEE 802.11n (HT Mixed, 65 Mbps, 64-QAM)	X	4.99	67.50	16.63	0.00	150.0	± 9.6 %
		Y	5.01	67.09	16.35		150.0	
		Z	4.79	67.16	16.31		150.0	
10219-CAB	IEEE 802.11n (HT Mixed, 7.2 Mbps, BPSK)	X	4.71	67.23	16.53	0.00	150.0	± 9.6 %
		Y	4.73	66.82	16.24		150.0	
		Z	4.53	66.87	16.14		150.0	
10220-CAB	IEEE 802.11n (HT Mixed, 43.3 Mbps, 16-QAM)	X	4.96	67.50	16.63	0.00	150.0	± 9.6 %
		Y	4.98	67.10	16.35		150.0	
		Z	4.76	67.11	16.29		150.0	
10221-CAB	IEEE 802.11n (HT Mixed, 72.2 Mbps, 64-QAM)	X	4.99	67.43	16.62	0.00	150.0	± 9.6 %
		Y	5.01	67.03	16.34		150.0	
		Z	4.80	67.09	16.30		150.0	
10222-CAB	IEEE 802.11n (HT Mixed, 15 Mbps, BPSK)	X	5.29	67.72	16.73	0.00	150.0	± 9.6 %
		Y	5.31	67.38	16.49		150.0	
		Z	5.12	67.29	16.41		150.0	

10223-CAB	IEEE 802.11n (HT Mixed, 90 Mbps, 16-QAM)	X	5.67	68.03	16.90	0.00	150.0	± 9.6 %
		Y	5.70	67.71	16.67		150.0	
		Z	5.43	67.50	16.54		150.0	
10224-CAB	IEEE 802.11n (HT Mixed, 150 Mbps, 64-QAM)	X	5.35	67.84	16.72	0.00	150.0	± 9.6 %
		Y	5.37	67.51	16.48		150.0	
		Z	5.17	67.40	16.39		150.0	
10225-CAB	UMTS-FDD (HSPA+)	X	3.03	67.01	16.18	0.00	150.0	± 9.6 %
		Y	3.00	66.12	15.59		150.0	
		Z	2.84	66.23	15.31		150.0	
10226-CAA	LTE-TDD (SC-FDMA, 1 RB, 1.4 MHz, 16-QAM)	X	100.00	125.13	35.58	6.02	65.0	± 9.6 %
		Y	23.60	98.91	28.82		65.0	
		Z	100.00	128.43	36.91		65.0	
10227-CAA	LTE-TDD (SC-FDMA, 1 RB, 1.4 MHz, 64-QAM)	X	61.16	114.83	32.47	6.02	65.0	± 9.6 %
		Y	19.96	94.87	27.16		65.0	
		Z	73.77	120.96	34.46		65.0	
10228-CAA	LTE-TDD (SC-FDMA, 1 RB, 1.4 MHz, QPSK)	X	72.18	126.53	38.01	6.02	65.0	± 9.6 %
		Y	21.44	101.40	31.05		65.0	
		Z	53.16	123.89	37.96		65.0	
10229-CAB	LTE-TDD (SC-FDMA, 1 RB, 3 MHz, 16-QAM)	X	94.57	123.93	35.21	6.02	65.0	± 9.6 %
		Y	22.66	98.06	28.49		65.0	
		Z	96.87	127.65	36.65		65.0	
10230-CAB	LTE-TDD (SC-FDMA, 1 RB, 3 MHz, 64-QAM)	X	56.39	113.28	31.99	6.02	65.0	± 9.6 %
		Y	19.26	94.16	26.88		65.0	
		Z	66.99	119.13	33.93		65.0	
10231-CAB	LTE-TDD (SC-FDMA, 1 RB, 3 MHz, QPSK)	X	66.18	124.67	37.45	6.02	65.0	± 9.6 %
		Y	20.62	100.55	30.72		65.0	
		Z	48.89	122.07	37.41		65.0	
10232-CAB	LTE-TDD (SC-FDMA, 1 RB, 5 MHz, 16-QAM)	X	94.69	123.96	35.21	6.02	65.0	± 9.6 %
		Y	22.64	98.05	28.48		65.0	
		Z	97.00	127.68	36.66		65.0	
10233-CAB	LTE-TDD (SC-FDMA, 1 RB, 5 MHz, 64-QAM)	X	56.52	113.33	32.00	6.02	65.0	± 9.6 %
		Y	19.26	94.17	26.88		65.0	
		Z	67.07	119.16	33.94		65.0	
10234-CAB	LTE-TDD (SC-FDMA, 1 RB, 5 MHz, QPSK)	X	60.26	122.59	36.81	6.02	65.0	± 9.6 %
		Y	19.81	99.63	30.34		65.0	
		Z	45.11	120.21	36.81		65.0	
10235-CAB	LTE-TDD (SC-FDMA, 1 RB, 10 MHz, 16-QAM)	X	95.38	124.09	35.25	6.02	65.0	± 9.6 %
		Y	22.67	98.09	28.50		65.0	
		Z	97.77	127.84	36.70		65.0	
10236-CAB	LTE-TDD (SC-FDMA, 1 RB, 10 MHz, 64-QAM)	X	57.18	113.50	32.04	6.02	65.0	± 9.6 %
		Y	19.38	94.26	26.90		65.0	
		Z	68.10	119.39	33.99		65.0	
10237-CAB	LTE-TDD (SC-FDMA, 1 RB, 10 MHz, QPSK)	X	67.28	125.01	37.54	6.02	65.0	± 9.6 %
		Y	20.74	100.68	30.76		65.0	
		Z	49.59	122.38	37.49		65.0	
10238-CAB	LTE-TDD (SC-FDMA, 1 RB, 15 MHz, 16-QAM)	X	95.00	124.02	35.23	6.02	65.0	± 9.6 %
		Y	22.64	98.06	28.49		65.0	
		Z	97.19	127.73	36.66		65.0	

10239-CAB	LTE-TDD (SC-FDMA, 1 RB, 15 MHz, 64-QAM)	X	56.67	113.39	32.01	6.02	65.0	± 9.6 %
		Y	19.26	94.19	26.88		65.0	
		Z	67.13	119.19	33.94		65.0	
10240-CAB	LTE-TDD (SC-FDMA, 1 RB, 15 MHz, QPSK)	X	67.00	124.93	37.52	6.02	65.0	± 9.6 %
		Y	20.68	100.63	30.74		65.0	
		Z	49.37	122.30	37.47		65.0	
10241-CAA	LTE-TDD (SC-FDMA, 50% RB, 1.4 MHz, 16-QAM)	X	14.43	89.77	28.56	6.98	65.0	± 9.6 %
		Y	12.31	85.00	26.80		65.0	
		Z	13.89	90.56	28.94		65.0	
10242-CAA	LTE-TDD (SC-FDMA, 50% RB, 1.4 MHz, 64-QAM)	X	13.70	88.57	28.03	6.98	65.0	± 9.6 %
		Y	10.82	82.08	25.53		65.0	
		Z	13.16	89.30	28.37		65.0	
10243-CAA	LTE-TDD (SC-FDMA, 50% RB, 1.4 MHz, QPSK)	X	10.55	84.90	27.56	6.98	65.0	± 9.6 %
		Y	8.88	79.49	25.25		65.0	
		Z	9.99	85.03	27.70		65.0	
10244-CAB	LTE-TDD (SC-FDMA, 50% RB, 3 MHz, 16-QAM)	X	11.43	83.67	22.47	3.98	65.0	± 9.6 %
		Y	9.78	80.48	21.64		65.0	
		Z	9.76	81.22	20.90		65.0	
10245-CAB	LTE-TDD (SC-FDMA, 50% RB, 3 MHz, 64-QAM)	X	11.21	83.09	22.22	3.98	65.0	± 9.6 %
		Y	9.71	80.13	21.47		65.0	
		Z	9.48	80.50	20.58		65.0	
10246-CAB	LTE-TDD (SC-FDMA, 50% RB, 3 MHz, QPSK)	X	10.58	85.22	23.00	3.98	65.0	± 9.6 %
		Y	8.86	81.57	21.94		65.0	
		Z	9.16	83.05	21.67		65.0	
10247-CAB	LTE-TDD (SC-FDMA, 50% RB, 5 MHz, 16-QAM)	X	8.25	78.94	21.22	3.98	65.0	± 9.6 %
		Y	7.85	77.32	20.79		65.0	
		Z	7.47	77.61	20.18		65.0	
10248-CAB	LTE-TDD (SC-FDMA, 50% RB, 5 MHz, 64-QAM)	X	8.20	78.37	20.99	3.98	65.0	± 9.6 %
		Y	7.89	76.93	20.61		65.0	
		Z	7.41	77.03	19.93		65.0	
10249-CAB	LTE-TDD (SC-FDMA, 50% RB, 5 MHz, QPSK)	X	11.20	86.28	23.89	3.98	65.0	± 9.6 %
		Y	9.29	82.26	22.62		65.0	
		Z	10.48	85.66	23.36		65.0	
10250-CAB	LTE-TDD (SC-FDMA, 50% RB, 10 MHz, 16-QAM)	X	8.93	80.25	22.81	3.98	65.0	± 9.6 %
		Y	8.46	78.37	22.14		65.0	
		Z	8.46	79.88	22.48		65.0	
10251-CAB	LTE-TDD (SC-FDMA, 50% RB, 10 MHz, 64-QAM)	X	8.39	77.98	21.64	3.98	65.0	± 9.6 %
		Y	8.12	76.54	21.14		65.0	
		Z	7.98	77.74	21.34		65.0	
10252-CAB	LTE-TDD (SC-FDMA, 50% RB, 10 MHz, QPSK)	X	10.53	84.51	23.78	3.98	65.0	± 9.6 %
		Y	9.19	81.18	22.63		65.0	
		Z	10.24	84.82	23.86		65.0	
10253-CAB	LTE-TDD (SC-FDMA, 50% RB, 15 MHz, 16-QAM)	X	8.25	76.95	21.44	3.98	65.0	± 9.6 %
		Y	8.10	75.77	21.00		65.0	
		Z	7.89	76.78	21.28		65.0	
10254-CAB	LTE-TDD (SC-FDMA, 50% RB, 15 MHz, 64-QAM)	X	8.62	77.66	22.02	3.98	65.0	± 9.6 %
		Y	8.44	76.43	21.56		65.0	
		Z	8.28	77.57	21.89		65.0	

10255-CAB	LTE-TDD (SC-FDMA, 50% RB, 15 MHz, QPSK)	X	9.25	80.67	22.52	3.98	65.0	± 9.6 %
		Y	8.61	78.53	21.74		65.0	
		Z	9.00	80.97	22.67		65.0	
10256-CAA	LTE-TDD (SC-FDMA, 100% RB, 1.4 MHz, 16-QAM)	X	10.45	81.80	21.06	3.98	65.0	± 9.6 %
		Y	9.25	79.43	20.63		65.0	
		Z	8.10	77.76	18.69		65.0	
10257-CAA	LTE-TDD (SC-FDMA, 100% RB, 1.4 MHz, 64-QAM)	X	10.14	80.97	20.68	3.98	65.0	± 9.6 %
		Y	9.17	78.95	20.38		65.0	
		Z	7.78	76.81	18.23		65.0	
10258-CAA	LTE-TDD (SC-FDMA, 100% RB, 1.4 MHz, QPSK)	X	9.51	83.16	21.76	3.98	65.0	± 9.6 %
		Y	8.34	80.46	21.12		65.0	
		Z	7.35	79.00	19.46		65.0	
10259-CAB	LTE-TDD (SC-FDMA, 100% RB, 3 MHz, 16-QAM)	X	8.50	79.32	21.74	3.98	65.0	± 9.6 %
		Y	8.08	77.61	21.22		65.0	
		Z	7.86	78.44	21.00		65.0	
10260-CAB	LTE-TDD (SC-FDMA, 100% RB, 3 MHz, 64-QAM)	X	8.50	79.04	21.65	3.98	65.0	± 9.6 %
		Y	8.14	77.44	21.18		65.0	
		Z	7.85	78.11	20.87		65.0	
10261-CAB	LTE-TDD (SC-FDMA, 100% RB, 3 MHz, QPSK)	X	10.46	84.88	23.66	3.98	65.0	± 9.6 %
		Y	8.99	81.35	22.49		65.0	
		Z	9.90	84.54	23.31		65.0	
10262-CAB	LTE-TDD (SC-FDMA, 100% RB, 5 MHz, 16-QAM)	X	8.92	80.22	22.77	3.98	65.0	± 9.6 %
		Y	8.45	78.35	22.11		65.0	
		Z	8.45	79.83	22.45		65.0	
10263-CAB	LTE-TDD (SC-FDMA, 100% RB, 5 MHz, 64-QAM)	X	8.39	77.98	21.64	3.98	65.0	± 9.6 %
		Y	8.12	76.54	21.14		65.0	
		Z	7.97	77.72	21.33		65.0	
10264-CAB	LTE-TDD (SC-FDMA, 100% RB, 5 MHz, QPSK)	X	10.46	84.37	23.71	3.98	65.0	± 9.6 %
		Y	9.15	81.08	22.57		65.0	
		Z	10.16	84.65	23.78		65.0	
10265-CAB	LTE-TDD (SC-FDMA, 100% RB, 10 MHz, 16-QAM)	X	8.50	77.59	21.64	3.98	65.0	± 9.6 %
		Y	8.29	76.32	21.16		65.0	
		Z	8.08	77.33	21.51		65.0	
10266-CAB	LTE-TDD (SC-FDMA, 100% RB, 10 MHz, 64-QAM)	X	8.85	78.27	22.25	3.98	65.0	± 9.6 %
		Y	8.62	76.95	21.75		65.0	
		Z	8.48	78.14	22.17		65.0	
10267-CAB	LTE-TDD (SC-FDMA, 100% RB, 10 MHz, QPSK)	X	9.58	81.04	22.42	3.98	65.0	± 9.6 %
		Y	8.86	78.85	21.63		65.0	
		Z	9.31	81.34	22.60		65.0	
10268-CAB	LTE-TDD (SC-FDMA, 100% RB, 15 MHz, 16-QAM)	X	8.89	76.95	21.70	3.98	65.0	± 9.6 %
		Y	8.78	75.95	21.31		65.0	
		Z	8.54	76.83	21.69		65.0	
10269-CAB	LTE-TDD (SC-FDMA, 100% RB, 15 MHz, 64-QAM)	X	8.79	76.51	21.59	3.98	65.0	± 9.6 %
		Y	8.71	75.58	21.23		65.0	
		Z	8.47	76.42	21.58		65.0	
10270-CAB	LTE-TDD (SC-FDMA, 100% RB, 15 MHz, QPSK)	X	8.98	78.26	21.47	3.98	65.0	± 9.6 %
		Y	8.66	76.86	20.96		65.0	
		Z	8.70	78.39	21.61		65.0	

10274-CAB	UMTS-FDD (HSUPA, Subtest 5, 3GPP Rel8.10)	X	2.76	67.40	16.12	0.00	150.0	± 9.6 %
		Y	2.68	66.20	15.35		150.0	
		Z	2.61	66.55	15.21		150.0	
10275-CAB	UMTS-FDD (HSUPA, Subtest 5, 3GPP Rel8.4)	X	1.97	71.33	17.64	0.00	150.0	± 9.6 %
		Y	1.71	67.84	15.61		150.0	
		Z	1.63	67.82	15.44		150.0	
10277-CAA	PHS (QPSK)	X	5.79	70.12	14.44	9.03	50.0	± 9.6 %
		Y	6.71	72.04	16.24		50.0	
		Z	5.20	69.01	13.39		50.0	
10278-CAA	PHS (QPSK, BW 884MHz, Rolloff 0.5)	X	10.14	81.72	21.64	9.03	50.0	± 9.6 %
		Y	10.00	81.13	22.16		50.0	
		Z	8.80	79.36	20.19		50.0	
10279-CAA	PHS (QPSK, BW 884MHz, Rolloff 0.38)	X	10.33	81.92	21.72	9.03	50.0	± 9.6 %
		Y	10.19	81.33	22.24		50.0	
		Z	8.92	79.53	20.27		50.0	
10290-AAB	CDMA2000, RC1, SO55, Full Rate	X	2.41	75.76	18.30	0.00	150.0	± 9.6 %
		Y	1.70	69.18	15.23		150.0	
		Z	1.46	68.58	14.00		150.0	
10291-AAB	CDMA2000, RC3, SO55, Full Rate	X	1.39	73.22	17.31	0.00	150.0	± 9.6 %
		Y	0.98	66.45	13.79		150.0	
		Z	0.85	65.74	12.53		150.0	
10292-AAB	CDMA2000, RC3, SO32, Full Rate	X	2.43	83.14	21.70	0.00	150.0	± 9.6 %
		Y	1.15	69.63	15.75		150.0	
		Z	1.04	69.40	14.71		150.0	
10293-AAB	CDMA2000, RC3, SO3, Full Rate	X	5.22	96.14	26.57	0.00	150.0	± 9.6 %
		Y	1.48	73.58	17.97		150.0	
		Z	1.47	74.43	17.37		150.0	
10295-AAB	CDMA2000, RC1, SO3, 1/8th Rate 25 fr.	X	10.48	83.75	24.32	9.03	50.0	± 9.6 %
		Y	9.84	81.54	23.85		50.0	
		Z	11.88	86.37	24.91		50.0	
10297-AAA	LTE-FDD (SC-FDMA, 50% RB, 20 MHz, QPSK)	X	3.28	72.37	17.95	0.00	150.0	± 9.6 %
		Y	2.98	69.95	16.59		150.0	
		Z	2.77	69.63	16.49		150.0	
10298-AAB	LTE-FDD (SC-FDMA, 50% RB, 3 MHz, QPSK)	X	2.26	72.62	17.48	0.00	150.0	± 9.6 %
		Y	1.88	68.51	15.39		150.0	
		Z	1.59	67.65	14.14		150.0	
10299-AAB	LTE-FDD (SC-FDMA, 50% RB, 3 MHz, 16-QAM)	X	6.40	81.89	20.37	0.00	150.0	± 9.6 %
		Y	3.78	73.44	17.26		150.0	
		Z	3.62	73.66	16.18		150.0	
10300-AAB	LTE-FDD (SC-FDMA, 50% RB, 3 MHz, 64-QAM)	X	3.72	72.73	16.07	0.00	150.0	± 9.6 %
		Y	2.96	68.88	14.55		150.0	
		Z	2.44	67.52	12.75		150.0	
10301-AAA	IEEE 802.16e WIMAX (29:18, 5ms, 10MHz, QPSK, PUSC)	X	5.70	68.03	18.84	4.17	80.0	± 9.6 %
		Y	5.77	67.36	18.35		80.0	
		Z	5.64	68.37	18.74		80.0	
10302-AAA	IEEE 802.16e WIMAX (29:18, 5ms, 10MHz, QPSK, PUSC, 3 CTRL symbols)	X	6.21	68.72	19.60	4.96	80.0	± 9.6 %
		Y	6.41	68.65	19.47		80.0	
		Z	6.13	69.05	19.54		80.0	

10303-AAA	IEEE 802.16e WiMAX (31:15, 5ms, 10MHz, 64QAM, PUSC)	X	6.07	68.83	19.70	4.96	80.0	± 9.6 %
		Y	6.30	68.82	19.58		80.0	
		Z	5.97	69.08	19.56		80.0	
10304-AAA	IEEE 802.16e WiMAX (29:18, 5ms, 10MHz, 64QAM, PUSC)	X	5.71	68.13	18.89	4.17	80.0	± 9.6 %
		Y	5.89	68.01	18.73		80.0	
		Z	5.61	68.35	18.73		80.0	
10305-AAA	IEEE 802.16e WiMAX (31:15, 10ms, 10MHz, 64QAM, PUSC, 15 symbols)	X	6.90	74.81	23.11	6.02	50.0	± 9.6 %
		Y	9.48	82.28	26.60		50.0	
		Z	9.03	82.45	26.20		50.0	
10306-AAA	IEEE 802.16e WiMAX (29:18, 10ms, 10MHz, 64QAM, PUSC, 18 symbols)	X	6.40	71.34	21.64	6.02	50.0	± 9.6 %
		Y	6.75	71.50	21.57		50.0	
		Z	6.43	72.04	21.56		50.0	
10307-AAA	IEEE 802.16e WiMAX (29:18, 10ms, 10MHz, QPSK, PUSC, 18 symbols)	X	6.49	72.10	21.82	6.02	50.0	± 9.6 %
		Y	6.85	72.21	21.70		50.0	
		Z	6.50	72.67	21.67		50.0	
10308-AAA	IEEE 802.16e WiMAX (29:18, 10ms, 10MHz, 16QAM, PUSC)	X	6.53	72.49	22.02	6.02	50.0	± 9.6 %
		Y	6.89	72.58	21.88		50.0	
		Z	6.59	73.18	21.92		50.0	
10309-AAA	IEEE 802.16e WiMAX (29:18, 10ms, 10MHz, 16QAM, AMC 2x3, 18 symbols)	X	6.52	71.66	21.81	6.02	50.0	± 9.6 %
		Y	6.86	71.77	21.70		50.0	
		Z	6.53	72.35	21.74		50.0	
10310-AAA	IEEE 802.16e WiMAX (29:18, 10ms, 10MHz, QPSK, AMC 2x3, 18 symbols)	X	6.41	71.57	21.66	6.02	50.0	± 9.6 %
		Y	6.75	71.71	21.56		50.0	
		Z	6.45	72.29	21.59		50.0	
10311-AAA	LTE-FDD (SC-FDMA, 100% RB, 15 MHz, QPSK)	X	3.66	71.55	17.51	0.00	150.0	± 9.6 %
		Y	3.33	69.32	16.27		150.0	
		Z	3.12	68.94	16.14		150.0	
10313-AAA	iDEN 1:3	X	8.19	79.62	19.16	6.99	70.0	± 9.6 %
		Y	7.35	77.72	18.90		70.0	
		Z	8.21	80.46	19.57		70.0	
10314-AAA	iDEN 1:6	X	11.35	86.83	24.06	10.00	30.0	± 9.6 %
		Y	8.72	81.68	22.69		30.0	
		Z	10.81	87.34	24.49		30.0	
10315-AAB	IEEE 802.11b WiFi 2.4 GHz (DSSS, 1 Mbps, 96pc duty cycle)	X	1.24	66.34	16.99	0.17	150.0	± 9.6 %
		Y	1.18	64.44	15.46		150.0	
		Z	1.17	64.45	15.36		150.0	
10316-AAB	IEEE 802.11g WiFi 2.4 GHz (ERP-OFDM, 6 Mbps, 96pc duty cycle)	X	4.83	67.25	16.68	0.17	150.0	± 9.6 %
		Y	4.86	66.88	16.43		150.0	
		Z	4.68	66.99	16.39		150.0	
10317-AAB	IEEE 802.11a WiFi 5 GHz (OFDM, 6 Mbps, 96pc duty cycle)	X	4.83	67.25	16.68	0.17	150.0	± 9.6 %
		Y	4.86	66.88	16.43		150.0	
		Z	4.68	66.99	16.39		150.0	
10400-AAC	IEEE 802.11ac WiFi (20MHz, 64-QAM, 99pc duty cycle)	X	4.96	67.54	16.61	0.00	150.0	± 9.6 %
		Y	4.98	67.13	16.32		150.0	
		Z	4.75	67.19	16.29		150.0	
10401-AAC	IEEE 802.11ac WiFi (40MHz, 64-QAM, 99pc duty cycle)	X	5.54	67.49	16.61	0.00	150.0	± 9.6 %
		Y	5.56	67.14	16.37		150.0	
		Z	5.45	67.43	16.49		150.0	

10402-AAC	IEEE 802.11ac WiFi (80MHz, 64-QAM, 99pc duty cycle)	X	5.87	68.11	16.75	0.00	150.0	± 9.6 %
		Y	5.89	67.80	16.54		150.0	
		Z	5.70	67.70	16.47		150.0	
10403-AAB	CDMA2000 (1xEV-DO, Rev. 0)	X	2.41	75.76	18.30	0.00	115.0	± 9.6 %
		Y	1.70	69.18	15.23		115.0	
		Z	1.46	68.58	14.00		115.0	
10404-AAB	CDMA2000 (1xEV-DO, Rev. A)	X	2.41	75.76	18.30	0.00	115.0	± 9.6 %
		Y	1.70	69.18	15.23		115.0	
		Z	1.46	68.58	14.00		115.0	
10406-AAB	CDMA2000, RC3, SO32, SCH0, Full Rate	X	100.00	120.32	30.30	0.00	100.0	± 9.6 %
		Y	37.67	108.93	28.46		100.0	
		Z	100.00	119.28	29.39		100.0	
10410-AAA	LTE-TDD (SC-FDMA, 1 RB, 10 MHz, QPSK, UL Subframe=2,3,4,7,8,9)	X	100.00	118.51	29.90	3.23	80.0	± 9.6 %
		Y	100.00	119.74	30.88		80.0	
		Z	100.00	120.99	30.71		80.0	
10415-AAA	IEEE 802.11b WiFi 2.4 GHz (DSSS, 1 Mbps, 99pc duty cycle)	X	1.06	64.54	16.02	0.00	150.0	± 9.6 %
		Y	1.03	62.90	14.57		150.0	
		Z	1.03	63.04	14.51		150.0	
10416-AAA	IEEE 802.11g WiFi 2.4 GHz (ERP-OFDM, 6 Mbps, 99pc duty cycle)	X	4.73	67.12	16.55	0.00	150.0	± 9.6 %
		Y	4.75	66.70	16.25		150.0	
		Z	4.58	66.83	16.23		150.0	
10417-AAA	IEEE 802.11a/h WiFi 5 GHz (OFDM, 6 Mbps, 99pc duty cycle)	X	4.73	67.12	16.55	0.00	150.0	± 9.6 %
		Y	4.75	66.70	16.25		150.0	
		Z	4.58	66.83	16.23		150.0	
10418-AAA	IEEE 802.11g WiFi 2.4 GHz (DSSS-OFDM, 6 Mbps, 99pc duty cycle, Long preamble)	X	4.72	67.27	16.56	0.00	150.0	± 9.6 %
		Y	4.73	66.83	16.25		150.0	
		Z	4.56	66.98	16.24		150.0	
10419-AAA	IEEE 802.11g WiFi 2.4 GHz (DSSS-OFDM, 6 Mbps, 99pc duty cycle, Short preamble)	X	4.75	67.23	16.56	0.00	150.0	± 9.6 %
		Y	4.76	66.80	16.26		150.0	
		Z	4.59	66.94	16.24		150.0	
10422-AAA	IEEE 802.11n (HT Greenfield, 7.2 Mbps, BPSK)	X	4.87	67.22	16.56	0.00	150.0	± 9.6 %
		Y	4.89	66.82	16.28		150.0	
		Z	4.71	66.94	16.26		150.0	
10423-AAA	IEEE 802.11n (HT Greenfield, 43.3 Mbps, 16-QAM)	X	5.09	67.62	16.71	0.00	150.0	± 9.6 %
		Y	5.12	67.23	16.44		150.0	
		Z	4.88	67.27	16.38		150.0	
10424-AAA	IEEE 802.11n (HT Greenfield, 72.2 Mbps, 64-QAM)	X	5.00	67.56	16.68	0.00	150.0	± 9.6 %
		Y	5.02	67.15	16.39		150.0	
		Z	4.80	67.22	16.35		150.0	
10425-AAA	IEEE 802.11n (HT Greenfield, 15 Mbps, BPSK)	X	5.55	67.83	16.78	0.00	150.0	± 9.6 %
		Y	5.59	67.55	16.57		150.0	
		Z	5.40	67.57	16.55		150.0	
10426-AAA	IEEE 802.11n (HT Greenfield, 90 Mbps, 16-QAM)	X	5.56	67.88	16.79	0.00	150.0	± 9.6 %
		Y	5.60	67.58	16.58		150.0	
		Z	5.41	67.59	16.56		150.0	



10427-AAA	IEEE 802.11n (HT Greenfield, 150 Mbps, 64-QAM)	X	5.59	67.91	16.80	0.00	150.0	± 9.6 %
		Y	5.63	67.61	16.59		150.0	
		Z	5.42	67.56	16.54		150.0	
10430-AAA	LTE-FDD (OFDMA, 5 MHz, E-TM 3.1)	X	4.54	71.07	18.70	0.00	150.0	± 9.6 %
		Y	4.46	69.99	18.11		150.0	
		Z	4.20	70.41	17.89		150.0	
10431-AAA	LTE-FDD (OFDMA, 10 MHz, E-TM 3.1)	X	4.50	67.77	16.69	0.00	150.0	± 9.6 %
		Y	4.51	67.23	16.34		150.0	
		Z	4.26	67.36	16.21		150.0	
10432-AAA	LTE-FDD (OFDMA, 15 MHz, E-TM 3.1)	X	4.78	67.63	16.67	0.00	150.0	± 9.6 %
		Y	4.80	67.18	16.37		150.0	
		Z	4.56	67.25	16.29		150.0	
10433-AAA	LTE-FDD (OFDMA, 20 MHz, E-TM 3.1)	X	5.01	67.62	16.71	0.00	150.0	± 9.6 %
		Y	5.04	67.21	16.43		150.0	
		Z	4.81	67.25	16.37		150.0	
10434-AAA	W-CDMA (BS Test Model 1, 64 DPCH)	X	4.66	71.93	18.79	0.00	150.0	± 9.6 %
		Y	4.53	70.61	18.11		150.0	
		Z	4.27	71.15	17.82		150.0	
10435-AAA	LTE-TDD (SC-FDMA, 1 RB, 20 MHz, QPSK, UL Subframe=2,3,4,7,8,9)	X	100.00	118.35	29.82	3.23	80.0	± 9.6 %
		Y	100.00	119.61	30.82		80.0	
		Z	100.00	120.81	30.62		80.0	
10447-AAA	LTE-FDD (OFDMA, 5 MHz, E-TM 3.1, Clipping 44%)	X	3.85	68.02	16.38	0.00	150.0	± 9.6 %
		Y	3.83	67.22	15.92		150.0	
		Z	3.54	67.32	15.53		150.0	
10448-AAA	LTE-FDD (OFDMA, 10 MHz, E-TM 3.1, Clipping 44%)	X	4.31	67.56	16.56	0.00	150.0	± 9.6 %
		Y	4.32	66.99	16.19		150.0	
		Z	4.10	67.13	16.07		150.0	
10449-AAA	LTE-FDD (OFDMA, 15 MHz, E-TM 3.1, Clipping 44%)	X	4.56	67.47	16.59	0.00	150.0	± 9.6 %
		Y	4.57	66.98	16.26		150.0	
		Z	4.37	67.07	16.19		150.0	
10450-AAA	LTE-FDD (OFDMA, 20 MHz, E-TM 3.1, Clipping 44%)	X	4.73	67.38	16.58	0.00	150.0	± 9.6 %
		Y	4.74	66.94	16.27		150.0	
		Z	4.56	67.01	16.22		150.0	
10451-AAA	W-CDMA (BS Test Model 1, 64 DPCH, Clipping 44%)	X	3.81	68.42	16.23	0.00	150.0	± 9.6 %
		Y	3.77	67.50	15.73		150.0	
		Z	3.44	67.49	15.16		150.0	
10456-AAA	IEEE 802.11ac WiFi (160MHz, 64-QAM, 99pc duty cycle)	X	6.40	68.45	16.93	0.00	150.0	± 9.6 %
		Y	6.44	68.23	16.77		150.0	
		Z	6.27	68.12	16.71		150.0	
10457-AAA	UMTS-FDD (DC-HSDPA)	X	3.89	65.77	16.30	0.00	150.0	± 9.6 %
		Y	3.90	65.36	15.99		150.0	
		Z	3.82	65.47	15.93		150.0	
10458-AAA	CDMA2000 (1xEV-DO, Rev. B, 2 carriers)	X	3.60	67.53	15.71	0.00	150.0	± 9.6 %
		Y	3.56	66.59	15.22		150.0	
		Z	3.27	66.88	14.62		150.0	
10459-AAA	CDMA2000 (1xEV-DO, Rev. B, 3 carriers)	X	4.70	65.53	16.21	0.00	150.0	± 9.6 %
		Y	4.63	64.60	15.71		150.0	
		Z	4.27	64.85	15.38		150.0	

10460-AAA	UMTS-FDD (WCDMA, AMR)	X	1.28	75.29	20.20	0.00	150.0	± 9.6 %
		Y	0.92	67.71	15.91		150.0	
		Z	0.90	67.71	15.78		150.0	
10461-AAA	LTE-TDD (SC-FDMA, 1 RB, 1.4 MHz, QPSK, UL Subframe=2,3,4,7,8,9)	X	100.00	122.97	32.01	3.29	80.0	± 9.6 %
		Y	100.00	121.34	31.70		80.0	
		Z	100.00	125.58	32.88		80.0	
10462-AAA	LTE-TDD (SC-FDMA, 1 RB, 1.4 MHz, 16-QAM, UL Subframe=2,3,4,7,8,9)	X	100.00	108.03	24.84	3.23	80.0	± 9.6 %
		Y	100.00	109.86	26.18		80.0	
		Z	100.00	108.99	24.93		80.0	
10463-AAA	LTE-TDD (SC-FDMA, 1 RB, 1.4 MHz, 64-QAM, UL Subframe=2,3,4,7,8,9)	X	100.00	105.21	23.49	3.23	80.0	± 9.6 %
		Y	47.92	99.26	23.13		80.0	
		Z	100.00	105.71	23.36		80.0	
10464-AAA	LTE-TDD (SC-FDMA, 1 RB, 3 MHz, QPSK, UL Subframe=2,3,4,7,8,9)	X	100.00	121.12	31.00	3.23	80.0	± 9.6 %
		Y	100.00	119.76	30.82		80.0	
		Z	100.00	123.61	31.80		80.0	
10465-AAA	LTE-TDD (SC-FDMA, 1 RB, 3 MHz, 16-QAM, UL Subframe=2,3,4,7,8,9)	X	100.00	107.54	24.59	3.23	80.0	± 9.6 %
		Y	92.10	108.50	25.75		80.0	
		Z	100.00	108.47	24.68		80.0	
10466-AAA	LTE-TDD (SC-FDMA, 1 RB, 3 MHz, 64-QAM, UL Subframe=2,3,4,7,8,9)	X	100.00	104.76	23.28	3.23	80.0	± 9.6 %
		Y	27.79	92.79	21.40		80.0	
		Z	53.71	98.96	21.73		80.0	
10467-AAA	LTE-TDD (SC-FDMA, 1 RB, 5 MHz, QPSK, UL Subframe=2,3,4,7,8,9)	X	100.00	121.32	31.10	3.23	80.0	± 9.6 %
		Y	100.00	119.93	30.90		80.0	
		Z	100.00	123.83	31.91		80.0	
10468-AAA	LTE-TDD (SC-FDMA, 1 RB, 5 MHz, 16-QAM, UL Subframe=2,3,4,7,8,9)	X	100.00	107.68	24.66	3.23	80.0	± 9.6 %
		Y	100.00	109.58	26.02		80.0	
		Z	100.00	108.64	24.75		80.0	
10469-AAA	LTE-TDD (SC-FDMA, 1 RB, 5 MHz, 64-QAM, UL Subframe=2,3,4,7,8,9)	X	100.00	104.76	23.27	3.23	80.0	± 9.6 %
		Y	28.45	93.06	21.47		80.0	
		Z	57.15	99.60	21.88		80.0	
10470-AAA	LTE-TDD (SC-FDMA, 1 RB, 10 MHz, QPSK, UL Subframe=2,3,4,7,8,9)	X	100.00	121.35	31.10	3.23	80.0	± 9.6 %
		Y	100.00	119.95	30.90		80.0	
		Z	100.00	123.86	31.91		80.0	
10471-AAA	LTE-TDD (SC-FDMA, 1 RB, 10 MHz, 16-QAM, UL Subframe=2,3,4,7,8,9)	X	100.00	107.63	24.63	3.23	80.0	± 9.6 %
		Y	100.00	109.54	26.00		80.0	
		Z	100.00	108.59	24.73		80.0	
10472-AAA	LTE-TDD (SC-FDMA, 1 RB, 10 MHz, 64-QAM, UL Subframe=2,3,4,7,8,9)	X	100.00	104.72	23.24	3.23	80.0	± 9.6 %
		Y	28.52	93.08	21.46		80.0	
		Z	57.07	99.54	21.85		80.0	
10473-AAA	LTE-TDD (SC-FDMA, 1 RB, 15 MHz, QPSK, UL Subframe=2,3,4,7,8,9)	X	100.00	121.32	31.09	3.23	80.0	± 9.6 %
		Y	100.00	119.92	30.89		80.0	
		Z	100.00	123.84	31.90		80.0	
10474-AAA	LTE-TDD (SC-FDMA, 1 RB, 15 MHz, 16-QAM, UL Subframe=2,3,4,7,8,9)	X	100.00	107.64	24.63	3.23	80.0	± 9.6 %
		Y	100.00	109.55	26.00		80.0	
		Z	100.00	108.60	24.73		80.0	
10475-AAA	LTE-TDD (SC-FDMA, 1 RB, 15 MHz, 64-QAM, UL Subframe=2,3,4,7,8,9)	X	100.00	104.73	23.25	3.23	80.0	± 9.6 %
		Y	28.13	92.93	21.42		80.0	
		Z	55.36	99.25	21.78		80.0	

10477-AAA	LTE-TDD (SC-FDMA, 1 RB, 20 MHz, 16-QAM, UL Subframe=2,3,4,7,8,9)	X	100.00	107.49	24.56	3.23	80.0	± 9.6 %
		Y	96.57	109.01	25.85		80.0	
		Z	100.00	108.42	24.64		80.0	
10478-AAA	LTE-TDD (SC-FDMA, 1 RB, 20 MHz, 64-QAM, UL Subframe=2,3,4,7,8,9)	X	100.00	104.68	23.23	3.23	80.0	± 9.6 %
		Y	27.68	92.72	21.36		80.0	
		Z	53.23	98.81	21.67		80.0	
10479-AAA	LTE-TDD (SC-FDMA, 50% RB, 1.4 MHz, QPSK, UL Subframe=2,3,4,7,8,9)	X	26.63	104.01	29.13	3.23	80.0	± 9.6 %
		Y	9.63	86.48	23.96		80.0	
		Z	24.30	102.59	28.22		80.0	
10480-AAA	LTE-TDD (SC-FDMA, 50% RB, 1.4 MHz, 16-QAM, UL Subframe=2,3,4,7,8,9)	X	38.31	102.90	27.02	3.23	80.0	± 9.6 %
		Y	11.50	85.06	22.20		80.0	
		Z	29.11	98.49	25.10		80.0	
10481-AAA	LTE-TDD (SC-FDMA, 50% RB, 1.4 MHz, 64-QAM, UL Subframe=2,3,4,7,8,9)	X	30.40	98.59	25.52	3.23	80.0	± 9.6 %
		Y	10.74	83.47	21.41		80.0	
		Z	20.94	92.98	23.18		80.0	
10482-AAA	LTE-TDD (SC-FDMA, 50% RB, 3 MHz, QPSK, UL Subframe=2,3,4,7,8,9)	X	8.51	84.82	22.25	2.23	80.0	± 9.6 %
		Y	5.60	77.58	19.80		80.0	
		Z	5.41	78.09	19.19		80.0	
10483-AAA	LTE-TDD (SC-FDMA, 50% RB, 3 MHz, 16-QAM, UL Subframe=2,3,4,7,8,9)	X	14.01	88.92	23.41	2.23	80.0	± 9.6 %
		Y	8.14	80.18	20.73		80.0	
		Z	9.32	82.50	20.44		80.0	
10484-AAA	LTE-TDD (SC-FDMA, 50% RB, 3 MHz, 64-QAM, UL Subframe=2,3,4,7,8,9)	X	12.47	87.00	22.82	2.23	80.0	± 9.6 %
		Y	7.81	79.33	20.43		80.0	
		Z	8.26	80.64	19.81		80.0	
10485-AAA	LTE-TDD (SC-FDMA, 50% RB, 5 MHz, QPSK, UL Subframe=2,3,4,7,8,9)	X	8.06	84.25	22.66	2.23	80.0	± 9.6 %
		Y	5.75	77.87	20.37		80.0	
		Z	5.68	79.10	20.42		80.0	
10486-AAA	LTE-TDD (SC-FDMA, 50% RB, 5 MHz, 16-QAM, UL Subframe=2,3,4,7,8,9)	X	5.66	75.87	19.43	2.23	80.0	± 9.6 %
		Y	4.94	72.86	18.29		80.0	
		Z	4.62	73.05	17.69		80.0	
10487-AAA	LTE-TDD (SC-FDMA, 50% RB, 5 MHz, 64-QAM, UL Subframe=2,3,4,7,8,9)	X	5.56	75.25	19.19	2.23	80.0	± 9.6 %
		Y	4.94	72.51	18.16		80.0	
		Z	4.56	72.51	17.46		80.0	
10488-AAA	LTE-TDD (SC-FDMA, 50% RB, 10 MHz, QPSK, UL Subframe=2,3,4,7,8,9)	X	7.10	80.82	21.84	2.23	80.0	± 9.6 %
		Y	5.79	76.47	20.13		80.0	
		Z	5.49	77.19	20.36		80.0	
10489-AAA	LTE-TDD (SC-FDMA, 50% RB, 10 MHz, 16-QAM, UL Subframe=2,3,4,7,8,9)	X	5.34	73.87	19.44	2.23	80.0	± 9.6 %
		Y	5.00	71.87	18.57		80.0	
		Z	4.68	72.17	18.47		80.0	
10490-AAA	LTE-TDD (SC-FDMA, 50% RB, 10 MHz, 64-QAM, UL Subframe=2,3,4,7,8,9)	X	5.35	73.36	19.26	2.23	80.0	± 9.6 %
		Y	5.06	71.53	18.46		80.0	
		Z	4.74	71.87	18.36		80.0	
10491-AAA	LTE-TDD (SC-FDMA, 50% RB, 15 MHz, QPSK, UL Subframe=2,3,4,7,8,9)	X	6.36	77.12	20.56	2.23	80.0	± 9.6 %
		Y	5.66	74.28	19.36		80.0	
		Z	5.31	74.67	19.54		80.0	
10492-AAA	LTE-TDD (SC-FDMA, 50% RB, 15 MHz, 16-QAM, UL Subframe=2,3,4,7,8,9)	X	5.41	72.24	18.98	2.23	80.0	± 9.6 %
		Y	5.23	70.84	18.33		80.0	
		Z	4.89	71.01	18.29		80.0	

10493-AAA	LTE-TDD (SC-FDMA, 50% RB, 15 MHz, 64-QAM, UL Subframe=2,3,4,7,8,9)	X	5.44	71.94	18.88	2.23	80.0	± 9.6 %
		Y	5.28	70.63	18.27		80.0	
		Z	4.94	70.81	18.22		80.0	
10494-AAA	LTE-TDD (SC-FDMA, 50% RB, 20 MHz, QPSK, UL Subframe=2,3,4,7,8,9)	X	7.43	79.70	21.31	2.23	80.0	± 9.6 %
		Y	6.30	76.13	19.88		80.0	
		Z	5.88	76.40	20.05		80.0	
10495-AAA	LTE-TDD (SC-FDMA, 50% RB, 20 MHz, 16-QAM, UL Subframe=2,3,4,7,8,9)	X	5.56	72.97	19.25	2.23	80.0	± 9.6 %
		Y	5.33	71.45	18.55		80.0	
		Z	4.97	71.48	18.50		80.0	
10496-AAA	LTE-TDD (SC-FDMA, 50% RB, 20 MHz, 64-QAM, UL Subframe=2,3,4,7,8,9)	X	5.54	72.39	19.06	2.23	80.0	± 9.6 %
		Y	5.37	71.03	18.42		80.0	
		Z	5.01	71.08	18.38		80.0	
10497-AAA	LTE-TDD (SC-FDMA, 100% RB, 1.4 MHz, QPSK, UL Subframe=2,3,4,7,8,9)	X	7.31	82.38	20.82	2.23	80.0	± 9.6 %
		Y	4.87	75.75	18.64		80.0	
		Z	4.03	73.68	16.68		80.0	
10498-AAA	LTE-TDD (SC-FDMA, 100% RB, 1.4 MHz, 16-QAM, UL Subframe=2,3,4,7,8,9)	X	4.73	73.29	16.69	2.23	80.0	± 9.6 %
		Y	4.12	70.77	15.97		80.0	
		Z	2.73	66.24	12.60		80.0	
10499-AAA	LTE-TDD (SC-FDMA, 100% RB, 1.4 MHz, 64-QAM, UL Subframe=2,3,4,7,8,9)	X	4.59	72.54	16.27	2.23	80.0	± 9.6 %
		Y	4.10	70.38	15.70		80.0	
		Z	2.62	65.47	12.11		80.0	
10500-AAA	LTE-TDD (SC-FDMA, 100% RB, 3 MHz, QPSK, UL Subframe=2,3,4,7,8,9)	X	7.19	81.83	22.01	2.23	80.0	± 9.6 %
		Y	5.57	76.69	20.07		80.0	
		Z	5.44	77.85	20.24		80.0	
10501-AAA	LTE-TDD (SC-FDMA, 100% RB, 3 MHz, 16-QAM, UL Subframe=2,3,4,7,8,9)	X	5.46	74.81	19.33	2.23	80.0	± 9.6 %
		Y	4.94	72.30	18.33		80.0	
		Z	4.65	72.67	17.97		80.0	
10502-AAA	LTE-TDD (SC-FDMA, 100% RB, 3 MHz, 64-QAM, UL Subframe=2,3,4,7,8,9)	X	5.46	74.43	19.15	2.23	80.0	± 9.6 %
		Y	4.98	72.05	18.20		80.0	
		Z	4.68	72.41	17.81		80.0	
10503-AAA	LTE-TDD (SC-FDMA, 100% RB, 5 MHz, QPSK, UL Subframe=2,3,4,7,8,9)	X	6.99	80.56	21.73	2.23	80.0	± 9.6 %
		Y	5.72	76.28	20.04		80.0	
		Z	5.42	76.98	20.27		80.0	
10504-AAA	LTE-TDD (SC-FDMA, 100% RB, 5 MHz, 16-QAM, UL Subframe=2,3,4,7,8,9)	X	5.31	73.78	19.39	2.23	80.0	± 9.6 %
		Y	4.98	71.79	18.52		80.0	
		Z	4.66	72.08	18.42		80.0	
10505-AAA	LTE-TDD (SC-FDMA, 100% RB, 5 MHz, 64-QAM, UL Subframe=2,3,4,7,8,9)	X	5.32	73.26	19.21	2.23	80.0	± 9.6 %
		Y	5.03	71.44	18.41		80.0	
		Z	4.72	71.78	18.31		80.0	
10506-AAA	LTE-TDD (SC-FDMA, 100% RB, 10 MHz, QPSK, UL Subframe=2,3,4,7,8,9)	X	7.35	79.52	21.23	2.23	80.0	± 9.6 %
		Y	6.24	75.99	19.82		80.0	
		Z	5.83	76.25	19.98		80.0	
10507-AAA	LTE-TDD (SC-FDMA, 100% RB, 10 MHz, 16-QAM, UL Subframe=2,3,4,7,8,9)	X	5.53	72.90	19.22	2.23	80.0	± 9.6 %
		Y	5.31	71.39	18.51		80.0	
		Z	4.95	71.42	18.47		80.0	

10508-AAA	LTE-TDD (SC-FDMA, 100% RB, 10 MHz, 64-QAM, UL Subframe=2,3,4,7,8,9)	X	5.52	72.31	19.02	2.23	80.0	± 9.6 %
		Y	5.35	70.96	18.38		80.0	
		Z	4.99	71.02	18.34		80.0	
10509-AAA	LTE-TDD (SC-FDMA, 100% RB, 15 MHz, QPSK, UL Subframe=2,3,4,7,8,9)	X	6.86	76.40	20.08	2.23	80.0	± 9.6 %
		Y	6.23	74.05	19.09		80.0	
		Z	5.83	74.13	19.18		80.0	
10510-AAA	LTE-TDD (SC-FDMA, 100% RB, 15 MHz, 16-QAM, UL Subframe=2,3,4,7,8,9)	X	5.89	72.04	18.91	2.23	80.0	± 9.6 %
		Y	5.75	70.91	18.36		80.0	
		Z	5.36	70.80	18.32		80.0	
10511-AAA	LTE-TDD (SC-FDMA, 100% RB, 15 MHz, 64-QAM, UL Subframe=2,3,4,7,8,9)	X	5.86	71.58	18.77	2.23	80.0	± 9.6 %
		Y	5.75	70.55	18.27		80.0	
		Z	5.39	70.48	18.23		80.0	
10512-AAA	LTE-TDD (SC-FDMA, 100% RB, 20 MHz, QPSK, UL Subframe=2,3,4,7,8,9)	X	7.85	79.24	20.97	2.23	80.0	± 9.6 %
		Y	6.75	76.04	19.69		80.0	
		Z	6.30	76.05	19.77		80.0	
10513-AAA	LTE-TDD (SC-FDMA, 100% RB, 20 MHz, 16-QAM, UL Subframe=2,3,4,7,8,9)	X	5.88	72.72	19.16	2.23	80.0	± 9.6 %
		Y	5.70	71.43	18.55		80.0	
		Z	5.29	71.21	18.47		80.0	
10514-AAA	LTE-TDD (SC-FDMA, 100% RB, 20 MHz, 64-QAM, UL Subframe=2,3,4,7,8,9)	X	5.77	72.00	18.94	2.23	80.0	± 9.6 %
		Y	5.64	70.86	18.38		80.0	
		Z	5.26	70.69	18.32		80.0	
10515-AAA	IEEE 802.11b WiFi 2.4 GHz (DSSS, 2 Mbps, 99pc duty cycle)	X	1.03	64.88	16.19	0.00	150.0	± 9.6 %
		Y	0.99	63.07	14.62		150.0	
		Z	0.99	63.20	14.56		150.0	
10516-AAA	IEEE 802.11b WiFi 2.4 GHz (DSSS, 5.5 Mbps, 99pc duty cycle)	X	1.64	91.04	26.85	0.00	150.0	± 9.6 %
		Y	0.59	69.22	16.60		150.0	
		Z	0.59	69.23	16.57		150.0	
10517-AAA	IEEE 802.11b WiFi 2.4 GHz (DSSS, 11 Mbps, 99pc duty cycle)	X	0.96	68.68	17.89	0.00	150.0	± 9.6 %
		Y	0.84	64.94	15.18		150.0	
		Z	0.84	64.94	15.09		150.0	
10518-AAA	IEEE 802.11a/h WiFi 5 GHz (OFDM, 9 Mbps, 99pc duty cycle)	X	4.73	67.22	16.54	0.00	150.0	± 9.6 %
		Y	4.75	66.79	16.24		150.0	
		Z	4.57	66.91	16.20		150.0	
10519-AAA	IEEE 802.11a/h WiFi 5 GHz (OFDM, 12 Mbps, 99pc duty cycle)	X	4.96	67.51	16.67	0.00	150.0	± 9.6 %
		Y	4.99	67.12	16.39		150.0	
		Z	4.76	67.15	16.33		150.0	
10520-AAA	IEEE 802.11a/h WiFi 5 GHz (OFDM, 18 Mbps, 99pc duty cycle)	X	4.82	67.52	16.62	0.00	150.0	± 9.6 %
		Y	4.84	67.09	16.32		150.0	
		Z	4.61	67.11	16.25		150.0	
10521-AAA	IEEE 802.11a/h WiFi 5 GHz (OFDM, 24 Mbps, 99pc duty cycle)	X	4.75	67.54	16.61	0.00	150.0	± 9.6 %
		Y	4.77	67.10	16.31		150.0	
		Z	4.54	67.10	16.23		150.0	
10522-AAA	IEEE 802.11a/h WiFi 5 GHz (OFDM, 36 Mbps, 99pc duty cycle)	X	4.79	67.47	16.62	0.00	150.0	± 9.6 %
		Y	4.80	67.00	16.30		150.0	
		Z	4.60	67.19	16.31		150.0	

10523-AAA	IEEE 802.11a/h WiFi 5 GHz (OFDM, 48 Mbps, 99pc duty cycle)	X	4.66	67.41	16.50	0.00	150.0	± 9.6 %
		Y	4.67	66.95	16.18		150.0	
		Z	4.48	67.04	16.16		150.0	
10524-AAA	IEEE 802.11a/h WiFi 5 GHz (OFDM, 54 Mbps, 99pc duty cycle)	X	4.74	67.44	16.62	0.00	150.0	± 9.6 %
		Y	4.76	66.99	16.31		150.0	
		Z	4.54	67.10	16.28		150.0	
10525-AAA	IEEE 802.11ac WiFi (20MHz, MCS0, 99pc duty cycle)	X	4.69	66.48	16.21	0.00	150.0	± 9.6 %
		Y	4.70	66.02	15.89		150.0	
		Z	4.53	66.15	15.87		150.0	
10526-AAA	IEEE 802.11ac WiFi (20MHz, MCS1, 99pc duty cycle)	X	4.91	66.90	16.35	0.00	150.0	± 9.6 %
		Y	4.91	66.43	16.04		150.0	
		Z	4.70	66.52	16.01		150.0	
10527-AAA	IEEE 802.11ac WiFi (20MHz, MCS2, 99pc duty cycle)	X	4.82	66.89	16.32	0.00	150.0	± 9.6 %
		Y	4.83	66.42	16.00		150.0	
		Z	4.62	66.47	15.95		150.0	
10528-AAA	IEEE 802.11ac WiFi (20MHz, MCS3, 99pc duty cycle)	X	4.84	66.91	16.35	0.00	150.0	± 9.6 %
		Y	4.85	66.44	16.03		150.0	
		Z	4.63	66.49	15.99		150.0	
10529-AAA	IEEE 802.11ac WiFi (20MHz, MCS4, 99pc duty cycle)	X	4.84	66.91	16.35	0.00	150.0	± 9.6 %
		Y	4.85	66.44	16.03		150.0	
		Z	4.63	66.49	15.99		150.0	
10531-AAA	IEEE 802.11ac WiFi (20MHz, MCS6, 99pc duty cycle)	X	4.86	67.08	16.39	0.00	150.0	± 9.6 %
		Y	4.87	66.60	16.06		150.0	
		Z	4.63	66.60	16.00		150.0	
10532-AAA	IEEE 802.11ac WiFi (20MHz, MCS7, 99pc duty cycle)	X	4.71	66.97	16.35	0.00	150.0	± 9.6 %
		Y	4.72	66.49	16.02		150.0	
		Z	4.49	66.45	15.93		150.0	
10533-AAA	IEEE 802.11ac WiFi (20MHz, MCS8, 99pc duty cycle)	X	4.86	66.93	16.33	0.00	150.0	± 9.6 %
		Y	4.87	66.45	16.01		150.0	
		Z	4.64	66.54	15.97		150.0	
10534-AAA	IEEE 802.11ac WiFi (40MHz, MCS0, 99pc duty cycle)	X	5.34	67.03	16.36	0.00	150.0	± 9.6 %
		Y	5.36	66.66	16.11		150.0	
		Z	5.17	66.62	16.06		150.0	
10535-AAA	IEEE 802.11ac WiFi (40MHz, MCS1, 99pc duty cycle)	X	5.42	67.17	16.42	0.00	150.0	± 9.6 %
		Y	5.43	66.80	16.16		150.0	
		Z	5.24	66.80	16.14		150.0	
10536-AAA	IEEE 802.11ac WiFi (40MHz, MCS2, 99pc duty cycle)	X	5.29	67.18	16.41	0.00	150.0	± 9.6 %
		Y	5.30	66.78	16.13		150.0	
		Z	5.11	66.74	16.09		150.0	
10537-AAA	IEEE 802.11ac WiFi (40MHz, MCS3, 99pc duty cycle)	X	5.35	67.14	16.39	0.00	150.0	± 9.6 %
		Y	5.36	66.75	16.12		150.0	
		Z	5.16	66.71	16.08		150.0	
10538-AAA	IEEE 802.11ac WiFi (40MHz, MCS4, 99pc duty cycle)	X	5.47	67.20	16.46	0.00	150.0	± 9.6 %
		Y	5.49	66.85	16.21		150.0	
		Z	5.26	66.74	16.13		150.0	
10540-AAA	IEEE 802.11ac WiFi (40MHz, MCS6, 99pc duty cycle)	X	5.36	67.15	16.45	0.00	150.0	± 9.6 %
		Y	5.38	66.77	16.18		150.0	
		Z	5.19	66.76	16.16		150.0	

10541-AAA	IEEE 802.11ac WiFi (40MHz, MCS7, 99pc duty cycle)	X	5.35	67.08	16.42	0.00	150.0	± 9.6 %
		Y	5.38	66.75	16.17		150.0	
		Z	5.16	66.62	16.08		150.0	
10542-AAA	IEEE 802.11ac WiFi (40MHz, MCS8, 99pc duty cycle)	X	5.49	67.08	16.42	0.00	150.0	± 9.6 %
		Y	5.51	66.73	16.18		150.0	
		Z	5.31	66.69	16.13		150.0	
10543-AAA	IEEE 802.11ac WiFi (40MHz, MCS9, 99pc duty cycle)	X	5.58	67.09	16.44	0.00	150.0	± 9.6 %
		Y	5.61	66.77	16.21		150.0	
		Z	5.39	66.74	16.17		150.0	
10544-AAA	IEEE 802.11ac WiFi (80MHz, MCS0, 99pc duty cycle)	X	5.61	67.12	16.33	0.00	150.0	± 9.6 %
		Y	5.62	66.77	16.09		150.0	
		Z	5.48	66.74	16.05		150.0	
10545-AAA	IEEE 802.11ac WiFi (80MHz, MCS1, 99pc duty cycle)	X	5.83	67.51	16.46	0.00	150.0	± 9.6 %
		Y	5.84	67.15	16.22		150.0	
		Z	5.68	67.16	16.22		150.0	
10546-AAA	IEEE 802.11ac WiFi (80MHz, MCS2, 99pc duty cycle)	X	5.72	67.42	16.44	0.00	150.0	± 9.6 %
		Y	5.73	67.08	16.20		150.0	
		Z	5.55	66.95	16.13		150.0	
10547-AAA	IEEE 802.11ac WiFi (80MHz, MCS3, 99pc duty cycle)	X	5.81	67.48	16.46	0.00	150.0	± 9.6 %
		Y	5.83	67.17	16.24		150.0	
		Z	5.62	66.99	16.14		150.0	
10548-AAA	IEEE 802.11ac WiFi (80MHz, MCS4, 99pc duty cycle)	X	6.10	68.50	16.94	0.00	150.0	± 9.6 %
		Y	6.15	68.24	16.74		150.0	
		Z	5.89	67.98	16.61		150.0	
10550-AAA	IEEE 802.11ac WiFi (80MHz, MCS6, 99pc duty cycle)	X	5.74	67.36	16.42	0.00	150.0	± 9.6 %
		Y	5.75	67.01	16.18		150.0	
		Z	5.57	66.96	16.14		150.0	
10551-AAA	IEEE 802.11ac WiFi (80MHz, MCS7, 99pc duty cycle)	X	5.76	67.47	16.43	0.00	150.0	± 9.6 %
		Y	5.78	67.14	16.20		150.0	
		Z	5.58	67.00	16.12		150.0	
10552-AAA	IEEE 802.11ac WiFi (80MHz, MCS8, 99pc duty cycle)	X	5.66	67.23	16.33	0.00	150.0	± 9.6 %
		Y	5.67	66.89	16.10		150.0	
		Z	5.49	66.80	16.03		150.0	
10553-AAA	IEEE 802.11ac WiFi (80MHz, MCS9, 99pc duty cycle)	X	5.75	67.26	16.37	0.00	150.0	± 9.6 %
		Y	5.76	66.93	16.14		150.0	
		Z	5.58	66.84	16.08		150.0	
10554-AAA	IEEE 1602.11ac WiFi (160MHz, MCS0, 99pc duty cycle)	X	6.01	67.49	16.42	0.00	150.0	± 9.6 %
		Y	6.02	67.17	16.20		150.0	
		Z	5.89	67.10	16.15		150.0	
10555-AAA	IEEE 1602.11ac WiFi (160MHz, MCS1, 99pc duty cycle)	X	6.17	67.85	16.56	0.00	150.0	± 9.6 %
		Y	6.20	67.56	16.36		150.0	
		Z	6.02	67.41	16.28		150.0	
10556-AAA	IEEE 1602.11ac WiFi (160MHz, MCS2, 99pc duty cycle)	X	6.18	67.83	16.55	0.00	150.0	± 9.6 %
		Y	6.19	67.51	16.33		150.0	
		Z	6.04	67.46	16.30		150.0	
10557-AAA	IEEE 1602.11ac WiFi (160MHz, MCS3, 99pc duty cycle)	X	6.17	67.82	16.57	0.00	150.0	± 9.6 %
		Y	6.19	67.52	16.36		150.0	
		Z	6.00	67.36	16.27		150.0	

10558-AAA	IEEE 1602.11ac WiFi (160MHz, MCS4, 99pc duty cycle)	X	6.23	68.01	16.68	0.00	150.0	± 9.6 %
		Y	6.25	67.72	16.47		150.0	
		Z	6.05	67.53	16.37		150.0	
10560-AAA	IEEE 1602.11ac WiFi (160MHz, MCS6, 99pc duty cycle)	X	6.22	67.85	16.63	0.00	150.0	± 9.6 %
		Y	6.25	67.56	16.43		150.0	
		Z	6.05	67.37	16.33		150.0	
10561-AAA	IEEE 1602.11ac WiFi (160MHz, MCS7, 99pc duty cycle)	X	6.13	67.79	16.64	0.00	150.0	± 9.6 %
		Y	6.15	67.49	16.43		150.0	
		Z	5.97	67.35	16.35		150.0	
10562-AAA	IEEE 1602.11ac WiFi (160MHz, MCS8, 99pc duty cycle)	X	6.29	68.28	16.89	0.00	150.0	± 9.6 %
		Y	6.33	68.01	16.70		150.0	
		Z	6.10	67.74	16.55		150.0	
10563-AAA	IEEE 1602.11ac WiFi (160MHz, MCS9, 99pc duty cycle)	X	6.57	68.63	17.00	0.00	150.0	± 9.6 %
		Y	6.57	68.27	16.77		150.0	
		Z	6.35	68.10	16.68		150.0	
10564-AAA	IEEE 802.11g WiFi 2.4 GHz (DSSS-OFDM, 9 Mbps, 99pc duty cycle)	X	5.07	67.31	16.69	0.46	150.0	± 9.6 %
		Y	5.10	66.95	16.44		150.0	
		Z	4.91	67.04	16.40		150.0	
10565-AAA	IEEE 802.11g WiFi 2.4 GHz (DSSS-OFDM, 12 Mbps, 99pc duty cycle)	X	5.34	67.80	17.01	0.46	150.0	± 9.6 %
		Y	5.38	67.46	16.78		150.0	
		Z	5.14	67.47	16.71		150.0	
10566-AAA	IEEE 802.11g WiFi 2.4 GHz (DSSS-OFDM, 18 Mbps, 99pc duty cycle)	X	5.17	67.69	16.85	0.46	150.0	± 9.6 %
		Y	5.21	67.33	16.61		150.0	
		Z	4.97	67.33	16.54		150.0	
10567-AAA	IEEE 802.11g WiFi 2.4 GHz (DSSS-OFDM, 24 Mbps, 99pc duty cycle)	X	5.20	68.09	17.20	0.46	150.0	± 9.6 %
		Y	5.23	67.71	16.94		150.0	
		Z	5.00	67.68	16.86		150.0	
10568-AAA	IEEE 802.11g WiFi 2.4 GHz (DSSS-OFDM, 36 Mbps, 99pc duty cycle)	X	5.08	67.38	16.59	0.46	150.0	± 9.6 %
		Y	5.11	67.01	16.33		150.0	
		Z	4.90	67.16	16.34		150.0	
10569-AAA	IEEE 802.11g WiFi 2.4 GHz (DSSS-OFDM, 48 Mbps, 99pc duty cycle)	X	5.14	68.11	17.22	0.46	150.0	± 9.6 %
		Y	5.16	67.71	16.95		150.0	
		Z	4.96	67.77	16.91		150.0	
10570-AAA	IEEE 802.11g WiFi 2.4 GHz (DSSS-OFDM, 54 Mbps, 99pc duty cycle)	X	5.18	67.92	17.15	0.46	150.0	± 9.6 %
		Y	5.21	67.52	16.88		150.0	
		Z	4.99	67.63	16.86		150.0	
10571-AAA	IEEE 802.11b WiFi 2.4 GHz (DSSS, 1 Mbps, 90pc duty cycle)	X	1.45	67.97	17.69	0.46	130.0	± 9.6 %
		Y	1.38	65.84	16.15		130.0	
		Z	1.34	65.80	16.05		130.0	
10572-AAA	IEEE 802.11b WiFi 2.4 GHz (DSSS, 2 Mbps, 90pc duty cycle)	X	1.49	68.86	18.18	0.46	130.0	± 9.6 %
		Y	1.40	66.47	16.51		130.0	
		Z	1.36	66.39	16.40		130.0	
10573-AAA	IEEE 802.11b WiFi 2.4 GHz (DSSS, 5.5 Mbps, 90pc duty cycle)	X	100.00	149.30	40.22	0.46	130.0	± 9.6 %
		Y	3.11	88.03	23.54		130.0	
		Z	3.23	89.37	24.00		130.0	
10574-AAA	IEEE 802.11b WiFi 2.4 GHz (DSSS, 11 Mbps, 90pc duty cycle)	X	2.21	80.01	23.13	0.46	130.0	± 9.6 %
		Y	1.65	72.75	19.44		130.0	
		Z	1.56	72.33	19.21		130.0	



10575-AAA	IEEE 802.11g WiFi 2.4 GHz (DSSS-OFDM, 6 Mbps, 90pc duty cycle)	X	4.88	67.15	16.77	0.46	130.0	± 9.6 %
		Y	4.92	66.81	16.54		130.0	
		Z	4.73	66.93	16.51		130.0	
10576-AAA	IEEE 802.11g WiFi 2.4 GHz (DSSS-OFDM, 9 Mbps, 90pc duty cycle)	X	4.91	67.32	16.84	0.46	130.0	± 9.6 %
		Y	4.94	66.97	16.61		130.0	
		Z	4.75	67.08	16.56		130.0	
10577-AAA	IEEE 802.11g WiFi 2.4 GHz (DSSS-OFDM, 12 Mbps, 90pc duty cycle)	X	5.15	67.65	17.01	0.46	130.0	± 9.6 %
		Y	5.20	67.33	16.79		130.0	
		Z	4.96	67.36	16.73		130.0	
10578-AAA	IEEE 802.11g WiFi 2.4 GHz (DSSS-OFDM, 18 Mbps, 90pc duty cycle)	X	5.05	67.86	17.13	0.46	130.0	± 9.6 %
		Y	5.09	67.50	16.89		130.0	
		Z	4.85	67.51	16.82		130.0	
10579-AAA	IEEE 802.11g WiFi 2.4 GHz (DSSS-OFDM, 24 Mbps, 90pc duty cycle)	X	4.82	67.24	16.51	0.46	130.0	± 9.6 %
		Y	4.87	66.90	16.27		130.0	
		Z	4.63	66.89	16.19		130.0	
10580-AAA	IEEE 802.11g WiFi 2.4 GHz (DSSS-OFDM, 36 Mbps, 90pc duty cycle)	X	4.86	67.17	16.48	0.46	130.0	± 9.6 %
		Y	4.91	66.83	16.25		130.0	
		Z	4.68	66.92	16.22		130.0	
10581-AAA	IEEE 802.11g WiFi 2.4 GHz (DSSS-OFDM, 48 Mbps, 90pc duty cycle)	X	4.96	67.97	17.11	0.46	130.0	± 9.6 %
		Y	5.00	67.61	16.86		130.0	
		Z	4.76	67.57	16.77		130.0	
10582-AAA	IEEE 802.11g WiFi 2.4 GHz (DSSS-OFDM, 54 Mbps, 90pc duty cycle)	X	4.78	66.97	16.29	0.46	130.0	± 9.6 %
		Y	4.83	66.64	16.06		130.0	
		Z	4.58	66.67	16.00		130.0	
10583-AAA	IEEE 802.11a/h WiFi 5 GHz (OFDM, 6 Mbps, 90pc duty cycle)	X	4.88	67.15	16.77	0.46	130.0	± 9.6 %
		Y	4.92	66.81	16.54		130.0	
		Z	4.73	66.93	16.51		130.0	
10584-AAA	IEEE 802.11a/h WiFi 5 GHz (OFDM, 9 Mbps, 90pc duty cycle)	X	4.91	67.32	16.84	0.46	130.0	± 9.6 %
		Y	4.94	66.97	16.61		130.0	
		Z	4.75	67.08	16.56		130.0	
10585-AAA	IEEE 802.11a/h WiFi 5 GHz (OFDM, 12 Mbps, 90pc duty cycle)	X	5.15	67.65	17.01	0.46	130.0	± 9.6 %
		Y	5.20	67.33	16.79		130.0	
		Z	4.96	67.36	16.73		130.0	
10586-AAA	IEEE 802.11a/h WiFi 5 GHz (OFDM, 18 Mbps, 90pc duty cycle)	X	5.05	67.86	17.13	0.46	130.0	± 9.6 %
		Y	5.09	67.50	16.89		130.0	
		Z	4.85	67.51	16.82		130.0	
10587-AAA	IEEE 802.11a/h WiFi 5 GHz (OFDM, 24 Mbps, 90pc duty cycle)	X	4.82	67.24	16.51	0.46	130.0	± 9.6 %
		Y	4.87	66.90	16.27		130.0	
		Z	4.63	66.89	16.19		130.0	
10588-AAA	IEEE 802.11a/h WiFi 5 GHz (OFDM, 36 Mbps, 90pc duty cycle)	X	4.86	67.17	16.48	0.46	130.0	± 9.6 %
		Y	4.91	66.83	16.25		130.0	
		Z	4.68	66.92	16.22		130.0	
10589-AAA	IEEE 802.11a/h WiFi 5 GHz (OFDM, 48 Mbps, 90pc duty cycle)	X	4.96	67.97	17.11	0.46	130.0	± 9.6 %
		Y	5.00	67.61	16.86		130.0	
		Z	4.76	67.57	16.77		130.0	
10590-AAA	IEEE 802.11a/h WiFi 5 GHz (OFDM, 54 Mbps, 90pc duty cycle)	X	4.78	66.97	16.29	0.46	130.0	± 9.6 %
		Y	4.83	66.64	16.06		130.0	
		Z	4.58	66.67	16.00		130.0	

10591-AAA	IEEE 802.11n (HT Mixed, 20MHz, MCS0, 90pc duty cycle)	X	5.03	67.20	16.86	0.46	130.0	± 9.6 %
		Y	5.07	66.88	16.64		130.0	
		Z	4.88	66.97	16.60		130.0	
10592-AAA	IEEE 802.11n (HT Mixed, 20MHz, MCS1, 90pc duty cycle)	X	5.21	67.55	16.98	0.46	130.0	± 9.6 %
		Y	5.26	67.23	16.76		130.0	
		Z	5.03	67.30	16.73		130.0	
10593-AAA	IEEE 802.11n (HT Mixed, 20MHz, MCS2, 90pc duty cycle)	X	5.14	67.52	16.89	0.46	130.0	± 9.6 %
		Y	5.19	67.20	16.68		130.0	
		Z	4.96	67.23	16.62		130.0	
10594-AAA	IEEE 802.11n (HT Mixed, 20MHz, MCS3, 90pc duty cycle)	X	5.19	67.66	17.03	0.46	130.0	± 9.6 %
		Y	5.24	67.33	16.81		130.0	
		Z	5.01	67.38	16.76		130.0	
10595-AAA	IEEE 802.11n (HT Mixed, 20MHz, MCS4, 90pc duty cycle)	X	5.17	67.65	16.95	0.46	130.0	± 9.6 %
		Y	5.23	67.33	16.73		130.0	
		Z	4.98	67.35	16.67		130.0	
10596-AAA	IEEE 802.11n (HT Mixed, 20MHz, MCS5, 90pc duty cycle)	X	5.11	67.64	16.94	0.46	130.0	± 9.6 %
		Y	5.16	67.30	16.71		130.0	
		Z	4.92	67.35	16.67		130.0	
10597-AAA	IEEE 802.11n (HT Mixed, 20MHz, MCS6, 90pc duty cycle)	X	5.06	67.59	16.86	0.46	130.0	± 9.6 %
		Y	5.11	67.26	16.64		130.0	
		Z	4.87	67.26	16.56		130.0	
10598-AAA	IEEE 802.11n (HT Mixed, 20MHz, MCS7, 90pc duty cycle)	X	5.05	67.87	17.14	0.46	130.0	± 9.6 %
		Y	5.09	67.53	16.91		130.0	
		Z	4.85	67.47	16.80		130.0	
10599-AAA	IEEE 802.11n (HT Mixed, 40MHz, MCS0, 90pc duty cycle)	X	5.68	67.76	17.01	0.46	130.0	± 9.6 %
		Y	5.74	67.54	16.84		130.0	
		Z	5.54	67.51	16.80		130.0	
10600-AAA	IEEE 802.11n (HT Mixed, 40MHz, MCS1, 90pc duty cycle)	X	5.91	68.42	17.31	0.46	130.0	± 9.6 %
		Y	6.00	68.29	17.19		130.0	
		Z	5.69	67.96	17.01		130.0	
10601-AAA	IEEE 802.11n (HT Mixed, 40MHz, MCS2, 90pc duty cycle)	X	5.75	68.03	17.13	0.46	130.0	± 9.6 %
		Y	5.81	67.81	16.96		130.0	
		Z	5.57	67.70	16.89		130.0	
10602-AAA	IEEE 802.11n (HT Mixed, 40MHz, MCS3, 90pc duty cycle)	X	5.85	68.05	17.05	0.46	130.0	± 9.6 %
		Y	5.93	67.91	16.93		130.0	
		Z	5.67	67.73	16.83		130.0	
10603-AAA	IEEE 802.11n (HT Mixed, 40MHz, MCS4, 90pc duty cycle)	X	5.97	68.46	17.38	0.46	130.0	± 9.6 %
		Y	6.05	68.29	17.25		130.0	
		Z	5.74	68.01	17.09		130.0	
10604-AAA	IEEE 802.11n (HT Mixed, 40MHz, MCS5, 90pc duty cycle)	X	5.70	67.75	17.03	0.46	130.0	± 9.6 %
		Y	5.76	67.53	16.86		130.0	
		Z	5.55	67.48	16.81		130.0	
10605-AAA	IEEE 802.11n (HT Mixed, 40MHz, MCS6, 90pc duty cycle)	X	5.80	68.03	17.16	0.46	130.0	± 9.6 %
		Y	5.86	67.81	17.00		130.0	
		Z	5.67	67.84	17.00		130.0	
10606-AAA	IEEE 802.11n (HT Mixed, 40MHz, MCS7, 90pc duty cycle)	X	5.58	67.53	16.79	0.46	130.0	± 9.6 %
		Y	5.62	67.26	16.60		130.0	
		Z	5.41	67.19	16.54		130.0	

10607-AAA	IEEE 802.11ac WiFi (20MHz, MCS0, 90pc duty cycle)	X	4.86	66.52	16.48	0.46	130.0	± 9.6 %
		Y	4.89	66.14	16.23		130.0	
		Z	4.71	66.27	16.21		130.0	
10608-AAA	IEEE 802.11ac WiFi (20MHz, MCS1, 90pc duty cycle)	X	5.09	66.96	16.64	0.46	130.0	± 9.6 %
		Y	5.12	66.58	16.39		130.0	
		Z	4.90	66.67	16.37		130.0	
10609-AAA	IEEE 802.11ac WiFi (20MHz, MCS2, 90pc duty cycle)	X	4.98	66.85	16.52	0.46	130.0	± 9.6 %
		Y	5.01	66.47	16.26		130.0	
		Z	4.79	66.53	16.22		130.0	
10610-AAA	IEEE 802.11ac WiFi (20MHz, MCS3, 90pc duty cycle)	X	5.03	67.01	16.67	0.46	130.0	± 9.6 %
		Y	5.06	66.63	16.42		130.0	
		Z	4.84	66.68	16.37		130.0	
10611-AAA	IEEE 802.11ac WiFi (20MHz, MCS4, 90pc duty cycle)	X	4.96	66.86	16.54	0.46	130.0	± 9.6 %
		Y	4.99	66.50	16.29		130.0	
		Z	4.76	66.50	16.23		130.0	
10612-AAA	IEEE 802.11ac WiFi (20MHz, MCS5, 90pc duty cycle)	X	4.97	67.00	16.58	0.46	130.0	± 9.6 %
		Y	5.01	66.61	16.31		130.0	
		Z	4.77	66.66	16.28		130.0	
10613-AAA	IEEE 802.11ac WiFi (20MHz, MCS6, 90pc duty cycle)	X	4.99	66.94	16.49	0.46	130.0	± 9.6 %
		Y	5.03	66.55	16.23		130.0	
		Z	4.77	66.56	16.17		130.0	
10614-AAA	IEEE 802.11ac WiFi (20MHz, MCS7, 90pc duty cycle)	X	4.92	67.15	16.73	0.46	130.0	± 9.6 %
		Y	4.95	66.76	16.47		130.0	
		Z	4.71	66.71	16.38		130.0	
10615-AAA	IEEE 802.11ac WiFi (20MHz, MCS8, 90pc duty cycle)	X	4.95	66.65	16.31	0.46	130.0	± 9.6 %
		Y	4.99	66.28	16.06		130.0	
		Z	4.76	66.36	16.03		130.0	
10616-AAA	IEEE 802.11ac WiFi (40MHz, MCS0, 90pc duty cycle)	X	5.51	67.07	16.65	0.46	130.0	± 9.6 %
		Y	5.55	66.78	16.45		130.0	
		Z	5.35	66.74	16.40		130.0	
10617-AAA	IEEE 802.11ac WiFi (40MHz, MCS1, 90pc duty cycle)	X	5.58	67.18	16.67	0.46	130.0	± 9.6 %
		Y	5.62	66.89	16.46		130.0	
		Z	5.43	66.92	16.46		130.0	
10618-AAA	IEEE 802.11ac WiFi (40MHz, MCS2, 90pc duty cycle)	X	5.47	67.27	16.74	0.46	130.0	± 9.6 %
		Y	5.50	66.95	16.52		130.0	
		Z	5.31	66.92	16.47		130.0	
10619-AAA	IEEE 802.11ac WiFi (40MHz, MCS3, 90pc duty cycle)	X	5.49	67.07	16.57	0.46	130.0	± 9.6 %
		Y	5.52	66.76	16.36		130.0	
		Z	5.33	66.76	16.33		130.0	
10620-AAA	IEEE 802.11ac WiFi (40MHz, MCS4, 90pc duty cycle)	X	5.62	67.19	16.68	0.46	130.0	± 9.6 %
		Y	5.67	66.93	16.49		130.0	
		Z	5.42	66.79	16.40		130.0	
10621-AAA	IEEE 802.11ac WiFi (40MHz, MCS5, 90pc duty cycle)	X	5.59	67.25	16.82	0.46	130.0	± 9.6 %
		Y	5.63	66.98	16.62		130.0	
		Z	5.41	66.88	16.56		130.0	
10622-AAA	IEEE 802.11ac WiFi (40MHz, MCS6, 90pc duty cycle)	X	5.58	67.35	16.86	0.46	130.0	± 9.6 %
		Y	5.62	67.06	16.66		130.0	
		Z	5.43	67.06	16.64		130.0	

10623-AAA	IEEE 802.11ac WiFi (40MHz, MCS7, 90pc duty cycle)	X	5.48	66.99	16.57	0.46	130.0	± 9.6 %
		Y	5.54	66.75	16.40		130.0	
		Z	5.31	66.61	16.29		130.0	
10624-AAA	IEEE 802.11ac WiFi (40MHz, MCS8, 90pc duty cycle)	X	5.65	67.09	16.68	0.46	130.0	± 9.6 %
		Y	5.69	66.81	16.49		130.0	
		Z	5.50	66.79	16.45		130.0	
10625-AAA	IEEE 802.11ac WiFi (40MHz, MCS9, 90pc duty cycle)	X	6.03	68.01	17.18	0.46	130.0	± 9.6 %
		Y	6.05	67.65	16.95		130.0	
		Z	5.88	67.81	17.01		130.0	
10626-AAA	IEEE 802.11ac WiFi (80MHz, MCS0, 90pc duty cycle)	X	5.76	67.09	16.57	0.46	130.0	± 9.6 %
		Y	5.79	66.81	16.38		130.0	
		Z	5.64	66.79	16.35		130.0	
10627-AAA	IEEE 802.11ac WiFi (80MHz, MCS1, 90pc duty cycle)	X	6.01	67.60	16.77	0.46	130.0	± 9.6 %
		Y	6.04	67.32	16.58		130.0	
		Z	5.89	67.37	16.60		130.0	
10628-AAA	IEEE 802.11ac WiFi (80MHz, MCS2, 90pc duty cycle)	X	5.83	67.28	16.56	0.46	130.0	± 9.6 %
		Y	5.87	67.01	16.37		130.0	
		Z	5.69	66.92	16.32		130.0	
10629-AAA	IEEE 802.11ac WiFi (80MHz, MCS3, 90pc duty cycle)	X	5.93	67.36	16.58	0.46	130.0	± 9.6 %
		Y	5.99	67.16	16.43		130.0	
		Z	5.77	67.00	16.35		130.0	
10630-AAA	IEEE 802.11ac WiFi (80MHz, MCS4, 90pc duty cycle)	X	6.47	69.11	17.45	0.46	130.0	± 9.6 %
		Y	6.56	68.99	17.34		130.0	
		Z	6.24	68.58	17.14		130.0	
10631-AAA	IEEE 802.11ac WiFi (80MHz, MCS5, 90pc duty cycle)	X	6.36	68.89	17.53	0.46	130.0	± 9.6 %
		Y	6.44	68.71	17.39		130.0	
		Z	6.09	68.24	17.15		130.0	
10632-AAA	IEEE 802.11ac WiFi (80MHz, MCS6, 90pc duty cycle)	X	6.00	67.73	16.97	0.46	130.0	± 9.6 %
		Y	6.05	67.48	16.79		130.0	
		Z	5.85	67.39	16.74		130.0	
10633-AAA	IEEE 802.11ac WiFi (80MHz, MCS7, 90pc duty cycle)	X	5.95	67.59	16.73	0.46	130.0	± 9.6 %
		Y	6.01	67.38	16.58		130.0	
		Z	5.74	67.05	16.41		130.0	
10634-AAA	IEEE 802.11ac WiFi (80MHz, MCS8, 90pc duty cycle)	X	5.92	67.56	16.78	0.46	130.0	± 9.6 %
		Y	5.98	67.34	16.62		130.0	
		Z	5.72	67.07	16.47		130.0	
10635-AAA	IEEE 802.11ac WiFi (80MHz, MCS9, 90pc duty cycle)	X	5.80	66.87	16.18	0.46	130.0	± 9.6 %
		Y	5.85	66.64	16.01		130.0	
		Z	5.62	66.48	15.93		130.0	
10636-AAA	IEEE 1602.11ac WiFi (160MHz, MCS0, 90pc duty cycle)	X	6.16	67.47	16.65	0.46	130.0	± 9.6 %
		Y	6.19	67.22	16.49		130.0	
		Z	6.06	67.16	16.44		130.0	
10637-AAA	IEEE 1602.11ac WiFi (160MHz, MCS1, 90pc duty cycle)	X	6.34	67.89	16.84	0.46	130.0	± 9.6 %
		Y	6.39	67.69	16.69		130.0	
		Z	6.22	67.55	16.62		130.0	
10638-AAA	IEEE 1602.11ac WiFi (160MHz, MCS2, 90pc duty cycle)	X	6.33	67.82	16.78	0.46	130.0	± 9.6 %
		Y	6.36	67.57	16.61		130.0	
		Z	6.21	67.52	16.58		130.0	

10639-AAA	IEEE 1602.11ac WiFi (160MHz, MCS3, 90pc duty cycle)	X	6.34	67.88	16.86	0.46	130.0	± 9.6 %
		Y	6.38	67.64	16.70		130.0	
		Z	6.19	67.47	16.60		130.0	
10640-AAA	IEEE 1602.11ac WiFi (160MHz, MCS4, 90pc duty cycle)	X	6.37	67.96	16.84	0.46	130.0	± 9.6 %
		Y	6.42	67.75	16.69		130.0	
		Z	6.20	67.51	16.57		130.0	
10641-AAA	IEEE 1602.11ac WiFi (160MHz, MCS5, 90pc duty cycle)	X	6.36	67.66	16.71	0.46	130.0	± 9.6 %
		Y	6.40	67.44	16.56		130.0	
		Z	6.24	67.40	16.53		130.0	
10642-AAA	IEEE 1602.11ac WiFi (160MHz, MCS6, 90pc duty cycle)	X	6.44	68.03	17.05	0.46	130.0	± 9.6 %
		Y	6.49	67.81	16.91		130.0	
		Z	6.28	67.62	16.80		130.0	
10643-AAA	IEEE 1602.11ac WiFi (160MHz, MCS7, 90pc duty cycle)	X	6.26	67.70	16.80	0.46	130.0	± 9.6 %
		Y	6.31	67.48	16.64		130.0	
		Z	6.12	67.34	16.57		130.0	
10644-AAA	IEEE 1602.11ac WiFi (160MHz, MCS8, 90pc duty cycle)	X	6.50	68.41	17.18	0.46	130.0	± 9.6 %
		Y	6.57	68.25	17.05		130.0	
		Z	6.29	67.86	16.85		130.0	
10645-AAA	IEEE 1602.11ac WiFi (160MHz, MCS9, 90pc duty cycle)	X	6.78	68.77	17.29	0.46	130.0	± 9.6 %
		Y	6.81	68.48	17.11		130.0	
		Z	6.68	68.60	17.18		130.0	
10646-AAB	LTE-TDD (SC-FDMA, 1 RB, 5 MHz, QPSK, UL Subframe=2,7)	X	37.14	116.21	38.03	9.30	60.0	± 9.6 %
		Y	19.95	100.33	33.06		60.0	
		Z	62.05	131.91	43.22		60.0	
10647-AAA	LTE-TDD (SC-FDMA, 1 RB, 20 MHz, QPSK, UL Subframe=2,7)	X	38.52	117.84	38.64	9.30	60.0	± 9.6 %
		Y	20.25	101.35	33.50		60.0	
		Z	63.43	133.45	43.81		60.0	
10648-AAA	CDMA2000 (1x Advanced)	X	1.03	68.68	14.68	0.00	150.0	± 9.6 %
		Y	0.85	64.54	12.30		150.0	
		Z	0.71	63.65	10.90		150.0	

<sup>E</sup> Uncertainty is determined using the max. deviation from linear response applying rectangular distribution and is expressed for the square of the field value.



Accredited by the Swiss Accreditation Service (SAS)  
The Swiss Accreditation Service is one of the signatories to the EA  
Multilateral Agreement for the recognition of calibration certificates

Accreditation No.: **SCS 0108**

Client **PC Test**

Certificate No: **ES3-3332\_Aug16**

## CALIBRATION CERTIFICATE

Object **ES3DV3 - SN:3332**

Calibration procedure(s) **QA CAL-01.v9, QA CAL-23.v5, QA CAL-25.v6**  
**Calibration procedure for dosimetric E-field probes**

Calibration date: **August 25, 2016**

*BNV*  
*09-01-2016*

This calibration certificate documents the traceability to national standards, which realize the physical units of measurements (SI).  
The measurements and the uncertainties with confidence probability are given on the following pages and are part of the certificate.

All calibrations have been conducted in the closed laboratory facility: environment temperature (22 ± 3)°C and humidity < 70%.

Calibration Equipment used (M&TE critical for calibration)

Primary Standards	ID	Cal Date (Certificate No.)	Scheduled Calibration
Power meter NRP	SN: 104778	06-Apr-16 (No. 217-02288/02289)	Apr-17
Power sensor NRP-Z91	SN: 103244	06-Apr-16 (No. 217-02288)	Apr-17
Power sensor NRP-Z91	SN: 103245	06-Apr-16 (No. 217-02289)	Apr-17
Reference 20 dB Attenuator	SN: S5277 (20x)	05-Apr-16 (No. 217-02293)	Apr-17
Reference Probe ES3DV2	SN: 3013	31-Dec-15 (No. ES3-3013_Dec15)	Dec-16
DAE4	SN: 660	23-Dec-15 (No. DAE4-660_Dec15)	Dec-16
Secondary Standards	ID	Check Date (in house)	Scheduled Check
Power meter E4419B	SN: GB41293874	06-Apr-16 (in house check Jun-16)	In house check: Jun-18
Power sensor E4412A	SN: MY41498087	06-Apr-16 (in house check Jun-16)	In house check: Jun-18
Power sensor E4412A	SN: 000110210	06-Apr-16 (in house check Jun-16)	In house check: Jun-18
RF generator HP 8648C	SN: US3642U01700	04-Aug-99 (in house check Jun-16)	In house check: Jun-18
Network Analyzer HP 8753E	SN: US37390585	18-Oct-01 (in house check Oct-15)	In house check: Oct-16

Calibrated by:	Name Leif Klysner	Function Laboratory Technician	Signature <i>Leif Klysner</i>
Approved by:	Katja Pokovic	Technical Manager	<i>Katja Pokovic</i>

Issued: August 25, 2016

This calibration certificate shall not be reproduced except in full without written approval of the laboratory.



Accredited by the Swiss Accreditation Service (SAS)

Accreditation No.: **SCS 0108**

The Swiss Accreditation Service is one of the signatories to the EA Multilateral Agreement for the recognition of calibration certificates

### Glossary:

TSL	tissue simulating liquid
NORM <sub>x,y,z</sub>	sensitivity in free space
ConvF	sensitivity in TSL / NORM <sub>x,y,z</sub>
DCP	diode compression point
CF	crest factor (1/duty_cycle) of the RF signal
A, B, C, D	modulation dependent linearization parameters
Polarization $\varphi$	$\varphi$ rotation around probe axis
Polarization $\vartheta$	$\vartheta$ rotation around an axis that is in the plane normal to probe axis (at measurement center), i.e., $\vartheta = 0$ is normal to probe axis
Connector Angle	information used in DASY system to align probe sensor X to the robot coordinate system

### Calibration is Performed According to the Following Standards:

- IEEE Std 1528-2013, "IEEE Recommended Practice for Determining the Peak Spatial-Averaged Specific Absorption Rate (SAR) in the Human Head from Wireless Communications Devices: Measurement Techniques", June 2013
- IEC 62209-1, "Procedure to measure the Specific Absorption Rate (SAR) for hand-held devices used in close proximity to the ear (frequency range of 300 MHz to 3 GHz)", February 2005
- IEC 62209-2, "Procedure to determine the Specific Absorption Rate (SAR) for wireless communication devices used in close proximity to the human body (frequency range of 30 MHz to 6 GHz)", March 2010
- KDB 865664, "SAR Measurement Requirements for 100 MHz to 6 GHz"

### Methods Applied and Interpretation of Parameters:

- NORM<sub>x,y,z</sub>**: Assessed for E-field polarization  $\vartheta = 0$  ( $f \leq 900$  MHz in TEM-cell;  $f > 1800$  MHz: R22 waveguide). NORM<sub>x,y,z</sub> are only intermediate values, i.e., the uncertainties of NORM<sub>x,y,z</sub> does not affect the E<sup>2</sup>-field uncertainty inside TSL (see below ConvF).
- NORM(f)<sub>x,y,z</sub>** = NORM<sub>x,y,z</sub> \* frequency\_response (see Frequency Response Chart). This linearization is implemented in DASY4 software versions later than 4.2. The uncertainty of the frequency response is included in the stated uncertainty of ConvF.
- DCP<sub>x,y,z</sub>**: DCP are numerical linearization parameters assessed based on the data of power sweep with CW signal (no uncertainty required). DCP does not depend on frequency nor media.
- PAR**: PAR is the Peak to Average Ratio that is not calibrated but determined based on the signal characteristics
- A<sub>x,y,z</sub>; B<sub>x,y,z</sub>; C<sub>x,y,z</sub>; D<sub>x,y,z</sub>; VR<sub>x,y,z</sub>**: A, B, C, D are numerical linearization parameters assessed based on the data of power sweep for specific modulation signal. The parameters do not depend on frequency nor media. VR is the maximum calibration range expressed in RMS voltage across the diode.
- ConvF and Boundary Effect Parameters**: Assessed in flat phantom using E-field (or Temperature Transfer Standard for  $f \leq 800$  MHz) and inside waveguide using analytical field distributions based on power measurements for  $f > 800$  MHz. The same setups are used for assessment of the parameters applied for boundary compensation (alpha, depth) of which typical uncertainty values are given. These parameters are used in DASY4 software to improve probe accuracy close to the boundary. The sensitivity in TSL corresponds to NORM<sub>x,y,z</sub> \* ConvF whereby the uncertainty corresponds to that given for ConvF. A frequency dependent ConvF is used in DASY version 4.4 and higher which allows extending the validity from  $\pm 50$  MHz to  $\pm 100$  MHz.
- Spherical isotropy (3D deviation from isotropy)**: in a field of low gradients realized using a flat phantom exposed by a patch antenna.
- Sensor Offset**: The sensor offset corresponds to the offset of virtual measurement center from the probe tip (on probe axis). No tolerance required.
- Connector Angle**: The angle is assessed using the information gained by determining the NORM<sub>x</sub> (no uncertainty required).

# Probe ES3DV3

## SN:3332

Manufactured:	January 24, 2012
Repaired:	August 22, 2016
Calibrated:	August 25, 2016

Calibrated for DASY/EASY Systems  
(Note: non-compatible with DASY2 system!)



## DASY/EASY - Parameters of Probe: ES3DV3 - SN:3332

### Basic Calibration Parameters

	Sensor X	Sensor Y	Sensor Z	Unc (k=2)
Norm ( $\mu\text{V}/(\text{V}/\text{m})^2$ ) <sup>A</sup>	1.00	0.93	0.88	$\pm 10.1\%$
DCP (mV) <sup>B</sup>	103.8	101.7	103.3	

### Modulation Calibration Parameters

UID	Communication System Name		A dB	B dB $\sqrt{\mu\text{V}}$	C	D dB	VR mV	Unc <sup>E</sup> (k=2)
0	CW	X	0.0	0.0	1.0	0.00	186.6	$\pm 3.5\%$
		Y	0.0	0.0	1.0		177.5	
		Z	0.0	0.0	1.0		195.2	

Note: For details on UID parameters see Appendix.

### Sensor Model Parameters

	C1 fF	C2 fF	$\alpha$ $\text{V}^{-1}$	T1 $\text{ms}\cdot\text{V}^{-2}$	T2 $\text{ms}\cdot\text{V}^{-1}$	T3 ms	T4 $\text{V}^{-2}$	T5 $\text{V}^{-1}$	T6
X	93.87	665.6	34.78	68.82	4.226	5.1	0.573	0.731	1.01
Y	56.07	408.1	36.28	28.84	2.507	5.1	0	0.527	1.008
Z	49.66	353.4	34.95	26.76	1.898	5.1	1.289	0.244	1.008

The reported uncertainty of measurement is stated as the standard uncertainty of measurement multiplied by the coverage factor  $k=2$ , which for a normal distribution corresponds to a coverage probability of approximately 95%.

<sup>A</sup> The uncertainties of Norm X,Y,Z do not affect the  $E^2$ -field uncertainty inside TSL (see Pages 5 and 6).

<sup>B</sup> Numerical linearization parameter: uncertainty not required.

<sup>E</sup> Uncertainty is determined using the max. deviation from linear response applying rectangular distribution and is expressed for the square of the field value.

## DASY/EASY - Parameters of Probe: ES3DV3 - SN:3332

### Calibration Parameter Determined in Head Tissue Simulating Media

f (MHz) <sup>C</sup>	Relative Permittivity <sup>F</sup>	Conductivity (S/m) <sup>F</sup>	ConvF X	ConvF Y	ConvF Z	Alpha <sup>G</sup>	Depth <sup>G</sup> (mm)	Unc (k=2)
750	41.9	0.89	7.03	7.03	7.03	0.72	1.30	± 12.0 %
835	41.5	0.90	6.82	6.82	6.82	0.80	1.15	± 12.0 %
1750	40.1	1.37	5.72	5.72	5.72	0.53	1.44	± 12.0 %
1900	40.0	1.40	5.45	5.45	5.45	0.80	1.22	± 12.0 %
2300	39.5	1.67	5.07	5.07	5.07	0.71	1.35	± 12.0 %
2450	39.2	1.80	4.80	4.80	4.80	0.79	1.30	± 12.0 %
2600	39.0	1.96	4.59	4.59	4.59	0.80	1.30	± 12.0 %

<sup>C</sup> Frequency validity above 300 MHz of ± 100 MHz only applies for DASY v4.4 and higher (see Page 2), else it is restricted to ± 50 MHz. The uncertainty is the RSS of the ConvF uncertainty at calibration frequency and the uncertainty for the indicated frequency band. Frequency validity below 300 MHz is ± 10, 25, 40, 50 and 70 MHz for ConvF assessments at 30, 64, 128, 150 and 220 MHz respectively. Above 5 GHz frequency validity can be extended to ± 110 MHz.

<sup>F</sup> At frequencies below 3 GHz, the validity of tissue parameters ( $\epsilon$  and  $\sigma$ ) can be relaxed to ± 10% if liquid compensation formula is applied to measured SAR values. At frequencies above 3 GHz, the validity of tissue parameters ( $\epsilon$  and  $\sigma$ ) is restricted to ± 5%. The uncertainty is the RSS of the ConvF uncertainty for indicated target tissue parameters.

<sup>G</sup> Alpha/Depth are determined during calibration. SPEAG warrants that the remaining deviation due to the boundary effect after compensation is always less than ± 1% for frequencies below 3 GHz and below ± 2% for frequencies between 3-6 GHz at any distance larger than half the probe tip diameter from the boundary.

## DASY/EASY - Parameters of Probe: ES3DV3 - SN:3332

### Calibration Parameter Determined in Body Tissue Simulating Media

f (MHz) <sup>C</sup>	Relative Permittivity <sup>F</sup>	Conductivity (S/m) <sup>F</sup>	ConvF X	ConvF Y	ConvF Z	Alpha <sup>G</sup>	Depth <sup>G</sup> (mm)	Unc (k=2)
750	55.5	0.96	6.70	6.70	6.70	0.80	1.19	± 12.0 %
835	55.2	0.97	6.58	6.58	6.58	0.60	1.39	± 12.0 %
1750	53.4	1.49	5.18	5.18	5.18	0.43	1.73	± 12.0 %
1900	53.3	1.52	4.96	4.96	4.96	0.49	1.65	± 12.0 %
2300	52.9	1.81	4.73	4.73	4.73	0.67	1.39	± 12.0 %
2450	52.7	1.95	4.55	4.55	4.55	0.80	1.17	± 12.0 %
2600	52.5	2.16	4.40	4.40	4.40	0.80	1.07	± 12.0 %

<sup>C</sup> Frequency validity above 300 MHz of ± 100 MHz only applies for DASY v4.4 and higher (see Page 2), else it is restricted to ± 50 MHz. The uncertainty is the RSS of the ConvF uncertainty at calibration frequency and the uncertainty for the indicated frequency band. Frequency validity below 300 MHz is ± 10, 25, 40, 50 and 70 MHz for ConvF assessments at 30, 64, 128, 150 and 220 MHz respectively. Above 5 GHz frequency validity can be extended to ± 110 MHz.

<sup>F</sup> At frequencies below 3 GHz, the validity of tissue parameters ( $\epsilon$  and  $\sigma$ ) can be relaxed to ± 10% if liquid compensation formula is applied to measured SAR values. At frequencies above 3 GHz, the validity of tissue parameters ( $\epsilon$  and  $\sigma$ ) is restricted to ± 5%. The uncertainty is the RSS of the ConvF uncertainty for indicated target tissue parameters.

<sup>G</sup> Alpha/Depth are determined during calibration. SPEAG warrants that the remaining deviation due to the boundary effect after compensation is always less than ± 1% for frequencies below 3 GHz and below ± 2% for frequencies between 3-6 GHz at any distance larger than half the probe tip diameter from the boundary.

### Frequency Response of E-Field (TEM-Cell:ifi110 EXX, Waveguide: R22)

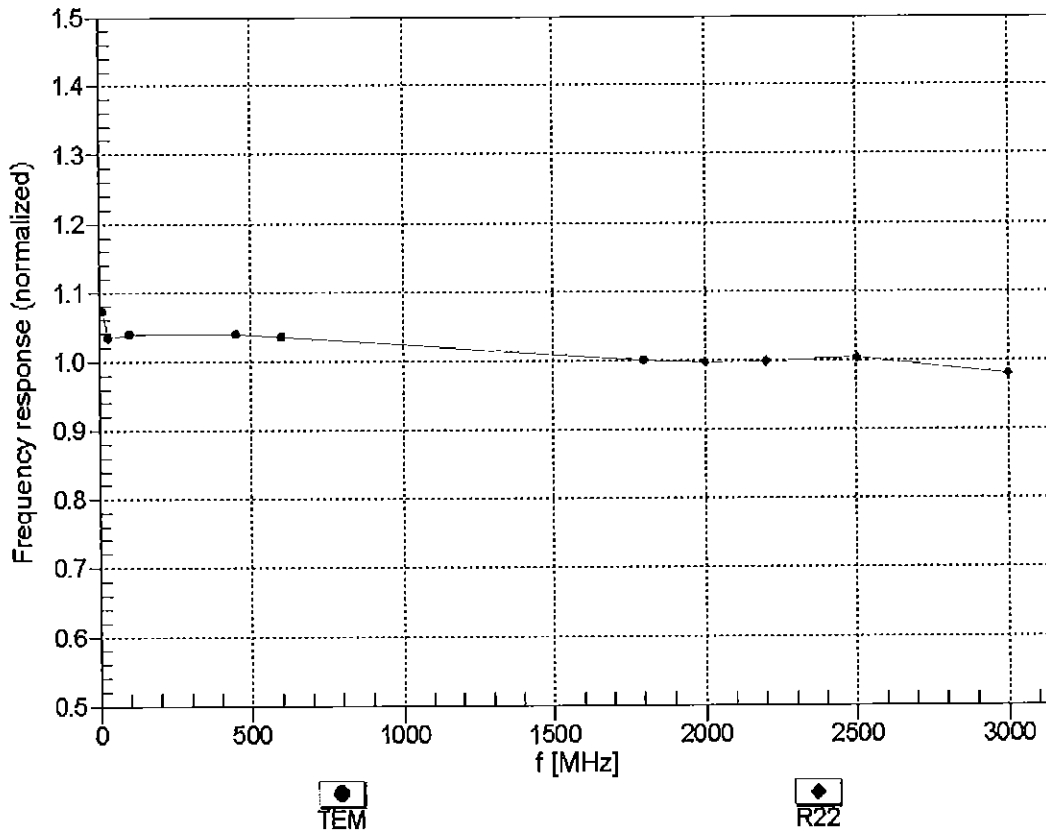

Uncertainty of Frequency Response of E-field:  $\pm 6.3\%$  (k=2)

### Receiving Pattern ( $\phi$ ), $\theta = 0^\circ$

f=600 MHz, TEM

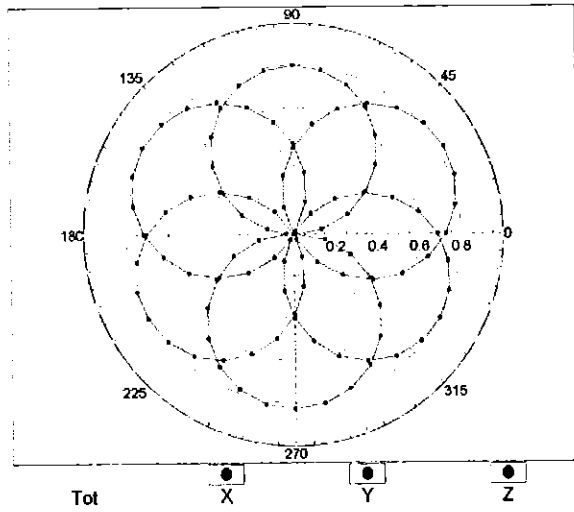

f=1800 MHz, R22

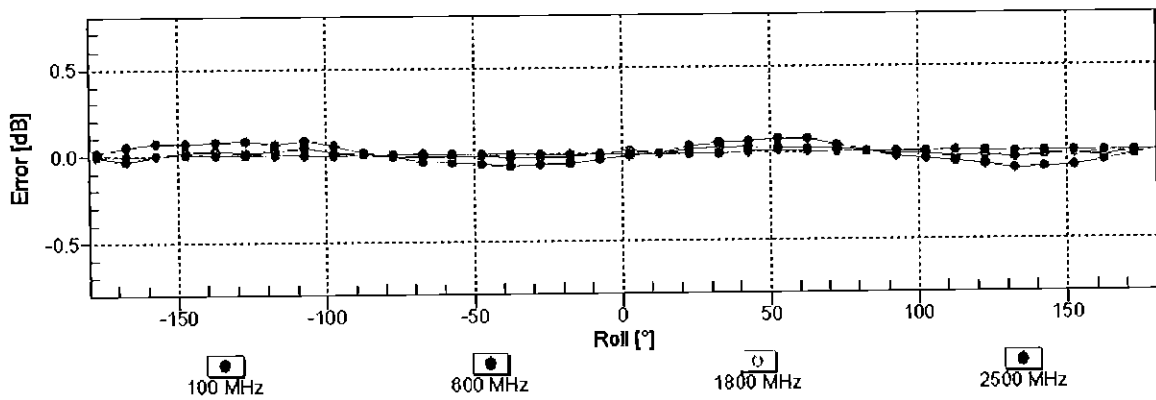
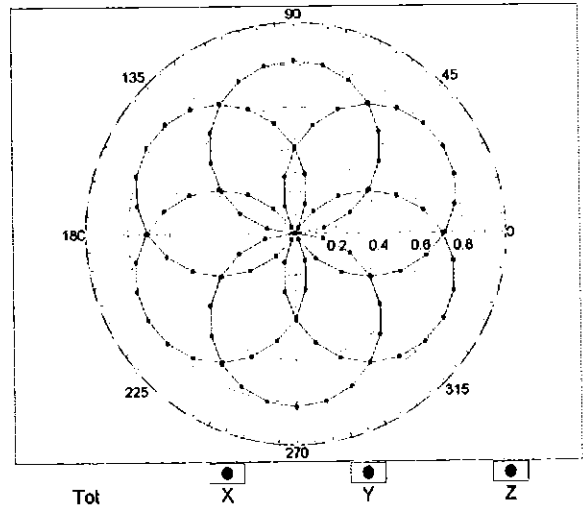

Uncertainty of Axial Isotropy Assessment:  $\pm 0.5\%$  ( $k=2$ )

### Dynamic Range f(SAR<sub>head</sub>) (TEM cell , f<sub>eval</sub>= 1900 MHz)

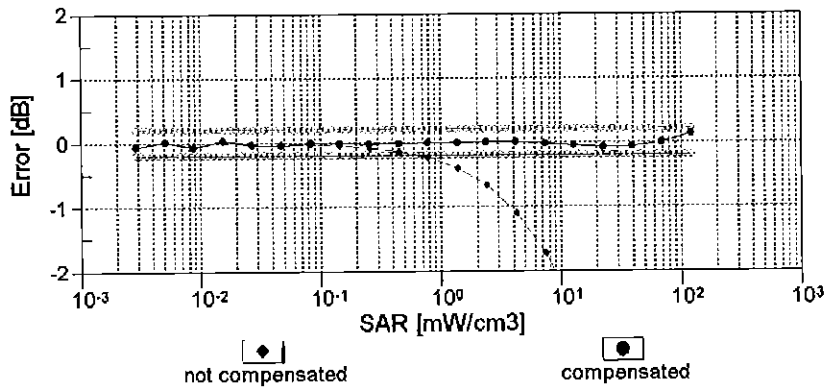
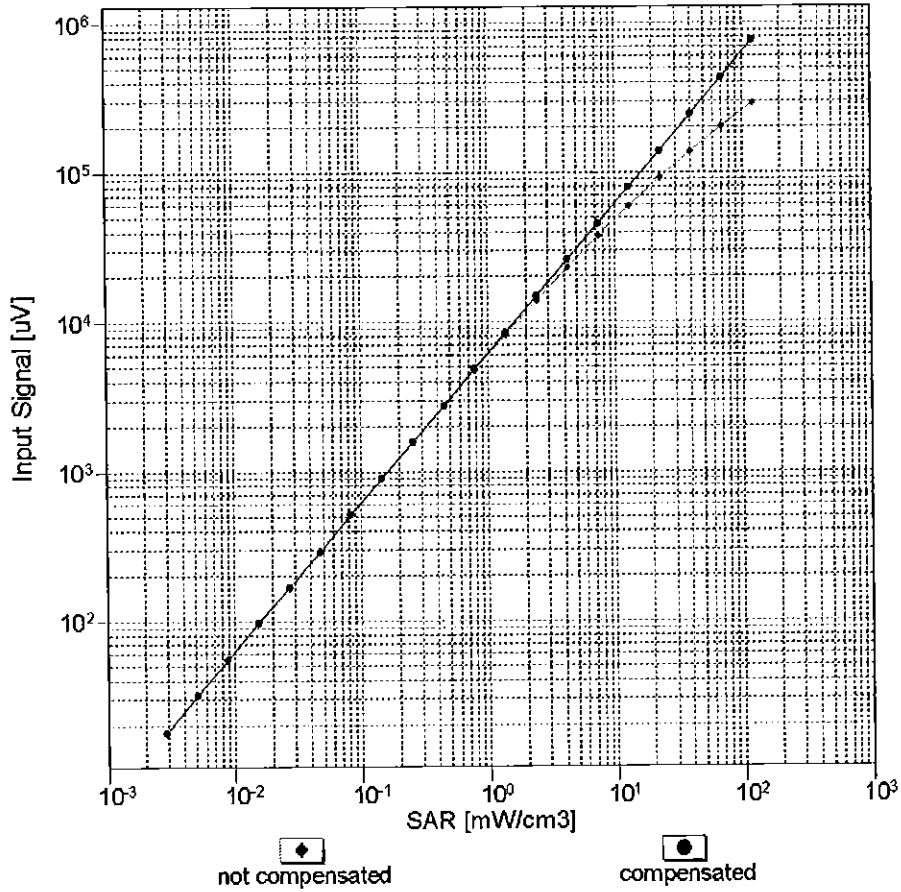

Uncertainty of Linearity Assessment: ± 0.6% (k=2)

# Conversion Factor Assessment

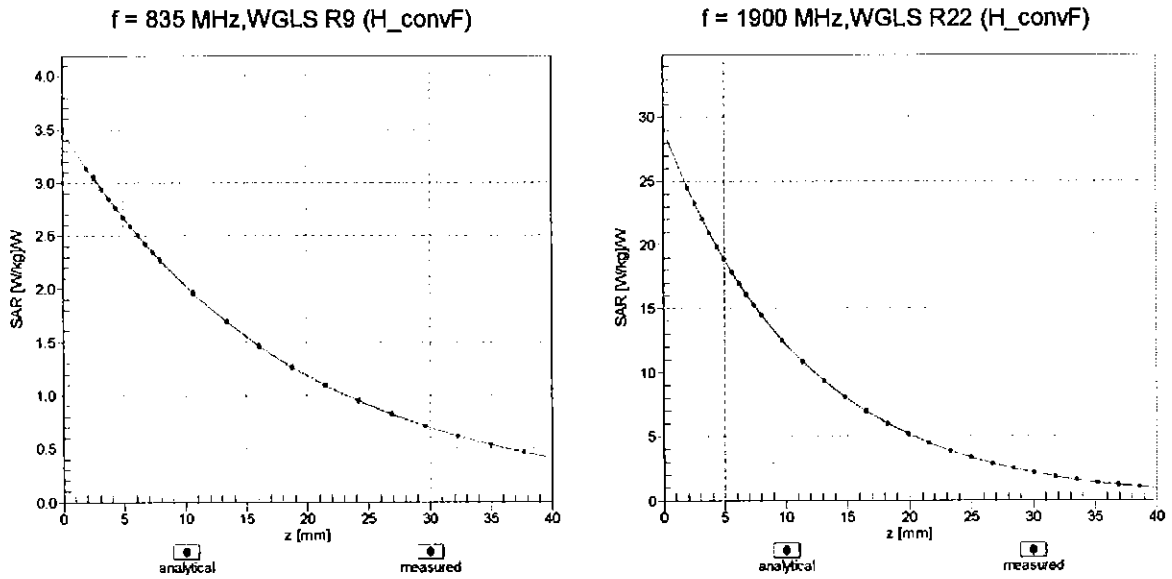

## Deviation from Isotropy in Liquid

Error ( $\phi, \vartheta$ ), f = 900 MHz

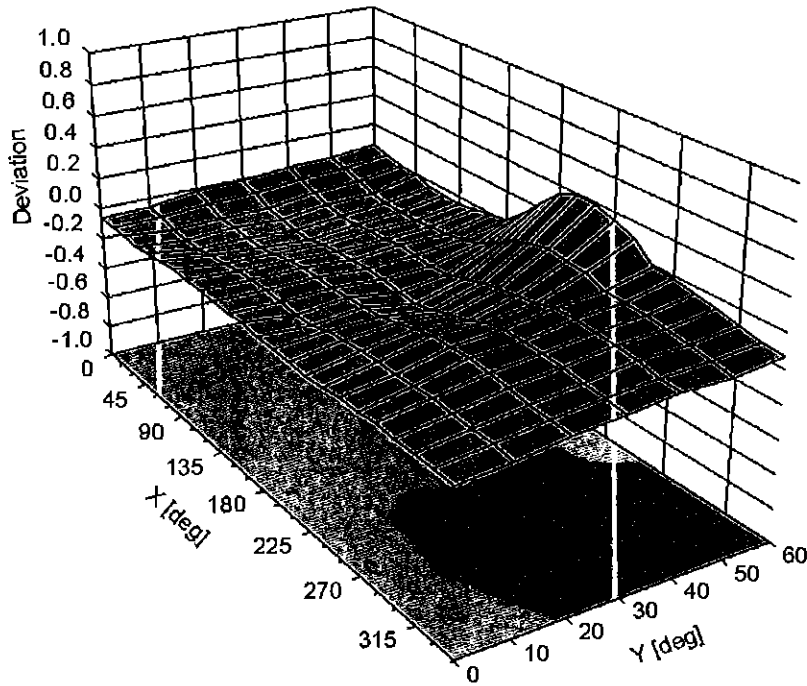

Uncertainty of Spherical Isotropy Assessment:  $\pm 2.6\%$  (k=2)

**DASY/EASY - Parameters of Probe: ES3DV3 - SN:3332****Other Probe Parameters**

Sensor Arrangement	Triangular
Connector Angle (°)	52.6
Mechanical Surface Detection Mode	enabled
Optical Surface Detection Mode	disabled
Probe Overall Length	337 mm
Probe Body Diameter	10 mm
Tip Length	10 mm
Tip Diameter	4 mm
Probe Tip to Sensor X Calibration Point	2 mm
Probe Tip to Sensor Y Calibration Point	2 mm
Probe Tip to Sensor Z Calibration Point	2 mm
Recommended Measurement Distance from Surface	3 mm



**Appendix: Modulation Calibration Parameters**

UID	Communication System Name		A dB	B dB $\sqrt{\mu V}$	C	D dB	VR mV	Max Unc <sup>E</sup> (k=2)
0	CW	X	0.00	0.00	1.00	0.00	186.6	$\pm 3.5\%$
		Y	0.00	0.00	1.00		177.5	
		Z	0.00	0.00	1.00		195.2	
10010- CAA	SAR Validation (Square, 100ms, 10ms)	X	9.69	77.93	19.31	10.00	25.0	$\pm 9.6\%$
		Y	10.94	84.09	20.78		25.0	
		Z	13.55	87.28	21.27		25.0	
10011- CAB	UMTS-FDD (WCDMA)	X	1.25	69.75	16.75	0.00	150.0	$\pm 9.6\%$
		Y	1.05	66.93	15.02		150.0	
		Z	1.12	68.64	16.04		150.0	
10012- CAB	IEEE 802.11b WiFi 2.4 GHz (DSSS, 1 Mbps)	X	1.53	67.02	16.86	0.41	150.0	$\pm 9.6\%$
		Y	1.30	64.73	15.63		150.0	
		Z	1.31	65.39	16.10		150.0	
10013- CAB	IEEE 802.11g WiFi 2.4 GHz (DSSS-OFDM, 6 Mbps)	X	5.48	67.50	17.61	1.46	150.0	$\pm 9.6\%$
		Y	5.15	67.18	17.44		150.0	
		Z	5.07	67.37	17.49		150.0	
10021- DAB	GSM-FDD (TDMA, GMSK)	X	11.77	81.97	22.25	9.39	50.0	$\pm 9.6\%$
		Y	54.42	112.91	31.42		50.0	
		Z	100.00	121.98	33.01		50.0	
10023- DAB	GPRS-FDD (TDMA, GMSK, TN 0)	X	11.70	81.77	22.24	9.57	50.0	$\pm 9.6\%$
		Y	40.68	107.94	30.12		50.0	
		Z	100.00	121.94	33.05		50.0	
10024- DAB	GPRS-FDD (TDMA, GMSK, TN 0-1)	X	12.67	84.47	21.75	6.56	60.0	$\pm 9.6\%$
		Y	100.00	119.84	31.18		60.0	
		Z	100.00	119.08	30.46		60.0	
10025- DAB	EDGE-FDD (TDMA, 8PSK, TN 0)	X	20.72	100.17	36.55	12.57	50.0	$\pm 9.6\%$
		Y	12.94	94.85	36.01		50.0	
		Z	15.97	104.01	40.19		50.0	
10026- DAB	EDGE-FDD (TDMA, 8PSK, TN 0-1)	X	18.90	95.39	31.72	9.56	60.0	$\pm 9.6\%$
		Y	17.05	100.19	34.68		60.0	
		Z	22.47	109.08	38.03		60.0	
10027- DAB	GPRS-FDD (TDMA, GMSK, TN 0-1-2)	X	17.89	90.71	22.87	4.80	80.0	$\pm 9.6\%$
		Y	100.00	118.79	29.76		80.0	
		Z	100.00	118.54	29.33		80.0	
10028- DAB	GPRS-FDD (TDMA, GMSK, TN 0-1-2-3)	X	46.15	104.57	25.98	3.55	100.0	$\pm 9.6\%$
		Y	100.00	119.01	29.04		100.0	
		Z	100.00	119.36	28.92		100.0	
10029- DAB	EDGE-FDD (TDMA, 8PSK, TN 0-1-2)	X	16.04	92.38	29.64	7.80	80.0	$\pm 9.6\%$
		Y	11.64	91.80	30.64		80.0	
		Z	13.10	96.16	32.51		80.0	
10030- CAA	IEEE 802.15.1 Bluetooth (GFSK, DH1)	X	13.88	86.44	21.79	5.30	70.0	$\pm 9.6\%$
		Y	100.00	118.21	29.83		70.0	
		Z	100.00	117.61	29.23		70.0	
10031- CAA	IEEE 802.15.1 Bluetooth (GFSK, DH3)	X	100.00	115.87	27.37	1.88	100.0	$\pm 9.6\%$
		Y	100.00	119.77	27.80		100.0	
		Z	100.00	121.28	28.22		100.0	

10032-CAA	IEEE 802.15.1 Bluetooth (GFSK, DH5)	X	100.00	119.38	27.78	1.17	100.0	± 9.6 %
		Y	100.00	123.90	28.44		100.0	
		Z	100.00	127.59	29.78		100.0	
10033-CAA	IEEE 802.15.1 Bluetooth (PI/4-DQPSK, DH1)	X	13.66	88.30	24.25	5.30	70.0	± 9.6 %
		Y	18.98	98.45	27.40		70.0	
		Z	35.75	109.11	30.11		70.0	
10034-CAA	IEEE 802.15.1 Bluetooth (PI/4-DQPSK, DH3)	X	10.34	89.43	23.47	1.88	100.0	± 9.6 %
		Y	6.78	85.99	21.86		100.0	
		Z	11.66	94.06	24.10		100.0	
10035-CAA	IEEE 802.15.1 Bluetooth (PI/4-DQPSK, DH5)	X	6.92	85.64	22.10	1.17	100.0	± 9.6 %
		Y	3.76	79.10	19.18		100.0	
		Z	5.48	84.83	20.93		100.0	
10036-CAA	IEEE 802.15.1 Bluetooth (8-DPSK, DH1)	X	14.68	89.65	24.76	5.30	70.0	± 9.6 %
		Y	23.98	102.55	28.67		70.0	
		Z	52.73	115.69	31.90		70.0	
10037-CAA	IEEE 802.15.1 Bluetooth (8-DPSK, DH3)	X	10.26	89.28	23.37	1.88	100.0	± 9.6 %
		Y	6.43	85.26	21.58		100.0	
		Z	10.58	92.73	23.67		100.0	
10038-CAA	IEEE 802.15.1 Bluetooth (8-DPSK, DH5)	X	7.33	86.69	22.50	1.17	100.0	± 9.6 %
		Y	3.87	79.73	19.50		100.0	
		Z	5.67	85.64	21.30		100.0	
10039-CAB	CDMA2000 (1xRTT, RC1)	X	2.29	72.93	17.78	0.00	150.0	± 9.6 %
		Y	1.83	71.25	15.78		150.0	
		Z	2.11	74.13	16.77		150.0	
10042-CAB	IS-54 / IS-136 FDD (TDMA/FDM, PI/4-DQPSK, Halfrate)	X	12.07	82.71	21.20	7.78	50.0	± 9.6 %
		Y	100.00	118.63	30.87		50.0	
		Z	100.00	117.56	29.99		50.0	
10044-CAA	IS-91/EIA/TIA-553 FDD (FDMA, FM)	X	0.01	106.13	1.54	0.00	150.0	± 9.6 %
		Y	0.00	93.75	0.63		150.0	
		Z	0.01	100.11	1.38		150.0	
10048-CAA	DECT (TDD, TDMA/FDM, GFSK, Full Slot, 24)	X	11.60	79.73	23.39	13.80	25.0	± 9.6 %
		Y	15.51	90.14	26.56		25.0	
		Z	23.68	98.24	28.53		25.0	
10049-CAA	DECT (TDD, TDMA/FDM, GFSK, Double Slot, 12)	X	11.58	80.99	22.41	10.79	40.0	± 9.6 %
		Y	20.29	95.84	27.01		40.0	
		Z	37.59	106.16	29.43		40.0	
10056-CAA	UMTS-TDD (TD-SCDMA, 1.28 Mcps)	X	12.26	82.69	23.28	9.03	50.0	± 9.6 %
		Y	14.90	90.82	25.94		50.0	
		Z	20.93	97.43	27.76		50.0	
10058-DAB	EDGE-FDD (TDMA, 8PSK, TN 0-1-2-3)	X	13.83	90.12	28.17	6.55	100.0	± 9.6 %
		Y	8.69	86.17	27.85		100.0	
		Z	9.10	88.55	29.00		100.0	
10059-CAB	IEEE 802.11b WiFi 2.4 GHz (DSSS, 2 Mbps)	X	1.93	70.36	18.25	0.61	110.0	± 9.6 %
		Y	1.46	66.73	16.63		110.0	
		Z	1.48	67.55	17.19		110.0	
10060-CAB	IEEE 802.11b WiFi 2.4 GHz (DSSS, 5.5 Mbps)	X	100.00	124.76	31.66	1.30	110.0	± 9.6 %
		Y	100.00	131.67	33.93		110.0	
		Z	100.00	133.96	34.79		110.0	

10061-CAB	IEEE 802.11b WiFi 2.4 GHz (DSSS, 11 Mbps)	X	16.14	97.85	26.70	2.04	110.0	± 9.6 %
		Y	8.08	92.61	26.00		110.0	
		Z	12.52	101.33	28.85		110.0	
10062-CAB	IEEE 802.11a/h WiFi 5 GHz (OFDM, 6 Mbps)	X	5.15	67.14	16.85	0.49	100.0	± 9.6 %
		Y	4.87	66.94	16.72		100.0	
		Z	4.80	67.15	16.79		100.0	
10063-CAB	IEEE 802.11a/h WiFi 5 GHz (OFDM, 9 Mbps)	X	5.22	67.37	17.03	0.72	100.0	± 9.6 %
		Y	4.91	67.10	16.86		100.0	
		Z	4.84	67.30	16.92		100.0	
10064-CAB	IEEE 802.11a/h WiFi 5 GHz (OFDM, 12 Mbps)	X	5.63	67.77	17.30	0.86	100.0	± 9.6 %
		Y	5.23	67.43	17.13		100.0	
		Z	5.14	67.59	17.17		100.0	
10065-CAB	IEEE 802.11a/h WiFi 5 GHz (OFDM, 18 Mbps)	X	5.54	67.87	17.49	1.21	100.0	± 9.6 %
		Y	5.13	67.46	17.30		100.0	
		Z	5.04	67.61	17.34		100.0	
10066-CAB	IEEE 802.11a/h WiFi 5 GHz (OFDM, 24 Mbps)	X	5.63	68.10	17.77	1.46	100.0	± 9.6 %
		Y	5.19	67.59	17.52		100.0	
		Z	5.09	67.72	17.56		100.0	
10067-CAB	IEEE 802.11a/h WiFi 5 GHz (OFDM, 36 Mbps)	X	6.00	68.32	18.28	2.04	100.0	± 9.6 %
		Y	5.51	67.78	17.99		100.0	
		Z	5.41	67.95	18.04		100.0	
10068-CAB	IEEE 802.11a/h WiFi 5 GHz (OFDM, 48 Mbps)	X	6.22	68.89	18.71	2.55	100.0	± 9.6 %
		Y	5.64	68.10	18.35		100.0	
		Z	5.52	68.18	18.37		100.0	
10069-CAB	IEEE 802.11a/h WiFi 5 GHz (OFDM, 54 Mbps)	X	6.25	68.61	18.82	2.67	100.0	± 9.6 %
		Y	5.72	68.06	18.53		100.0	
		Z	5.60	68.19	18.57		100.0	
10071-CAB	IEEE 802.11g WiFi 2.4 GHz (DSSS/OFDM, 9 Mbps)	X	5.67	67.85	18.05	1.99	100.0	± 9.6 %
		Y	5.29	67.41	17.82		100.0	
		Z	5.21	67.58	17.87		100.0	
10072-CAB	IEEE 802.11g WiFi 2.4 GHz (DSSS/OFDM, 12 Mbps)	X	5.81	68.59	18.42	2.30	100.0	± 9.6 %
		Y	5.35	67.95	18.14		100.0	
		Z	5.25	68.10	18.19		100.0	
10073-CAB	IEEE 802.11g WiFi 2.4 GHz (DSSS/OFDM, 18 Mbps)	X	6.03	69.13	18.93	2.83	100.0	± 9.6 %
		Y	5.48	68.29	18.56		100.0	
		Z	5.38	68.44	18.61		100.0	
10074-CAB	IEEE 802.11g WiFi 2.4 GHz (DSSS/OFDM, 24 Mbps)	X	6.14	69.49	19.35	3.30	100.0	± 9.6 %
		Y	5.51	68.36	18.81		100.0	
		Z	5.41	68.49	18.85		100.0	
10075-CAB	IEEE 802.11g WiFi 2.4 GHz (DSSS/OFDM, 36 Mbps)	X	6.47	70.44	20.05	3.82	90.0	± 9.6 %
		Y	5.66	68.80	19.29		90.0	
		Z	5.53	68.86	19.30		90.0	
10076-CAB	IEEE 802.11g WiFi 2.4 GHz (DSSS/OFDM, 48 Mbps)	X	6.47	70.32	20.20	4.15	90.0	± 9.6 %
		Y	5.67	68.61	19.41		90.0	
		Z	5.56	68.71	19.45		90.0	
10077-CAB	IEEE 802.11g WiFi 2.4 GHz (DSSS/OFDM, 54 Mbps)	X	6.53	70.47	20.33	4.30	90.0	± 9.6 %
		Y	5.71	68.70	19.52		90.0	
		Z	5.60	68.81	19.56		90.0	

10081-CAB	CDMA2000 (1xRTT, RC3)	X	1.23	69.13	15.82	0.00	150.0	± 9.6 %
		Y	0.90	65.96	12.93		150.0	
		Z	0.95	67.61	13.58		150.0	
10082-CAB	IS-54 / IS-136 FDD (TDMA/FDM, PI/4-DQPSK, Fullrate)	X	3.84	66.59	11.26	4.77	80.0	± 9.6 %
		Y	2.12	64.11	8.98		80.0	
		Z	1.88	63.53	8.34		80.0	
10090-DAB	GPRS-FDD (TDMA, GMSK, TN 0-4)	X	12.59	84.38	21.75	6.56	60.0	± 9.6 %
		Y	100.00	119.92	31.24		60.0	
		Z	100.00	119.15	30.51		60.0	
10097-CAB	UMTS-FDD (HSDPA)	X	1.98	68.10	16.38	0.00	150.0	± 9.6 %
		Y	1.84	67.22	15.54		150.0	
		Z	1.90	68.33	16.08		150.0	
10098-CAB	UMTS-FDD (HSUPA, Subtest 2)	X	1.94	68.07	16.35	0.00	150.0	± 9.6 %
		Y	1.80	67.18	15.50		150.0	
		Z	1.86	68.30	16.06		150.0	
10099-DAB	EDGE-FDD (TDMA, 8PSK, TN 0-4)	X	18.80	95.23	31.67	9.56	60.0	± 9.6 %
		Y	17.02	100.10	34.65		60.0	
		Z	22.42	108.97	37.99		60.0	
10100-CAB	LTE-FDD (SC-FDMA, 100% RB, 20 MHz, QPSK)	X	3.68	72.06	17.34	0.00	150.0	± 9.6 %
		Y	3.18	70.15	16.57		150.0	
		Z	3.24	70.94	17.02		150.0	
10101-CAB	LTE-FDD (SC-FDMA, 100% RB, 20 MHz, 16-QAM)	X	3.63	68.60	16.42	0.00	150.0	± 9.6 %
		Y	3.33	67.57	15.94		150.0	
		Z	3.31	67.94	16.16		150.0	
10102-CAB	LTE-FDD (SC-FDMA, 100% RB, 20 MHz, 64-QAM)	X	3.73	68.43	16.47	0.00	150.0	± 9.6 %
		Y	3.43	67.53	16.04		150.0	
		Z	3.41	67.87	16.23		150.0	
10103-CAB	LTE-TDD (SC-FDMA, 100% RB, 20 MHz, QPSK)	X	9.88	77.18	20.43	3.98	65.0	± 9.6 %
		Y	8.55	78.27	21.41		65.0	
		Z	8.67	79.30	21.85		65.0	
10104-CAB	LTE-TDD (SC-FDMA, 100% RB, 20 MHz, 16-QAM)	X	10.16	76.88	21.19	3.98	65.0	± 9.6 %
		Y	8.42	76.71	21.60		65.0	
		Z	8.41	77.44	21.93		65.0	
10105-CAB	LTE-TDD (SC-FDMA, 100% RB, 20 MHz, 64-QAM)	X	9.24	75.08	20.67	3.98	65.0	± 9.6 %
		Y	8.00	75.66	21.43		65.0	
		Z	7.67	75.58	21.41		65.0	
10108-CAC	LTE-FDD (SC-FDMA, 100% RB, 10 MHz, QPSK)	X	3.28	71.12	17.13	0.00	150.0	± 9.6 %
		Y	2.81	69.41	16.41		150.0	
		Z	2.83	70.19	16.86		150.0	
10109-CAC	LTE-FDD (SC-FDMA, 100% RB, 10 MHz, 16-QAM)	X	3.32	68.34	16.39	0.00	150.0	± 9.6 %
		Y	2.99	67.37	15.85		150.0	
		Z	2.97	67.81	16.08		150.0	
10110-CAC	LTE-FDD (SC-FDMA, 100% RB, 5 MHz, QPSK)	X	2.73	70.00	16.84	0.00	150.0	± 9.6 %
		Y	2.30	68.48	16.04		150.0	
		Z	2.32	69.37	16.53		150.0	
10111-CAC	LTE-FDD (SC-FDMA, 100% RB, 5 MHz, 16-QAM)	X	2.99	68.54	16.68	0.00	150.0	± 9.6 %
		Y	2.68	67.96	16.09		150.0	
		Z	2.68	68.64	16.39		150.0	

10112-CAC	LTE-FDD (SC-FDMA, 100% RB, 10 MHz, 64-QAM)	X	3.43	68.13	16.38	0.00	150.0	± 9.6 %
		Y	3.11	67.35	15.91		150.0	
		Z	3.09	67.77	16.12		150.0	
10113-CAC	LTE-FDD (SC-FDMA, 100% RB, 5 MHz, 64-QAM)	X	3.16	68.50	16.72	0.00	150.0	± 9.6 %
		Y	2.84	68.08	16.22		150.0	
		Z	2.83	68.75	16.50		150.0	
10114-CAB	IEEE 802.11n (HT Greenfield, 13.5 Mbps, BPSK)	X	5.45	67.54	16.57	0.00	150.0	± 9.6 %
		Y	5.24	67.31	16.51		150.0	
		Z	5.20	67.52	16.60		150.0	
10115-CAB	IEEE 802.11n (HT Greenfield, 81 Mbps, 16-QAM)	X	5.96	68.11	16.85	0.00	150.0	± 9.6 %
		Y	5.61	67.66	16.70		150.0	
		Z	5.50	67.68	16.69		150.0	
10116-CAB	IEEE 802.11n (HT Greenfield, 135 Mbps, 64-QAM)	X	5.63	67.89	16.66	0.00	150.0	± 9.6 %
		Y	5.37	67.59	16.57		150.0	
		Z	5.30	67.73	16.63		150.0	
10117-CAB	IEEE 802.11n (HT Mixed, 13.5 Mbps, BPSK)	X	5.45	67.55	16.60	0.00	150.0	± 9.6 %
		Y	5.23	67.25	16.49		150.0	
		Z	5.16	67.37	16.54		150.0	
10118-CAB	IEEE 802.11n (HT Mixed, 81 Mbps, 16-QAM)	X	5.93	67.92	16.75	0.00	150.0	± 9.6 %
		Y	5.70	67.89	16.82		150.0	
		Z	5.59	67.92	16.81		150.0	
10119-CAB	IEEE 802.11n (HT Mixed, 135 Mbps, 64-QAM)	X	5.55	67.72	16.59	0.00	150.0	± 9.6 %
		Y	5.34	67.53	16.56		150.0	
		Z	5.28	67.67	16.61		150.0	
10140-CAB	LTE-FDD (SC-FDMA, 100% RB, 15 MHz, 16-QAM)	X	3.79	68.43	16.40	0.00	150.0	± 9.6 %
		Y	3.48	67.53	15.96		150.0	
		Z	3.45	67.88	16.15		150.0	
10141-CAB	LTE-FDD (SC-FDMA, 100% RB, 15 MHz, 64-QAM)	X	3.90	68.37	16.49	0.00	150.0	± 9.6 %
		Y	3.60	67.61	16.12		150.0	
		Z	3.57	67.96	16.31		150.0	
10142-CAC	LTE-FDD (SC-FDMA, 100% RB, 3 MHz, QPSK)	X	2.49	69.76	16.76	0.00	150.0	± 9.6 %
		Y	2.07	68.39	15.76		150.0	
		Z	2.10	69.47	16.26		150.0	
10143-CAC	LTE-FDD (SC-FDMA, 100% RB, 3 MHz, 16-QAM)	X	2.89	69.03	16.74	0.00	150.0	± 9.6 %
		Y	2.54	68.58	15.87		150.0	
		Z	2.56	69.50	16.18		150.0	
10144-CAC	LTE-FDD (SC-FDMA, 100% RB, 3 MHz, 64-QAM)	X	2.76	67.50	15.63	0.00	150.0	± 9.6 %
		Y	2.36	66.66	14.46		150.0	
		Z	2.33	67.24	14.59		150.0	
10145-CAC	LTE-FDD (SC-FDMA, 100% RB, 1.4 MHz, QPSK)	X	1.96	69.33	16.13	0.00	150.0	± 9.6 %
		Y	1.38	66.00	12.81		150.0	
		Z	1.34	66.37	12.62		150.0	
10146-CAC	LTE-FDD (SC-FDMA, 100% RB, 1.4 MHz, 16-QAM)	X	4.17	75.23	18.46	0.00	150.0	± 9.6 %
		Y	2.35	68.49	13.59		150.0	
		Z	2.38	68.77	12.96		150.0	
10147-CAC	LTE-FDD (SC-FDMA, 100% RB, 1.4 MHz, 64-QAM)	X	4.89	77.80	19.69	0.00	150.0	± 9.6 %
		Y	2.82	71.02	14.91		150.0	
		Z	3.01	71.75	14.40		150.0	

10149-CAB	LTE-FDD (SC-FDMA, 50% RB, 20 MHz, 16-QAM)	X	3.33	68.39	16.43	0.00	150.0	± 9.6 %
		Y	3.00	67.43	15.89		150.0	
		Z	2.98	67.87	16.13		150.0	
10150-CAB	LTE-FDD (SC-FDMA, 50% RB, 20 MHz, 64-QAM)	X	3.44	68.18	16.41	0.00	150.0	± 9.6 %
		Y	3.12	67.40	15.95		150.0	
		Z	3.10	67.83	16.16		150.0	
10151-CAB	LTE-TDD (SC-FDMA, 50% RB, 20 MHz, QPSK)	X	9.93	78.08	20.89	3.98	65.0	± 9.6 %
		Y	9.12	80.67	22.44		65.0	
		Z	9.65	82.56	23.18		65.0	
10152-CAB	LTE-TDD (SC-FDMA, 50% RB, 20 MHz, 16-QAM)	X	9.86	77.05	21.14	3.98	65.0	± 9.6 %
		Y	8.03	76.89	21.43		65.0	
		Z	8.05	77.75	21.77		65.0	
10153-CAB	LTE-TDD (SC-FDMA, 50% RB, 20 MHz, 64-QAM)	X	10.15	77.56	21.66	3.98	65.0	± 9.6 %
		Y	8.43	77.73	22.12		65.0	
		Z	8.48	78.64	22.48		65.0	
10154-CAC	LTE-FDD (SC-FDMA, 50% RB, 10 MHz, QPSK)	X	2.81	70.59	17.19	0.00	150.0	± 9.6 %
		Y	2.35	68.90	16.31		150.0	
		Z	2.36	69.78	16.78		150.0	
10155-CAC	LTE-FDD (SC-FDMA, 50% RB, 10 MHz, 16-QAM)	X	2.99	68.52	16.66	0.00	150.0	± 9.6 %
		Y	2.68	67.96	16.10		150.0	
		Z	2.69	68.66	16.40		150.0	
10156-CAC	LTE-FDD (SC-FDMA, 50% RB, 5 MHz, QPSK)	X	2.39	70.13	16.93	0.00	150.0	± 9.6 %
		Y	1.92	68.51	15.63		150.0	
		Z	1.95	69.68	16.13		150.0	
10157-CAC	LTE-FDD (SC-FDMA, 50% RB, 5 MHz, 16-QAM)	X	2.59	68.07	15.87	0.00	150.0	± 9.6 %
		Y	2.19	67.20	14.53		150.0	
		Z	2.18	67.93	14.70		150.0	
10158-CAC	LTE-FDD (SC-FDMA, 50% RB, 10 MHz, 64-QAM)	X	3.16	68.53	16.75	0.00	150.0	± 9.6 %
		Y	2.84	68.13	16.26		150.0	
		Z	2.84	68.81	16.54		150.0	
10159-CAC	LTE-FDD (SC-FDMA, 50% RB, 5 MHz, 64-QAM)	X	2.70	68.40	16.12	0.00	150.0	± 9.6 %
		Y	2.30	67.63	14.81		150.0	
		Z	2.29	68.38	14.98		150.0	
10160-CAB	LTE-FDD (SC-FDMA, 50% RB, 15 MHz, QPSK)	X	3.14	69.43	16.71	0.00	150.0	± 9.6 %
		Y	2.84	68.62	16.29		150.0	
		Z	2.84	69.26	16.64		150.0	
10161-CAB	LTE-FDD (SC-FDMA, 50% RB, 15 MHz, 16-QAM)	X	3.32	67.99	16.37	0.00	150.0	± 9.6 %
		Y	3.01	67.31	15.88		150.0	
		Z	2.99	67.77	16.10		150.0	
10162-CAB	LTE-FDD (SC-FDMA, 50% RB, 15 MHz, 64-QAM)	X	3.41	67.88	16.36	0.00	150.0	± 9.6 %
		Y	3.12	67.42	15.97		150.0	
		Z	3.10	67.90	16.20		150.0	
10166-CAC	LTE-FDD (SC-FDMA, 50% RB, 1.4 MHz, QPSK)	X	4.36	70.41	19.63	3.01	150.0	± 9.6 %
		Y	3.66	69.23	19.03		150.0	
		Z	3.73	70.55	19.68		150.0	
10167-CAC	LTE-FDD (SC-FDMA, 50% RB, 1.4 MHz, 16-QAM)	X	5.73	73.59	20.29	3.01	150.0	± 9.6 %
		Y	4.43	71.79	19.40		150.0	
		Z	4.81	74.43	20.51		150.0	

10168-CAC	LTE-FDD (SC-FDMA, 50% RB, 1.4 MHz, 64-QAM)	X	6.11	74.96	21.16	3.01	150.0	± 9.6 %
		Y	4.84	73.78	20.63		150.0	
		Z	5.40	76.98	21.93		150.0	
10169-CAB	LTE-FDD (SC-FDMA, 1 RB, 20 MHz, QPSK)	X	4.63	74.36	21.10	3.01	150.0	± 9.6 %
		Y	3.06	68.99	18.96		150.0	
		Z	3.17	70.74	19.84		150.0	
10170-CAB	LTE-FDD (SC-FDMA, 1 RB, 20 MHz, 16-QAM)	X	7.14	81.00	23.31	3.01	150.0	± 9.6 %
		Y	4.06	74.30	21.07		150.0	
		Z	4.90	79.16	23.07		150.0	
10171-AAB	LTE-FDD (SC-FDMA, 1 RB, 20 MHz, 64-QAM)	X	5.84	76.64	20.78	3.01	150.0	± 9.6 %
		Y	3.40	70.54	18.47		150.0	
		Z	3.84	73.94	19.92		150.0	
10172-CAB	LTE-TDD (SC-FDMA, 1 RB, 20 MHz, QPSK)	X	21.59	96.42	28.73	6.02	65.0	± 9.6 %
		Y	17.89	100.99	31.31		65.0	
		Z	27.42	111.88	34.81		65.0	
10173-CAB	LTE-TDD (SC-FDMA, 1 RB, 20 MHz, 16-QAM)	X	18.76	90.78	25.77	6.02	65.0	± 9.6 %
		Y	25.32	103.41	30.42		65.0	
		Z	100.00	129.46	37.16		65.0	
10174-CAB	LTE-TDD (SC-FDMA, 1 RB, 20 MHz, 64-QAM)	X	16.94	88.22	24.62	6.02	65.0	± 9.6 %
		Y	19.74	97.71	28.21		65.0	
		Z	54.07	116.72	33.41		65.0	
10175-CAC	LTE-FDD (SC-FDMA, 1 RB, 10 MHz, QPSK)	X	4.54	73.91	20.81	3.01	150.0	± 9.6 %
		Y	3.02	68.69	18.71		150.0	
		Z	3.13	70.41	19.59		150.0	
10176-CAC	LTE-FDD (SC-FDMA, 1 RB, 10 MHz, 16-QAM)	X	7.15	81.03	23.32	3.01	150.0	± 9.6 %
		Y	4.06	74.32	21.08		150.0	
		Z	4.91	79.19	23.08		150.0	
10177-CAE	LTE-FDD (SC-FDMA, 1 RB, 5 MHz, QPSK)	X	4.60	74.15	20.96	3.01	150.0	± 9.6 %
		Y	3.05	68.85	18.81		150.0	
		Z	3.16	70.57	19.68		150.0	
10178-CAC	LTE-FDD (SC-FDMA, 1 RB, 5 MHz, 16-QAM)	X	7.00	80.62	23.13	3.01	150.0	± 9.6 %
		Y	4.02	74.08	20.95		150.0	
		Z	4.84	78.90	22.94		150.0	
10179-CAC	LTE-FDD (SC-FDMA, 1 RB, 10 MHz, 64-QAM)	X	6.37	78.49	21.84	3.01	150.0	± 9.6 %
		Y	3.70	72.30	19.64		150.0	
		Z	4.32	76.41	21.35		150.0	
10180-CAC	LTE-FDD (SC-FDMA, 1 RB, 5 MHz, 64-QAM)	X	5.80	76.48	20.69	3.01	150.0	± 9.6 %
		Y	3.39	70.46	18.42		150.0	
		Z	3.83	73.85	19.87		150.0	
10181-CAB	LTE-FDD (SC-FDMA, 1 RB, 15 MHz, QPSK)	X	4.59	74.12	20.94	3.01	150.0	± 9.6 %
		Y	3.04	68.83	18.80		150.0	
		Z	3.15	70.56	19.68		150.0	
10182-CAB	LTE-FDD (SC-FDMA, 1 RB, 15 MHz, 16-QAM)	X	6.99	80.60	23.12	3.01	150.0	± 9.6 %
		Y	4.01	74.05	20.94		150.0	
		Z	4.83	78.87	22.93		150.0	
10183-AAA	LTE-FDD (SC-FDMA, 1 RB, 15 MHz, 64-QAM)	X	5.79	76.46	20.68	3.01	150.0	± 9.6 %
		Y	3.39	70.44	18.40		150.0	
		Z	3.82	73.82	19.85		150.0	

10184-CAC	LTE-FDD (SC-FDMA, 1 RB, 3 MHz, QPSK)	X	4.61	74.17	20.97	3.01	150.0	± 9.6 %
		Y	3.05	68.87	18.82		150.0	
		Z	3.16	70.60	19.70		150.0	
10185-CAC	LTE-FDD (SC-FDMA, 1 RB, 3 MHz, 16-QAM)	X	7.03	80.67	23.15	3.01	150.0	± 9.6 %
		Y	4.03	74.12	20.97		150.0	
		Z	4.86	78.97	22.97		150.0	
10186-AAC	LTE-FDD (SC-FDMA, 1 RB, 3 MHz, 64-QAM)	X	5.81	76.52	20.71	3.01	150.0	± 9.6 %
		Y	3.40	70.50	18.44		150.0	
		Z	3.84	73.91	19.89		150.0	
10187-CAC	LTE-FDD (SC-FDMA, 1 RB, 1.4 MHz, QPSK)	X	4.61	74.16	20.98	3.01	150.0	± 9.6 %
		Y	3.06	68.91	18.88		150.0	
		Z	3.17	70.66	19.76		150.0	
10188-CAC	LTE-FDD (SC-FDMA, 1 RB, 1.4 MHz, 16-QAM)	X	7.32	81.50	23.57	3.01	150.0	± 9.6 %
		Y	4.15	74.76	21.35		150.0	
		Z	5.06	79.82	23.41		150.0	
10189-AAC	LTE-FDD (SC-FDMA, 1 RB, 1.4 MHz, 64-QAM)	X	5.97	77.05	21.01	3.01	150.0	± 9.6 %
		Y	3.47	70.90	18.71		150.0	
		Z	3.94	74.44	20.21		150.0	
10193-CAB	IEEE 802.11n (HT Greenfield, 6.5 Mbps, BPSK)	X	4.89	66.83	16.38	0.00	150.0	± 9.6 %
		Y	4.64	66.67	16.22		150.0	
		Z	4.58	66.90	16.29		150.0	
10194-CAB	IEEE 802.11n (HT Greenfield, 39 Mbps, 16-QAM)	X	5.13	67.27	16.47	0.00	150.0	± 9.6 %
		Y	4.83	67.02	16.34		150.0	
		Z	4.76	67.22	16.42		150.0	
10195-CAB	IEEE 802.11n (HT Greenfield, 65 Mbps, 64-QAM)	X	5.16	67.22	16.45	0.00	150.0	± 9.6 %
		Y	4.87	67.04	16.36		150.0	
		Z	4.80	67.25	16.43		150.0	
10196-CAB	IEEE 802.11n (HT Mixed, 6.5 Mbps, BPSK)	X	4.94	66.97	16.42	0.00	150.0	± 9.6 %
		Y	4.65	66.76	16.25		150.0	
		Z	4.59	66.97	16.31		150.0	
10197-CAB	IEEE 802.11n (HT Mixed, 39 Mbps, 16-QAM)	X	5.14	67.27	16.47	0.00	150.0	± 9.6 %
		Y	4.84	67.04	16.36		150.0	
		Z	4.77	67.25	16.43		150.0	
10198-CAB	IEEE 802.11n (HT Mixed, 65 Mbps, 64-QAM)	X	5.17	67.23	16.45	0.00	150.0	± 9.6 %
		Y	4.87	67.06	16.37		150.0	
		Z	4.80	67.27	16.45		150.0	
10219-CAB	IEEE 802.11n (HT Mixed, 7.2 Mbps, BPSK)	X	4.89	67.00	16.40	0.00	150.0	± 9.6 %
		Y	4.60	66.77	16.21		150.0	
		Z	4.54	66.98	16.28		150.0	
10220-CAB	IEEE 802.11n (HT Mixed, 43.3 Mbps, 16-QAM)	X	5.15	67.29	16.48	0.00	150.0	± 9.6 %
		Y	4.84	67.02	16.35		150.0	
		Z	4.77	67.22	16.42		150.0	
10221-CAB	IEEE 802.11n (HT Mixed, 72.2 Mbps, 64-QAM)	X	5.18	67.20	16.47	0.00	150.0	± 9.6 %
		Y	4.88	66.99	16.36		150.0	
		Z	4.81	67.20	16.43		150.0	
10222-CAB	IEEE 802.11n (HT Mixed, 15 Mbps, BPSK)	X	5.44	67.59	16.61	0.00	150.0	± 9.6 %
		Y	5.21	67.26	16.49		150.0	
		Z	5.14	67.38	16.54		150.0	



10223-CAB	IEEE 802.11n (HT Mixed, 90 Mbps, 16-QAM)	X	5.85	67.86	16.74	0.00	150.0	± 9.6 %
		Y	5.54	67.53	16.65		150.0	
		Z	5.45	67.60	16.67		150.0	
10224-CAB	IEEE 802.11n (HT Mixed, 150 Mbps, 64-QAM)	X	5.54	67.82	16.64	0.00	150.0	± 9.6 %
		Y	5.25	67.35	16.46		150.0	
		Z	5.18	67.49	16.52		150.0	
10225-CAB	UMTS-FDD (HSPA+)	X	3.14	66.40	15.95	0.00	150.0	± 9.6 %
		Y	2.89	66.08	15.41		150.0	
		Z	2.86	66.50	15.54		150.0	
10226-CAA	LTE-TDD (SC-FDMA, 1 RB, 1.4 MHz, 16-QAM)	X	19.13	91.19	25.97	6.02	65.0	± 9.6 %
		Y	27.02	104.73	30.89		65.0	
		Z	100.00	129.68	37.30		65.0	
10227-CAA	LTE-TDD (SC-FDMA, 1 RB, 1.4 MHz, 64-QAM)	X	17.13	88.50	24.79	6.02	65.0	± 9.6 %
		Y	23.15	100.58	29.15		65.0	
		Z	93.34	126.19	35.81		65.0	
10228-CAA	LTE-TDD (SC-FDMA, 1 RB, 1.4 MHz, QPSK)	X	21.41	96.70	28.93	6.02	65.0	± 9.6 %
		Y	21.98	105.42	32.75		65.0	
		Z	52.34	124.97	38.40		65.0	
10229-CAB	LTE-TDD (SC-FDMA, 1 RB, 3 MHz, 16-QAM)	X	18.76	90.76	25.78	6.02	65.0	± 9.6 %
		Y	25.40	103.45	30.44		65.0	
		Z	100.00	129.46	37.17		65.0	
10230-CAB	LTE-TDD (SC-FDMA, 1 RB, 3 MHz, 64-QAM)	X	16.83	88.14	24.61	6.02	65.0	± 9.6 %
		Y	21.92	99.53	28.77		65.0	
		Z	82.35	123.82	35.15		65.0	
10231-CAB	LTE-TDD (SC-FDMA, 1 RB, 3 MHz, QPSK)	X	20.94	96.21	28.71	6.02	65.0	± 9.6 %
		Y	20.82	104.24	32.32		65.0	
		Z	47.61	122.90	37.78		65.0	
10232-CAB	LTE-TDD (SC-FDMA, 1 RB, 5 MHz, 16-QAM)	X	18.76	90.77	25.78	6.02	65.0	± 9.6 %
		Y	25.38	103.45	30.44		65.0	
		Z	100.00	129.47	37.17		65.0	
10233-CAB	LTE-TDD (SC-FDMA, 1 RB, 5 MHz, 64-QAM)	X	16.84	88.16	24.62	6.02	65.0	± 9.6 %
		Y	21.91	99.53	28.77		65.0	
		Z	82.43	123.85	35.16		65.0	
10234-CAB	LTE-TDD (SC-FDMA, 1 RB, 5 MHz, QPSK)	X	20.43	95.64	28.46	6.02	65.0	± 9.6 %
		Y	19.79	103.07	31.87		65.0	
		Z	43.63	120.88	37.13		65.0	
10235-CAB	LTE-TDD (SC-FDMA, 1 RB, 10 MHz, 16-QAM)	X	18.78	90.80	25.79	6.02	65.0	± 9.6 %
		Y	25.45	103.51	30.45		65.0	
		Z	100.00	129.48	37.17		65.0	
10236-CAB	LTE-TDD (SC-FDMA, 1 RB, 10 MHz, 64-QAM)	X	16.89	88.21	24.63	6.02	65.0	± 9.6 %
		Y	22.11	99.66	28.80		65.0	
		Z	84.03	124.15	35.23		65.0	
10237-CAB	LTE-TDD (SC-FDMA, 1 RB, 10 MHz, QPSK)	X	21.05	96.32	28.74	6.02	65.0	± 9.6 %
		Y	20.95	104.39	32.37		65.0	
		Z	48.31	123.22	37.87		65.0	
10238-CAB	LTE-TDD (SC-FDMA, 1 RB, 15 MHz, 16-QAM)	X	18.76	90.78	25.78	6.02	65.0	± 9.6 %
		Y	25.37	103.45	30.44		65.0	
		Z	100.00	129.48	37.17		65.0	

10239-CAB	LTE-TDD (SC-FDMA, 1 RB, 15 MHz, 64-QAM)	X	16.84	88.17	24.62	6.02	65.0	± 9.6 %
		Y	21.89	99.53	28.77		65.0	
		Z	82.47	123.88	35.17		65.0	
10240-CAB	LTE-TDD (SC-FDMA, 1 RB, 15 MHz, QPSK)	X	21.01	96.29	28.73	6.02	65.0	± 9.6 %
		Y	20.88	104.33	32.35		65.0	
		Z	48.10	123.14	37.85		65.0	
10241-CAA	LTE-TDD (SC-FDMA, 50% RB, 1.4 MHz, 16-QAM)	X	15.45	87.26	27.54	6.98	65.0	± 9.6 %
		Y	11.04	84.82	26.82		65.0	
		Z	12.90	89.71	28.70		65.0	
10242-CAA	LTE-TDD (SC-FDMA, 50% RB, 1.4 MHz, 64-QAM)	X	14.94	86.42	27.15	6.98	65.0	± 9.6 %
		Y	9.99	82.59	25.84		65.0	
		Z	10.58	85.38	26.97		65.0	
10243-CAA	LTE-TDD (SC-FDMA, 50% RB, 1.4 MHz, QPSK)	X	13.20	85.87	27.69	6.98	65.0	± 9.6 %
		Y	8.19	79.71	25.49		65.0	
		Z	8.16	81.11	26.18		65.0	
10244-CAB	LTE-TDD (SC-FDMA, 50% RB, 3 MHz, 16-QAM)	X	11.50	80.68	21.87	3.98	65.0	± 9.6 %
		Y	8.87	79.76	20.74		65.0	
		Z	9.52	81.24	20.81		65.0	
10245-CAB	LTE-TDD (SC-FDMA, 50% RB, 3 MHz, 64-QAM)	X	11.46	80.43	21.75	3.98	65.0	± 9.6 %
		Y	8.72	79.23	20.48		65.0	
		Z	9.20	80.44	20.46		65.0	
10246-CAB	LTE-TDD (SC-FDMA, 50% RB, 3 MHz, QPSK)	X	10.21	80.78	21.55	3.98	65.0	± 9.6 %
		Y	9.21	83.14	22.01		65.0	
		Z	10.18	85.32	22.50		65.0	
10247-CAB	LTE-TDD (SC-FDMA, 50% RB, 5 MHz, 16-QAM)	X	9.64	78.21	21.09	3.98	65.0	± 9.6 %
		Y	7.56	77.67	20.49		65.0	
		Z	7.61	78.43	20.54		65.0	
10248-CAB	LTE-TDD (SC-FDMA, 50% RB, 5 MHz, 64-QAM)	X	9.70	77.89	20.98	3.98	65.0	± 9.6 %
		Y	7.51	77.10	20.25		65.0	
		Z	7.49	77.71	20.24		65.0	
10249-CAB	LTE-TDD (SC-FDMA, 50% RB, 5 MHz, QPSK)	X	10.31	80.78	21.79	3.98	65.0	± 9.6 %
		Y	10.17	85.03	23.37		65.0	
		Z	11.76	88.25	24.33		65.0	
10250-CAB	LTE-TDD (SC-FDMA, 50% RB, 10 MHz, 16-QAM)	X	10.06	78.79	21.99	3.98	65.0	± 9.6 %
		Y	8.41	79.53	22.52		65.0	
		Z	8.60	80.75	22.93		65.0	
10251-CAB	LTE-TDD (SC-FDMA, 50% RB, 10 MHz, 64-QAM)	X	9.73	77.29	21.23	3.98	65.0	± 9.6 %
		Y	7.93	77.32	21.34		65.0	
		Z	8.00	78.29	21.64		65.0	
10252-CAB	LTE-TDD (SC-FDMA, 50% RB, 10 MHz, QPSK)	X	10.18	79.83	21.68	3.98	65.0	± 9.6 %
		Y	9.87	83.90	23.66		65.0	
		Z	11.01	86.77	24.67		65.0	
10253-CAB	LTE-TDD (SC-FDMA, 50% RB, 15 MHz, 16-QAM)	X	9.71	76.75	21.13	3.98	65.0	± 9.6 %
		Y	7.84	76.32	21.21		65.0	
		Z	7.85	77.16	21.53		65.0	
10254-CAB	LTE-TDD (SC-FDMA, 50% RB, 15 MHz, 64-QAM)	X	10.03	77.26	21.61	3.98	65.0	± 9.6 %
		Y	8.23	77.13	21.85		65.0	
		Z	8.26	78.00	22.17		65.0	

10255-CAB	LTE-TDD (SC-FDMA, 50% RB, 15 MHz, QPSK)	X	9.84	78.12	21.15	3.98	65.0	± 9.6 %
		Y	8.79	80.23	22.49		65.0	
		Z	9.26	82.06	23.20		65.0	
10256-CAA	LTE-TDD (SC-FDMA, 100% RB, 1.4 MHz, 16-QAM)	X	11.29	80.30	21.28	3.98	65.0	± 9.6 %
		Y	7.73	77.21	18.92		65.0	
		Z	7.68	77.31	18.36		65.0	
10257-CAA	LTE-TDD (SC-FDMA, 100% RB, 1.4 MHz, 64-QAM)	X	11.33	80.06	21.15	3.98	65.0	± 9.6 %
		Y	7.53	76.45	18.53		65.0	
		Z	7.33	76.27	17.86		65.0	
10258-CAA	LTE-TDD (SC-FDMA, 100% RB, 1.4 MHz, QPSK)	X	10.31	80.91	21.35	3.98	65.0	± 9.6 %
		Y	7.76	79.92	20.19		65.0	
		Z	7.82	80.45	19.98		65.0	
10259-CAB	LTE-TDD (SC-FDMA, 100% RB, 3 MHz, 16-QAM)	X	9.79	78.29	21.36	3.98	65.0	± 9.6 %
		Y	7.89	78.31	21.20		65.0	
		Z	8.01	79.28	21.39		65.0	
10260-CAB	LTE-TDD (SC-FDMA, 100% RB, 3 MHz, 64-QAM)	X	9.86	78.18	21.35	3.98	65.0	± 9.6 %
		Y	7.89	78.02	21.10		65.0	
		Z	7.96	78.87	21.24		65.0	
10261-CAB	LTE-TDD (SC-FDMA, 100% RB, 3 MHz, QPSK)	X	10.13	80.23	21.74	3.98	65.0	± 9.6 %
		Y	9.61	83.83	23.25		65.0	
		Z	10.78	86.66	24.15		65.0	
10262-CAB	LTE-TDD (SC-FDMA, 100% RB, 5 MHz, 16-QAM)	X	10.06	78.78	21.97	3.98	65.0	± 9.6 %
		Y	8.40	79.48	22.49		65.0	
		Z	8.58	80.70	22.89		65.0	
10263-CAB	LTE-TDD (SC-FDMA, 100% RB, 5 MHz, 64-QAM)	X	9.74	77.31	21.24	3.98	65.0	± 9.6 %
		Y	7.92	77.31	21.33		65.0	
		Z	7.99	78.27	21.64		65.0	
10264-CAB	LTE-TDD (SC-FDMA, 100% RB, 5 MHz, QPSK)	X	10.16	79.77	21.64	3.98	65.0	± 9.6 %
		Y	9.80	83.74	23.58		65.0	
		Z	10.90	86.57	24.58		65.0	
10265-CAB	LTE-TDD (SC-FDMA, 100% RB, 10 MHz, 16-QAM)	X	9.86	77.05	21.15	3.98	65.0	± 9.6 %
		Y	8.03	76.90	21.43		65.0	
		Z	8.05	77.75	21.78		65.0	
10266-CAB	LTE-TDD (SC-FDMA, 100% RB, 10 MHz, 64-QAM)	X	10.15	77.56	21.65	3.98	65.0	± 9.6 %
		Y	8.43	77.72	22.11		65.0	
		Z	8.48	78.63	22.47		65.0	
10267-CAB	LTE-TDD (SC-FDMA, 100% RB, 10 MHz, QPSK)	X	9.92	78.07	20.89	3.98	65.0	± 9.6 %
		Y	9.10	80.63	22.42		65.0	
		Z	9.63	82.52	23.16		65.0	
10268-CAB	LTE-TDD (SC-FDMA, 100% RB, 15 MHz, 16-QAM)	X	10.25	76.65	21.26	3.98	65.0	± 9.6 %
		Y	8.52	76.45	21.62		65.0	
		Z	8.48	77.13	21.92		65.0	
10269-CAB	LTE-TDD (SC-FDMA, 100% RB, 15 MHz, 64-QAM)	X	10.19	76.42	21.27	3.98	65.0	± 9.6 %
		Y	8.45	76.04	21.51		65.0	
		Z	8.40	76.67	21.79		65.0	
10270-CAB	LTE-TDD (SC-FDMA, 100% RB, 15 MHz, QPSK)	X	9.86	76.75	20.51	3.98	65.0	± 9.6 %
		Y	8.62	77.91	21.51		65.0	
		Z	8.79	79.05	21.99		65.0	

10274-CAB	UMTS-FDD (HSUPA, Subtest 5, 3GPP Rel8.10)	X	2.77	66.49	15.71	0.00	150.0	± 9.6 %
		Y	2.64	66.30	15.24		150.0	
		Z	2.65	66.91	15.49		150.0	
10275-CAB	UMTS-FDD (HSUPA, Subtest 5, 3GPP Rel8.4)	X	1.88	69.31	16.53	0.00	150.0	± 9.6 %
		Y	1.64	67.55	15.40		150.0	
		Z	1.70	68.78	16.07		150.0	
10277-CAA	PHS (QPSK)	X	8.68	73.85	17.59	9.03	50.0	± 9.6 %
		Y	5.42	69.49	13.89		50.0	
		Z	4.74	68.12	12.61		50.0	
10278-CAA	PHS (QPSK, BW 884MHz, Rolloff 0.5)	X	11.80	81.35	22.35	9.03	50.0	± 9.6 %
		Y	9.38	80.62	21.03		50.0	
		Z	9.08	80.35	20.35		50.0	
10279-CAA	PHS (QPSK, BW 884MHz, Rolloff 0.38)	X	12.00	81.57	22.44	9.03	50.0	± 9.6 %
		Y	9.52	80.78	21.11		50.0	
		Z	9.21	80.51	20.43		50.0	
10290-AAB	CDMA2000, RC1, SO55, Full Rate	X	1.97	70.58	16.54	0.00	150.0	± 9.6 %
		Y	1.53	68.60	14.31		150.0	
		Z	1.62	70.34	14.87		150.0	
10291-AAB	CDMA2000, RC3, SO55, Full Rate	X	1.20	68.77	15.64	0.00	150.0	± 9.6 %
		Y	0.88	65.75	12.81		150.0	
		Z	0.93	67.33	13.43		150.0	
10292-AAB	CDMA2000, RC3, SO32, Full Rate	X	1.42	72.46	17.76	0.00	150.0	± 9.6 %
		Y	1.05	69.10	14.86		150.0	
		Z	1.29	72.85	16.37		150.0	
10293-AAB	CDMA2000, RC3, SO3, Full Rate	X	1.79	76.28	19.83	0.00	150.0	± 9.6 %
		Y	1.44	73.75	17.39		150.0	
		Z	2.22	81.02	20.07		150.0	
10295-AAB	CDMA2000, RC1, SO3, 1/8th Rate 25 fr.	X	11.75	82.61	24.25	9.03	50.0	± 9.6 %
		Y	11.50	85.78	24.97		50.0	
		Z	13.16	88.95	25.79		50.0	
10297-AAA	LTE-FDD (SC-FDMA, 50% RB, 20 MHz, QPSK)	X	3.30	71.22	17.19	0.00	150.0	± 9.6 %
		Y	2.82	69.50	16.47		150.0	
		Z	2.85	70.29	16.93		150.0	
10298-AAB	LTE-FDD (SC-FDMA, 50% RB, 3 MHz, QPSK)	X	2.18	69.85	16.58	0.00	150.0	± 9.6 %
		Y	1.67	67.77	14.48		150.0	
		Z	1.69	68.80	14.77		150.0	
10299-AAB	LTE-FDD (SC-FDMA, 50% RB, 3 MHz, 16-QAM)	X	4.23	74.55	18.49	0.00	150.0	± 9.6 %
		Y	2.86	70.57	15.39		150.0	
		Z	3.26	72.64	15.67		150.0	
10300-AAB	LTE-FDD (SC-FDMA, 50% RB, 3 MHz, 64-QAM)	X	3.53	70.72	16.20	0.00	150.0	± 9.6 %
		Y	2.22	66.27	12.62		150.0	
		Z	2.22	66.71	12.25		150.0	
10301-AAA	IEEE 802.16e WIMAX (29:18, 5ms, 10MHz, QPSK, PUSC)	X	6.36	68.85	19.32	4.17	80.0	± 9.6 %
		Y	5.68	68.17	18.80		80.0	
		Z	5.55	68.25	18.76		80.0	
10302-AAA	IEEE 802.16e WIMAX (29:18, 5ms, 10MHz, QPSK, PUSC, 3 CTRL symbols)	X	7.00	70.03	20.38	4.96	80.0	± 9.6 %
		Y	6.06	68.21	19.20		80.0	
		Z	5.98	68.63	19.38		80.0	

10303-AAA	IEEE 802.16e WiMAX (31:15, 5ms, 10MHz, 64QAM, PUSC)	X	6.98	70.52	20.65	4.96	80.0	± 9.6 %
		Y	5.89	68.20	19.20		80.0	
		Z	5.80	68.59	19.37		80.0	
10304-AAA	IEEE 802.16e WiMAX (29:18, 5ms, 10MHz, 64QAM, PUSC)	X	6.46	69.38	19.61	4.17	80.0	± 9.6 %
		Y	5.55	67.58	18.44		80.0	
		Z	5.48	68.00	18.61		80.0	
10305-AAA	IEEE 802.16e WiMAX (31:15, 10ms, 10MHz, 64QAM, PUSC, 15 symbols)	X	9.75	80.93	26.10	6.02	50.0	± 9.6 %
		Y	7.80	78.66	24.74		50.0	
		Z	7.67	79.09	24.85		50.0	
10306-AAA	IEEE 802.16e WiMAX (29:18, 10ms, 10MHz, 64QAM, PUSC, 18 symbols)	X	7.97	74.84	23.57	6.02	50.0	± 9.6 %
		Y	6.61	73.09	22.49		50.0	
		Z	6.07	70.95	21.08		50.0	
10307-AAA	IEEE 802.16e WiMAX (29:18, 10ms, 10MHz, QPSK, PUSC, 18 symbols)	X	8.31	76.06	23.89	6.02	50.0	± 9.6 %
		Y	6.81	74.21	22.83		50.0	
		Z	6.09	71.46	21.16		50.0	
10308-AAA	IEEE 802.16e WiMAX (29:18, 10ms, 10MHz, 16QAM, PUSC)	X	8.49	76.81	24.22	6.02	50.0	± 9.6 %
		Y	6.91	74.82	23.13		50.0	
		Z	6.73	75.04	23.19		50.0	
10309-AAA	IEEE 802.16e WiMAX (29:18, 10ms, 10MHz, 16QAM, AMC 2x3, 18 symbols)	X	8.03	74.86	23.58	6.02	50.0	± 9.6 %
		Y	6.73	73.43	22.67		50.0	
		Z	6.15	71.24	21.25		50.0	
10310-AAA	IEEE 802.16e WiMAX (29:18, 10ms, 10MHz, QPSK, AMC 2x3, 18 symbols)	X	8.06	75.25	23.64	6.02	50.0	± 9.6 %
		Y	6.67	73.52	22.60		50.0	
		Z	6.07	71.16	21.10		50.0	
10311-AAA	LTE-FDD (SC-FDMA, 100% RB, 15 MHz, QPSK)	X	3.66	70.59	16.87	0.00	150.0	± 9.6 %
		Y	3.17	68.80	16.13		150.0	
		Z	3.21	69.53	16.54		150.0	
10313-AAA	iDEN 1:3	X	8.35	75.49	17.72	6.99	70.0	± 9.6 %
		Y	7.95	79.95	19.50		70.0	
		Z	9.26	82.77	20.34		70.0	
10314-AAA	iDEN 1:6	X	11.10	81.08	21.83	10.00	30.0	± 9.6 %
		Y	10.75	87.12	24.53		30.0	
		Z	13.73	92.29	26.13		30.0	
10315-AAB	IEEE 802.11b WiFi 2.4 GHz (DSSS, 1 Mbps, 96pc duty cycle)	X	1.32	66.13	16.48	0.17	150.0	± 9.6 %
		Y	1.16	64.22	15.34		150.0	
		Z	1.18	64.92	15.85		150.0	
10316-AAB	IEEE 802.11g WiFi 2.4 GHz (ERP-OFDM, 6 Mbps, 96pc duty cycle)	X	5.02	67.07	16.57	0.17	150.0	± 9.6 %
		Y	4.75	66.87	16.44		150.0	
		Z	4.68	67.09	16.52		150.0	
10317-AAB	IEEE 802.11a WiFi 5 GHz (OFDM, 6 Mbps, 96pc duty cycle)	X	5.02	67.07	16.57	0.17	150.0	± 9.6 %
		Y	4.75	66.87	16.44		150.0	
		Z	4.68	67.09	16.52		150.0	
10400-AAC	IEEE 802.11ac WiFi (20MHz, 64-QAM, 99pc duty cycle)	X	5.16	67.30	16.45	0.00	150.0	± 9.6 %
		Y	4.83	67.08	16.34		150.0	
		Z	4.75	67.29	16.42		150.0	
10401-AAC	IEEE 802.11ac WiFi (40MHz, 64-QAM, 99pc duty cycle)	X	5.77	67.53	16.58	0.00	150.0	± 9.6 %
		Y	5.52	67.31	16.53		150.0	
		Z	5.47	67.54	16.62		150.0	

10402-AAC	IEEE 802.11ac WiFi (80MHz, 64-QAM, 99pc duty cycle)	X	6.05	68.07	16.68	0.00	150.0	± 9.6 %
		Y	5.79	67.71	16.57		150.0	
		Z	5.71	67.77	16.58		150.0	
10403-AAB	CDMA2000 (1xEV-DO, Rev. 0)	X	1.97	70.58	16.54	0.00	115.0	± 9.6 %
		Y	1.53	68.60	14.31		115.0	
		Z	1.62	70.34	14.87		115.0	
10404-AAB	CDMA2000 (1xEV-DO, Rev. A)	X	1.97	70.58	16.54	0.00	115.0	± 9.6 %
		Y	1.53	68.60	14.31		115.0	
		Z	1.62	70.34	14.87		115.0	
10406-AAB	CDMA2000, RC3, SO32, SCH0, Full Rate	X	28.32	105.49	28.28	0.00	100.0	± 9.6 %
		Y	14.90	98.73	25.93		100.0	
		Z	100.00	120.76	29.81		100.0	
10410-AAA	LTE-TDD (SC-FDMA, 1 RB, 10 MHz, QPSK, UL Subframe=2,3,4,7,8,9)	X	4.66	69.85	12.19	2.23	80.0	± 9.6 %
		Y	1.26	61.35	6.31		80.0	
		Z	0.95	60.00	4.82		80.0	
10415-AAA	IEEE 802.11b WiFi 2.4 GHz (DSSS, 1 Mbps, 99pc duty cycle)	X	1.05	63.52	15.18	0.00	150.0	± 9.6 %
		Y	1.03	62.82	14.49		150.0	
		Z	1.04	63.47	14.98		150.0	
10416-AAA	IEEE 802.11g WiFi 2.4 GHz (ERP-OFDM, 6 Mbps, 99pc duty cycle)	X	4.88	66.81	16.36	0.00	150.0	± 9.6 %
		Y	4.64	66.71	16.28		150.0	
		Z	4.59	66.94	16.36		150.0	
10417-AAA	IEEE 802.11a/h WiFi 5 GHz (OFDM, 6 Mbps, 99pc duty cycle)	X	4.88	66.81	16.36	0.00	150.0	± 9.6 %
		Y	4.64	66.71	16.28		150.0	
		Z	4.59	66.94	16.36		150.0	
10418-AAA	IEEE 802.11g WiFi 2.4 GHz (DSSS-OFDM, 6 Mbps, 99pc duty cycle, Long preamble)	X	4.86	66.93	16.35	0.00	150.0	± 9.6 %
		Y	4.63	66.85	16.28		150.0	
		Z	4.58	67.10	16.38		150.0	
10419-AAA	IEEE 802.11g WiFi 2.4 GHz (DSSS-OFDM, 6 Mbps, 99pc duty cycle, Short preamble)	X	4.89	66.90	16.37	0.00	150.0	± 9.6 %
		Y	4.65	66.81	16.29		150.0	
		Z	4.60	67.05	16.38		150.0	
10422-AAA	IEEE 802.11n (HT Greenfield, 7.2 Mbps, BPSK)	X	5.03	66.92	16.38	0.00	150.0	± 9.6 %
		Y	4.78	66.83	16.31		150.0	
		Z	4.72	67.05	16.39		150.0	
10423-AAA	IEEE 802.11n (HT Greenfield, 43.3 Mbps, 16-QAM)	X	5.30	67.39	16.55	0.00	150.0	± 9.6 %
		Y	4.96	67.18	16.44		150.0	
		Z	4.88	67.37	16.51		150.0	
10424-AAA	IEEE 802.11n (HT Greenfield, 72.2 Mbps, 64-QAM)	X	5.19	67.31	16.51	0.00	150.0	± 9.6 %
		Y	4.88	67.12	16.41		150.0	
		Z	4.80	67.32	16.48		150.0	
10425-AAA	IEEE 802.11n (HT Greenfield, 15 Mbps, BPSK)	X	5.73	67.72	16.66	0.00	150.0	± 9.6 %
		Y	5.50	67.56	16.64		150.0	
		Z	5.42	67.67	16.68		150.0	
10426-AAA	IEEE 802.11n (HT Greenfield, 90 Mbps, 16-QAM)	X	5.76	67.78	16.68	0.00	150.0	± 9.6 %
		Y	5.50	67.57	16.65		150.0	
		Z	5.43	67.71	16.70		150.0	

10427-AAA	IEEE 802.11n (HT Greenfield, 150 Mbps, 64-QAM)	X	5.81	67.91	16.74	0.00	150.0	± 9.6 %
		Y	5.51	67.53	16.62		150.0	
		Z	5.43	67.67	16.67		150.0	
10430-AAA	LTE-FDD (OFDMA, 5 MHz, E-TM 3.1)	X	4.62	69.59	18.10	0.00	150.0	± 9.6 %
		Y	4.31	70.41	18.12		150.0	
		Z	4.28	70.94	18.23		150.0	
10431-AAA	LTE-FDD (OFDMA, 10 MHz, E-TM 3.1)	X	4.73	67.38	16.53	0.00	150.0	± 9.6 %
		Y	4.34	67.24	16.29		150.0	
		Z	4.27	67.52	16.37		150.0	
10432-AAA	LTE-FDD (OFDMA, 15 MHz, E-TM 3.1)	X	4.99	67.36	16.52	0.00	150.0	± 9.6 %
		Y	4.64	67.14	16.35		150.0	
		Z	4.57	67.38	16.44		150.0	
10433-AAA	LTE-FDD (OFDMA, 20 MHz, E-TM 3.1)	X	5.22	67.42	16.56	0.00	150.0	± 9.6 %
		Y	4.89	67.15	16.43		150.0	
		Z	4.82	67.36	16.50		150.0	
10434-AAA	W-CDMA (BS Test Model 1, 64 DPCH)	X	4.68	70.02	18.09	0.00	150.0	± 9.6 %
		Y	4.40	71.16	18.09		150.0	
		Z	4.38	71.81	18.21		150.0	
10435-AAA	LTE-TDD (SC-FDMA, 1 RB, 20 MHz, QPSK, UL Subframe=2,3,4,7,8,9)	X	4.61	69.70	12.13	2.23	80.0	± 9.6 %
		Y	1.27	61.33	6.29		80.0	
		Z	0.95	60.00	4.82		80.0	
10447-AAA	LTE-FDD (OFDMA, 5 MHz, E-TM 3.1, Clipping 44%)	X	4.07	67.39	16.27	0.00	150.0	± 9.6 %
		Y	3.63	67.20	15.67		150.0	
		Z	3.57	67.58	15.72		150.0	
10448-AAA	LTE-FDD (OFDMA, 10 MHz, E-TM 3.1, Clipping 44%)	X	4.50	67.14	16.38	0.00	150.0	± 9.6 %
		Y	4.17	67.00	16.14		150.0	
		Z	4.11	67.30	16.23		150.0	
10449-AAA	LTE-FDD (OFDMA, 15 MHz, E-TM 3.1, Clipping 44%)	X	4.72	67.15	16.41	0.00	150.0	± 9.6 %
		Y	4.44	66.96	16.24		150.0	
		Z	4.38	67.21	16.33		150.0	
10450-AAA	LTE-FDD (OFDMA, 20 MHz, E-TM 3.1, Clipping 44%)	X	4.87	67.12	16.42	0.00	150.0	± 9.6 %
		Y	4.63	66.90	16.27		150.0	
		Z	4.58	67.12	16.36		150.0	
10451-AAA	W-CDMA (BS Test Model 1, 64 DPCH, Clipping 44%)	X	4.03	67.67	16.16	0.00	150.0	± 9.6 %
		Y	3.54	67.41	15.35		150.0	
		Z	3.46	67.78	15.35		150.0	
10456-AAA	IEEE 802.11ac WiFi (160MHz, 64-QAM, 99pc duty cycle)	X	6.57	68.45	16.88	0.00	150.0	± 9.6 %
		Y	6.36	68.13	16.80		150.0	
		Z	6.29	68.20	16.82		150.0	
10457-AAA	UMTS-FDD (DC-HSDPA)	X	3.96	65.55	16.17	0.00	150.0	± 9.6 %
		Y	3.86	65.34	15.98		150.0	
		Z	3.83	65.58	16.07		150.0	
10458-AAA	CDMA2000 (1xEV-DO, Rev. B, 2 carriers)	X	3.73	66.33	15.59	0.00	150.0	± 9.6 %
		Y	3.37	66.75	14.83		150.0	
		Z	3.29	67.13	14.77		150.0	
10459-AAA	CDMA2000 (1xEV-DO, Rev. B, 3 carriers)	X	4.80	64.25	15.81	0.00	150.0	± 9.6 %
		Y	4.44	64.93	15.63		150.0	
		Z	4.47	65.77	15.89		150.0	

10460-AAA	UMTS-FDD (WCDMA, AMR)	X	1.06	70.38	17.59	0.00	150.0	± 9.6 %
		Y	0.90	67.32	15.64		150.0	
		Z	0.98	69.52	16.94		150.0	
10461-AAA	LTE-TDD (SC-FDMA, 1 RB, 1.4 MHz, QPSK, UL Subframe=2,3,4,7,8,9)	X	100.00	116.53	30.21	3.29	80.0	± 9.6 %
		Y	100.00	124.93	32.76		80.0	
		Z	100.00	126.81	33.20		80.0	
10462-AAA	LTE-TDD (SC-FDMA, 1 RB, 1.4 MHz, 16-QAM, UL Subframe=2,3,4,7,8,9)	X	70.18	103.94	25.18	3.23	80.0	± 9.6 %
		Y	100.00	110.54	25.86		80.0	
		Z	100.00	108.56	24.48		80.0	
10463-AAA	LTE-TDD (SC-FDMA, 1 RB, 1.4 MHz, 64-QAM, UL Subframe=2,3,4,7,8,9)	X	34.47	94.04	22.31	3.23	80.0	± 9.6 %
		Y	24.86	92.54	20.87		80.0	
		Z	100.00	104.83	22.72		80.0	
10464-AAA	LTE-TDD (SC-FDMA, 1 RB, 3 MHz, QPSK, UL Subframe=2,3,4,7,8,9)	X	100.00	115.32	29.52	3.23	80.0	± 9.6 %
		Y	100.00	123.01	31.71		80.0	
		Z	100.00	124.63	32.03		80.0	
10465-AAA	LTE-TDD (SC-FDMA, 1 RB, 3 MHz, 16-QAM, UL Subframe=2,3,4,7,8,9)	X	51.21	99.84	24.08	3.23	80.0	± 9.6 %
		Y	70.70	106.13	24.73		80.0	
		Z	100.00	107.97	24.20		80.0	
10466-AAA	LTE-TDD (SC-FDMA, 1 RB, 3 MHz, 64-QAM, UL Subframe=2,3,4,7,8,9)	X	27.09	90.97	21.41	3.23	80.0	± 9.6 %
		Y	13.41	85.62	18.91		80.0	
		Z	31.05	92.96	19.89		80.0	
10467-AAA	LTE-TDD (SC-FDMA, 1 RB, 5 MHz, QPSK, UL Subframe=2,3,4,7,8,9)	X	100.00	115.43	29.57	3.23	80.0	± 9.6 %
		Y	100.00	123.23	31.81		80.0	
		Z	100.00	124.89	32.14		80.0	
10468-AAA	LTE-TDD (SC-FDMA, 1 RB, 5 MHz, 16-QAM, UL Subframe=2,3,4,7,8,9)	X	54.96	100.78	24.34	3.23	80.0	± 9.6 %
		Y	94.28	109.52	25.53		80.0	
		Z	100.00	108.16	24.29		80.0	
10469-AAA	LTE-TDD (SC-FDMA, 1 RB, 5 MHz, 64-QAM, UL Subframe=2,3,4,7,8,9)	X	27.59	91.19	21.47	3.23	80.0	± 9.6 %
		Y	13.74	85.89	18.98		80.0	
		Z	32.90	93.53	20.03		80.0	
10470-AAA	LTE-TDD (SC-FDMA, 1 RB, 10 MHz, QPSK, UL Subframe=2,3,4,7,8,9)	X	100.00	115.44	29.58	3.23	80.0	± 9.6 %
		Y	100.00	123.25	31.82		80.0	
		Z	100.00	124.92	32.15		80.0	
10471-AAA	LTE-TDD (SC-FDMA, 1 RB, 10 MHz, 16-QAM, UL Subframe=2,3,4,7,8,9)	X	55.24	100.82	24.34	3.23	80.0	± 9.6 %
		Y	94.55	109.51	25.51		80.0	
		Z	100.00	108.10	24.25		80.0	
10472-AAA	LTE-TDD (SC-FDMA, 1 RB, 10 MHz, 64-QAM, UL Subframe=2,3,4,7,8,9)	X	27.68	91.21	21.47	3.23	80.0	± 9.6 %
		Y	13.71	85.85	18.96		80.0	
		Z	32.46	93.35	19.96		80.0	
10473-AAA	LTE-TDD (SC-FDMA, 1 RB, 15 MHz, QPSK, UL Subframe=2,3,4,7,8,9)	X	100.00	115.43	29.57	3.23	80.0	± 9.6 %
		Y	100.00	123.22	31.80		80.0	
		Z	100.00	124.89	32.13		80.0	
10474-AAA	LTE-TDD (SC-FDMA, 1 RB, 15 MHz, 16-QAM, UL Subframe=2,3,4,7,8,9)	X	54.80	100.73	24.32	3.23	80.0	± 9.6 %
		Y	91.93	109.20	25.45		80.0	
		Z	100.00	108.10	24.25		80.0	
10475-AAA	LTE-TDD (SC-FDMA, 1 RB, 15 MHz, 64-QAM, UL Subframe=2,3,4,7,8,9)	X	27.50	91.14	21.45	3.23	80.0	± 9.6 %
		Y	13.50	85.69	18.91		80.0	
		Z	31.52	93.08	19.90		80.0	



10477-AAA	LTE-TDD (SC-FDMA, 1 RB, 20 MHz, 16-QAM, UL Subframe=2,3,4,7,8,9)	X	52.37	100.09	24.13	3.23	80.0	± 9.6 %
		Y	75.38	106.81	24.87		80.0	
		Z	100.00	107.91	24.16		80.0	
10478-AAA	LTE-TDD (SC-FDMA, 1 RB, 20 MHz, 64-QAM, UL Subframe=2,3,4,7,8,9)	X	27.26	91.02	21.41	3.23	80.0	± 9.6 %
		Y	13.26	85.47	18.84		80.0	
		Z	30.16	92.61	19.77		80.0	
10479-AAA	LTE-TDD (SC-FDMA, 50% RB, 1.4 MHz, QPSK, UL Subframe=2,3,4,7,8,9)	X	100.00	110.48	26.81	1.99	80.0	± 9.6 %
		Y	2.73	68.06	11.81		80.0	
		Z	1.43	62.45	8.56		80.0	
10480-AAA	LTE-TDD (SC-FDMA, 50% RB, 1.4 MHz, 16-QAM, UL Subframe=2,3,4,7,8,9)	X	10.33	78.63	17.34	1.99	80.0	± 9.6 %
		Y	1.46	60.00	7.26		80.0	
		Z	1.33	60.00	6.36		80.0	
10481-AAA	LTE-TDD (SC-FDMA, 50% RB, 1.4 MHz, 64-QAM, UL Subframe=2,3,4,7,8,9)	X	8.08	75.22	15.95	1.99	80.0	± 9.6 %
		Y	1.48	60.00	7.04		80.0	
		Z	1.36	60.00	6.13		80.0	
10482-AAA	LTE-TDD (SC-FDMA, 50% RB, 3 MHz, QPSK, UL Subframe=2,3,4,7,8,9)	X	9.61	82.86	21.13	1.99	80.0	± 9.6 %
		Y	5.81	78.79	19.00		80.0	
		Z	7.49	82.61	19.95		80.0	
10483-AAA	LTE-TDD (SC-FDMA, 50% RB, 3 MHz, 16-QAM, UL Subframe=2,3,4,7,8,9)	X	11.05	82.78	21.52	1.99	80.0	± 9.6 %
		Y	7.68	79.55	19.16		80.0	
		Z	9.15	81.77	19.31		80.0	
10484-AAA	LTE-TDD (SC-FDMA, 50% RB, 3 MHz, 64-QAM, UL Subframe=2,3,4,7,8,9)	X	10.66	82.06	21.31	1.99	80.0	± 9.6 %
		Y	6.96	78.04	18.65		80.0	
		Z	7.77	79.52	18.59		80.0	
10485-AAA	LTE-TDD (SC-FDMA, 50% RB, 5 MHz, QPSK, UL Subframe=2,3,4,7,8,9)	X	10.18	83.77	21.74	1.99	80.0	± 9.6 %
		Y	6.53	81.04	20.70		80.0	
		Z	8.63	85.83	22.16		80.0	
10486-AAA	LTE-TDD (SC-FDMA, 50% RB, 5 MHz, 16-QAM, UL Subframe=2,3,4,7,8,9)	X	6.80	75.85	19.18	1.99	80.0	± 9.6 %
		Y	4.63	73.14	17.52		80.0	
		Z	4.93	74.63	17.85		80.0	
10487-AAA	LTE-TDD (SC-FDMA, 50% RB, 5 MHz, 64-QAM, UL Subframe=2,3,4,7,8,9)	X	6.74	75.42	19.05	1.99	80.0	± 9.6 %
		Y	4.56	72.57	17.30		80.0	
		Z	4.76	73.82	17.53		80.0	
10488-AAA	LTE-TDD (SC-FDMA, 50% RB, 10 MHz, QPSK, UL Subframe=2,3,4,7,8,9)	X	9.26	81.31	21.14	1.99	80.0	± 9.6 %
		Y	6.04	78.74	20.60		80.0	
		Z	6.88	81.70	21.70		80.0	
10489-AAA	LTE-TDD (SC-FDMA, 50% RB, 10 MHz, 16-QAM, UL Subframe=2,3,4,7,8,9)	X	6.70	74.94	19.37	1.99	80.0	± 9.6 %
		Y	4.74	72.58	18.49		80.0	
		Z	4.87	73.80	18.93		80.0	
10490-AAA	LTE-TDD (SC-FDMA, 50% RB, 10 MHz, 64-QAM, UL Subframe=2,3,4,7,8,9)	X	6.63	74.31	19.19	1.99	80.0	± 9.6 %
		Y	4.78	72.20	18.37		80.0	
		Z	4.88	73.31	18.77		80.0	
10491-AAA	LTE-TDD (SC-FDMA, 50% RB, 15 MHz, QPSK, UL Subframe=2,3,4,7,8,9)	X	7.99	77.79	20.04	1.99	80.0	± 9.6 %
		Y	5.54	75.44	19.58		80.0	
		Z	5.85	77.18	20.31		80.0	
10492-AAA	LTE-TDD (SC-FDMA, 50% RB, 15 MHz, 16-QAM, UL Subframe=2,3,4,7,8,9)	X	6.64	73.40	18.97	1.99	80.0	± 9.6 %
		Y	4.89	71.22	18.27		80.0	
		Z	4.91	72.02	18.60		80.0	

10493-AAA	LTE-TDD (SC-FDMA, 50% RB, 15 MHz, 64-QAM, UL Subframe=2,3,4,7,8,9)	X	6.63	73.05	18.88	1.99	80.0	± 9.6 %
		Y	4.93	70.98	18.19		80.0	
		Z	4.94	71.73	18.50		80.0	
10494-AAA	LTE-TDD (SC-FDMA, 50% RB, 20 MHz, QPSK, UL Subframe=2,3,4,7,8,9)	X	9.25	79.94	20.55	1.99	80.0	± 9.6 %
		Y	6.29	77.48	20.14		80.0	
		Z	6.82	79.60	20.99		80.0	
10495-AAA	LTE-TDD (SC-FDMA, 50% RB, 20 MHz, 16-QAM, UL Subframe=2,3,4,7,8,9)	X	6.90	74.24	19.21	1.99	80.0	± 9.6 %
		Y	5.00	71.81	18.51		80.0	
		Z	5.02	72.61	18.86		80.0	
10496-AAA	LTE-TDD (SC-FDMA, 50% RB, 20 MHz, 64-QAM, UL Subframe=2,3,4,7,8,9)	X	6.80	73.58	19.03	1.99	80.0	± 9.6 %
		Y	5.02	71.34	18.37		80.0	
		Z	5.02	72.06	18.68		80.0	
10497-AAA	LTE-TDD (SC-FDMA, 100% RB, 1.4 MHz, QPSK, UL Subframe=2,3,4,7,8,9)	X	8.70	81.61	20.39	1.99	80.0	± 9.6 %
		Y	3.68	72.36	15.74		80.0	
		Z	3.73	72.83	15.43		80.0	
10498-AAA	LTE-TDD (SC-FDMA, 100% RB, 1.4 MHz, 16-QAM, UL Subframe=2,3,4,7,8,9)	X	6.14	74.45	17.47	1.99	80.0	± 9.6 %
		Y	2.42	64.76	11.65		80.0	
		Z	2.01	63.29	10.42		80.0	
10499-AAA	LTE-TDD (SC-FDMA, 100% RB, 1.4 MHz, 64-QAM, UL Subframe=2,3,4,7,8,9)	X	6.10	74.03	17.25	1.99	80.0	± 9.6 %
		Y	2.34	64.14	11.24		80.0	
		Z	1.93	62.60	9.95		80.0	
10500-AAA	LTE-TDD (SC-FDMA, 100% RB, 3 MHz, QPSK, UL Subframe=2,3,4,7,8,9)	X	9.20	81.83	21.24	1.99	80.0	± 9.6 %
		Y	6.05	79.44	20.47		80.0	
		Z	7.38	83.28	21.74		80.0	
10501-AAA	LTE-TDD (SC-FDMA, 100% RB, 3 MHz, 16-QAM, UL Subframe=2,3,4,7,8,9)	X	6.68	75.21	19.15	1.99	80.0	± 9.6 %
		Y	4.68	72.89	17.89		80.0	
		Z	4.92	74.35	18.29		80.0	
10502-AAA	LTE-TDD (SC-FDMA, 100% RB, 3 MHz, 64-QAM, UL Subframe=2,3,4,7,8,9)	X	6.61	74.73	18.98	1.99	80.0	± 9.6 %
		Y	4.69	72.56	17.72		80.0	
		Z	4.90	73.90	18.06		80.0	
10503-AAA	LTE-TDD (SC-FDMA, 100% RB, 5 MHz, QPSK, UL Subframe=2,3,4,7,8,9)	X	9.12	81.09	21.05	1.99	80.0	± 9.6 %
		Y	5.94	78.46	20.49		80.0	
		Z	6.74	81.37	21.57		80.0	
10504-AAA	LTE-TDD (SC-FDMA, 100% RB, 5 MHz, 16-QAM, UL Subframe=2,3,4,7,8,9)	X	6.67	74.86	19.32	1.99	80.0	± 9.6 %
		Y	4.71	72.47	18.43		80.0	
		Z	4.83	73.67	18.86		80.0	
10505-AAA	LTE-TDD (SC-FDMA, 100% RB, 5 MHz, 64-QAM, UL Subframe=2,3,4,7,8,9)	X	6.59	74.22	19.14	1.99	80.0	± 9.6 %
		Y	4.75	72.08	18.31		80.0	
		Z	4.84	73.19	18.70		80.0	
10506-AAA	LTE-TDD (SC-FDMA, 100% RB, 10 MHz, QPSK, UL Subframe=2,3,4,7,8,9)	X	9.16	79.78	20.48	1.99	80.0	± 9.6 %
		Y	6.22	77.28	20.05		80.0	
		Z	6.73	79.37	20.90		80.0	
10507-AAA	LTE-TDD (SC-FDMA, 100% RB, 10 MHz, 16-QAM, UL Subframe=2,3,4,7,8,9)	X	6.87	74.17	19.18	1.99	80.0	± 9.6 %
		Y	4.97	71.74	18.47		80.0	
		Z	5.00	72.54	18.82		80.0	

10508-AAA	LTE-TDD (SC-FDMA, 100% RB, 10 MHz, 64-QAM, UL Subframe=2,3,4,7,8,9)	X	6.78	73.51	18.99	1.99	80.0	± 9.6 %
		Y	5.00	71.26	18.32		80.0	
		Z	4.99	71.98	18.64		80.0	
10509-AAA	LTE-TDD (SC-FDMA, 100% RB, 15 MHz, QPSK, UL Subframe=2,3,4,7,8,9)	X	8.19	76.69	19.48	1.99	80.0	± 9.6 %
		Y	5.96	74.56	19.11		80.0	
		Z	6.18	75.85	19.67		80.0	
10510-AAA	LTE-TDD (SC-FDMA, 100% RB, 15 MHz, 16-QAM, UL Subframe=2,3,4,7,8,9)	X	7.09	73.18	18.86	1.99	80.0	± 9.6 %
		Y	5.35	70.96	18.27		80.0	
		Z	5.32	71.51	18.53		80.0	
10511-AAA	LTE-TDD (SC-FDMA, 100% RB, 15 MHz, 64-QAM, UL Subframe=2,3,4,7,8,9)	X	7.01	72.71	18.76	1.99	80.0	± 9.6 %
		Y	5.36	70.59	18.17		80.0	
		Z	5.32	71.09	18.41		80.0	
10512-AAA	LTE-TDD (SC-FDMA, 100% RB, 20 MHz, QPSK, UL Subframe=2,3,4,7,8,9)	X	9.39	79.21	20.17	1.99	80.0	± 9.6 %
		Y	6.60	76.78	19.74		80.0	
		Z	7.04	78.51	20.46		80.0	
10513-AAA	LTE-TDD (SC-FDMA, 100% RB, 20 MHz, 16-QAM, UL Subframe=2,3,4,7,8,9)	X	7.22	74.05	19.13	1.99	80.0	± 9.6 %
		Y	5.31	71.48	18.45		80.0	
		Z	5.29	72.06	18.74		80.0	
10514-AAA	LTE-TDD (SC-FDMA, 100% RB, 20 MHz, 64-QAM, UL Subframe=2,3,4,7,8,9)	X	7.01	73.30	18.95	1.99	80.0	± 9.6 %
		Y	5.25	70.89	18.29		80.0	
		Z	5.21	71.40	18.54		80.0	
10515-AAA	IEEE 802.11b WiFi 2.4 GHz (DSSS, 2 Mbps, 99pc duty cycle)	X	1.01	63.76	15.28	0.00	150.0	± 9.6 %
		Y	0.99	62.98	14.53		150.0	
		Z	1.00	63.68	15.06		150.0	
10516-AAA	IEEE 802.11b WiFi 2.4 GHz (DSSS, 5.5 Mbps, 99pc duty cycle)	X	0.80	75.28	19.93	0.00	150.0	± 9.6 %
		Y	0.58	68.61	16.24		150.0	
		Z	0.70	72.93	18.74		150.0	
10517-AAA	IEEE 802.11b WiFi 2.4 GHz (DSSS, 11 Mbps, 99pc duty cycle)	X	0.91	66.46	16.32	0.00	150.0	± 9.6 %
		Y	0.83	64.68	15.01		150.0	
		Z	0.86	65.89	15.88		150.0	
10518-AAA	IEEE 802.11a/h WiFi 5 GHz (OFDM, 9 Mbps, 99pc duty cycle)	X	4.89	66.93	16.38	0.00	150.0	± 9.6 %
		Y	4.64	66.79	16.26		150.0	
		Z	4.58	67.02	16.34		150.0	
10519-AAA	IEEE 802.11a/h WiFi 5 GHz (OFDM, 12 Mbps, 99pc duty cycle)	X	5.17	67.29	16.52	0.00	150.0	± 9.6 %
		Y	4.84	67.06	16.39		150.0	
		Z	4.77	67.26	16.46		150.0	
10520-AAA	IEEE 802.11a/h WiFi 5 GHz (OFDM, 18 Mbps, 99pc duty cycle)	X	5.01	67.26	16.44	0.00	150.0	± 9.6 %
		Y	4.69	67.02	16.31		150.0	
		Z	4.62	67.22	16.38		150.0	
10521-AAA	IEEE 802.11a/h WiFi 5 GHz (OFDM, 24 Mbps, 99pc duty cycle)	X	4.93	67.28	16.44	0.00	150.0	± 9.6 %
		Y	4.62	67.01	16.29		150.0	
		Z	4.55	67.22	16.37		150.0	
10522-AAA	IEEE 802.11a/h WiFi 5 GHz (OFDM, 36 Mbps, 99pc duty cycle)	X	4.95	67.09	16.39	0.00	150.0	± 9.6 %
		Y	4.68	67.06	16.36		150.0	
		Z	4.61	67.31	16.46		150.0	

10523-AAA	IEEE 802.11a/h WiFi 5 GHz (OFDM, 48 Mbps, 99pc duty cycle)	X	4.83	67.13	16.32	0.00	150.0	± 9.6 %
		Y	4.55	66.92	16.20		150.0	
		Z	4.49	67.17	16.30		150.0	
10524-AAA	IEEE 802.11a/h WiFi 5 GHz (OFDM, 54 Mbps, 99pc duty cycle)	X	4.91	67.07	16.40	0.00	150.0	± 9.6 %
		Y	4.62	66.99	16.33		150.0	
		Z	4.55	67.23	16.42		150.0	
10525-AAA	IEEE 802.11ac WiFi (20MHz, MCS0, 99pc duty cycle)	X	4.83	66.16	16.01	0.00	150.0	± 9.6 %
		Y	4.59	66.02	15.91		150.0	
		Z	4.54	66.27	16.01		150.0	
10526-AAA	IEEE 802.11ac WiFi (20MHz, MCS1, 99pc duty cycle)	X	5.08	66.58	16.15	0.00	150.0	± 9.6 %
		Y	4.78	66.41	16.06		150.0	
		Z	4.71	66.64	16.15		150.0	
10527-AAA	IEEE 802.11ac WiFi (20MHz, MCS2, 99pc duty cycle)	X	5.00	66.62	16.14	0.00	150.0	± 9.6 %
		Y	4.69	66.37	16.00		150.0	
		Z	4.63	66.60	16.10		150.0	
10528-AAA	IEEE 802.11ac WiFi (20MHz, MCS3, 99pc duty cycle)	X	5.02	66.63	16.17	0.00	150.0	± 9.6 %
		Y	4.71	66.39	16.04		150.0	
		Z	4.65	66.62	16.13		150.0	
10529-AAA	IEEE 802.11ac WiFi (20MHz, MCS4, 99pc duty cycle)	X	5.02	66.63	16.17	0.00	150.0	± 9.6 %
		Y	4.71	66.39	16.04		150.0	
		Z	4.65	66.62	16.13		150.0	
10531-AAA	IEEE 802.11ac WiFi (20MHz, MCS6, 99pc duty cycle)	X	5.05	66.78	16.18	0.00	150.0	± 9.6 %
		Y	4.71	66.51	16.06		150.0	
		Z	4.64	66.73	16.14		150.0	
10532-AAA	IEEE 802.11ac WiFi (20MHz, MCS7, 99pc duty cycle)	X	4.92	66.80	16.21	0.00	150.0	± 9.6 %
		Y	4.57	66.36	15.99		150.0	
		Z	4.50	66.58	16.08		150.0	
10533-AAA	IEEE 802.11ac WiFi (20MHz, MCS8, 99pc duty cycle)	X	5.04	66.62	16.13	0.00	150.0	± 9.6 %
		Y	4.72	66.42	16.02		150.0	
		Z	4.66	66.67	16.12		150.0	
10534-AAA	IEEE 802.11ac WiFi (40MHz, MCS0, 99pc duty cycle)	X	5.50	66.89	16.23	0.00	150.0	± 9.6 %
		Y	5.25	66.56	16.12		150.0	
		Z	5.18	66.72	16.18		150.0	
10535-AAA	IEEE 802.11ac WiFi (40MHz, MCS1, 99pc duty cycle)	X	5.61	67.07	16.29	0.00	150.0	± 9.6 %
		Y	5.32	66.72	16.19		150.0	
		Z	5.26	66.91	16.27		150.0	
10536-AAA	IEEE 802.11ac WiFi (40MHz, MCS2, 99pc duty cycle)	X	5.45	67.03	16.27	0.00	150.0	± 9.6 %
		Y	5.18	66.67	16.15		150.0	
		Z	5.12	66.85	16.22		150.0	
10537-AAA	IEEE 802.11ac WiFi (40MHz, MCS3, 99pc duty cycle)	X	5.51	66.97	16.23	0.00	150.0	± 9.6 %
		Y	5.25	66.66	16.15		150.0	
		Z	5.18	66.81	16.21		150.0	
10538-AAA	IEEE 802.11ac WiFi (40MHz, MCS4, 99pc duty cycle)	X	5.66	67.09	16.33	0.00	150.0	± 9.6 %
		Y	5.35	66.71	16.21		150.0	
		Z	5.27	66.83	16.26		150.0	
10540-AAA	IEEE 802.11ac WiFi (40MHz, MCS6, 99pc duty cycle)	X	5.52	66.96	16.29	0.00	150.0	± 9.6 %
		Y	5.27	66.69	16.22		150.0	
		Z	5.21	66.87	16.29		150.0	

10541-AAA	IEEE 802.11ac WiFi (40MHz, MCS7, 99pc duty cycle)	X	5.54	67.03	16.32	0.00	150.0	± 9.6 %
		Y	5.24	66.55	16.14		150.0	
		Z	5.17	66.72	16.20		150.0	
10542-AAA	IEEE 802.11ac WiFi (40MHz, MCS8, 99pc duty cycle)	X	5.66	66.95	16.30	0.00	150.0	± 9.6 %
		Y	5.40	66.64	16.20		150.0	
		Z	5.33	66.79	16.25		150.0	
10543-AAA	IEEE 802.11ac WiFi (40MHz, MCS9, 99pc duty cycle)	X	5.85	67.19	16.42	0.00	150.0	± 9.6 %
		Y	5.49	66.69	16.24		150.0	
		Z	5.41	66.83	16.30		150.0	
10544-AAA	IEEE 802.11ac WiFi (80MHz, MCS0, 99pc duty cycle)	X	5.73	67.00	16.21	0.00	150.0	± 9.6 %
		Y	5.55	66.66	16.11		150.0	
		Z	5.50	66.82	16.17		150.0	
10545-AAA	IEEE 802.11ac WiFi (80MHz, MCS1, 99pc duty cycle)	X	5.97	67.35	16.30	0.00	150.0	± 9.6 %
		Y	5.77	67.14	16.30		150.0	
		Z	5.70	67.27	16.35		150.0	
10546-AAA	IEEE 802.11ac WiFi (80MHz, MCS2, 99pc duty cycle)	X	5.89	67.40	16.36	0.00	150.0	± 9.6 %
		Y	5.63	66.93	16.21		150.0	
		Z	5.56	67.04	16.25		150.0	
10547-AAA	IEEE 802.11ac WiFi (80MHz, MCS3, 99pc duty cycle)	X	5.98	67.45	16.37	0.00	150.0	± 9.6 %
		Y	5.72	67.02	16.25		150.0	
		Z	5.63	67.08	16.26		150.0	
10548-AAA	IEEE 802.11ac WiFi (80MHz, MCS4, 99pc duty cycle)	X	6.20	68.21	16.72	0.00	150.0	± 9.6 %
		Y	6.10	68.30	16.85		150.0	
		Z	5.92	68.12	16.75		150.0	
10550-AAA	IEEE 802.11ac WiFi (80MHz, MCS6, 99pc duty cycle)	X	5.90	67.28	16.30	0.00	150.0	± 9.6 %
		Y	5.65	66.91	16.21		150.0	
		Z	5.59	67.06	16.27		150.0	
10551-AAA	IEEE 802.11ac WiFi (80MHz, MCS7, 99pc duty cycle)	X	5.89	67.30	16.27	0.00	150.0	± 9.6 %
		Y	5.66	66.95	16.19		150.0	
		Z	5.60	67.09	16.24		150.0	
10552-AAA	IEEE 802.11ac WiFi (80MHz, MCS8, 99pc duty cycle)	X	5.82	67.18	16.24	0.00	150.0	± 9.6 %
		Y	5.56	66.72	16.09		150.0	
		Z	5.51	66.88	16.15		150.0	
10553-AAA	IEEE 802.11ac WiFi (80MHz, MCS9, 99pc duty cycle)	X	5.91	67.18	16.26	0.00	150.0	± 9.6 %
		Y	5.65	66.78	16.14		150.0	
		Z	5.59	66.92	16.19		150.0	
10554-AAA	IEEE 1602.11ac WiFi (160MHz, MCS0, 99pc duty cycle)	X	6.12	67.39	16.31	0.00	150.0	± 9.6 %
		Y	5.96	67.06	16.22		150.0	
		Z	5.91	67.18	16.26		150.0	
10555-AAA	IEEE 1602.11ac WiFi (160MHz, MCS1, 99pc duty cycle)	X	6.35	67.90	16.52	0.00	150.0	± 9.6 %
		Y	6.10	67.40	16.36		150.0	
		Z	6.04	67.50	16.40		150.0	
10556-AAA	IEEE 1602.11ac WiFi (160MHz, MCS2, 99pc duty cycle)	X	6.31	67.76	16.45	0.00	150.0	± 9.6 %
		Y	6.12	67.42	16.37		150.0	
		Z	6.06	67.55	16.41		150.0	
10557-AAA	IEEE 1602.11ac WiFi (160MHz, MCS3, 99pc duty cycle)	X	6.32	67.78	16.49	0.00	150.0	± 9.6 %
		Y	6.09	67.35	16.35		150.0	
		Z	6.02	67.44	16.38		150.0	

10558-AAA	IEEE 1602.11ac WiFi (160MHz, MCS4, 99pc duty cycle)	X	6.37	67.94	16.58	0.00	150.0	± 9.6 %
		Y	6.15	67.54	16.46		150.0	
		Z	6.07	67.61	16.48		150.0	
10560-AAA	IEEE 1602.11ac WiFi (160MHz, MCS6, 99pc duty cycle)	X	6.41	67.89	16.59	0.00	150.0	± 9.6 %
		Y	6.13	67.35	16.40		150.0	
		Z	6.06	67.45	16.43		150.0	
10561-AAA	IEEE 1602.11ac WiFi (160MHz, MCS7, 99pc duty cycle)	X	6.29	67.78	16.58	0.00	150.0	± 9.6 %
		Y	6.06	67.32	16.43		150.0	
		Z	5.99	67.43	16.46		150.0	
10562-AAA	IEEE 1602.11ac WiFi (160MHz, MCS8, 99pc duty cycle)	X	6.44	68.21	16.80	0.00	150.0	± 9.6 %
		Y	6.22	67.82	16.68		150.0	
		Z	6.12	67.82	16.66		150.0	
10563-AAA	IEEE 1602.11ac WiFi (160MHz, MCS9, 99pc duty cycle)	X	6.59	68.18	16.73	0.00	150.0	± 9.6 %
		Y	6.63	68.58	17.01		150.0	
		Z	6.34	68.11	16.76		150.0	
10564-AAA	IEEE 802.11g WiFi 2.4 GHz (DSSS-OFDM, 9 Mbps, 99pc duty cycle)	X	5.25	67.12	16.59	0.46	150.0	± 9.6 %
		Y	4.98	66.92	16.45		150.0	
		Z	4.92	67.13	16.52		150.0	
10565-AAA	IEEE 802.11g WiFi 2.4 GHz (DSSS-OFDM, 12 Mbps, 99pc duty cycle)	X	5.57	67.65	16.90	0.46	150.0	± 9.6 %
		Y	5.23	67.39	16.77		150.0	
		Z	5.14	67.56	16.83		150.0	
10566-AAA	IEEE 802.11g WiFi 2.4 GHz (DSSS-OFDM, 18 Mbps, 99pc duty cycle)	X	5.38	67.52	16.73	0.46	150.0	± 9.6 %
		Y	5.06	67.25	16.60		150.0	
		Z	4.98	67.42	16.66		150.0	
10567-AAA	IEEE 802.11g WiFi 2.4 GHz (DSSS-OFDM, 24 Mbps, 99pc duty cycle)	X	5.40	67.87	17.04	0.46	150.0	± 9.6 %
		Y	5.08	67.62	16.93		150.0	
		Z	5.01	67.79	16.99		150.0	
10568-AAA	IEEE 802.11g WiFi 2.4 GHz (DSSS-OFDM, 36 Mbps, 99pc duty cycle)	X	5.28	67.17	16.47	0.46	150.0	± 9.6 %
		Y	4.98	67.02	16.37		150.0	
		Z	4.90	67.24	16.46		150.0	
10569-AAA	IEEE 802.11g WiFi 2.4 GHz (DSSS-OFDM, 48 Mbps, 99pc duty cycle)	X	5.33	67.87	17.05	0.46	150.0	± 9.6 %
		Y	5.03	67.67	16.98		150.0	
		Z	4.97	67.89	17.06		150.0	
10570-AAA	IEEE 802.11g WiFi 2.4 GHz (DSSS-OFDM, 54 Mbps, 99pc duty cycle)	X	5.37	67.60	16.95	0.46	150.0	± 9.6 %
		Y	5.07	67.53	16.92		150.0	
		Z	5.00	67.73	16.99		150.0	
10571-AAA	IEEE 802.11b WiFi 2.4 GHz (DSSS, 1 Mbps, 90pc duty cycle)	X	1.66	68.44	17.44	0.46	130.0	± 9.6 %
		Y	1.33	65.54	16.01		130.0	
		Z	1.35	66.28	16.53		130.0	
10572-AAA	IEEE 802.11b WiFi 2.4 GHz (DSSS, 2 Mbps, 90pc duty cycle)	X	1.71	69.24	17.84	0.46	130.0	± 9.6 %
		Y	1.36	66.15	16.37		130.0	
		Z	1.37	66.96	16.93		130.0	
10573-AAA	IEEE 802.11b WiFi 2.4 GHz (DSSS, 5.5 Mbps, 90pc duty cycle)	X	23.25	116.08	31.04	0.46	130.0	± 9.6 %
		Y	2.80	86.95	23.21		130.0	
		Z	7.22	103.82	28.80		130.0	
10574-AAA	IEEE 802.11b WiFi 2.4 GHz (DSSS, 11 Mbps, 90pc duty cycle)	X	2.45	78.44	21.67	0.46	130.0	± 9.6 %
		Y	1.56	72.17	19.23		130.0	
		Z	1.66	74.16	20.33		130.0	

10575-AAA	IEEE 802.11g WiFi 2.4 GHz (DSSS-OFDM, 6 Mbps, 90pc duty cycle)	X	5.08	67.00	16.69	0.46	130.0	± 9.6 %
		Y	4.80	66.81	16.56		130.0	
		Z	4.73	67.01	16.63		130.0	
10576-AAA	IEEE 802.11g WiFi 2.4 GHz (DSSS-OFDM, 9 Mbps, 90pc duty cycle)	X	5.11	67.18	16.76	0.46	130.0	± 9.6 %
		Y	4.82	66.96	16.62		130.0	
		Z	4.76	67.17	16.69		130.0	
10577-AAA	IEEE 802.11g WiFi 2.4 GHz (DSSS-OFDM, 12 Mbps, 90pc duty cycle)	X	5.40	67.54	16.94	0.46	130.0	± 9.6 %
		Y	5.04	67.27	16.80		130.0	
		Z	4.96	67.45	16.85		130.0	
10578-AAA	IEEE 802.11g WiFi 2.4 GHz (DSSS-OFDM, 18 Mbps, 90pc duty cycle)	X	5.29	67.72	17.03	0.46	130.0	± 9.6 %
		Y	4.94	67.44	16.89		130.0	
		Z	4.86	67.61	16.95		130.0	
10579-AAA	IEEE 802.11g WiFi 2.4 GHz (DSSS-OFDM, 24 Mbps, 90pc duty cycle)	X	5.09	67.24	16.49	0.46	130.0	± 9.6 %
		Y	4.71	66.78	16.24		130.0	
		Z	4.63	66.96	16.30		130.0	
10580-AAA	IEEE 802.11g WiFi 2.4 GHz (DSSS-OFDM, 36 Mbps, 90pc duty cycle)	X	5.13	67.14	16.47	0.46	130.0	± 9.6 %
		Y	4.76	66.78	16.25		130.0	
		Z	4.68	67.00	16.33		130.0	
10581-AAA	IEEE 802.11g WiFi 2.4 GHz (DSSS-OFDM, 48 Mbps, 90pc duty cycle)	X	5.24	67.96	17.05	0.46	130.0	± 9.6 %
		Y	4.84	67.49	16.84		130.0	
		Z	4.76	67.68	16.91		130.0	
10582-AAA	IEEE 802.11g WiFi 2.4 GHz (DSSS-OFDM, 54 Mbps, 90pc duty cycle)	X	5.05	66.95	16.29	0.46	130.0	± 9.6 %
		Y	4.66	66.55	16.03		130.0	
		Z	4.58	66.73	16.10		130.0	
10583-AAA	IEEE 802.11a/h WiFi 5 GHz (OFDM, 6 Mbps, 90pc duty cycle)	X	5.08	67.00	16.69	0.46	130.0	± 9.6 %
		Y	4.80	66.81	16.56		130.0	
		Z	4.73	67.01	16.63		130.0	
10584-AAA	IEEE 802.11a/h WiFi 5 GHz (OFDM, 9 Mbps, 90pc duty cycle)	X	5.11	67.18	16.76	0.46	130.0	± 9.6 %
		Y	4.82	66.96	16.62		130.0	
		Z	4.76	67.17	16.69		130.0	
10585-AAA	IEEE 802.11a/h WiFi 5 GHz (OFDM, 12 Mbps, 90pc duty cycle)	X	5.40	67.54	16.94	0.46	130.0	± 9.6 %
		Y	5.04	67.27	16.80		130.0	
		Z	4.96	67.45	16.85		130.0	
10586-AAA	IEEE 802.11a/h WiFi 5 GHz (OFDM, 18 Mbps, 90pc duty cycle)	X	5.29	67.72	17.03	0.46	130.0	± 9.6 %
		Y	4.94	67.44	16.89		130.0	
		Z	4.86	67.61	16.95		130.0	
10587-AAA	IEEE 802.11a/h WiFi 5 GHz (OFDM, 24 Mbps, 90pc duty cycle)	X	5.09	67.24	16.49	0.46	130.0	± 9.6 %
		Y	4.71	66.78	16.24		130.0	
		Z	4.63	66.96	16.30		130.0	
10588-AAA	IEEE 802.11a/h WiFi 5 GHz (OFDM, 36 Mbps, 90pc duty cycle)	X	5.13	67.14	16.47	0.46	130.0	± 9.6 %
		Y	4.76	66.78	16.25		130.0	
		Z	4.68	67.00	16.33		130.0	
10589-AAA	IEEE 802.11a/h WiFi 5 GHz (OFDM, 48 Mbps, 90pc duty cycle)	X	5.24	67.96	17.05	0.46	130.0	± 9.6 %
		Y	4.84	67.49	16.84		130.0	
		Z	4.76	67.68	16.91		130.0	
10590-AAA	IEEE 802.11a/h WiFi 5 GHz (OFDM, 54 Mbps, 90pc duty cycle)	X	5.05	66.95	16.29	0.46	130.0	± 9.6 %
		Y	4.66	66.55	16.03		130.0	
		Z	4.58	66.73	16.10		130.0	

10591-AAA	IEEE 802.11n (HT Mixed, 20MHz, MCS0, 90pc duty cycle)	X	5.23	67.05	16.77	0.46	130.0	± 9.6 %
		Y	4.95	66.86	16.65		130.0	
		Z	4.88	67.05	16.71		130.0	
10592-AAA	IEEE 802.11n (HT Mixed, 20MHz, MCS1, 90pc duty cycle)	X	5.44	67.40	16.87	0.46	130.0	± 9.6 %
		Y	5.11	67.20	16.78		130.0	
		Z	5.03	67.39	16.84		130.0	
10593-AAA	IEEE 802.11n (HT Mixed, 20MHz, MCS2, 90pc duty cycle)	X	5.39	67.43	16.83	0.46	130.0	± 9.6 %
		Y	5.04	67.14	16.68		130.0	
		Z	4.96	67.31	16.73		130.0	
10594-AAA	IEEE 802.11n (HT Mixed, 20MHz, MCS3, 90pc duty cycle)	X	5.42	67.52	16.93	0.46	130.0	± 9.6 %
		Y	5.09	67.29	16.82		130.0	
		Z	5.01	67.47	16.88		130.0	
10595-AAA	IEEE 802.11n (HT Mixed, 20MHz, MCS4, 90pc duty cycle)	X	5.44	67.58	16.88	0.46	130.0	± 9.6 %
		Y	5.06	67.25	16.72		130.0	
		Z	4.98	67.43	16.78		130.0	
10596-AAA	IEEE 802.11n (HT Mixed, 20MHz, MCS5, 90pc duty cycle)	X	5.36	67.53	16.86	0.46	130.0	± 9.6 %
		Y	5.00	67.25	16.73		130.0	
		Z	4.92	67.44	16.79		130.0	
10597-AAA	IEEE 802.11n (HT Mixed, 20MHz, MCS6, 90pc duty cycle)	X	5.32	67.55	16.82	0.46	130.0	± 9.6 %
		Y	4.95	67.17	16.62		130.0	
		Z	4.87	67.35	16.68		130.0	
10598-AAA	IEEE 802.11n (HT Mixed, 20MHz, MCS7, 90pc duty cycle)	X	5.31	67.84	17.09	0.46	130.0	± 9.6 %
		Y	4.93	67.41	16.88		130.0	
		Z	4.85	67.56	16.93		130.0	
10599-AAA	IEEE 802.11n (HT Mixed, 40MHz, MCS0, 90pc duty cycle)	X	5.98	68.04	17.10	0.46	130.0	± 9.6 %
		Y	5.63	67.46	16.88		130.0	
		Z	5.55	67.59	16.92		130.0	
10600-AAA	IEEE 802.11n (HT Mixed, 40MHz, MCS1, 90pc duty cycle)	X	6.16	68.48	17.29	0.46	130.0	± 9.6 %
		Y	5.84	68.13	17.18		130.0	
		Z	5.70	68.07	17.13		130.0	
10601-AAA	IEEE 802.11n (HT Mixed, 40MHz, MCS2, 90pc duty cycle)	X	6.01	68.11	17.11	0.46	130.0	± 9.6 %
		Y	5.68	67.73	17.00		130.0	
		Z	5.58	67.79	17.01		130.0	
10602-AAA	IEEE 802.11n (HT Mixed, 40MHz, MCS3, 90pc duty cycle)	X	6.12	68.18	17.08	0.46	130.0	± 9.6 %
		Y	5.77	67.72	16.91		130.0	
		Z	5.68	67.84	16.95		130.0	
10603-AAA	IEEE 802.11n (HT Mixed, 40MHz, MCS4, 90pc duty cycle)	X	6.27	68.61	17.40	0.46	130.0	± 9.6 %
		Y	5.85	68.00	17.18		130.0	
		Z	5.75	68.10	17.21		130.0	
10604-AAA	IEEE 802.11n (HT Mixed, 40MHz, MCS5, 90pc duty cycle)	X	5.96	67.89	17.04	0.46	130.0	± 9.6 %
		Y	5.63	67.42	16.88		130.0	
		Z	5.56	67.56	16.93		130.0	
10605-AAA	IEEE 802.11n (HT Mixed, 40MHz, MCS6, 90pc duty cycle)	X	6.05	68.09	17.15	0.46	130.0	± 9.6 %
		Y	5.76	67.82	17.08		130.0	
		Z	5.68	67.94	17.13		130.0	
10606-AAA	IEEE 802.11n (HT Mixed, 40MHz, MCS7, 90pc duty cycle)	X	5.81	67.58	16.78	0.46	130.0	± 9.6 %
		Y	5.51	67.17	16.62		130.0	
		Z	5.42	67.25	16.64		130.0	



10607-AAA	IEEE 802.11ac WiFi (20MHz, MCS0, 90pc duty cycle)	X	5.04	66.30	16.36	0.46	130.0	± 9.6 %
		Y	4.78	66.14	16.25		130.0	
		Z	4.72	66.37	16.34		130.0	
10608-AAA	IEEE 802.11ac WiFi (20MHz, MCS1, 90pc duty cycle)	X	5.30	66.73	16.50	0.46	130.0	± 9.6 %
		Y	4.98	66.56	16.42		130.0	
		Z	4.90	66.77	16.50		130.0	
10609-AAA	IEEE 802.11ac WiFi (20MHz, MCS2, 90pc duty cycle)	X	5.19	66.70	16.41	0.46	130.0	± 9.6 %
		Y	4.87	66.42	16.27		130.0	
		Z	4.79	66.63	16.35		130.0	
10610-AAA	IEEE 802.11ac WiFi (20MHz, MCS3, 90pc duty cycle)	X	5.25	66.83	16.55	0.46	130.0	± 9.6 %
		Y	4.92	66.58	16.43		130.0	
		Z	4.84	66.79	16.50		130.0	
10611-AAA	IEEE 802.11ac WiFi (20MHz, MCS4, 90pc duty cycle)	X	5.20	66.77	16.47	0.46	130.0	± 9.6 %
		Y	4.84	66.40	16.28		130.0	
		Z	4.76	66.60	16.36		130.0	
10612-AAA	IEEE 802.11ac WiFi (20MHz, MCS5, 90pc duty cycle)	X	5.21	66.84	16.45	0.46	130.0	± 9.6 %
		Y	4.85	66.56	16.33		130.0	
		Z	4.77	66.77	16.41		130.0	
10613-AAA	IEEE 802.11ac WiFi (20MHz, MCS6, 90pc duty cycle)	X	5.23	66.80	16.38	0.46	130.0	± 9.6 %
		Y	4.86	66.47	16.23		130.0	
		Z	4.78	66.66	16.30		130.0	
10614-AAA	IEEE 802.11ac WiFi (20MHz, MCS7, 90pc duty cycle)	X	5.17	67.09	16.66	0.46	130.0	± 9.6 %
		Y	4.79	66.63	16.45		130.0	
		Z	4.72	66.82	16.52		130.0	
10615-AAA	IEEE 802.11ac WiFi (20MHz, MCS8, 90pc duty cycle)	X	5.19	66.51	16.22	0.46	130.0	± 9.6 %
		Y	4.84	66.23	16.06		130.0	
		Z	4.76	66.45	16.15		130.0	
10616-AAA	IEEE 802.11ac WiFi (40MHz, MCS0, 90pc duty cycle)	X	5.70	67.02	16.57	0.46	130.0	± 9.6 %
		Y	5.44	66.69	16.47		130.0	
		Z	5.36	66.82	16.52		130.0	
10617-AAA	IEEE 802.11ac WiFi (40MHz, MCS1, 90pc duty cycle)	X	5.80	67.16	16.60	0.46	130.0	± 9.6 %
		Y	5.50	66.84	16.51		130.0	
		Z	5.44	67.03	16.59		130.0	
10618-AAA	IEEE 802.11ac WiFi (40MHz, MCS2, 90pc duty cycle)	X	5.66	67.20	16.64	0.46	130.0	± 9.6 %
		Y	5.39	66.87	16.55		130.0	
		Z	5.32	67.02	16.60		130.0	
10619-AAA	IEEE 802.11ac WiFi (40MHz, MCS3, 90pc duty cycle)	X	5.69	67.00	16.48	0.46	130.0	± 9.6 %
		Y	5.42	66.71	16.40		130.0	
		Z	5.34	66.85	16.45		130.0	
10620-AAA	IEEE 802.11ac WiFi (40MHz, MCS4, 90pc duty cycle)	X	5.85	67.18	16.62	0.46	130.0	± 9.6 %
		Y	5.52	66.78	16.49		130.0	
		Z	5.43	66.87	16.51		130.0	
10621-AAA	IEEE 802.11ac WiFi (40MHz, MCS5, 90pc duty cycle)	X	5.81	67.25	16.76	0.46	130.0	± 9.6 %
		Y	5.50	66.84	16.63		130.0	
		Z	5.42	66.97	16.68		130.0	
10622-AAA	IEEE 802.11ac WiFi (40MHz, MCS6, 90pc duty cycle)	X	5.76	67.22	16.74	0.46	130.0	± 9.6 %
		Y	5.51	67.01	16.71		130.0	
		Z	5.44	67.16	16.77		130.0	

10623-AAA	IEEE 802.11ac WiFi (40MHz, MCS7, 90pc duty cycle)	X	5.73	67.10	16.58	0.46	130.0	± 9.6 %
		Y	5.38	66.53	16.35		130.0	
		Z	5.32	66.69	16.41		130.0	
10624-AAA	IEEE 802.11ac WiFi (40MHz, MCS8, 90pc duty cycle)	X	5.85	67.03	16.60	0.46	130.0	± 9.6 %
		Y	5.59	66.76	16.53		130.0	
		Z	5.51	66.88	16.57		130.0	
10625-AAA	IEEE 802.11ac WiFi (40MHz, MCS9, 90pc duty cycle)	X	6.18	67.71	16.97	0.46	130.0	± 9.6 %
		Y	6.05	68.01	17.20		130.0	
		Z	5.89	67.91	17.13		130.0	
10626-AAA	IEEE 802.11ac WiFi (80MHz, MCS0, 90pc duty cycle)	X	5.90	67.04	16.50	0.46	130.0	± 9.6 %
		Y	5.71	66.72	16.41		130.0	
		Z	5.66	66.86	16.46		130.0	
10627-AAA	IEEE 802.11ac WiFi (80MHz, MCS1, 90pc duty cycle)	X	6.16	67.44	16.62	0.46	130.0	± 9.6 %
		Y	5.99	67.38	16.70		130.0	
		Z	5.91	67.48	16.73		130.0	
10628-AAA	IEEE 802.11ac WiFi (80MHz, MCS2, 90pc duty cycle)	X	6.03	67.34	16.53	0.46	130.0	± 9.6 %
		Y	5.77	66.89	16.39		130.0	
		Z	5.70	66.99	16.42		130.0	
10629-AAA	IEEE 802.11ac WiFi (80MHz, MCS3, 90pc duty cycle)	X	6.14	67.42	16.56	0.46	130.0	± 9.6 %
		Y	5.85	66.95	16.41		130.0	
		Z	5.78	67.06	16.45		130.0	
10630-AAA	IEEE 802.11ac WiFi (80MHz, MCS4, 90pc duty cycle)	X	6.60	68.90	17.30	0.46	130.0	± 9.6 %
		Y	6.51	69.06	17.46		130.0	
		Z	6.28	68.74	17.29		130.0	
10631-AAA	IEEE 802.11ac WiFi (80MHz, MCS5, 90pc duty cycle)	X	6.69	69.20	17.61	0.46	130.0	± 9.6 %
		Y	6.27	68.46	17.35		130.0	
		Z	6.11	68.34	17.28		130.0	
10632-AAA	IEEE 802.11ac WiFi (80MHz, MCS6, 90pc duty cycle)	X	6.24	67.82	16.94	0.46	130.0	± 9.6 %
		Y	5.94	67.39	16.84		130.0	
		Z	5.87	67.50	16.88		130.0	
10633-AAA	IEEE 802.11ac WiFi (80MHz, MCS7, 90pc duty cycle)	X	6.15	67.59	16.67	0.46	130.0	± 9.6 %
		Y	5.84	67.04	16.49		130.0	
		Z	5.75	67.11	16.51		130.0	
10634-AAA	IEEE 802.11ac WiFi (80MHz, MCS8, 90pc duty cycle)	X	6.17	67.68	16.78	0.46	130.0	± 9.6 %
		Y	5.81	67.04	16.55		130.0	
		Z	5.73	67.14	16.58		130.0	
10635-AAA	IEEE 802.11ac WiFi (80MHz, MCS9, 90pc duty cycle)	X	6.04	67.02	16.21	0.46	130.0	± 9.6 %
		Y	5.71	66.42	15.98		130.0	
		Z	5.62	66.52	16.02		130.0	
10636-AAA	IEEE 1602.11ac WiFi (160MHz, MCS0, 90pc duty cycle)	X	6.29	67.42	16.59	0.46	130.0	± 9.6 %
		Y	6.13	67.13	16.52		130.0	
		Z	6.07	67.23	16.55		130.0	
10637-AAA	IEEE 1602.11ac WiFi (160MHz, MCS1, 90pc duty cycle)	X	6.55	68.03	16.85	0.46	130.0	± 9.6 %
		Y	6.31	67.56	16.71		130.0	
		Z	6.24	67.64	16.74		130.0	
10638-AAA	IEEE 1602.11ac WiFi (160MHz, MCS2, 90pc duty cycle)	X	6.48	67.77	16.71	0.46	130.0	± 9.6 %
		Y	6.31	67.53	16.68		130.0	
		Z	6.23	67.61	16.70		130.0	

10639-AAA	IEEE 1602.11ac WiFi (160MHz, MCS3, 90pc duty cycle)	X	6.52	67.90	16.82	0.46	130.0	± 9.6 %
		Y	6.29	67.48	16.70		130.0	
		Z	6.21	67.54	16.71		130.0	
10640-AAA	IEEE 1602.11ac WiFi (160MHz, MCS4, 90pc duty cycle)	X	6.53	67.94	16.79	0.46	130.0	± 9.6 %
		Y	6.31	67.55	16.68		130.0	
		Z	6.22	67.57	16.67		130.0	
10641-AAA	IEEE 1602.11ac WiFi (160MHz, MCS5, 90pc duty cycle)	X	6.56	67.74	16.70	0.46	130.0	± 9.6 %
		Y	6.32	67.33	16.59		130.0	
		Z	6.26	67.47	16.64		130.0	
10642-AAA	IEEE 1602.11ac WiFi (160MHz, MCS6, 90pc duty cycle)	X	6.66	68.15	17.06	0.46	130.0	± 9.6 %
		Y	6.37	67.62	16.89		130.0	
		Z	6.29	67.69	16.90		130.0	
10643-AAA	IEEE 1602.11ac WiFi (160MHz, MCS7, 90pc duty cycle)	X	6.45	67.77	16.79	0.46	130.0	± 9.6 %
		Y	6.21	67.32	16.65		130.0	
		Z	6.14	67.41	16.67		130.0	
10644-AAA	IEEE 1602.11ac WiFi (160MHz, MCS8, 90pc duty cycle)	X	6.70	68.51	17.19	0.46	130.0	± 9.6 %
		Y	6.43	67.99	17.00		130.0	
		Z	6.30	67.92	16.95		130.0	
10645-AAA	IEEE 1602.11ac WiFi (160MHz, MCS9, 90pc duty cycle)	X	6.82	68.38	17.06	0.46	130.0	± 9.6 %
		Y	6.97	69.10	17.51		130.0	
		Z	6.66	68.59	17.25		130.0	
10646-AAB	LTE-TDD (SC-FDMA, 1 RB, 5 MHz, QPSK, UL Subframe=2,7)	X	20.33	96.08	30.98	9.30	60.0	± 9.6 %
		Y	28.65	112.39	37.39		60.0	
		Z	69.08	135.74	44.36		60.0	
10647-AAA	LTE-TDD (SC-FDMA, 1 RB, 20 MHz, QPSK, UL Subframe=2,7)	X	21.13	97.54	31.55	9.30	60.0	± 9.6 %
		Y	28.75	113.30	37.80		60.0	
		Z	67.82	136.37	44.71		60.0	
10648-AAA	CDMA2000 (1x Advanced)	X	1.02	66.50	14.04	0.00	150.0	± 9.6 %
		Y	0.75	63.83	11.28		150.0	
		Z	0.75	64.56	11.47		150.0	

<sup>E</sup> Uncertainty is determined using the max. deviation from linear response applying rectangular distribution and is expressed for the square of the field value.



Accredited by the Swiss Accreditation Service (SAS)  
The Swiss Accreditation Service is one of the signatories to the EA  
Multilateral Agreement for the recognition of calibration certificates

Accreditation No.: **SCS 0108**

Client **PC Test**

Certificate No: **EX3-7357\_Apr16**

## CALIBRATION CERTIFICATE

Object: **EX3DV4 - SN:7357**

Calibration procedure(s): **QA CAL-01.v9, QA CAL-14.v4, QA CAL-23.v5, QA CAL-25.v6**  
**Calibration procedure for dosimetric E-field probes**

Calibration date: **April 19, 2016**

BN 04126116

This calibration certificate documents the traceability to national standards, which realize the physical units of measurements (SI).  
The measurements and the uncertainties with confidence probability are given on the following pages and are part of the certificate.

All calibrations have been conducted in the closed laboratory facility: environment temperature (22 ± 3)°C and humidity < 70%.

Calibration Equipment used (M&TE critical for calibration)

Primary Standards	ID	Cal Date (Certificate No.)	Scheduled Calibration
Power meter NRP	SN: 104778	06-Apr-16 (No. 217-02288/02289)	Apr-17
Power sensor NRP-Z91	SN: 103244	06-Apr-16 (No. 217-02288)	Apr-17
Power sensor NRP-Z91	SN: 103245	06-Apr-16 (No. 217-02289)	Apr-17
Reference 20 dB Attenuator	SN: S5277 (20x)	05-Apr-16 (No. 217-02293)	Apr-17
Reference Probe ES3DV2	SN: 3013	31-Dec-15 (No. ES3-3013_Dec15)	Dec-16
DAE4	SN: 660	23-Dec-15 (No. DAE4-660_Dec15)	Dec-16
Secondary Standards	ID	Check Date (in house)	Scheduled Check
Power meter E4419B	SN: GB41293874	06-Apr-16 (No. 217-02285/02284)	In house check: Jun-16
Power sensor E4412A	SN: MY41498087	06-Apr-16 (No. 217-02285)	In house check: Jun-16
Power sensor E4412A	SN: 000110210	06-Apr-16 (No. 217-02284)	In house check: Jun-16
RF generator HP 8648C	SN: US3642U01700	04-Aug-99 (in house check Apr-13)	In house check: Jun-16
Network Analyzer HP 8753E	SN: US37390585	18-Oct-01 (in house check Oct-15)	In house check: Oct-16

Calibrated by:	Name <b>Leif Klynsner</b>	Function <b>Laboratory Technician</b>	Signature 
Approved by:	Name <b>Katja Pokovic</b>	Function <b>Technical Manager</b>	

Issued: April 21, 2016

This calibration certificate shall not be reproduced except in full without written approval of the laboratory.



Accredited by the Swiss Accreditation Service (SAS)

The Swiss Accreditation Service is one of the signatories to the EA  
Multilateral Agreement for the recognition of calibration certificates

Accreditation No.: **SCS 0108**

**Glossary:**

TSL	tissue simulating liquid
NORM <sub>x,y,z</sub>	sensitivity in free space
ConvF	sensitivity in TSL / NORM <sub>x,y,z</sub>
DCP	diode compression point
CF	crest factor (1/duty_cycle) of the RF signal
A, B, C, D	modulation dependent linearization parameters
Polarization $\varphi$	$\varphi$ rotation around probe axis
Polarization $\vartheta$	$\vartheta$ rotation around an axis that is in the plane normal to probe axis (at measurement center), i.e., $\vartheta = 0$ is normal to probe axis
Connector Angle	information used in DASY system to align probe sensor X to the robot coordinate system

**Calibration is Performed According to the Following Standards:**

- a) IEEE Std 1528-2013, "IEEE Recommended Practice for Determining the Peak Spatial-Averaged Specific Absorption Rate (SAR) in the Human Head from Wireless Communications Devices: Measurement Techniques", June 2013
- b) IEC 62209-1, "Procedure to measure the Specific Absorption Rate (SAR) for hand-held devices used in close proximity to the ear (frequency range of 300 MHz to 3 GHz)", February 2005
- c) IEC 62209-2, "Procedure to determine the Specific Absorption Rate (SAR) for wireless communication devices used in close proximity to the human body (frequency range of 30 MHz to 6 GHz)", March 2010
- d) KDB 865664, "SAR Measurement Requirements for 100 MHz to 6 GHz"

**Methods Applied and Interpretation of Parameters:**

- *NORM<sub>x,y,z</sub>*: Assessed for E-field polarization  $\vartheta = 0$  ( $f \leq 900$  MHz in TEM-cell;  $f > 1800$  MHz: R22 waveguide). *NORM<sub>x,y,z</sub>* are only intermediate values, i.e., the uncertainties of *NORM<sub>x,y,z</sub>* does not affect the  $E^2$ -field uncertainty inside TSL (see below *ConvF*).
- *NORM(f)<sub>x,y,z</sub> = NORM<sub>x,y,z</sub> \* frequency\_response* (see Frequency Response Chart). This linearization is implemented in DASY4 software versions later than 4.2. The uncertainty of the frequency response is included in the stated uncertainty of *ConvF*.
- *DCP<sub>x,y,z</sub>*: DCP are numerical linearization parameters assessed based on the data of power sweep with CW signal (no uncertainty required). DCP does not depend on frequency nor media.
- *PAR*: PAR is the Peak to Average Ratio that is not calibrated but determined based on the signal characteristics
- *A<sub>x,y,z</sub>; B<sub>x,y,z</sub>; C<sub>x,y,z</sub>; D<sub>x,y,z</sub>; VR<sub>x,y,z</sub>; A, B, C, D* are numerical linearization parameters assessed based on the data of power sweep for specific modulation signal. The parameters do not depend on frequency nor media. *VR* is the maximum calibration range expressed in RMS voltage across the diode.
- *ConvF and Boundary Effect Parameters*: Assessed in flat phantom using E-field (or Temperature Transfer Standard for  $f \leq 800$  MHz) and inside waveguide using analytical field distributions based on power measurements for  $f > 800$  MHz. The same setups are used for assessment of the parameters applied for boundary compensation (alpha, depth) of which typical uncertainty values are given. These parameters are used in DASY4 software to improve probe accuracy close to the boundary. The sensitivity in TSL corresponds to *NORM<sub>x,y,z</sub> \* ConvF* whereby the uncertainty corresponds to that given for *ConvF*. A frequency dependent *ConvF* is used in DASY version 4.4 and higher which allows extending the validity from  $\pm 50$  MHz to  $\pm 100$  MHz.
- *Spherical isotropy (3D deviation from isotropy)*: in a field of low gradients realized using a flat phantom exposed by a patch antenna.
- *Sensor Offset*: The sensor offset corresponds to the offset of virtual measurement center from the probe tip (on probe axis). No tolerance required.
- *Connector Angle*: The angle is assessed using the information gained by determining the *NORM<sub>x</sub>* (no uncertainty required).

# Probe EX3DV4

## SN:7357

Manufactured: February 5, 2015  
Calibrated: April 19, 2016

Calibrated for DASY/EASY Systems  
(Note: non-compatible with DASY2 system!)

## DASY/EASY - Parameters of Probe: EX3DV4 - SN:7357

### Basic Calibration Parameters

	Sensor X	Sensor Y	Sensor Z	Unc (k=2)
Norm ( $\mu\text{V}/(\text{V}/\text{m})^2$ ) <sup>A</sup>	0.41	0.49	0.41	$\pm 10.1 \%$
DCP (mV) <sup>B</sup>	100.8	97.2	96.9	

### Modulation Calibration Parameters

UID	Communication System Name		A dB	B dB $\sqrt{\mu\text{V}}$	C	D dB	VR mV	Unc <sup>E</sup> (k=2)
0	CW	X	0.0	0.0	1.0	0.00	153.4	$\pm 3.5 \%$
		Y	0.0	0.0	1.0		128.2	
		Z	0.0	0.0	1.0		136.1	
10010- CAA	SAR Validation (Square, 100ms, 10ms)	X	0.91	56.3	8.7	10.00	47.8	$\pm 0.9 \%$
		Y	4.06	72.5	15.7		44.9	
		Z	1.42	61.4	10.6		43.6	
10062- CAB	IEEE 802.11a/h WiFi 5 GHz (OFDM, 6 Mbps)	X	10.02	67.8	20.9	8.68	112.1	$\pm 2.7 \%$
		Y	10.67	69.9	22.4		141.6	
		Z	10.36	68.8	21.5		139.7	
10117- CAB	IEEE 802.11n (HT Mixed, 13.5 Mbps, BPSK)	X	10.12	68.1	20.6	8.07	121.4	$\pm 2.2 \%$
		Y	10.75	69.9	21.9		149.3	
		Z	10.43	68.9	21.1		147.5	
10196- CAB	IEEE 802.11n (HT Mixed, 6.5 Mbps, BPSK)	X	9.77	67.9	20.6	8.10	116.1	$\pm 2.2 \%$
		Y	10.28	69.5	21.8		141.5	
		Z	10.05	68.6	21.0		138.3	
10400- AAC	IEEE 802.11ac WiFi (20MHz, 64-QAM, 99pc duty cycle)	X	10.02	68.1	20.9	8.37	116.5	$\pm 2.2 \%$
		Y	10.56	69.7	22.1		142.1	
		Z	10.23	68.6	21.2		137.4	
10401- AAC	IEEE 802.11ac WiFi (40MHz, 64-QAM, 99pc duty cycle)	X	10.73	68.6	21.1	8.60	123.1	$\pm 2.5 \%$
		Y	10.37	67.9	21.0		99.7	
		Z	11.03	69.3	21.6		147.8	
10402- AAC	IEEE 802.11ac WiFi (80MHz, 64-QAM, 99pc duty cycle)	X	10.70	68.5	20.9	8.53	121.8	$\pm 2.2 \%$
		Y	10.46	68.2	21.0		99.9	
		Z	10.94	69.1	21.3		146.0	

The reported uncertainty of measurement is stated as the standard uncertainty of measurement multiplied by the coverage factor  $k=2$ , which for a normal distribution corresponds to a coverage probability of approximately 95%.

<sup>A</sup> The uncertainties of Norm X,Y,Z do not affect the  $E^2$ -field uncertainty inside TSL. (see Pages 5 and 6).

<sup>B</sup> Numerical linearization parameter: uncertainty not required.

<sup>E</sup> Uncertainty is determined using the max. deviation from linear response applying rectangular distribution and is expressed for the square of the field value.

## DASY/EASY - Parameters of Probe: EX3DV4 - SN:7357

### Calibration Parameter Determined in Head Tissue Simulating Media

f (MHz) <sup>C</sup>	Relative Permittivity <sup>F</sup>	Conductivity (S/m) <sup>F</sup>	ConvF X	ConvF Y	ConvF Z	Alpha <sup>G</sup>	Depth <sup>G</sup> (mm)	Unc (k=2)
5250	35.9	4.71	5.10	5.10	5.10	0.40	1.80	± 13.1 %
5600	35.5	5.07	4.41	4.41	4.41	0.50	1.80	± 13.1 %
5750	35.4	5.22	4.65	4.65	4.65	0.50	1.80	± 13.1 %

<sup>C</sup> Frequency validity above 300 MHz of ± 100 MHz only applies for DASY v4.4 and higher (see Page 2), else it is restricted to ± 50 MHz. The uncertainty is the RSS of the ConvF uncertainty at calibration frequency and the uncertainty for the indicated frequency band. Frequency validity below 300 MHz is ± 10, 25, 40, 50 and 70 MHz for ConvF assessments at 30, 64, 128, 150 and 220 MHz respectively. Above 5 GHz frequency validity can be extended to ± 110 MHz.

<sup>F</sup> At frequencies below 3 GHz, the validity of tissue parameters ( $\epsilon$  and  $\sigma$ ) can be relaxed to ± 10% if liquid compensation formula is applied to measured SAR values. At frequencies above 3 GHz, the validity of tissue parameters ( $\epsilon$  and  $\sigma$ ) is restricted to ± 5%. The uncertainty is the RSS of the ConvF uncertainty for indicated target tissue parameters.

<sup>G</sup> Alpha/Depth are determined during calibration. SPEAG warrants that the remaining deviation due to the boundary effect after compensation is always less than ± 1% for frequencies below 3 GHz and below ± 2% for frequencies between 3-6 GHz at any distance larger than half the probe tip diameter from the boundary.



## DASY/EASY - Parameters of Probe: EX3DV4 - SN:7357

### Calibration Parameter Determined in Body Tissue Simulating Media

f (MHz) <sup>C</sup>	Relative Permittivity <sup>F</sup>	Conductivity (S/m) <sup>F</sup>	ConvF X	ConvF Y	ConvF Z	Alpha <sup>G</sup>	Depth <sup>G</sup> (mm)	Unc (k=2)
750	55.5	0.96	9.90	9.90	9.90	0.53	0.80	± 12.0 %
835	55.2	0.97	9.82	9.82	9.82	0.46	0.80	± 12.0 %
1750	53.4	1.49	8.06	8.06	8.06	0.39	0.80	± 12.0 %
1900	53.3	1.52	7.84	7.84	7.84	0.40	0.80	± 12.0 %
2300	52.9	1.81	7.20	7.20	7.20	0.38	0.86	± 12.0 %
2450	52.7	1.95	7.14	7.14	7.14	0.30	0.90	± 12.0 %
2600	52.5	2.16	6.82	6.82	6.82	0.29	0.95	± 12.0 %
5250	48.9	5.36	4.28	4.28	4.28	0.50	1.90	± 13.1 %
5600	48.5	5.77	3.63	3.63	3.63	0.60	1.90	± 13.1 %
5750	48.3	5.94	3.77	3.77	3.77	0.60	1.90	± 13.1 %

<sup>C</sup> Frequency validity above 300 MHz of ± 100 MHz only applies for DASY v4.4 and higher (see Page 2), else it is restricted to ± 50 MHz. The uncertainty is the RSS of the ConvF uncertainty at calibration frequency and the uncertainty for the indicated frequency band. Frequency validity below 300 MHz is ± 10, 25, 40, 50 and 70 MHz for ConvF assessments at 30, 64, 128, 150 and 220 MHz respectively. Above 5 GHz frequency validity can be extended to ± 110 MHz.

<sup>F</sup> At frequencies below 3 GHz, the validity of tissue parameters ( $\epsilon$  and  $\sigma$ ) can be relaxed to ± 10% if liquid compensation formula is applied to measured SAR values. At frequencies above 3 GHz, the validity of tissue parameters ( $\epsilon$  and  $\sigma$ ) is restricted to ± 5%. The uncertainty is the RSS of the ConvF uncertainty for indicated target tissue parameters.

<sup>G</sup> Alpha/Depth are determined during calibration. SPEAG warrants that the remaining deviation due to the boundary effect after compensation is always less than ± 1% for frequencies below 3 GHz and below ± 2% for frequencies between 3-6 GHz at any distance larger than half the probe tip diameter from the boundary.

### Frequency Response of E-Field (TEM-Cell:ifi110 EXX, Waveguide: R22)

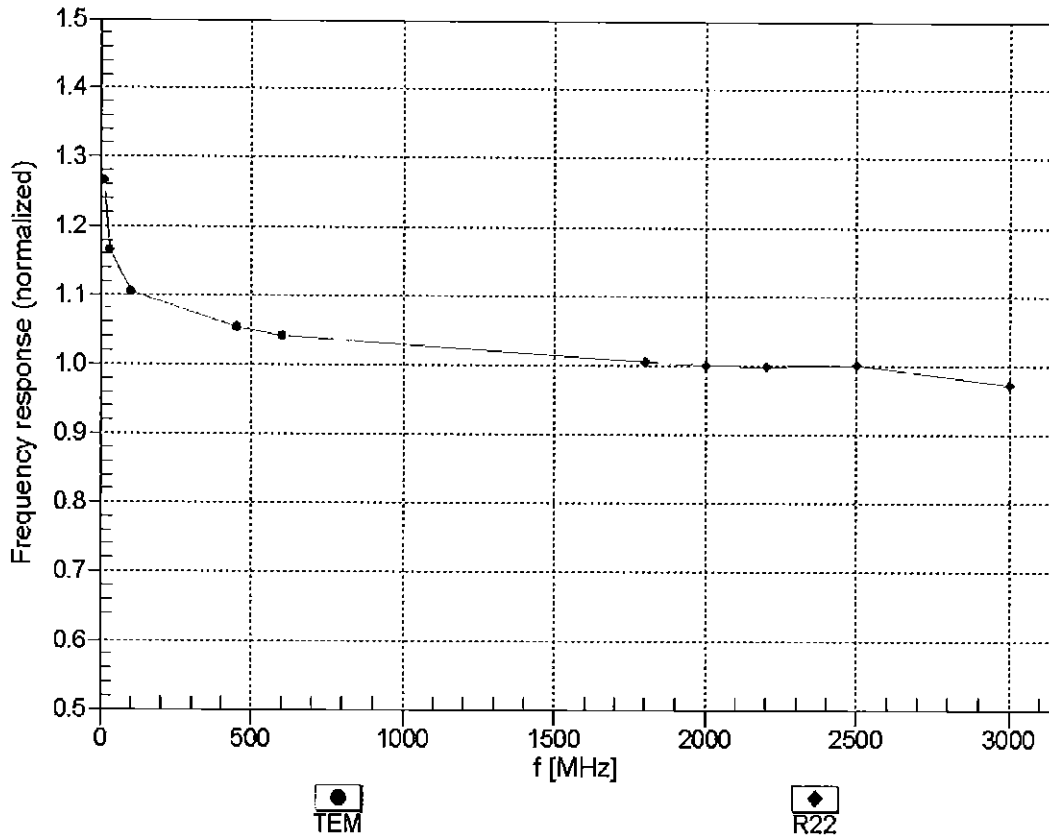

Uncertainty of Frequency Response of E-field:  $\pm 6.3\%$  (k=2)

### Receiving Pattern ( $\phi$ ), $\theta = 0^\circ$

f=600 MHz,TEM

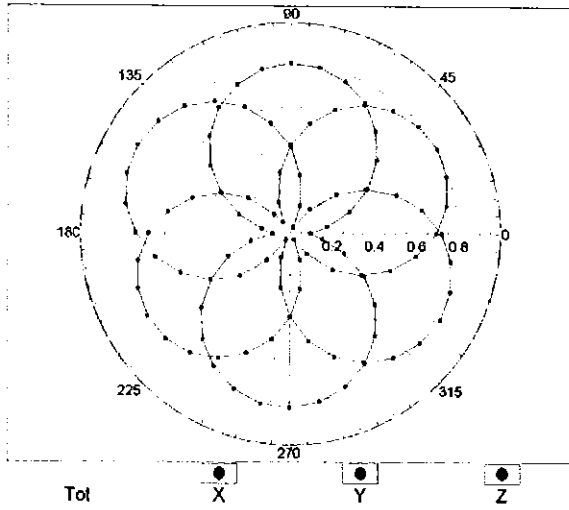

f=1800 MHz,R22

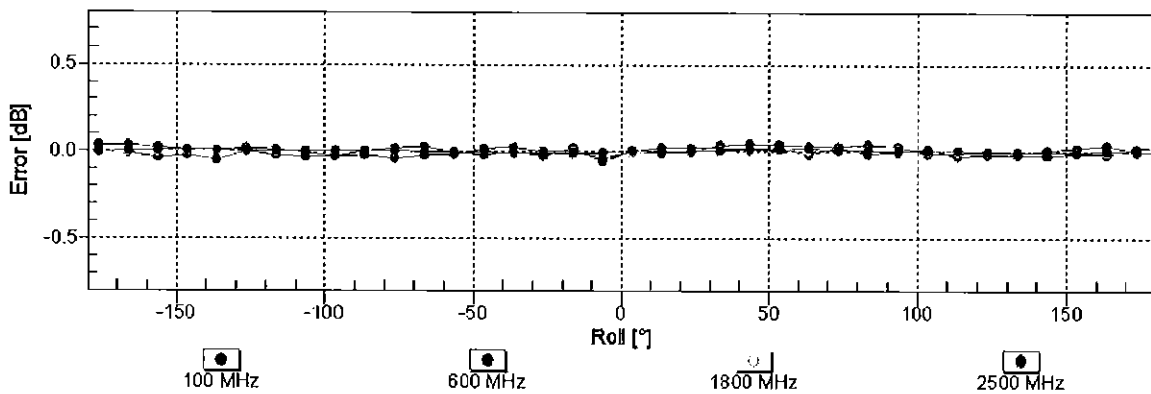
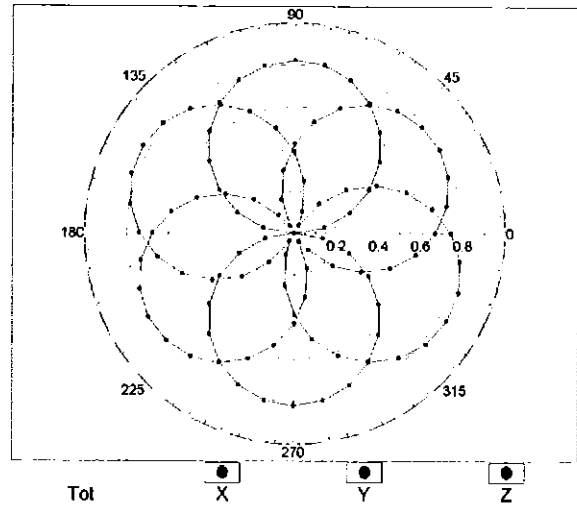

Uncertainty of Axial Isotropy Assessment:  $\pm 0.5\%$  (k=2)

### Dynamic Range $f(SAR_{head})$ (TEM cell, $f_{eval}=1900$ MHz)

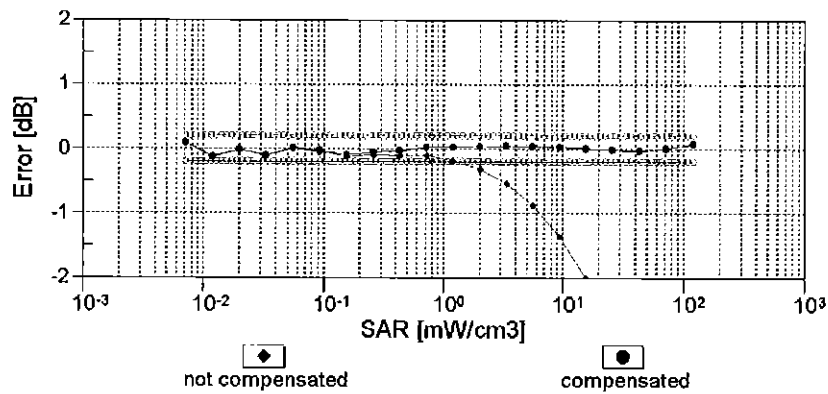
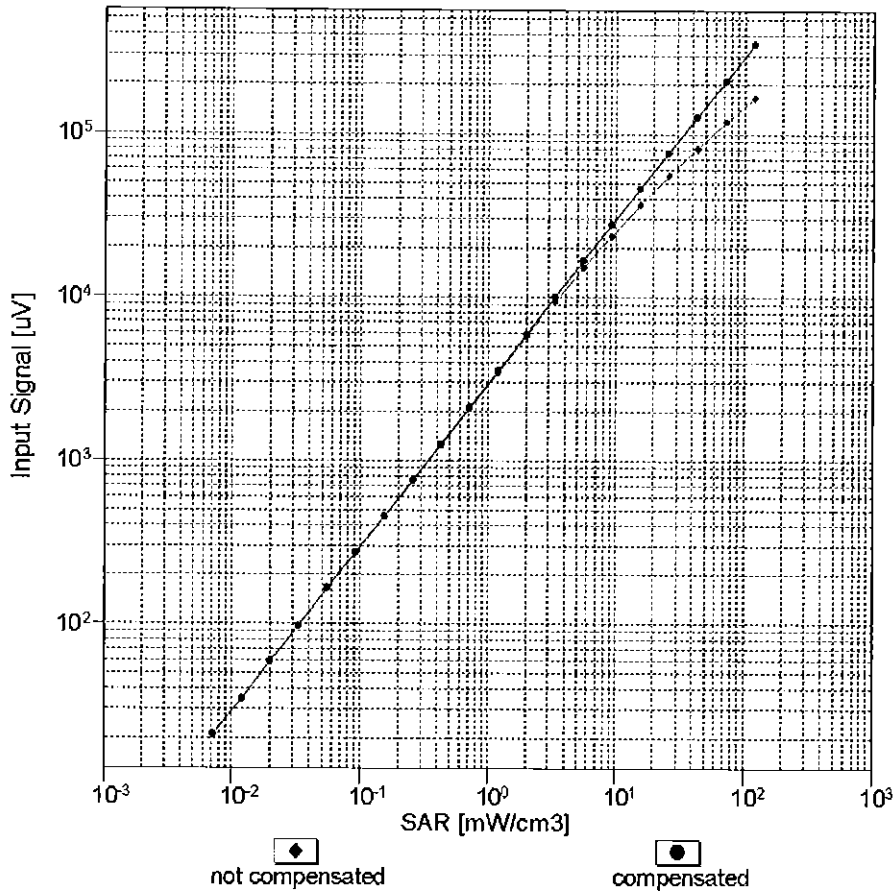

Uncertainty of Linearity Assessment:  $\pm 0.6\%$  ( $k=2$ )

# Conversion Factor Assessment

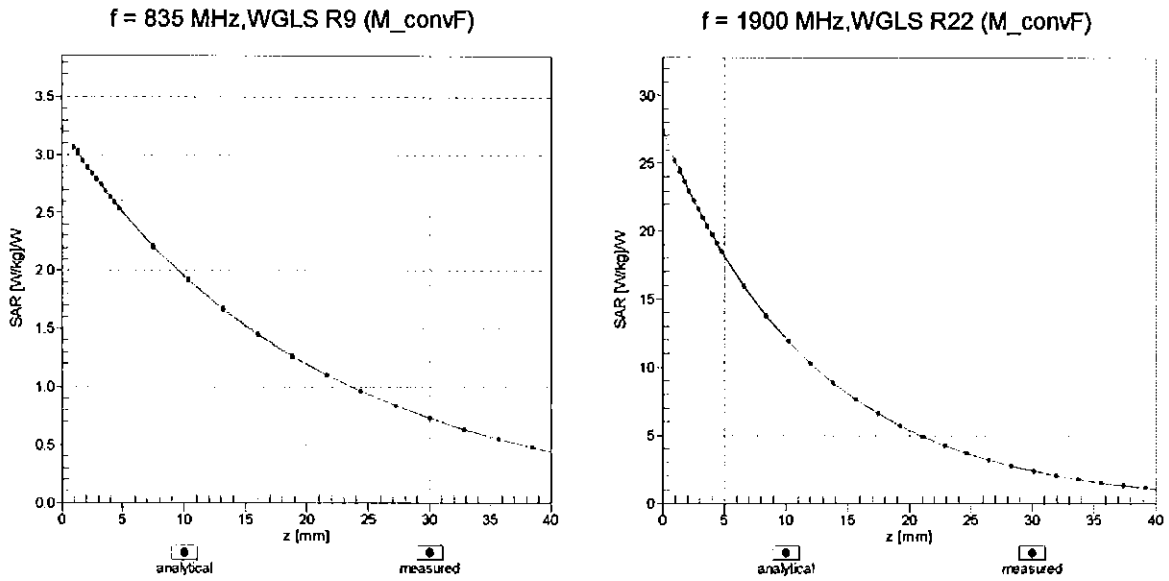

## Deviation from Isotropy in Liquid Error ( $\phi, \vartheta$ ), f = 900 MHz

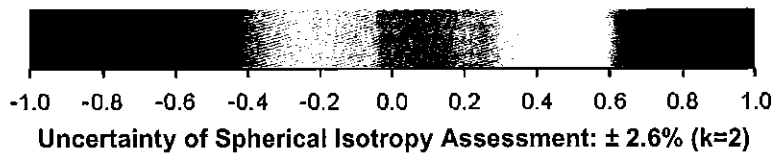
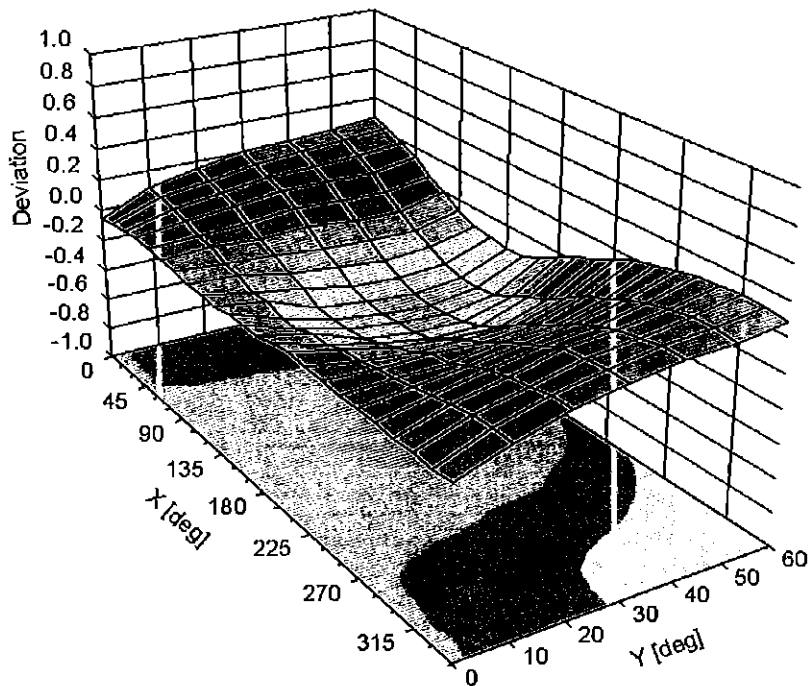

## DASY/EASY - Parameters of Probe: EX3DV4 - SN:7357

### Other Probe Parameters

Sensor Arrangement	Triangular
Connector Angle (°)	13.5
Mechanical Surface Detection Mode	enabled
Optical Surface Detection Mode	disabled
Probe Overall Length	337 mm
Probe Body Diameter	10 mm
Tip Length	9 mm
Tip Diameter	2.5 mm
Probe Tip to Sensor X Calibration Point	1 mm
Probe Tip to Sensor Y Calibration Point	1 mm
Probe Tip to Sensor Z Calibration Point	1 mm
Recommended Measurement Distance from Surface	1.4 mm



Accredited by the Swiss Accreditation Service (SAS)  
The Swiss Accreditation Service is one of the signatories to the EA  
Multilateral Agreement for the recognition of calibration certificates

Accreditation No.: **SCS 0108**

Client **PC Test**

Certificate No: **ES3-3318\_Feb16**

**CALIBRATION CERTIFICATE**

Object: **ES3DV3 - SN:3318**

Calibration procedure(s): **QA CAL-01.v9, QA CAL-23.v5, QA CAL-25.v6  
Calibration procedure for dosimetric E-field probes**

Calibration date: **February 19, 2016**

*BN ✓  
05/01/2016*

This calibration certificate documents the traceability to national standards, which realize the physical units of measurements (SI).  
The measurements and the uncertainties with confidence probability are given on the following pages and are part of the certificate.

All calibrations have been conducted in the closed laboratory facility: environment temperature (22 ± 3)°C and humidity < 70%.

Calibration Equipment used (M&TE critical for calibration)

Primary Standards	ID	Cal Date (Certificate No.)	Scheduled Calibration
Power meter E4419B	GB41293874	01-Apr-15 (No. 217-02128)	Mar-16
Power sensor E4412A	MY41498087	01-Apr-15 (No. 217-02128)	Mar-16
Reference 3 dB Attenuator	SN: S5054 (3c)	01-Apr-15 (No. 217-02129)	Mar-16
Reference 20 dB Attenuator	SN: S5277 (20x)	01-Apr-15 (No. 217-02132)	Mar-16
Reference 30 dB Attenuator	SN: S5129 (30b)	01-Apr-15 (No. 217-02133)	Mar-16
Reference Probe ES3DV2	SN: 3013	31-Dec-15 (No. ES3-3013_Dec15)	Dec-16
DAE4	SN: 660	23-Dec-15 (No. DAE4-660_Dec15)	Dec-16
Secondary Standards	ID	Check Date (in house)	Scheduled Check
RF generator HP 8648C	US3642U01700	4-Aug-99 (in house check Apr-13)	In house check: Apr-16
Network Analyzer HP 8753E	US37390585	18-Oct-01 (in house check Oct-15)	In house check: Oct-16

Calibrated by:	Name <b>Jeton Kastri</b>	Function <b>Laboratory Technician</b>	Signature 
Approved by:	Name <b>Katja Pokovic</b>	Function <b>Technical Manager</b>	Signature 

Issued: February 20, 2016

This calibration certificate shall not be reproduced except in full without written approval of the laboratory.



Accredited by the Swiss Accreditation Service (SAS)

The Swiss Accreditation Service is one of the signatories to the EA  
Multilateral Agreement for the recognition of calibration certificates

Accreditation No.: **SCS 0108**

### Glossary:

TSL	tissue simulating liquid
NORM <sub>x,y,z</sub>	sensitivity in free space
ConvF	sensitivity in TSL / NORM <sub>x,y,z</sub>
DCP	diode compression point
CF	crest factor (1/duty_cycle) of the RF signal
A, B, C, D	modulation dependent linearization parameters
Polarization $\varphi$	$\varphi$ rotation around probe axis
Polarization $\vartheta$	$\vartheta$ rotation around an axis that is in the plane normal to probe axis (at measurement center), i.e., $\vartheta = 0$ is normal to probe axis
Connector Angle	information used in DASY system to align probe sensor X to the robot coordinate system

### Calibration is Performed According to the Following Standards:

- IEEE Std 1528-2013, "IEEE Recommended Practice for Determining the Peak Spatial-Averaged Specific Absorption Rate (SAR) in the Human Head from Wireless Communications Devices: Measurement Techniques", June 2013
- IEC 62209-1, "Procedure to measure the Specific Absorption Rate (SAR) for hand-held devices used in close proximity to the ear (frequency range of 300 MHz to 3 GHz)", February 2005
- IEC 62209-2, "Procedure to determine the Specific Absorption Rate (SAR) for wireless communication devices used in close proximity to the human body (frequency range of 30 MHz to 6 GHz)", March 2010
- KDB 865664, "SAR Measurement Requirements for 100 MHz to 6 GHz"

### Methods Applied and Interpretation of Parameters:

- NORM<sub>x,y,z</sub>**: Assessed for E-field polarization  $\vartheta = 0$  ( $f \leq 900$  MHz in TEM-cell;  $f > 1800$  MHz: R22 waveguide). NORM<sub>x,y,z</sub> are only intermediate values, i.e., the uncertainties of NORM<sub>x,y,z</sub> does not affect the E<sup>2</sup>-field uncertainty inside TSL (see below ConvF).
- NORM(f)<sub>x,y,z</sub>** = NORM<sub>x,y,z</sub> \* frequency\_response (see Frequency Response Chart). This linearization is implemented in DASY4 software versions later than 4.2. The uncertainty of the frequency response is included in the stated uncertainty of ConvF.
- DCP<sub>x,y,z</sub>**: DCP are numerical linearization parameters assessed based on the data of power sweep with CW signal (no uncertainty required). DCP does not depend on frequency nor media.
- PAR**: PAR is the Peak to Average Ratio that is not calibrated but determined based on the signal characteristics
- A<sub>x,y,z</sub>; B<sub>x,y,z</sub>; C<sub>x,y,z</sub>; D<sub>x,y,z</sub>; VR<sub>x,y,z</sub>; A, B, C, D** are numerical linearization parameters assessed based on the data of power sweep for specific modulation signal. The parameters do not depend on frequency nor media. VR is the maximum calibration range expressed in RMS voltage across the diode.
- ConvF and Boundary Effect Parameters**: Assessed in flat phantom using E-field (or Temperature Transfer Standard for  $f \leq 800$  MHz) and inside waveguide using analytical field distributions based on power measurements for  $f > 800$  MHz. The same setups are used for assessment of the parameters applied for boundary compensation (alpha, depth) of which typical uncertainty values are given. These parameters are used in DASY4 software to improve probe accuracy close to the boundary. The sensitivity in TSL corresponds to NORM<sub>x,y,z</sub> \* ConvF whereby the uncertainty corresponds to that given for ConvF. A frequency dependent ConvF is used in DASY version 4.4 and higher which allows extending the validity from  $\pm 50$  MHz to  $\pm 100$  MHz.
- Spherical isotropy (3D deviation from isotropy)**: in a field of low gradients realized using a flat phantom exposed by a patch antenna.
- Sensor Offset**: The sensor offset corresponds to the offset of virtual measurement center from the probe tip (on probe axis). No tolerance required.
- Connector Angle**: The angle is assessed using the information gained by determining the NORM<sub>x</sub> (no uncertainty required).



# Probe ES3DV3

## SN:3318

Manufactured: January 10, 2012  
Calibrated: February 19, 2016

Calibrated for DASY/EASY Systems  
(Note: non-compatible with DASY2 system!)

# DASY/EASY - Parameters of Probe: ES3DV3 - SN:3318

## Basic Calibration Parameters

	Sensor X	Sensor Y	Sensor Z	Unc (k=2)
Norm ( $\mu\text{V}/(\text{V}/\text{m})^2$ ) <sup>A</sup>	1.16	0.93	1.29	$\pm 10.1 \%$
DCP (mV) <sup>B</sup>	102.2	104.2	103.7	

## Modulation Calibration Parameters

UID	Communication System Name		A dB	B dB $\sqrt{\mu\text{V}}$	C	D dB	VR mV	Unc <sup>F</sup> (k=2)
0	CW	X	0.0	0.0	1.0	0.00	199.2	$\pm 3.5 \%$
		Y	0.0	0.0	1.0		176.5	
		Z	0.0	0.0	1.0		194.6	
10010-CAA	SAR Validation (Square, 100ms, 10ms)	X	3.19	63.2	12.6	10.00	42.3	$\pm 1.4 \%$
		Y	19.74	82.9	18.6		35.5	
		Z	4.87	67.6	14.6		43.3	
10012-CAB	IEEE 802.11b WiFi 2.4 GHz (DSSS, 1 Mbps)	X	2.99	68.6	18.5	1.87	141.3	$\pm 0.9 \%$
		Y	3.46	71.1	19.6		145.1	
		Z	3.19	70.2	19.5		144.7	
10100-CAB	LTE-FDD (SC-FDMA, 100% RB, 20 MHz, QPSK)	X	6.30	67.0	19.4	5.67	128.2	$\pm 1.4 \%$
		Y	6.32	67.0	19.2		129.9	
		Z	6.36	67.5	19.8		131.3	
10103-CAB	LTE-TDD (SC-FDMA, 100% RB, 20 MHz, QPSK)	X	11.31	78.0	27.3	9.29	146.7	$\pm 3.5 \%$
		Y	9.35	72.8	24.3		141.3	
		Z	11.02	76.9	26.7		131.7	
10108-CAC	LTE-FDD (SC-FDMA, 100% RB, 10 MHz, QPSK)	X	6.22	66.7	19.4	5.80	126.2	$\pm 1.4 \%$
		Y	6.20	66.5	19.1		128.1	
		Z	6.27	67.1	19.7		131.1	
10151-CAB	LTE-TDD (SC-FDMA, 50% RB, 20 MHz, QPSK)	X	10.46	76.6	26.8	9.28	138.8	$\pm 3.3 \%$
		Y	8.80	72.0	24.0		134.3	
		Z	10.01	75.0	25.9		122.1	
10154-CAC	LTE-FDD (SC-FDMA, 50% RB, 10 MHz, QPSK)	X	6.12	67.0	19.6	5.75	146.0	$\pm 1.7 \%$
		Y	6.15	67.1	19.5		148.7	
		Z	5.95	66.5	19.4		127.4	
10160-CAB	LTE-FDD (SC-FDMA, 50% RB, 15 MHz, QPSK)	X	6.33	66.7	19.4	5.82	127.2	$\pm 1.4 \%$
		Y	6.33	66.6	19.2		128.2	
		Z	6.38	67.1	19.7		133.6	
10169-CAB	LTE-FDD (SC-FDMA, 1 RB, 20 MHz, QPSK)	X	5.10	67.2	20.0	5.73	147.9	$\pm 1.2 \%$
		Y	4.85	66.3	19.3		127.1	
		Z	4.97	66.7	19.8		133.9	
10172-CAB	LTE-TDD (SC-FDMA, 1 RB, 20 MHz, QPSK)	X	8.71	78.3	27.8	9.21	127.5	$\pm 3.0 \%$
		Y	7.52	74.8	25.7		144.7	
		Z	10.09	81.9	29.5		136.4	
10175-CAC	LTE-FDD (SC-FDMA, 1 RB, 10 MHz, QPSK)	X	5.09	67.2	20.0	5.72	146.9	$\pm 1.2 \%$
		Y	4.97	66.9	19.6		140.9	
		Z	4.95	66.6	19.7		133.1	

10181-CAB	LTE-FDD (SC-FDMA, 1 RB, 15 MHz, QPSK)	X	5.11	67.3	20.0	5.72	146.8	±1.2 %
		Y	5.03	67.2	19.8		147.0	
		Z	5.00	66.8	19.8		135.0	
10237-CAB	LTE-TDD (SC-FDMA, 1 RB, 10 MHz, QPSK)	X	8.73	78.3	27.8	9.21	126.7	±3.0 %
		Y	7.60	75.1	25.9		146.1	
		Z	10.76	83.8	30.4		143.4	
10252-CAB	LTE-TDD (SC-FDMA, 50% RB, 10 MHz, QPSK)	X	9.61	75.3	26.2	9.24	129.4	±3.3 %
		Y	8.55	72.3	24.3		143.1	
		Z	11.05	79.1	28.1		146.1	
10267-CAB	LTE-TDD (SC-FDMA, 100% RB, 10 MHz, QPSK)	X	10.44	76.5	26.8	9.30	137.7	±3.3 %
		Y	8.62	71.3	23.6		125.8	
		Z	10.24	75.6	26.2		125.3	
10297-AAA	LTE-FDD (SC-FDMA, 50% RB, 20 MHz, QPSK)	X	6.51	67.8	20.0	5.81	148.5	±1.7 %
		Y	6.42	67.3	19.6		144.3	
		Z	6.31	67.3	19.8		134.7	
10311-AAA	LTE-FDD (SC-FDMA, 100% RB, 15 MHz, QPSK)	X	6.80	67.4	19.9	6.06	128.6	±1.4 %
		Y	6.69	66.9	19.4		125.3	
		Z	6.91	68.0	20.3		140.1	

The reported uncertainty of measurement is stated as the standard uncertainty of measurement multiplied by the coverage factor  $k=2$ , which for a normal distribution corresponds to a coverage probability of approximately 95%.

<sup>A</sup> The uncertainties of Norm X,Y,Z do not affect the  $E^2$ -field uncertainty inside TSL (see Pages 6 and 7).

<sup>B</sup> Numerical linearization parameter: uncertainty not required.

<sup>E</sup> Uncertainty is determined using the max. deviation from linear response applying rectangular distribution and is expressed for the square of the field value.

## DASY/EASY - Parameters of Probe: ES3DV3 - SN:3318

### Calibration Parameter Determined in Head Tissue Simulating Media

f (MHz) <sup>C</sup>	Relative Permittivity <sup>F</sup>	Conductivity (S/m) <sup>F</sup>	ConvF X	ConvF Y	ConvF Z	Alpha <sup>G</sup>	Depth <sup>G</sup> (mm)	Unc (k=2)
750	41.9	0.89	6.48	6.48	6.48	0.54	1.35	± 12.0 %
835	41.5	0.90	6.23	6.23	6.23	0.70	1.21	± 12.0 %
1750	40.1	1.37	5.34	5.34	5.34	0.72	1.27	± 12.0 %
1900	40.0	1.40	5.13	5.13	5.13	0.80	1.18	± 12.0 %
2300	39.5	1.67	4.78	4.78	4.78	0.76	1.29	± 12.0 %
2450	39.2	1.80	4.57	4.57	4.57	0.59	1.49	± 12.0 %
2600	39.0	1.96	4.40	4.40	4.40	0.80	1.31	± 12.0 %

<sup>C</sup> Frequency validity above 300 MHz of ± 100 MHz only applies for DASY v4.4 and higher (see Page 2), else it is restricted to ± 50 MHz. The uncertainty is the RSS of the ConvF uncertainty at calibration frequency and the uncertainty for the indicated frequency band. Frequency validity below 300 MHz is ± 10, 25, 40, 50 and 70 MHz for ConvF assessments at 30, 64, 128, 150 and 220 MHz respectively. Above 5 GHz frequency validity can be extended to ± 110 MHz.

<sup>F</sup> At frequencies below 3 GHz, the validity of tissue parameters ( $\epsilon$  and  $\sigma$ ) can be relaxed to ± 10% if liquid compensation formula is applied to measured SAR values. At frequencies above 3 GHz, the validity of tissue parameters ( $\epsilon$  and  $\sigma$ ) is restricted to ± 5%. The uncertainty is the RSS of the ConvF uncertainty for indicated target tissue parameters.

<sup>G</sup> Alpha/Depth are determined during calibration. SPEAG warrants that the remaining deviation due to the boundary effect after compensation is always less than ± 1% for frequencies below 3 GHz and below ± 2% for frequencies between 3-6 GHz at any distance larger than half the probe tip diameter from the boundary.

## DASY/EASY - Parameters of Probe: ES3DV3 - SN:3318

### Calibration Parameter Determined in Body Tissue Simulating Media

f (MHz) <sup>C</sup>	Relative Permittivity <sup>F</sup>	Conductivity (S/m) <sup>F</sup>	ConvF X	ConvF Y	ConvF Z	Alpha <sup>G</sup>	Depth <sup>G</sup> (mm)	Unc (k=2)
750	55.5	0.96	6.19	6.19	6.19	0.50	1.51	± 12.0 %
835	55.2	0.97	6.11	6.11	6.11	0.47	1.56	± 12.0 %
1750	53.4	1.49	5.02	5.02	5.02	0.49	1.55	± 12.0 %
1900	53.3	1.52	4.81	4.81	4.81	0.80	1.24	± 12.0 %
2300	52.9	1.81	4.55	4.55	4.55	0.80	1.27	± 12.0 %
2450	52.7	1.95	4.45	4.45	4.45	0.80	1.16	± 12.0 %
2600	52.5	2.16	4.18	4.18	4.18	0.80	1.13	± 12.0 %

<sup>C</sup> Frequency validity above 300 MHz of ± 100 MHz only applies for DASY v4.4 and higher (see Page 2), else it is restricted to ± 50 MHz. The uncertainty is the RSS of the ConvF uncertainty at calibration frequency and the uncertainty for the indicated frequency band. Frequency validity below 300 MHz is ± 10, 25, 40, 50 and 70 MHz for ConvF assessments at 30, 64, 128, 150 and 220 MHz respectively. Above 5 GHz frequency validity can be extended to ± 110 MHz.

<sup>F</sup> At frequencies below 3 GHz, the validity of tissue parameters ( $\epsilon$  and  $\sigma$ ) can be relaxed to ± 10% if liquid compensation formula is applied to measured SAR values. At frequencies above 3 GHz, the validity of tissue parameters ( $\epsilon$  and  $\sigma$ ) is restricted to ± 5%. The uncertainty is the RSS of the ConvF uncertainty for indicated target tissue parameters.

<sup>G</sup> Alpha/Depth are determined during calibration. SPEAG warrants that the remaining deviation due to the boundary effect after compensation is always less than ± 1% for frequencies below 3 GHz and below ± 2% for frequencies between 3-6 GHz at any distance larger than half the probe tip diameter from the boundary.

### Frequency Response of E-Field (TEM-Cell:ifi110 EXX, Waveguide: R22)

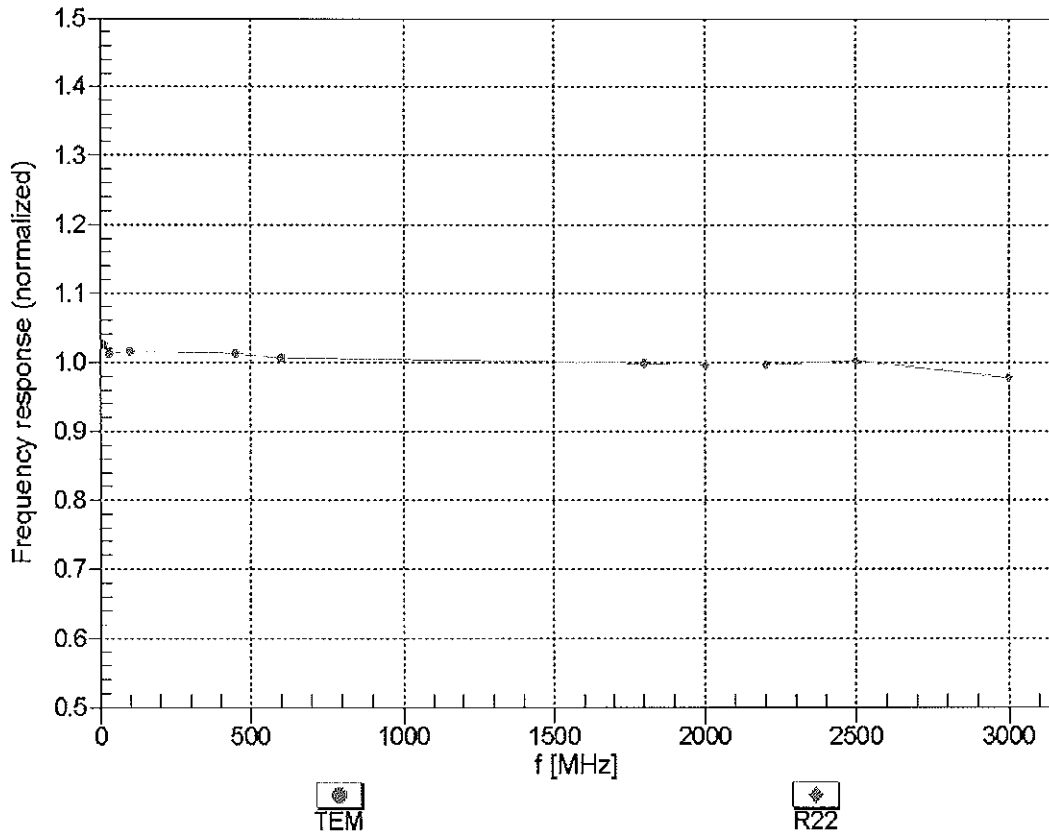

Uncertainty of Frequency Response of E-field:  $\pm 6.3\%$  (k=2)

### Receiving Pattern ( $\phi$ ), $\theta = 0^\circ$

f=600 MHz,TEM

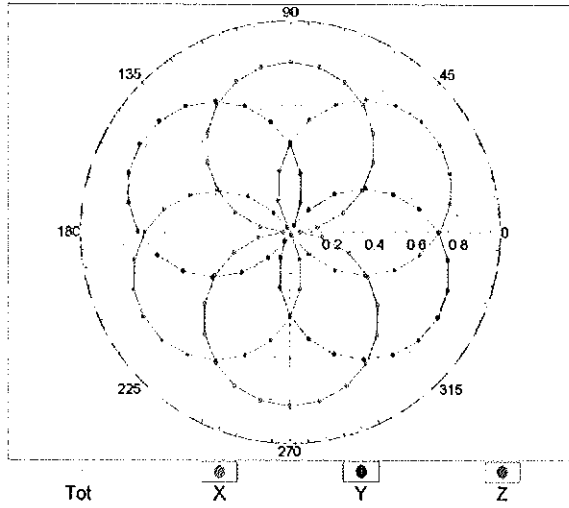

f=1800 MHz,R22

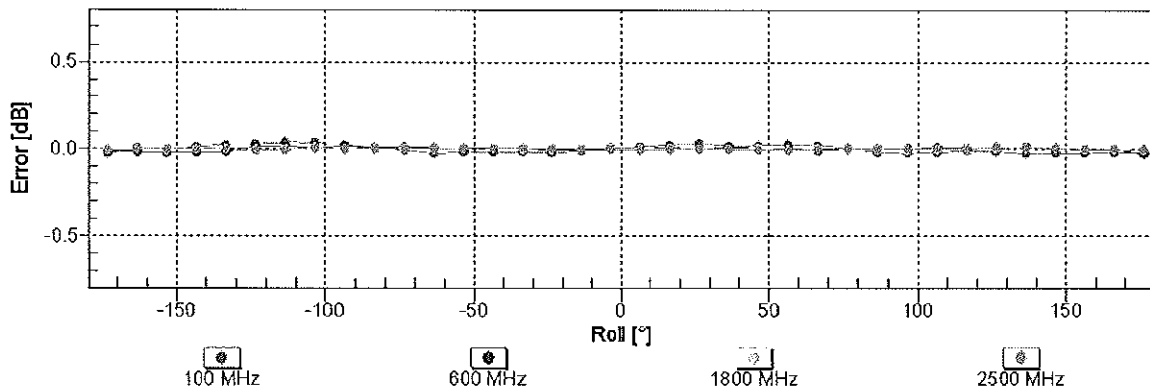
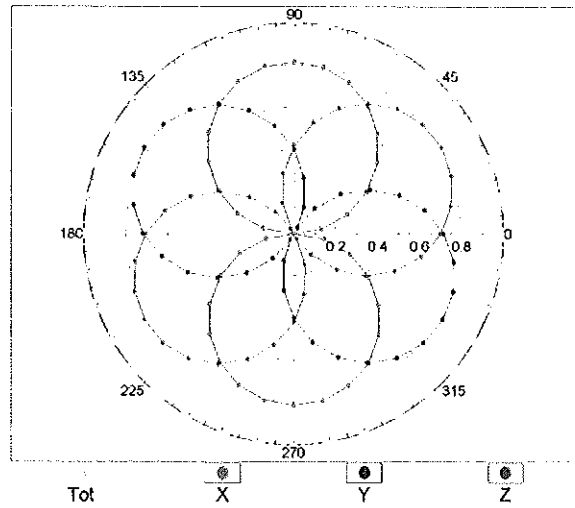

Uncertainty of Axial Isotropy Assessment:  $\pm 0.5\%$  (k=2)

### Dynamic Range $f(SAR_{head})$ (TEM cell , $f_{eval}= 1900$ MHz)

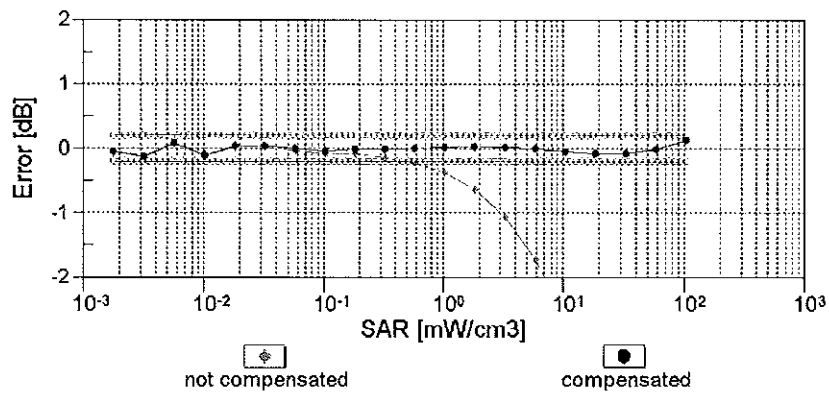
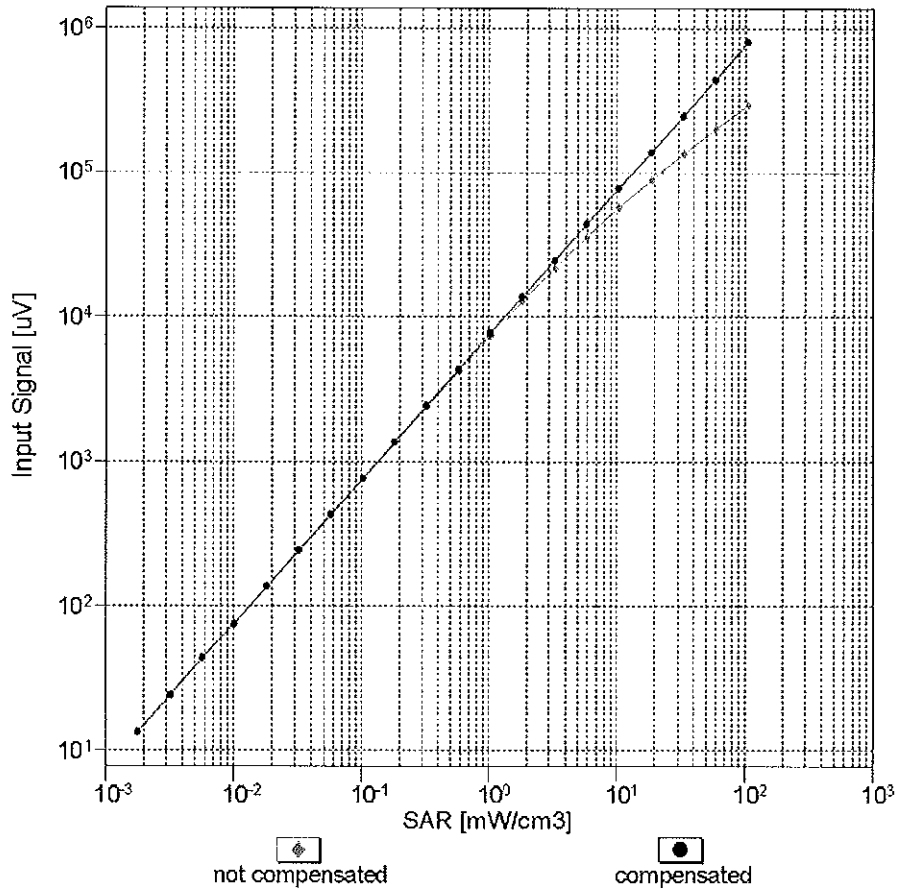

Uncertainty of Linearity Assessment:  $\pm 0.6\%$  ( $k=2$ )



# Conversion Factor Assessment

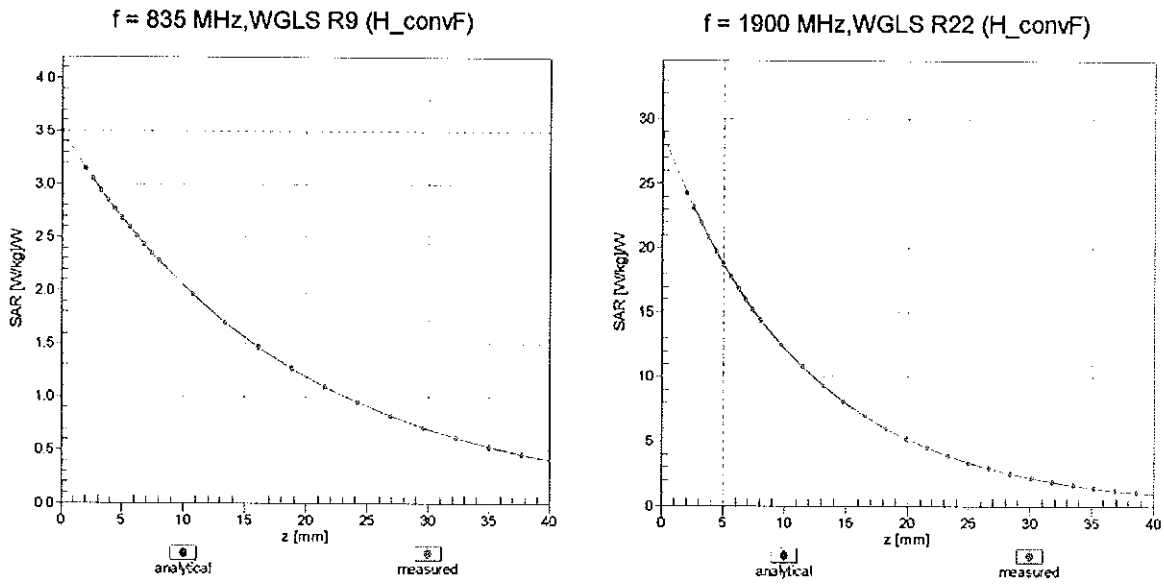

## Deviation from Isotropy in Liquid Error ( $\phi, \vartheta$ ), $f = 900$ MHz

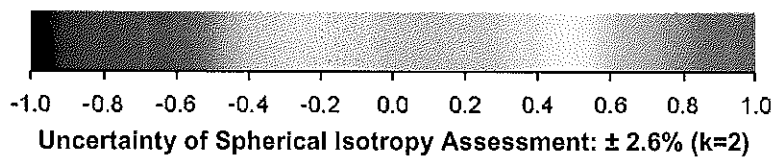
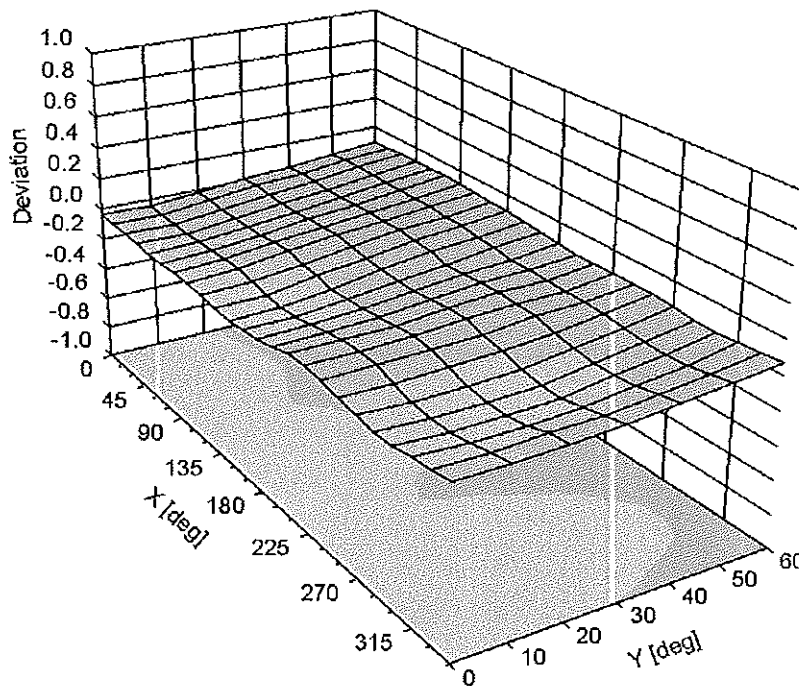

**DASY/EASY - Parameters of Probe: ES3DV3 - SN:3318****Other Probe Parameters**

Sensor Arrangement	Triangular
Connector Angle (°)	76.5
Mechanical Surface Detection Mode	enabled
Optical Surface Detection Mode	disabled
Probe Overall Length	337 mm
Probe Body Diameter	10 mm
Tip Length	10 mm
Tip Diameter	4 mm
Probe Tip to Sensor X Calibration Point	2 mm
Probe Tip to Sensor Y Calibration Point	2 mm
Probe Tip to Sensor Z Calibration Point	2 mm
Recommended Measurement Distance from Surface	3 mm



Accredited by the Swiss Accreditation Service (SAS)  
 The Swiss Accreditation Service is one of the signatories to the EA  
 Multilateral Agreement for the recognition of calibration certificates

Accreditation No.: **SCS 0108**

Client **PC Test**

Certificate No: **ES3-3319\_Mar16**

**CALIBRATION CERTIFICATE**

Object: **ES3DV3 - SN:3319**

Calibration procedure(s): **QA CAL-01.v9, QA CAL-23.v5, QA CAL-25.v6  
 Calibration procedure for dosimetric E-field probes**

Calibration date: **March 18, 2016**

*BN  
 03/18/2016*

This calibration certificate documents the traceability to national standards, which realize the physical units of measurements (SI).  
 The measurements and the uncertainties with confidence probability are given on the following pages and are part of the certificate.

All calibrations have been conducted in the closed laboratory facility: environment temperature (22 ± 3)°C and humidity < 70%.

Calibration Equipment used (M&TE critical for calibration)

Primary Standards	ID	Cal Date (Certificate No.)	Scheduled Calibration
Power meter E4419B	GB41293874	01-Apr-15 (No. 217-02128)	Mar-16
Power sensor E4412A	MY41498087	01-Apr-15 (No. 217-02128)	Mar-16
Reference 3 dB Attenuator	SN: S5054 (3c)	01-Apr-15 (No. 217-02129)	Mar-16
Reference 20 dB Attenuator	SN: S5277 (20x)	01-Apr-15 (No. 217-02132)	Mar-16
Reference 30 dB Attenuator	SN: S5129 (30b)	01-Apr-15 (No. 217-02133)	Mar-16
Reference Probe ES3DV2	SN: 3013	31-Dec-15 (No. ES3-3013_Dec15)	Dec-16
DAE4	SN: 660	23-Dec-15 (No. DAE4-660_Dec15)	Dec-16
Secondary Standards	ID	Check Date (in house)	Scheduled Check
RF generator HP 8648C	US3642U01700	4-Aug-99 (in house check Apr-13)	In house check: Apr-16
Network Analyzer HP 8753E	US37390585	18-Oct-01 (in house check Oct-15)	In house check: Oct-16

	Name	Function	Signature
Calibrated by:	Leif Klysner	Laboratory Technician	<i>Leif Klysner</i>
Approved by:	Katja Pokovic	Technical Manager	<i>Katja Pokovic</i>

Issued: March 21, 2016

This calibration certificate shall not be reproduced except in full without written approval of the laboratory.



Accredited by the Swiss Accreditation Service (SAS)

Accreditation No.: **SCS 0108**

The Swiss Accreditation Service is one of the signatories to the EA Multilateral Agreement for the recognition of calibration certificates

### Glossary:

TSL	tissue simulating liquid
NORM <sub>x,y,z</sub>	sensitivity in free space
ConvF	sensitivity in TSL / NORM <sub>x,y,z</sub>
DCP	diode compression point
CF	crest factor (1/duty_cycle) of the RF signal
A, B, C, D	modulation dependent linearization parameters
Polarization $\varphi$	$\varphi$ rotation around probe axis
Polarization $\vartheta$	$\vartheta$ rotation around an axis that is in the plane normal to probe axis (at measurement center), i.e., $\vartheta = 0$ is normal to probe axis
Connector Angle	information used in DASY system to align probe sensor X to the robot coordinate system

### Calibration is Performed According to the Following Standards:

- IEEE Std 1528-2013, "IEEE Recommended Practice for Determining the Peak Spatial-Averaged Specific Absorption Rate (SAR) in the Human Head from Wireless Communications Devices: Measurement Techniques", June 2013
- IEC 62209-1, "Procedure to measure the Specific Absorption Rate (SAR) for hand-held devices used in close proximity to the ear (frequency range of 300 MHz to 3 GHz)", February 2005
- IEC 62209-2, "Procedure to determine the Specific Absorption Rate (SAR) for wireless communication devices used in close proximity to the human body (frequency range of 30 MHz to 6 GHz)", March 2010
- KDB 865664, "SAR Measurement Requirements for 100 MHz to 6 GHz"

### Methods Applied and Interpretation of Parameters:

- NORM<sub>x,y,z</sub>**: Assessed for E-field polarization  $\vartheta = 0$  ( $f \leq 900$  MHz in TEM-cell;  $f > 1800$  MHz: R22 waveguide). NORM<sub>x,y,z</sub> are only intermediate values, i.e., the uncertainties of NORM<sub>x,y,z</sub> does not affect the E<sup>2</sup>-field uncertainty inside TSL (see below ConvF).
- NORM(f)<sub>x,y,z</sub> = NORM<sub>x,y,z</sub> \* frequency\_response** (see Frequency Response Chart). This linearization is implemented in DASY4 software versions later than 4.2. The uncertainty of the frequency response is included in the stated uncertainty of ConvF.
- DCP<sub>x,y,z</sub>**: DCP are numerical linearization parameters assessed based on the data of power sweep with CW signal (no uncertainty required). DCP does not depend on frequency nor media.
- PAR**: PAR is the Peak to Average Ratio that is not calibrated but determined based on the signal characteristics
- A<sub>x,y,z</sub>; B<sub>x,y,z</sub>; C<sub>x,y,z</sub>; D<sub>x,y,z</sub>; VR<sub>x,y,z</sub>**: A, B, C, D are numerical linearization parameters assessed based on the data of power sweep for specific modulation signal. The parameters do not depend on frequency nor media. VR is the maximum calibration range expressed in RMS voltage across the diode.
- ConvF and Boundary Effect Parameters**: Assessed in flat phantom using E-field (or Temperature Transfer Standard for  $f \leq 800$  MHz) and inside waveguide using analytical field distributions based on power measurements for  $f > 800$  MHz. The same setups are used for assessment of the parameters applied for boundary compensation (alpha, depth) of which typical uncertainty values are given. These parameters are used in DASY4 software to improve probe accuracy close to the boundary. The sensitivity in TSL corresponds to NORM<sub>x,y,z</sub> \* ConvF whereby the uncertainty corresponds to that given for ConvF. A frequency dependent ConvF is used in DASY version 4.4 and higher which allows extending the validity from  $\pm 50$  MHz to  $\pm 100$  MHz.
- Spherical isotropy (3D deviation from isotropy)**: in a field of low gradients realized using a flat phantom exposed by a patch antenna.
- Sensor Offset**: The sensor offset corresponds to the offset of virtual measurement center from the probe tip (on probe axis). No tolerance required.
- Connector Angle**: The angle is assessed using the information gained by determining the NORM<sub>x</sub> (no uncertainty required).

# Probe ES3DV3

## SN:3319

Manufactured: January 10, 2012  
Calibrated: March 18, 2016

Calibrated for DASY/EASY Systems  
(Note: non-compatible with DASY2 system!)

## DASY/EASY - Parameters of Probe: ES3DV3 - SN:3319

### Basic Calibration Parameters

	Sensor X	Sensor Y	Sensor Z	Unc (k=2)
Norm ( $\mu\text{V}/(\text{V}/\text{m})^2$ ) <sup>A</sup>	1.12	1.08	1.16	$\pm 10.1\%$
DCP (mV) <sup>B</sup>	104.1	104.5	103.7	

### Modulation Calibration Parameters

UID	Communication System Name		A dB	B dB $\sqrt{\mu\text{V}}$	C	D dB	VR mV	Unc <sup>E</sup> (k=2)
0	CW	X	0.0	0.0	1.0	0.00	203.1	$\pm 3.5\%$
		Y	0.0	0.0	1.0		203.8	
		Z	0.0	0.0	1.0		200.4	
10010- CAA	SAR Validation (Square, 100ms, 10ms)	X	2.29	60.1	11.2	10.00	42.0	$\pm 1.2\%$
		Y	1.95	58.7	10.4		42.0	
		Z	3.15	62.5	12.1		42.9	
10012- CAB	IEEE 802.11b WiFi 2.4 GHz (DSSS, 1 Mbps)	X	3.45	71.5	19.9	1.87	122.0	$\pm 0.5\%$
		Y	2.88	68.4	18.6		122.8	
		Z	3.35	70.8	19.5		120.5	
10100- CAB	LTE-FDD (SC-FDMA, 100% RB, 20 MHz, QPSK)	X	6.39	67.3	19.5	5.67	132.3	$\pm 1.2\%$
		Y	6.54	68.2	20.1		134.5	
		Z	6.40	67.4	19.6		130.2	
10103- CAB	LTE-TDD (SC-FDMA, 100% RB, 20 MHz, QPSK)	X	10.41	75.3	25.6	9.29	124.2	$\pm 2.2\%$
		Y	10.45	76.3	26.6		122.6	
		Z	10.82	75.9	25.8		124.8	
10108- CAC	LTE-FDD (SC-FDMA, 100% RB, 10 MHz, QPSK)	X	6.30	67.1	19.5	5.80	130.7	$\pm 1.2\%$
		Y	6.35	67.5	19.9		131.5	
		Z	6.33	67.1	19.6		128.5	
10151- CAB	LTE-TDD (SC-FDMA, 50% RB, 20 MHz, QPSK)	X	9.70	74.1	25.2	9.28	118.8	$\pm 2.2\%$
		Y	9.65	74.9	26.0		117.1	
		Z	10.15	75.0	25.5		119.2	
10154- CAC	LTE-FDD (SC-FDMA, 50% RB, 10 MHz, QPSK)	X	6.00	66.6	19.3	5.75	127.4	$\pm 1.2\%$
		Y	6.01	66.9	19.6		128.9	
		Z	6.02	66.6	19.3		125.6	
10160- CAB	LTE-FDD (SC-FDMA, 50% RB, 15 MHz, QPSK)	X	6.45	67.2	19.6	5.82	132.2	$\pm 1.2\%$
		Y	6.47	67.5	19.9		133.5	
		Z	6.45	67.1	19.5		130.0	
10169- CAB	LTE-FDD (SC-FDMA, 1 RB, 20 MHz, QPSK)	X	4.76	65.7	19.0	5.73	110.8	$\pm 0.9\%$
		Y	4.80	66.3	19.5		112.0	
		Z	4.84	65.9	19.1		109.2	
10172- CAB	LTE-TDD (SC-FDMA, 1 RB, 20 MHz, QPSK)	X	8.98	78.7	27.7	9.21	132.0	$\pm 2.5\%$
		Y	9.71	82.4	30.0		132.2	
		Z	9.79	80.4	28.4		133.4	
10175- CAC	LTE-FDD (SC-FDMA, 1 RB, 10 MHz, QPSK)	X	4.76	65.6	19.0	5.72	109.8	$\pm 0.9\%$
		Y	4.76	66.1	19.4		111.4	
		Z	4.83	65.8	19.1		108.9	

10181-CAB	LTE-FDD (SC-FDMA, 1 RB, 15 MHz, QPSK)	X	4.77	65.7	19.1	5.72	109.2	±0.9 %
		Y	4.78	66.2	19.4		111.9	
		Z	5.24	67.7	20.2		149.0	
10237-CAB	LTE-TDD (SC-FDMA, 1 RB, 10 MHz, QPSK)	X	8.93	78.5	27.6	9.21	131.4	±2.5 %
		Y	9.48	81.7	29.7		131.7	
		Z	9.69	80.3	28.3		131.6	
10252-CAB	LTE-TDD (SC-FDMA, 50% RB, 10 MHz, QPSK)	X	8.94	73.0	24.7	9.24	111.2	±2.2 %
		Y	9.05	74.3	25.9		111.8	
		Z	9.29	73.6	24.9		111.3	
10267-CAB	LTE-TDD (SC-FDMA, 100% RB, 10 MHz, QPSK)	X	9.62	73.9	25.1	9.30	117.4	±2.2 %
		Y	9.73	75.1	26.1		118.2	
		Z	10.08	74.8	25.5		118.2	
10297-AAA	LTE-FDD (SC-FDMA, 50% RB, 20 MHz, QPSK)	X	6.31	67.1	19.6	5.81	128.6	±1.2 %
		Y	6.39	67.6	20.0		132.2	
		Z	6.33	67.1	19.6		127.2	
10311-AAA	LTE-FDD (SC-FDMA, 100% RB, 15 MHz, QPSK)	X	6.87	67.6	19.9	6.06	132.8	±1.4 %
		Y	6.96	68.2	20.3		137.0	
		Z	6.88	67.6	19.9		131.3	

The reported uncertainty of measurement is stated as the standard uncertainty of measurement multiplied by the coverage factor  $k=2$ , which for a normal distribution corresponds to a coverage probability of approximately 95%.

<sup>A</sup> The uncertainties of Norm X,Y,Z do not affect the  $E^2$ -field uncertainty inside TSL (see Pages 6 and 7).

<sup>B</sup> Numerical linearization parameter: uncertainty not required.

<sup>E</sup> Uncertainty is determined using the max. deviation from linear response applying rectangular distribution and is expressed for the square of the field value.

## DASY/EASY - Parameters of Probe: ES3DV3 - SN:3319

### Calibration Parameter Determined in Head Tissue Simulating Media

f (MHz) <sup>C</sup>	Relative Permittivity <sup>F</sup>	Conductivity (S/m) <sup>F</sup>	ConvF X	ConvF Y	ConvF Z	Alpha <sup>G</sup>	Depth <sup>G</sup> (mm)	Unc (k=2)
750	41.9	0.89	6.44	6.44	6.44	0.49	1.80	± 12.0 %
835	41.5	0.90	6.16	6.16	6.16	0.46	1.80	± 12.0 %
1750	40.1	1.37	5.20	5.20	5.20	0.51	1.45	± 12.0 %
1900	40.0	1.40	5.03	5.03	5.03	0.58	1.40	± 12.0 %
2300	39.5	1.67	4.69	4.69	4.69	0.80	1.21	± 12.0 %
2450	39.2	1.80	4.47	4.47	4.47	0.75	1.32	± 12.0 %
2600	39.0	1.96	4.33	4.33	4.33	0.80	1.31	± 12.0 %

<sup>C</sup> Frequency validity above 300 MHz of ± 100 MHz only applies for DASY v4.4 and higher (see Page 2), else it is restricted to ± 50 MHz. The uncertainty is the RSS of the ConvF uncertainty at calibration frequency and the uncertainty for the indicated frequency band. Frequency validity below 300 MHz is ± 10, 25, 40, 50 and 70 MHz for ConvF assessments at 30, 64, 128, 150 and 220 MHz respectively. Above 5 GHz frequency validity can be extended to ± 110 MHz.

<sup>F</sup> At frequencies below 3 GHz, the validity of tissue parameters ( $\epsilon$  and  $\sigma$ ) can be relaxed to ± 10% if liquid compensation formula is applied to measured SAR values. At frequencies above 3 GHz, the validity of tissue parameters ( $\epsilon$  and  $\sigma$ ) is restricted to ± 5%. The uncertainty is the RSS of the ConvF uncertainty for indicated target tissue parameters.

<sup>G</sup> Alpha/Depth are determined during calibration. SPEAG warrants that the remaining deviation due to the boundary effect after compensation is always less than ± 1% for frequencies below 3 GHz and below ± 2% for frequencies between 3-6 GHz at any distance larger than half the probe tip diameter from the boundary.



## DASY/EASY - Parameters of Probe: ES3DV3 - SN:3319

### Calibration Parameter Determined in Body Tissue Simulating Media

f (MHz) <sup>C</sup>	Relative Permittivity <sup>F</sup>	Conductivity (S/m) <sup>F</sup>	ConvF X	ConvF Y	ConvF Z	Alpha <sup>G</sup>	Depth <sup>G</sup> (mm)	Unc (k=2)
750	55.5	0.96	6.06	6.06	6.06	0.47	1.45	± 12.0 %
835	55.2	0.97	6.04	6.04	6.04	0.63	1.27	± 12.0 %
1750	53.4	1.49	4.91	4.91	4.91	0.46	1.66	± 12.0 %
1900	53.3	1.52	4.70	4.70	4.70	0.80	1.24	± 12.0 %
2300	52.9	1.81	4.36	4.36	4.36	0.74	1.33	± 12.0 %
2450	52.7	1.95	4.20	4.20	4.20	0.80	1.25	± 12.0 %
2600	52.5	2.16	3.99	3.99	3.99	0.80	1.20	± 12.0 %

<sup>C</sup> Frequency validity above 300 MHz of ± 100 MHz only applies for DASY v4.4 and higher (see Page 2), else it is restricted to ± 50 MHz. The uncertainty is the RSS of the ConvF uncertainty at calibration frequency and the uncertainty for the indicated frequency band. Frequency validity below 300 MHz is ± 10, 25, 40, 50 and 70 MHz for ConvF assessments at 30, 64, 128, 150 and 220 MHz respectively. Above 5 GHz frequency validity can be extended to ± 110 MHz.

<sup>F</sup> At frequencies below 3 GHz, the validity of tissue parameters ( $\epsilon$  and  $\sigma$ ) can be relaxed to ± 10% if liquid compensation formula is applied to measured SAR values. At frequencies above 3 GHz, the validity of tissue parameters ( $\epsilon$  and  $\sigma$ ) is restricted to ± 5%. The uncertainty is the RSS of the ConvF uncertainty for indicated target tissue parameters.

<sup>G</sup> Alpha/Depth are determined during calibration. SPEAG warrants that the remaining deviation due to the boundary effect after compensation is always less than ± 1% for frequencies below 3 GHz and below ± 2% for frequencies between 3-6 GHz at any distance larger than half the probe tip diameter from the boundary.

# Frequency Response of E-Field (TEM-Cell:ifi110 EXX, Waveguide: R22)

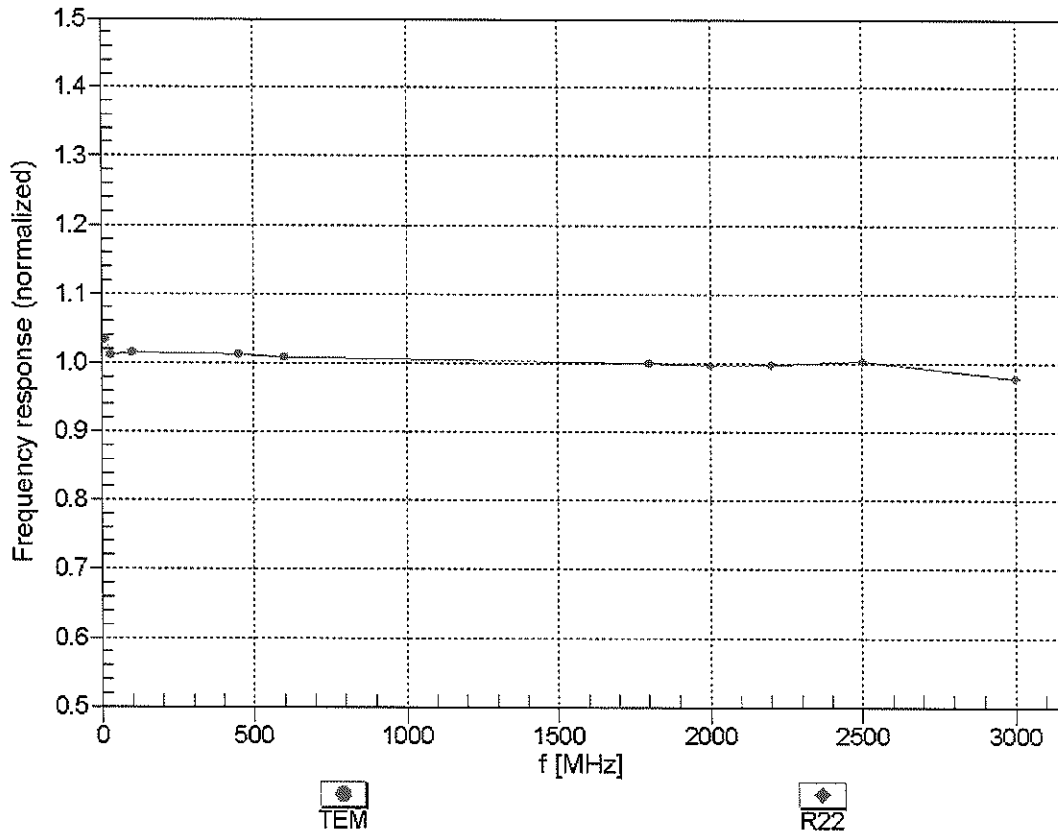

Uncertainty of Frequency Response of E-field:  $\pm 6.3\%$  (k=2)

### Receiving Pattern ( $\phi$ ), $\theta = 0^\circ$

f=600 MHz,TEM

f=1800 MHz,R22

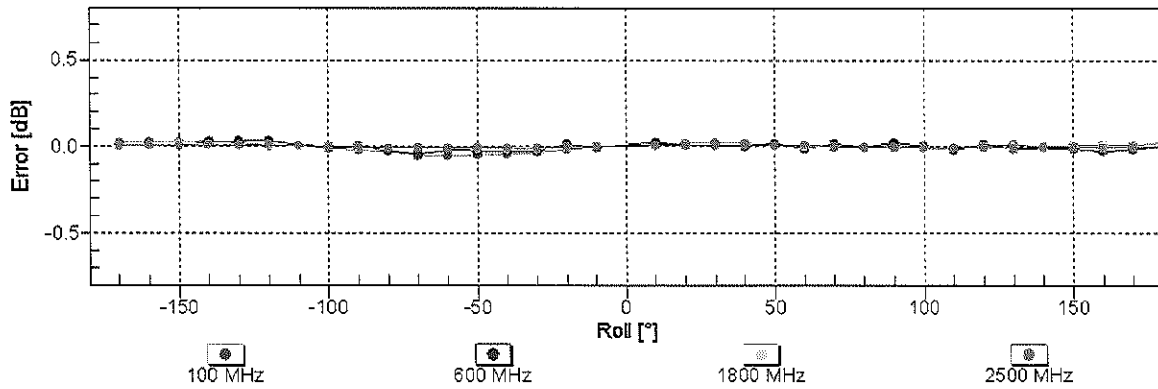
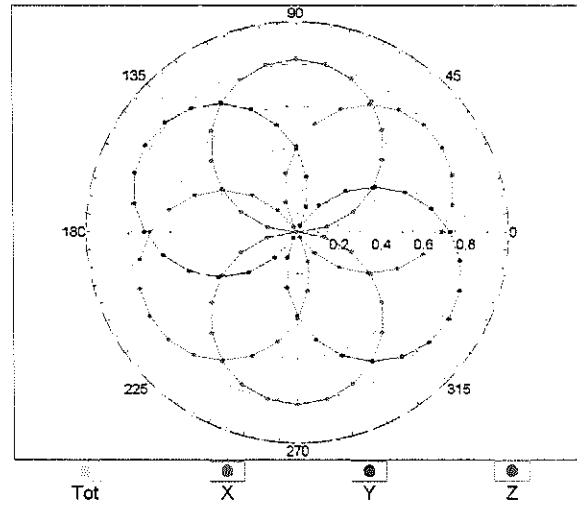
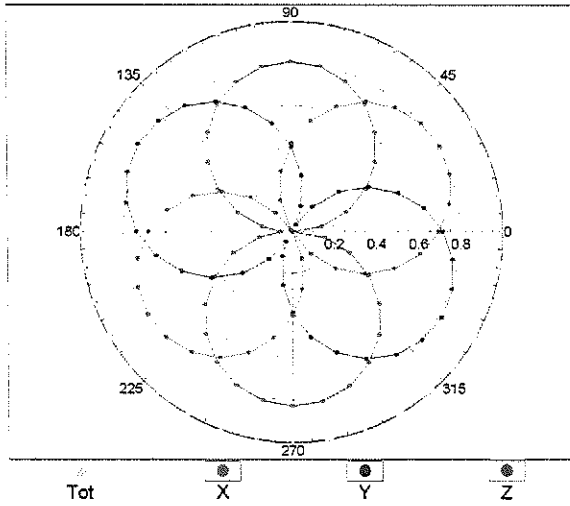

Uncertainty of Axial Isotropy Assessment:  $\pm 0.5\%$  (k=2)

### Dynamic Range f(SAR<sub>head</sub>) (TEM cell , f<sub>eval</sub>= 1900 MHz)

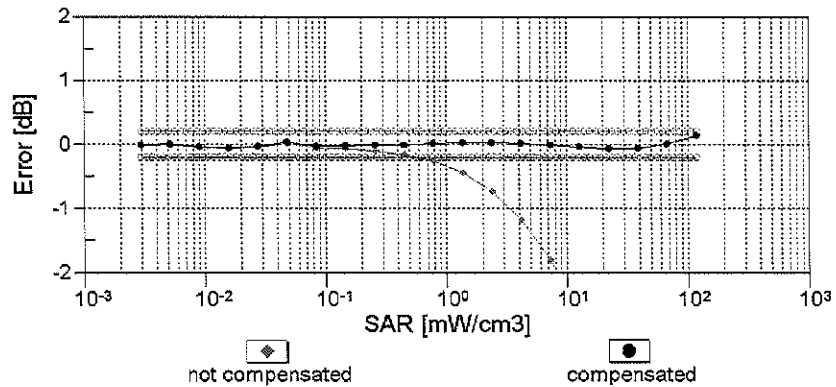
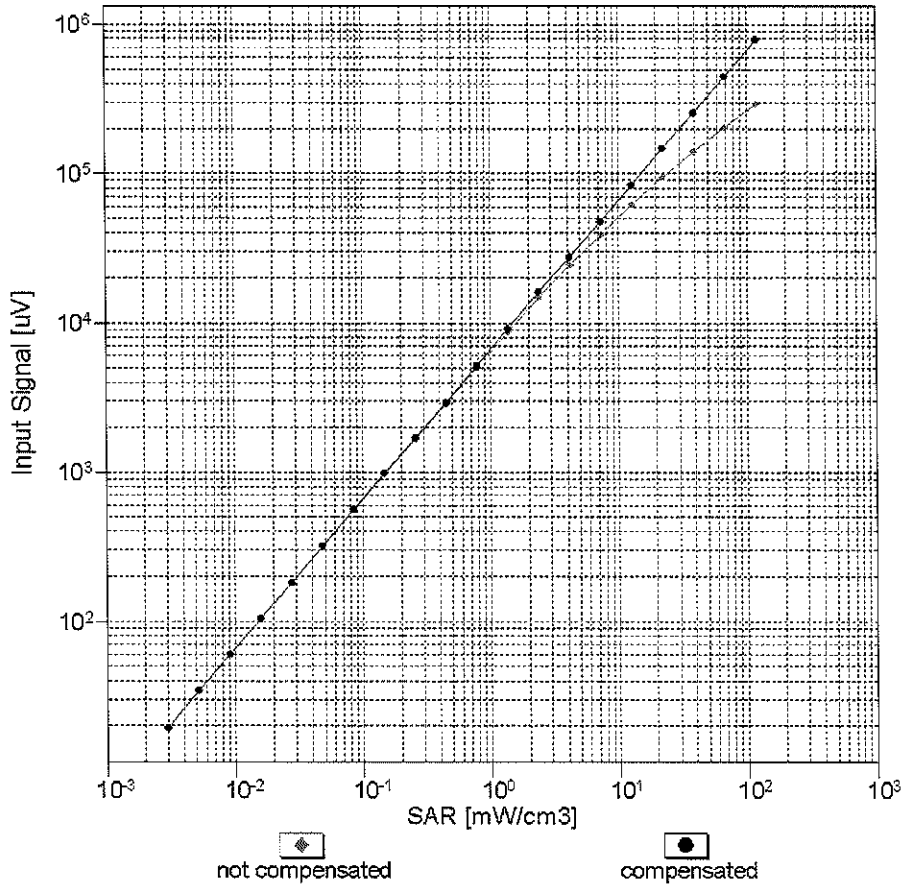

Uncertainty of Linearity Assessment: ± 0.6% (k=2)

# Conversion Factor Assessment

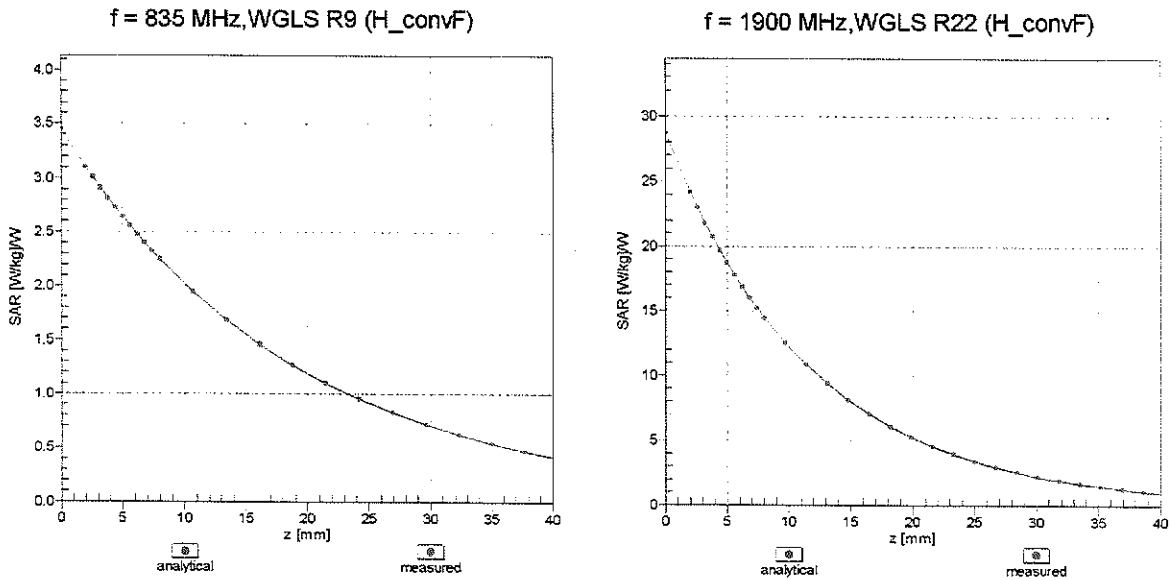

## Deviation from Isotropy in Liquid Error ( $\phi, \vartheta$ ), f = 900 MHz

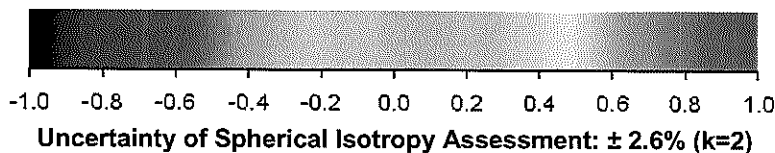
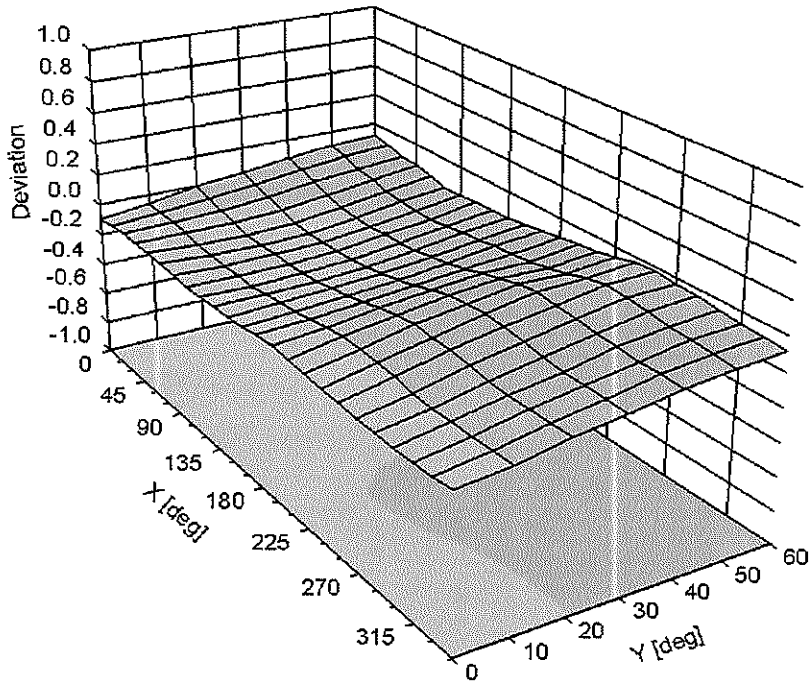

## DASY/EASY - Parameters of Probe: ES3DV3 - SN:3319

### Other Probe Parameters

Sensor Arrangement	Triangular
Connector Angle (°)	60
Mechanical Surface Detection Mode	enabled
Optical Surface Detection Mode	disabled
Probe Overall Length	337 mm
Probe Body Diameter	10 mm
Tip Length	10 mm
Tip Diameter	4 mm
Probe Tip to Sensor X Calibration Point	2 mm
Probe Tip to Sensor Y Calibration Point	2 mm
Probe Tip to Sensor Z Calibration Point	2 mm
Recommended Measurement Distance from Surface	3 mm



Accredited by the Swiss Accreditation Service (SAS)  
The Swiss Accreditation Service is one of the signatories to the EA  
Multilateral Agreement for the recognition of calibration certificates

Accreditation No.: **SCS 0108**

Client **PC Test**

Certificate No: **ES3-3213\_Feb16**

## CALIBRATION CERTIFICATE

Object: **ES3DV3 - SN:3213**

Calibration procedure(s): **QA CAL-01.v9, QA CAL-23.v5, QA CAL-25.v6  
Calibration procedure for dosimetric E-field probes**

Calibration date: **February 19, 2016**

*BN ✓  
03/01/2016*

This calibration certificate documents the traceability to national standards, which realize the physical units of measurements (SI).  
The measurements and the uncertainties with confidence probability are given on the following pages and are part of the certificate.

All calibrations have been conducted in the closed laboratory facility: environment temperature (22 ± 3)°C and humidity < 70%.

Calibration Equipment used (M&TE critical for calibration)

Primary Standards	ID	Cal Date (Certificate No.)	Scheduled Calibration
Power meter E4419B	GB41293874	01-Apr-15 (No. 217-02128)	Mar-16
Power sensor E4412A	MY41498087	01-Apr-15 (No. 217-02128)	Mar-16
Reference 3 dB Attenuator	SN: S5054 (3c)	01-Apr-15 (No. 217-02129)	Mar-16
Reference 20 dB Attenuator	SN: S5277 (20x)	01-Apr-15 (No. 217-02132)	Mar-16
Reference 30 dB Attenuator	SN: S5129 (30b)	01-Apr-15 (No. 217-02133)	Mar-16
Reference Probe ES3DV2	SN: 3013	31-Dec-15 (No. ES3-3013_Dec15)	Dec-16
DAE4	SN: 660	23-Dec-15 (No. DAE4-660_Dec15)	Dec-16
Secondary Standards	ID	Check Date (in house)	Scheduled Check
RF generator HP 8648C	US3642U01700	4-Aug-99 (in house check Apr-13)	In house check: Apr-16
Network Analyzer HP 8753E	US37390585	18-Oct-01 (in house check Oct-15)	In house check: Oct-16

	Name	Function	Signature
Calibrated by:	Jeton Kastrati	Laboratory Technician	
Approved by:	Katja Pokovic	Technical Manager	

Issued: February 20, 2016

This calibration certificate shall not be reproduced except in full without written approval of the laboratory.



Accredited by the Swiss Accreditation Service (SAS)

Accreditation No.: **SCS 0108**

The Swiss Accreditation Service is one of the signatories to the EA  
Multilateral Agreement for the recognition of calibration certificates

**Glossary:**

TSL	tissue simulating liquid
NORM <sub>x,y,z</sub>	sensitivity in free space
ConvF	sensitivity in TSL / NORM <sub>x,y,z</sub>
DCP	diode compression point
CF	crest factor (1/duty_cycle) of the RF signal
A, B, C, D	modulation dependent linearization parameters
Polarization $\phi$	$\phi$ rotation around probe axis
Polarization $\vartheta$	$\vartheta$ rotation around an axis that is in the plane normal to probe axis (at measurement center), i.e., $\vartheta = 0$ is normal to probe axis
Connector Angle	information used in DASY system to align probe sensor X to the robot coordinate system

**Calibration is Performed According to the Following Standards:**

- a) IEEE Std 1528-2013, "IEEE Recommended Practice for Determining the Peak Spatial-Averaged Specific Absorption Rate (SAR) in the Human Head from Wireless Communications Devices: Measurement Techniques", June 2013
- b) IEC 62209-1, "Procedure to measure the Specific Absorption Rate (SAR) for hand-held devices used in close proximity to the ear (frequency range of 300 MHz to 3 GHz)", February 2005
- c) IEC 62209-2, "Procedure to determine the Specific Absorption Rate (SAR) for wireless communication devices used in close proximity to the human body (frequency range of 30 MHz to 6 GHz)", March 2010
- d) KDB 865664, "SAR Measurement Requirements for 100 MHz to 6 GHz"

**Methods Applied and Interpretation of Parameters:**

- **NORM<sub>x,y,z</sub>**: Assessed for E-field polarization  $\vartheta = 0$  ( $f \leq 900$  MHz in TEM-cell;  $f > 1800$  MHz: R22 waveguide). NORM<sub>x,y,z</sub> are only intermediate values, i.e., the uncertainties of NORM<sub>x,y,z</sub> does not affect the  $E^2$ -field uncertainty inside TSL (see below **ConvF**).
- **NORM(f)<sub>x,y,z</sub> = NORM<sub>x,y,z</sub> \* frequency\_response** (see Frequency Response Chart). This linearization is implemented in DASY4 software versions later than 4.2. The uncertainty of the frequency response is included in the stated uncertainty of **ConvF**.
- **DCP<sub>x,y,z</sub>**: DCP are numerical linearization parameters assessed based on the data of power sweep with CW signal (no uncertainty required). DCP does not depend on frequency nor media.
- **PAR**: PAR is the Peak to Average Ratio that is not calibrated but determined based on the signal characteristics
- **A<sub>x,y,z</sub>; B<sub>x,y,z</sub>; C<sub>x,y,z</sub>; D<sub>x,y,z</sub>; VR<sub>x,y,z</sub>; A, B, C, D** are numerical linearization parameters assessed based on the data of power sweep for specific modulation signal. The parameters do not depend on frequency nor media. VR is the maximum calibration range expressed in RMS voltage across the diode.
- **ConvF and Boundary Effect Parameters**: Assessed in flat phantom using E-field (or Temperature Transfer Standard for  $f \leq 800$  MHz) and inside waveguide using analytical field distributions based on power measurements for  $f > 800$  MHz. The same setups are used for assessment of the parameters applied for boundary compensation (alpha, depth) of which typical uncertainty values are given. These parameters are used in DASY4 software to improve probe accuracy close to the boundary. The sensitivity in TSL corresponds to **NORM<sub>x,y,z</sub> \* ConvF** whereby the uncertainty corresponds to that given for **ConvF**. A frequency dependent **ConvF** is used in DASY version 4.4 and higher which allows extending the validity from  $\pm 50$  MHz to  $\pm 100$  MHz.
- **Spherical isotropy (3D deviation from isotropy)**: in a field of low gradients realized using a flat phantom exposed by a patch antenna.
- **Sensor Offset**: The sensor offset corresponds to the offset of virtual measurement center from the probe tip (on probe axis). No tolerance required.
- **Connector Angle**: The angle is assessed using the information gained by determining the **NORM<sub>x</sub>** (no uncertainty required).



# Probe ES3DV3

## SN:3213

Manufactured: October 14, 2008  
Calibrated: February 19, 2016

Calibrated for DASY/EASY Systems  
(Note: non-compatible with DASY2 system!)

## DASY/EASY - Parameters of Probe: ES3DV3 - SN:3213

### Basic Calibration Parameters

	Sensor X	Sensor Y	Sensor Z	Unc (k=2)
Norm ( $\mu\text{V}/(\text{V}/\text{m})^2$ ) <sup>A</sup>	1.50	1.38	1.34	$\pm 10.1\%$
DCP (mV) <sup>B</sup>	99.8	101.9	99.8	

### Modulation Calibration Parameters

UID	Communication System Name		A dB	B dB $\sqrt{\mu\text{V}}$	C	D dB	VR mV	Unc <sup>E</sup> (k=2)
0	CW	X	0.0	0.0	1.0	0.00	195.2	$\pm 3.5\%$
		Y	0.0	0.0	1.0		214.0	
		Z	0.0	0.0	1.0		215.1	
10010- CAA	SAR Validation (Square, 100ms, 10ms)	X	5.06	68.1	14.5	10.00	42.1	$\pm 0.9\%$
		Y	11.23	76.3	17.0		39.8	
		Z	6.02	70.0	14.9		39.7	
10012- CAB	IEEE 802.11b WiFi 2.4 GHz (DSSS, 1 Mbps)	X	3.09	69.2	18.8	1.87	137.2	$\pm 0.7\%$
		Y	3.15	70.3	19.6		133.1	
		Z	2.82	67.6	18.0		132.3	
10100- CAB	LTE-FDD (SC-FDMA, 100% RB, 20 MHz, QPSK)	X	6.22	66.6	19.2	5.67	125.7	$\pm 1.7\%$
		Y	6.51	68.0	20.1		146.0	
		Z	6.41	67.3	19.6		143.7	
10103- CAB	LTE-TDD (SC-FDMA, 100% RB, 20 MHz, QPSK)	X	10.84	76.7	26.6	9.29	143.8	$\pm 3.3\%$
		Y	10.81	77.3	27.2		137.5	
		Z	10.28	75.3	25.8		136.3	
10108- CAC	LTE-FDD (SC-FDMA, 100% RB, 10 MHz, QPSK)	X	6.44	67.4	19.8	5.80	148.4	$\pm 1.7\%$
		Y	6.38	67.6	20.0		142.8	
		Z	6.32	67.1	19.5		141.5	
10151- CAB	LTE-TDD (SC-FDMA, 50% RB, 20 MHz, QPSK)	X	10.08	75.4	26.1	9.28	137.0	$\pm 3.3\%$
		Y	10.08	76.2	26.8		131.6	
		Z	9.63	74.3	25.4		130.7	
10154- CAC	LTE-FDD (SC-FDMA, 50% RB, 10 MHz, QPSK)	X	6.09	66.7	19.5	5.75	144.2	$\pm 1.4\%$
		Y	6.07	67.1	19.8		139.5	
		Z	5.98	66.4	19.3		137.4	
10160- CAB	LTE-FDD (SC-FDMA, 50% RB, 15 MHz, QPSK)	X	6.59	67.5	19.8	5.82	149.8	$\pm 1.7\%$
		Y	6.51	67.6	20.1		146.2	
		Z	6.44	67.0	19.5		145.3	
10169- CAB	LTE-FDD (SC-FDMA, 1 RB, 20 MHz, QPSK)	X	5.13	67.0	19.8	5.73	146.8	$\pm 1.4\%$
		Y	5.10	67.4	20.2		144.4	
		Z	4.99	66.5	19.5		141.2	
10172- CAB	LTE-TDD (SC-FDMA, 1 RB, 20 MHz, QPSK)	X	8.31	76.6	26.9	9.21	125.5	$\pm 3.3\%$
		Y	10.61	84.9	31.4		149.4	
		Z	8.76	78.4	27.8		143.6	
10175- CAC	LTE-FDD (SC-FDMA, 1 RB, 10 MHz, QPSK)	X	5.05	66.6	19.6	5.72	144.9	$\pm 1.4\%$
		Y	5.06	67.2	20.1		142.1	
		Z	4.99	66.5	19.5		140.5	

10181-CAB	LTE-FDD (SC-FDMA, 1 RB, 15 MHz, QPSK)	X	5.12	66.9	19.8	5.72	145.1	±1.4 %
		Y	5.09	67.3	20.2		143.7	
		Z	5.00	66.6	19.5		140.2	
10237-CAB	LTE-TDD (SC-FDMA, 1 RB, 10 MHz, QPSK)	X	8.18	76.1	26.7	9.21	124.8	±3.3 %
		Y	10.45	84.4	31.2		148.6	
		Z	8.75	78.3	27.7		143.4	
10252-CAB	LTE-TDD (SC-FDMA, 50% RB, 10 MHz, QPSK)	X	9.24	74.1	25.5	9.24	126.6	±2.7 %
		Y	9.21	74.8	26.2		122.2	
		Z	9.78	76.0	26.5		147.7	
10267-CAB	LTE-TDD (SC-FDMA, 100% RB, 10 MHz, QPSK)	X	9.92	75.0	25.9	9.30	133.4	±3.3 %
		Y	9.95	75.8	26.6		128.8	
		Z	9.55	74.0	25.3		127.2	
10297-AAA	LTE-FDD (SC-FDMA, 50% RB, 20 MHz, QPSK)	X	6.43	67.3	19.8	5.81	146.2	±1.4 %
		Y	6.42	67.7	20.1		141.6	
		Z	6.28	66.9	19.5		140.2	
10311-AAA	LTE-FDD (SC-FDMA, 100% RB, 15 MHz, QPSK)	X	6.70	66.9	19.5	6.06	128.1	±1.7 %
		Y	6.97	68.2	20.4		147.3	
		Z	6.91	67.7	20.0		146.2	

The reported uncertainty of measurement is stated as the standard uncertainty of measurement multiplied by the coverage factor  $k=2$ , which for a normal distribution corresponds to a coverage probability of approximately 95%.

<sup>A</sup> The uncertainties of Norm X,Y,Z do not affect the  $E^2$ -field uncertainty inside TSL (see Pages 6 and 7).

<sup>B</sup> Numerical linearization parameter: uncertainty not required.

<sup>E</sup> Uncertainty is determined using the max. deviation from linear response applying rectangular distribution and is expressed for the square of the field value.

## DASY/EASY - Parameters of Probe: ES3DV3 - SN:3213

### Calibration Parameter Determined in Head Tissue Simulating Media

f (MHz) <sup>C</sup>	Relative Permittivity <sup>F</sup>	Conductivity (S/m) <sup>F</sup>	ConvF X	ConvF Y	ConvF Z	Alpha <sup>G</sup>	Depth <sup>G</sup> (mm)	Unc (k=2)
750	41.9	0.89	6.43	6.43	6.43	0.55	1.36	± 12.0 %
835	41.5	0.90	6.18	6.18	6.18	0.58	1.33	± 12.0 %
1750	40.1	1.37	5.23	5.23	5.23	0.80	1.14	± 12.0 %
1900	40.0	1.40	5.05	5.05	5.05	0.60	1.30	± 12.0 %
2300	39.5	1.67	4.78	4.78	4.78	0.59	1.41	± 12.0 %
2450	39.2	1.80	4.58	4.58	4.58	0.75	1.30	± 12.0 %
2600	39.0	1.96	4.38	4.38	4.38	0.71	1.38	± 12.0 %

<sup>C</sup> Frequency validity above 300 MHz of ± 100 MHz only applies for DASY v4.4 and higher (see Page 2), else it is restricted to ± 50 MHz. The uncertainty is the RSS of the ConvF uncertainty at calibration frequency and the uncertainty for the indicated frequency band. Frequency validity below 300 MHz is ± 10, 25, 40, 50 and 70 MHz for ConvF assessments at 30, 64, 128, 150 and 220 MHz respectively. Above 5 GHz frequency validity can be extended to ± 110 MHz.

<sup>F</sup> At frequencies below 3 GHz, the validity of tissue parameters ( $\epsilon$  and  $\sigma$ ) can be relaxed to ± 10% if liquid compensation formula is applied to measured SAR values. At frequencies above 3 GHz, the validity of tissue parameters ( $\epsilon$  and  $\sigma$ ) is restricted to ± 5%. The uncertainty is the RSS of the ConvF uncertainty for indicated target tissue parameters.

<sup>G</sup> Alpha/Depth are determined during calibration. SPEAG warrants that the remaining deviation due to the boundary effect after compensation is always less than ± 1% for frequencies below 3 GHz and below ± 2% for frequencies between 3-6 GHz at any distance larger than half the probe tip diameter from the boundary.

## DASY/EASY - Parameters of Probe: ES3DV3 - SN:3213

### Calibration Parameter Determined in Body Tissue Simulating Media

f (MHz) <sup>C</sup>	Relative Permittivity <sup>F</sup>	Conductivity (S/m) <sup>F</sup>	ConvF X	ConvF Y	ConvF Z	Alpha <sup>G</sup>	Depth <sup>G</sup> (mm)	Unc (k=2)
750	55.5	0.96	5.98	5.98	5.98	0.60	1.31	± 12.0 %
835	55.2	0.97	6.00	6.00	6.00	0.36	1.70	± 12.0 %
1750	53.4	1.49	4.94	4.94	4.94	0.48	1.57	± 12.0 %
1900	53.3	1.52	4.78	4.78	4.78	0.52	1.55	± 12.0 %
2300	52.9	1.81	4.50	4.50	4.50	0.74	1.34	± 12.0 %
2450	52.7	1.95	4.41	4.41	4.41	0.80	1.20	± 12.0 %
2600	52.5	2.16	4.21	4.21	4.21	0.90	1.05	± 12.0 %

<sup>C</sup> Frequency validity above 300 MHz of ± 100 MHz only applies for DASY v4.4 and higher (see Page 2), else it is restricted to ± 50 MHz. The uncertainty is the RSS of the ConvF uncertainty at calibration frequency and the uncertainty for the indicated frequency band. Frequency validity below 300 MHz is ± 10, 25, 40, 50 and 70 MHz for ConvF assessments at 30, 64, 128, 150 and 220 MHz respectively. Above 5 GHz frequency validity can be extended to ± 110 MHz.

<sup>F</sup> At frequencies below 3 GHz, the validity of tissue parameters ( $\epsilon$  and  $\sigma$ ) can be relaxed to ± 10% if liquid compensation formula is applied to measured SAR values. At frequencies above 3 GHz, the validity of tissue parameters ( $\epsilon$  and  $\sigma$ ) is restricted to ± 5%. The uncertainty is the RSS of the ConvF uncertainty for indicated target tissue parameters.

<sup>G</sup> Alpha/Depth are determined during calibration. SPEAG warrants that the remaining deviation due to the boundary effect after compensation is always less than ± 1% for frequencies below 3 GHz and below ± 2% for frequencies between 3-6 GHz at any distance larger than half the probe tip diameter from the boundary.

# Frequency Response of E-Field

(TEM-Cell:ifi110 EXX, Waveguide: R22)

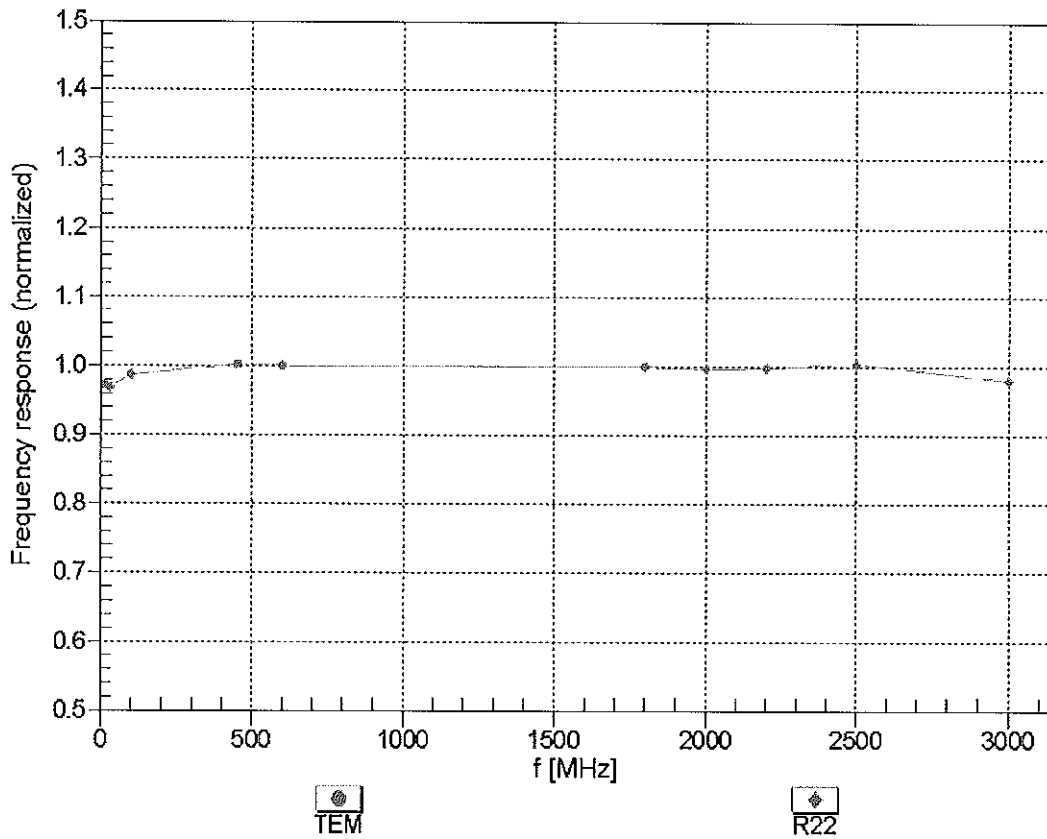

Uncertainty of Frequency Response of E-field:  $\pm 6.3\%$  (k=2)

### Receiving Pattern ( $\phi$ ), $\theta = 0^\circ$

f=600 MHz,TEM

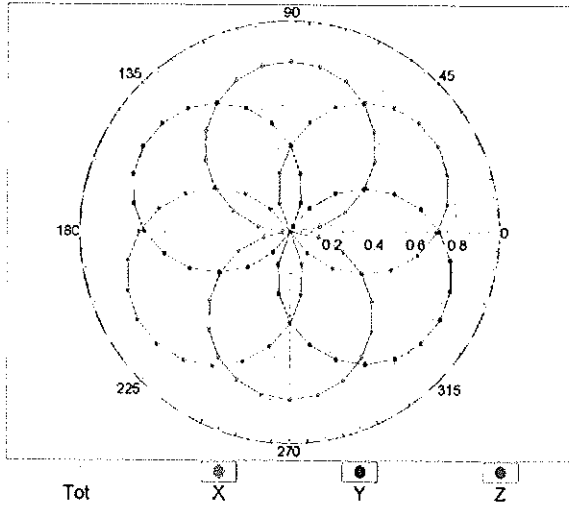

f=1800 MHz,R22

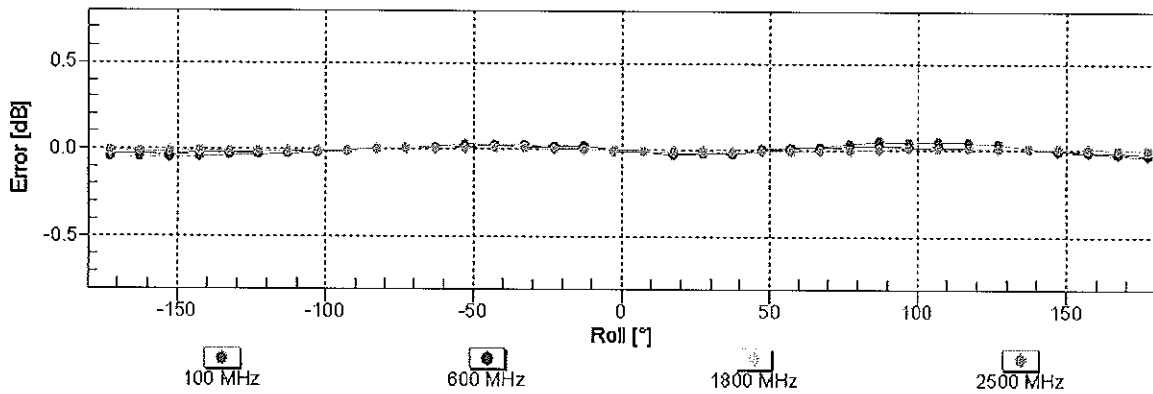
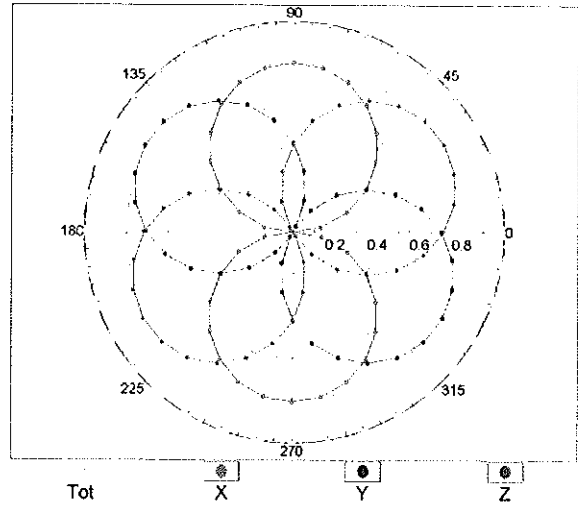

Uncertainty of Axial Isotropy Assessment:  $\pm 0.5\%$  (k=2)

### Dynamic Range f(SAR<sub>head</sub>) (TEM cell , f<sub>eval</sub>= 1900 MHz)

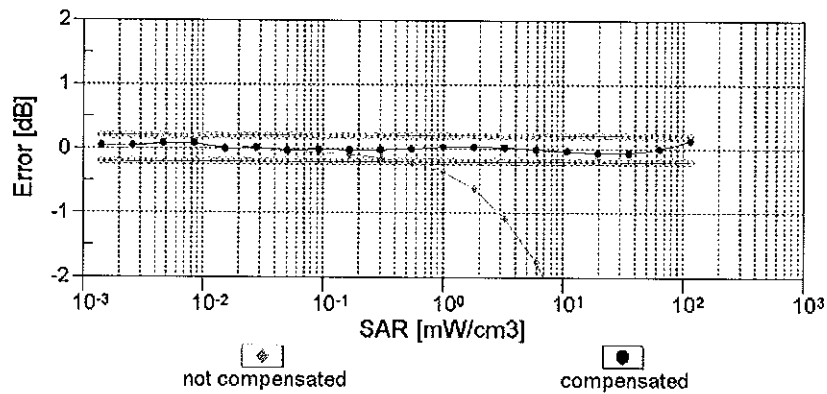
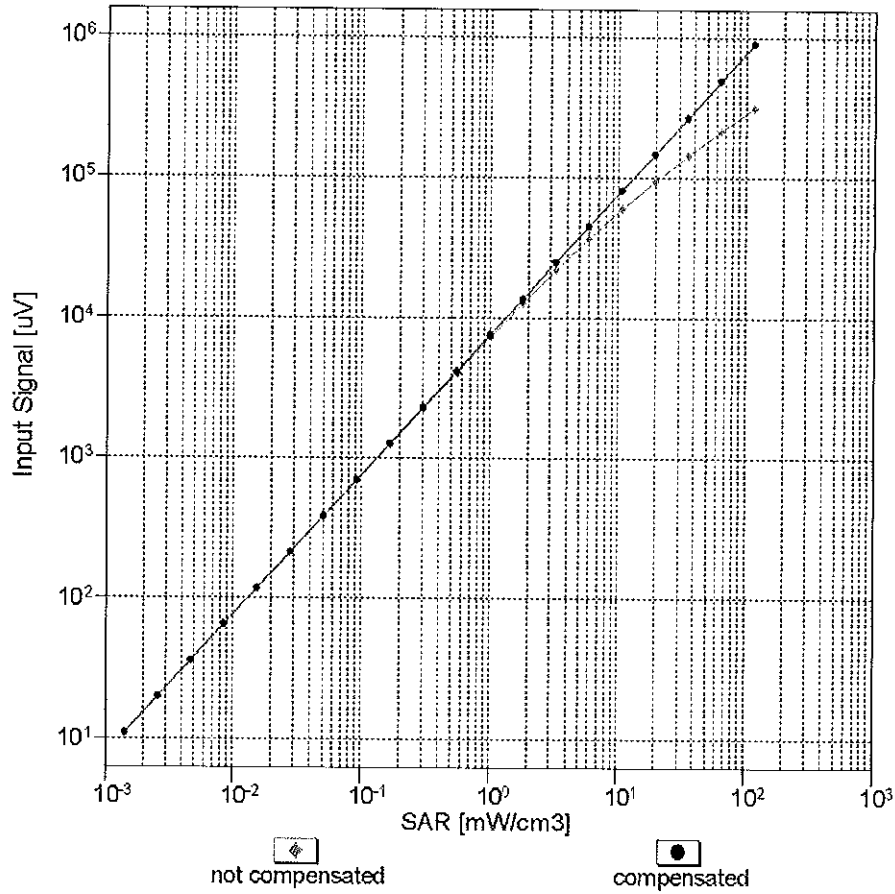

Uncertainty of Linearity Assessment: ± 0.6% (k=2)



# Conversion Factor Assessment

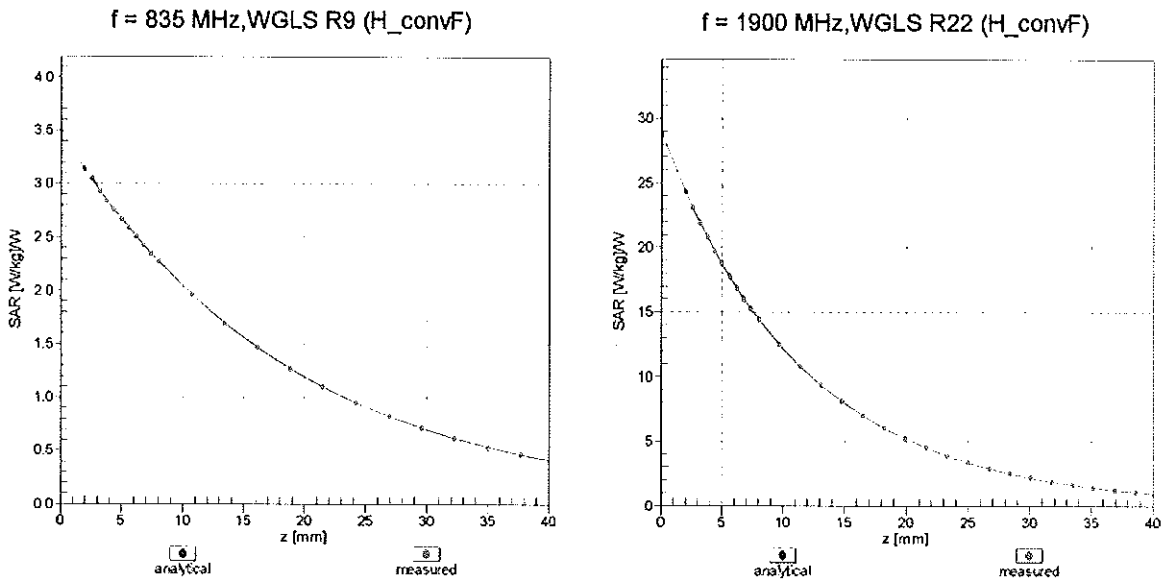

## Deviation from Isotropy in Liquid Error ( $\phi, \theta$ ), f = 900 MHz

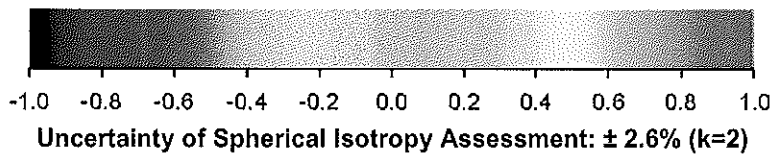
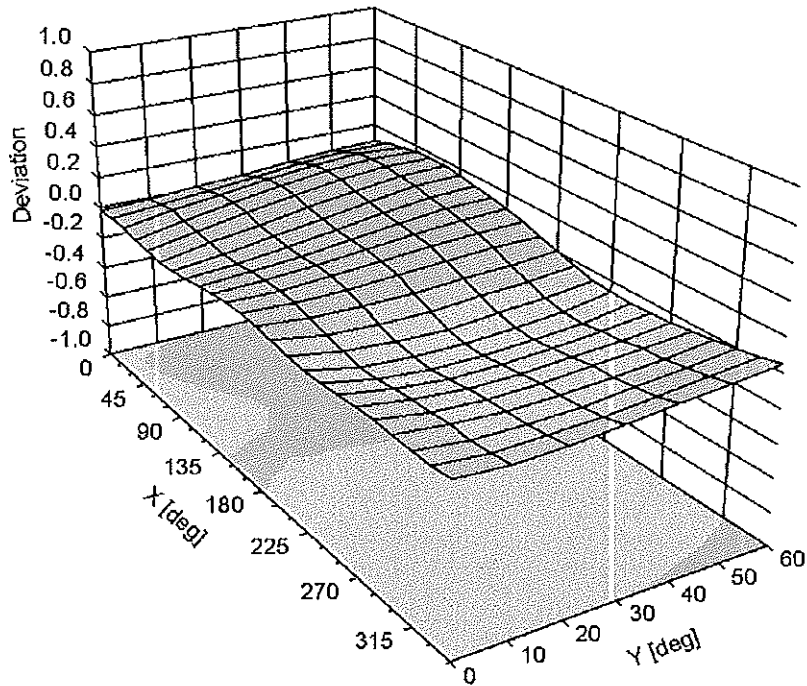

## DASY/EASY - Parameters of Probe: ES3DV3 - SN:3213

### Other Probe Parameters

Sensor Arrangement	Triangular
Connector Angle (°)	97.2
Mechanical Surface Detection Mode	enabled
Optical Surface Detection Mode	disabled
Probe Overall Length	337 mm
Probe Body Diameter	10 mm
Tip Length	10 mm
Tip Diameter	4 mm
Probe Tip to Sensor X Calibration Point	2 mm
Probe Tip to Sensor Y Calibration Point	2 mm
Probe Tip to Sensor Z Calibration Point	2 mm
Recommended Measurement Distance from Surface	3 mm



Accredited by the Swiss Accreditation Service (SAS)  
The Swiss Accreditation Service is one of the signatories to the EA  
Multilateral Agreement for the recognition of calibration certificates

Accreditation No.: **SCS 0108**

Client **PC Test**

Certificate No: **EX3-7409\_May16**

**CALIBRATION CERTIFICATE**

Object **EX3DV4 - SN:7409**

Calibration procedure(s) **QA CAL-01.v9, QA CAL-23.v5, QA CAL-25.v6**  
**Calibration procedure for dosimetric E-field probes**

Calibration date: **May 17, 2016**

This calibration certificate documents the traceability to national standards, which realize the physical units of measurements (SI).  
The measurements and the uncertainties with confidence probability are given on the following pages and are part of the certificate.

All calibrations have been conducted in the closed laboratory facility: environment temperature (22 ± 3)°C and humidity < 70%.

Calibration Equipment used (M&TE critical for calibration)

*BN ✓  
05/23/16*

Primary Standards	ID	Cal Date (Certificate No.)	Scheduled Calibration
Power meter NRP	SN: 104778	06-Apr-16 (No. 217-02288/02289)	Apr-17
Power sensor NRP-Z91	SN: 103244	06-Apr-16 (No. 217-02288)	Apr-17
Power sensor NRP-Z91	SN: 103245	06-Apr-16 (No. 217-02289)	Apr-17
Reference 20 dB Attenuator	SN: S5277 (20x)	05-Apr-16 (No. 217-02293)	Apr-17
Reference Probe ES3DV2	SN: 3013	31-Dec-15 (No. ES3-3013_Dec15)	Dec-16
DAE4	SN: 660	23-Dec-15 (No. DAE4-660_Dec15)	Dec-16
Secondary Standards	ID	Check Date (in house)	Scheduled Check
Power meter E4419B	SN: GB41293874	06-Apr-16 (No. 217-02285/02284)	In house check: Jun-16
Power sensor E4412A	SN: MY41498087	06-Apr-16 (No. 217-02285)	In house check: Jun-16
Power sensor E4412A	SN: 000110210	06-Apr-16 (No. 217-02284)	In house check: Jun-16
RF generator HP 8648C	SN: US3642U01700	04-Aug-99 (in house check Apr-13)	In house check: Jun-16
Network Analyzer HP 8753E	SN: US37390585	18-Oct-01 (in house check Oct-15)	In house check: Oct-16

Calibrated by:	Name <b>Michael Weber</b>	Function <b>Laboratory Technician</b>	Signature <i>M. Weber</i>
Approved by:	Name <b>Katja Pokovic</b>	Function <b>Technical Manager</b>	<i>[Signature]</i>
			Issued: May 18, 2016

This calibration certificate shall not be reproduced except in full without written approval of the laboratory.



Accredited by the Swiss Accreditation Service (SAS)

Accreditation No.: **SCS 0108**

The Swiss Accreditation Service is one of the signatories to the EA  
Multilateral Agreement for the recognition of calibration certificates

**Glossary:**

TSL	tissue simulating liquid
NORM <sub>x,y,z</sub>	sensitivity in free space
ConvF	sensitivity in TSL / NORM <sub>x,y,z</sub>
DCP	diode compression point
CF	crest factor (1/duty_cycle) of the RF signal
A, B, C, D	modulation dependent linearization parameters
Polarization φ	φ rotation around probe axis
Polarization θ	θ rotation around an axis that is in the plane normal to probe axis (at measurement center), i.e., θ = 0 is normal to probe axis
Connector Angle	information used in DASY system to align probe sensor X to the robot coordinate system

**Calibration is Performed According to the Following Standards:**

- a) IEEE Std 1528-2013, "IEEE Recommended Practice for Determining the Peak Spatial-Averaged Specific Absorption Rate (SAR) in the Human Head from Wireless Communications Devices: Measurement Techniques", June 2013
- b) IEC 62209-1, "Procedure to measure the Specific Absorption Rate (SAR) for hand-held devices used in close proximity to the ear (frequency range of 300 MHz to 3 GHz)", February 2005
- c) IEC 62209-2, "Procedure to determine the Specific Absorption Rate (SAR) for wireless communication devices used in close proximity to the human body (frequency range of 30 MHz to 6 GHz)", March 2010
- d) KDB 865664, "SAR Measurement Requirements for 100 MHz to 6 GHz"

**Methods Applied and Interpretation of Parameters:**

- *NORM<sub>x,y,z</sub>*: Assessed for E-field polarization θ = 0 (f ≤ 900 MHz in TEM-cell; f > 1800 MHz: R22 waveguide). *NORM<sub>x,y,z</sub>* are only intermediate values, i.e., the uncertainties of *NORM<sub>x,y,z</sub>* does not affect the E<sup>2</sup>-field uncertainty inside TSL (see below *ConvF*).
- *NORM(f)<sub>x,y,z</sub>* = *NORM<sub>x,y,z</sub>* \* *frequency\_response* (see Frequency Response Chart). This linearization is implemented in DASY4 software versions later than 4.2. The uncertainty of the frequency response is included in the stated uncertainty of *ConvF*.
- *DCP<sub>x,y,z</sub>*: DCP are numerical linearization parameters assessed based on the data of power sweep with CW signal (no uncertainty required). DCP does not depend on frequency nor media.
- *PAR*: PAR is the Peak to Average Ratio that is not calibrated but determined based on the signal characteristics
- *A<sub>x,y,z</sub>; B<sub>x,y,z</sub>; C<sub>x,y,z</sub>; D<sub>x,y,z</sub>; VR<sub>x,y,z</sub>; A, B, C, D* are numerical linearization parameters assessed based on the data of power sweep for specific modulation signal. The parameters do not depend on frequency nor media. *VR* is the maximum calibration range expressed in RMS voltage across the diode.
- *ConvF and Boundary Effect Parameters*: Assessed in flat phantom using E-field (or Temperature Transfer Standard for f ≤ 800 MHz) and inside waveguide using analytical field distributions based on power measurements for f > 800 MHz. The same setups are used for assessment of the parameters applied for boundary compensation (alpha, depth) of which typical uncertainty values are given. These parameters are used in DASY4 software to improve probe accuracy close to the boundary. The sensitivity in TSL corresponds to *NORM<sub>x,y,z</sub>* \* *ConvF* whereby the uncertainty corresponds to that given for *ConvF*. A frequency dependent *ConvF* is used in DASY version 4.4 and higher which allows extending the validity from ± 50 MHz to ± 100 MHz.
- *Spherical isotropy (3D deviation from isotropy)*: in a field of low gradients realized using a flat phantom exposed by a patch antenna.
- *Sensor Offset*: The sensor offset corresponds to the offset of virtual measurement center from the probe tip (on probe axis). No tolerance required.
- *Connector Angle*: The angle is assessed using the information gained by determining the *NORM<sub>x</sub>* (no uncertainty required).

# Probe EX3DV4

## SN:7409

Manufactured: November 24, 2015  
Calibrated: May 17, 2016

Calibrated for DASY/EASY Systems  
(Note: non-compatible with DASY2 system!)

## DASY/EASY - Parameters of Probe: EX3DV4 - SN:7409

### Basic Calibration Parameters

	Sensor X	Sensor Y	Sensor Z	Unc (k=2)
Norm ( $\mu\text{V}/(\text{V}/\text{m})^2$ ) <sup>A</sup>	0.39	0.34	0.39	$\pm 10.1 \%$
DCP (mV) <sup>B</sup>	106.3	102.2	99.4	

### Modulation Calibration Parameters

UID	Communication System Name		A dB	B dB $\sqrt{\mu\text{V}}$	C	D dB	VR mV	Unc <sup>F</sup> (k=2)
0	CW	X	0.0	0.0	1.0	0.00	141.2	$\pm 3.3 \%$
		Y	0.0	0.0	1.0		127.3	
		Z	0.0	0.0	1.0		131.8	
10010- CAA	SAR Validation (Square, 100ms, 10ms)	X	0.39	53.8	5.5	10.00	42.5	$\pm 1.2 \%$
		Y	0.55	54.7	5.9		41.8	
		Z	0.85	58.7	9.1		41.6	
10012- CAB	IEEE 802.11b WiFi 2.4 GHz (DSSS, 1 Mbps)	X	3.55	75.3	22.2	1.87	149.7	$\pm 0.7 \%$
		Y	3.32	72.6	21.0		139.7	
		Z	2.84	68.8	19.0		144.7	
10100- CAB	LTE-FDD (SC-FDMA, 100% RB, 20 MHz, QPSK)	X	5.98	66.6	19.3	5.67	113.6	$\pm 0.9 \%$
		Y	6.17	66.7	19.4		107.1	
		Z	6.13	66.1	18.8		110.9	
10103- CAB	LTE-TDD (SC-FDMA, 100% RB, 20 MHz, QPSK)	X	6.59	66.2	21.1	9.29	123.5	$\pm 1.4 \%$
		Y	7.27	67.9	22.1		121.1	
		Z	7.01	66.4	21.1		119.9	
10108- CAC	LTE-FDD (SC-FDMA, 100% RB, 10 MHz, QPSK)	X	5.72	66.1	19.2	5.80	111.4	$\pm 1.2 \%$
		Y	6.34	67.6	20.0		149.2	
		Z	6.02	65.9	19.0		109.0	
10151- CAB	LTE-TDD (SC-FDMA, 50% RB, 20 MHz, QPSK)	X	6.27	66.1	21.2	9.28	116.8	$\pm 1.4 \%$
		Y	6.89	67.6	22.1		114.7	
		Z	6.69	66.0	21.0		116.4	
10154- CAC	LTE-FDD (SC-FDMA, 50% RB, 10 MHz, QPSK)	X	5.37	65.9	19.1	5.75	107.3	$\pm 1.2 \%$
		Y	5.98	67.2	19.9		143.3	
		Z	6.01	66.7	19.4		149.2	
10160- CAB	LTE-FDD (SC-FDMA, 50% RB, 15 MHz, QPSK)	X	5.76	66.2	19.2	5.82	109.5	$\pm 1.2 \%$
		Y	6.43	67.6	20.0		148.3	
		Z	6.05	65.6	18.7		107.5	
10169- CAB	LTE-FDD (SC-FDMA, 1 RB, 20 MHz, QPSK)	X	4.24	65.6	19.3	5.73	127.4	$\pm 0.9 \%$
		Y	4.54	66.4	19.8		120.4	
		Z	4.62	65.9	19.3		123.8	
10172- CAB	LTE-TDD (SC-FDMA, 1 RB, 20 MHz, QPSK)	X	4.91	68.0	22.7	9.21	126.7	$\pm 1.4 \%$
		Y	5.24	68.8	23.3		124.0	
		Z	5.35	68.1	22.5		125.0	
10175- CAC	LTE-FDD (SC-FDMA, 1 RB, 10 MHz, QPSK)	X	4.27	65.8	19.4	5.72	128.9	$\pm 0.9 \%$
		Y	4.52	66.2	19.7		121.2	
		Z	4.63	65.9	19.3		125.2	

10181-CAB	LTE-FDD (SC-FDMA, 1 RB, 15 MHz, QPSK)	X	4.26	65.7	19.4	5.72	125.9	±0.9 %
		Y	4.47	66.0	19.5		120.6	
		Z	4.60	65.7	19.2		123.0	
10237-CAB	LTE-TDD (SC-FDMA, 1 RB, 10 MHz, QPSK)	X	4.89	67.9	22.6	9.21	125.9	±1.7 %
		Y	5.26	69.0	23.4		123.8	
		Z	5.32	67.8	22.3		124.3	
10252-CAB	LTE-TDD (SC-FDMA, 50% RB, 10 MHz, QPSK)	X	6.04	66.8	21.7	9.24	149.2	±1.4 %
		Y	6.64	68.1	22.6		148.9	
		Z	6.48	66.5	21.4		147.5	
10267-CAB	LTE-TDD (SC-FDMA, 100% RB, 10 MHz, QPSK)	X	6.27	66.1	21.2	9.30	119.1	±1.4 %
		Y	6.88	67.4	22.0		115.9	
		Z	6.73	66.1	21.1		117.6	
10297-AAA	LTE-FDD (SC-FDMA, 50% RB, 20 MHz, QPSK)	X	5.71	66.0	19.2	5.81	110.7	±0.9 %
		Y	6.41	67.8	20.2		149.8	
		Z	5.98	65.7	18.9		107.9	
10311-AAA	LTE-FDD (SC-FDMA, 100% RB, 15 MHz, QPSK)	X	6.23	66.3	19.4	6.06	112.8	±0.9 %
		Y	6.51	66.6	19.5		107.4	
		Z	6.49	66.1	19.0		109.4	

The reported uncertainty of measurement is stated as the standard uncertainty of measurement multiplied by the coverage factor  $k=2$ , which for a normal distribution corresponds to a coverage probability of approximately 95%.

<sup>A</sup> The uncertainties of Norm X,Y,Z do not affect the  $E^2$ -field uncertainty inside TSL. (see Pages 6 and 7).

<sup>B</sup> Numerical linearization parameter: uncertainty not required.

<sup>E</sup> Uncertainty is determined using the max. deviation from linear response applying rectangular distribution and is expressed for the square of the field value.

## DASY/EASY - Parameters of Probe: EX3DV4 - SN:7409

### Calibration Parameter Determined in Head Tissue Simulating Media

f (MHz) <sup>C</sup>	Relative Permittivity <sup>F</sup>	Conductivity (S/m) <sup>F</sup>	ConvF X	ConvF Y	ConvF Z	Alpha <sup>G</sup>	Depth <sup>G</sup> (mm)	Unc (k=2)
750	41.9	0.89	10.73	10.73	10.73	0.62	0.83	± 12.0 %
835	41.5	0.90	10.04	10.04	10.04	0.45	0.93	± 12.0 %
1750	40.1	1.37	8.05	8.05	8.05	0.38	0.80	± 12.0 %
1900	40.0	1.40	7.69	7.69	7.69	0.41	0.80	± 12.0 %
2300	39.5	1.67	7.22	7.22	7.22	0.25	0.92	± 12.0 %
2450	39.2	1.80	6.90	6.90	6.90	0.30	0.93	± 12.0 %
2600	39.0	1.96	6.77	6.77	6.77	0.32	0.83	± 12.0 %

<sup>C</sup> Frequency validity above 300 MHz of ± 100 MHz only applies for DASY v4.4 and higher (see Page 2), else it is restricted to ± 50 MHz. The uncertainty is the RSS of the ConvF uncertainty at calibration frequency and the uncertainty for the indicated frequency band. Frequency validity below 300 MHz is ± 10, 25, 40, 50 and 70 MHz for ConvF assessments at 30, 64, 128, 150 and 220 MHz respectively. Above 5 GHz frequency validity can be extended to ± 110 MHz.

<sup>F</sup> At frequencies below 3 GHz, the validity of tissue parameters ( $\epsilon$  and  $\sigma$ ) can be relaxed to ± 10% if liquid compensation formula is applied to measured SAR values. At frequencies above 3 GHz, the validity of tissue parameters ( $\epsilon$  and  $\sigma$ ) is restricted to ± 5%. The uncertainty is the RSS of the ConvF uncertainty for indicated target tissue parameters.

<sup>G</sup> Alpha/Depth are determined during calibration. SPEAG warrants that the remaining deviation due to the boundary effect after compensation is always less than ± 1% for frequencies below 3 GHz and below ± 2% for frequencies between 3-6 GHz at any distance larger than half the probe lip diameter from the boundary.



## DASY/EASY - Parameters of Probe: EX3DV4 - SN:7409

### Calibration Parameter Determined in Body Tissue Simulating Media

f (MHz) <sup>C</sup>	Relative Permittivity <sup>F</sup>	Conductivity (S/m) <sup>F</sup>	ConvF X	ConvF Y	ConvF Z	Alpha <sup>G</sup>	Depth <sup>G</sup> (mm)	Unc (k=2)
750	55.5	0.96	9.46	9.46	9.46	0.52	0.80	± 12.0 %
835	55.2	0.97	9.33	9.33	9.33	0.34	1.04	± 12.0 %
1750	53.4	1.49	7.72	7.72	7.72	0.44	0.80	± 12.0 %
1900	53.3	1.52	7.47	7.47	7.47	0.43	0.80	± 12.0 %
2300	52.9	1.81	7.22	7.22	7.22	0.36	0.85	± 12.0 %
2450	52.7	1.95	7.10	7.10	7.10	0.39	0.80	± 12.0 %
2600	52.5	2.16	6.83	6.83	6.83	0.39	0.86	± 12.0 %

<sup>C</sup> Frequency validity above 300 MHz of ± 100 MHz only applies for DASY v4.4 and higher (see Page 2), else it is restricted to ± 50 MHz. The uncertainty is the RSS of the ConvF uncertainty at calibration frequency and the uncertainty for the indicated frequency band. Frequency validity below 300 MHz is ± 10, 25, 40, 50 and 70 MHz for ConvF assessments at 30, 64, 128, 150 and 220 MHz respectively. Above 5 GHz frequency validity can be extended to ± 110 MHz.

<sup>F</sup> At frequencies below 3 GHz, the validity of tissue parameters ( $\epsilon$  and  $\sigma$ ) can be relaxed to ± 10% if liquid compensation formula is applied to measured SAR values. At frequencies above 3 GHz, the validity of tissue parameters ( $\epsilon$  and  $\sigma$ ) is restricted to ± 5%. The uncertainty is the RSS of the ConvF uncertainty for indicated target tissue parameters.

<sup>G</sup> Alpha/Depth are determined during calibration. SPEAG warrants that the remaining deviation due to the boundary effect after compensation is always less than ± 1% for frequencies below 3 GHz and below ± 2% for frequencies between 3-6 GHz at any distance larger than half the probe tip diameter from the boundary.

### Frequency Response of E-Field (TEM-Cell:ifi110 EXX, Waveguide: R22)

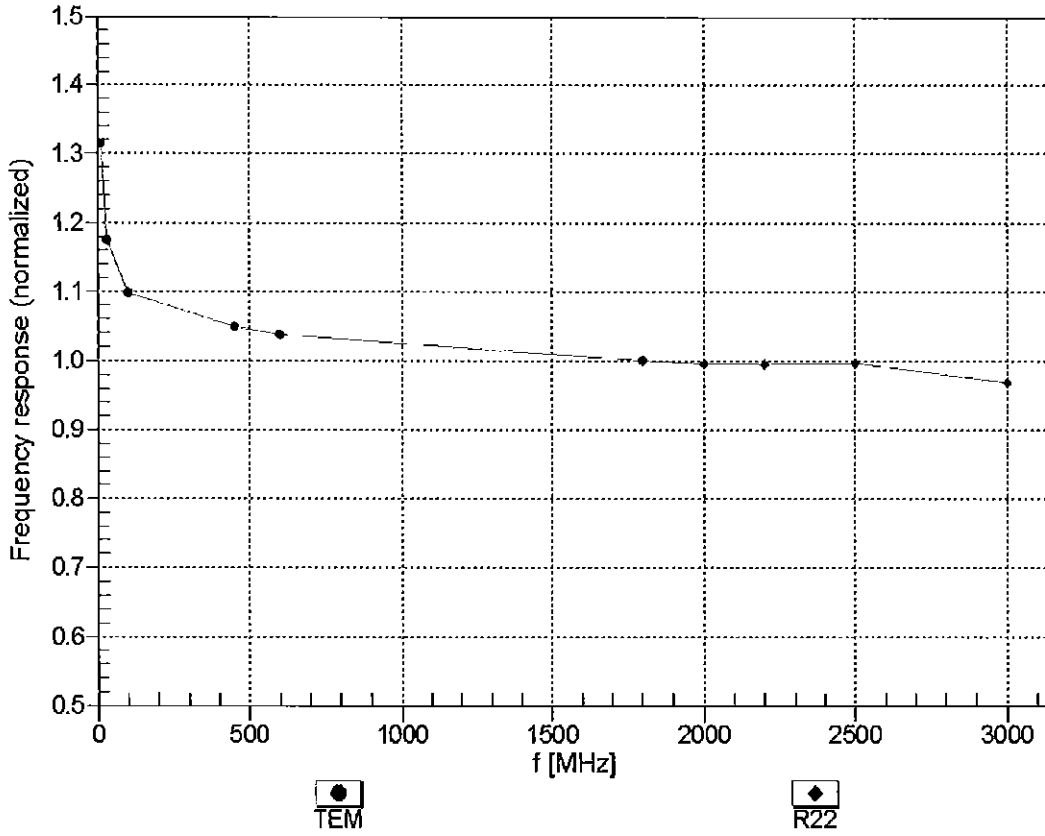

Uncertainty of Frequency Response of E-field:  $\pm 6.3\%$  (k=2)

## Receiving Pattern ( $\phi$ ), $\theta = 0^\circ$

f=600 MHz,TEM

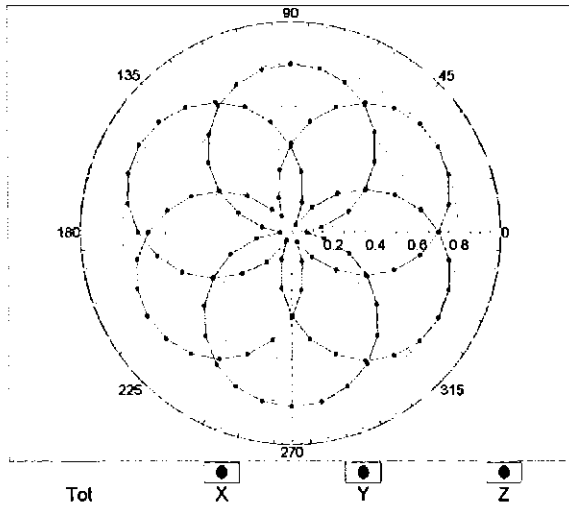

f=1800 MHz,R22

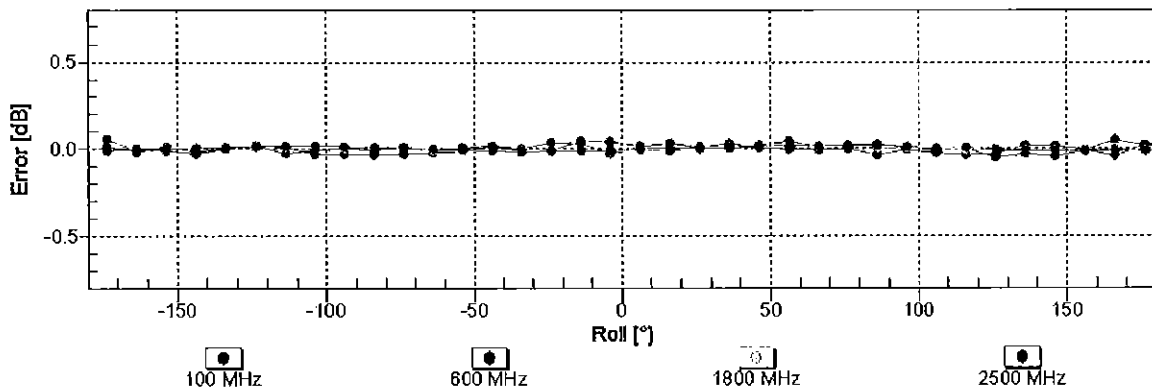
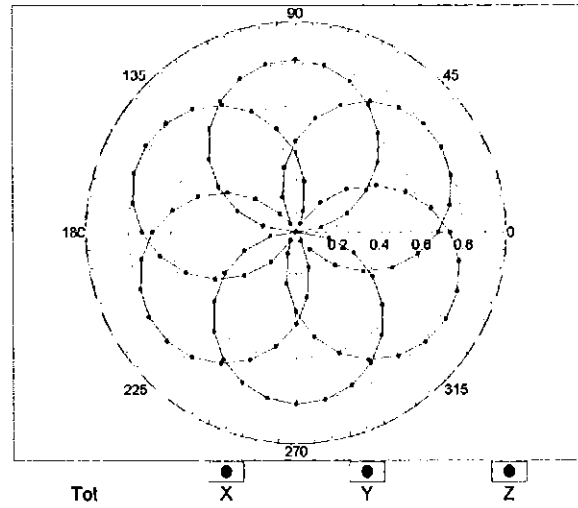

Uncertainty of Axial Isotropy Assessment:  $\pm 0.5\%$  (k=2)

### Dynamic Range f(SAR<sub>head</sub>) (TEM cell , f<sub>eval</sub>= 1900 MHz)

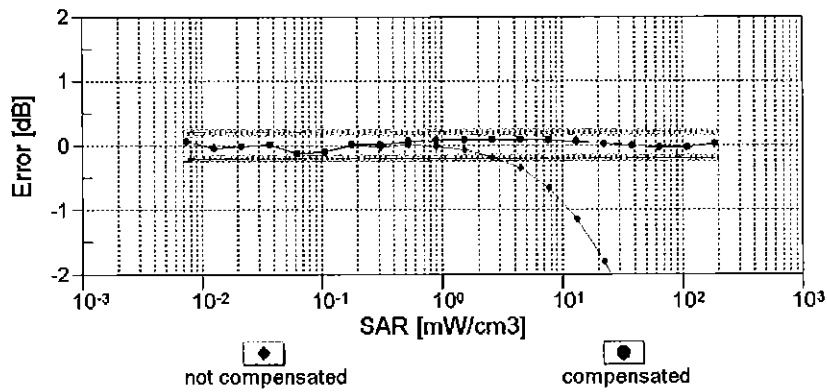
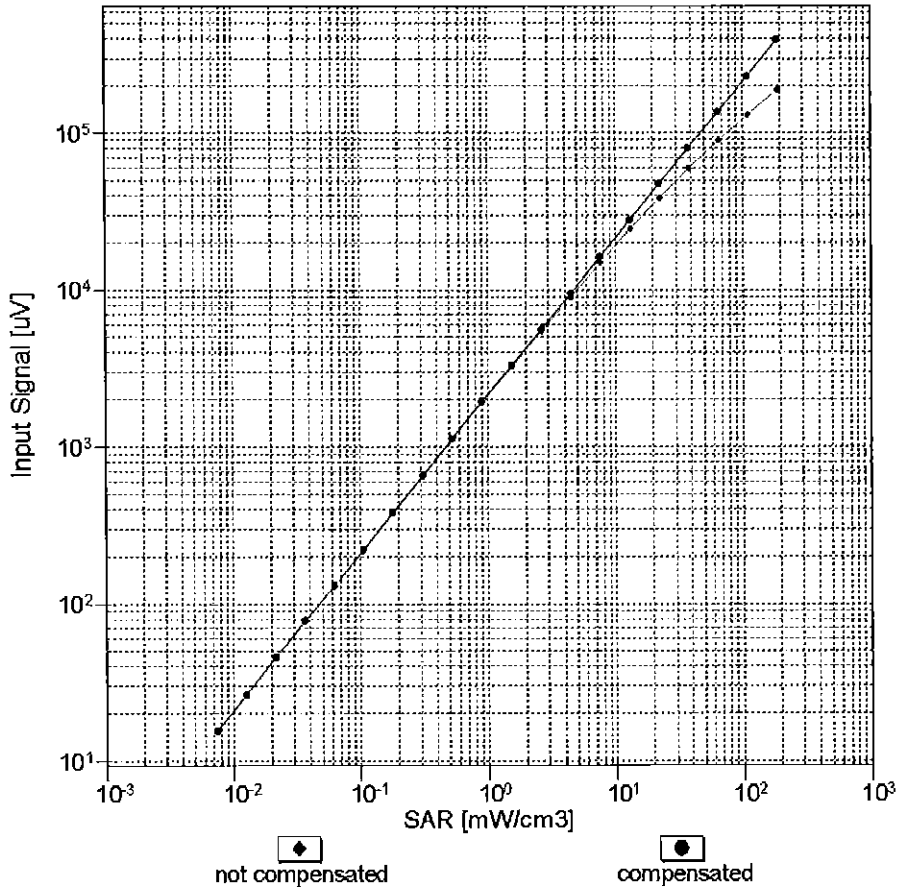

Uncertainty of Linearity Assessment: ± 0.6% (k=2)

# Conversion Factor Assessment

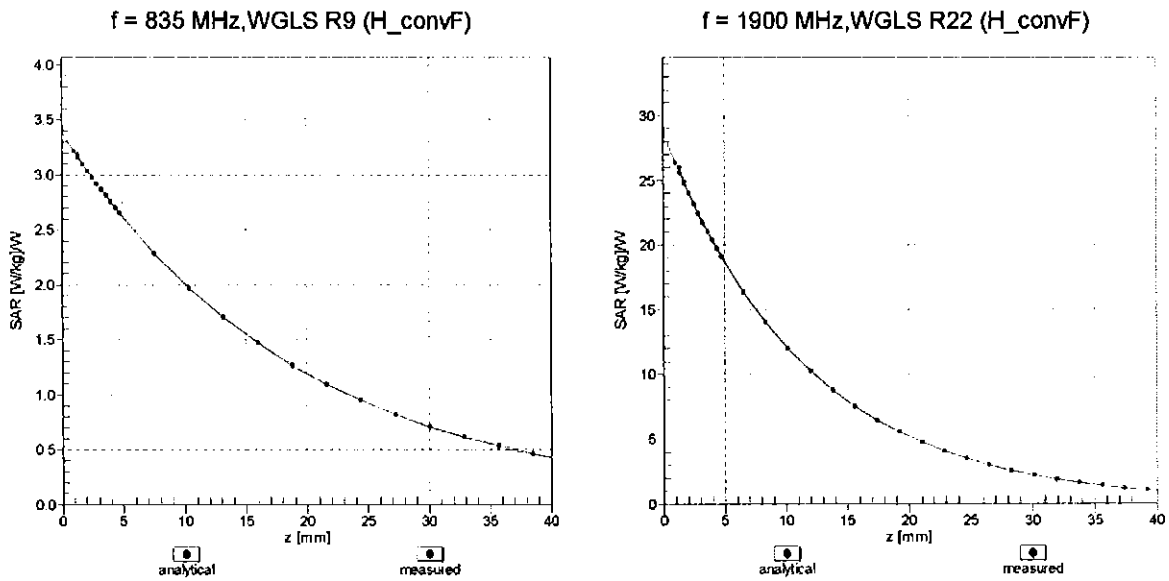

## Deviation from Isotropy in Liquid Error ( $\phi, \vartheta$ ), f = 900 MHz

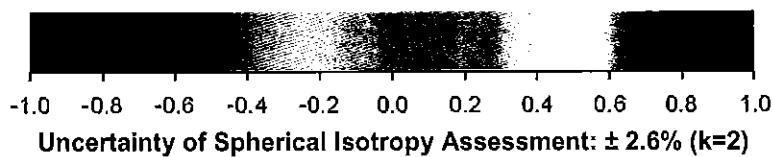
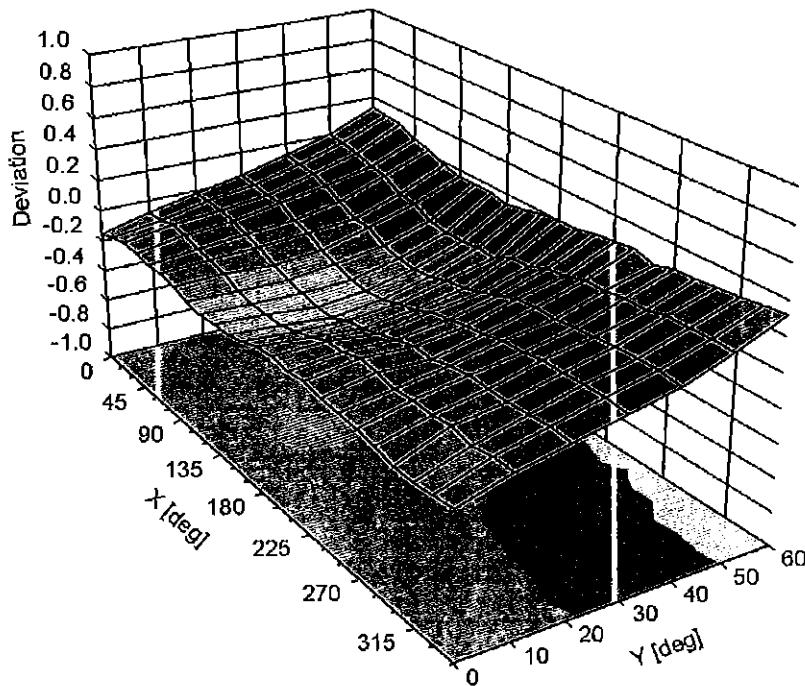

**DASY/EASY - Parameters of Probe: EX3DV4 - SN:7409****Other Probe Parameters**

Sensor Arrangement	Triangular
Connector Angle (°)	36.2
Mechanical Surface Detection Mode	enabled
Optical Surface Detection Mode	disabled
Probe Overall Length	337 mm
Probe Body Diameter	10 mm
Tip Length	9 mm
Tip Diameter	2.5 mm
Probe Tip to Sensor X Calibration Point	1 mm
Probe Tip to Sensor Y Calibration Point	1 mm
Probe Tip to Sensor Z Calibration Point	1 mm
Recommended Measurement Distance from Surface	1.4 mm



Accredited by the Swiss Accreditation Service (SAS)  
The Swiss Accreditation Service is one of the signatories to the EA  
Multilateral Agreement for the recognition of calibration certificates

Accreditation No.: **SCS 0108**

Client **PC Test**

Certificate No: **EX3-7406\_Apr16**

## CALIBRATION CERTIFICATE

Object: **EX3DV4 - SN:7406**

Calibration procedure(s): **QA CAL-01.v9, QA CAL-23.v5, QA CAL-25.v6**  
Calibration procedure for dosimetric E-field probes

Calibration date: **April 19, 2016**

This calibration certificate documents the traceability to national standards, which realize the physical units of measurements (SI).  
The measurements and the uncertainties with confidence probability are given on the following pages and are part of the certificate.

All calibrations have been conducted in the closed laboratory facility: environment temperature (22 ± 3)°C and humidity < 70%.

Calibration Equipment used (M&TE critical for calibration)

BN 04/26/2d6 ✓

Primary Standards	ID	Cal Date (Certificate No.)	Scheduled Calibration
Power meter NRP	SN: 104778	06-Apr-16 (No. 217-02288/02289)	Apr-17
Power sensor NRP-Z91	SN: 103244	06-Apr-16 (No. 217-02288)	Apr-17
Power sensor NRP-Z91	SN: 103245	06-Apr-16 (No. 217-02289)	Apr-17
Reference 20 dB Attenuator	SN: S5277 (20x)	05-Apr-16 (No. 217-02293)	Apr-17
Reference Probe ES3DV2	SN: 3013	31-Dec-15 (No. ES3-3013_Dec15)	Dec-16
DAE4	SN: 660	23-Dec-15 (No. DAE4-660_Dec15)	Dec-16
Secondary Standards	ID	Check Date (in house)	Scheduled Check
Power meter E4419B	SN: GB41293874	06-Apr-16 (No. 217-02285/02284)	In house check: Jun-16
Power sensor E4412A	SN: MY41498087	06-Apr-16 (No. 217-02285)	In house check: Jun-16
Power sensor E4412A	SN: 000110210	06-Apr-16 (No. 217-02284)	In house check: Jun-16
RF generator HP 8648C	SN: US3642U01700	04-Aug-99 (in house check Apr-13)	In house check: Jun-16
Network Analyzer HP 8753E	SN: US37390585	18-Oct-01 (in house check Oct-15)	In house check: Oct-16

Calibrated by:	Name <b>Jeton Kastrati</b>	Function <b>Laboratory Technician</b>	Signature 
Approved by:	Name <b>Katja Pokovic</b>	Function <b>Technical Manager</b>	Signature 
			Issued: April 20, 2016
This calibration certificate shall not be reproduced except in full without written approval of the laboratory.			



Accredited by the Swiss Accreditation Service (SAS)

Accreditation No.: **SCS 0108**

The Swiss Accreditation Service is one of the signatories to the EA  
Multilateral Agreement for the recognition of calibration certificates

**Glossary:**

TSL	tissue simulating liquid
NORM <sub>x,y,z</sub>	sensitivity in free space
ConvF	sensitivity in TSL / NORM <sub>x,y,z</sub>
DCP	diode compression point
CF	crest factor (1/duty_cycle) of the RF signal
A, B, C, D	modulation dependent linearization parameters
Polarization $\varphi$	$\varphi$ rotation around probe axis
Polarization $\vartheta$	$\vartheta$ rotation around an axis that is in the plane normal to probe axis (at measurement center), i.e., $\vartheta = 0$ is normal to probe axis
Connector Angle	information used in DASY system to align probe sensor X to the robot coordinate system

**Calibration is Performed According to the Following Standards:**

- a) IEEE Std 1528-2013, "IEEE Recommended Practice for Determining the Peak Spatial-Averaged Specific Absorption Rate (SAR) in the Human Head from Wireless Communications Devices: Measurement Techniques", June 2013
- b) IEC 62209-1, "Procedure to measure the Specific Absorption Rate (SAR) for hand-held devices used in close proximity to the ear (frequency range of 300 MHz to 3 GHz)", February 2005
- c) IEC 62209-2, "Procedure to determine the Specific Absorption Rate (SAR) for wireless communication devices used in close proximity to the human body (frequency range of 30 MHz to 6 GHz)", March 2010
- d) KDB 865664, "SAR Measurement Requirements for 100 MHz to 6 GHz"

**Methods Applied and Interpretation of Parameters:**

- *NORM<sub>x,y,z</sub>*: Assessed for E-field polarization  $\vartheta = 0$  ( $f \leq 900$  MHz in TEM-cell;  $f > 1800$  MHz: R22 waveguide). *NORM<sub>x,y,z</sub>* are only intermediate values, i.e., the uncertainties of *NORM<sub>x,y,z</sub>* does not affect the  $E^2$ -field uncertainty inside TSL (see below *ConvF*).
- *NORM(f)<sub>x,y,z</sub>* = *NORM<sub>x,y,z</sub>* \* *frequency\_response* (see Frequency Response Chart). This linearization is implemented in DASY4 software versions later than 4.2. The uncertainty of the frequency response is included in the stated uncertainty of *ConvF*.
- *DCP<sub>x,y,z</sub>*: DCP are numerical linearization parameters assessed based on the data of power sweep with CW signal (no uncertainty required). DCP does not depend on frequency nor media.
- *PAR*: PAR is the Peak to Average Ratio that is not calibrated but determined based on the signal characteristics
- *A<sub>x,y,z</sub>*; *B<sub>x,y,z</sub>*; *C<sub>x,y,z</sub>*; *D<sub>x,y,z</sub>*; *VR<sub>x,y,z</sub>*: *A, B, C, D* are numerical linearization parameters assessed based on the data of power sweep for specific modulation signal. The parameters do not depend on frequency nor media. *VR* is the maximum calibration range expressed in RMS voltage across the diode.
- *ConvF* and *Boundary Effect Parameters*: Assessed in flat phantom using E-field (or Temperature Transfer Standard for  $f \leq 800$  MHz) and inside waveguide using analytical field distributions based on power measurements for  $f > 800$  MHz. The same setups are used for assessment of the parameters applied for boundary compensation (alpha, depth) of which typical uncertainty values are given. These parameters are used in DASY4 software to improve probe accuracy close to the boundary. The sensitivity in TSL corresponds to *NORM<sub>x,y,z</sub>* \* *ConvF* whereby the uncertainty corresponds to that given for *ConvF*. A frequency dependent *ConvF* is used in DASY version 4.4 and higher which allows extending the validity from  $\pm 50$  MHz to  $\pm 100$  MHz.
- *Spherical isotropy (3D deviation from isotropy)*: in a field of low gradients realized using a flat phantom exposed by a patch antenna.
- *Sensor Offset*: The sensor offset corresponds to the offset of virtual measurement center from the probe tip (on probe axis). No tolerance required.
- *Connector Angle*: The angle is assessed using the information gained by determining the *NORM<sub>x</sub>* (no uncertainty required).



# Probe EX3DV4

## SN:7406

Manufactured: November 24, 2015  
Calibrated: April 19, 2016

Calibrated for DASY/EASY Systems  
(Note: non-compatible with DASY2 system!)

## DASY/EASY - Parameters of Probe: EX3DV4 - SN:7406

### Basic Calibration Parameters

	Sensor X	Sensor Y	Sensor Z	Unc (k=2)
Norm ( $\mu\text{V}/(\text{V}/\text{m})^2$ ) <sup>A</sup>	0.48	0.44	0.47	$\pm 10.1 \%$
DCP (mV) <sup>B</sup>	100.7	97.9	98.6	

### Modulation Calibration Parameters

UID	Communication System Name		A dB	B dB $\sqrt{\mu\text{V}}$	C	D dB	VR mV	Unc <sup>E</sup> (k=2)
0	CW	X	0.0	0.0	1.0	0.00	120.4	$\pm 3.3 \%$
		Y	0.0	0.0	1.0		148.3	
		Z	0.0	0.0	1.0		146.7	
10010- CAA	SAR Validation (Square, 100ms, 10ms)	X	0.81	54.6	7.4	10.00	50.3	$\pm 2.2 \%$
		Y	0.68	55.1	7.9		47.9	
		Z	1.34	61.0	11.0		46.8	
10012- CAB	IEEE 802.11b WiFi 2.4 GHz (DSSS, 1 Mbps)	X	2.83	68.0	18.3	1.87	127.8	$\pm 0.5 \%$
		Y	2.82	68.4	18.4		117.8	
		Z	3.00	69.2	19.0		115.9	
10100- CAB	LTE-FDD (SC-FDMA, 100% RB, 20 MHz, QPSK)	X	6.54	67.4	19.5	5.67	142.1	$\pm 1.2 \%$
		Y	6.19	66.7	19.3		127.6	
		Z	6.37	66.7	19.2		125.7	
10103- CAB	LTE-TDD (SC-FDMA, 100% RB, 20 MHz, QPSK)	X	7.58	67.9	21.8	9.29	114.4	$\pm 1.7 \%$
		Y	7.34	68.3	22.5		144.3	
		Z	7.53	67.7	21.8		139.5	
10108- CAC	LTE-FDD (SC-FDMA, 100% RB, 10 MHz, QPSK)	X	6.34	66.9	19.4	5.80	137.5	$\pm 1.2 \%$
		Y	5.90	65.9	19.0		123.8	
		Z	6.24	66.4	19.2		123.7	
10151- CAB	LTE-TDD (SC-FDMA, 50% RB, 20 MHz, QPSK)	X	7.17	67.2	21.5	9.28	109.5	$\pm 1.7 \%$
		Y	6.83	67.6	22.3		137.0	
		Z	7.23	67.4	21.7		135.1	
10154- CAC	LTE-FDD (SC-FDMA, 50% RB, 10 MHz, QPSK)	X	5.99	66.4	19.2	5.75	132.4	$\pm 0.9 \%$
		Y	5.61	65.8	19.1		119.4	
		Z	5.91	65.9	19.0		120.1	
10160- CAB	LTE-FDD (SC-FDMA, 50% RB, 15 MHz, QPSK)	X	6.47	67.0	19.5	5.82	137.0	$\pm 1.2 \%$
		Y	5.96	66.0	19.1		123.9	
		Z	6.33	66.3	19.1		124.2	
10169- CAB	LTE-FDD (SC-FDMA, 1 RB, 20 MHz, QPSK)	X	4.71	65.5	18.9	5.73	113.2	$\pm 1.2 \%$
		Y	4.60	66.2	19.6		144.2	
		Z	4.93	66.5	19.5		143.2	
10172- CAB	LTE-TDD (SC-FDMA, 1 RB, 20 MHz, QPSK)	X	5.68	68.2	22.4	9.21	117.6	$\pm 1.7 \%$
		Y	5.56	70.1	24.1		146.1	
		Z	5.87	69.4	23.2		143.7	
10175- CAC	LTE-FDD (SC-FDMA, 1 RB, 10 MHz, QPSK)	X	4.75	65.7	19.1	5.72	112.3	$\pm 0.9 \%$
		Y	4.58	66.1	19.5		143.2	
		Z	4.95	66.7	19.6		142.0	

10181-CAB	LTE-FDD (SC-FDMA, 1 RB, 15 MHz, QPSK)	X	4.71	65.5	18.9	5.72	110.2	±0.9 %
		Y	4.53	65.8	19.4		141.4	
		Z	4.90	66.5	19.5		138.1	
10237-CAB	LTE-TDD (SC-FDMA, 1 RB, 10 MHz, QPSK)	X	5.69	68.3	22.5	9.21	117.3	±1.7 %
		Y	5.47	69.5	23.8		145.1	
		Z	5.85	69.3	23.1		142.0	
10252-CAB	LTE-TDD (SC-FDMA, 50% RB, 10 MHz, QPSK)	X	7.04	68.1	22.2	9.24	141.2	±1.9 %
		Y	6.35	67.2	22.2		125.4	
		Z	6.82	67.1	21.7		127.5	
10267-CAB	LTE-TDD (SC-FDMA, 100% RB, 10 MHz, QPSK)	X	7.45	68.3	22.2	9.30	148.0	±1.9 %
		Y	6.84	67.5	22.3		132.0	
		Z	7.24	67.4	21.8		134.6	
10297-AAA	LTE-FDD (SC-FDMA, 50% RB, 20 MHz, QPSK)	X	6.35	66.9	19.4	5.81	135.3	±1.2 %
		Y	5.92	65.9	19.0		122.9	
		Z	6.26	66.4	19.2		122.1	
10311-AAA	LTE-FDD (SC-FDMA, 100% RB, 15 MHz, QPSK)	X	6.92	67.4	19.7	6.06	139.3	±1.2 %
		Y	6.52	66.6	19.5		127.9	
		Z	6.82	66.9	19.5		126.8	

The reported uncertainty of measurement is stated as the standard uncertainty of measurement multiplied by the coverage factor  $k=2$ , which for a normal distribution corresponds to a coverage probability of approximately 95%.

<sup>A</sup> The uncertainties of Norm X,Y,Z do not affect the  $E^2$ -field uncertainty inside TSL (see Pages 6 and 7).

<sup>B</sup> Numerical linearization parameter: uncertainty not required.

<sup>E</sup> Uncertainty is determined using the max. deviation from linear response applying rectangular distribution and is expressed for the square of the field value.

## DASY/EASY - Parameters of Probe: EX3DV4 - SN:7406

### Calibration Parameter Determined in Head Tissue Simulating Media

f (MHz) <sup>C</sup>	Relative Permittivity <sup>F</sup>	Conductivity (S/m) <sup>F</sup>	ConvF X	ConvF Y	ConvF Z	Alpha <sup>G</sup>	Depth <sup>G</sup> (mm)	Unc (k=2)
750	41.9	0.89	10.52	10.52	10.52	0.52	0.89	± 12.0 %
835	41.5	0.90	9.83	9.83	9.83	0.54	0.80	± 12.0 %
1750	40.1	1.37	8.85	8.85	8.85	0.49	0.85	± 12.0 %
1900	40.0	1.40	8.22	8.22	8.22	0.40	0.88	± 12.0 %
2300	39.5	1.67	7.67	7.67	7.67	0.36	0.89	± 12.0 %
2450	39.2	1.80	7.29	7.29	7.29	0.40	0.80	± 12.0 %
2600	39.0	1.96	7.08	7.08	7.08	0.37	0.95	± 12.0 %

<sup>C</sup> Frequency validity above 300 MHz of ± 100 MHz only applies for DASY v4.4 and higher (see Page 2), else it is restricted to ± 50 MHz. The uncertainty is the RSS of the ConvF uncertainty at calibration frequency and the uncertainty for the indicated frequency band. Frequency validity below 300 MHz is ± 10, 25, 40, 50 and 70 MHz for ConvF assessments at 30, 64, 128, 150 and 220 MHz respectively. Above 5 GHz frequency validity can be extended to ± 110 MHz.

<sup>F</sup> At frequencies below 3 GHz, the validity of tissue parameters ( $\epsilon$  and  $\sigma$ ) can be relaxed to ± 10% if liquid compensation formula is applied to measured SAR values. At frequencies above 3 GHz, the validity of tissue parameters ( $\epsilon$  and  $\sigma$ ) is restricted to ± 5%. The uncertainty is the RSS of the ConvF uncertainty for indicated target tissue parameters.

<sup>G</sup> Alpha/Depth are determined during calibration. SPEAG warrants that the remaining deviation due to the boundary effect after compensation is always less than ± 1% for frequencies below 3 GHz and below ± 2% for frequencies between 3-6 GHz at any distance larger than half the probe tip diameter from the boundary.

## DASY/EASY - Parameters of Probe: EX3DV4 - SN:7406

### Calibration Parameter Determined in Body Tissue Simulating Media

f (MHz) <sup>C</sup>	Relative Permittivity <sup>F</sup>	Conductivity (S/m) <sup>F</sup>	ConvF X	ConvF Y	ConvF Z	Alpha <sup>G</sup>	Depth <sup>G</sup> (mm)	Unc (k=2)
750	55.5	0.96	9.54	9.54	9.54	0.46	0.80	± 12.0 %
835	55.2	0.97	9.35	9.35	9.35	0.45	0.84	± 12.0 %
1750	53.4	1.49	7.78	7.78	7.78	0.37	0.85	± 12.0 %
1900	53.3	1.52	7.49	7.49	7.49	0.33	0.91	± 12.0 %
2300	52.9	1.81	7.37	7.37	7.37	0.42	0.80	± 12.0 %
2450	52.7	1.95	7.24	7.24	7.24	0.37	0.88	± 12.0 %
2600	52.5	2.16	6.94	6.94	6.94	0.27	0.99	± 12.0 %

<sup>C</sup> Frequency validity above 300 MHz of ± 100 MHz only applies for DASY v4.4 and higher (see Page 2), else it is restricted to ± 50 MHz. The uncertainty is the RSS of the ConvF uncertainty at calibration frequency and the uncertainty for the indicated frequency band. Frequency validity below 300 MHz is ± 10, 25, 40, 50 and 70 MHz for ConvF assessments at 30, 64, 128, 150 and 220 MHz respectively. Above 5 GHz frequency validity can be extended to ± 110 MHz.

<sup>F</sup> At frequencies below 3 GHz, the validity of tissue parameters ( $\epsilon$  and  $\sigma$ ) can be relaxed to ± 10% if liquid compensation formula is applied to measured SAR values. At frequencies above 3 GHz, the validity of tissue parameters ( $\epsilon$  and  $\sigma$ ) is restricted to ± 5%. The uncertainty is the RSS of the ConvF uncertainty for indicated target tissue parameters.

<sup>G</sup> Alpha/Depth are determined during calibration. SPEAG warrants that the remaining deviation due to the boundary effect after compensation is always less than ± 1% for frequencies below 3 GHz and below ± 2% for frequencies between 3-6 GHz at any distance larger than half the probe tip diameter from the boundary.

### Frequency Response of E-Field (TEM-Cell:ifi110 EXX, Waveguide: R22)

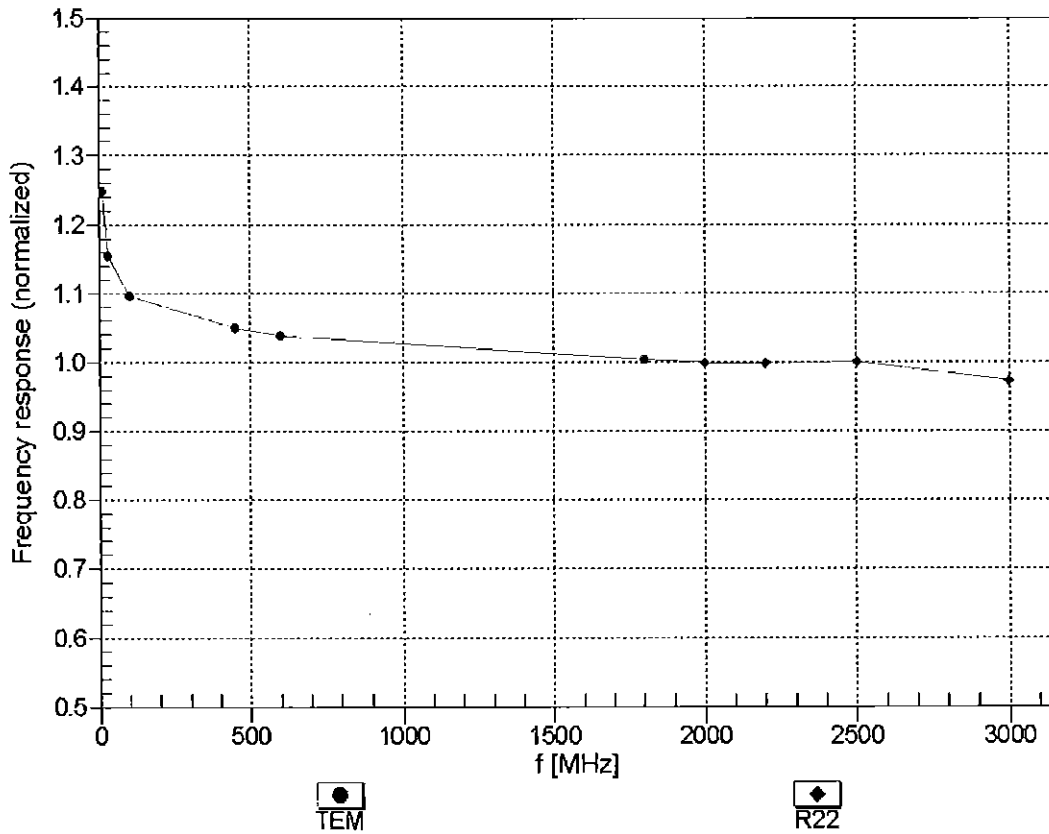

Uncertainty of Frequency Response of E-field:  $\pm 6.3\%$  (k=2)

### Receiving Pattern ( $\phi$ ), $\theta = 0^\circ$

f=600 MHz,TEM

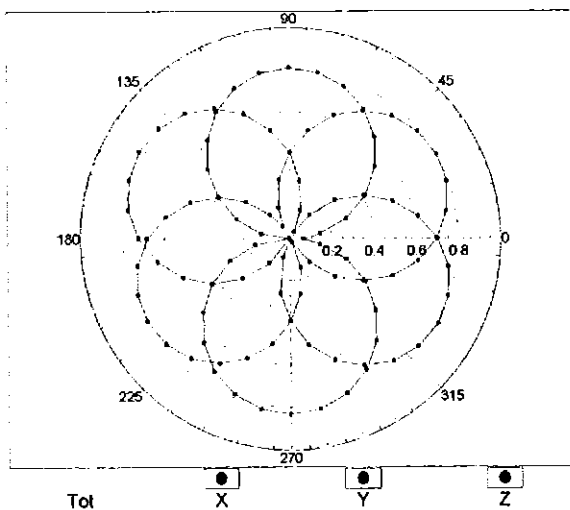

f=1800 MHz,R22

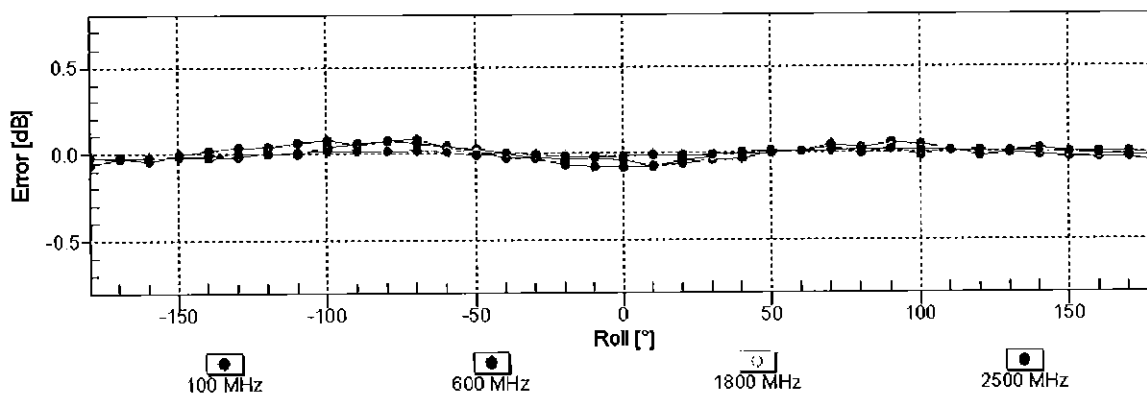
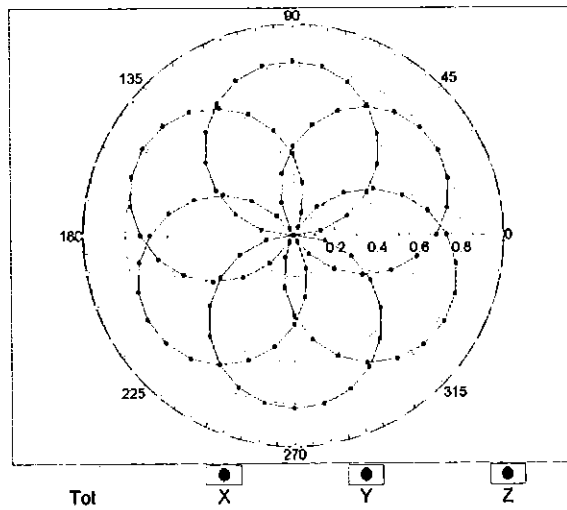

Uncertainty of Axial Isotropy Assessment:  $\pm 0.5\%$  (k=2)

### Dynamic Range f(SAR<sub>head</sub>) (TEM cell , f<sub>eval</sub>= 1900 MHz)

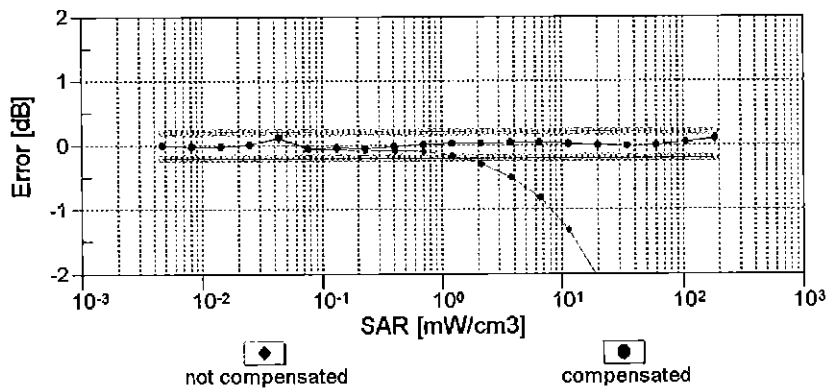
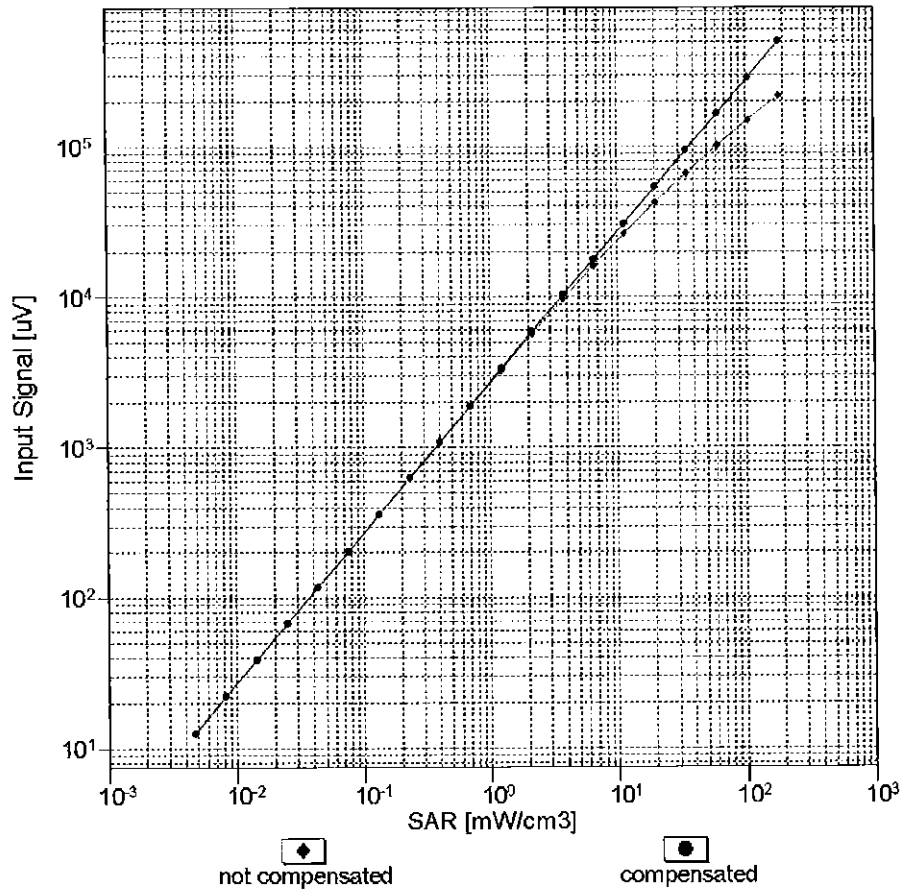

Uncertainty of Linearity Assessment: ± 0.6% (k=2)



# Conversion Factor Assessment

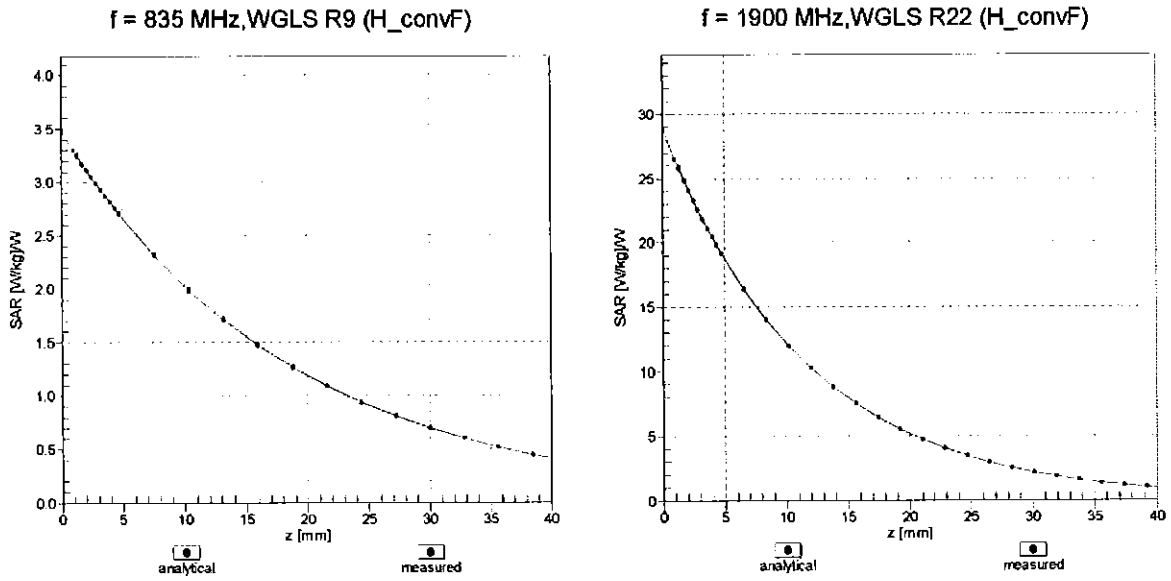

## Deviation from Isotropy in Liquid Error ( $\phi, \theta$ ), f = 900 MHz

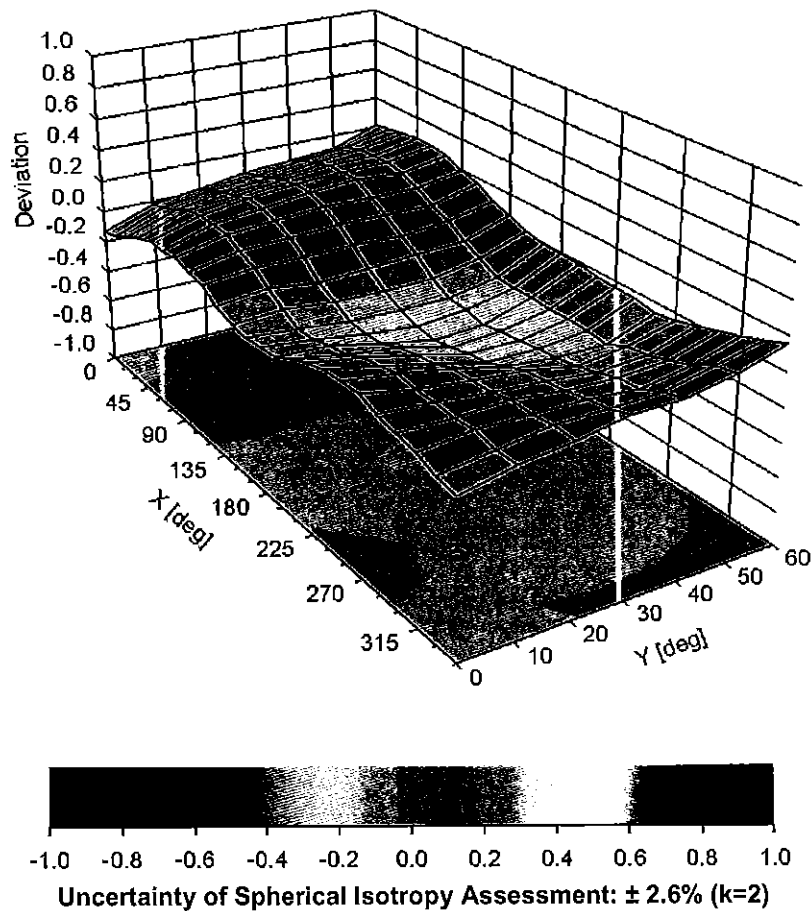

**DASY/EASY - Parameters of Probe: EX3DV4 - SN:7406****Other Probe Parameters**

Sensor Arrangement	Triangular
Connector Angle (°)	0.4
Mechanical Surface Detection Mode	enabled
Optical Surface Detection Mode	disabled
Probe Overall Length	337 mm
Probe Body Diameter	10 mm
Tip Length	9 mm
Tip Diameter	2.5 mm
Probe Tip to Sensor X Calibration Point	1 mm
Probe Tip to Sensor Y Calibration Point	1 mm
Probe Tip to Sensor Z Calibration Point	1 mm
Recommended Measurement Distance from Surface	1.4 mm



Accredited by the Swiss Accreditation Service (SAS)  
The Swiss Accreditation Service is one of the signatories to the EA  
Multilateral Agreement for the recognition of calibration certificates

Accreditation No.: **SCS 0108**

Client **PC Test**

Certificate No: **EX3-3914\_Feb16**

**CALIBRATION CERTIFICATE**

Object **EX3DV4 - SN:3914**

Calibration procedure(s) **QA CAL-01.v9, QA CAL-14.v4, QA CAL-23.v5, QA CAL-25.v6  
Calibration procedure for dosimetric E-field probes**

*BN  
03/01/2016*

Calibration date: **February 22, 2016**

This calibration certificate documents the traceability to national standards, which realize the physical units of measurements (SI).  
The measurements and the uncertainties with confidence probability are given on the following pages and are part of the certificate.

All calibrations have been conducted in the closed laboratory facility: environment temperature (22 ± 3)°C and humidity < 70%.

Calibration Equipment used (M&TE critical for calibration)

Primary Standards	ID	Cal Date (Certificate No.)	Scheduled Calibration
Power meter E4419B	GB41293874	01-Apr-15 (No. 217-02128)	Mar-16
Power sensor E4412A	MY41498087	01-Apr-15 (No. 217-02128)	Mar-16
Reference 3 dB Attenuator	SN: S5054 (3c)	01-Apr-15 (No. 217-02129)	Mar-16
Reference 20 dB Attenuator	SN: S5277 (20x)	01-Apr-15 (No. 217-02132)	Mar-16
Reference 30 dB Attenuator	SN: S5129 (30b)	01-Apr-15 (No. 217-02133)	Mar-16
Reference Probe ES3DV2	SN: 3013	31-Dec-15 (No. ES3-3013_Dec15)	Dec-16
DAE4	SN: 660	23-Dec-15 (No. DAE4-660_Dec15)	Dec-16
Secondary Standards	ID	Check Date (in house)	Scheduled Check
RF generator HP 8648C	US3642U01700	4-Aug-99 (in house check Apr-13)	In house check: Apr-16
Network Analyzer HP 8753E	US37390585	18-Oct-01 (in house check Oct-15)	In house check: Oct-16

Calibrated by:	Name <b>Jeon Kastrati</b>	Function <b>Laboratory Technician</b>	Signature 
Approved by:	Name <b>Katja Pokovic</b>	Function <b>Technical Manager</b>	Signature 

Issued: February 22, 2016

This calibration certificate shall not be reproduced except in full without written approval of the laboratory.



Accredited by the Swiss Accreditation Service (SAS)

Accreditation No.: **SCS 0108**

The Swiss Accreditation Service is one of the signatories to the EA  
Multilateral Agreement for the recognition of calibration certificates

### Glossary:

TSL	tissue simulating liquid
NORM <sub>x,y,z</sub>	sensitivity in free space
ConvF	sensitivity in TSL / NORM <sub>x,y,z</sub>
DCP	diode compression point
CF	crest factor (1/duty_cycle) of the RF signal
A, B, C, D	modulation dependent linearization parameters
Polarization $\varphi$	$\varphi$ rotation around probe axis
Polarization $\vartheta$	$\vartheta$ rotation around an axis that is in the plane normal to probe axis (at measurement center), i.e., $\vartheta = 0$ is normal to probe axis
Connector Angle	information used in DASY system to align probe sensor X to the robot coordinate system

### Calibration is Performed According to the Following Standards:

- IEEE Std 1528-2013, "IEEE Recommended Practice for Determining the Peak Spatial-Averaged Specific Absorption Rate (SAR) in the Human Head from Wireless Communications Devices: Measurement Techniques", June 2013
- IEC 62209-1, "Procedure to measure the Specific Absorption Rate (SAR) for hand-held devices used in close proximity to the ear (frequency range of 300 MHz to 3 GHz)", February 2005
- IEC 62209-2, "Procedure to determine the Specific Absorption Rate (SAR) for wireless communication devices used in close proximity to the human body (frequency range of 30 MHz to 6 GHz)", March 2010
- KDB 865664, "SAR Measurement Requirements for 100 MHz to 6 GHz"

### Methods Applied and Interpretation of Parameters:

- NORM<sub>x,y,z</sub>**: Assessed for E-field polarization  $\vartheta = 0$  ( $f \leq 900$  MHz in TEM-cell;  $f > 1800$  MHz: R22 waveguide). NORM<sub>x,y,z</sub> are only intermediate values, i.e., the uncertainties of NORM<sub>x,y,z</sub> does not affect the E<sup>2</sup>-field uncertainty inside TSL (see below ConvF).
- NORM(f)<sub>x,y,z</sub>** = NORM<sub>x,y,z</sub> \* frequency\_response (see Frequency Response Chart). This linearization is implemented in DASY4 software versions later than 4.2. The uncertainty of the frequency response is included in the stated uncertainty of ConvF.
- DCP<sub>x,y,z</sub>**: DCP are numerical linearization parameters assessed based on the data of power sweep with CW signal (no uncertainty required). DCP does not depend on frequency nor media.
- PAR**: PAR is the Peak to Average Ratio that is not calibrated but determined based on the signal characteristics
- A<sub>x,y,z</sub>; B<sub>x,y,z</sub>; C<sub>x,y,z</sub>; D<sub>x,y,z</sub>; VR<sub>x,y,z</sub>**: A, B, C, D are numerical linearization parameters assessed based on the data of power sweep for specific modulation signal. The parameters do not depend on frequency nor media. VR is the maximum calibration range expressed in RMS voltage across the diode.
- ConvF and Boundary Effect Parameters**: Assessed in flat phantom using E-field (or Temperature Transfer Standard for  $f \leq 800$  MHz) and inside waveguide using analytical field distributions based on power measurements for  $f > 800$  MHz. The same setups are used for assessment of the parameters applied for boundary compensation (alpha, depth) of which typical uncertainty values are given. These parameters are used in DASY4 software to improve probe accuracy close to the boundary. The sensitivity in TSL corresponds to NORM<sub>x,y,z</sub> \* ConvF whereby the uncertainty corresponds to that given for ConvF. A frequency dependent ConvF is used in DASY version 4.4 and higher which allows extending the validity from  $\pm 50$  MHz to  $\pm 100$  MHz.
- Spherical isotropy (3D deviation from isotropy)**: in a field of low gradients realized using a flat phantom exposed by a patch antenna.
- Sensor Offset**: The sensor offset corresponds to the offset of virtual measurement center from the probe tip (on probe axis). No tolerance required.
- Connector Angle**: The angle is assessed using the information gained by determining the NORM<sub>x</sub> (no uncertainty required).

# Probe EX3DV4

## SN:3914

Manufactured: December 18, 2012  
Calibrated: February 22, 2016

Calibrated for DASY/EASY Systems  
(Note: non-compatible with DASY2 system!)

## DASY/EASY - Parameters of Probe: EX3DV4 - SN:3914

### Basic Calibration Parameters

	Sensor X	Sensor Y	Sensor Z	Unc (k=2)
Norm ( $\mu\text{V}/(\text{V}/\text{m})^2$ ) <sup>A</sup>	0.48	0.42	0.46	$\pm 10.1 \%$
DCP (mV) <sup>B</sup>	100.1	102.6	97.6	

### Modulation Calibration Parameters

UID	Communication System Name		A dB	B dB $\sqrt{\mu\text{V}}$	C	D dB	VR mV	Unc <sup>E</sup> (k=2)
0	CW	X	0.0	0.0	1.0	0.00	137.4	$\pm 2.7 \%$
		Y	0.0	0.0	1.0		139.7	
		Z	0.0	0.0	1.0		133.7	
10010- CAA	SAR Validation (Square, 100ms, 10ms)	X	4.02	69.7	14.2	10.00	41.0	$\pm 0.9 \%$
		Y	2.42	64.8	12.4		41.8	
		Z	2.11	63.9	12.8		44.9	
10062- CAB	IEEE 802.11a/h WiFi 5 GHz (OFDM, 6 Mbps)	X	10.26	68.5	21.3	8.68	127.9	$\pm 3.3 \%$
		Y	10.16	68.6	21.4		127.8	
		Z	10.42	68.8	21.4		144.6	
10117- CAB	IEEE 802.11n (HT Mixed, 13.5 Mbps, BPSK)	X	10.15	68.2	20.7	8.07	129.4	$\pm 3.3 \%$
		Y	10.18	68.5	20.9		131.7	
		Z	10.42	68.8	20.9		148.3	
10196- CAB	IEEE 802.11n (HT Mixed, 6.5 Mbps, BPSK)	X	10.13	68.8	21.1	8.10	146.4	$\pm 2.7 \%$
		Y	9.80	68.3	20.9		126.3	
		Z	9.98	68.3	20.8		139.8	
10400- AAC	IEEE 802.11ac WiFi (20MHz, 64-QAM, 99pc duty cycle)	X	10.33	68.8	21.3	8.37	145.0	$\pm 2.7 \%$
		Y	10.13	68.7	21.3		132.0	
		Z	10.21	68.5	21.0		140.2	
10401- AAC	IEEE 802.11ac WiFi (40MHz, 64-QAM, 99pc duty cycle)	X	10.67	68.4	21.1	8.60	125.8	$\pm 3.3 \%$
		Y	10.92	69.3	21.6		140.7	
		Z	10.94	69.0	21.3		148.7	
10402- AAC	IEEE 802.11ac WiFi (80MHz, 64-QAM, 99pc duty cycle)	X	10.64	68.4	20.8	8.53	125.5	$\pm 3.3 \%$
		Y	11.11	69.7	21.6		142.1	
		Z	10.93	69.0	21.1		149.2	

The reported uncertainty of measurement is stated as the standard uncertainty of measurement multiplied by the coverage factor k=2, which for a normal distribution corresponds to a coverage probability of approximately 95%.

<sup>A</sup> The uncertainties of Norm X,Y,Z do not affect the E<sup>2</sup>-field uncertainty inside TSL (see Pages 5 and 6).

<sup>B</sup> Numerical linearization parameter: uncertainty not required.

<sup>E</sup> Uncertainty is determined using the max. deviation from linear response applying rectangular distribution and is expressed for the square of the field value.

## DASY/EASY - Parameters of Probe: EX3DV4 - SN:3914

### Calibration Parameter Determined in Head Tissue Simulating Media

f (MHz) <sup>C</sup>	Relative Permittivity <sup>F</sup>	Conductivity (S/m) <sup>F</sup>	ConvF X	ConvF Y	ConvF Z	Alpha <sup>G</sup>	Depth <sup>G</sup> (mm)	Unc (k=2)
5250	35.9	4.71	5.07	5.07	5.07	0.35	1.80	± 13.1 %
5600	35.5	5.07	4.66	4.66	4.66	0.40	1.80	± 13.1 %
5750	35.4	5.22	4.74	4.74	4.74	0.40	1.80	± 13.1 %

<sup>C</sup> Frequency validity above 300 MHz of ± 100 MHz only applies for DASY v4.4 and higher (see Page 2), else it is restricted to ± 50 MHz. The uncertainty is the RSS of the ConvF uncertainty at calibration frequency and the uncertainty for the indicated frequency band. Frequency validity below 300 MHz is ± 10, 25, 40, 50 and 70 MHz for ConvF assessments at 30, 64, 128, 150 and 220 MHz respectively. Above 5 GHz frequency validity can be extended to ± 110 MHz.

<sup>F</sup> At frequencies below 3 GHz, the validity of tissue parameters ( $\epsilon$  and  $\sigma$ ) can be relaxed to ± 10% if liquid compensation formula is applied to measured SAR values. At frequencies above 3 GHz, the validity of tissue parameters ( $\epsilon$  and  $\sigma$ ) is restricted to ± 5%. The uncertainty is the RSS of the ConvF uncertainty for indicated target tissue parameters.

<sup>G</sup> Alpha/Depth are determined during calibration. SPEAG warrants that the remaining deviation due to the boundary effect after compensation is always less than ± 1% for frequencies below 3 GHz and below ± 2% for frequencies between 3-6 GHz at any distance larger than half the probe tip diameter from the boundary.

## DASY/EASY - Parameters of Probe: EX3DV4 - SN:3914

### Calibration Parameter Determined in Body Tissue Simulating Media

f (MHz) <sup>C</sup>	Relative Permittivity <sup>F</sup>	Conductivity (S/m) <sup>F</sup>	ConvF X	ConvF Y	ConvF Z	Alpha <sup>G</sup>	Depth <sup>G</sup> (mm)	Unc (k=2)
750	55.5	0.96	9.57	9.57	9.57	0.47	0.85	± 12.0 %
835	55.2	0.97	9.44	9.44	9.44	0.47	0.85	± 12.0 %
1750	53.4	1.49	7.82	7.82	7.82	0.42	0.83	± 12.0 %
1900	53.3	1.52	7.50	7.50	7.50	0.45	0.80	± 12.0 %
2300	52.9	1.81	7.27	7.27	7.27	0.48	0.80	± 12.0 %
2450	52.7	1.95	7.22	7.22	7.22	0.46	0.80	± 12.0 %
2600	52.5	2.16	6.90	6.90	6.90	0.32	0.99	± 12.0 %
5250	48.9	5.36	4.32	4.32	4.32	0.50	1.90	± 13.1 %
5600	48.5	5.77	3.63	3.63	3.63	0.60	1.90	± 13.1 %
5750	48.3	5.94	3.86	3.86	3.86	0.60	1.90	± 13.1 %

<sup>C</sup> Frequency validity above 300 MHz of ± 100 MHz only applies for DASY v4.4 and higher (see Page 2), else it is restricted to ± 50 MHz. The uncertainty is the RSS of the ConvF uncertainty at calibration frequency and the uncertainty for the indicated frequency band. Frequency validity below 300 MHz is ± 10, 25, 40, 50 and 70 MHz for ConvF assessments at 30, 64, 128, 150 and 220 MHz respectively. Above 5 GHz frequency validity can be extended to ± 110 MHz.

<sup>F</sup> At frequencies below 3 GHz, the validity of tissue parameters ( $\epsilon$  and  $\sigma$ ) can be relaxed to ± 10% if liquid compensation formula is applied to measured SAR values. At frequencies above 3 GHz, the validity of tissue parameters ( $\epsilon$  and  $\sigma$ ) is restricted to ± 5%. The uncertainty is the RSS of the ConvF uncertainty for indicated target tissue parameters.

<sup>G</sup> Alpha/Depth are determined during calibration. SPEAG warrants that the remaining deviation due to the boundary effect after compensation is always less than ± 1% for frequencies below 3 GHz and below ± 2% for frequencies between 3-6 GHz at any distance larger than half the probe tip diameter from the boundary.



### Frequency Response of E-Field (TEM-Cell:ifi110 EXX, Waveguide: R22)

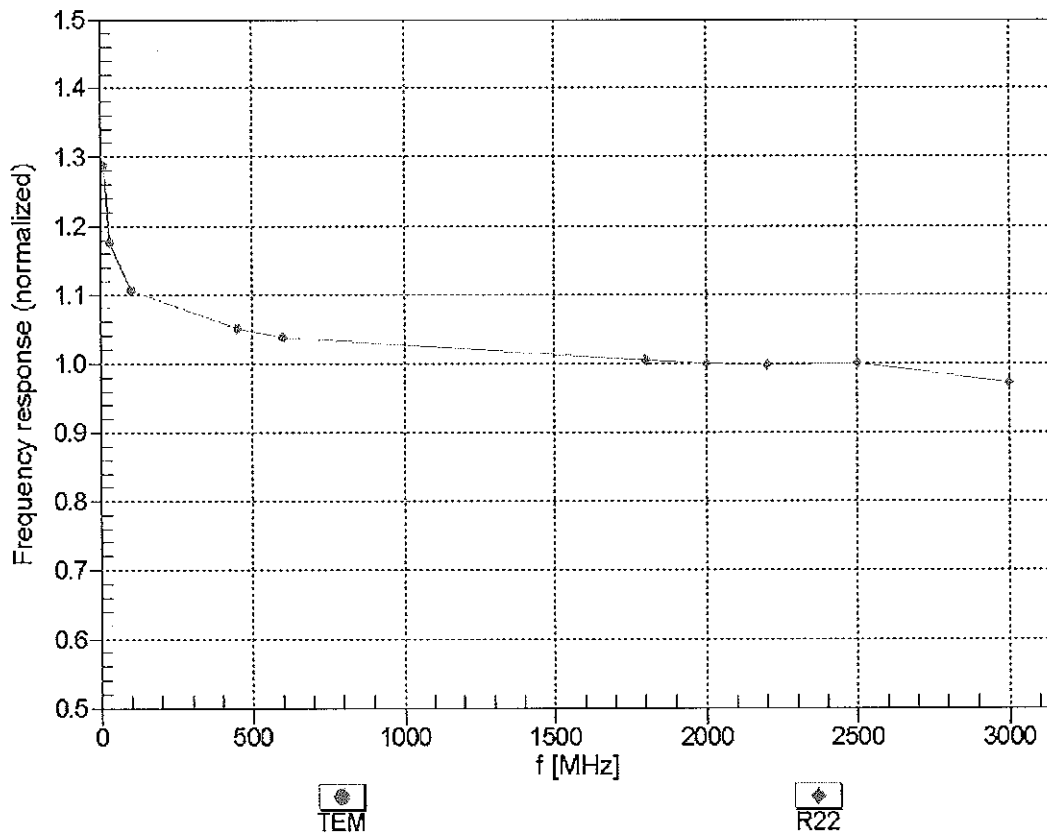

Uncertainty of Frequency Response of E-field:  $\pm 6.3\%$  (k=2)

### Receiving Pattern ( $\phi$ ), $\vartheta = 0^\circ$

f=600 MHz,TEM

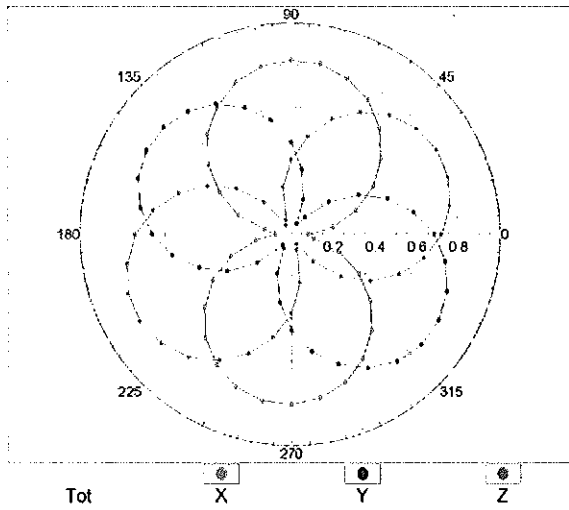

f=1800 MHz,R22

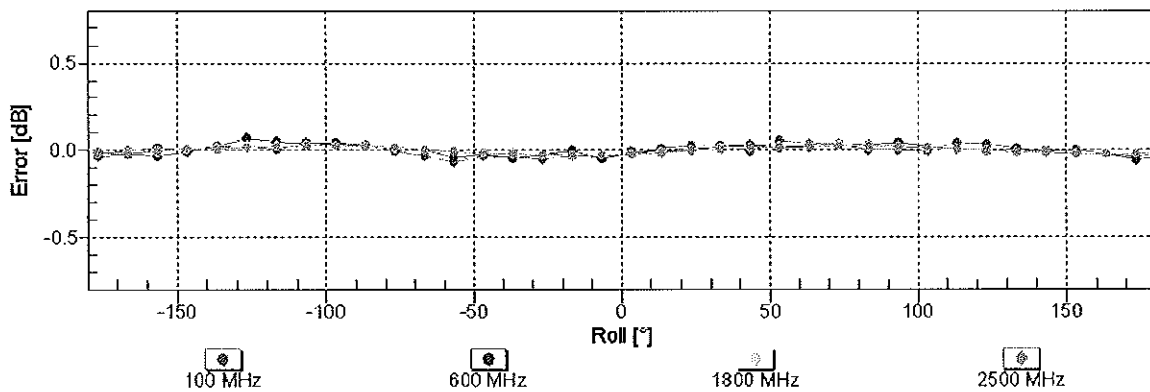
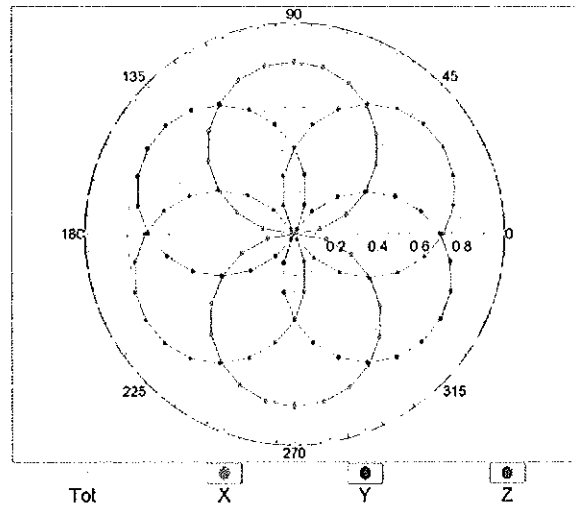

Uncertainty of Axial Isotropy Assessment:  $\pm 0.5\%$  (k=2)

### Dynamic Range $f(SAR_{head})$ (TEM cell , $f_{eval}= 1900$ MHz)

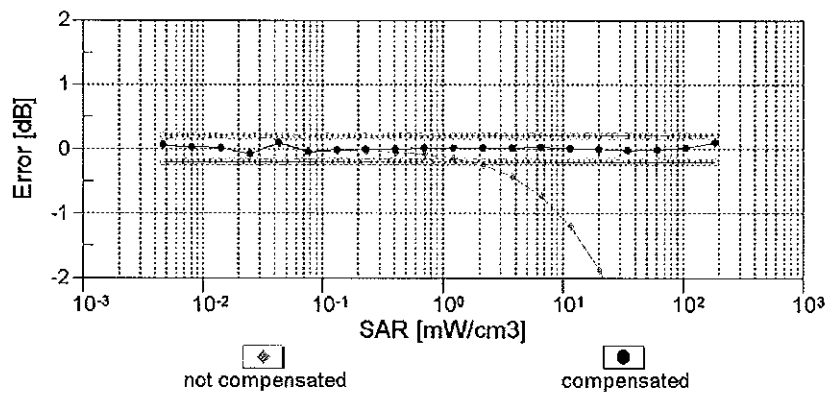
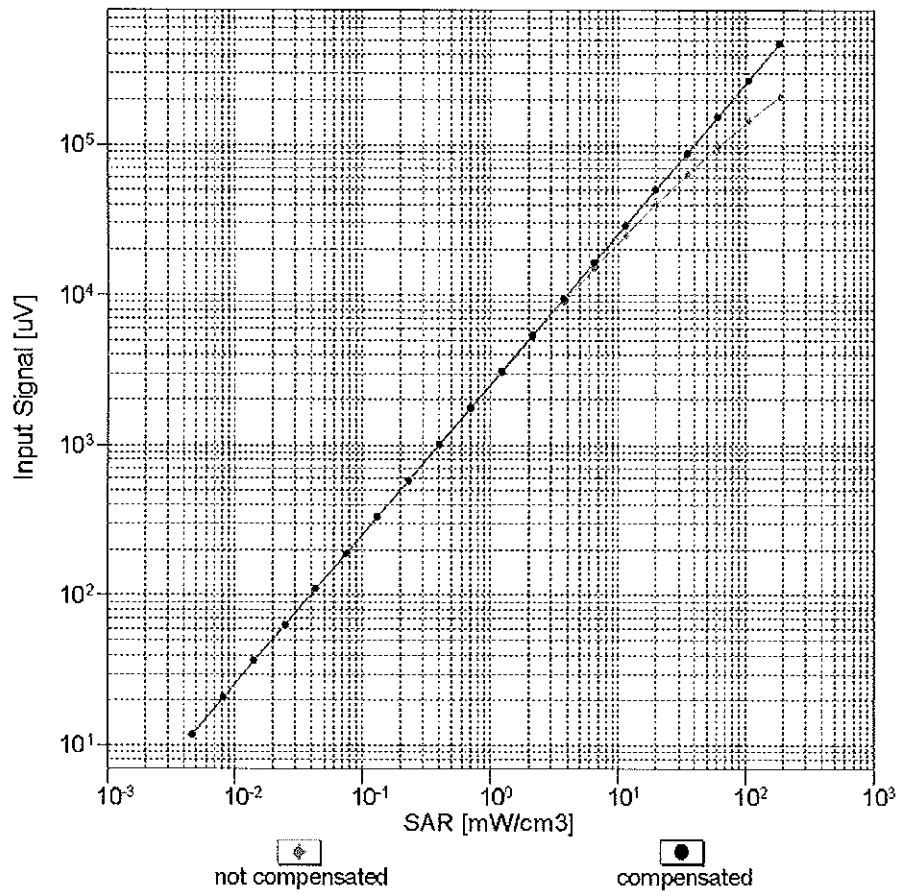

Uncertainty of Linearity Assessment:  $\pm 0.6\%$  ( $k=2$ )

# Conversion Factor Assessment

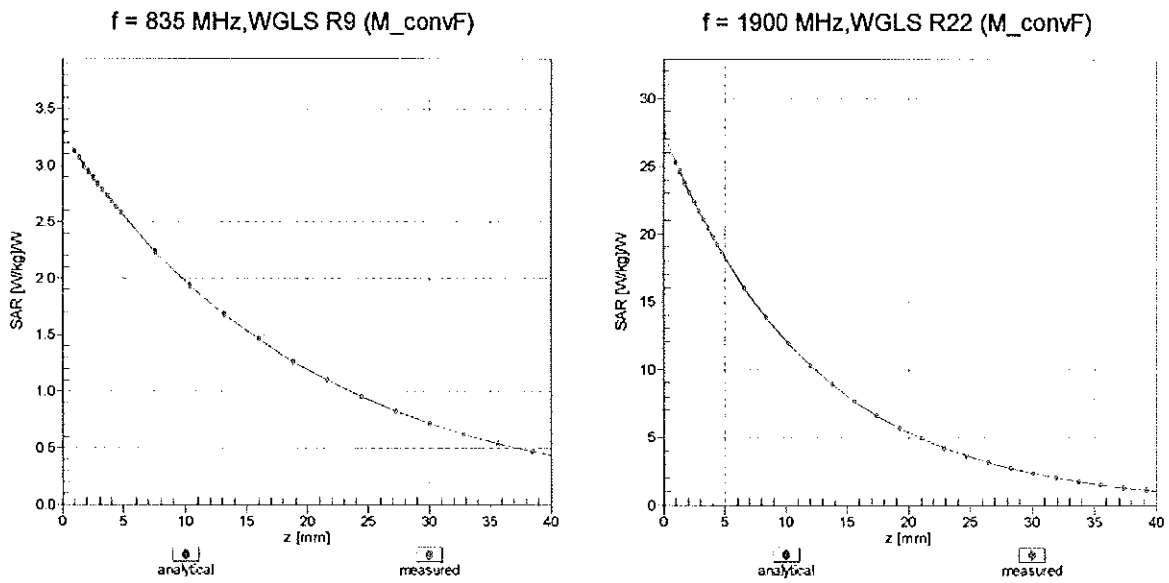

## Deviation from Isotropy in Liquid Error ( $\phi, \theta$ ), f = 900 MHz

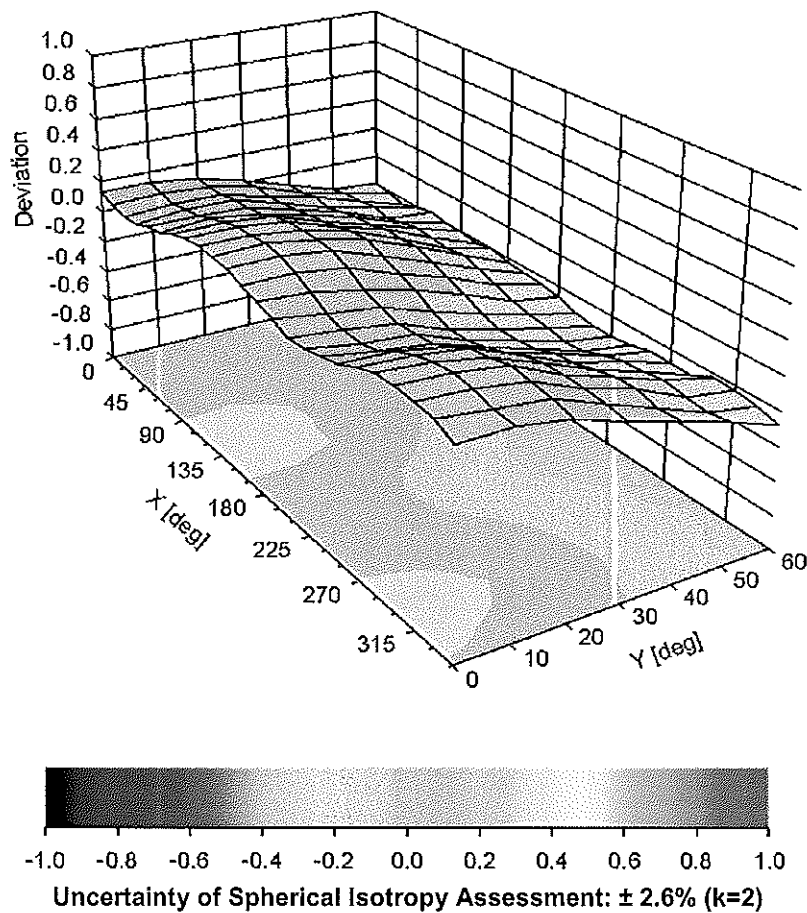

## DASY/EASY - Parameters of Probe: EX3DV4 - SN:3914

### Other Probe Parameters

Sensor Arrangement	Triangular
Connector Angle (°)	133.3
Mechanical Surface Detection Mode	enabled
Optical Surface Detection Mode	disabled
Probe Overall Length	337 mm
Probe Body Diameter	10 mm
Tip Length	9 mm
Tip Diameter	2.5 mm
Probe Tip to Sensor X Calibration Point	1 mm
Probe Tip to Sensor Y Calibration Point	1 mm
Probe Tip to Sensor Z Calibration Point	1 mm
Recommended Measurement Distance from Surface	1.4 mm

## APPENDIX D: SAR TISSUE SPECIFICATIONS

Measurement Procedure for Tissue verification:

- 1) The network analyzer and probe system was configured and calibrated.
- 2) The probe was immersed in the tissue. The tissue was placed in a nonmetallic container. Trapped air bubbles beneath the flange were minimized by placing the probe at a slight angle.
- 3) The complex admittance with respect to the probe aperture was measured
- 4) The complex relative permittivity  $\epsilon'$  can be calculated from the below equation (Pournaropoulos and Misra):

$$Y = \frac{j2\omega\epsilon_r\epsilon_0}{[\ln(b/a)]^2} \int_a^b \int_a^b \int_0^\pi \cos\phi' \frac{\exp[-j\omega r(\mu_0\epsilon_r'\epsilon_0)^{1/2}]}{r} d\phi' d\rho' d\rho$$

where  $Y$  is the admittance of the probe in contact with the sample, the primed and unprimed coordinates refer to source and observation points, respectively,  $r^2 = \rho^2 + \rho'^2 - 2\rho\rho' \cos\phi'$ ,  $\omega$  is the angular frequency, and  $j = \sqrt{-1}$ .

**Table D-I  
Composition of the Tissue Equivalent Matter**

Frequency (MHz)	750	750	835	835	1750	1750	1900	1900	2450	2450	5200-5800	5200-5800
Tissue	Head	Body	Head	Body	Head	Body	Head	Body	Head	Body	Head	Body
Ingredients (% by weight)												
Bactericide	See page 2,3	See page 2	0.1	0.1					See page 4		See page 5	
DGBE					47	31	44.92	29.44		26.7		
HEC			1	1								
NaCl			1.45	0.94	0.4	0.2	0.18	0.39		0.1		
Sucrose			57	44.9								
Polysorbate (Tween) 80												20
Water			40.45	53.06	52.6	68.8	54.9	70.17		73.2		80

<b>FCC ID:</b> ZNFVS501	<b>PCTEST</b> <small>ENGINEERING LABORATORY, INC.</small>	<b>SAR EVALUATION REPORT</b>		<b>Approved by:</b> Quality Manager
<b>Test Dates:</b> 01/14/17 - 01/27/17	<b>DUT Type:</b> Portable Handset			APPENDIX D: Page 1 of 5

## 2 Composition / Information on ingredients

The Item is composed of the following ingredients:

H <sub>2</sub> O	Water, 35 – 58%
Sucrose	Sugar, white, refined, 40 – 60%
NaCl	Sodium Chloride, 0 – 6%
Hydroxyethyl-cellulose	Medium Viscosity (CAS# 9004-62-0), <0.3%
Preventol-D7	Preservative: aqueous preparation, (CAS# 55965-84-9), containing 5-chloro-2-methyl-3(2H)-isothiazolone and 2-methyl-3(2H)-isothiazolone, 0.1 – 0.7%

Relevant for safety; Refer to the respective Safety Data Sheet\*.

**Figure D-1  
Composition of 750 MHz Head and Body Tissue Equivalent Matter**

**Note:** 750MHz liquid recipes are proprietary SPEAG. Since the composition is approximate to the actual liquids utilized, the manufacturer tissue-equivalent liquid data sheets are provided below.

### Measurement Certificate / Material Test

Item Name	Body Tissue Simulating Liquid (MSL750V2)
Product No.	SL AAM 075 AA (Charge: 150223-3)
Manufacturer	SPEAG

#### Measurement Method

TSL dielectric parameters measured using calibrated OCP probe.

#### Setup Validation

Validation results were within  $\pm 2.5\%$  towards the target values of Methanol.

#### Target Parameters

Target parameters as defined in the IEEE 1528 and IEC 62209 compliance standards.

#### Test Condition

Ambient	Environment temperatur ( $22 \pm 3$ )°C and humidity < 70%.
TSL Temperature	22°C
Test Date	25-Feb-15
Operator	IEN



#### Additional Information

TSL Density	1.212 g/cm <sup>3</sup>
TSL Heat-capacity	3.006 kJ/(kg*K)

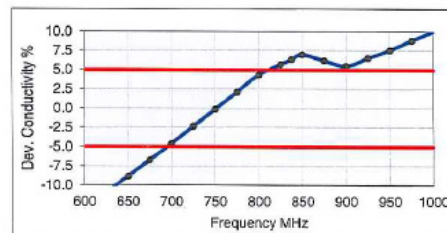
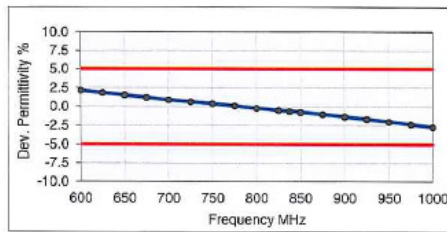
f [MHz]	Measured			Target		Diff. to Target [%]	
	HP-e'	HP-e''	sigma	eps	sigma	$\Delta$ -eps	$\Delta$ -sigma
600	57.3	24.76	0.83	56.1	0.95	2.2	-13.2
625	57.1	24.43	0.85	56.0	0.95	1.8	-11.0
650	56.8	24.09	0.87	55.9	0.96	1.5	-8.8
675	56.5	23.80	0.89	55.8	0.96	1.2	-6.7
700	56.2	23.51	0.92	55.7	0.96	0.9	-4.6
725	56.0	23.28	0.94	55.6	0.96	0.6	-2.4
750	55.7	23.06	0.96	55.5	0.96	0.4	-0.1
775	55.5	22.87	0.99	55.4	0.97	0.1	2.1
800	55.2	22.68	1.01	55.3	0.97	-0.2	4.4
825	55.0	22.52	1.03	55.2	0.98	-0.5	5.7
838	54.9	22.44	1.05	55.2	0.98	-0.6	6.3
850	54.8	22.36	1.06	55.2	0.99	-0.7	7.0
875	54.5	22.24	1.08	55.1	1.02	-1.0	6.2
900	54.3	22.12	1.11	55.0	1.05	-1.3	5.5
925	54.1	22.01	1.13	55.0	1.06	-1.6	6.5
950	53.9	21.89	1.16	54.9	1.08	-2.0	7.6
975	53.6	21.81	1.18	54.9	1.09	-2.3	8.8
1000	53.4	21.73	1.21	54.8	1.10	-2.7	10.1



**Figure D-2  
750MHz Body Tissue Equivalent Matter**

FCC ID: ZNFVS501		SAR EVALUATION REPORT		Approved by: Quality Manager
Test Dates: 01/14/17 - 01/27/17	DUT Type: Portable Handset			APPENDIX D: Page 2 of 5

## Measurement Certificate / Material Test

Item Name	Head Tissue Simulating Liquid (HSL750V2)
Product No.	SL AAH 075 AA (Charge: 150213-1)
Manufacturer	SPEAG

### Measurement Method

TSL dielectric parameters measured using calibrated OCP probe.

### Setup Validation

Validation results were within  $\pm 2.5\%$  towards the target values of Methanol.

### Target Parameters

Target parameters as defined in the IEEE 1528 and IEC 62209 compliance standards.

### Test Condition

Ambient	Environment temperatur ( $22 \pm 3$ )°C and humidity < 70%.
TSL Temperature	22°C
Test Date	18-Feb-15
Operator	IEN

### Additional Information

TSL Density	1.284 g/cm <sup>3</sup>
TSL Heat-capacity	2.701 kJ/(kg*K)

f [MHz]	Measured			Target		Diff.to Target [%]	
	HP-e'	HP-e''	sigma	eps	sigma	Δ-eps	Δ-sigma
600	44.6	22.42	0.75	42.7	0.88	4.5	-15.1
625	44.3	22.20	0.77	42.6	0.88	3.9	-12.7
650	43.9	21.98	0.79	42.5	0.89	3.3	-10.3
675	43.5	21.75	0.82	42.3	0.89	2.8	-8.0
700	43.1	21.53	0.84	42.2	0.89	2.2	-5.7
725	42.8	21.36	0.86	42.1	0.89	1.8	-3.3
750	42.5	21.22	0.89	41.9	0.89	1.3	-0.9
775	42.2	21.06	0.91	41.8	0.90	0.8	1.4
800	41.8	20.90	0.93	41.7	0.90	0.3	3.7
825	41.5	20.77	0.95	41.6	0.91	-0.2	5.1
838	41.4	20.71	0.96	41.5	0.91	-0.4	5.8
850	41.2	20.65	0.98	41.5	0.92	-0.7	6.6
875	40.9	20.53	1.00	41.5	0.94	-1.4	6.0
900	40.6	20.42	1.02	41.5	0.97	-2.1	5.4
925	40.4	20.32	1.05	41.5	0.98	-2.6	6.5
950	40.1	20.22	1.07	41.4	0.99	-3.2	7.5
975	39.8	20.14	1.09	41.4	1.00	-3.8	8.7
1000	39.5	20.05	1.12	41.3	1.01	-4.3	9.9

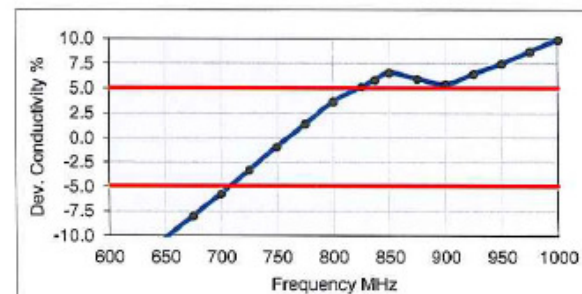
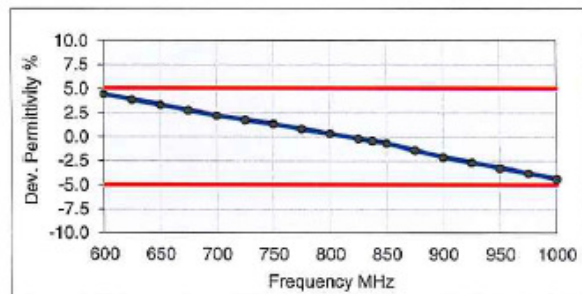



Figure D-3  
750MHz Head Tissue Equivalent Matter

FCC ID: ZNFVS501		SAR EVALUATION REPORT		Approved by: Quality Manager
Test Dates: 01/14/17 - 01/27/17	DUT Type: Portable Handset			APPENDIX D: Page 3 of 5



## 2 Composition / Information on ingredients

The Item is composed of the following ingredients:

H <sub>2</sub> O	Water, 52 – 75%
C <sub>8</sub> H <sub>18</sub> O <sub>3</sub>	Diethylene glycol monobutyl ether (DGBE), 25 – 48% (CAS-No. 112-34-5, EC-No. 203-961-6, EC-index-No. 603-096-00-8) Relevant for safety; Refer to the respective Safety Data Sheet*.
NaCl	Sodium Chloride, <1.0%

**Figure D-4**  
**Composition of 2.4 GHz Head Tissue Equivalent Matter**

**Note:** 2.4 GHz head liquid recipes are proprietary SPEAG. Since the composition is approximate to the actual liquids utilized, the manufacturer tissue-equivalent liquid data sheets are provided below.

### Measurement Certificate / Material Test

Item Name	Head Tissue Simulating Liquid (HSL2450V2)
Product No.	SL AAH 245 BA (Charge: 150206-3)
Manufacturer	SPEAG

#### Measurement Method

TSL dielectric parameters measured using calibrated OCP probe.

#### Setup Validation

Validation results were within  $\pm 2.5\%$  towards the target values of Methanol.

#### Target Parameters

Target parameters as defined in the IEEE 1528 and IEC 62209 compliance standards.

#### Test Condition

Ambient	Environment temperatur ( $22 \pm 3$ )°C and humidity < 70%.
TSL Temperature	23°C
Test Date	11-Feb-15
Operator	IEN



#### Additional Information

TSL Density	0.988 g/cm <sup>3</sup>
TSL Heat-capacity	3.680 kJ/(kg*K)

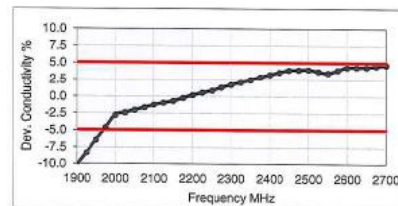
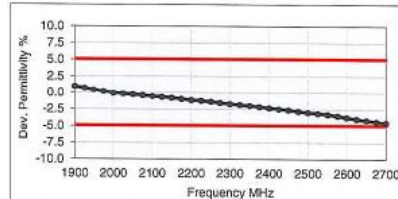
f (MHz)	Measured			Target		Diff.to Target (%)	
	HP-e'	HP-e''	sigma	eps	sigma	$\Delta$ -eps	$\Delta$ -sigma
1900	40.4	11.89	1.26	40.0	1.40	1.0	-10.2
1925	40.3	11.98	1.28	40.0	1.40	0.7	-8.3
1950	40.2	12.07	1.31	40.0	1.40	0.4	-6.4
1975	40.1	12.15	1.34	40.0	1.40	0.2	-4.6
2000	40.0	12.23	1.36	40.0	1.40	-0.1	-2.8
2025	39.9	12.32	1.39	40.0	1.42	-0.2	-2.4
2050	39.8	12.41	1.42	39.9	1.44	-0.3	-2.0
2075	39.7	12.50	1.44	39.9	1.47	-0.4	-1.6
2100	39.6	12.59	1.47	39.8	1.49	-0.5	-1.2
2125	39.5	12.66	1.50	39.8	1.51	-0.7	-0.9
2150	39.4	12.73	1.52	39.7	1.53	-0.8	-0.7
2175	39.3	12.83	1.55	39.7	1.56	-0.9	-0.2
2200	39.2	12.92	1.58	39.6	1.58	-1.1	0.2
2225	39.1	13.00	1.61	39.6	1.60	-1.2	0.6
2250	39.0	13.08	1.64	39.6	1.62	-1.3	0.9
2275	38.9	13.17	1.67	39.5	1.64	-1.5	1.4
2300	38.8	13.26	1.70	39.5	1.67	-1.7	1.8
2325	38.7	13.34	1.73	39.4	1.69	-1.8	2.2
2350	38.6	13.42	1.75	39.4	1.71	-2.0	2.5
2375	38.5	13.50	1.78	39.3	1.73	-2.1	2.9
2400	38.4	13.58	1.81	39.3	1.76	-2.3	3.3
2425	38.3	13.65	1.84	39.2	1.78	-2.4	3.6
2450	38.2	13.73	1.87	39.2	1.80	-2.6	3.9
2475	38.1	13.80	1.90	39.2	1.83	-2.8	4.0
2500	38.0	13.87	1.93	39.1	1.85	-3.0	4.0
2525	37.9	13.90	1.95	39.1	1.88	-3.1	3.8
2550	37.8	13.93	1.98	39.1	1.91	-3.2	3.5
2575	37.7	14.05	2.01	39.0	1.94	-3.5	4.0
2600	37.6	14.17	2.05	39.0	1.96	-3.7	4.4
2625	37.4	14.23	2.08	39.0	1.99	-3.9	4.4
2650	37.3	14.29	2.11	38.9	2.02	-4.1	4.4
2675	37.2	14.37	2.14	38.9	2.05	-4.3	4.6
2700	37.1	14.45	2.17	38.9	2.07	-4.5	4.7



**Figure D-5**  
**2.4 GHz Head Tissue Equivalent Matter**

FCC ID: ZNFVS501	 <b>PCTEST</b> <small>Engineering Laboratory, Inc.</small>	<b>SAR EVALUATION REPORT</b>		<b>Approved by:</b> Quality Manager
<b>Test Dates:</b> 01/14/17 - 01/27/17	<b>DUT Type:</b> Portable Handset	<b>APPENDIX D:</b> Page 4 of 5		

## 2 Composition / Information on ingredients

The Item is composed of the following ingredients:

Water	50 – 65%
Mineral oil	10 – 30%
Emulsifiers	8 – 25%
Sodium salt	0 – 1.5%

**Figure D-6**  
**Composition of 5 GHz Head Tissue Equivalent Matter**

**Note:** 5GHz head liquid recipes are proprietary SPEAG. Since the composition is approximate to the actual liquids utilized, the manufacturer tissue-equivalent liquid data sheets are provided below.

### Measurement Certificate / Material Test

Item Name	Head Tissue Simulating Liquid (HBBL3500-5800V5)
Product No.	SL AAH 502 AE (Charge: 141104-1)
Manufacturer	SPEAG

### Measurement Method

TSL dielectric parameters measured using calibrated OCP probe.

### Setup Validation

Validation results were within  $\pm 2.5\%$  towards the target values of Methanol.

### Target Parameters

Target parameters as defined in the IEEE 1528 and IEC 62209 compliance standards.

### Test Condition

Ambient	Environment temperatur ( $22 \pm 3$ )°C and humidity < 70%.
TSL Temperature	22°C
Test Date	25-Feb-15
Operator	IEH



### Additional Information

TSL Density	0.985 g/cm <sup>3</sup>
TSL Heat-capacity	3.383 kJ/(kg·K)

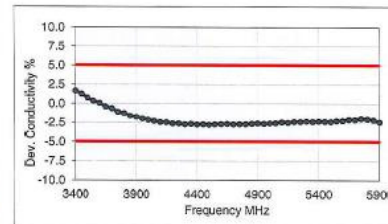
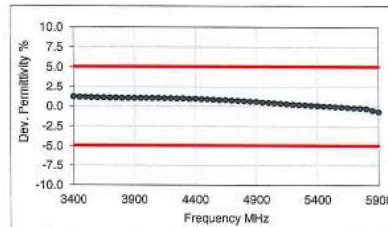
f [MHz]	Measured			Target		Diff.to Target [%]	
	HP-e'	HP-e''	sigma	eps	sigma	Δ-eps	Δ-sigma
3400	38.5	15.11	2.86	38.0	2.81	1.2	1.8
3500	38.4	15.08	2.94	37.9	2.91	1.2	0.9
3600	38.2	15.07	3.02	37.8	3.02	1.0	0.2
3700	38.1	15.05	3.10	37.7	3.12	1.1	-0.6
3800	38.0	15.04	3.18	37.6	3.22	1.1	-1.2
3900	37.9	15.05	3.27	37.5	3.32	1.1	-1.6
4000	37.8	15.07	3.35	37.4	3.43	1.2	-2.2
4100	37.6	15.09	3.44	37.2	3.53	1.0	-2.5
4200	37.5	15.14	3.54	37.1	3.63	1.0	-2.5
4300	37.4	15.18	3.63	37.0	3.73	1.0	-2.7
4400	37.3	15.24	3.73	36.9	3.84	1.1	-2.7
4500	37.1	15.29	3.83	36.8	3.94	0.9	-2.7
4600	37.0	15.37	3.93	36.7	4.04	0.9	-2.7
4700	36.8	15.42	4.03	36.6	4.14	0.7	-2.7
4800	36.7	15.47	4.13	36.4	4.25	0.7	-2.7
4850	36.6	15.50	4.18	36.4	4.30	0.6	-2.7
4900	36.5	15.54	4.24	36.3	4.35	0.5	-2.5
4950	36.5	15.55	4.28	36.3	4.40	0.6	-2.7
5000	36.4	15.59	4.34	36.2	4.45	0.5	-2.5
5050	36.3	15.62	4.39	36.2	4.50	0.4	-2.5
5100	36.2	15.66	4.44	36.1	4.55	0.3	-2.5
5150	36.2	15.67	4.49	36.0	4.60	0.4	-2.5
5200	36.1	15.71	4.55	36.0	4.66	0.3	-2.3
5250	36.0	15.73	4.59	35.9	4.71	0.2	-2.5
5300	35.9	15.76	4.65	35.9	4.76	0.1	-2.3
5350	35.9	15.78	4.70	35.8	4.81	0.2	-2.3
5400	35.8	15.81	4.75	35.8	4.86	0.1	-2.3
5450	35.7	15.82	4.80	35.7	4.91	0.0	-2.3
5500	35.6	15.84	4.85	35.6	4.96	-0.1	-2.3
5550	35.6	15.87	4.90	35.6	5.01	0.0	-2.3
5600	35.5	15.90	4.95	35.5	5.07	-0.1	-2.3
5650	35.4	15.94	5.01	35.5	5.12	-0.2	-2.1
5700	35.4	15.96	5.06	35.4	5.17	0.0	-2.1
5750	35.3	16.00	5.12	35.4	5.22	-0.2	-1.9
5800	35.2	16.01	5.16	35.3	5.27	-0.3	-2.1
5850	35.1	16.04	5.22	35.3	5.34	-0.6	-2.2
5900	35.1	16.06	5.27	35.3	5.40	-0.6	-2.4



**Figure D-7**  
**5GHz Head Tissue Equivalent Matter**

FCC ID: ZNFVS501		SAR EVALUATION REPORT		Approved by: Quality Manager
Test Dates: 01/14/17 - 01/27/17	DUT Type: Portable Handset			APPENDIX D: Page 5 of 5

## APPENDIX E: SAR SYSTEM VALIDATION



Per FCC KDB Publication 865664 D02v01r02, SAR system validation status should be documented to confirm measurement accuracy. The SAR systems (including SAR probes, system components and software versions) used for this device were validated against its performance specifications prior to the SAR measurements. Reference dipoles were used with the required tissue- equivalent media for system validation, according to the procedures outlined in FCC KDB Publication 865664 D01v01r04 and IEEE 1528-2013. Since SAR probe calibrations are frequency dependent, each probe calibration point was validated at a frequency within the valid frequency range of the probe calibration point, using the system that normally operates with the probe for routine SAR measurements and according to the required tissue-equivalent media.

A tabulated summary of the system validation status including the validation date(s), measurement frequencies, SAR probes and tissue dielectric parameters has been included.

**Table E-I**  
**SAR System Validation Summary**

SAR SYSTEM #	FREQ. [MHz]	DATE	PROBE SN	PROBE TYPE	PROBE CAL. POINT		COND.	PERM.	CW VALIDATION			MOD. VALIDATION		
							( $\sigma$ )	( $\epsilon_r$ )	SENSITIVITY	PROBE LINEARITY	PROBE ISOTROPY	MOD. TYPE	DUTY FACTOR	PAR
I	750	12/13/2016	3209	ES3DV3	750	Head	0.894	42.310	PASS	PASS	PASS	N/A	N/A	N/A
G	835	9/29/2016	3287	ES3DV3	835	Head	0.910	42.146	PASS	PASS	PASS	GMSK	PASS	N/A
I	1750	1/12/2017	3209	ES3DV3	1750	Head	1.342	39.160	PASS	PASS	PASS	N/A	N/A	N/A
F	1900	10/9/2016	3332	ES3DV3	1900	Head	1.430	38.937	PASS	PASS	PASS	GMSK	PASS	N/A
G	2450	9/28/2016	3287	ES3DV3	2450	Head	1.875	37.737	PASS	PASS	PASS	OFDM/TDD	PASS	PASS
J	5250	4/25/2016	7357	EX3DV4	5250	Head	4.508	34.565	PASS	PASS	PASS	OFDM	N/A	PASS
J	5600	4/25/2016	7357	EX3DV4	5600	Head	4.852	34.028	PASS	PASS	PASS	OFDM	N/A	PASS
J	5750	4/25/2016	7357	EX3DV4	5750	Head	5.021	33.850	PASS	PASS	PASS	OFDM	N/A	PASS
J	750	3/9/2016	3318	ES3DV3	750	Body	0.956	53.115	PASS	PASS	PASS	N/A	N/A	N/A
H	835	4/7/2016	3319	ES3DV3	835	Body	1.000	54.246	PASS	PASS	PASS	GMSK	PASS	N/A
I	1750	12/19/2016	3209	ES3DV3	1750	Body	1.503	51.815	PASS	PASS	PASS	N/A	N/A	N/A
D	1750	5/5/2016	3213	ES3DV3	1750	Body	1.452	53.235	PASS	PASS	PASS	N/A	N/A	N/A
K	1900	5/24/2016	7409	EX3DV4	1900	Body	1.583	51.303	PASS	PASS	PASS	GMSK	PASS	N/A
E	2450	4/27/2016	7406	EX3DV4	2450	Body	2.016	51.629	PASS	PASS	PASS	OFDM/TDD	PASS	PASS
D	5250	3/1/2016	3914	EX3DV4	5250	Body	5.438	47.912	PASS	PASS	PASS	OFDM	N/A	PASS
D	5600	3/1/2016	3914	EX3DV4	5600	Body	5.895	47.321	PASS	PASS	PASS	OFDM	N/A	PASS
D	5750	3/1/2016	3914	EX3DV4	5750	Body	6.111	47.085	PASS	PASS	PASS	OFDM	N/A	PASS

NOTE: While the probes have been calibrated for both CW and modulated signals, all measurements were performed using communication systems calibrated for CW signals only. Modulations in the table above represent test configurations for which the measurement system has been validated per FCC KDB Publication 865664 D01v01r04 for scenarios when CW probe calibrations are used with other signal types. SAR systems were validated for modulated signals with a periodic duty cycle, such as GMSK, or with a high peak to average ratio (>5 dB), such as OFDM according to FCC KDB Publication 865664 D01v01r04.

FCC ID: ZNFVS501		SAR EVALUATION REPORT		Approved by: Quality Manager
Test Dates: 01/14/17 - 01/27/17	DUT Type: Portable Handset			APPENDIX E: Page 1 of 1