



## 18. TEST PHOTOGRAPHS

See following Attached Pages for setup photographs.



|                                      |                                                                                                                                   |                                       |                                                                                                 |                                        |
|--------------------------------------|-----------------------------------------------------------------------------------------------------------------------------------|---------------------------------------|-------------------------------------------------------------------------------------------------|----------------------------------------|
| <b>FCC ID:</b> ZNFVS450PP            |  <b>PCTEST</b><br>ENGINEERING LABORATORY, INC. | <b>HAC (RF EMISSIONS) TEST REPORT</b> |  <b>LG</b> | <b>Reviewed by:</b><br>Quality Manager |
| <b>Filename:</b><br>0Y1402250505.ZNF | <b>Test Dates:</b><br>2/28/2014                                                                                                   | <b>EUT Type:</b><br>Portable Handset  | Page 61 of 63                                                                                   |                                        |

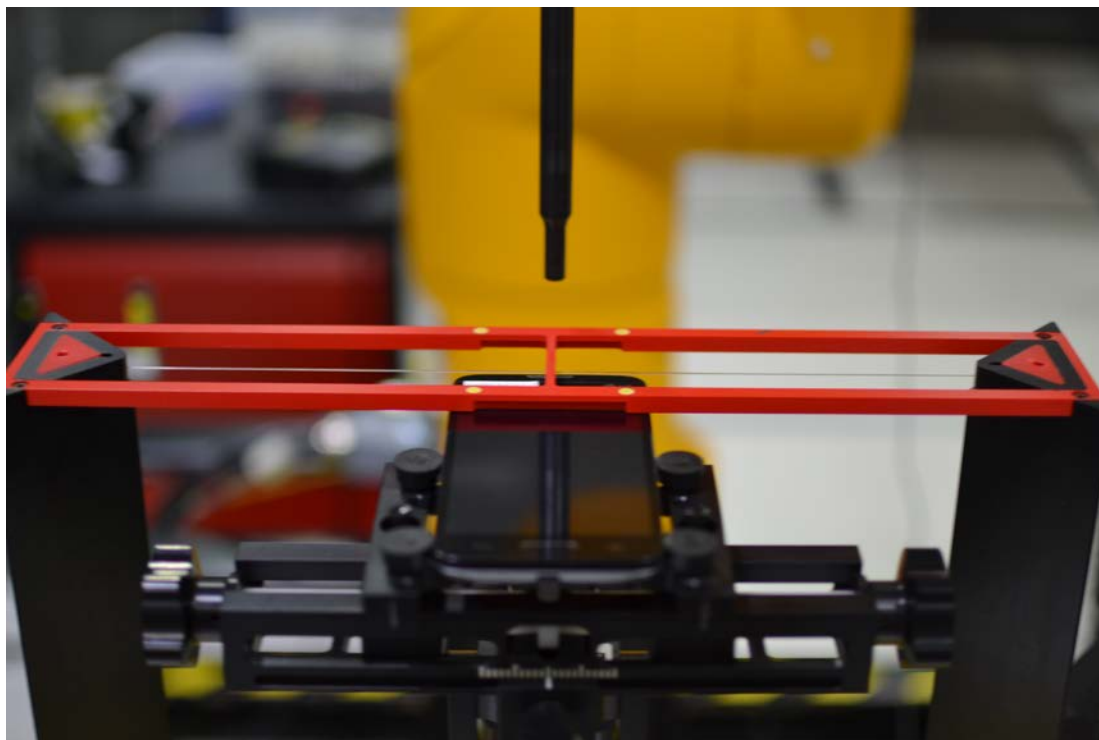

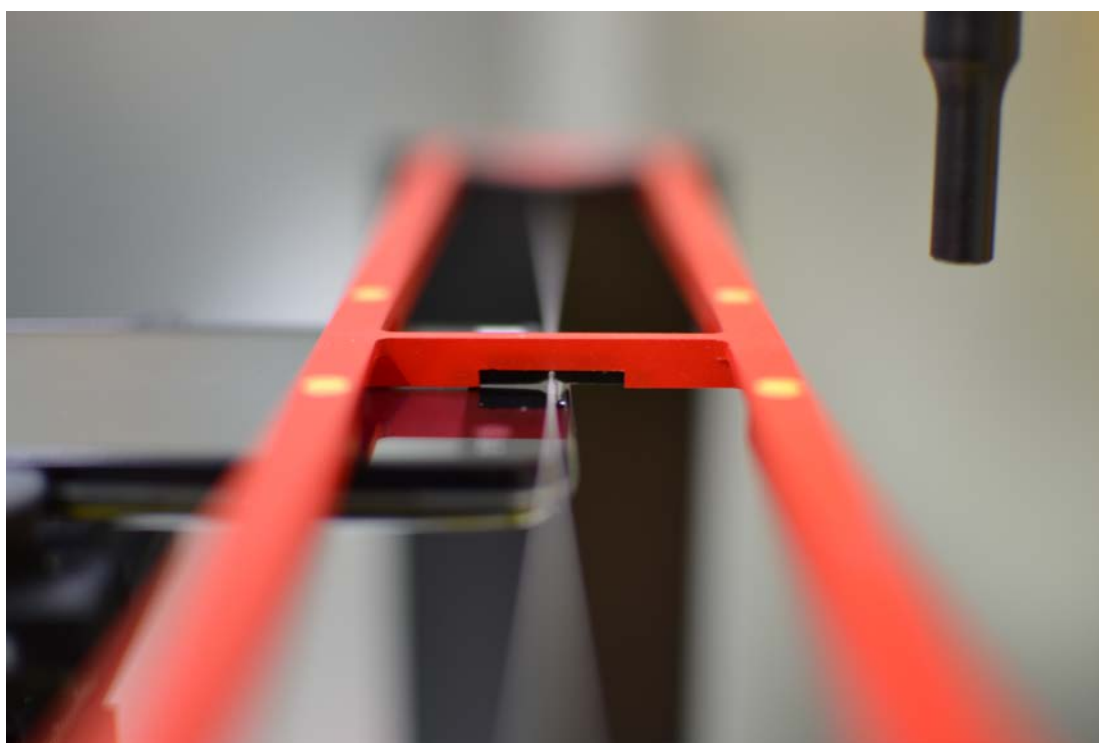
**Figure 18-1**  
**Ear Reference Point HAC Phantom Alignment**



**Figure 18-2**  
**HAC Phantom Plane Alignment**

|                               |                                                                                                                                                  |                                |                                                                                                 |                                 |
|-------------------------------|--------------------------------------------------------------------------------------------------------------------------------------------------|--------------------------------|-------------------------------------------------------------------------------------------------|---------------------------------|
| FCC ID: ZNFVS450PP            |  <b>PCTEST</b><br><small>ENGINEERING LABORATORY, INC.</small> | HAC (RF EMISSIONS) TEST REPORT |  <b>LG</b> | Reviewed by:<br>Quality Manager |
| Filename:<br>0Y1402250505.ZNF | Test Dates:<br>2/28/2014                                                                                                                         | EUT Type:<br>Portable Handset  | Page 62 of 63                                                                                   |                                 |

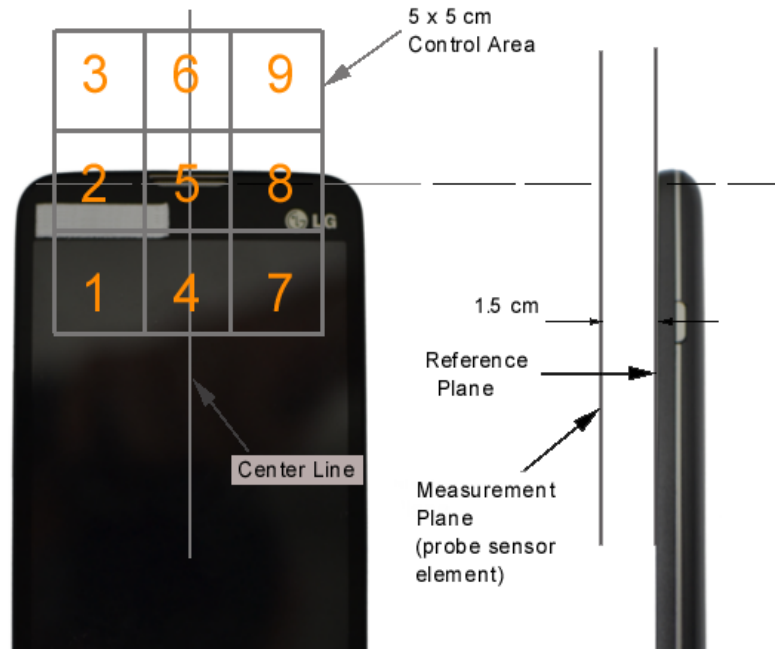

Figure 18-3 5x5 Scan grid above WD



Figure 18-4 E-Field WD Scan overlay

|                               |                                        |                                |    |                                 |
|-------------------------------|----------------------------------------|--------------------------------|----|---------------------------------|
| FCC ID: ZNFVS450PP            | PCTEST<br>ENGINEERING LABORATORY, INC. | HAC (RF EMISSIONS) TEST REPORT | LG | Reviewed by:<br>Quality Manager |
| Filename:<br>0Y1402250505.ZNF | Test Dates:<br>2/28/2014               | EUT Type:<br>Portable Handset  |    | Page 63 of 63                   |