



Accredited by the Swiss Accreditation Service (SAS)  
 The Swiss Accreditation Service is one of the signatories to the EA  
 Multilateral Agreement for the recognition of calibration certificates

Accreditation No.: **SCS 108**

Client **PC Test**

Certificate No: **ES3-3022\_Aug13**

**CALIBRATION CERTIFICATE**

Object **ES3DV2 - SN:3022**

Calibration procedure(s) **QA CAL-01.v9, QA CAL-23.v5, QA CAL-25.v6  
 Calibration procedure for dosimetric E-field probes**

Calibration date: **August 22, 2013** *UTC*  
*9/13/13*

This calibration certificate documents the traceability to national standards, which realize the physical units of measurements (SI).  
 The measurements and the uncertainties with confidence probability are given on the following pages and are part of the certificate.

All calibrations have been conducted in the closed laboratory facility: environment temperature (22 ± 3)°C and humidity < 70%.

Calibration Equipment used (M&TE critical for calibration)

Primary Standards	ID	Cal Date (Certificate No.)	Scheduled Calibration
Power meter E4419B	GB41293874	04-Apr-13 (No. 217-01733)	Apr-14
Power sensor E4412A	MY41498087	04-Apr-13 (No. 217-01733)	Apr-14
Reference 3 dB Attenuator	SN: S5054 (3c)	04-Apr-13 (No. 217-01737)	Apr-14
Reference 20 dB Attenuator	SN: S5277 (20x)	04-Apr-13 (No. 217-01735)	Apr-14
Reference 30 dB Attenuator	SN: S5129 (30b)	04-Apr-13 (No. 217-01738)	Apr-14
Reference Probe ES3DV2	SN: 3013	28-Dec-12 (No. ES3-3013_Dec12)	Dec-13
DAE4	SN: 660	31-Jan-13 (No. DAE4-660_Jan13)	Jan-14
Secondary Standards	ID	Check Date (in house)	Scheduled Check
RF generator HP 8648C	US3642U01700	4-Aug-99 (in house check Apr-13)	In house check: Apr-15
Network Analyzer HP 8753E	US37390585	18-Oct-01 (in house check Oct-12)	In house check: Oct-13

	Name	Function	Signature
Calibrated by:	Jeton Kastrati	Laboratory Technician	
Approved by:	Katja Pokovic	Technical Manager	

Issued: August 23, 2013

This calibration certificate shall not be reproduced except in full without written approval of the laboratory.



Accredited by the Swiss Accreditation Service (SAS)

Accreditation No.: **SCS 108**

The Swiss Accreditation Service is one of the signatories to the EA  
Multilateral Agreement for the recognition of calibration certificates

### Glossary:

TSL	tissue simulating liquid
NORM <sub>x,y,z</sub>	sensitivity in free space
ConvF	sensitivity in TSL / NORM <sub>x,y,z</sub>
DCP	diode compression point
CF	crest factor (1/duty_cycle) of the RF signal
A, B, C, D	modulation dependent linearization parameters
Polarization $\varphi$	$\varphi$ rotation around probe axis
Polarization $\vartheta$	$\vartheta$ rotation around an axis that is in the plane normal to probe axis (at measurement center), i.e., $\vartheta = 0$ is normal to probe axis

### Calibration is Performed According to the Following Standards:

- IEEE Std 1528-2003, "IEEE Recommended Practice for Determining the Peak Spatial-Averaged Specific Absorption Rate (SAR) in the Human Head from Wireless Communications Devices: Measurement Techniques", December 2003
- IEC 62209-1, "Procedure to measure the Specific Absorption Rate (SAR) for hand-held devices used in close proximity to the ear (frequency range of 300 MHz to 3 GHz)", February 2005

### Methods Applied and Interpretation of Parameters:

- NORM<sub>x,y,z</sub>**: Assessed for E-field polarization  $\vartheta = 0$  ( $f \leq 900$  MHz in TEM-cell;  $f > 1800$  MHz: R22 waveguide). NORM<sub>x,y,z</sub> are only intermediate values, i.e., the uncertainties of NORM<sub>x,y,z</sub> does not affect the E<sup>2</sup>-field uncertainty inside TSL (see below ConvF).
- NORM(f)<sub>x,y,z</sub>** = NORM<sub>x,y,z</sub> \* frequency\_response (see Frequency Response Chart). This linearization is implemented in DASY4 software versions later than 4.2. The uncertainty of the frequency response is included in the stated uncertainty of ConvF.
- DCP<sub>x,y,z</sub>**: DCP are numerical linearization parameters assessed based on the data of power sweep with CW signal (no uncertainty required). DCP does not depend on frequency nor media.
- PAR**: PAR is the Peak to Average Ratio that is not calibrated but determined based on the signal characteristics
- A<sub>x,y,z</sub>; B<sub>x,y,z</sub>; C<sub>x,y,z</sub>; D<sub>x,y,z</sub>; VR<sub>x,y,z</sub>**: A, B, C, D are numerical linearization parameters assessed based on the data of power sweep for specific modulation signal. The parameters do not depend on frequency nor media. VR is the maximum calibration range expressed in RMS voltage across the diode.
- ConvF and Boundary Effect Parameters**: Assessed in flat phantom using E-field (or Temperature Transfer Standard for  $f \leq 800$  MHz) and inside waveguide using analytical field distributions based on power measurements for  $f > 800$  MHz. The same setups are used for assessment of the parameters applied for boundary compensation (alpha, depth) of which typical uncertainty values are given. These parameters are used in DASY4 software to improve probe accuracy close to the boundary. The sensitivity in TSL corresponds to NORM<sub>x,y,z</sub> \* ConvF whereby the uncertainty corresponds to that given for ConvF. A frequency dependent ConvF is used in DASY version 4.4 and higher which allows extending the validity from  $\pm 50$  MHz to  $\pm 100$  MHz.
- Spherical isotropy (3D deviation from isotropy)**: in a field of low gradients realized using a flat phantom exposed by a patch antenna.
- Sensor Offset**: The sensor offset corresponds to the offset of virtual measurement center from the probe tip (on probe axis). No tolerance required.

# Probe ES3DV2

## SN:3022

Manufactured: April 15, 2003  
Calibrated: August 22, 2013

Calibrated for DASY/EASY Systems  
(Note: non-compatible with DASY2 system!)

## DASY/EASY - Parameters of Probe: ES3DV2 - SN:3022

### Basic Calibration Parameters

	Sensor X	Sensor Y	Sensor Z	Unc (k=2)
Norm ( $\mu\text{V}/(\text{V}/\text{m})^2$ ) <sup>A</sup>	1.00	1.04	0.99	± 10.1 %
DCP (mV) <sup>B</sup>	100.7	97.4	99.7	

### Modulation Calibration Parameters

UID	Communication System Name		A dB	B dB/μV	C	D dB	VR mV	Unc <sup>E</sup> (k=2)
0	CW	X	0.0	0.0	1.0	0.00	178.6	±3.0 %
		Y	0.0	0.0	1.0		141.9	
		Z	0.0	0.0	1.0		134.7	

The reported uncertainty of measurement is stated as the standard uncertainty of measurement multiplied by the coverage factor k=2, which for a normal distribution corresponds to a coverage probability of approximately 95%.

<sup>A</sup> The uncertainties of NormX,Y,Z do not affect the E<sup>2</sup>-field uncertainty inside TSL (see Pages 5 and 6).

<sup>B</sup> Numerical linearization parameter: uncertainty not required.

<sup>E</sup> Uncertainty is determined using the max. deviation from linear response applying rectangular distribution and is expressed for the square of the field value.

## DASY/EASY - Parameters of Probe: ES3DV2 - SN:3022

### Calibration Parameter Determined in Head Tissue Simulating Media

f (MHz) <sup>C</sup>	Relative Permittivity <sup>F</sup>	Conductivity (S/m) <sup>F</sup>	ConvF X	ConvF Y	ConvF Z	Alpha	Depth (mm)	Unct. (k=2)
750	41.9	0.89	6.21	6.21	6.21	0.19	2.37	± 12.0 %
835	41.5	0.90	6.09	6.09	6.09	0.30	1.70	± 12.0 %
1750	40.1	1.37	5.19	5.19	5.19	0.65	1.23	± 12.0 %
1900	40.0	1.40	5.03	5.03	5.03	0.51	1.43	± 12.0 %
2450	39.2	1.80	4.36	4.36	4.36	0.51	1.51	± 12.0 %
2600	39.0	1.96	4.16	4.16	4.16	0.74	1.29	± 12.0 %

<sup>C</sup> Frequency validity of ± 100 MHz only applies for DASY v4.4 and higher (see Page 2), else it is restricted to ± 50 MHz. The uncertainty is the RSS of the ConvF uncertainty at calibration frequency and the uncertainty for the indicated frequency band.

<sup>F</sup> At frequencies below 3 GHz, the validity of tissue parameters ( $\epsilon$  and  $\sigma$ ) can be relaxed to ± 10% if liquid compensation formula is applied to measured SAR values. At frequencies above 3 GHz, the validity of tissue parameters ( $\epsilon$  and  $\sigma$ ) is restricted to ± 5%. The uncertainty is the RSS of the ConvF uncertainty for indicated target tissue parameters.

## DASY/EASY - Parameters of Probe: ES3DV2 - SN:3022

### Calibration Parameter Determined in Body Tissue Simulating Media

f (MHz) <sup>C</sup>	Relative Permittivity <sup>F</sup>	Conductivity (S/m) <sup>F</sup>	ConvF X	ConvF Y	ConvF Z	Alpha	Depth (mm)	Unct. (k=2)
750	55.5	0.96	5.92	5.92	5.92	0.24	1.99	± 12.0 %
835	55.2	0.97	5.91	5.91	5.91	0.29	1.85	± 12.0 %
1750	53.4	1.49	4.75	4.75	4.75	0.52	1.52	± 12.0 %
1900	53.3	1.52	4.49	4.49	4.49	0.49	1.56	± 12.0 %
2450	52.7	1.95	4.01	4.01	4.01	0.70	1.02	± 12.0 %
2600	52.5	2.16	3.85	3.85	3.85	0.58	0.90	± 12.0 %

<sup>C</sup> Frequency validity of ± 100 MHz only applies for DASY v4.4 and higher (see Page 2), else it is restricted to ± 50 MHz. The uncertainty is the RSS of the ConvF uncertainty at calibration frequency and the uncertainty for the indicated frequency band.

<sup>F</sup> At frequencies below 3 GHz, the validity of tissue parameters ( $\epsilon$  and  $\sigma$ ) can be relaxed to ± 10% if liquid compensation formula is applied to measured SAR values. At frequencies above 3 GHz, the validity of tissue parameters ( $\epsilon$  and  $\sigma$ ) is restricted to ± 5%. The uncertainty is the RSS of the ConvF uncertainty for indicated target tissue parameters.

# Frequency Response of E-Field

(TEM-Cell:ifi110 EXX, Waveguide: R22)

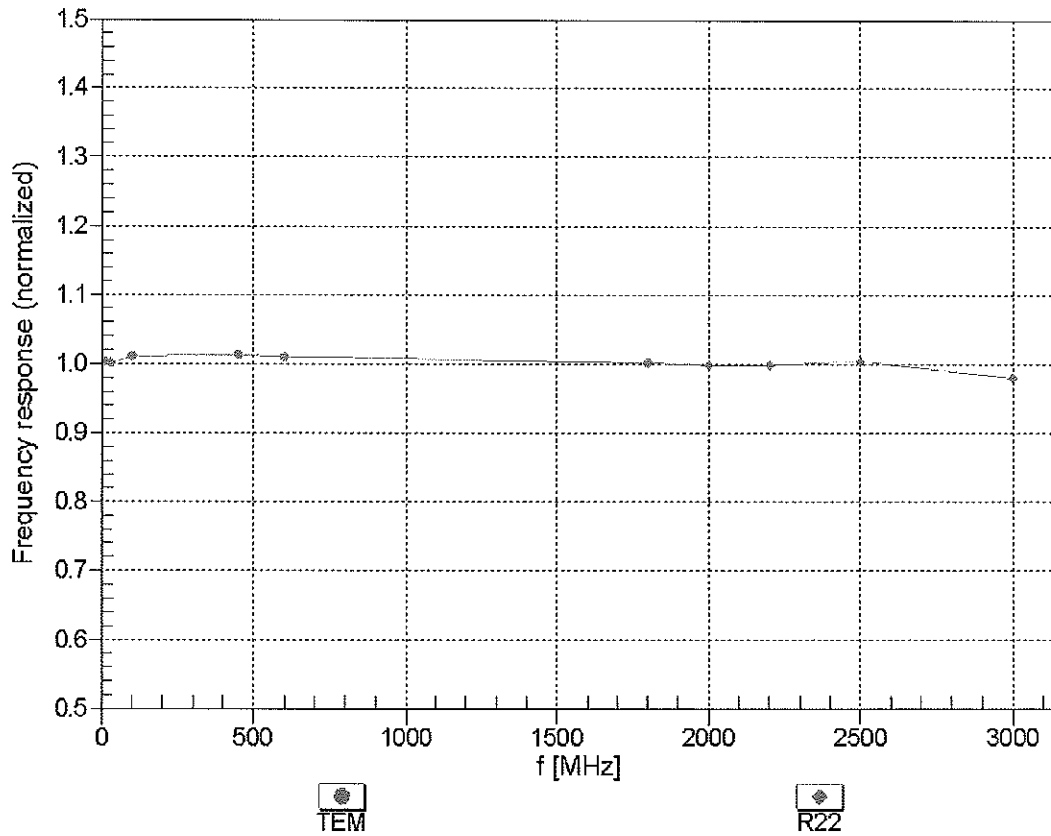

Uncertainty of Frequency Response of E-field:  $\pm 6.3\%$  (k=2)

### Receiving Pattern ( $\phi$ ), $\theta = 0^\circ$

f=600 MHz,TEM

f=1800 MHz,R22

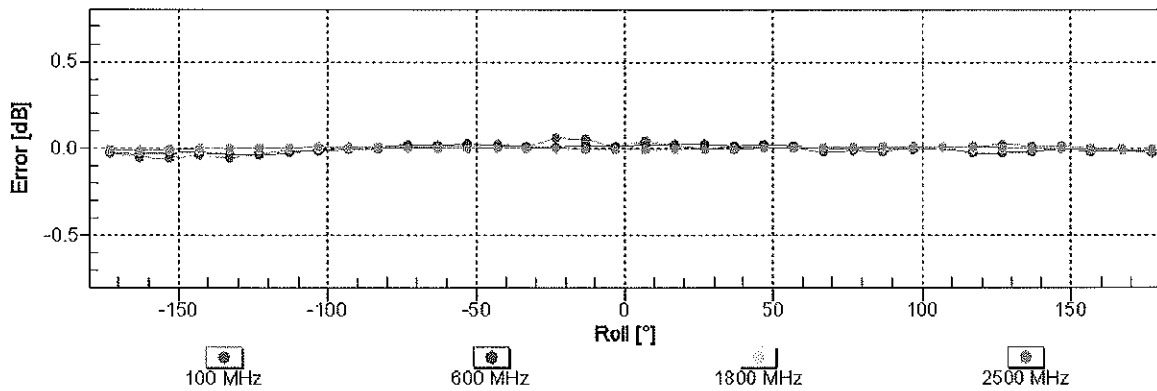
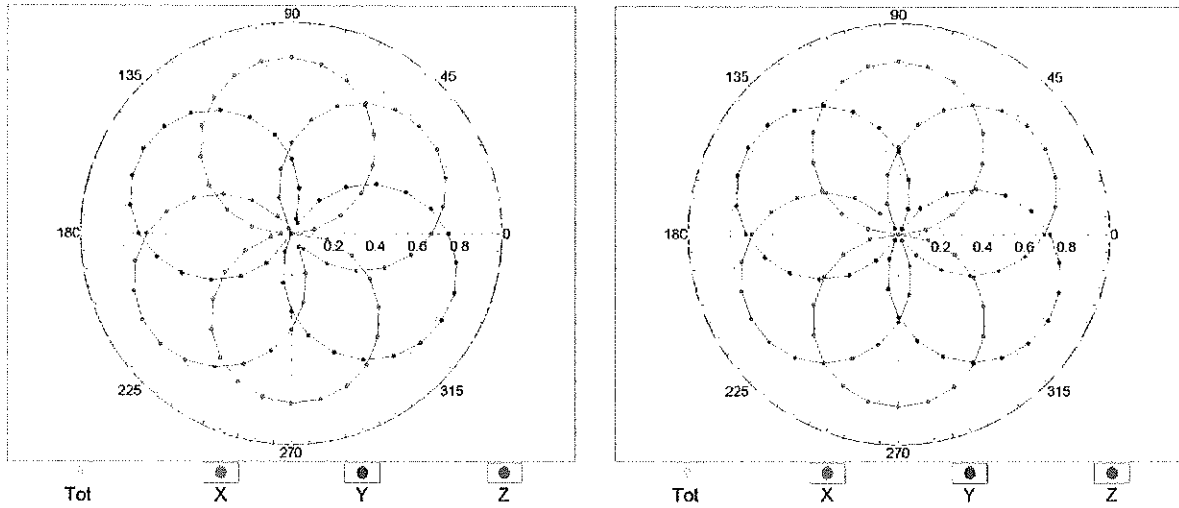

Uncertainty of Axial Isotropy Assessment:  $\pm 0.5\%$  ( $k=2$ )



### Dynamic Range $f(\text{SAR}_{\text{head}})$ (TEM cell , $f = 900 \text{ MHz}$ )

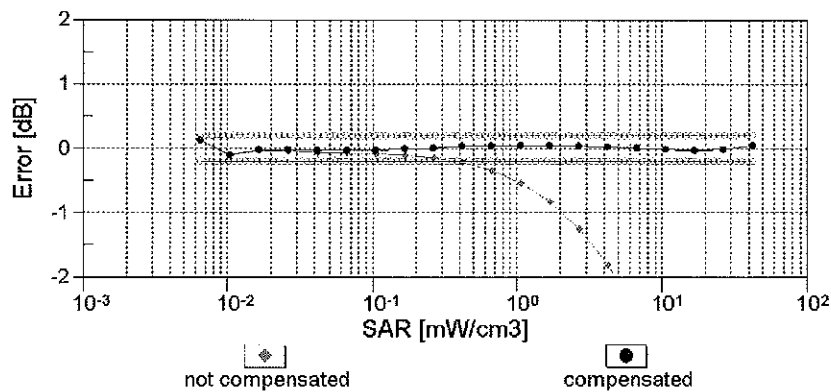
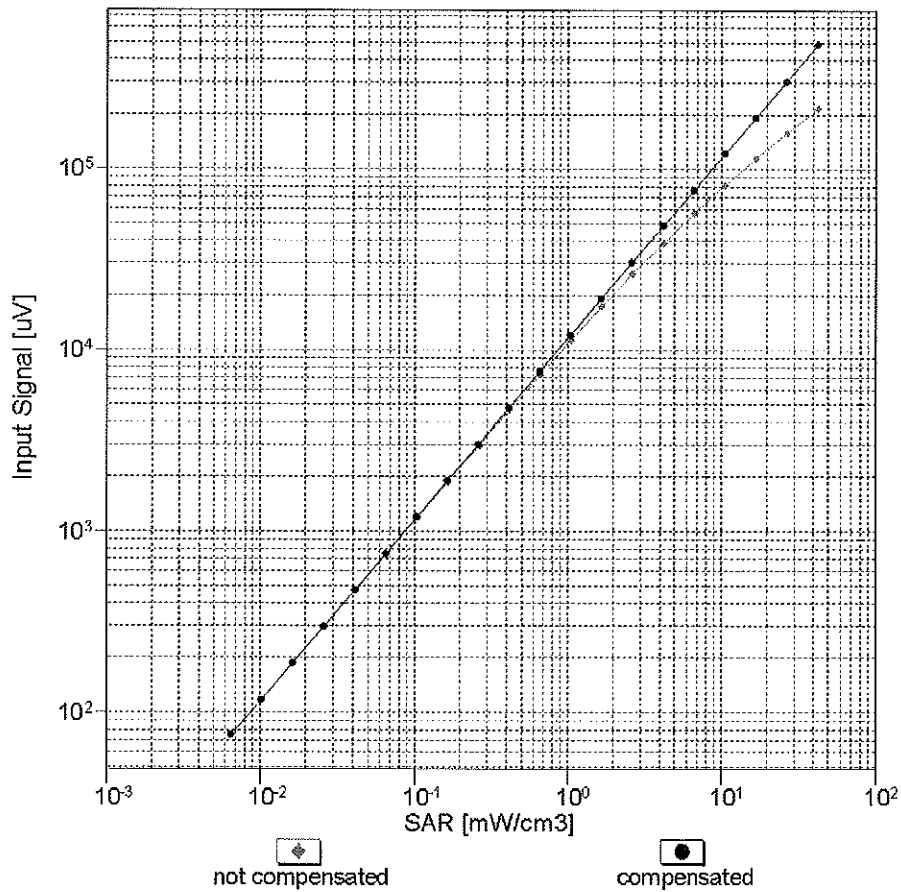

Uncertainty of Linearity Assessment:  $\pm 0.6\%$  ( $k=2$ )

# Conversion Factor Assessment

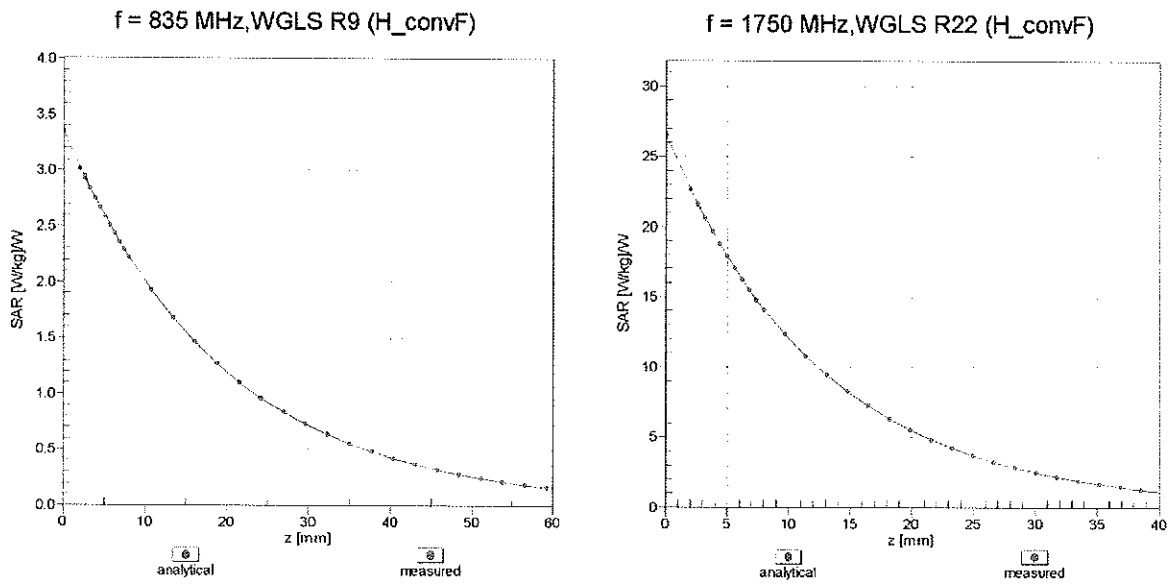

## Deviation from Isotropy in Liquid Error ( $\phi, \theta$ ), f = 900 MHz

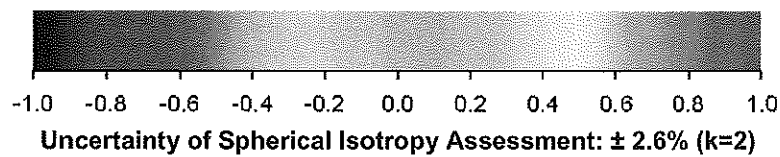
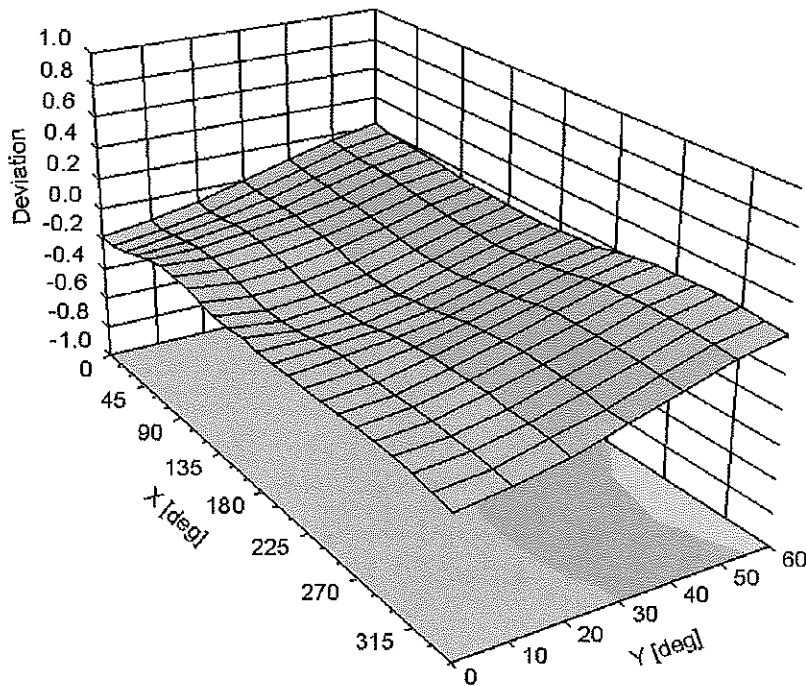

## DASY/EASY - Parameters of Probe: ES3DV2 - SN:3022

### Other Probe Parameters

Sensor Arrangement	Triangular
Connector Angle (°)	-83.1
Mechanical Surface Detection Mode	enabled
Optical Surface Detection Mode	disabled
Probe Overall Length	337 mm
Probe Body Diameter	10 mm
Tip Length	10 mm
Tip Diameter	4 mm
Probe Tip to Sensor X Calibration Point	2 mm
Probe Tip to Sensor Y Calibration Point	2 mm
Probe Tip to Sensor Z Calibration Point	2 mm
Recommended Measurement Distance from Surface	3 mm



Accredited by the Swiss Accreditation Service (SAS)  
The Swiss Accreditation Service is one of the signatories to the EA  
Multilateral Agreement for the recognition of calibration certificates

Accreditation No.: **SCS 108**

Client **PC Test**

Certificate No: **ES3-3209\_Mar13**

**CALIBRATION CERTIFICATE**

Object **ES3DV3 - SN:3209**

Calibration procedure(s) **QA CAL-01.v8, QA CAL-23.v4, QA CAL-25.v4  
Calibration procedure for dosimetric E-field probes**

Calibration date: **March 15, 2013**

This calibration certificate documents the traceability to national standards, which realize the physical units of measurements (SI).  
The measurements and the uncertainties with confidence probability are given on the following pages and are part of the certificate.

All calibrations have been conducted in the closed laboratory facility: environment temperature (22 ± 3)°C and humidity < 70%.

*✓ Kojk  
3/22/13*

Calibration Equipment used (M&TE critical for calibration)

Primary Standards	ID	Cal Date (Certificate No.)	Scheduled Calibration
Power meter E4419B	GB41293874	29-Mar-12 (No. 217-01508)	Apr-13
Power sensor E4412A	MY41498087	29-Mar-12 (No. 217-01508)	Apr-13
Reference 3 dB Attenuator	SN: S5054 (3c)	27-Mar-12 (No. 217-01531)	Apr-13
Reference 20 dB Attenuator	SN: S5086 (20b)	27-Mar-12 (No. 217-01529)	Apr-13
Reference 30 dB Attenuator	SN: S5129 (30b)	27-Mar-12 (No. 217-01532)	Apr-13
Reference Probe ES3DV2	SN: 3013	28-Dec-12 (No. ES3-3013_Dec12)	Dec-13
DAE4	SN: 660	31-Jan-13 (No. DAE4-660_Jan13)	Jan-14
Secondary Standards	ID	Check Date (in house)	Scheduled Check
RF generator HP 8648C	US3642U01700	4-Aug-99 (in house check Apr-11)	In house check: Apr-13
Network Analyzer HP 8753E	US37390585	18-Oct-01 (in house check Oct-12)	In house check: Oct-13

	Name	Function	Signature
Calibrated by:	Israe El-Naouq	Laboratory Technician	<i>Israe El-Naouq</i>
Approved by:	Katja Pokovic	Technical Manager	<i>Katja Pokovic</i>

Issued: March 15, 2013

This calibration certificate shall not be reproduced except in full without written approval of the laboratory.

80244



Accredited by the Swiss Accreditation Service (SAS)

Accreditation No.: **SCS 108**

The Swiss Accreditation Service is one of the signatories to the EA  
 Multilateral Agreement for the recognition of calibration certificates

### Glossary:

TSL	tissue simulating liquid
NORM <sub>x,y,z</sub>	sensitivity in free space
ConvF	sensitivity in TSL / NORM <sub>x,y,z</sub>
DCP	diode compression point
CF	crest factor (1/duty_cycle) of the RF signal
A, B, C, D	modulation dependent linearization parameters
Polarization $\varphi$	$\varphi$ rotation around probe axis
Polarization $\vartheta$	$\vartheta$ rotation around an axis that is in the plane normal to probe axis (at measurement center), i.e., $\vartheta = 0$ is normal to probe axis

### Calibration is Performed According to the Following Standards:

- IEEE Std 1528-2003, "IEEE Recommended Practice for Determining the Peak Spatial-Averaged Specific Absorption Rate (SAR) in the Human Head from Wireless Communications Devices: Measurement Techniques", December 2003
- IEC 62209-1, "Procedure to measure the Specific Absorption Rate (SAR) for hand-held devices used in close proximity to the ear (frequency range of 300 MHz to 3 GHz)", February 2005

### Methods Applied and Interpretation of Parameters:

- NORM<sub>x,y,z</sub>**: Assessed for E-field polarization  $\vartheta = 0$  ( $f \leq 900$  MHz in TEM-cell;  $f > 1800$  MHz: R22 waveguide). NORM<sub>x,y,z</sub> are only intermediate values, i.e., the uncertainties of NORM<sub>x,y,z</sub> does not affect the  $E^2$ -field uncertainty inside TSL (see below *ConvF*).
- NORM(f)<sub>x,y,z</sub>** = NORM<sub>x,y,z</sub> \* *frequency\_response* (see Frequency Response Chart). This linearization is implemented in DASY4 software versions later than 4.2. The uncertainty of the frequency response is included in the stated uncertainty of *ConvF*.
- DCP<sub>x,y,z</sub>**: DCP are numerical linearization parameters assessed based on the data of power sweep with CW signal (no uncertainty required). DCP does not depend on frequency nor media.
- PAR**: PAR is the Peak to Average Ratio that is not calibrated but determined based on the signal characteristics
- A<sub>x,y,z</sub>; B<sub>x,y,z</sub>; C<sub>x,y,z</sub>; D<sub>x,y,z</sub>; VR<sub>x,y,z</sub>; A, B, C, D** are numerical linearization parameters assessed based on the data of power sweep for specific modulation signal. The parameters do not depend on frequency nor media. VR is the maximum calibration range expressed in RMS voltage across the diode.
- ConvF and Boundary Effect Parameters**: Assessed in flat phantom using E-field (or Temperature Transfer Standard for  $f \leq 800$  MHz) and inside waveguide using analytical field distributions based on power measurements for  $f > 800$  MHz. The same setups are used for assessment of the parameters applied for boundary compensation (alpha, depth) of which typical uncertainty values are given. These parameters are used in DASY4 software to improve probe accuracy close to the boundary. The sensitivity in TSL corresponds to NORM<sub>x,y,z</sub> \* *ConvF* whereby the uncertainty corresponds to that given for *ConvF*. A frequency dependent *ConvF* is used in DASY version 4.4 and higher which allows extending the validity from  $\pm 50$  MHz to  $\pm 100$  MHz.
- Spherical isotropy (3D deviation from isotropy)**: in a field of low gradients realized using a flat phantom exposed by a patch antenna.
- Sensor Offset**: The sensor offset corresponds to the offset of virtual measurement center from the probe tip (on probe axis). No tolerance required.

# Probe ES3DV3

## SN:3209

Manufactured: October 14, 2008  
Calibrated: March 15, 2013

Calibrated for DASY/EASY Systems  
(Note: non-compatible with DASY2 system!)

## DASY/EASY - Parameters of Probe: ES3DV3 - SN:3209

### Basic Calibration Parameters

	Sensor X	Sensor Y	Sensor Z	Unc (k=2)
Norm ( $\mu\text{V}/(\text{V}/\text{m})^2$ ) <sup>A</sup>	1.35	1.33	1.14	$\pm 10.1 \%$
DCP (mV) <sup>B</sup>	99.2	97.8	98.3	

### Modulation Calibration Parameters

UID	Communication System Name		A dB	B dB $\sqrt{\mu\text{V}}$	C	D dB	VR mV	Unc <sup>E</sup> (k=2)
0	CW	X	0.0	0.0	1.0	0.00	163.6	$\pm 3.5 \%$
		Y	0.0	0.0	1.0		170.3	
		Z	0.0	0.0	1.0		158.7	

The reported uncertainty of measurement is stated as the standard uncertainty of measurement multiplied by the coverage factor  $k=2$ , which for a normal distribution corresponds to a coverage probability of approximately 95%.

<sup>A</sup> The uncertainties of NormX,Y,Z do not affect the  $E^2$ -field uncertainty inside TSL (see Pages 5 and 6).

<sup>B</sup> Numerical linearization parameter: uncertainty not required.

<sup>E</sup> Uncertainty is determined using the max. deviation from linear response applying rectangular distribution and is expressed for the square of the field value.

## DASY/EASY - Parameters of Probe: ES3DV3 - SN:3209

### Calibration Parameter Determined in Head Tissue Simulating Media

f (MHz) <sup>C</sup>	Relative Permittivity <sup>F</sup>	Conductivity (S/m) <sup>F</sup>	ConvF X	ConvF Y	ConvF Z	Alpha	Depth (mm)	Unct. (k=2)
750	41.9	0.89	6.74	6.74	6.74	0.76	1.18	± 12.0 %
835	41.5	0.90	6.46	6.46	6.46	0.31	1.81	± 12.0 %
1750	40.1	1.37	5.39	5.39	5.39	0.80	1.21	± 12.0 %
1900	40.0	1.40	5.21	5.21	5.21	0.78	1.26	± 12.0 %
2450	39.2	1.80	4.57	4.57	4.57	0.65	1.43	± 12.0 %
2600	39.0	1.96	4.43	4.43	4.43	0.75	1.36	± 12.0 %

<sup>C</sup> Frequency validity of ± 100 MHz only applies for DASY v4.4 and higher (see Page 2), else it is restricted to ± 50 MHz. The uncertainty is the RSS of the ConvF uncertainty at calibration frequency and the uncertainty for the indicated frequency band.

<sup>F</sup> At frequencies below 3 GHz, the validity of tissue parameters ( $\epsilon$  and  $\sigma$ ) can be relaxed to ± 10% if liquid compensation formula is applied to measured SAR values. At frequencies above 3 GHz, the validity of tissue parameters ( $\epsilon$  and  $\sigma$ ) is restricted to ± 5%. The uncertainty is the RSS of the ConvF uncertainty for indicated target tissue parameters.



## DASY/EASY - Parameters of Probe: ES3DV3 - SN:3209

### Calibration Parameter Determined in Body Tissue Simulating Media

f (MHz) <sup>C</sup>	Relative Permittivity <sup>F</sup>	Conductivity (S/m) <sup>F</sup>	ConvF X	ConvF Y	ConvF Z	Alpha	Depth (mm)	Unct. (k=2)
750	55.5	0.96	6.38	6.38	6.38	0.80	1.16	± 12.0 %
835	55.2	0.97	6.28	6.28	6.28	0.52	1.45	± 12.0 %
1750	53.4	1.49	5.03	5.03	5.03	0.58	1.45	± 12.0 %
1900	53.3	1.52	4.77	4.77	4.77	0.70	1.36	± 12.0 %
2450	52.7	1.95	4.34	4.34	4.34	0.80	1.15	± 12.0 %
2600	52.5	2.16	4.11	4.11	4.11	0.80	1.00	± 12.0 %

<sup>C</sup> Frequency validity of ± 100 MHz only applies for DASY v4.4 and higher (see Page 2), else it is restricted to ± 50 MHz. The uncertainty is the RSS of the ConvF uncertainty at calibration frequency and the uncertainty for the indicated frequency band.

<sup>F</sup> At frequencies below 3 GHz, the validity of tissue parameters ( $\epsilon$  and  $\sigma$ ) can be relaxed to ± 10% if liquid compensation formula is applied to measured SAR values. At frequencies above 3 GHz, the validity of tissue parameters ( $\epsilon$  and  $\sigma$ ) is restricted to ± 5%. The uncertainty is the RSS of the ConvF uncertainty for indicated target tissue parameters.

# Frequency Response of E-Field (TEM-Cell:ifi110 EXX, Waveguide: R22)

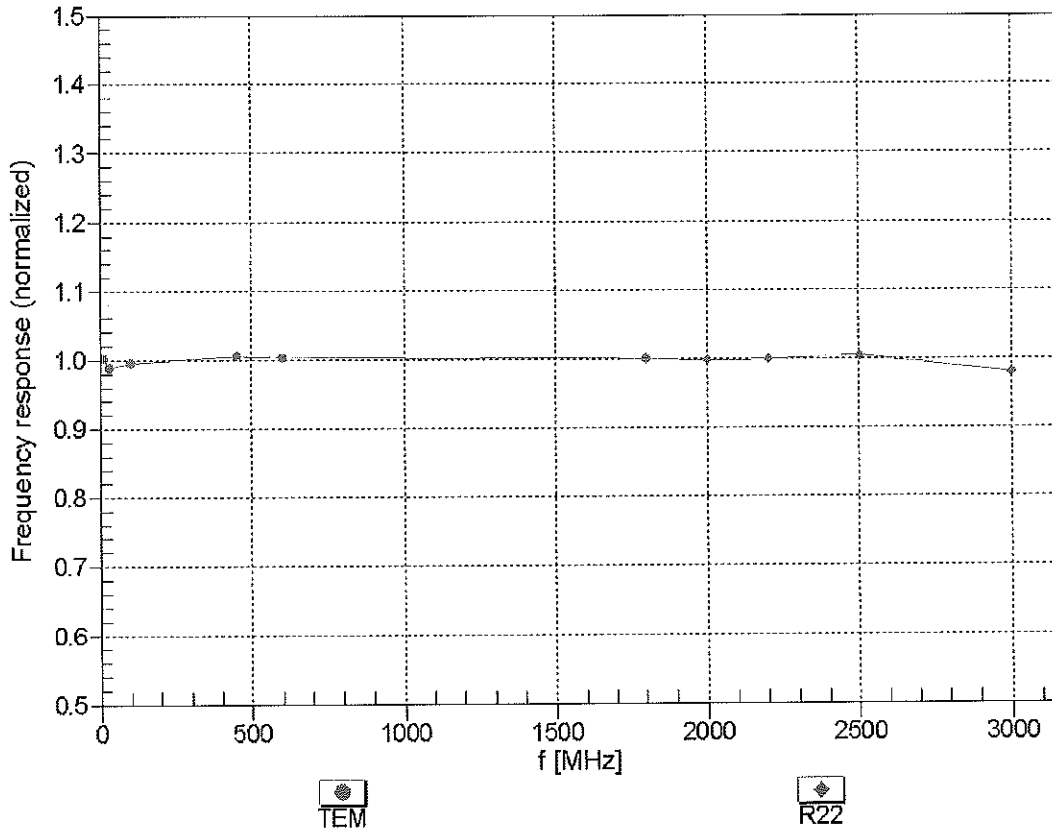

Uncertainty of Frequency Response of E-field:  $\pm 6.3\%$  (k=2)

### Receiving Pattern ( $\phi$ ), $\theta = 0^\circ$

f=600 MHz,TEM

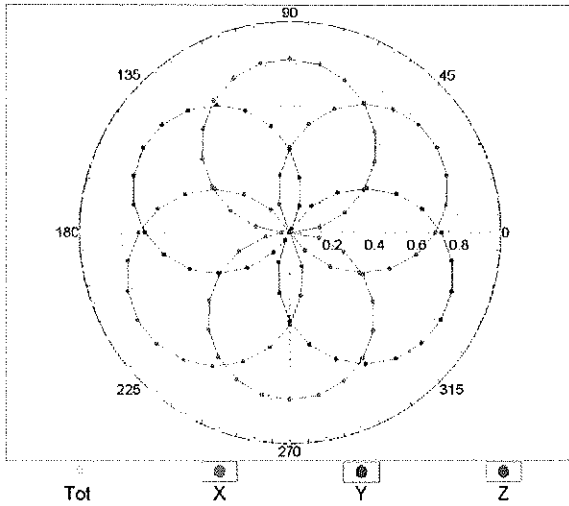

f=1800 MHz,R22

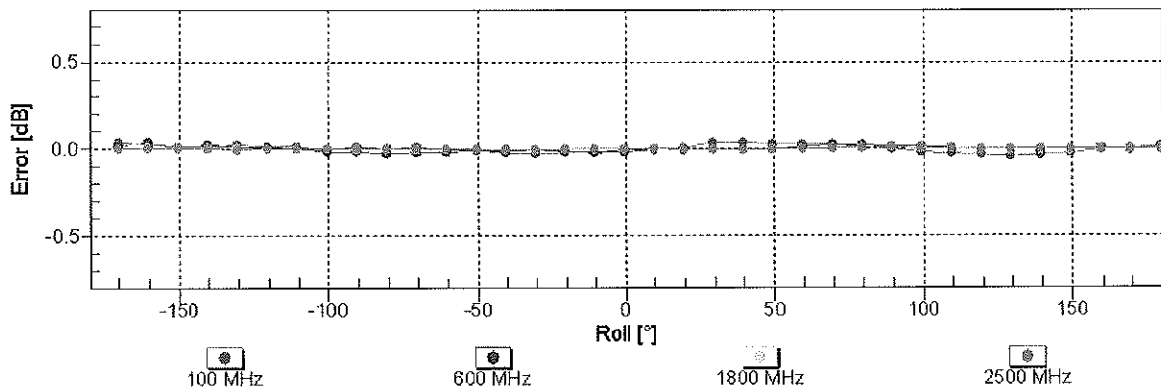
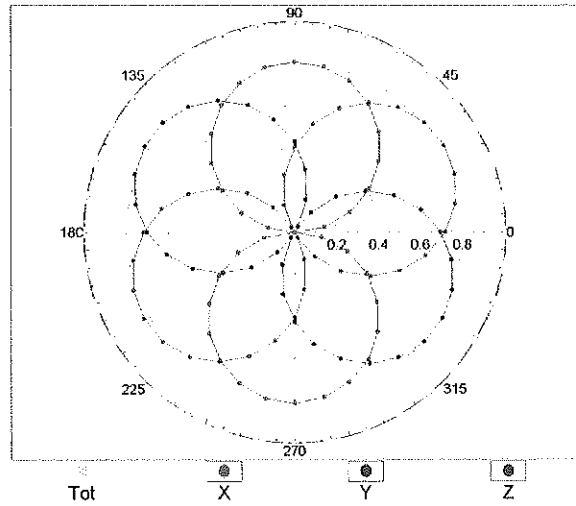

Uncertainty of Axial Isotropy Assessment:  $\pm 0.5\%$  (k=2)

### Dynamic Range $f(SAR_{head})$ (TEM cell , $f = 900$ MHz)

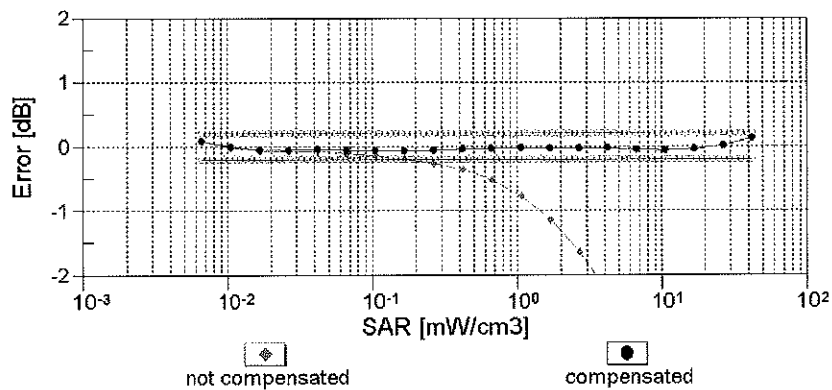
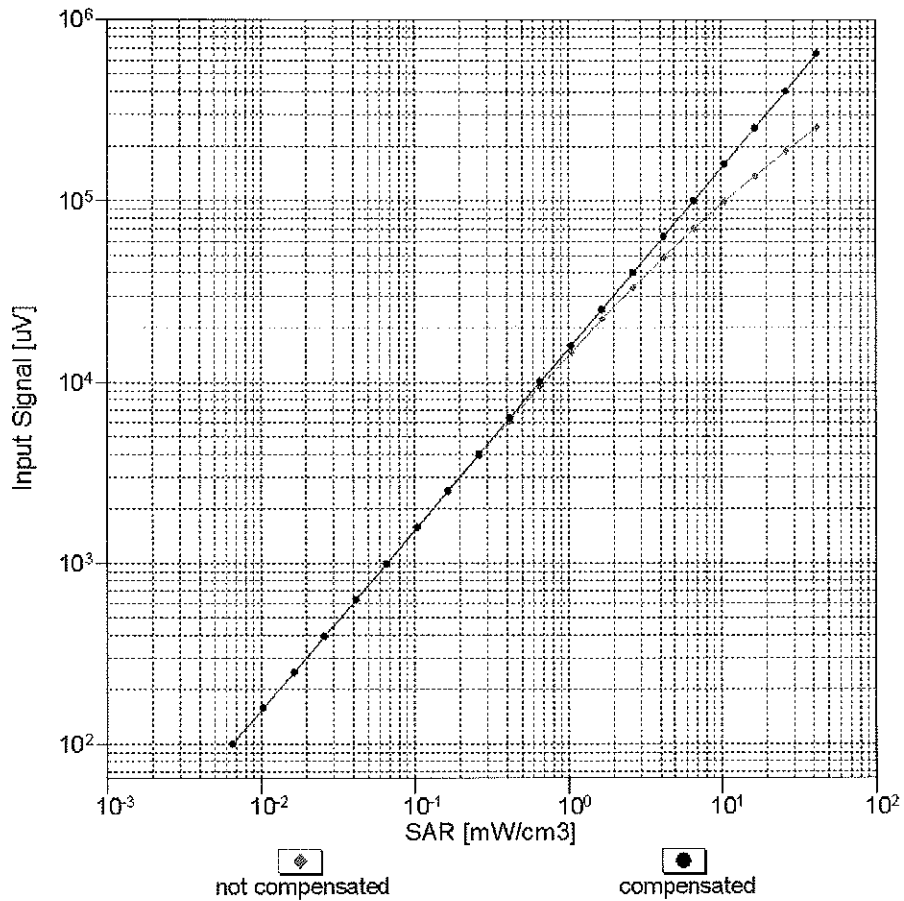

Uncertainty of Linearity Assessment:  $\pm 0.6\%$  ( $k=2$ )

# Conversion Factor Assessment

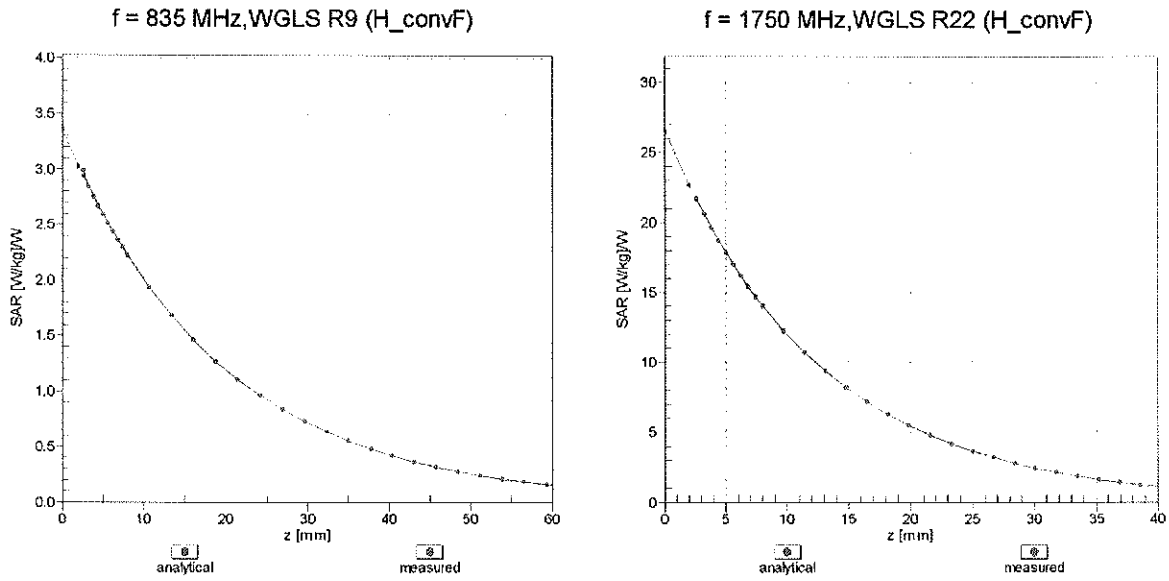

## Deviation from Isotropy in Liquid Error ( $\phi, \theta$ ), f = 900 MHz

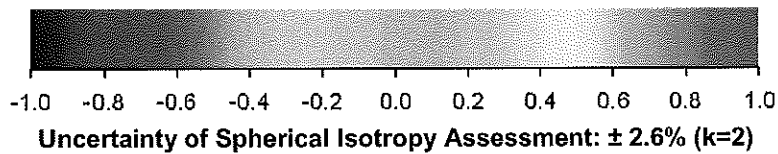
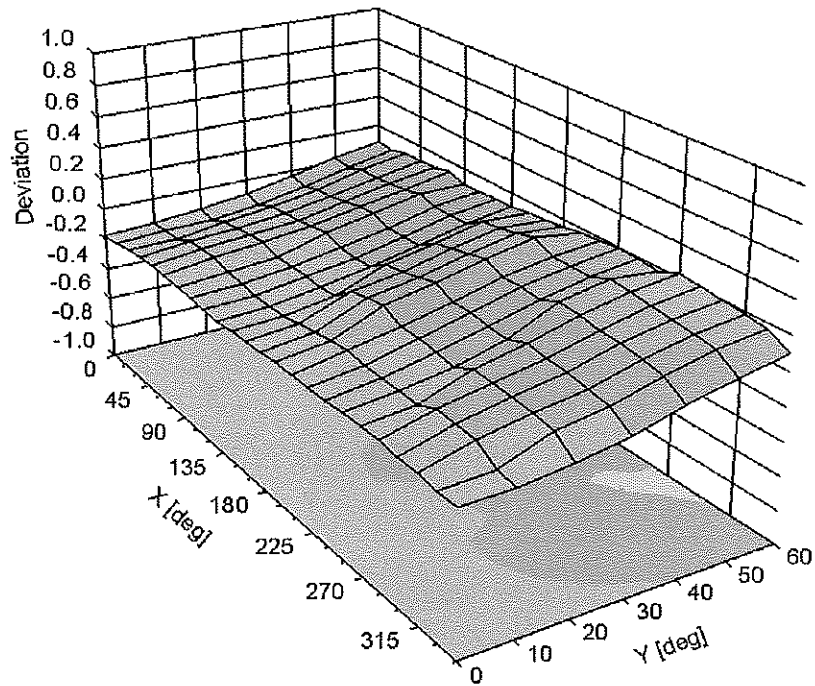

**DASY/EASY - Parameters of Probe: ES3DV3 - SN:3209****Other Probe Parameters**

Sensor Arrangement	Triangular
Connector Angle (°)	-40.6
Mechanical Surface Detection Mode	enabled
Optical Surface Detection Mode	disabled
Probe Overall Length	337 mm
Probe Body Diameter	10 mm
Tip Length	10 mm
Tip Diameter	4 mm
Probe Tip to Sensor X Calibration Point	2 mm
Probe Tip to Sensor Y Calibration Point	2 mm
Probe Tip to Sensor Z Calibration Point	2 mm
Recommended Measurement Distance from Surface	3 mm

**Calibration Laboratory of  
Schmid & Partner  
Engineering AG**  
Zeughausstrasse 43, 8004 Zurich, Switzerland



**SCS** Schweizerischer Kalibrierdienst  
Service suisse d'étalonnage  
Servizio svizzero di taratura  
Swiss Calibration Service

Accredited by the Swiss Accreditation Service (SAS)  
The Swiss Accreditation Service is one of the signatories to the EA  
Multilateral Agreement for the recognition of calibration certificates

Accreditation No.: **SCS 108**

Client **PC Test**

Certificate No: **EX3-3914\_Oct13**

**CALIBRATION CERTIFICATE**

Object **EX3DV4 - SN:3914**

Calibration procedure(s) **QA CAL-01.v9, QA CAL-14.v4, QA CAL-23.v5, QA CAL-25.v6  
Calibration procedure for dosimetric E-field probes**

Calibration date: **October 23, 2013** VCC  
11/20/2013

This calibration certificate documents the traceability to national standards, which realize the physical units of measurements (SI).  
The measurements and the uncertainties with confidence probability are given on the following pages and are part of the certificate.

All calibrations have been conducted in the closed laboratory facility: environment temperature (22 ± 3)°C and humidity < 70%.

Calibration Equipment used (M&TE critical for calibration)

Primary Standards	ID	Cal Date (Certificate No.)	Scheduled Calibration
Power meter E4419B	GB41293874	04-Apr-13 (No. 217-01733)	Apr-14
Power sensor E4412A	MY41498087	04-Apr-13 (No. 217-01733)	Apr-14
Reference 3 dB Attenuator	SN: S5054 (3c)	04-Apr-13 (No. 217-01737)	Apr-14
Reference 20 dB Attenuator	SN: S5277 (20x)	04-Apr-13 (No. 217-01735)	Apr-14
Reference 30 dB Attenuator	SN: S5129 (30b)	04-Apr-13 (No. 217-01738)	Apr-14
Reference Probe ES3DV2	SN: 3013	28-Dec-12 (No. ES3-3013_Dec12)	Dec-13
DAE4	SN: 660	4-Sep-13 (No. DAE4-660_Sep13)	Sep-14
Secondary Standards	ID	Check Date (in house)	Scheduled Check
RF generator HP 8648C	US3642U01700	4-Aug-99 (in house check Apr-13)	In house check: Apr-15
Network Analyzer HP 8753E	US37390585	18-Oct-01 (in house check Oct-13)	In house check: Oct-14

Calibrated by:	<b>Name</b> Leif Klysner	<b>Function</b> Laboratory Technician	<b>Signature</b> 
Approved by:	<b>Name</b> Katja Pokovic	<b>Function</b> Technical Manager	<b>Signature</b> 

Issued: October 25, 2013

This calibration certificate shall not be reproduced except in full without written approval of the laboratory.

PC# 81072



Accredited by the Swiss Accreditation Service (SAS)  
 The Swiss Accreditation Service is one of the signatories to the EA  
 Multilateral Agreement for the recognition of calibration certificates

Accreditation No.: **SCS 108**

**Glossary:**

TSL	tissue simulating liquid
NORM <sub>x,y,z</sub>	sensitivity in free space
ConvF	sensitivity in TSL / NORM <sub>x,y,z</sub>
DCP	diode compression point
CF	crest factor (1/duty_cycle) of the RF signal
A, B, C, D	modulation dependent linearization parameters
Polarization $\varphi$	$\varphi$ rotation around probe axis
Polarization $\vartheta$	$\vartheta$ rotation around an axis that is in the plane normal to probe axis (at measurement center), i.e., $\vartheta = 0$ is normal to probe axis
Connector Angle	information used in DASY system to align probe sensor X to the robot coordinate system

**Calibration is Performed According to the Following Standards:**

- a) IEEE Std 1528-2013, "IEEE Recommended Practice for Determining the Peak Spatial-Averaged Specific Absorption Rate (SAR) in the Human Head from Wireless Communications Devices: Measurement Techniques", June 2013
- b) IEC 62209-1, "Procedure to measure the Specific Absorption Rate (SAR) for hand-held devices used in close proximity to the ear (frequency range of 300 MHz to 3 GHz)", February 2005

**Methods Applied and Interpretation of Parameters:**

- *NORM<sub>x,y,z</sub>*: Assessed for E-field polarization  $\vartheta = 0$  ( $f \leq 900$  MHz in TEM-cell;  $f > 1800$  MHz: R22 waveguide). *NORM<sub>x,y,z</sub>* are only intermediate values, i.e., the uncertainties of *NORM<sub>x,y,z</sub>* does not affect the  $E^2$ -field uncertainty inside TSL (see below *ConvF*).
- *NORM(f)<sub>x,y,z</sub>* = *NORM<sub>x,y,z</sub>* \* *frequency\_response* (see Frequency Response Chart). This linearization is implemented in DASY4 software versions later than 4.2. The uncertainty of the frequency response is included in the stated uncertainty of *ConvF*.
- *DCP<sub>x,y,z</sub>*: DCP are numerical linearization parameters assessed based on the data of power sweep with CW signal (no uncertainty required). DCP does not depend on frequency nor media.
- *PAR*: PAR is the Peak to Average Ratio that is not calibrated but determined based on the signal characteristics
- *A<sub>x,y,z</sub>*; *B<sub>x,y,z</sub>*; *C<sub>x,y,z</sub>*; *D<sub>x,y,z</sub>*; *VR<sub>x,y,z</sub>*; *A, B, C, D* are numerical linearization parameters assessed based on the data of power sweep for specific modulation signal. The parameters do not depend on frequency nor media. *VR* is the maximum calibration range expressed in RMS voltage across the diode.
- *ConvF* and *Boundary Effect Parameters*: Assessed in flat phantom using E-field (or Temperature Transfer Standard for  $f \leq 800$  MHz) and inside waveguide using analytical field distributions based on power measurements for  $f > 800$  MHz. The same setups are used for assessment of the parameters applied for boundary compensation (alpha, depth) of which typical uncertainty values are given. These parameters are used in DASY4 software to improve probe accuracy close to the boundary. The sensitivity in TSL corresponds to *NORM<sub>x,y,z</sub>* \* *ConvF* whereby the uncertainty corresponds to that given for *ConvF*. A frequency dependent *ConvF* is used in DASY version 4.4 and higher which allows extending the validity from  $\pm 50$  MHz to  $\pm 100$  MHz.
- *Spherical isotropy (3D deviation from isotropy)*: in a field of low gradients realized using a flat phantom exposed by a patch antenna.
- *Sensor Offset*: The sensor offset corresponds to the offset of virtual measurement center from the probe tip (on probe axis). No tolerance required.
- *Connector Angle*: The angle is assessed using the information gained by determining the *NORM<sub>x</sub>* (no uncertainty required).



# Probe EX3DV4

## SN:3914

Manufactured: December 18, 2012  
Calibrated: October 23, 2013

Calibrated for DASY/EASY Systems  
(Note: non-compatible with DASY2 system!)

## DASY/EASY - Parameters of Probe: EX3DV4 - SN:3914

### Basic Calibration Parameters

	Sensor X	Sensor Y	Sensor Z	Unc (k=2)
Norm ( $\mu\text{V}/(\text{V}/\text{m})^2$ ) <sup>A</sup>	0.47	0.49	0.51	$\pm 10.1 \%$
DCP (mV) <sup>B</sup>	99.2	98.9	98.2	

### Modulation Calibration Parameters

UID	Communication System Name		A dB	B dB $\sqrt{\mu\text{V}}$	C	D dB	VR mV	Unc <sup>E</sup> (k=2)
0	CW	X	0.0	0.0	1.0	0.00	158.3	$\pm 3.0 \%$
		Y	0.0	0.0	1.0		154.6	
		Z	0.0	0.0	1.0		170.8	
10010- CAA	SAR Validation (Square, 100ms, 10ms)	X	0.71	53.3	6.1	10.00	48.4	$\pm 2.5 \%$
		Y	2.43	67.0	13.8		39.9	
		Z	4.18	68.7	13.8		45.7	
10011- CAA	UMTS-FDD (WCDMA)	X	3.05	64.4	16.5	2.91	122.4	$\pm 0.5 \%$
		Y	3.31	66.5	18.2		123.5	
		Z	3.34	66.3	17.8		136.6	
10012- CAA	IEEE 802.11b WiFi 2.4 GHz (DSSS, 1 Mbps)	X	2.49	64.8	16.1	1.87	120.6	$\pm 0.5 \%$
		Y	2.94	68.6	18.7		123.6	
		Z	2.63	65.9	17.0		135.4	
10021- DAA	GSM-FDD (TDMA, GMSK)	X	1.52	61.5	10.9	9.39	83.6	$\pm 1.2 \%$
		Y	2.22	67.4	15.0		116.0	
		Z	2.47	66.8	14.7		95.9	
10023- DAA	GPRS-FDD (TDMA, GMSK, TN 0)	X	1.73	63.3	11.9	9.57	81.5	$\pm 1.7 \%$
		Y	2.11	66.2	14.2		111.8	
		Z	2.76	69.0	16.0		93.6	
10024- DAA	GPRS-FDD (TDMA, GMSK, TN 0-1)	X	1.34	62.1	9.4	6.56	121.0	$\pm 1.2 \%$
		Y	4.24	78.6	17.9		130.0	
		Z	2.91	70.7	14.9		141.4	
10027- DAA	GPRS-FDD (TDMA, GMSK, TN 0-1-2)	X	1.25	63.5	9.7	4.80	143.5	$\pm 1.4 \%$
		Y	1.59	66.9	12.2		149.7	
		Z	2.98	71.5	14.0		123.3	
10028- DAA	GPRS-FDD (TDMA, GMSK, TN 0-1-2-3)	X	0.51	58.3	7.4	3.55	113.4	$\pm 1.2 \%$
		Y	25.43	100.0	22.6		121.3	
		Z	38.67	97.5	20.6		133.3	
10032- CAA	IEEE 802.15.1 Bluetooth (GFSK, DH5)	X	0.28	58.6	5.3	1.16	134.7	$\pm 0.9 \%$
		Y	65.75	99.6	18.6		141.3	
		Z	0.20	55.6	4.1		112.1	
10039- CAA	CDMA2000 (1xRTT, RC1)	X	4.33	64.6	17.4	4.57	113.8	$\pm 0.7 \%$
		Y	4.55	66.0	18.6		120.8	
		Z	4.85	66.2	18.4		135.9	
10062- CAA	IEEE 802.11a/h WiFi 5 GHz (OFDM, 6 Mbps)	X	9.83	67.6	20.7	8.68	109.0	$\pm 2.5 \%$
		Y	10.06	68.4	21.5		118.2	
		Z	10.66	69.2	21.7		134.0	

10081-CAA	CDMA2000 (1xRTT, RC3)	X	3.59	63.9	16.9	3.97	113.6	±0.7 %
		Y	3.84	65.6	18.2		119.6	
		Z	3.95	65.4	17.8		134.5	
10098-CAA	UMTS-FDD (HSUPA, Subtest 2)	X	4.41	65.2	17.3	3.98	126.0	±0.7 %
		Y	4.73	66.9	18.6		132.5	
		Z	4.51	65.5	17.7		105.6	
10100-CAB	LTE-FDD (SC-FDMA, 100% RB, 20 MHz, QPSK)	X	6.26	66.2	18.6	5.67	130.5	±1.2 %
		Y	6.61	67.7	19.8		139.3	
		Z	6.21	66.0	18.7		107.7	
10108-CAB	LTE-FDD (SC-FDMA, 100% RB, 10 MHz, QPSK)	X	6.13	65.8	18.6	5.80	126.3	±1.2 %
		Y	6.40	67.1	19.6		135.6	
		Z	6.10	65.5	18.5		107.4	
10110-CAB	LTE-FDD (SC-FDMA, 100% RB, 5 MHz, QPSK)	X	5.78	65.3	18.3	5.75	123.1	±1.2 %
		Y	5.97	66.3	19.2		131.5	
		Z	5.86	65.3	18.4		104.9	
10114-CAA	IEEE 802.11n (HT Greenfield, 13.5 Mbps, BPSK)	X	9.92	67.7	20.3	8.10	115.7	±2.5 %
		Y	10.25	68.7	21.2		126.8	
		Z	10.71	69.4	21.3		146.0	
10117-CAA	IEEE 802.11n (HT Mixed, 13.5 Mbps, BPSK)	X	9.95	67.8	20.3	8.07	116.6	±2.5 %
		Y	10.26	68.7	21.1		128.3	
		Z	10.70	69.4	21.3		146.9	
10151-CAB	LTE-TDD (SC-FDMA, 50% RB, 20 MHz, QPSK)	X	7.19	67.3	21.5	9.28	145.0	±2.2 %
		Y	7.40	68.3	22.4		110.8	
		Z	7.79	68.4	22.0		128.0	
10154-CAB	LTE-FDD (SC-FDMA, 50% RB, 10 MHz, QPSK)	X	5.79	65.3	18.3	5.75	124.2	±1.2 %
		Y	6.03	66.5	19.4		131.9	
		Z	6.29	66.9	19.3		149.7	
10160-CAB	LTE-FDD (SC-FDMA, 50% RB, 15 MHz, QPSK)	X	6.23	65.9	18.6	5.82	128.3	±1.2 %
		Y	6.51	67.2	19.7		136.9	
		Z	6.24	65.7	18.6		107.3	
10169-CAB	LTE-FDD (SC-FDMA, 1 RB, 20 MHz, QPSK)	X	4.83	66.0	18.9	5.73	147.5	±1.2 %
		Y	4.72	65.8	19.2		113.8	
		Z	5.03	66.1	19.1		129.7	
10172-CAB	LTE-TDD (SC-FDMA, 1 RB, 20 MHz, QPSK)	X	5.83	69.2	22.8	9.21	149.9	±1.9 %
		Y	5.81	69.4	23.4		120.3	
		Z	6.38	70.0	23.2		137.2	
10175-CAB	LTE-FDD (SC-FDMA, 1 RB, 10 MHz, QPSK)	X	4.86	66.1	18.9	5.72	149.8	±1.2 %
		Y	4.72	65.8	19.2		113.3	
		Z	5.09	66.4	19.1		126.0	
10181-CAB	LTE-FDD (SC-FDMA, 1 RB, 15 MHz, QPSK)	X	4.83	66.0	18.9	5.72	146.3	±1.2 %
		Y	4.69	65.6	19.1		112.2	
		Z	5.02	66.1	19.0		125.1	
10193-CAA	IEEE 802.11n (HT Greenfield, 6.5 Mbps, BPSK)	X	9.51	67.4	20.2	8.09	108.6	±2.5 %
		Y	9.72	68.1	20.9		118.2	
		Z	10.30	68.9	21.1		135.0	

10196-CAA	IEEE 802.11n (HT Mixed, 6.5 Mbps, BPSK)	X	9.52	67.4	20.2	8.10	111.6	±2.5 %
		Y	9.79	68.3	21.1		121.3	
		Z	10.30	68.9	21.2		139.2	
10219-CAA	IEEE 802.11n (HT Mixed, 7.2 Mbps, BPSK)	X	9.47	67.4	20.2	8.03	111.8	±2.2 %
		Y	9.67	68.3	21.0		120.0	
		Z	10.20	68.9	21.1		138.0	
10222-CAA	IEEE 802.11n (HT Mixed, 15 Mbps, BPSK)	X	9.96	67.9	20.4	8.06	118.4	±2.5 %
		Y	10.25	68.8	21.2		128.2	
		Z	10.65	69.3	21.3		144.5	
10225-CAA	UMTS-FDD (HSPA+)	X	6.96	66.7	18.9	5.97	140.0	±1.4 %
		Y	7.23	67.9	20.0		148.9	
		Z	7.03	66.4	18.9		115.6	
10237-CAB	LTE-TDD (SC-FDMA, 1 RB, 10 MHz, QPSK)	X	5.51	67.5	21.8	9.21	114.2	±1.9 %
		Y	5.82	69.4	23.4		123.0	
		Z	6.49	70.6	23.6		140.2	
10252-CAB	LTE-TDD (SC-FDMA, 50% RB, 10 MHz, QPSK)	X	6.83	67.1	21.4	9.24	136.6	±1.9 %
		Y	7.30	69.4	23.2		147.3	
		Z	7.36	68.1	22.0		117.5	
10267-CAB	LTE-TDD (SC-FDMA, 100% RB, 10 MHz, QPSK)	X	7.26	67.5	21.6	9.30	142.7	±1.9 %
		Y	7.44	68.4	22.4		110.5	
		Z	7.84	68.7	22.2		122.6	
10274-CAA	UMTS-FDD (HSUPA, Subtest 5, 3GPP Rel8.10)	X	5.86	66.2	18.2	4.87	135.4	±0.9 %
		Y	6.12	67.5	19.2		142.3	
		Z	5.91	65.9	18.2		107.6	
10275-CAA	UMTS-FDD (HSUPA, Subtest 5, 3GPP Rel8.4)	X	4.17	64.8	17.3	3.96	115.6	±0.7 %
		Y	4.42	66.4	18.5		124.6	
		Z	4.47	66.0	18.0		132.6	
10291-AAA	CDMA2000, RC3, SO55, Full Rate	X	3.36	64.7	17.1	3.46	109.4	±0.5 %
		Y	3.55	66.2	18.3		118.2	
		Z	3.60	65.6	17.7		120.9	
10292-AAA	CDMA2000, RC3, SO32, Full Rate	X	3.34	64.9	17.2	3.39	110.1	±0.5 %
		Y	3.57	66.7	18.5		121.0	
		Z	3.54	65.6	17.7		123.9	
10297-AAA	LTE-FDD (SC-FDMA, 50% RB, 20 MHz, QPSK)	X	6.14	65.8	18.6	5.81	125.1	±1.2 %
		Y	6.44	67.2	19.7		135.7	
		Z	6.52	67.0	19.3		142.2	
10311-AAA	LTE-FDD (SC-FDMA, 100% RB, 15 MHz, QPSK)	X	6.76	66.6	19.1	6.06	131.8	±1.4 %
		Y	7.03	67.8	20.0		142.5	
		Z	7.15	67.7	19.7		148.6	
10315-AAA	IEEE 802.11b WiFi 2.4 GHz (DSSS, 1 Mbps, 96pc duty cycle)	X	2.42	64.6	16.1	1.71	116.8	±0.5 %
		Y	3.00	69.3	19.0		126.9	
		Z	2.61	66.3	17.2		128.2	
10317-AAA	IEEE 802.11a WiFi 5 GHz (OFDM, 6 Mbps, 96pc duty cycle)	X	9.71	67.6	20.5	8.36	111.7	±2.5 %
		Y	9.99	68.6	21.4		122.2	
		Z	10.38	68.9	21.3		129.5	

10400-AAA	IEEE 802.11ac WiFi (20MHz, 64-QAM, 99pc duty cycle)	X	9.83	67.8	20.6	8.37	112.9	±2.5 %
		Y	10.09	68.7	21.4		123.9	
		Z	10.48	68.9	21.3		130.5	
10402-AAA	IEEE 802.11ac WiFi (80MHz, 64-QAM, 99pc duty cycle)	X	10.61	68.3	20.7	8.53	121.1	±2.5 %
		Y	11.25	70.0	21.9		135.4	
		Z	11.15	69.4	21.4		137.4	
10403-AAA	CDMA2000 (1xEV-DO, Rev. 0)	X	4.51	67.4	17.8	3.76	119.2	±0.5 %
		Y	4.91	69.5	19.3		128.3	
		Z	4.84	67.5	18.1		135.4	
10404-AAA	CDMA2000 (1xEV-DO, Rev. A)	X	4.51	67.7	18.0	3.77	117.4	±0.5 %
		Y	4.92	69.8	19.5		125.4	
		Z	4.71	67.3	18.0		131.9	

The reported uncertainty of measurement is stated as the standard uncertainty of measurement multiplied by the coverage factor  $k=2$ , which for a normal distribution corresponds to a coverage probability of approximately 95%.

<sup>A</sup> The uncertainties of NormX,Y,Z do not affect the  $E^2$ -field uncertainty inside TSL (see Pages 8 and 9).

<sup>B</sup> Numerical linearization parameter: uncertainty not required.

<sup>E</sup> Uncertainty is determined using the max. deviation from linear response applying rectangular distribution and is expressed for the square of the field value.

## DASY/EASY - Parameters of Probe: EX3DV4 - SN:3914

### Calibration Parameter Determined in Head Tissue Simulating Media

f (MHz) <sup>C</sup>	Relative Permittivity <sup>F</sup>	Conductivity (S/m) <sup>F</sup>	ConvF X	ConvF Y	ConvF Z	Alpha <sup>G</sup>	Depth <sup>G</sup> (mm)	Unct. (k=2)
750	41.9	0.89	9.70	9.70	9.70	0.34	1.01	± 12.0 %
835	41.5	0.90	9.34	9.34	9.34	0.67	0.67	± 12.0 %
1750	40.1	1.37	7.99	7.99	7.99	0.79	0.56	± 12.0 %
1900	40.0	1.40	7.69	7.69	7.69	0.80	0.58	± 12.0 %
2450	39.2	1.80	6.95	6.95	6.95	0.41	0.77	± 12.0 %
2600	39.0	1.96	6.79	6.79	6.79	0.40	0.82	± 12.0 %
5200	36.0	4.66	4.99	4.99	4.99	0.30	1.80	± 13.1 %
5300	35.9	4.76	4.82	4.82	4.82	0.30	1.80	± 13.1 %
5500	35.6	4.96	4.55	4.55	4.55	0.35	1.80	± 13.1 %
5600	35.5	5.07	4.37	4.37	4.37	0.35	1.80	± 13.1 %
5800	35.3	5.27	4.52	4.52	4.52	0.35	1.80	± 13.1 %

<sup>C</sup> Frequency validity of ± 100 MHz only applies for DASY v4.4 and higher (see Page 2), else it is restricted to ± 50 MHz. The uncertainty is the RSS of the ConvF uncertainty at calibration frequency and the uncertainty for the indicated frequency band.

<sup>F</sup> At frequencies below 3 GHz, the validity of tissue parameters ( $\epsilon$  and  $\sigma$ ) can be relaxed to ± 10% if liquid compensation formula is applied to measured SAR values. At frequencies above 3 GHz, the validity of tissue parameters ( $\epsilon$  and  $\sigma$ ) is restricted to ± 5%. The uncertainty is the RSS of the ConvF uncertainty for indicated target tissue parameters.

<sup>G</sup> Alpha/Depth are determined during calibration. SPEAG warrants that the remaining deviation due to the boundary effect after compensation is always less than ± 1% for frequencies below 3 GHz and below ± 2% for frequencies between 3-6 GHz at any distance larger than half the probe tip diameter from the boundary.

## DASY/EASY - Parameters of Probe: EX3DV4 - SN:3914

### Calibration Parameter Determined in Body Tissue Simulating Media

f (MHz) <sup>C</sup>	Relative Permittivity <sup>F</sup>	Conductivity (S/m) <sup>F</sup>	ConvF X	ConvF Y	ConvF Z	Alpha <sup>G</sup>	Depth <sup>G</sup> (mm)	Unct. (k=2)
750	55.5	0.96	9.39	9.39	9.39	0.63	0.74	± 12.0 %
835	55.2	0.97	9.31	9.31	9.31	0.56	0.76	± 12.0 %
1750	53.4	1.49	7.89	7.89	7.89	0.32	1.03	± 12.0 %
1900	53.3	1.52	7.51	7.51	7.51	0.51	0.76	± 12.0 %
2450	52.7	1.95	7.02	7.02	7.02	0.80	0.50	± 12.0 %
2600	52.5	2.16	6.81	6.81	6.81	0.80	0.50	± 12.0 %
5200	49.0	5.30	4.52	4.52	4.52	0.35	1.90	± 13.1 %
5300	48.9	5.42	4.32	4.32	4.32	0.35	1.90	± 13.1 %
5500	48.6	5.65	4.07	4.07	4.07	0.35	1.90	± 13.1 %
5600	48.5	5.77	3.97	3.97	3.97	0.35	1.90	± 13.1 %
5800	48.2	6.00	4.14	4.14	4.14	0.40	1.90	± 13.1 %

<sup>C</sup> Frequency validity of ± 100 MHz only applies for DASY v4.4 and higher (see Page 2), else it is restricted to ± 50 MHz. The uncertainty is the RSS of the ConvF uncertainty at calibration frequency and the uncertainty for the indicated frequency band.

<sup>F</sup> At frequencies below 3 GHz, the validity of tissue parameters ( $\epsilon$  and  $\sigma$ ) can be relaxed to ± 10% if liquid compensation formula is applied to measured SAR values. At frequencies above 3 GHz, the validity of tissue parameters ( $\epsilon$  and  $\sigma$ ) is restricted to ± 5%. The uncertainty is the RSS of the ConvF uncertainty for indicated target tissue parameters.

<sup>G</sup> Alpha/Depth are determined during calibration. SPEAG warrants that the remaining deviation due to the boundary effect after compensation is always less than ± 1% for frequencies below 3 GHz and below ± 2% for frequencies between 3-6 GHz at any distance larger than half the probe tip diameter from the boundary.

### Frequency Response of E-Field (TEM-Cell:ifi110 EXX, Waveguide: R22)

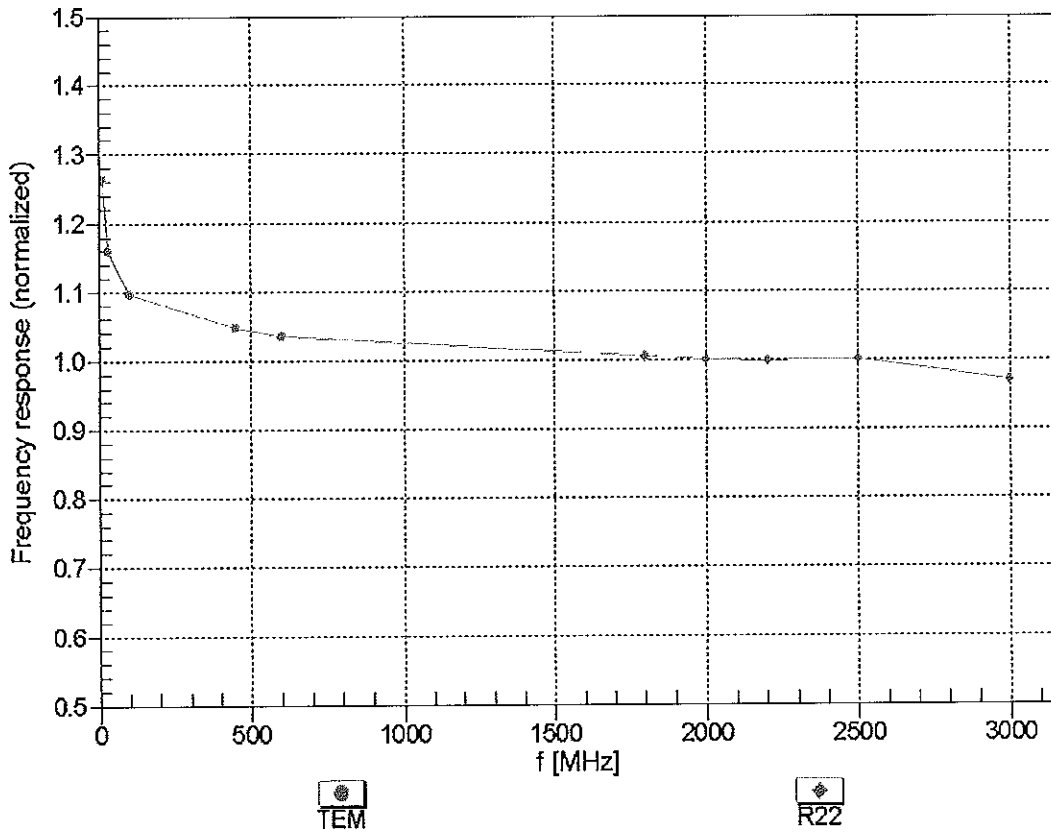

Uncertainty of Frequency Response of E-field:  $\pm 6.3\%$  (k=2)



### Receiving Pattern ( $\phi$ ), $\theta = 0^\circ$

f=600 MHz,TEM

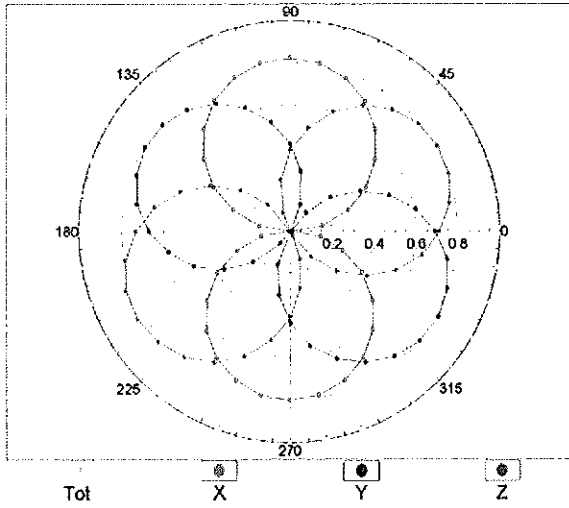

f=1800 MHz,R22

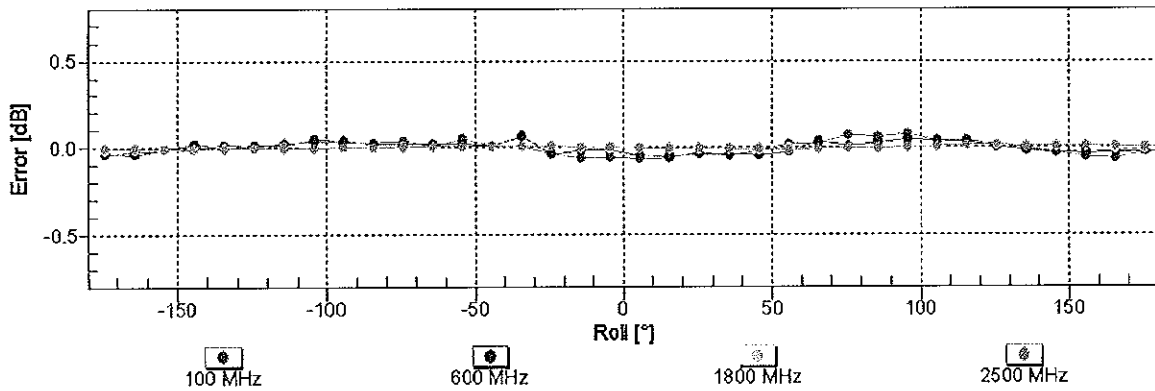
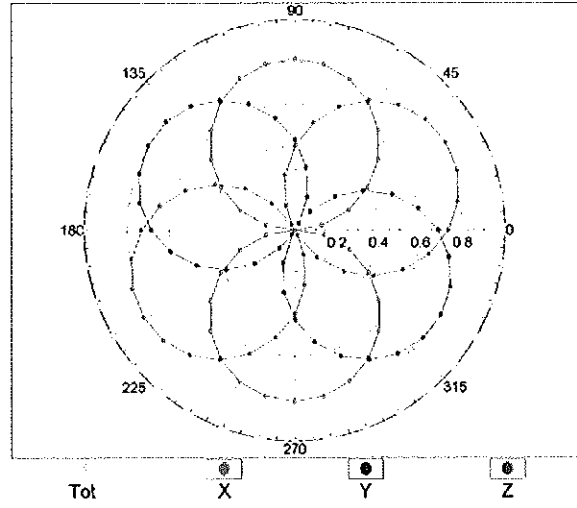

Uncertainty of Axial Isotropy Assessment:  $\pm 0.5\%$  ( $k=2$ )

### Dynamic Range $f(SAR_{head})$ (TEM cell , $f = 900$ MHz)

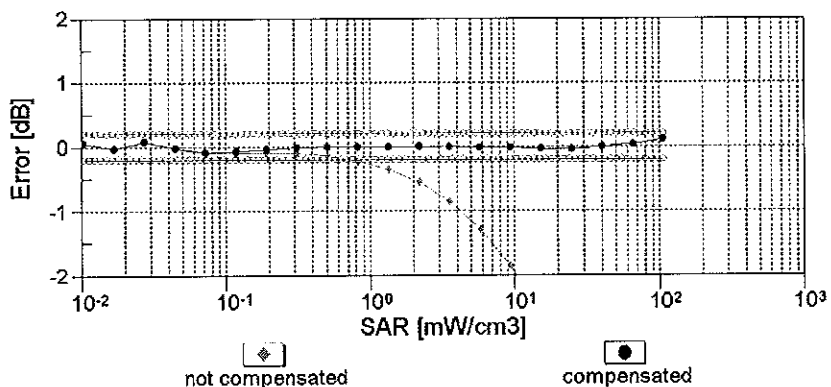
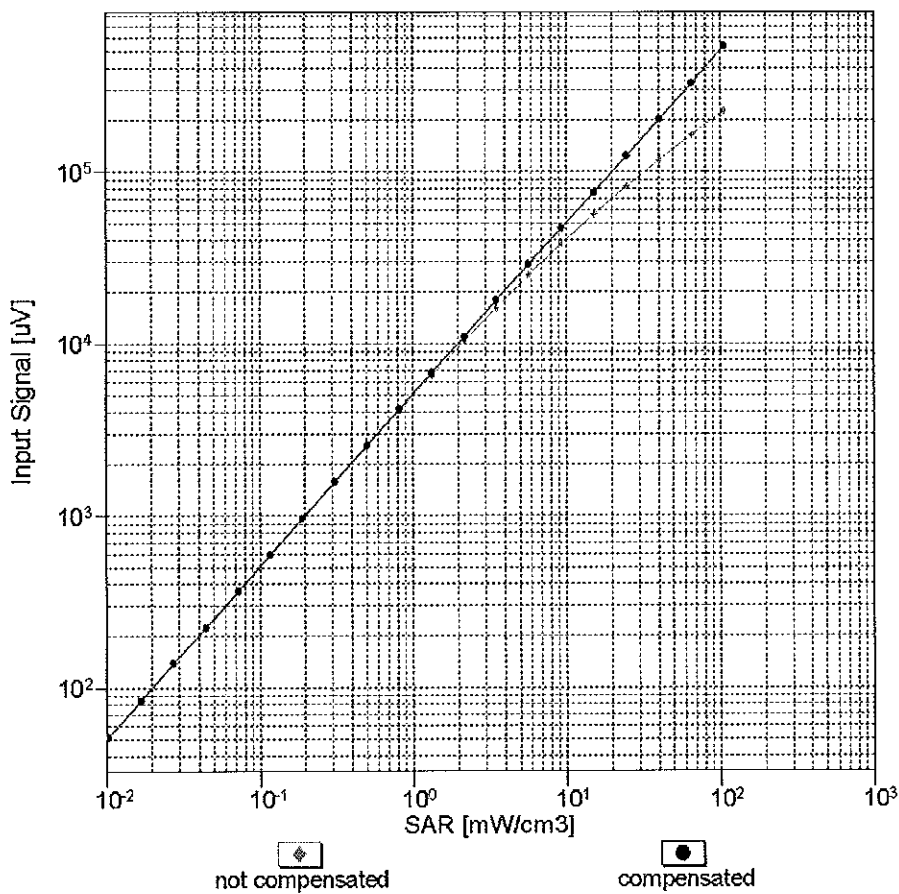

Uncertainty of Linearity Assessment:  $\pm 0.6\%$  ( $k=2$ )

# Conversion Factor Assessment

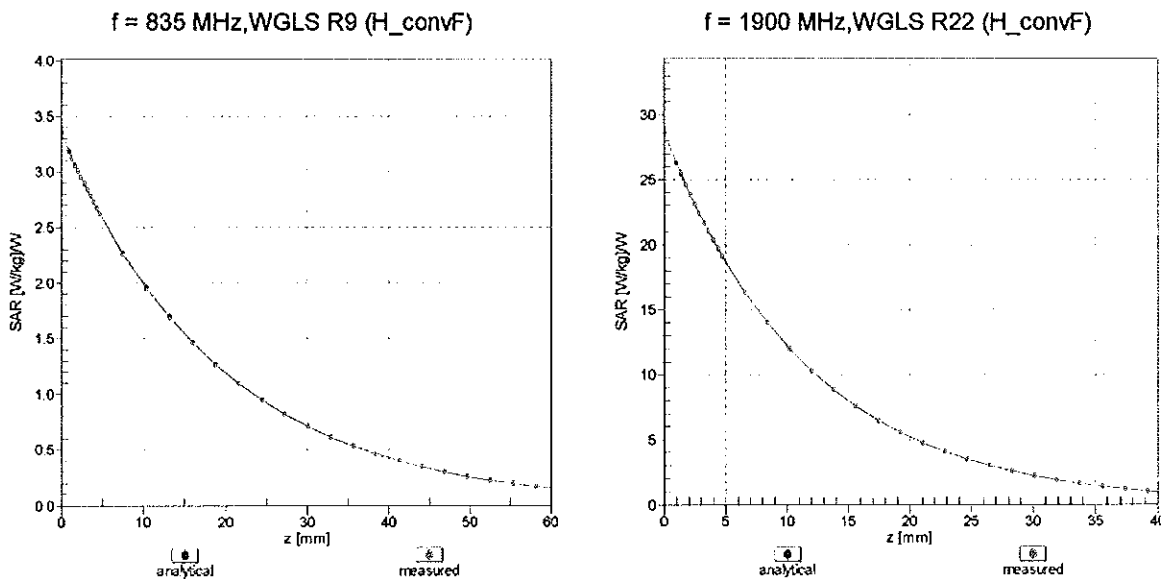

## Deviation from Isotropy in Liquid

Error ( $\phi, \theta$ ), f = 900 MHz

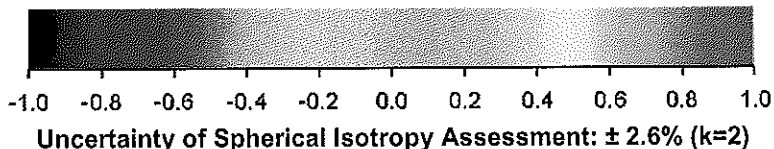
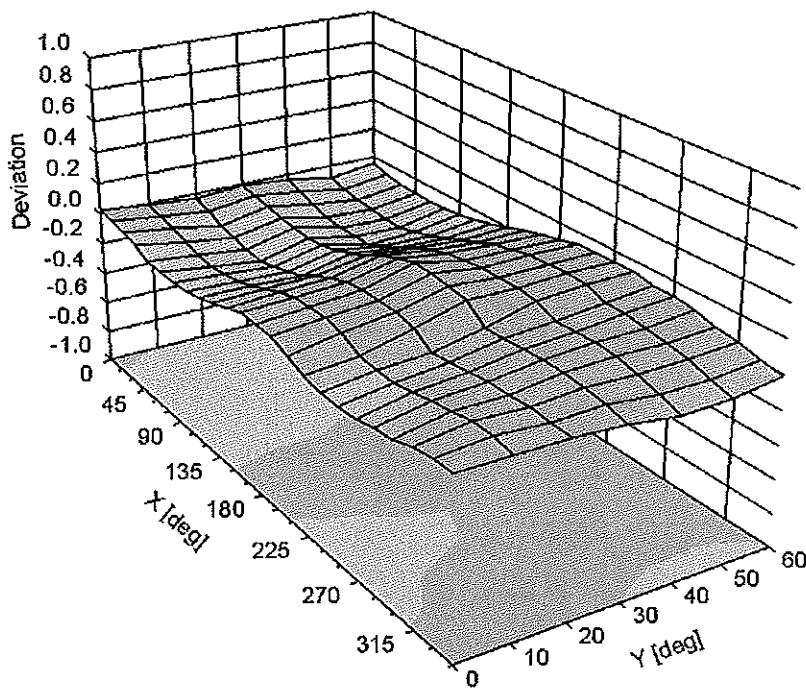

**DASY/EASY - Parameters of Probe: EX3DV4 - SN:3914****Other Probe Parameters**

Sensor Arrangement	Triangular
Connector Angle (°)	-24.3
Mechanical Surface Detection Mode	enabled
Optical Surface Detection Mode	disabled
Probe Overall Length	337 mm
Probe Body Diameter	10 mm
Tip Length	9 mm
Tip Diameter	2.5 mm
Probe Tip to Sensor X Calibration Point	1 mm
Probe Tip to Sensor Y Calibration Point	1 mm
Probe Tip to Sensor Z Calibration Point	1 mm
Recommended Measurement Distance from Surface	2 mm

## APPENDIX D: SAR TISSUE SPECIFICATIONS

Measurement Procedure for Tissue verification:



- 1) The network analyzer and probe system was configured and calibrated.
- 2) The probe was immersed in the tissue. The tissue was placed in a nonmetallic container. Trapped air bubbles beneath the flange were minimized by placing the probe at a slight angle.
- 3) The complex admittance with respect to the probe aperture was measured
- 4) The complex relative permittivity  $\epsilon$  can be calculated from the below equation (Pournaropoulos and Misra):

$$Y = \frac{j2\omega\epsilon_r\epsilon_0}{[\ln(b/a)]^2} \int_a^b \int_a^b \int_0^\pi \cos\phi' \frac{\exp[-j\omega r(\mu_0\epsilon_r'\epsilon_0)^{1/2}]}{r} d\phi' d\rho' d\rho$$

where  $Y$  is the admittance of the probe in contact with the sample, the primed and unprimed coordinates refer to source and observation points, respectively,  $r^2 = \rho^2 + \rho'^2 - 2\rho\rho' \cos\phi'$ ,  $\omega$  is the angular frequency, and  $j = \sqrt{-1}$ .

**Table D-I  
Composition of the Tissue Equivalent Matter**

Frequency (MHz)	835	835	1900	1900
Tissue	Head	Body	Head	Body
Ingredients (% by weight)				
Bactericide	0.1	0.1		
DGBE			44.92	29.44
HEC	1	1		
NaCl	1.45	0.94	0.18	0.39
Sucrose	57	44.9		
Water	40.45	53.06	54.9	70.17

FCC ID: ZNFVN280		SAR EVALUATION REPORT		Reviewed by: Quality Manager
Test Dates: 02/17/14 - 02/21/14	DUT Type: Portable Handset			APPENDIX D: Page 1 of 1

## APPENDIX E: SAR SYSTEM VALIDATION



Per FCC KDB 865664 D02v01r02, SAR system validation status should be documented to confirm measurement accuracy. The SAR systems (including SAR probes, system components and software versions) used for this device were validated against its performance specifications prior to the SAR measurements. Reference dipoles were used with the required tissue- equivalent media for system validation, according to the procedures outlined in FCC KDB 865664 D01v01r02 and IEEE 1528-2013. Since SAR probe calibrations are frequency dependent, each probe calibration point was validated at a frequency within the valid frequency range of the probe calibration point, using the system that normally operates with the probe for routine SAR measurements and according to the required tissue-equivalent media.

A tabulated summary of the system validation status including the validation date(s), measurement frequencies, SAR probes and tissue dielectric parameters has been included.

**Table E-I**  
**SAR System Validation Summary**

SAR SYSTEM #	FREQ. [MHz]	DATE	PROBE SN	PROBE TYPE	PROBE CAL. POINT		COND.	PERM.	CW VALIDATION			MOD. VALIDATION		
							( $\sigma$ )	( $\epsilon_r$ )	SENSI-TIVITY	PROBE LINEARITY	PROBE ISOTROPY	MOD. TYPE	DUTY FACTOR	PAR
J	835	1/15/2014	3332	ES3DV3	835	Head	0.900	40.49	PASS	PASS	PASS	GMSK	PASS	N/A
D	1900	9/30/2013	3022	ES3DV2	1900	Head	1.419	39.22	PASS	PASS	PASS	GMSK	PASS	N/A
G	1900	1/13/2014	3209	ES3DV3	1900	Body	1.576	51.59	PASS	PASS	PASS	GMSK	PASS	N/A
E	1900	12/18/2013	3914	EX3DV4	1900	Body	1.579	51.41	PASS	PASS	PASS	GMSK	PASS	N/A

NOTE: While the probes have been calibrated for both a CW and modulated signals, all measurements were performed using communication systems calibrated for CW signals only. Modulations in the table above represent test configurations for which the measurement system has been validated per FCC KDB Publication 865664 D01v01r02 for scenarios when CW probe calibrations are used with other signal types. SAR systems were validated for modulated signals with a periodic duty cycle, such as GMSK, or with a high peak to average ratio (>5 dB), such as OFDM according to KDB 865664.

FCC ID: ZNFVN280		SAR EVALUATION REPORT		Reviewed by: Quality Manager
Test Dates: 02/17/14 - 02/21/14	DUT Type: Portable Handset			APPENDIX E: Page 1 of 1