

9 kHz ~ 25 GHz Data (Modulation : GFSK) With Wireless Charging

▪ Highest Channel

Frequency (MHz)	ANT Pol	EUT Position (Axis)	Detector Mode	Reading (dBuV)	T.F (dB/m)	D.C.F (dB)	Distance Factor (dB)	Result (dBuV/m)	Limit (dBuV/m)	Margin (dB)
2483.92	H	X	PK	51.68	5.79	N/A	N/A	57.47	74.00	16.53
2483.92	H	X	AV	51.68	5.79	-24.79	N/A	32.68	54.00	21.32
4959.68	H	X	PK	50.25	2.17	N/A	N/A	52.42	74.00	21.58
4959.68	H	X	AV	50.25	2.17	-24.79	N/A	27.63	54.00	26.37
7439.73	H	X	PK	46.79	9.58	N/A	N/A	56.37	74.00	17.63
7439.73	H	X	AV	46.79	9.58	-24.79	N/A	31.58	54.00	22.42

 ▪ Note.

- The radiated emissions were investigated 9 kHz to 25 GHz. And no other spurious and harmonic emissions were found above listed frequencies.
- Information of Distance Factor
 For finding emissions, the test distance might be reduced from 3m to 1m. In this case, the distance factor(-9.54dB) is applied to the result.
 - Calculation of distance factor = $20 \log(\text{applied distance} / \text{required distance}) = 20 \log(1 \text{ m} / 3 \text{ m}) = \underline{-9.54 \text{ dB}}$
 When distance factor is "N/A", the distance is 3 m and distance factor is not applied.
- D.C.F Calculation. (D.C.F = Duty Cycle Correction Factor)
 - Time to cycle through all channels = $\Delta t = T [\text{ms}] \times 20$ minimum hopping channels, where T = pulse width = **2.88 ms**
 - $100 \text{ ms} / \Delta t [\text{ms}] = H \rightarrow$ Round up to next highest integer, to account for worst case, $H' = 100 / (2.88 \times 20) = 1.74 \approx 2$
 - The Worst Case Dwell Time = $T [\text{ms}] \times H' = 2.88 \text{ ms} \times 2 = 5.76 \text{ ms}$
 - D.C.F = $20 \text{ Log}(\text{The Worst Case Dwell Time} / 100 \text{ ms}) \text{ dB} = 20 \text{ log}(5.76 / 100) = \underline{-24.79 \text{ dB}}$
- Sample Calculation.
 $\text{Margin} = \text{Limit} - \text{Result} / \text{Result} = \text{Reading} + \text{T.F} + \text{D.C.F} / \text{T.F} = \text{AF} + \text{CL} - \text{AG}$
 Where, T.F = Total Factor, AF = Antenna Factor, CL = Cable Loss, AG = Amplifier Gain.

9 kHz ~ 25 GHz Data (Modulation : GFSK) With Dual Display

▪ Highest Channel

Frequency (MHz)	ANT Pol	EUT Position (Axis)	Detector Mode	Reading (dBuV)	T.F (dB/m)	D.C.F (dB)	Distance Factor (dB)	Result (dBuV/m)	Limit (dBuV/m)	Margin (dB)
2484.43	H	X	PK	51.89	5.80	N/A	N/A	57.69	74.00	16.31
2484.43	H	X	AV	51.89	5.80	-24.79	N/A	32.90	54.00	21.10
4960.09	H	X	PK	50.10	2.17	N/A	N/A	52.27	74.00	21.73
4960.09	H	X	AV	50.10	2.17	-24.79	N/A	27.48	54.00	26.52
7440.32	H	X	PK	47.01	9.58	N/A	N/A	56.59	74.00	17.41
7440.32	H	X	AV	47.01	9.58	-24.79	N/A	31.80	54.00	22.20

 ▪ Note.

1. The radiated emissions were investigated 9 kHz to 25 GHz. And no other spurious and harmonic emissions were found above listed frequencies.

2. Information of Distance Factor

For finding emissions, the test distance might be reduced from 3m to 1m. In this case, the distance factor(-9.54dB) is applied to the result.

- Calculation of distance factor = $20 \log(\text{applied distance} / \text{required distance}) = 20 \log(1 \text{ m} / 3 \text{ m}) = \underline{\underline{-9.54 \text{ dB}}}$

When distance factor is "N/A", the distance is 3 m and distance factor is not applied.

3. D.C.F Calculation. (D.C.F = Duty Cycle Correction Factor)

- Time to cycle through all channels = $\Delta t = T [\text{ms}] \times 20$ minimum hopping channels, where T = pulse width = **2.88 ms**

- $100 \text{ ms} / \Delta t [\text{ms}] = H \rightarrow$ Round up to next highest integer, to account for worst case, $H' = 100 / (2.88 \times 20) = 1.74 \approx 2$

- The Worst Case Dwell Time = $T [\text{ms}] \times H' = 2.88 \text{ ms} \times 2 = 5.76 \text{ ms}$

- D.C.F = $20 \log(\text{The Worst Case Dwell Time} / 100 \text{ ms}) \text{ dB} = 20 \log(5.76 / 100) = \underline{\underline{-24.79 \text{ dB}}}$

4. Sample Calculation.

Margin = Limit – Result / Result = Reading + T.F + D.C.F / T.F = AF + CL – AG

Where, T.F = Total Factor, AF = Antenna Factor, CL = Cable Loss, AG = Amplifier Gain.

9 kHz ~ 25 GHz Data (Modulation : GFSK) With Dual Display+WPC

▪ Highest Channel

Frequency (MHz)	ANT Pol	EUT Position (Axis)	Detector Mode	Reading (dBuV)	T.F (dB/m)	D.C.F (dB)	Distance Factor (dB)	Result (dBuV/m)	Limit (dBuV/m)	Margin (dB)
2484.05	H	X	PK	51.37	5.79	N/A	N/A	57.16	74.00	16.84
2484.05	H	X	AV	51.37	5.79	-24.79	N/A	32.37	54.00	21.63
4960.20	H	X	PK	50.20	2.17	N/A	N/A	52.37	74.00	21.63
4960.20	H	X	AV	50.20	2.17	-24.79	N/A	27.58	54.00	26.42
7439.71	H	X	PK	46.47	9.58	N/A	N/A	56.05	74.00	17.95
7439.71	H	X	AV	46.47	9.58	-24.79	N/A	31.26	54.00	22.74

 ▪ **Note.**

1. The radiated emissions were investigated 9 kHz to 25 GHz. And no other spurious and harmonic emissions were found above listed frequencies.

2. Information of Distance Factor

For finding emissions, the test distance might be reduced from 3m to 1m. In this case, the distance factor(-9.54dB) is applied to the result.

- Calculation of distance factor = $20 \log(\text{applied distance} / \text{required distance}) = 20 \log(1 \text{ m} / 3 \text{ m}) = \underline{\underline{-9.54 \text{ dB}}}$

When distance factor is "N/A", the distance is 3 m and distance factor is not applied.

3. D.C.F Calculation. (D.C.F = Duty Cycle Correction Factor)

- Time to cycle through all channels = $\Delta t = T [\text{ms}] \times 20$ minimum hopping channels, where T = pulse width = **2.88 ms**

- $100 \text{ ms} / \Delta t [\text{ms}] = H \rightarrow$ Round up to next highest integer, to account for worst case, $H' = 100 / (2.88 \times 20) = 1.74 \approx 2$

- The Worst Case Dwell Time = $T [\text{ms}] \times H' = 2.88 \text{ ms} \times 2 = 5.76 \text{ ms}$

- D.C.F = $20 \text{ Log}(\text{The Worst Case Dwell Time} / 100 \text{ ms}) \text{ dB} = 20 \text{ log}(5.76 / 100) = \underline{\underline{-24.79 \text{ dB}}}$

4. Sample Calculation.

Margin = Limit – Result / Result = Reading + T.F + D.C.F / T.F = AF + CL – AG

Where, T.F = Total Factor, AF = Antenna Factor, CL = Cable Loss, AG = Amplifier Gain.

7.4.2. Conducted Spurious Emissions

Low Band-edge

Lowest Channel & Modulation : GFSK

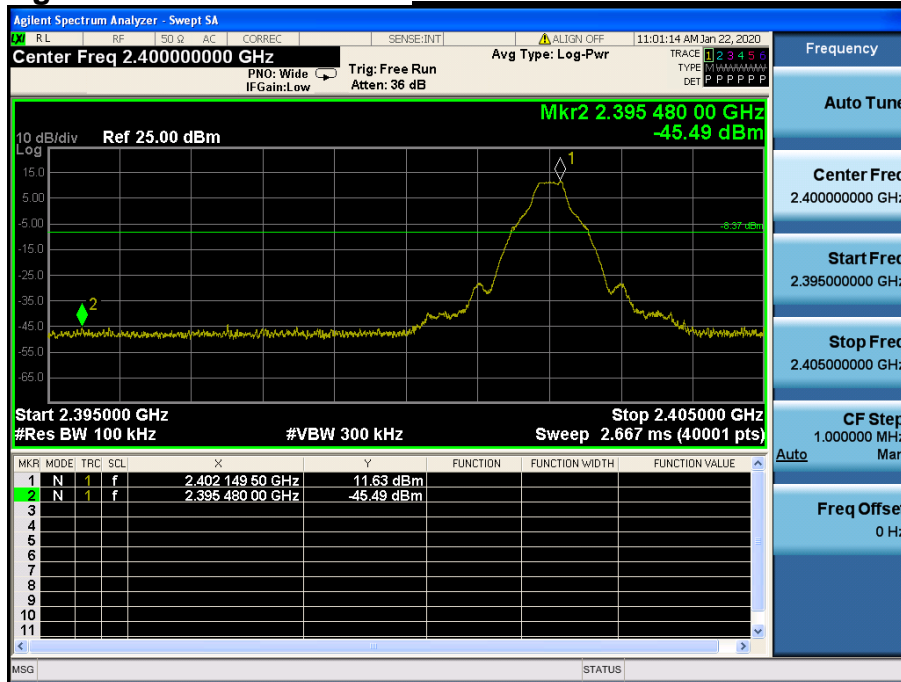

Low Band-edge

Hopping mode & Modulation : GFSK

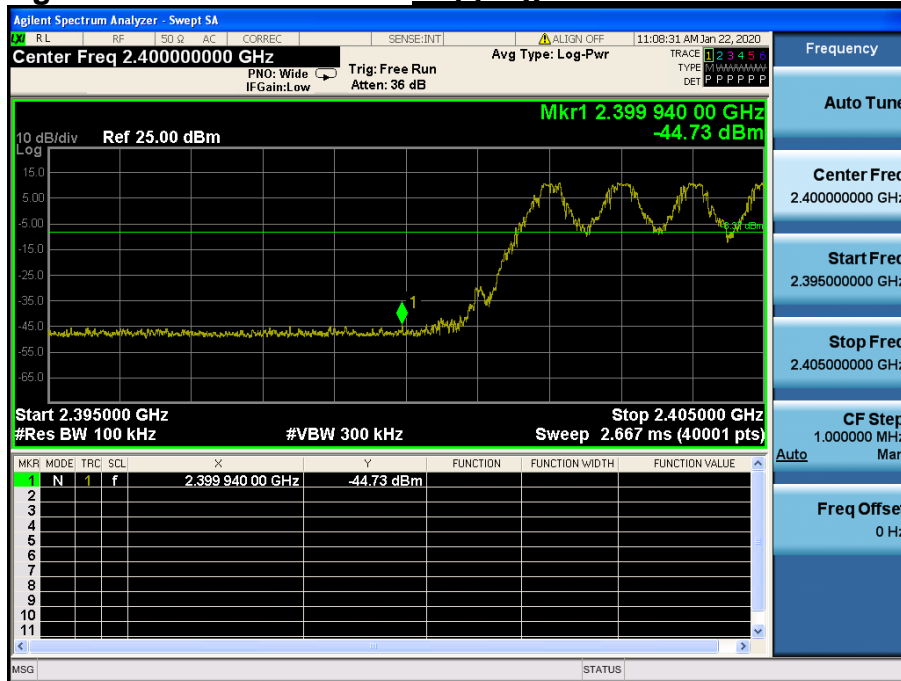

Conducted Spurious Emissions **Lowest Channel & Modulation : GFSK**

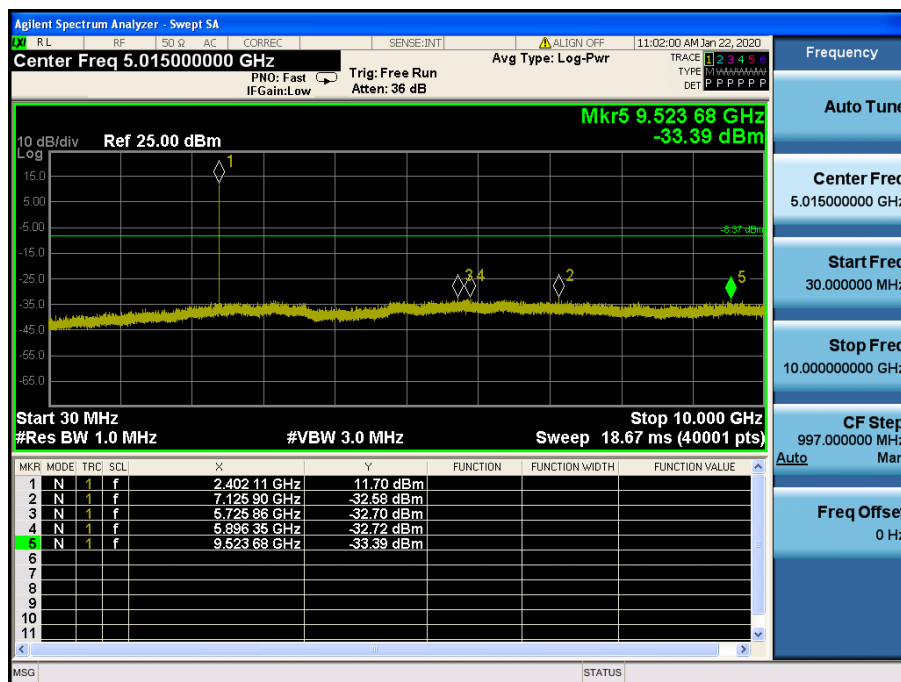
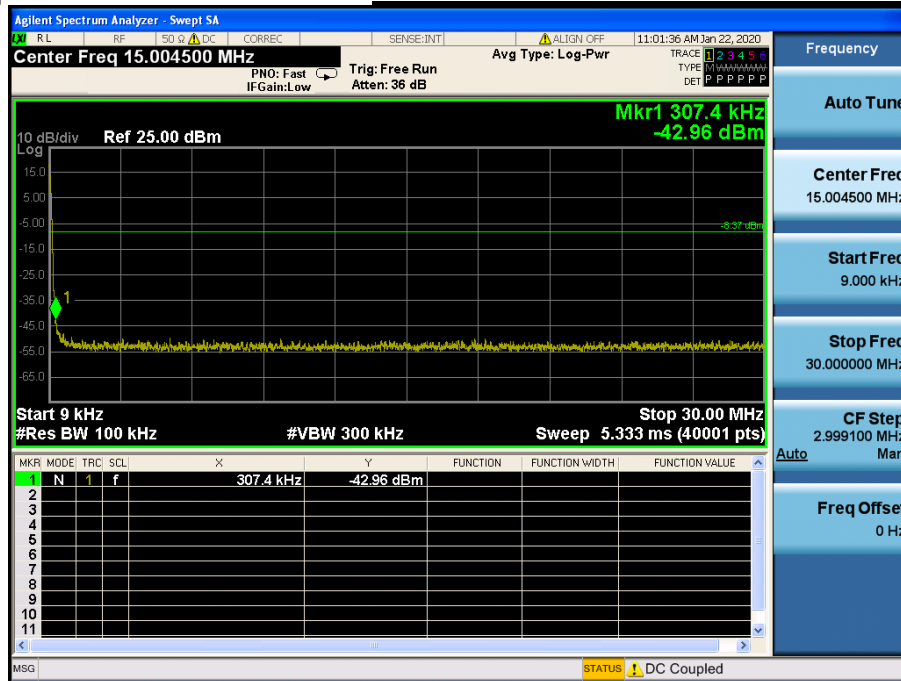

Conducted Spurious Emissions **Lowest Channel & Modulation : GFSK**

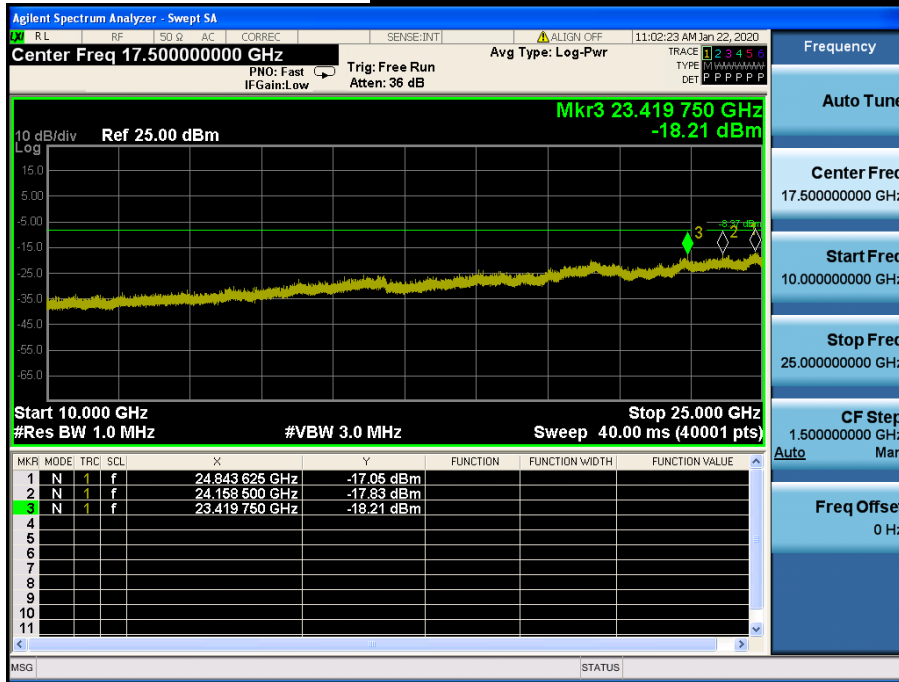

Reference for limit

Middle Channel & Modulation : GFSK

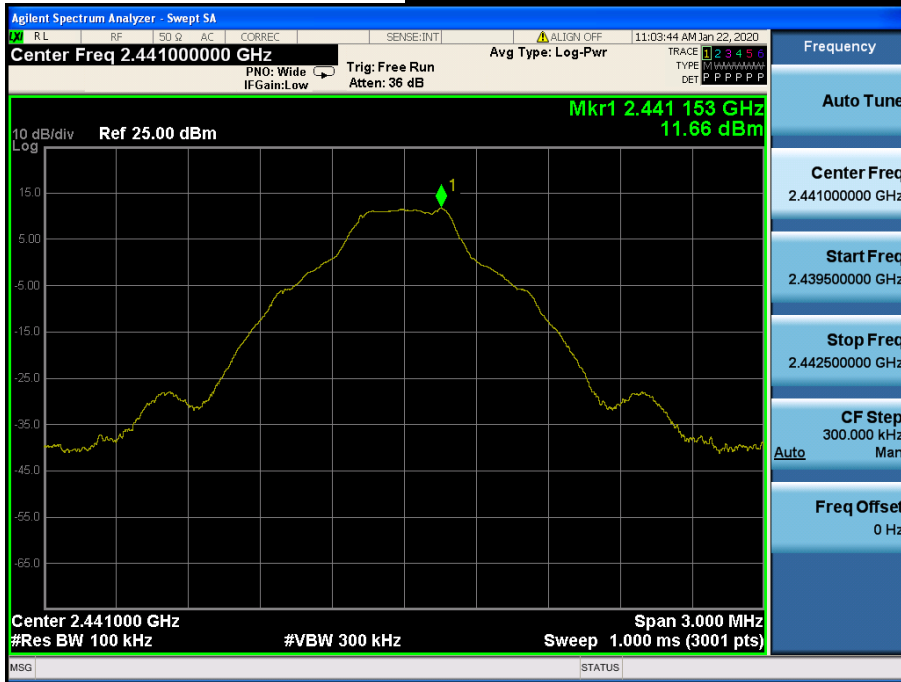

Conducted Spurious Emissions

Middle Channel & Modulation : GFSK

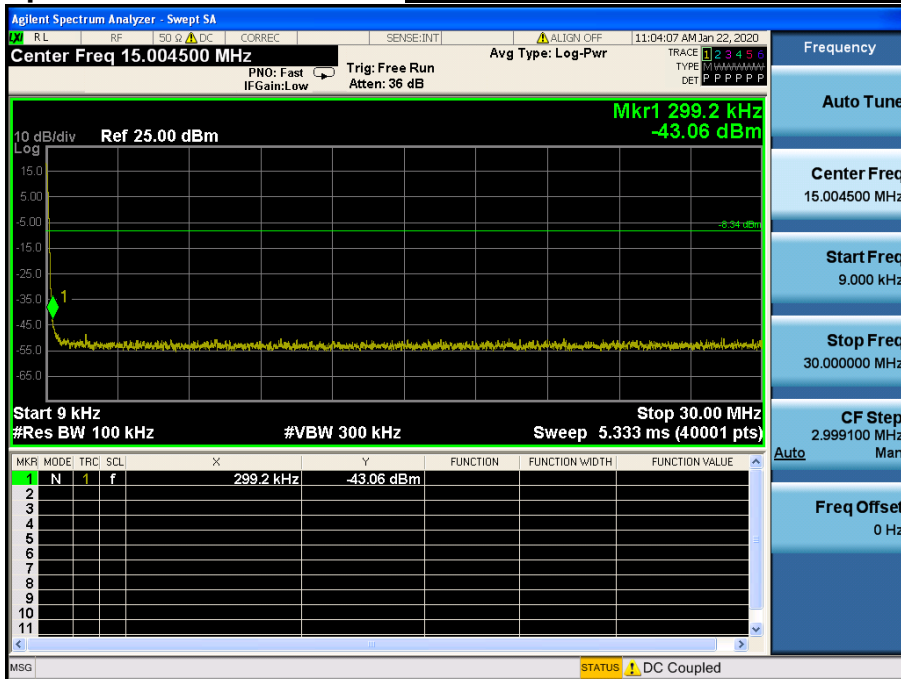

Conducted Spurious Emissions *Middle Channel & Modulation : GFSK*

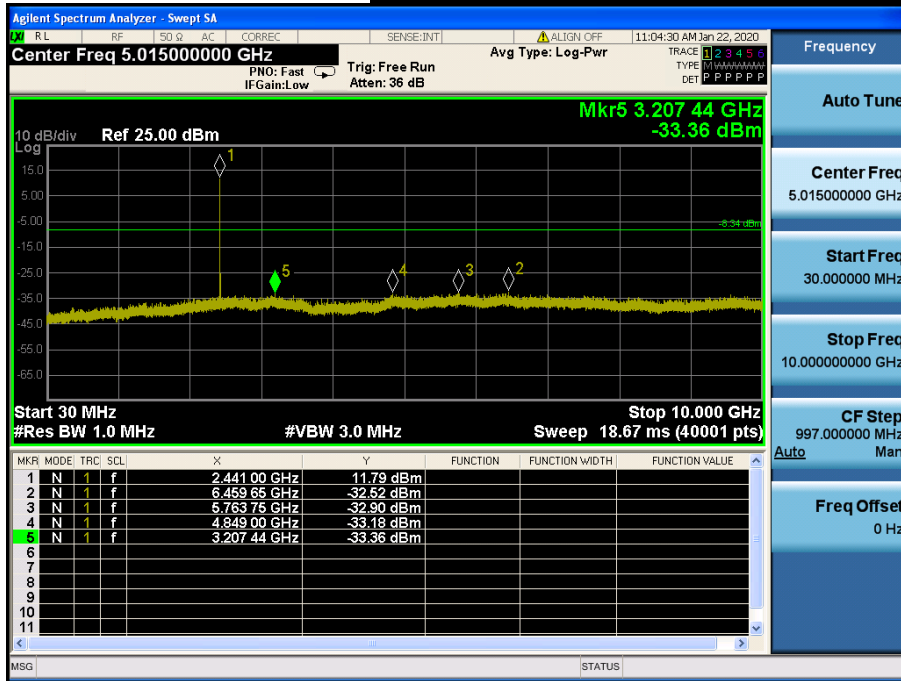

High Band-edge

Highest Channel & Modulation : GFSK

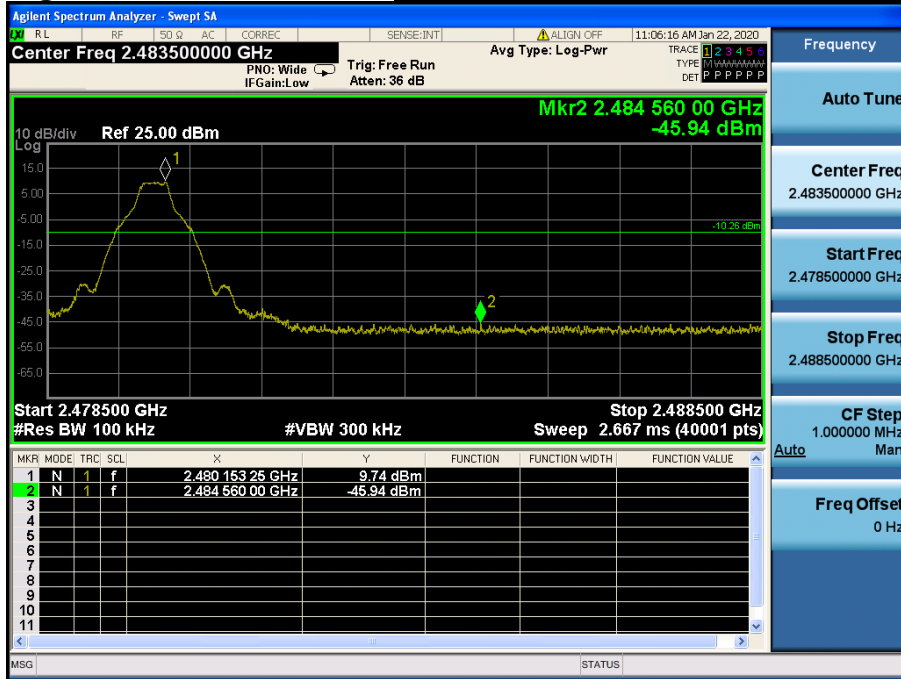

High Band-edge

Hopping mode & Modulation : GFSK



Conducted Spurious Emissions **Highest Channel & Modulation : GFSK**

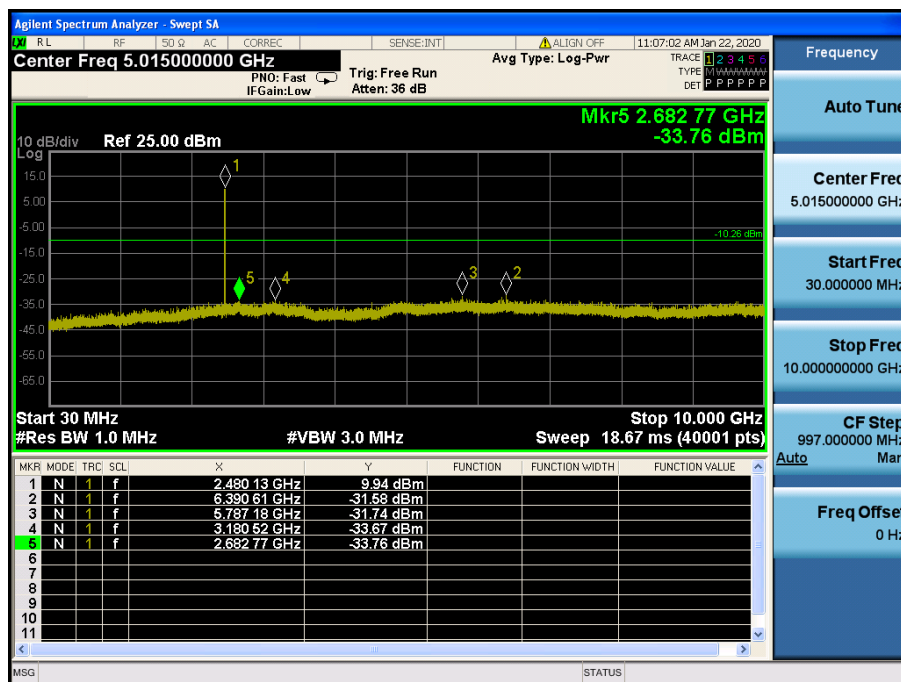
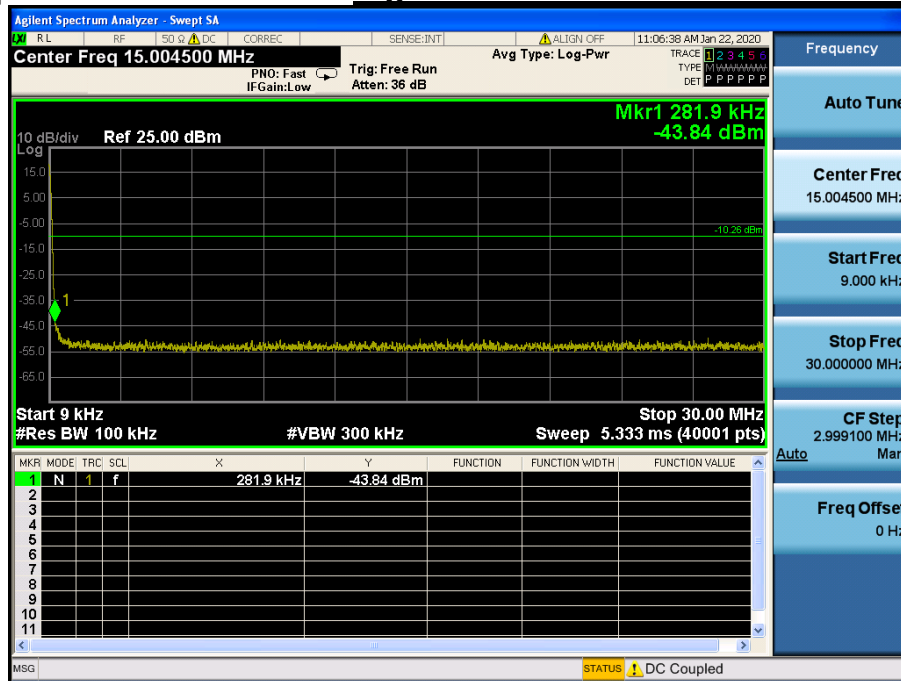

Conducted Spurious Emissions **Highest Channel & Modulation : GFSK**



Low Band-edge

Lowest Channel & Modulation : $\pi/4$ DQPSK

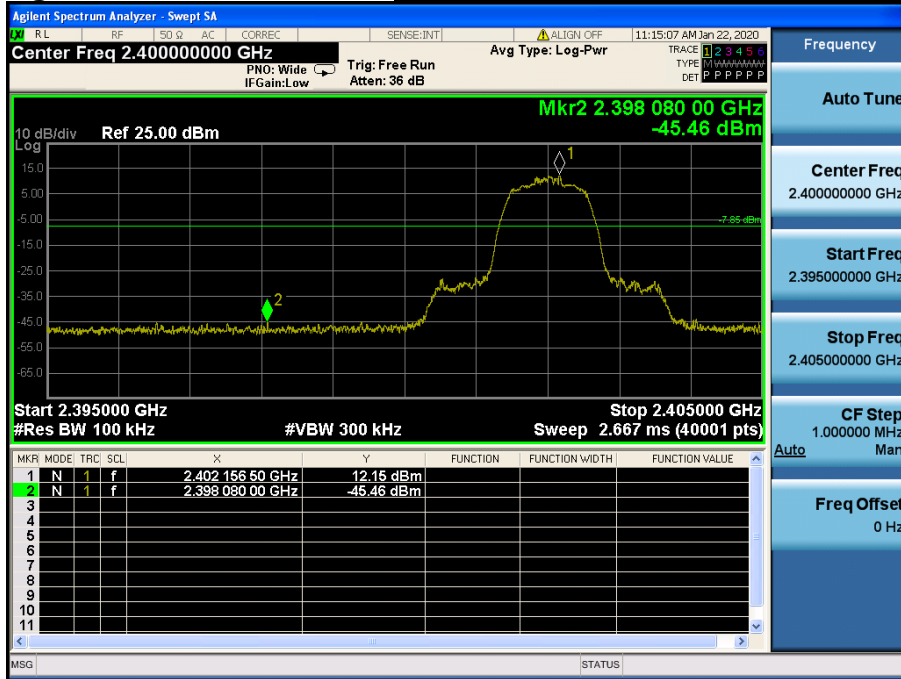

Low Band-edge

Hopping mode & Modulation : $\pi/4$ DQPSK



Conducted Spurious Emissions **Lowest Channel & Modulation : $\pi/4$ DQPSK**

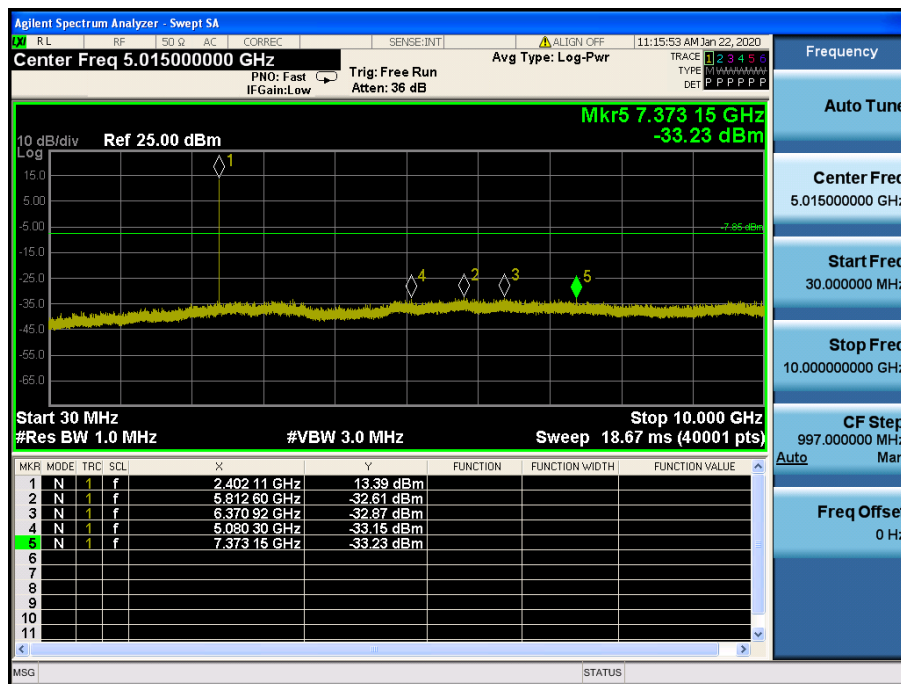
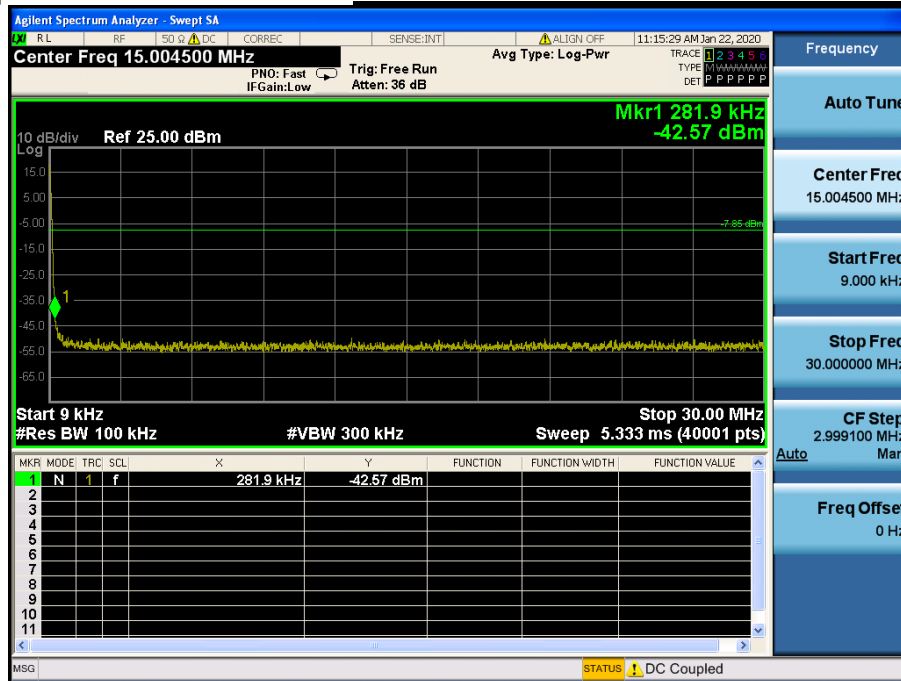

Conducted Spurious Emissions **Lowest Channel & Modulation : $\pi/4$ DQPSK**



Reference for limit

Middle Channel & Modulation : $\pi/4$ DQPSK

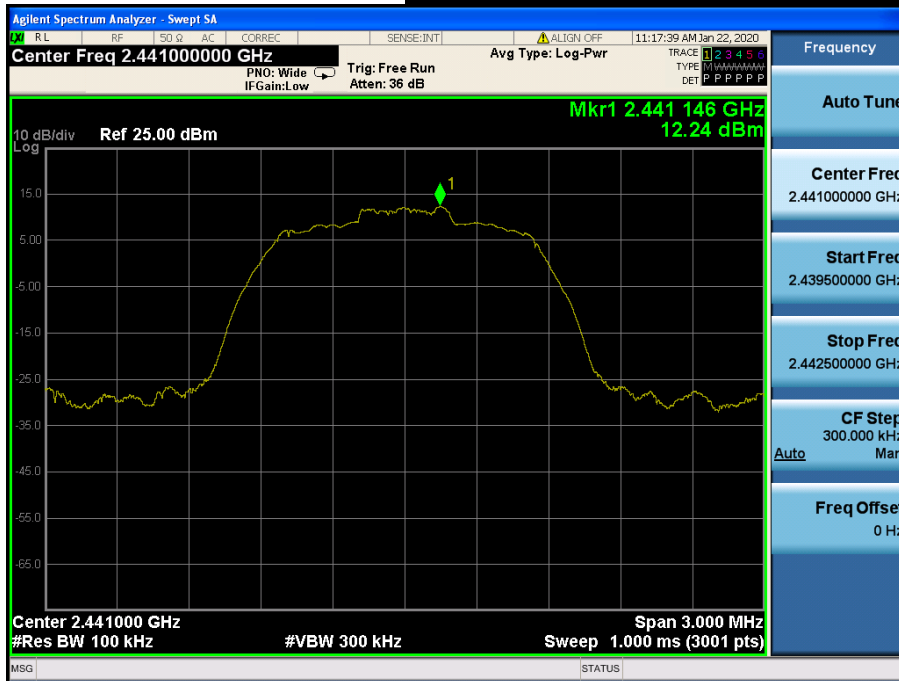

Conducted Spurious Emissions

Middle Channel & Modulation : $\pi/4$ DQPSK

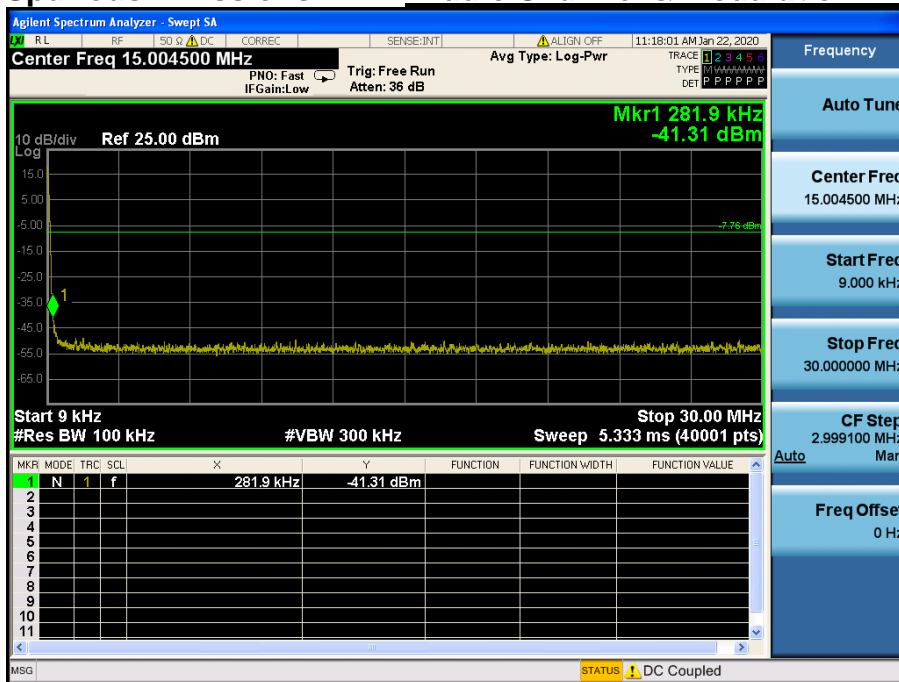

Conducted Spurious Emissions *Middle Channel & Modulation : $\pi/4$ DQPSK*

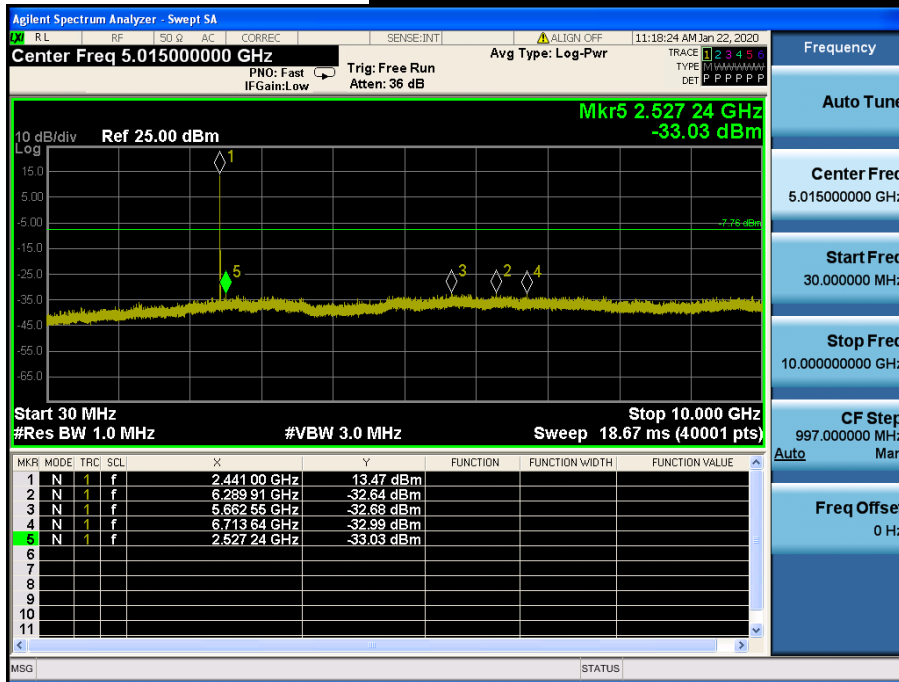

High Band-edge

Highest Channel & Modulation : $\pi/4$ DQPSK

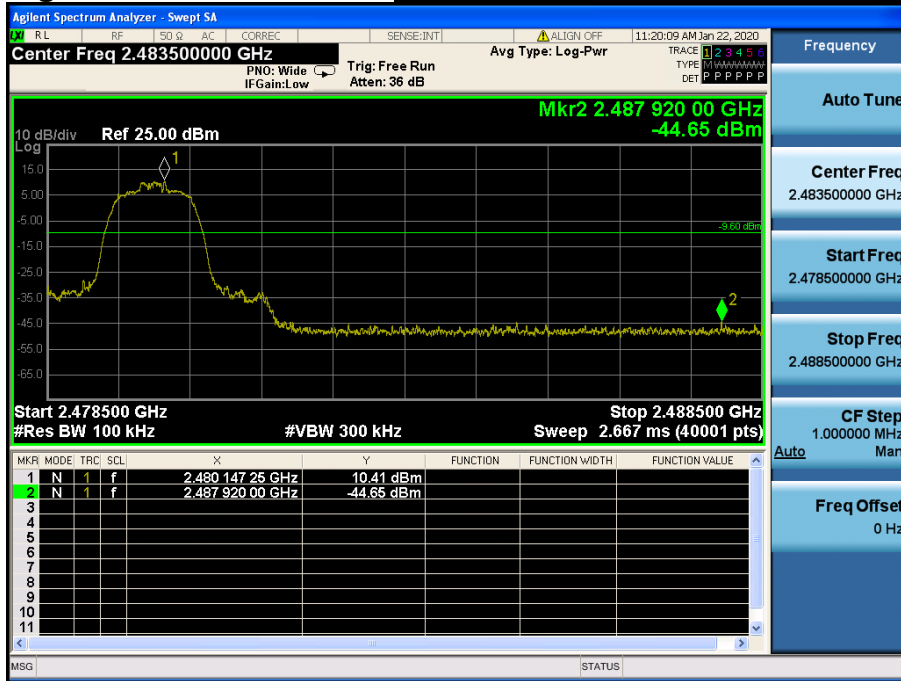

High Band-edge

Hopping mode & Modulation : $\pi/4$ DQPSK

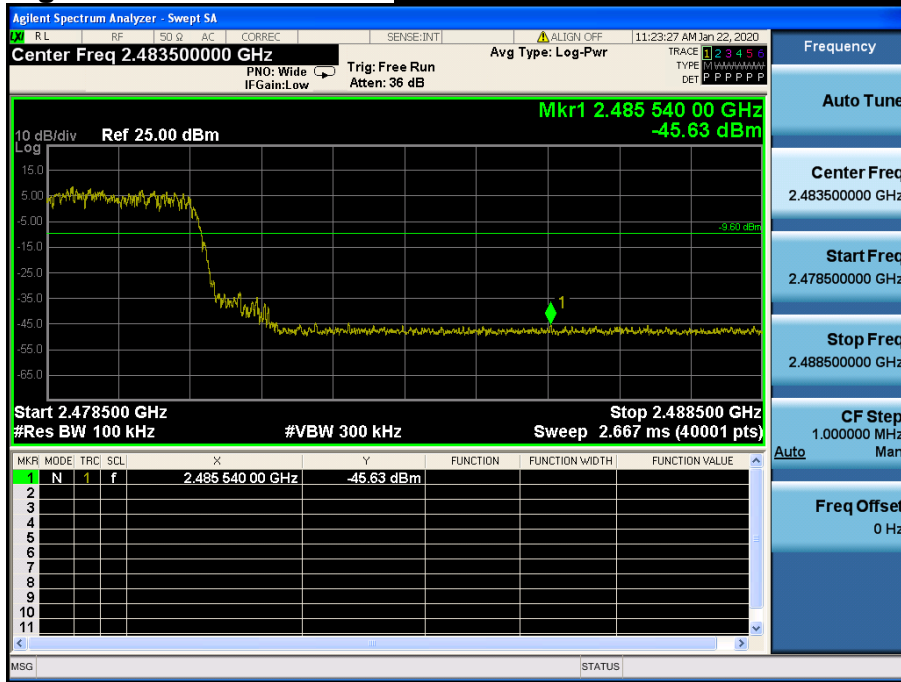

Conducted Spurious Emissions **Highest Channel & Modulation : $\pi/4$ DQPSK**

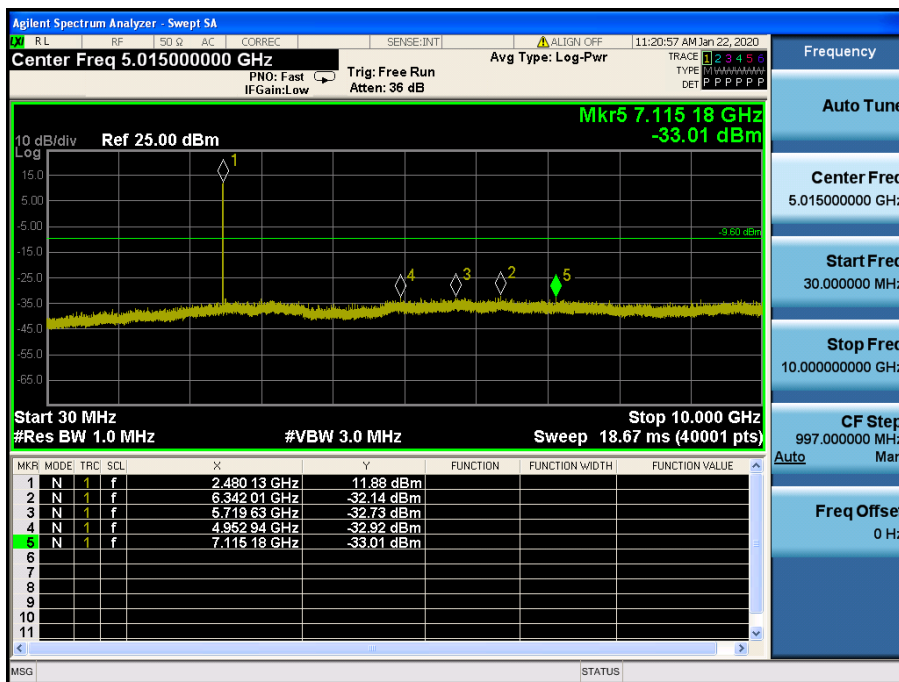
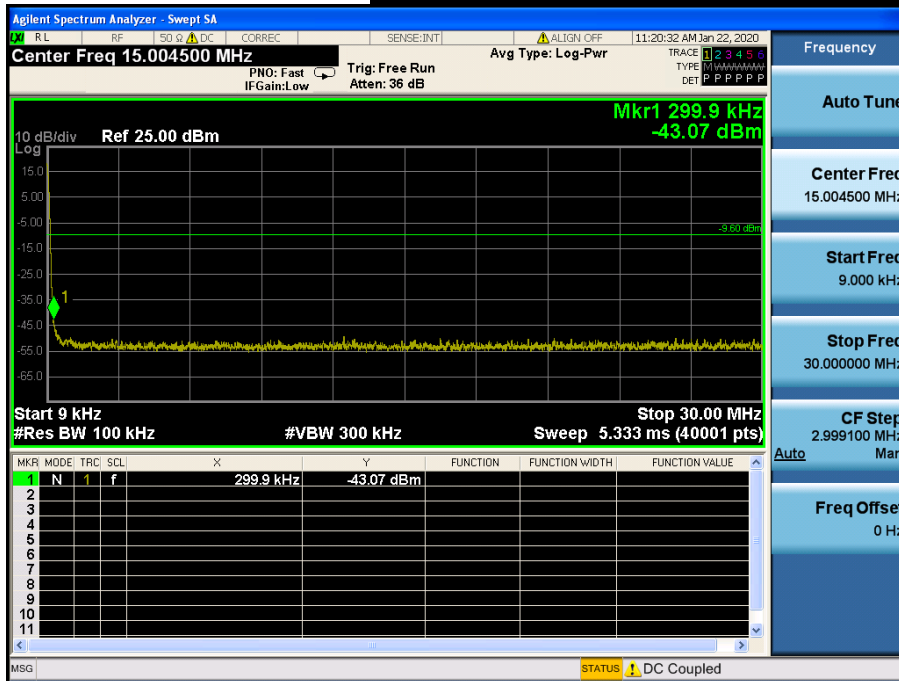

Conducted Spurious Emissions *Highest Channel & Modulation : $\pi/4$ DQPSK*

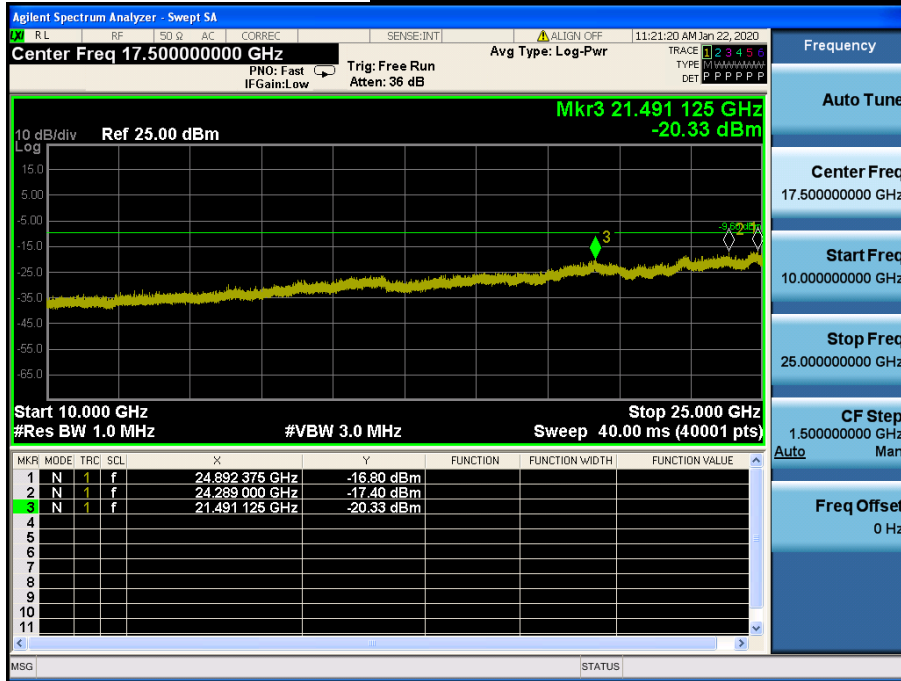

Low Band-edge

Lowest Channel & Modulation : 8DPSK

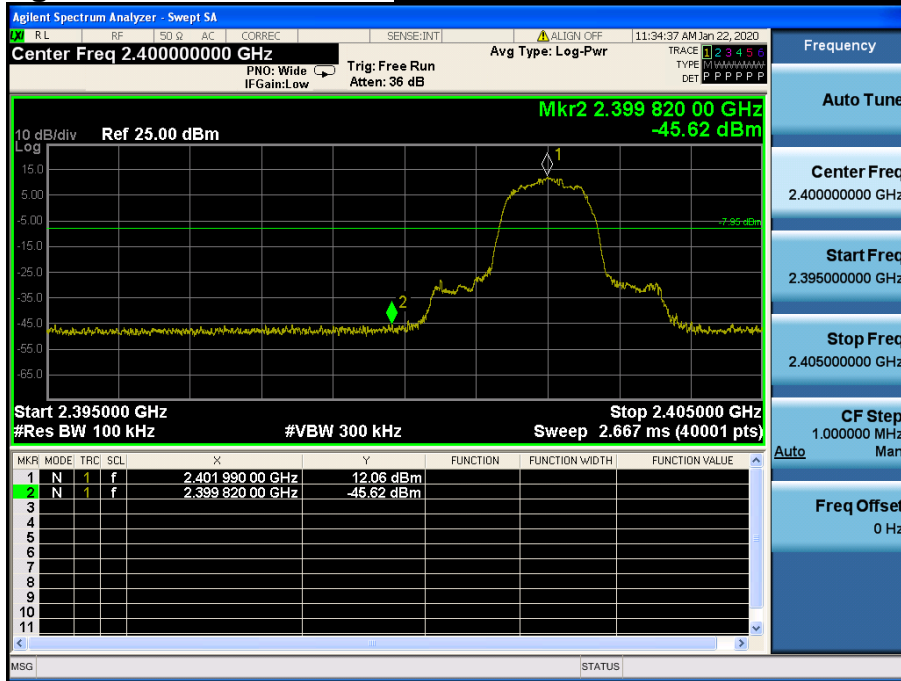

Low Band-edge

Hopping mode & Modulation : 8DPSK

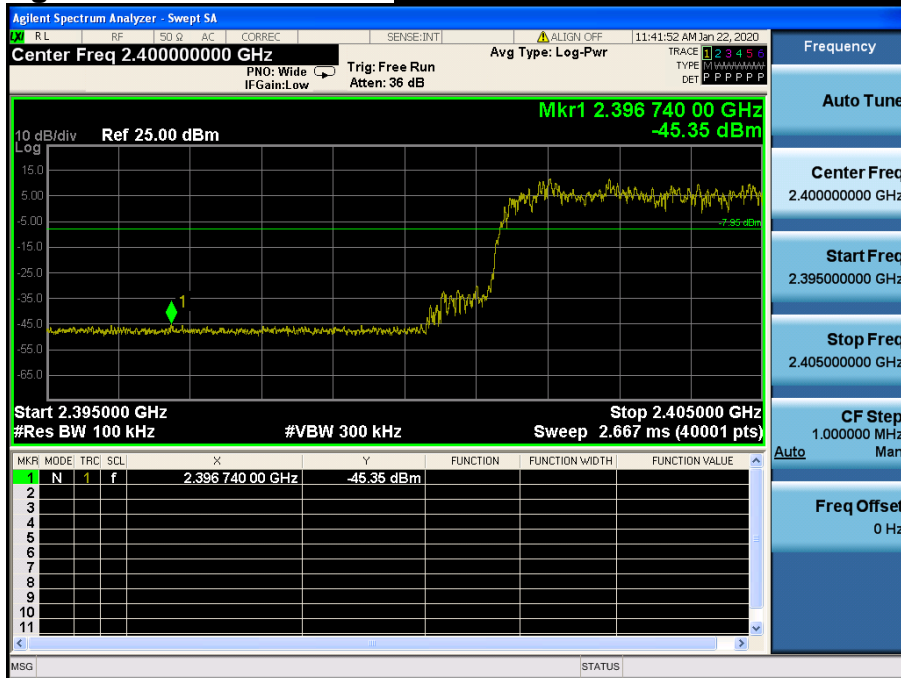

Conducted Spurious Emissions **Lowest Channel & Modulation : 8DPSK**

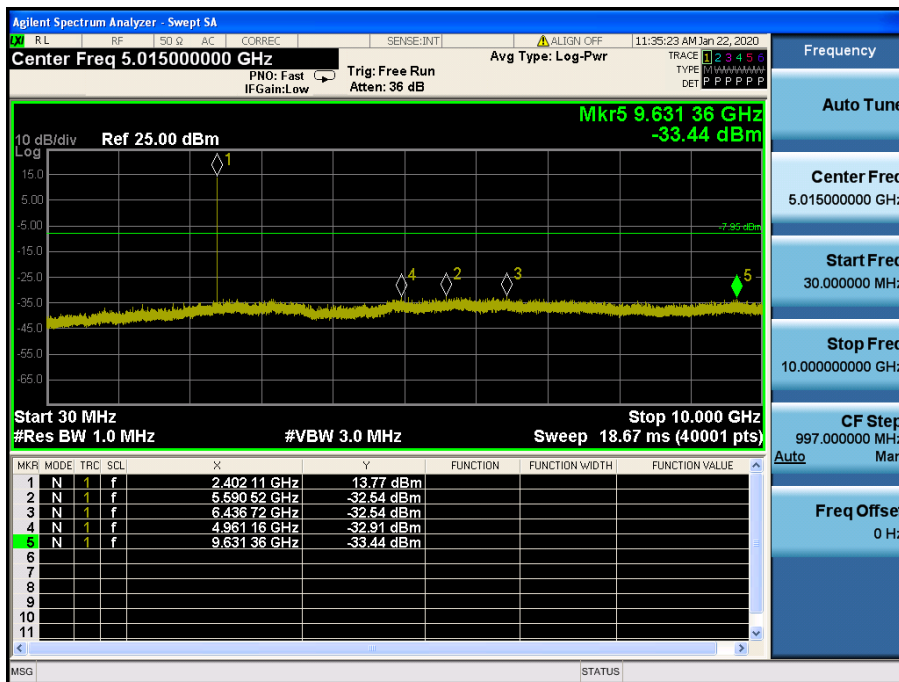
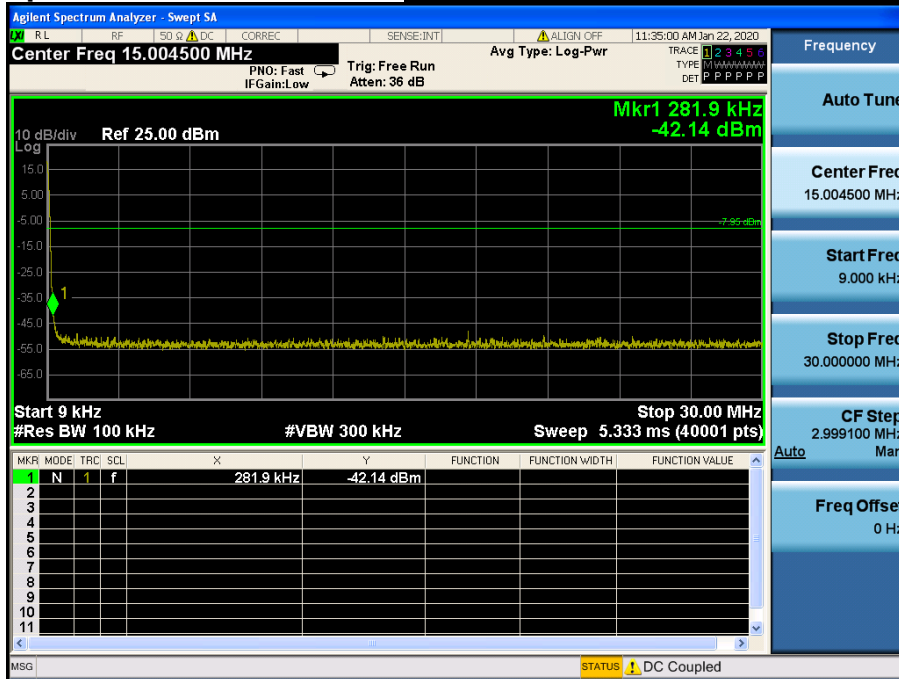

Conducted Spurious Emissions ***Lowest Channel & Modulation : 8DPSK***



Reference for limit

Middle Channel & Modulation : 8DPSK

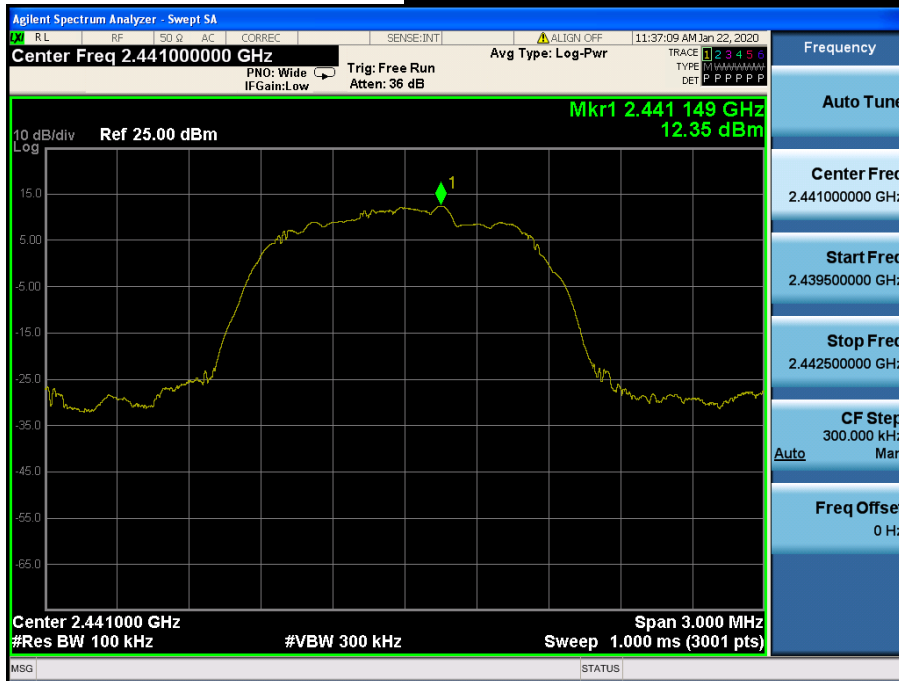

Conducted Spurious Emissions

Middle Channel & Modulation : 8DPSK

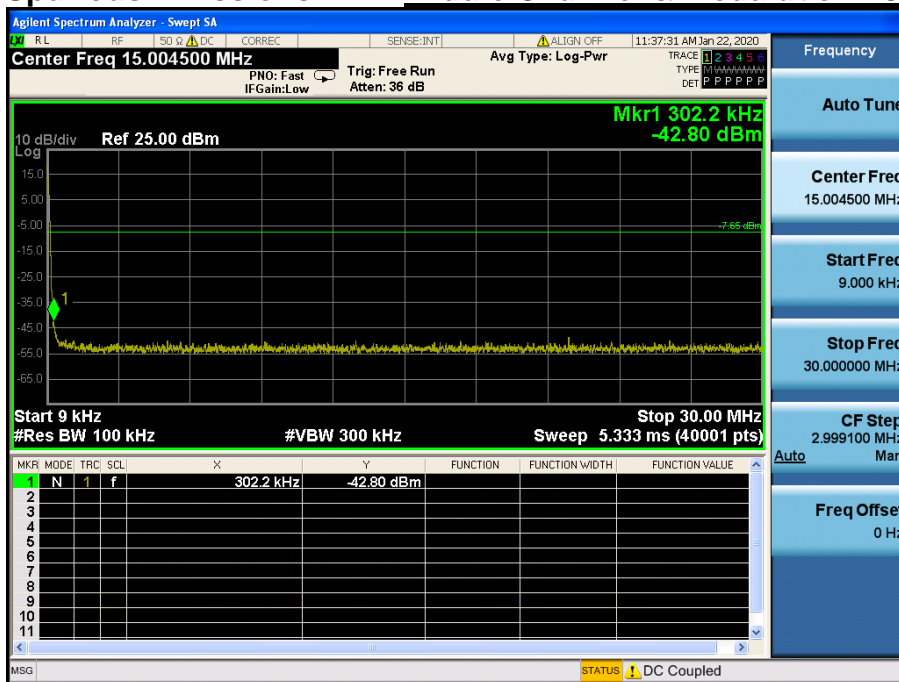

Conducted Spurious Emissions

Middle Channel & Modulation : 8DPSK

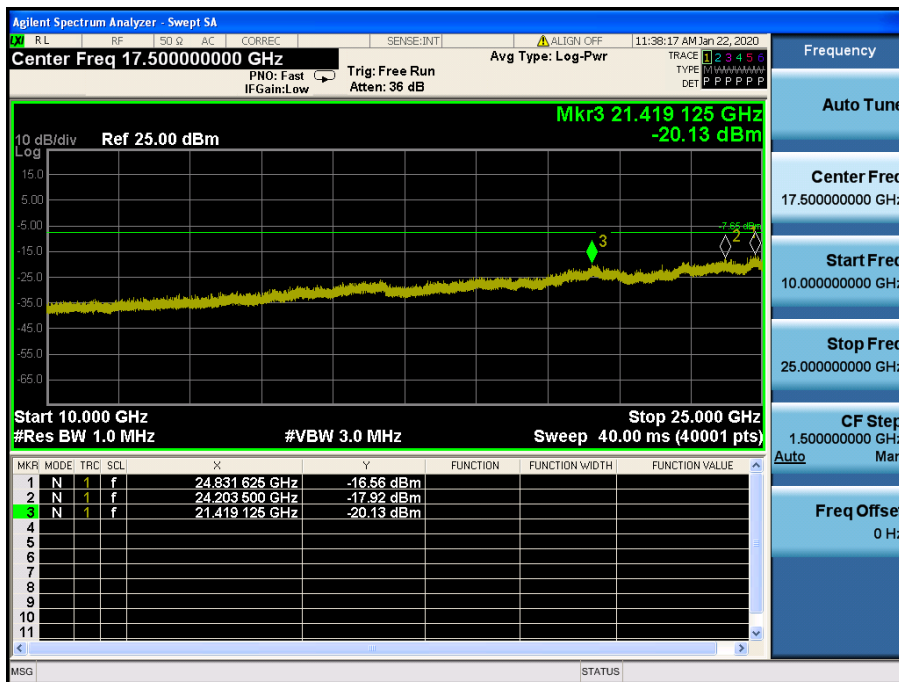
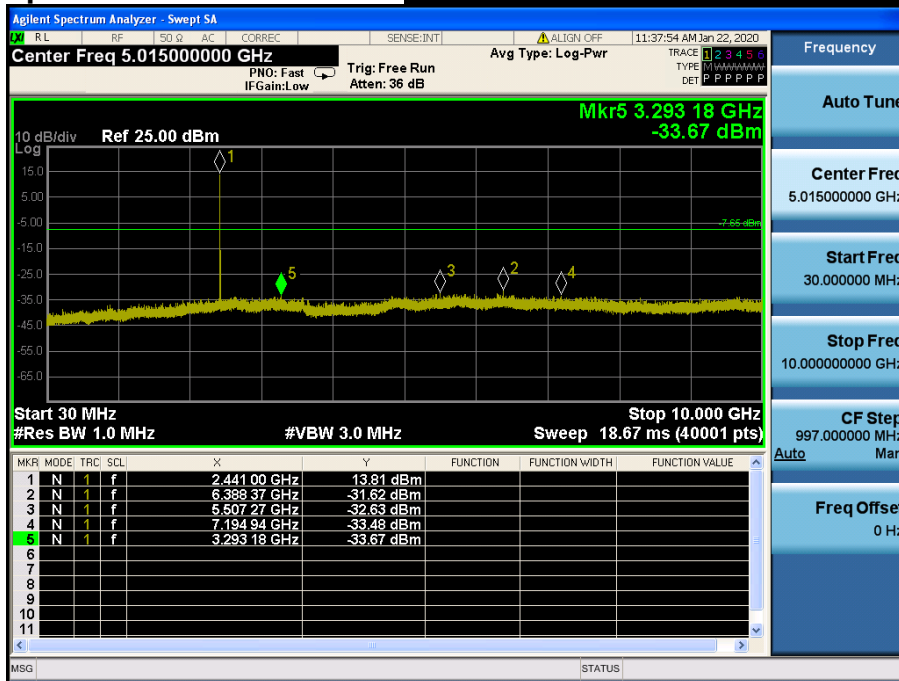

High Band-edge

Highest Channel & Modulation : 8DPSK

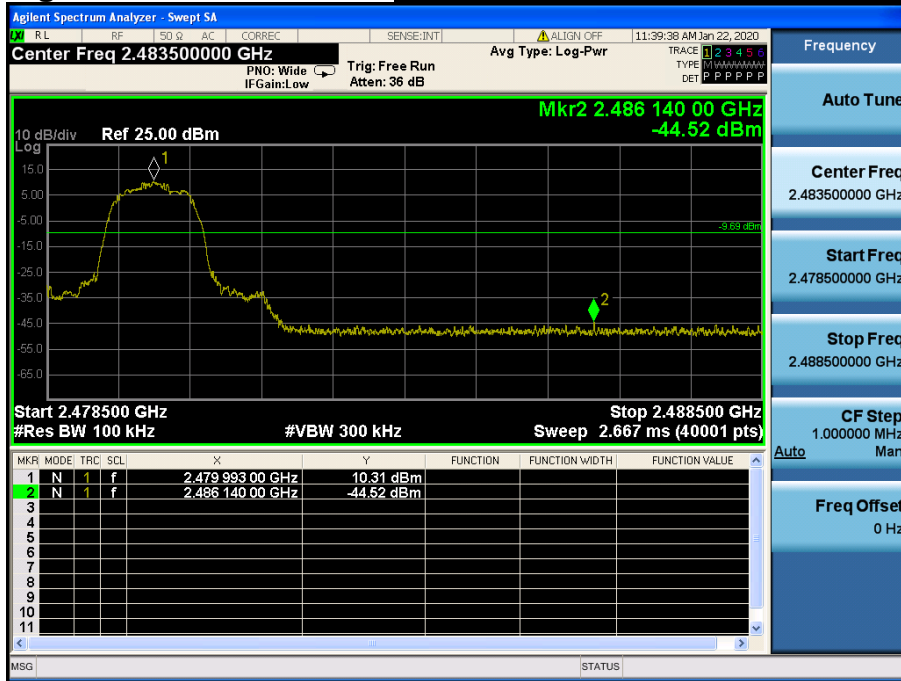

High Band-edge

Hopping mode & Modulation : 8DPSK

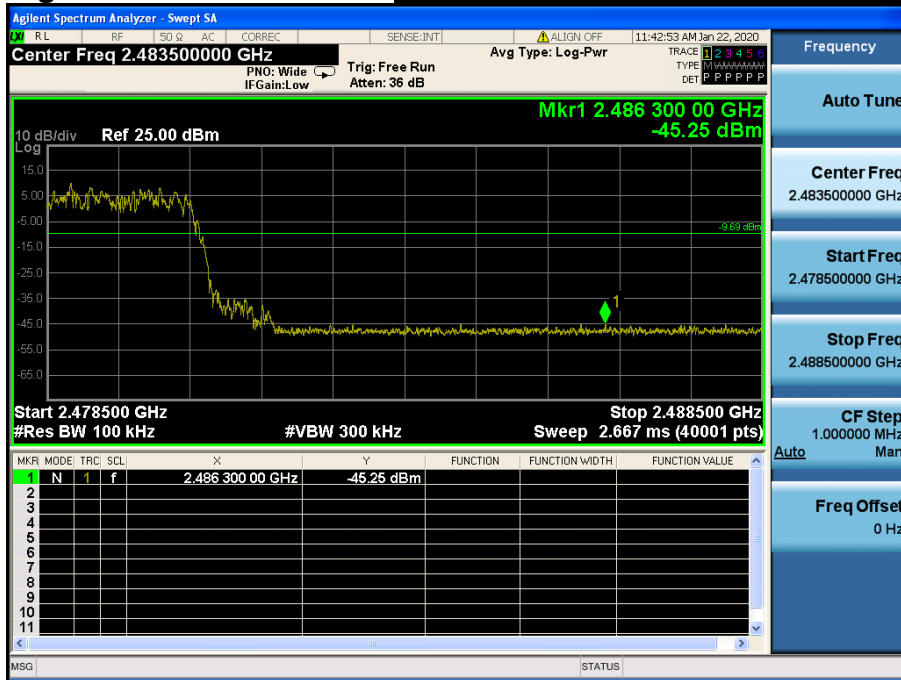

Conducted Spurious Emissions **Highest Channel & Modulation : 8DPSK**

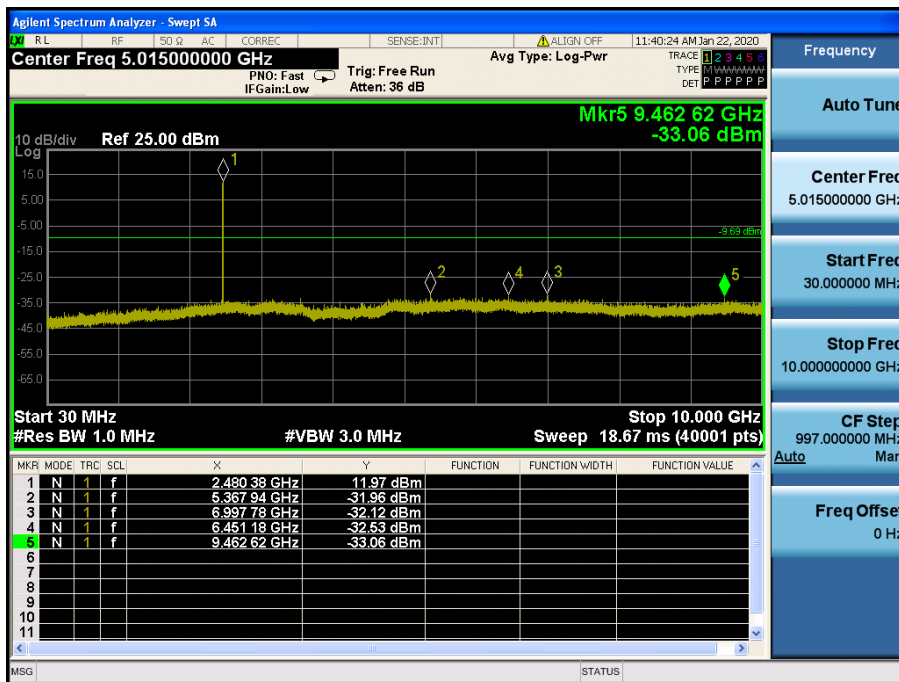
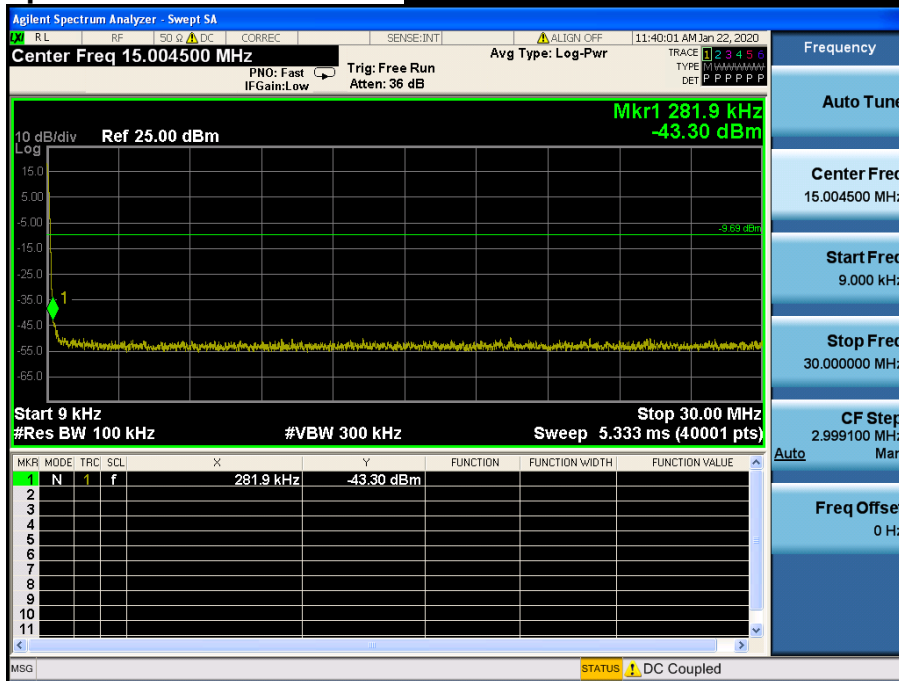

Conducted Spurious Emissions **Highest Channel & Modulation : 8DPSK**

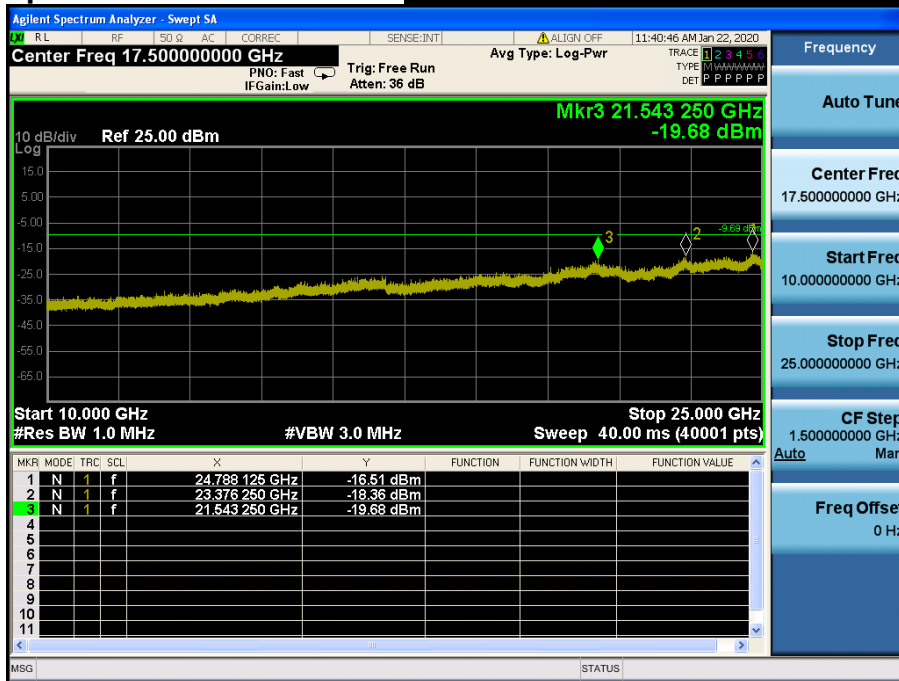

8. Transmitter AC Power Line Conducted Emission

8.1 Test Setup

See test photographs for the actual connections between EUT and support equipment.

8.2 Limit

According to §15.207(a) for an intentional radiator that is designed to be connected to the public utility (AC) power line, the radio frequency voltage that is conducted back onto the AC power line on any frequency or frequencies, within the band 150 kHz to 30 MHz, shall not exceed the limits in the following table, as measured using a 50 uH/50 ohm line impedance stabilization network (LISN).

Compliance with the provision of this paragraph shall on the measurement of the radio frequency voltage between each power line and ground at the power terminal. The lower applies at the boundary between the frequency ranges.

Frequency Range (MHz)	Conducted Limit (dBuV)	
	Quasi-Peak	Average
0.15 ~ 0.5	66 to 56 *	56 to 46 *
0.5 ~ 5	56	46
5 ~ 30	60	50

* Decreases with the logarithm of the frequency

8.3 Test Procedures

Conducted emissions from the EUT were measured according to the ANSI C63.10.

1. The test procedure is performed in a 6.5 m × 3.5 m × 3.5 m (L × W × H) shielded room. The EUT along with its peripherals were placed on a 1.0 m (W) × 1.5 m (L) and 0.8 m in height wooden table and the EUT was adjusted to maintain a 0.4 meter space from a vertical reference plane.
2. The EUT was connected to power mains through a line impedance stabilization network (LISN) which provides 50 ohm coupling impedance for measuring instrument and the chassis ground was bounded to the horizontal ground plane of shielded room.
3. All peripherals were connected to the second LISN and the chassis ground also bounded to the horizontal ground plane of shielded room.
4. The excess power cable between the EUT and the LISN was bundled. The power cables of peripherals were unbundled. All connecting cables of EUT and peripherals were moved to find the maximum emission.

8.4 Test Results

AC Line Conducted Emissions (Graph) = Modulation : 8DPSK

Results of Conducted Emission

DTNC

Date 2020-01-24

Order No.
Model No. LM-V600EA
Serial No.
Test Condition BT

Reference No.
Power Supply 120 V, 60 Hz
Temp/Humi. 23 °C / 35 %
Operator Kim Jung woo

Memo

LIMIT : FCC P15.207 QP
FCC P15.207 AV

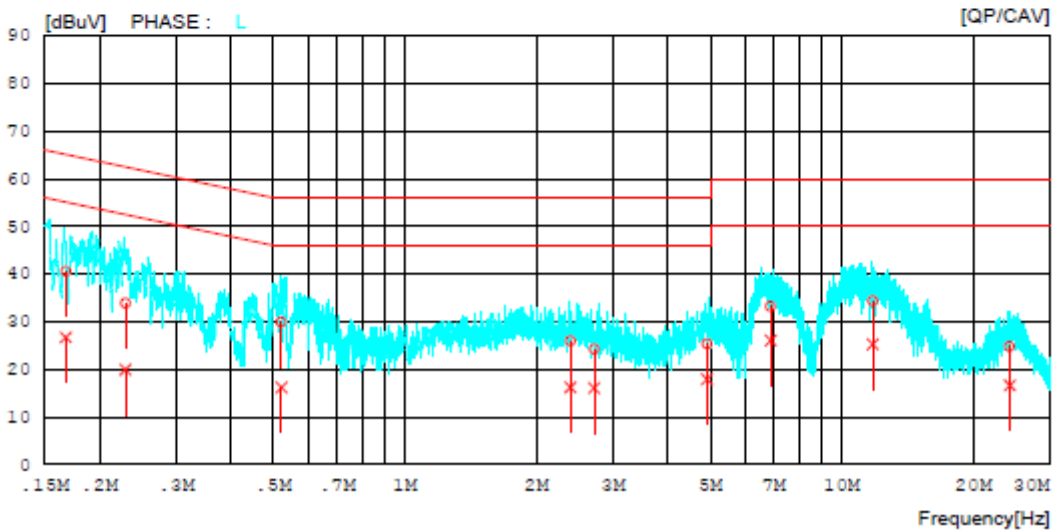
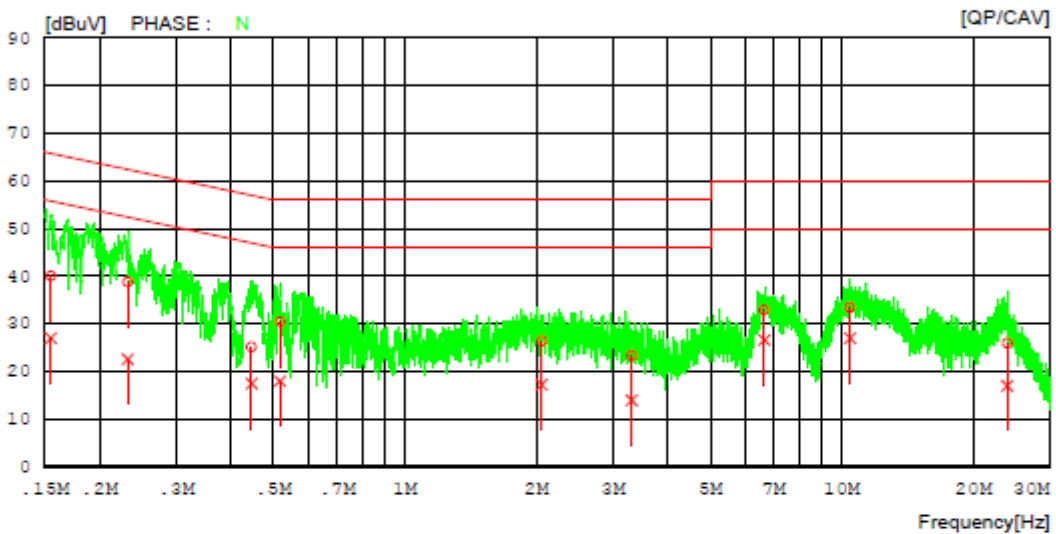

AC Line Conducted Emissions (List) = Modulation : 8DPSK

Results of Conducted Emission

DTNC

Date 2020-01-24

Order No.		Reference No.	
Model No.	LM-V600EA	Power Supply	120 V, 60 Hz
Serial No.		Temp/Humi.	23 'C / 35 %
Test Condition	BT	Operator	Kim Jung woo

Memo

 LIMIT : FCC P15.207 QP
 FCC P15.207 AV

NO	FREQ [MHz]	READING		C. FACTOR [dB]	RESULT		LIMIT		MARGIN		PHASE
		QP [dBuV]	CAV [dBuV]		QP [dBuV]	CAV [dBuV]	QP [dBuV]	CAV [dBuV]	QP [dBuV]	CAV [dBuV]	
1	0.15475	30.08	17.07	9.94	40.02	27.01	65.74	55.74	25.72	28.73	N
2	0.23184	28.81	12.62	9.94	38.75	22.56	62.38	52.38	23.63	29.82	N
3	0.44570	15.19	7.47	9.95	25.14	17.42	56.95	46.95	31.81	29.53	N
4	0.51757	20.37	8.00	9.95	30.32	17.95	56.00	46.00	25.68	28.05	N
5	2.05687	16.36	7.19	10.03	26.39	17.22	56.00	46.00	29.61	28.78	N
6	3.30215	13.24	3.78	10.09	23.33	13.87	56.00	46.00	32.67	32.13	N
7	6.64719	22.68	16.39	10.20	32.88	26.59	60.00	50.00	27.12	23.41	N
8	10.43814	23.04	16.63	10.35	33.39	26.98	60.00	50.00	26.61	23.02	N
9	23.92739	15.30	6.40	10.62	25.92	17.02	60.00	50.00	34.08	32.98	N
10	0.16749	30.58	16.72	9.94	40.52	26.66	65.08	55.08	24.56	28.42	L
11	0.22933	23.93	9.92	9.94	33.87	19.86	62.47	52.47	28.60	32.61	L
12	0.52139	19.83	6.20	9.95	29.78	16.15	56.00	46.00	26.22	29.85	L
13	2.39265	15.86	6.14	10.04	25.90	16.18	56.00	46.00	30.10	29.82	L
14	2.71263	14.06	6.01	10.04	24.10	16.05	56.00	46.00	31.90	29.95	L
15	4.91622	15.11	7.73	10.16	25.27	17.89	56.00	46.00	30.73	28.11	L
16	6.87783	22.96	15.84	10.22	33.18	26.06	60.00	50.00	26.82	23.94	L
17	11.77538	23.85	14.81	10.38	34.23	25.19	60.00	50.00	25.77	24.81	L
18	24.24963	14.14	5.98	10.62	24.76	16.60	60.00	50.00	35.24	33.40	L

9. Antenna Requirement

Describe how the EUT complies with the requirement that either its antenna is permanently attached, or that it employs a unique antenna connector, for every antenna proposed for use with the EUT.

Conclusion: Comply

**The antenna is attached on the device by means of unique coupling method (Spring Tension).
Therefore this E.U.T Complies with the requirement of §15.203**

- Minimum Standard :

An intentional radiator shall be designed to ensure that no antenna other than that furnished by the responsible party shall be used with the device. The use of a permanently attached antenna or of an antenna that uses a unique coupling to the intentional radiator shall be considered sufficient to comply with the provisions.
--

APPENDIX I

Test set up diagrams

▪ Radiated Measurement

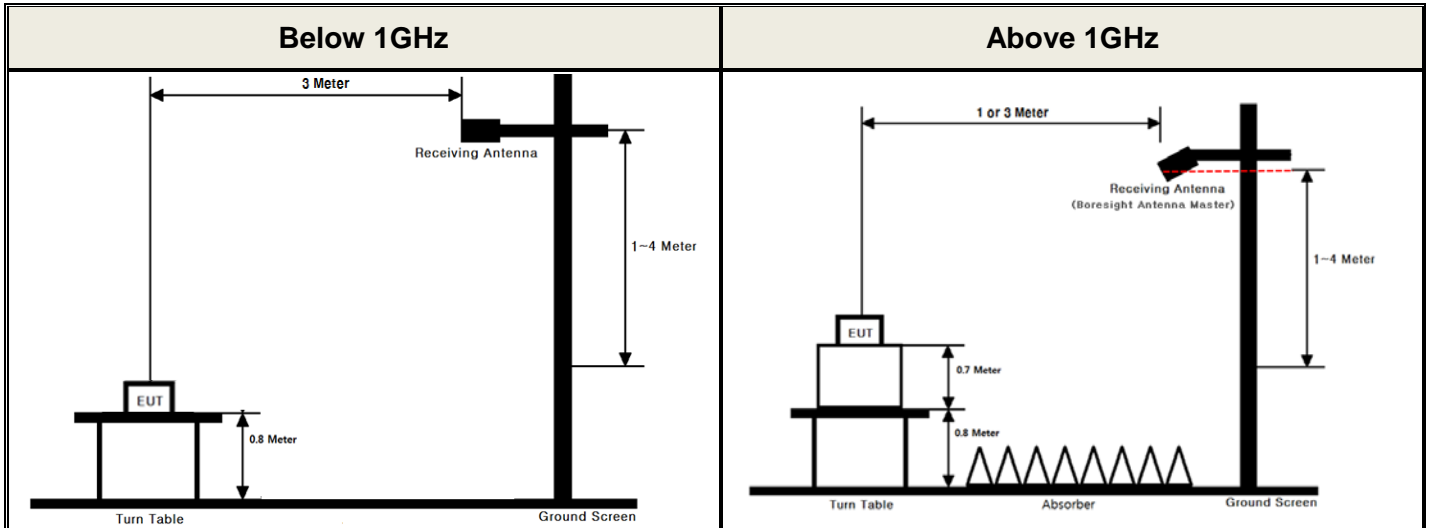

▪ Conducted Measurement

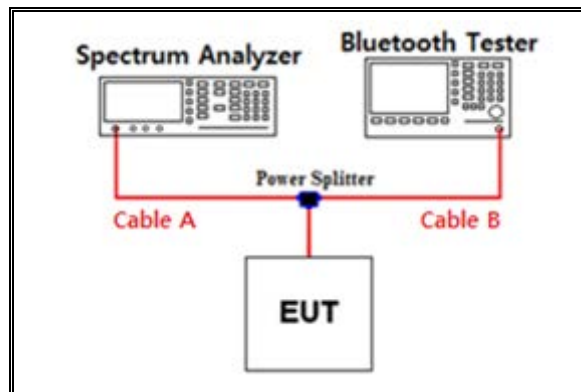

Path loss information

Frequency (GHz)	Path Loss (dB)	Frequency (GHz)	Path Loss (dB)
0.03	6.09	15	9.42
1	6.52	20	13.70
2.402 & 2.440 & 2.480	7.19	25	17.40
5	7.87	-	-
10	9.00	-	-

Note 1 : The path loss from EUT to Spectrum analyzer were measured and used for test.

Path loss (S/A's Correction factor) = Cable A + Power splitter

APPENDIX II

Unwanted Emissions (Radiated) Test Plot

GFSK & Lowest & X & Hor

Detector Mode : PK

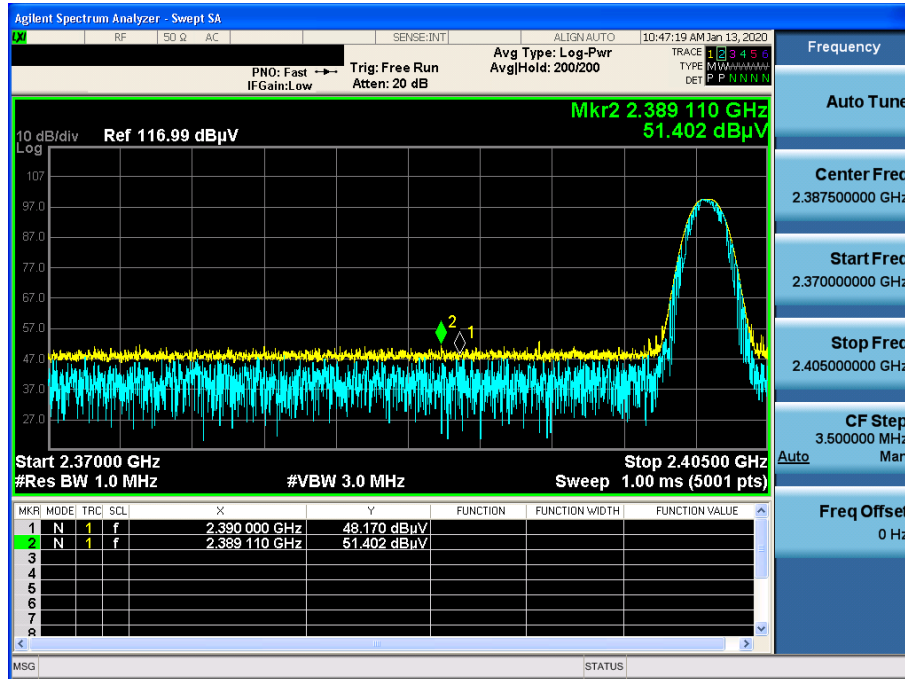

GFSK & Highest & X & Hor

Detector Mode : PK

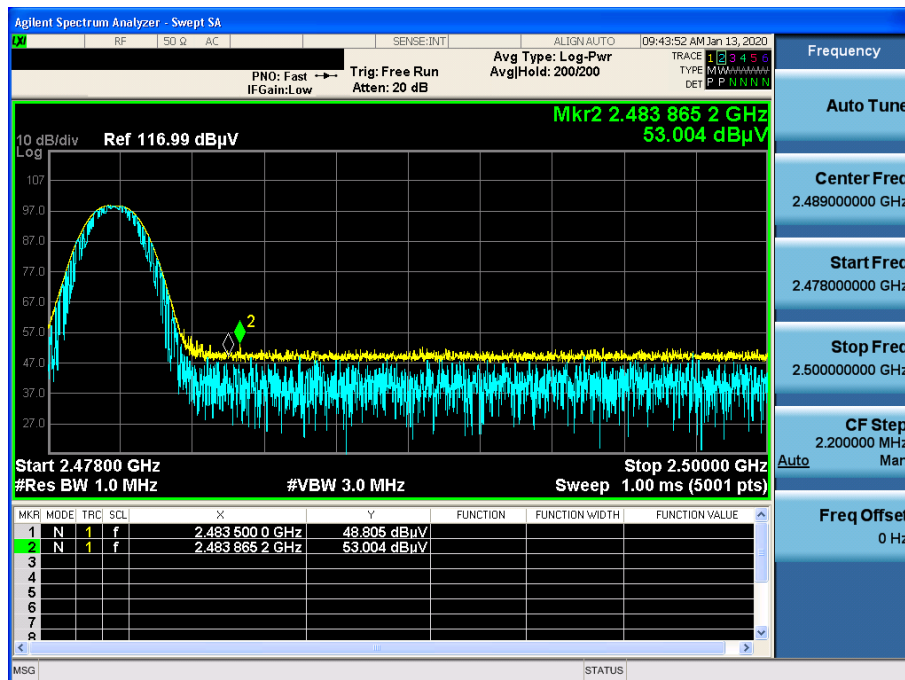

$\pi/4$ DQPSK & Lowest & X & Hor

Detector Mode : PK

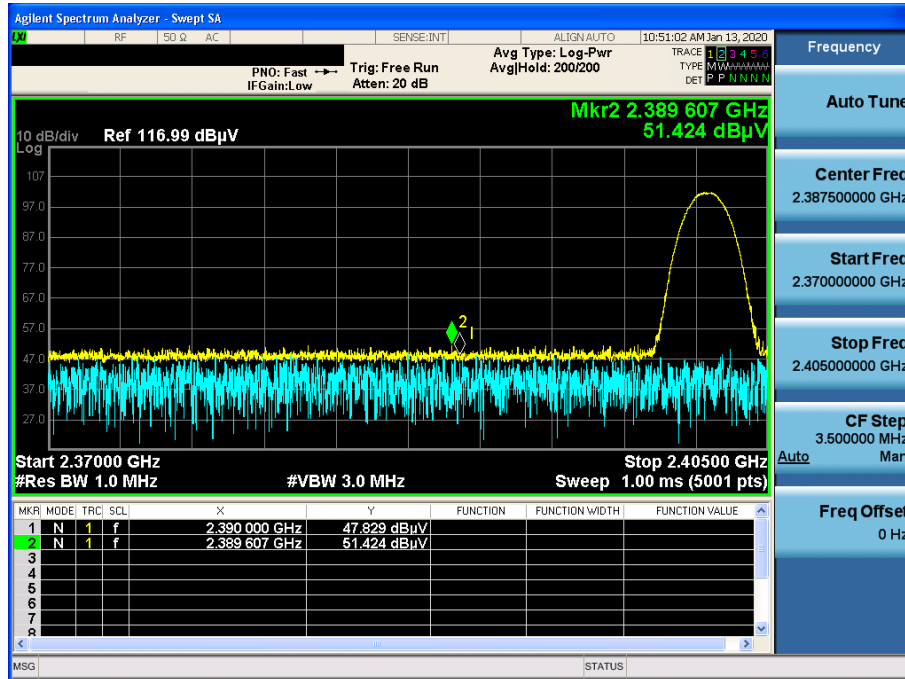

$\pi/4$ DQPSK & Highest & X & Hor

Detector Mode : PK

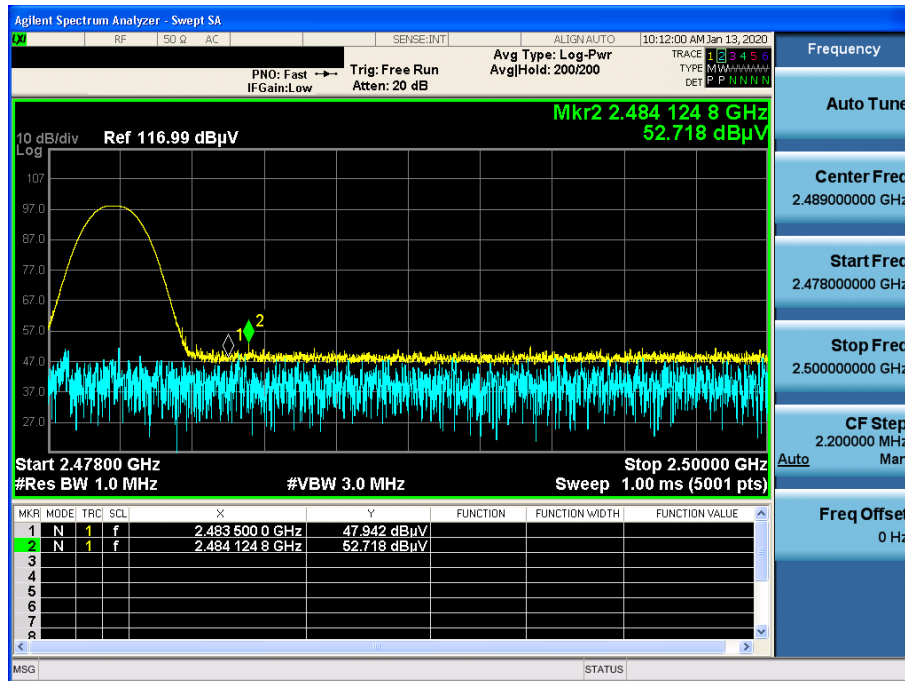

8DPSK & Lowest & X & Hor

Detector Mode : PK

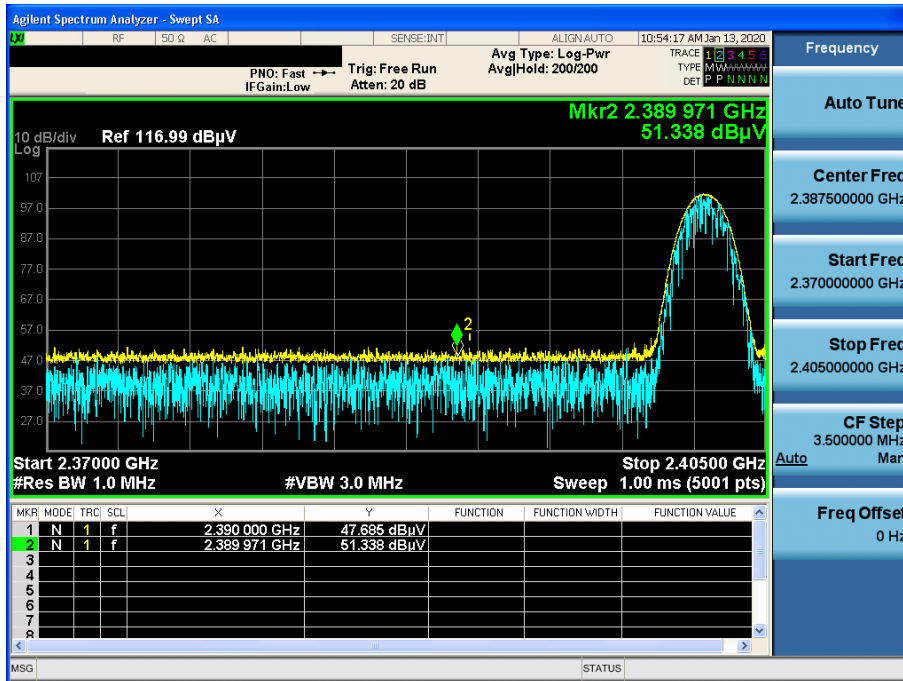

8DPSK & Highest & X & Hor

Detector Mode : PK

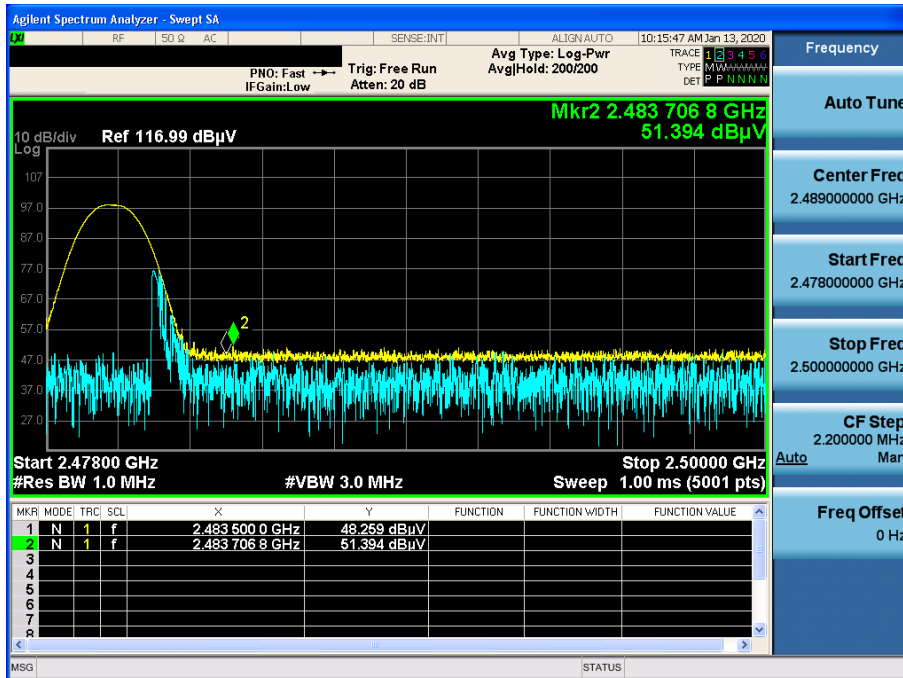

GFSK & Highest & X & Hor

Detector Mode : PK

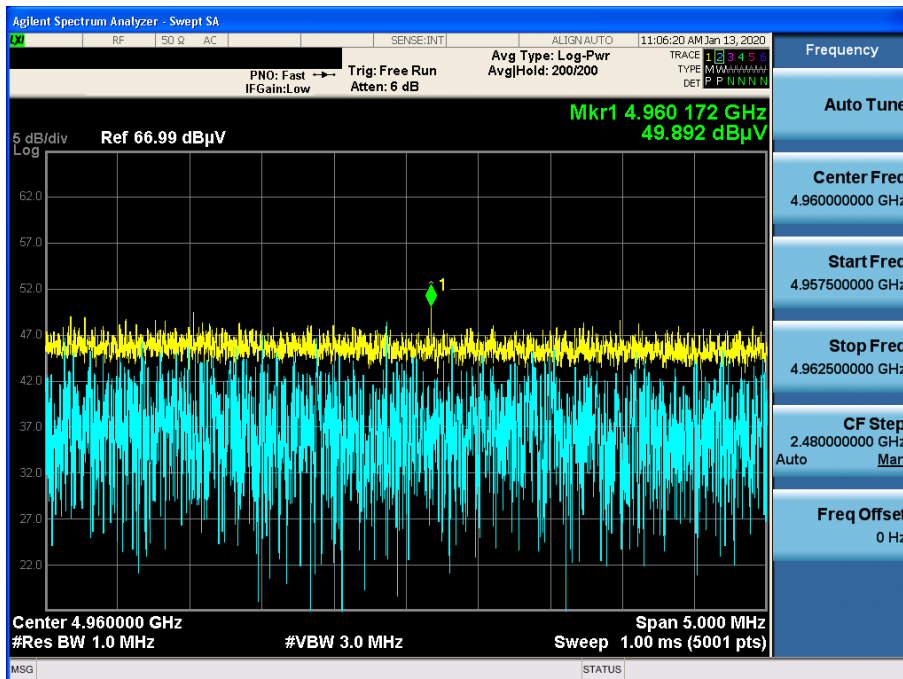

$\pi/4$ DQPSK & Middle & X & Hor

Detector Mode : PK

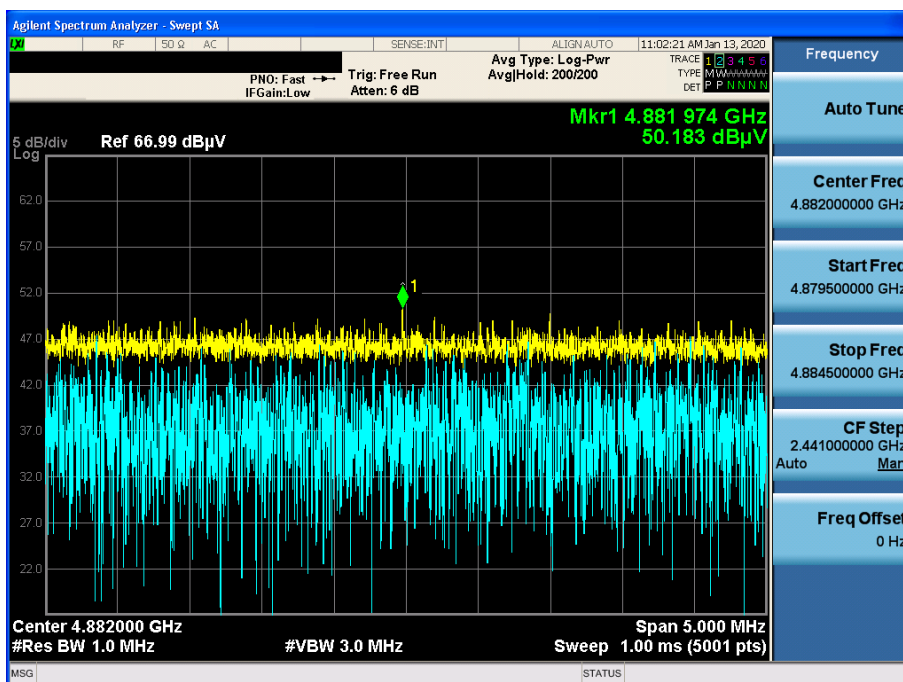

8DPSK & Middle & X & Hor

Detector Mode : PK

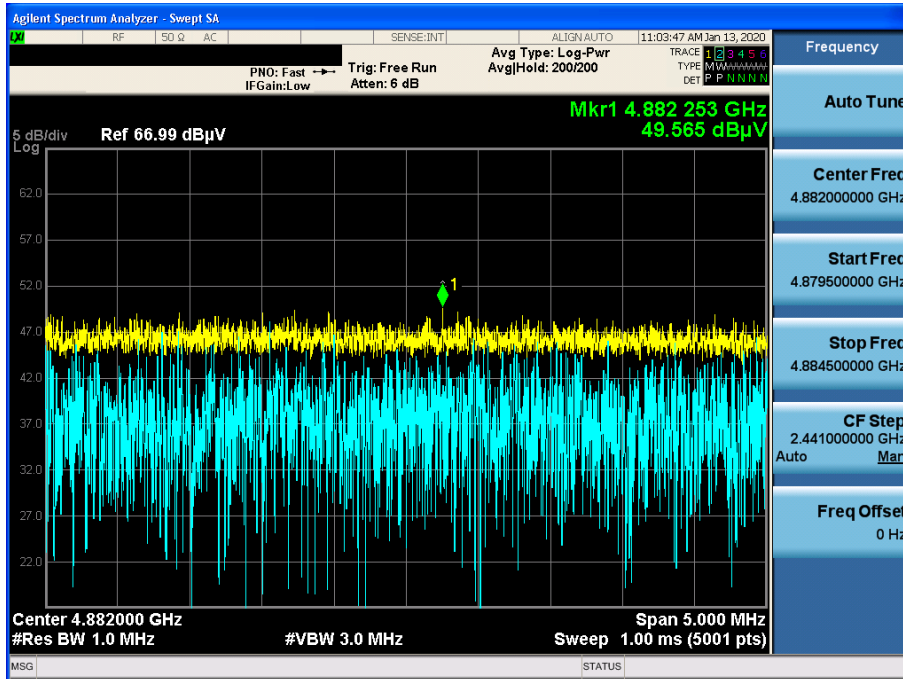

Unwanted Emissions (Radiated) Test Plot _ Wireless Charging

GFSK & Highest & X & Hor

Detector Mode : PK

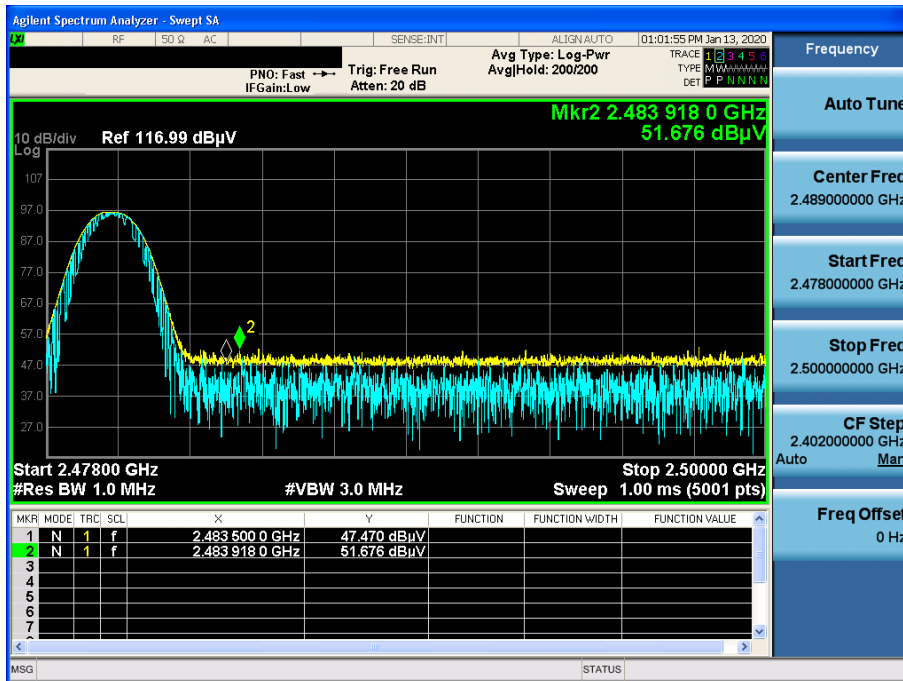

GFSK & Highest & X & Hor

Detector Mode : PK

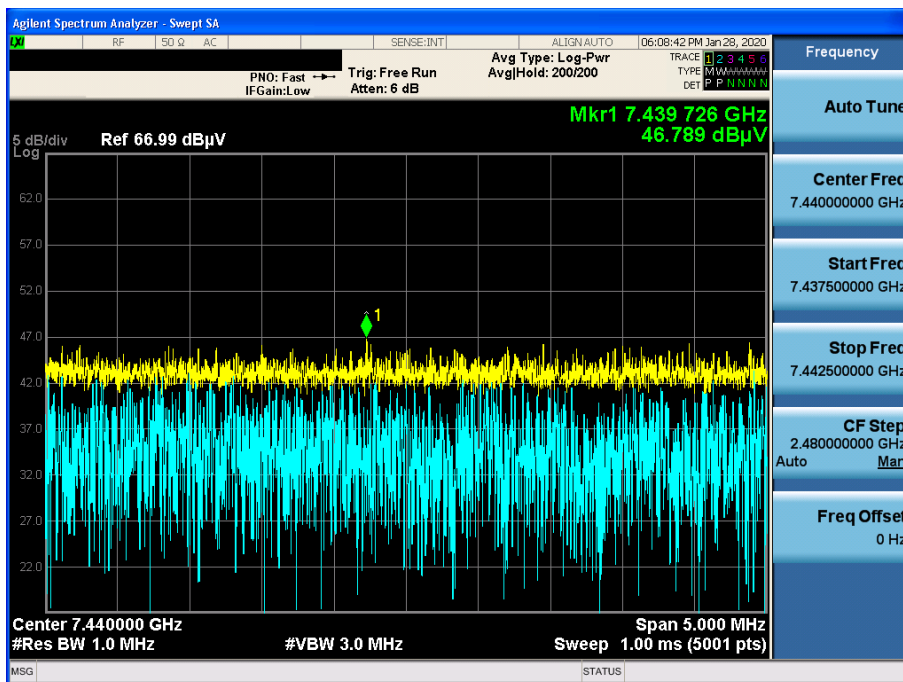

Unwanted Emissions (Radiated) Test Plot _ With Dual Display

GFSK & Highest & X & Hor

Detector Mode : PK

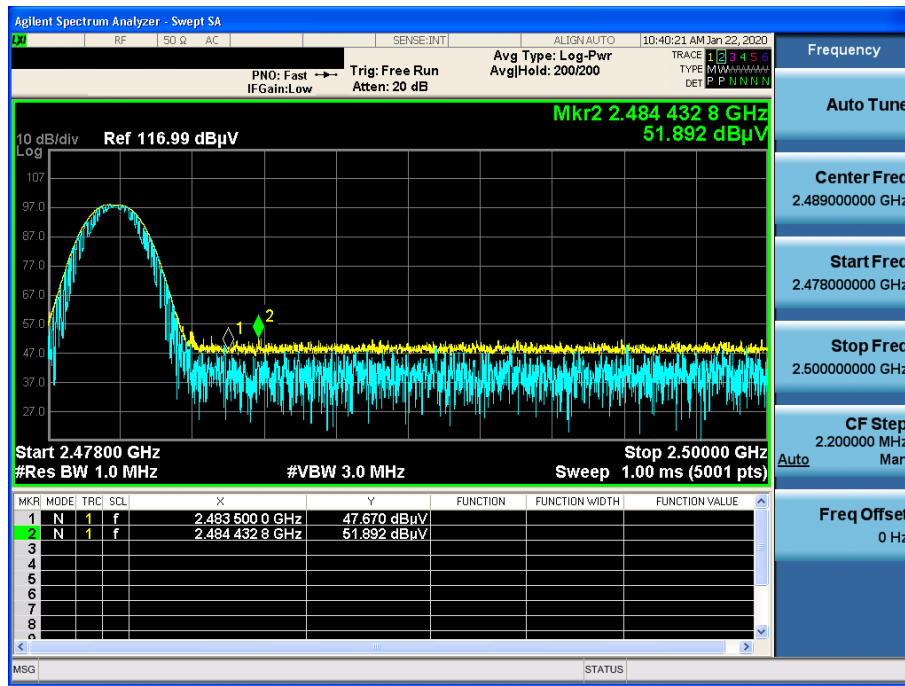

GFSK & Highest & X & Hor

Detector Mode : PK

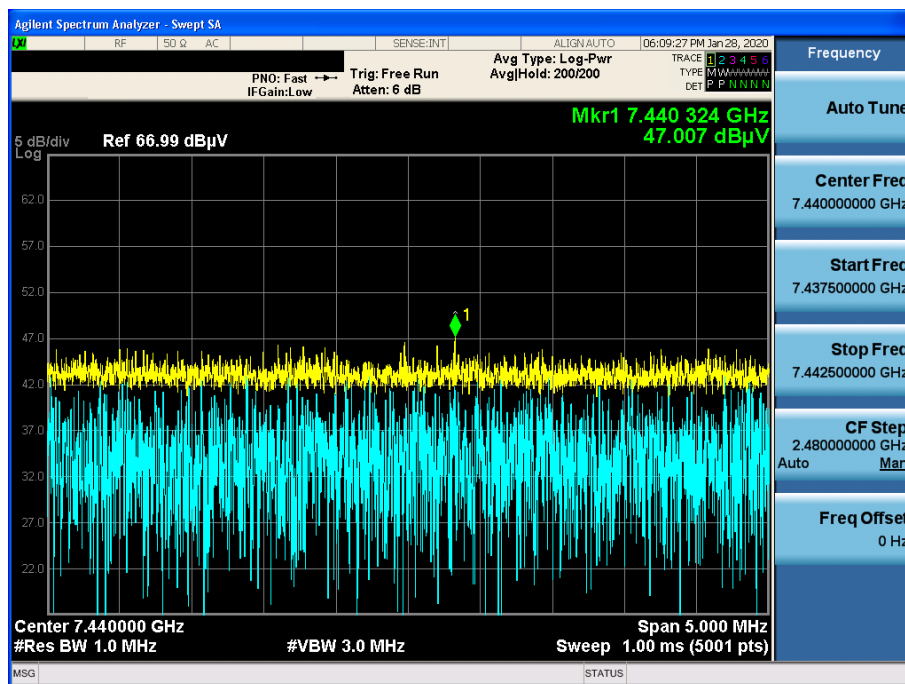

Unwanted Emissions (Radiated) Test Plot _ With Dual Display+WPC

GFSK & Highest & X & Hor

Detector Mode : PK

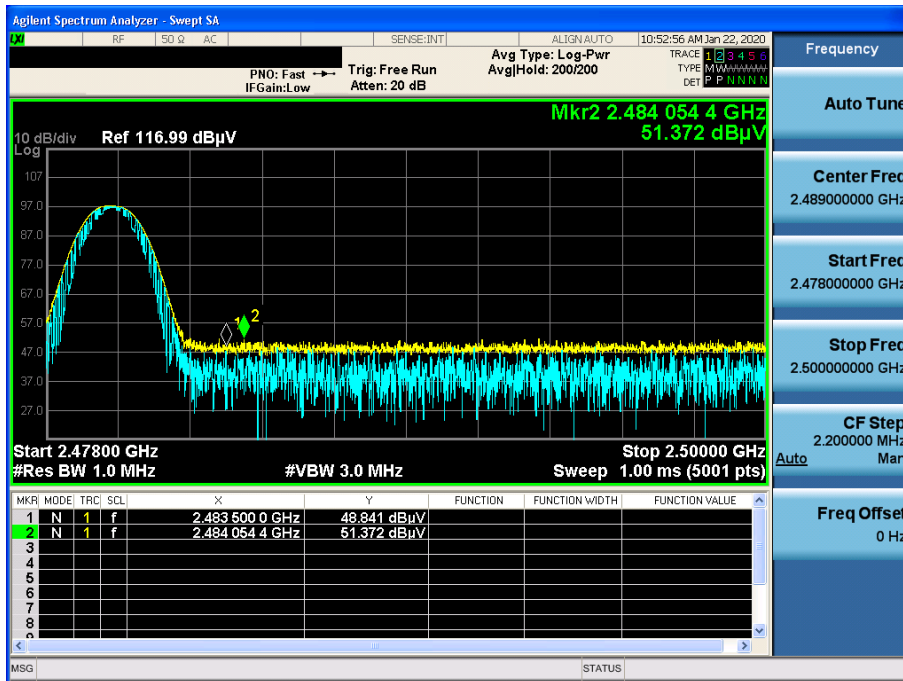

GFSK & Highest & X & Hor

Detector Mode : PK

