



Qualcomm Technologies, Inc.

LGE portable handset (FCC ID: ZNFV600TM) RF Exposure Compliance Test Report

(Part 2: Test Under Dynamic Transmission Condition)

80-W5674-2 Rev. C

February 16, 2020

All Qualcomm products mentioned herein are products of Qualcomm Technologies, Inc. and/or its subsidiaries.

Qualcomm is a trademark of Qualcomm Incorporated, registered in the United States and other countries. Other product and brand names may be trademarks or registered trademarks of their respective owners.

This technical data may be subject to U.S. and international export, re-export, or transfer ("export") laws. Diversion contrary to U.S. and international law is strictly prohibited.

Qualcomm Technologies, Inc.
5775 Morehouse Drive
San Diego, CA 92121
U.S.A.

Revision history

Revision	Date	Description
A	January 28, 2020	Initial release
B	February 14, 2020	Updated typos in Tables 4-1, 4-2 and 5-1
C	February 16, 2020	Updated LTE B30/41(PC2)/41(PC3) Plimit values in Table 4-1

Contents

1 Introduction	7
2 Tx Varying Transmission Test Cases and Test Proposal	8
3 SAR Time Averaging Validation Test Procedures	10
3.1 Test sequence determination for validation	10
3.2 Test configuration selection criteria for validating Smart Transmit feature	10
3.2.1 Test configuration selection for time-varying Tx power transmission	10
3.2.2 Test configuration selection for change in call	11
3.2.3 Test configuration selection for change in technology/band	11
3.2.4 Test configuration selection for change in antenna	12
3.2.5 Test configuration selection for change in DSI	12
3.2.6 Test configuration selection for change in time window	12
3.2.7 Test configuration selection for SAR exposure switching	12
3.3 Test procedures for conducted power measurements	13
3.3.1 Time-varying Tx power transmission scenario	13
3.3.2 Change in call scenario	15
3.3.3 Change in technology and band	16
3.3.4 Change in antenna	17
3.3.5 Change in DSI	17
3.3.6 Change in time window	17
3.3.7 SAR exposure switching	19
3.4 Test procedure for time-varying SAR measurements	20
4 Test Configurations	22
4.1 WWAN (sub-6) transmission	22
5 Conducted Power Test Results for Sub-6 Smart Transmit Feature Validation	25
5.1 Measurement setup	25
5.2 P_{limit} and P_{max} measurement results	28
5.3 Time-varying Tx power measurement results	29
5.3.1 LTE Band 7 (test case 1 in Table 4-2)	30
5.3.2 LTE Band 2 (test case 2 in Table 4-2)	32
5.3.3 WCDMA Band 4 (test case 3 in Table 4-2)	34
5.3.4 CDMA/EVDO BC1 (test case 4 in Table 4-2)	36
5.3.5 Sub6 NR Band n66 (test case 5 in Table 4-2)	38
5.4 Change in Call Test Results (test case 6 in Table 4-2)	40
5.5 Change in technology/band test results (test case 7 in Table 4-2)	42
5.6 Change in DSI test results (test case 8 in Table 4-2)	44
5.7 Change in Time window / antenna switch test results (test case 9 in Table 4-2)	46
5.7.1 Test case 1: transition from LTE B7 to LTE B48 (i.e., 100s to 60s), then back to LTE B7	46
5.7.2 Test case 2: transition from LTE B48 to LTE B7 (i.e., 60s to 100s), then back to LTE B48	48
5.8 Switch in SAR exposure test results (test case 10 in Table 4-2)	50
5.8.1 Test case 1: SAR exposure switch in same time window	50

6 SAR Test Results for Sub-6 Smart Transmit Feature Validation	52
6.1 Measurement setup	52
6.2 SAR measurement results for time-varying Tx power transmission scenario	53
6.2.1 LTE Band 7 SAR test results	54
6.2.2 LTE Band 2 SAR test results	56
6.2.3 WCDMA Band 4 SAR test results	58
6.2.4 CDMA/EVDO BC1 SAR test results	60
6.2.5 Sub6 NR Band n66 SAR test results	62
7 Conclusions	64
A Test Sequences	65
B Test Procedures for sub6 NR + LTE.....	68
B.1 Time-varying Tx power test for sub6 NR in NSA mode	68
B.2 Switch in SAR exposure between LTE vs. Sub6 NR during transmission	68
C cDASY6 System Validation	70
C.1 SAR system verification and validation	70
D SPEAG Certificates of cDASY6 SAR Probe, DAE and Dipole.....	76
E Test Setup Photos	77

Figures

Figure 3-1 100s running average illustration	14
Figure 5-1 Conducted power measurement setup	27
Figure 6-1 SAR measurement setup.....	52
Figure A-1 Test sequence 1 waveform	65
Figure A-2 Test Sequence 2 waveform.....	67
Figure C-1 SAR measurement system verification plot for 2600MHz performed on 1/18/2020. Input power = 10.0mW.	72
Figure C-2 SAR measurement system verification plot for 1800MHz performed on 1/19/2020. Input power = 10.0mW.	73
Figure C-3 SAR measurement system verification plot for 1800MHz performed on 1/20/2020. Input power = 10.0mW.	74
Figure C-4 SAR measurement system verification plot for 1800MHz performed on 1/21/2020. Input power = 10.0mW.	75



Tables

Table 4-1: P_{limit} for supported technologies and bands (P_{limit} in EFS file)	22
Table 4-2: Radio configurations selected for Part 2 test.....	23
Table 5-1: Measured P_{limit} and P_{max} of selected radio configurations	28
Table A-1 Test Sequence 2	66
Table C-1 List of calibrated equipment.....	70
Table C-2 System validation results.....	70
Table C-3 Tissue dielectric properties at the time of testing.....	71



5775 Morehouse Dr.
San Diego CA 92121

Overview

Test Report Reference:	80-W5674-2 Rev. C
Responsible Engineer:	Lin Lu / Jagadish Nadakuduti
Signature:	
Test Engineer:	Pete Pereira / Neil Primero / Gary Johnson / Cang Nguyen / Sushant Kadimdivan / Daniel Wong
Signature:	
Date(s) of lab activity:	17 January 2020 – 14 February 2020
Date of issue:	16 February 2020
Test Location	Qualcomm Incorporated 5665 Morehouse Dr Building QRC, Room 513. San Diego CA 92121 (General Telephone) 1 858 845 7428
Temperature Range	18-25 °C (21.1°C actual)
Humidity Range	25-75% (54% actual)
Customer:	LGE ELECTRONICS U.S.A., Inc. 1000 Sylvan Avenue, Englewood Cliffs, NJ 07632, USA.
Model Tested:	ZNFV600TM

Test Specification Standard(s):	FCC CFR §2.1093
Results:	Passed

1 Introduction

The equipment under test (EUT) is LGE portable handset (FCC ID: ZNFV600TM), it contains the Qualcomm SM8250 modem supporting 2G/3G/4G technologies. This modem is enabled with Qualcomm Smart Transmit feature to control and manage transmitting power in real time and to ensure at all times the time-averaged RF exposure is in compliance with the FCC requirement.

This purpose of the Part 2 report is to demonstrate the EUT complies with FCC RF exposure requirement under Tx varying transmission scenarios, thereby validity of Qualcomm Smart Transmit feature for FCC equipment authorization of LGE portable handset (FCC ID: ZNFV600TM).

The P_{limit} values used in this report is determined based on Part 0 and Part 1 reports.

Refer to Compliance summary report for product description and terminology used in this report.

2 Tx Varying Transmission Test Cases and Test Proposal

To validate time averaging feature and demonstrate the compliance in Tx varying transmission conditions, the following transmission scenarios are covered in Part 2 test:

1. During a time-varying Tx power transmission: To prove that the Smart Transmit feature accounts for Tx power variations in time accurately.
2. During a call disconnect and re-establish scenario: To prove that the Smart Transmit feature accounts for history of past Tx power transmissions accurately.
3. During technology/band handover: To prove that the Smart Transmit feature functions correctly during transitions in technology/band.
4. During DSI (Device State Index) change: To prove that the Smart Transmit feature functions correctly during transition from one device state (DSI) to another.
5. During antenna (or beam) switch: To prove that the Smart Transmit feature functions correctly during transitions in antenna (such as AsDiv scenario).
6. During time window switch: To prove that the Smart Transmit feature correctly handles the transition from one time window to another specified by FCC, and maintains the normalized time-averaged RF exposure to be less than normalized FCC limit of 1.0 at all times.
7. SAR exposure switching between two active radios (radio1 and radio2): To prove that the Smart Transmit feature functions correctly and ensures total RF exposure compliance when exposure varies among SAR_radio1 only, SAR_radio1 + SAR_radio2, and SAR_radio2 only scenarios.

As described in Part 0 report, the RF exposure is proportional to the Tx power for a SAR characterized wireless device. Thus, feature validation in Part 2 can be effectively performed through conducted (for $f < 6\text{GHz}$) power measurement. Therefore, the compliance demonstration under dynamic transmission conditions and feature validation are done in conducted/radiated power measurement setup for transmission scenario 1 through 7.

To add confidence in the feature validation, the time-averaged SAR measurements are also performed but only performed for transmission scenario 1 to avoid the complexity in SAR measurement (such as, for scenario 3 requiring change in SAR probe calibration file to accommodate different bands and/or tissue simulating liquid).

The strategy for testing in Tx varying transmission condition is outlined as follows:

- Demonstrate the total RF exposure averaged over FCC defined time windows does not exceed FCC's SAR limits, through time-averaged power measurements
 - Measure conducted Tx power (for $f < 6\text{GHz}$) versus time.

- Convert it into RF exposure and divide by respective FCC limits to get normalized exposure versus time.
- Perform running time-averaging over FCC defined time windows.
- Demonstrate that the total normalized time-averaged RF exposure is less than 1 for all transmission scenarios (i.e., transmission scenarios 1, 2, 3, 4, 5, 6, and 7) at all times.

Mathematical expression:

- For sub-6 transmission only:

$$1g_or_10gSAR(t) = \frac{conducted_Tx_power(t)}{conducted_Tx_power_P_{limit}} * 1g_or_10gSAR_P_{limit} \quad (1a)$$

$$\frac{\frac{1}{T_{SAR}} \int_{t-T_{SAR}}^t 1g_or_10gSAR(t) dt}{FCC\ SAR\ limit} \leq 1 \quad (1b)$$

where, $conducted_Tx_power(t)$, $conducted_Tx_power_P_{limit}$, and $1g_or_10gSAR_P_{limit}$ correspond to the measured instantaneous conducted Tx power, measured conducted Tx power at P_{limit} , and measured $1gSAR$ or $10gSAR$ values at P_{limit} corresponding to sub-6 transmission. Both P_{limit} and $input.power.limit$ are the parameters pre-defined and loaded via Embedded File System (EFS) onto the EUT. T_{SAR} is the FCC defined time window for sub-6 radio.

- Demonstrate the total RF exposure averaged over FCC defined time windows does not exceed FCC's SAR limits, through time-averaged SAR measurements. Note as mentioned earlier, this measurement is performed for transmission scenario 1 only.
 - For sub-6 transmission only, measure instantaneous SAR versus time; for LTE+sub6 NR transmission, request low power (or all-down bits) on LTE so that measured SAR predominantly corresponds to sub6 NR.
 - Convert it into RF exposure and divide by respective FCC limits to obtain normalized exposure versus time.
 - Perform time averaging over FCC defined time window.
 - Demonstrate that the total normalized time-averaged RF exposure is less than 1 for transmission scenario 1 at all times.

Mathematical expression:

- For sub-6 transmission only:

$$1g_or_10gSAR(t) = \frac{pointSAR(t)}{pointSAR_P_{limit}} * 1g_or_10gSAR(t)_P_{limit} \quad (2a)$$

$$\frac{\frac{1}{T_{SAR}} \int_{t-T_{SAR}}^t 1g_or_10gSAR(t) dt}{FCC\ SAR\ limit} \leq 1 \quad (2b)$$

where, $pointSAR(t)$, $pointSAR_P_{limit}$, and $1g_or_10gSAR_P_{limit}$ correspond to the measured instantaneous point SAR, measured point SAR at P_{limit} , and measured $1gSAR$ or $10gSAR$ values at P_{limit} corresponding to sub-6 transmission.

3 SAR Time Averaging Validation Test Procedures

This chapter provides the test plan and test procedure for validating Qualcomm Smart Transmit feature for sub-6 transmission. The 100 seconds time window for operating $f < 3\text{GHz}$ is used as an example to detail the test procedures in this chapter. The same test plan and test procedures described in this chapter apply to 60 seconds time window for operating $f \geq 3\text{GHz}$.

3.1 Test sequence determination for validation

Following the FCC recommendation, two test sequences having time-variation in Tx power are predefined for sub-6 ($f < 6\text{GHz}$) validation:

- Test sequence 1: request EUT's Tx power to be at maximum power, measured P_{max}^\dagger , for 80s, then requesting for half of the maximum power, i.e., measured $P_{max}/2$, for the rest of the time.
- Test sequence 2: request EUT's Tx power to vary with time. This sequence is generated relative to measured P_{max} , measured P_{limit} and calculated $P_{reserve}$ (= measured P_{limit} in dBm - *Reserve_power_margin* in dB) of EUT based on measured P_{limit} .

The details for generating these two test sequences is described and listed in Appendix A.

NOTE: For test sequence generation, “measured P_{limit} ” and “measured P_{max} ” are used instead of the “ P_{limit} ” specified in EFS entry and “ P_{max} ” specified for the device, because Smart Transmit feature operates against the actual power level of the “ P_{limit} ” that was calibrated for the EUT. The “measured P_{limit} ” accurately reflects what the feature is referencing to, therefore, it should be used during feature validation testing. The RF tune up and device-to-device variation are already considered in Part 0 report prior to determining P_{limit} .

3.2 Test configuration selection criteria for validating Smart Transmit feature

For validating Smart Transmit feature, this section provides a general guidance to select test cases. In practice, an adjustment can be made in test case selection. The justification/clarification may be provided.

3.2.1 Test configuration selection for time-varying Tx power transmission

The Smart Transmit time averaging feature operation is independent of bands, modes, and channels for a given technology. Hence, validation of Smart Transmit in one band/mode/channel

per technology is sufficient. Two bands per technology are proposed and selected for this testing to provide high confidence in this validation.

The criteria for the selection are based on the P_{limit} values determined in Part 0 report. Select two bands* in each supported technology that correspond to least** and highest*** P_{limit} values that are less than P_{max} for validating Smart Transmit.

- * If one P_{limit} level applies to all the bands within a technology or if only one band within a technology has $P_{limit} < P_{max}$, then only one band needs to be tested. In this case, select one band/radio configuration (e.g., # of RBs, channel#) for this test. Use the highest *measured* $1g_or_10gSAR$ shown in Part 1 report for the selected tech/band/antenna/DSI is selected.
- ** In case of multiple bands having the same least P_{limit} within the technology, then select any one band out of these bands.
- *** The band having a higher P_{limit} needs to be properly selected so that the power limiting enforced by Smart Transmit can be validated using the pre-defined test sequences. If the highest P_{limit} in a technology is too high where the power limiting enforcement is not needed when testing with the pre-defined test sequences, then the next highest level is checked. This process is continued within the technology until the second band for validation testing is determined.

3.2.2 Test configuration selection for change in call

The criteria to select a test configuration for call-drop measurement is:

- Select technology/band with least P_{limit} among all supported technologies/bands, and select the radio configuration (e.g., # of RBs, channel#) in this technology/band that corresponds to the highest *measured* $1gSAR$ at P_{limit} listed in Part 1 report.
- In case of multiple bands having same least P_{limit} , then select the band having the highest *measured* $1gSAR$ at P_{limit} in Part 1 report.

This test is performed with the EUT's Tx power requested to be at maximum power, the above band selection will result in Tx power enforcement (i.e., EUT forced to have Tx power at $P_{reserve}$) for longest duration in one FCC defined time window. The call change (call drop/reestablish) is performed during the Tx power enforcement duration (i.e., during the time when EUT is forced to have Tx power at $P_{reserve}$). One test is sufficient as the feature operation is independent of technology and band.

3.2.3 Test configuration selection for change in technology/band

The selection criteria for this measurement is, for a given antenna, to have EUT switch from a technology/band with lowest P_{limit} within the technology group (in case of multiple bands having the same P_{limit} , then select the band with highest *measured* $1gSAR$ at P_{limit}) to a technology/band with highest P_{limit} within the technology group, in case of multiple bands having the same P_{limit} , then select the band with lowest *measured* $1gSAR$ at P_{limit} in Part 1 report, or vice versa.

This test is performed with the EUT's Tx power requested to be at maximum power, the technology/band switch is performed during Tx power enforcement duration (i.e., during the time when EUT is forced to have Tx power at $P_{reserve}$).

3.2.4 Test configuration selection for change in antenna

The criteria to select a test configuration for antenna switch measurement is:

- Whenever possible and supported by the EUT, first select antenna switch configuration within the same technology/band (i.e., same technology and band combination).
- Then, select any technology/band that supports multiple Tx antennas, and has the highest difference in P_{limit} among all supported antennas.
- In case of multiple bands having same difference in P_{limit} among supported antennas, then select the band having the highest *measured* 1gSAR at P_{limit} in Part 1 report.

This test is performed with the EUT's Tx power requested to be at maximum power in selected technology/band, and antenna change is conducted during Tx power enforcement duration (i.e., during the time when EUT is forced to have Tx power at $P_{reserve}$).

3.2.5 Test configuration selection for change in DSI

The criteria to select a test configuration for DSI change test is

- Select a technology/band having the $P_{limit} < P_{max}$ within any technology and DSI group, and for the same technology/band having a different P_{limit} in any other DSI group. Note that the selected DSI transition need to be supported by the device.

This test is performed with the EUT's Tx power requested to be at maximum power in selected technology/band, and DSI change is conducted during Tx power enforcement duration (i.e., during the time when EUT is forced to have Tx power at $P_{reserve}$).

3.2.6 Test configuration selection for change in time window

FCC specifies different time window for time averaging based on operation frequency. The criteria to select a test configuration for validating Smart Transmit feature and demonstrating the compliance during the change in time window is

- Select any technology/band that has operation frequency classified in one time window defined by FCC (such as 100-seconds time window), and its corresponding P_{limit} is less than P_{max} if possible.
- Select the 2nd technology/band that has operation frequency classified in a different time window defined by FCC (such as 60-seconds time window), and its corresponding P_{limit} is less than P_{max} if possible.
- Note it is preferred both P_{limit} values of two selected technology/band less than corresponding P_{max} , but if not possible, at least one of technologies/bands has its P_{limit} less than P_{max} .

This test is performed with the EUT's Tx power requested to be at maximum power in selected technology/band. Test for one pair of time windows selected is sufficient as the feature operation is the same.

3.2.7 Test configuration selection for SAR exposure switching

If supported, the test configuration for SAR exposure switching should cover

1. SAR exposure switch when two active radios are in the same time window
2. SAR exposure switch when two active radios are in different time windows

The Smart Transmit time averaging operation is independent of the source of SAR exposure (for example, LTE vs. Sub6 NR) and ensures total time-averaged RF exposure compliance. Hence, validation of Smart Transmit in simultaneous SAR transmission scenario (i.e., one combination for LTE + Sub6 NR transmission) for one radio configuration (i.e. modulation/RB configuration/bandwidth/DSI/antenna) is sufficient, where the SAR exposure varies among SAR_{radio1} only, $SAR_{\text{radio1}} + SAR_{\text{radio2}}$, and SAR_{radio2} only scenarios.

The criteria to select a test configuration for validating Smart Transmit feature during SAR exposure switching scenarios is

- Select any two < 6GHz technologies/bands that the EUT supports simultaneous transmission (for example, LTE+Sub6 NR).
- Among all supported simultaneous transmission configurations, the selection order is
 1. select one configuration where both P_{limit} of radio1 and radio2 is less than their corresponding P_{max} , preferably, with different P_{limits} . If this configuration is not available, then,
 2. select one configuration that has P_{limit} less than its P_{max} for at least one radio. If this can not be found, then,
 3. select one configuration that has P_{limit} of radio1 and radio2 greater than P_{max} but with least $(P_{\text{limit}} - P_{\text{max}})$ delta.

Test for one simultaneous transmission scenario is sufficient as the feature operation is the same.

3.3 Test procedures for conducted power measurements

This section provides general conducted power measurement procedures to perform compliance test under dynamic transmission scenarios described in Section 2. In practice, an adjustment can be made in these procedures. The justification/clarification may be provided.

3.3.1 Time-varying Tx power transmission scenario

This test is performed with the two pre-defined test sequences described in Section 3.1 for all the technologies and bands selected in Section 3.2.1. The purpose of the test is to demonstrate the effectiveness of power limiting enforcement and that the time-averaged SAR (corresponding time-averaged Tx power) does not exceed the FCC limit at all times (see Eq. (1a) and (1b)).

Test procedure

1. Measure P_{max} , measure P_{limit} and calculate P_{reserve} (= measured P_{limit} in dBm – *Reserve_power_margin* in dB) and follow Section 3.1 to generate the test sequences for all the technologies and bands selected in Section 3.2.1. Both test sequence 1 and test sequence 2 are created based on measured P_{max} and measured P_{limit} of the EUT. Test condition to measure P_{max} and P_{limit} is:
 - Measure P_{max} with Smart Transmit disabled and callbox set to request maximum power.
 - Measure P_{limit} with Smart Transmit enabled and *Reserve_power_margin* set to 0 dB, callbox set to request maximum power.
2. Set *Reserve_power_margin* to actual (intended) value (3dB for this EUT based on Part 1 report) and reset power on EUT to enable Smart Transmit, establish radio link in desired radio configuration, with callbox requesting the EUT's Tx power to be at pre-defined test

Procedures

sequence 1, measure and record Tx power versus time, and then convert the conducted Tx power into 1gSAR or 10gSAR value (see Eq. (1a)) using measured P_{limit} from above Step 1. Perform running time average to determine time-averaged power and 1gSAR or 10gSAR versus time as illustrated in Figure 3-1 where using 100-seconds time window as an example.

NOTE: In Eq.(1a), instantaneous Tx power is converted into instantaneous 1gSAR or 10gSAR value by applying the measured worst-case 1gSAR or 10gSAR value at P_{limit} for the corresponding technology/band/antenna/DSI reported in Part 1 report.

NOTE: For an easier computation of the running time average, 0 dBm can be added at the beginning of the test sequences the length of the responding time window, for example, add 0dBm for 100-seconds so the running time average can be directly performed starting with the first 100-seconds data using excel spreadsheet. This technique applies to all tests performed in this Part 2 report for easier time-averaged computation using excel spreadsheet.

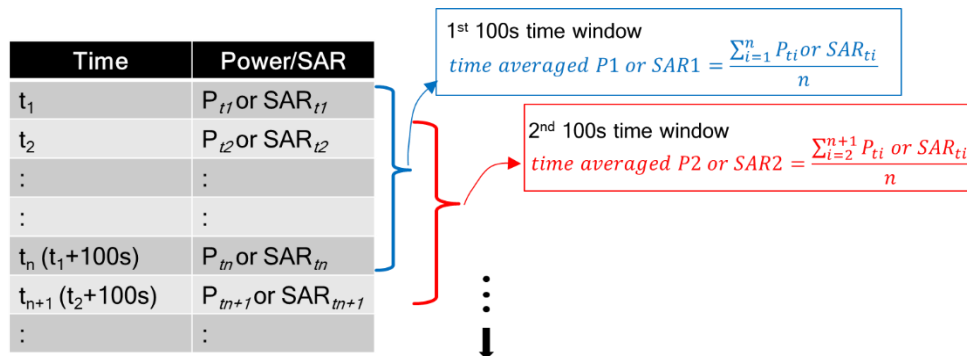

Figure 3-1 100s running average illustration

3. Make one plot containing:
 - a. Instantaneous Tx power versus time measured in Step 2,
 - b. Requested Tx power used in Step 2 (test sequence 1),
 - c. Computed time-averaged power versus time determined in Step 2,
 - d. Time-averaged power limit (corresponding to FCC SAR limit of 1.6 W/kg for 1gSAR or 4.0W/kg for 10gSAR) given by

$$\text{Time avearged power limit} = \text{meas. } P_{limit} + 10 \times \log\left(\frac{\text{FCC SAR limit}}{\text{meas. SAR}_{Plimit}}\right) \quad (3)$$

where $\text{meas. } P_{limit}$ and $\text{meas. SAR}_{Plimit}$ correspond to measured power at P_{limit} and measured SAR at P_{limit} .

4. Make another plot containing:
 - a. Computed time-averaged 1gSAR or 10gSAR versus time determined in Step 2
 - b. FCC $1gSAR_{limit}$ of 1.6W/kg or FCC $10gSAR_{limit}$ of 4.0W/kg.
5. Repeat Steps 2 ~ 4 for pre-defined test sequence 2 and replace the requested Tx power (test sequence 1) in Step 2 with test sequence 2.
6. Repeat Steps 2 ~ 5 for all the selected technologies and bands.

The validation criteria are, at all times, the time-averaged power versus time shown in Step 3 plot shall not exceed the time-averaged power limit (defined in Eq. (3)), in turn, the time-averaged 1gSAR or 10gSAR versus time shown in Step 4 plot shall not exceed the FCC limit of 1.6 W/kg for 1gSAR or 4.0 W/kg for 10gSAR (i.e., Eq. (1b)).

3.3.2 Change in call scenario

This test is to demonstrate that Smart Transmit feature accurately accounts for the past Tx powers during time-averaging when a new call is established.

The call disconnect and re-establishment needs to be performed during power limit enforcement, i.e., when the EUT's Tx power is at $P_{reserve}$ level, to demonstrate the continuity of RF exposure management and limiting in call change scenario. In other words, the RF exposure averaged over any FCC defined time window (including the time windows containing the call change) doesn't exceed FCC limit of 1.6 W/kg for 1gSAR or 4.0 W/kg for 10gSAR.

Test procedure

1. Measure P_{limit} for the technology/band selected in Section 3.2.2. Measure P_{limit} with Smart Transmit enabled and *Reserve_power_margin* set to 0 dB, callbox set to request maximum power.
2. Set *Reserve_power_margin* to actual (intended) value and reset power on EUT to enable Smart Transmit.
3. Establish radio link with callbox in the selected technology/band.
4. Request EUT's Tx power at 0 dBm for at least one time window specified for the selected technology/band, followed by requesting EUT's Tx power to be at maximum power for about ~60 seconds, and then drop the call for ~10 seconds. Afterwards, re-establish another call in the same radio configuration (i.e., same technology/band/channel) and continue callbox requesting EUT's Tx power to be at maximum power for the remaining time of at least another full duration of the specified time window. Measure and record Tx power versus time. Once the measurement is done, extract instantaneous Tx power versus time, convert the measured conducted Tx power into 1gSAR or 10gSAR value using Eq. (1a), and then perform the running time average to determine time-averaged power and 1gSAR or 10gSAR versus time.

NOTE: In Eq.(1a), instantaneous Tx power is converted into instantaneous 1gSAR or 10gSAR value by applying the measured worst-case 1gSAR or 10gSAR value at P_{limit} for the corresponding technology/band/antenna/DSI reported in Part 1 report.

5. Make one plot containing: (a) instantaneous Tx power versus time, (b) requested power, (c) computed time-averaged power, (d) time-averaged power limit calculated using Eq.(3).
6. Make another plot containing: (a) computed time-averaged 1gSAR or 10gSAR versus time, and (b) FCC limit of 1.6 W/kg for 1gSAR or 4.0 W/kg for 10gSAR.

The validation criteria are, at all times, the time-averaged power versus time shall not exceed the time-averaged power limit (defined in Eq.(3)), in turn, the time-averaged 1gSAR or 10gSAR versus time shall not exceed the FCC limit of 1.6 W/kg for 1gSAR or 4.0 W/kg for 10gSAR (i.e., Eq. (1b)).

3.3.3 Change in technology and band

This test is to demonstrate the correct power control by Smart Transmit during technology switches and/or band handovers.

Similar to the change in call test in Section 3.3.2, to validate the continuity of RF exposure limiting during the transition, the technology and band handover needs to be performed when EUT's Tx power is at $P_{reserve}$ level (i.e., during Tx power enforcement) to make sure that the EUT's Tx power from previous $P_{reserve}$ level to the new $P_{reserve}$ level (corresponding to new technology/band). Since the P_{limit} could vary with technology and band, Eq. (1a) can be written as follows to convert the instantaneous Tx power in 1gSAR or 10gSAR exposure for the two given radios, respectively:

$$1g_or_10gSAR_1(t) = \frac{conducted_Tx_power_1(t)}{conducted_Tx_power_P_{limit_1}} * 1g_or_10gSAR_P_{limit_1} \quad (4a)$$

$$1g_or_10gSAR_2(t) = \frac{conducted_Tx_power_2(t)}{conducted_Tx_power_P_{limit_2}} * 1g_or_10gSAR_P_{limit_2} \quad (4b)$$

$$\frac{1}{T_{SAR}} \left[\int_{t-T_{SAR}}^{t_1} \frac{1g_or_10gSAR_1(t)}{FCC\ SAR\ limit} dt + \int_{t-T_{SAR}}^t \frac{1g_or_10gSAR_2(t)}{FCC\ SAR\ limit} dt \right] \leq 1 \quad (4c)$$

where, $conducted_Tx_power_1(t)$, $conducted_Tx_power_P_{limit_1}$, and $1g_or_10gSAR_P_{limit_1}$ correspond to the measured instantaneous conducted Tx power, measured conducted Tx power at P_{limit} , and measured 1gSAR or 10gSAR value at P_{limit} of technology1/band1; $conducted_Tx_power_2(t)$, $conducted_Tx_power_P_{limit_2}(t)$, and $1g_or_10gSAR_P_{limit_2}$ correspond to the measured instantaneous conducted Tx power, measured conducted Tx power at P_{limit} , and measured 1gSAR or 10gSAR value at P_{limit} of technology2/band2. Transition from technology1/band1 to the technology2/band2 happens at time-instant ' tI '.

Test procedure

1. Measure P_{limit} for both the technologies and bands selected in Section 3.2.3. Measure P_{limit} with Smart Transmit enabled and *Reserve_power_margin* set to 0 dB, callbox set to request maximum power.
2. Set *Reserve_power_margin* to actual (intended) value and reset power on EUT to enable Smart Transmit
3. Establish radio link with callbox in first technology/band selected.
4. Request EUT's Tx power at 0 dBm for at least one time window specified for the selected technology/band, followed by requesting EUT's Tx power to be at maximum power for about ~60 seconds, and then switch to second technology/band selected. Continue with callbox requesting EUT's Tx power to be at maximum power for the remaining time of at least another full duration of the specified time window. Measure and record Tx power versus time for the full duration of the test.
5. Once the measurement is done, extract instantaneous Tx power versus time, and convert the conducted Tx power into 1gSAR or 10gSAR value using Eq. (4a) and (4b) and corresponding measured P_{limit} values from Step 1 of this section. Perform the running time average to determine time-averaged power and 1gSAR or 10gSAR versus time.

NOTE: In Eq.(4a) & (4b), instantaneous Tx power is converted into instantaneous 1gSAR or 10gSAR value by applying the measured worst-case 1gSAR or 10gSAR value at P_{limit} for the corresponding technology/band/antenna/DSI reported in Part 1 report.

Procedures

6. Make one plot containing: (a) instantaneous Tx power versus time, (b) requested power, (c) computed time-averaged power, (d) time-averaged power limit calculated using Eq.(3).
7. Make another plot containing: (a) computed time-averaged 1gSAR or 10gSAR versus time, and (b) FCC limit of 1.6 W/kg for 1gSAR or 4.0 W/kg for 10gSAR.

The validation criteria are, at all times, the time-averaged 1gSAR or 10gSAR versus time shall not exceed the FCC limit of 1.6 W/kg for 1gSAR or 4.0 W/kg for 10gSAR (i.e., Eq. (4c)).

3.3.4 Change in antenna

This test is to demonstrate the correct power control by Smart Transmit during antenna switches from one antenna to another. The test procedure is identical to Section 3.3.3, by replacing technology/band switch operation with antenna switch. The validation criteria are, at all times, the time-averaged 1gSAR or 10gSAR versus time shall not exceed FCC limit of 1.6 W/kg for 1gSAR or 4.0 W/kg for 10gSAR.

NOTE: If the EUT does not support antenna switch within the same technology/band, but has multiple antennas to support different frequency bands, then the antenna switch test is included as part of change in technology and band (Section 3.3.3) test.

3.3.5 Change in DSI

This test is to demonstrate the correct power control by Smart Transmit during DSI switches from one DSI to another. The test procedure is identical to Section 3.3.3, by replacing technology/band switch operation with DSI switch. The validation criteria are, at all times, the time-averaged 1gSAR or 10gSAR versus time shall not exceed FCC limit of 1.6 W/kg for 1gSAR or 4.0 W/kg for 10gSAR.

3.3.6 Change in time window

This test is to demonstrate the correct power control by Smart Transmit during the change in averaging time window when a specific band handover occurs. FCC specifies time-averaging windows of 100s for Tx frequency < 3GHz, and 60s for Tx frequency between 3GHz and 6GHz.

To validate the continuity of RF exposure limiting during the transition, the band handover test needs to be performed when EUT handovers from operation band less than 3GHz to greater than 3GHz and vice versa. The equations (2a) and (2b) in Section 2 can be written as follows for transmission scenario having change in time window,

$$1gSAR_1(t) = \frac{\text{conducted_Tx_power_1}(t)}{\text{conducted_Tx_power_P_limit_1}} * 1g_or\ 10g_SAR_P_limit_1 \quad (5a)$$

$$1gSAR_2(t) = \frac{\text{conducted_Tx_power_2}(t)}{\text{conducted_Tx_power_P_limit_2}} * 1g_or\ 10g_SAR_P_limit_2 \quad (5b)$$

$$\frac{1}{T1_{SAR}} \left[\int_{t-T1_{SAR}}^{t_1} \frac{1g_or\ 10g_SAR_1(t)}{FCC\ SAR\ limit} dt \right] + \frac{1}{T2_{SAR}} \left[\int_{t-T2_{SAR}}^t \frac{1g_or\ 10g_SAR_2(t)}{FCC\ SAR\ limit} dt \right] \leq 1 \quad (5c)$$

where, $\text{conducted_Tx_power_1}(t)$, $\text{conducted_Tx_power_P_limit_1}(t)$, and $1g_or\ 10g_SAR_P_limit_1$ correspond to the instantaneous Tx power, conducted Tx power at P_{limit} , and compliance $1g_or\ 10g_SAR$ values at P_{limit_1} of band1 with time-averaging window ' $T1_{SAR}$ '; $\text{conducted_Tx_power_2}(t)$, $\text{conducted_Tx_power_P_limit_2}(t)$, and $1g_or\ 10g_SAR_P_limit_2$ correspond to the instantaneous Tx power, conducted Tx power at P_{limit} , and compliance $1g_or\ 10g_SAR$ values at P_{limit_2} of band2 with time-averaging window ' $T2_{SAR}$ '. One of the two bands is

Procedures

less than 3GHz, another is greater than 3GHz. Transition from first band with time-averaging window ' $T1_{SAR}$ ' to the second band with time-averaging window ' $T2_{SAR}$ ' happens at time-instant ' t_I '.

Test procedure

1. Measure P_{limit} for both the technologies and bands selected in Section 3.2.6. Measure P_{limit} with Smart Transmit enabled and *Reserve_power_margin* set to 0 dB, callbox set to request maximum power.
2. Set *Reserve_power_margin* to actual (intended) value and enable Smart Transmit

Transition from 100s time window to 60s time window, and vice versa

3. Establish radio link with callbox in the technology/band having 100s time window selected in Section 3.2.6.
4. Request EUT's Tx power to be at 0 dBm for at least 100 seconds, followed by requesting EUT's Tx power to be at maximum power for about ~140 seconds, and then switch to second technology/band (having 60s time window) selected in Section 3.2.6. Continue with callbox requesting EUT's Tx power to be at maximum power for about ~60s in this second technology/band, and then switch back to the first technology/band. Continue with callbox requesting EUT's Tx power to be at maximum power for at least another 100s. Measure and record Tx power versus time for the entire duration of the test.
5. Once the measurement is done, extract instantaneous Tx power versus time, and convert the conducted Tx power into 1gSAR or 10gSAR value (see Eq. (5a) and (5b)) using corresponding technology/band Step 1 result, and then perform 100s running average to determine time-averaged 1gSAR or 10gSAR versus time. Note that in Eq.(5a) & (5b), instantaneous Tx power is converted into instantaneous 1gSAR or 10gSAR value by applying the worst-case 1gSAR or 10gSAR value tested in Part 1 for the selected technologies/bands at P_{limit} .
6. Make one plot containing: (a) instantaneous Tx power versus time measured in Step 4.
7. Make another plot containing: (a) instantaneous 1gSAR versus time determined in Step 5, (b) computed time-averaged 1gSAR versus time determined in Step 5, and (c) corresponding regulatory $1gSAR_{limit}$ of 1.6W/kg or $10gSAR_{limit}$ of 4.0W/kg.

Transition from 60s time window to 100s time window, and vice versa

8. Establish radio link with callbox in the technology/band having 60s time window selected in Section 3.2.6.
9. Request EUT's Tx power to be at 0 dBm for at least 60 seconds, followed by requesting EUT's Tx power to be at maximum power for about ~80 seconds, and then switch to second technology/band (having 100s time window) selected in Section 3.2.6. Continue with callbox requesting EUT's Tx power to be at maximum power for about ~100s in this second technology/band, and then switch back to the first technology/band. Continue with callbox requesting EUT's Tx power to be at maximum power for the remaining time for a total test time of 500 seconds. Measure and record Tx power versus time for the entire duration of the test.
10. Repeat above Step 5~7 to generate the plots

The validation criteria is, at all times, the time-averaged 1gSAR or 10gSAR versus time shall not exceed the regulatory $1gSAR_{limit}$ of 1.6W/kg or $10gSAR_{limit}$ of 4.0W/kg.

3.3.7 SAR exposure switching

This test is to demonstrate that Smart Transmit feature is accurately accounts for switching in exposures among SAR from radio1 only, SAR from both radio1 and radio2, and SAR from radio2 only scenarios, and ensures total time-averaged RF exposure complies with the FCC limit. The detailed test procedure for SAR exposure switching in the case of LTE+Sub6 NR non-standalone mode transmission scenario is provided in Appendix B.2.

Test procedure:

1. Measure conducted Tx power corresponding to P_{limit} for radio1 and radio2 in selected band. Test condition to measure conducted P_{limit} is:
 - Establish device in call with the callbox for radio1 technology/band. Measure conducted Tx power corresponding to radio1 P_{limit} with Smart Transmit enabled and *Reserve_power_margin* set to 0 dB, callbox set to request maximum power.
 - Repeat above step to measure conducted Tx power corresponding to radio2 P_{limit} . If radio2 is dependent on radio1 (for example, non-standalone mode of Sub6 NR requiring radio1 LTE as anchor), then establish radio1 + radio2 call with callbox, and request all down bits for radio1 LTE. In this scenario, with callbox requesting maximum power from radio2 Sub6 NR, measured conducted Tx power corresponds to radio2 P_{limit} (as radio1 LTE is at all-down bits)
2. Set *Reserve_power_margin* to actual (intended) value, with EUT setup for radio1 + radio2 call. In this description, it is assumed that radio2 has lower priority than radio1. Establish device in radio1+radio2 call, and request all-down bits or low power on radio1, with callbox requesting EUT's Tx power to be at maximum power in radio2 for at least one time window. After one time window, set callbox to request EUT's Tx power to be at maximum power on radio1, i.e., all-up bits. Continue radio1+radio2 call with both radios at maximum power for at least one time window, and drop (or request all-down bits on) radio2. Continue radio1 at maximum power for at least one time window. Record the conducted Tx power for both radio1 and radio2 for the entire duration of this test.
3. Once the measurement is done, extract instantaneous Tx power versus time for both radio1 and radio2 links. Convert the conducted Tx power for both these radios into 1gSAR or 10gSAR value (see Eq. (4a) and (4b)) using corresponding technology/band P_{limit} measured in Step 1, and then perform the running time average to determine time-averaged 1gSAR or 10gSAR versus time.
4. Make one plot containing: (a) instantaneous Tx power versus time measured in Step 2.
5. Make another plot containing: (a) instantaneous 1gSAR versus time determined in Step 3, (b) computed time-averaged 1gSAR versus time determined in Step 3, and (c) corresponding regulatory $1gSAR_{limit}$ of 1.6W/kg or $10gSAR_{limit}$ of 4.0W/kg.

The validation criteria is, at all times, the time-averaged 1gSAR or 10gSAR versus time shall not exceed the regulatory $1gSAR_{limit}$ of 1.6W/kg or $10gSAR_{limit}$ of 4.0W/kg.

3.4 Test procedure for time-varying SAR measurements

This section provides general time-varying SAR measurement procedures to perform compliance test under dynamic transmission scenarios described in Section 2. In practice, an adjustment can be made in these procedures. The justification/clarification may be provided.

To perform the validation through SAR measurement for transmission scenario 1 described in Section 2, the “path loss” between callbox antenna and EUT needs to be calibrated to ensure that the EUT Tx power reacts to the requested power from callbox in a radiated call. It should be noted that when signaling in closed loop mode, protocol-level power control is in play, resulting in EUT not solely following callbox TPC (Tx power control) commands. In other words, EUT response has many dependencies (RSSI, quality of signal, path loss variation, fading, etc.) other than just TPC commands. These dependencies have less impact in conducted setup (as it is a controlled environment and the path loss can be very well calibrated) but have significant impact on radiated testing in an uncontrolled environment, such as SAR test setup. Therefore, the deviation in EUT Tx power from callbox requested power is expected, however the time-averaged SAR should not exceed FCC SAR requirement at all times as Smart Transmit controls Tx power at EUT.

The following steps are for time averaging feature validation through SAR measurement:

1. “Path Loss” calibration: Place the EUT against the phantom in the worst-case position determined based on Section 3.2.1. For each band selected, prior to SAR measurement, perform “path loss” calibration between callbox antenna and EUT. Since the SAR test environment is not controlled and well calibrated for OTA (Over the Air) test, extreme care needs to be taken to avoid the influence from reflections. The test setup is described in Section 6.1.
2. Time averaging feature validation:
 - i For a given radio configuration (technology/band) selected in Section 3.2.1, enable Smart Transmit and set *Reserve_power_margin* to 0 dB, with callbox to request maximum power, perform area scan, conduct pointSAR measurement at peak location of the area scan. This point SAR value, *pointSAR_P_{limit}*, corresponds to point SAR at the measured *P_{limit}* (i.e., measured *P_{limit}* from the EUT in Step 1 of Section 3.3.1).
 - ii Set *Reserve_power_margin* to actual (intended) value and reset power on EUT to enable Smart Transmit. Note, if *Reserve_power_margin* cannot be set wirelessly, care must be taken to re-position the EUT in the exact same position relative to the SAM phantom as in above Step 2.i. Establish radio link in desired radio configuration, with callbox requesting the EUT’s Tx power at power levels described by test sequence 1 generated in Step 1 of Section 3.3.1, conduct point SAR measurement versus time at peak location of the area scan determined in Step 2.i of this section. Once the measurement is done, extract instantaneous point SAR vs time data, *pointSAR(t)*, and convert it into instantaneous 1gSAR or 10gSAR vs. time using Eq. (2a), re-written below:

$$1g_or_10gSAR(t) = \frac{pointSAR(t)}{pointSAR_P_{limit}} * 1g_or_10gSAR_P_{limit}$$

where, *pointSAR_P_{limit}* is the value determined in Step 2.i, and *pointSAR(t)* is the instantaneous point SAR measured in Step 2.ii, *1g_or_10gSAR_P_{limit}* is the measured 1gSAR or 10gSAR value listed in Part 1 report.

- iii Perform 100s running average to determine time-averaged 1gSAR or 10gSAR versus time.

Procedures

- iv Make one plot containing: (a) time-averaged 1gSAR or 10gSAR versus time determined in Step 2.iii of this section, (b) FCC limit of 1.6 W/kg for 1gSAR or 4.0 W/kg for 10gSAR.
- v Repeat 2.ii ~ 2.iv for test sequence 2 generated in Step 1 of Section 3.3.1.
- vi Repeat 2.i ~ 2.v for all the technologies and bands selected in Section 3.2.1.

The time-averaging validation criteria for SAR measurement is that, at all times, the time-averaged 1gSAR or 10gSAR versus time shall not exceed FCC limit of 1.6 W/kg for 1gSAR or 4.0 W/kg for 10gSAR (i.e., Eq. (2b)).

4 Test Configurations

4.1 WWAN (sub-6) transmission

The P_{limit} values, corresponding to 1.13 W/kg (1gSAR) and 2.83 W/kg (10gSAR) of SAR_{design_target} , for technologies and bands supported by EUT are derived in Part 0 report and summarized in Table 4-1. Note all P_{limit} power levels entered in Table 4-1 correspond to average power levels after accounting for duty cycle in the case of TDD modulation schemes (for e.g., GSM, LTE TDD & Sub6 NR TDD).

Table 4-1: P_{limit} for supported technologies and bands (P_{limit} in EFS file)

FCC ID: xxxx					
Exposure scenario		head / body worn / extremity	hotspot	extremity (proximity sensor ON)	Maximum tune up target power*
avg. vol:		1g / 1g / 10g	1g	10g	
spacing:		0mm / 10mm / 1-3mm	10mm	0mm	
DSI:		1	5	8	
Tech/Band	Antenna				
GSM/GPRS/EDGE 850 MHz	1	29.2	29.2	29.2	25.5
GSM/GPRS/EDGE 1900 MHz	2	24.8	24.8	24.8	22.5
UMTS B5	1	27.8	27.8	27.8	25.0
UMTS B4	2	26.5	22.2	22.2	24.7
UMTS B2	2	26.7	22.2	22.2	24.7
CDMA/EVDO BC0	1	28.8	28.8	28.8	25.0
CDMA/EVDO BC10	1	29.3	29.3	29.3	25.0
CDMA/EVDO BC1	2	26.3	22.2	22.2	24.7
LTE FDD B2 / B25	2	26.6	22.2	22.2	24.7
LTE FDD B4 / B66	2	26.1	22.2	22.2	24.7
LTE FDD B5 / B26	1	29.4	29.4	29.4	25.0
LTE FDD B7	2	27.6	21.2	21.2	23.2
LTE FDD B12 / B17	1	30.0	30.0	30.0	25.0
LTE FDD B13	1	29.9	29.9	29.9	25.0
LTE FDD B30	2	25.0	25.0	25.0	22.2
LTE TDD B41 (PC3)	2	23.8	23.8	23.8	22.7
LTE TDD B41 (PC2)	2	23.8	23.8	23.8	23.6
LTE TDD B48	11	21.5	21.5	21.5	21.2
LTE FDD B71	1	29.7	29.7	29.7	25.0
SUB6 NR FDD n2 / n25	3	22.9	22.9	22.9	25.0
SUB6 NR TDD n41 (PC3)	3	23.2	23.2	23.2	18.9
SUB6 NR TDD n41 (PC2)	3	23.2	23.2	23.2	20.9
SUB6 NR FDD n66	3	22.9	22.9	22.9	25.0
SUB6 NR FDD n71	1	32.8	32.8	32.8	25.0

* Maximum tune up target power, P_{max} , is configured in NV settings in EUT to limit maximum transmitting power. This power is converted into peak power in NV settings for TDD schemes. The EUT maximum allowed output power is equal to $P_{max} + 0.5\text{dB}$ device uncertainty.

Based on selection criteria described in Section 3.2.1, the selected technologies/bands for testing time-varying test sequences are highlighted in yellow in Table 4-1. As per Part 1 report, the

Reserve_power_margin (dB) for LGE portable handset (FCC ID: ZNFV600TM) is set to 3dB in EFS, and is used in Part 2 test.

The radio configurations used in Part 2 test for selected technologies, bands, DSIs and antennas are listed in Table 4-2. The corresponding worst-case radio configuration 1gSAR or 10gSAR values for selected technology/band/DSI are extracted from Part 1 report and are listed in the last column of Table 4-2.

Based on equations (1a) and (2a), it is clear that Part 2 testing outcome is normalized quantity, which implies that it can be applied to any radio configuration within a selected technology/band/DSI. Thus, as long as applying the worst-case SAR obtained from the worst radio configuration in Part 1 testing to calculate time-varying SAR exposure in equations (1a) and (2a), the accuracy in compliance demonstration remains the same.

Table 4-2: Radio configurations selected for Part 2 test

Part 2 test configurations												Part 1 worst-case radio config 1g or 10g SAR measured at Plimit (W/kg)
Test case#	Test scenario	Tech	Band	Ant	DSI	Channel	Freq (MHz)	RB/offset	Mode	Device position	Detail	
1	time-varying Tx power transmission	LTE	B7	2	5	mid	2535	1/0/20 MHz	QPSK	bottom	hotspot/1g/10mm	0.486
2			B2	2	5	mid	1880	1/0/10 MHz	QPSK	bottom	hotspot/1g/10mm	0.752
3		WCDMA	B4	2	5	1412	1732.4	-	RMC	bottom	hotspot/1g/10mm	0.691
4		CDMA	BC1	2	5	600	1880	-	EVDO Rev. 0	bottom	hotspot/1g/10mm	0.655
5		sub6 NR	n66	3	5	349000	1745	1/25/20 MHz	QPSK	Right	hotspot/1g/10mm	0.431
6	change in call	LTE	B7	2	5	mid	2535	1/0/20 MHz	QPSK			0.486
7	Tech/band switch	LTE	B7	2	5	mid	2535	1/0/20 MHz	QPSK			0.486
		WCDMA	B4	2	5	1412	1732.4	-	RMC			0.691
8	DSI switch	LTE	B7	2	5	mid	2535	1/0/20 MHz	QPSK			0.486
		LTE	B7	2	1	mid	2535	1/0/20 MHz	QPSK			1.11
9	Time window/ antenna switch	LTE	B7	2	5	mid	2535	1/0/20 MHz	QPSK			0.486
		LTE	B48	11	5	55990	3625	1/0/20 MHz	QPSK			1.18
10	SAR1 vs SAR2	LTE	B5	1	5	20525	836.5	1/0/20 MHz	QPSK			0.385
		sub6 NR	n66	3	5	349000	1745	1/25/20 MHz	QPSK			0.431

Note that the EUT has a proximity sensor to manage extremity exposure at 0mm on front/back/bottom surfaces, which is represented using DSI = 8; the hotspot exposure is distinguished via hotspot mode, represented as DSI = 5; DSI = 1 represents all other exposures which cannot be distinguished (i.e., when proximity sensor is not active), thus, in this case, the maximum 1gSAR and/or 10gSAR among all remaining exposure scenarios or the minimum P_{limit} among all remaining exposure scenarios (i.e., head exposure, body worn 1gSAR evaluation, phablet 10gSAR extremity evaluation at 0mm spacing on left surface, 1mm on front, 2mm on back, and 3mm on bottom surface). These DSIs are used in Smart Transmit feature for time averaging operation.

Based on the selection criteria described in Section 3.2, the radio configurations for the Tx varying transmission test cases listed in Section 2 are:

1. Technologies and bands for time-varying Tx power transmission: The test case 1~5 listed in Table 4-2 are selected to test with the test sequences defined in Section 3.1 in both time-varying conducted power measurement and time-varying SAR measurement. Note that only one CDMA EVDO band, one WCDMA band, and one sub6 NR band (and no GSM bands) were selected as the second band for these technologies has P_{limit} greater than P_{max} , requiring no Tx power limitation.

2. Technology and band for change in call test: LTE B7 having the lowest P_{limit} among all technologies and bands (test case 6 in Table 4-2) is selected for performing the call drop test in conducted power setup.
3. Technologies and bands for change in technology/band test: Following the guidelines in Section 3.2.3 and 3.2.4, test case 7 in Table 4-2 is selected for handover test from a technology/band/antenna with lowest P_{limit} within one technology group (LTE B7, DSI=5, antenna 2), to a technology/band in the same DSI with highest P_{limit} within another technology group (WCDMA B4, DSI=5, antenna 2) in conducted power setup.
4. Technologies and bands for change in DSI: Based on selection criteria in Section 3.2.5, for a given technology and band, test case 8 in Table 4-2 is selected for DSI switch test by establishing a call in LTE B7 in DSI=5 (hotspot condition), and then handing over to DSI = 1 (no hotspot, no proximity sensor) in conducted power setup.
5. Technologies and bands for change in time-window/antenna: Based on selection criteria in Section 3.2.6, for a given DSI=5, test case 9 in Table 4-2 is selected for time window switch between 60s window (LTE B48, Antenna 11) and 100s window (LTE B7, Antenna 2) in conducted power setup.
6. Technologies and bands for switch in SAR exposure: Based on selection criteria in Section 3.2.7 Scenario 1 (test case 10 in Table 4-2) is the supported simultaneous WWAN transmission scenario, i.e., LTE + Sub6 NR, selected for SAR exposure switching test in conducted power setup. Scenario 2 in Section 3.2.7 is not supported by this device.

5 Conducted Power Test Results for Sub-6 Smart Transmit Feature Validation

5.1 Measurement setup

The Rohde & Schwarz CMW500 callbox is used in this test. The test setup picture and schematic are shown in Figures 5-1a & 5-1c for measurements with a single antenna of EUT, and in Figures 5-1b & 5-1d for measurements involving antenna switch (see Appendix E for missing figures). For single antenna measurement, one port (RF1 COM) of the callbox is connected to the RF port of the EUT using a directional coupler. For antenna & technology switch measurement, two ports (RF1 COM and RF3 COM) of the callbox used for signaling two different technologies are connected to a combiner, which is in turn connected to a directional coupler. The other end of the directional coupler is connected to a splitter to connect to two RF ports of the EUT corresponding to the two antennas of interest. In both the setups, power meter is used to tap the directional coupler for measuring the conducted output power of the EUT. For time averaging validation test (Section 3.3.1), call drop test (Section 3.3.2), and DSI switch test (Section 3.3.4), only RF1 COM port of the callbox is used to communicate with the EUT. For technology/band switch measurement (Section. 3.3.3), both RF1 COM and RF3 COM port of callbox are used to switch from one technology communicating on RF1 COM port to another technology communicating on RF3 COM port. Note that for this EUT, antenna switch test (Section 3.3.4) is included within time-window switch test (Section 3.3.6) as the selected technology/band combinations for the time-window switch test are on two different antennas. All the path losses from RF port of EUT to the callbox RF COM port and to the power meter are calibrated and automatically entered as offsets in the callbox and the power meter via test scripts on the PC used to control callbox and power meter.

LTE+Sub6 NR test setup:

If LTE conducted port and Sub6 NR conducted port are same on the device (i.e., they share the same antenna), then low-/high-pass filter is used to separate LTE and Sub6 NR signals for power meter measurement via directional couplers. On the other hand, if LTE and Sub6 NR have two different conducted ports, then power meter measurement via directional couplers is performed for both the ports separately, as shown in below Figures 5-1e & 5-1f.

See Figure 5-1(a) in Appendix E

(a)

See Figure 5-1(b) in Appendix E

(b)

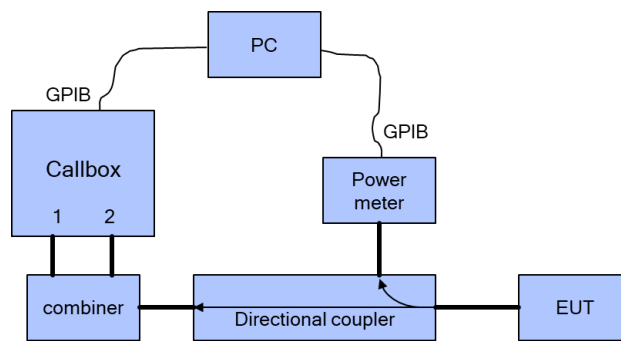

(c)

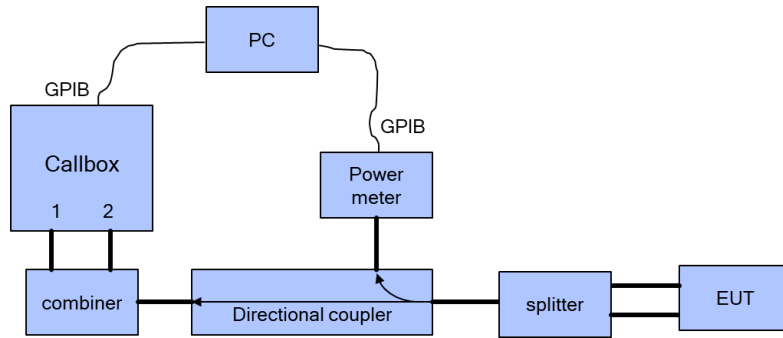

(d)

See Figure 5-1(e) in Appendix E

(e)

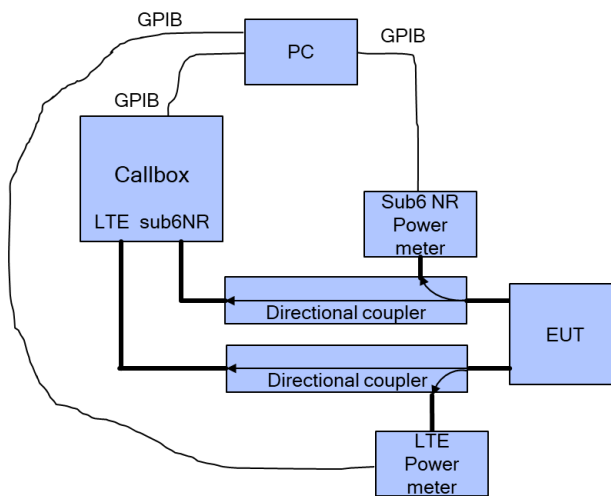

(f)

Figure 5-1 Conducted power measurement setup

Both the callbox and power meter are connected to the PC using GPIB cables. Two test scripts are custom made for automation, and the test duration set in the test scripts is 500 seconds.

For time-varying Tx power measurement, the PC runs the 1st test script to send GPIB commands to control the callbox's requested power versus time, while at the same time to record the conducted power measured at EUT RF port using the power meter. The commands sent to the callbox to request power are:

- 0dBm for 100 seconds
- test sequence 1 or test sequence 2 (defined in Section 3.1 and generated in Section 3.2.1), for 360 seconds
- stay at the last power level of test sequence 1 or test sequence 2 for the remaining time.

Power meter readings are periodically recorded every 100ms. A running average of this measured Tx power over 100 seconds is performed in the post-data processing to determine the 100s-time averaged power.

For call drop, technology/band/antenna switch, and DSI switch tests, after the call is established, the callbox is set to request the EUT's Tx power at 0dBm for 100 seconds while simultaneously starting the 2nd test script runs at the same time to start recording the Tx power measured at EUT RF port using the power meter. After the initial 100 seconds since starting the Tx power recording, the callbox is set to request maximum power from the EUT for the rest of the test. Note that the call drop/re-establish, or technology/band/antenna switch or DSI switch is manually performed when the Tx power of EUT is at $P_{reserve}$ level. See Section 3.3 for detailed test procedure of call drop test, technology/band/antenna switch test and DSI switch test.

5.2 P_{limit} and P_{max} measurement results

The measured P_{limit} for all the selected radio configurations given in Table 4-2 are listed in below Table 5-1. P_{max} was also measured for radio configurations selected for testing time-varying Tx power transmission scenarios in order to generate test sequences following the test procedures in Section 3.1.

Table 5-1: Measured P_{limit} and P_{max} of selected radio configurations

Test case#	Test scenario	Tech	Band	Ant	DSI	Channel	Freq (MHz)	RB/offset	Mode	Detail	Device Serial Number	Plimit EFS setting (dBm)	Max tune up target power Pmax (dBm) (avg power)	measured Plimit (dBm)	measured Pmax (dBm)
1	time-varying Tx power transmission	LTE	B7	2	5	mid	2535	1/0/20 MHz	QPSK	hotspot/1g/10mm	4547	21.20	23.20	21.23	23.25
2			B2	2	5	mid	1880	1/0/10 MHz	QPSK	hotspot/1g/10mm	4554	22.20	24.70	22.17	24.58
3		WCDMA	B4	2	5	1412	1732.4	-	RMC	hotspot/1g/10mm	4547	22.20	24.70	22.36	24.46
4		CDMA	BC1	2	5	600	1880	-	EVDO Rev. 0	hotspot/1g/10mm	4554	22.20	24.70	21.80	23.87
5		sub6 NR	n66	3	5	349000	1745	1/25/20 MHz	QPSK	hotspot/1g/10mm	4547	22.90	25.00	22.98	24.47
6	change in call	LTE	B7	2	5	mid	2535	1/0/20 MHz	QPSK		4554	21.20	23.20	19.99	
7	Tech/band switch	LTE	B7	2	5	mid	2535	1/0/20 MHz	QPSK		4554	21.20	23.20	19.99	
		WCDMA	B4	2	5	1412	1732.4	-	RMC			22.20	24.70	22.40	
8	DSI switch	LTE	B7	2	5	mid	2535	1/0/20 MHz	QPSK		4554	21.20	23.20	19.99	
		LTE	B7	2	1	mid	2535	1/0/20 MHz	QPSK			25.20	23.20	21.91	
9	Time window / Antenna switch	LTE	B7	2	5	mid	2535	1/0/20 MHz	QPSK		4547	21.20	23.20	21.23	
		LTE	B48	11	5	55990	3625	1/0/20 MHz	QPSK			21.50	21.20	21.35	
10	SAR1 vs SAR2	LTE	B5	1	5	20525	836.5	1/0/20 MHz	QPSK		4547	29.40	25.00	25.02	
		sub6 NR	n66	3	5	349000	1745	1/25/20 MHz	QPSK			22.90	25.00	22.98	

Note: the device uncertainty of P_{max} is +0.5dB/-1.5dB as provided by manufacturer.

5.3 Time-varying Tx power measurement results

The measurement setup is shown in Figures 5-1(a) and 5-1(c). The purpose of the time-varying Tx power measurement is to demonstrate the effectiveness of power limiting enforcement and that the time-averaged Tx power when represented in time-averaged 1gSAR or 10gSAR values does not exceed FCC limit as shown in Eq. (1a) and (1b), rewritten below:

$$1g_or_10gSAR(t) = \frac{conducted_Tx_power(t)}{conducted_Tx_power_P_{limit}} * 1g_or_10gSAR_P_{limit} \quad (1a)$$

$$\frac{\frac{1}{T_{SAR}} \int_{t-T_{SAR}}^t 1g_or_10gSAR(t) dt}{FCC\ SAR\ limit} \leq 1 \quad (1b)$$

where, $conducted_Tx_power(t)$, $conducted_Tx_power_P_{limit}$, and $1g_or_10gSAR_P_{limit}$ correspond to the measured instantaneous conducted Tx power, measured conducted Tx power at P_{limit} , and measured 1gSAR and 10gSAR values at P_{limit} reported in Part 1 test (listed in Table 4-2 of this report as well).

Following the test procedure in Section 3.3, the conducted Tx power measurement for all selected configurations are reported in this section. In all the conducted Tx power plots, the dotted line represents the requested power by callbox (test sequence 1 or test sequence 2), the blue curve represents the instantaneous conducted Tx power measured using power meter, the green curve represents time-averaged power and red line represents the conducted power limit that corresponds to FCC limit of 1.6 W/kg for 1gSAR or 4.0 W/kg for 10gSAR.

Similarly, in all the 1g or 10gSAR plots (when converted using Eq. (1a)), the green curve represents the 100s/60s-time averaged 1gSAR or 10gSAR value calculated based on instantaneous 1gSAR or 10gSAR; and the red line limit represents the FCC limit of 1.6 W/kg for 1gSAR or 4.0 W/kg for 10gSAR.

Time-varying Tx power measurements were conducted on test cases #1 ~ #5 in Table 4-2, by generating test sequence 1 and test sequence 2 given in Appendix A using measured P_{limit} and measured P_{max} (last two columns of Table 5-1) for each of these test cases. Measurement results for test cases #1 ~ #5 are given in Sections 5.3.1 - 5.3.5.

5.3.1 LTE Band 7 (test case 1 in Table 4-2)

Test result for test sequence 1:

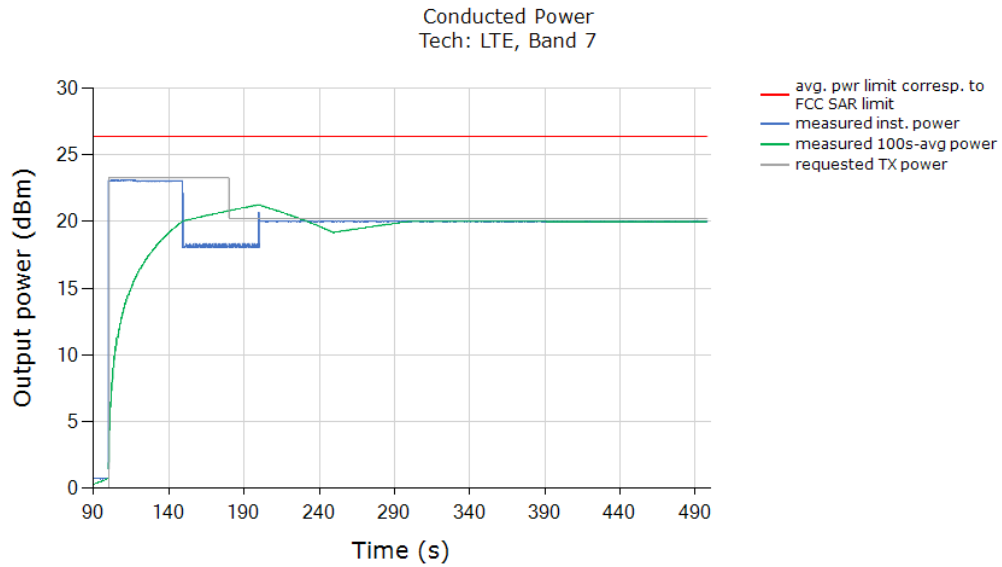

Above time-averaged conducted Tx power is converted/calculated into time-averaged 1gSAR using Equation (1a) and plotted below to demonstrate that the time-averaged 1gSAR versus time does not exceed the FCC limit of 1.6 W/kg for 1gSAR:

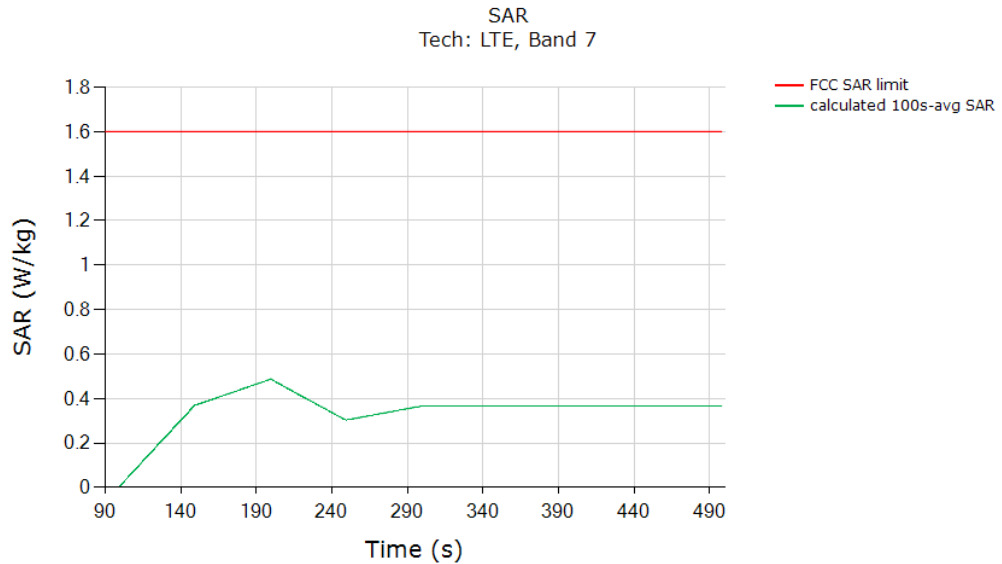

	(W/kg)
FCC 1gSAR limit	1.6
Max 100s-time averaged 1gSAR (green curve)	0.487
<p>Validated: Max time averaged SAR (green curve) is within +0.5dB/-1.5dB device uncertainty of 0.486 W/kg of measured SAR at P_{limit} (last column in Table 4-2).</p>	

Test result for test sequence 2:

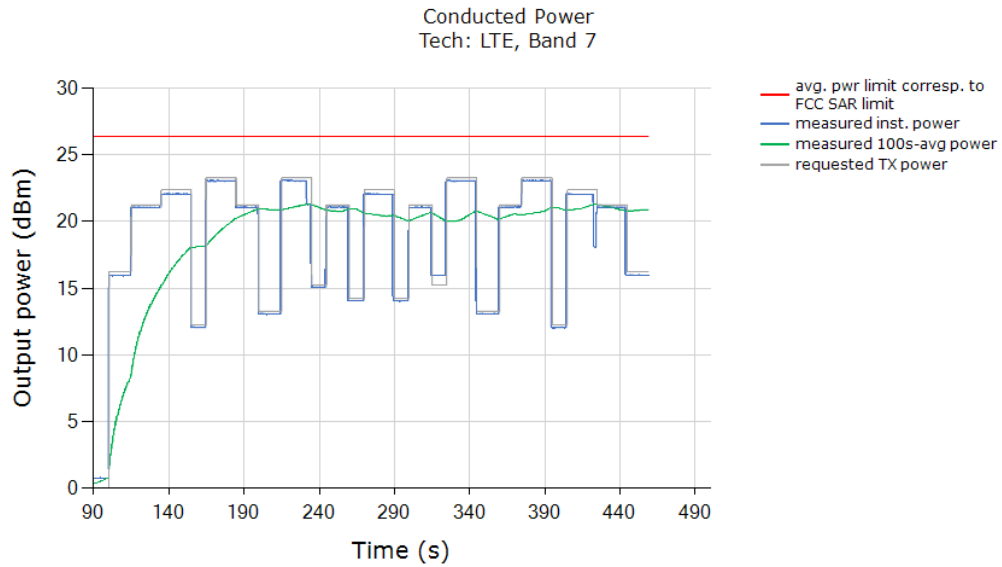

Above time-averaged conducted Tx power is converted/calculated into time-averaged 1gSAR using Equation (1a) and plotted below to demonstrate that the time-averaged 1gSAR versus time does not exceed the FCC limit of 1.6 W/kg for 1gSAR:

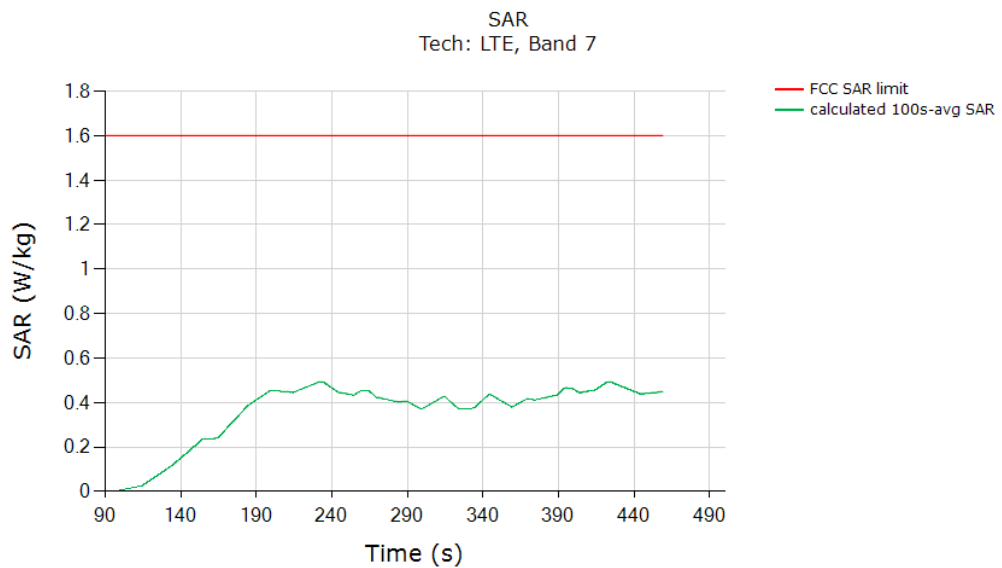

	(W/kg)
FCC 1gSAR limit	1.6
Max 100s-time averaged 1gSAR (green curve)	0.492
Validated: Max time averaged SAR (green curve) is within +0.5dB/-1.5dB device uncertainty of 0.486 W/kg of measured SAR at P_{limit} (last column in Table 4-2).	

5.3.2 LTE Band 2 (test case 2 in Table 4-2)

Test result for test sequence 1:

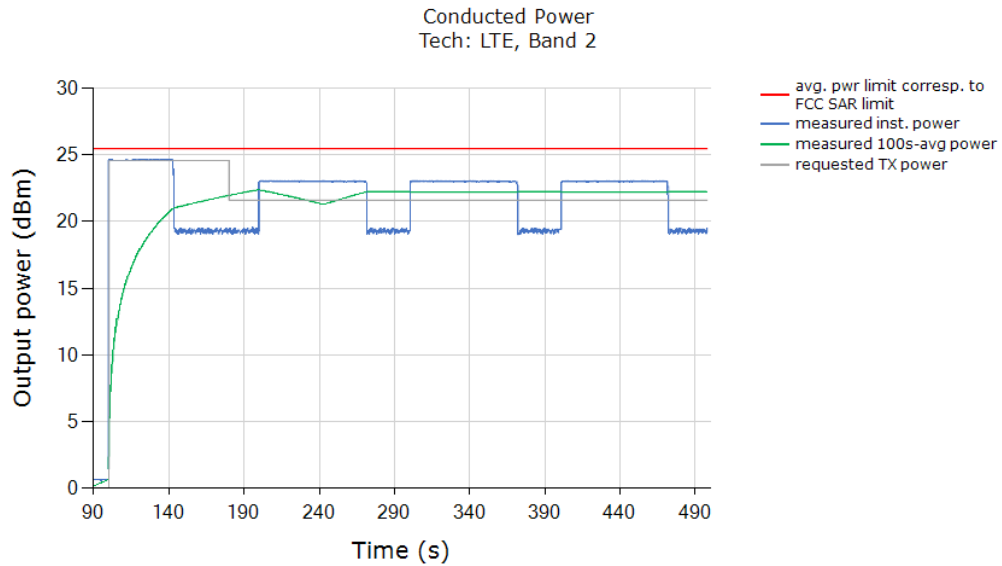

Above time-averaged conducted Tx power is converted/calculated into time-averaged 1gSAR using Equation (1a) and plotted below to demonstrate that the time-averaged 1gSAR versus time does not exceed the FCC limit of 1.6 W/kg for 1gSAR:

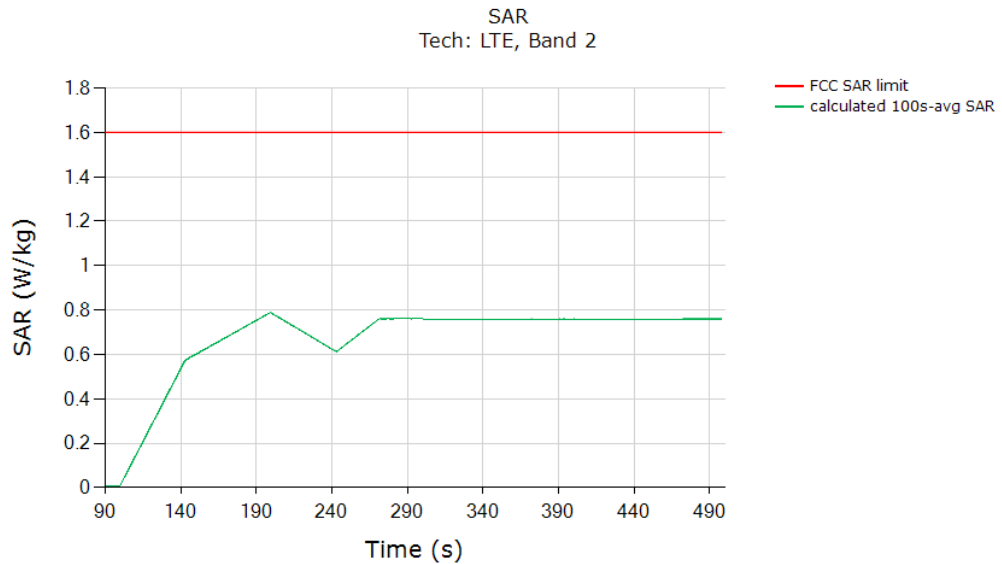

	(W/kg)
FCC 1gSAR limit	1.6
Max 100s-time averaged 1gSAR (green curve)	0.789
Validated: Max time averaged SAR (green curve) is within +0.5dB/-1.5dB device uncertainty of 0.752 W/kg of measured SAR at P_{limit} (last column in Table 4-2).	

Test result for test sequence 2:

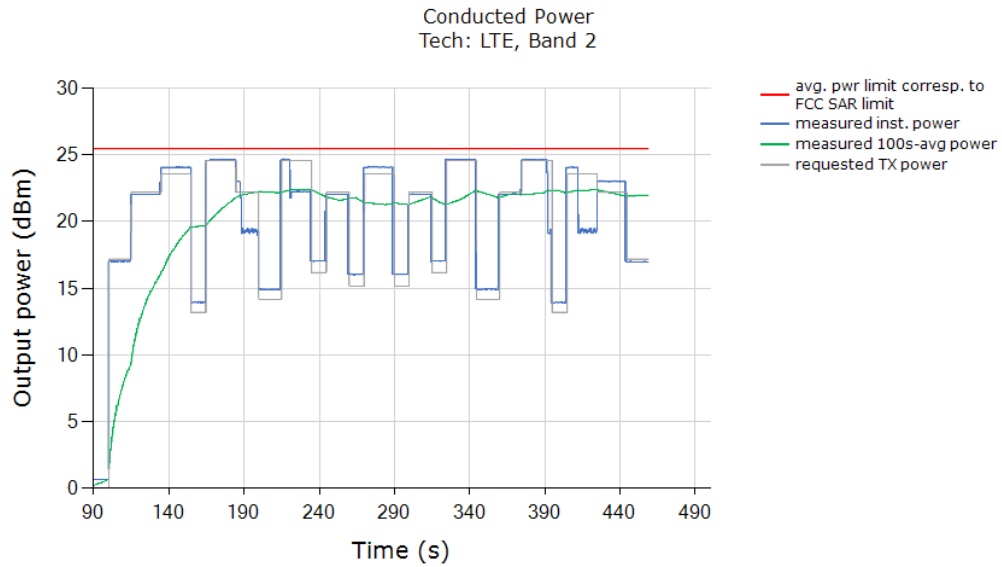

Above time-averaged conducted Tx power is converted/calculated into time-averaged 1gSAR using Equation (1a) and plotted below to demonstrate that the time-averaged 1gSAR versus time does not exceed the FCC limit of 1.6 W/kg for 1gSAR:

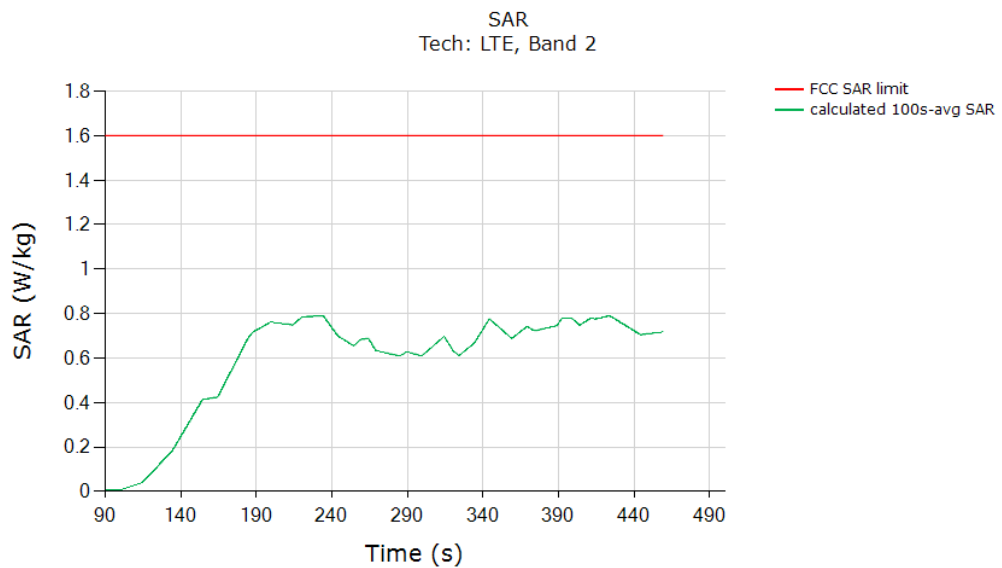

	(W/kg)
FCC 1gSAR limit	1.6
Max 100s-time averaged 1gSAR (green curve)	0.79
Validated: Max time averaged SAR (green curve) is within +0.5dB/-1.5dB device uncertainty of 0.752 W/kg of measured SAR at P_{limit} (last column in Table 4-2).	

5.3.3 WCDMA Band 4 (test case 3 in Table 4-2)

Test result for test sequence 1:

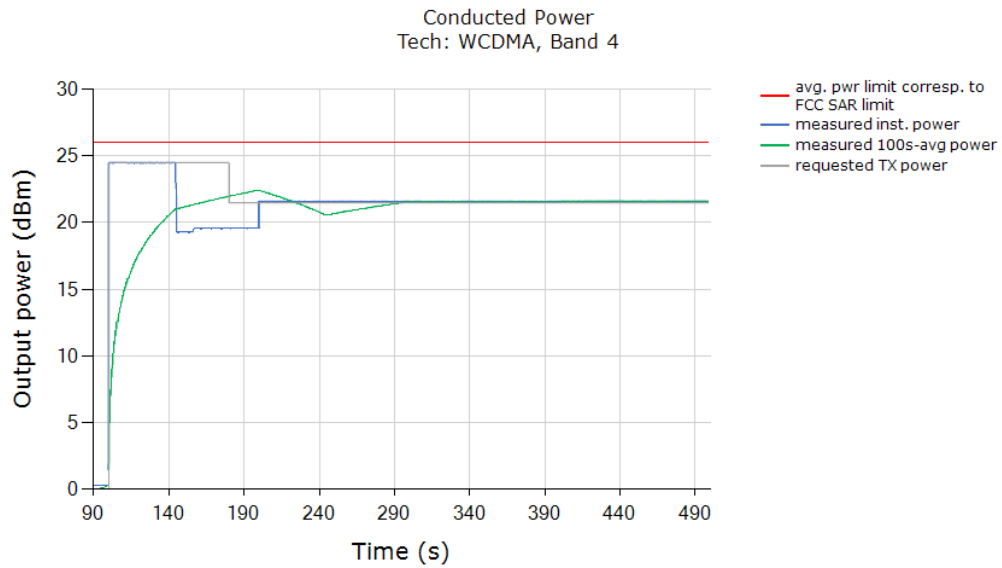

Above time-averaged conducted Tx power is converted/calculated into time-averaged 1gSAR using Equation (1a) and plotted below to demonstrate that the time-averaged 1gSAR versus time does not exceed the FCC limit of 1.6 W/kg for 1gSAR:

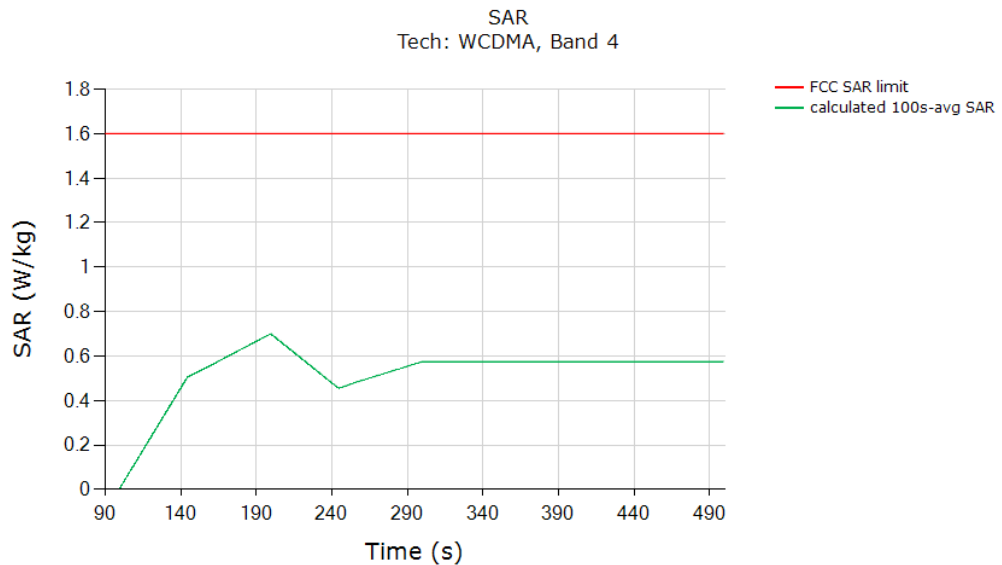

	(W/kg)
FCC 1gSAR limit	1.6
Max 100s-time averaged 1gSAR (green curve)	0.700
Validated: Max time averaged SAR (green curve) is within +0.5dB/-1.5dB device uncertainty of 0.691 W/kg of measured SAR at P_{limit} (last column in Table 4-2).	

Test result for test sequence 2:

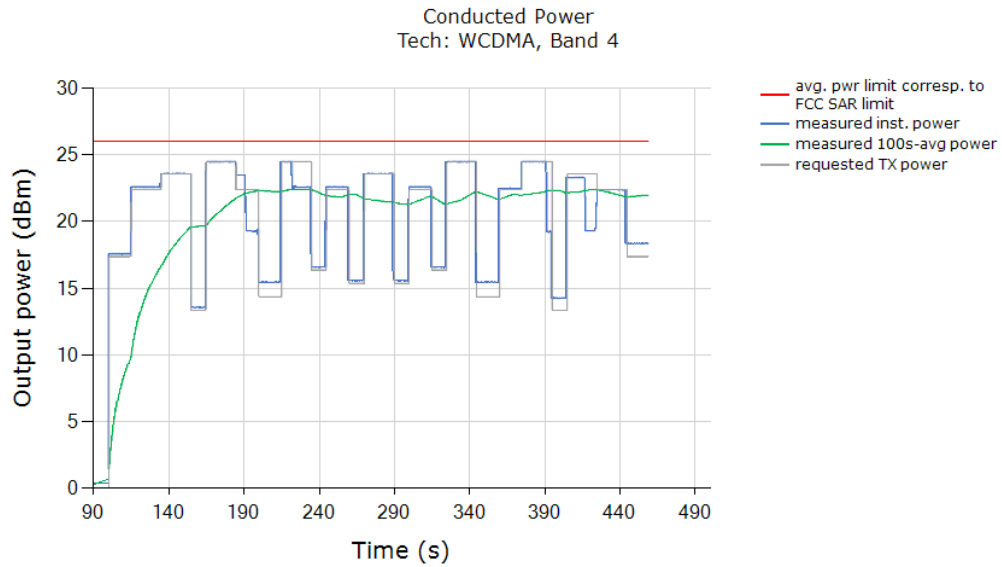

Above time-averaged conducted Tx power is converted/calculated into time-averaged 1gSAR using Equation (1a) and plotted below to demonstrate that the time-averaged 1gSAR versus time does not exceed the FCC limit of 1.6 W/kg for 1gSAR:

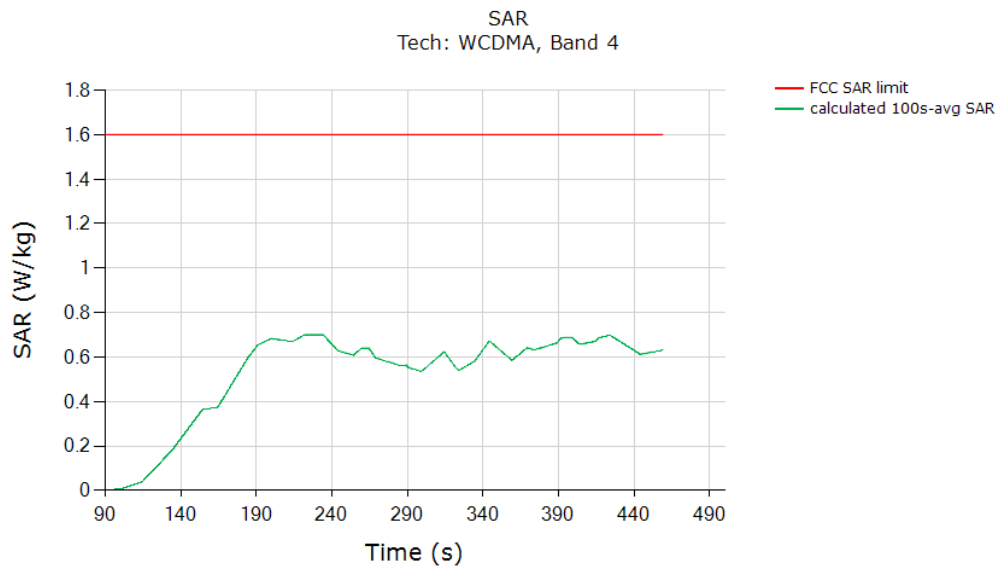

	(W/kg)
FCC 1gSAR limit	1.6
Max 100s-time averaged 1gSAR (green curve)	0.699
Validated: Max time averaged SAR (green curve) is within +0.5dB/-1.5dB device uncertainty of 0.691 W/kg of measured SAR at P_{limit} (last column in Table 4-2).	

5.3.4 CDMA/EVDO BC1 (test case 4 in Table 4-2)

Test result for test sequence 1:

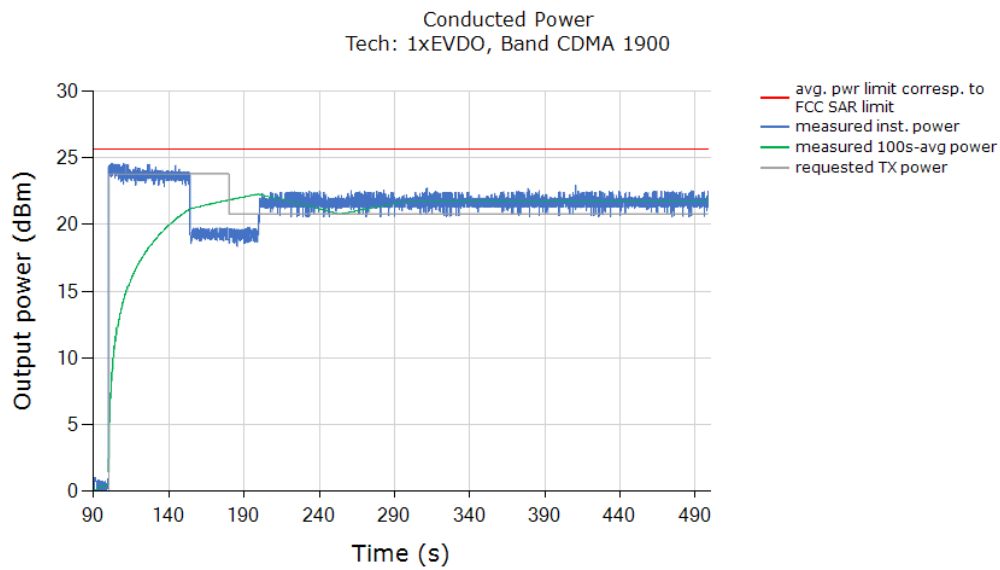

Above time-averaged conducted Tx power is converted/calculated into time-averaged 1gSAR using Equation (1a) and plotted below to demonstrate that the time-averaged 1gSAR versus time does not exceed the FCC limit of 1.6 W/kg for 1gSAR:

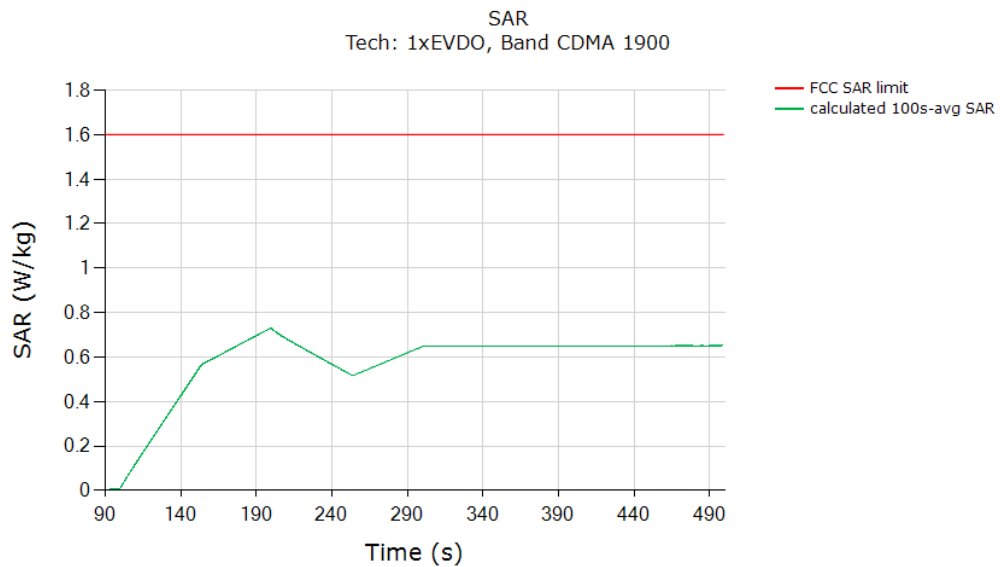

	(W/kg)
FCC 1gSAR limit	1.6
Max 100s-time averaged 1gSAR (green curve)	0.730
Validated: Max time averaged SAR (green curve) is within +0.5dB/-1.5dB device uncertainty of 0.655 W/kg of measured SAR at P_{limit} (last column in Table 4-2).	

Test result for test sequence 2:

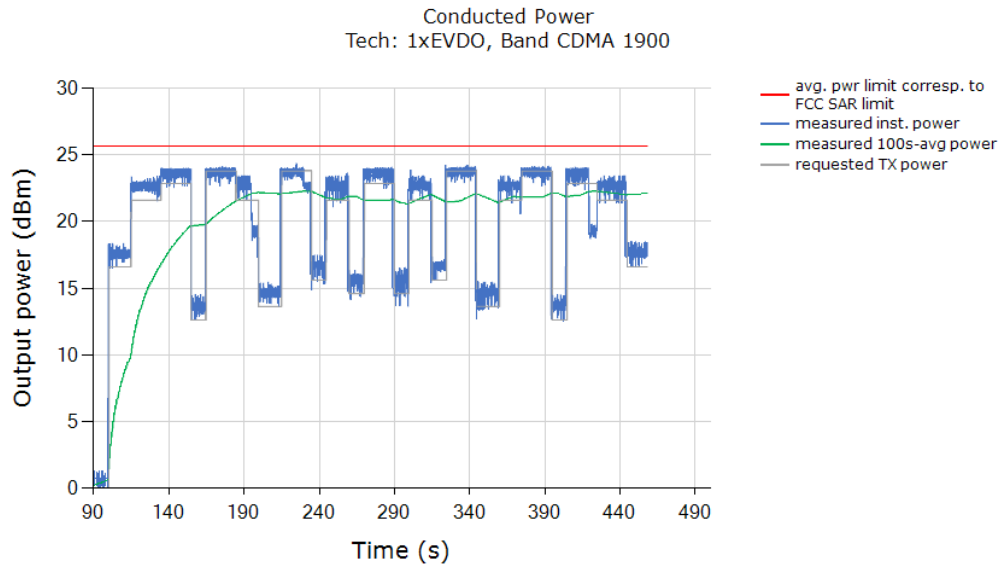

Above time-averaged conducted Tx power is converted/calculated into time-averaged 1gSAR using Equation (1a) and plotted below to demonstrate that the time-averaged 1gSAR versus time does not exceed the FCC limit of 1.6 W/kg for 1gSAR:

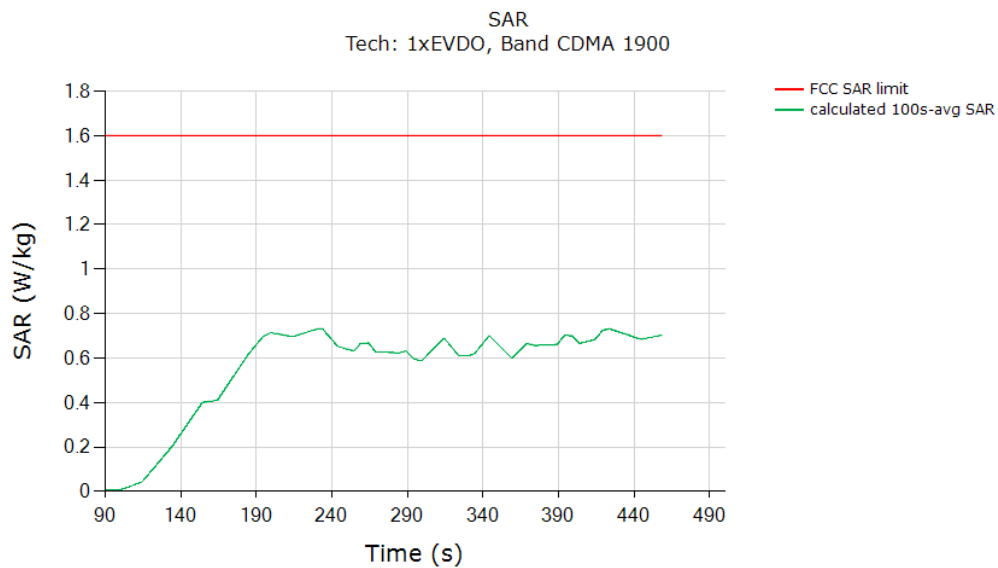

	(W/kg)
FCC 1gSAR limit	1.6
Max 100s-time averaged 1gSAR (green curve)	0.731
Validated: Max time averaged SAR (green curve) is within +0.5dB/-1.5dB device uncertainty of 0.655 W/kg of measured SAR at P_{limit} (last column in Table 4-2).	

5.3.5 Sub6 NR Band n66 (test case 5 in Table 4-2)

Test result for test sequence 1:

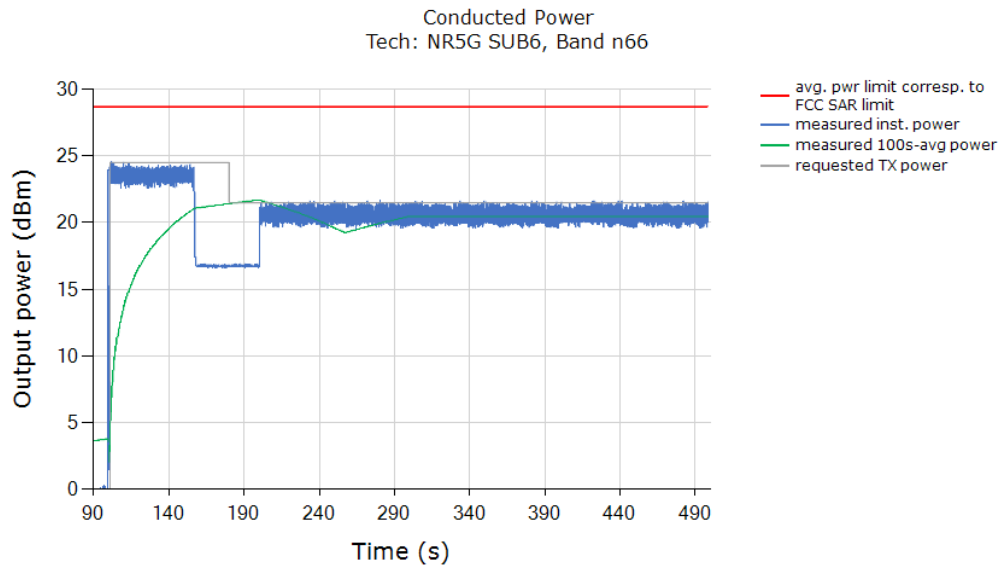

Above time-averaged conducted Tx power is converted/calculated into time-averaged 1gSAR using Equation (1a) and plotted below to demonstrate that the time-averaged 1gSAR versus time does not exceed the FCC limit of 1.6 W/kg for 1gSAR:

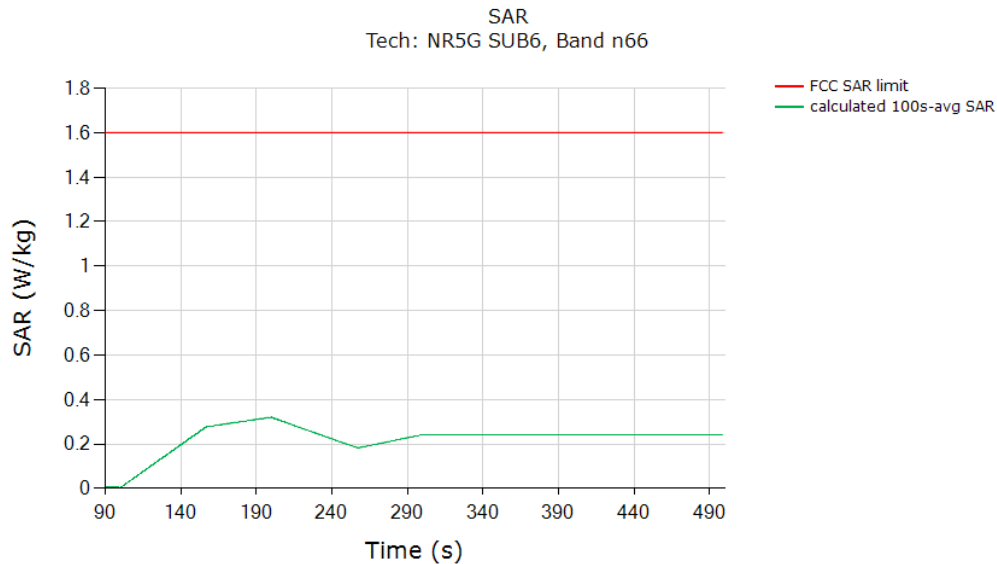

	(W/kg)
FCC 1gSAR limit	1.6
Max 100s-time averaged 1gSAR (green curve)	0.320
<p>Validated: Max time averaged SAR (green curve) is within +0.5dB/-1.5dB device uncertainty of 75% (with 3dB Reserve_power_margin setting) of 0.431 W/kg measured SAR at P_{limit} (last column in Table 4-2).</p>	

Test result for test sequence 2:

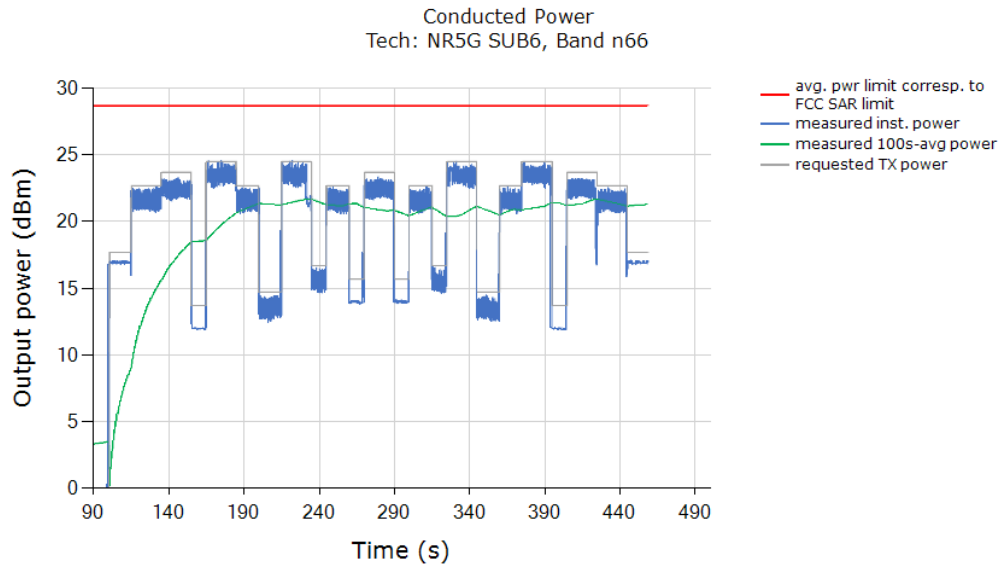

Above time-averaged conducted Tx power is converted/calculated into time-averaged 1gSAR using Equation (1a) and plotted below to demonstrate that the time-averaged 1gSAR versus time does not exceed the FCC limit of 1.6 W/kg for 1gSAR:

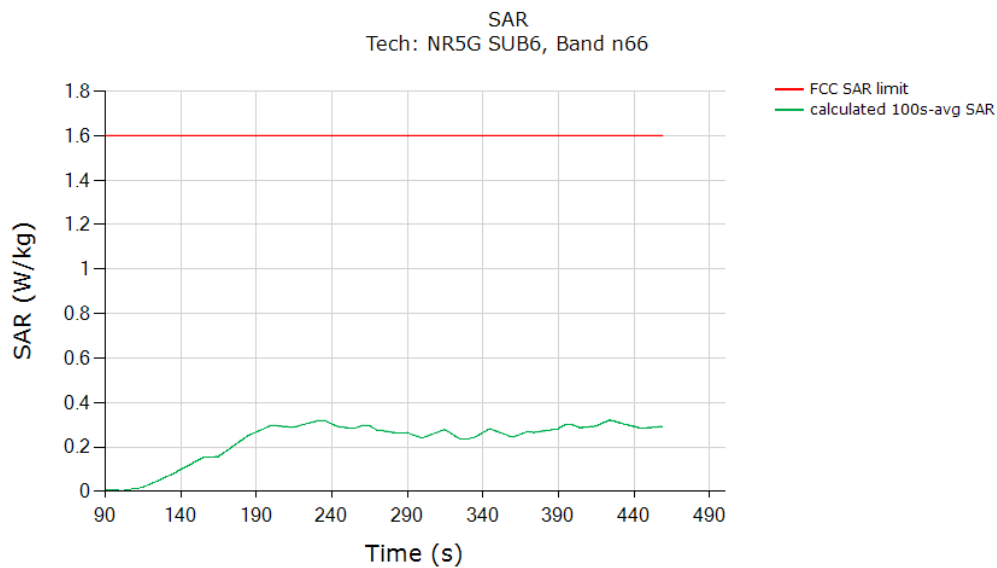

	(W/kg)
FCC 1gSAR limit	1.6
Max 100s-time averaged 1gSAR (green curve)	0.320
Validated: Max time averaged SAR (green curve) is within +0.5dB/-1.5dB device uncertainty of 75% (with 3dB Reserve_power_margin setting) of 0.431 W/kg measured SAR at P_{limit} (last column in Table 4-2).	

5.4 Change in Call Test Results (test case 6 in Table 4-2)

This test was measured with LTE B7, Antenna 2, DSI=5, and with callbox requesting maximum power. The call drop was manually performed when the EUT is transmitting at $P_{reserve}$ level as shown in the plot below (dotted black region). The measurement setup is shown in Figure 5-1(a) and (c). The detailed test procedure is described in Section 3.3.2.

Call drop test result:

Plot 1: Measured Tx power (dBm) versus time shows that the transmitting power kept the same $P_{reserve}$ level of LTE B7 after the call was re-established:

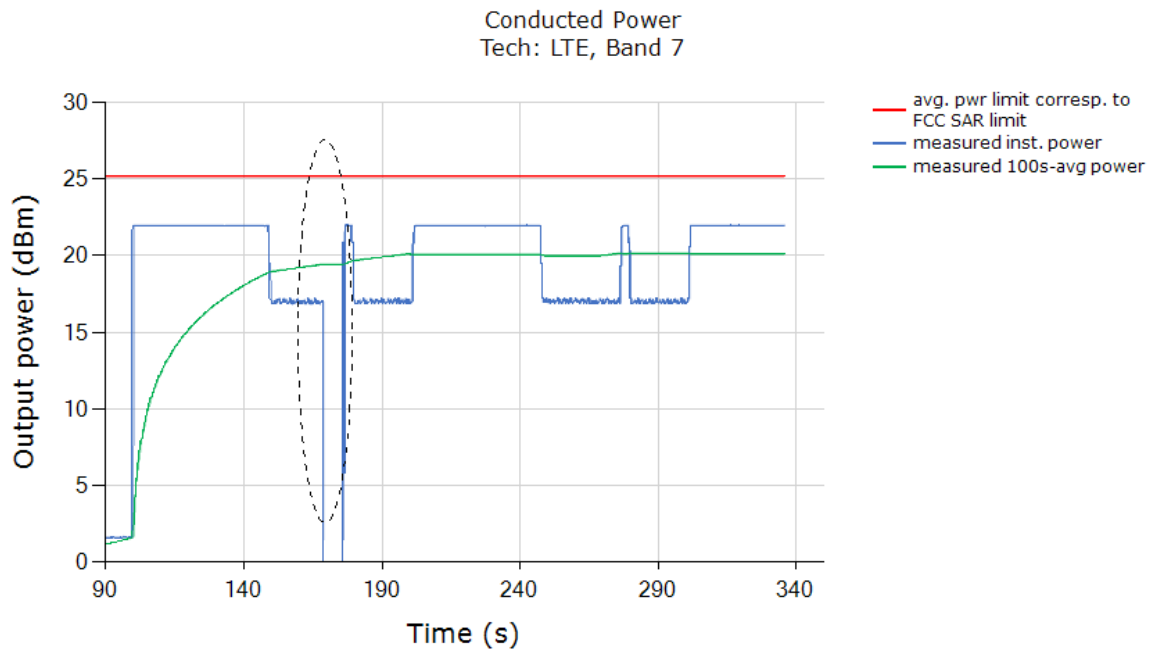

Note: The power level after the change in call kept the same $P_{reserve}$ level of LTE B7. The conducted power plot shows expected Tx transition.

Plot 2: Above time-averaged conducted Tx power is converted/calculated into time-averaged 1gSAR using Equation (1a) and plotted below to demonstrate that the time-averaged 1gSAR versus time does not exceed the FCC limit of 1.6 W/kg for 1gSAR:

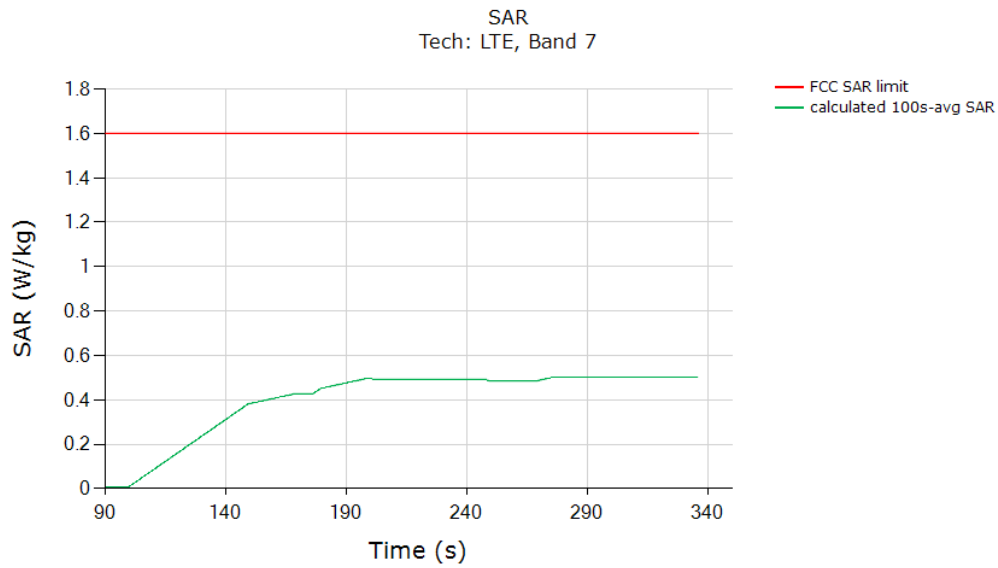

	(W/kg)
FCC 1gSAR limit	1.6
Max 60s-time averaged 1gSAR (green curve)	0.501
Validated: The test result showed the continuity of power limiting in call change scenario, and maximum time averaged SAR (green curve) is within +0.5dB/-1.5dB device uncertainty of 0.486 W/kg of measured SAR at P_{limit} (last column in Table 4-2).	

5.5 Change in technology/band test results (test case 7 in Table 4-2)

This test was conducted with callbox requesting maximum power, and with antenna & technology switch from LTE B7, Antenna 2, DSI = 5, to WCDMA B4, Antenna 2, DSI =5. Following procedure detailed in Section 3.3.3, and using the measurement setup shown in Figure 5-1(a) and (c), the technology/band switch was performed as shown in the plot below (dotted black region).

Test result for change in technology/band:

Plot 1: Measured Tx power (dBm) versus time shows that the transmitting power changed when tech/band changed from LTE B7, Antenna 2, DSI =5 to WCDMA B4, Antenna 2, DSI = 5:

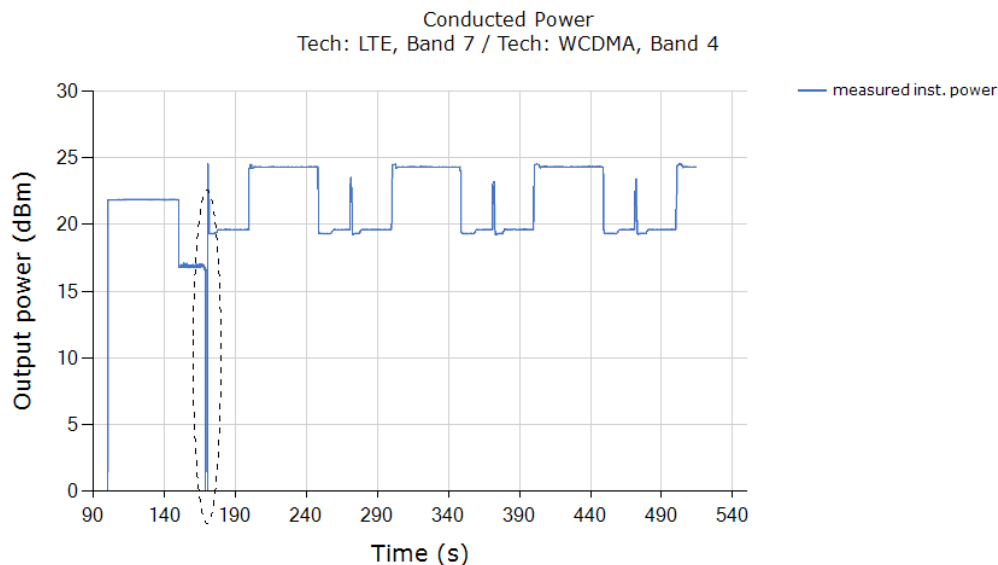

Note: As per Part 1 report, $Reserve_power_margin = 3\text{dB}$. Based on Table 4-1, EFS $P_{limit} = 21.2\text{dBm}$ (measured $P_{limit} = 19.99\text{dBm}$) for LTE B7 (DSI=5), and EFS $P_{limit} = 22.2\text{dBm}$ (measured $P_{limit} = 22.4\text{dBm}$) for WCDMA B4 (DSI=5), it can be seen from above plot that the difference in $P_{reserve} (= P_{limit} - 3\text{dB } Reserve_power_margin)$ power level corresponds directly to the expected difference in measured P_{limit} levels, which are within $+0.5\text{dB}/-1.5\text{dB}$ sub6 radio design-related uncertainty. Therefore, the conducted power plot shows expected transition in Tx power.

Plot 2: All the time-averaged conducted Tx power measurement results were converted into time-averaged normalized SAR values using Equation (4a), (4b) and (4c), and plotted below to demonstrate that the time-averaged normalized SAR versus time does not exceed the normalized FCC limit of 1.0:

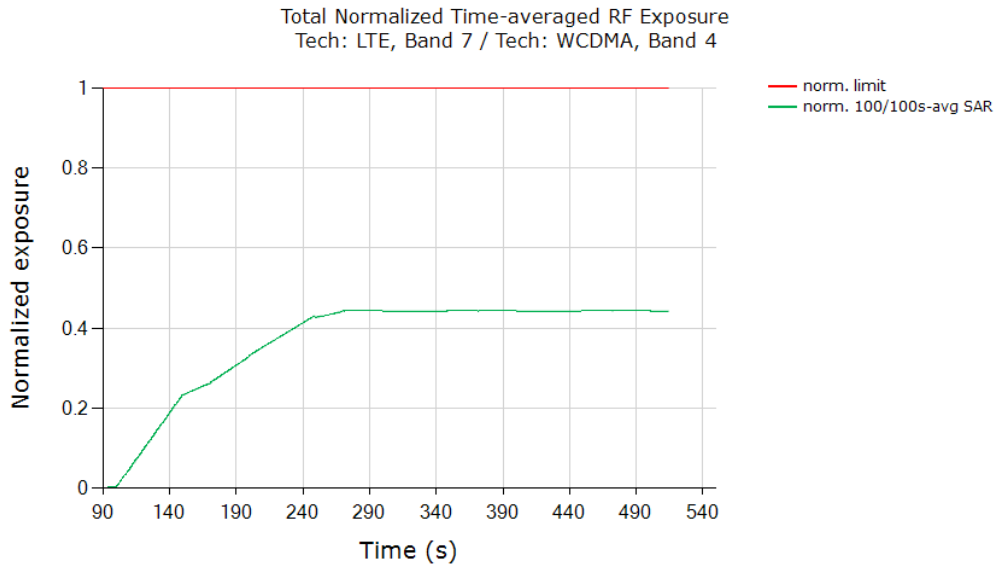

	(W/kg)
FCC normalized SAR limit	1.0
Max 100s-time averaged normalized SAR (green curve)	0.444
<p>Validated: The test result showed the continuity of power limiting in technology/band switch scenario, and maximum time averaged normalized SAR (green curve) is within +0.5dB/-1.5dB device uncertainty of 0.432 (=0.691 W/kg /1.6 W/kg for WCDMA B4) measured normalized SAR at P_{limit} (last column in Table 4-2).</p>	

5.6 Change in DSI test results (test case 8 in Table 4-2)

This test was conducted with callbox requesting maximum power, and with DSI switch from LTE B7 DSI = 5 (hotspot) to DSI = 1 (no hotspot, no proximity sensor triggered). Following procedure detailed in Section 3.3.5 using the measurement setup shown in Figure 5-1(a) and (c), the DSI switch was performed when the EUT is transmitting at $P_{reserve}$ level as shown in the plot below (dotted black circle).

Test result for change in DSI:

Plot 1: Measured Tx power (dBm) versus time shows that the transmitting power changed when DSI = 5 switches to DSI = 1:

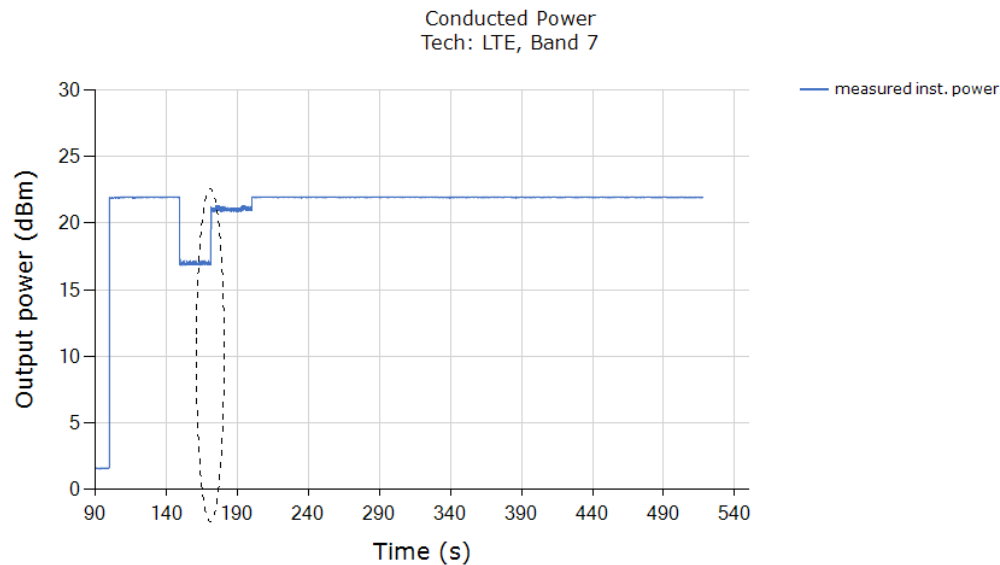

Note: As per Part 1 report, $Reserve_power_margin = 3\text{dB}$. Based on Table 4-1, EFS $P_{limit} = 21.2\text{dBm}$ (measured $P_{limit} = 19.99\text{dBm}$) for LTE B7 hotspot DSI = 5, and EFS $P_{limit} = 25.2\text{dBm}$ ($P_{max} = 23.2\text{dBm}$, measured $P_{max} = 21.9\text{dBm}$) for extremity DSI = 1. The conducted power plot shows expected Tx power transition, i.e., from $P_{reserve}$ for the first DSI (=5) before transition (~171s) to the $P_{reserve}$ for the second DSI (=1) after transition in the plot above. The difference in $P_{reserve}$ ($= P_{limit} - 3\text{dB } Reserve_power_margin$) level corresponds to the expected difference in P_{limit} levels of 4.0dB (within sub6 radio design-related uncertainty). As the call continues in DSI=1, EUT keeps transmitting at its measured P_{max} of 21.9dBm, which is within +0.5dB/-1.5dB uncertainty of EUT's P_{max} of 23.2dBm, without ever going to $P_{reserve}$. Therefore, the conducted power plot shows expected transition in Tx power.

Plot 2: All the time-averaged conducted Tx power measurement results were converted into time-averaged normalized SAR values using Equation (4a), (4b) and (4c), and plotted below to demonstrate that the time-averaged normalized SAR versus time does not exceed the FCC limit of 1 unit.

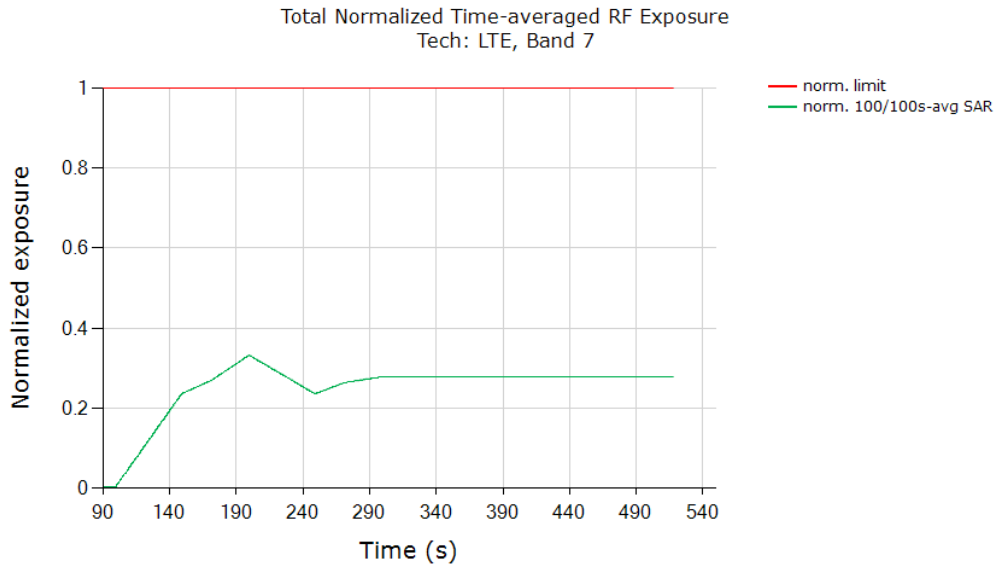

	(W/kg)
FCC normalized total exposure limit	1.0
Max 100s-time averaged normalized SAR (green curve)	0.332
Validated: The test result showed the continuity of power limiting in DSI switch scenario, and Max time averaged normalized SAR (green curve) is within +0.5dB/-1.5dB device uncertainty of 0.304 (=0.486 W/kg /1.6 W/kg for LTE B7 DSI=5) measured normalized SAR at P_{limit} (last column in Table 4-2)	

5.7 Change in Time window / antenna switch test results (test case 9 in Table 4-2)

This test was conducted with callbox requesting maximum power, and with time-window/antenna switch between LTE B7, Antenna 2, DSI = 5 (100s window) and LTE B48, Antenna 11, DSI = 5 (60s window). Following procedure detailed in Section 3.3.6, and using the measurement setup shown in Figure 5-1(b) and (d), the time-window switch via tech/band/antenna switch was performed when the EUT is transmitting at $P_{reserve}$ level.

5.7.1 Test case 1: transition from LTE B7 to LTE B48 (i.e., 100s to 60s), then back to LTE B7

Test result for change in time-window (from 100s to 60s to 100s):

Plot 1: Measured Tx power (dBm) versus time shows that the transmitting power changed when LTE B7 switches to LTE B48 (~250s timestamp) and switches back to LTE B7 (~330s timestamp):

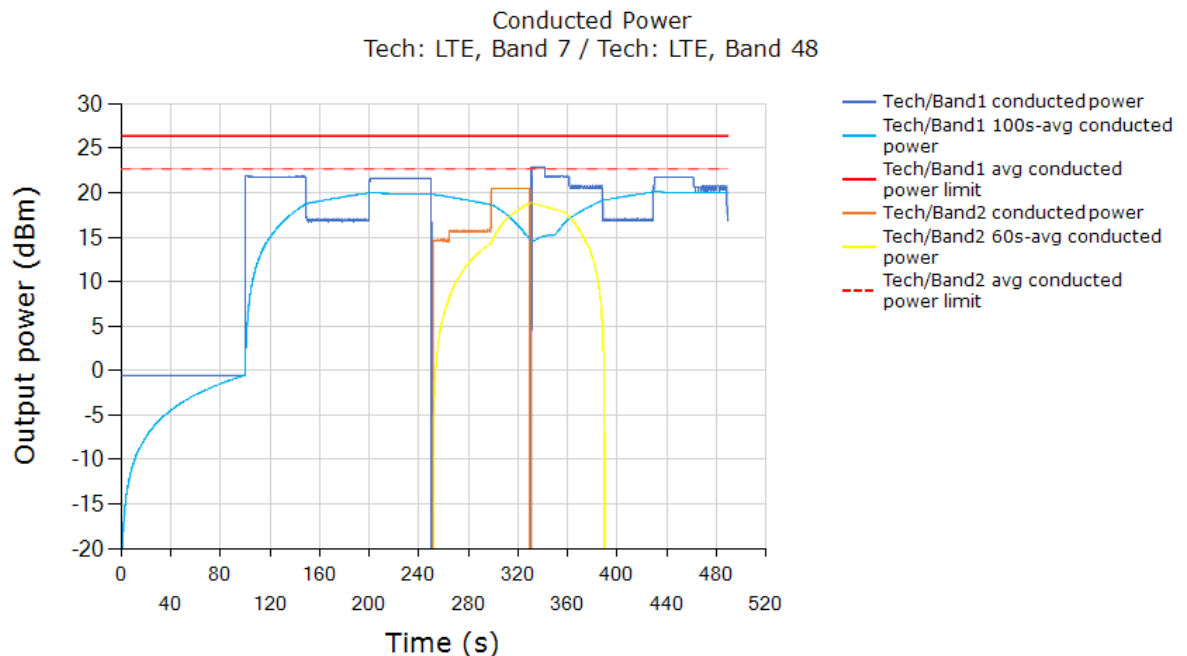

Note: As per Part 1 report, $Reserve_power_margin = 3\text{dB}$. Based on Table 4-1, EFS $P_{limit} = 21.2\text{dBm}$ for LTE B7 DSI = 5 (100s window), and EFS $P_{limit} = 21.5\text{dBm}$ ($P_{max} = 21.2\text{dBm}$) for LTE B48 DSI = 5 (60s window). The conducted power plot shows expected transitions in Tx power at ~250s (100s-to-60s transition) and at ~330s (60s-to-100s transition) in order to maintain total time-averaged RF exposure compliance across time windows, as show in next plot.

Plot 2: All the conducted Tx power measurement results were converted into time-averaged normalized SAR values using Equation (5a), (5b) and (5c), and plotted below to demonstrate that the time-averaged normalized SAR versus time does not exceed the FCC limit of 1 unit. Equation (5a) is used to convert the Tx power of device to obtain 100s-averaged normalized SAR in LTE B7 as shown in black curve. Similarly, equation (5b) is used to obtain 60s-averaged normalized SAR in LTE B48 as shown in orange curve. Equation (5c) is used to obtain total time-averaged normalized SAR as shown in green curve (i.e., sum of black and orange curves).

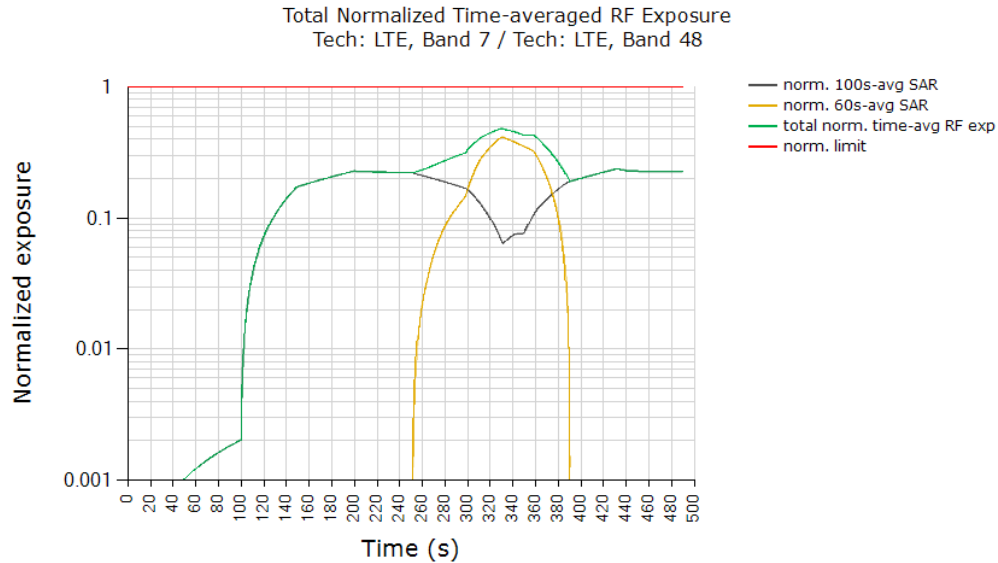

	(W/kg)
FCC normalized total exposure limit	1.0
Max time averaged normalized SAR (green curve)	0.482
Validated	

Plot Notes: Maximum power is requested by callbox for the entire duration of the test, with tech/band switches from 100s-to-60s window at ~250s time stamp, and from 60s-to-100s window at ~330s time stamp. Smart Transmit controls the Tx power during these time-window switches to ensure total time-averaged RF exposure, i.e., sum of black and orange curves given by equation (5c), is always compliant. In time-window switch test, at all times the total time-averaged normalized RF exposure (green curve) should not exceed normalized SAR_{design_target} + 1dB device uncertainty. In this test, with a maximum normalized SAR of 0.482 being ≤ 0.79 ($= 1.13/1.6 + 0.5\text{dB}$ device uncertainty), the above test result validated the continuity of power limiting in time-window switch scenario.

5.7.2 Test case 2: transition from LTE B48 to LTE B7 (i.e., 60s to 100s), then back to LTE B48

Test result for change in time-window (from 60s to 100s to 60s):

Plot 1: Measured Tx power (dBm) versus time shows that the transmitting power changed when LTE B48 switches to LTE B7 (~185s timestamp) and switches back to LTE B48 (~288s timestamp):

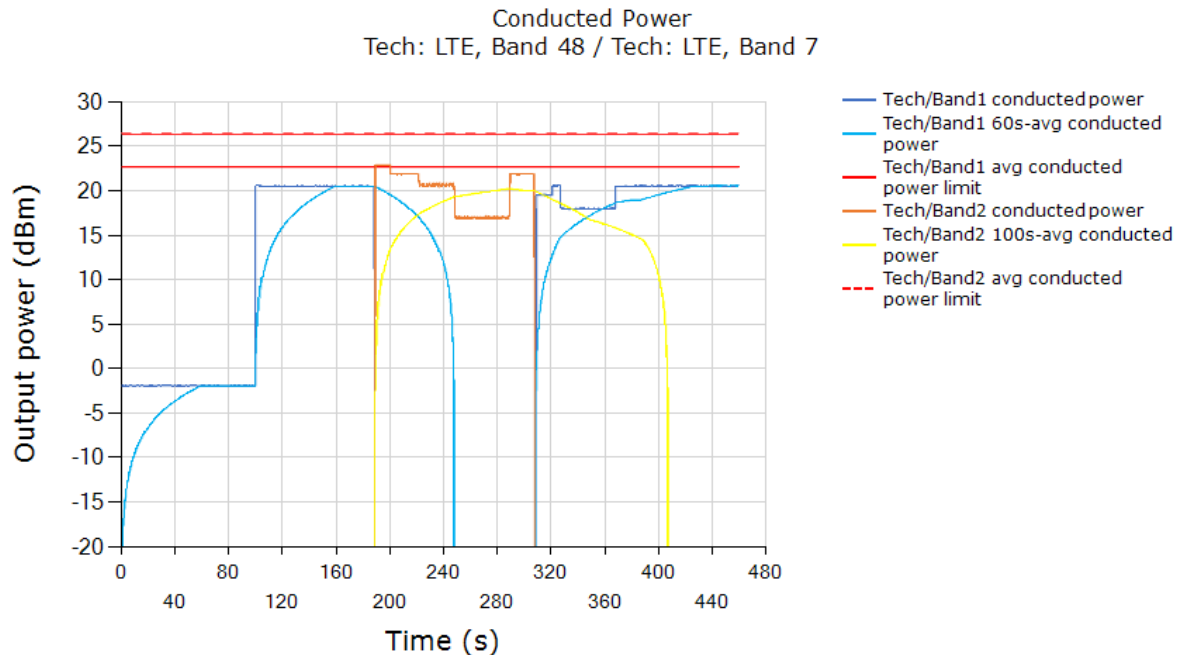

Note: As per Part 1 report, $Reserve_power_margin = 3\text{dB}$. Based on Table 4-1, EFS $P_{limit} = 21.5\text{dBm}$ ($P_{max} = 21.2\text{dBm}$) for LTE B48 DSI = 5 (60s window), and EFS $P_{limit} = 21.2\text{dBm}$ for LTE B7 DSI = 5 (100s window). The conducted power plot shows expected transitions in Tx power at ~185s (60s-to-100s transition) and at ~308s (100s-to-60s transition) in order to maintain total time-averaged RF exposure compliance across time windows, as show in next plot.

Plot 2: All the conducted Tx power measurement results were converted into time-averaged normalized SAR values using Equation (5a), (5b) and (5c), and plotted below to demonstrate that the time-averaged normalized SAR versus time does not exceed the FCC limit of 1 unit. Equation (5a) is used to convert the Tx power of device to obtain 60s-averaged normalized SAR in LTE B48 as shown in black curve. Similarly, equation (5b) is used to obtain 100s-averaged normalized SAR in LTE B7 as shown in orange curve. Equation (5c) is used to obtain total time-averaged normalized SAR as shown in green curve (i.e., sum of black and orange curves).

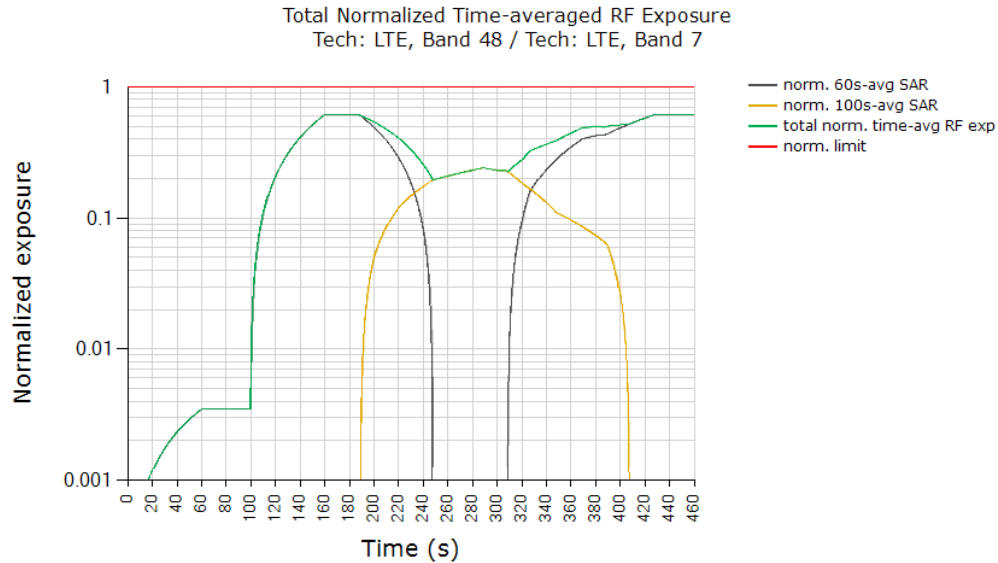

	(W/kg)
FCC normalized total exposure limit	1.0
Max time averaged normalized SAR (green curve)	0.613
Validated	

Plot Notes: Maximum power is requested by callbox for the entire duration of the test, with tech/band switches from 60s-to-100s window at ~185s time stamp, and from 100s-to-60s window at ~308s time stamp. Smart Transmit controls the Tx power during these time-window switches to ensure total time-averaged RF exposure, i.e., sum of black and orange curves given by equation (5c), is always compliant. In time-window switch test, at all times the total time-averaged normalized RF exposure (green curve) should not exceed normalized SAR_{design_target} + 1dB device uncertainty. In this test, with a maximum normalized SAR of 0.613 being ≤ 0.79 ($= 1.13/1.6 + 0.5\text{dB}$ device uncertainty), the above test result validated the continuity of power limiting in time-window switch scenario.

5.8 Switch in SAR exposure test results (test case 10 in Table 4-2)

5.8.1 Test case 1: SAR exposure switch in same time window

This test was conducted with callbox requesting maximum power, and with the EUT in LTE B5 + Sub6 NR Band n66 call. Here, LTE B5, Antenna 2, DSI = 5 (100s window, EFS $P_{limit} = 29.4$ dBm, $P_{max} = 25.0$ dBm, measured $P_{limit} = 25.02$ dBm), and Sub6 NR Band n66, Antenna 3, DSI = 5 (100s window, $P_{limit} = 22.9$ dBm in EFS setting, EUT's average $P_{max} = 25.0$ dBm, measured $P_{limit} = 22.98$ dBm). Following procedure detailed in Section 3.3.7 and Appendix B.2, and using the measurement setup shown in Figure 5-1(e) and (f) since LTE and Sub6 NR are on two different antenna ports, the SAR exposure switch measurement is performed with the EUT in various SAR exposure scenarios, i.e., in SAR_{sub6NR} only scenario ($t = 5s \sim 125s$), SAR_{sub6NR} + SAR_{LTE} scenario ($t = 125s \sim 245s$) and SAR_{LTE} only scenario ($t > 245s$).

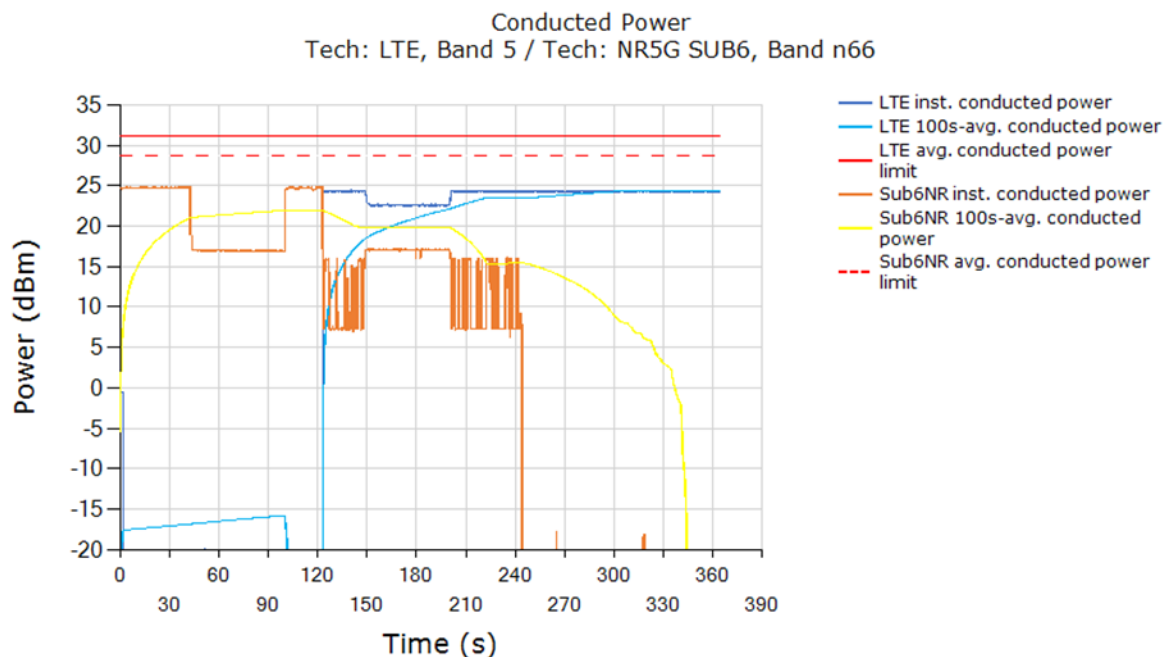

Plot 2: All the conducted Tx power measurement results were converted into time-averaged normalized SAR values using Equation (5a), (5b) and (5c), and plotted below to demonstrate that the time-averaged normalized SAR versus time does not exceed the FCC limit of 1 unit. Equation (5a) is used to convert the LTE Tx power of device to obtain 100s-averaged normalized SAR in LTE B5 as shown in black curve. Similarly, equation (5b) is used to obtain 100s-averaged normalized SAR in Sub6 NR n66 as shown in orange curve. Equation (5c) is used to obtain total time-averaged normalized SAR as shown in green curve (i.e., sum of black and orange curves).

Total Normalized Time-averaged RF Exposure
 Tech: LTE, Band 5 / Tech: NR5G SUB6, Band n66

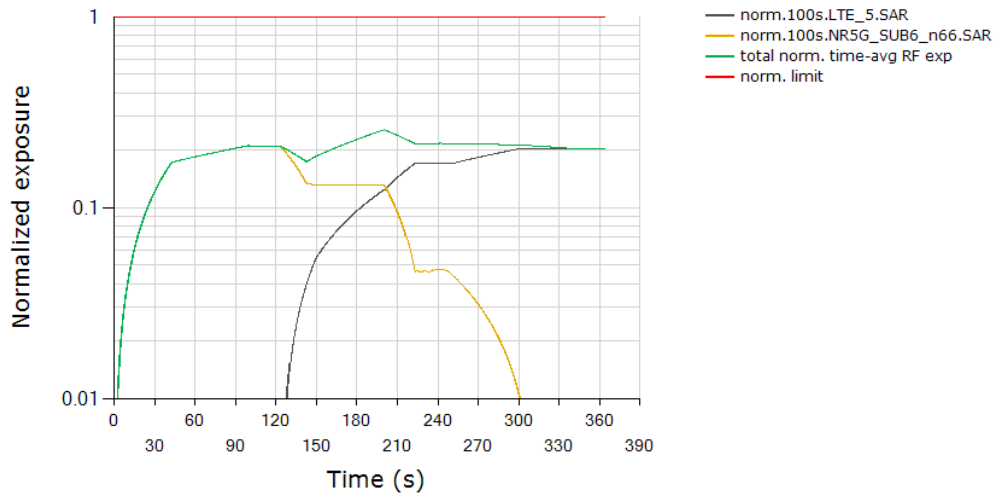

	(W/kg)
FCC normalized total exposure limit	1.0
Max time averaged normalized SAR (green curve)	0.256
Validated	

Plot Notes: Device starts predominantly in Sub6 NR SAR exposure scenario between 5s and 125s, and in LTE SAR + Sub6 NR SAR exposure scenario between 125s and 245s, and in predominantly in LTE SAR exposure scenario after t=245s. Here, Smart Transmit allocates a maximum of 75% of exposure margin (based on 3dB reserve margin setting) for Sub6 NR. This corresponds to a normalized 1gSAR exposure value = 75% * 0.431W/kg measured SAR at Sub6 NR P_{limit} / 1.6W/kg limit = 0.202 +0.5dB/-1.5dB device related uncertainty (see orange curve between 5s~120s). For predominantly LTE SAR exposure scenario, maximum normalized 1gSAR exposure should correspond to 100% exposure margin = 0.385W/kg measured SAR at LTE P_{limit} / 1.6W/kg limit = 0.241 +0.5dB/-1.5dB device related uncertainty (see black curve after t = 245s). Additionally, in SAR exposure switch test, at all times the total time-averaged normalized RF exposure (green curve) should not exceed normalized SAR_{design_target} + 1dB device uncertainty. In this test, with a maximum normalized SAR of 0.256 being ≤ 0.79 (= 1.13/1.6 + 0.5dB device uncertainty), the above test result validated the continuity of power limiting in SAR exposure switch scenario.

6 SAR Test Results for Sub-6 Smart Transmit Feature Validation

6.1 Measurement setup

The measurement setup in Figure 6-1 is similar to normal SAR measurements (see Appendix E for missing figures). The difference in SAR measurement setup for time averaging feature validation is that the callbox is signaling in close loop power control mode (instead of requesting maximum power in open loop control mode) and callbox is connected to the PC using GPIB so that the test script executed on PC can send GPIB commands to control the callbox's requested power over time (test sequence). The same test script used in conducted setup for time-varying Tx power measurements is also used in this section for running the test sequences during SAR measurements, and the recorded values from the disconnected power meter by the test script were discarded.

As mentioned in Section 3.4, for EUT to follow TPC command sent from the callbox wirelessly, the "path loss" between callbox antenna and the EUT needs to be very well calibrated. Since the SAR chamber is in uncontrolled environment, precautions must be taken to minimize the environmental influences on "path loss". Similarly, in the case of time-varying SAR measurements in Sub6 NR (with LTE as anchor), "path loss" between callbox antenna and the EUT needs to be carefully calibrated for both LTE link as well as for Sub6 NR link.

The EUT is placed in worst-case position according to Table 4-2.

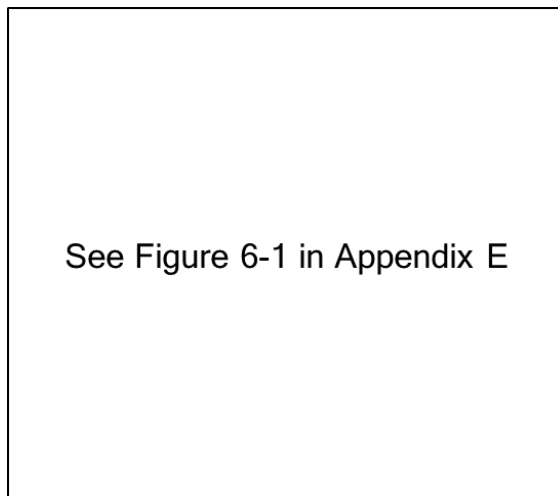

Figure 6-1 SAR measurement setup

6.2 SAR measurement results for time-varying Tx power transmission scenario

Following Section 3.4 procedure, time-averaged SAR measurements are conducted using EX3DV4 probe at peak location of area scan over 500 seconds. cDASY6 system validation for SAR measurement is provided in Appendix C, and the associated SPEAG certificates are attached in Appendix D.

SAR probe integration times depend on the communication signal being tested. Integration times used by SPEAG for their probe calibrations can be downloaded from here (integration time is listed on the bottom of the first page for each tech):

<https://www.speag.com/assets/downloads/services/cs/UIDSummary171205.pdf>

Since the sampling rate used by cDASY6 for pointSAR measurements is not in user control, the number of points in 100s or 60s interval is determined from the scan duration setting in cDASY6 time-average pointSAR measurement by (100s or 60s / cDASY6_scan_duration * total number of pointSAR values recorded). Running average is performed over these number of points in excel spreadsheet to obtain 100s-/60s-averaged pointSAR.

Following Section 3.4, for each of selected technology/band (listed in Table 4-2):

1. With *Reserve_power_margin* set to 0 dB, area scan is performed at P_{limit} , and time-averaged pointSAR measurements are conducted to determine the pointSAR at P_{limit} at peak location, denoted as $pointSAR_{P_{limit}}$.
2. With *Reserve_power_margin* set to actual (intended) value, two more time-averaged pointSAR measurements are performed at the same peak location for test sequences 1 and 2.

To demonstrate compliance, all the pointSAR measurement results were converted into 1gSAR or 10gSAR values by using Equation (2a), rewritten below:

$$1g_or_10gSAR(t) = \frac{pointSAR(t)}{pointSAR_{P_{limit}}} * 1g_or_10gSAR_{P_{limit}} \quad (2a)$$

where, $pointSAR(t)$, $pointSAR_{P_{limit}}$, and $1g_or_10gSAR_{P_{limit}}$ correspond to the measured instantaneous point SAR, measured point SAR at P_{limit} from above step 1 and 2, and measured 1gSAR or 10gSAR values at P_{limit} obtained from Part 1 report and listed in Table 4-2 in Section 5.1 of this report.

6.2.1 LTE Band 7 SAR test results

SAR test results for test sequence 1:

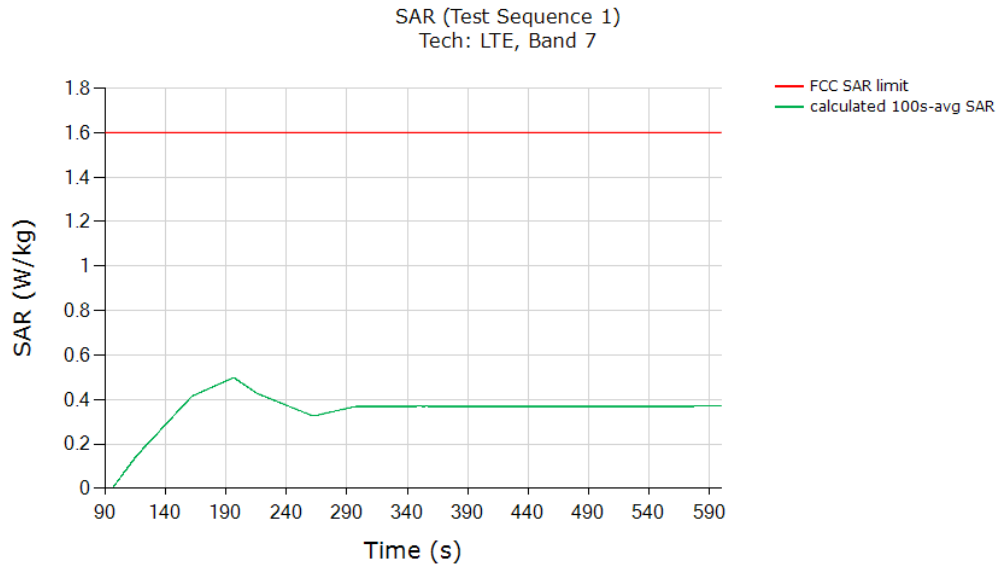

	(W/kg)
FCC 1gSAR limit	1.6
Max 100s-time averaged point 1gSAR (green curve)	0.498
Validated: Max time averaged SAR (green curve) is within +0.5dB/-1.5dB device uncertainty of 0.486 W/kg of measured SAR at P_{limit} (last column in Table 4-2).	

SAR test results for test sequence 2:

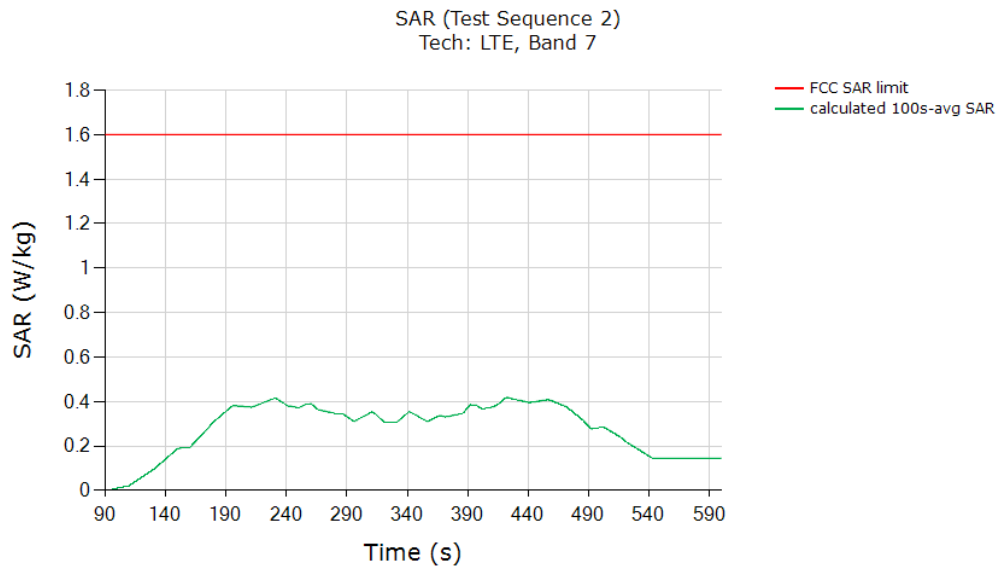

	(W/kg)
FCC 1gSAR limit	1.6
Max 100s-time averaged 1gSAR (green curve)	0.417
<p>Validated: Max time averaged SAR (green curve) is within +0.5dB/-1.5dB device uncertainty of 0.486 W/kg of measured SAR at P_{limit} (last column in Table 4-2).</p>	

6.2.2 LTE Band 2 SAR test results

SAR test results for test sequence 1:

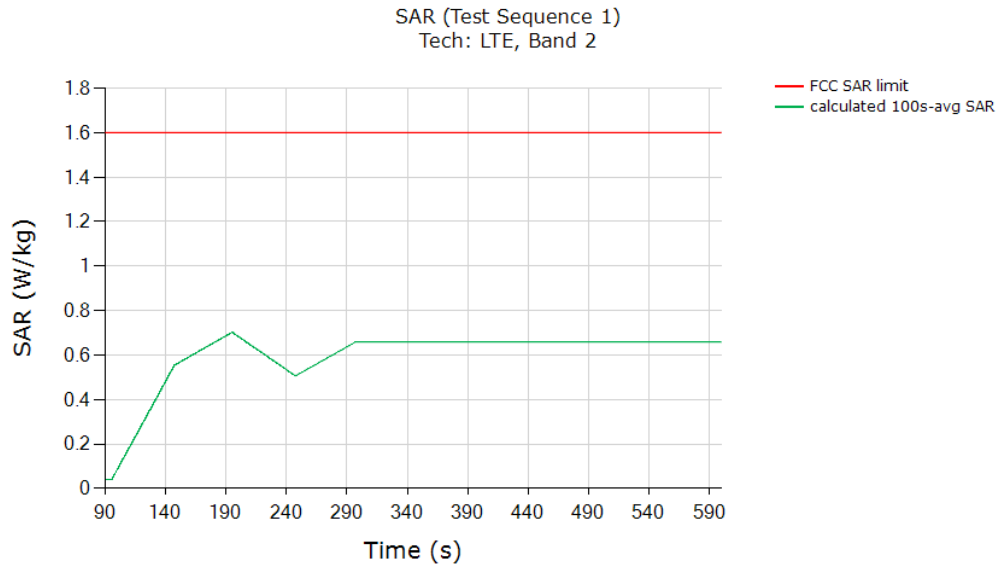

	(W/kg)
FCC 1gSAR limit	1.6
Max 100s-time averaged point 1gSAR (green curve)	0.703
Validated: Max time averaged SAR (green curve) is within +0.5dB/-1.5dB device uncertainty of 0.752 W/kg of measured SAR at P_{limit} (last column in Table 4-2).	

SAR test results for test sequence 2:

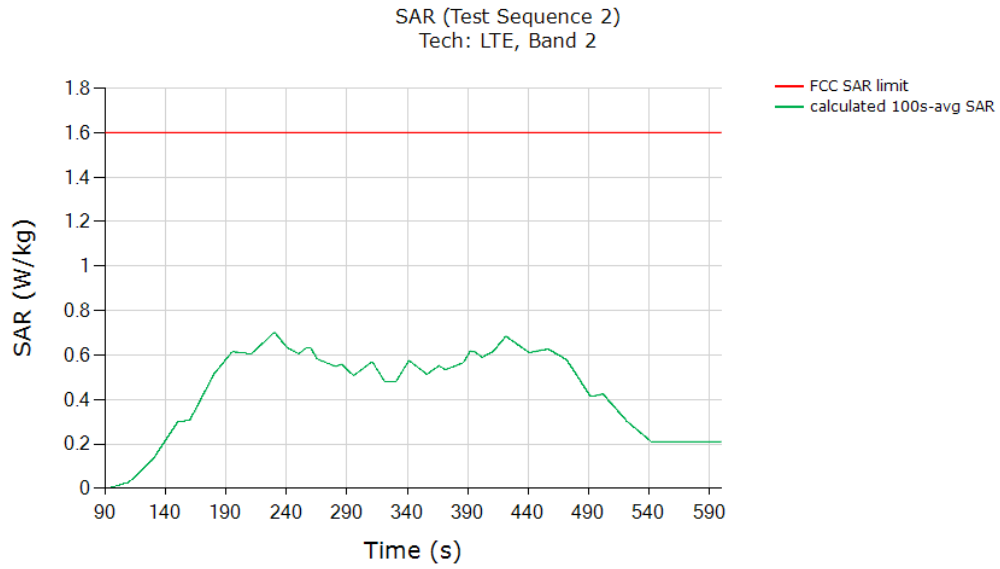

	(W/kg)
FCC 1gSAR limit	1.6
Max 100s-time averaged 1gSAR (green curve)	0.701
<p>Validated: Max time averaged SAR (green curve) is within +0.5dB/-1.5dB device uncertainty of 0.752 W/kg of measured SAR at P_{limit} (last column in Table 4-2).</p>	

6.2.3 WCDMA Band 4 SAR test results

SAR test results for test sequence 1:

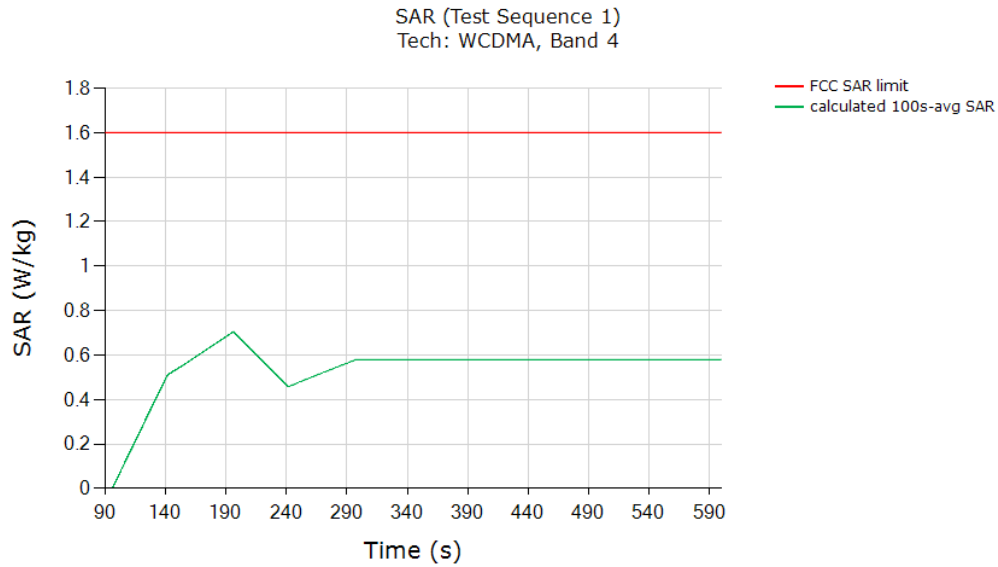

	(W/kg)
FCC 1gSAR limit	1.6
Max 100s-time averaged point 1gSAR (green curve)	0.704
<p>Validated: Max time averaged SAR (green curve) is within +0.5dB/-1.5dB device uncertainty of 0.691 W/kg of measured SAR at P_{limit} (last column in Table 4-2).</p>	

SAR test results for test sequence 2:

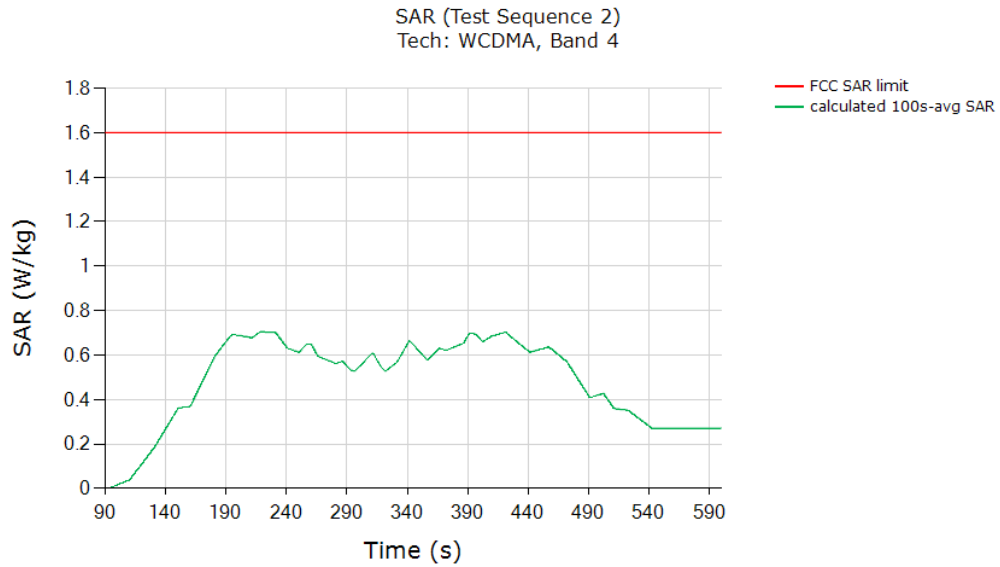

	(W/kg)
FCC 1gSAR limit	1.6
Max 100s-time averaged point 1gSAR (green curve)	0.703
Validated: Max time averaged SAR (green curve) is within +0.5dB/-1.5dB device uncertainty of 0.691 W/kg of measured SAR at P_{limit} (last column in Table 4-2).	

6.2.4 CDMA/EVDO BC1 SAR test results

SAR test results for test sequence 1:

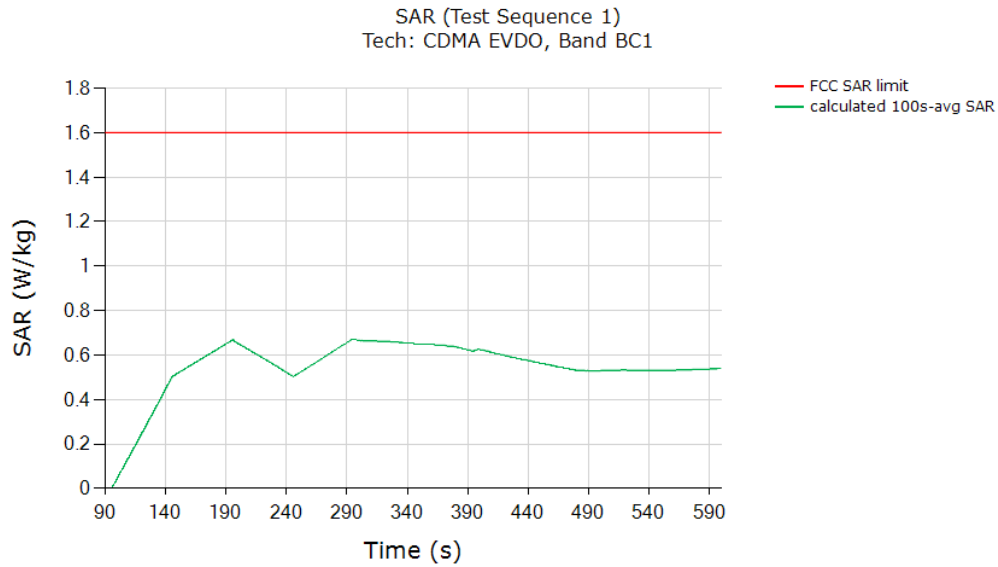

	(W/kg)
FCC 1gSAR limit	1.6
Max 100s-time averaged point 1gSAR (green curve)	0.670
Validated: Max time averaged SAR (green curve) is within +0.5dB/-1.5dB device uncertainty of 0.655 W/kg of measured SAR at P_{limit} (last column in Table 4-2).	

SAR test results for test sequence 2:

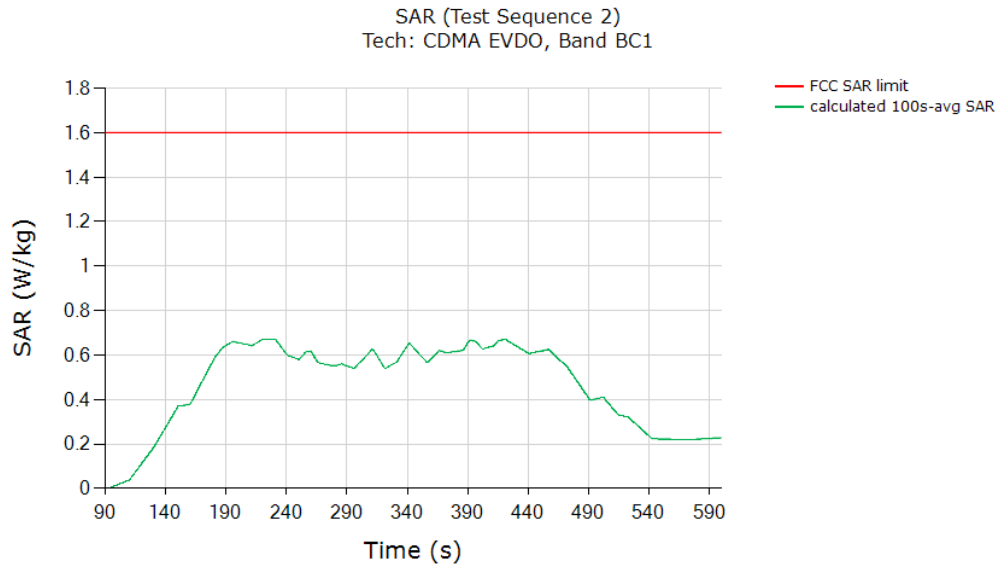

	(W/kg)
FCC 1gSAR limit	1.6
Max 100s-time averaged point 1gSAR (green curve)	0.655
Validated: Max time averaged SAR (green curve) is within +0.5dB/-1.5dB device uncertainty of 0.655 W/kg of measured SAR at P_{limit} (last column in Table 4-2).	

6.2.5 Sub6 NR Band n66 SAR test results

SAR test results for test sequence 1:

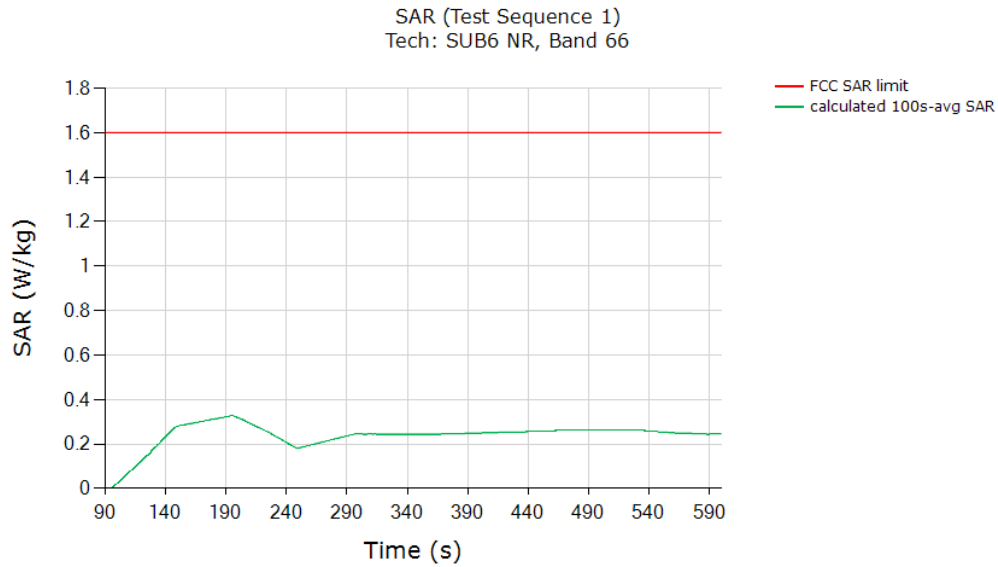

	(W/kg)
FCC 1gSAR limit	1.6
Max 100s-time averaged point 1gSAR (green curve)	0.328
Validated: Max time averaged SAR (green curve) is within +0.5dB/-1.5dB device uncertainty of 75% (with 3dB <i>Reserve_power_margin</i> setting) of 0.431 W/kg measured SAR at P_{limit} (last column in Table 4-2).	

SAR test results for test sequence 2:

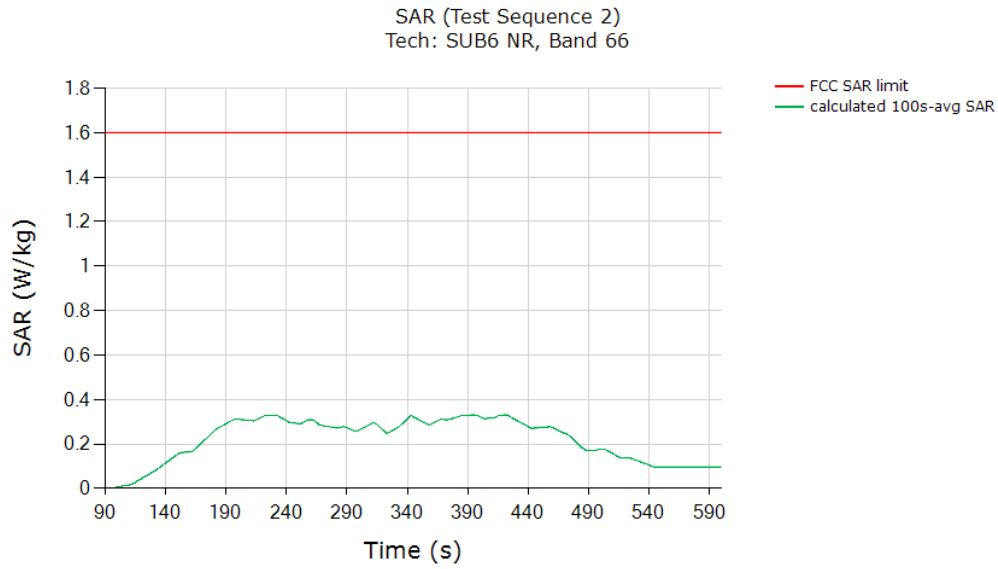

	(W/kg)
FCC 1gSAR limit	1.6
Max 100s-time averaged 1gSAR (green curve)	0.330
<p>Validated: Max time averaged SAR (green curve) is within +0.5dB/-1.5dB device uncertainty of 75% (with 3dB <i>Reserve_power_margin</i> setting) of 0.431 W/kg measured SAR at P_{limit} (last column in Table 4-2).</p>	

7 Conclusions

Qualcomm Smart Transmit feature employed in LGE portable handset (FCC ID: ZNFV600TM) has been validated through the conducted power measurement (as demonstrated in Chapter 5), as well as SAR measurement (as demonstrated in Chapter 6).

As demonstrated in this report, the power limiting enforcement is effective and the total normalized time-averaged RF exposure does not exceed 1.0 for all the transmission scenarios described in Section 2. Therefore, the EUT complies with FCC RF exposure requirement.

A Test Sequences

1. Test sequence is generated based on below parameters of the EUT:
 - a. Measured maximum power (P_{max})
 - b. Measured Tx_power_at_SAR_design_target (P_{limit})
 - c. Reserve_power_margin (dB)
 - $P_{reserve}$ (dBm) = measured P_{limit} (dBm) – Reserve_power_margin (dB)
 - d. SAR_time_window (100s for FCC)
2. Test Sequence 1 Waveform:

Based on the parameters above, the Test Sequence 1 is generated with one transition between high and low Tx powers. Here, high power = P_{max} ; low power = $P_{max}/2$, and the transition occurs after 80 seconds at high power P_{max} . As long as the power enforcement is taking into effective during one 100s/60s time window, the validation test with this defined test sequence 1 is valid, otherwise, select other radio configuration (band/DSI within the same technology group) having lower P_{limit} for this test. The Test sequence 1 waveform is shown below:

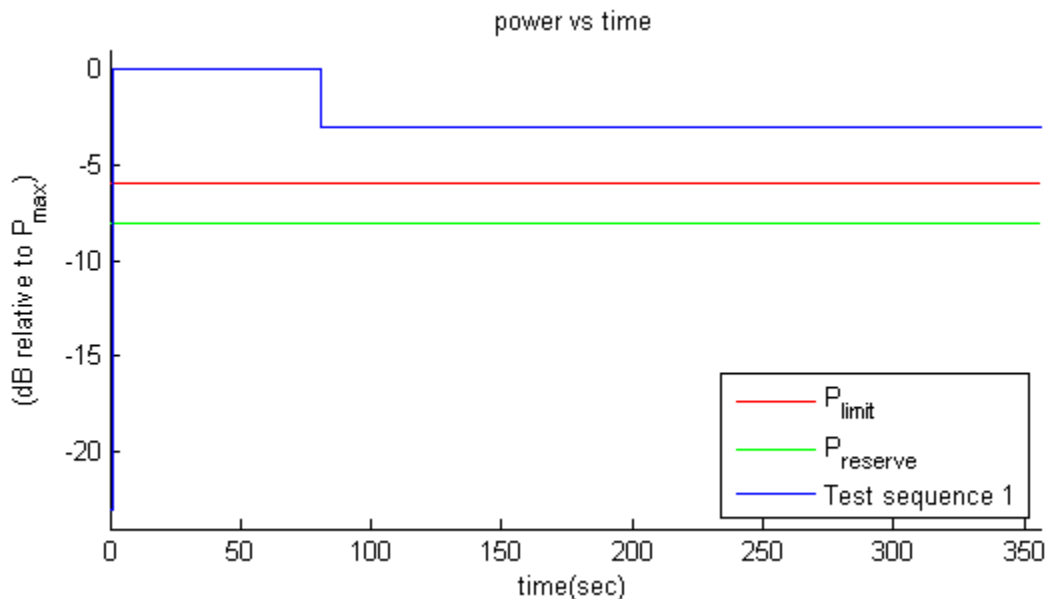

Figure A-1 Test sequence 1 waveform

3. Test Sequence 2 Waveform:

Based on the parameters in A-1, the Test Sequence 2 is generated as described in Table 10-1, which contains two 170 second-long sequences (yellow and green highlighted rows) that are mirrored around the center row of 20s, resulting in a total duration of 360 seconds:

Table A-1 Test Sequence 2

Time duration (seconds)	dB relative to P_{limit} or $P_{reserve}$
15	$P_{reserve} - 2$
20	P_{limit}
20	$(P_{limit} + P_{max})/2$ averaged in mW and rounded to nearest 0.1 dB step
10	$P_{reserve} - 6$
20	P_{max}
15	P_{limit}
15	$P_{reserve} - 5$
20	P_{max}
10	$P_{reserve} - 3$
15	P_{limit}
10	$P_{reserve} - 4$
20	$(P_{limit} + P_{max})/2$ averaged in mW and rounded to nearest 0.1 dB step
10	$P_{reserve} - 4$
15	P_{limit}
10	$P_{reserve} - 3$
20	P_{max}
15	$P_{reserve} - 5$
15	P_{limit}
20	P_{max}
10	$P_{reserve} - 6$
20	$(P_{limit} + P_{max})/2$ averaged in mW and rounded to nearest 0.1 dB step
20	P_{limit}
15	$P_{reserve} - 2$

The Test Sequence 2 waveform is shown in Figure A-2.

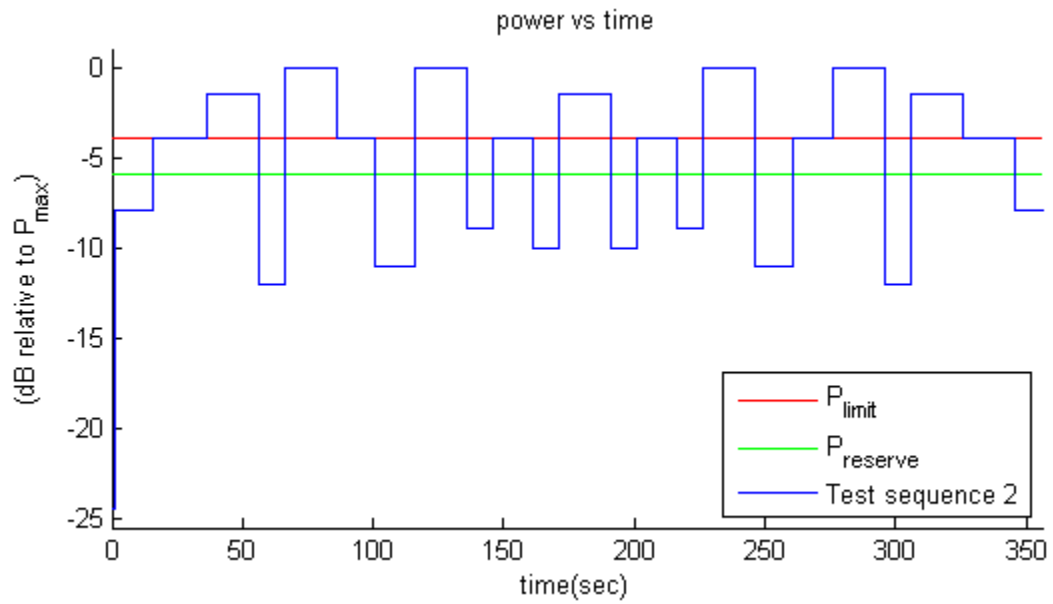

Figure A-2 Test Sequence 2 waveform

B Test Procedures for sub6 NR + LTE

Appendix B provides the test procedures for validating Qualcomm Smart Transmit feature for LTE + Sub6 NR non-standalone (NSA) mode transmission scenario, where sub-6GHz LTE link acts as an anchor.

B.1 Time-varying Tx power test for sub6 NR in NSA mode

Follows Section 3.2.1 to select test configurations for time-varying test. This test is performed with two pre-defined test sequences (described in Section 3.1) applied to Sub6 NR (with LTE on all-down bits or low power for the entire test after establishing the LTE+Sub6 NR call with the callbox). Follow the test procedures described in Section 3.3.1 to demonstrate the effectiveness of power limiting enforcement and that the time averaged Tx power of Sub6 NR when converted into 1gSAR values does not exceed the regulatory limit at all times (see Eq. (2a) and (2b)). Sub6 NR response to test sequence1 and test sequence2 will be similar to other technologies (say, LTE), and are shown in Sections 5.3.7 and 5.3.8.

B.2 Switch in SAR exposure between LTE vs. Sub6 NR during transmission

This test is to demonstrate that Smart Transmit feature accurately accounts for switching in exposures among SAR for LTE radio only, SAR from both LTE radio and sub6 NR, and SAR from sub6 NR only scenarios, and ensures total time-averaged RF exposure compliance with FCC limit.

Test procedure:

1. Measure conducted Tx power corresponding to P_{limit} for LTE and sub6 NR in selected band. Test condition to measure conducted P_{limit} is:
 - Establish device in call with the callbox for LTE in desired band. Measure conducted Tx power corresponding to LTE P_{limit} with Smart Transmit enabled and *Reserve_power_margin* set to 0 dB, callbox set to request maximum power.
 - Repeat above step to measure conducted Tx power corresponding to Sub6 NR P_{limit} . If testing LTE+Sub6 NR in non-standalone mode, then establish LTE+Sub6 NR call with callbox and request all down bits for radio1 LTE. In this scenario, with callbox requesting maximum power from Sub6 NR, measured conducted Tx power corresponds to radio2 P_{limit} (as radio1 LTE is at all-down bits)

2. Set *Reserve_power_margin* to actual (intended) value with EUT setup for LTE + Sub6 NR call. First, establish LTE connection in all-up bits with the callbox, and then Sub6 NR connection is added with callbox requesting UE to continue transmission at maximum power in Sub6 NR. As soon as the Sub6 NR connection is established, request all-down bits on LTE link (otherwise, Sub6 NR will not have sufficient RF exposure margin to sustain the call with LTE in all-up bits). Continue LTE (all-down bits)+Sub6 NR transmission for more than one time-window duration to test predominantly Sub6 NR SAR exposure scenario (as SAR exposure is negligible from all-down bits in LTE). After at least one time-window, request LTE to go all-up bits to test LTE SAR and Sub6 NR SAR exposure scenario. After at least one more time-window, drop (or request all-down bits) Sub6 NR transmission to test predominantly LTE SAR exposure scenario. Continue the test for at least one more time-window. Record the conducted Tx powers for both LTE and Sub6 NR for the entire duration of this test.
3. Once the measurement is done, extract instantaneous Tx power versus time for both LTE and Sub6 NR links. Similar to technology/band switch test in Section 3.3.3, convert the conducted Tx power for both these radios into 1gSAR value (see Eq. (4a) and (4b)) using corresponding technology/band P_{limit} measured in Step 1, and then perform 100s running average to determine time-averaged 1gSAR versus time as illustrated in Figure 3-1. Note that here it is assumed both radios have Tx frequencies < 3GHz, otherwise, 60s running average should be performed for radios having Tx frequency between 3GHz and 6GHz.
4. Make one plot containing: (a) instantaneous Tx power versus time measured in Step 2.
5. Make another plot containing: (a) instantaneous 1gSAR versus time determined in Step 3, (b) computed time-averaged 1gSAR versus time determined in Step 3, and (c) corresponding regulatory $1gSAR_{limit}$ of 1.6W/kg.

The validation criteria is, at all times, the time-averaged 1gSAR versus time shall not exceed the regulatory $1gSAR_{limit}$ of 1.6W/kg.

C cDASY6 System Validation

C.1 SAR system verification and validation

Table C-1 provides the list of calibrated equipment for SAR measurement system verification.

Table C-1 List of calibrated equipment

Equipment Manufacturer and Type	Serial number	Last Calibrated	Next Calibration
Schmid & Partner Engineering AG Dosimetric E-field Probe, ES3DV4	3618	4/15/2019	4/15/2020
Schmid & Partner Engineering AG dipole validation kit, D3700V2	1035	4/11/2019	4/11/2020
Schmid & Partner Engineering AG dipole validation kit, D2600V2	1159	4/24/2019	4/24/2020
Schmid & Partner Engineering AG dipole validation kit, D2450V2	775	4/9/2019	4/9/2020
Schmid & Partner Engineering AG dipole validation kit, D1800V2	269	6/8/2019	6/8/2020
Schmid & Partner Engineering AG Data Acquisition Electronics, DAE3	400	2/13/2019	2/13/2020
Rohde & Schwarz NR50S Power Sensor	101085	5/6/2019	2/18/2020
Agilent N5230A PNA	MY45000533	1/23/2019	1/23/2020
Rohde & Schwarz CMW500 Radio Communication Tester	1201.0002K50- 150738-Hv	9/23/2019	9/23/2020

The system verification was performed using a dipole antenna against the flat section of the SAM phantom. Table C-2 shows the verification test results and the relevant plots are provided in Figures C-1 to C-13. The measured SAR values for the frequency bands of interest were within $\pm 10\%$ of the corresponding target SAR levels.

Table C-2 System validation results

Validation dipole	S/N	Frequency (MHz)	1W Target 1gSAR (mW/g)	Measured 1gSAR scaled to 1W (mW/g)	Deviation (%)	Date
D2600V2	1159	2600	53.0	58.7	7.6	1/18/20
D1800V2	269	1800	38.7	40.7	5.8	1/19/20
D1800V2	269	1800	38.7	40.1	5.6	1/20/20
D1800V2	269	1800	38.7	41.7	7.6	1/21/20

The broad-band solution MBBL600-6000V6 is used for body tissue-simulating liquid. Table C-3 list the tissue dielectric properties.

Table C-3 Tissue dielectric properties at the time of testing

Test Date	Frequency (MHz)	Permittivity (ϵ_r)				Conductivity (σ)			
		Measured Values	Target Values	Deviation (%)	Limit	Measured Values	Target Values	Deviation (%)	Limit
1/18/20	2600	53.7	52.5	2.20%	$\pm 10\%$	2.34	2.16	7.3%	$\pm 10\%$
1/19/20	1800	54.6	53.3	2.4%	$\pm 10\%$	1.52	1.52	0.0%	$\pm 10\%$
1/20/20	1800	54.1	53.3	1.5%	$\pm 10\%$	1.48	1.52	-2.7%	$\pm 10\%$
1/21/20	1800	51.5	53.3	-3.4%	$\pm 10\%$	1.51	1.52	-0.6%	$\pm 10\%$

NOTE: The deviation should be controlled within $\pm 5\%$. If the deviation is between $\pm 5\%$ to $\pm 10\%$, the correction will be made in the corresponding SAR result to compensate the additional deviation.

Appendix D provides the calibration certificates for SAR measurement equipment used in this report.

QualcommTechnologies Inc.

Measurement Report

Exposure Conditions

Phantom Section, TSL	Position, Test Distance [mm]	Band	Group, UID	Frequency [MHz], Channel Number	Modulation	TSL Conductivity [S/m]	TSL Permittivity
Flat, MSL	Flat, 1.0cm	--	0--	2600.0	CW	2.34	53.7

Hardware Setup

Phantom	TSL, Measured Date	Probe, Calibration Date	DAE, Calibration Date
Twin-SAM V4.0 (30deg probe tilt) - 209	MBBL-600-6000 Batch: 171204-1, 2020-Jan-18	EX3DV4 - 5N3618, 2019-04-15	DAE3 5n400, 2019-02-13

Scan Setup

	Area Scan	Zoom Scan
Grid Extents [mm]	48.0 x 96.0	30.0 x 30.0 x 30.0
Grid Steps [mm]	12.0 x 12.0	5.0 x 5.0 x 5.0
Sensor Surface [mm]	3.0	1.4

Measurement Results

	Area Scan	Zoom Scan
Date	2020-01-18, 14:32	2020-01-18, 14:37
psSAR1g [W/Kg]	0.523	0.587
psSAR10g [W/Kg]	0.231	0.258
Power Drift [dB]	-0.03	-0.01

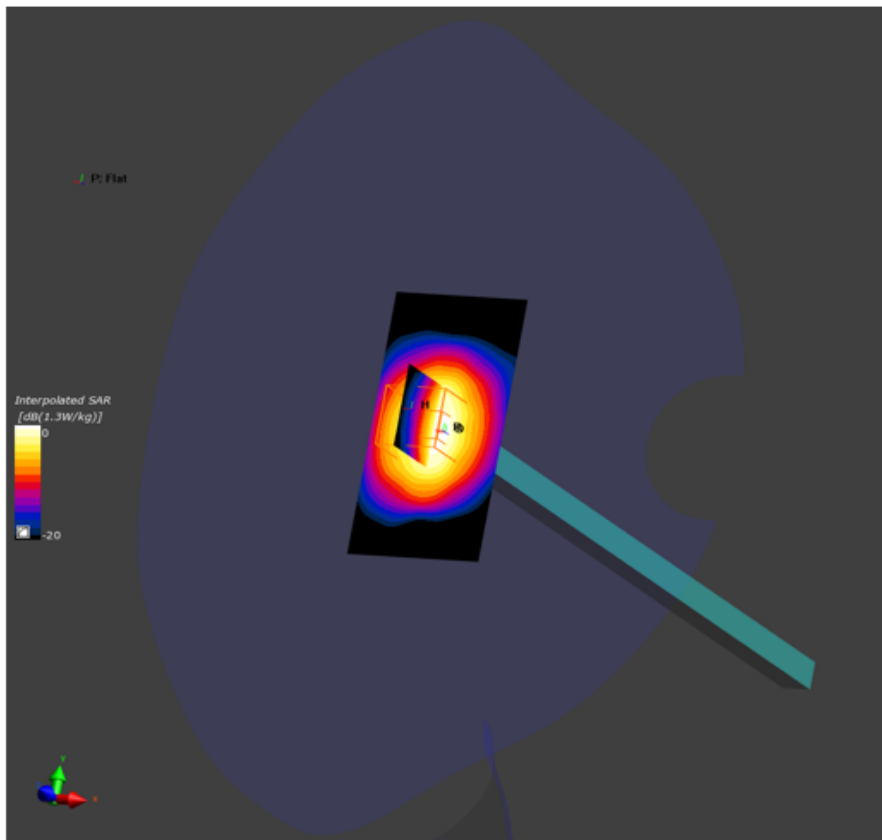

Figure C-1 SAR measurement system verification plot for 2600MHz performed on 1/18/2020. Input power = 10.0mW.

QualcommTechnologies Inc.

Measurement Report

Exposure Conditions

Phantom Section, TSL	Position, Test Distance [mm]	Band	Group, UID	Frequency [MHz], Channel Number	Modulation	TSL Conductivity [S/m]	TSL Permittivity
Flat, MSL	Flat, 1.0cm	--	0--	1800.0	CW	1.52	54.6

Hardware Setup

Phantom	TSL, Measured Date	Probe, Calibration Date	DAE, Calibration Date
Twin-SAM V4.0 (30deg probe tilt) - 209	MBBL-600-6000 Batch: 171204-1, 2020-Jan-19	EX3DV4 - SN3618, 2019-04-15	DAE3 Sn400, 2019-02-13

Scan Setup

	Area Scan	Zoom Scan
Grid Extents [mm]	56.0 x 84.0	30.0 x 30.0 x 30.0
Grid Steps [mm]	14.0 x 14.0	5.0 x 5.0 x 5.0
Sensor Surface [mm]	3.0	1.4

Measurement Results

	Area Scan	Zoom Scan
Date	2020-01-19, 20:09	2020-01-19, 20:14
psSAR1g [W/Kg]	0.392	0.407
psSAR10g [W/Kg]	0.202	0.211
Power Drift [dB]	0.01	-0.02

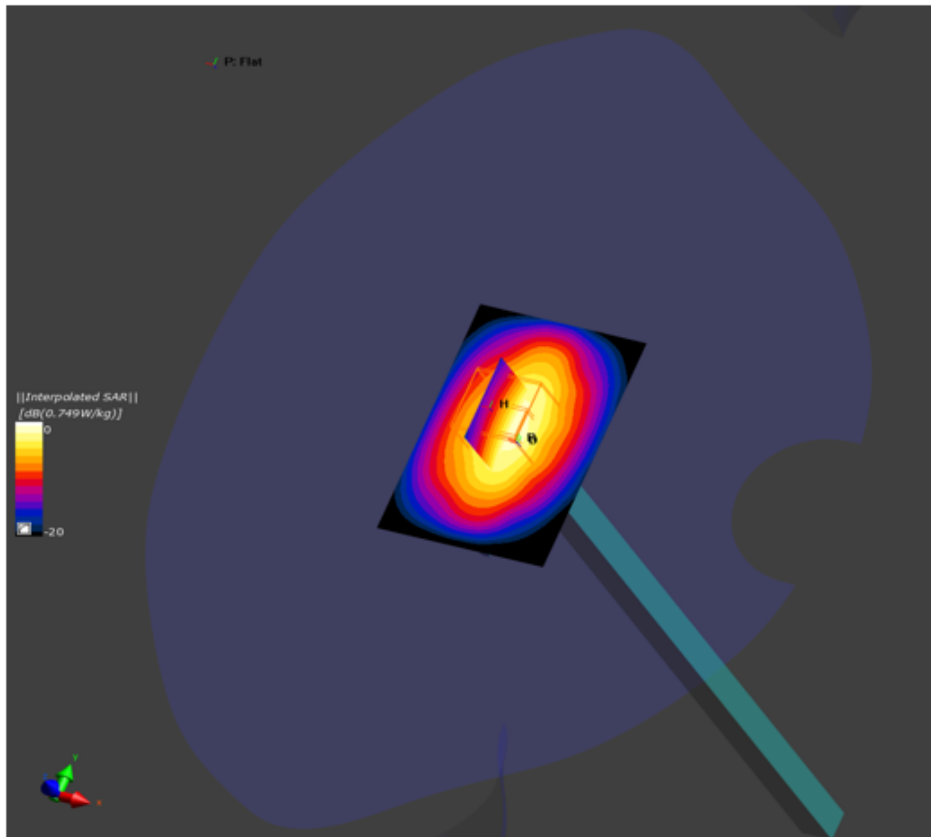

Figure C-2 SAR measurement system verification plot for 1800MHz performed on 1/19/2020. Input power = 10.0mW.

QualcommTechnologies Inc.

Measurement Report

Exposure Conditions

Phantom Section, TSL	Position, Test Distance [mm]	Band	Group, UID	Frequency [MHz], Channel Number	Modulation	TSL Conductivity [S/m]	TSL Permittivity
Flat, MSL	Flat, 1.0cm	--	0--	1800.0	CW	1.48	54.1

Hardware Setup

Phantom	TSL, Measured Date	Probe, Calibration Date	DAE, Calibration Date
Twin-SAM V4.0 (30deg probe tilt) - 209	MBBL-600-6000 Batch: 171204-1, 2020-Jan-20	EX3DV4 - SN3618, 2019-04-15	DAE3 Sn400, 2019-02-13

Scan Setup

	Area Scan	Zoom Scan
Grid Extents [mm]	56.0 x 84.0	30.0 x 30.0 x 30.0
Grid Steps [mm]	14.0 x 14.0	5.0 x 5.0 x 5.0
Sensor Surface [mm]	3.0	1.4

Measurement Results

	Area Scan	Zoom Scan
Date	2020-01-20, 10:01	2020-01-20, 10:06
psSAR1g [W/Kg]	0.387	0.401
psSAR10g [W/Kg]	0.200	0.208
Power Drift [dB]	-0.04	-0.03

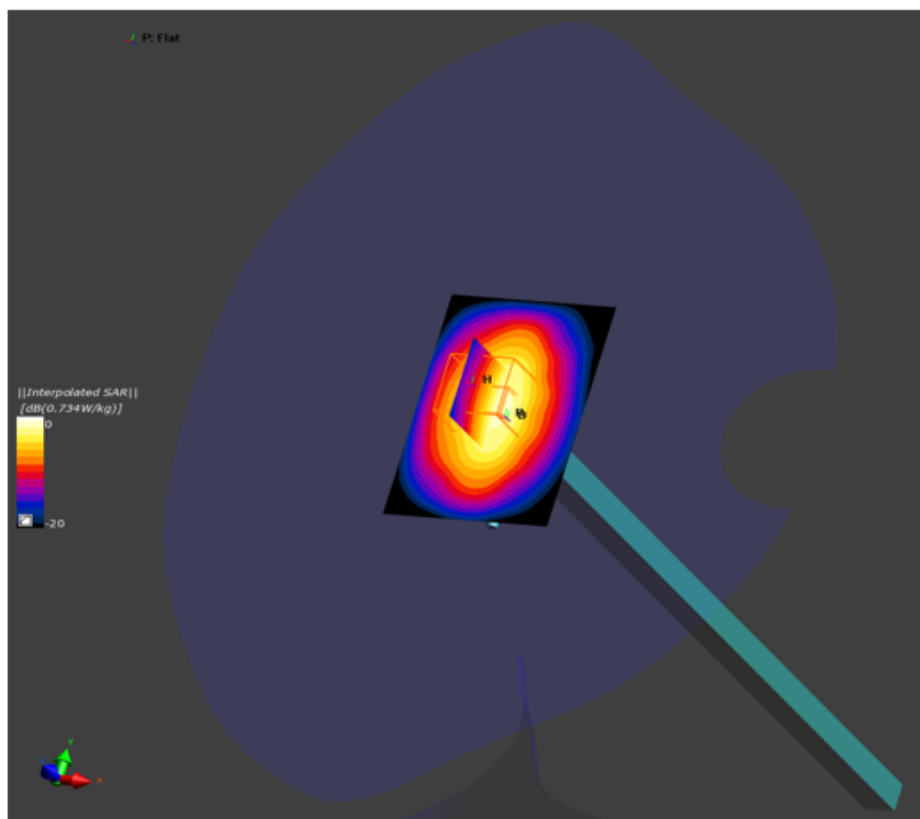

Figure C-3 SAR measurement system verification plot for 1800MHz performed on 1/20/2020. Input power = 10.0mW.

QualcommTechnologies, Inc.

Measurement Report for Unknown

Exposure Conditions

Phantom Section, TSL	Position, Test Distance [mm]	Band	Group, UID	Frequency [MHz], Channel Number	Modulation	TSL Conductivity [S/m]	TSL Permittivity
Flat, MSL	Flat, 1.0cm		0--	1800.0	CW	1.51	51.5

Hardware Setup

Phantom	TSL, Measured Date	Probe, Calibration Date	DAE, Calibration Date
Twin-SAM V4.0 (30deg probe tilt) - 209	MBBL-600-6000 Batch: 171204-1, 2020-Jan-21	EX3DV4 - 5N3618, 2019-04-15	DAE3 5n400, 2019-02-13

Scan Setup

	Area Scan	Zoom Scan
Grid Extents [mm]	56.0 x 84.0	30.0 x 30.0 x 30.0
Grid Steps [mm]	14.0 x 14.0	5.0 x 5.0 x 5.0
Sensor Surface [mm]	3.0	1.4

Measurement Results

	Area Scan	Zoom Scan
Date	2020-01-21, 10:01	2020-01-21, 10:06
psSAR1g [W/Kg]	0.412	0.417
psSAR10g [W/Kg]	0.211	0.216
Power Drift [dB]	-0.03	0.01

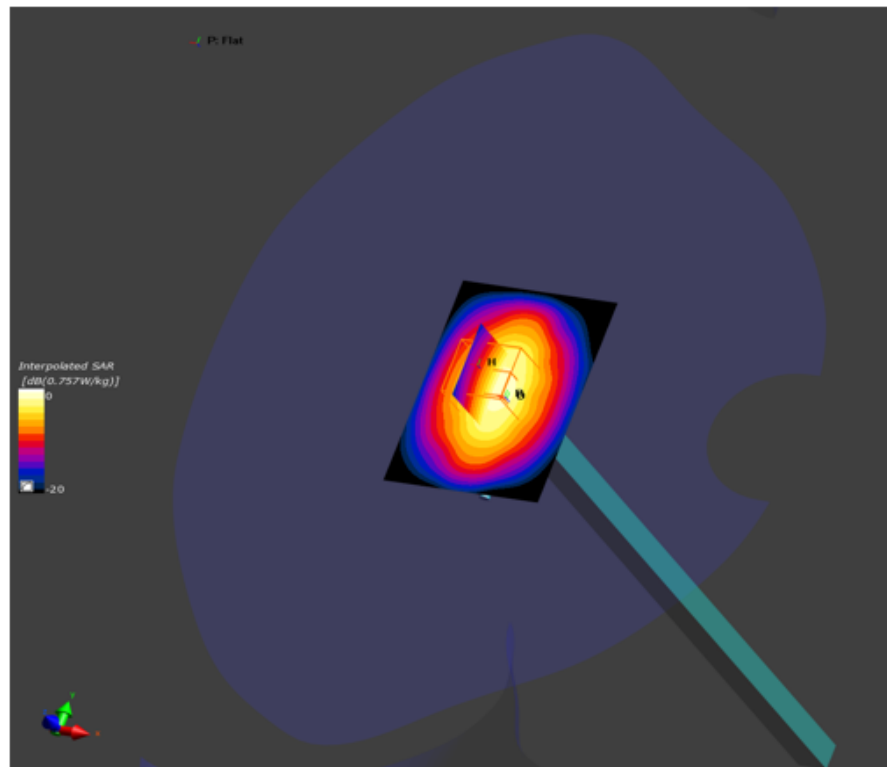

Figure C-4 SAR measurement system verification plot for 1800MHz performed on 1/21/2020. Input power = 10.0mW.

D SPEAG Certificates of cDASY6 SAR Probe, DAE and Dipole

E Test Setup Photos



Accredited by the Swiss Accreditation Service (SAS)
The Swiss Accreditation Service is one of the signatories to the EA
Multilateral Agreement for the recognition of calibration certificates

Accreditation No.: **SCS 0108**

Client **Qualcomm USA**

Certificate No: **EX3-3618_Apr19**

CALIBRATION CERTIFICATE

Object **EX3DV4 - SN:3618**

Calibration procedure(s) **QA CAL-01.v9, QA CAL-12.v9, QA CAL-14.v5, QA CAL-23.v5,
QA CAL-25.v7
Calibration procedure for dosimetric E-field probes**

Calibration date: **April 15, 2019 (Additional Conversion Factors)**

This calibration certificate documents the traceability to national standards, which realize the physical units of measurements (SI).
The measurements and the uncertainties with confidence probability are given on the following pages and are part of the certificate.

All calibrations have been conducted in the closed laboratory facility: environment temperature (22 ± 3)°C and humidity < 70%.

Calibration Equipment used (M&TE critical for calibration)

Primary Standards	ID	Cal Date (Certificate No.)	Scheduled Calibration
Power meter NRP	SN: 104778	03-Apr-19 (No. 217-02892/02893)	Apr-20
Power sensor NRP-Z91	SN: 103244	03-Apr-19 (No. 217-02892)	Apr-20
Power sensor NRP-Z91	SN: 103245	03-Apr-19 (No. 217-02893)	Apr-20
Reference 20 dB Attenuator	SN: S5277 (20x)	04-Apr-19 (No. 217-02894)	Apr-20
DAE4	SN: 660	19-Dec-18 (No. DAE4-660_Dec18)	Dec-19
Reference Probe ES3DV2	SN: 3013	31-Dec-18 (No. ES3-3013_Dec18)	Dec-19
Secondary Standards	ID	Check Date (in house)	Scheduled Check
Power meter E4419B	SN: GB41293874	06-Apr-16 (in house check Jun-18)	In house check: Jun-20
Power sensor E4412A	SN: MY41498087	06-Apr-16 (in house check Jun-18)	In house check: Jun-20
Power sensor E4412A	SN: 000110210	06-Apr-16 (in house check Jun-18)	In house check: Jun-20
RF generator HP 8648C	SN: US3642U01700	04-Aug-99 (in house check Jun-18)	In house check: Jun-20
Network Analyzer E8358A	SN: US41080477	31-Mar-14 (in house check Oct-18)	In house check: Oct-19

Calibrated by:	Name Jeton Kastrati	Function Laboratory Technician	Signature
Approved by:	Name Katja Pokovic	Function Technical Manager	

Issued: April 18, 2019

This calibration certificate shall not be reproduced except in full without written approval of the laboratory.



Accredited by the Swiss Accreditation Service (SAS)

Accreditation No.: **SCS 0108**

The Swiss Accreditation Service is one of the signatories to the EA
Multilateral Agreement for the recognition of calibration certificates

Glossary:

TSL	tissue simulating liquid
NORM _{x,y,z}	sensitivity in free space
ConvF	sensitivity in TSL / NORM _{x,y,z}
DCP	diode compression point
CF	crest factor (1/duty_cycle) of the RF signal
A, B, C, D	modulation dependent linearization parameters
Polarization φ	φ rotation around probe axis
Polarization ϑ	ϑ rotation around an axis that is in the plane normal to probe axis (at measurement center), i.e., $\vartheta = 0$ is normal to probe axis
Connector Angle	information used in DASY system to align probe sensor X to the robot coordinate system

Calibration is Performed According to the Following Standards:

- IEEE Std 1528-2013, "IEEE Recommended Practice for Determining the Peak Spatial-Averaged Specific Absorption Rate (SAR) in the Human Head from Wireless Communications Devices: Measurement Techniques", June 2013
- IEC 62209-1, "Measurement procedure for the assessment of Specific Absorption Rate (SAR) from hand-held and body-mounted devices used next to the ear (frequency range of 300 MHz to 6 GHz)", July 2016
- IEC 62209-2, "Procedure to determine the Specific Absorption Rate (SAR) for wireless communication devices used in close proximity to the human body (frequency range of 30 MHz to 6 GHz)", March 2010
- KDB 865664, "SAR Measurement Requirements for 100 MHz to 6 GHz"

Methods Applied and Interpretation of Parameters:

- NORM_{x,y,z}**: Assessed for E-field polarization $\vartheta = 0$ ($f \leq 900$ MHz in TEM-cell; $f > 1800$ MHz: R22 waveguide). NORM_{x,y,z} are only intermediate values, i.e., the uncertainties of NORM_{x,y,z} does not affect the E^2 -field uncertainty inside TSL (see below *ConvF*).
- NORM(f)_{x,y,z}** = NORM_{x,y,z} * *frequency_response* (see Frequency Response Chart). This linearization is implemented in DASY4 software versions later than 4.2. The uncertainty of the frequency response is included in the stated uncertainty of *ConvF*.
- DCP_{x,y,z}**: DCP are numerical linearization parameters assessed based on the data of power sweep with CW signal (no uncertainty required). DCP does not depend on frequency nor media.
- PAR**: PAR is the Peak to Average Ratio that is not calibrated but determined based on the signal characteristics
- A_{x,y,z}; B_{x,y,z}; C_{x,y,z}; D_{x,y,z}; VR_{x,y,z}; A, B, C, D** are numerical linearization parameters assessed based on the data of power sweep for specific modulation signal. The parameters do not depend on frequency nor media. VR is the maximum calibration range expressed in RMS voltage across the diode.
- ConvF and Boundary Effect Parameters**: Assessed in flat phantom using E-field (or Temperature Transfer Standard for $f \leq 800$ MHz) and inside waveguide using analytical field distributions based on power measurements for $f > 800$ MHz. The same setups are used for assessment of the parameters applied for boundary compensation (alpha, depth) of which typical uncertainty values are given. These parameters are used in DASY4 software to improve probe accuracy close to the boundary. The sensitivity in TSL corresponds to NORM_{x,y,z} * *ConvF* whereby the uncertainty corresponds to that given for *ConvF*. A frequency dependent *ConvF* is used in DASY version 4.4 and higher which allows extending the validity from ± 50 MHz to ± 100 MHz.
- Spherical isotropy (3D deviation from isotropy)**: in a field of low gradients realized using a flat phantom exposed by a patch antenna.
- Sensor Offset**: The sensor offset corresponds to the offset of virtual measurement center from the probe tip (on probe axis). No tolerance required.
- Connector Angle**: The angle is assessed using the information gained by determining the NORM_x (no uncertainty required).

DASY/EASY - Parameters of Probe: EX3DV4 - SN:3618

Basic Calibration Parameters

	Sensor X	Sensor Y	Sensor Z	Unc (k=2)
Norm ($\mu\text{V}/(\text{V}/\text{m})^2$) ^A	0.39	0.30	0.34	± 10.1 %
DCP (mV) ^B	93.5	104.9	99.5	

Calibration Results for Modulation Response

UID	Communication System Name		A dB	B dB $\sqrt{\mu\text{V}}$	C	D dB	VR mV	Max dev.	Max Unc ^E (k=2)
0	CW	X	0.00	0.00	1.00	0.00	138.5	± 3.3 %	± 4.7 %
		Y	0.00	0.00	1.00		141.5		
		Z	0.00	0.00	1.00		140.2		
10352- AAA	Pulse Waveform (200Hz, 10%)	X	5.27	72.88	14.98	10.00	60.0	± 2.3 %	± 9.6 %
		Y	11.48	83.16	18.67		60.0		
		Z	6.44	74.92	15.48		60.0		
10353- AAA	Pulse Waveform (200Hz, 20%)	X	4.72	73.44	13.81	6.99	80.0	± 1.6 %	± 9.6 %
		Y	15.00	87.29	18.66		80.0		
		Z	4.86	74.12	13.92		80.0		
10354- AAA	Pulse Waveform (200Hz, 40%)	X	2.28	68.77	10.40	3.98	95.0	± 1.1 %	± 9.6 %
		Y	15.00	88.79	17.77		95.0		
		Z	2.37	69.58	10.52		95.0		
10355- AAA	Pulse Waveform (200Hz, 60%)	X	0.43	60.00	5.18	2.22	120.0	± 1.3 %	± 9.6 %
		Y	15.00	91.31	17.63		120.0		
		Z	0.39	60.00	4.89		120.0		
10387- AAA	QPSK Waveform, 1 MHz	X	0.53	60.00	7.16	0.00	150.0	± 3.6 %	± 9.6 %
		Y	0.85	63.99	10.58		150.0		
		Z	0.47	60.00	5.94		150.0		
10388- AAA	QPSK Waveform, 10 MHz	X	2.07	67.51	15.34	0.00	150.0	± 1.2 %	± 9.6 %
		Y	2.45	69.84	16.71		150.0		
		Z	2.10	68.27	15.74		150.0		
10396- AAA	64-QAM Waveform, 100 kHz	X	3.18	71.25	19.37	3.01	150.0	± 1.3 %	± 9.6 %
		Y	3.19	70.91	18.75		150.0		
		Z	3.03	70.60	18.85		150.0		
10399- AAA	64-QAM Waveform, 40 MHz	X	3.38	66.72	15.61	0.00	150.0	± 2.6 %	± 9.6 %
		Y	3.52	67.39	16.01		150.0		
		Z	3.42	67.21	15.87		150.0		
10414- AAA	WLAN CCDF, 64-QAM, 40MHz	X	4.94	66.02	15.85	0.00	150.0	± 4.6 %	± 9.6 %
		Y	4.83	65.65	15.61		150.0		
		Z	4.75	65.73	15.70		150.0		

Note: For details on UID parameters see Appendix

The reported uncertainty of measurement is stated as the standard uncertainty of measurement multiplied by the coverage factor k=2, which for a normal distribution corresponds to a coverage probability of approximately 95%.

^A The uncertainties of Norm X,Y,Z do not affect the E²-field uncertainty inside TSL (see Pages 5 and 6).

^B Numerical linearization parameter: uncertainty not required.

^E Uncertainty is determined using the max. deviation from linear response applying rectangular distribution and is expressed for the square of the field value.

DASY/EASY - Parameters of Probe: EX3DV4 - SN:3618

Sensor Model Parameters

	C1 fF	C2 fF	α V ⁻¹	T1 ms.V ⁻²	T2 ms.V ⁻¹	T3 ms	T4 V ⁻²	T5 V ⁻¹	T6
X	46.3	363.45	38.76	14.00	1.25	5.04	0.00	0.65	1.01
Y	46.1	342.68	35.40	11.88	0.91	5.01	0.55	0.49	1.00
Z	38.4	299.76	38.40	10.78	1.14	5.04	0.00	0.62	1.01

Other Probe Parameters

Sensor Arrangement	Triangular
Connector Angle (°)	105.6
Mechanical Surface Detection Mode	enabled
Optical Surface Detection Mode	disabled
Probe Overall Length	337 mm
Probe Body Diameter	10 mm
Tip Length	9 mm
Tip Diameter	2.5 mm
Probe Tip to Sensor X Calibration Point	1 mm
Probe Tip to Sensor Y Calibration Point	1 mm
Probe Tip to Sensor Z Calibration Point	1 mm
Recommended Measurement Distance from Surface	1.4 mm

DASY/EASY - Parameters of Probe: EX3DV4 - SN:3618

Calibration Parameter Determined in Head Tissue Simulating Media

f (MHz) ^C	Relative Permittivity ^F	Conductivity (S/m) ^F	ConvF X	ConvF Y	ConvF Z	Alpha ^G	Depth ^G (mm)	Unc (k=2)
450	43.5	0.87	10.01	10.01	10.01	0.15	1.30	± 13.3 %
750	41.9	0.89	9.20	9.20	9.20	0.46	0.80	± 12.0 %
835	41.5	0.90	8.92	8.92	8.92	0.43	0.80	± 12.0 %
900	41.5	0.97	8.73	8.73	8.73	0.45	0.81	± 12.0 %
1450	40.5	1.20	8.05	8.05	8.05	0.32	0.80	± 12.0 %
1640	40.2	1.31	7.83	7.83	7.83	0.38	0.85	± 12.0 %
1750	40.1	1.37	7.57	7.57	7.57	0.34	0.84	± 12.0 %
1900	40.0	1.40	7.34	7.34	7.34	0.30	0.80	± 12.0 %
1950	40.0	1.40	7.32	7.32	7.32	0.37	0.80	± 12.0 %
2300	39.5	1.67	7.26	7.26	7.26	0.30	0.80	± 12.0 %
2450	39.2	1.80	6.98	6.98	6.98	0.39	0.80	± 12.0 %
2600	39.0	1.96	6.86	6.86	6.86	0.34	0.80	± 12.0 %
3300	38.2	2.71	6.81	6.81	6.81	0.30	1.30	± 13.1 %
3500	37.9	2.91	6.58	6.58	6.58	0.30	1.30	± 13.1 %
3700	37.7	3.12	6.35	6.35	6.35	0.30	1.30	± 13.1 %
3900	37.5	3.32	6.30	6.30	6.30	0.35	1.60	± 13.1 %
4100	37.2	3.53	6.10	6.10	6.10	0.35	1.60	± 13.1 %
4200	37.1	3.63	5.99	5.99	5.99	0.35	1.60	± 13.1 %
4400	36.9	3.84	5.92	5.92	5.92	0.40	1.80	± 13.1 %

^C Frequency validity above 300 MHz of ± 100 MHz only applies for DASY v4.4 and higher (see Page 2), else it is restricted to ± 50 MHz. The uncertainty is the RSS of the ConvF uncertainty at calibration frequency and the uncertainty for the indicated frequency band. Frequency validity below 300 MHz is ± 10, 25, 40, 50 and 70 MHz for ConvF assessments at 30, 64, 128, 150 and 220 MHz respectively. Validity of ConvF assessed at 6 MHz is 4-9 MHz, and ConvF assessed at 13 MHz is 9-19 MHz. Above 5 GHz frequency validity can be extended to ± 110 MHz.

^F At frequencies below 3 GHz, the validity of tissue parameters (ϵ and σ) can be relaxed to ± 10% if liquid compensation formula is applied to measured SAR values. At frequencies above 3 GHz, the validity of tissue parameters (ϵ and σ) is restricted to ± 5%. The uncertainty is the RSS of the ConvF uncertainty for indicated target tissue parameters.

^G Alpha/Depth are determined during calibration. SPEAG warrants that the remaining deviation due to the boundary effect after compensation is always less than ± 1% for frequencies below 3 GHz and below ± 2% for frequencies between 3-6 GHz at any distance larger than half the probe tip diameter from the boundary.

DASY/EASY - Parameters of Probe: EX3DV4 - SN:3618

Calibration Parameter Determined in Body Tissue Simulating Media

f (MHz) ^C	Relative Permittivity ^F	Conductivity (S/m) ^F	ConvF X	ConvF Y	ConvF Z	Alpha ^G	Depth ^G (mm)	Unc (k=2)
450	56.7	0.94	10.16	10.16	10.16	0.09	1.30	± 13.3 %
750	55.5	0.96	8.84	8.84	8.84	0.34	0.93	± 12.0 %
835	55.2	0.97	8.68	8.68	8.68	0.40	0.80	± 12.0 %
900	55.0	1.05	8.40	8.40	8.40	0.45	0.84	± 12.0 %
1450	54.0	1.30	7.82	7.82	7.82	0.37	0.80	± 12.0 %
1640	53.7	1.42	7.80	7.80	7.80	0.20	1.23	± 12.0 %
1750	53.4	1.49	7.41	7.41	7.41	0.51	0.80	± 12.0 %
1900	53.3	1.52	7.31	7.31	7.31	0.38	0.91	± 12.0 %
1950	53.3	1.52	7.24	7.24	7.24	0.37	0.80	± 12.0 %
2300	52.9	1.81	7.28	7.28	7.28	0.30	0.80	± 12.0 %
2450	52.7	1.95	7.19	7.19	7.19	0.32	0.80	± 12.0 %
2600	52.5	2.16	6.98	6.98	6.98	0.26	0.80	± 12.0 %
3300	51.6	3.08	6.11	6.11	6.11	0.40	1.35	± 13.1 %
3500	51.3	3.31	6.21	6.21	6.21	0.40	1.35	± 13.1 %
3700	51.0	3.55	6.17	6.17	6.17	0.40	1.35	± 13.1 %
3900	51.2	3.78	5.63	5.63	5.63	0.40	1.75	± 13.1 %
4100	50.5	4.01	5.43	5.43	5.43	0.40	1.75	± 13.1 %
4200	50.4	4.13	5.34	5.34	5.34	0.50	1.80	± 13.1 %
4400	50.1	4.37	5.01	5.01	5.01	0.50	1.80	± 13.1 %

^C Frequency validity above 300 MHz of ± 100 MHz only applies for DASY v4.4 and higher (see Page 2), else it is restricted to ± 50 MHz. The uncertainty is the RSS of the ConvF uncertainty at calibration frequency and the uncertainty for the indicated frequency band. Frequency validity below 300 MHz is ± 10, 25, 40, 50 and 70 MHz for ConvF assessments at 30, 64, 128, 150 and 220 MHz respectively. Validity of ConvF assessed at 6 MHz is 4-9 MHz, and ConvF assessed at 13 MHz is 9-19 MHz. Above 5 GHz frequency validity can be extended to ± 110 MHz.

^F At frequencies below 3 GHz, the validity of tissue parameters (ϵ and σ) can be relaxed to ± 10% if liquid compensation formula is applied to measured SAR values. At frequencies above 3 GHz, the validity of tissue parameters (ϵ and σ) is restricted to ± 5%. The uncertainty is the RSS of the ConvF uncertainty for indicated target tissue parameters.

^G Alpha/Depth are determined during calibration. SPEAG warrants that the remaining deviation due to the boundary effect after compensation is always less than ± 1% for frequencies below 3 GHz and below ± 2% for frequencies between 3-6 GHz at any distance larger than half the probe tip diameter from the boundary.

Conversion Factor Assessment

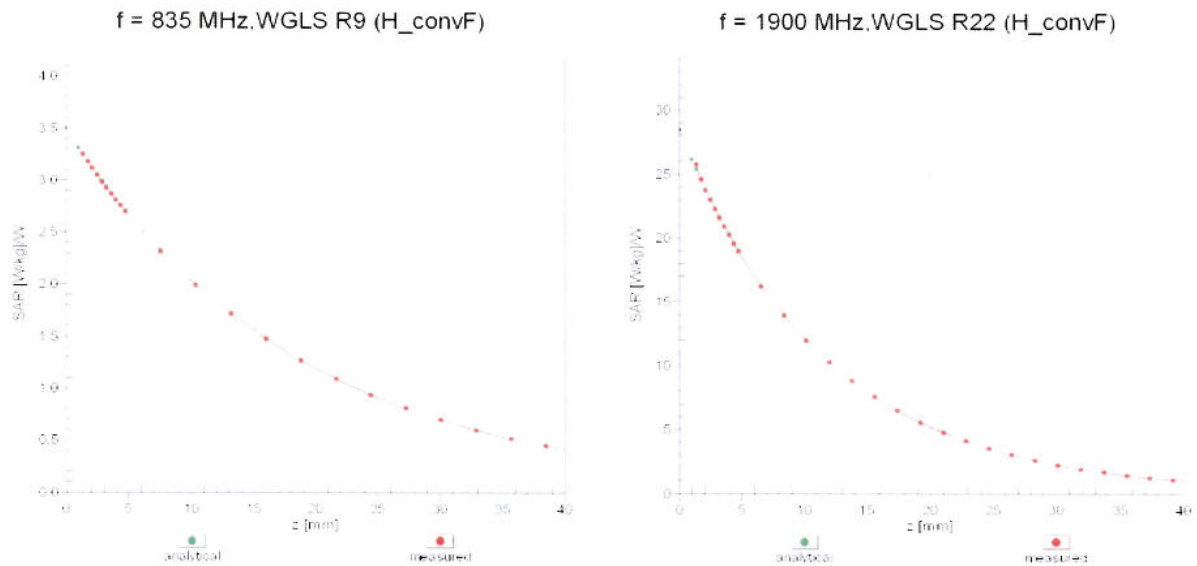

Deviation from Isotropy in Liquid Error (ϕ, θ), f = 900 MHz

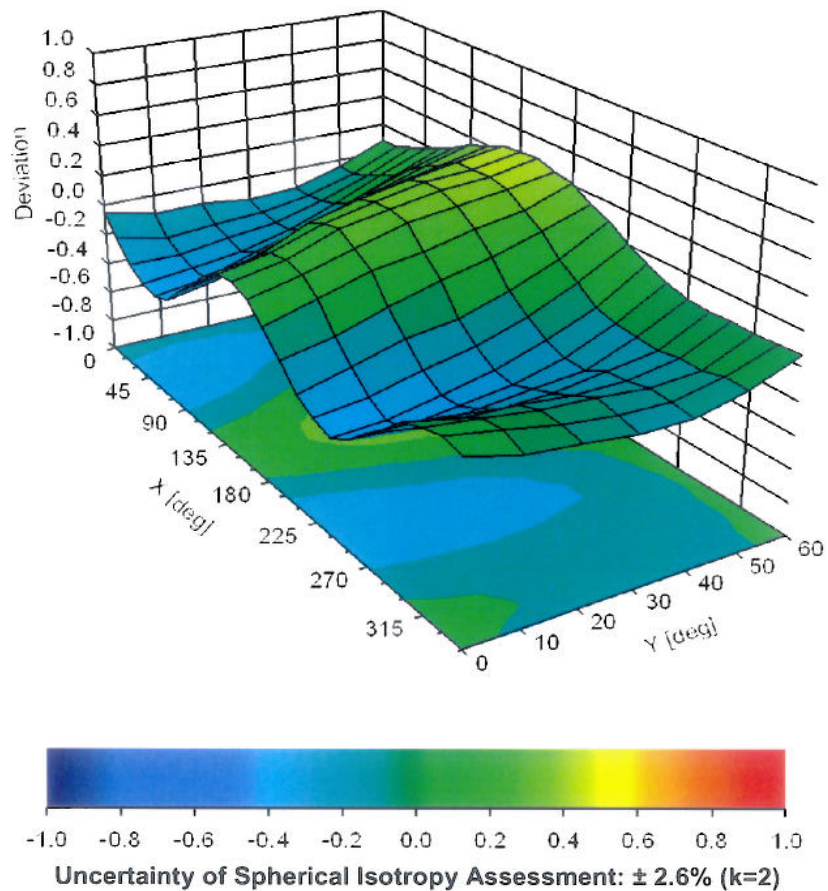

Appendix: Modulation Calibration Parameters

UID	Rev	Communication System Name	Group	PAR (dB)	Unc ^E (k=2)
0		CW	CW	0.00	± 4.7 %
10010	CAA	SAR Validation (Square, 100ms, 10ms)	Test	10.00	± 9.6 %
10011	CAB	UMTS-FDD (WCDMA)	WCDMA	2.91	± 9.6 %
10012	CAB	IEEE 802.11b WiFi 2.4 GHz (DSSS, 1 Mbps)	WLAN	1.87	± 9.6 %
10013	CAB	IEEE 802.11g WiFi 2.4 GHz (DSSS-OFDM, 6 Mbps)	WLAN	9.46	± 9.6 %
10021	DAC	GSM-FDD (TDMA, GMSK)	GSM	9.39	± 9.6 %
10023	DAC	GPRS-FDD (TDMA, GMSK, TN 0)	GSM	9.57	± 9.6 %
10024	DAC	GPRS-FDD (TDMA, GMSK, TN 0-1)	GSM	6.56	± 9.6 %
10025	DAC	EDGE-FDD (TDMA, 8PSK, TN 0)	GSM	12.62	± 9.6 %
10026	DAC	EDGE-FDD (TDMA, 8PSK, TN 0-1)	GSM	9.55	± 9.6 %
10027	DAC	GPRS-FDD (TDMA, GMSK, TN 0-1-2)	GSM	4.80	± 9.6 %
10028	DAC	GPRS-FDD (TDMA, GMSK, TN 0-1-2-3)	GSM	3.55	± 9.6 %
10029	DAC	EDGE-FDD (TDMA, 8PSK, TN 0-1-2)	GSM	7.78	± 9.6 %
10030	CAA	IEEE 802.15.1 Bluetooth (GFSK, DH1)	Bluetooth	5.30	± 9.6 %
10031	CAA	IEEE 802.15.1 Bluetooth (GFSK, DH3)	Bluetooth	1.87	± 9.6 %
10032	CAA	IEEE 802.15.1 Bluetooth (GFSK, DH5)	Bluetooth	1.16	± 9.6 %
10033	CAA	IEEE 802.15.1 Bluetooth (PI/4-DQPSK, DH1)	Bluetooth	7.74	± 9.6 %
10034	CAA	IEEE 802.15.1 Bluetooth (PI/4-DQPSK, DH3)	Bluetooth	4.53	± 9.6 %
10035	CAA	IEEE 802.15.1 Bluetooth (PI/4-DQPSK, DH5)	Bluetooth	3.83	± 9.6 %
10036	CAA	IEEE 802.15.1 Bluetooth (8-DPSK, DH1)	Bluetooth	8.01	± 9.6 %
10037	CAA	IEEE 802.15.1 Bluetooth (8-DPSK, DH3)	Bluetooth	4.77	± 9.6 %
10038	CAA	IEEE 802.15.1 Bluetooth (8-DPSK, DH5)	Bluetooth	4.10	± 9.6 %
10039	CAB	CDMA2000 (1xRTT, RC1)	CDMA2000	4.57	± 9.6 %
10042	CAB	IS-54 / IS-136 FDD (TDMA/FDM, PI/4-DQPSK, Halfrate)	AMPS	7.78	± 9.6 %
10044	CAA	IS-91/EIA/TIA-553 FDD (FDMA, FM)	AMPS	0.00	± 9.6 %
10048	CAA	DECT (TDD, TDMA/FDM, GFSK, Full Slot, 24)	DECT	13.80	± 9.6 %
10049	CAA	DECT (TDD, TDMA/FDM, GFSK, Double Slot, 12)	DECT	10.79	± 9.6 %
10056	CAA	UMTS-TDD (TD-SCDMA, 1.28 Mcps)	TD-SCDMA	11.01	± 9.6 %
10058	DAC	EDGE-FDD (TDMA, 8PSK, TN 0-1-2-3)	GSM	6.52	± 9.6 %
10059	CAB	IEEE 802.11b WiFi 2.4 GHz (DSSS, 2 Mbps)	WLAN	2.12	± 9.6 %
10060	CAB	IEEE 802.11b WiFi 2.4 GHz (DSSS, 5.5 Mbps)	WLAN	2.83	± 9.6 %
10061	CAB	IEEE 802.11b WiFi 2.4 GHz (DSSS, 11 Mbps)	WLAN	3.60	± 9.6 %
10062	CAC	IEEE 802.11a/h WiFi 5 GHz (OFDM, 6 Mbps)	WLAN	8.68	± 9.6 %
10063	CAC	IEEE 802.11a/h WiFi 5 GHz (OFDM, 9 Mbps)	WLAN	8.63	± 9.6 %
10064	CAC	IEEE 802.11a/h WiFi 5 GHz (OFDM, 12 Mbps)	WLAN	9.09	± 9.6 %
10065	CAC	IEEE 802.11a/h WiFi 5 GHz (OFDM, 18 Mbps)	WLAN	9.00	± 9.6 %
10066	CAC	IEEE 802.11a/h WiFi 5 GHz (OFDM, 24 Mbps)	WLAN	9.38	± 9.6 %
10067	CAC	IEEE 802.11a/h WiFi 5 GHz (OFDM, 36 Mbps)	WLAN	10.12	± 9.6 %
10068	CAC	IEEE 802.11a/h WiFi 5 GHz (OFDM, 48 Mbps)	WLAN	10.24	± 9.6 %
10069	CAC	IEEE 802.11a/h WiFi 5 GHz (OFDM, 54 Mbps)	WLAN	10.56	± 9.6 %
10071	CAB	IEEE 802.11g WiFi 2.4 GHz (DSSS/OFDM, 9 Mbps)	WLAN	9.83	± 9.6 %
10072	CAB	IEEE 802.11g WiFi 2.4 GHz (DSSS/OFDM, 12 Mbps)	WLAN	9.62	± 9.6 %
10073	CAB	IEEE 802.11g WiFi 2.4 GHz (DSSS/OFDM, 18 Mbps)	WLAN	9.94	± 9.6 %
10074	CAB	IEEE 802.11g WiFi 2.4 GHz (DSSS/OFDM, 24 Mbps)	WLAN	10.30	± 9.6 %
10075	CAB	IEEE 802.11g WiFi 2.4 GHz (DSSS/OFDM, 36 Mbps)	WLAN	10.77	± 9.6 %
10076	CAB	IEEE 802.11g WiFi 2.4 GHz (DSSS/OFDM, 48 Mbps)	WLAN	10.94	± 9.6 %
10077	CAB	IEEE 802.11g WiFi 2.4 GHz (DSSS/OFDM, 54 Mbps)	WLAN	11.00	± 9.6 %
10081	CAB	CDMA2000 (1xRTT, RC3)	CDMA2000	3.97	± 9.6 %
10082	CAB	IS-54 / IS-136 FDD (TDMA/FDM, PI/4-DQPSK, Fullrate)	AMPS	4.77	± 9.6 %
10090	DAC	GPRS-FDD (TDMA, GMSK, TN 0-4)	GSM	6.56	± 9.6 %
10097	CAB	UMTS-FDD (HSDPA)	WCDMA	3.98	± 9.6 %
10098	CAB	UMTS-FDD (HSUPA, Subtest 2)	WCDMA	3.98	± 9.6 %
10099	DAC	EDGE-FDD (TDMA, 8PSK, TN 0-4)	GSM	9.55	± 9.6 %
10100	CAE	LTE-FDD (SC-FDMA, 100% RB, 20 MHz, QPSK)	LTE-FDD	5.67	± 9.6 %
10101	CAE	LTE-FDD (SC-FDMA, 100% RB, 20 MHz, 16-QAM)	LTE-FDD	6.42	± 9.6 %
10102	CAE	LTE-FDD (SC-FDMA, 100% RB, 20 MHz, 64-QAM)	LTE-FDD	6.60	± 9.6 %
10103	CAG	LTE-TDD (SC-FDMA, 100% RB, 20 MHz, QPSK)	LTE-TDD	9.29	± 9.6 %
10104	CAG	LTE-TDD (SC-FDMA, 100% RB, 20 MHz, 16-QAM)	LTE-TDD	9.97	± 9.6 %
10105	CAG	LTE-TDD (SC-FDMA, 100% RB, 20 MHz, 64-QAM)	LTE-TDD	10.01	± 9.6 %
10108	CAG	LTE-FDD (SC-FDMA, 100% RB, 10 MHz, QPSK)	LTE-FDD	5.80	± 9.6 %

10220	CAC	IEEE 802.11n (HT Mixed, 43.3 Mbps, 16-QAM)	WLAN	8.13	± 9.6 %
10221	CAC	IEEE 802.11n (HT Mixed, 72.2 Mbps, 64-QAM)	WLAN	8.27	± 9.6 %
10222	CAC	IEEE 802.11n (HT Mixed, 15 Mbps, BPSK)	WLAN	8.06	± 9.6 %
10223	CAC	IEEE 802.11n (HT Mixed, 90 Mbps, 16-QAM)	WLAN	8.48	± 9.6 %
10224	CAC	IEEE 802.11n (HT Mixed, 150 Mbps, 64-QAM)	WLAN	8.08	± 9.6 %
10225	CAB	UMTS-FDD (HSPA+)	WCDMA	5.97	± 9.6 %
10226	CAA	LTE-TDD (SC-FDMA, 1 RB, 1.4 MHz, 16-QAM)	LTE-TDD	9.49	± 9.6 %
10227	CAA	LTE-TDD (SC-FDMA, 1 RB, 1.4 MHz, 64-QAM)	LTE-TDD	10.26	± 9.6 %
10228	CAA	LTE-TDD (SC-FDMA, 1 RB, 1.4 MHz, QPSK)	LTE-TDD	9.22	± 9.6 %
10229	CAC	LTE-TDD (SC-FDMA, 1 RB, 3 MHz, 16-QAM)	LTE-TDD	9.48	± 9.6 %
10230	CAC	LTE-TDD (SC-FDMA, 1 RB, 3 MHz, 64-QAM)	LTE-TDD	10.25	± 9.6 %
10231	CAC	LTE-TDD (SC-FDMA, 1 RB, 3 MHz, QPSK)	LTE-TDD	9.19	± 9.6 %
10232	CAF	LTE-TDD (SC-FDMA, 1 RB, 5 MHz, 16-QAM)	LTE-TDD	9.48	± 9.6 %
10233	CAF	LTE-TDD (SC-FDMA, 1 RB, 5 MHz, 64-QAM)	LTE-TDD	10.25	± 9.6 %
10234	CAF	LTE-TDD (SC-FDMA, 1 RB, 5 MHz, QPSK)	LTE-TDD	9.21	± 9.6 %
10235	CAF	LTE-TDD (SC-FDMA, 1 RB, 10 MHz, 16-QAM)	LTE-TDD	9.48	± 9.6 %
10236	CAF	LTE-TDD (SC-FDMA, 1 RB, 10 MHz, 64-QAM)	LTE-TDD	10.25	± 9.6 %
10237	CAF	LTE-TDD (SC-FDMA, 1 RB, 10 MHz, QPSK)	LTE-TDD	9.21	± 9.6 %
10238	CAF	LTE-TDD (SC-FDMA, 1 RB, 15 MHz, 16-QAM)	LTE-TDD	9.48	± 9.6 %
10239	CAF	LTE-TDD (SC-FDMA, 1 RB, 15 MHz, 64-QAM)	LTE-TDD	10.25	± 9.6 %
10240	CAF	LTE-TDD (SC-FDMA, 1 RB, 15 MHz, QPSK)	LTE-TDD	9.21	± 9.6 %
10241	CAA	LTE-TDD (SC-FDMA, 50% RB, 1.4 MHz, 16-QAM)	LTE-TDD	9.82	± 9.6 %
10242	CAA	LTE-TDD (SC-FDMA, 50% RB, 1.4 MHz, 64-QAM)	LTE-TDD	9.86	± 9.6 %
10243	CAA	LTE-TDD (SC-FDMA, 50% RB, 1.4 MHz, QPSK)	LTE-TDD	9.46	± 9.6 %
10244	CAC	LTE-TDD (SC-FDMA, 50% RB, 3 MHz, 16-QAM)	LTE-TDD	10.06	± 9.6 %
10245	CAC	LTE-TDD (SC-FDMA, 50% RB, 3 MHz, 64-QAM)	LTE-TDD	10.06	± 9.6 %
10246	CAC	LTE-TDD (SC-FDMA, 50% RB, 3 MHz, QPSK)	LTE-TDD	9.30	± 9.6 %
10247	CAF	LTE-TDD (SC-FDMA, 50% RB, 5 MHz, 16-QAM)	LTE-TDD	9.91	± 9.6 %
10248	CAF	LTE-TDD (SC-FDMA, 50% RB, 5 MHz, 64-QAM)	LTE-TDD	10.09	± 9.6 %
10249	CAF	LTE-TDD (SC-FDMA, 50% RB, 5 MHz, QPSK)	LTE-TDD	9.29	± 9.6 %
10250	CAF	LTE-TDD (SC-FDMA, 50% RB, 10 MHz, 16-QAM)	LTE-TDD	9.81	± 9.6 %
10251	CAF	LTE-TDD (SC-FDMA, 50% RB, 10 MHz, 64-QAM)	LTE-TDD	10.17	± 9.6 %
10252	CAF	LTE-TDD (SC-FDMA, 50% RB, 10 MHz, QPSK)	LTE-TDD	9.24	± 9.6 %
10253	CAF	LTE-TDD (SC-FDMA, 50% RB, 15 MHz, 16-QAM)	LTE-TDD	9.90	± 9.6 %
10254	CAF	LTE-TDD (SC-FDMA, 50% RB, 15 MHz, 64-QAM)	LTE-TDD	10.14	± 9.6 %
10255	CAF	LTE-TDD (SC-FDMA, 50% RB, 15 MHz, QPSK)	LTE-TDD	9.20	± 9.6 %
10256	CAA	LTE-TDD (SC-FDMA, 100% RB, 1.4 MHz, 16-QAM)	LTE-TDD	9.96	± 9.6 %
10257	CAA	LTE-TDD (SC-FDMA, 100% RB, 1.4 MHz, 64-QAM)	LTE-TDD	10.08	± 9.6 %
10258	CAA	LTE-TDD (SC-FDMA, 100% RB, 1.4 MHz, QPSK)	LTE-TDD	9.34	± 9.6 %
10259	CAC	LTE-TDD (SC-FDMA, 100% RB, 3 MHz, 16-QAM)	LTE-TDD	9.98	± 9.6 %
10260	CAC	LTE-TDD (SC-FDMA, 100% RB, 3 MHz, 64-QAM)	LTE-TDD	9.97	± 9.6 %
10261	CAC	LTE-TDD (SC-FDMA, 100% RB, 3 MHz, QPSK)	LTE-TDD	9.24	± 9.6 %
10262	CAF	LTE-TDD (SC-FDMA, 100% RB, 5 MHz, 16-QAM)	LTE-TDD	9.83	± 9.6 %
10263	CAF	LTE-TDD (SC-FDMA, 100% RB, 5 MHz, 64-QAM)	LTE-TDD	10.16	± 9.6 %
10264	CAF	LTE-TDD (SC-FDMA, 100% RB, 5 MHz, QPSK)	LTE-TDD	9.23	± 9.6 %
10265	CAF	LTE-TDD (SC-FDMA, 100% RB, 10 MHz, 16-QAM)	LTE-TDD	9.92	± 9.6 %
10266	CAF	LTE-TDD (SC-FDMA, 100% RB, 10 MHz, 64-QAM)	LTE-TDD	10.07	± 9.6 %
10267	CAF	LTE-TDD (SC-FDMA, 100% RB, 10 MHz, QPSK)	LTE-TDD	9.30	± 9.6 %
10268	CAF	LTE-TDD (SC-FDMA, 100% RB, 15 MHz, 16-QAM)	LTE-TDD	10.06	± 9.6 %
10269	CAF	LTE-TDD (SC-FDMA, 100% RB, 15 MHz, 64-QAM)	LTE-TDD	10.13	± 9.6 %
10270	CAF	LTE-TDD (SC-FDMA, 100% RB, 15 MHz, QPSK)	LTE-TDD	9.58	± 9.6 %
10274	CAB	UMTS-FDD (HSUPA, Subtest 5, 3GPP Rel8.10)	WCDMA	4.87	± 9.6 %
10275	CAB	UMTS-FDD (HSUPA, Subtest 5, 3GPP Rel8.4)	WCDMA	3.96	± 9.6 %
10277	CAA	PHS (QPSK)	PHS	11.81	± 9.6 %
10278	CAA	PHS (QPSK, BW 884MHz, Rolloff 0.5)	PHS	11.81	± 9.6 %
10279	CAA	PHS (QPSK, BW 884MHz, Rolloff 0.38)	PHS	12.18	± 9.6 %
10290	AAB	CDMA2000, RC1, SO55, Full Rate	CDMA2000	3.91	± 9.6 %
10291	AAB	CDMA2000, RC3, SO55, Full Rate	CDMA2000	3.46	± 9.6 %
10292	AAB	CDMA2000, RC3, SO32, Full Rate	CDMA2000	3.39	± 9.6 %
10293	AAB	CDMA2000, RC3, SO3, Full Rate	CDMA2000	3.50	± 9.6 %
10295	AAB	CDMA2000, RC1, SO3, 1/8th Rate 25 fr.	CDMA2000	12.49	± 9.6 %
10297	AAD	LTE-FDD (SC-FDMA, 50% RB, 20 MHz, QPSK)	LTE-FDD	5.81	± 9.6 %
10298	AAD	LTE-FDD (SC-FDMA, 50% RB, 3 MHz, QPSK)	LTE-FDD	5.72	± 9.6 %
10299	AAD	LTE-FDD (SC-FDMA, 50% RB, 3 MHz, 16-QAM)	LTE-FDD	6.39	± 9.6 %

10451	AAA	W-CDMA (BS Test Model 1, 64 DPCH, Clipping 44%)	WCDMA	7.59	± 9.6 %
10456	AAB	IEEE 802.11ac WiFi (160MHz, 64-QAM, 99pc duty cycle)	WLAN	8.63	± 9.6 %
10457	AAA	UMTS-FDD (DC-HSDPA)	WCDMA	6.62	± 9.6 %
10458	AAA	CDMA2000 (1xEV-DO, Rev. B, 2 carriers)	CDMA2000	6.55	± 9.6 %
10459	AAA	CDMA2000 (1xEV-DO, Rev. B, 3 carriers)	CDMA2000	8.25	± 9.6 %
10460	AAA	UMTS-FDD (WCDMA, AMR)	WCDMA	2.39	± 9.6 %
10461	AAA	LTE-TDD (SC-FDMA, 1 RB, 1.4 MHz, QPSK, UL Subframe=2,3,4,7,8,9)	LTE-TDD	7.82	± 9.6 %
10462	AAA	LTE-TDD (SC-FDMA, 1 RB, 1.4 MHz, 16-QAM, UL Subframe=2,3,4,7,8,9)	LTE-TDD	8.30	± 9.6 %
10463	AAA	LTE-TDD (SC-FDMA, 1 RB, 1.4 MHz, 64-QAM, UL Subframe=2,3,4,7,8,9)	LTE-TDD	8.56	± 9.6 %
10464	AAB	LTE-TDD (SC-FDMA, 1 RB, 3 MHz, QPSK, UL Subframe=2,3,4,7,8,9)	LTE-TDD	7.82	± 9.6 %
10465	AAB	LTE-TDD (SC-FDMA, 1 RB, 3 MHz, 16-QAM, UL Subframe=2,3,4,7,8,9)	LTE-TDD	8.32	± 9.6 %
10466	AAB	LTE-TDD (SC-FDMA, 1 RB, 3 MHz, 64-QAM, UL Subframe=2,3,4,7,8,9)	LTE-TDD	8.57	± 9.6 %
10467	AAE	LTE-TDD (SC-FDMA, 1 RB, 5 MHz, QPSK, UL Subframe=2,3,4,7,8,9)	LTE-TDD	7.82	± 9.6 %
10468	AAE	LTE-TDD (SC-FDMA, 1 RB, 5 MHz, 16-QAM, UL Subframe=2,3,4,7,8,9)	LTE-TDD	8.32	± 9.6 %
10469	AAE	LTE-TDD (SC-FDMA, 1 RB, 5 MHz, 64-QAM, UL Subframe=2,3,4,7,8,9)	LTE-TDD	8.56	± 9.6 %
10470	AAE	LTE-TDD (SC-FDMA, 1 RB, 10 MHz, QPSK, UL Subframe=2,3,4,7,8,9)	LTE-TDD	7.82	± 9.6 %
10471	AAE	LTE-TDD (SC-FDMA, 1 RB, 10 MHz, 16-QAM, UL Subframe=2,3,4,7,8,9)	LTE-TDD	8.32	± 9.6 %
10472	AAE	LTE-TDD (SC-FDMA, 1 RB, 10 MHz, 64-QAM, UL Subframe=2,3,4,7,8,9)	LTE-TDD	8.57	± 9.6 %
10473	AAE	LTE-TDD (SC-FDMA, 1 RB, 15 MHz, QPSK, UL Subframe=2,3,4,7,8,9)	LTE-TDD	7.82	± 9.6 %
10474	AAE	LTE-TDD (SC-FDMA, 1 RB, 15 MHz, 16-QAM, UL Subframe=2,3,4,7,8,9)	LTE-TDD	8.32	± 9.6 %
10475	AAE	LTE-TDD (SC-FDMA, 1 RB, 15 MHz, 64-QAM, UL Subframe=2,3,4,7,8,9)	LTE-TDD	8.57	± 9.6 %
10477	AAF	LTE-TDD (SC-FDMA, 1 RB, 20 MHz, 16-QAM, UL Subframe=2,3,4,7,8,9)	LTE-TDD	8.32	± 9.6 %
10478	AAF	LTE-TDD (SC-FDMA, 1 RB, 20 MHz, 64-QAM, UL Subframe=2,3,4,7,8,9)	LTE-TDD	8.57	± 9.6 %
10479	AAA	LTE-TDD (SC-FDMA, 50% RB, 1.4 MHz, QPSK, UL Subframe=2,3,4,7,8,9)	LTE-TDD	7.74	± 9.6 %
10480	AAA	LTE-TDD (SC-FDMA, 50% RB, 1.4 MHz, 16-QAM, UL Subframe=2,3,4,7,8,9)	LTE-TDD	8.18	± 9.6 %
10481	AAA	LTE-TDD (SC-FDMA, 50% RB, 1.4 MHz, 64-QAM, UL Subframe=2,3,4,7,8,9)	LTE-TDD	8.45	± 9.6 %
10482	AAB	LTE-TDD (SC-FDMA, 50% RB, 3 MHz, QPSK, UL Subframe=2,3,4,7,8,9)	LTE-TDD	7.71	± 9.6 %
10483	AAB	LTE-TDD (SC-FDMA, 50% RB, 3 MHz, 16-QAM, UL Subframe=2,3,4,7,8,9)	LTE-TDD	8.39	± 9.6 %
10484	AAB	LTE-TDD (SC-FDMA, 50% RB, 3 MHz, 64-QAM, UL Subframe=2,3,4,7,8,9)	LTE-TDD	8.47	± 9.6 %
10485	AAE	LTE-TDD (SC-FDMA, 50% RB, 5 MHz, QPSK, UL Subframe=2,3,4,7,8,9)	LTE-TDD	7.59	± 9.6 %
10486	AAE	LTE-TDD (SC-FDMA, 50% RB, 5 MHz, 16-QAM, UL Subframe=2,3,4,7,8,9)	LTE-TDD	8.38	± 9.6 %
10487	AAE	LTE-TDD (SC-FDMA, 50% RB, 5 MHz, 64-QAM, UL Subframe=2,3,4,7,8,9)	LTE-TDD	8.60	± 9.6 %
10488	AAE	LTE-TDD (SC-FDMA, 50% RB, 10 MHz, QPSK, UL Subframe=2,3,4,7,8,9)	LTE-TDD	7.70	± 9.6 %
10489	AAE	LTE-TDD (SC-FDMA, 50% RB, 10 MHz, 16-QAM, UL Subframe=2,3,4,7,8,9)	LTE-TDD	8.31	± 9.6 %
10490	AAE	LTE-TDD (SC-FDMA, 50% RB, 10 MHz, 64-QAM, UL Subframe=2,3,4,7,8,9)	LTE-TDD	8.54	± 9.6 %
10491	AAE	LTE-TDD (SC-FDMA, 50% RB, 15 MHz, QPSK, UL Subframe=2,3,4,7,8,9)	LTE-TDD	7.74	± 9.6 %