



18. TEST PHOTOGRAPHS

See following Attached Pages for setup photographs.

FCC ID: ZNFUS990	 PCTEST ENGINEERING LABORATORY, INC.	HAC (RF EMISSIONS) TEST REPORT	 LG	Reviewed by: Quality Manager
Filename: 0Y1406171294.ZNF	Test Dates: 6/16/2014 - 6/19/2014, 7/25/2014	EUT Type: Portable Handset	Page 73 of 77	

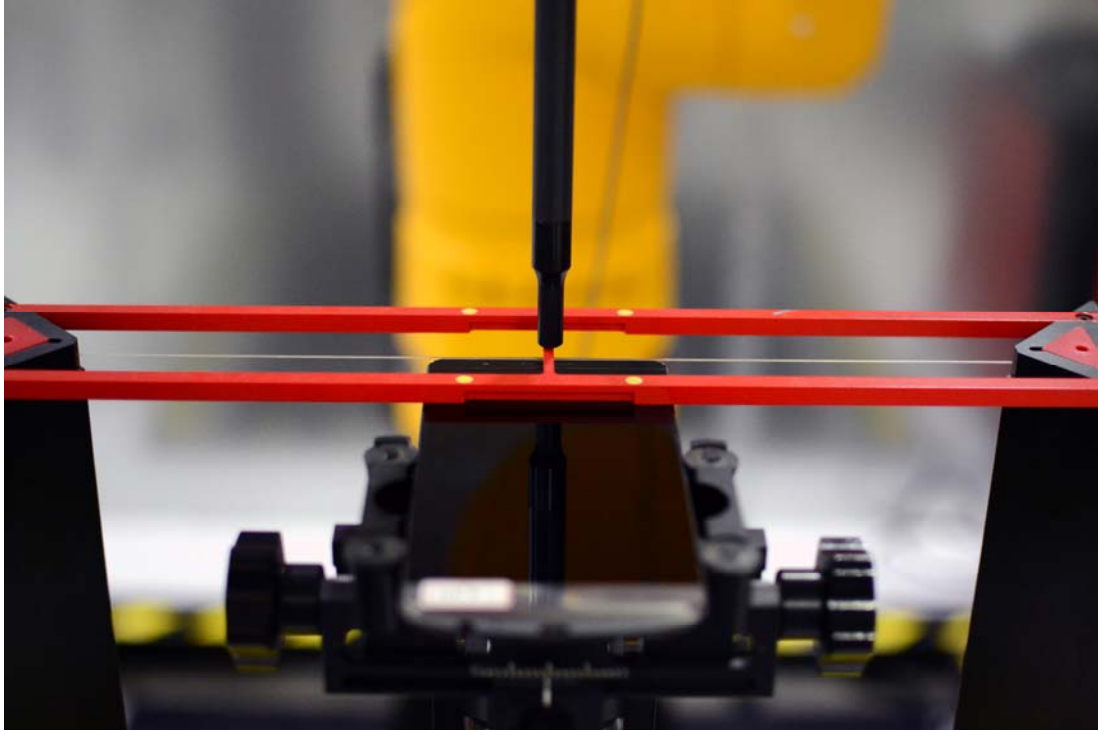

Figure 18-1
Ear Reference Point HAC Phantom Alignment (Standard Battery Cover)

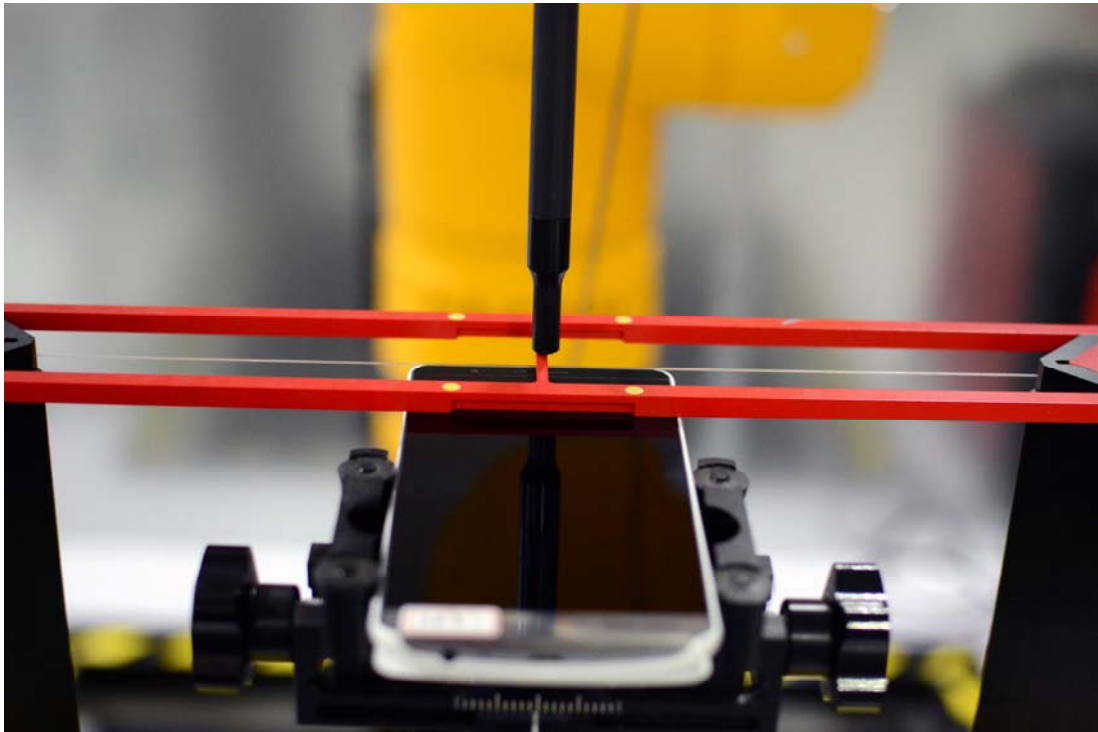



Figure 18-2
Ear Reference Point HAC Phantom Alignment (Wireless Charging Cover - Open)

FCC ID: ZNFUS990	 PCTEST <small>ENGINEERING LABORATORY, INC.</small>	HAC (RF EMISSIONS) TEST REPORT	 LG	Reviewed by: Quality Manager
Filename: 0Y1406171294.ZNF	Test Dates: 6/16/2014 - 6/19/2014, 7/25/2014	EUT Type: Portable Handset	Page 74 of 77	

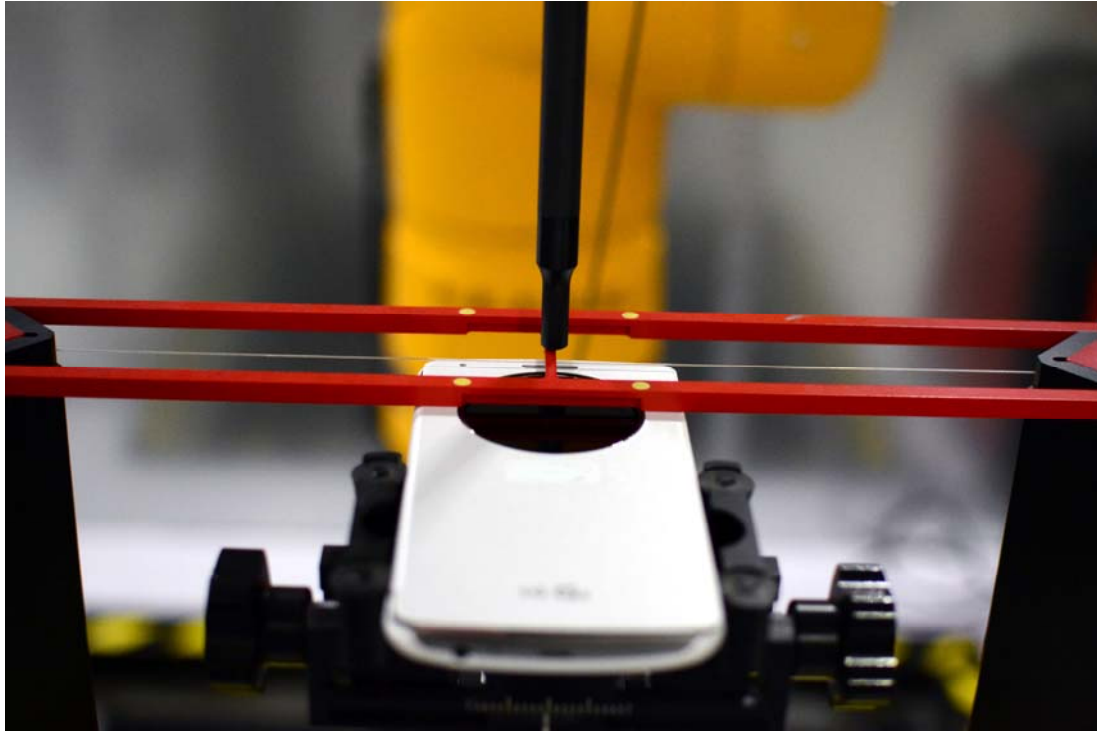

Figure 18-3
Ear Reference Point HAC Phantom Alignment (Wireless Charging Cover - Closed)

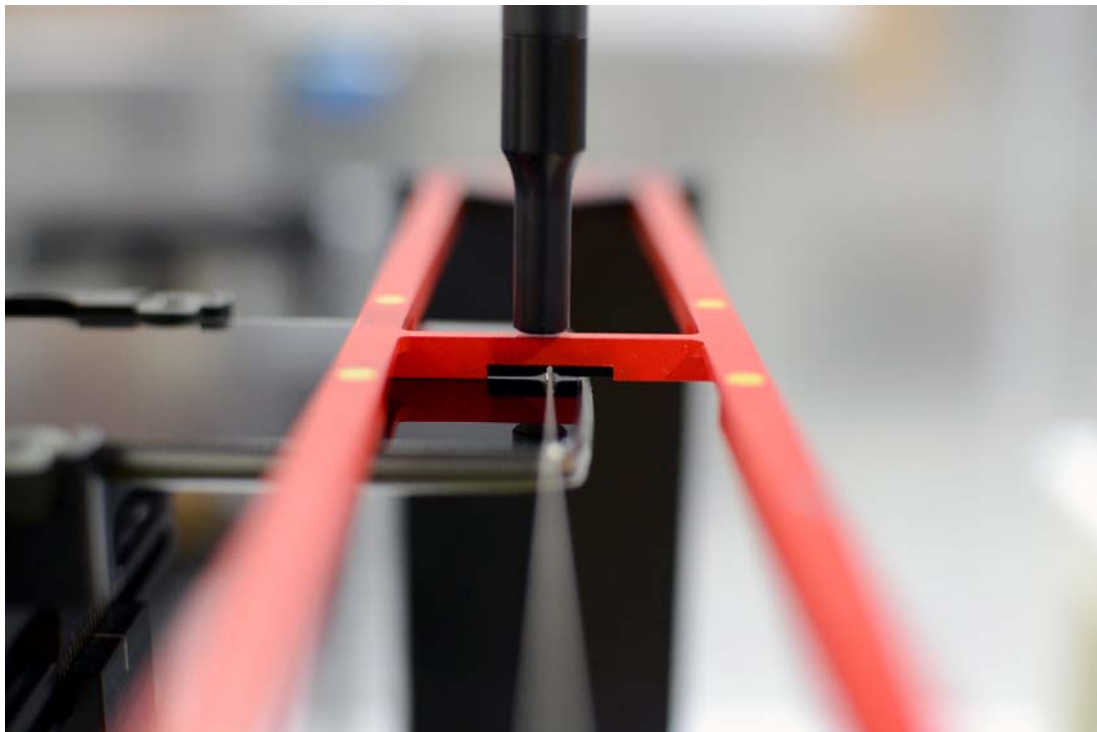

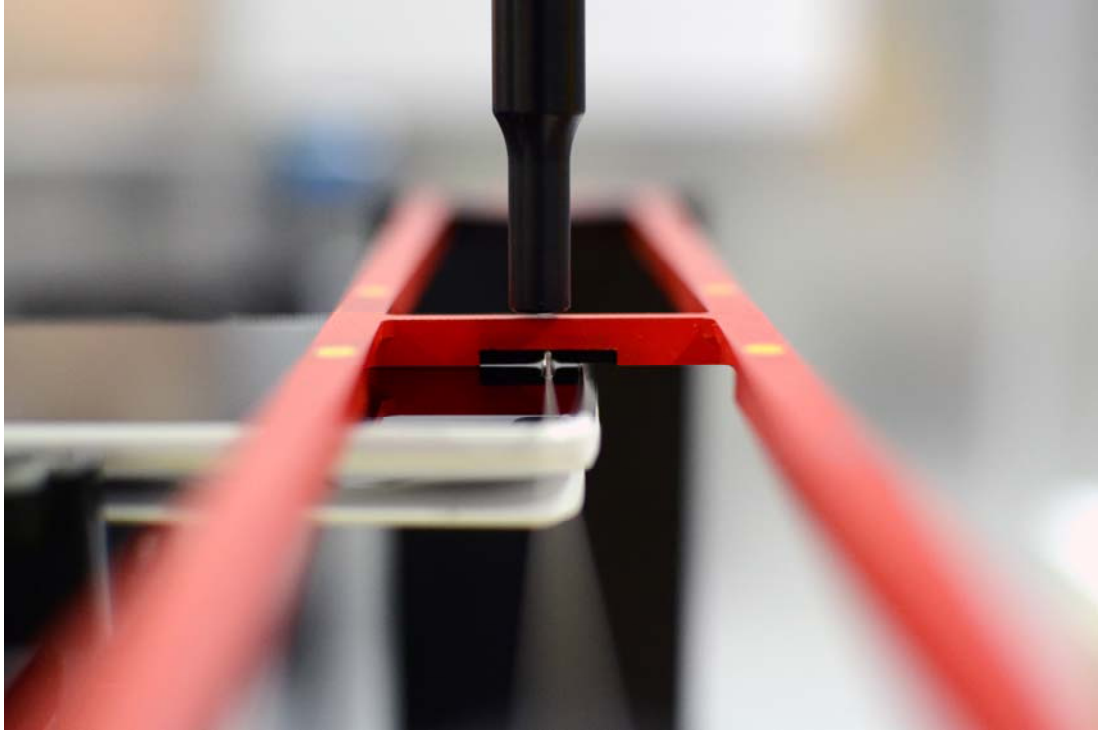
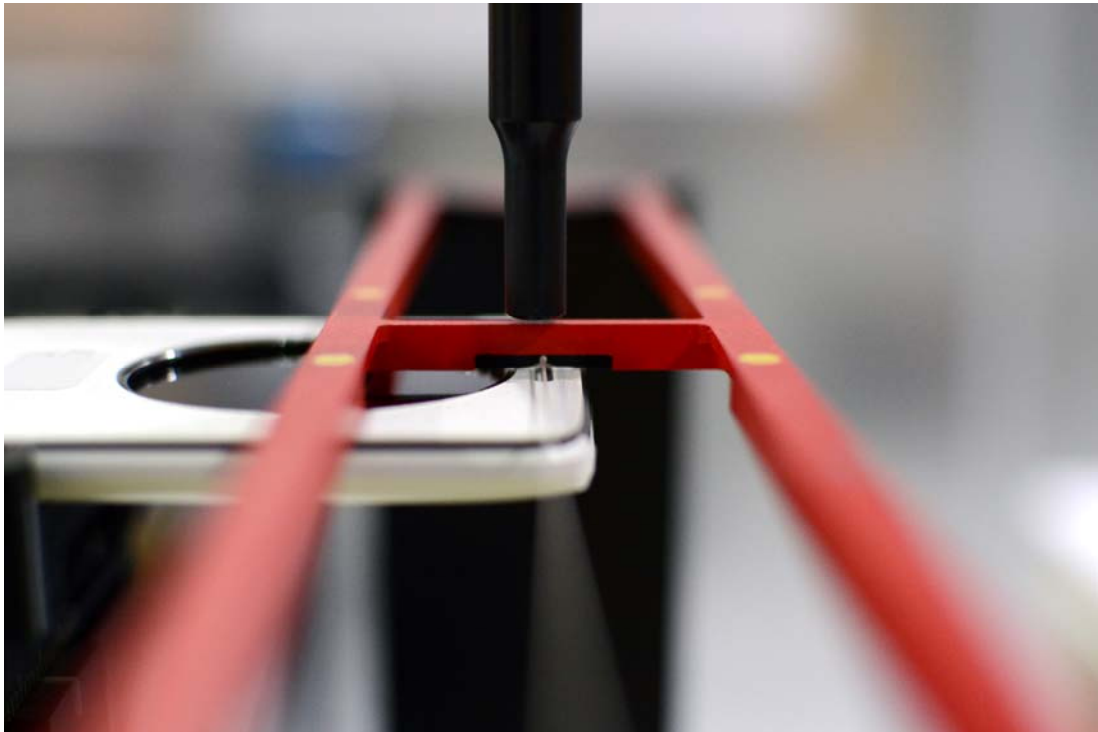

Figure 18-4
HAC Phantom Plane Alignment (Standard Battery Cover)



FCC ID: ZNFUS990		HAC (RF EMISSIONS) TEST REPORT	 Reviewed by: Quality Manager
Filename: 0Y1406171294.ZNF	Test Dates: 6/16/2014 - 6/19/2014, 7/25/2014	EUT Type: Portable Handset	Page 75 of 77



**Figure 18-5
HAC Phantom Plane Alignment (Wireless Charging Cover – Open)**



**Figure 18-6
HAC Phantom Plane Alignment (Wireless Charging Cover – Closed)**

FCC ID: ZNFUS990		HAC (RF EMISSIONS) TEST REPORT	 Reviewed by: Quality Manager
Filename: 0Y1406171294.ZNF	Test Dates: 6/16/2014 - 6/19/2014, 7/25/2014	EUT Type: Portable Handset	Page 76 of 77

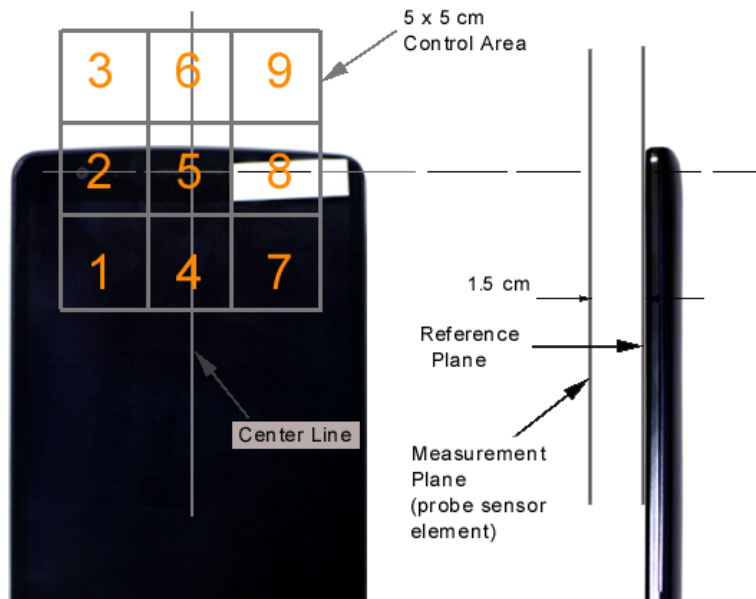

Figure 18-7 5x5 Scan grid above WD



Figure 18-8 E-Field WD Scan Overlay (Acoustic Center Scan)

FCC ID: ZNFUS990	PCTEST ENGINEERING LABORATORY, INC.	HAC (RF EMISSIONS) TEST REPORT	LG	Reviewed by: Quality Manager
Filename: 0Y1406171294.ZNF	Test Dates: 6/16/2014 - 6/19/2014, 7/25/2014	EUT Type: Portable Handset		Page 77 of 77