



# PCTEST ENGINEERING LABORATORY, INC.

6660-B Dobbin Road, Columbia, MD 21045 USA  
Tel. 410.290.6652 / Fax 410.290.6554  
http://www.pctestlab.com



## HEARING AID COMPATIBILITY

**Applicant Name:**  
LG Electronics MobileComm U.S.A., Inc.  
1000 Sylvan Avenue  
Englewood Cliffs, NJ 07632  
United States

**Date of Testing:**  
July 10-12, 2012  
**Test Site/Location:**  
PCTEST Lab, Columbia, MD, USA  
**Test Report Serial No.:**  
0Y1207090916.ZNF

**FCC ID:** ZNFUS730

**APPLICANT:** LG ELECTRONICS MOBILECOMM U.S.A., INC.

**Scope of Test:** RF Emissions Testing  
**Application Type:** Class II Permissive Change  
**FCC Rule Part(s):** § 20.19(b)  
**EUT Type:** Portable Handset  
**Model(s):** US730, LG-US730, LW730, LG-LW730  
**Tx Frequency:** 824.70 - 848.31 MHz (Cellular CDMA)  
1711.25 - 1753.75 MHz (AWS CDMA)  
1851.25 - 1908.75 MHz (PCS CDMA)  
**Test Device Serial No.:** Pre-Production Sample [S/N: HAC RFE]  
**Class II Permissive Change(s):** See FCC Change Document  
**Original Grant Date:** 05/07/2012

**C63.19-2007 HAC Category:** M4 (RF EMISSIONS CATEGORY)

This wireless portable device has been shown to be hearing-aid compatible under the above rated category, specified in ANSI/IEEE Std. C63.19-2007 and had been tested in accordance with the specified measurement procedures. Hearing-Aid Compatibility is based on the assumption that all production units will be designed electrically identical to the device tested in this report. Test results reported herein relate only to the item(s) tested and are for North American Bands only.

I attest to the accuracy of data. All measurements reported herein were performed by me or were made under my supervision and are correct to the best of my knowledge and belief. I assume full responsibility for the completeness of these measurements and vouch for the qualifications of all persons taking them.

PCTEST certifies that no party to this application has been subject to a denial of Federal benefits that includes FCC benefits pursuant to Section 5301 of the Anti-Drug Abuse Act of 1988, 21 U.S.C. 862.

Randy Ortanez  
President





FCC ID: ZNFUS730	PCTEST ENGINEERING LABORATORY, INC.	HAC (RF EMISSIONS) TEST REPORT	LG	Reviewed by: Quality Manager
HAC Filename: 0Y1207090916.ZNF	Test Dates: July 10-12, 2012	EUT Type: Portable Handset		Page 1 of 81

# TABLE OF CONTENTS

---

1.	INTRODUCTION .....	3
2.	TEST SITE LOCATION .....	4
3.	EUT DESCRIPTION .....	5
4.	ANSI/IEEE C63.19 PERFORMANCE CATEGORIES .....	6
5.	SYSTEM SPECIFICATIONS .....	7
6.	TEST PROCEDURE .....	13
7.	SYSTEM CHECK .....	15
8.	MODULATION FACTOR .....	18
9.	FCC 3G MEASUREMENTS .....	20
10.	OVERALL MEASUREMENT SUMMARY .....	21
11.	EQUIPMENT LIST .....	24
12.	MEASUREMENT UNCERTAINTY .....	25
13.	TEST DATA .....	26
14.	CALIBRATION CERTIFICATES .....	39
15.	CONCLUSION .....	76
16.	REFERENCES .....	77
17.	TEST PHOTOGRAPHS .....	79

<b>FCC ID:</b> ZNFUS730	 <b>PCTEST</b> <small>ENGINEERING LABORATORY, INC.</small>	<b>HAC (RF EMISSIONS) TEST REPORT</b>	 <b>LG</b>	<b>Reviewed by:</b> Quality Manager
<b>HAC Filename:</b> 0Y1207090916.ZNF	<b>Test Dates:</b> July 10-12, 2012	<b>EUT Type:</b> Portable Handset		Page 2 of 81

# 1. INTRODUCTION

On July 10, 2003, the Federal Communications Commission (FCC) adopted new rules requiring wireless manufacturers and service providers to provide digital wireless phones that are compatible with hearing aids. The FCC has modified the exemption for wireless phones under the Hearing Aid Compatibility Act of 1998 (HAC Act) in WT Docket 01-309 RM-8658<sup>1</sup> to extend the benefits of wireless telecommunications to individuals with hearing disabilities. These benefits encompass business, social and emergency communications, which increase the value of the wireless network for everyone. An estimated more than 10% of the population in the United States show signs of hearing impairment and of that fraction, almost 80% use hearing aids. Approximately 500 million people worldwide suffer from hearing loss.

## Compatibility Tests Involved:

The standard calls for wireless communications devices to be measured for:

- RF Electric-field emissions
- RF Magnetic-field emissions
- T-coil mode, magnetic-signal strength in the audio band
- T-coil mode, magnetic-signal frequency response through the audio band
- T-coil mode, magnetic-signal and noise articulation index

The hearing aid must be measured for:



- RF immunity in microphone mode
- RF immunity in T-coil mode

In the following tests and results, this report includes the evaluation for a wireless communications device.



Figure 1-1 Hearing Aid *in-vitu*

<sup>1</sup> FCC Rule & Order, WT Docket 01-309 RM-8658

FCC ID: ZNFUS730	 PCTEST ENGINEERING LABORATORY, INC.	HAC (RF EMISSIONS) TEST REPORT	 LG	Reviewed by: Quality Manager
HAC Filename: 0Y1207090916.ZNF	Test Dates: July 10-12, 2012	EUT Type: Portable Handset	Page 3 of 81	

## 2. TEST SITE LOCATION

### 2.1 INTRODUCTION

The map at the right shows the location of the PCTEST LABORATORY in Columbia, Maryland. It is in proximity to the FCC Laboratory, the Baltimore-Washington International (BWI) airport, the city of Baltimore and Washington, DC (See Figure 2).

These measurement tests were conducted at the PCTEST Engineering Laboratory, Inc. facility in New Concept Business Park, Guilford Industrial Park, Columbia, Maryland. The site address is 6660-B Dobbin Road, Columbia, MD 21045. The test site is one of the highest points in the Columbia area with an elevation of 390 feet above mean sea level. The site coordinates are 39° 11'15" N latitude and 76° 49' 38" W longitude. The facility is 1.5 miles North of the FCC laboratory, and the ambient signal and ambient signal strength are approximately equal to those of the FCC laboratory. There are no FM or TV transmitters within 15 miles of the site. The detailed description of the measurement facility was found to be in compliance with the requirements of § 2.948 according to ANSI C63.4 on January 27, 2006 and Industry Canada.





**Figure 2-1**  
Map of the Greater Baltimore and Metropolitan Washington D.C. area

### 2.2 Test Facility / Accreditations:

Measurements were performed at an independent accredited PCTEST Engineering Lab located in Columbia, MD 21045, U.S.A.



- PCTEST Lab is accredited to ISO 17025-2005 by the American Association for Laboratory Accreditation (A2LA) in Specific Absorption Rate (SAR) testing, Hearing-Aid Compatibility (HAC), CTIA Test Plans, and wireless testing for FCC and Industry Canada Rules.
- PCTEST Lab is accredited to ISO 17025 by U.S. National Institute of Standards and Technology (NIST) under the National Voluntary Laboratory Accreditation Program (NVLAP Lab code: 100431-0) in EMC, FCC and Telecommunications.
- PCTEST facility is an FCC registered (PCTEST Reg. No. 90864) test facility with the site description report on file and has met all the requirements specified in Section 2.948 of the FCC Rules and Industry Canada (IC-2451).
- PCTEST Lab is a recognized U.S. Conformity Assessment Body (CAB) in EMC and R&TTE (n.b. 0982) under the U.S.-EU Mutual Recognition Agreement (MRA).
- PCTEST TCB is a Telecommunication Certification Body (TCB) accredited to ISO/IEC Guide 65 by the American National Standards Institute (ANSI) in all scopes of FCC Rules and all Industry Canada Standards (RSS).
- PCTEST facility is an IC registered (IC-2451) test laboratory with the site description on file at Industry Canada.
- PCTEST is a CTIA Authorized Test Laboratory (CATL) for AMPS and CDMA, and EvDO mobile phones.
- PCTEST is a CTIA Authorized Test Laboratory (CATL) for Over-the-Air (OTA) Antenna Performance testing for AMPS, CDMA, GSM, GPRS, EGPRS, UMTS (W-CDMA), CDMA 1xEVDO Data, CDMA 1xRTT Data.

FCC ID: ZNFUS730	 PCTEST ENGINEERING LABORATORY, INC.	HAC (RF EMISSIONS) TEST REPORT	 LG	Reviewed by: Quality Manager
HAC Filename: OY1207090916.ZNF	Test Dates: July 10-12, 2012	EUT Type: Portable Handset	Page 4 of 81	

### 3. EUT DESCRIPTION



FCC ID: ZNFUS730  
 Manufacturer: LG Electronics MobileComm U.S.A., Inc.  
 1000 Sylvan Avenue  
 Englewood Cliffs, NJ 07632  
 United States

Model(s): US730, LG-US730, LW730, LG-LW730  
 Serial Number: HAC RFE  
 Tx Frequencies: 824.70 - 848.31 MHz (Cellular CDMA)  
 1711.25 - 1753.75 MHz (AWS CDMA)  
 1851.25 - 1908.75 MHz (PCS CDMA)

Antenna Configurations: Internal Antenna  
 Maximum Conducted Power (HAC): 24.67 dBm (Cell. CDMA), 24.60 dBm (AWS CDMA),  
 24.46 dBm (PCS CDMA)  
 HAC Test Configurations: Cell. CDMA, 1013, 384, 777, BT Off, WLAN Off  
 AWS CDMA, 25, 450, 875, BT Off, WLAN Off  
 PCS CDMA, 25, 600, 1175, BT Off, WLAN Off

EUT Type: Portable Handset

Air-Interface	Band (MHz)	Type	C63.19/tested	Simultaneous Transmissions (Not to be tested)	Reduced power 20.19 (c)(1)	Voice Over Digital Transport (Data)
CDMA	850	Voice	Yes	Yes: BT or WIFI	N/A	N/A
	1750				N/A	N/A
	1900				N/A	N/A
	EVDO	Data			N/A	Yes
BT	2450	Data	N/A	Yes: CDMA	N/A	N/A
WIFI	2450	Data	N/A	Yes: CDMA	N/A	Yes

NOTE: HAC Rating was not based on concurrent voice and data modes. Standalone mode was found to represent worst case rating for both M and T rating.

Figure 3-1 ZNFUS730 Air Interfaces

FCC ID: ZNFUS730	PCTEST ENGINEERING LABORATORY, INC.	HAC (RF EMISSIONS) TEST REPORT	LG	Reviewed by: Quality Manager
HAC Filename: OY1207090916.ZNF	Test Dates: July 10-12, 2012	EUT Type: Portable Handset		Page 5 of 81

## 4. ANSI/IEEE C63.19 PERFORMANCE CATEGORIES



### I. RF EMISSIONS

The ANSI Standard presents performance requirements for acceptable interoperability of hearing aids with wireless communications devices. When these parameters are met, a hearing aid operates acceptably in close proximity to a wireless communications device.

Category	Telephone RF Parameters	
Near field Category	E-field emissions CW dB(V/m)	H-field emissions CW dB(A/m)
<b>f &lt; 960 MHz</b>		
<b>M1</b>	56 to 61 + 0.5 x AWF	5.6 to 10.6 +0.5 x AWF
<b>M2</b>	51 to 56 + 0.5 x AWF	0.6 to 5.6 +0.5 x AWF
<b>M3</b>	46 to 51 + 0.5 x AWF	-4.4 to 0.6 +0.5 x AWF
<b>M4</b>	< 46 + 0.5 x AWF	< -4.4 + 0.5 x AWF
<b>f &gt; 960 MHz</b>		
<b>M1</b>	46 to 51 + 0.5 x AWF	-4.4 to 0.6 +0.5 x AWF
<b>M2</b>	41 to 46 + 0.5 x AWF	-9.4 to -4.4 +0.5 x AWF
<b>M3</b>	36 to 41 + 0.5 x AWF	-14.4 to -9.4 +0.5 x AWF
<b>M4</b>	< 36 + 0.5 x AWF	< -14.4 + 0.5 x AWF
<b>Table 4-1 Hearing aid and WD near-field categories as defined in ANSI C63.19-2007</b>		

### II. ARTICULATION WEIGHTING FACTOR (AWF)

Standard	Technology	Articulation Weighing Factor (AWF)
T1/T1P1/3GPP	UMTS (WCDMA)	0
TIA/EIA/IS-2000	CDMA	0
iDEN <sup>T</sup>	TDMA (22 and 11 Hz)	0
J-STD-007	GSM (217 Hz)	-5
<b>Table 4-2 Articulation Weighing Factors</b>		

FCC ID: ZNFUS730	 PCTEST ENGINEERING LABORATORY, INC.	HAC (RF EMISSIONS) TEST REPORT	 LG	Reviewed by: Quality Manager
HAC Filename: OY1207090916.ZNF	Test Dates: July 10-12, 2012	EUT Type: Portable Handset	Page 6 of 81	

## 5. SYSTEM SPECIFICATIONS

### ER3DV6 E-Field Probe Description

Construction:	One dipole parallel, two dipoles normal to probe axis Built-in shielding against static charges
Calibration:	In air from 100 MHz to 3.0 GHz (absolute accuracy $\pm 6.0\%$ , $k=2$ )
Frequency:	100 MHz to > 6 GHz; Linearity: $\pm 0.2$ dB (100 MHz to 3 GHz)
Directivity	$\pm 0.2$ dB in air (rotation around probe axis) $\pm 0.4$ dB in air (rotation normal to probe axis)
Dynamic Range	2 V/m to > 1000 V/m (M3 or better device readings fall well below diode compression point)
Linearity:	$\pm 0.2$ dB
Dimensions	Overall length: 330 mm (Tip: 16 mm) Tip diameter: 8 mm (Body: 12 mm) Distance from probe tip to dipole centers: 2.5 mm



**Figure 5-1**  
E-field Free-space Probe

### H3DV6 H-Field Probe Description

Construction:	Three concentric loop sensors with 3.8 mm loop diameters Resistively loaded detector diodes for linear response Built-in shielding against static charges
Frequency:	200 MHz to 3 GHz (absolute accuracy $\pm 6.0\%$ , $k=2$ ); Output linearized
Directivity:	$\pm 0.25$ dB (spherical isotropy error)
Dynamic Range:	10 mA/m to 2 A/m at 1 GHz (M3 or better device readings fall well below diode compression point)
Dimensions:	Overall length: 330 mm (Tip: 40 mm) Tip diameter: 6 mm (Body: 12 mm) Distance from probe tip to dipole centers: 3 mm
E-Field Interference:	< 10% at 3 GHz (for plane wave)





**Figure 5-2**  
H-Field Free-space Probe

### Probe Tip Description

HAC field measurements take place in the close near field with high gradients. Increasing the measuring distance from the source will generally decrease the measured field values (in case of the validation dipole approx. 10% per mm).

Magnetic field sensors are measuring the integral of the H-field across their sensor area surrounded by the loop. They are calibrated in a precise, homogeneous field. When measuring a gradient field, the result will be very close to the field in the center of the loop which is equivalent to the value of a homogeneous field equivalent to the center value. But it will be different from the field at the border of the loop.

FCC ID: ZNFUS730	 PCTEST ENGINEERING LABORATORY, INC.	HAC (RF EMISSIONS) TEST REPORT	 LG	Reviewed by: Quality Manager
HAC Filename: OY1207090916.ZNF	Test Dates: July 10-12, 2012	EUT Type: Portable Handset	Page 7 of 81	

Consequently, two sensors with different loop diameters - both calibrated ideally - would give different results when measuring from the edge of the probe sensor elements. The behavior for electrically small E-field sensors is equivalent.

The magnetic field loops of the H3D probes are concentric, with the center 3mm from the tip for H3DV6. Their radius is 1.9mm.

The electric field probes have a more irregular internal geometry because it is physically not possible to have the 3 orthogonal sensors situated with the same center. The effect of the different sensor centers is accounted for in the HAC uncertainty budget ("sensor displacement"). Their geometric center is at 2.5mm from the tip, and the element ends are 1.1mm closer to the tip.

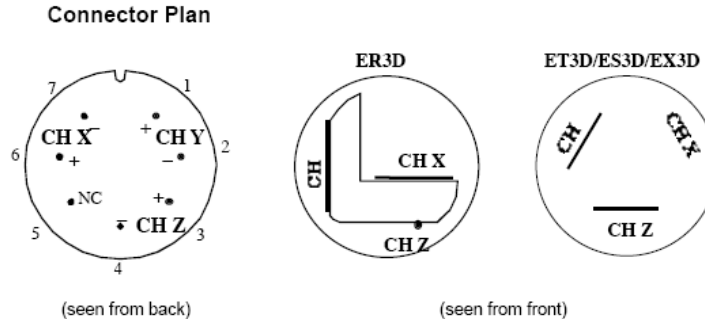

The antistatic shielding inside the probe is connected to the probe connector case.

**Instrumentation Chain**

**Equation 1**

**Conversion of Connector Voltage  $u_i$  to E-Field  $E_i$**

$$E_i = \sqrt{\frac{u_i + (u_i^2 \cdot CF) / (DCP)}{Norm_i \cdot ConvF}}$$

whereby

- $E_i$ : electric field in V/m
- $u_i$ : voltage of channel i at the connector in  $\mu V$
- $Norm_i$ : sensitivity of channel i in  $\mu V / (V/m)^2$
- $ConvF$ : enhancement factor in liquid (ConvF=1 for Air)
- $DCP$ : diode compression point in  $\mu V$
- $CF$ : signal crest factor (peak power/average power)

**Conditions of Calibration**

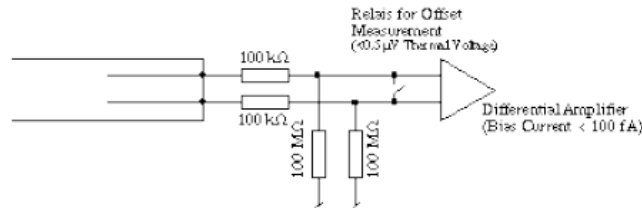

Please note:

- a lower input impedance of the amplifier will result in different sensitivity factors  $Norm_i$  and  $DCP$
- larger bias currents will cause higher offset

FCC ID: ZNFUS730	PCTEST ENGINEERING LABORATORY, INC.	HAC (RF EMISSIONS) TEST REPORT	LG	Reviewed by: Quality Manager
HAC Filename: 0Y1207090916.ZNF	Test Dates: July 10-12, 2012	EUT Type: Portable Handset		Page 8 of 81



## Probe Response to Frequency

The E-field sensors have inherently a very flat frequency response. They are calibrated with a number of frequencies resulting in a common calibration factor, with the frequency behavior documented in the calibration certificate (See also below).

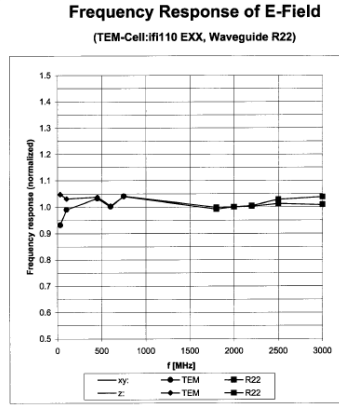

Uncertainty of Frequency Response of E-field:  $\pm 6.3\%$  ( $k=2$ )

**Figure 5-3 E-Field Probe Frequency Response**

H-field sensors have a frequency dependent sensitivity which is evaluated for a series of frequencies also visible in the probe calibration certificate. The calibration factors result from a fitting algorithm. The proper conversion is calculated by the DASY4 software depending on the frequency setting in the procedure. See below for H-field frequency response:

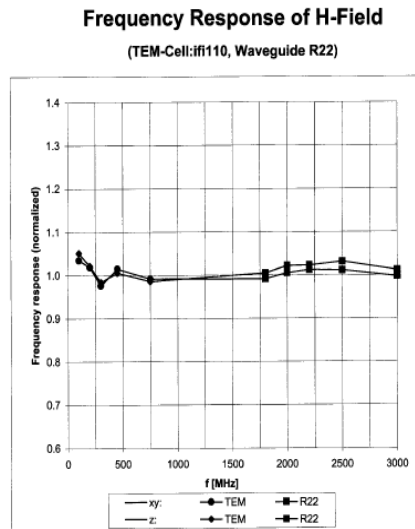

Uncertainty of Frequency Response of E-field:  $\pm 6.3\%$  ( $k=2$ )

**Figure 5-4 H-Field Probe Frequency Response**

FCC ID: ZNFUS730	PCTEST ENGINEERING LABORATORY, INC.	HAC (RF EMISSIONS) TEST REPORT	LG	Reviewed by: Quality Manager
HAC Filename: 0Y1207090916.ZNF	Test Dates: July 10-12, 2012	EUT Type: Portable Handset		Page 9 of 81

## Conversion to Peak

Peak is defined as Peak Envelope Power. All raw measurements from the HAC measurement system are RMS values. The DASY4 system incorporates the crest factor of the signal in the computation of the RMS values (See Equation 1). Although the software also has capability to estimate the peak field by applying a square root of crest factor value to the readings, the probe modulation factor was applied manually instead per C63.19 in the measurement tables in this report. The equation to convert the raw measurements in the data tables are:

$$\text{Peak Field} = 20 \cdot \log(\text{Raw} \cdot \text{PMF})$$

Where:

Peak Field = Peak field (in dBV/m or dBA/m)

Raw = Raw field measurement from the measurement system (in V/m or A/m).

PMF = Probe Modulation Factor (in linear units).

## SPEAG Robotic System



E-field and H-field measurements are performed using the DASY4 automated dosimetric assessment system. The DASY4 is made by Schmid & Partner Engineering AG (SPEAG) in Zurich, Switzerland and consists of high precision robotics system (Staubli), robot controller, Pentium 4 computer, near-field probe, probe alignment sensor, and the HAC phantom. The robot is a six-axis industrial robot performing precise movements to position the probe to the location (points) of maximum electromagnetic field (EMF).



**Figure 5-5**  
SPEAG Robotic System

## System Hardware

A cell controller system contains the power supply, robot controller, teach pendant (Joystick), and a remote control used to drive the robot motors. The PC consists of the Gateway Pentium 4 2.53 GHz computer with Windows XP system and RF Measurement Software DASY4 v4.5 (with HAC Extension), A/D interface card, monitor, mouse, and keyboard. The Staubli Robot is connected to the cell controller to allow software manipulation of the robot. A data acquisition electronic (DAE) circuit that performs the signal amplification, signal multiplexing, AD-conversion, offset measurements, mechanical surface detection, collision detection, etc. is connected to the Electro-optical coupler (EOC). The EOC performs the conversion from the optical into digital electric signal of the DAE and transfers data to the PC plug-in card.

FCC ID: ZNFUS730	 PCTEST ENGINEERING LABORATORY, INC.	HAC (RF EMISSIONS) TEST REPORT	 LG	Reviewed by: Quality Manager
HAC Filename: 0Y1207090916.ZNF	Test Dates: July 10-12, 2012	EUT Type: Portable Handset		Page 10 of 81



From the compensated input signals the primary field data for each channel can be evaluated:

$$\begin{aligned} \text{E - fieldprobes :} \quad E_i &= \sqrt{\frac{V_i}{Norm_i \cdot ConvF}} \\ \text{H - fieldprobes :} \quad H_i &= \sqrt{V_i} \cdot \frac{a_{i0} + a_{i1}f + a_{i2}f^2}{f} \end{aligned}$$

with  $V_i$  = compensated signal of channel i (i = x, y, z)  
 $Norm_i$  = sensor sensitivity of channel i (i = x, y, z)  
 $\mu\text{V}/(\text{V}/\text{m})^2$  for E-field Probes  
 $ConvF$  = sensitivity enhancement in solution  
 $a_{ij}$  = sensor sensitivity factors for H-field probes  
 $f$  = carrier frequency [GHz]  
 $E_i$  = electric field strength of channel i in V/m  
 $H_i$  = magnetic field strength of channel i in A/m

The RSS value of the field components gives the total field strength (Hermitian magnitude):



$$E_{tot} = \sqrt{E_x^2 + E_y^2 + E_z^2}$$

The primary field data are used to calculate the derived field units.

The measurement/integration time per point, as specified by the system manufacturer is >500 ms.

The signal response time is evaluated as the time required by the system to reach 90% of the expected final value after an on/off switch of the power source with an integration time of 500 ms and a probe response time of <5 ms. In the current implementation, DASY4 waits longer than 100 ms after having reached the grid point before starting a measurement, i.e., the response time uncertainty is negligible.

If the device under test does not emit a CW signal, the integration time applied to measure the electric field at a specific point may introduce additional uncertainties due to the discretization. The tolerances for the different systems had the worst-case of 2.6%.

FCC ID: ZNFUS730	 <b>PCTEST</b> ENGINEERING LABORATORY, INC.	HAC (RF EMISSIONS) TEST REPORT	 LG	Reviewed by: Quality Manager
HAC Filename: 0Y1207090916.ZNF	Test Dates: July 10-12, 2012	EUT Type: Portable Handset	Page 12 of 81	

## 6. TEST PROCEDURE

### I. RF EMISSIONS

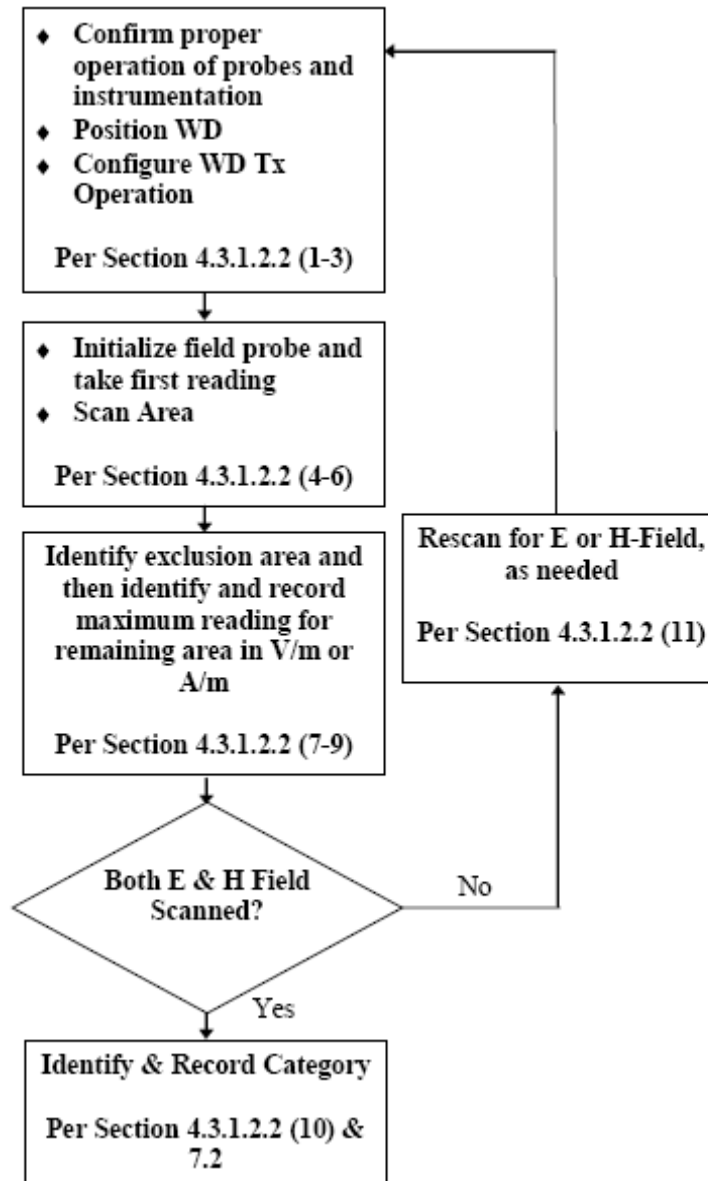
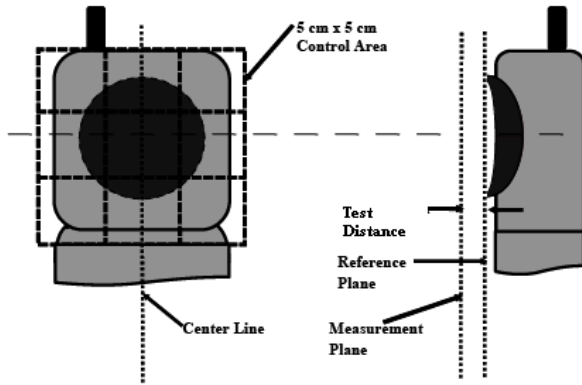

Figure 6-1  
WD Near-Field Emissions Flow Chart

FCC ID: ZNFUS730	PCTEST ENGINEERING LABORATORY, INC.	HAC (RF EMISSIONS) TEST REPORT	LG	Reviewed by: Quality Manager
HAC Filename: 0Y1207090916.ZNF	Test Dates: July 10-12, 2012	EUT Type: Portable Handset	Page 13 of 81	

## Test Setup



**Figure 6-2**

E/H-Field Emissions Test Setup Diagram (See Test Photographs for actual WD scan grid overlay)

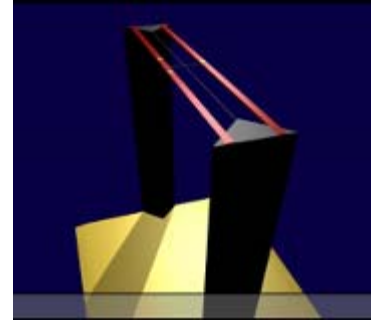



**Figure 6-3**  
HAC Phantom

## RF Emissions Test Procedure:

The following illustrate a typical RF emissions test scan over a wireless communications device:

1. Proper operation of the field probe, probe measurement system, other instrumentation, and the positioning system was confirmed.
2. WD is positioned in its intended test position, acoustic output point of the device perpendicular to the field probe.
3. The WD operation for maximum rated RF output power was configured and confirmed with the base station simulator, at the test channel and other normal operating parameters as intended for the test. The battery was ensured to be fully charged before each test.
4. The center sub-grid was centered over the center of the acoustic output (also audio band magnetic output, if applicable). The WD audio output was positioned tangent (as physically possible) to the measurement plane.
5. A surface calibration was performed before each setup change to ensure repeatable spacing and proper maintenance of the measurement plane using the HAC Phantom.
6. The measurement system measured the field strength at the reference location.
7. Measurements at 2mm or 5mm increments in the 5 x 5 cm region were performed at a distance 15 mm from the center point of the probe measurement element to the WD. A 360° rotation about the azimuth axis at the maximum interpolated position was measured. For the worst-case condition, the peak reading from this rotation was used in re-evaluating the HAC category.
8. The system performed a drift evaluation by measuring the field at the reference location.
9. Steps 1-8 were done for both the E and H-Field measurements.

FCC ID: ZNFUS730	 PCTEST ENGINEERING LABORATORY, INC.	HAC (RF EMISSIONS) TEST REPORT	 LG	Reviewed by: Quality Manager
HAC Filename: 0Y1207090916.ZNF	Test Dates: July 10-12, 2012	EUT Type: Portable Handset		Page 14 of 81

## 7. SYSTEM CHECK

### I. System Check Parameters

The input signal was an un-modulated continuous wave. The following points were taken into consideration in performing this check:

- Average Input Power  $P = 100\text{mW RMS}$  ( $20\text{dBm RMS}$ ) after adjustment for return loss
- The test fixture must meet the 2 wavelength separation criterion
- The proper measurement of the 1 cm probe to dipole separation, which is measured from top surface of the dipole to the calibration reference point of the sensor, defined by the probe manufacturer is shown in the following diagram:

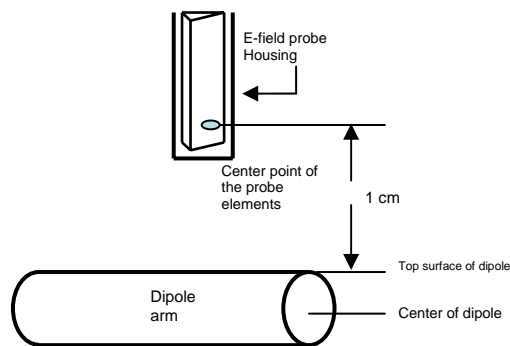

**Figure 7-1**  
Separation Distance from Dipole to Field Probe

RF power was recorded using both an average reading meter and a peak reading meter. Readings of the probe are provided by the measurement system.

To assure proper operation of the near-field measurement probe the input power to the dipole shall be commensurate with the full rated output power of the wireless device (e.g. - for a cellular phone wireless device the average peak antenna input power will be on the order of  $100\text{mW}$  (i.e. -  $20\text{dBm}$ ) RMS after adjustment for any mismatch.



### II. Validation Procedure

A dipole antenna meeting the requirements given in C63.19 was placed in the position normally occupied by the WD.

The length of the dipole was scanned with both E-field and H-field probes and the maximum values for each were recorded.

#### Measurement of CW

Using the near-field measurement system, scan the antenna over the radiating dipole and record the greatest field reading observed. Due to the nature of E-fields about free-space dipoles, the two E-field peaks measured over the dipole are averaged to compensate for non-parallelity of the setup (

FCC ID: ZNFUS730	 PCTEST ENGINEERING LABORATORY, INC.	HAC (RF EMISSIONS) TEST REPORT		Reviewed by: Quality Manager
HAC Filename: 0Y1207090916.ZNF	Test Dates: July 10-12, 2012	EUT Type: Portable Handset		Page 15 of 81

see manufacturer method on dipole calibration certificates, page 2). Field strength measurements shall be made only when the probe is stationary.

RF power was recorded using both an average and a peak power reading meter.

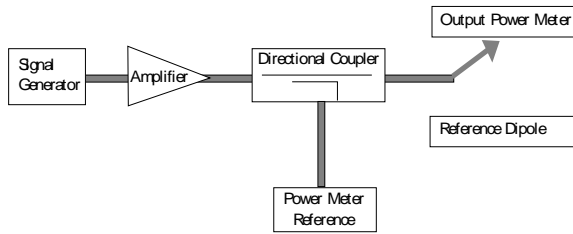

**Figure 7-2**  
Setup for Desired Output Power to Dipole

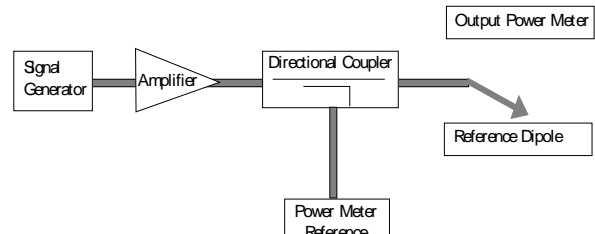

**Figure 7-3**  
Setup to Dipole

Using this setup configuration, the signal generator was adjusted for the desired output power (100mW) at a specified frequency. The reference power from the coupled port of the directional coupler is recorded. Next, the output cable is connected to the reference dipole, as shown in Figure 7-3.

The input signal level was adjusted until the reference power from the coupled port of the directional coupler was the same as previously recorded, to compensate for the impedance mismatch between the output cable and the reference dipole. To assure proper operation of the near-field measurement probe the input power to the reference dipole was verified to the full rated output power of the wireless device. The dipole was secured in a holder in a manner to meet the 20 dB reflection. The near-field measurement probe was positioned over the dipole. The antenna was scanned over the appropriate sized area to cover the dipole from end to end. SPEAG uses 2D interpolation algorithms between the measured points. Please see below two dimensional plots showing that the interpolated values interpolate smoothly between 5mm steps for a free-space RF dipole:

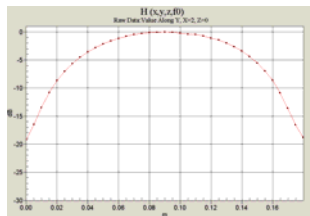

**Figure 7-4**

2-D Raw Data from scan along dipole axis

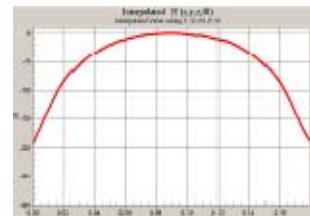

**Figure 7-5**

2-D Interpolated points from scan along dipole axis

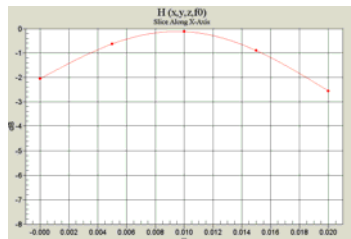

**Figure 7-6**

2-D Raw Data from scan along transverse axis

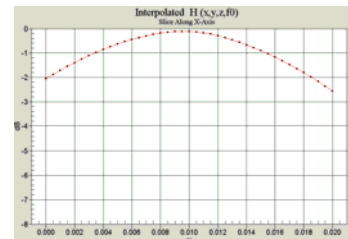

**Figure 7-7**

2-D Interpolated points from scan along transverse axis

FCC ID: ZNFUS730	PCTEST ENGINEERING LABORATORY, INC.	HAC (RF EMISSIONS) TEST REPORT	LG	Reviewed by: Quality Manager
HAC Filename: OY1207090916.ZNF	Test Dates: July 10-12, 2012	EUT Type: Portable Handset		Page 16 of 81



### III. System Check Results

#### Validation Results

Frequency (MHz)	Dipole S/N	Input Power (dBm)	E-field Result (V/m)	Target Field (V/m)	% Deviation
835	1003	20.0	169.1	166.0	1.9%
1730	1137	20.0	152.9	151.5	0.9%
1880	1137	20.0	136.1	136.8	-0.5%
Frequency (MHz)	Dipole S/N	Input Power (dBm)	H-field Result (A/m)	Target Field (A/m)	% Deviation
835	1003	20.0	0.451	0.458	-1.5%
1730	1137	20.0	0.476	0.489	-2.8%
1880	1137	20.0	0.433	0.460	-5.8%

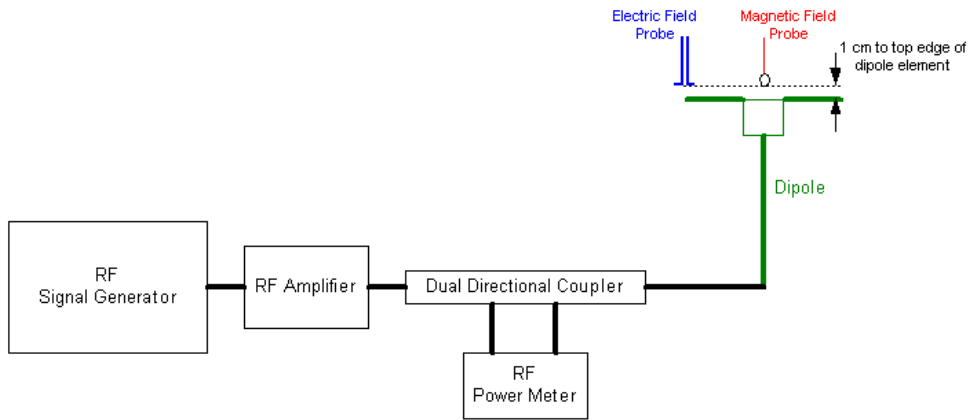

**Figure 7-8**  
System Check Setup

FCC ID: ZNFUS730	PCTEST ENGINEERING LABORATORY, INC.	HAC (RF EMISSIONS) TEST REPORT	LG	Reviewed by: Quality Manager
HAC Filename: OY1207090916.ZNF	Test Dates: July 10-12, 2012	EUT Type: Portable Handset		Page 17 of 81

## 8. MODULATION FACTOR

A calibration was made of the modulation response of the probe and its instrumentation chain. This calibration was performed with the field probe, attached to its instrumentation. The response of the probe system to a CW field at the frequency of interest is compared to its response to a modulated signal with equal peak amplitude to that of a CW signal. The field level of the test signals are ensured to be more than 10 dB above the ambient level and the noise floor of the instrumentation being used. The ratio of the CW reading to that taken with a modulated reading was applied to the DUT measurements.

All voice modes for this device have been investigated in this section of the report. According to the FCC 3G Measurement Procedures, May 2006 for RF Emissions, variations in peak field and power readings.

### This was done using the following procedure:

1. The probe was illuminated with a CW signal at the intended measurement frequency and wireless device power.
2. The probe was positioned at the field maxima over the dipole antenna (determined after an area scan over the dipole) illuminated with the CW signal.
3. The reading of the probe measurement system of the CW signal at the maximum point was recorded.
4. Using a Spectrum Analyzer, the modulated signal adjusted with the same peak level of the CW signal was determined.
5. The probe measurement system reading was recorded with the modulated signal. The appropriate system crest factors for the modulation type were configured in the software to the system measurements.
6. The ratio of the CW reading to modulated signal reading is the probe modulation factor (PMF) for the modulation and field probe combination. This was repeated for 80% AM.
7. Steps 1-6 were repeated at all frequency bands and for both E and H field probes.

The modulation factors obtained were applied to readings taken of the actual wireless device, in order to obtain an accurate peak field reading using the formula:

$$\text{Peak} = 20 \cdot \log (\text{Raw} \cdot \text{PMF})$$

This method correlates well with the modulation using the DUT in the alternative substitution method. See below for correlation of signal:

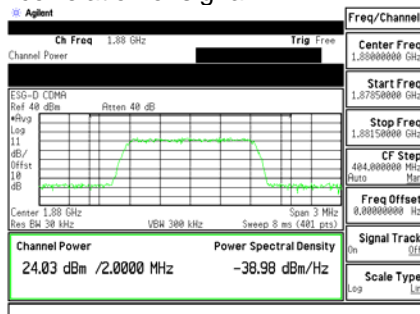

**Figure 8-1**  
Signal Generator Modulated Signal

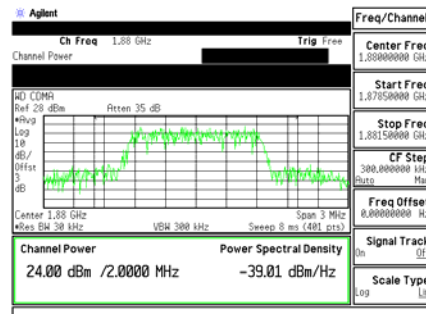

**Figure 8-2**  
Wireless Device Modulated Signal

FCC ID: ZNFUS730	<b>PCTEST</b> ENGINEERING LABORATORY, INC.	HAC (RF EMISSIONS) TEST REPORT		Reviewed by: Quality Manager
HAC Filename: OY1207090916.ZNF	Test Dates: July 10-12, 2012	EUT Type: Portable Handset	Page 18 of 81	

**Modulation Factors:**

f (MHz)	Protocol	E-Field (V/m)	H-Field (A/m)	E-Field Modulation Factor	H-Field Modulation Factor
835	AM	204.50	0.5971	1.411	1.326
835	CDMA	311.00	0.9799	0.928	0.808
835	CW	288.60	0.7915		
1730	AM	136.90	0.5584	1.449	1.222
1730	CDMA	201.10	0.7426	0.986	0.919
1730	CW	198.30	0.6825		
1880	AM	155.40	0.6561	1.445	1.501
1880	CDMA	226.80	1.2010	0.990	0.820
1880	CW	224.50	0.9846		
1880	CDMA / SO3	72.17	0.0823	2.765	2.969
1880	CW	199.55	0.2443		

**Figure 8-3**  
Modulation Factors

FCC 3G Note: "CDMA" represents worst-case mode, while "CDMA/SO3" represents RC1/SO3 mode.

**CW and Modulated Signal Zero-Span plots:**

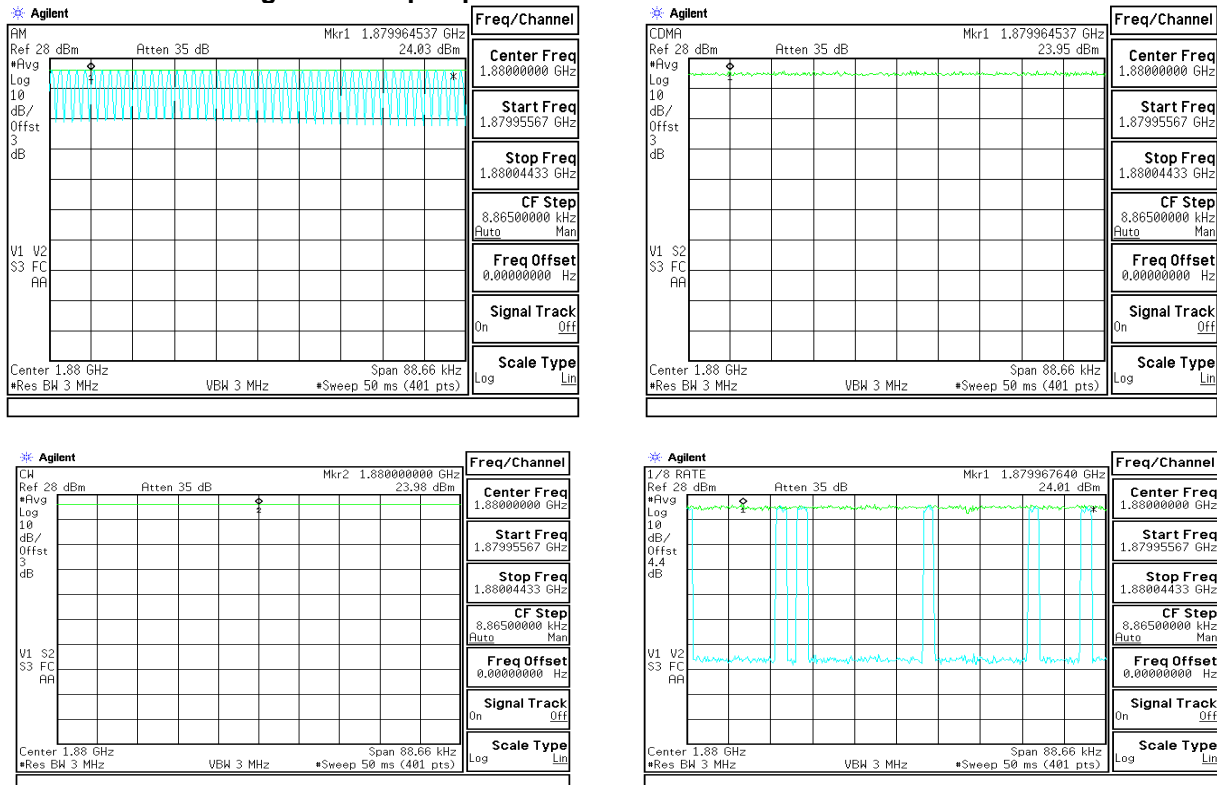

**Figure 8-4** Zero-Span Plots

FCC ID: ZNFUS730	PCTEST ENGINEERING LABORATORY, INC.	HAC (RF EMISSIONS) TEST REPORT	LG	Reviewed by: Quality Manager
HAC Filename: OY1207090916.ZNF	Test Dates: July 10-12, 2012	EUT Type: Portable Handset		Page 19 of 81

## 9. FCC 3G MEASUREMENTS

Sample pre-testing of the various modes were performed at the worst case probe location as part of subset testing justification. See below for measured conducted power for applicable device modes:

### I. Conducted RF Output Power Measurements:

Band	Channel	SO2 [dBm]	SO2 [dBm]	SO2 [dBm]	SO55 [dBm]	SO55 [dBm]	SO75 [dBm]	SO9 [dBm]	SO9 [dBm]	SO3 [dBm]	SO3 [dBm]	SO3 [dBm]
	F-RC	RC1	RC3	RC4	RC1	RC3	RC11	RC2	RC5	RC1	RC3	RC4
Cellular	1013	24.87	24.68	24.68	24.83	24.61	24.76	24.87	24.67	24.90	24.59	24.69
	384	24.75	24.62	24.57	24.75	24.51	24.60	24.81	24.59	24.90	24.55	24.58
	777	24.88	24.62	24.75	24.82	24.63	24.81	24.86	24.60	24.72	24.60	24.57
AWS	25	24.69	24.50	24.42	24.69	24.50	24.50	24.67	24.60	24.69	24.56	24.51
	450	24.60	24.31	24.35	24.49	24.25	24.39	24.65	24.50	24.65	24.27	24.35
	875	24.55	24.32	24.42	24.63	24.61	24.47	24.60	24.30	24.60	24.37	24.40
PCS	25	24.45	24.60	24.58	24.66	24.54	24.59	24.56	24.45	24.61	24.43	24.61
	600	24.50	24.50	24.47	24.69	24.46	24.54	24.55	24.46	24.68	24.51	24.44
	1175	24.46	24.42	24.38	24.61	24.41	24.49	24.50	24.44	24.65	24.53	24.41

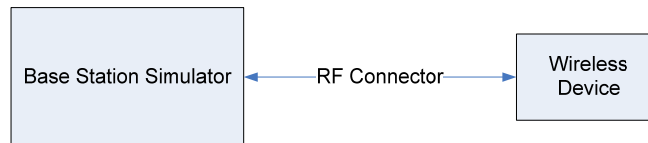

Figure 9-1  
Power Measurement Setup

### II. Worst-Case Probe Location Measurements

Below are RC/SO mode investigation results of the device at the worst-case (maximum) field point location. The worst-case RC/SO was used for HAC testing.

Table 9-1  
Handset 3G mode variation on RF Emissions

Mode	Channel	Backlight	RC/SO	Scan Center	Battery	Time Avg. Field (V/m)	Peak Field (V/m)	Peak Field (dBV/m)	FCC Limit (dBV/m)	FCC MARGIN (dB)	RESULT	Excl Blocks per 4.4
PCS	25	off	SO3/RC1	Acoustic	Standard	17.34	47.9	33.6	41.0	-7.39	M4	none
PCS	25	off	SO3/RC3	Acoustic	Standard	45.48	45.0	33.1	41.0	-7.93	M4	none
PCS	25	off	SO3/RC4	Acoustic	Standard	47.53	47.0	33.5	41.0	-7.55	M4	none
PCS	25	off	SO55/RC3	Acoustic	Standard	47.06	46.6	33.4	41.0	-7.64	M4	none
PCS	25	off	SO55/RC1	Acoustic	Standard	47.40	46.9	33.4	41.0	-7.57	M4	none
PCS	25	off	SO2/RC1	Acoustic	Standard	47.76	47.3	33.5	41.0	-7.51	M4	none
PCS	25	off	SO2/RC3	Acoustic	Standard	47.04	46.6	33.4	41.0	-7.64	M4	none
PCS	25	off	SO9/RC2	Acoustic	Standard	47.05	46.6	33.4	41.0	-7.64	M4	none
PCS	25	on	SO9/RC5	Acoustic	Standard	48.67	48.2	33.7	41.0	-7.34	M4	none

FCC ID: ZNFUS730	PCTEST ENGINEERING LABORATORY, INC.	HAC (RF EMISSIONS) TEST REPORT	LG	Reviewed by: Quality Manager
HAC Filename: OY1207090916.ZNF	Test Dates: July 10-12, 2012	EUT Type: Portable Handset		Page 20 of 81

## 10. OVERALL MEASUREMENT SUMMARY

<b>FCC ID:</b>	ZNFUS730
<b>Model:</b>	US730, LG-US730, LW730, LG-LW730
<b>S/N:</b>	HAC RFE

### I. E-FIELD EMISSIONS:

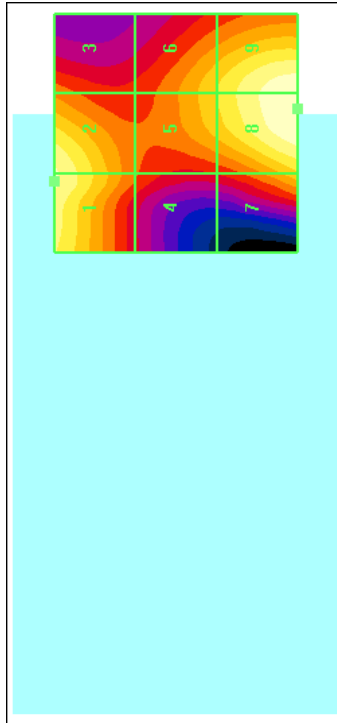

**Table 10-1  
HAC Data Summary for E-field**

Band	Channel	Backlight	RC/SO	Scan Center	Battery	Conducted Power at BS (dBm)	Time Avg. Field (V/m)	Peak Field (V/m)	Peak Field (dBV/m)	FCC Limit (dBV/m)	FCC MARGIN (dB)	RESULT	Excl Blocks per 4.4
<b>E-field Emissions</b>													
CDMA	1013	off	SO9/RC5	Acoustic	Standard	24.67	83.76	77.7	37.8	51.0	-13.19	M4	none
CDMA	384	off	SO9/RC5	Acoustic	Standard	24.59	75.83	70.4	36.9	51.0	-14.05	M4	none
CDMA	777	off	SO9/RC5	Acoustic	Standard	24.60	81.64	75.8	37.6	51.0	-13.41	M4	none
AWS	25	off	SO9/RC5	Acoustic	Standard	24.60	27.67	27.3	28.7	41.0	-12.28	M4	none
AWS	450	off	SO9/RC5	Acoustic	Standard	24.50	34.09	33.6	30.5	41.0	-10.47	M4	none
AWS	875	off	SO9/RC5	Acoustic	Standard	24.30	37.75	37.2	31.4	41.0	-9.58	M4	none
PCS	25	off	SO9/RC5	Acoustic	Standard	24.45	48.77	48.3	33.7	41.0	-7.33	M4	none
PCS	600	off	SO9/RC5	Acoustic	Standard	24.46	44.89	44.4	33.0	41.0	-8.05	M4	none
PCS	1175	off	SO9/RC5	Acoustic	Standard	24.44	42.69	42.3	32.5	41.0	-8.48	M4	none
PCS	25	off	SO9/RC5	T-coil	Standard	24.45	48.77	48.3	33.7	41.0	-7.33	M4	none



**Figure 10-1**  
Sample E-field Scan Overlay  
(See Test Setup Photographs for actual WD overlay)

Note: Worst-case measurement evaluated for worst-case 1/8 rate gating condition in RC1/SO3; Mute=Yes

<b>FCC ID:</b> ZNFUS730	 <b>PCTEST</b> ENGINEERING LABORATORY, INC.	<b>HAC (RF EMISSIONS) TEST REPORT</b>	 <b>LG</b>	<b>Reviewed by:</b> Quality Manager
<b>HAC Filename:</b> 0Y1207090916.ZNF	<b>Test Dates:</b> July 10-12, 2012	<b>EUT Type:</b> Portable Handset	Page 21 of 81	

<b>FCC ID:</b>	ZNFUS730
<b>Model:</b>	US730, LG-US730, LW730, LG-LW730
<b>S/N:</b>	HAC RFE



## II. H-FIELD EMISSIONS:

**Table 10-2  
HAC Data Summary for H-field**

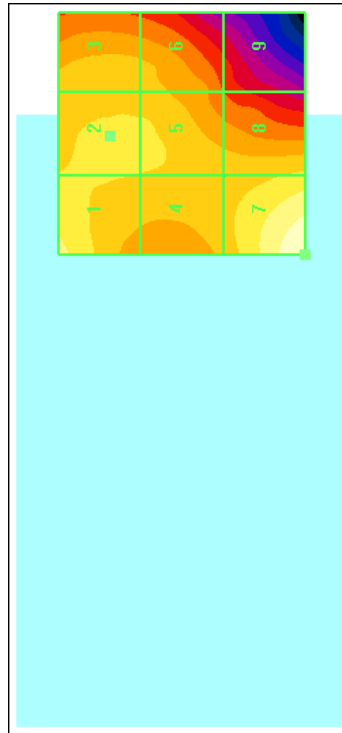
Mode	Channel	Backlight	RC/SO	Scan Center	Battery	Conducted Power at BS (dBm)	Time Avg. Field (A/m)	Peak Field (A/m)	Peak Field (dBA/m)	FCC Limit (dBA/m)	FCC MARGIN (dB)	RESULT	Excl Blocks per 4.4
<b>H-field Emissions</b>													
CDMA	1013	off	SO9/RC5	Acoustic	Standard	24.67	0.1589	0.128	-17.8	0.6	-18.43	M4	none
CDMA	384	off	SO9/RC5	Acoustic	Standard	24.59	0.1448	0.117	-18.6	0.6	-19.24	M4	none
CDMA	777	off	SO9/RC5	Acoustic	Standard	24.60	0.1098	0.089	-21.0	0.6	-21.64	M4	none
AWS	25	off	SO9/RC5	Acoustic	Standard	24.60	0.0777	0.071	-22.9	-9.4	-13.53	M4	none
AWS	450	off	SO9/RC5	Acoustic	Standard	24.50	0.0875	0.080	-21.9	-9.4	-12.49	M4	none
AWS	875	off	SO9/RC5	Acoustic	Standard	24.30	0.0805	0.074	-22.6	-9.4	-13.22	M4	none
PCS	25	off	SO9/RC5	Acoustic	Standard	24.45	0.1115	0.091	-20.8	-9.4	-11.38	M4	none
PCS	600	off	SO9/RC5	Acoustic	Standard	24.46	0.1073	0.088	-21.1	-9.4	-11.71	M4	none
PCS	1175	off	SO9/RC5	Acoustic	Standard	24.44	0.1187	0.097	-20.2	-9.4	-10.84	M4	none



**Figure 10-2**  
Sample H-field Scan Overlay  
(See Test Setup Photographs for actual WD overlay)

<b>FCC ID:</b> ZNFUS730	 <b>PCTEST</b> ENGINEERING LABORATORY, INC.	<b>HAC (RF EMISSIONS) TEST REPORT</b>	 <b>LG</b>	<b>Reviewed by:</b> Quality Manager
<b>HAC Filename:</b> OY1207090916.ZNF	<b>Test Dates:</b> July 10-12, 2012	<b>EUT Type:</b> Portable Handset		Page 22 of 81

FCC ID:	ZNFUS730
Model:	US730, LG-US730, LW730, LG-LW730
S/N:	HAC RFE

### III. Worst-case Configuration Evaluation

**Table 10-3**  
**Peak Reading 360° Probe Rotation at Azimuth axis**

Mode	Channel	Backlight	RC/SO	Scan Center	Battery	Time Avg. Field (V/m)	Peak Field (V/m)	Peak Field (dBV/m)	FCC Limit (dBV/m)	FCC MARGIN (dB)	RESULT
<b>Probe Rotation at Worst-case</b>											
PCS	25	off	SO9/RC5	Acoustic	Standard	50.27	49.8	33.9	41.0	-7.06	M4

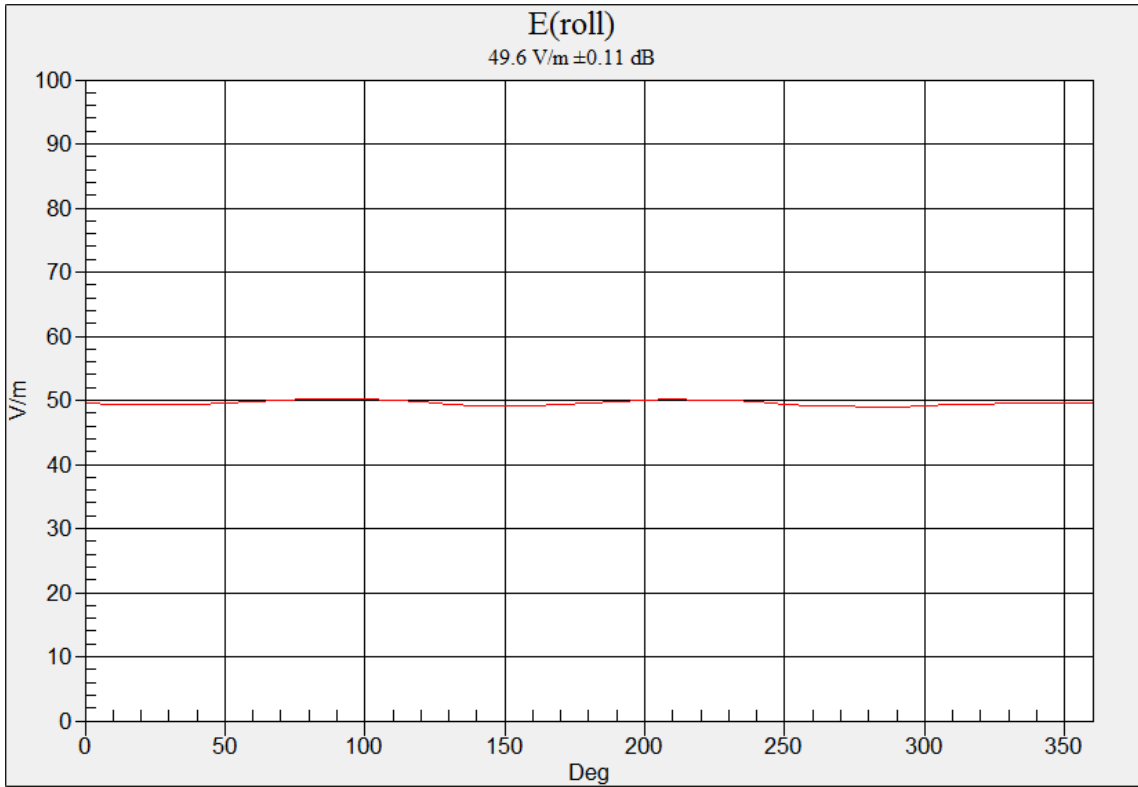

**Figure 10-3**  
**Worst-Case Probe Rotation about Azimuth axis**

\*Note: Locations of probe rotation (with and without exclusions) are shown in Figure 10-1 or Figure 10-2 denoted by the green square markers.

FCC ID: ZNFUS730	PCTEST ENGINEERING LABORATORY, INC.	HAC (RF EMISSIONS) TEST REPORT	LG	Reviewed by: Quality Manager
HAC Filename: 0Y1207090916.ZNF	Test Dates: July 10-12, 2012	EUT Type: Portable Handset	Page 23 of 81	



## 11. EQUIPMENT LIST

Manufacturer	Model	Description	Cal Date	Cal Interval	Cal Due	Serial Number
Agilent	E5515C	Wireless Communications Test Set	10/10/2011	Annual	10/10/2012	GB46110872
Agilent	E5515C	Wireless Communications Test Set	10/14/2011	Annual	10/14/2012	GB41450275
Agilent	E5515C	Wireless Communications Test Set	10/20/2011	Annual	10/20/2012	GB46310798
Agilent	E5515C	Wireless Communications Test Set	2/9/2012	Annual	2/9/2013	GB43460554
Agilent	E5515C	Wireless Communications Test Set	2/12/2012	Annual	2/12/2013	GB45360985
Agilent	E5515C	Wireless Communications Test Set	2/14/2012	Annual	2/14/2013	GB43304447
Agilent	E5515C	Wireless Communications Test Set	2/14/2012	Annual	2/14/2013	GB43163447
Agilent	E4432B	ESG-D Series Signal Generator	3/15/2012	Annual	3/15/2013	US40053896
Agilent	E4407B	ESA Spectrum Analyzer	4/3/2012	Annual	4/3/2013	US39210313
Agilent	E5515C	Wireless Communications Tester	4/4/2012	Annual	4/4/2013	US41140256
Anritsu	MA2481A	Power Sensor	2/14/2012	Annual	2/14/2013	3681
Control Company	36934-158	Wall-Mounted Thermometer	1/4/2012	Biennial	1/4/2014	122014497
Control Company	36934-158	Wall-Mounted Thermometer	1/4/2012	Biennial	1/4/2014	122014488
Mini-Circuits	NLP-2950+	Low Pass Filter DC to 2700 MHz	N/A	CBT*	N/A	N/A
Mini-Circuits	NLP-1200+	Low Pass Filter DC to 1000 MHz	N/A	CBT*	N/A	N/A
Rohde & Schwarz	NRVD	Dual Channel Power Meter	4/8/2011	Biennial	4/8/2013	101695
Rohde & Schwarz	CMU200	Base Station Simulator	5/22/2012	Annual	5/22/2013	109892
Seekonk	NC-100	Torque Wrench (8" lb)	11/29/2011	Triennial	11/29/2014	21053
SPEAG	DAE3	Dasy Data Acquisition Electronics	11/9/2011	Annual	11/9/2012	455
SPEAG	DAE4	Dasy Data Acquisition Electronics	1/18/2012	Annual	1/18/2013	1272
SPEAG	ER3DV6	Freespace E-field Probe	1/20/2012	Annual	1/20/2013	2353
SPEAG	H3DV6	Freespace H-field Probe	1/20/2012	Annual	1/20/2013	6207
SPEAG	CD835V3	Freespace 835 MHz Dipole	2/8/2011	Biennial	2/8/2013	1003
SPEAG	CD1880V3	Freespace 1880 MHz Dipole	2/9/2011	Biennial	2/9/2013	1137
SPEAG	DAE4	Dasy Data Acquisition Electronics	2/20/2012	Annual	2/20/2013	649
SPEAG	DAE4	Dasy Data Acquisition Electronics	4/19/2012	Annual	4/19/2013	665
SPEAG	DAE4	Dasy Data Acquisition Electronics	5/15/2012	Annual	5/15/2013	859

**Table 11-1**  
Equipment List

Calibration traceable to the National Institute of Standards and Technology (NIST)

**\*Note: CBT (Calibrated Before Testing).** Prior to testing, the measurement paths containing a cable, attenuator, coupler or filter were connected to a calibrated source (i.e. a signal generator) to determine the losses of the measurement path. The power meter offset was then adjusted to compensate for the measurement system losses. This level offset is stored within the power meter before measurements are made. This calibration verification procedure applies to the system verification and output power measurements. The calibrated reading is then taken directly from the power meter after compensation of the losses for all final power measurements.

FCC ID: ZNFUS730	 PCTEST ENGINEERING LABORATORY, INC.	HAC (RF EMISSIONS) TEST REPORT	 LG	Reviewed by: Quality Manager
HAC Filename: 0Y1207090916.ZNF	Test Dates: July 10-12, 2012	EUT Type: Portable Handset	Page 24 of 81	



## 12. MEASUREMENT UNCERTAINTY

Wireless Communications Device Near-Field Measurement								
Uncertainty Estimation								
Uncertainty Component	Data (dB)	Data Type	Prob. Dist.	Divisor	Ci (E)	Ci (H)	Unc. (dB)	Notes/Comments
<b>Measurement System</b>								
RF System Reflections	0.50	Tolerance	N	1.00	1	1	0.50	Refl. < -20 dB
Field Probe Calibration	0.21	Tolerance	N	1.00	1	1	0.21	
Field Probe Isotropy	0.01	Tolerance	N	1.00	1	1	0.01	
Field Probe Frequency Response	0.135	Tolerance	N	1.00	1	1	0.14	
Field Probe Linearity	0.013	Tolerance	N	1.00	1	1	0.01	
Probe Modulation Factor	0.270	Accuracy	R	1.73	1	1	0.16	
Boundary Effects	0.105	Accuracy	R	1.73	1	1	0.06	*
Probe Positioning Accuracy	0.20	Accuracy	R	1.73	1	0.670	0.12	*
Probe Positioner	0.050	Accuracy	R	1.73	1	0.670	0.03	*
Extrapolation/Interpolation	0.045	Tolerance	R	1.73	1	1	0.03	*
Resolution to 2mm error	0.210	Tolerance	N	1.00	1	1	0.21	
System Detection Limit	0.05	Tolerance	R	1.73	1	1	0.03	*
Readout Electronics	0.015	Tolerance	N	1.00	1	1	0.02	*
Integration Time	0.11	Tolerance	R	1.73	1	1	0.06	*
Response Time	0.033	Tolerance	R	1.73	1	1	0.02	*
Phantom Thickness	0.10	Tolerance	R	1.73	1	1	0.06	*
System Repeatability (Field x 2=power)	0.17	Tolerance	N	1.00	1	1	0.17	
<b>Test Sample Related</b>								
Device Positioning Vertical	0.2	Tolerance	R	1.73	1	1	0.12	*
Device Positioning Lateral	0.045	Tolerance	R	1.73	1	1	0.03	*
Device Holder and Phantom	0.1	Tolerance	R	1.73	1	1	0.06	*
Power Drift	0.21	Tolerance	R	1.73	1	1	0.12	
<i>Combined Standard Uncertainty (k=1)</i>							0.66	16.5%
<i>Expanded Uncertainty [95% confidence] (k=2)</i>							1.33	32.3%
<b><i>Expanded Uncertainty [95% confidence] on Field</i></b>							<b>0.66</b>	<b>16.2%</b>

**Table 12-1**  
Uncertainty Estimation Table

**Notes:**



1. Test equipments are calibrated according to techniques outlined in NIS81, NIS3003 and NIST Tech Note 1297. All equipments have traceability according to NIST. Measurement Uncertainties are defined in further detail in NIS 81 and NIST Tech Note 1297 and UKAS M3003.
2. \* Uncertainty specifications from Schmidt & Partner Engineering AG (not site specific)

Measurement uncertainty reflects the quality and accuracy of a measured result as compared to the true value. Such statements are generally required when stating results of measurements so that it is clear to the intended audience that the results may differ when reproduced by different facilities. Measurement results vary due to the measurement uncertainty of the instrumentation, measurement technique, and test engineer. Most uncertainties are calculated using the tolerances of the instrumentation used in the measurement, the measurement setup variability, and the technique used in performing the test. While not generally included, the variability of the equipment under test also figures into the overall measurement uncertainty. Another component of the overall uncertainty is based on the variability of repeated measurements (so-called Type A uncertainty). This may mean that the Hearing Aid immunity tests may have to be repeated by taking down the test setup and resetting it up so that there are a statistically significant number of repeat measurements to identify the measurement uncertainty. By combining the repeat measurement results with that of the instrumentation chain using the technique contained in NIS 81 and NIS 3003, the overall measurement uncertainty was estimated.

FCC ID: ZNFUS730	<b>PCTEST</b> <small>ENGINEERING LABORATORY, INC.</small>	<b>HAC (RF EMISSIONS) TEST REPORT</b>	<b>LG</b>	Reviewed by: Quality Manager
HAC Filename: OY1207090916.ZNF	Test Dates: July 10-12, 2012	EUT Type: Portable Handset	Page 25 of 81	

## 13. TEST DATA

See following Attached Pages for Test Data.

<b>FCC ID:</b> ZNFUS730	 <b>PCTEST</b> ENGINEERING LABORATORY, INC.	<b>HAC (RF EMISSIONS) TEST REPORT</b>	 <b>LG</b>	<b>Reviewed by:</b> Quality Manager
<b>HAC Filename:</b> 0Y1207090916.ZNF	<b>Test Dates:</b> July 10-12, 2012	<b>EUT Type:</b> Portable Handset	Page 26 of 81	



**PCTEST Hearing-Aid Compatibility Facility**

**DUT: CD835V3 - SN1003**

Type: CD835V3  
Serial: 1003

**Communication System: CW; Frequency: 835 MHz;**

Measurement Standard: DASYS (High Precision Assessment)

DASY5 Configuration:

- Probe: ER3DV6 - SN2353; Calibrated: 1/20/2012
- Sensor-Surface: 0mm (Fix Surface)
- Electronics: DAE4 Sn1322; Calibrated: 2/10/2012
- Phantom: HAC Test Arch with AMCC; Type: SD HAC P01 BA;
- Measurement SW: DASY52, V52.8 Build 1;

**835 MHz / 100mW HAC Dipole Validation at 10mm/Hearing Aid Compatibility Test (41x361x1):**

Measurement grid: dx=5mm, dy=5mm  
 Probe Modulation Factor = 1.00  
 Device Reference Point: 0.000, 0.000, -6.30 mm  
 Reference Value = 109.9 V/m; Power Drift = 0.099 dB  
 Average value of Peak (interpolated) = 169.1 V/m

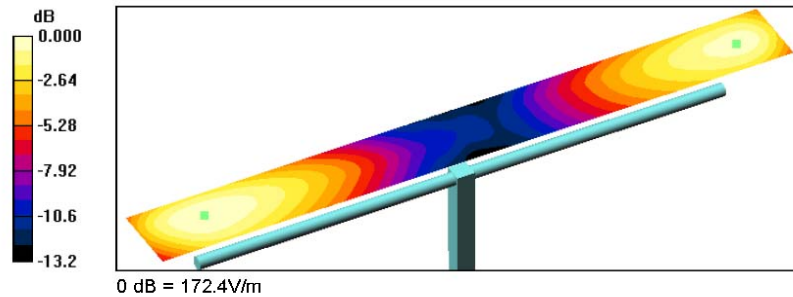

2012 PCTEST

FCC ID: ZNFUS730	PCTEST ENGINEERING LABORATORY, INC.	HAC (RF EMISSIONS) TEST REPORT	LG	Reviewed by: Quality Manager
HAC Filename: 0Y1207090916.ZNF	Test Dates: July 10-12, 2012	EUT Type: Portable Handset	Page 27 of 81	



**PCTEST Hearing-Aid Compatibility Facility**

**DUT: CD835V3 - SN1003**

Type: CD835V3  
Serial: 1003

**Communication System: CW; Frequency: 835 MHz;**

Measurement Standard: DASYS (High Precision Assessment)

DASY5 Configuration:

- Probe: HBDV6 - SN6207; Calibrated: 1/20/2012
- Sensor-Surface: 0mm (Fix Surface)
- Electronics: DAE4 Sn1322; Calibrated: 2/10/2012
- Phantom: HAC Test Arch with AMCC; Type: SD HAC P01 BA;
- Measurement SW: DASY52, V52.8 Build 1;

**835 MHz / 100 mW HAC Validation at 10 mm/Hearing Aid Compatibility Test (41x361x1):**

Measurement grid: dx=5mm, dy=5mm  
 Probe Modulation Factor = 1.00  
 Device Reference Point: 0.000, 0.000, -6.30 mm  
 Reference Value = 0.480 A/m; Power Drift = -0.048 dB  
 Maximum value of Total (interpolated) = 0.451 A/m

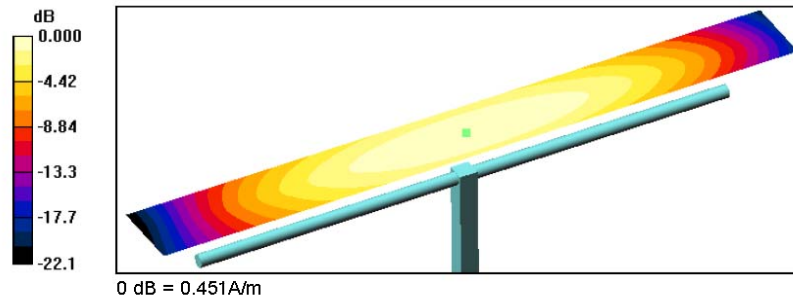

2012 PCTEST

FCC ID: ZNFUS730	PCTEST ENGINEERING LABORATORY, INC.	HAC (RF EMISSIONS) TEST REPORT	LG	Reviewed by: Quality Manager
HAC Filename: 0Y1207090916.ZNF	Test Dates: July 10-12, 2012	EUT Type: Portable Handset	Page 28 of 81	



**PCTEST Hearing-Aid Compatibility Facility**

**DUT: CD1880V3 - SN1137**

Type: CD1880V3  
Serial: 1137

**Communication System: CW; Frequency: 1730 MHz;**

Measurement Standard: DASYS (High Precision Assessment)

DASY5 Configuration:

- Probe: ER3DV6 - SN2353; Calibrated: 1/20/2012
- Sensor-Surface: 0mm (Fix Surface)
- Electronics: DAE4 Sn1322; Calibrated: 2/10/2012
- Phantom: HAC Test Arch with AMCC; Type: SD HAC P01 BA;
- Measurement SW: DASY52, V52.8 Build 1;

**1730 MHz / 100mW HAC Dipole Validation at 10mm/Hearing Aid Compatibility Test (41x181x1):**

Measurement grid: dx=5mm, dy=5mm  
 Probe Modulation Factor = 1.00  
 Device Reference Point: 0.000, 0.000, -6.30 mm  
 Reference Value = 171.6 V/m; Power Drift = -0.044 dB  
 Average value of Peak (interpolated) = 152.9 V/m

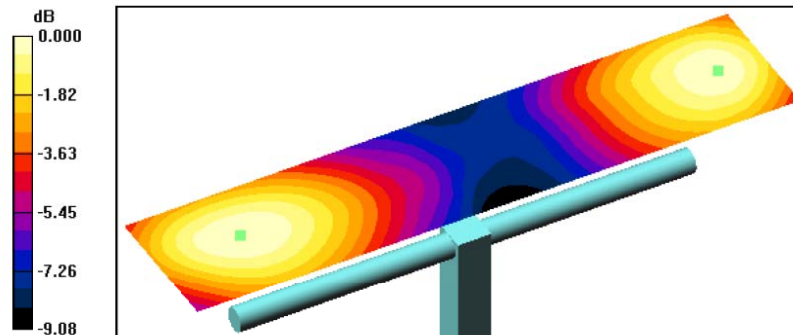

0 dB = 153.2V/m

2012 PCTEST

<b>FCC ID:</b> ZNFUS730	PCTEST ENGINEERING LABORATORY, INC.	<b>HAC (RF EMISSIONS) TEST REPORT</b>	LG	<b>Reviewed by:</b> Quality Manager
<b>HAC Filename:</b> 0Y1207090916.ZNF	<b>Test Dates:</b> July 10-12, 2012	<b>EUT Type:</b> Portable Handset	Page 29 of 81	



**PCTEST Hearing-Aid Compatibility Facility**

**DUT: CD1880V3 - SN1137**

Type: CD1880V3  
Serial: 1137

**Communication System: CW; Frequency: 1730 MHz;**

Measurement Standard: DASYS (High Precision Assessment)

DASY5 Configuration:

- Probe: HBDV6 - SN6207; Calibrated: 1/20/2012
- Sensor-Surface: 0mm (Fix Surface)
- Electronics: DAE4 Sn1322; Calibrated: 2/10/2012
- Phantom: HAC Test Arch with AMCC; Type: SD HAC P01 BA;
- Measurement SW: DASY52, V52.8 Build 1;

**1730 MHz / 100 mW HAC Validation at 10 mm/Hearing Aid Compatibility Test (41x181x1):**

Measurement grid: dx=5mm, dy=5mm  
 Probe Modulation Factor = 1.00  
 Device Reference Point: 0.000, 0.000, -6.30 mm  
 Reference Value = 0.506 A/m; Power Drift = -0.077 dB  
 Maximum value of Total (interpolated) = 0.476 A/m

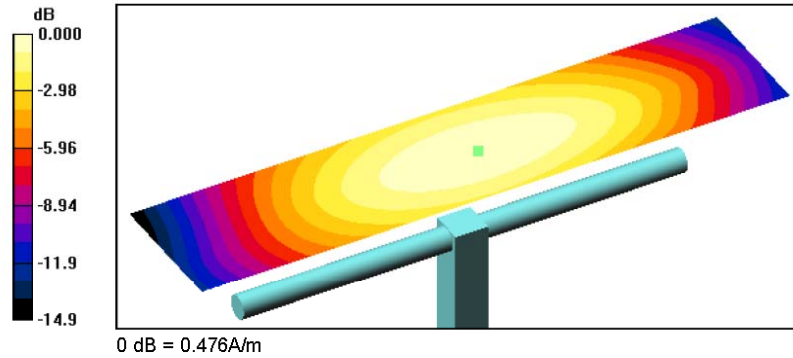

2012 PCTEST

<b>FCC ID:</b> ZNFUS730	PCTEST ENGINEERING LABORATORY, INC.	<b>HAC (RF EMISSIONS) TEST REPORT</b>	LG	<b>Reviewed by:</b> Quality Manager
<b>HAC Filename:</b> 0Y1207090916.ZNF	<b>Test Dates:</b> July 10-12, 2012	<b>EUT Type:</b> Portable Handset	Page 30 of 81	



**PCTEST Hearing-Aid Compatibility Facility**

**DUT: CD1880V3 - SN1137**

Type: CD1880V3  
Serial: 1137

**Communication System: CW; Frequency: 1880 MHz;**

Measurement Standard: DASYS (High Precision Assessment)

DASY5 Configuration:

- Probe: ER3DV6 - SN2353; Calibrated: 1/20/2012
- Sensor-Surface: 0mm (Fix Surface)
- Electronics: DAE4 Sn1322; Calibrated: 2/10/2012
- Phantom: HAC Test Arch with AMCC; Type: SD HAC P01 BA;
- Measurement SW: DASY52, V52.8 Build 1;

**1880 MHz / 100mW HAC Dipole Validation at 10mm/Hearing Aid Compatibility Test (41x181x1):**

Measurement grid: dx=5mm, dy=5mm  
 Probe Modulation Factor = 1.00  
 Device Reference Point: 0.000, 0.000, -6.30 mm  
 Reference Value = 152.8 V/m; Power Drift = 0.185 dB  
 Average value of Peak (interpolated) = 136.1 V/m

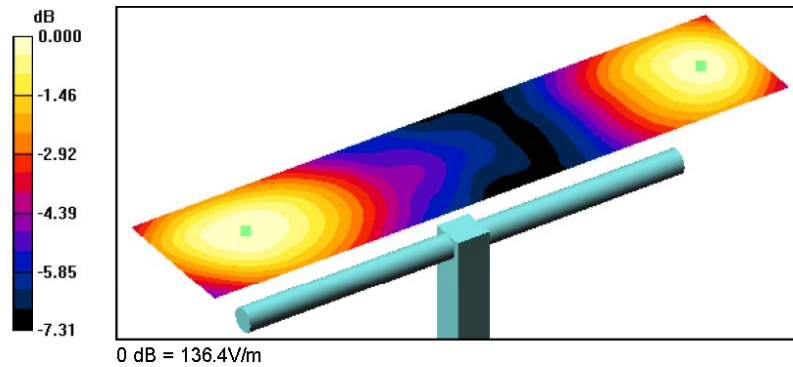

2012 PCTEST

<b>FCC ID:</b> ZNFUS730	PCTEST ENGINEERING LABORATORY, INC.	<b>HAC (RF EMISSIONS) TEST REPORT</b>	LG	<b>Reviewed by:</b> Quality Manager
<b>HAC Filename:</b> 0Y1207090916.ZNF	<b>Test Dates:</b> July 10-12, 2012	<b>EUT Type:</b> Portable Handset	Page 31 of 81	



**PCTEST Hearing-Aid Compatibility Facility**

**DUT: CD1880V3 - SN1137**

Type: CD1880V3  
Serial: 1137

**Communication System: CW; Frequency: 1880 MHz;**

Measurement Standard: DASYS (High Precision Assessment)

DASY5 Configuration:

- Probe: HBDV6 - SN6207; Calibrated: 1/20/2012
- Sensor-Surface: 0mm (Fix Surface)
- Electronics: DAE4 Sn1322; Calibrated: 2/10/2012
- Phantom: HAC Test Arch with AMCC; Type: SD HAC P01 BA;
- Measurement SW: DASY52, V52.8 Build 1;

**1880 MHz / 100 mW HAC Validation at 10 mm/Hearing Aid Compatibility Test (41x181x1):**

Measurement grid: dx=5mm, dy=5mm  
 Probe Modulation Factor = 1.00  
 Device Reference Point: 0.000, 0.000, -6.30 mm  
 Reference Value = 0.446 A/m; Power Drift = 0.177 dB  
 Maximum value of Total (interpolated) = 0.433 A/m

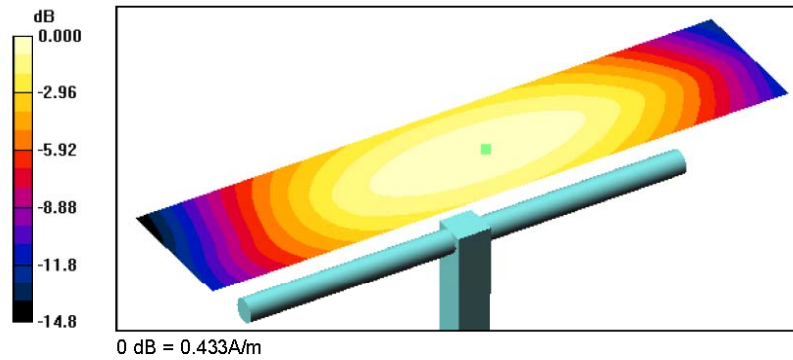

2012 PCTEST

FCC ID: ZNFUS730	PCTEST ENGINEERING LABORATORY, INC.	HAC (RF EMISSIONS) TEST REPORT	LG	Reviewed by: Quality Manager
HAC Filename: 0Y1207090916.ZNF	Test Dates: July 10-12, 2012	EUT Type: Portable Handset	Page 32 of 81	





**PCTEST Hearing-Aid Compatibility Facility**

**DUT: ZNFUS730**

Type: Portable Handset  
 Serial: HAC RFE  
*Backlight off*  
 Duty Cycle: 1:1

**Communication System: Cell. CDMA; Frequency: 824.7 MHz;**

Measurement Standard: DASYS (High Precision Assessment)

DASY5 Configuration:

- Probe: ER3DV6 - SN2353; Calibrated: 1/20/2012
- Sensor-Surface: (Fix Surface)
- Electronics: DAE4 Sn1322; Calibrated: 2/10/2012
- Phantom: HAC Test Arch with AMCC; Type: SD HAC P01 BA;
- Measurement SW: DASY52, V52.8 Build 1;

**Cell. CDMA Low Channel/Hearing Aid Compatibility Test (101x101x1):**

Measurement grid: dx=5mm, dy=5mm  
 Maximum value of peak Total field = 77.7 V/m  
 Probe Modulation Factor = 0.928  
 Device Reference Point: 0.000, 0.000, -6.30 mm  
 Reference Value = 110.0 V/m; Power Drift = -0.104 dB  
**Hearing Aid Near-Field Category: M4 (AWF 0 dB)**

Peak E-field in V/m

Grid 1	Grid 2	Grid 3
<b>69.7 M4</b>	<b>72.7 M4</b>	<b>66.0 M4</b>
Grid 4	Grid 5	Grid 6
<b>74.1 M4</b>	<b>76.8 M4</b>	<b>69.4 M4</b>
Grid 7	Grid 8	Grid 9
<b>75.7 M4</b>	<b>77.7 M4</b>	<b>69.4 M4</b>

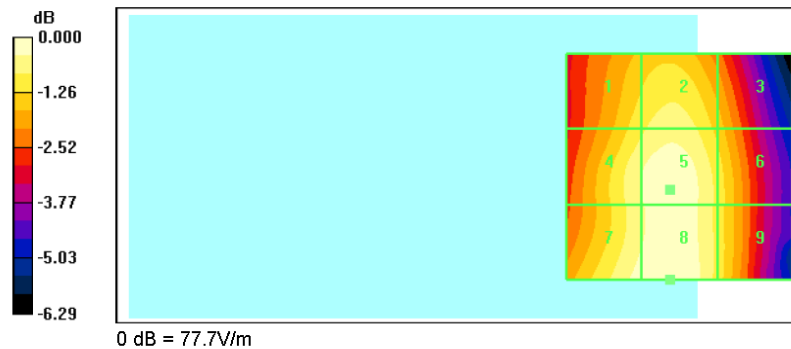

2012 PCTEST

<b>FCC ID:</b> ZNFUS730	<b>PCTEST</b> ENGINEERING LABORATORY, INC.	<b>HAC (RF EMISSIONS) TEST REPORT</b>	<b>LG</b>	<b>Reviewed by:</b> Quality Manager
<b>HAC Filename:</b> OY1207090916.ZNF	<b>Test Dates:</b> July 10-12, 2012	<b>EUT Type:</b> Portable Handset	Page 33 of 81	



**PCTEST Hearing-Aid Compatibility Facility**

**DUT: ZNFUS730**

Type: Portable Handset  
 Serial: HAC RFE  
*Backlight off*  
 Duty Cycle: 1:1

**Communication System: Cell. CDMA; Frequency: 824.7 MHz;**

Measurement Standard: DASYS (High Precision Assessment)

DASY5 Configuration:

- Probe: HBDV6 - SN6207; Calibrated: 1/20/2012
- Sensor-Surface: (Fix Surface)
- Electronics: DAE4 Sn1322; Calibrated: 2/10/2012
- Phantom: HAC Test Arch with AMCC; Type: SD HAC P01 BA;
- Measurement SW: DASY52, V52.8 Build 1;

**Cell. CDMA Low Channel/Hearing Aid Compatibility Test (101x101x1):**

Measurement grid: dx=5mm, dy=5mm  
 Maximum value of peak Total field = 0.128 A/m  
 Probe Modulation Factor = 0.808  
 Device Reference Point: 0.000, 0.000, -6.30 mm  
 Reference Value = 0.078 A/m; Power Drift = 0.165 dB  
**Hearing Aid Near-Field Category: M4 (AWF 0 dB)**

Peak H-field in A/m

Grid 1	Grid 2	Grid 3
<b>0.121 M4</b>	<b>0.084 M4</b>	<b>0.051 M4</b>
Grid 4	Grid 5	Grid 6
<b>0.112 M4</b>	<b>0.080 M4</b>	<b>0.048 M4</b>
Grid 7	Grid 8	Grid 9
<b>0.128 M4</b>	<b>0.087 M4</b>	<b>0.055 M4</b>

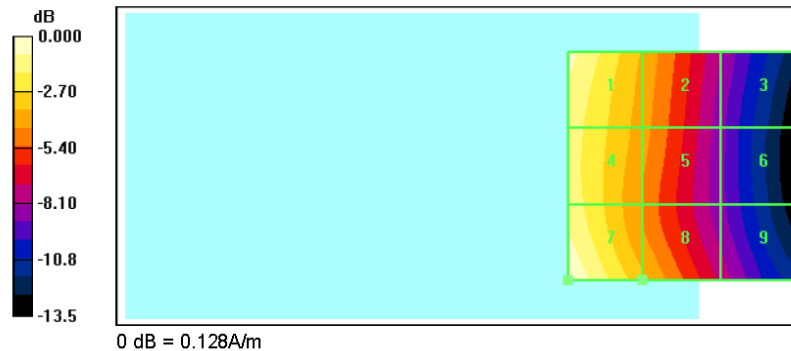

2012 PCTEST

<b>FCC ID:</b> ZNFUS730	PCTEST ENGINEERING LABORATORY, INC.	<b>HAC (RF EMISSIONS) TEST REPORT</b>	LG	<b>Reviewed by:</b> Quality Manager
<b>HAC Filename:</b> OY1207090916.ZNF	<b>Test Dates:</b> July 10-12, 2012	<b>EUT Type:</b> Portable Handset	Page 34 of 81	



**PCTEST Hearing-Aid Compatibility Facility**

**DUT: ZNFUS730**

Type: Portable Handset  
 Serial: HAC RFE  
*Backlight off*  
 Duty Cycle: 1:1

**Communication System: AWS CDMA; Frequency: 1753.75 MHz;**

Measurement Standard: DASYS (High Precision Assessment)

DASY5 Configuration:

- Probe: ER3DV6 - SN2353; Calibrated: 1/20/2012
- Sensor-Surface: (Fix Surface)
- Electronics: DAE4 Sn1322; Calibrated: 2/10/2012
- Phantom: HAC Test Arch with AMCC; Type: SD HAC P01 BA;
- Measurement SW: DASY52, V52.8 Build 1;

**AWS CDMA High Channel/Hearing Aid Compatibility Test (101x101x1):**

Measurement grid: dx=5mm, dy=5mm  
 Maximum value of peak Total field = 37.2 V/m  
 Probe Modulation Factor = 0.986  
 Device Reference Point: 0.000, 0.000, -6.30 mm  
 Reference Value = 29.4 V/m; Power Drift = -0.016 dB  
**Hearing Aid Near-Field Category: M4 (AWF 0 dB)**

Peak E-field in V/m

Grid 1	Grid 2	Grid 3
<b>30.4 M4</b>	<b>24.8 M4</b>	<b>21.6 M4</b>
Grid 4	Grid 5	Grid 6
<b>22.6 M4</b>	<b>30.1 M4</b>	<b>29.8 M4</b>
Grid 7	Grid 8	Grid 9
<b>31.9 M4</b>	<b>37.2 M4</b>	<b>35.8 M4</b>

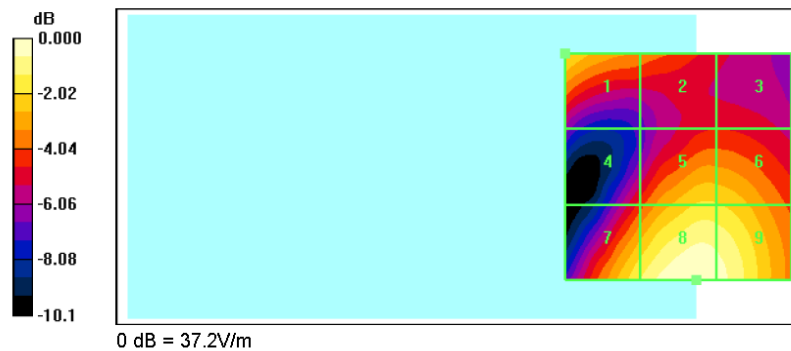

2012 PCTEST

<b>FCC ID:</b> ZNFUS730	<b>PCTEST</b> ENGINEERING LABORATORY, INC.	<b>HAC (RF EMISSIONS) TEST REPORT</b>	<b>LG</b>	<b>Reviewed by:</b> Quality Manager
<b>HAC Filename:</b> OY1207090916.ZNF	<b>Test Dates:</b> July 10-12, 2012	<b>EUT Type:</b> Portable Handset	Page 35 of 81	



**PCTEST Hearing-Aid Compatibility Facility**

**DUT: ZNFUS730**

Type: Portable Handset  
 Serial: HAC RFE  
*Backlight off*  
 Duty Cycle: 1:1

**Communication System: AWS CDMA; Frequency: 1732.5 MHz;**

Measurement Standard: DASYS (High Precision Assessment)

DASY5 Configuration:

- Probe: HBDV6 - SN6207; Calibrated: 1/20/2012
- Sensor-Surface: (Fix Surface)
- Electronics: DAE4 Sn1322; Calibrated: 2/10/2012
- Phantom: HAC Test Arch with AMCC; Type: SD HAC P01 BA;
- Measurement SW: DASY52, V52.8 Build 1;

**AWS CDMA Mid Channel/Hearing Aid Compatibility Test (101x101x1):**

Measurement grid: dx=5mm, dy=5mm  
 Maximum value of peak Total field = 0.080 A/m  
 Probe Modulation Factor = 0.919  
 Device Reference Point: 0.000, 0.000, -6.30 mm  
 Reference Value = 0.080 A/m; Power Drift = 0.149 dB  
**Hearing Aid Near-Field Category: M4 (AWF 0 dB)**

Peak H-field in A/m

Grid 1	Grid 2	Grid 3
<b>0.080 M4</b>	<b>0.074 M4</b>	<b>0.067 M4</b>
Grid 4	Grid 5	Grid 6
<b>0.071 M4</b>	<b>0.071 M4</b>	<b>0.067 M4</b>
Grid 7	Grid 8	Grid 9
<b>0.067 M4</b>	<b>0.065 M4</b>	<b>0.058 M4</b>

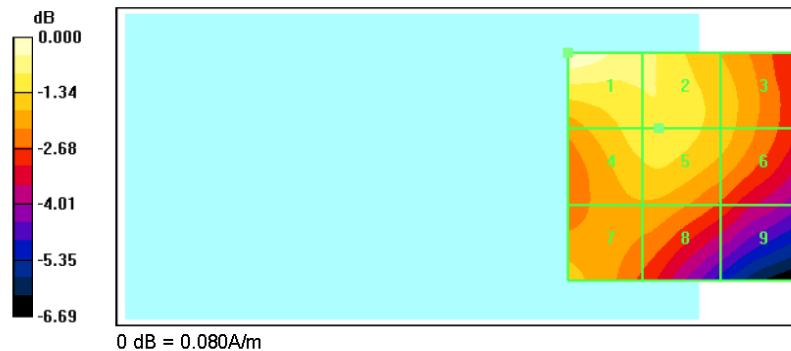

2012 PCTEST

<b>FCC ID:</b> ZNFUS730	PCTEST ENGINEERING LABORATORY, INC.	<b>HAC (RF EMISSIONS) TEST REPORT</b>	LG	<b>Reviewed by:</b> Quality Manager
<b>HAC Filename:</b> OY1207090916.ZNF	<b>Test Dates:</b> July 10-12, 2012	<b>EUT Type:</b> Portable Handset	Page 36 of 81	



**PCTEST Hearing-Aid Compatibility Facility**

**DUT: ZNFUS730**

Type: Portable Handset  
 Serial: HAC RFE  
*Backlight off*  
 Duty Cycle: 1:1

**Communication System: PCS CDMA; Frequency: 1851.25 MHz;**

Measurement Standard: DASYS (High Precision Assessment)

DASY5 Configuration:

- Probe: ER3DV6 - SN2353; Calibrated: 1/20/2012
- Sensor-Surface: (Fix Surface)
- Electronics: DAE4 Sn1322; Calibrated: 2/10/2012
- Phantom: HAC Test Arch with AMCC; Type: SD HAC P01 BA;
- Measurement SW: DASY52, V52.8 Build 1;

**PCS CDMA Low Channel/Hearing Aid Compatibility Test (101x101x1):**

Measurement grid: dx=5mm, dy=5mm  
 Maximum value of peak Total field = 48.3 V/m  
 Probe Modulation Factor = 0.990  
 Device Reference Point: 0.000, 0.000, -6.30 mm  
 Reference Value = 40.0 V/m; Power Drift = 0.162 dB  
**Hearing Aid Near-Field Category: M4 (AWF 0 dB)**

Peak E-field in V/m

Grid 1	Grid 2	Grid 3
<b>46.1 M4</b>	<b>45.9 M4</b>	<b>34.9 M4</b>
Grid 4	Grid 5	Grid 6
<b>33.8 M4</b>	<b>40.2 M4</b>	<b>40.2 M4</b>
Grid 7	Grid 8	Grid 9
<b>39.6 M4</b>	<b>48.3 M4</b>	<b>48.1 M4</b>

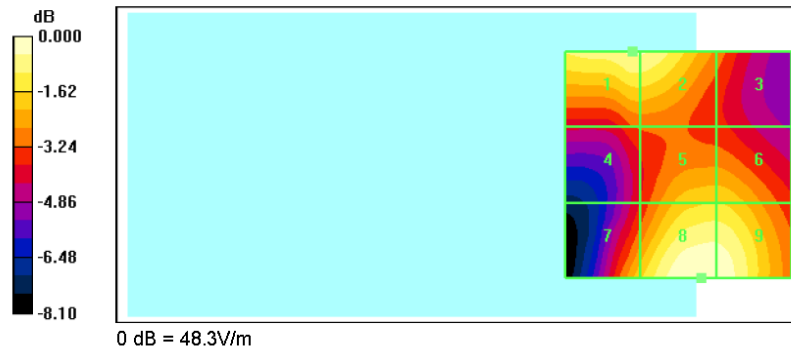

2012 PCTEST

<b>FCC ID:</b> ZNFUS730	<b>PCTEST</b> ENGINEERING LABORATORY, INC.	<b>HAC (RF EMISSIONS) TEST REPORT</b>	<b>LG</b>	<b>Reviewed by:</b> Quality Manager
<b>HAC Filename:</b> OY1207090916.ZNF	<b>Test Dates:</b> July 10-12, 2012	<b>EUT Type:</b> Portable Handset	Page 37 of 81	



**PCTEST Hearing-Aid Compatibility Facility**

**DUT: ZNFUS730**

Type: Portable Handset  
 Serial: HAC RFE  
*Backlight off*  
 Duty Cycle: 1:1

**Communication System: PCS CDMA; Frequency: 1908.75 MHz;**

Measurement Standard: DASYS (High Precision Assessment)

DASY5 Configuration:

- Probe: HBDV6 - SN6207; Calibrated: 1/20/2012
- Sensor-Surface: (Fix Surface)
- Electronics: DAE4 Sn1322; Calibrated: 2/10/2012
- Phantom: HAC Test Arch with AMCC; Type: SD HAC P01 BA;
- Measurement SW: DASY52, V52.8 Build 1;

**PCS CDMA High Channel/Hearing Aid Compatibility Test (101x101x1):**

Measurement grid: dx=5mm, dy=5mm  
 Maximum value of peak Total field = 0.097 A/m  
 Probe Modulation Factor = 0.820  
 Device Reference Point: 0.000, 0.000, -6.30 mm  
 Reference Value = 0.112 A/m; Power Drift = 0.159 dB  
**Hearing Aid Near-Field Category: M4 (AWF 0 dB)**

Peak H-field in A/m

Grid 1	Grid 2	Grid 3
<b>0.087 M4</b>	<b>0.085 M4</b>	<b>0.079 M4</b>
Grid 4	Grid 5	Grid 6
<b>0.079 M4</b>	<b>0.081 M4</b>	<b>0.077 M4</b>
Grid 7	Grid 8	Grid 9
<b>0.097 M4</b>	<b>0.080 M4</b>	<b>0.064 M4</b>

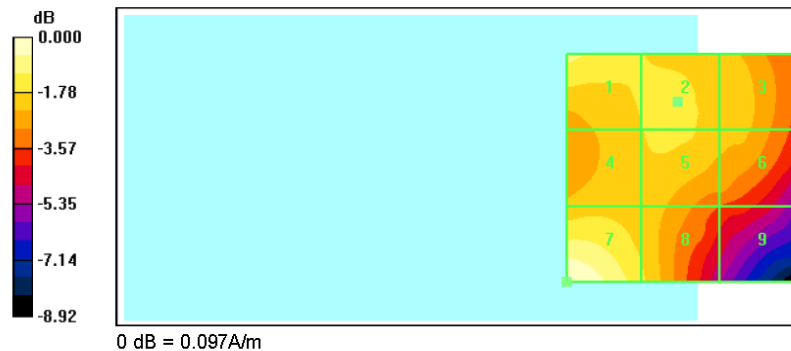



2012 PCTEST

<b>FCC ID:</b> ZNFUS730	<b>PCTEST</b> ENGINEERING LABORATORY, INC.	<b>HAC (RF EMISSIONS) TEST REPORT</b>	<b>LG</b>	<b>Reviewed by:</b> Quality Manager
<b>HAC Filename:</b> OY1207090916.ZNF	<b>Test Dates:</b> July 10-12, 2012	<b>EUT Type:</b> Portable Handset	Page 38 of 81	

## 14. CALIBRATION CERTIFICATES

The following pages include the probe calibration used to evaluate HAC for the DUT.

<b>FCC ID:</b> ZNFUS730	 <b>PCTEST</b> ENGINEERING LABORATORY, INC.	<b>HAC (RF EMISSIONS) TEST REPORT</b>	 <b>LG</b>	<b>Reviewed by:</b> Quality Manager
<b>HAC Filename:</b> 0Y1207090916.ZNF	<b>Test Dates:</b> July 10-12, 2012	<b>EUT Type:</b> Portable Handset		Page 39 of 81



Accredited by the Swiss Accreditation Service (SAS)  
The Swiss Accreditation Service is one of the signatories to the EA  
Multilateral Agreement for the recognition of calibration certificates

Accreditation No.: SCS 108

Client **PC Test**

Certificate No: **ER3-2353\_Jan12**

### CALIBRATION CERTIFICATE

Object: **ER3DV6 - SN:2353**

Calibration procedure(s): **QA CAL-02.v6, QA CAL-25.v4  
Calibration procedure for E-field probes optimized for close near field evaluations in air**

Calibration date: **January 20, 2012**

This calibration certificate documents the traceability to national standards, which realize the physical units of measurements (SI). The measurements and the uncertainties with confidence probability are given on the following pages and are part of the certificate.

All calibrations have been conducted in the closed laboratory facility: environment temperature (22 ± 3)°C and humidity < 70%.

Calibration Equipment used (M&TE critical for calibration)

✓  
KOK  
2/6/2012

Primary Standards	ID	Cal Date (Certificate No.)	Scheduled Calibration
Power meter E4419B	GB41293874	31-Mar-11 (No. 217-01372)	Apr-12
Power sensor E4412A	MY41498087	31-Mar-11 (No. 217-01372)	Apr-12
Reference 3 dB Attenuator	SN: S5054 (3c)	29-Mar-11 (No. 217-01369)	Apr-12
Reference 20 dB Attenuator	SN: S5086 (20b)	29-Mar-11 (No. 217-01367)	Apr-12
Reference 30 dB Attenuator	SN: S5129 (30b)	29-Mar-11 (No. 217-01370)	Apr-12
Reference Probe ER3DV6	SN: 2328	11-Oct-11 (No. ER3-2328_Oct11)	Oct-12
DAE4	SN: 789	6-Apr-11 (No. DAE4-789_Apr11)	Apr-12
Secondary Standards	ID	Check Date (in house)	Scheduled Check
RF generator HP 8648C	US3642U01700	4-Aug-99 (in house check Apr-11)	In house check: Apr-13
Network Analyzer HP 8753E	US37390585	18-Oct-01 (in house check Oct-11)	In house check: Oct-12

Calibrated by: **Dirce Iliev** (Name), **Laboratory Technician** (Function), *[Signature]* (Signature)

Approved by: **Katja Pokovic** (Name), **Technical Manager** (Function), *[Signature]* (Signature)

Issued: January 25, 2012

This calibration certificate shall not be reproduced except in full without written approval of the laboratory.

FCC ID: ZNFUS730	PCTEST ENGINEERING LABORATORY, INC.	HAC (RF EMISSIONS) TEST REPORT	LG	Reviewed by: Quality Manager
HAC Filename: OY1207090916.ZNF	Test Dates: July 10-12, 2012	EUT Type: Portable Handset		Page 40 of 81





Accredited by the Swiss Accreditation Service (SAS)  
The Swiss Accreditation Service is one of the signatories to the EA  
Multilateral Agreement for the recognition of calibration certificates

Accreditation No.: SCS 108

**Glossary:**

NORM <sub>x,y,z</sub>	sensitivity in free space
DCP	diode compression point
CF	crest factor (1/duty_cycle) of the RF signal
A, B, C	modulation dependent linearization parameters
Polarization $\varphi$	$\varphi$ rotation around probe axis
Polarization $\vartheta$	$\vartheta$ rotation around an axis that is in the plane normal to probe axis (at measurement center), i.e., $\vartheta = 0$ is normal to probe axis
Connector Angle	information used in DASY system to align probe sensor X to the robot coordinate system

**Calibration is Performed According to the Following Standards:**

- a) IEEE Std 1309-2005, "IEEE Standard for calibration of electromagnetic field sensors and probes, excluding antennas, from 9 kHz to 40 GHz", December 2005.

**Methods Applied and Interpretation of Parameters:**

- *NORM<sub>x,y,z</sub>*: Assessed for E-field polarization  $\vartheta = 0$  for XY sensors and  $\vartheta = 90$  for Z sensor ( $f \leq 900$  MHz in TEM-cell;  $f > 1800$  MHz: R22 waveguide).
- *NORM(f)<sub>x,y,z</sub>* = *NORM<sub>x,y,z</sub>* \* *frequency\_response* (see Frequency Response Chart).
- *DCP<sub>x,y,z</sub>*: DCP are numerical linearization parameters assessed based on the data of power sweep with CW signal (no uncertainty required). DCP does not depend on frequency nor media.
- *PAR*: PAR is the Peak to Average Ratio that is not calibrated but determined based on the signal characteristics
- *A<sub>x,y,z</sub>; B<sub>x,y,z</sub>; C<sub>x,y,z</sub>; VR<sub>x,y,z</sub>*: A, B, C are numerical linearization parameters assessed based on the data of power sweep for specific modulation signal. The parameters do not depend on frequency nor media. VR is the maximum calibration range expressed in RMS voltage across the diode.
- *Spherical isotropy (3D deviation from isotropy)*: in a locally homogeneous field realized using an open waveguide setup.
- *Sensor Offset*: The sensor offset corresponds to the offset of virtual measurement center from the probe tip (on probe axis). No tolerance required.
- *Connector Angle*: The angle is assessed using the information gained by determining the *NORM<sub>x</sub>* (no uncertainty required).



FCC ID: ZNFUS730	PCTEST ENGINEERING LABORATORY, INC.	HAC (RF EMISSIONS) TEST REPORT	LG	Reviewed by: Quality Manager
HAC Filename: 0Y1207090916.ZNF	Test Dates: July 10-12, 2012	EUT Type: Portable Handset		Page 41 of 81

# Probe ER3DV6

## SN:2353

Manufactured: March 8, 2005  
 Calibrated: January 20, 2012

Calibrated for DASY/EASY Systems  
 (Note: non-compatible with DASY2 system!)

<b>FCC ID:</b> ZNFUS730	 <b>PCTEST</b> ENGINEERING LABORATORY, INC.	<b>HAC (RF EMISSIONS) TEST REPORT</b>	 <b>LG</b>	<b>Reviewed by:</b> Quality Manager
<b>HAC Filename:</b> 0Y1207090916.ZNF	<b>Test Dates:</b> July 10-12, 2012	<b>EUT Type:</b> Portable Handset	Page 42 of 81	



### DASY/EASY - Parameters of Probe: ER3DV6 - SN:2353

#### Basic Calibration Parameters

	Sensor X	Sensor Y	Sensor Z	Unc (k=2)
Norm ( $\mu\text{V}/(\text{V}/\text{m})^2$ )	1.53	1.73	1.81	$\pm 10.1\%$
DCP (mV) <sup>B</sup>	100.9	98.7	102.3	

#### Modulation Calibration Parameters

UID	Communication System Name	PAR		A dB	B dB	C dB	VR mV	Unc <sup>E</sup> (k=2)
10000	CW	0.00	X	0.00	0.00	1.00	103.6	$\pm 3.0\%$
			Y	0.00	0.00	1.00	88.2	
			Z	0.00	0.00	1.00	105.7	
10011	UMTS-FDD (WCDMA)	3.40	X	3.44	65.6	18.3	111.4	$\pm 0.7\%$
			Y	3.51	65.9	18.5	130.9	
			Z	3.53	66.6	18.9	114.5	
10021	GSM-FDD (TDMA, GMSK)	9.40	X	16.75	99.3	28.2	144.6	$\pm 1.7\%$
			Y	16.85	99.3	28.8	124.1	
			Z	22.94	99.8	28.7	128.7	
10039	CDMA2000 (1xRTT, RC1)	4.57	X	4.56	66.0	18.8	112.4	$\pm 0.9\%$
			Y	4.84	67.1	19.5	133.1	
			Z	4.49	65.9	18.7	115.8	
10081	CDMA2000 (1xRTT, RC3)	3.96	X	3.68	64.9	18.0	109.1	$\pm 0.7\%$
			Y	3.89	65.9	18.7	129.0	
			Z	3.71	65.4	18.4	113.2	
10169	LTE-FDD (SC-FDMA, 1 RB, 20 MHz, QPSK)	5.73	X	5.16	67.7	20.5	145.7	$\pm 1.7\%$
			Y	5.14	67.1	20.3	124.7	
			Z	4.82	65.7	19.3	108.5	
10170	LTE-FDD (SC-FDMA, 1 RB, 20 MHz, 16-QAM)	6.52	X	6.10	69.5	21.9	146.2	$\pm 2.7\%$
			Y	6.13	69.1	21.8	125.5	
			Z	5.66	67.0	20.2	110.4	
10175	LTE-FDD (SC-FDMA, 1 RB, 10 MHz, QPSK)	5.73	X	5.13	67.6	20.5	145.7	$\pm 1.7\%$
			Y	5.15	67.1	20.3	124.9	
			Z	4.88	66.0	19.4	110.1	
10176	LTE-FDD (SC-FDMA, 1 RB, 10 MHz, 16-QAM)	6.52	X	6.12	69.6	22.0	145.7	$\pm 3.0\%$
			Y	6.12	69.2	21.9	124.6	
			Z	5.69	67.2	20.4	110.6	
10177	LTE-FDD (SC-FDMA, 1 RB, 5 MHz, QPSK)	5.73	X	5.19	67.8	20.6	145.8	$\pm 1.7\%$
			Y	5.17	67.3	20.4	124.7	
			Z	4.88	66.0	19.4	110.3	
10178	LTE-FDD (SC-FDMA, 1 RB, 5 MHz, 16-QAM)	6.52	X	6.05	69.3	21.8	146.8	$\pm 2.5\%$
			Y	5.98	68.5	21.5	123.9	
			Z	5.55	66.6	20.1	109.9	
10181	LTE-FDD (SC-FDMA, 1 RB, 15 MHz, QPSK)	5.73	X	5.17	67.8	20.6	145.9	$\pm 1.7\%$
			Y	4.92	66.1	19.7	123.5	
			Z	4.90	66.1	19.5	110.0	



FCC ID: ZNFUS730	 PCTEST ENGINEERING LABORATORY, INC.	HAC (RF EMISSIONS) TEST REPORT	 LG	Reviewed by: Quality Manager
HAC Filename: OY1207090916.ZNF	Test Dates: July 10-12, 2012	EUT Type: Portable Handset		Page 43 of 81

10182	LTE-FDD (SC-FDMA, 1 RB, 15 MHz, 16-QAM)	6.52	X	6.00	69.1	21.7	146.3	±3.0 %
			Y	6.43	70.5	22.6	125.7	
			Z	5.70	67.2	20.4	110.4	

The reported uncertainty of measurement is stated as the standard uncertainty of measurement multiplied by the coverage factor  $k=2$ , which for a normal distribution corresponds to a coverage probability of approximately 95%.

<sup>B</sup> Numerical linearization parameter: uncertainty not required.

<sup>E</sup> Uncertainty is determined using the max. deviation from linear response applying rectangular distribution and is expressed for the square of the field value.

<b>FCC ID:</b> ZNFUS730	 <b>PCTEST</b> ENGINEERING LABORATORY, INC.	<b>HAC (RF EMISSIONS) TEST REPORT</b>	 <b>LG</b>	<b>Reviewed by:</b> Quality Manager
<b>HAC Filename:</b> 0Y1207090916.ZNF	<b>Test Dates:</b> July 10-12, 2012	<b>EUT Type:</b> Portable Handset		Page 44 of 81

### Frequency Response of E-Field (TEM-Cell:ifi110 EXX, Waveguide: R22)

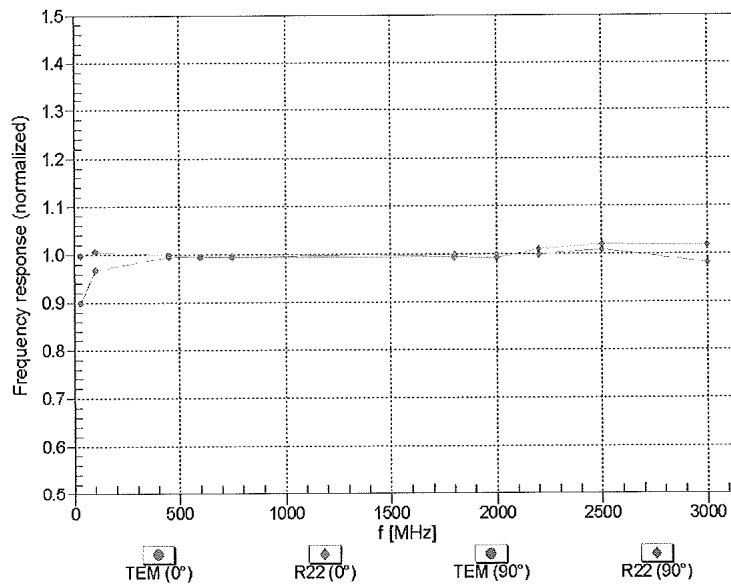

Uncertainty of Frequency Response of E-field:  $\pm 6.3\%$  (k=2)

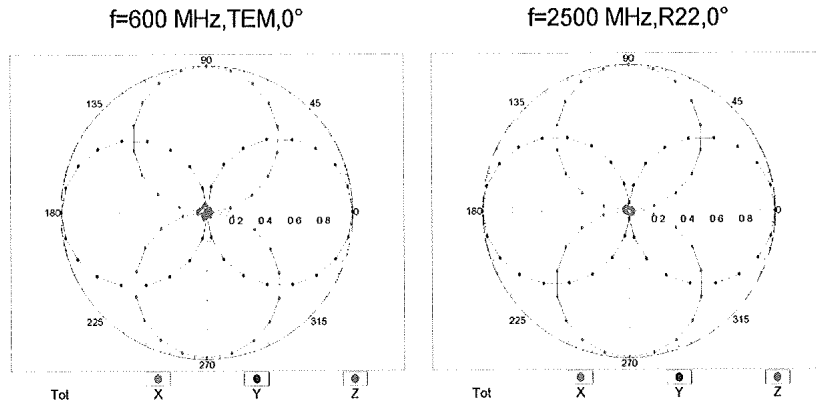

FCC ID: ZNFUS730	PCTEST ENGINEERING LABORATORY, INC.	HAC (RF EMISSIONS) TEST REPORT	LG	Reviewed by: Quality Manager
HAC Filename: 0Y1207090916.ZNF	Test Dates: July 10-12, 2012	EUT Type: Portable Handset		Page 45 of 81

### Receiving Pattern ( $\phi$ ), $\vartheta = 0^\circ$

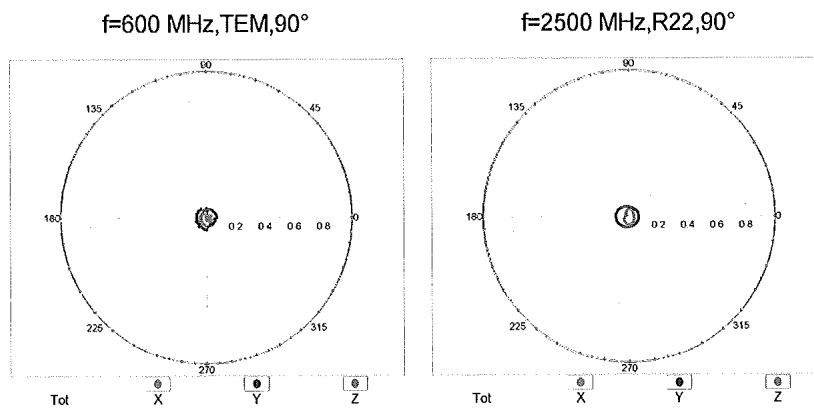

### Receiving Pattern ( $\phi$ ), $\vartheta = 90^\circ$



FCC ID: ZNFUS730		HAC (RF EMISSIONS) TEST REPORT		Reviewed by: Quality Manager
HAC Filename: 0Y1207090916.ZNF	Test Dates: July 10-12, 2012	EUT Type: Portable Handset		Page 46 of 81

### Receiving Pattern ( $\phi$ ), $\vartheta = 0^\circ$

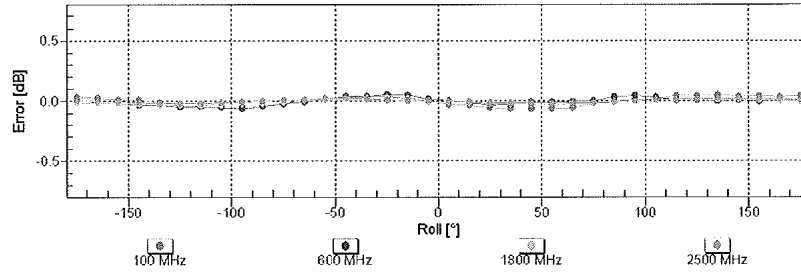

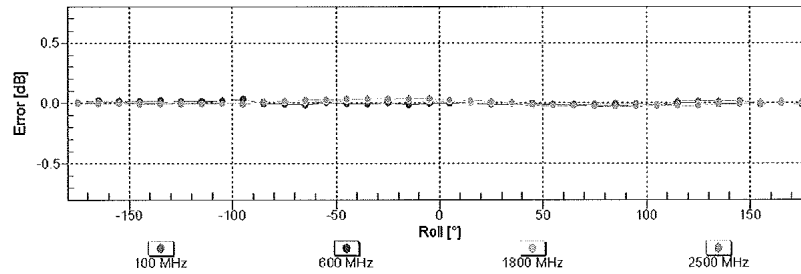

Uncertainty of Axial Isotropy Assessment:  $\pm 0.5\%$  (k=2)

### Receiving Pattern ( $\phi$ ), $\vartheta = 90^\circ$



Uncertainty of Axial Isotropy Assessment:  $\pm 0.5\%$  (k=2)

<p>FCC ID: ZNFUS730</p>		<p>HAC (RF EMISSIONS) TEST REPORT</p> 	<p>Reviewed by: Quality Manager</p>
<p>HAC Filename: OY1207090916.ZNF</p>	<p>Test Dates: July 10-12, 2012</p>	<p>EUT Type: Portable Handset</p>	<p>Page 47 of 81</p>

### Dynamic Range f(E-field) (TEM cell , f = 900 MHz)

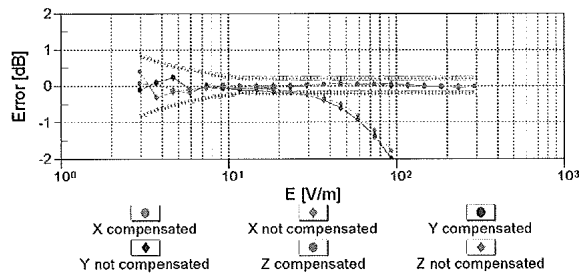
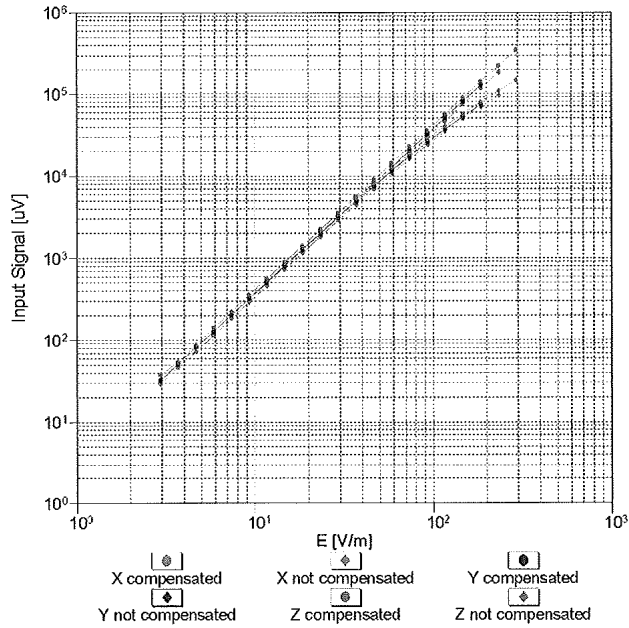

Uncertainty of Linearity Assessment: ± 0.6% (k=2)

FCC ID: ZNFUS730	PCTEST ENGINEERING LABORATORY, INC.	HAC (RF EMISSIONS) TEST REPORT	LG	Reviewed by: Quality Manager
HAC Filename: 0Y1207090916.ZNF	Test Dates: July 10-12, 2012	EUT Type: Portable Handset		Page 48 of 81



### Deviation from Isotropy in Air

Error ( $\phi, \theta$ ),  $f = 900 \text{ MHz}$

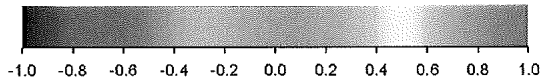
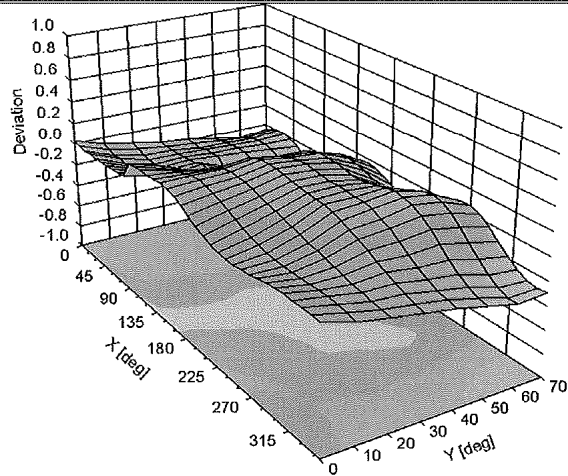



Uncertainty of Spherical Isotropy Assessment:  $\pm 2.6\%$  ( $k=2$ )

FCC ID: ZNFUS730		HAC (RF EMISSIONS) TEST REPORT		Reviewed by: Quality Manager
HAC Filename: 0Y1207090916.ZNF	Test Dates: July 10-12, 2012	EUT Type: Portable Handset	Page 49 of 81	

## DASY/EASY - Parameters of Probe: ER3DV6 - SN:2353

### Other Probe Parameters

Sensor Arrangement	Rectangular
Connector Angle (°)	-4.9
Mechanical Surface Detection Mode	enabled
Optical Surface Detection Mode	disabled
Probe Overall Length	337 mm
Probe Body Diameter	10 mm
Tip Length	10 mm
Tip Diameter	8 mm
Probe Tip to Sensor X Calibration Point	2.5 mm
Probe Tip to Sensor Y Calibration Point	2.5 mm
Probe Tip to Sensor Z Calibration Point	2.5 mm

<b>FCC ID:</b> ZNFUS730	 <b>PCTEST</b> ENGINEERING LABORATORY, INC.	<b>HAC (RF EMISSIONS) TEST REPORT</b>	 <b>LG</b>	<b>Reviewed by:</b> Quality Manager
<b>HAC Filename:</b> 0Y1207090916.ZNF	<b>Test Dates:</b> July 10-12, 2012	<b>EUT Type:</b> Portable Handset	Page 50 of 81	



Accredited by the Swiss Accreditation Service (SAS)  
The Swiss Accreditation Service is one of the signatories to the EA  
Multilateral Agreement for the recognition of calibration certificates

Accreditation No.: SCS 108

Client **PC Test**

Certificate No: **H3-6207\_Jan12**

### CALIBRATION CERTIFICATE

Object: **H3DV6 - SN:6207**

Calibration procedure(s): **QA CAL-03.v6, QA CAL-25.v4  
Calibration procedure for H-field probes optimized for close near field evaluations in air**

Calibration date: **January 20, 2012** ✓ KOK 2/6/12

This calibration certificate documents the traceability to national standards, which realize the physical units of measurements (SI). The measurements and the uncertainties with confidence probability are given on the following pages and are part of the certificate.

All calibrations have been conducted in the closed laboratory facility: environment temperature (22 ± 3)°C and humidity < 70%.

Calibration Equipment used (M&TE critical for calibration)

Primary Standards	ID	Cal Date (Certificate No.)	Scheduled Calibration
Power meter E4419B	GB41293874	31-Mar-11 (No. 217-01372)	Apr-12
Power sensor E4412A	MY41498087	31-Mar-11 (No. 217-01372)	Apr-12
Reference 3 dB Attenuator	SN: S5054 (3c)	29-Mar-11 (No. 217-01369)	Apr-12
Reference 20 dB Attenuator	SN: S5086 (20b)	29-Mar-11 (No. 217-01367)	Apr-12
Reference 30 dB Attenuator	SN: S5129 (30b)	29-Mar-11 (No. 217-01370)	Apr-12
Reference Probe H3DV6	SN: 6182	11-Oct-11 (No. H3-6182_Oct11)	Oct-12
DAE4	SN: 789	6-Apr-11 (No. DAE4-789_Apr11)	Apr-12
Secondary Standards	ID	Check Date (in house)	Scheduled Check
RF generator HP 8648C	US3642U01700	4-Aug-99 (in house check Apr-11)	In house check: Apr-13
Network Analyzer HP 8753E	US37390585	18-Oct-01 (in house check Oct-11)	In house check: Oct-12

Calibrated by: **Dimce Iliev** (Name), **Laboratory Technician** (Function), *[Signature]* (Signature)

Approved by: **Katja Pokovic** (Name), **Technical Manager** (Function), *[Signature]* (Signature)

Issued: January 25, 2012

This calibration certificate shall not be reproduced except in full without written approval of the laboratory.

FCC ID: ZNFUS730	PCTEST ENGINEERING LABORATORY, INC.	HAC (RF EMISSIONS) TEST REPORT	LG	Reviewed by: Quality Manager
HAC Filename: OY1207090916.ZNF	Test Dates: July 10-12, 2012	EUT Type: Portable Handset		Page 51 of 81



Accredited by the Swiss Accreditation Service (SAS)  
The Swiss Accreditation Service is one of the signatories to the EA  
Multilateral Agreement for the recognition of calibration certificates

Accreditation No.: SCS 108

**Glossary:**

NORM <sub>x,y,z</sub>	sensitivity in free space
DCP	diode compression point
CF	crest factor (1/duty_cycle) of the RF signal
A, B, C	modulation dependent linearization parameters
Polarization $\varphi$	$\varphi$ rotation around probe axis
Polarization $\vartheta$	$\vartheta$ rotation around an axis that is in the plane normal to probe axis (at measurement center), i.e., $\vartheta = 0$ is normal to probe axis
Connector Angle	information used in DASYS system to align probe sensor X to the robot coordinate system

**Calibration is Performed According to the Following Standards:**

- a) IEEE Std 1309-2005, "IEEE Standard for calibration of electromagnetic field sensors and probes, excluding antennas, from 9 kHz to 40 GHz", December 2005.

**Methods Applied and Interpretation of Parameters:**

- NORM<sub>x,y,z</sub>: Assessed for E-field polarization  $\vartheta = 0$  for XY sensors and  $\vartheta = 90$  for Z sensor ( $f \leq 900$  MHz in TEM-cell;  $f > 1800$  MHz: R22 waveguide).
- X,Y,Z(f)\_a0a1a2 = X,Y,Z\_a0a1a2\* frequency\_response (see Frequency Response Chart).
- DCP<sub>x,y,z</sub>: DCP are numerical linearization parameters assessed based on the data of power sweep with CW signal (no uncertainty required). DCP does not depend on frequency nor media.
- PAR: PAR is the Peak to Average Ratio that is not calibrated but determined based on the signal characteristics
- Ax,y,z; Bx,y,z; Cx,y,z, VRx,y,z: A, B, C are numerical linearization parameters assessed based on the data of power sweep for specific modulation signal. The parameters do not depend on frequency nor media. VR is the maximum calibration range expressed in RMS voltage across the diode.
- Spherical isotropy (3D deviation from isotropy): in a locally homogeneous field realized using an open waveguide setup.
- Sensor Offset: The sensor offset corresponds to the offset of virtual measurement center from the probe tip (on probe axis). No tolerance required.
- Connector Angle: The angle is assessed using the information gained by determining the X\_a0a1a2 (no uncertainty required).

FCC ID: ZNFUS730	PCTEST ENGINEERING LABORATORY, INC.	HAC (RF EMISSIONS) TEST REPORT	LG	Reviewed by: Quality Manager
HAC Filename: 0Y1207090916.ZNF	Test Dates: July 10-12, 2012	EUT Type: Portable Handset		Page 52 of 81



---

# Probe H3DV6

## SN:6207

Manufactured: June 12, 2006  
Calibrated: January 20, 2012

Calibrated for DASY/EASY Systems  
(Note: non-compatible with DASY2 system!)

<b>FCC ID:</b> ZNFUS730	 <b>PCTEST</b> ENGINEERING LABORATORY, INC.	<b>HAC (RF EMISSIONS) TEST REPORT</b>	 <b>LG</b>	<b>Reviewed by:</b> Quality Manager
<b>HAC Filename:</b> 0Y1207090916.ZNF	<b>Test Dates:</b> July 10-12, 2012	<b>EUT Type:</b> Portable Handset	Page 53 of 81	

**DASY/EASY - Parameters of Probe: H3DV6 - SN:6207****Basic Calibration Parameters**

		Sensor X	Sensor Y	Sensor Z	Unc (k=2)
Norm (A/m / $\sqrt{\text{mV}}$ )	a0	2.41E-003	2.37E-003	2.94E-003	$\pm 5.1 \%$
Norm (A/m / $\sqrt{\text{mV}}$ )	a1	1.77E-004	6.07E-004	8.69E-005	$\pm 5.1 \%$
Norm (A/m / $\sqrt{\text{mV}}$ )	a2	1.63E-004	2.45E-004	1.96E-004	$\pm 5.1 \%$
DCP (mV) <sup>B</sup>		94.0	94.6	94.5	



**Modulation Calibration Parameters**

UID	Communication System Name	PAR		A dB	B dB	C dB	VR mV	Unc <sup>E</sup> (k=2)
10000	CW	0.00	X	0.00	0.00	1.00	92.5	$\pm 2.7 \%$
			Y	0.00	0.00	1.00	107.4	
			Z	0.00	0.00	1.00	119.1	

The reported uncertainty of measurement is stated as the standard uncertainty of measurement multiplied by the coverage factor k=2, which for a normal distribution corresponds to a coverage probability of approximately 95%.

<sup>B</sup> Numerical linearization parameter: uncertainty not required.



<sup>E</sup> Uncertainty is determined using the max. deviation from linear response applying rectangular distribution and is expressed for the square of the field value.

FCC ID: ZNFUS730		HAC (RF EMISSIONS) TEST REPORT		Reviewed by: Quality Manager
HAC Filename: 0Y1207090916.ZNF	Test Dates: July 10-12, 2012	EUT Type: Portable Handset		Page 54 of 81

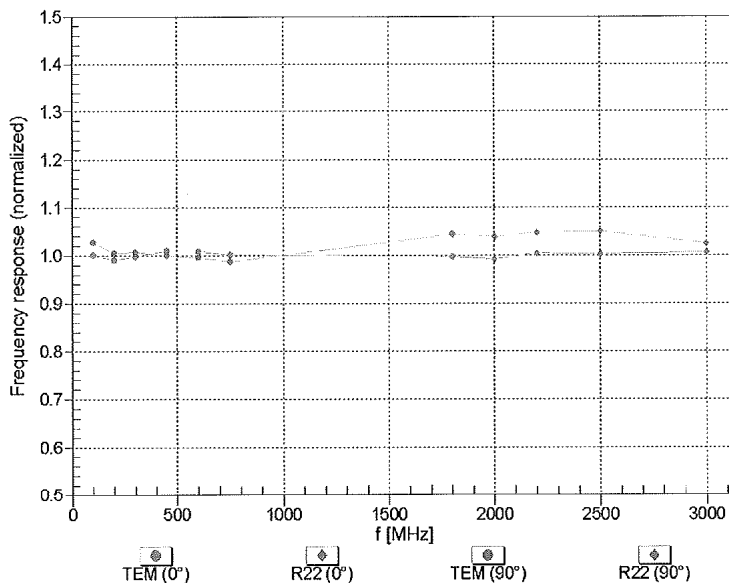
### Frequency Response of H-Field (TEM-Cell:ifi110 EXX, Waveguide: R22)



Uncertainty of Frequency Response of H-field:  $\pm 6.3\%$  (k=2)

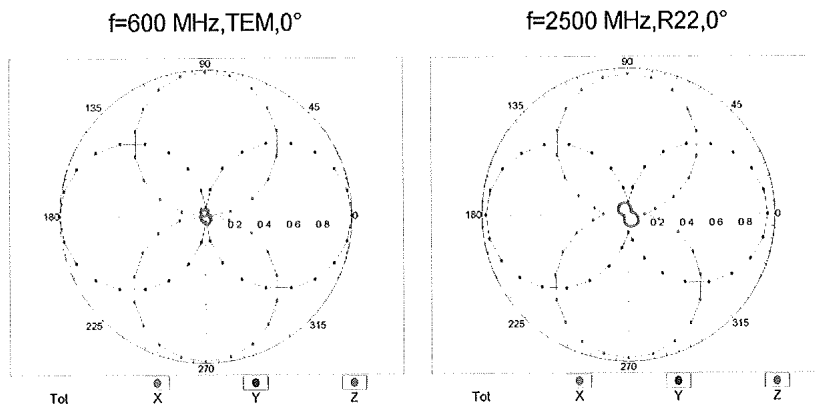

<b>FCC ID:</b> ZNFUS730		<b>HAC (RF EMISSIONS) TEST REPORT</b>	 <b>Reviewed by:</b> Quality Manager
<b>HAC Filename:</b> OY1207090916.ZNF	<b>Test Dates:</b> July 10-12, 2012	<b>EUT Type:</b> Portable Handset	Page 55 of 81

### Receiving Pattern ( $\phi$ ), $\vartheta = 0^\circ$

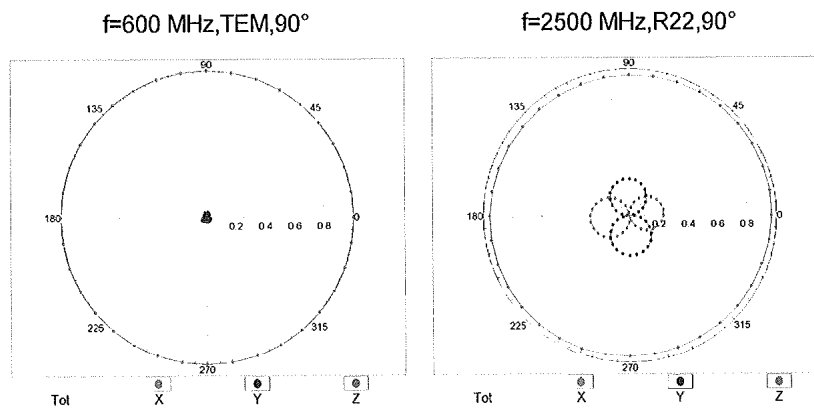

### Receiving Pattern ( $\phi$ ), $\vartheta = 90^\circ$



FCC ID: ZNFUS730	 PCTEST ENGINEERING LABORATORY, INC.	HAC (RF EMISSIONS) TEST REPORT	 LG	Reviewed by: Quality Manager
HAC Filename: 0Y1207090916.ZNF	Test Dates: July 10-12, 2012	EUT Type: Portable Handset		Page 56 of 81



### Receiving Pattern ( $\phi$ ), $\vartheta = 0^\circ$

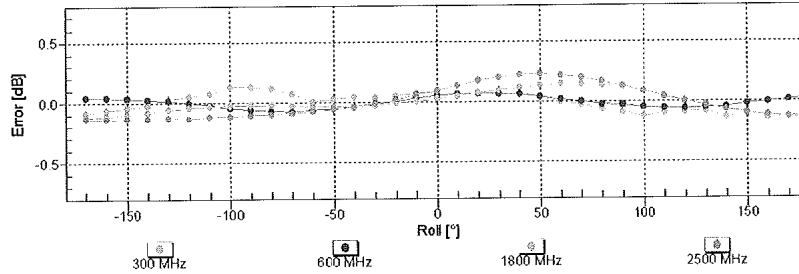

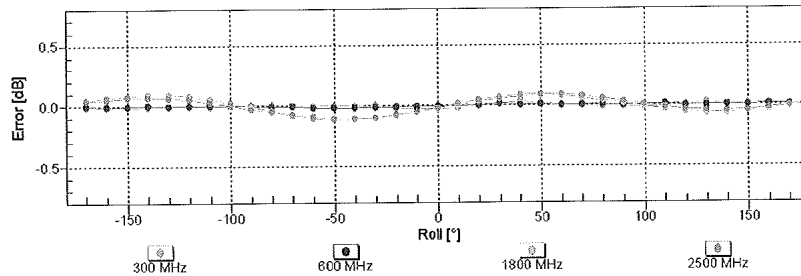

Uncertainty of Axial Isotropy Assessment:  $\pm 0.5\%$  (k=2)

### Receiving Pattern ( $\phi$ ), $\vartheta = 90^\circ$



Uncertainty of Axial Isotropy Assessment:  $\pm 0.5\%$  (k=2)

<p>FCC ID: ZNFUS730</p>		<p>HAC (RF EMISSIONS) TEST REPORT</p> 	<p>Reviewed by: Quality Manager</p>
<p>HAC Filename: OY1207090916.ZNF</p>	<p>Test Dates: July 10-12, 2012</p>	<p>EUT Type: Portable Handset</p>	<p>Page 57 of 81</p>

### Dynamic Range f(H-field) (TEM cell, f = 900 MHz)

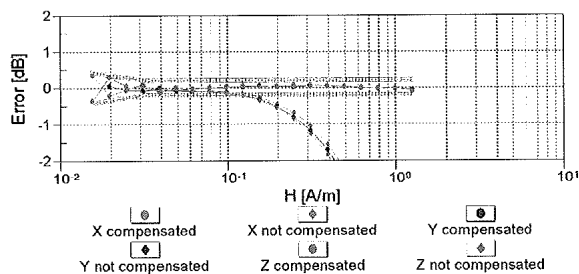
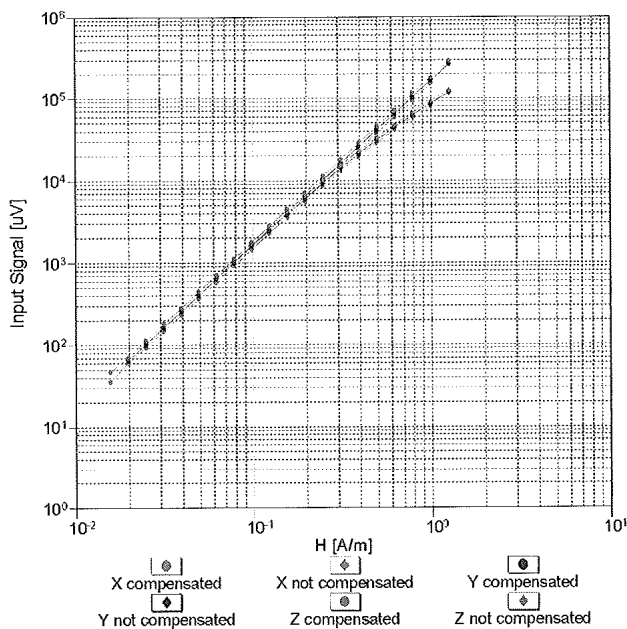

Uncertainty of Linearity Assessment: ± 0.6% (k=2)

FCC ID: ZNFUS730	PCTEST ENGINEERING LABORATORY, INC.	HAC (RF EMISSIONS) TEST REPORT	LG	Reviewed by: Quality Manager
HAC Filename: 0Y1207090916.ZNF	Test Dates: July 10-12, 2012	EUT Type: Portable Handset		Page 58 of 81

### Deviation from Isotropy in Air

Error ( $\phi, \theta$ ),  $f = 900$  MHz

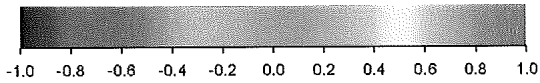
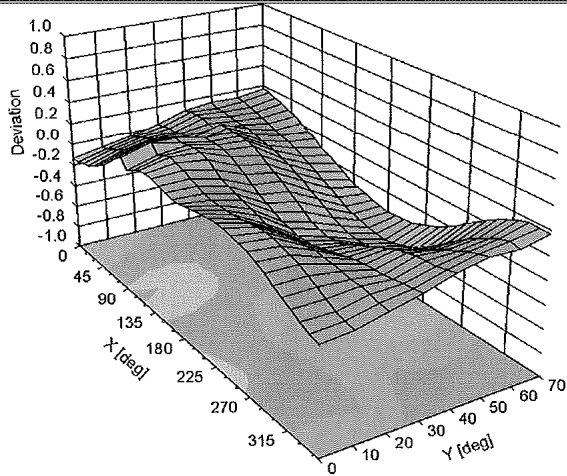



Uncertainty of Spherical Isotropy Assessment:  $\pm 2.6\%$  ( $k=2$ )

<b>FCC ID:</b> ZNFUS730		<b>HAC (RF EMISSIONS) TEST REPORT</b>		<b>Reviewed by:</b> Quality Manager
<b>HAC Filename:</b> 0Y1207090916.ZNF	<b>Test Dates:</b> July 10-12, 2012	<b>EUT Type:</b> Portable Handset	Page 59 of 81	

## DASY/EASY - Parameters of Probe: H3DV6 - SN:6207

### Other Probe Parameters

Sensor Arrangement	Rectangular
Connector Angle (°)	179.8
Mechanical Surface Detection Mode	enabled
Optical Surface Detection Mode	disabled
Probe Overall Length	337 mm
Probe Body Diameter	10 mm
Tip Length	20 mm
Tip Diameter	6 mm
Probe Tip to Sensor X Calibration Point	3 mm
Probe Tip to Sensor Y Calibration Point	3 mm
Probe Tip to Sensor Z Calibration Point	3 mm

<b>FCC ID:</b> ZNFUS730	 <b>PCTEST</b> ENGINEERING LABORATORY, INC.	<b>HAC (RF EMISSIONS) TEST REPORT</b>	 <b>LG</b>	<b>Reviewed by:</b> Quality Manager
<b>HAC Filename:</b> 0Y1207090916.ZNF	<b>Test Dates:</b> July 10-12, 2012	<b>EUT Type:</b> Portable Handset	Page 60 of 81	

**Calibration Laboratory of  
Schmid & Partner  
Engineering AG**  
Zeughausstrasse 43, 8004 Zurich, Switzerland



**S** Schweizerischer Kalibrierdienst  
**C** Service suisse d'étalonnage  
**S** Servizio svizzero di taratura  
**S** Swiss Calibration Service

Accredited by the Swiss Accreditation Service (SAS)  
The Swiss Accreditation Service is one of the signatories to the EA  
Multilateral Agreement for the recognition of calibration certificates

Accreditation No.: **SCS 108**

Client **PC Test**

Certificate No: **CD835V3-1003\_Feb11**

<b>CALIBRATION CERTIFICATE</b>																																																			
Object	CD835V3 - SN: 1003																																																		
Calibration procedure(s)	QA CAL-20.v5 Calibration procedure for dipoles in air																																																		
Calibration date:	February 08, 2011																																																		
<p>This calibration certificate documents the traceability to national standards, which realize the physical units of measurements (SI). All calibrations have been conducted in the closed laboratory facility: environment temperature (22 ± 3)°C and humidity &lt; 70%.</p> <p>Calibration Equipment used (M&amp;TE critical for calibration)</p> <table border="1"> <thead> <tr> <th>Primary Standards</th> <th>ID #</th> <th>Cal Date (Certificate No.)</th> <th>Scheduled Calibration</th> </tr> </thead> <tbody> <tr> <td>Power meter EPM-442A</td> <td>GB37480704</td> <td>06-Oct-10 (No. 217-01266)</td> <td>Oct-11</td> </tr> <tr> <td>Power sensor HP 8481A</td> <td>US37292783</td> <td>06-Oct-10 (No. 217-01266)</td> <td>Oct-11</td> </tr> <tr> <td>Probe ER3DV6</td> <td>SN: 2336</td> <td>29-Dec-10 (No. ER3-2336_Dec10)</td> <td>Dec-11</td> </tr> <tr> <td>Probe H3DV6</td> <td>SN: 6065</td> <td>29-Dec-10 (No. H3-6065_Dec10)</td> <td>Dec-11</td> </tr> <tr> <td>DAE4</td> <td>SN: 781</td> <td>20-Oct-10 (No. DAE4-781_Oct10)</td> <td>Oct-11</td> </tr> </tbody> </table> <table border="1"> <thead> <tr> <th>Secondary Standards</th> <th>ID #</th> <th>Check Date (in house)</th> <th>Scheduled Check</th> </tr> </thead> <tbody> <tr> <td>Power meter Agilent 4419B</td> <td>SN: GB42420191</td> <td>09-Oct-09 (in house check Oct-10)</td> <td>In house check: Oct-11</td> </tr> <tr> <td>Power sensor HP 8482H</td> <td>SN: 3318A09450</td> <td>09-Oct-09 (in house check Oct-10)</td> <td>In house check: Oct-11</td> </tr> <tr> <td>Power sensor HP 8482A</td> <td>SN: US37295597</td> <td>09-Oct-09 (in house check Oct-10)</td> <td>In house check: Oct-11</td> </tr> <tr> <td>Network Analyzer HP 8753E</td> <td>US37390585</td> <td>18-Oct-01 (in house check Oct-10)</td> <td>In house check: Oct-11</td> </tr> <tr> <td>RF generator E4433B</td> <td>MY 41000675</td> <td>03-Nov-04 (in house check Oct-09)</td> <td>In house check: Oct-11</td> </tr> </tbody> </table>				Primary Standards	ID #	Cal Date (Certificate No.)	Scheduled Calibration	Power meter EPM-442A	GB37480704	06-Oct-10 (No. 217-01266)	Oct-11	Power sensor HP 8481A	US37292783	06-Oct-10 (No. 217-01266)	Oct-11	Probe ER3DV6	SN: 2336	29-Dec-10 (No. ER3-2336_Dec10)	Dec-11	Probe H3DV6	SN: 6065	29-Dec-10 (No. H3-6065_Dec10)	Dec-11	DAE4	SN: 781	20-Oct-10 (No. DAE4-781_Oct10)	Oct-11	Secondary Standards	ID #	Check Date (in house)	Scheduled Check	Power meter Agilent 4419B	SN: GB42420191	09-Oct-09 (in house check Oct-10)	In house check: Oct-11	Power sensor HP 8482H	SN: 3318A09450	09-Oct-09 (in house check Oct-10)	In house check: Oct-11	Power sensor HP 8482A	SN: US37295597	09-Oct-09 (in house check Oct-10)	In house check: Oct-11	Network Analyzer HP 8753E	US37390585	18-Oct-01 (in house check Oct-10)	In house check: Oct-11	RF generator E4433B	MY 41000675	03-Nov-04 (in house check Oct-09)	In house check: Oct-11
Primary Standards	ID #	Cal Date (Certificate No.)	Scheduled Calibration																																																
Power meter EPM-442A	GB37480704	06-Oct-10 (No. 217-01266)	Oct-11																																																
Power sensor HP 8481A	US37292783	06-Oct-10 (No. 217-01266)	Oct-11																																																
Probe ER3DV6	SN: 2336	29-Dec-10 (No. ER3-2336_Dec10)	Dec-11																																																
Probe H3DV6	SN: 6065	29-Dec-10 (No. H3-6065_Dec10)	Dec-11																																																
DAE4	SN: 781	20-Oct-10 (No. DAE4-781_Oct10)	Oct-11																																																
Secondary Standards	ID #	Check Date (in house)	Scheduled Check																																																
Power meter Agilent 4419B	SN: GB42420191	09-Oct-09 (in house check Oct-10)	In house check: Oct-11																																																
Power sensor HP 8482H	SN: 3318A09450	09-Oct-09 (in house check Oct-10)	In house check: Oct-11																																																
Power sensor HP 8482A	SN: US37295597	09-Oct-09 (in house check Oct-10)	In house check: Oct-11																																																
Network Analyzer HP 8753E	US37390585	18-Oct-01 (in house check Oct-10)	In house check: Oct-11																																																
RF generator E4433B	MY 41000675	03-Nov-04 (in house check Oct-09)	In house check: Oct-11																																																
Calibrated by:	Name Claudio Leubler	Function Laboratory Technician	Signature 																																																
Approved by:	Name Katja Pokovic	Function Technical Manager	Signature 																																																
			Issued: February 10, 2011																																																
This calibration certificate shall not be reproduced except in full without written approval of the laboratory.																																																			

✓  
KOK  
2/12/11

Certificate No: CD835V3-1003\_Feb11

Page 1 of 6

FCC ID: ZNFUS730	PCTEST ENGINEERING LABORATORY, INC.	HAC (RF EMISSIONS) TEST REPORT	LG	Reviewed by: Quality Manager
HAC Filename: OY1207090916.ZNF	Test Dates: July 10-12, 2012	EUT Type: Portable Handset		Page 61 of 81



Accredited by the Swiss Accreditation Service (SAS)  
The Swiss Accreditation Service is one of the signatories to the EA  
Multilateral Agreement for the recognition of calibration certificates

Accreditation No.: SCS 108

**References**

- [1] ANSI-C63.19-2006  
American National Standard for Methods of Measurement of Compatibility between Wireless Communications Devices and Hearing Aids.
- [2] ANSI-C63.19-2007  
American National Standard for Methods of Measurement of Compatibility between Wireless Communications Devices and Hearing Aids.

**Methods Applied and Interpretation of Parameters:**

- *Coordinate System:* y-axis is in the direction of the dipole arms. z-axis is from the basis of the antenna (mounted on the table) towards its feed point between the two dipole arms. x-axis is normal to the other axes. In coincidence with the standards [1, 2], the measurement planes (probe sensor center) are selected to be at a distance of 10 mm above the top edge of the dipole arms.
- *Measurement Conditions:* Further details are available from the hardcopies at the end of the certificate. All figures stated in the certificate are valid at the frequency indicated. The forward power to the dipole connector is set with a calibrated power meter connected and monitored with an auxiliary power meter connected to a directional coupler. While the dipole under test is connected, the forward power is adjusted to the same level.
- *Antenna Positioning:* The dipole is mounted on a HAC Test Arch phantom using the matching dipole positioner with the arms horizontal and the feeding cable coming from the floor. The measurements are performed in a shielded room with absorbers around the setup to reduce the reflections. It is verified before the mounting of the dipole under the Test Arch phantom, that its arms are perfectly in a line. It is installed on the HAC dipole positioner with its arms parallel below the dielectric reference wire and able to move elastically in vertical direction without changing its relative position to the top center of the Test Arch phantom. The vertical distance to the probe is adjusted after dipole mounting with a DASY5 Surface Check job. Before the measurement, the distance between phantom surface and probe tip is verified. The proper measurement distance is selected by choosing the matching section of the HAC Test Arch phantom with the proper device reference point (upper surface of the dipole) and the matching grid reference point (tip of the probe) considering the probe sensor offset. The vertical distance to the probe is essential for the accuracy.
- *Feed Point Impedance and Return Loss:* These parameters are measured using a HP 8753E Vector Network Analyzer. The impedance is specified at the SMA connector of the dipole. The influence of reflections was eliminating by applying the averaging function while moving the dipole in the air, at least 70cm away from any obstacles.
- *E- field distribution:* E field is measured in the x-y-plane with an isotropic ER3D-field probe with 100 mW forward power to the antenna feed point. In accordance with [1, 2], the scan area is 20mm wide, its length exceeds the dipole arm length (180 or 90mm). The sensor center is 10 mm (in z) above the top of the dipole arms. Two 3D maxima are available near the end of the dipole arms. Assuming the dipole arms are perfectly in one line, the average of these two maxima (in subgrid 2 and subgrid 8) is determined to compensate for any non-parallelity to the measurement plane as well as the sensor displacement. The E-field value stated as calibration value represents the maximum of the interpolated 3D-E-field, 10mm above the dipole surface.
- *H-field distribution:* H-field is measured with an isotropic H-field probe with 100mW forward power to the antenna feed point, in the x-y-plane. The scan area and sensor distance is equivalent to the E-field scan. The maximum of the field is available at the center (subgrid 5) above the feed point. The H-field value stated as calibration value represents the maximum of the interpolated H-field, 10mm above the dipole surface at the feed point.

FCC ID: ZNFUS730	PCTEST ENGINEERING LABORATORY, INC.	HAC (RF EMISSIONS) TEST REPORT	LG	Reviewed by: Quality Manager
HAC Filename: 0Y1207090916.ZNF	Test Dates: July 10-12, 2012	EUT Type: Portable Handset		Page 62 of 81

## 1 Measurement Conditions

DASY system configuration, as far as not given on page 1.

<b>DASY Version</b>	DASY5	V52.6.1 (408)
<b>DASY PP Version</b>	SEMCAD X	V14.4.2 (2595)
<b>Phantom</b>	HAC Test Arch	SD HAC P01 BA, #1070
<b>Distance Dipole Top - Probe Center</b>	10 mm	
<b>Scan resolution</b>	dx, dy = 5 mm	area = 20 x 180 mm
<b>Frequency</b>	<b>835 MHz ± 1 MHz</b>	
<b>Forward power at dipole connector</b>	20.0 dBm = 100mW	
<b>Input power drift</b>	< 0.05 dB	

## 2 Maximum Field values

H-field 10 mm above dipole surface	condition	interpolated maximum
Maximum measured	100 mW forward power	<b>0.458 A/m</b>

Uncertainty for H-field measurement: 8.2% (k=2)

E-field 10 mm above dipole surface	condition	Interpolated maximum
Maximum measured above high end-	100 mW forward power	170.7 V/m
Maximum measured above low end	100 mW forward power	161.3 V/m
Averaged maximum above arm	100 mW forward power	<b>166.0 V/m</b>

Uncertainty for E-field measurement: 12.8% (k=2)

## 3 Appendix

### 3.1 Antenna Parameters

Frequency	Return Loss	Impedance
800 MHz	16.6 dB	( 41.9 – j11.1 ) Ohm
<b>835 MHz</b>	<b>24.1 dB</b>	<b>( 48.2 + j5.9 ) Ohm</b>
900 MHz	16.5 dB	( 58.5 – j14.0 ) Ohm
950 MHz	17.9 dB	( 49.3 + j12.8 ) Ohm
960 MHz	12.9 dB	( 62.2 + j22.8 ) Ohm



### 3.2 Antenna Design and Handling

The calibration dipole has a symmetric geometry with a built-in two stub matching network, which leads to the enhanced bandwidth.

The dipole is built of standard semirigid coaxial cable. The internal matching line is open ended. The antenna is therefore open for DC signals.

Do not apply force to dipole arms, as they are liable to bend. The soldered connections near the feedpoint may be damaged. After excessive mechanical stress or overheating, check the impedance characteristics to ensure that the internal matching network is not affected.



After long term use with 40W radiated power, only a slight warming of the dipole near the feedpoint can be measured.

<b>FCC ID:</b> ZNFUS730	 <b>PCTEST</b> ENGINEERING LABORATORY, INC.	<b>HAC (RF EMISSIONS) TEST REPORT</b>		<b>Reviewed by:</b> Quality Manager
<b>HAC Filename:</b> 0Y1207090916.ZNF	<b>Test Dates:</b> July 10-12, 2012	<b>EUT Type:</b> Portable Handset		Page 63 of 81

### 3.3 Measurement Sheets

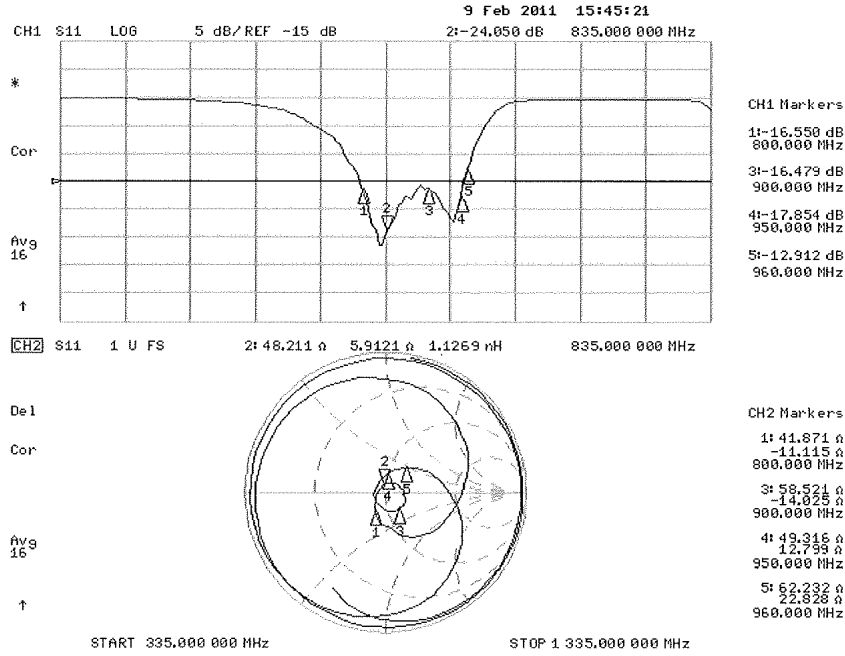
#### 3.3.1 Return Loss and Smith Chart



FCC ID: ZNFUS730	 PCTEST ENGINEERING LABORATORY, INC.	HAC (RF EMISSIONS) TEST REPORT	 LG	Reviewed by: Quality Manager
HAC Filename: 0Y1207090916.ZNF	Test Dates: July 10-12, 2012	EUT Type: Portable Handset		Page 64 of 81



**3.3.3 DASY4 H-field Result**

Date/Time: 08.02.2011 13:00:11

Test Laboratory: SPEAG Lab2

**HAC RF\_CD835\_1003\_H\_110208\_CL**

**DUT: HAC-Dipole 835 MHz; Type: CD835V3; Serial: 1003**

Communication System: CW; Frequency: 835 MHz  
 Medium parameters used:  $\sigma = 0$  mho/m,  $\epsilon_r = 1$ ;  $\rho = 1$  kg/m<sup>3</sup>  
 Phantom section: RF Section  
 Measurement Standard: DASY5 (IEBEE/IEC/ANSI C63.19-2007)

DASY5 Configuration:

- Probe: H3DV6 - SN6065; ; Calibrated: 29.12.2010
- Sensor-Surface: (Fix Surface)
- Electronics: DAE4 Sn781; Calibrated: 20.10.2010
- Phantom: HAC Test Arch with AMCC; Type: SD HAC P01 BA; Serial: 1070
- Measurement SW: DASY52, V52.6.1 Build (408)
- Postprocessing SW: SEMCAD X, V14.4.2 Build (2595)

**Dipole H-Field measurement @ 835MHz/H Scan - measurement distance from the probe sensor center to CD835**

**Dipole = 10mm/Hearing Aid Compatibility Test (41x361x1):**



Measurement grid: dx=5mm, dy=5mm  
 Maximum value of peak Total field = 0.458 A/m  
 Probe Modulation Factor = 1.000  
 Device Reference Point: 0, 0, -6.3 mm  
 Reference Value = 0.488 A/m; Power Drift = -0.0088 dB  
**Hearing Aid Near-Field Category: M4 (AWF 0 dB)**

Peak H-field in A/m

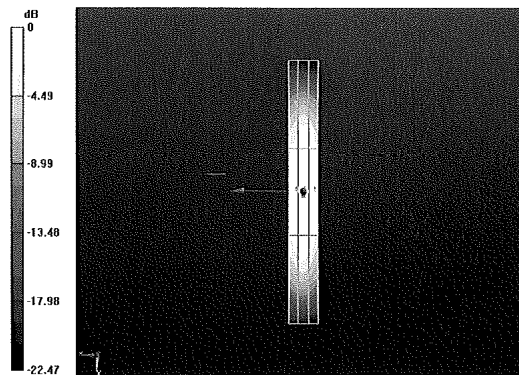
Grid 1 <b>0.376</b> M4	Grid 2 <b>0.398</b> M4	Grid 3 <b>0.379</b> M4
Grid 4 <b>0.435</b> M4	Grid 5 <b>0.458</b> M4	Grid 6 <b>0.434</b> M4
Grid 7 <b>0.388</b> M4	Grid 8 <b>0.407</b> M4	Grid 9 <b>0.381</b> M4



0 dB = 0.460A/m

FCC ID: ZNFUS730	 <b>PCTEST</b> ENGINEERING LABORATORY, INC.	<b>HAC (RF EMISSIONS) TEST REPORT</b>		<b>Reviewed by:</b> Quality Manager
<b>HAC Filename:</b> OY1207090916.ZNF	<b>Test Dates:</b> July 10-12, 2012	<b>EUT Type:</b> Portable Handset	Page 65 of 81	

**3.3.2 DASY4 E-field Result**

Date/Time: 08.02.2011 13:58:56

Test Laboratory: SPEAG Lab2

**HAC RF\_CD835\_1003\_E\_110208\_CL**

**DUT: HAC-Dipole 835 MHz; Type: CD835V3; Serial: 1003**

Communication System: CW; Frequency: 835 MHz

Medium parameters used:  $\sigma = 0$  mho/m,  $\epsilon_r = 1$ ;  $\rho = 1000$  kg/m<sup>3</sup>

Phantom section: RF Section

Measurement Standard: DASY5 (IEEE/IEC/ANSI C63.19-2007)

DASY5 Configuration:

- Probe: ER3DV6 - SN2336; ConvF(1, 1, 1); Calibrated: 29.12.2010
- Sensor-Surface: (Fix Surface)
- Electronics: DAE4 Sn781; Calibrated: 20.10.2010
- Phantom: HAC Test Arch with AMCC; Type: SD HAC P01 BA; Serial: 1070
- Measurement SW: DASY52, V52.6.1 Build (408)
- Postprocessing SW: SEMCAD X, V14.4.2 Build (2595)

**Dipole E-Field measurement @ 835MHz/E Scan - measurement distance from the probe sensor center to CD835**

**Dipole = 10mm/Hearing Aid Compatibility Test (41x361x1):**

Measurement grid: dx=5mm, dy=5mm

Maximum value of peak Total field = 170.7 V/m

Probe Modulation Factor = 1.000

Device Reference Point: 0, 0, -6.3 mm

Reference Value = 123.4 V/m; Power Drift = 0.02 dB



Hearing Aid Near-Field Category: M4 (AWF 0 dB)

Peak E-field in V/m

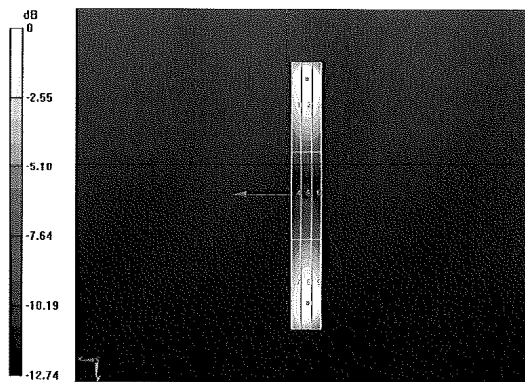
Grid 1 <b>164.3</b> M4	Grid 2 <b>170.7</b> M4	Grid 3 <b>164.5</b> M4
Grid 4 <b>85.8</b> M4	Grid 5 <b>90.5</b> M4	Grid 6 <b>88.8</b> M4
Grid 7 <b>152.9</b> M4	Grid 8 <b>161.3</b> M4	Grid 9 <b>158.3</b> M4



0 dB = 170.7V/m

FCC ID: ZNFUS730	 <b>PCTEST</b> ENGINEERING LABORATORY, INC.	<b>HAC (RF EMISSIONS) TEST REPORT</b>		<b>Reviewed by:</b> Quality Manager
<b>HAC Filename:</b> 0Y1207090916.ZNF	<b>Test Dates:</b> July 10-12, 2012	<b>EUT Type:</b> Portable Handset	Page 66 of 81	



Accredited by the Swiss Accreditation Service (SAS)  
The Swiss Accreditation Service is one of the signatories to the EA  
Multilateral Agreement for the recognition of calibration certificates

Accreditation No.: SCS 108

Client **PC Test**

Certificate No: **CD1880V3-1137\_Feb11/2**

**CALIBRATION CERTIFICATE (Replacement of No: CD1880V3-1137\_Feb11)**

Object: **CD1880V3 - SN: 1137**

Calibration procedure(s): **QA CAL-20.v5  
Calibration procedure for dipoles in air**

Calibration date: **February 09, 2011**

*✓  
Kok  
2/2/11*

This calibration certificate documents the traceability to national standards, which realize the physical units of measurements (SI).  
All calibrations have been conducted in the closed laboratory facility: environment temperature (22 ± 3)°C and humidity < 70%.

Calibration Equipment used (M&TE critical for calibration)

Primary Standards	ID #	Cal Date (Certificate No.)	Scheduled Calibration
Power meter EPM-442A	GB37480704	06-Oct-10 (No. 217-01266)	Oct-11
Power sensor HP 8481A	US37292783	06-Oct-10 (No. 217-01266)	Oct-11
Probe ER3DV6	SN: 2336	29-Dec-10 (No. ER3-2336_Dec10)	Dec-11
Probe H3DV6	SN: 6065	29-Dec-10 (No. H3-6065_Dec10)	Dec-11
DAE4	SN: 781	20-Oct-10 (No. DAE4-781_Oct10)	Oct-11
Secondary Standards	ID #	Check Date (in house)	Scheduled Check
Power meter Agilent 4419B	SN: GB42420191	09-Oct-09 (in house check Oct-10)	In house check: Oct-11
Power sensor HP 8482H	SN: 3318A09450	09-Oct-09 (in house check Oct-10)	In house check: Oct-11
Power sensor HP 8482A	SN: US37295597	09-Oct-09 (in house check Oct-10)	In house check: Oct-11
Network Analyzer HP 8753E	US37390585	18-Oct-01 (in house check Oct-10)	In house check: Oct-11
RF generator E4433B	MY 41000675	03-Nov-04 (in house check Oct-09)	In house check: Oct-11

Calibrated by: **Claudio Leubler** (Name), **Laboratory Technician** (Function), *[Signature]* (Signature)

Approved by: **Katja Pokovic** (Name), **Technical Manager** (Function), *[Signature]* (Signature)

Issued: February 23, 2011

This calibration certificate shall not be reproduced except in full without written approval of the laboratory.

FCC ID: ZNFUS730	PCTEST ENGINEERING LABORATORY, INC.	HAC (RF EMISSIONS) TEST REPORT	LG	Reviewed by: Quality Manager
HAC Filename: OY1207090916.ZNF	Test Dates: July 10-12, 2012	EUT Type: Portable Handset		Page 67 of 81



Accredited by the Swiss Accreditation Service (SAS)  
The Swiss Accreditation Service is one of the signatories to the EA  
Multilateral Agreement for the recognition of calibration certificates

Accreditation No.: **SCS 108**

**References**

- [1] ANSI-C63.19-2007  
American National Standard for Methods of Measurement of Compatibility between Wireless  
Communications Devices and Hearing Aids.

**Methods Applied and Interpretation of Parameters:**

- *Coordinate System:* y-axis is in the direction of the dipole arms. z-axis is from the basis of the antenna (mounted on the table) towards its feed point between the two dipole arms. x-axis is normal to the other axes. In coincidence with the standards [1], the measurement planes (probe sensor center) are selected to be at a distance of 10 mm above the top edge of the dipole arms.
- *Measurement Conditions:* Further details are available from the hardcopies at the end of the certificate. All figures stated in the certificate are valid at the frequency indicated. The forward power to the dipole connector is set with a calibrated power meter connected and monitored with an auxiliary power meter connected to a directional coupler. While the dipole under test is connected, the forward power is adjusted to the same level.
- *Antenna Positioning:* The dipole is mounted on a HAC Test Arch phantom using the matching dipole positioner with the arms horizontal and the feeding cable coming from the floor. The measurements are performed in a shielded room with absorbers around the setup to reduce the reflections. It is verified before the mounting of the dipole under the Test Arch phantom, that its arms are perfectly in a line. It is installed on the HAC dipole positioner with its arms parallel below the dielectric reference wire and able to move elastically in vertical direction without changing its relative position to the top center of the Test Arch phantom. The vertical distance to the probe is adjusted after dipole mounting with a DASY5 Surface Check job. Before the measurement, the distance between phantom surface and probe tip is verified. The proper measurement distance is selected by choosing the matching section of the HAC Test Arch phantom with the proper device reference point (upper surface of the dipole) and the matching grid reference point (tip of the probe) considering the probe sensor offset. The vertical distance to the probe is essential for the accuracy.
- *Feed Point Impedance and Return Loss:* These parameters are measured using a HP 8753E Vector Network Analyzer. The impedance is specified at the SMA connector of the dipole. The influence of reflections was eliminated by applying the averaging function while moving the dipole in the air, at least 70cm away from any obstacles.
- *E-field distribution:* E field is measured in the x-y-plane with an isotropic ER3D-field probe with 100 mW forward power to the antenna feed point. In accordance with [1], the scan area is 20mm wide, its length exceeds the dipole arm length (180 or 90mm). The sensor center is 10 mm (in z) above the top of the dipole arms. Two 3D maxima are available near the end of the dipole arms. Assuming the dipole arms are perfectly in one line, the average of these two maxima (in subgrid 2 and subgrid 8) is determined to compensate for any non-parallelity to the measurement plane as well as the sensor displacement. The E-field value stated as calibration value represents the maximum of the interpolated 3D-E-field, 10mm above the dipole surface.
- *H-field distribution:* H-field is measured with an isotropic H-field probe with 100mW forward power to the antenna feed point, in the x-y-plane. The scan area and sensor distance is equivalent to the E-field scan. The maximum of the field is available at the center (subgrid 5) above the feed point. The H-field value stated as calibration value represents the maximum of the interpolated H-field, 10mm above the dipole surface at the feed point.

<b>FCC ID:</b> ZNFUS730	<b>PCTEST</b> ENGINEERING LABORATORY, INC.	<b>HAC (RF EMISSIONS) TEST REPORT</b>	<b>LG</b>	<b>Reviewed by:</b> Quality Manager
<b>HAC Filename:</b> OY1207090916.ZNF	<b>Test Dates:</b> July 10-12, 2012	<b>EUT Type:</b> Portable Handset		Page 68 of 81

1. Measurement Conditions

DASY system configuration, as far as not given on page 1.

DASY Version	DASY5	V52.6.1 (408)
DASY PP Version	SEMCAD X	V14.4.2 (2595)
Phantom	HAC Test Arch	SD HAC P01 BA, #1070
Distance Dipole Top - Probe Center	10 mm	
Scan resolution	dx, dy = 5 mm	area = 20 x 90 mm
Frequency	1880 MHz ± 1 MHz	
Forward power at dipole connector	20.0 dBm = 100mW	
Input power drift	< 0.05 dB	

2. Maximum Field values

H-field 10 mm above dipole surface	condition	Interpolated maximum
Maximum measured	100 mW forward power	0.460 A/m

Uncertainty for H-field measurement: 8.2% (k=2)

E-field 10 mm above dipole surface	condition	Interpolated maximum
Maximum measured above high end	100 mW forward power	139.0 V/m
Maximum measured above low end	100 mW forward power	134.5 V/m
Averaged maximum above arm	100 mW forward power	136.8 V/m

Uncertainty for E-field measurement: 12.8% (k=2)

3. Appendix

3.1 Antenna Parameters

Frequency	Return Loss	Impedance
1730 MHz	23.0 dB	( 49.6 + j7.1 ) Ohm
1880 MHz	21.2 dB	( 51.1 + j8.7 ) Ohm
1900 MHz	21.8 dB	( 53.3 + j7.7 ) Ohm
1950 MHz	28.1 dB	( 54.1 - j0.2 ) Ohm
2000 MHz	20.5 dB	( 41.4 - j0.8 ) Ohm



3.2 Antenna Design and Handling

The calibration dipole has a symmetric geometry with a built-in two stub matching network, which leads to the enhanced bandwidth.

The dipole is built of standard semirigid coaxial cable. The internal matching line is open ended. The antenna is therefore open for DC signals.

Do not apply force to dipole arms, as they are liable to bend. The soldered connections near the feedpoint may be damaged. After excessive mechanical stress or overheating, check the impedance characteristics to ensure that the internal matching network is not affected.

After long term use with 40W radiated power, only a slight warming of the dipole near the feedpoint can be measured.

FCC ID: ZNFUS730	 PCTEST ENGINEERING LABORATORY, INC.	HAC (RF EMISSIONS) TEST REPORT	 LG	Reviewed by: Quality Manager
HAC Filename: 0Y1207090916.ZNF	Test Dates: July 10-12, 2012	EUT Type: Portable Handset		Page 69 of 81

3.3 Measurement Sheets

3.3.1 Return Loss and Smith Chart

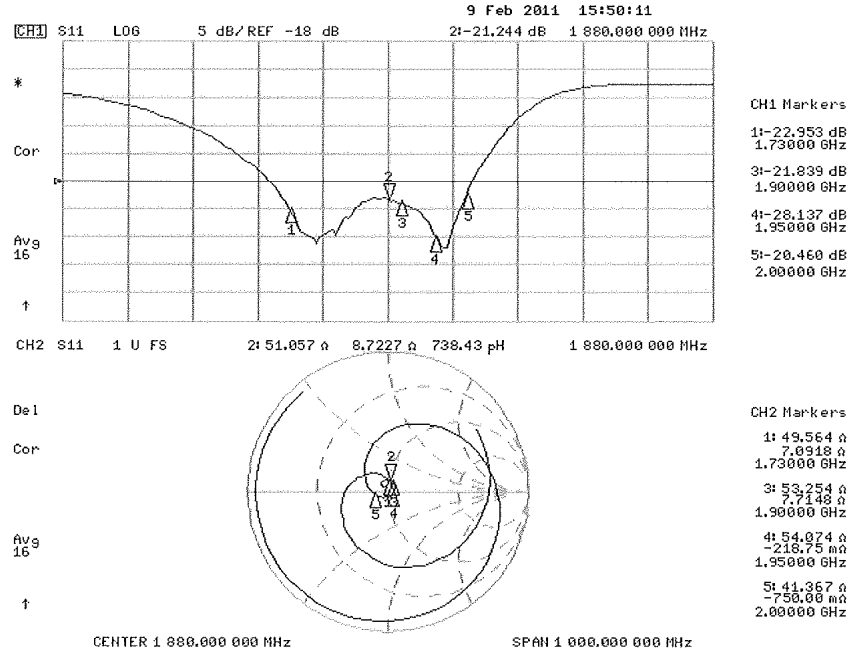

FCC ID: ZNFUS730	PCTEST ENGINEERING LABORATORY, INC.	HAC (RF EMISSIONS) TEST REPORT	LG	Reviewed by: Quality Manager
HAC Filename: 0Y1207090916.ZNF	Test Dates: July 10-12, 2012	EUT Type: Portable Handset		Page 70 of 81

3.3.2 DASY4 H-Field Result

Date/Time: 09.02.2011 11:34:28

Test Laboratory: SPEAG Lab2

HAC\_RF\_CD1880\_1137\_H\_110208\_CL

DUT: HAC Dipole 1880 MHz; Type: CD1880V3; Serial: 1137

Communication System: CW; Frequency: 1880 MHz

Medium parameters used:  $\sigma = 0$  mho/m,  $\epsilon_r = 1$ ;  $\rho = 1$  kg/m<sup>3</sup>

Phantom section: RF Section

Measurement Standard: DASY5 (IBEE/IEC/ANSI C63.19-2007)

DASY5 Configuration:

- Probe: H3DV6 - SN6065; ; Calibrated: 29.12.2010
- Sensor-Surface: (Fix Surface)
- Electronics: DAE4 Sn781; Calibrated: 20.10.2010
- Phantom: HAC Test Arch with AMCC; Type: SD HAC P01 BA; Serial: 1070
- Measurement SW: DASY52, V52.6.1 Build (408)
- Postprocessing SW: SEMCAD X, V14.4.2 Build (2595)

Dipole H-Field measurement @ 1880MHz/H Scan - measurement distance from the probe sensor center to CD1880

Dipole = 10mm/Hearing Aid Compatibility Test (41x181x1):

Measurement grid: dx=5mm, dy=5mm

Maximum value of peak Total field = 0.460 A/m

Probe Modulation Factor = 1.000

Device Reference Point: 0, 0, -6.3 mm

Reference Value = 0.487 A/m; Power Drift = 0.0057 dB

Hearing Aid Near-Field Category: M2 (AWF 0 dB)

Peak H-field in A/m

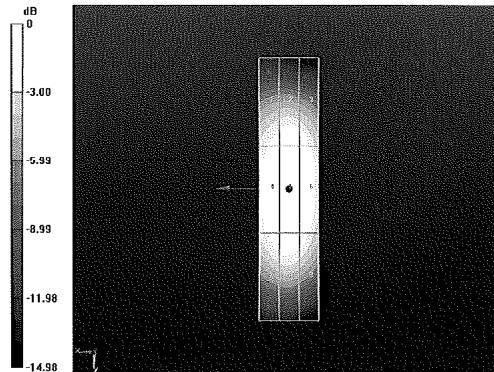

Grid 1 <b>0.401</b> M2	Grid 2 <b>0.418</b> M2	Grid 3 <b>0.396</b> M2
Grid 4 <b>0.443</b> M2	Grid 5 <b>0.460</b> M2	Grid 6 <b>0.435</b> M2
Grid 7 <b>0.409</b> M2	Grid 8 <b>0.426</b> M2	Grid 9 <b>0.399</b> M2



0 dB = 0.460A/m

Certificate No: CD1880V3-1137\_Feb11/2

Page 5 of 9

FCC ID: ZNFUS730	 PCTEST ENGINEERING LABORATORY, INC.	HAC (RF EMISSIONS) TEST REPORT	 LG	Reviewed by: Quality Manager
HAC Filename: 0Y1207090916.ZNF	Test Dates: July 10-12, 2012	EUT Type: Portable Handset		Page 71 of 81

3.3.3 DASYS4 E-Field Result

Date/Time: 08.02.2011 16:54:42

Test Laboratory: SPEAG Lab2

HAC\_RF\_CD1880\_1137\_E\_110208\_CL

DUT: HAC Dipole 1880 MHz; Type: CD1880V3; Serial: 1137

Communication System: CW; Frequency: 1880 MHz  
 Medium parameters used:  $\sigma = 0$  mho/m,  $\epsilon_r = 1$ ;  $\rho = 1000$  kg/m<sup>3</sup>  
 Phantom section: RF Section  
 Measurement Standard: DASYS5 (IEEE/IEC/ANSI C63.19-2007)

DASYS5 Configuration:

- Probe: ER3DV6 - SN2336; ConvF(1, 1, 1); Calibrated: 29.12.2010
- Sensor-Surface: (Fix Surface)
- Electronics: DAE4 Sn781; Calibrated: 20.10.2010
- Phantom: HAC Test Arch with AMCC; Type: SD HAC P01 BA; Serial: 1070
- Measurement SW: DASYS2, V52.6.1 Build (408)
- Postprocessing SW: SEMCAD X, V14.4.2 Build (2595)

Dipole E-Field measurement @ 1880MHz/E.Scan - measurement distance from the probe sensor center to CD1880

Dipole = 10mm/Hearing Aid Compatibility Test (41x181x1):

Measurement grid: dx=5mm, dy=5mm  
 Maximum value of peak Total field = 139.0 V/m  
 Probe Modulation Factor = 1.000

Device Reference Point: 0, 0, -6.3 mm  
 Reference Value = 138.8 V/m; Power Drift = -0.05 dB  
 Hearing Aid Near-Field Category: M2 (AWF 0 dB)

Peak E-field in V/m

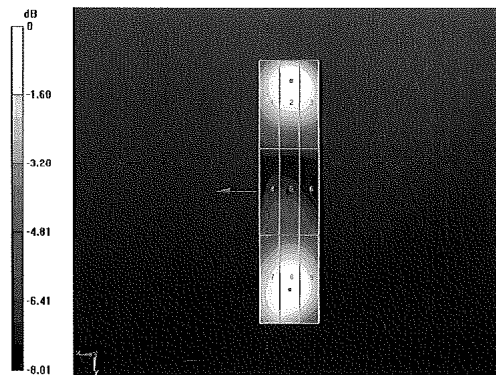

Grid 1 <b>131.8</b> M2	Grid 2 <b>139.0</b> M2	Grid 3 <b>135.0</b> M2
Grid 4 <b>84.076</b> M3	Grid 5 <b>87.648</b> M3	Grid 6 <b>85.767</b> M3
Grid 7 <b>131.1</b> M2	Grid 8 <b>134.5</b> M2	Grid 9 <b>130.5</b> M2



0 dB = 139.0V/m

Certificate No: CD1880V3-1137\_Feb11/2

Page 6 of 9

FCC ID: ZNFUS730	 PCTEST ENGINEERING LABORATORY, INC.	HAC (RF EMISSIONS) TEST REPORT	 LG	Reviewed by: Quality Manager
HAC Filename: 0Y1207090916.ZNF	Test Dates: July 10-12, 2012	EUT Type: Portable Handset	Page 72 of 81	



#### 4. Additional Measurements

##### 4.1 Measurement Conditions

DASY system configuration, as far as not given on page 1.

DASY Version	DASY5	V52.6.1 (408)
DASY PP Version	SEMCAD X	V14.4.2 (2595)
Phantom	HAC Test Arch	SD HAC P01 BA, #1070
Distance Dipole Top - Probe Center	10 mm	
Scan resolution	dx, dy = 5 mm	area = 20 x 90 mm
Frequency	1730 MHz $\pm$ 1 MHz	
Forward power at dipole connector	20.0 dBm = 100mW	
Input power drift	< 0.05 dB	



##### 4.1.1 Maximum Field values

H-field 10 mm above dipole surface	condition	interpolated maximum
Maximum measured	100 mW forward power	0.489 A/m

Uncertainty for H-field measurement: 8.2% (k=2)

E-field 10 mm above dipole surface	condition	Interpolated maximum
Maximum measured above high end	100 mW forward power	152.7 V/m
Maximum measured above low end	100 mW forward power	150.2 V/m
Averaged maximum above arm	100 mW forward power	151.5 V/m

Uncertainty for E-field measurement: 12.8% (k=2)

FCC ID: ZNFUS730	 PCTEST ENGINEERING LABORATORY, INC.	HAC (RF EMISSIONS) TEST REPORT	 LG	Reviewed by: Quality Manager
HAC Filename: 0Y1207090916.ZNF	Test Dates: July 10-12, 2012	EUT Type: Portable Handset		Page 73 of 81

4.1.2 DASYS4 H-field result

Date/Time: 09.02.2011 11:27:03

Test Laboratory: SPEAG Lab2

**HAC\_RF\_CD1880\_1137\_H\_1730\_110208\_CL**

**DUT: HAC Dipole 1880 MHz; Type: CD1880V3; Serial: 1137**

Communication System: CW; Frequency: 1730 MHz

Medium parameters used:  $\sigma = 0$  mho/m,  $\epsilon_r = 1$ ;  $\rho = 1$  kg/m<sup>3</sup>

Phantom section: RF Section

Measurement Standard: DASYS (IEEE/IEC/ANSI C63.19-2007)

DASYS Configuration:

- Probe: H3DV6 - SN6065; ; Calibrated: 29.12.2010
- Sensor-Surface: (Fix Surface)
- Electronics: DAE4 Sn781; Calibrated: 20.10.2010
- Phantom: HAC Test Arch with AMCC; Type: SD HAC P01 BA; Serial: 1070
- Measurement SW: DASYS2, V52.6.1 Build (408)
- Postprocessing SW: SEMCAD X, V14.4.2 Build (2595)

**Dipole H-Field measurement @ 1880MHz/H Scan - measurement distance from the probe sensor center to CD1880**

**Dipole = 10mm @ 1730 MHz/Hearing Aid Compatibility Test (41x181x1):**

Measurement grid: dx=5mm, dy=5mm

Maximum value of peak Total field = 0.489 A/m

Probe Modulation Factor = 1.000

Device Reference Point: 0, 0, -6.3 mm

Reference Value = 0.519 A/m; Power Drift = 0.02 dB



Hearing Aid Near-Field Category: M2 (AWF 0 dB)

Peak H-field in A/m

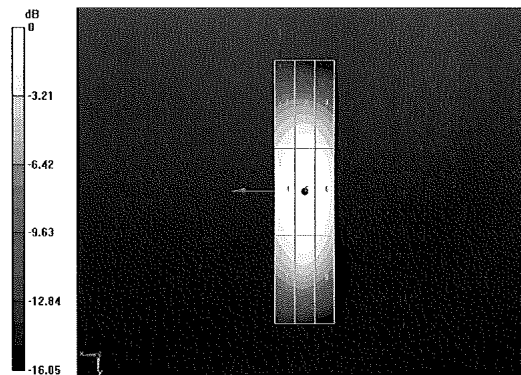
Grid 1 <b>0.407</b> M2	Grid 2 <b>0.424</b> M2	Grid 3 <b>0.403</b> M2
Grid 4 <b>0.467</b> M2	Grid 5 <b>0.489</b> M2	Grid 6 <b>0.462</b> M2
Grid 7 <b>0.418</b> M2	Grid 8 <b>0.437</b> M2	Grid 9 <b>0.409</b> M2



0 dB = 0.490A/m

FCC ID: ZNFUS730	 <b>PCTEST</b> ENGINEERING LABORATORY, INC.	<b>HAC (RF EMISSIONS) TEST REPORT</b>	 <b>LG</b>	<b>Reviewed by:</b> Quality Manager
<b>HAC Filename:</b> OY1207090916.ZNF	<b>Test Dates:</b> July 10-12, 2012	<b>EUT Type:</b> Portable Handset	Page 74 of 81	

**4.1.3 DASY4 E-field result**

Date/Time: 08.02.2011 16:26:13

Test Laboratory: SPEAG Lab2

**HAC\_RF\_CD1880\_1137\_E\_1730\_110208\_CL**

**DUT: HAC Dipole 1880 MHz; Type: CD1880V3; Serial: 1137**

Communication System: CW; Frequency: 1730 MHz  
 Medium parameters used:  $\sigma = 0$  mho/m,  $\epsilon_r = 1$ ;  $\rho = 1000$  kg/m<sup>3</sup>  
 Phantom section: RF Section  
 Measurement Standard: DASY5 (IEEE/IEC/ANSI C63.19-2007)

DASY5 Configuration:

- Probe: ER3DV6 - SN2336; ConvF(1, 1, 1); Calibrated: 29.12.2010
- Sensor-Surface: (Fix Surface)
- Electronics: DAE4 Sn781; Calibrated: 20.10.2010
- Phantom: HAC Test Arch with AMCC; Type: SD HAC P01 BA; Serial: 1070
- Measurement SW: DASY52, V52.6.1 Build (408)
- Postprocessing SW: SEMCAD X, V14.4.2 Build (2595)

**Dipole E-Field measurement @ 1880MHz/E Scan - measurement distance from the probe sensor center to CD1880**

**Dipole = 10mm @ 1730 MHz/Hearing Aid Compatibility Test (41x181x1):**

Measurement grid: dx=5mm, dy=5mm  
 Maximum value of peak Total field = 152.7 V/m  
 Probe Modulation Factor = 1.000

Device Reference Point: 0, 0, -6.3 mm  
 Reference Value = 156.8 V/m; Power Drift = 0.0092 dB  
**Hearing Aid Near-Field Category: M2 (AWF 0 dB)**

Peak E-field in V/m

Grid 1 <b>143.8</b> M2	Grid 2 <b>150.2</b> M2	Grid 3 <b>144.8</b> M2
Grid 4 <b>97.621</b> M3	Grid 5 <b>103.8</b> M3	Grid 6 <b>102.2</b> M3
Grid 7 <b>145.9</b> M2	Grid 8 <b>152.7</b> M2	Grid 9 <b>149.2</b> M2

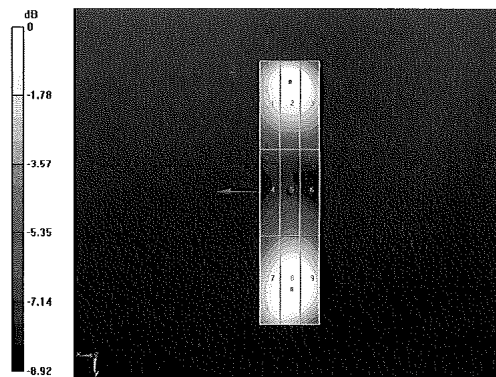



0 dB = 152.7V/m

FCC ID: ZNFUS730	PCTEST ENGINEERING LABORATORY, INC.	HAC (RF EMISSIONS) TEST REPORT	LG	Reviewed by: Quality Manager
HAC Filename: OY1207090916.ZNF	Test Dates: July 10-12, 2012	EUT Type: Portable Handset	Page 75 of 81	

## 15. CONCLUSION



The measurements indicate that the wireless communications device complies with the HAC limits specified in accordance with the ANSI C63.19 Standard and FCC WT Docket No. 01-309 RM-8658. Precise laboratory measures were taken to assure repeatability of the tests. The tested device complies with the requirements in respect to all parameters specific to the test. The test results and statements relate only to the item(s) tested.

Please note that the M-rating for this equipment only represents the field interference possible against a hypothetical and typical hearing aid. The measurement system and techniques presented in this evaluation are proposed in the ANSI standard as a means of best approximating wireless device compatibility with a hearing-aid. The literature is under continual re-construction.



<b>FCC ID:</b> ZNFUS730	 <b>PCTEST</b> ENGINEERING LABORATORY, INC.	<b>HAC (RF EMISSIONS) TEST REPORT</b>	 <b>LG</b>	<b>Reviewed by:</b> Quality Manager
<b>HAC Filename:</b> 0Y1207090916.ZNF	<b>Test Dates:</b> July 10-12, 2012	<b>EUT Type:</b> Portable Handset	Page 76 of 81	

## 16. REFERENCES

1. ANSI/IEEE C63.19-2007, American National Standard for Methods of Measurement of Compatibility between Wireless Communication Devices and Hearing Aids.”, New York, NY, IEEE, June 2007
2. FCC Public Notice DA 06-1215, *Wireless Telecommunications Bureau and Office of Engineering and Technology Clarify Use of Revised Wireless Phone Hearing Aid Compatibility Standard*, June 6, 2006
3. Review Guidance for Reviewing Applications for Certification of 3G Devices, May/June 2006
4. Berger, H. S., “Compatibility Between Hearing Aids and Wireless Devices,” Electronic Industries Forum, Boston, MA, May, 1997
5. Berger, H. S., “Hearing Aid and Cellular Phone Compatibility: Working Toward Solutions,” *Wireless Telephones and Hearing Aids: New Challenges for Audiology*, Gallaudet University, Washington, D.C., May, 1997 (To be reprinted in the American Journal of Audiology).
6. Berger, H. S., “Hearing Aid Compatibility with Wireless Communications Devices,” IEEE International Symposium on Electromagnetic Compatibility, Austin, TX, August, 1997.
7. Bronaugh, E. L., “Simplifying EMI Immunity (Susceptibility) Tests in TEM Cells,” in the 1990 IEEE International Symposium on Electromagnetic Compatibility Symposium Record, Washington, D.C., August 1990, pp. 488-491
8. Byrne, D. and Dillon, H., The National Acoustics Laboratory (NAL) New Procedure for Selecting the Gain and Frequency Response of a Hearing Aid, Ear and Hearing 7:257-265, 1986.
9. Crawford, M. L., “Measurement of Electromagnetic Radiation from Electronic Equipment using TEM Transmission Cells,” U.S. Department of Commerce, National Bureau of Standards, NBSIR 73-306, Feb. 1973.
10. Crawford, M. L., and Workman, J. L., “Using a TEM Cell for EMC Measurements of Electronic Equipment,” U.S. Department of Commerce, National Bureau of Standards. Technical Note 1013, July 1981.
11. EHIMA GSM Project, Development phase, Project Report (1<sup>st</sup> part) Revision A. Technical-Audiological Laboratory and Telecom Denmark, October 1993.
12. EHIMA GSM Project, Development phase, Part II Project Report. Technical-Audiological Laboratory and Telecom Denmark, June 1994.
13. EHIMA GSM Project Final Report, Hearing Aids and GSM Mobile Telephones: Interference Problems, Methods of Measurement and Levels of Immunity. Technical-Audiological Laboratory and Telecom Denmark, 1995.
14. HAMPIS Report, Comparison of Mobile phone electromagnetic near field with an upscaled electromagnetic far field, using hearing aid as reference, 21 October 1999.

FCC ID: ZNFUS730	 PCTEST ENGINEERING LABORATORY, INC.	HAC (RF EMISSIONS) TEST REPORT	 LG	Reviewed by: Quality Manager
HAC Filename: OY1207090916.ZNF	Test Dates: July 10-12, 2012	EUT Type: Portable Handset		Page 77 of 81

15. Hearing Aids/GSM, Report from OTWIDAM, Technical-Audiological Laboratory and Telecom Denmark, April 1993.
16. IEEE 100, The Authoritative Dictionary of IEEE Standards Terms, Seventh Edition.
17. Joyner, K. H., et. al., Interference to Hearing Aids by the New Digital Mobile Telephone System, Global System for Mobile (GSM) Communication Standard, National Acoustic Laboratory, Australian Hearing Series, Sydney 1993.
18. Joyner, K. H., et. al., Interference to Hearing Aids by the Digital Mobile Telephone System, Global System for Mobile Communications (GSM), NAL Report #131, National Acoustic Laboratory, Australian Hearing Series, Sydney, 1995.
19. Kecker, W. T., Crawford, M. L., and Wilson, W. A., "Construction of a Transverse Electromagnetic Cell", U.S. Department of Commerce, National Bureau of Standards, Technical Note 1011, Nov. 1978.
20. Konigstein, D., and Hansen, D., "A New Family of TEM Cells with enlarged bandwidth and Optimized working Volume," in the Proceedings of the 7<sup>th</sup> International Symposium on EMC, Zurich, Switzerland, March 1987; 50:9, pp. 127-132.
21. Kuk, F., and Hjorstgaard, N. K., "Factors affecting interference from digital cellular telephones," Hearing Journal, 1997; 50:9, pp 32-34.
22. Ma, M. A., and Kanda, M., "Electromagnetic Compatibility and Interference Metrology," U.S. Department of Commerce, National Bureau of Standards, Technical Note 1099, July 1986, pp. 17-43.
23. Ma, M. A., Sreenivashiah, I. , and Chang, D. C., "A Method of Determining the Emission and Susceptibility Levels of Electrically Small Objects Using a TEM Cell," U.S. Department of Commerce, National Bureau of Standards, Technial Note 1040, July 1981.
24. McCandless, G. A., and Lyregaard, P. E., Prescription of Gain/Output (POGO) for Hearing Aids, Hearing Instruments 1:16-21, 1983
25. Skopec, M., "Hearing Aid Electromagnetic Interference from Digital Wireless Telephones, "IEEE Transactions on Rehabilitation Engineering, vol. 6, no. 2, pp. 235-239, June 1998.
26. Technical Report, GSM 05.90, GSM EMC Considerations, European Telecommunications Standards Institute, January 1993.
27. Victorian, T. A., "Digital Cellular Telephone Interference and Hearing Aid Compatibility—an Update," Hearing Journal 1998; 51:10, pp. 53-60
28. Wong, G. S. K., and Embleton, T. F. W., eds., AIP Handbook of Condenser Microphones: Theory, Calibration and Measurements, AIP Press.

FCC ID: ZNFUS730	 <b>PCTEST</b> ENGINEERING LABORATORY, INC.	<b>HAC (RF EMISSIONS) TEST REPORT</b>	 <b>LG</b>	<b>Reviewed by:</b> Quality Manager
<b>HAC Filename:</b> OY1207090916.ZNF	<b>Test Dates:</b> July 10-12, 2012	<b>EUT Type:</b> Portable Handset	Page 78 of 81	