

EMC TEST REPORT

Test item : Cellular/PCS GSM/GPRS Phone with Bluetooth and WLAN
Model No. : LG-T565
Additional Model(s) : T565, LGT565
Order No. : 1108-01119
Date of receipt : 2011-08-16
Test duration : 2011-08-17 ~ 2011-08-18
Use of report : FCC Marking
Date of Issue : 2011-09-15

Applicant : LG Electronics MobileComm U.S.A., Inc.
10101 Old Grove Road., San Diego, CA 92131

Test laboratory : Digital EMC Co., Ltd.
683-3, Yubang-Dong, Cheoin-Gu, Yongin-Si, Gyeonggi-Do, 449-080, Korea

Test specification : ANSI C 63.4:2003
FCC Part 15 Subpart B
(Type of Device : Class B Personal Computers and Peripherals (JBP))

Test environment : Temperature (20 ~ 24) °C,
Humidity (36 ~ 51) % R.H.

Test result : Comply Not Comply

The test results presented in this test report are limited only to the sample supplied by applicant and the use of this test report is inhibited other than its purpose. This test report shall not be reproduced except in full, without the written approval of DIGITAL EMC CO., LTD.

Tested by:

Reviewed by:



Manager
H.S.KO



General Manager
C.H.LEE

The above test report is the accredited test results by Korea Laboratory Accreditation Scheme, which signed the ILAC-MRA.

PRESIDENT OF DIGITAL EMC CO., LTD.

CONTENTS

1. General Remarks	3
2. Test Laboratory	3
3. General Information of EUT	4
3.1 Product Description	4
3.2 Product Information	4
4. Test Summary	5
4.1 Applied standards and test results	5
4.2 Test environment and conditions	5
4.3 Test result Summary	5
5. Test Set-up and operation mode	6
5.1 Principle of Configuration Selection	6
5.2 Test Operation Mode	6
5.3 Support Equipment Used	6
6. Test Results : Emission	7
6.1 Conducted Disturbance	7
6.2 Radiated Disturbance	10
Appendix 1	18
List of Test and Measurement Instruments	18

1. General Remarks

This report contains the result of tests performed by:

DIGITAL EMC CO., LTD.

Address : 683-3, Yubang-Dong, Cheoin-Gu, Yongin-Si, Gyeonggi-Do, 449-080, Korea

<http://www.digitalemco.com>

Tel: +82-31-321-2664 Fax: +82-31-321-1664

2. Test Laboratory

Digital EMC Co., Ltd. has been accredited / filed / authorized by the agencies listed in the following table;

Certificate	Nation	Agency	Code	Mark
Accreditation	Korea	KOLAS	393	ISO/IEC 17025
Site Filing	USA	FCC	101842	Test Facility list & NSA Data
	Japan	VCCI	C-1427 R-1364, R-3385 T-1442, G-338	Test Facility list & NSA Data
Certification	Korea	KC	KR0034	Test Facility list & NSA Data
	Germany	TUV	ROK1028C	ISO/IEC 17025

Quality control in the testing laboratory is implemented as per ISO/IEC 17025 which is the "General requirements for the competent of calibration and testing laboratory".

3. General Information of EUT

3.1 Product Description

Equipment Under Test (E.U.T) is Cellular/PCS GSM/GPRS Phone with Bluetooth, and WLAN Model: LG-T565 manufactured by LG Electronics Inc. Its basic purpose is used for communications.

3.2 Product Information

Model No.	LG-T565
Add Model No.	T565, LGT565
EUT Type	Cellular/PCS GSM/GPRS Phone with Bluetooth, and WLAN
Serial No	NONE
FCC ID	ZNFT565
Type of Sample Tested	Pre-Production
High Frequency	208MHz
Supplied Power for Test	AC120.V, 60Hz
Applicant	LG Electronics MobileComm U.S.A., Inc. 10101 Old Grove Road., San Diego, CA 92131
TX Frequency	824.20 MHz to 848.80 MHz (GSM850) 1850.20 MHz to 1909.80 MHz (GSM1900)
RX Frequency	869.20 MHz to 893.80 MHz (GSM850) 1930.20 MHz to 1989.80 MHz (GSM1900)
Date of Receipt of Sample	2011-08-16

Related Submittal(s) / Grant(s)

Original submittal only.

4. Test Summary

4.1 Applied standards and test results

Test Items	Applied Standards	Results
Conducted Disturbance	ANSI C63.4:2003	Comply
Radiated Disturbance	ANSI C63.4:2003	Comply

The data in this test report are traceable to the national or international standards.

4.2 Test environment and conditions

Test Items	Test date (MM-DD)	Temp ()	Humidity (% R.H.)	Pressure (hPa)
Conducted Disturbance	08-18	20	36	-
Radiated Disturbance	08-17	24	51	

4.3 Test result Summary

(1) Conducted Emission

Power Line Conducted Emissions			FCC PART 15b Class B		
Frequency (MHz)	Amplitude (dB μ V)	Conductor	Detector	Limit (dB μ V)	Margin (dB)
30.000	53.7	L1	Quasi-Peak	60.0	5.7
30.000	53.4	N	Quasi-Peak	60.0	6.0

(2) Radiated emission

Frequency [MHz]	Pol.	Reading [dB μ V]	C.F. [dB/m]	Result [dB(μ V/m)]	Limit [dB(μ V/m)]	Margin [dB]
79.800	H	42.8	-14.1	28.7	40.0	11.3

- Note) 1. Emission Level = Reading Value + Correction Factor.
 2. Correction Factor = Cable loss - Amp gain + Antenna Factor
 3. Margin = Limit - Emission level

5. Test Set-up and operation mode

5.1 Principle of Configuration Selection

Emission : The equipment under test (EUT) was configured to measure its highest possible radiation level. The test modes were adapted accordingly in reference to the instructions for use.

5.2 Test Operation Mode

- PC LINK MODE

5.3 Support Equipment Used

Unit	Model No.	Serial No.	Manufacturer	CABLE			Backshell	FCC ID
				Connect type	Length (m)	shield		
Notebook	X140-L75BK	009QTAF022136	LG	USB Cable Power	1.4 1.8	Shield Non-Shield	Plastic Plastic	DOC
AC/DC ADAPTER	ADP-40PH AD	-	DELTA ELECTRONICS,INC	POWER	1.6	Non-Shield	Plastic	VER
HEADSET	SGEY0003744	-	Cresyn	Stereo	1.2	Shield	Plastic	VER

(Configuration of Tested System)

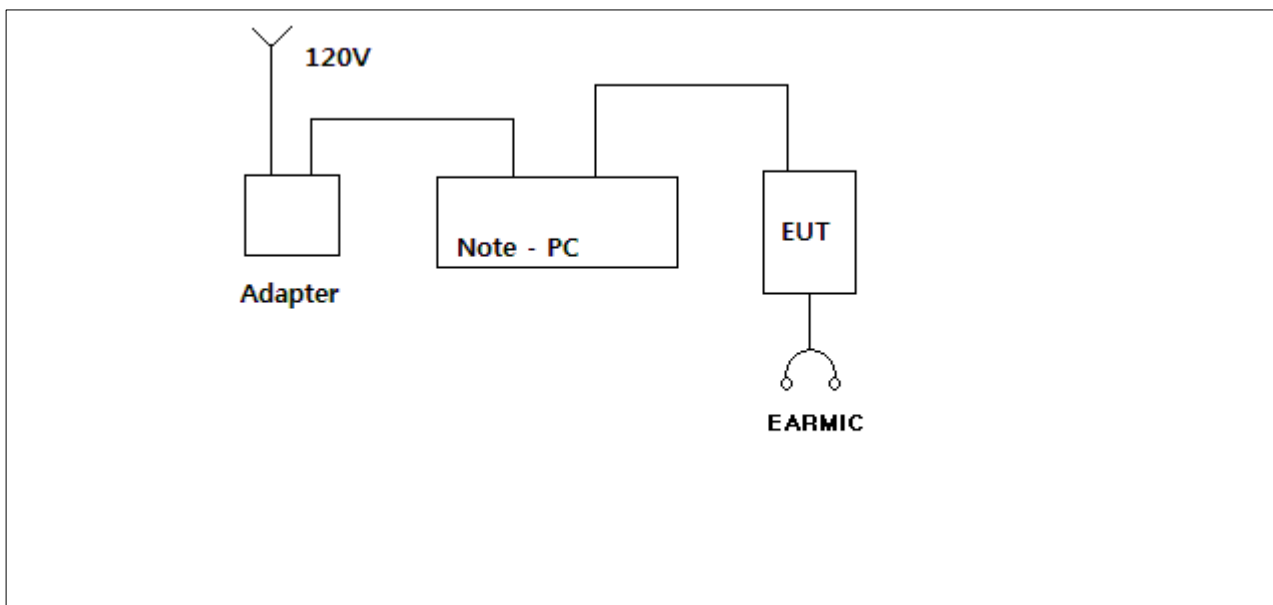

6. Test Results : Emission

6.1 Conducted Disturbance

6.1.1 Measurement Procedure

In the range of 0.15MHz to 30MHz, the conducted disturbance was measured and set-up was made accordance with **ANSI C63.4:2003**.

If the EUT is table top equipment, it was placed on a wooden table with a height of 0.8m above the reference ground plane and 0.4m from the conducting wall of the shielded room.

Also if the EUT is floor-standing equipment, it was placed on a non-conducted support with a height up to 0.15m above the reference ground plane.

Connect the EUT's power source lines to the appropriate power mains / peripherals through the LISN. All the other peripherals are connected to the 2nd LISN, if any.

Unused measuring port of the LISN was resistively terminated by 50 ohm terminator.

The measuring port of the LISN for EUT was connected to spectrum analyzer.

Using conducted emission test software, the emissions were scanned with peak detector mode.

After scanning over the frequency range, suspected emissions were selected to perform final measurement. When performing final measurement, the receiver was used which has Quasi-Peak detector and Average detector.

By varying the configuration of the test sample and the cable routing it was attempted to maximize the emission.

For further description of the configuration refer to the picture of the test set-up.

6.1.2 Limit for Conducted Disturbance

(1) Conducted disturbance at mains ports.

Frequency range (MHz)	Limits dB(μ V)			
	Quasi-peak		Average	
	Class A	Class B	Class A	Class B
0.15 to 0.50	79	66 to 56	66	56 to 46
0.50 to 5	73	56	60	46
5 to 30		60		50

Note 1 The lower limit shall apply at the transition frequencies.
 Note 2 The limit decreases linearly with the logarithm of the frequency in the range 0.15MHz to 0.5MHz.

Test Result



Results of Conducted Emission

Digital EMC
 Date : 2011/08/18

Model No. : LG-T565
 Type :
 Serial No. :
 Test Condition : PC link mode

Reference No. :
 Power Supply : 120 V 60 Hz
 Temp/Humi. : 20 °C 36 % R.H.
 Operator : H.S KO

Memo :
 LIMIT : CISPR22_B OP
 CISPR22_B AV

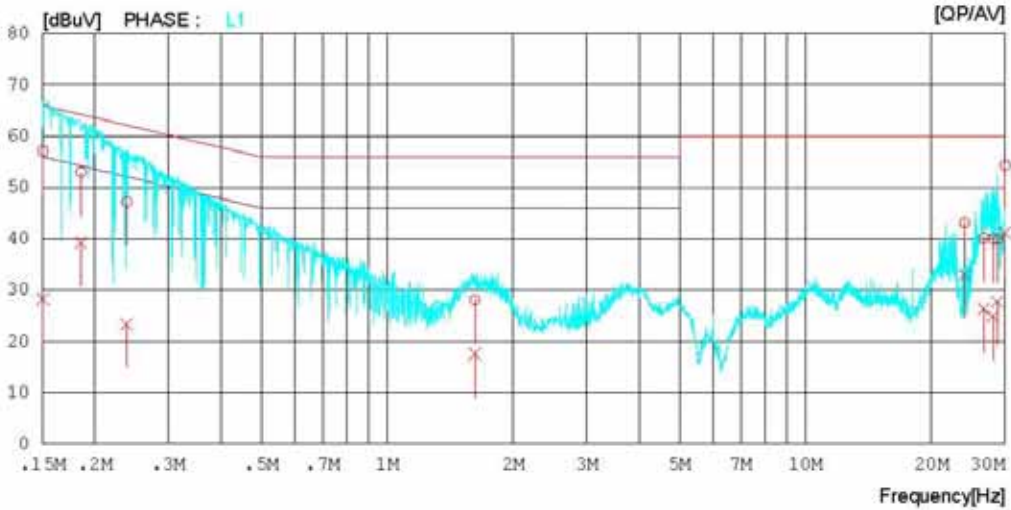
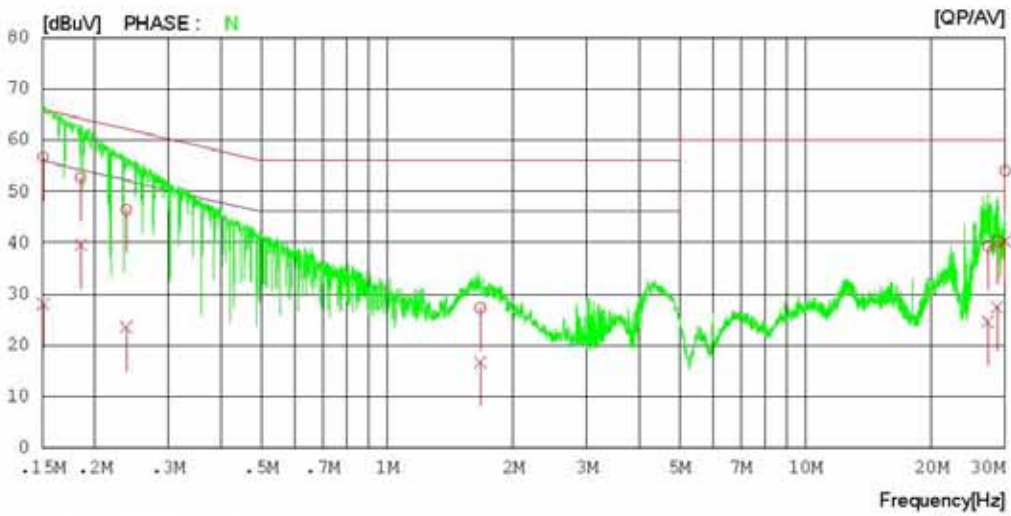

Results of Conducted Emission

Digital EMC
Date : 2011/08/18

Model No.	: LG-T565	Reference No.	:
Type	:	Power Supply	: 120 V 60 Hz
Serial No.	:	Temp/Humi.	: 20°C 36 % R.H.
Test Condition	: PC link mode	Operator	: H.S KO

Memo :

LIMIT : CISPR22_B QP
CISPR22_B AV

NO	FREQ [MHz]	READING		C. FACTOR [dB]	RESULT		LIMIT		MARGIN		PHASE
		QP [dBuV]	AV [dBuV]		QP [dBuV]	AV [dBuV]	QP [dBuV]	AV [dBuV]	QP [dBuV]	AV [dBuV]	
1	0.15049	56.6	27.9	0.1	56.7	28.0	66.0	56.0	9.3	28.0	N
2	0.18498	52.6	39.5	0.1	52.7	39.6	64.3	54.3	11.6	14.7	N
3	0.23790	46.3	23.4	0.1	46.4	23.5	62.2	52.2	15.8	28.7	N
4	1.66850	27.1	16.5	0.2	27.3	16.7	56.0	46.0	28.7	29.3	N
5	27.26050	38.8	24.1	0.5	39.3	24.6	60.0	50.0	20.7	25.4	N
6	28.78300	39.8	26.8	0.6	40.4	27.4	60.0	50.0	19.6	22.6	N
7	30.00000	53.4	39.7	0.6	54.0	40.3	60.0	50.0	6.0	9.7	N
8	0.15031	57.0	28.1	0.1	57.1	28.2	66.0	56.0	8.9	27.8	L1
9	0.18515	52.9	39.1	0.1	53.0	39.2	64.3	54.3	11.3	15.1	L1
10	0.23836	47.0	23.3	0.1	47.1	23.4	62.2	52.2	15.1	28.8	L1
11	1.62050	27.9	17.4	0.2	28.1	17.6	56.0	46.0	27.9	28.4	L1
12	24.00050	42.7	32.5	0.4	43.1	32.9	60.0	50.0	16.9	17.1	L1
13	26.68550	39.7	25.8	0.5	40.2	26.3	60.0	50.0	19.8	23.7	L1
14	28.04300	39.5	24.4	0.5	40.0	24.9	60.0	50.0	20.0	25.1	L1
15	28.78450	39.4	27.1	0.6	40.0	27.7	60.0	50.0	20.0	22.3	L1
16	30.00000	53.7	40.5	0.6	54.3	41.1	60.0	50.0	5.7	8.9	L1

6.2 Radiated Disturbance

6.2.1 Measurement Procedure

The radiated disturbance was measured and set-up was made accordance with **ANSI C63.4:2003**.

If the EUT is tabletop equipment, it was placed on a wooden table with a height of 0.8m above the reference ground plane and 3m away from the interference receiving antenna in the **10m semi-anechoic chamber**.

Also if the EUT is floor-standing equipment, it was placed on a non-conducted support with a height up to 0.15m above the reference ground plane.

Rotate the EUT from 0° to 360° and position the receiving antenna at heights from 1 to 4m above the reference ground plane continuously to determine associated with higher emission levels and record them.

The measurement was made in both the vertical and horizontal polarization, and the maximum value is presented in the report.

For below 1GHz frequency range, Quasi-Peak detector with 120kHz RBW was used.

Also Peak and Average detector with 1MHz RBW were used for above 1GHz frequency range.

For further description of the configuration refer to the picture of the test set-up.

6.2.2 Limit for Radiated Disturbance

- The test frequency range of Radiated Disturbance measurements are listed below.

Highest frequency generated or used in the device or on which the device operates or tunes (MHz)	Upper frequency of measurement range (MHz)
Below 108	1000
108 – 500	2000
500 – 1000	5000
Above 1000	5 th harmonic of the highest frequency or 6GHz, whichever is lower

(1) Limit for Radiated Emission below 1000MHz

Frequency range (MHz)	Class A Equipment (10m distance)	Class B Equipment (3m distance)
	Quasi-peak limits (dB μ V/m)	Quasi-peak limits (dB μ V/m)
30 to 88	39.1	40
88 to 216	43.5	43.5
216 to 960	46.4	46
960 to 1000	49.5	54

Note 1 The lower limit shall apply at the transition frequency.
 Note 2 Additional provisions may be required for cases where interference occurs.
 Note 3 According to 15.109(g), as an alternative to the radiated emission limit shown above, digital devices may be shown to comply with the standards(CISPR), Pub. 22 shown as below.

30 to 230	40	30
230 to 1000	47	37

(2) Limits for Radiated Emission in the frequency range 1000 - 2000MHz at a measuring distance of 10m

Frequency (GHz)	Class A Equipment		Class B Equipment	
	peak (dB μ V/m)	peak (dB μ V/m)	peak (dB μ V/m)	Average (dB μ V/m)
1 to 2	69.5	49.5	63.5	43.5

(3) Limits for Radiated Emission above 1000MHz at a measuring distance of 3m

Frequency (GHz)	Class A Equipment		Class B Equipment	
	peak (dB μ V/m)	peak (dB μ V/m)	peak (dB μ V/m)	Average (dB μ V/m)
1 to 40	80	60	74	54

Test Result

< 30MHz-1GHz >

RADIATED EMISSION

Date : 2011-08-17

Model Name	: LG-T565	Reference No.	:
Model No.	:	Power Supply	: 120 V 60 Hz
Serial No.	:	Temp/Humi	: 24 °C 51 % R.H.
Test Condition	: PC Link mode	Operator	: H.S KO

Memo :

LIMIT : FCC Part15 Subpart B Class B (3m)
 MARGIN: 3 dB

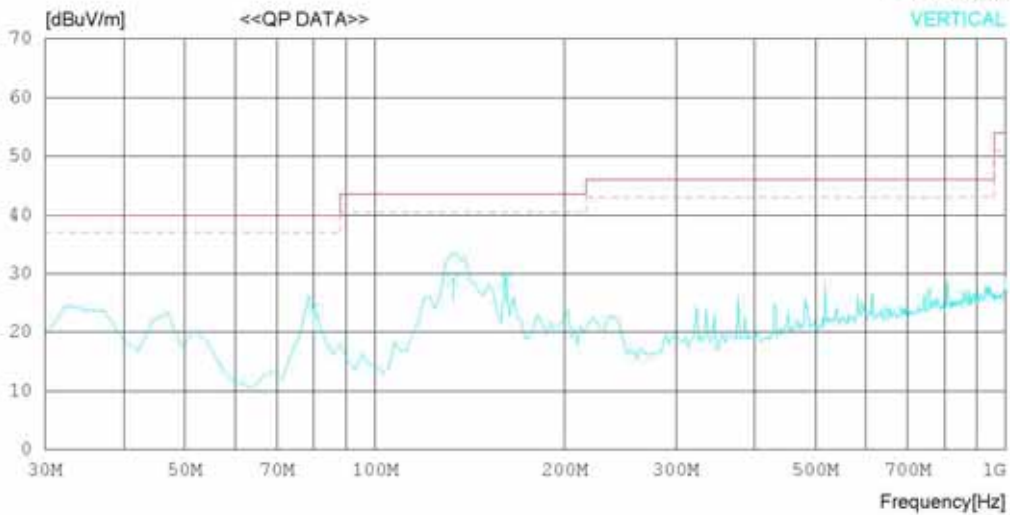
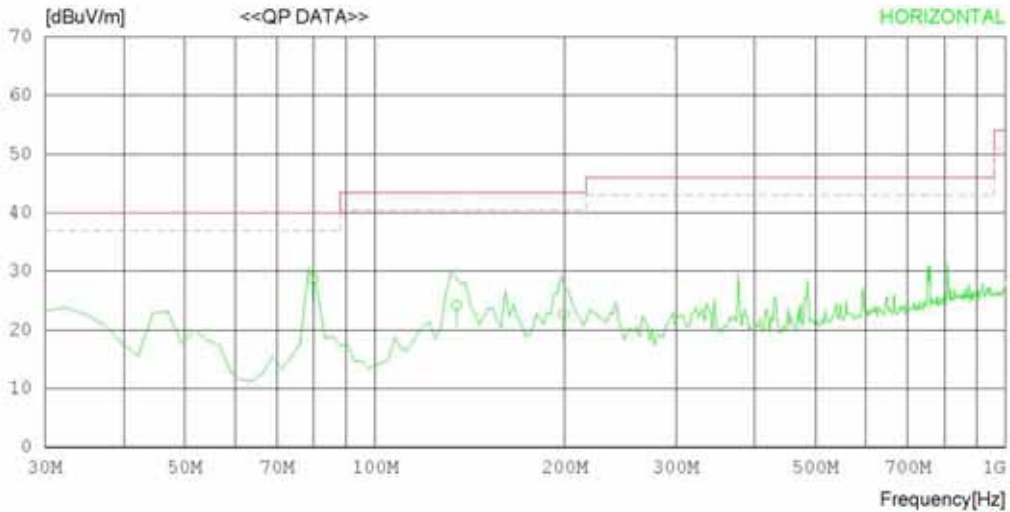

RADIATED EMISSION

Date : 2011-08-17

Model Name	: LG-T565	Reference No.	:
Model No.	:	Power Supply	: 120 V 60 Hz
Serial No.	:	Temp/Humi	: 24 °C 51 % R.H.
Test Condition	: PC Link mode	Operator	: H.S KO

Memo :

LIMIT : FCC Part15 Subpart B Class B (3m)
 MARGIN: 3 dB

No.	FREQ [MHz]	READING QP [dBuV]	ANT FACTOR [dB]	LOSS [dB]	GAIN [dB]	RESULT [dBuV/m]	LIMIT [dBuV/m]	MARGIN [dB]	ANTENNA [cm]	TABLE [DEG]
----- Horizontal -----										
1	79.800	42.8	7.2	1.3	22.6	28.7	40.0	11.3	400	358
2	134.770	34.3	11.3	1.6	23.0	24.2	43.5	19.3	210	358
3	199.369	34.2	9.7	2.0	23.2	22.7	43.5	20.8	203	189
----- Vertical -----										
4	79.825	38.0	7.2	1.3	22.6	23.9	40.0	16.1	148	299
5	132.992	38.9	11.4	1.6	22.9	29.0	43.5	14.5	100	154
6	161.550	40.0	10.2	1.8	23.1	28.9	43.5	14.6	100	148

< 1GHz-6GHz_PEAK >

RADIATED EMISSION

Date : 2011-08-17

Model Name	: LG-T565	Reference No.	:
Model No.	:	Power Supply	: 120 V 60 Hz
Serial No.	:	Temp/Humi	: 24 °C 51 % R.H.
Test Condition	: PC Link mode	Operator	: H.S KO

Memo :

LIMIT : FCC Part15 Subpart.B Class B (3m) - 18G(Peak)
 FCC Part15 Subpart.B Class B (3m) - 18G(Avg)

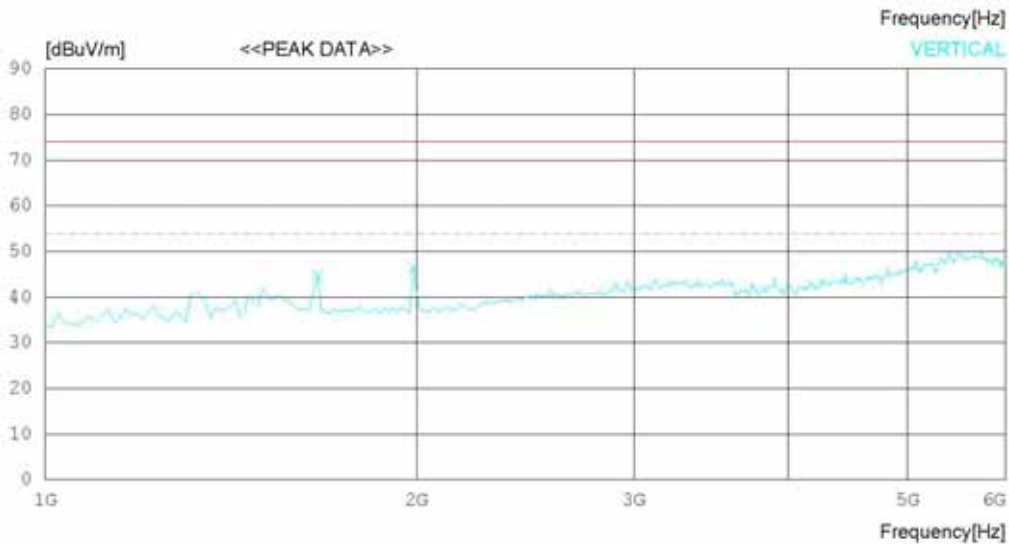
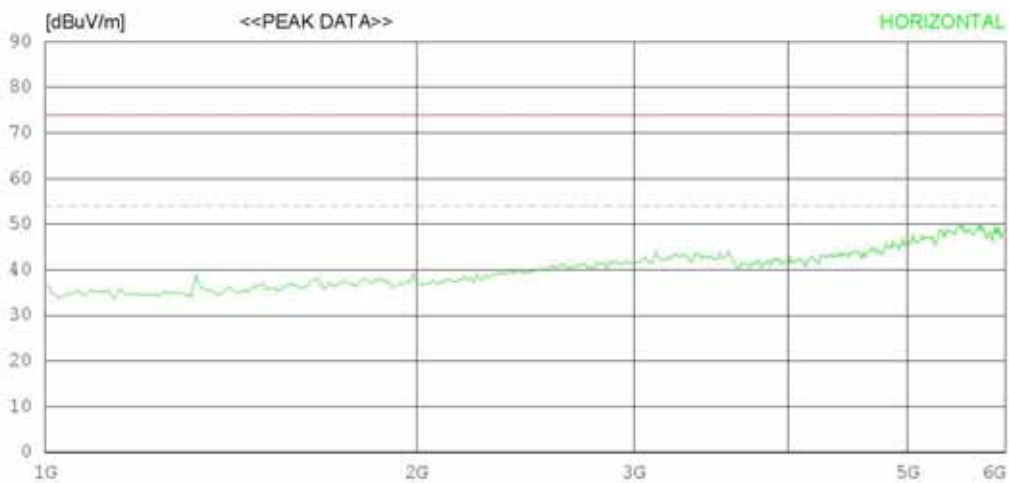

RADIATED EMISSION

Date : 2011-08-17

Model Name	: LG-T565	Reference No.	:
Model No.	:	Power Supply	: 120 V 60 Hz
Serial No.	:	Temp/Humi	: 24 °C 51 % R.H.
Test Condition	: PC Link mode	Operator	: H.S KO
Memo	:		

LIMIT : FCC Part15 Subpart B Class B (3m) - 18G(Peak)
 FCC Part15 Subpart B Class B (3m) - 18G(Avg)

No.	FREQ [MHz]	READING PEAK [dBuV]	ANT FACTOR [dB]	LOSS [dB]	GAIN [dB]	RESULT [dBuV/m]	LIMIT [dBuV/m]	MARGIN [dB]	ANTENNA [cm]	TABLE [DEG]
----- Vertical -----										
1	1662.500	55.2	25.2	6.3	41.9	44.8	74.0	29.2	200	1
2	1987.500	56.2	25.2	7.0	42.0	46.4	74.0	27.6	100	358

< 1GHz-2GHz_Average >

RADIATED EMISSION

Date : 2011-08-17

Model Name	: LG-T565	Reference No.	:
Model No.	:	Power Supply	: 120 V 60 Hz
Serial No.	:	Temp/Humi	: 24 °C 51 % R.H.
Test Condition	: PC Link mode	Operator	: H.S KO

Memo :

LIMIT : FCC Part15 Subpart.B Class B (3m) - 18G(Avg)
 FCC Part15 Subpart.B Class B (3m) - 18G(Peak)

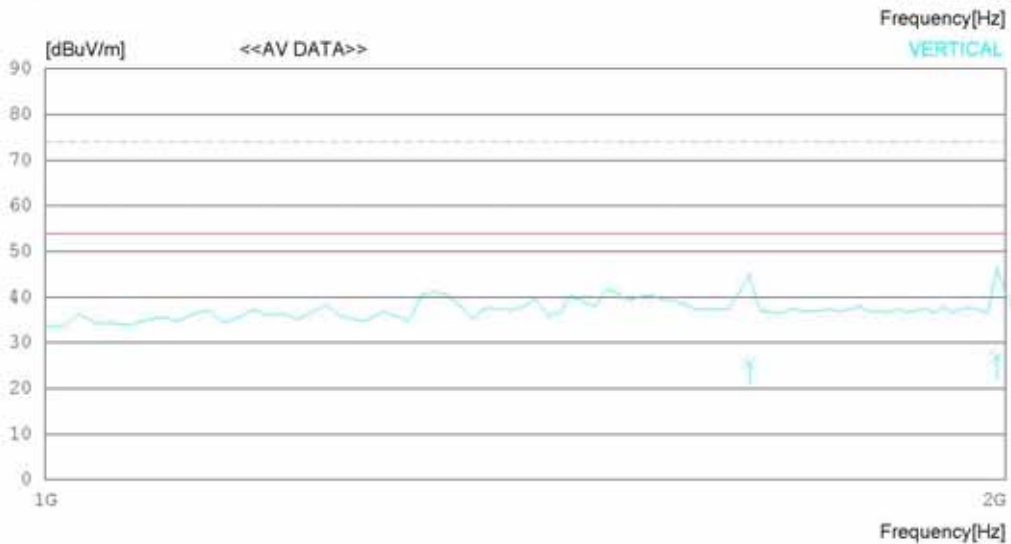

RADIATED EMISSION

Date : 2011-08-17

Model Name	: LG-T565	Reference No.	:
Model No.	:	Power Supply	: 120 V 60 Hz
Serial No.	:	Temp/Humi	: 24 °C 51 % R.H.
Test Condition	: PC Link mode	Operator	: H.S KO
Memo	:		

LIMIT : FCC Part15 Subpart B Class B (3m) - 18G(Avg)
 FCC Part15 Subpart B Class B (3m) - 18G(Peak)

No.	FREQ	READING	ANT	LOSS	GAIN	RESULT	LIMIT	MARGIN	ANTENNA	TABLE
	[MHz]	[dBuV]	FACTOR	[dB]	[dB]	[dBuV/m]	[dBuV/m]	[dB]	[cm]	[DEG]
----- Vertical -----										
1	1662.500	35.6	25.2	6.3	41.9	25.2	54.0	28.8	200	1
2	1987.500	36.6	25.2	7.0	42.0	26.8	54.0	27.2	100	358

Appendix 1**List of Test and Measurement Instruments**

1. Conducted Disturbance

Name of Instrument	Model No.	Serial No.	Manufacturer	Cal. Date	Next Cal. Date
<input checked="" type="checkbox"/> EMI Test Receiver	ESCI	100364	Rohde & Schwarz	2011.03.08	2012.03.08
<input type="checkbox"/> LISN	LISN1600	197204	TTI	2011.07.02	2012.07.02
<input checked="" type="checkbox"/> LISN(EUT)	ESH2-Z5	828739/006	R&S	2010.10.01	2011.10.01
<input checked="" type="checkbox"/> 50 ohm Terminator	CT-01	N/A	TME	2011.01.11	2012.01.11
<input type="checkbox"/> Spectrum Analyzer	8591E	3649A05889	H/P	2011.03.07	2012.03.07
<input type="checkbox"/> RFI/Field intensity Meter	KNM-2402	4N-170-3	KYORITSU	2011.07.02	2012.07.02
<input type="checkbox"/> LISN	KNW-407	8-317-8	KYORITSU	2011.01.11	2012.01.11
<input type="checkbox"/> LISN	KNW-242	8-654-15	KYORITSU	2011.07.02	2012.07.02
<input type="checkbox"/> 50 ohm Terminator	CT-01	N/A	TME	2011.01.11	2012.01.11
<input type="checkbox"/> ISN	T4A	24869	Teseq GmbH	2011.01.11	2012.01.11
<input type="checkbox"/> LISN(DC)	NNBM8125	8125-821	SCHWARZBECK	2011.07.01	2012.07.01

2. Radiated Disturbance

Name of Instrument	Model No.	Serial No.	Manufacturer	Cal. Date	Next Cal. Date
<input checked="" type="checkbox"/> EMI Test Receiver	ESU	100014	Rohde & Schwarz	2011.01.20	2012.01.20
<input checked="" type="checkbox"/> Bilog Antenna	CBL6112B	2737	SCHAFFNER	2010.07.14	2012.07.14
<input checked="" type="checkbox"/> Horn Antenna	BBHA9120A	322	SCHWARZBECK	2010.04.13	2012.04.13
<input checked="" type="checkbox"/> Amplifier(22dB)	8447E	2945A02865	H/P	2011.01.11	2012.01.11
<input checked="" type="checkbox"/> Pre Amplifier	MLA-00108-B02-36	1518831	TSJ	2011.01.11	2012.01.11
<input checked="" type="checkbox"/> Controller	5905A	N/A	TOKIN	-	-
<input checked="" type="checkbox"/> ANT.master	N/A	N/A	TOKIN	-	-
<input type="checkbox"/> EMI Test Receiver	ESCI	100364	Rohde & Schwarz	2011.03.08	2012.03.08
<input type="checkbox"/> BICONICAL ANT.	VHA 9103	91031946	SCHWARZBECK	2010.12.21	2012.12.21
<input type="checkbox"/> LOG-PERIODIC ANT.	UHALP 9108A-A1	1098	SCHWARZBECK	2010.11.29	2012.11.29
<input type="checkbox"/> Pre Amplifier	MLA-100K01-B01-26	1252741	TSJ	2011.03.07	2012.03.07
<input type="checkbox"/> Position Controller	5901T	14173	TOKIN	-	-
<input type="checkbox"/> DRIVER	5902T2	14174	TOKIN	-	-
<input type="checkbox"/> Spectrum Analyzer	E4411B	US41062735	Agilent	2011.07.01	2012.07.01
<input type="checkbox"/> Amplifier (25dB)	8447D	2443A03690	Agilent	2011.07.01	2012.07.01
<input type="checkbox"/> Bilog Antenna	VULB9160	3151	SCHAFFNER	2010.08.25	2012.08.25
<input type="checkbox"/> Controller	5900	N/A	TOKIN	-	-