

# TEST REPORT



**DT&C Co., Ltd.**

42, Yurim-ro, 154Beon-gil, Cheoin-gu, Yongin-si, Gyeonggi-do, Korea, 17042  
Tel : 031-321-2664, Fax : 031-321-1664

1. Report No : DRTFCC1809-0229
2. Customer
  - Name : LG Electronics USA, Inc.
  - Address : 1000 Sylvan Ave. Englewood Cliffs, New Jersey, United States 07632
3. Use of Report : FCC Original Grant
4. Product Name / Model Name : Mobile Phone / LM-Q850FA  
FCC ID : ZNFQ850FA
5. Test Method Used : KDB971168 D01v03, ANSI/TIA-603-E-2016, ANSI C63.26-2015  
Test Specification : §2, §22, §24(E), §27
6. Date of Test : 2018.08.01 ~ 2018.09.03
7. Testing Environment : Refer to appended test report.
8. Test Result : Refer to the attached test result.

Affirmation	Tested by	Reviewed by
	Name : JaeHyeok Bang 	Name : Geunki Son  (Signature)

The test results presented in this test report are limited only to the sample supplied by applicant and the use of this test report is inhibited other than its purpose. This test report shall not be reproduced except in full, without the written approval of DT&C Co., Ltd.

2018 . 09 . 04 .

**DT&C Co., Ltd.**

If this report is required to confirmation of authenticity, please contact to [report@dtnc.net](mailto:report@dtnc.net)

## Test Report Version

Test Report No.	Date	Description
DRTFCC1809-0229	Sep. 04, 2018	Initial issue

# Table of Contents

<b>1. GENERAL INFORMATION .....</b>	<b>5</b>
<b>2. INTRODUCTION .....</b>	<b>8</b>
2.1 EUT DESCRIPTION .....	8
2.2. EUT CAPABILITIES .....	8
2.3. TESTING ENVIRONMENT .....	8
2.4 MEASURING INSTRUMENT CALIBRATION.....	8
2.5. MEASUREMENT UNCERTAINTY .....	8
2.6. TEST FACILITY.....	8
<b>3. DESCRIPTION OF TESTS.....</b>	<b>9</b>
3.1 ERP & EIRP (Effective Radiated Power & Equivalent Isotropic Radiated Power) .....	9
3.2 PEAK TO AVERAGE RATIO .....	11
3.3 OCCUPIED BANDWIDTH.....	12
3.4 BAND EDGE EMISSIONS AT ANTENNA TERMINAL .....	13
3.5 SPURIOUS AND HARMONIC EMISSIONS AT ANTENNA TERMINAL .....	14
3.6 UNDESIRABLE EMISSIONS .....	15
3.7 FREQUENCY STABILITY .....	16
<b>4. LIST OF TEST EQUIPMENT .....</b>	<b>17</b>
<b>5. SUMMARY OF TEST RESULTS .....</b>	<b>18</b>
<b>6. SAMPLE CALCULATION .....</b>	<b>19</b>
<b>7. TEST DATA.....</b>	<b>22</b>
7.1 OCCUPIED BANDWIDTH.....	22
7.2 PEAK TO AVERAGE RATIO.....	22
7.3 BAND EDEG EMISSIONS (Conducted).....	22
7.4 SPURIOUS AND HARMONICS EMISSIONS (Conducted) .....	22
7.5 ERP & EIRP .....	23
7.5.1 LTE Band 12,17 .....	23
7.5.2 LTE Band 12.....	24
7.5.3 LTE Band 5.....	25
7.5.4 LTE Band 4, 66.....	26
7.5.5 LTE Band 2.....	28
7.5.6 LTE Band 41.....	30
7.5.7 LTE Band 7.....	31
7.6 UNDESIRABLE EMISSIONS (Radiated).....	32
7.6.1 LTE Band 12,17.....	32
7.6.2 LTE Band 12.....	33
7.6.3 LTE Band 5.....	34
7.6.4 LTE Band 4, 66.....	35
7.6.5 LTE Band 2.....	37
7.6.6 LTE Band 41.....	39

7.6.7 LTE Band 7.....	41
<b>7.7 FREQUENCY STABILITY .....</b>	<b>43</b>
7.7.1 LTE Band 12,17.....	43
7.7.2 LTE Band 5.....	44
7.7.3 LTE Band 4, 66.....	45
7.7.4 LTE Band 2.....	46
7.7.5 LTE Band 41.....	47
7.7.6 LTE Band 7.....	48
<b>8. TEST PLOTS .....</b>	<b>49</b>
<b>8.1 OCCUPIED BANDWIDTH.....</b>	<b>49</b>
8.1.1 LTE Band 12,17.....	49
8.1.2 LTE Band 12.....	53
8.1.3 LTE Band 5.....	57
8.1.4 LTE Band 4,66.....	65
8.1.5 LTE Band 2.....	77
8.1.6 LTE Band 41.....	89
8.1.7 LTE Band 7.....	97
<b>8.2 PEAK TO AVERAGE RATIO.....</b>	<b>105</b>
8.2.1 LTE Band 12,17.....	105
8.2.2 LTE Band 12.....	109
8.2.3 LTE Band 5.....	113
8.2.4 LTE Band 4,66.....	121
8.2.5 LTE Band 2.....	133
8.2.6 LTE Band 41.....	145
8.2.7 LTE Band 7.....	153
<b>8.3 BAND EDGE EMISSIONS(Conducted).....</b>	<b>161</b>
8.3.1 LTE Band 12,17.....	161
8.3.2 LTE Band 12.....	165
8.3.3 LTE Band 5.....	169
8.3.4 LTE Band 4,66.....	177
8.3.5 LTE Band 2.....	189
8.3.6 LTE Band 41.....	201
8.3.7 LTE Band 7.....	207
<b>8.4 SPURIOUS AND HARMONICS EMISSIONS(Conducted) .....</b>	<b>213</b>
8.4.1 LTE Band 12,17.....	213
8.4.2 LTE Band 12.....	216
8.4.3 LTE Band 5.....	219
8.4.4 LTE Band 4,66.....	225
8.4.5 LTE Band 2.....	243
8.4.6 LTE Band 41.....	261
8.4.7 LTE Band 7.....	273

## 1. GENERAL INFORMATION

**Applicant Name** : LG Electronics USA, Inc.  
**Address** : 1000 Sylvan Ave. Englewood Cliffs, New Jersey, United States 07632  
**FCC ID** : ZNFQ850FA  
**FCC Classification** : PCS Licensed Transmitter held to ear (PCE)  
**EUT Type** : Mobile Phone  
**Model Name** : LM-Q850FA  
**Add Model Name** : LMQ850FA, Q850FA, LM-Q850FM, LMQ850FM, Q850FM, LM-Q850EA, LMQ850EA, Q850EA, LM-Q850EM, LMQ850EM, Q850EM, LM-Q850EAW, LMQ850EAW, Q850EAW, LM-Q850EMW, LMQ850EMW, Q850EMW  
**Supplying power** : DC 3.85 V  
**Antenna Information** : PIFA Antenna

Mode	TX Frequency (MHz)	Emission Designator	Modulation	ERP	
				Max power (dBm)	Max power (W)
LTE Band 12,17	704 ~ 711	8M95G7D	QPSK	16.51	0.045
LTE Band 12,17	704 ~ 711	8M95W7D	16QAM	15.64	0.037
LTE Band 12,17	704 ~ 711	8M97W7D	64QAM	14.63	0.029
LTE Band 12,17	701.5 ~ 713.5	4M48G7D	QPSK	16.21	0.042
LTE Band 12,17	701.5 ~ 713.5	4M48W7D	16QAM	15.50	0.035
LTE Band 12,17	701.5 ~ 713.5	4M50W7D	64QAM	14.51	0.028
LTE Band 12	700.5 ~ 714.5	2M69G7D	QPSK	16.36	0.043
LTE Band 12	700.5 ~ 714.5	2M70W7D	16QAM	15.57	0.036
LTE Band 12	700.5 ~ 714.5	2M69W7D	64QAM	14.52	0.028
LTE Band 12	699.7 ~ 715.3	1M09G7D	QPSK	16.08	0.041
LTE Band 12	699.7 ~ 715.3	1M08W7D	16QAM	15.42	0.035
LTE Band 12	699.7 ~ 715.3	1M09W7D	64QAM	14.31	0.027
LTE Band 5	829 ~ 844	8M96G7D	QPSK	23.10	0.204
LTE Band 5	829 ~ 844	8M94W7D	16QAM	22.47	0.177
LTE Band 5	829 ~ 844	8M95W7D	64QAM	21.55	0.143
LTE Band 5	826.5 ~ 846.5	4M48G7D	QPSK	22.55	0.180
LTE Band 5	826.5 ~ 846.5	4M50W7D	16QAM	21.94	0.156
LTE Band 5	826.5 ~ 846.5	4M49W7D	64QAM	20.81	0.121
LTE Band 5	825.5 ~ 847.5	2M69G7D	QPSK	21.78	0.151
LTE Band 5	825.5 ~ 847.5	2M70W7D	16QAM	20.92	0.124
LTE Band 5	825.5 ~ 847.5	2M70W7D	64QAM	20.14	0.103
LTE Band 5	824.7 ~ 848.3	1M09G7D	QPSK	22.07	0.161
LTE Band 5	824.7 ~ 848.3	1M09W7D	16QAM	21.33	0.136
LTE Band 5	824.7 ~ 848.3	1M09W7D	64QAM	20.37	0.109

Mode	TX Frequency (MHz)	Emission Designator	Modulation	EIRP	
				Max power(dBm)	Max power(W)
LTE Band 4,66	1720 ~ 1745	17M9G7D	QPSK	21.35	0.136
LTE Band 4,66	1720 ~ 1745	17M9W7D	16QAM	20.64	0.116
LTE Band 4,66	1720 ~ 1745	17M9W7D	64QAM	19.69	0.093
LTE Band 4,66	1717.5 ~ 1747.5	13M4G7D	QPSK	22.42	0.175
LTE Band 4,66	1717.5 ~ 1747.5	13M4W7D	16QAM	21.55	0.143
LTE Band 4,66	1717.5 ~ 1747.5	13M4W7D	64QAM	20.05	0.101
LTE Band 4,66	1715 ~ 1750	8M97G7D	QPSK	21.96	0.157
LTE Band 4,66	1715 ~ 1750	8M96W7D	16QAM	21.27	0.134
LTE Band 4,66	1715 ~ 1750	8M96W7D	64QAM	20.18	0.104
LTE Band 4,66	1712.5 ~ 1752.5	4M48G7D	QPSK	21.36	0.137
LTE Band 4,66	1712.5 ~ 1752.5	4M50W7D	16QAM	20.85	0.122
LTE Band 4,66	1712.5 ~ 1752.5	4M49W7D	64QAM	19.53	0.090
LTE Band 4,66	1711.5 ~ 1753.5	2M70G7D	QPSK	20.96	0.125
LTE Band 4,66	1711.5 ~ 1753.5	2M70W7D	16QAM	20.30	0.107
LTE Band 4,66	1711.5 ~ 1753.5	2M69W7D	64QAM	19.22	0.084
LTE Band 4,66	1710.7 ~ 1754.3	1M09G7D	QPSK	21.53	0.142
LTE Band 4,66	1710.7 ~ 1754.3	1M08W7D	16QAM	20.89	0.123
LTE Band 4,66	1710.7 ~ 1754.3	1M08W7D	64QAM	19.77	0.095
LTE Band 2	1860 ~ 1900	17M9G7D	QPSK	21.57	0.144
LTE Band 2	1860 ~ 1900	17M9W7D	16QAM	20.99	0.126
LTE Band 2	1860 ~ 1900	17M9W7D	64QAM	19.27	0.085
LTE Band 2	1857.5 ~ 1902.5	13M5G7D	QPSK	20.86	0.122
LTE Band 2	1857.5 ~ 1902.5	13M4W7D	16QAM	19.98	0.100
LTE Band 2	1857.5 ~ 1902.5	13M4W7D	64QAM	19.15	0.082
LTE Band 2	1855 ~ 1905	8M97G7D	QPSK	20.67	0.117
LTE Band 2	1855 ~ 1905	8M94W7D	16QAM	20.45	0.111
LTE Band 2	1855 ~ 1905	8M97W7D	64QAM	19.47	0.089
LTE Band 2	1852.5 ~ 1907.5	4M49G7D	QPSK	20.52	0.113
LTE Band 2	1852.5 ~ 1907.5	4M50W7D	16QAM	19.76	0.095
LTE Band 2	1852.5 ~ 1907.5	4M50W7D	64QAM	18.63	0.073
LTE Band 2	1851.5 ~ 1908.5	2M69G7D	QPSK	20.68	0.117
LTE Band 2	1851.5 ~ 1908.5	2M70W7D	16QAM	19.72	0.094
LTE Band 2	1851.5 ~ 1908.5	2M68W7D	64QAM	18.57	0.072
LTE Band 2	1850.7 ~ 1909.3	1M09G7D	QPSK	20.54	0.113
LTE Band 2	1850.7 ~ 1909.3	1M09W7D	16QAM	19.79	0.095
LTE Band 2	1850.7 ~ 1909.3	1M09W7D	64QAM	18.92	0.078

Mode	TX Frequency (MHz)	Emission Designator	Modulation	EIRP	
				Max power(dBm)	Max power(W)
LTE Band 41	2506 ~ 2680	17M8G7D	QPSK	21.07	0.128
LTE Band 41	2506 ~ 2680	17M8W7D	16QAM	19.78	0.095
LTE Band 41	2506 ~ 2680	17M9W7D	64QAM	20.55	0.114
LTE Band 41	2503.5 ~ 2682.5	13M3G7D	QPSK	21.87	0.154
LTE Band 41	2503.5 ~ 2682.5	13M2W7D	16QAM	19.55	0.090
LTE Band 41	2503.5 ~ 2682.5	13M4W7D	64QAM	18.92	0.078
LTE Band 41	2501 ~ 2685	8M93G7D	QPSK	21.85	0.153
LTE Band 41	2501 ~ 2685	8M89W7D	16QAM	21.38	0.137
LTE Band 41	2501 ~ 2685	8M80W7D	64QAM	20.22	0.105
LTE Band 41	2498.5 ~ 2687.5	4M47G7D	QPSK	20.29	0.107
LTE Band 41	2498.5 ~ 2687.5	4M47W7D	16QAM	19.54	0.090
LTE Band 41	2498.5 ~ 2687.5	4M44W7D	64QAM	18.68	0.074
LTE Band 7	2510 ~ 2560	17M9G7D	QPSK	19.74	0.094
LTE Band 7	2510 ~ 2560	17M9W7D	16QAM	18.68	0.074
LTE Band 7	2510 ~ 2560	17M9W7D	64QAM	17.81	0.060
LTE Band 7	2507.5 ~ 2562.5	13M4G7D	QPSK	19.27	0.085
LTE Band 7	2507.5 ~ 2562.5	13M4W7D	16QAM	18.66	0.073
LTE Band 7	2507.5 ~ 2562.5	13M4W7D	64QAM	17.63	0.058
LTE Band 7	2505 ~ 2565	8M96G7D	QPSK	19.72	0.094
LTE Band 7	2505 ~ 2565	8M96W7D	16QAM	18.89	0.077
LTE Band 7	2505 ~ 2565	8M96W7D	64QAM	17.79	0.060
LTE Band 7	2502.5 ~ 2567.5	4M48G7D	QPSK	19.61	0.091
LTE Band 7	2502.5 ~ 2567.5	4M49W7D	16QAM	18.97	0.079
LTE Band 7	2502.5 ~ 2567.5	4M48W7D	64QAM	17.82	0.061

## 2. INTRODUCTION

### 2.1 EUT DESCRIPTION

The Equipment Under Test (EUT) supports GSM/WCDMA/LTE Phone with Bluetooth, WLAN, NFC.

### 2.2. EUT CAPABILITIES

This EUT contains the following capabilities:

850/1900 GSM/EDGE, 850/1700/1900 WCDMA/HSUPA, Multi-band LTE, 802.11b/g/n/ac WLAN(2.4GHz)  
802.11a/n/ac WLAN(5GHz), Bluetooth(BDR, EDR, LE), NFC.

### 2.3. TESTING ENVIRONMENT

Ambient Condition	
▪ Temperature	+20 °C ~ +25 °C
▪ Relative Humidity	41 % ~ 45 %

### 2.4 MEASURING INSTRUMENT CALIBRATION

The measuring equipment, which was utilized in performing the tests documented herein, has been calibrated in accordance with the manufacturer's recommendations for utilizing calibration equipment, which is traceable to recognized national standards.

### 2.5. MEASUREMENT UNCERTAINTY

The measurement uncertainties shown below were calculated in accordance with requirements of ANSI C 63.4-2014. All measurement uncertainty values are shown with a coverage factor of  $k = 2$  to indicate a 95 % level of confidence.

Parameter	Measurement uncertainty
Radiated Disturbance (Below 1 GHz)	5.1 dB (The confidence level is about 95 %, $k = 2$ )
Radiated Disturbance (1 GHz ~ 18 GHz)	5.4 dB (The confidence level is about 95 %, $k = 2$ )
Radiated Disturbance (Above 18 GHz)	5.3 dB (The confidence level is about 95 %, $k = 2$ )

### 2.6. TEST FACILITY

<b>DT&amp;C Co., Ltd.</b>	
The 3 m test site and conducted measurement facility used to collect the radiated data are located at the 42, Yurim-ro, 154beon-gil, Cheoin-gu, Yongin-si, Gyeonggi-do, Korea 17042. The test site comply with the requirements of § 2.948 according to ANSI 63.4-2014.	
<b>- FCC MRA Accredited Test Firm No. : KR0034</b>	
<a href="http://www.dtnet.net">www.dtnet.net</a>	
Telephone	: + 82-31-321-2664
FAX	: + 82-31-321-1664



### 3. DESCRIPTION OF TESTS

#### 3.1 ERP & EIRP (Effective Radiated Power & Equivalent Isotropic Radiated Power)

##### Test Set-up

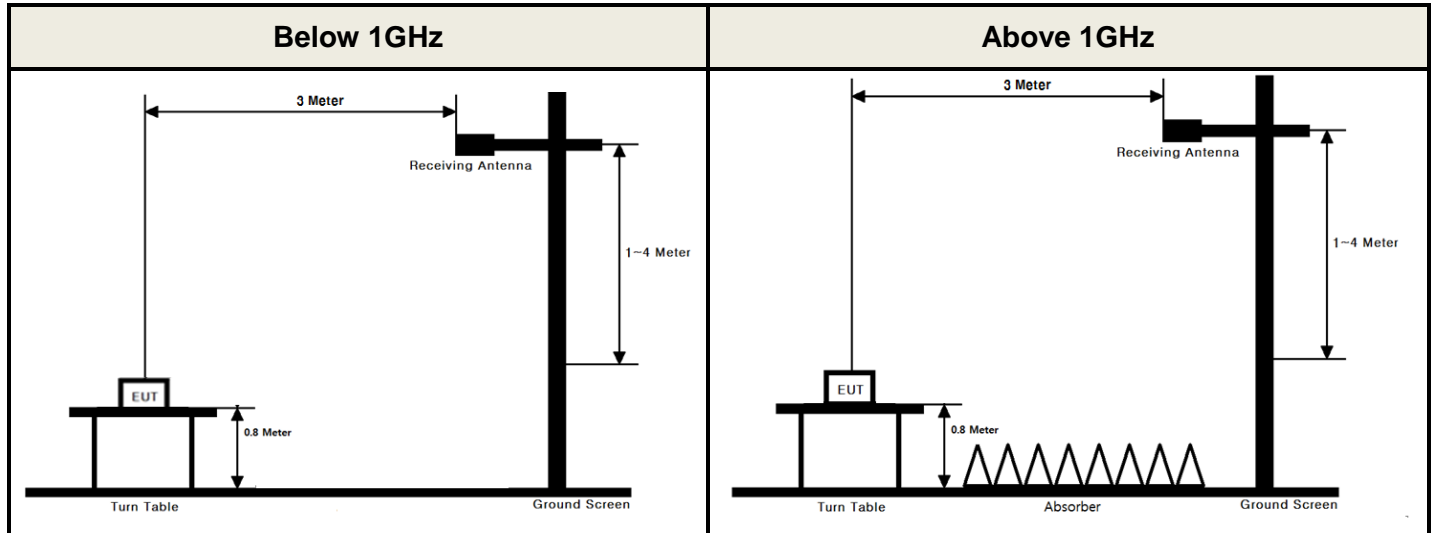

These measurements were performed at 3 m test site. The equipment under test is placed on a non-conductive table 0.8-meters above a turntable which is flush with the ground plane and 3 meters from the receive antenna. For measurements above 1GHz absorbers are placed on the floor between the turn table and the antenna mast in such a way so as to maximize the reduction of reflections. For measurements below 1 GHz, the absorbers are removed.

##### Test Procedure

- ANSI/TIA-603-E-2016 - Section 2.2.17
- KDB971168 D01v03 - Section 5.2.2
- ANSI C63.26-2015 – Section 5.2.4.4.1

##### Test setting

1. Set span to 2 x to 3 x the OBW.
2. Set RBW = 1% to 5% of the OBW.
3. Set VBW  $\geq$  3 x RBW.
4. Set number of points in sweep  $\geq$  2 x span / RBW.
5. Sweep time:
  - 1) Set = auto-couple, or
  - 2) Set  $\geq$  [10 x (number of points in sweep) x (transmission period)] for single sweep (automation-compatible) measurement. Transmission period is the on and off time of the transmitter.
6. Detector = power averaging (rms).
7. If the EUT can be configured to transmit continuously, then set the trigger to free run.
8. If the EUT cannot be configured to transmit continuously, then use a sweep trigger with the level set to enable triggering only on full power bursts and configure the EUT to transmit at full power for the entire duration of each sweep. Verify that the sweep time is less than or equal to the transmission burst duration. Time gating can also be used under similar constraints (i.e., configured such that measurement data is collected only during active full-power transmissions).
9. Trace average at least 100 traces in power averaging (rms) mode if sweep is set to auto-couple. To accurately determine the average power over multiple symbols, it can be necessary to increase the number of traces to be averaged above 100 or, if using a manually configured sweep time, increase the sweep time.

10. Compute the power by integrating the spectrum across the OBW of the signal using the instrument's band or channel power measurement function, with the band/channel limits set equal to the OBW band edges. If the instrument does not have a band or channel power function, then sum the spectrum levels (in linear power units) at intervals equal to the RBW extending across the entire OBW of the spectrum.

The receiver antenna height and turntable rotations were adjusted for the highest reading on the receive spectrum analyzer.

A half-wave dipole was substituted in place of the EUT. This dipole antenna was driven by a signal generator and the level of the signal generator was adjusted to obtain the same receive spectrum analyzer reading. The conducted power at the terminal of the substitute antenna is measured.

The ERP/EIRP is calculated using the following formula:

**ERP/EIRP = The conducted power at the substitute antenna's terminal [dBm] + Substitute Antenna gain [dBd for ERP , dBi for EIRP]**

For readings above 1 GHz, the above procedure is repeated using horn antennas and the difference between the gain of the horn antenna and an isotropic antenna are taken into consideration.

## 3.2 PEAK TO AVERAGE RATIO

### Test set-up

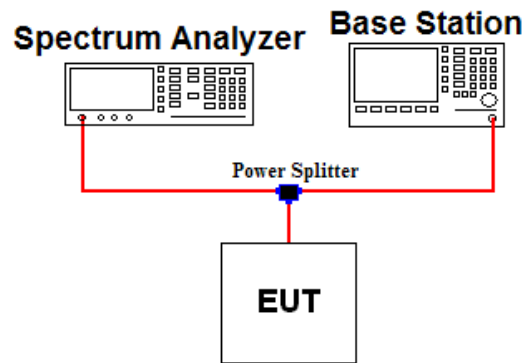

### Test Procedure

- KDB971168 D01v03 - Section 5.7.2
- ANSI C63.26-2015 – Section 5.2.3.4

A peak to average ratio measurement is performed at the conducted port of the EUT.

The spectrum analyzers Complementary Cumulative Distribution Function (CCDF) measurement profile is used to determine the largest deviation between the average and the peak power of the EUT in a given bandwidth. The CCDF curve shows how much time the peak waveform spends at or above a given average power level. The present of time the signal spends at or above the level defines the probability for that particular power level.

### Test setting

The spectrum Analyzer's CCDF measurement function is enabled.

1. Set resolution/measurement bandwidth  $\geq$  OBW or specified reference bandwidth.
2. Set the number of counts to a value that stabilizes the measured CCDF curve.
3. Set the measurement interval as follows:
  - 1) For continuous transmissions, set to the greater of  $[10 \times (\text{number of points in sweep}) \times (\text{transmission symbol period})]$  or 1 ms.
  - 2) For burst transmissions, employ an external trigger that is synchronized with the EUT burst timing sequence, or use the internal burst trigger with a trigger level that allows the burst to stabilize. Set the measurement interval to a time that is less than or equal to the burst duration.
  - 3) If there are several carriers in a single antenna port, the peak power shall be determined for each individual carrier (by disabling the other carriers while measuring the required carrier) and the total peak power calculated from the sum of the individual carrier peak powers.
4. Record the maximum PAPR level associated with a probability of 0.1%.
5. The peak power level is calculated from the sum of the PAPR value from step d) to the measured average power.

### 3.3 OCCUPIED BANDWIDTH.

#### *Test set-up*

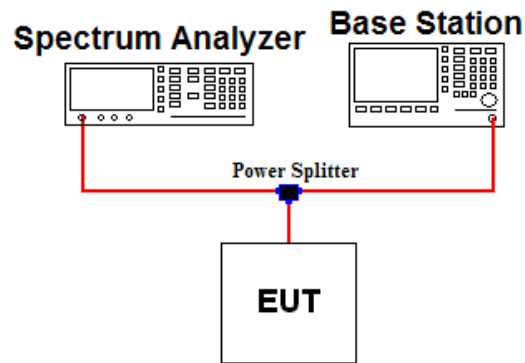

#### *Test Procedure*

- KDB971168 D01v03 - Section 4.3
- ANSI C63.26-2015 – Section 5.4.4

The occupied bandwidth, that is the frequency bandwidth such that, below its lower and above its upper frequency limits, the mean powers radiated are each equal to 0.5 percent of the total mean power of a given emission.

#### Test setting

1. The signal analyzer's automatic bandwidth measurement capability was used to perform the 99 % occupied bandwidth and the 26 dB bandwidth. The bandwidth measurement was not influenced by any intermediate power nulls in the fundamental emission.
2.  $RBW = 1 \sim 5 \%$  of the expected OBW &  $VBW \geq 3 \times RBW$
3. Detector = Peak
4. Trance mode = Max hold
5. Sweep = Auto couple
6. The trace was allowed to stabilize
7. If necessary, step 2 ~ 6 were repeated after changing the RBW such that it would be within 1 ~ 5 % of the 99 % occupied bandwidth observed in step 6.

### 3.4 BAND EDGE EMISSIONS AT ANTENNA TERMINAL

#### Test set-up

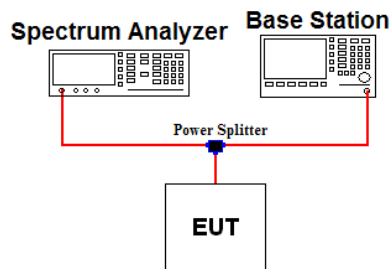

#### Test Procedure

- KDB971168 D01v03 - Section 6
- ANSI C63.26-2015 – Section 5.7

All out of band emissions are measured by means of a calibrated spectrum analyzer. The EUT was setup to maximum output power at its lowest and highest channel with all bandwidths, modulations and RB configurations.

The power of any spurious emission shall be attenuated below the transmitter power (P) by at least  $43 + 10 \log(P)$  dB.

#### Test setting

1. Start and stop frequency were set such that the band edge would be placed in the center of the plot
2. Span was set large enough so as to capture all out of band emissions near the band edge
3. RBW  $\geq 1\%$  of the emission bandwidth
4. VBW  $\geq 3 \times$  RBW
5. Detector = RMS & Trace mode = Max hold
6. Sweep time = Auto couple or 1 s for band edge
7. Number of sweep point  $\geq 2 \times$  span / RBW
8. The trace was allowed to stabilize

Note 1: Per Part 22.917(b)(1) / 24.238(b) / 27.53(h) in the 1 MHz bands immediately outside and adjacent to the frequency block a resolution bandwidth of at least one percent of the emission bandwidth of the fundamental emission of the transmitter may be employed to demonstrate compliance with the out-of-band emissions limit.

The emission bandwidth is defined as the width of the signal between two points, one below the carrier center frequency and one above the carrier center frequency, outside of which all emission are attenuated at least 26 dB below the transmitter power.

Note 2: Per Part 27(g) for operations in the 600 MHz band and the 698-746 MHz band, compliance with this provision is based on the use of measurement instrumentation employing a resolution bandwidth of 100 kilohertz or greater. However, in the 100 kilohertz bands immediately outside and adjacent to a licensee's frequency block, a resolution bandwidth of at least 30 kHz may be employed.

Note 3: For part 27.53(m)(4) the attenuation factor shall be not less than  $40 + 10 \log(P)$  dB on all frequencies between the channel edge and 5 megahertz from the channel edge,  $43 + 10 \log(P)$  dB on all frequencies between 5 megahertz and X megahertz from the channel edge, and  $55 + 10 \log(P)$  dB on all frequencies more than X megahertz from the channel edge, where X is the greater of 6 megahertz or the actual emission bandwidth as defined in paragraph (m)(6) of this section. In addition, the attenuation factor shall not be less than  $43 + 10 \log(P)$  dB on all frequencies between 2490.5 MHz and 2496 MHz and  $55 + 10 \log(P)$  dB at or below 2490.5 MHz.

Note 4: Per part 27.53(m)(6) in the 1 MHz bands immediately outside and adjacent to the frequency block a resolution bandwidth of at least two percent may be employed, except when the 1 MHz band is 2495-2496 MHz, in which case a resolution bandwidth of at least one percent may be employed.

### 3.5 SPURIOUS AND HARMONIC EMISSIONS AT ANTENNA TERMINAL

#### Test set-up

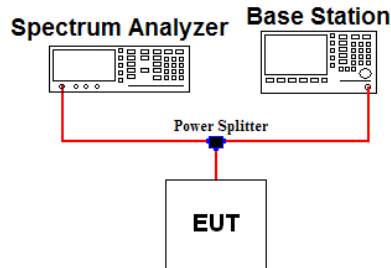

#### Test Procedure

- KDB971168 D01v03 - Section 6
- ANSI C63.26-2015 – Section 5.7

The level of the carrier and the various conducted spurious and harmonic frequencies is measured by means of a calibrated spectrum analyzer. The EUT was setup to maximum output power at its low, middle, high channel with all bandwidths, modulations and RB configurations. The spectrum is scanned from 9 kHz up to a frequency including its 10<sup>th</sup> harmonic.

The power of any spurious emission shall be attenuated below the transmitter power (P) by at least  $43 + 10 \log(P)$  dB.

#### Test setting

1. RBW = 100 kHz(Below 1 GHz) or 1 MHz(Above 1 GHz) & VBW  $\geq 3 \times$  RBW ( Refer to Note 1)
2. Detector = RMS & Trace mode = Max hold
3. Sweep time = Auto couple
4. Number of sweep point  $\geq 2 \times$  span / RBW
5. The trace was allowed to stabilize

Note 1: Compliance with these provisions is based on the use of measurement instrumentation employing a resolution bandwidth of 100 kHz or greater for frequencies less than 1GHz and 1MHz or greater for frequencies greater than 1GHz.

### 3.6 UNDESIRABLE EMISSIONS

#### Test Set-up

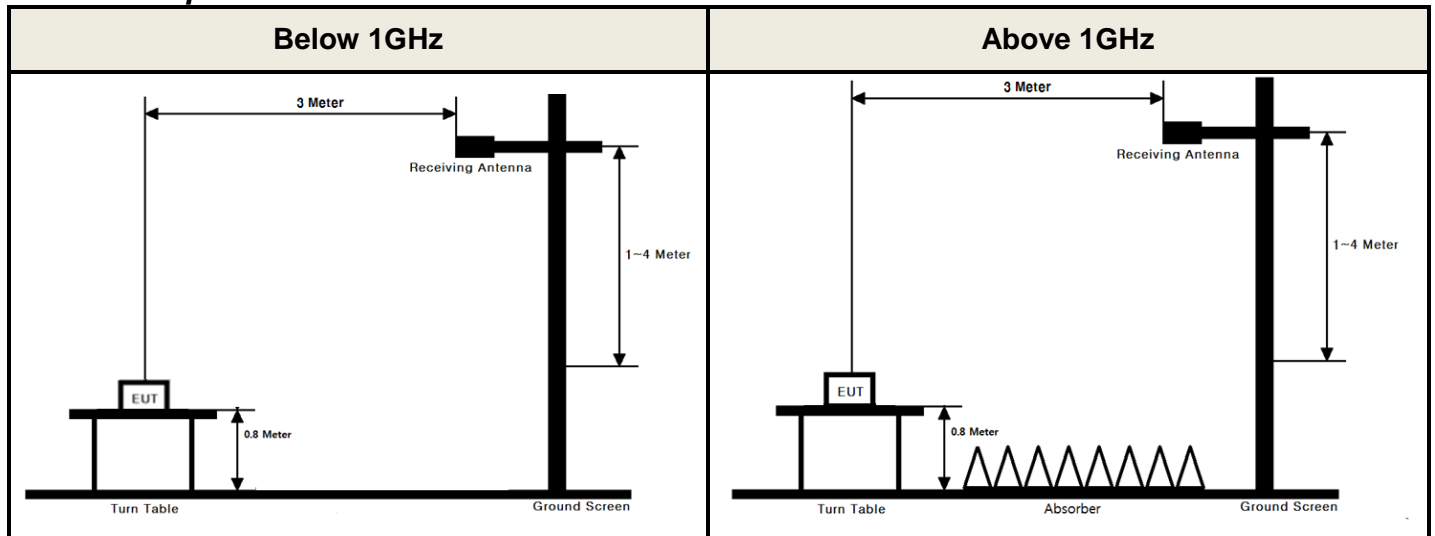

These measurements were performed at 3 test site. The equipment under test is placed on a non-conductive table 0.8-meters above a turntable which is flush with the ground plane and 3 meters from the receive antenna. For measurements above 1 GHz absorbers are placed on the floor between the turn table and the antenna mast in such a way so as to maximize the reduction of reflections. For measurements below 1 GHz, the absorbers are removed.

#### Test Procedure

- ANSI/TIA-603-E-2016 - Section 2.2.12
- KDB971168 D01v03 - Section 5.8
- ANSI C63.26-2015 – Section 5.5

#### Test setting

1. RBW = 100 kHz for below 1 GHz and 1 MHz for above 1 GHz / VBW  $\geq$  3 X RBW
2. Detector = RMS & Trace mode = Max hold
3. Sweep time = Auto couple
4. Number of sweep point  $\geq$  2 X span / RBW
5. The trace was allowed to stabilize

The receive antenna height and turntable rotations were adjusted for the highest reading on the receive spectrum analyzer.

For radiated power measurements below 1 GHz, a half-wave dipole was substituted in place of the EUT. This dipole antenna was driven by a signal generator and the level of the signal generator was adjusted to obtain the same spectrum analyzer reading.

For radiated power measurements above 1 GHz, a Horn antenna was substituted in place of the EUT. This Horn antenna was driven by a signal generator and the level of the signal generator was adjusted to obtain the same spectrum analyzer reading. The difference between the gain of the horn and an isotropic antenna are taken into consideration.

This measurement was performed with the EUT oriented in 3 orthogonal axis.

### 3.7 FREQUENCY STABILITY

#### Test Set-up

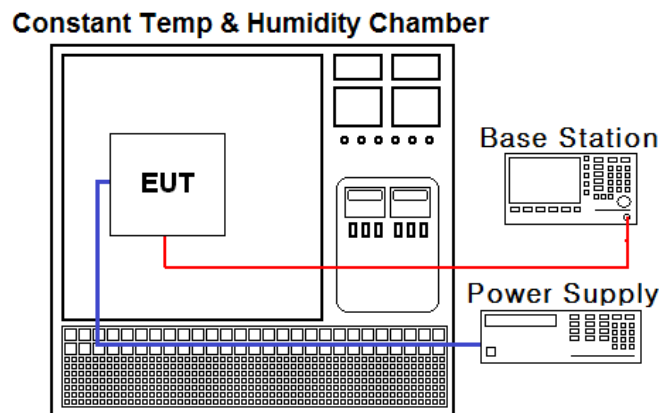

#### Test Procedure

- ANSI/TIA-603-E-2016
- KDB971168 D01v03 - Section 9

The frequency stability of the transmitter is measured by:

a.) **Temperature:**

The temperature is varied from - 30 °C to + 50 °C using an environmental chamber.

b.) **Primary Supply Voltage:**

The primary supply voltage is varied from 85 % to 115 % of the nominal value for non hand-carried battery and AC powered equipment. For hand-carried, battery-powered equipment, primary supply voltage is reduced to the battery operating end point which shall be specified by the manufacturer.

#### Specification:

The frequency stability shall be sufficient to ensure that the fundamental emission stays within the authorized frequency block for Part 24, 27. The frequency stability of the transmitter shall be maintained within  $\pm 0.00025\%$  ( $\pm 2.5$  ppm) of the center frequency for Part 22.

#### Time Period and Procedure:

1. The carrier frequency of the transmitter is measured at room temperature.  
(20 °C to provide a reference)
2. The equipment is turned on in a "standby" condition for one minute before applying power to the transmitter. Measurement of the carrier frequency of the transmitter is made within one minute after applying power to the transmitter.
3. Frequency measurements are made at 10 °C intervals ranging from -30 °C to +50 °C.  
A period of at least one half-hour is provided to allow stabilization of the equipment at each temperature level.



#### 4. LIST OF TEST EQUIPMENT

Type	Manufacturer	Model	Cal.Date (yy/mm/dd)	Next.Cal. Date (yy/mm/dd)	S/N
Spectrum Analyzer	Agilent Technologies	N9020A	17/09/05	18/09/05	MY46471251
Spectrum Analyzer	Agilent Technologies	N9020A	17/12/26	18/12/26	MY50200828
Spectrum Analyzer	Agilent Technologies	N9020A	18/07/09	19/07/09	MY50410163
Spectrum Analyzer	Agilent Technologies	N9030A	17/09/07	18/09/07	MY53310140
DC power supply	Agilent Technologies	66332A	18/07/02	19/07/02	MY43001172
Multimeter	FLUKE	17B	17/12/26	18/12/26	26030065WS
Power Splitter	Anritsu	K241B	17/12/27	18/12/27	1301182
Temp & Humi	SJ Science	SJ-TH-S50	17/09/07	18/09/07	U5542113
Radio Communication Analyzer	Anritsu	MT8820C	18/07/03	19/07/03	6200978101
Thermohygrometer	BODYCOM	BJ5478	18/01/03	19/01/03	120612-1
Thermohygrometer	BODYCOM	BJ5478	18/01/03	19/01/03	120612-2
Signal Generator	Rohde Schwarz	SMBV100A	17/12/27	18/12/27	255571
Signal Generator	Rohde Schwarz	SMF100A	18/06/07	19/06/07	102341
Loop Antenna	Schwarzbeck	FMZB1513	18/01/03	20/01/03	1513-128
BILOG ANTENNA	Schwarzbeck	VULB 9160	18/07/13	20/07/13	3359
Dipole Antenna	Schwarzbeck	VHA9103	17/03/14	19/03/14	2116
Dipole Antenna	Schwarzbeck	VHA9103	18/04/13	20/04/13	2117
Dipole Antenna	Schwarzbeck	UHA9105	17/03/14	19/03/14	2261
Dipole Antenna	Schwarzbeck	UHA9105	18/04/13	20/04/13	2262
HORN ANT	ETS	3117	18/05/10	20/05/10	00140394
HORN ANT	ETS	3117	18/03/26	20/03/26	00152145
HORN ANT	A.H.Systems	SAS-574	17/04/25	19/04/25	154
HORN ANT	A.H.Systems	SAS-574	17/07/31	19/07/31	155
Amplifier	RFBAY.Inc	MPA-40-40	17/12/28	19/12/28	21151801
Amplifier	EMPOWER	BBS3Q7ELU	17/09/06	18/09/06	1020
PreAmplifier	TSJ	MLA-010K01-B01-27	18/03/05	19/03/05	1844539
PreAmplifier	Agilent	8449B	17/09/05	18/09/05	3008A02108
PreAmplifier	A.H.Systems Inc.	PAM-1840VH	18/07/06	19/07/06	163
High-pass filter	Wainwright	WHKX12-935-1000-15000-40SS	17/09/05	18/09/05	7
High-pass filter	Wainwright	WHKX12-2580-3000-18000-80SS	17/09/05	18/09/05	3
High-pass filter	Wainwright	WHNX8.0/26.5-6SS	17/09/05	18/09/05	3
Cable	DTNC	Cable	18/02/28	19/02/28	C-016-4
Cable	DTNC	Cable	18/02/28	19/02/28	RF-81
Cable	Radiall	TESTPRO3	18/02/28	19/02/28	RF-74
Cable	DTNC	Cable	18/02/28	19/02/28	RF-66
Cable	DTNC	Cable	18/02/28	19/02/28	RF-76
Cable	DTNC	Cable	18/02/28	19/02/28	RF-54
Cable	DTNC	Cable	18/02/28	19/02/28	RF-32
Cable	DTNC	Cable	18/06/22	19/06/22	RF-61

Note1: The measurement antennas were calibrated in accordance to the requirements of ANSI C63.5-2017.

Note2: The cable is not a regular calibration item, so it has been calibrated by DT & C itself.

## 5. SUMMARY OF TEST RESULTS

FCC Part Section(s)	Test Description	Test Limit	Test Condition	Status Note 1
2.1046	Conducted Output Power	N/A	Conducted	<b>C</b> Note2
2.1049	Occupied Bandwidth	N/A		<b>C</b>
24.232(d) 27.50(d.5)	Peak to Average Ratio	< 13 dB		<b>C</b>
2.1051 22.917(a) 24.238(a) 27.53(g) 27.53(h)	Band Edge / Conducted Spurious Emissions	> 43 + 10log <sub>10</sub> (P) dB at Band edge and for all out-of-band emissions		<b>C</b>
27.53(m)	Band Edge / Conducted Spurious Emissions	> 40 + 10log <sub>10</sub> (P) dB at channel edge and 5 MHz from the channel edge > 43 + 10log <sub>10</sub> (P) dB at 5 MHz and X MHz from the channel edge > 55 + 10log <sub>10</sub> (P) dB at all frequencies more than X MHz from the channel edge		<b>C</b>
2.1055 22.355 24.235 27.54	Frequency Stability	< 2.5 ppm (Part 22) Fundamental emissions must stay within Authorized frequency block (Part 27)		<b>C</b>
27.50(c.10)	Radiated Output Power (B12, 17)	< 3 Watts max. ERP	Radiated	<b>C</b>
22.913(a.5)	Radiated Output Power (B5)	< 7 Watts max. ERP		<b>C</b>
27.50(d.4)	Radiated Output Power (B4, 66)	< 1 Watts max. EIRP		<b>C</b>
24.232(c) 27.50(h.2)	Radiated Output Power(B2, 7, 41)	< 2 Watts max. EIRP		<b>C</b>
2.1053 22.917(a) 24.238(a) 27.53(g) 27.53(h)	Undesirable Emissions	> 43 + 10log <sub>10</sub> (P) dB for all out-of-band emissions		<b>C</b>
27.53(m)	Undesirable Emissions(B7, 41)	> 55 + 10log <sub>10</sub> (P) dB for all out-of-band emissions		<b>C</b>
Note 1: <b>C</b> =Comply <b>NC</b> =Not Comply <b>NT</b> =Not Tested <b>NA</b> =Not Applicable Note 2: Refer to RF Exposure Report (Test Report SAR)				

## 6. SAMPLE CALCULATION

### A. Emission Designator

#### LTE Band 12,17(QPSK)

Emission Designator = **8M95G7D**  
LTE OBW = 8.950 MHz  
G = Phase Modulation  
7 = Quantized/Digital Info  
D = Data Transmission

#### LTE Band 12,17(64QAM)

Emission Designator = **8M97W7D**  
LTE OBW = 8.968 MHz  
W = Amplitude/Angle Modulated  
7 = Quantized/Digital Info  
D = Data Transmission

#### LTE Band 5(QPSK)

Emission Designator = **8M96G7D**  
LTE OBW = 8.961 MHz  
G = Phase Modulation  
7 = Quantized/Digital Info  
D = Data Transmission

#### LTE Band 5(64QAM)

Emission Designator = **8M95W7D**  
LTE OBW = 8.954 MHz  
W = Amplitude/Angle Modulated  
7 = Quantized/Digital Info  
D = Data Transmission

#### LTE Band 4,66(QPSK)

Emission Designator = **17M9G7D**  
LTE OBW = 17.943 MHz  
G = Phase Modulation  
7 = Quantized/Digital Info  
D = Data Transmission

#### LTE Band 4,66(64QAM)

Emission Designator = **17M9W7D**  
LTE OBW = 17.909 MHz  
W = Amplitude/Angle Modulated  
7 = Quantized/Digital Info  
D = Data Transmission

#### LTE Band 12,17(16QAM)

Emission Designator = **8M95W7D**  
LTE OBW = 8.954 MHz  
W = Amplitude/Angle Modulated  
7 = Quantized/Digital Info  
D = Data Transmission

#### LTE Band 5(16QAM)

Emission Designator = **8M94W7D**  
LTE OBW = 8.944 MHz  
W = Amplitude/Angle Modulated  
7 = Quantized/Digital Info  
D = Data Transmission

#### LTE Band 4,66(16QAM)

Emission Designator = **17M9W7D**  
LTE OBW = 17.944 MHz  
W = Amplitude/Angle Modulated  
7 = Quantized/Digital Info  
D = Data Transmission

**LTE Band 2(QPSK)**

Emission Designator = **17M9G7D**  
LTE OBW = 17.911 MHz  
G = Phase Modulation  
7 = Quantized/Digital Info  
D = Data Transmission

**LTE Band 2(64QAM)**

Emission Designator = **17M9W7D**  
LTE OBW = 17.924 MHz  
W = Amplitude/Angle Modulated  
7 = Quantized/Digital Info  
D = Data Transmission

**LTE Band 41(QPSK)**

Emission Designator = **17M8G7D**  
LTE OBW = 17.777 MHz  
G = Phase Modulation  
7 = Quantized/Digital Info  
D = Data Transmission

**LTE Band 41(64QAM)**

Emission Designator = **17M9W7D**  
LTE OBW = 17.933 MHz  
W = Amplitude/Angle Modulated  
7 = Quantized/Digital Info  
D = Data Transmission

**LTE Band 7(QPSK)**

Emission Designator = **17M9G7D**  
LTE OBW = 17.938 MHz  
G = Phase Modulation  
7 = Quantized/Digital Info  
D = Data Transmission

**LTE Band 7(64QAM)**

Emission Designator = **17M9W7D**  
LTE OBW = 17.901 MHz  
W = Amplitude/Angle Modulated  
7 = Quantized/Digital Info  
D = Data Transmission

**LTE Band 2(16QAM)**

Emission Designator = **17M9W7D**  
LTE OBW = 17.896 MHz  
W = Amplitude/Angle Modulated  
7 = Quantized/Digital Info  
D = Data Transmission

**LTE Band 41(16QAM)**

Emission Designator = **17M8W7D**  
LTE OBW = 17.797 MHz  
W = Amplitude/Angle Modulated  
7 = Quantized/Digital Info  
D = Data Transmission

**LTE Band 7(16QAM)**

Emission Designator = **17M9W7D**  
LTE OBW = 17.883 MHz  
W = Amplitude/Angle Modulated  
7 = Quantized/Digital Info  
D = Data Transmission

## B. For substitution method

Channel Bandwidth (MHz)	Test Frequency (MHz)	Test Mode	RB Size/ Offset	Spectrum Reading Value(dBm)	EUT Axis	Ant Pol (H/V)	Level(dBm) @ Ant Terminal	TX Ant Gain (dBi)	EIRP (dBm)	EIRP (W)
20	1720	QPSK	1/0	-24.59	X	H	15.40	5.95	21.35	0.136

### ERP or EIRP = Level @ Ant Terminal LEVEL(dBm) + Tx Ant. Gain

- 1) The EUT mounted on a non-conductive turntable is 0.8 meter above test site ground level.
- 2) During the test, the turn table is rotated until the maximum signal is found.
- 3) Record the field strength meter's level.
- 4) Replace the EUT with dipole/Horn antenna that is connected to a calibrated signal generator.
- 5) Increase the signal generator output till the field strength meter's level is equal to the item (3).
- 6) The signal generator output level with substituted antenna gain is the rating of ERP, EIRP or Radiated spurious emission.

## 7. TEST DATA

### 7.1 OCCUPIED BANDWIDTH

- Plots of the EUT's Occupied Bandwidth are shown in Clause 8.1

### 7.2 PEAK TO AVERAGE RATIO

- Plots of the EUT's Peak- to- Average Ratio are shown in Clause 8.2

### 7.3 BAND EDGE EMISSIONS (Conducted)

- Plots of the EUT's Band Edge Emissions are shown in Clause 8.3

### 7.4 SPURIOUS AND HARMONICS EMISSIONS (Conducted)

- Plots of the EUT's Spurious Emissions are shown in Clause 8.4

## 7.5 ERP & EIRP

### 7.5.1 LTE Band 12,17

Channel Bandwidth (MHz)	Test Frequency (MHz)	Test Mode	RB Size/ Offset	Ant Pol (H/V)	Level(dBm) @ Ant Terminal	TX Ant Gain (dBd)	ERP (dBm)	ERP (W)
10	704	QPSK	1/49	H	15.23	1.28	16.51	0.045
		16QAM	1/49	H	14.36	1.28	15.64	0.037
		64QAM	1/49	H	13.35	1.28	14.63	0.029
	711	QPSK	1/49	H	14.11	1.28	15.39	0.035
		16QAM	1/49	H	13.23	1.28	14.51	0.028
		64QAM	1/49	H	12.28	1.28	13.56	0.023
5	701.5	QPSK	1/24	H	14.69	1.28	15.97	0.040
		16QAM	1/24	H	13.99	1.28	15.27	0.034
		64QAM	1/24	H	12.83	1.28	14.11	0.026
	707.5	QPSK	1/12	H	14.93	1.28	16.21	0.042
		16QAM	1/12	H	14.22	1.28	15.50	0.035
		64QAM	1/12	H	13.23	1.28	14.51	0.028
	713.5	QPSK	1/12	H	13.87	1.28	15.15	0.033
		16QAM	1/12	H	13.29	1.28	14.57	0.029
		64QAM	1/12	H	12.02	1.28	13.30	0.021

Note: This device was tested under all bandwidths, modulations and RB configurations and the worst case data are reported in the table above.

**7.5.2 LTE Band 12**

Channel Bandwidth (MHz)	Test Frequency (MHz)	Test Mode	RB Size/ Offset	Ant Pol (H/V)	Level(dBm) @ Ant Terminal	TX Ant Gain (dBd)	ERP (dBm)	ERP (W)
3	700.5	QPSK	1/7	H	14.45	1.28	15.73	0.037
		16QAM	1/7	H	13.97	1.28	15.25	0.033
		64QAM	1/7	H	12.70	1.28	13.98	0.025
	707.5	QPSK	1/7	H	15.08	1.28	16.36	0.043
		16QAM	1/7	H	14.29	1.28	15.57	0.036
		64QAM	1/7	H	13.24	1.28	14.52	0.028
	714.5	QPSK	1/7	H	13.20	1.28	14.48	0.028
		16QAM	1/7	H	12.89	1.28	14.17	0.026
		64QAM	1/7	H	11.54	1.28	12.82	0.019
1.4	699.7	QPSK	1/2	H	14.59	1.28	15.87	0.039
		16QAM	1/2	H	13.73	1.28	15.01	0.032
		64QAM	1/2	H	12.76	1.28	14.04	0.025
	707.5	QPSK	1/2	H	14.80	1.28	16.08	0.041
		16QAM	1/2	H	14.14	1.28	15.42	0.035
		64QAM	1/2	H	13.03	1.28	14.31	0.027
	715.3	QPSK	1/2	H	13.48	1.28	14.76	0.030
		16QAM	1/2	H	12.59	1.28	13.87	0.024
		64QAM	1/2	H	12.64	1.28	13.92	0.025



### 7.5.3 LTE Band 5

Channel Bandwidth (MHz)	Test Frequency (MHz)	Test Mode	RB Size/Offset	Ant Pol (H/V)	Level(dBm) @ Ant Terminal	TX Ant Gain (dBd)	ERP (dBm)	ERP (W)
10	829	QPSK	1/49	H	20.27	1.23	21.50	0.141
		16QAM	1/49	H	19.57	1.23	20.80	0.120
		64QAM	1/49	H	18.28	1.23	19.51	0.089
	836.5	QPSK	1/49	H	20.21	1.22	21.43	0.139
		16QAM	1/49	H	19.59	1.22	20.81	0.121
		64QAM	1/49	H	18.51	1.22	19.73	0.094
	844	QPSK	1/0	H	21.89	1.21	23.10	0.204
		16QAM	1/0	H	21.26	1.21	22.47	0.177
		64QAM	1/0	H	20.34	1.21	21.55	0.143
5	826.5	QPSK	1/12	H	20.49	1.23	21.72	0.149
		16QAM	1/12	H	19.76	1.23	20.99	0.126
		64QAM	1/12	H	18.92	1.23	20.15	0.104
	836.5	QPSK	1/12	H	20.28	1.22	21.50	0.141
		16QAM	1/12	H	19.66	1.22	20.88	0.122
		64QAM	1/12	H	18.57	1.22	19.79	0.095
	846.5	QPSK	1/12	H	21.34	1.21	22.55	0.180
		16QAM	1/12	H	20.73	1.21	21.94	0.156
		64QAM	1/12	H	19.60	1.21	20.81	0.121
3	825.5	QPSK	1/14	H	20.55	1.23	21.78	0.151
		16QAM	1/14	H	19.69	1.23	20.92	0.124
		64QAM	1/14	H	18.91	1.23	20.14	0.103
	836.5	QPSK	1/0	H	20.21	1.22	21.43	0.139
		16QAM	1/0	H	19.58	1.22	20.80	0.120
		64QAM	1/0	H	18.43	1.22	19.65	0.092
	847.5	QPSK	1/0	H	20.30	1.21	21.51	0.142
		16QAM	1/0	H	19.48	1.21	20.69	0.117
		64QAM	1/0	H	18.56	1.21	19.77	0.095
1.4	824.7	QPSK	1/2	H	20.78	1.23	22.01	0.159
		16QAM	1/2	H	20.02	1.23	21.25	0.133
		64QAM	1/2	H	19.03	1.23	20.26	0.106
	836.5	QPSK	1/2	H	19.83	1.22	21.05	0.127
		16QAM	1/2	H	19.32	1.22	20.54	0.113
		64QAM	1/2	H	17.98	1.22	19.20	0.083
	848.3	QPSK	1/0	H	20.86	1.21	22.07	0.161
		16QAM	1/0	H	20.12	1.21	21.33	0.136
		64QAM	1/0	H	19.16	1.21	20.37	0.109

Note: This device was tested under all bandwidths, modulations and RB configurations and the worst case data are reported in the table above.

## 7.5.4 LTE Band 4, 66

Channel Bandwidth (MHz)	Test Frequency (MHz)	Test Mode	RB Size/ Offset	Ant Pol (H/V)	Level(dBm) @ Ant Terminal	TX Ant Gain (dBi)	EIRP (dBm)	EIRP (W)
20	1720	QPSK	1/0	H	15.40	5.95	21.35	0.136
		16QAM	1/0	H	14.31	5.95	20.26	0.106
		64QAM	1/0	H	13.74	5.95	19.69	0.093
	1745	QPSK	1/0	H	15.36	5.73	21.09	0.129
		16QAM	1/0	H	14.91	5.73	20.64	0.116
		64QAM	1/0	H	13.79	5.73	19.52	0.090
	1770	QPSK	1/0	H	15.44	5.42	20.86	0.122
		16QAM	1/0	H	14.33	5.42	19.75	0.094
		64QAM	1/0	H	13.37	5.42	18.79	0.076
15	1717.5	QPSK	1/0	H	14.62	5.97	20.59	0.115
		16QAM	1/0	H	13.54	5.97	19.51	0.089
		64QAM	1/0	H	12.97	5.97	18.94	0.078
	1745	QPSK	1/0	H	16.69	5.73	22.42	0.175
		16QAM	1/0	H	15.82	5.73	21.55	0.143
		64QAM	1/0	H	14.32	5.73	20.05	0.101
	1772.5	QPSK	1/0	H	15.78	5.39	21.17	0.131
		16QAM	1/0	H	15.30	5.39	20.69	0.117
		64QAM	1/0	H	13.79	5.39	19.18	0.083
10	1715	QPSK	1/0	H	14.66	6.00	20.66	0.116
		16QAM	1/0	H	14.07	6.00	20.07	0.102
		64QAM	1/0	H	12.99	6.00	18.99	0.079
	1745	QPSK	1/0	H	15.94	5.73	21.67	0.147
		16QAM	1/0	H	15.19	5.73	20.92	0.124
		64QAM	1/0	H	14.45	5.73	20.18	0.104
	1775	QPSK	1/0	H	16.60	5.36	21.96	0.157
		16QAM	1/0	H	15.91	5.36	21.27	0.134
		64QAM	1/0	H	14.69	5.36	20.05	0.101

Channel Bandwidth (MHz)	Test Frequency (MHz)	Test Mode	RB Size/ Offset	Ant Pol (H/V)	Level(dBm) @ Ant Terminal	TX Ant Gain (dBi)	EIRP (dBm)	EIRP (W)
5	1712.5	QPSK	1/0	H	14.35	6.02	20.37	0.109
		16QAM	1/0	H	13.82	6.02	19.84	0.096
		64QAM	1/0	H	12.58	6.02	18.60	0.072
	1745	QPSK	1/0	H	15.38	5.73	21.11	0.129
		16QAM	1/0	H	15.12	5.73	20.85	0.122
		64QAM	1/0	H	13.80	5.73	19.53	0.090
	1777.5	QPSK	1/0	H	16.04	5.32	21.36	0.137
		16QAM	1/0	H	15.36	5.32	20.68	0.117
		64QAM	1/0	H	14.12	5.32	19.44	0.088
3	1711.5	QPSK	1/0	H	13.99	6.03	20.02	0.100
		16QAM	1/0	H	13.20	6.03	19.23	0.084
		64QAM	1/0	H	12.11	6.03	18.14	0.065
	1745	QPSK	1/7	H	15.17	5.73	20.90	0.123
		16QAM	1/7	H	14.55	5.73	20.28	0.107
		64QAM	1/7	H	13.38	5.73	19.11	0.081
	1778.5	QPSK	1/0	H	15.65	5.31	20.96	0.125
		16QAM	1/0	H	14.99	5.31	20.30	0.107
		64QAM	1/0	H	13.91	5.31	19.22	0.084
1.4	1710.7	QPSK	1/2	H	13.92	6.03	19.95	0.099
		16QAM	1/2	H	13.20	6.03	19.23	0.084
		64QAM	1/2	H	12.13	6.03	18.16	0.065
	1745	QPSK	1/2	H	15.80	5.73	21.53	0.142
		16QAM	1/2	H	15.16	5.73	20.89	0.123
		64QAM	1/2	H	14.04	5.73	19.77	0.095
	1779.3	QPSK	1/2	H	15.80	5.30	21.10	0.129
		16QAM	1/2	H	15.06	5.30	20.36	0.109
		64QAM	1/2	H	13.97	5.30	19.27	0.085

Note: This device was tested under all bandwidths, modulations and RB configurations and the worst case data are reported in the table above.

**7.5.5 LTE Band 2**

Channel Bandwidth (MHz)	Test Frequency (MHz)	Test Mode	RB Size/ Offset	Ant Pol (H/V)	Level(dBm) @ Ant Terminal	TX Ant Gain (dBi)	EIRP (dBm)	EIRP (W)
20	1860	QPSK	1/0	H	16.66	4.91	21.57	0.144
		16QAM	1/0	H	16.08	4.91	20.99	0.126
		64QAM	1/0	H	14.36	4.91	19.27	0.085
	1880	QPSK	1/0	H	15.98	4.80	20.78	0.120
		16QAM	1/0	H	15.01	4.80	19.81	0.096
		64QAM	1/0	H	14.20	4.80	19.00	0.079
	1900	QPSK	1/0	H	16.01	4.69	20.70	0.117
		16QAM	1/0	H	15.03	4.69	19.72	0.094
		64QAM	1/0	H	14.56	4.69	19.25	0.084
15	1857.5	QPSK	1/36	H	15.68	4.92	20.60	0.115
		16QAM	1/36	H	14.70	4.92	19.62	0.092
		64QAM	1/36	H	14.23	4.92	19.15	0.082
	1880	QPSK	1/36	H	15.24	4.80	20.04	0.101
		16QAM	1/36	H	14.51	4.80	19.31	0.085
		64QAM	1/36	H	13.67	4.80	18.47	0.070
	1902.5	QPSK	1/36	H	16.18	4.68	20.86	0.122
		16QAM	1/36	H	15.30	4.68	19.98	0.100
		64QAM	1/36	H	14.44	4.68	19.12	0.082
10	1855	QPSK	1/0	H	15.73	4.94	20.67	0.117
		16QAM	1/0	H	15.02	4.94	19.96	0.099
		64QAM	1/0	H	13.91	4.94	18.85	0.077
	1880	QPSK	1/0	H	15.46	4.80	20.26	0.106
		16QAM	1/0	H	14.79	4.80	19.59	0.091
		64QAM	1/0	H	13.67	4.80	18.47	0.070
	1905	QPSK	1/0	H	16.00	4.67	20.67	0.117
		16QAM	1/0	H	15.78	4.67	20.45	0.111
		64QAM	1/0	H	14.80	4.67	19.47	0.089

Channel Bandwidth (MHz)	Test Frequency (MHz)	Test Mode	RB Size/ Offset	Ant Pol (H/V)	Level(dBm) @ Ant Terminal	TX Ant Gain (dBi)	EIRP (dBm)	EIRP (W)
5	1852.5	QPSK	1/0	H	15.57	4.95	20.52	0.113
		16QAM	1/0	H	14.81	4.95	19.76	0.095
		64QAM	1/0	H	13.68	4.95	18.63	0.073
	1880	QPSK	1/0	H	15.35	4.80	20.15	0.104
		16QAM	1/0	H	14.44	4.80	19.24	0.084
		64QAM	1/0	H	13.65	4.80	18.45	0.070
	1907.5	QPSK	1/0	H	15.84	4.65	20.49	0.112
		16QAM	1/0	H	14.94	4.65	19.59	0.091
		64QAM	1/0	H	13.78	4.65	18.43	0.070
3	1851.5	QPSK	1/0	H	15.73	4.95	20.68	0.117
		16QAM	1/0	H	14.77	4.95	19.72	0.094
		64QAM	1/0	H	13.62	4.95	18.57	0.072
	1880	QPSK	1/0	H	15.11	4.80	19.91	0.098
		16QAM	1/0	H	14.78	4.80	19.58	0.091
		64QAM	1/0	H	13.58	4.80	18.38	0.069
	1908.5	QPSK	1/0	H	15.58	4.65	20.23	0.105
		16QAM	1/0	H	14.99	4.65	19.64	0.092
		64QAM	1/0	H	13.79	4.65	18.44	0.070
1.4	1850.7	QPSK	1/2	H	15.58	4.96	20.54	0.113
		16QAM	1/2	H	14.83	4.96	19.79	0.095
		64QAM	1/2	H	13.96	4.96	18.92	0.078
	1880	QPSK	1/2	H	15.55	4.80	20.35	0.108
		16QAM	1/2	H	14.87	4.80	19.67	0.093
		64QAM	1/2	H	13.85	4.80	18.65	0.073
	1909.3	QPSK	1/2	H	15.77	4.64	20.41	0.110
		16QAM	1/2	H	14.89	4.64	19.53	0.090
		64QAM	1/2	H	13.96	4.64	18.60	0.072

Note: This device was tested under all bandwidths, modulations and RB configurations and the worst case data are reported in the table above.

**7.5.6 LTE Band 41**

Channel Bandwidth (MHz)	Test Frequency (MHz)	Test Mode	RB Size/ Offset	Ant Pol (H/V)	Level(dBm) @ Ant Terminal	TX Ant Gain (dBi)	EIRP (dBm)	EIRP (W)
20	2506	QPSK	1/0	H	14.37	5.96	20.33	0.108
		16QAM	1/0	H	13.82	5.96	19.78	0.095
		64QAM	1/0	H	12.77	5.96	18.73	0.075
	2593	QPSK	1/0	H	15.16	5.91	21.07	0.128
		16QAM	1/0	H	13.84	5.91	19.75	0.094
		64QAM	1/0	H	14.64	5.91	20.55	0.114
	2680	QPSK	1/99	H	11.05	6.18	17.23	0.053
		16QAM	1/99	H	10.06	6.18	16.24	0.042
		64QAM	1/99	H	9.05	6.18	15.23	0.033
15	2503.5	QPSK	1/36	H	14.46	5.97	20.43	0.110
		16QAM	1/36	H	13.15	5.97	19.12	0.082
		64QAM	1/36	H	11.60	5.97	17.57	0.057
	2593	QPSK	1/36	H	15.96	5.91	21.87	0.154
		16QAM	1/36	H	13.64	5.91	19.55	0.090
		64QAM	1/36	H	13.01	5.91	18.92	0.078
	2682.5	QPSK	1/36	H	10.89	6.19	17.08	0.051
		16QAM	1/36	H	10.01	6.19	16.20	0.042
		64QAM	1/36	H	8.99	6.19	15.18	0.033
10	2501	QPSK	1/0	H	14.95	5.98	20.93	0.124
		16QAM	1/0	H	13.64	5.98	19.62	0.092
		64QAM	1/0	H	12.90	5.98	18.88	0.077
	2593	QPSK	1/0	H	15.94	5.91	21.85	0.153
		16QAM	1/0	H	15.47	5.91	21.38	0.137
		64QAM	1/0	H	14.31	5.91	20.22	0.105
	2685	QPSK	1/0	H	11.65	6.20	17.85	0.061
		16QAM	1/0	H	10.62	6.20	16.82	0.048
		64QAM	1/0	H	8.99	6.20	15.19	0.033
5	2498.5	QPSK	1/0	H	14.31	5.98	20.29	0.107
		16QAM	1/0	H	13.56	5.98	19.54	0.090
		64QAM	1/0	H	12.70	5.98	18.68	0.074
	2593	QPSK	1/0	H	14.04	5.91	19.95	0.099
		16QAM	1/0	H	13.20	5.91	19.11	0.081
		64QAM	1/0	H	12.55	5.91	18.46	0.070
	2687.5	QPSK	1/0	H	11.45	6.21	17.66	0.058
		16QAM	1/0	H	10.41	6.21	16.62	0.046
		64QAM	1/0	H	9.33	6.21	15.54	0.036

Note: This device was tested under all bandwidths, modulations and RB configurations and the worst case data are reported in the table above.

**7.5.7 LTE Band 7**

Channel Bandwidth (MHz)	Test Frequency (MHz)	Test Mode	RB Size/Offset	Ant Pol (H/V)	Level(dBm) @ Ant Terminal	TX Ant Gain (dBi)	EIRP (dBm)	EIRP (W)
20	2510	QPSK	1/50	H	14.37	5.96	20.33	0.108
		16QAM	1/50	H	13.82	5.96	19.78	0.095
		64QAM	1/50	H	12.77	5.96	18.73	0.075
	2535	QPSK	1/50	H	15.16	5.91	21.07	0.128
		16QAM	1/50	H	13.84	5.91	19.75	0.094
		64QAM	1/50	H	12.94	5.91	18.85	0.077
	2560	QPSK	1/50	H	11.05	6.18	17.23	0.053
		16QAM	1/50	H	10.06	6.18	16.24	0.042
		64QAM	1/50	H	9.05	6.18	15.23	0.033
15	2507.5	QPSK	1/74	H	14.46	5.97	20.43	0.110
		16QAM	1/74	H	13.15	5.97	19.12	0.082
		64QAM	1/74	H	11.60	5.97	17.57	0.057
	2535	QPSK	1/36	H	15.96	5.91	21.87	0.154
		16QAM	1/36	H	13.64	5.91	19.55	0.090
		64QAM	1/36	H	12.01	5.91	17.92	0.062
	2562.5	QPSK	1/74	H	10.89	6.19	17.08	0.051
		16QAM	1/74	H	10.01	6.19	16.20	0.042
		64QAM	1/74	H	8.99	6.19	15.18	0.033
10	2505	QPSK	1/49	H	14.95	5.98	20.93	0.124
		16QAM	1/49	H	13.64	5.98	19.62	0.092
		64QAM	1/49	H	12.90	5.98	18.88	0.077
	2535	QPSK	1/49	H	15.94	5.91	21.85	0.153
		16QAM	1/49	H	15.57	5.91	21.48	0.141
		64QAM	1/49	H	14.72	5.91	20.63	0.116
	2565	QPSK	1/25	H	11.65	6.20	17.85	0.061
		16QAM	1/25	H	10.62	6.20	16.82	0.048
		64QAM	1/25	H	8.99	6.20	15.19	0.033
5	2502.5	QPSK	1/12	H	14.31	5.98	20.29	0.107
		16QAM	1/12	H	13.56	5.98	19.54	0.090
		64QAM	1/12	H	13.10	5.98	19.08	0.081
	2535	QPSK	1/12	H	14.04	5.91	19.95	0.099
		16QAM	1/12	H	13.20	5.91	19.11	0.081
		64QAM	1/12	H	12.75	5.91	18.66	0.073
	2567.5	QPSK	1/12	H	10.95	6.21	17.16	0.052
		16QAM	1/12	H	10.41	6.21	16.62	0.046
		64QAM	1/12	H	9.33	6.21	15.54	0.036

Note: This device was tested under all bandwidths, modulations and RB configurations and the worst case data are reported in the table above.

## 7.6 UNDESIRABLE EMISSIONS (Radiated)

### 7.6.1 LTE Band 12,17

B.W (MHz)	Test Freq. (MHz)	RB Size/ Offset	Test Mode	Freq.(MHz)	Ant Pol (H/V)	Level(dBm) @ Ant Terminal	TX Ant Gain(dBd)	Result		Limit (dBc)		
								(dBm)	(dBc)			
10	704	1/49	QPSK	1416.71	H	-57.71	2.86	-54.85	71.36	29.51		
				2125.35	H	-46.41	3.12	-43.29	59.80			
			16QAM	1416.94	H	-58.17	2.86	-55.31	70.95	28.64		
				2125.15	H	-46.42	3.12	-43.30	58.94			
			64QAM	1416.90	H	-58.26	2.86	-55.40	71.04	27.63		
				2125.28	H	-46.57	3.12	-43.45	59.09			
	711	1/49	QPSK	1431.03	H	-57.41	3.01	-54.40	69.79	28.39		
				2146.46	H	-45.47	3.21	-42.26	57.65			
			16QAM	1431.06	H	-57.74	3.01	-54.73	69.24	27.51		
				2146.21	H	-46.00	3.20	-42.80	57.31			
			64QAM	1431.85	H	-57.20	3.01	-54.19	68.70	26.56		
				2146.26	H	-46.42	3.20	-43.22	57.73			
5	701.5	1/24	QPSK	1407.30	H	-57.13	2.76	-54.37	70.34	28.97		
				2110.87	H	-46.76	3.06	-43.70	59.67			
			16QAM	1407.23	H	-57.91	2.76	-55.15	70.42	28.27		
				2111.02	H	-46.96	3.06	-43.90	59.17			
			64QAM	1407.16	H	-57.23	2.76	-54.47	69.74	27.11		
				2110.89	H	-47.28	3.06	-44.22	59.49			
			707.5	1/12	QPSK	1414.92	H	-57.94	2.84	-55.10	71.31	29.21
						2122.53	H	-46.14	3.10	-43.04	59.25	
	16QAM	1415.02			H	-57.52	2.84	-54.68	70.18	28.50		
		2122.48			H	-45.96	3.10	-42.86	58.36			
	64QAM	1415.37			H	-57.52	2.85	-54.67	70.17	27.51		
		2122.60			H	-46.70	3.10	-43.60	59.10			
	713.5	1/12			QPSK	1427.73	H	-57.55	2.97	-54.58	69.73	28.15
						2140.47	H	-45.67	3.18	-42.49	57.64	
			16QAM	1428.19	H	-58.26	2.98	-55.28	69.85	27.57		
				2140.54	H	-46.07	3.18	-42.89	57.46			
			64QAM	1427.41	H	-58.38	2.97	-55.41	69.98	26.30		
				2140.74	H	-46.14	3.18	-42.96	57.53			

Note 1: Limit Calculation =  $43 + 10\log_{10}(P[\text{Watts}])$

Note 2: This device was tested under all bandwidths, modulations and RB configurations and the worst case data are reported in the table above.

Note 3: The frequency spectrum is examined from 9 kHz to the 10th harmonic of the fundamental frequency of the transmitter. No other spurious and harmonic emissions were reported greater than listed emissions above table.



**7.6.2 LTE Band 12**

B.W (MHz)	Test Freq. (MHz)	RB Size/ Offset	Test Mode	Freq.(MHz)	Ant Pol (H/V)	Level(dBm) @ Ant Terminal	TX Ant Gain(dBd)	Result		Limit (dBc)
								(dBm)	(dBc)	
3	700.5	1/7	QPSK	1401.08	H	-56.02	2.70	-53.32	69.05	28.73
				2101.58	H	-46.76	3.02	-43.74	59.47	
			16QAM	1401.10	H	-56.98	2.70	-54.28	69.53	28.25
				2101.33	H	-47.80	3.02	-44.78	60.03	
			64QAM	1401.62	H	-56.93	2.71	-54.22	69.47	26.98
				2101.55	H	-47.57	3.02	-44.55	59.80	
	707.5	1/7	QPSK	1414.67	H	-55.65	2.84	-52.81	69.17	29.36
				2122.42	H	-46.16	3.10	-43.06	59.42	
			16QAM	1415.00	H	-57.40	2.84	-54.56	70.13	28.57
				2122.64	H	-46.22	3.11	-43.11	58.68	
			64QAM	1415.19	H	-57.84	2.84	-55.00	70.57	27.52
				2122.53	H	-46.14	3.10	-43.04	58.61	
	714.5	1/7	QPSK	1429.21	H	-57.02	2.99	-54.03	68.51	27.48
				2143.67	H	-45.95	3.19	-42.76	57.24	
			16QAM	1429.23	H	-57.78	2.99	-54.79	68.96	27.17
				2143.23	H	-46.29	3.19	-43.10	57.27	
			64QAM	1428.81	H	-57.63	2.98	-54.65	68.82	25.82
				2143.55	H	-46.62	3.19	-43.43	57.60	
1.4	699.7	1/2	QPSK	1398.95	H	-56.57	2.69	-53.88	69.75	28.87
				2098.75	H	-47.16	3.00	-44.16	60.03	
			16QAM	1399.43	H	-56.85	2.69	-54.16	69.17	28.01
				2098.74	H	-47.00	3.00	-44.00	59.01	
			64QAM	1399.22	H	-57.06	2.69	-54.37	69.38	27.04
				2098.90	H	-46.62	3.01	-43.61	58.62	
	707.5	1/2	QPSK	1414.50	H	-56.60	2.84	-53.76	69.84	29.08
				2122.13	H	-46.69	3.10	-43.59	59.67	
			16QAM	1414.42	H	-57.68	2.84	-54.84	70.26	28.42
				2122.04	H	-46.49	3.10	-43.39	58.81	
			64QAM	1414.76	H	-57.41	2.84	-54.57	69.99	27.31
				2122.21	H	-47.34	3.10	-44.24	59.66	
	715.3	1/2	QPSK	1430.32	H	-56.93	3.00	-53.93	68.69	27.76
				2145.70	H	-45.95	3.20	-42.75	57.51	
			16QAM	1430.28	H	-55.95	3.00	-52.95	66.82	26.87
				2145.58	H	-46.08	3.20	-42.88	56.75	
			64QAM	1430.75	H	-57.07	3.00	-54.07	67.94	26.92
				2145.48	H	-46.44	3.20	-43.24	57.11	

Note 1: Limit Calculation =  $43 + 10\log_{10}(P[\text{Watts}])$

Note 2: This device was tested under all bandwidths, modulations and RB configurations and the worst case data are reported in the table above.

Note 3: The frequency spectrum is examined from 9 kHz to the 10th harmonic of the fundamental frequency of the transmitter. No other spurious and harmonic emissions were reported greater than listed emissions above table.

### 7.6.3 LTE Band 5

B.W (MHz)	Test Freq. (MHz)	RB Size/ Offset	Test Mode	Freq.(MHz)	Ant Pol (H/V)	Level(dBm) @ Ant Terminal	TX Ant Gain(dBd)	Result		Limit (dBc)
								(dBm)	(dBc)	
10	829	1/49	QPSK	1668.85	H	-61.16	3.88	-57.28	78.78	34.50
			16QAM	1668.99	H	-61.19	3.88	-57.31	78.11	33.80
			64QAM	1670.50	H	-60.83	3.89	-56.94	77.74	32.51
	836.5	1/49	QPSK	1678.16	H	-60.27	3.91	-56.36	77.79	34.43
			16QAM	1680.96	H	-61.48	3.92	-57.56	78.37	33.81
			64QAM	1680.34	H	-61.25	3.92	-57.33	78.14	32.73
	844	1/0	QPSK	1680.48	H	-61.18	3.92	-57.26	80.36	36.10
			16QAM	1679.06	H	-61.07	3.91	-57.16	79.63	35.47
			64QAM	1677.25	H	-61.07	3.91	-57.16	79.63	34.55
5	826.5	1/12	QPSK	1655.70	H	-59.67	3.84	-55.83	77.55	34.72
			16QAM	1653.84	H	-60.89	3.83	-57.06	78.05	33.99
			64QAM	1653.23	H	-60.15	3.83	-56.32	77.31	33.15
	836.5	1/12	QPSK	1669.50	H	-60.75	3.88	-56.87	78.37	34.50
			16QAM	1670.68	H	-62.05	3.89	-58.16	79.04	33.88
			64QAM	1669.47	H	-61.59	3.88	-57.71	78.59	32.79
	846.5	1/12	QPSK	1695.74	H	-61.07	3.97	-57.10	79.65	35.55
			16QAM	1694.78	H	-61.42	3.96	-57.46	79.40	34.94
			64QAM	1693.22	H	-61.17	3.96	-57.21	79.15	33.81
3	825.5	1/14	QPSK	1651.19	H	-59.45	3.82	-55.63	77.41	34.78
			16QAM	1653.09	H	-58.91	3.83	-55.08	76.00	33.92
			64QAM	1651.37	H	-59.33	3.82	-55.51	76.43	33.14
	836.5	1/0	QPSK	1666.10	H	-59.79	3.87	-55.92	77.35	34.43
			16QAM	1665.40	H	-60.66	3.87	-56.79	77.59	33.80
			64QAM	1665.38	H	-60.59	3.87	-56.72	77.52	32.65
	847.5	1/0	QPSK	1691.20	H	-61.67	3.95	-57.72	79.23	34.51
			16QAM	1692.94	H	-61.82	3.96	-57.86	78.55	33.69
			64QAM	1692.90	H	-63.30	3.96	-59.34	80.03	32.77
1.4	824.7	1/2	QPSK	1650.70	H	-60.06	3.82	-56.24	78.25	35.01
			16QAM	1652.73	H	-60.53	3.83	-56.70	77.95	34.25
			64QAM	1652.82	H	-61.44	3.83	-57.61	78.86	33.26
	836.5	1/2	QPSK	1671.11	H	-60.17	3.89	-56.28	77.33	34.05
			16QAM	1672.52	H	-60.71	3.89	-56.82	77.36	33.54
			64QAM	1672.70	H	-62.30	3.89	-58.41	78.95	32.20
	848.3	1/0	QPSK	1698.84	H	-61.12	3.98	-57.14	79.21	35.07
			16QAM	1699.02	H	-62.53	3.98	-58.55	79.88	34.33
			64QAM	1698.85	H	-63.94	3.98	-59.96	81.29	33.37

Note 1: Limit Calculation =  $43 + 10\log_{10}(P[\text{Watts}])$

Note 2: This device was tested under all bandwidths, modulations and RB configurations and the worst case data are reported in the table above.

Note 3: The frequency spectrum is examined from 9 kHz to the 10th harmonic of the fundamental frequency of the transmitter. No other spurious and harmonic emissions were reported greater than listed emissions above table.

**7.6.4 LTE Band 4, 66**

B.W (MHz)	Test Freq. (MHz)	RB Size/ Offset	Test Mode	Freq.(MHz)	Ant Pol (H/V)	Level(dBm) @ Ant Terminal	TX Ant Gain(dBi)	Result		Limit (dBc)
								(dBm)	(dBc)	
20	1720	1/0	QPSK	3422.18	H	-50.89	8.01	-42.88	64.23	34.35
			16QAM	3422.24	H	-49.92	8.01	-41.91	62.17	33.26
			64QAM	3422.26	H	-50.98	8.01	-42.97	63.23	32.69
	1745	1/0	QPSK	3472.27	H	-51.25	8.13	-43.12	64.21	34.09
			16QAM	3472.34	H	-51.92	8.13	-43.79	64.43	33.64
			64QAM	3472.26	H	-51.79	8.13	-43.66	64.30	32.52
	1770	1/0	QPSK	3522.48	H	-54.18	8.25	-45.93	66.79	33.86
			16QAM	3522.41	H	-54.81	8.25	-46.56	66.31	32.75
			64QAM	3522.38	H	-55.21	8.25	-46.96	66.71	31.79
15	1717.5	1/0	QPSK	3421.68	H	-49.04	8.01	-41.03	61.62	33.59
			16QAM	3421.70	H	-50.76	8.01	-42.75	62.26	32.51
			64QAM	3421.54	H	-50.00	8.01	-41.99	61.50	31.94
	1745	1/0	QPSK	3476.82	H	-52.26	8.14	-44.12	66.54	35.42
			16QAM	3476.76	H	-51.78	8.14	-43.64	65.19	34.55
			64QAM	3476.78	H	-52.31	8.14	-44.17	65.72	33.05
	1772.5	1/0	QPSK	3531.85	H	-53.59	8.28	-45.31	66.48	34.17
			16QAM	3531.83	H	-54.74	8.28	-46.46	67.15	33.69
			64QAM	3531.88	H	-54.56	8.28	-46.28	66.97	32.18
10	1715	1/0	QPSK	3421.01	H	-49.74	8.00	-41.74	62.40	33.66
			16QAM	3421.47	H	-50.81	8.01	-42.80	62.87	33.07
			64QAM	3421.03	H	-51.09	8.00	-43.09	63.16	31.99
	1745	1/0	QPSK	3481.23	H	-51.98	8.15	-43.83	65.50	34.67
			16QAM	3481.18	H	-51.60	8.15	-43.45	64.37	33.92
			64QAM	3480.96	H	-53.50	8.15	-45.35	66.27	33.18
	1775	1/0	QPSK	3541.25	H	-54.36	8.30	-46.06	68.02	34.96
			16QAM	3541.11	H	-53.59	8.30	-45.29	66.56	34.27
			64QAM	3540.90	H	-54.57	8.30	-46.27	67.54	33.05
5	1712.5	1/0	QPSK	3420.62	H	-49.74	8.00	-41.74	62.11	33.37
			16QAM	3420.76	H	-51.18	8.00	-43.18	63.02	32.84
			64QAM	3420.61	H	-50.43	8.00	-42.43	62.27	31.60
	1745	1/0	QPSK	3485.96	H	-51.63	8.17	-43.46	64.57	34.11
			16QAM	3485.52	H	-53.05	8.17	-44.88	65.73	33.85
			64QAM	3485.70	H	-52.85	8.17	-44.68	65.53	32.53
	1777.5	1/0	QPSK	3550.54	H	-54.65	8.32	-46.33	67.69	34.36
			16QAM	3550.99	H	-55.68	8.32	-47.36	68.04	33.68
			64QAM	3550.88	H	-55.36	8.32	-47.04	67.72	32.44

B.W (MHz)	Test Freq. (MHz)	RB Size/ Offset	Test Mode	Freq.(MHz)	Ant Pol (H/V)	Level(dBm) @ Ant Terminal	TX Ant Gain(dBi)	Result		Limit (dBc)
								(dBm)	(dBc)	
3	1711.5	1/0	QPSK	3420.52	H	-49.79	8.00	-41.79	61.81	33.02
			16QAM	3420.62	H	-50.54	8.00	-42.54	61.77	32.23
			64QAM	3420.59	H	-50.73	8.00	-42.73	61.96	31.14
	1745	1/7	QPSK	3489.97	H	-53.88	8.18	-45.70	66.60	33.90
			16QAM	3490.09	H	-53.75	8.18	-45.57	65.85	33.28
			64QAM	3489.67	H	-53.68	8.18	-45.50	65.78	32.11
	1778.5	1/0	QPSK	3553.07	H	-56.19	8.32	-47.87	68.83	33.96
			16QAM	3552.27	H	-55.11	8.32	-46.79	67.09	33.30
			64QAM	3551.36	H	-56.11	8.32	-47.79	68.09	32.22
1.4	1710.7	1/2	QPSK	3421.34	H	-50.25	8.01	-42.24	62.19	32.95
			16QAM	3421.27	H	-51.54	8.01	-43.53	62.76	32.23
			64QAM	3421.27	H	-51.26	8.01	-43.25	62.48	31.16
	1745	1/2	QPSK	3489.79	H	-53.07	8.18	-44.89	66.42	34.53
			16QAM	3489.58	H	-53.49	8.17	-45.32	66.21	33.89
			64QAM	3490.37	H	-54.52	8.18	-46.34	67.23	32.77
	1779.3	1/2	QPSK	3558.61	H	-55.68	8.33	-47.35	68.45	34.10
			16QAM	3558.64	H	-57.50	8.33	-49.17	69.53	33.36
			64QAM	3558.56	H	-56.86	8.33	-48.53	68.89	32.27

Note 1: Limit Calculation =  $43 + 10\log_{10}(P[\text{Watts}])$

Note 2: This device was tested under all bandwidths, modulations and RB configurations and the worst case data are reported in the table above.

Note 3: The frequency spectrum is examined from 9 kHz to the 10th harmonic of the fundamental frequency of the transmitter. No other spurious and harmonic emissions were reported greater than listed emissions above table.

**7.6.5 LTE Band 2**

B.W (MHz)	Test Freq. (MHz)	RB Size/ Offset	Test Mode	Freq.(MHz)	Ant Pol (H/V)	Level(dBm) @ Ant Terminal	TX Ant Gain(dBi)	Result		Limit (dBc)
								(dBm)	(dBc)	
20	1860	1/0	QPSK	3703.22	H	-54.42	8.38	-46.04	67.61	34.57
			16QAM	3705.93	H	-54.60	8.38	-46.22	67.21	33.99
			64QAM	3705.59	H	-56.37	8.38	-47.99	68.98	32.27
	1880	1/0	QPSK	3744.28	H	-54.56	8.40	-46.16	66.94	33.78
			16QAM	3744.62	H	-55.84	8.40	-47.44	67.25	32.81
			64QAM	3744.60	H	-57.61	8.40	-49.21	69.02	32.00
	1900	1/0	QPSK	3777.55	H	-54.47	8.30	-46.17	66.87	33.70
			16QAM	3777.55	H	-54.47	8.30	-46.17	65.89	32.72
			64QAM	3776.93	H	-54.32	8.30	-46.02	65.74	32.25
15	1857.5	1/36	QPSK	3715.08	H	-53.87	8.39	-45.48	66.08	33.60
			16QAM	3717.79	H	-54.27	8.39	-45.88	65.50	32.62
			64QAM	3715.52	H	-54.67	8.39	-46.28	65.90	32.15
	1880	1/36	QPSK	3760.93	H	-54.36	8.36	-46.00	66.04	33.04
			16QAM	3760.99	H	-54.78	8.36	-46.42	65.73	32.31
			64QAM	3758.02	H	-54.29	8.37	-45.92	65.23	31.47
	1902.5	1/36	QPSK	3805.23	H	-55.03	8.22	-46.81	67.67	33.86
			16QAM	3804.43	H	-54.90	8.22	-46.68	66.66	32.98
			64QAM	3806.53	H	-55.45	8.22	-47.23	67.21	32.12
10	1855	1/0	QPSK	3702.91	H	-54.01	8.38	-45.63	66.30	33.67
			16QAM	3699.59	H	-53.82	8.38	-45.44	65.40	32.96
			64QAM	3699.00	H	-54.73	8.38	-46.35	66.31	31.85
	1880	1/0	QPSK	3751.64	H	-54.82	8.39	-46.43	66.69	33.26
			16QAM	3749.06	H	-54.16	8.40	-45.76	65.35	32.59
			64QAM	3752.61	H	-53.62	8.39	-45.23	64.82	31.47
	1905	1/0	QPSK	3801.40	H	-54.48	8.22	-46.26	66.93	33.67
			16QAM	3801.34	H	-55.62	8.22	-47.40	67.85	33.45
			64QAM	3800.28	H	-55.05	8.22	-46.83	67.28	32.47
5	1852.5	1/0	QPSK	3702.76	H	-54.52	8.38	-46.14	66.66	33.52
			16QAM	3702.76	H	-54.81	8.38	-46.43	66.19	32.76
			64QAM	3704.71	H	-54.73	8.38	-46.35	66.11	31.63
	1880	1/0	QPSK	3758.09	H	-53.48	8.37	-45.11	65.26	33.15
			16QAM	3759.18	H	-54.98	8.37	-46.61	65.85	32.24
			64QAM	3759.63	H	-55.85	8.37	-47.48	66.72	31.45
	1907.5	1/0	QPSK	3813.40	H	-55.14	8.22	-46.92	67.41	33.49
			16QAM	3813.71	H	-57.24	8.22	-49.02	68.61	32.59
			64QAM	3813.41	H	-56.28	8.22	-48.06	67.65	31.43

B.W (MHz)	Test Freq. (MHz)	RB Size/ Offset	Test Mode	Freq.(MHz)	Ant Pol (H/V)	Level(dBm) @ Ant Terminal	TX Ant Gain(dBi)	Result		Limit (dBc)
								(dBm)	(dBc)	
3	1851.5	1/0	QPSK	3704.02	H	-54.80	8.38	-46.42	67.10	33.68
			16QAM	3703.94	H	-56.17	8.38	-47.79	67.51	32.72
			64QAM	3703.98	H	-56.24	8.38	-47.86	67.58	31.57
	1880	1/0	QPSK	3756.21	H	-54.34	8.38	-45.96	65.87	32.91
			16QAM	3756.36	H	-54.11	8.38	-45.73	65.31	32.58
			64QAM	3756.33	H	-55.85	8.38	-47.47	67.05	31.38
	1908.5	1/0	QPSK	3814.14	H	-55.25	8.22	-47.03	67.26	33.23
			16QAM	3815.05	H	-55.39	8.22	-47.17	66.81	32.64
			64QAM	3815.06	H	-57.12	8.22	-48.90	68.54	31.44
1.4	1850.7	1/2	QPSK	3703.14	H	-54.00	8.38	-45.62	66.16	33.54
			16QAM	3703.21	H	-56.64	8.38	-48.26	68.05	32.79
			64QAM	3703.22	H	-56.00	8.38	-47.62	67.41	31.92
	1880	1/2	QPSK	3762.38	H	-54.91	8.36	-46.55	66.90	33.35
			16QAM	3762.43	H	-55.39	8.36	-47.03	66.70	32.67
			64QAM	3762.35	H	-56.03	8.36	-47.67	67.34	31.65
	1909.3	1/2	QPSK	3821.23	H	-55.71	8.22	-47.49	67.90	33.41
			16QAM	3821.23	H	-57.43	8.22	-49.21	68.74	32.53
			64QAM	3821.22	H	-57.23	8.22	-49.01	68.54	31.60

Note 1: Limit Calculation =  $43 + 10\log_{10}(P[\text{Watts}])$

Note 2: This device was tested under all bandwidths, modulations and RB configurations and the worst case data are reported in the table above.

Note 3: The frequency spectrum is examined from 9 kHz to the 10th harmonic of the fundamental frequency of the transmitter. No other spurious and harmonic emissions were reported greater than listed emissions above table.

## 7.6.6 LTE Band 41

B.W (MHz)	Test Freq. (MHz)	RB Size/ Offset	Test Mode	Freq.(MHz)	Ant Pol (H/V)	Level(dBm) @ Ant Terminal	TX Ant Gain(dBi)	Result		Limit (dBc)
								(dBm)	(dBc)	
20	2506	1/0	QPSK	4990.62	H	-53.09	9.98	-43.11	63.44	45.33
				7491.28	H	-40.83	11.89	-28.94	49.27	
			16QAM	4990.06	H	-53.05	9.98	-43.07	62.85	44.78
				7491.47	H	-40.52	11.89	-28.63	48.41	
			64QAM	4991.49	H	-53.08	9.98	-43.10	62.88	43.73
				7491.16	H	-40.81	11.89	-28.92	48.70	
	2593	1/0	QPSK	5166.44	H	-53.49	10.29	-43.20	64.27	46.07
				7752.25	H	-40.99	12.31	-28.68	49.75	
			16QAM	5167.27	H	-53.26	10.29	-42.97	62.72	44.75
				7752.21	H	-41.06	12.31	-28.75	48.50	
			64QAM	5168.45	H	-52.71	10.29	-42.42	62.17	45.55
				7752.27	H	-41.67	12.31	-29.36	49.11	
2680	1/99	QPSK	5379.30	H	-53.03	10.28	-42.75	59.98	42.23	
			8069.79	H	-49.36	12.56	-36.80	54.03		
		16QAM	5379.28	H	-53.34	10.28	-43.06	59.30	41.24	
			8070.23	H	-50.10	12.56	-37.54	53.78		
		64QAM	5379.28	H	-54.84	10.28	-44.56	60.80	40.23	
			8069.40	H	-49.70	12.56	-37.14	53.38		
15	2503.5	1/36	QPSK	5006.18	H	-52.94	10.01	-42.93	63.36	45.43
				7509.94	H	-41.44	11.93	-29.51	49.94	
			16QAM	5005.07	H	-53.40	10.01	-43.39	62.51	44.12
				7509.76	H	-41.57	11.93	-29.64	48.76	
			64QAM	5006.56	H	-53.23	10.01	-43.22	62.34	42.57
				7509.89	H	-41.16	11.93	-29.23	48.35	
	2593	1/36	QPSK	5188.09	H	-52.87	10.32	-42.55	64.42	46.87
				7778.34	H	-41.20	12.28	-28.92	50.79	
			16QAM	5189.09	H	-53.50	10.32	-43.18	62.73	44.55
				7778.56	H	-40.76	12.28	-28.48	48.03	
			64QAM	5187.62	H	-53.62	10.32	-43.30	62.85	43.92
				7778.33	H	-41.29	12.28	-29.01	48.56	
2682.5	1/36	QPSK	5362.84	H	-52.40	10.28	-42.12	59.20	42.08	
			8048.10	H	-49.96	12.54	-37.42	54.50		
		16QAM	5361.76	H	-52.63	10.29	-42.34	58.54	41.20	
			8047.02	H	-50.51	12.54	-37.97	54.17		
		64QAM	5363.90	H	-53.23	10.28	-42.95	59.15	40.18	
			8047.64	H	-51.39	12.54	-38.85	55.05		

B.W (MHz)	Test Freq. (MHz)	RB Size/ Offset	Test Mode	Freq.(MHz)	Ant Pol (H/V)	Level(dBm) @ Ant Terminal	TX Ant Gain(dBi)	Result		Limit (dBc)
								(dBm)	(dBc)	
10	2501	1/0	QPSK	4991.29	H	-52.99	9.98	-43.01	63.94	45.93
				7489.76	H	-40.09	11.89	-28.20	49.13	
			16QAM	4990.67	H	-53.48	9.98	-43.50	63.12	44.62
				7489.71	H	-40.22	11.89	-28.33	47.95	
	64QAM	4992.14	H	-51.98	9.99	-41.99	62.61	43.88		
		7489.83	H	-40.16	11.89	-28.27	47.89			
	2593	1/0	QPSK	5174.53	H	-53.47	10.30	-43.17	65.02	46.85
				7765.76	H	-40.80	12.29	-28.51	50.36	
			16QAM	5176.14	H	-52.89	10.30	-42.59	63.97	46.38
				7765.74	H	-41.00	12.29	-28.71	50.09	
	64QAM	5174.57	H	-53.28	10.30	-42.98	64.36	45.22		
		7765.83	H	-41.35	12.29	-29.06	50.44			
2685	1/0	QPSK	5361.43	H	-52.41	10.29	-42.12	59.97	42.85	
			8043.04	H	-49.70	12.53	-37.17	55.02		
		16QAM	5362.21	H	-53.33	10.29	-43.04	59.86	41.82	
			8042.23	H	-51.05	12.53	-38.52	55.34		
64QAM	5360.56	H	-53.10	10.29	-42.81	59.63	40.19			
	8042.62	H	-50.40	12.53	-37.87	54.69				
5	2498.5	1/0	QPSK	4992.72	H	-52.70	9.99	-42.71	63.00	45.29
				7488.90	H	-40.05	11.88	-28.17	48.46	
			16QAM	4992.19	H	-52.98	9.99	-42.99	62.53	44.54
				7489.26	H	-39.10	11.89	-27.21	46.75	
	64QAM	4992.42	H	-53.15	9.99	-43.16	62.70	43.68		
		7488.96	H	-40.63	11.88	-28.75	48.29			
	2593	1/0	QPSK	5182.06	H	-53.01	10.31	-42.70	62.65	44.95
				7772.63	H	-41.15	12.29	-28.86	48.81	
			16QAM	5183.12	H	-53.79	10.31	-43.48	62.59	44.11
				7772.62	H	-40.37	12.29	-28.08	47.19	
	64QAM	5183.97	H	-54.58	10.31	-44.27	63.38	43.46		
		7772.57	H	-42.24	12.29	-29.95	49.06			
2687.5	1/0	QPSK	5368.85	H	-52.95	10.28	-42.67	60.33	42.66	
			8056.39	H	-50.15	12.55	-37.60	55.26		
		16QAM	5368.89	H	-53.25	10.28	-42.97	59.59	41.62	
			8056.72	H	-49.87	12.55	-37.32	53.94		
64QAM	5368.64	H	-52.85	10.28	-42.57	59.19	40.54			
	8055.73	H	-50.21	12.55	-37.66	54.28				



## 7.6.7 LTE Band 7

B.W (MHz)	Test Freq. (MHz)	RB Size/ Offset	Test Mode	Freq.(MHz)	Ant Pol (H/V)	Level(dBm) @ Ant Terminal	TX Ant Gain(dBi)	Result		Limit (dBc)
								(dBm)	(dBc)	
20	2510	1/50	QPSK	5022.71	H	-53.00	10.04	-42.96	62.70	44.74
				7530.54	H	-48.23	11.96	-36.27	56.01	
			16QAM	5022.56	H	-54.83	10.04	-44.79	63.38	43.59
				7530.26	H	-48.18	11.96	-36.22	54.81	
	64QAM	5022.59	H	-55.78	10.04	-45.74	64.33	42.73		
		7530.25	H	-48.63	11.96	-36.67	55.26			
	2535	1/50	QPSK	5071.16	H	-53.47	10.17	-43.30	62.46	44.16
				7605.05	H	-45.88	12.15	-33.73	52.89	
			16QAM	5071.18	H	-55.83	10.17	-45.66	64.09	43.43
				7605.15	H	-46.22	12.15	-34.07	52.50	
	64QAM	5071.17	H	-56.54	10.17	-46.37	64.80	42.56		
		7605.03	H	-47.33	12.15	-35.18	53.61			
2560	1/50	QPSK	5120.84	H	-54.02	10.27	-43.75	63.08	44.33	
			7680.44	H	-48.38	12.23	-36.15	55.48		
		16QAM	5120.79	H	-55.38	10.27	-45.11	63.79	43.68	
			7680.16	H	-48.63	12.23	-36.40	55.08		
64QAM	5120.84	H	-55.83	10.27	-45.56	64.24	42.81			
	7680.69	H	-48.91	12.23	-36.68	55.36				
15	2507.5	1/74	QPSK	5027.37	H	-53.56	10.05	-43.51	62.66	44.15
				7542.89	H	-47.29	11.97	-35.32	54.47	
			16QAM	5027.35	H	-54.00	10.05	-43.95	62.59	43.64
				7542.81	H	-47.53	11.97	-35.56	54.20	
	64QAM	5027.13	H	-55.24	10.05	-45.19	63.83	42.57		
		7542.81	H	-53.32	11.97	-41.35	59.99			
	2535	1/36	QPSK	5070.31	H	-53.48	10.16	-43.32	62.59	44.27
				7604.62	H	-46.09	12.14	-33.95	53.22	
			16QAM	5070.29	H	-53.91	10.16	-43.75	62.41	43.66
				7604.54	H	-46.33	12.14	-34.19	52.85	
	64QAM	5070.34	H	-55.30	10.16	-45.14	63.80	42.63		
		7604.45	H	-46.69	12.14	-34.55	53.21			
2562.5	1/74	QPSK	5137.87	H	-52.08	10.26	-41.82	60.61	43.79	
			7707.83	H	-48.24	12.26	-35.98	54.77		
		16QAM	5137.98	H	-53.97	10.26	-43.71	61.76	43.05	
			7707.41	H	-49.01	12.26	-36.75	54.80		
64QAM	5138.10	H	-55.22	10.26	-44.96	63.01	41.82			
	7707.27	H	-49.33	12.26	-37.07	55.12				

B.W (MHz)	Test Freq. (MHz)	RB Size/ Offset	Test Mode	Freq.(MHz)	Ant Pol (H/V)	Level(dBm) @ Ant Terminal	TX Ant Gain(dBi)	Result		Limit (dBc)
								(dBm)	(dBc)	
10	2505	1/49	QPSK	5015.67	H	-53.33	10.03	-43.30	63.02	44.72
				7528.09	H	-47.24	11.95	-35.29	55.01	
			16QAM	5015.84	H	-55.21	10.03	-45.18	64.07	43.89
				7527.94	H	-48.82	11.95	-36.87	55.76	
	64QAM	5015.85	H	-54.58	10.03	-44.55	63.44	42.79		
		7528.21	H	-48.80	11.95	-36.85	55.74			
	2535	1/49	QPSK	5078.33	H	-53.39	10.19	-43.20	62.61	44.41
				7618.43	H	-46.25	12.16	-34.09	53.50	
			16QAM	5078.35	H	-55.42	10.19	-45.23	63.87	43.64
				7618.28	H	-46.20	12.16	-34.04	52.68	
	64QAM	5078.43	H	-55.93	10.19	-45.74	64.38	42.55		
		7618.67	H	-47.37	12.16	-35.21	53.85			
2565	1/25	QPSK	5130.98	H	-53.70	10.26	-43.44	62.25	43.81	
			7695.04	H	-47.90	12.24	-35.66	54.47		
		16QAM	5131.11	H	-55.38	10.26	-45.12	63.19	43.07	
			7695.13	H	-47.85	12.24	-35.61	53.68		
64QAM	5131.14	H	-54.82	10.26	-44.56	62.63	42.32			
	7695.26	H	-48.60	12.24	-36.36	54.43				
5	2502.5	1/12	QPSK	5003.90	H	-53.17	10.01	-43.16	62.77	44.61
				7507.21	H	-47.95	11.93	-36.02	55.63	
			16QAM	5004.00	H	-55.21	10.01	-45.20	64.17	43.97
				7507.66	H	-48.62	11.93	-36.69	55.66	
	64QAM	5003.98	H	-54.87	10.01	-44.86	63.83	42.82		
		7507.69	H	-50.25	11.93	-38.32	57.29			
	2535	1/12	QPSK	5070.23	H	-52.56	10.16	-42.40	61.54	44.14
				7605.08	H	-49.23	12.15	-37.08	56.22	
			16QAM	5070.40	H	-54.14	10.16	-43.98	62.43	43.45
				7605.31	H	-46.87	12.15	-34.72	53.17	
	64QAM	5070.42	H	-55.37	10.16	-45.21	63.66	42.43		
		7605.14	H	-48.11	12.15	-35.96	54.41			
2567.5	1/12	QPSK	5069.55	H	-52.63	10.16	-42.47	61.11	43.64	
			7702.67	H	-48.18	12.25	-35.93	54.57		
		16QAM	5069.60	H	-54.96	10.16	-44.80	62.41	42.61	
			7702.41	H	-48.95	12.25	-36.70	54.31		
64QAM	5069.61	H	-55.05	10.16	-44.89	62.50	41.65			
	7702.31	H	-48.35	12.25	-36.10	53.71				

Note 1: Limit Calculation =  $55 + 10\log_{10}(P[\text{Watts}])$

Note 2: This device was tested under all bandwidths, modulations and RB configurations and the worst case data are reported in the table above.

Note 3: The frequency spectrum is examined from 9 kHz to the 10<sup>th</sup> harmonic of the fundamental frequency of the transmitter. No other spurious and harmonic emissions were reported greater than listed

## 7.7 FREQUENCY STABILITY

### 7.7.1 LTE Band 12,17

OPERATING FREQUENCY : 707.5 MHz  
 REFERENCE VOLTAGE : 3.85 VDC  
 LIMIT : The frequency stability shall be sufficient to ensure that the fundamental emission stays within the authorized frequency block.

VOLTAGE (%)	POWER (V DC)	TEMP (°C)	FREQUENCY (Hz)	FREQ.Dev (Hz)	Deviation	
					(ppm)	(%)
100%	3.85	+20(Ref)	707,499,991	-9	-0.0127	-0.000001272
100%		-30	707,499,990	-10	-0.0141	-0.000001413
100%		-20	707,499,996	-4	-0.0057	-0.000000565
100%		-10	707,499,991	-9	-0.0127	-0.000001272
100%		0	707,499,991	-9	-0.0127	-0.000001272
100%		+10	707,499,990	-10	-0.0141	-0.000001413
100%		+20	707,499,991	-9	-0.0127	-0.000001272
100%		+30	707,500,013	13	0.0184	0.000001837
100%		+40	707,499,992	-8	-0.0113	-0.000001131
100%		+50	707,499,991	-9	-0.0127	-0.000001272
115%	4.43	+20	707,499,992	-8	-0.0113	-0.000001131
BATT.ENDPOINT	3.40	+20	707,499,988	-12	-0.0170	-0.000001696

**Note.** Based on the results of the frequency stability test at the center channel the frequency deviation results measured are very small. As such it is determined that the channels at the band edge would remain inband when the maximum measured frequency deviation noted during the frequency stability tests is applied. Therefore the device is determined to remain operating in band over the temperature and voltage range as tested.

**7.7.2 LTE Band 5**

OPERATING FREQUENCY : 836.5 MHz  
 REFERENCE VOLTAGE : 3.85 VDC  
 DEVIATION LIMIT :  $\pm 0.00025\%$  or 2.5 ppm

VOLTAGE (%)	POWER (V DC)	TEMP (°C)	FREQUENCY (Hz)	FREQ.Dev (Hz)	Deviation	
					(ppm)	(%)
100%	3.85	+20(Ref)	836,500,003	3	0.0036	0.000000359
100%		-30	836,500,008	8	0.0096	0.000000956
100%		-20	836,500,003	3	0.0036	0.000000359
100%		-10	836,500,010	10	0.0120	0.000001195
100%		0	836,500,008	8	0.0096	0.000000956
100%		+10	836,499,991	-9	-0.0108	-0.000001076
100%		+20	836,500,003	3	0.0036	0.000000359
100%		+30	836,499,993	-7	-0.0084	-0.000000837
100%		+40	836,499,993	-7	-0.0084	-0.000000837
100%		+50	836,499,989	-11	-0.0132	-0.000001315
115%		4.43	+20	836,499,993	-7	-0.0084
BATT.ENDPOINT	3.40	+20	836,499,996	-4	-0.0048	-0.000000478

**7.7.3 LTE Band 4, 66**

OPERATING FREQUENCY : 1745 MHz  
 REFERENCE VOLTAGE : 3.85 VDC  
 LIMIT : The frequency stability shall be sufficient to ensure that the fundamental emission stays within the authorized frequency block.

VOLTAGE (%)	POWER (V DC)	TEMP (°C)	FREQUENCY (Hz)	FREQ.Dev (Hz)	Deviation	
					(ppm)	(%)
100%	3.85	+20(Ref)	1,744,999,994	-6	-0.0034	-0.000000344
100%		-30	1,745,000,004	4	0.0023	0.000000229
100%		-20	1,745,000,004	4	0.0023	0.000000229
100%		-10	1,744,999,992	-8	-0.0046	-0.000000458
100%		0	1,745,000,005	5	0.0029	0.000000287
100%		+10	1,744,999,994	-6	-0.0034	-0.000000344
100%		+20	1,744,999,994	-6	-0.0034	-0.000000344
100%		+30	1,744,999,993	-7	-0.0040	-0.000000401
100%		+40	1,744,999,989	-11	-0.0063	-0.000000630
100%		+50	1,744,999,990	-10	-0.0057	-0.000000573
115%		4.43	+20	1,744,999,994	-6	-0.0034
BATT.ENDPOINT	3.40	+20	1,745,000,003	3	0.0017	0.000000172

**Note.** Based on the results of the frequency stability test at the center channel the frequency deviation results measured are very small. As such it is determined that the channels at the band edge would remain inband when the maximum measured frequency deviation noted during the frequency stability tests is applied. Therefore the device is determined to remain operating in band over the temperature and voltage range as tested.

### 7.7.4 LTE Band 2

OPERATING FREQUENCY : 1880 MHz  
 REFERENCE VOLTAGE : 3.85 VDC  
 LIMIT : The frequency stability shall be sufficient to ensure that the fundamental emission stays within the authorized frequency block.

VOLTAGE (%)	POWER (V DC)	TEMP (°C)	FREQUENCY (Hz)	FREQ.Dev (Hz)	Deviation	
					(ppm)	(%)
100%	3.85	+20(Ref)	1,879,999,994	-6	-0.0032	-0.000000319
100%		-30	1,880,000,006	6	0.0032	0.000000319
100%		-20	1,880,000,010	10	0.0053	0.000000532
100%		-10	1,880,000,005	5	0.0027	0.000000266
100%		0	1,879,999,993	-7	-0.0037	-0.000000372
100%		+10	1,879,999,992	-8	-0.0043	-0.000000426
100%		+20	1,879,999,994	-6	-0.0032	-0.000000319
100%		+30	1,879,999,992	-8	-0.0043	-0.000000426
100%		+40	1,879,999,994	-6	-0.0032	-0.000000319
100%		+50	1,879,999,993	-7	-0.0037	-0.000000372
115%		4.43	+20	1,879,999,991	-9	-0.0048
BATT.ENDPOINT	3.40	+20	1,879,999,990	-10	-0.0053	-0.000000532

**Note.** Based on the results of the frequency stability test at the center channel the frequency deviation results measured are very small. As such it is determined that the channels at the band edge would remain inband when the maximum measured frequency deviation noted during the frequency stability tests is applied. Therefore the device is determined to remain operating in band over the temperature and voltage range as tested.

### 7.7.5 LTE Band 41

OPERATING FREQUENCY : 2593 MHz  
 REFERENCE VOLTAGE : 3.85 VDC  
 LIMIT : The frequency stability shall be sufficient to ensure that the fundamental emission stays within the authorized frequency block.

VOLTAGE (%)	POWER (V DC)	TEMP (°C)	FREQUENCY (Hz)	FREQ.Dev (Hz)	Deviation	
					(ppm)	(%)
100%	3.85	+20(Ref)	2,593,000,006	6	0.0023	0.000000231
100%		-30	2,593,000,005	5	0.0019	0.000000193
100%		-20	2,593,000,002	2	0.0008	0.000000077
100%		-10	2,593,000,002	2	0.0008	0.000000077
100%		0	2,593,000,004	4	0.0015	0.000000154
100%		+10	2,593,000,005	5	0.0019	0.000000193
100%		+20	2,593,000,006	6	0.0023	0.000000231
100%		+30	2,593,000,002	2	0.0008	0.000000077
100%		+40	2,592,999,994	-6	-0.0023	-0.000000231
100%		+50	2,592,999,991	-9	-0.0035	-0.000000347
115%	4.43	+20	2,592,999,991	-9	-0.0035	-0.000000347
BATT.ENDPOINT	3.40	+20	2,592,999,994	-6	-0.0023	-0.000000231

**Note.** Based on the results of the frequency stability test at the center channel the frequency deviation results measured are very small. As such it is determined that the channels at the band edge would remain inband when the maximum measured frequency deviation noted during the frequency stability tests is applied. Therefore the device is determined to remain operating in band over the temperature and voltage range as tested.

### 7.7.6 LTE Band 7

OPERATING FREQUENCY : 2535 MHz  
 REFERENCE VOLTAGE : 3.85 VDC  
 LIMIT : The frequency stability shall be sufficient to ensure that the fundamental emission stays within the authorized frequency block.

VOLTAGE (%)	POWER (V DC)	TEMP (°C)	FREQUENCY (Hz)	FREQ.Dev (Hz)	Deviation	
					(ppm)	(%)
100%	3.85	+20(Ref)	2,534,999,995	-5	-0.0020	-0.000000197
100%		-30	2,534,999,994	-6	-0.0024	-0.000000237
100%		-20	2,534,999,994	-6	-0.0024	-0.000000237
100%		-10	2,534,999,993	-7	-0.0028	-0.000000276
100%		0	2,535,000,007	7	0.0028	0.000000276
100%		+10	2,534,999,995	-5	-0.0020	-0.000000197
100%		+20	2,534,999,995	-5	-0.0020	-0.000000197
100%		+30	2,535,000,009	9	0.0036	0.000000355
100%		+40	2,535,000,006	6	0.0024	0.000000237
100%		+50	2,535,000,005	5	0.0020	0.000000197
115%		4.43	+20	2,534,999,992	-8	-0.0032
BATT.ENDPOINT	3.40	+20	2,534,999,995	-5	-0.0020	-0.000000197

**Note.** Based on the results of the frequency stability test at the center channel the frequency deviation results measured are very small. As such it is determined that the channels at the band edge would remain inband when the maximum measured frequency deviation noted during the frequency stability tests is applied. Therefore the device is determined to remain operating in band over the temperature and voltage range as tested.



## 8. TEST PLOTS

Note: All bandwidths, RB configurations, and modulations were investigated.  
The worst case test results are reported.

### 8.1 OCCUPIED BANDWIDTH

#### 8.1.1 LTE Band 12,17

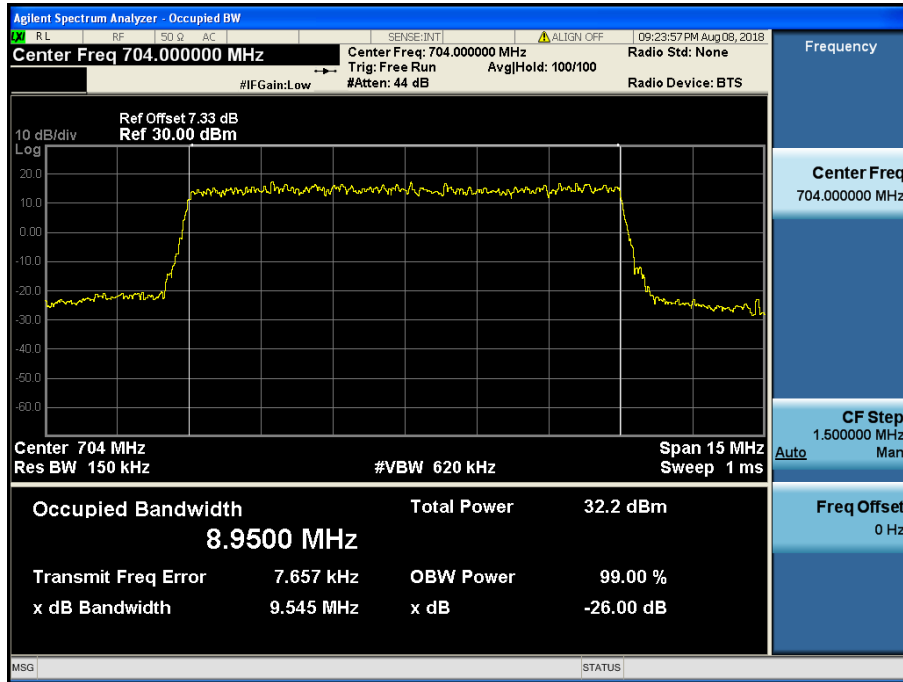

LTE Band 12,17 / 10 MHz / QPSK - RB Size 50

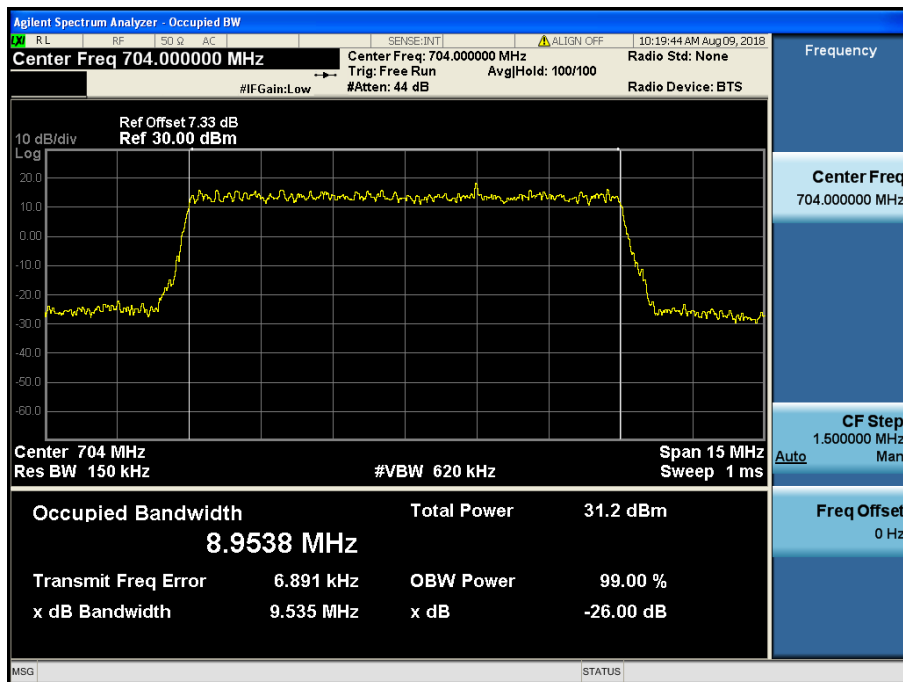

LTE Band 12,17 / 10 MHz / 16QAM - RB Size 50

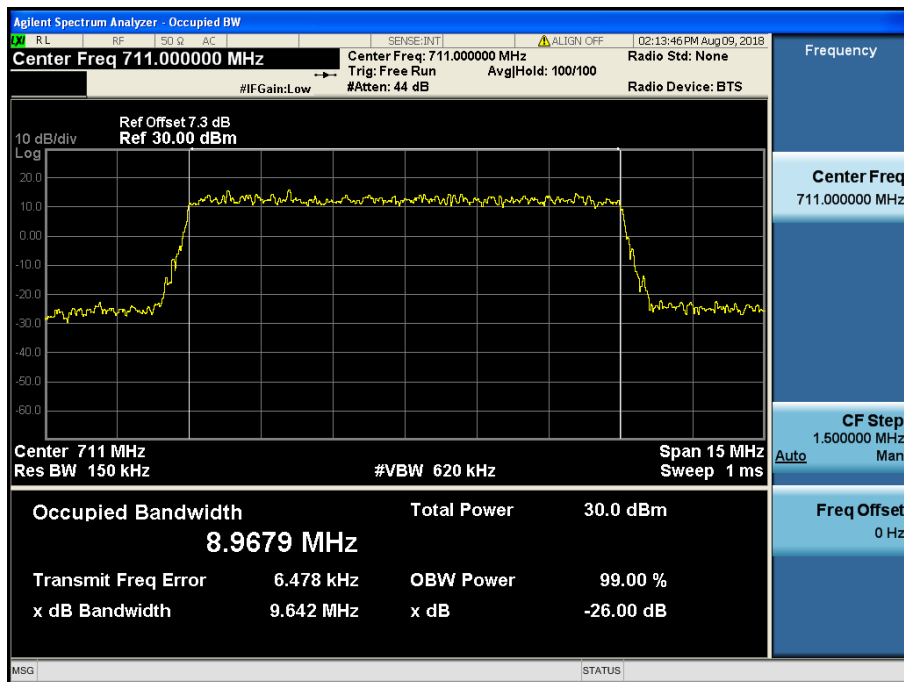

LTE Band 12,17 / 10 MHz / 64QAM- RB Size 50

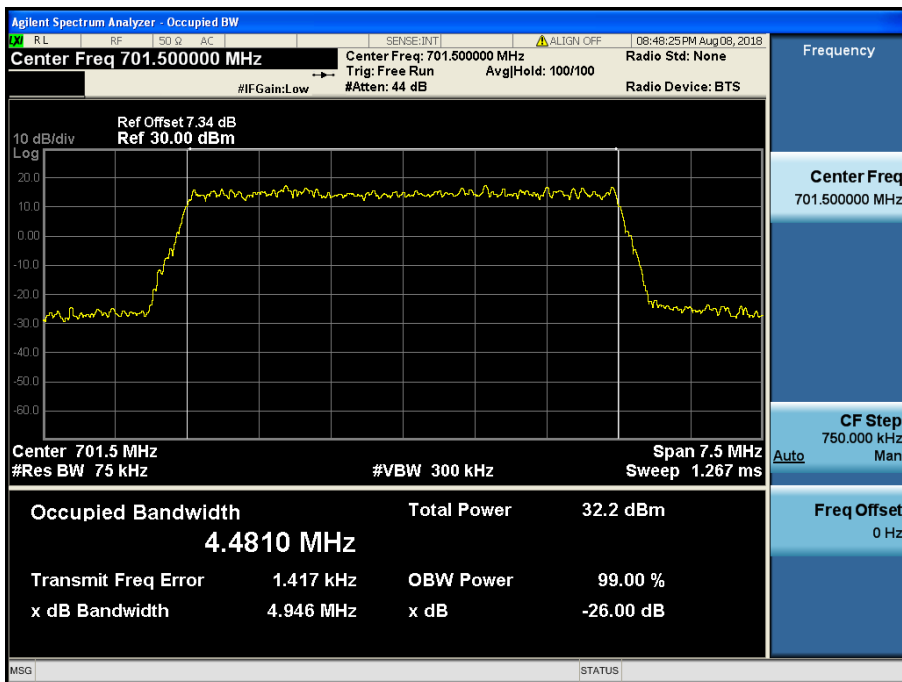

LTE Band 12,17 / 5 MHz / QPSK - RB Size 25

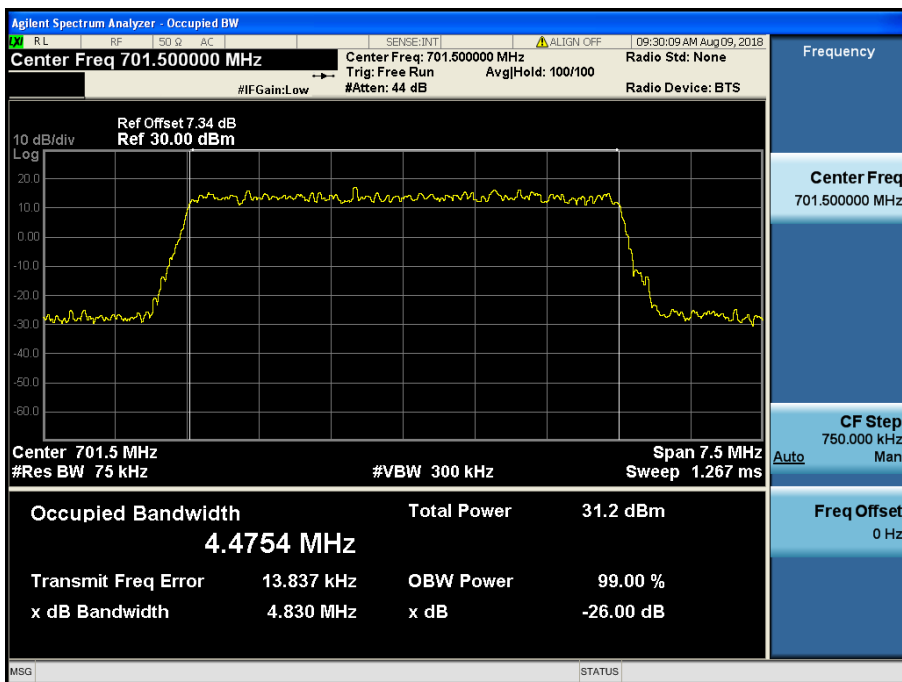

LTE Band 12,17 / 5 MHz / 16QAM - RB Size 25

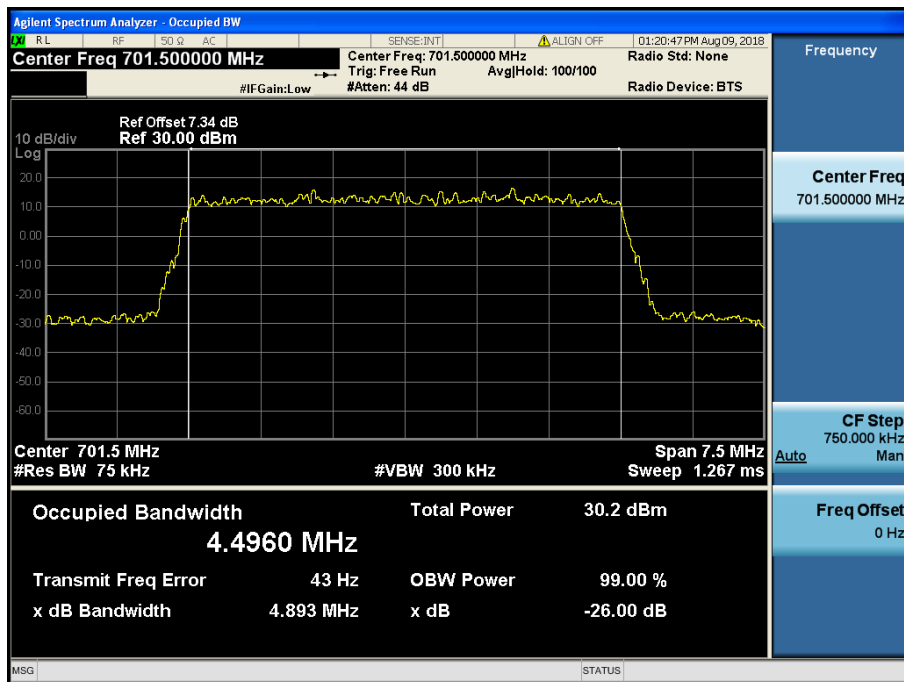

LTE Band 12,17 / 5 MHz / 64QAM - RB Size 25

8.1.2 LTE Band 12

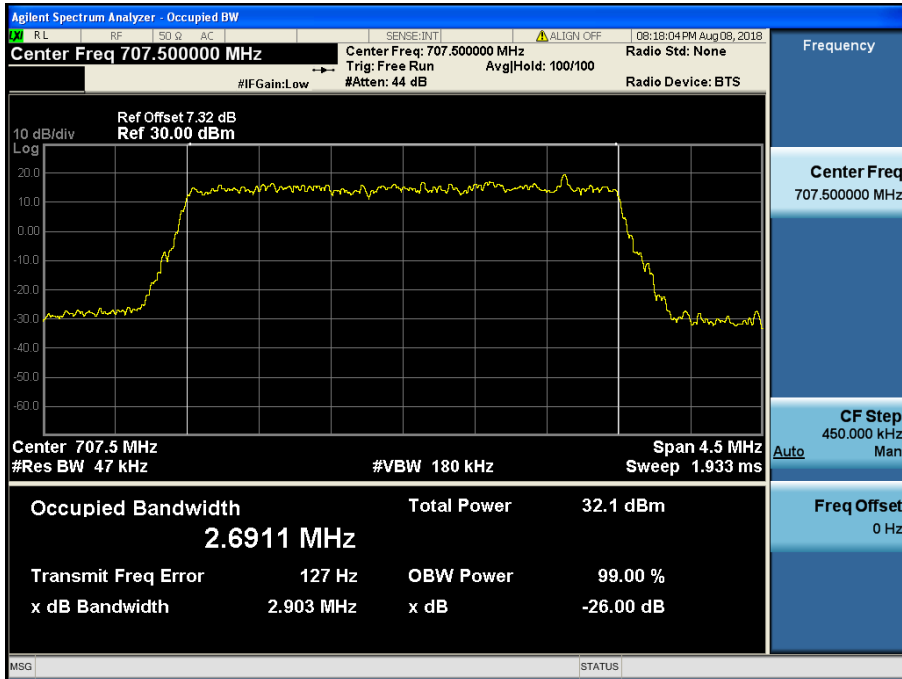

LTE Band 12 / 3 MHz / QPSK - RB Size 15

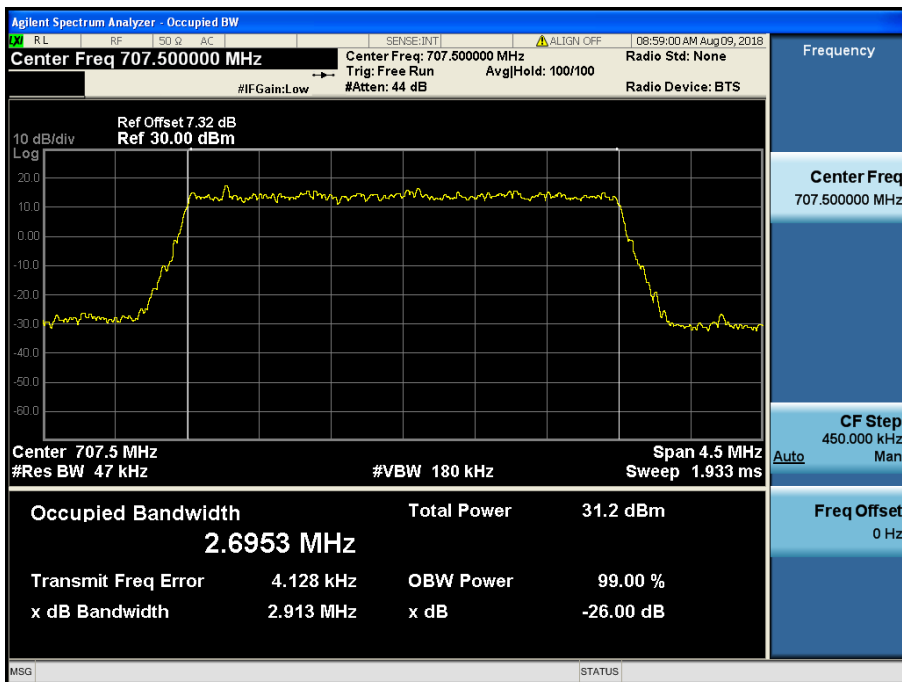

LTE Band 12 / 3 MHz / 16QAM - RB Size 15

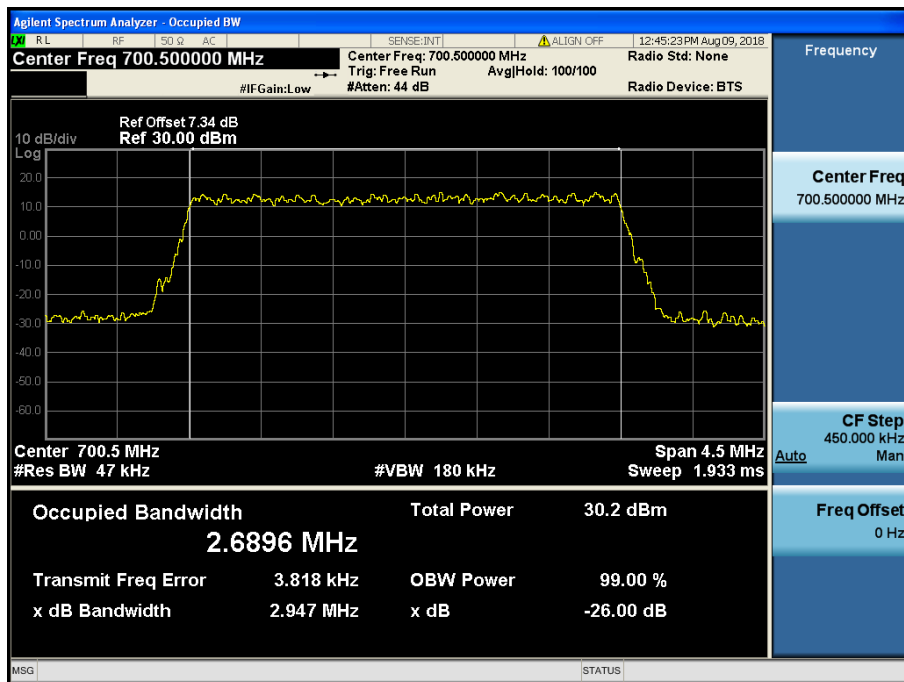

LTE Band 12 / 3 MHz / 64QAM - RB Size 15

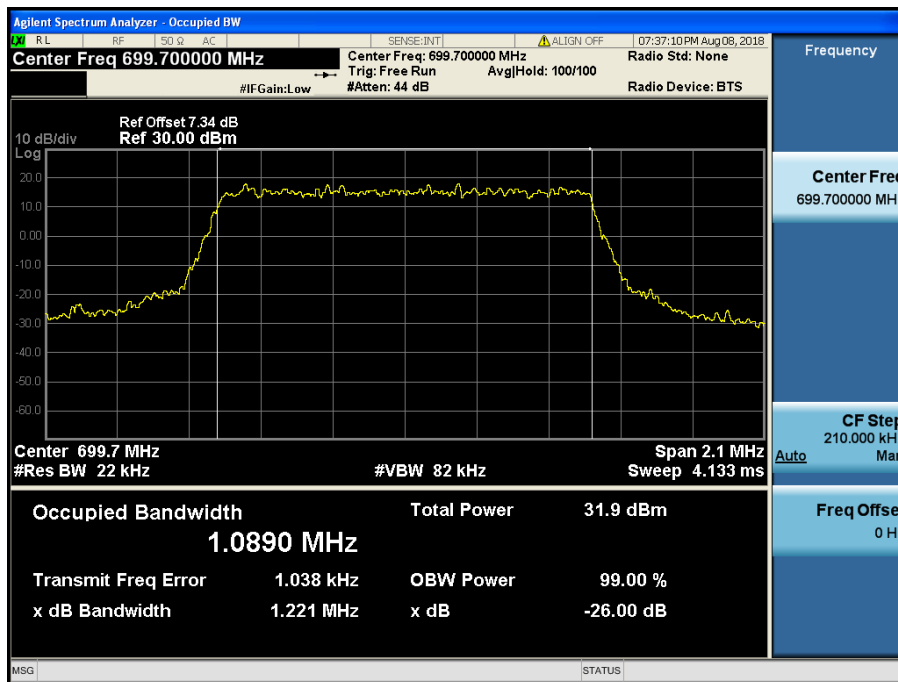

LTE Band 12 / 1.4 MHz / QPSK - RB Size 6

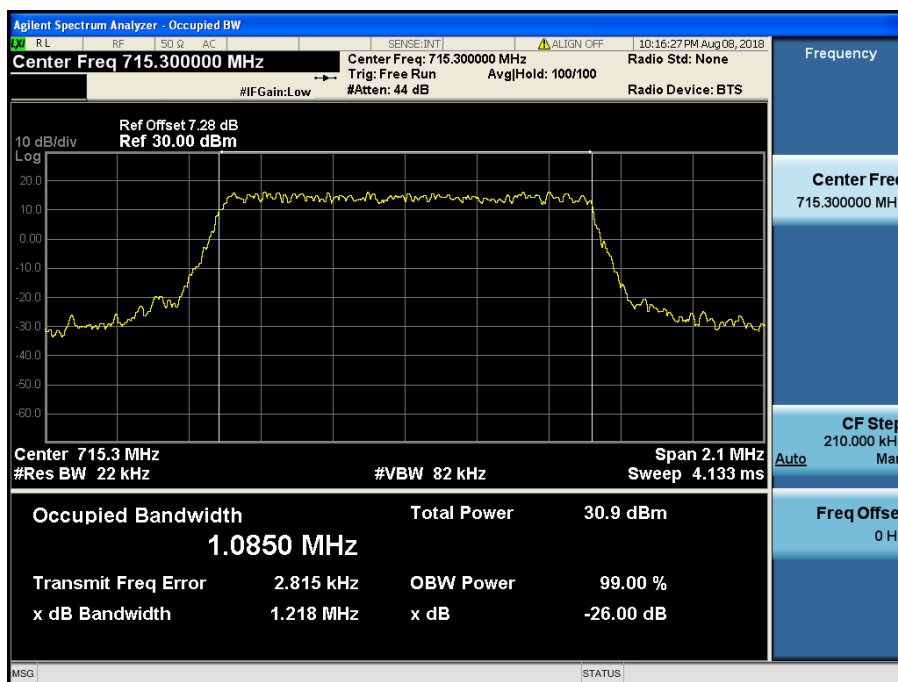

LTE Band 12 / 1.4 MHz / 16QAM - RB Size 6

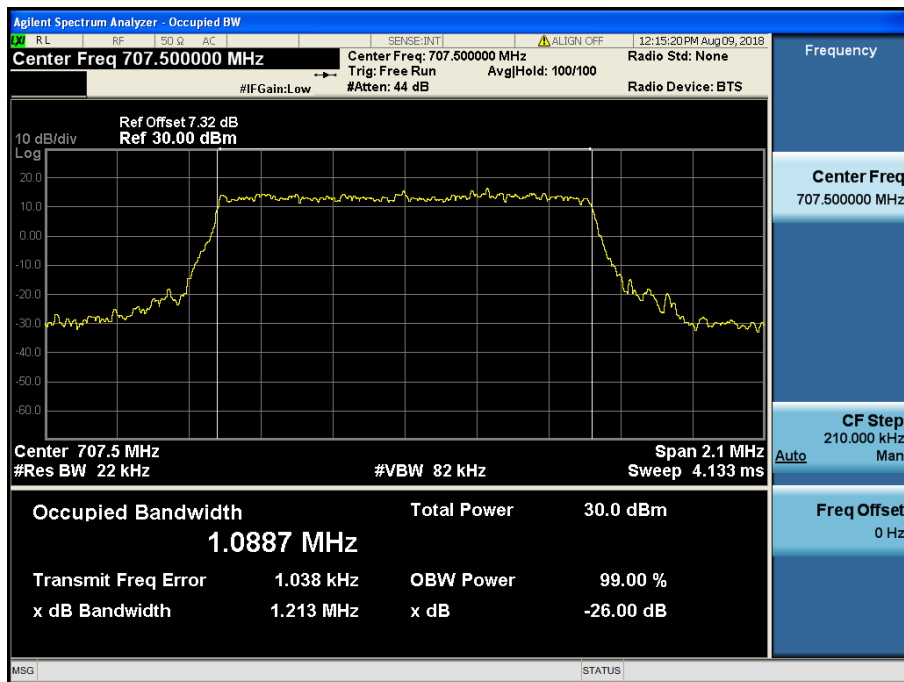

LTE Band 12 / 1.4 MHz / 64QAM - RB Size 6



8.1.3 LTE Band 5

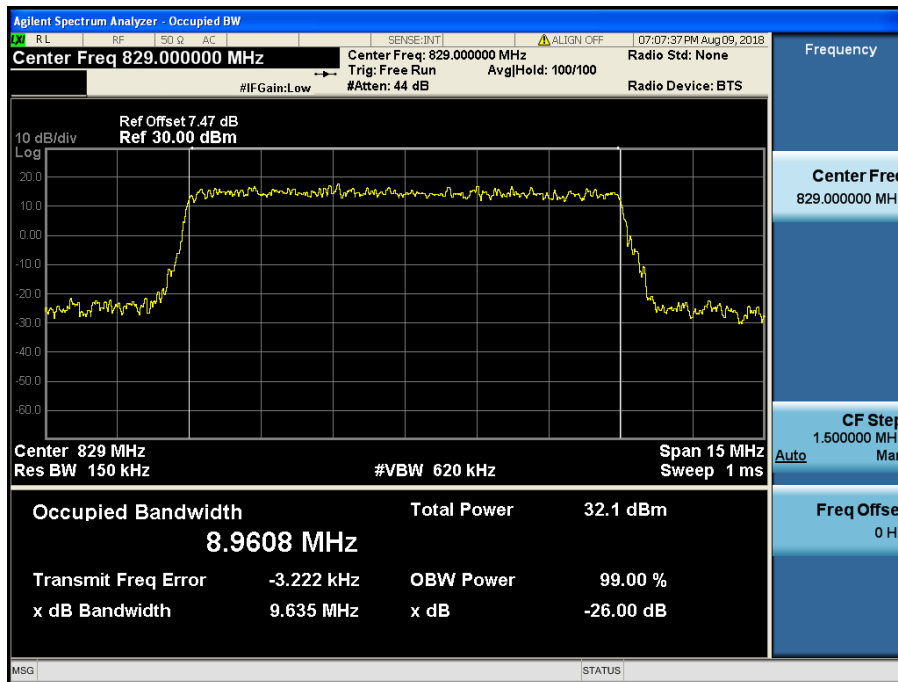

LTE Band 5 / 10 MHz / QPSK - RB Size 50

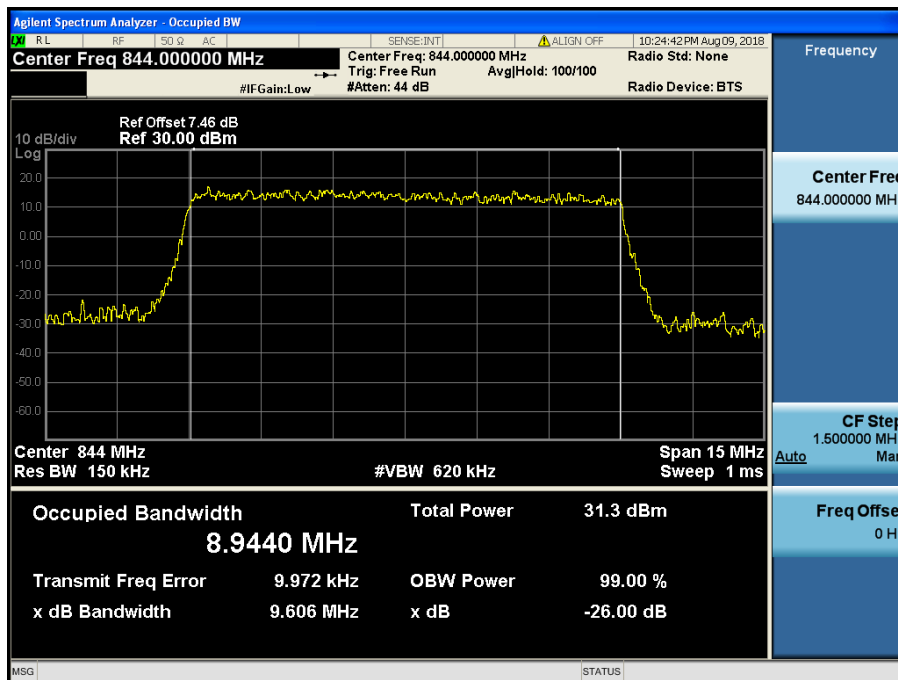

LTE Band 5 / 10 MHz / 16QAM - RB Size 50

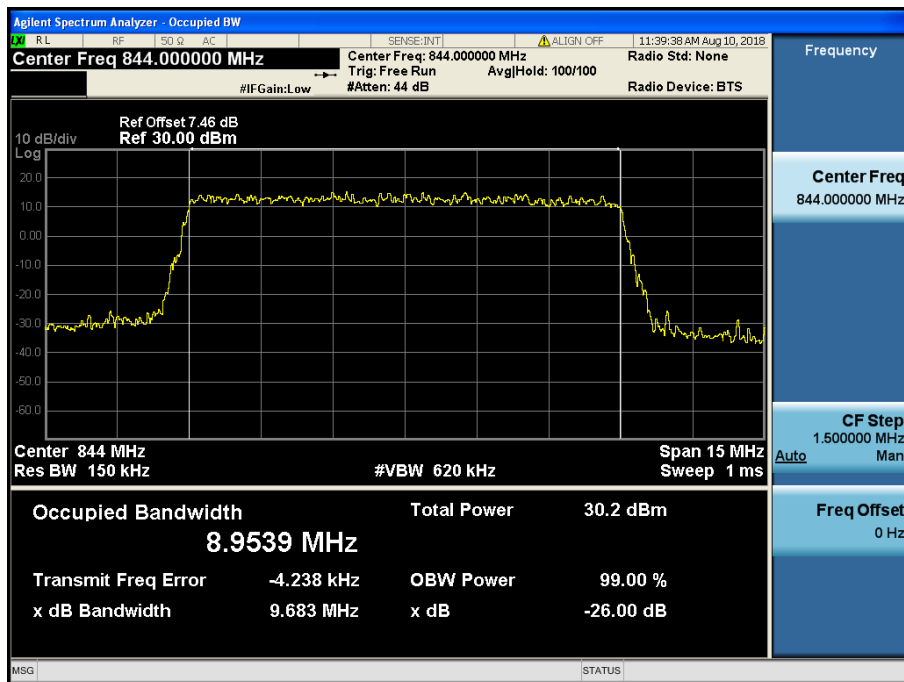

LTE Band 5 / 10 MHz / 64QAM - RB Size 50

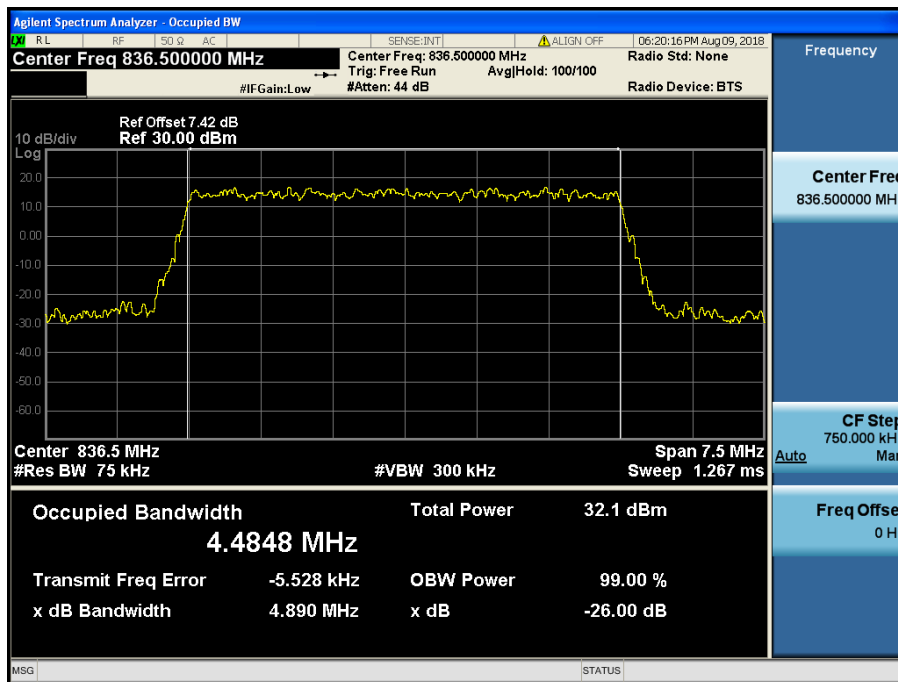

LTE Band 5 / 5 MHz / QPSK - RB Size 25

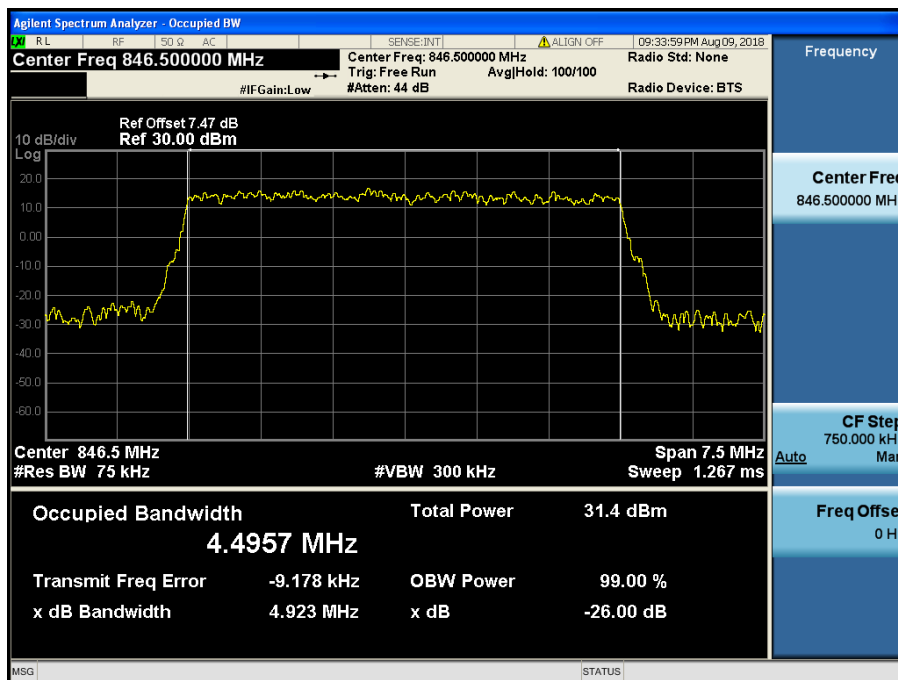

LTE Band 5 / 5 MHz / 16QAM - RB Size 25

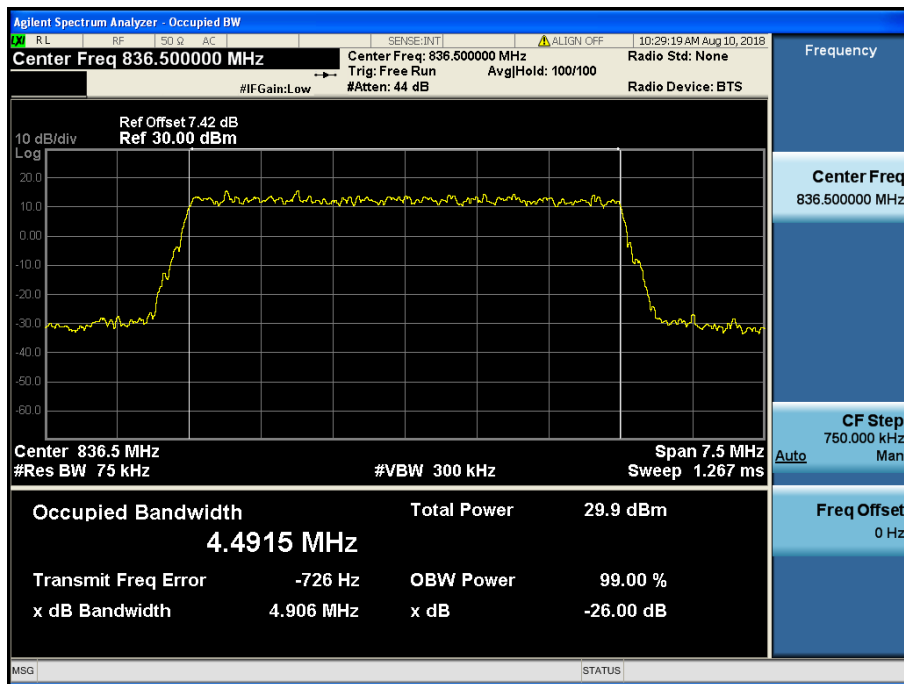

LTE Band 5 / 5 MHz / 64QAM - RB Size 25

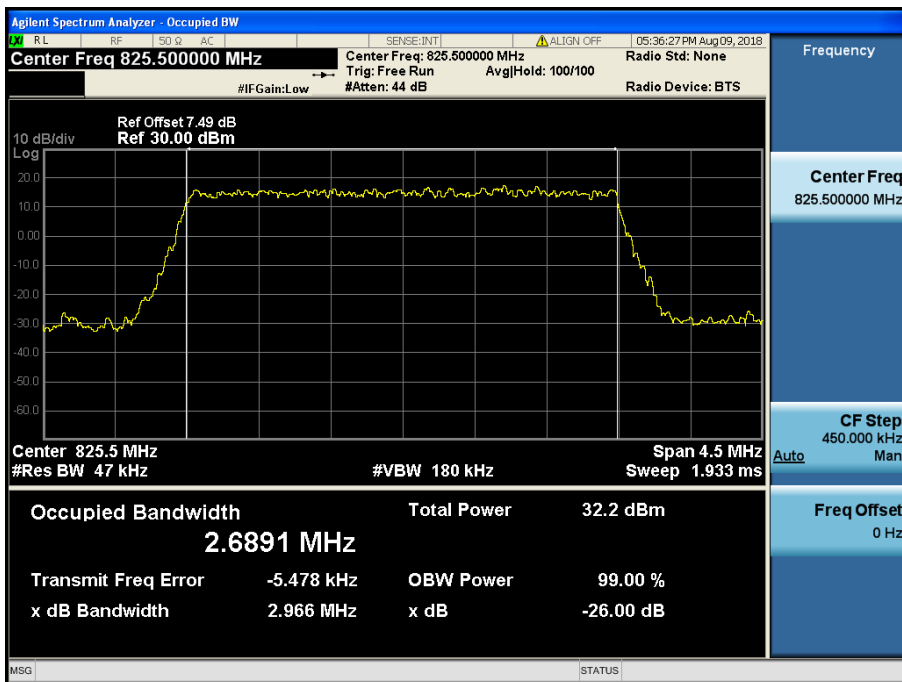

LTE Band 5 / 3 MHz / QPSK - RB Size 15

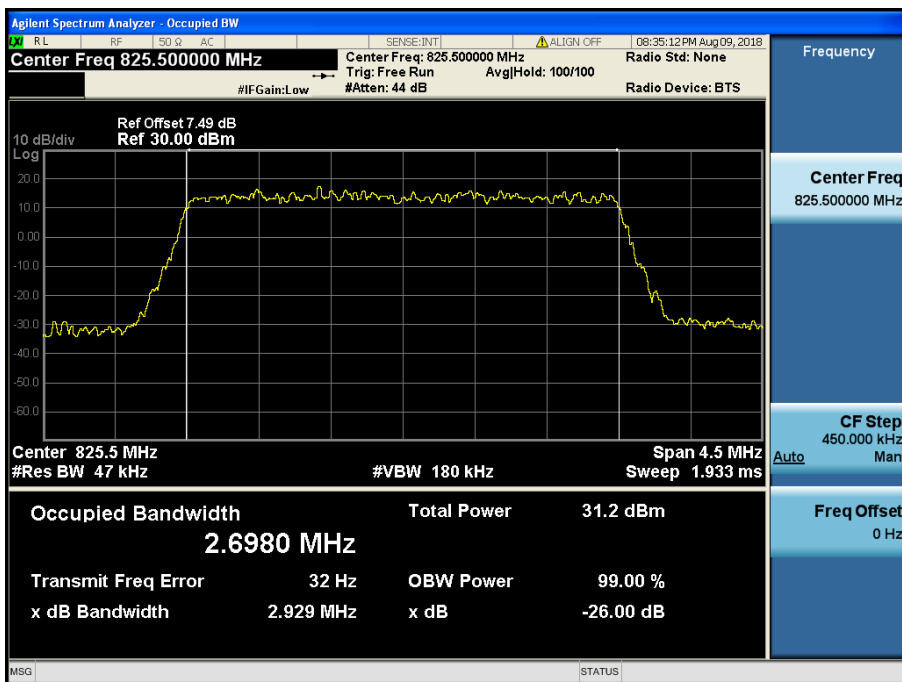

LTE Band 5 / 3 MHz / 16QAM - RB Size 15

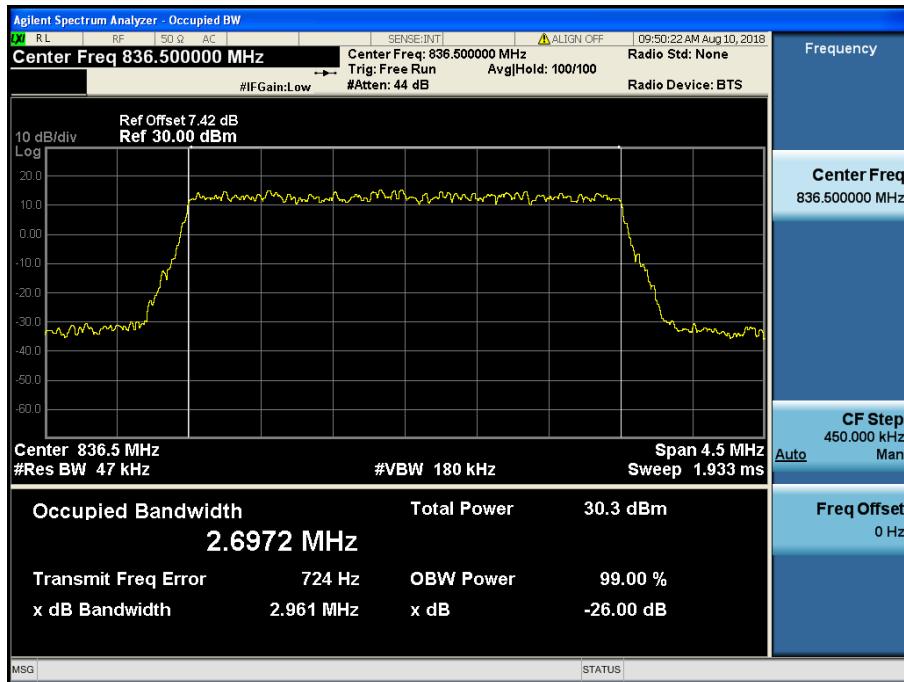

LTE Band 5 / 3 MHz / 64QAM - RB Size 15

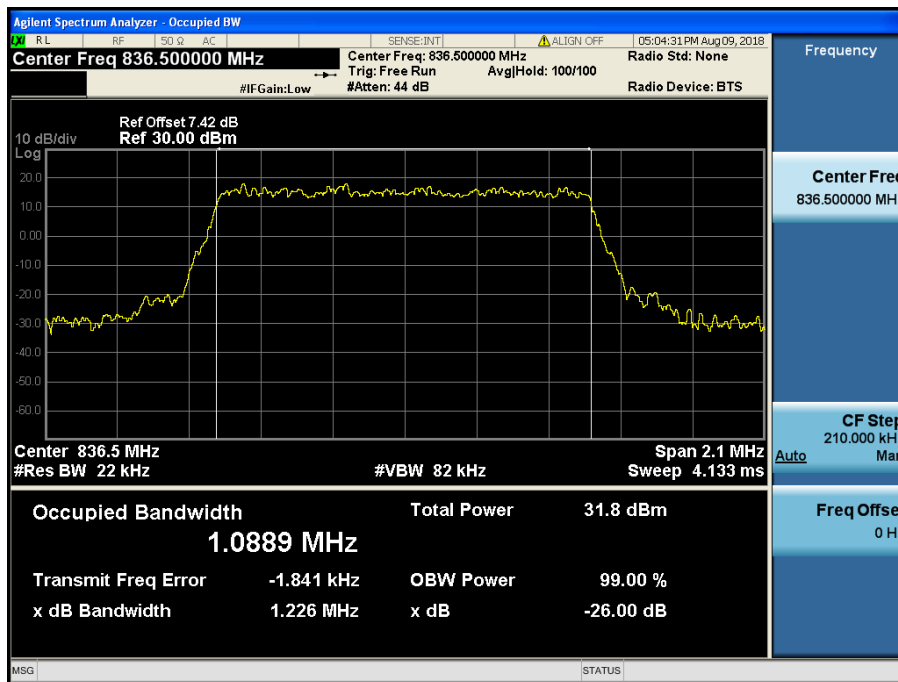

LTE Band 5 / 1.4 MHz / QPSK - RB Size 6

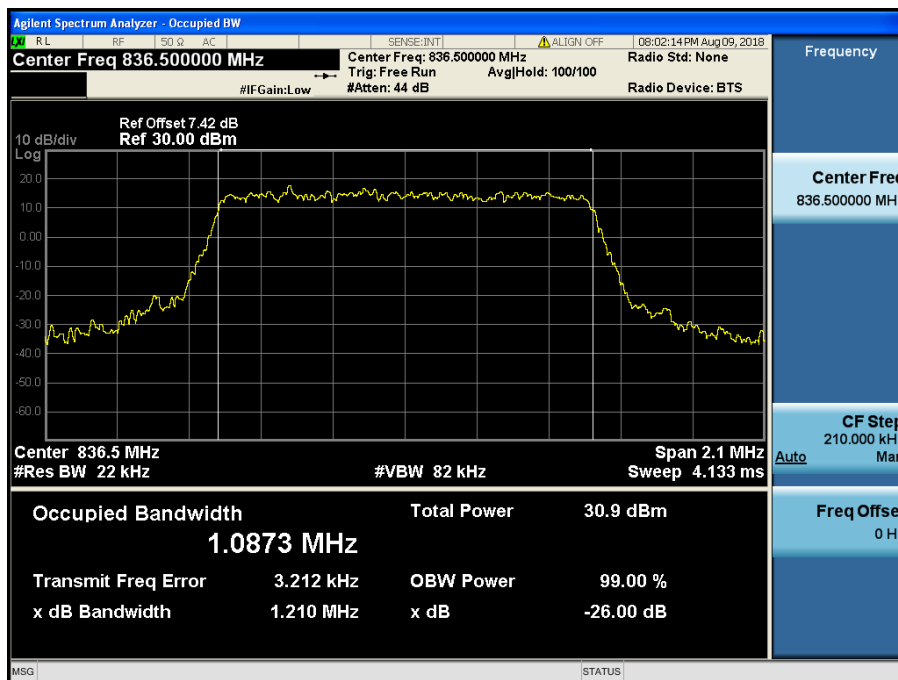

LTE Band 5 / 1.4 MHz / 16QAM - RB Size 6

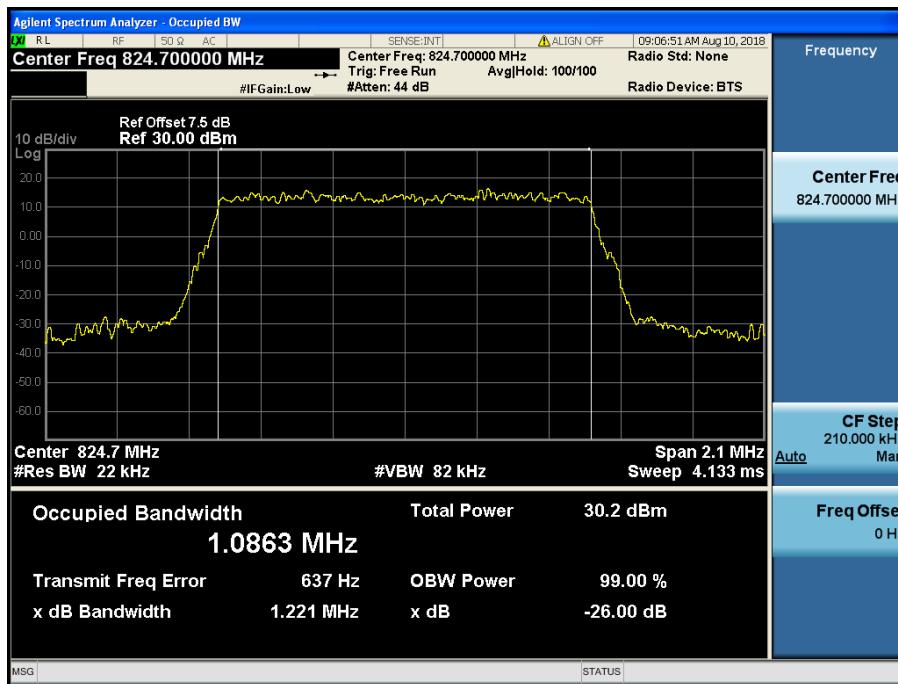

LTE Band 5 / 1.4 MHz / 64QAM - RB Size 6



8.1.4 LTE Band 4,66

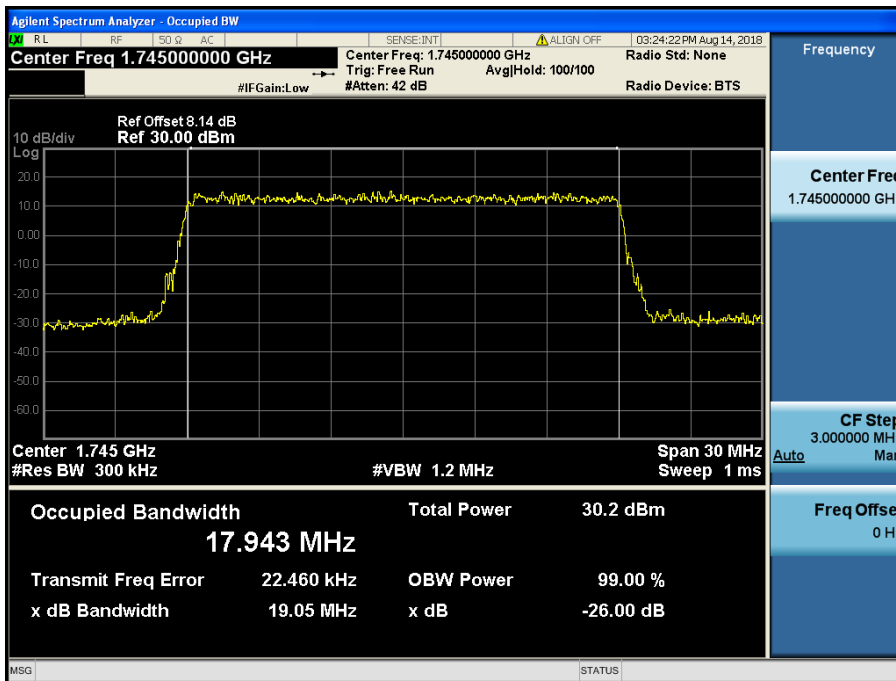

LTE Band 4,66 / 20 MHz / QPSK - RB Size 100

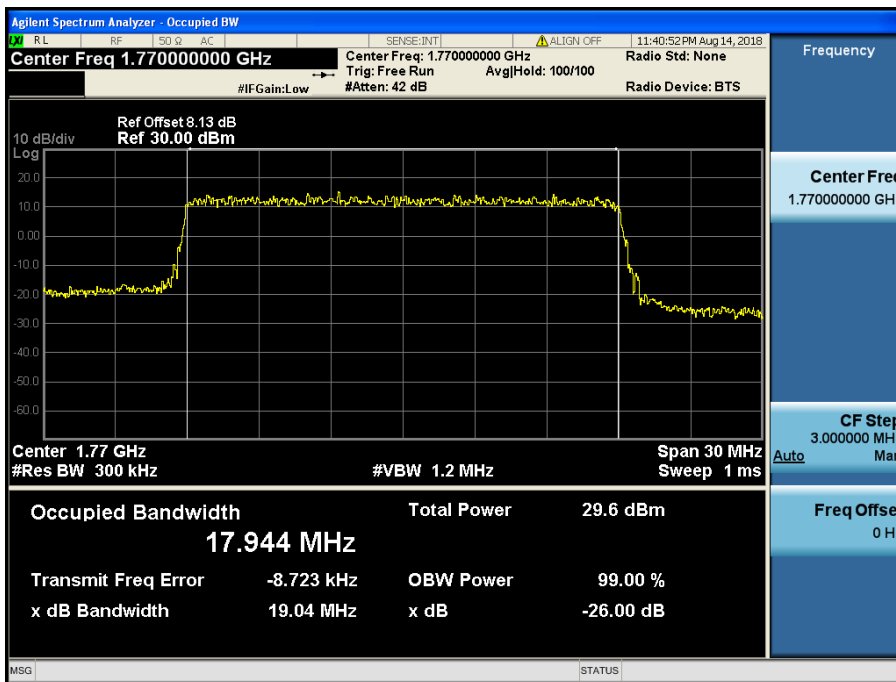

LTE Band 4,66 / 20 MHz / 16QAM - RB Size 100

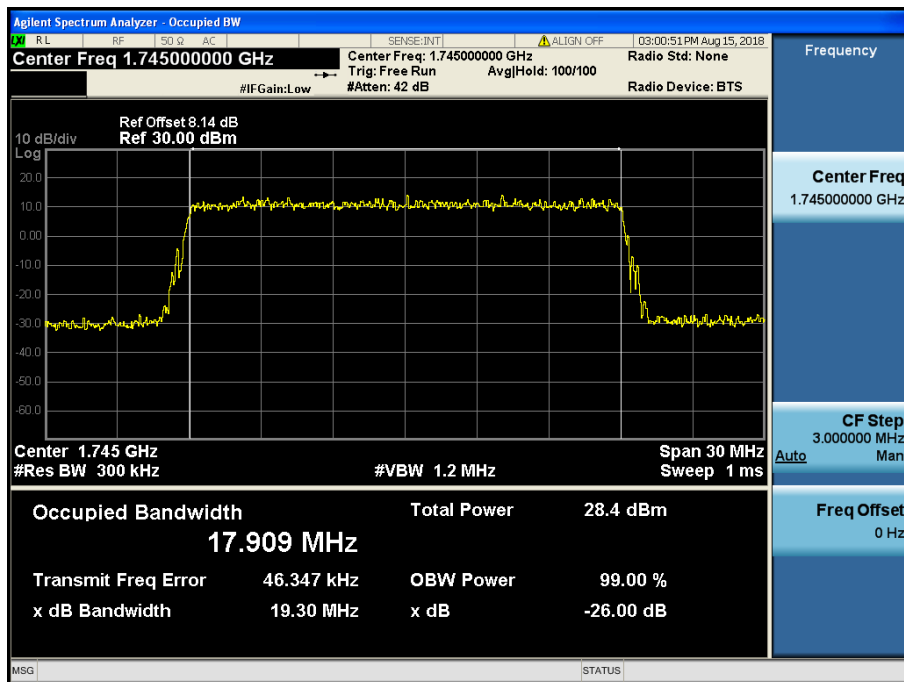

LTE Band 4,66 / 20 MHz / 64QAM - RB Size 100

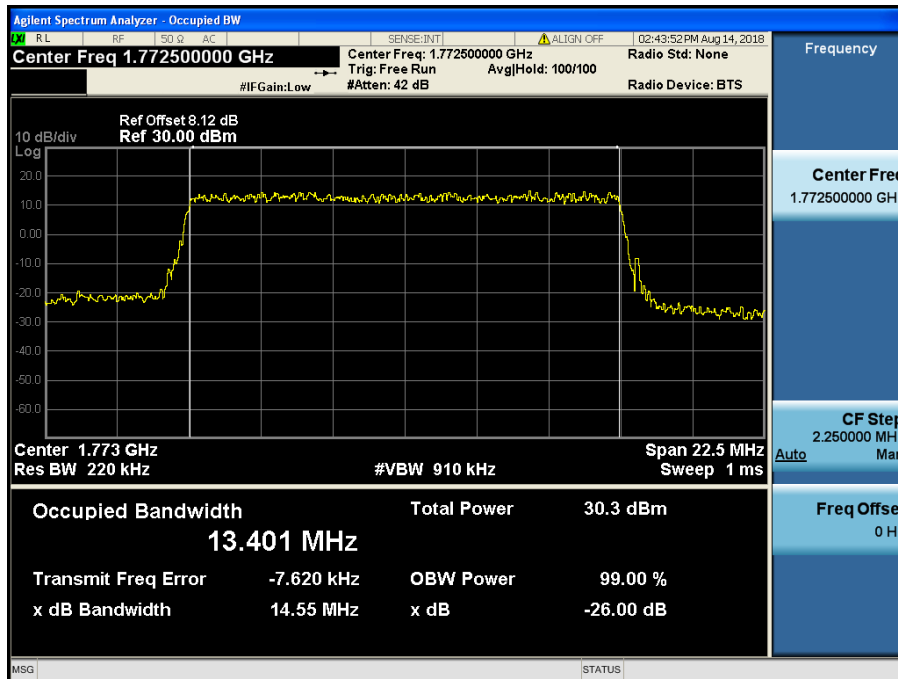

LTE Band 4,66 / 15 MHz / QPSK - RB Size 75

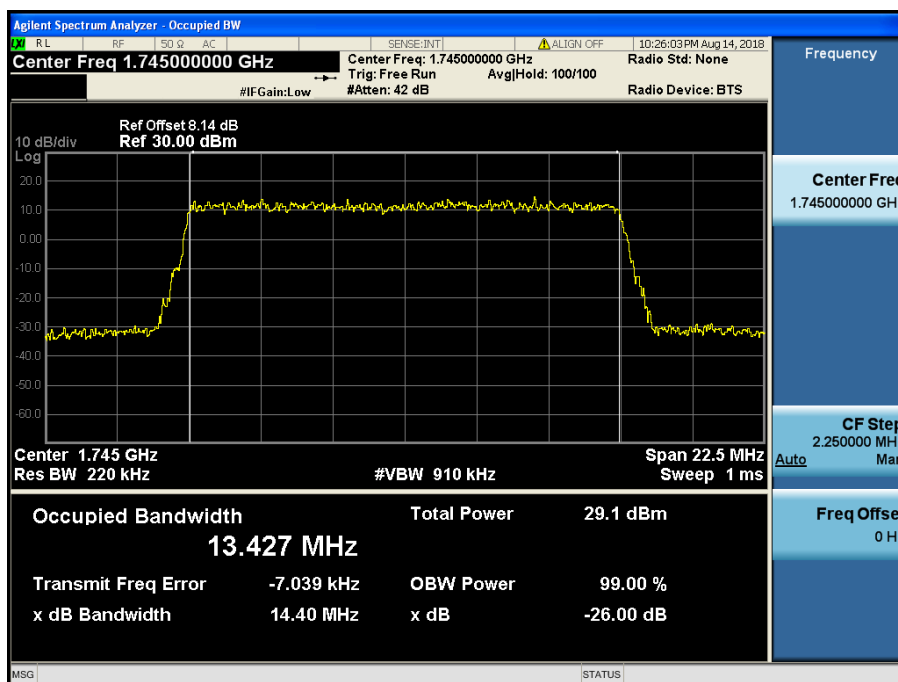

LTE Band 4,66 / 15 MHz / 16QAM - RB Size 75

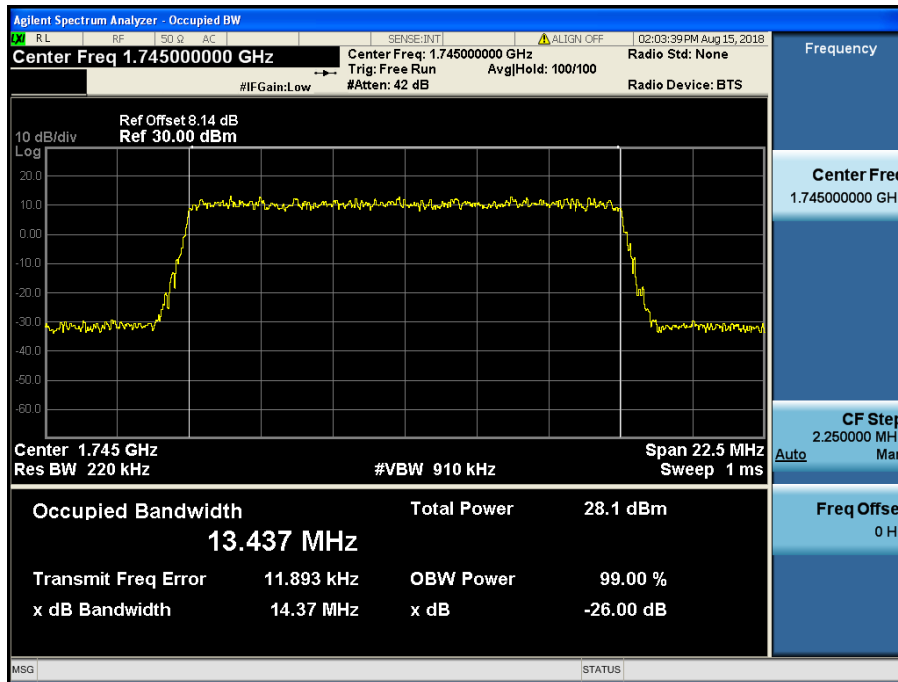

LTE Band 4,66 / 15 MHz / 64QAM - RB Size 75

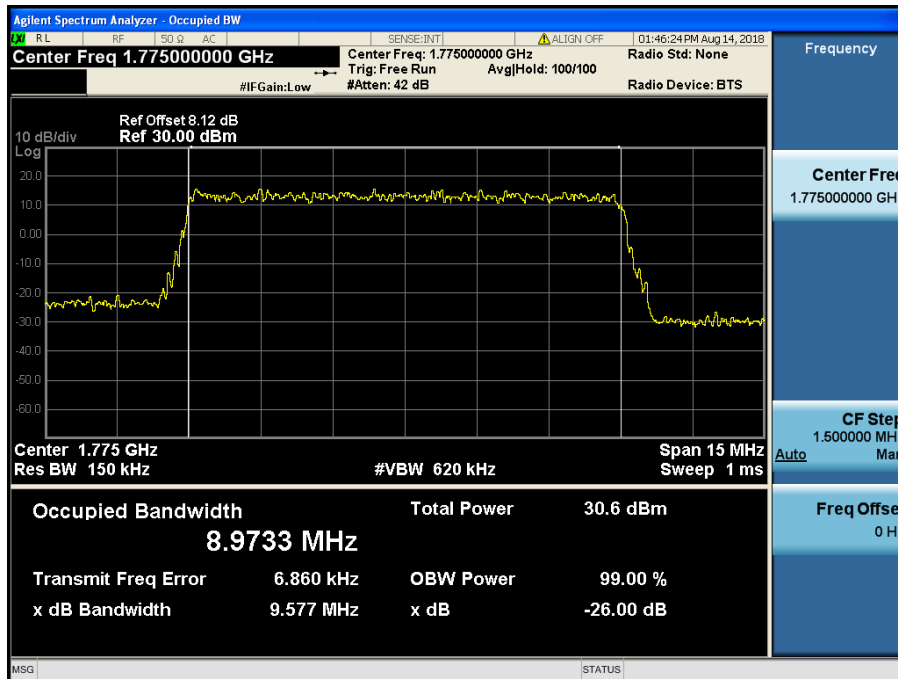

LTE Band 4,66 / 10 MHz / QPSK - RB Size 50

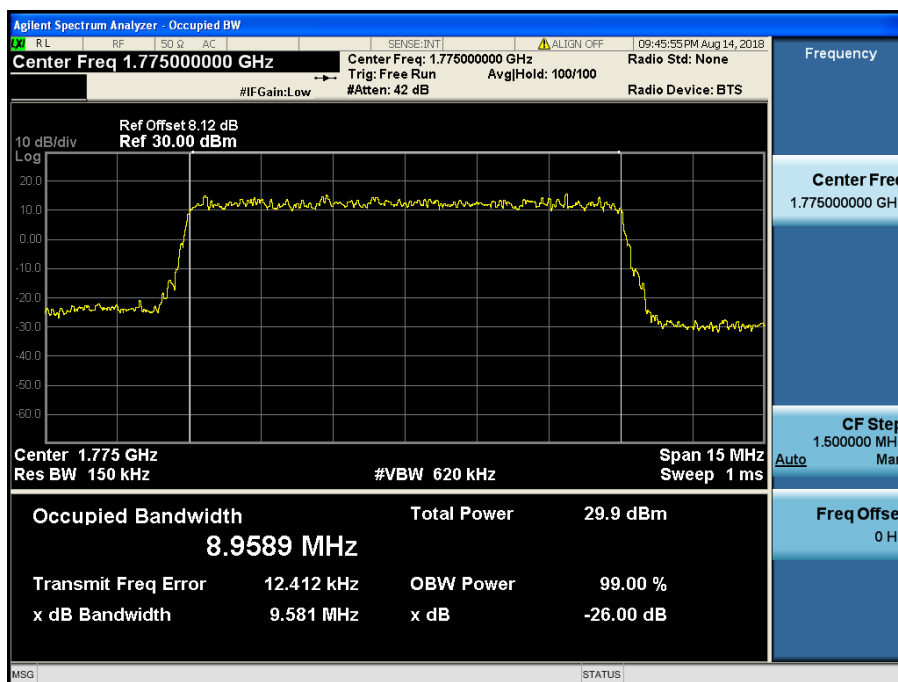

LTE Band 4,66 / 10 MHz / 16QAM - RB Size 50

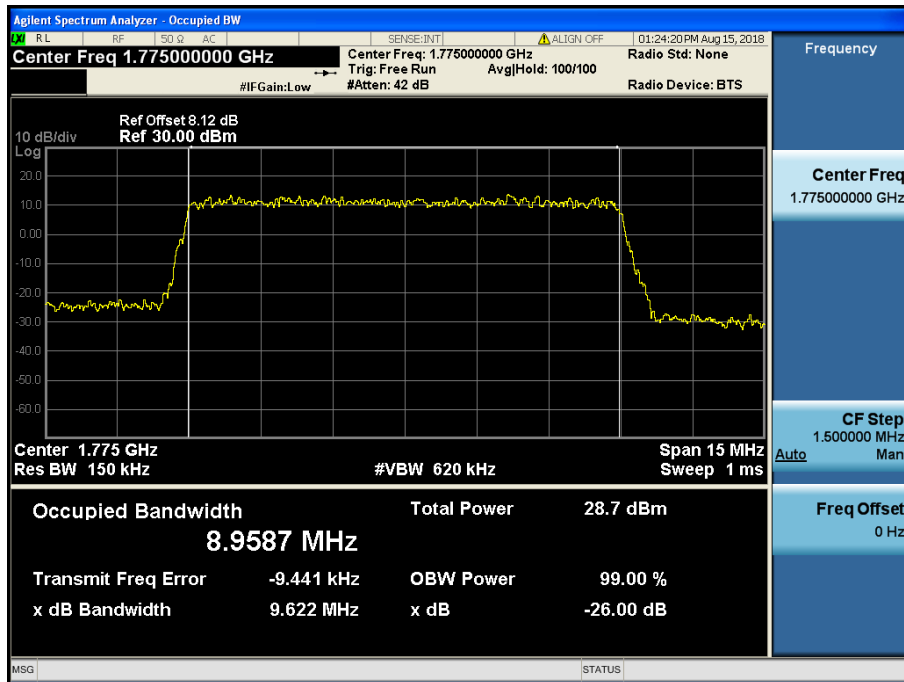

LTE Band 4,66 / 10 MHz / 64QAM - RB Size 50

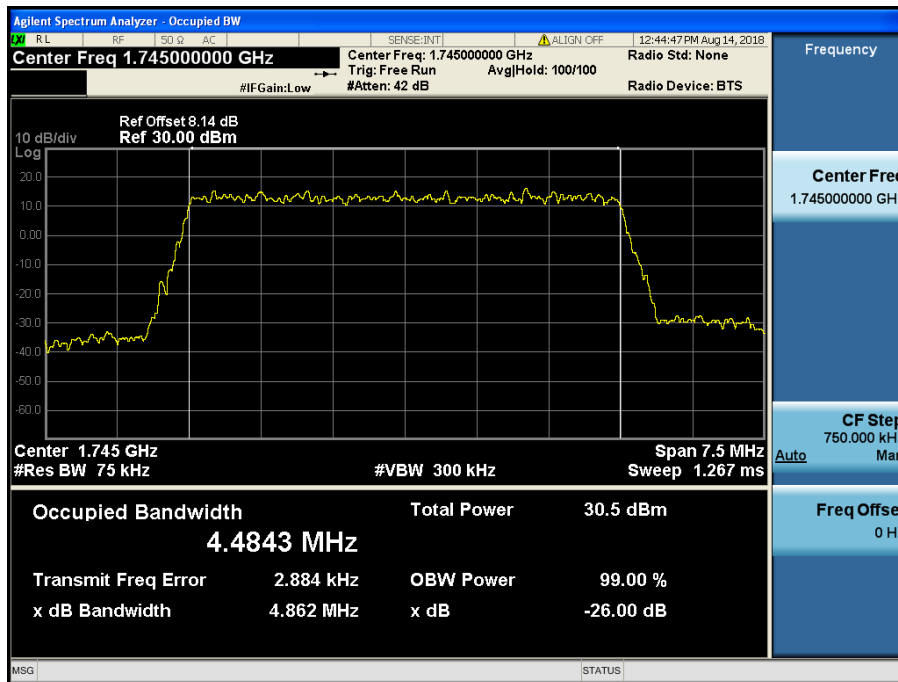

LTE Band 4,66 / 5 MHz / QPSK - RB Size 25

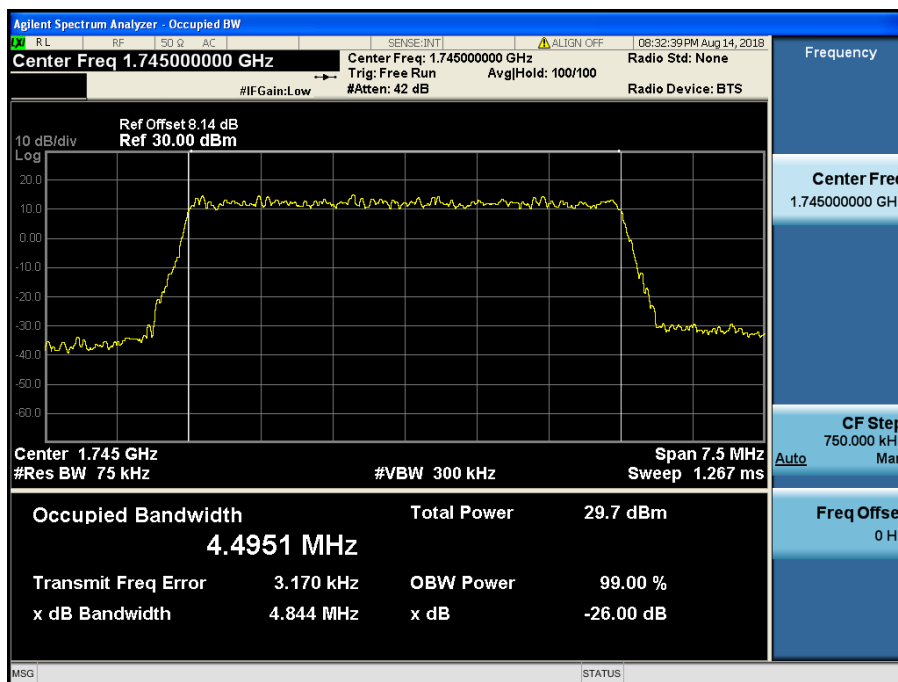

LTE Band 4,66 / 5 MHz / 16QAM - RB Size 25

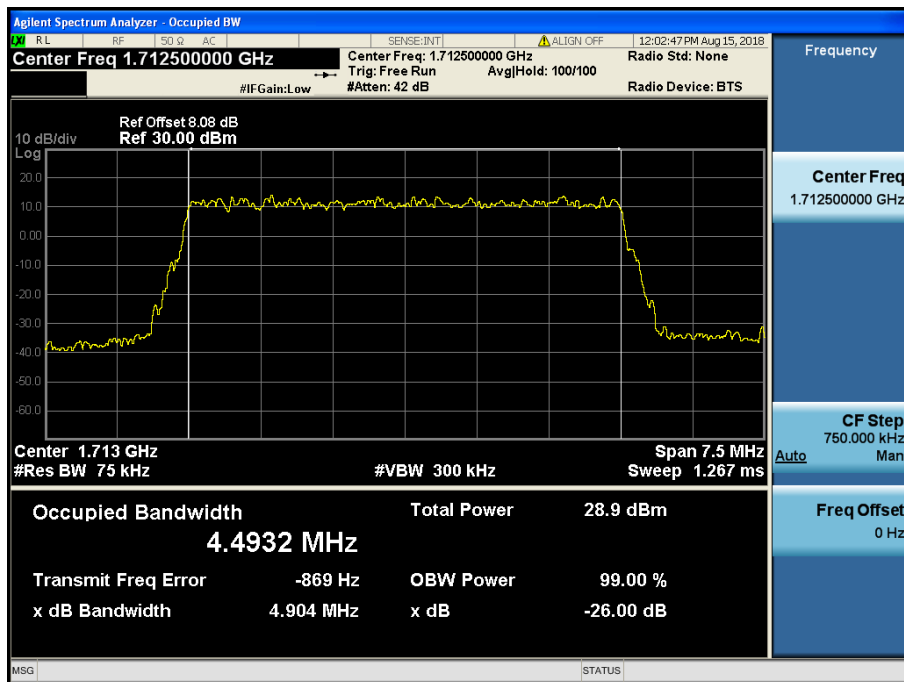

LTE Band 4,66 / 5 MHz / 64QAM - RB Size 25



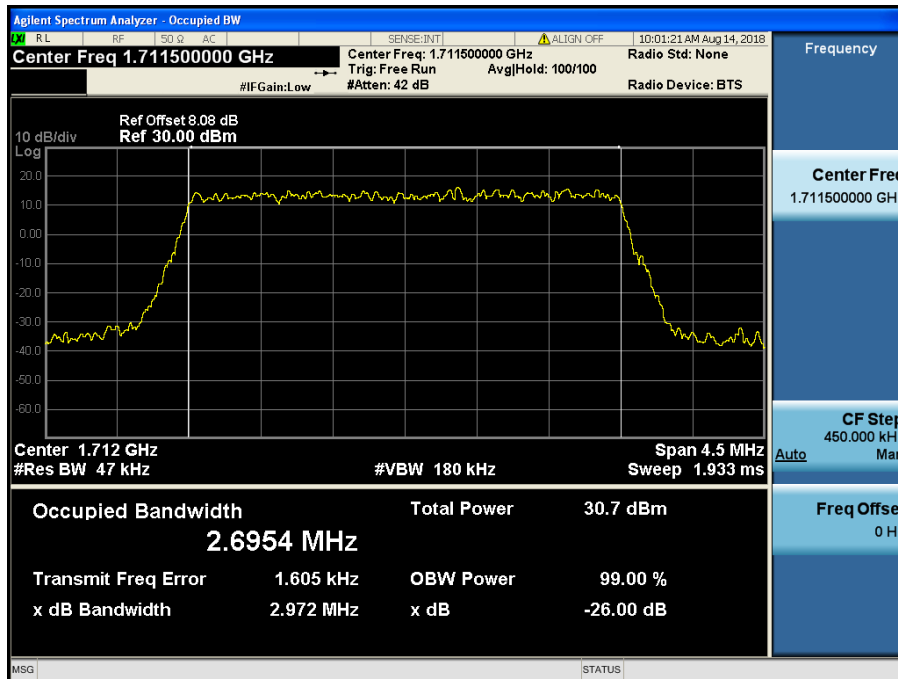

LTE Band 4,66 / 3 MHz / QPSK - RB Size 15

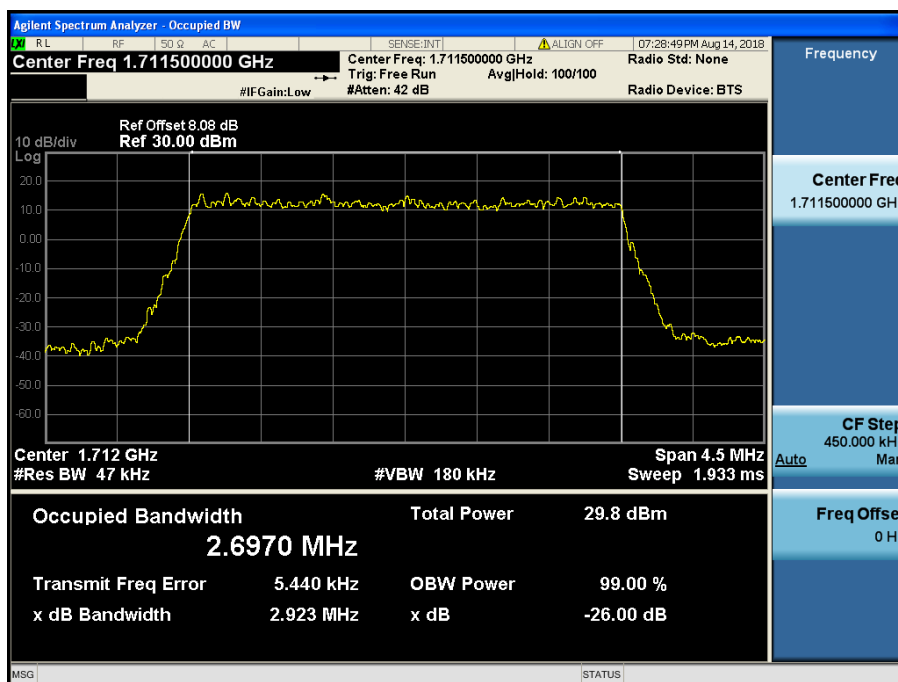

LTE Band 4,66 / 3 MHz / 16QAM - RB Size 15

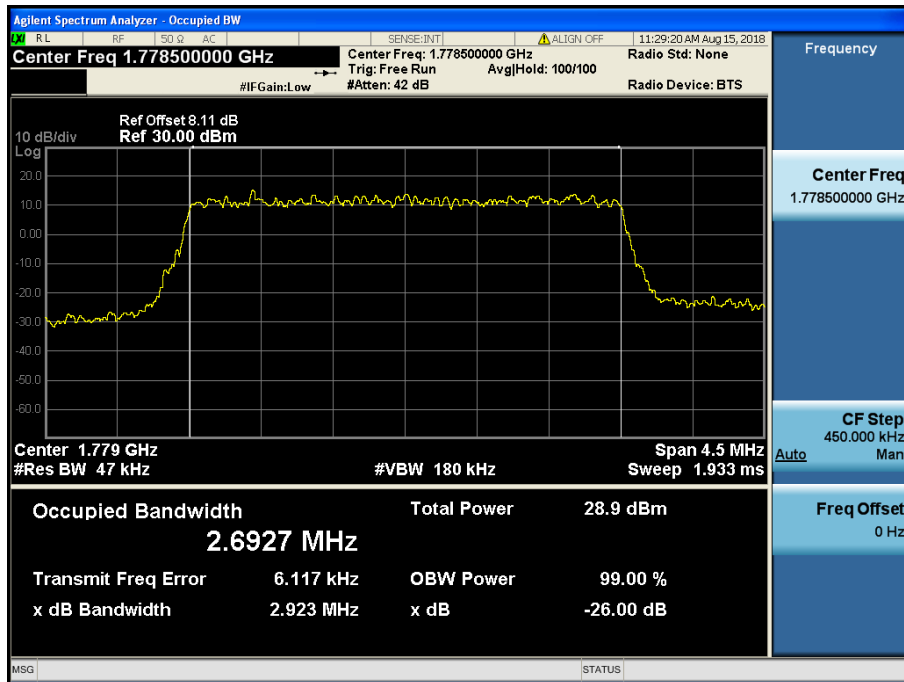

LTE Band 4,66 / 3 MHz / 64QAM - RB Size 15

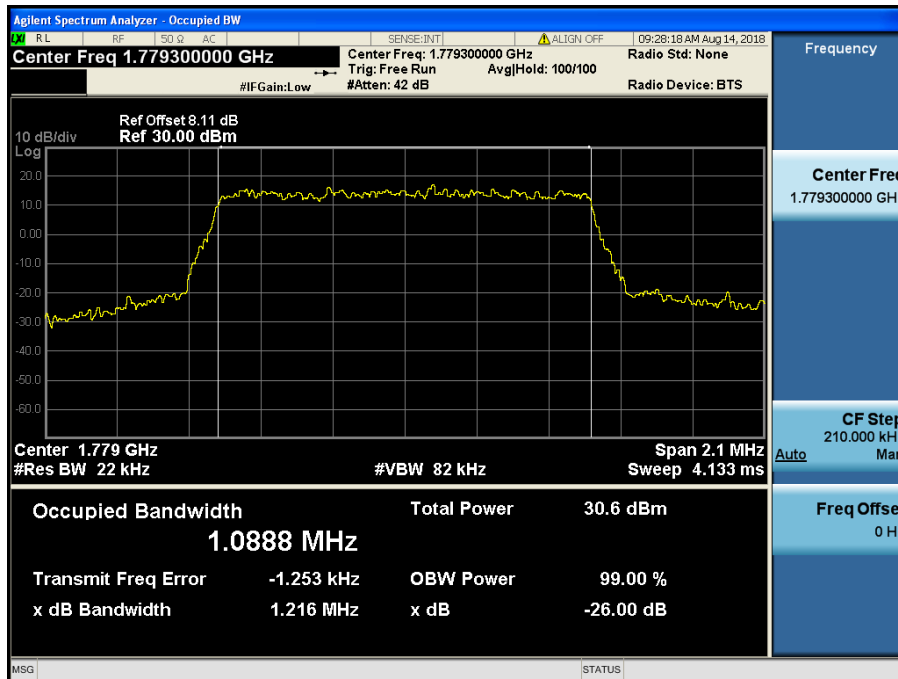

LTE Band 4,66 / 1.4 MHz / QPSK - RB Size 6

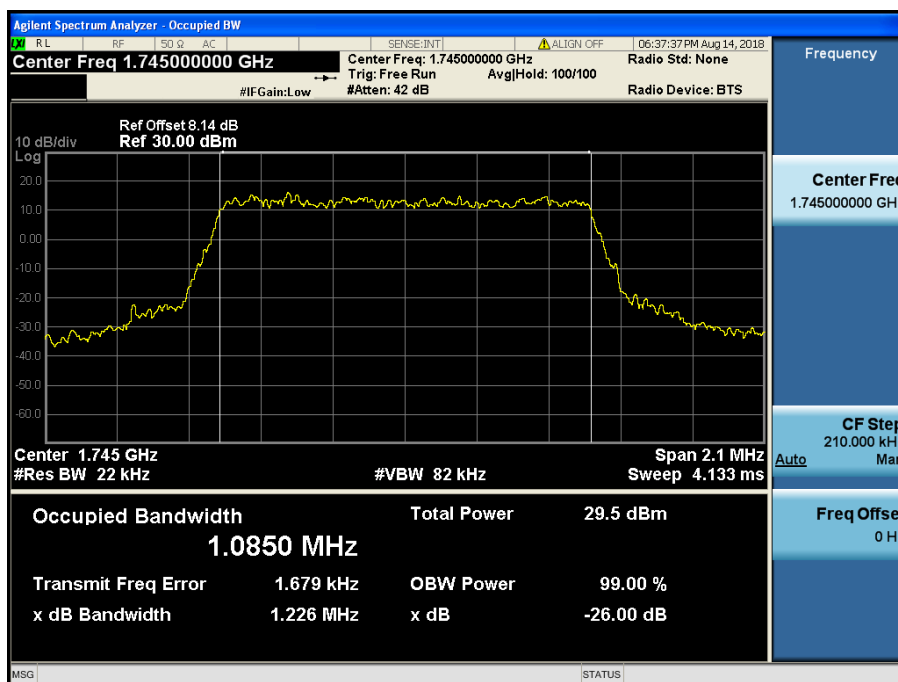

LTE Band 4,66 / 1.4 MHz / 16QAM - RB Size 6

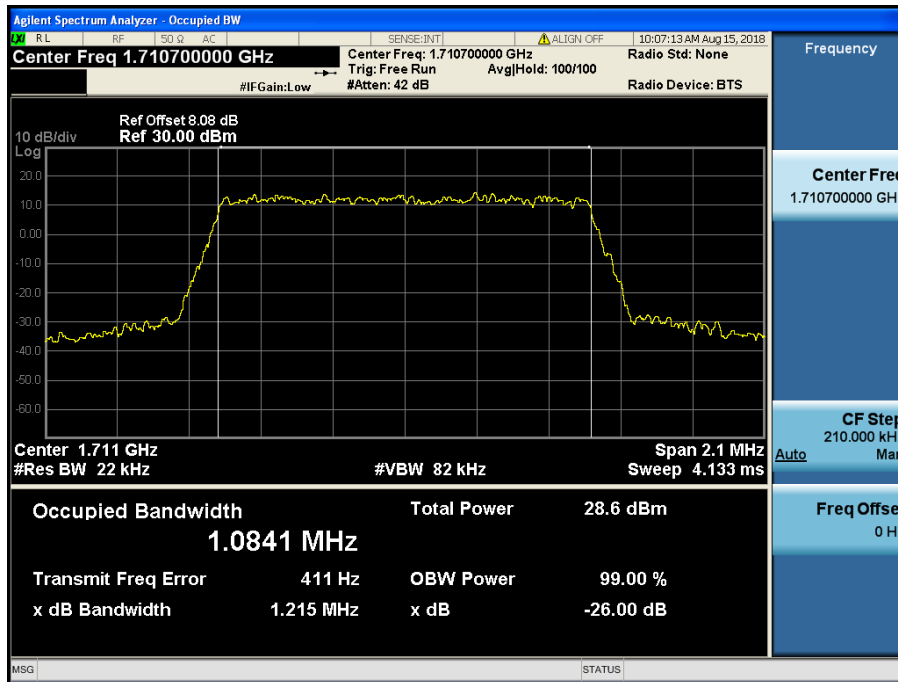

LTE Band 4,66 / 1.4 MHz / 64QAM - RB Size 6

8.1.5 LTE Band 2

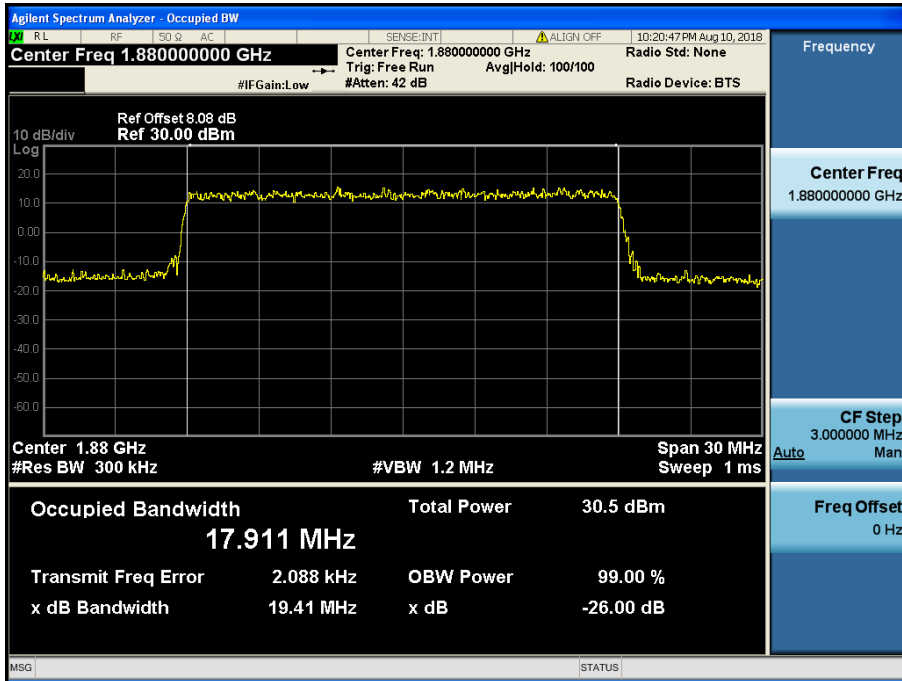

LTE Band 2 / 20 MHz / QPSK - RB Size 100

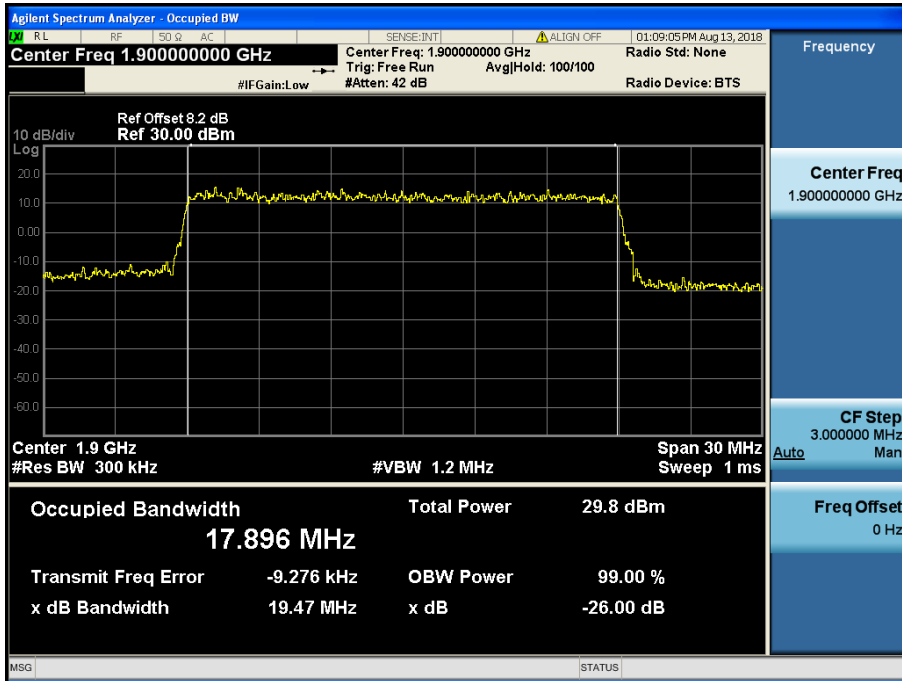

LTE Band 2 / 20 MHz / 16QAM - RB Size 100

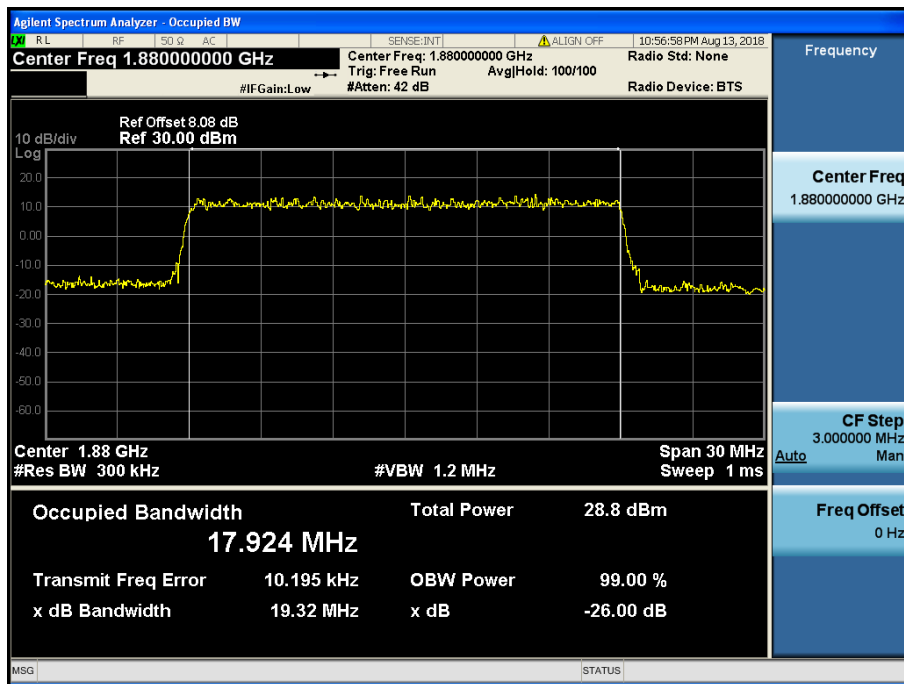

LTE Band 2 / 20 MHz / 64QAM - RB Size 100

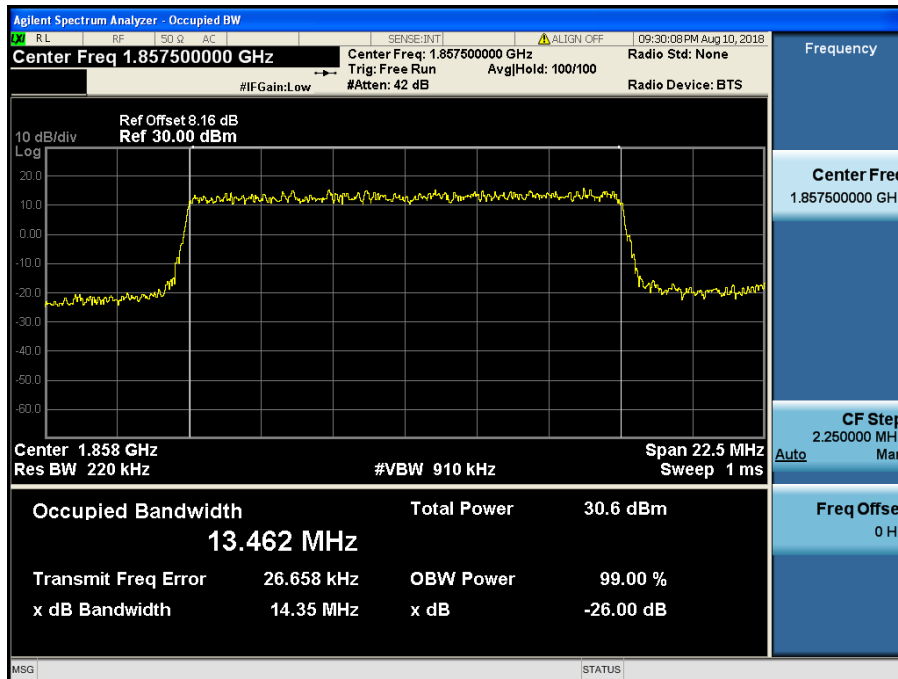

LTE Band 2 / 15 MHz / QPSK - RB Size 75

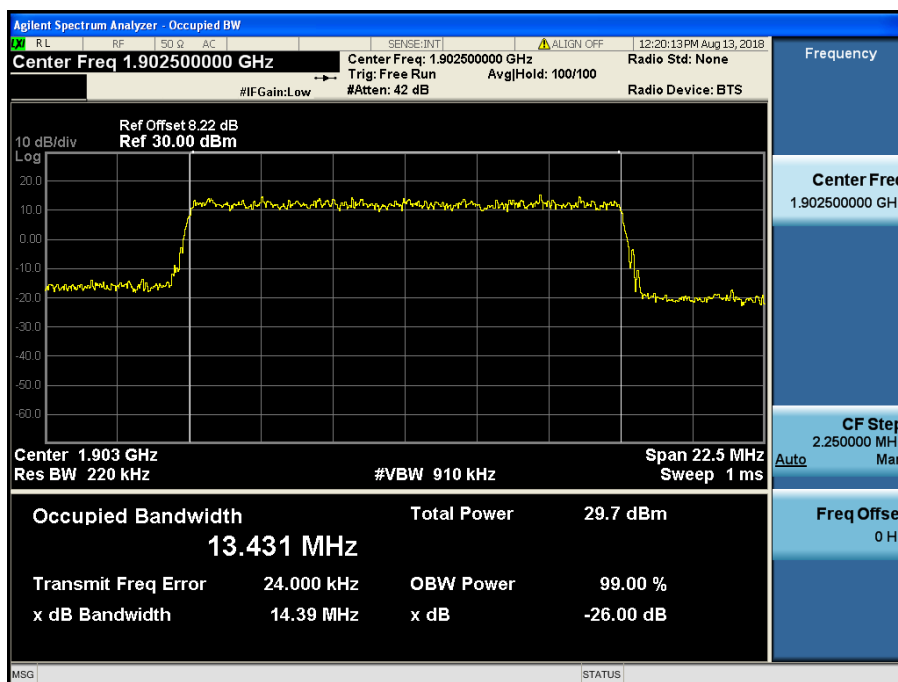

LTE Band 2 / 15 MHz / 16QAM - RB Size 75

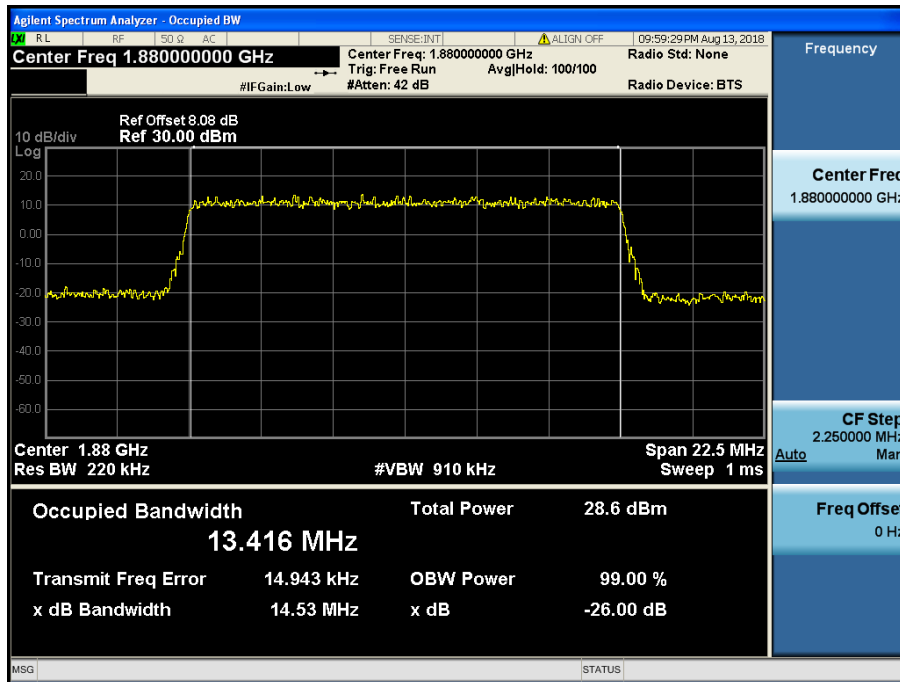

LTE Band 2 / 15 MHz / 64QAM - RB Size 75



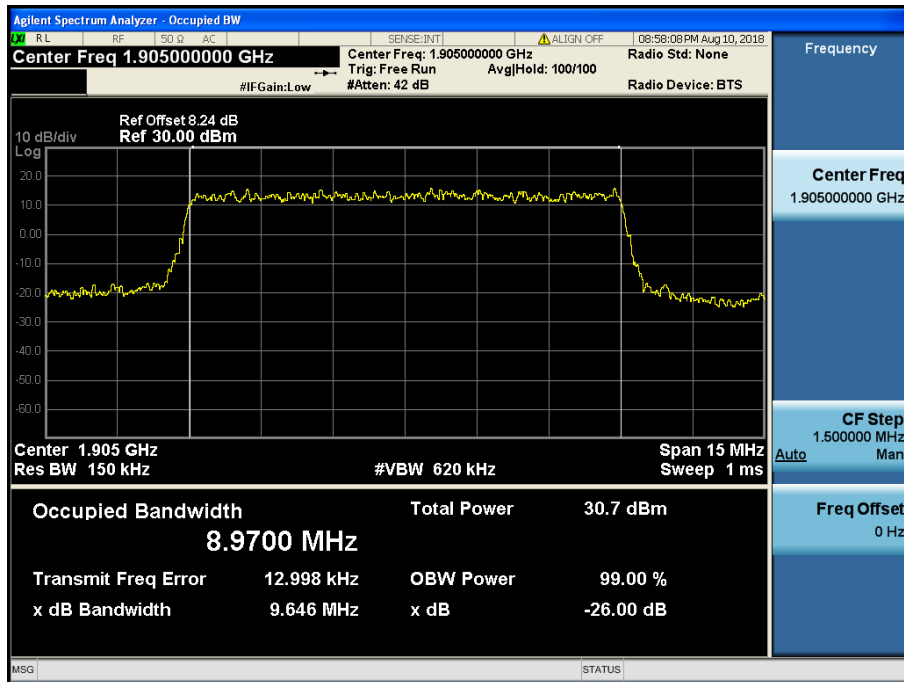

LTE Band 2 / 10 MHz / QPSK - RB Size 50

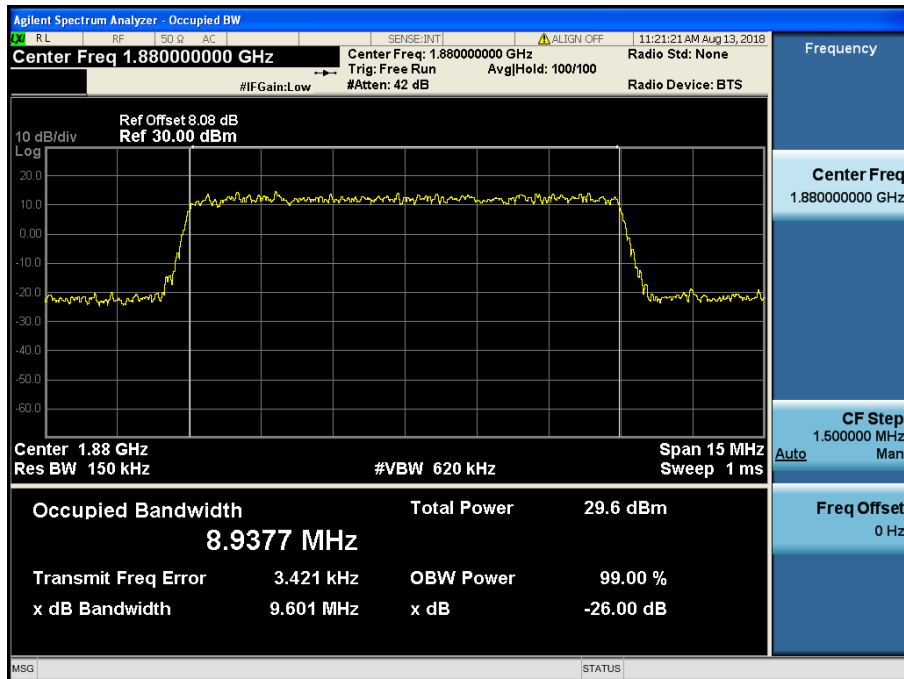

LTE Band 2 / 10 MHz / 16QAM - RB Size 50

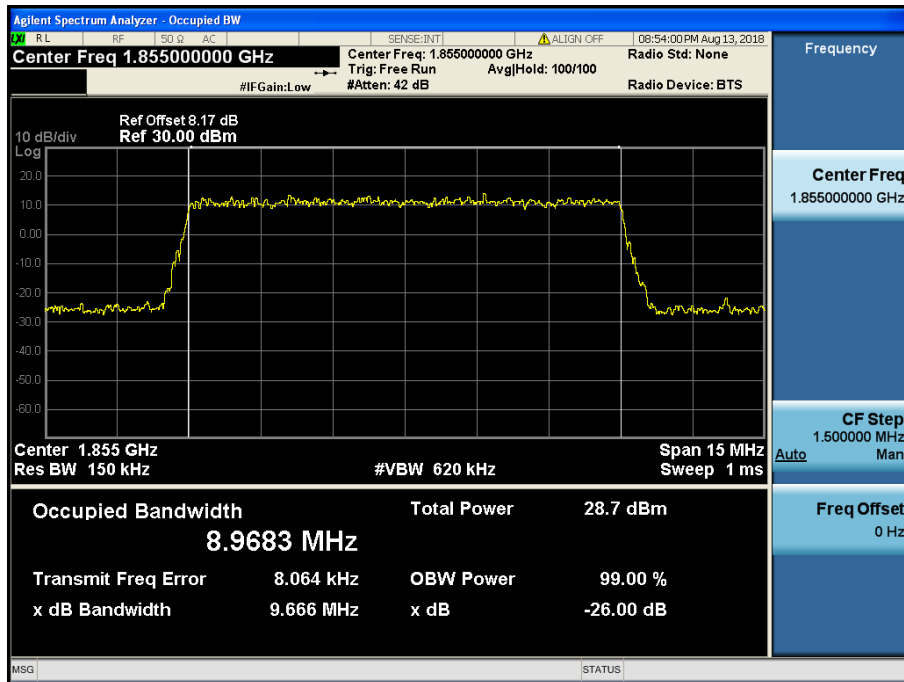

LTE Band 2 / 10 MHz / 64QAM - RB Size 50

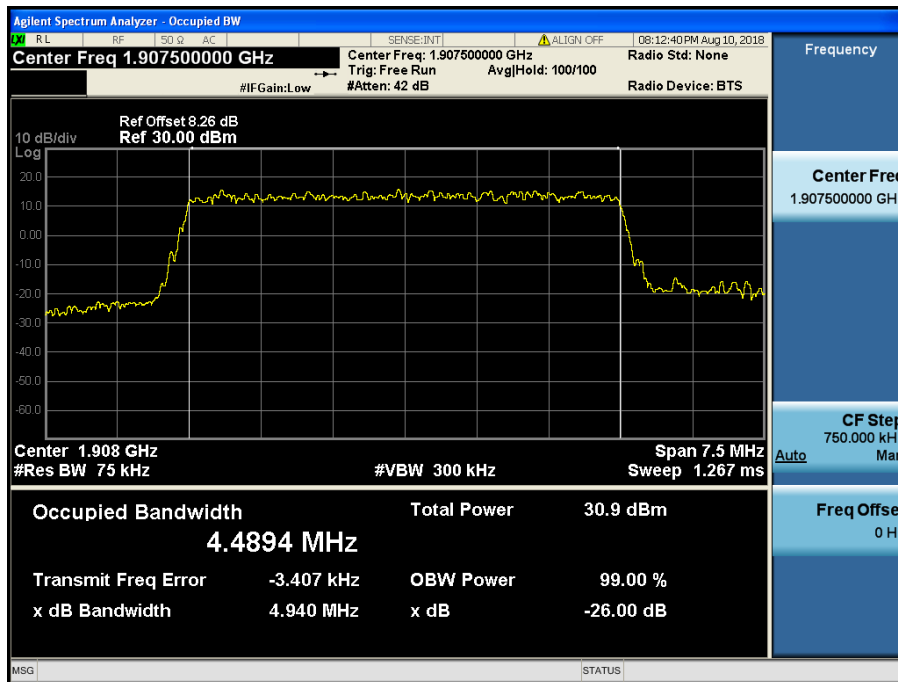

LTE Band 2 / 5 MHz / QPSK - RB Size 25

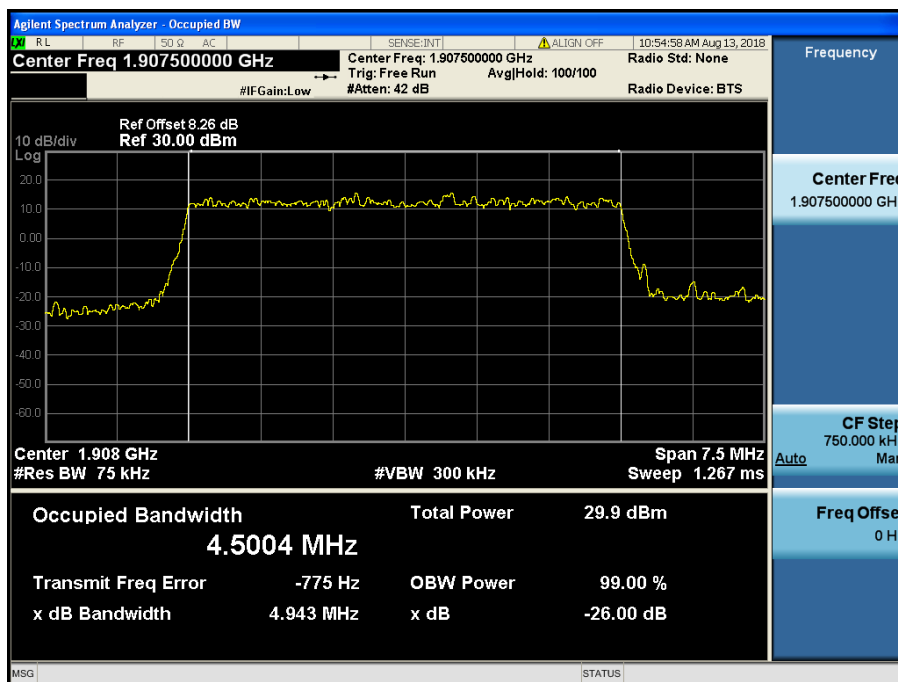

LTE Band 2 / 5 MHz / 16QAM - RB Size 25

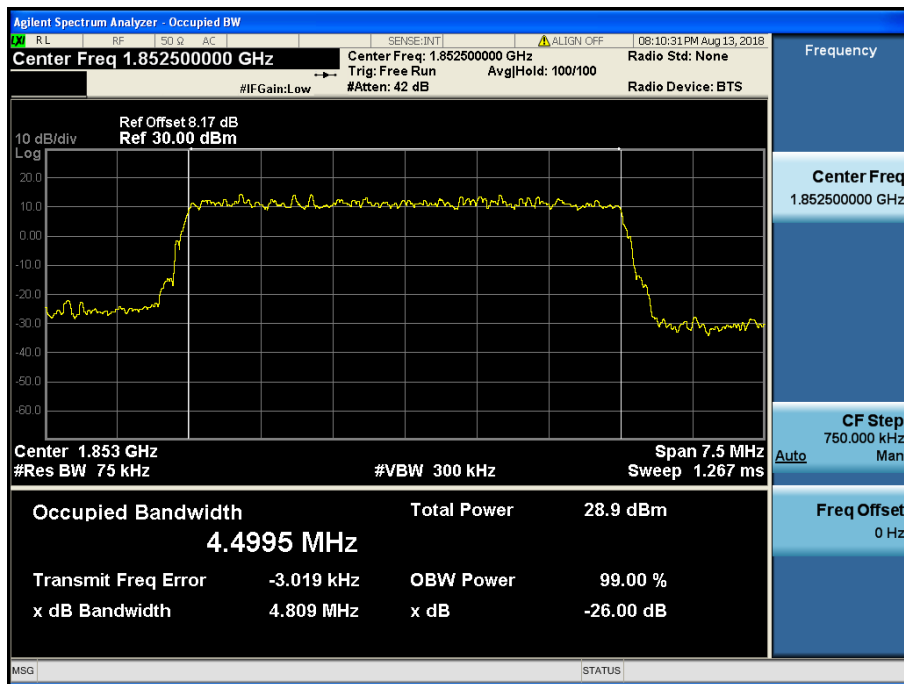

LTE Band 2 / 5 MHz / 64QAM - RB Size 25

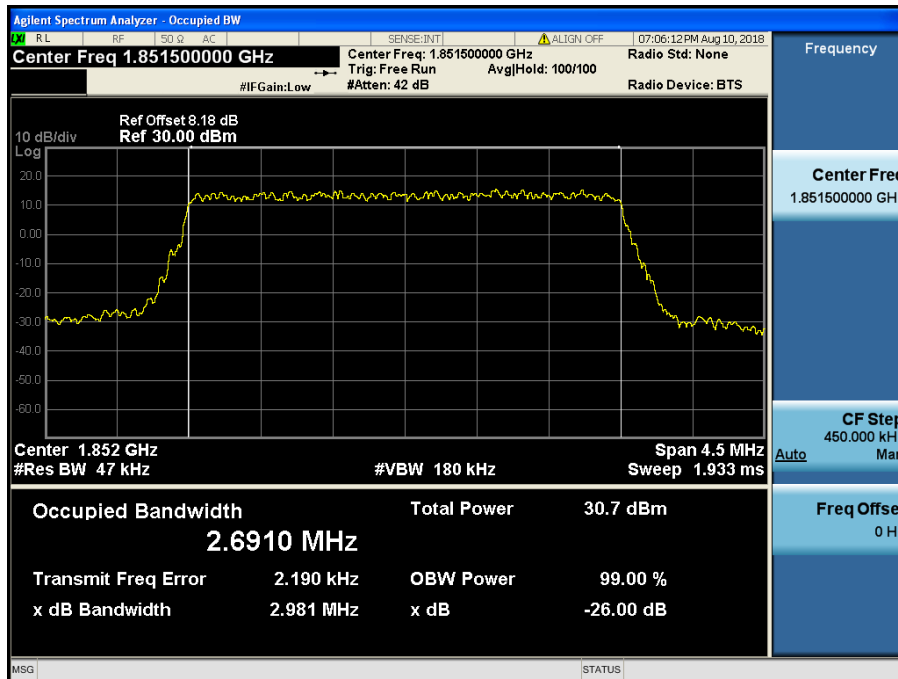

LTE Band 2 / 3 MHz / QPSK - RB Size 15

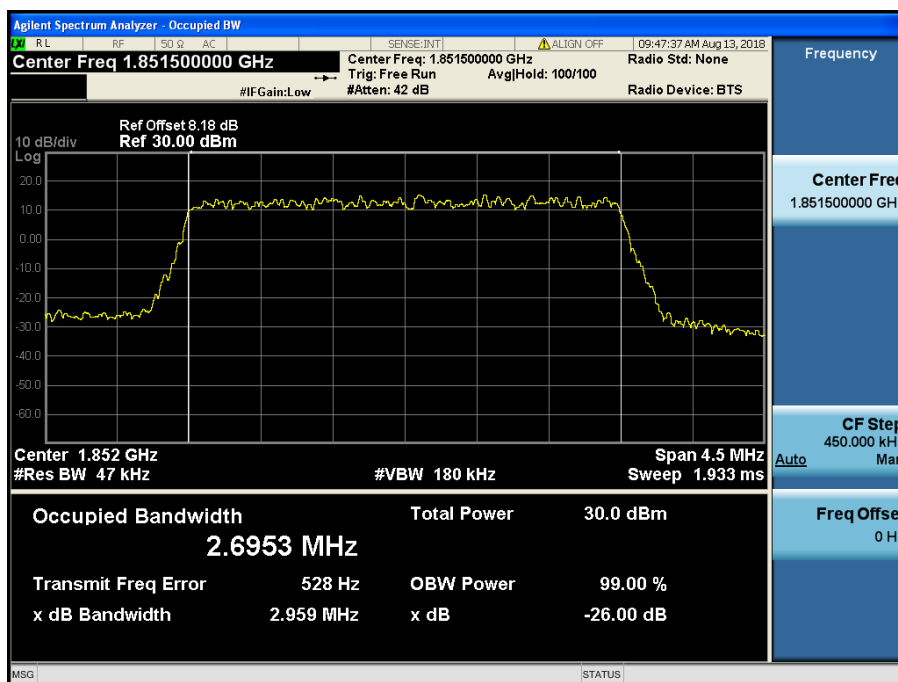

LTE Band 2 / 3 MHz / 16QAM - RB Size 15

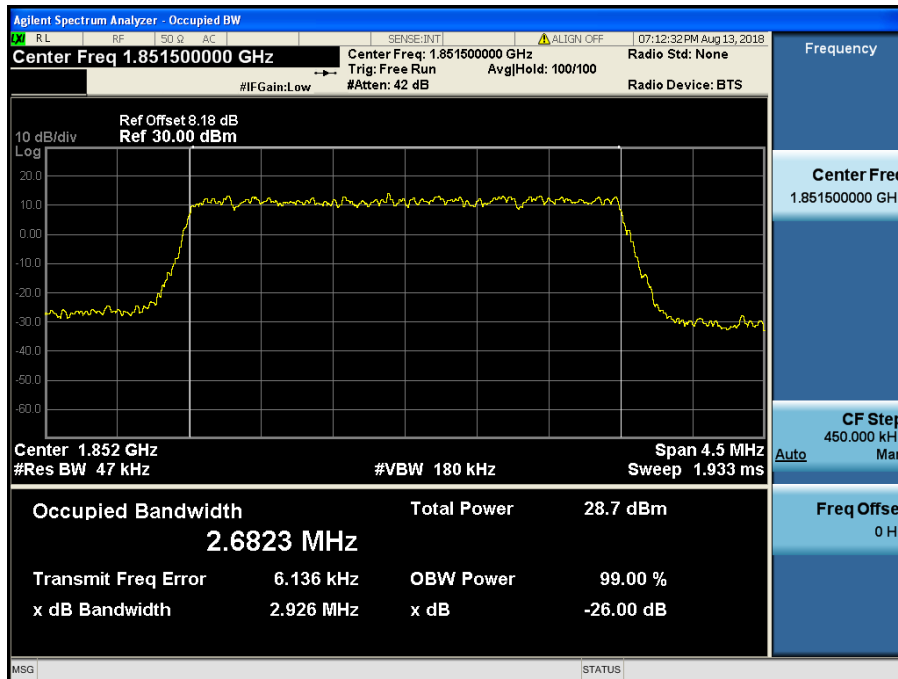

LTE Band 2 / 3 MHz / 64QAM - RB Size 15

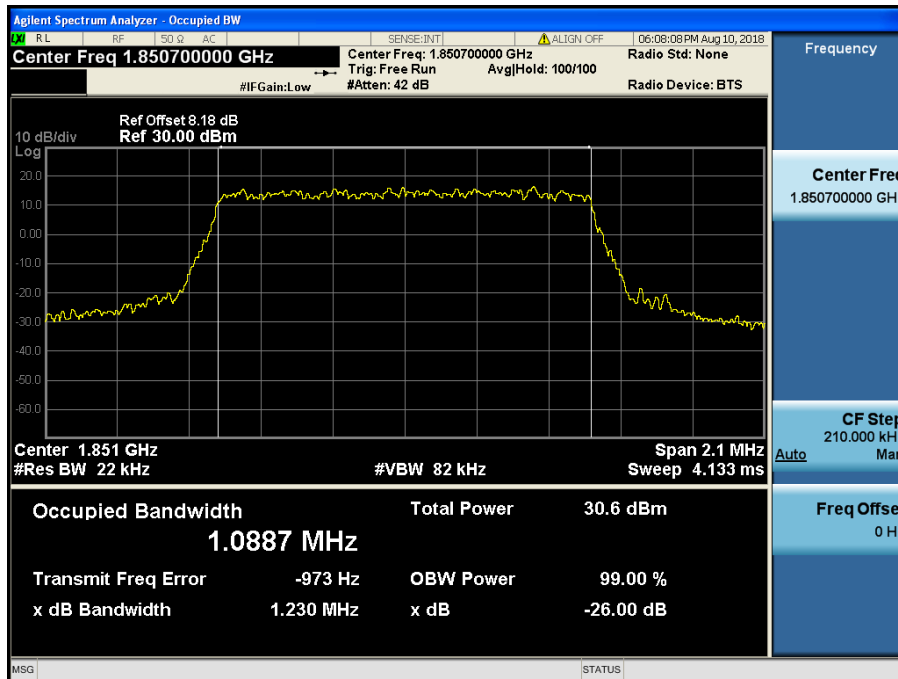

LTE Band 2 / 1.4 MHz / QPSK - RB Size 6

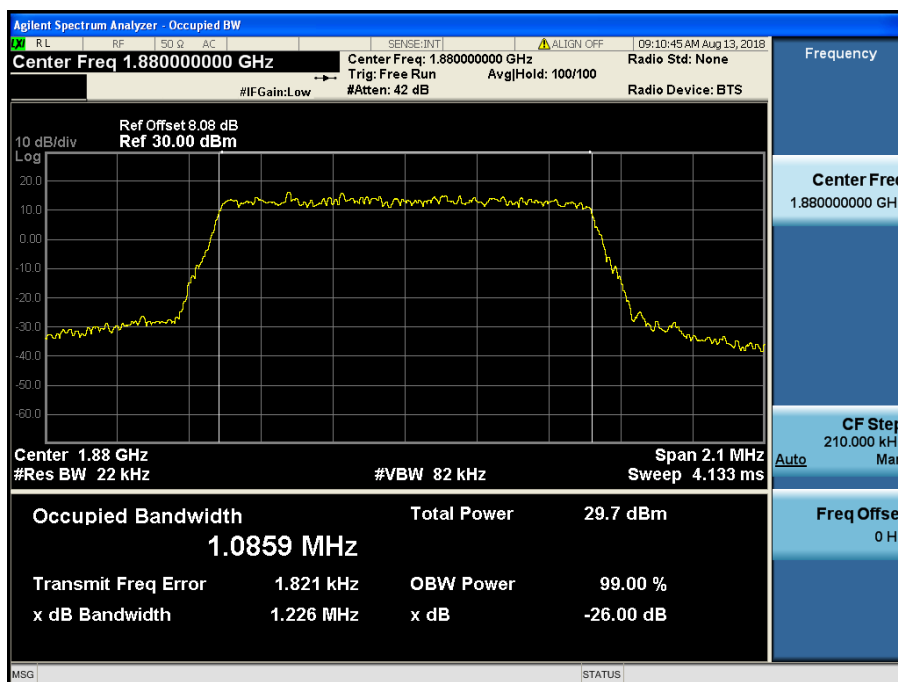

LTE Band 2 / 1.4 MHz / 16QAM - RB Size 6

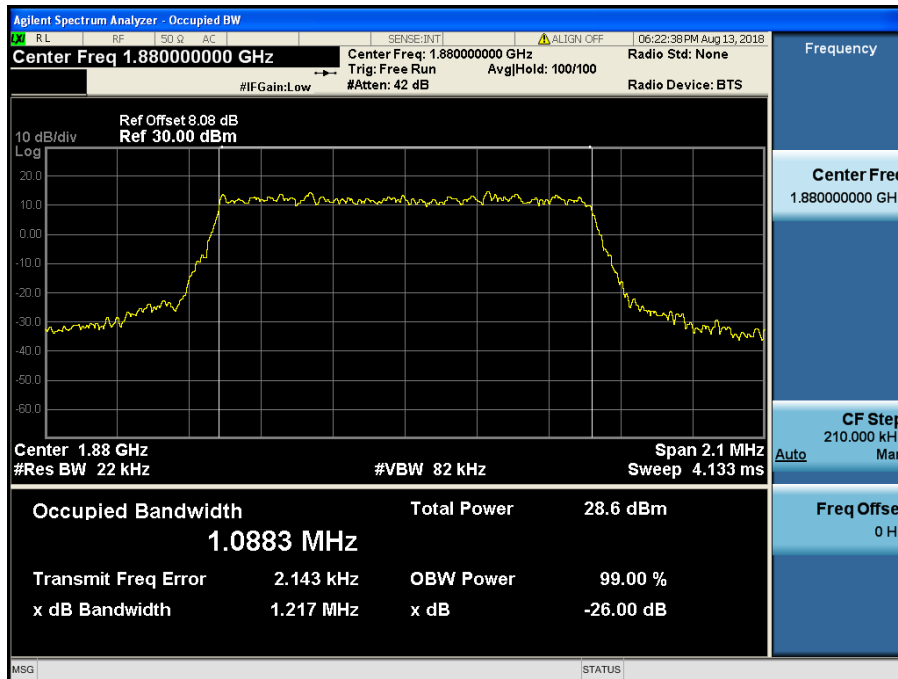

LTE Band 2 / 1.4 MHz / 64QAM - RB Size 6



8.1.6 LTE Band 41

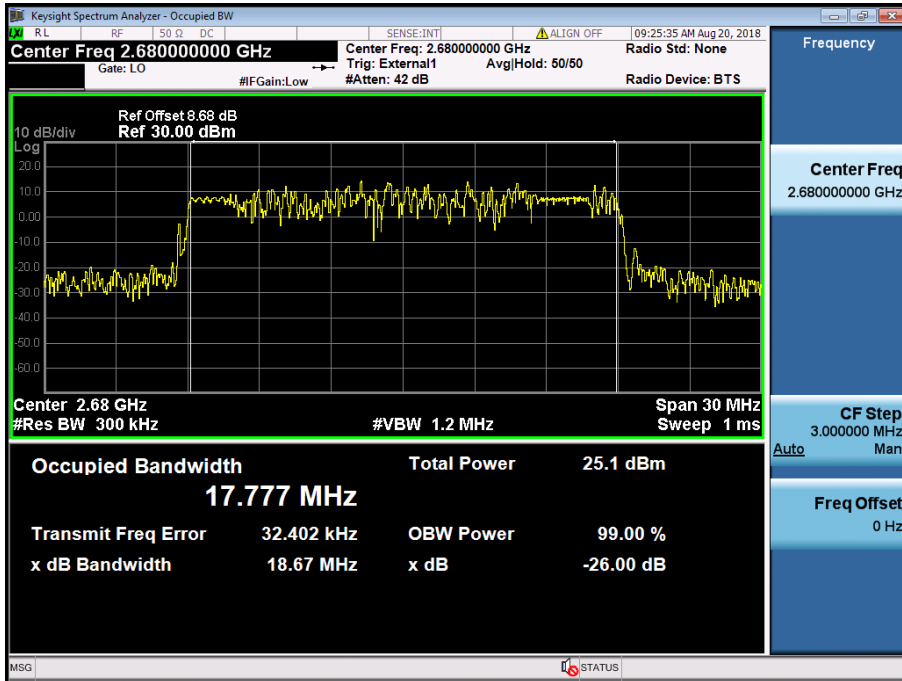

LTE Band 41 / 20 MHz / QPSK - RB Size 100

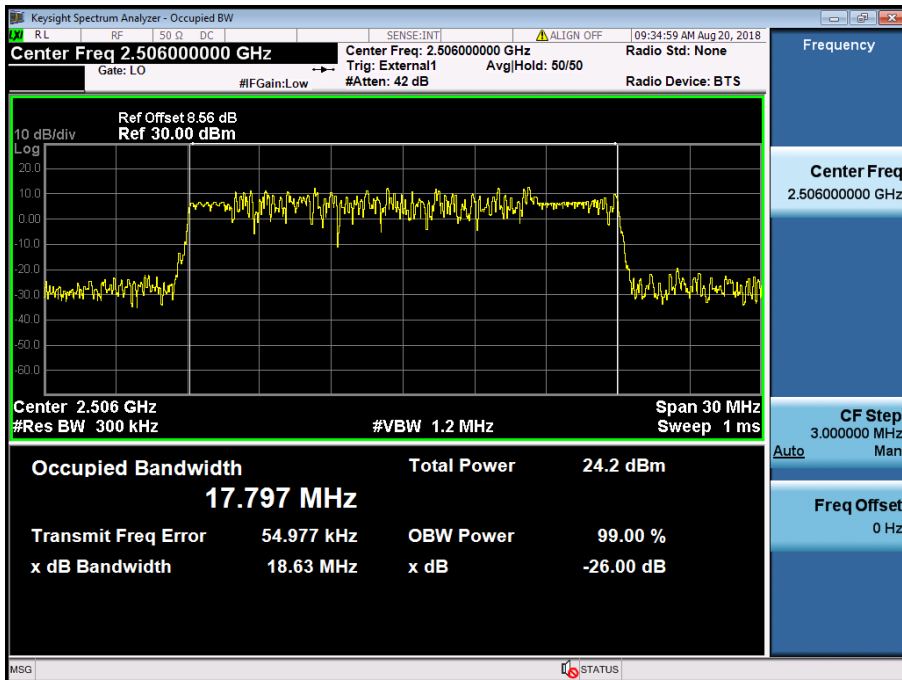

LTE Band 41 / 20 MHz / 16QAM - RB Size 100

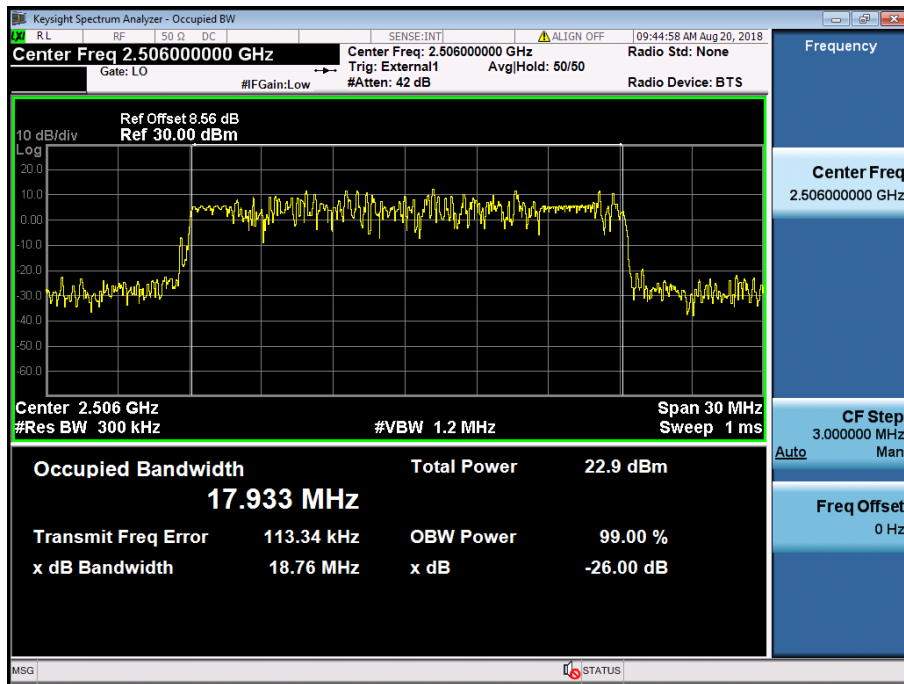

LTE Band 41 / 20 MHz / 64QAM - RB Size 100

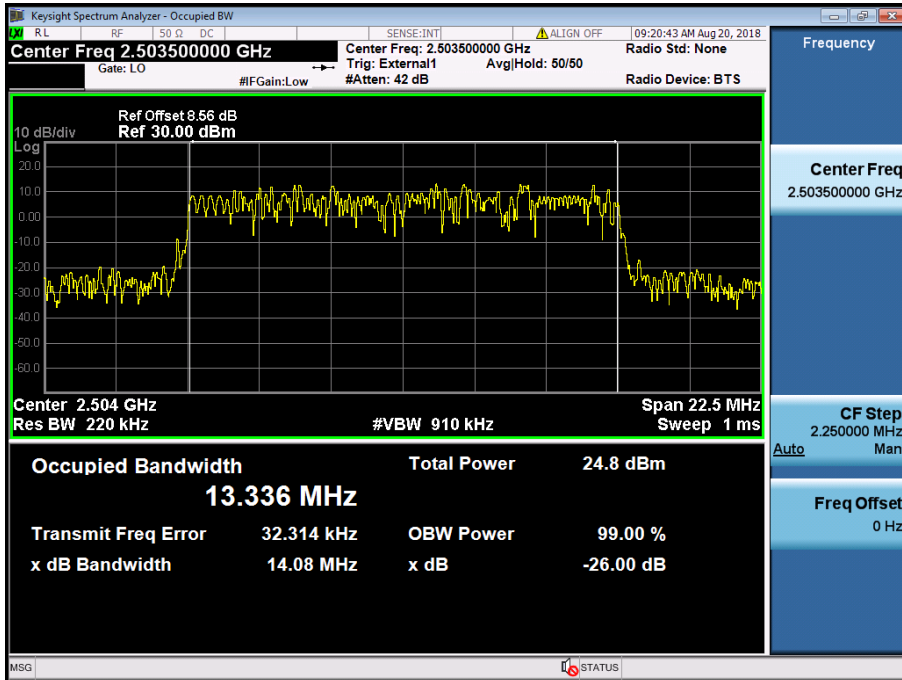

LTE Band 41 / 15 MHz / QPSK - RB Size 75

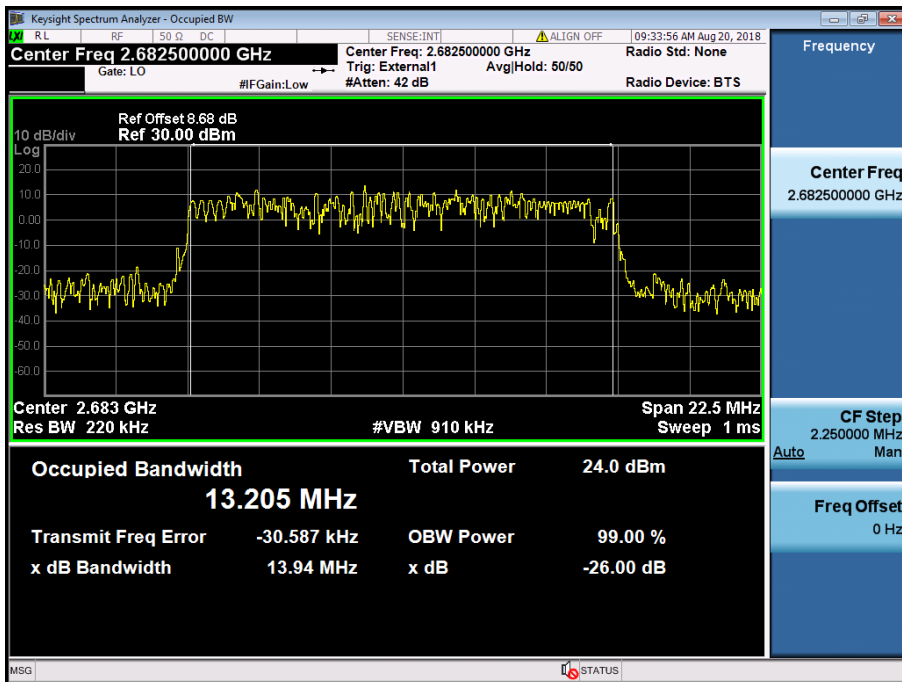

LTE Band 41 / 15 MHz / 16QAM - RB Size 75

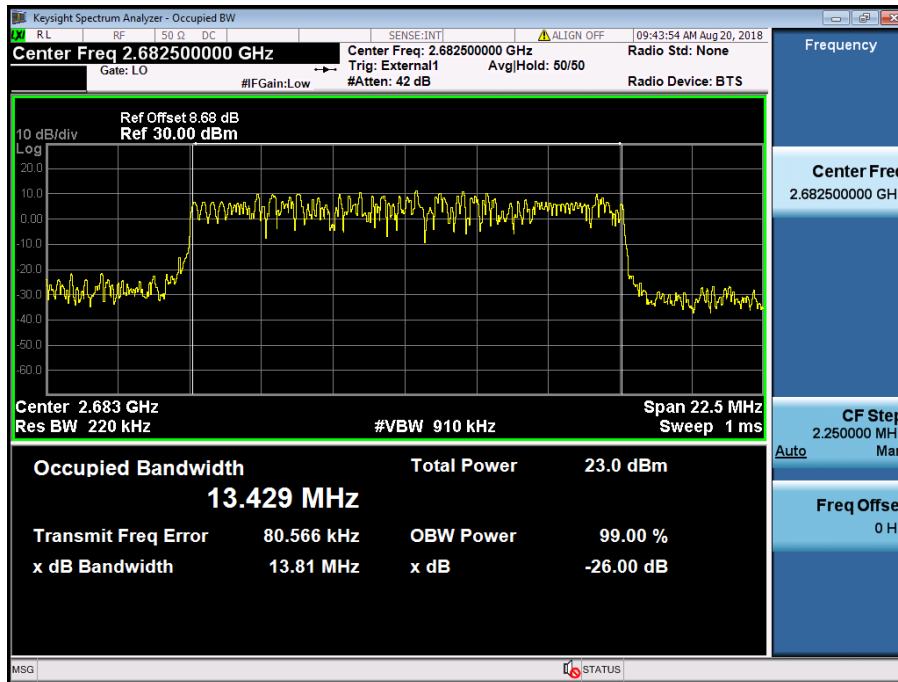

LTE Band 41 / 15 MHz / 64QAM - RB Size 75

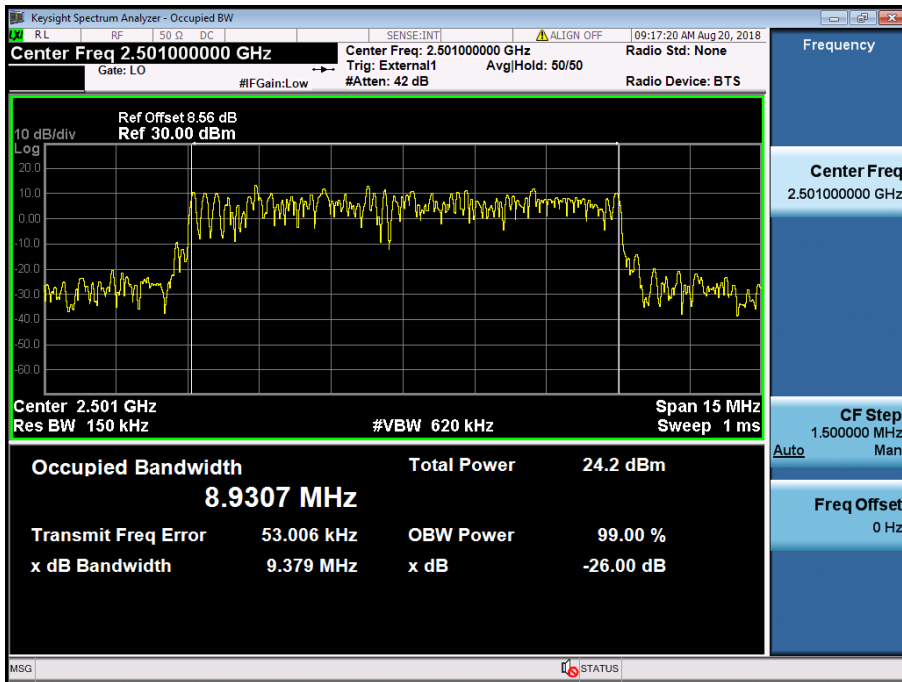

LTE Band 41 / 10 MHz / QPSK - RB Size 50

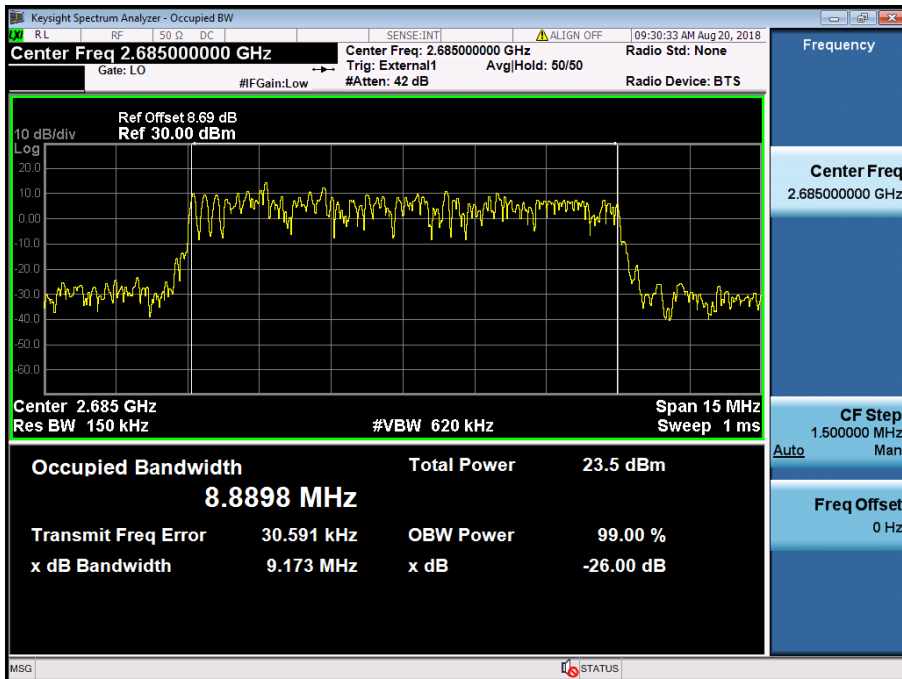

LTE Band 41 / 10 MHz / 16QAM - RB Size 50

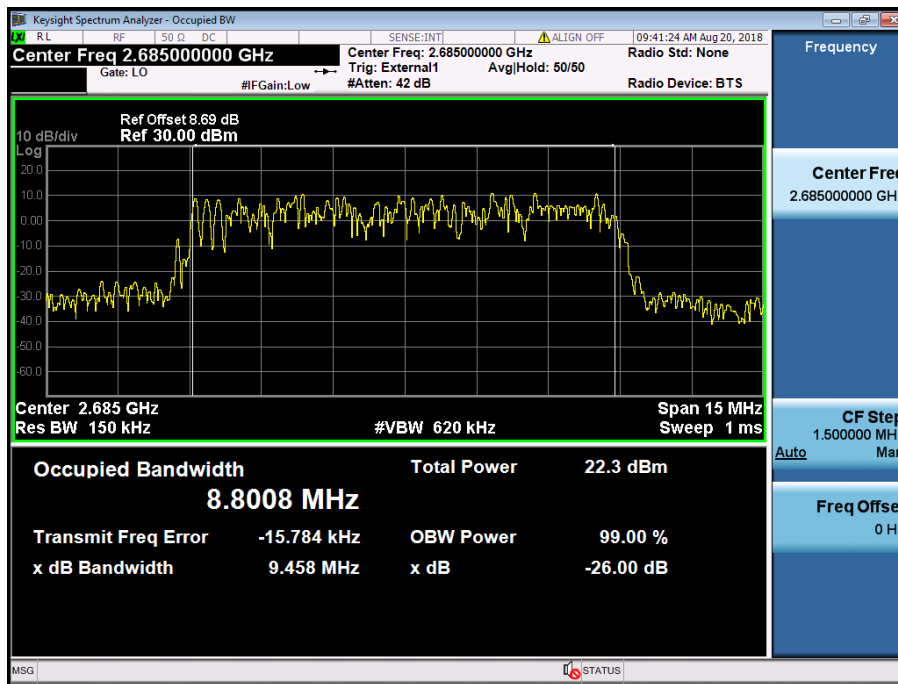

LTE Band 41 / 10 MHz / 64QAM - RB Size 50

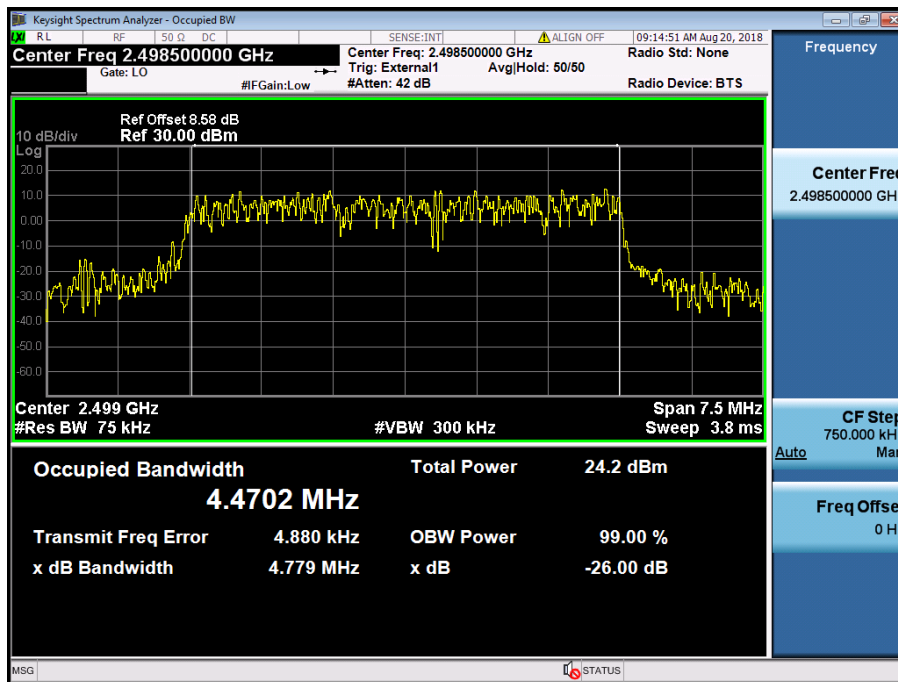

LTE Band 41 / 5 MHz / QPSK - RB Size 25

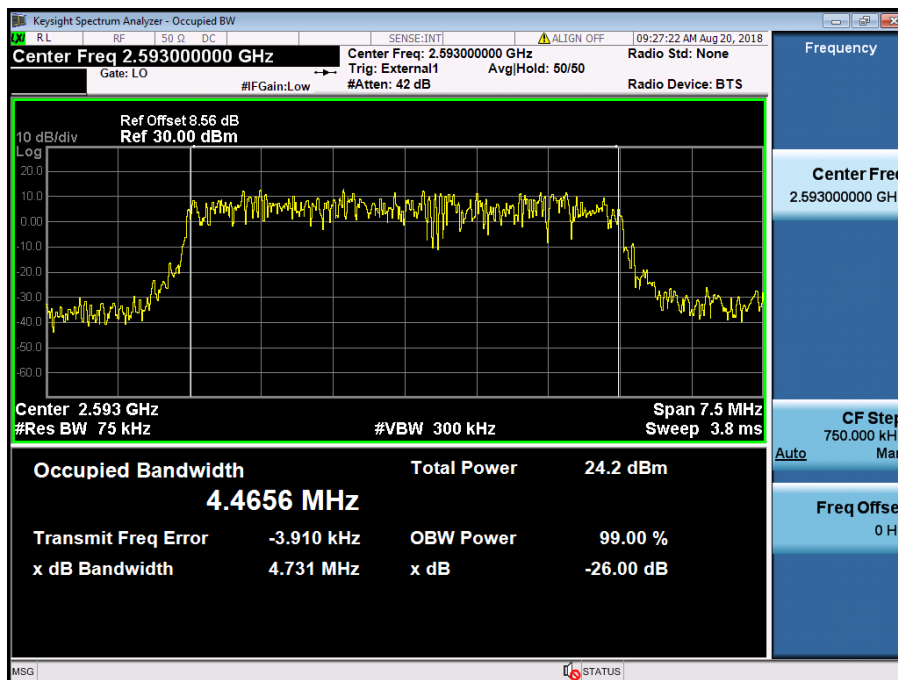

LTE Band 41 / 5 MHz / 16QAM - RB Size 25

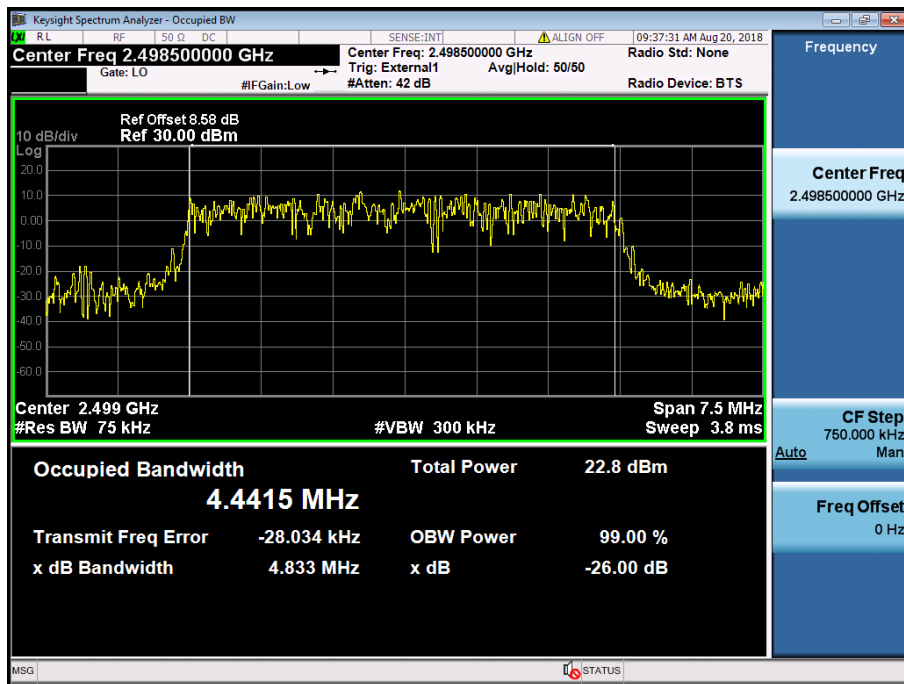

LTE Band 41 / 5 MHz / 64QAM - RB Size 25



8.1.7 LTE Band 7

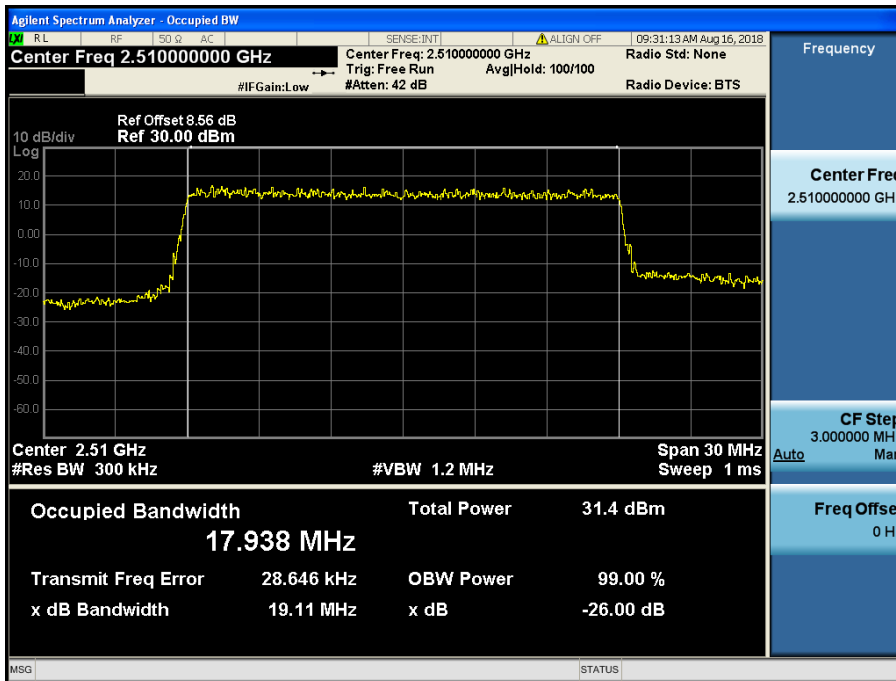

LTE Band 7 / 20 MHz / QPSK - RB Size 100

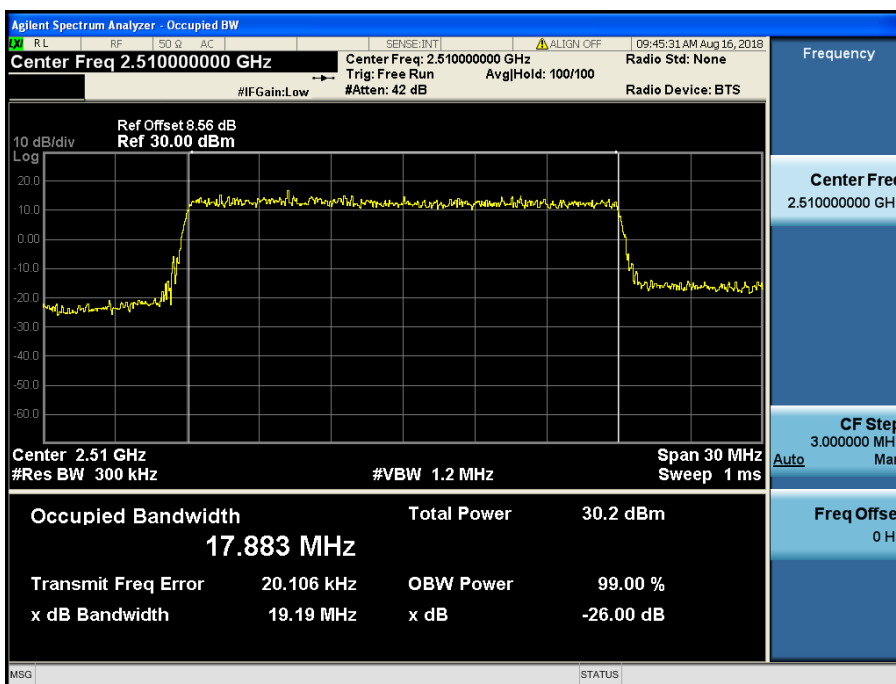

LTE Band 7 / 20 MHz / 16QAM - RB Size 100

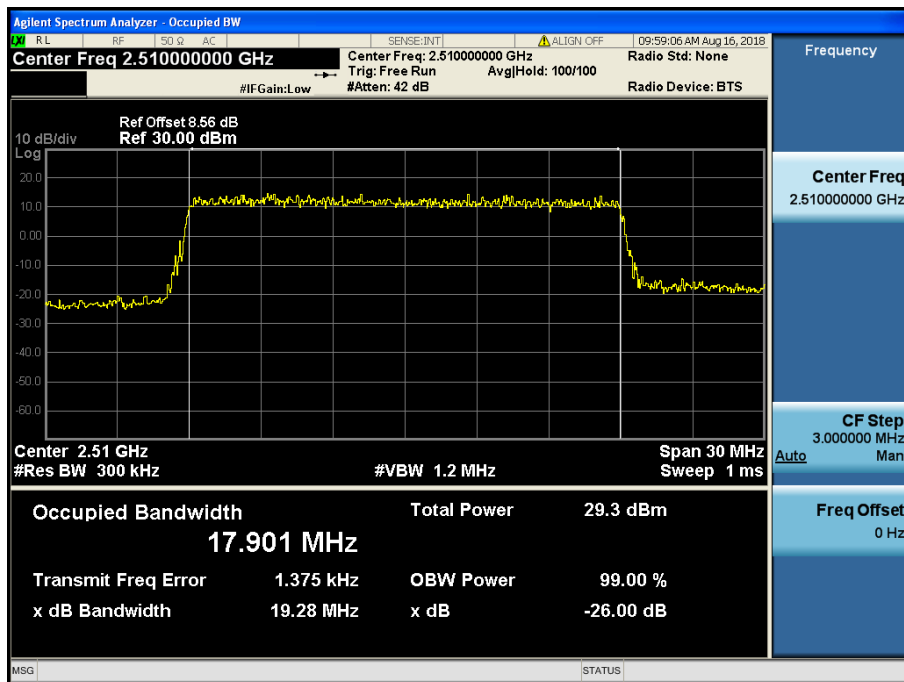

LTE Band 7 / 20 MHz / 64QAM - RB Size 100

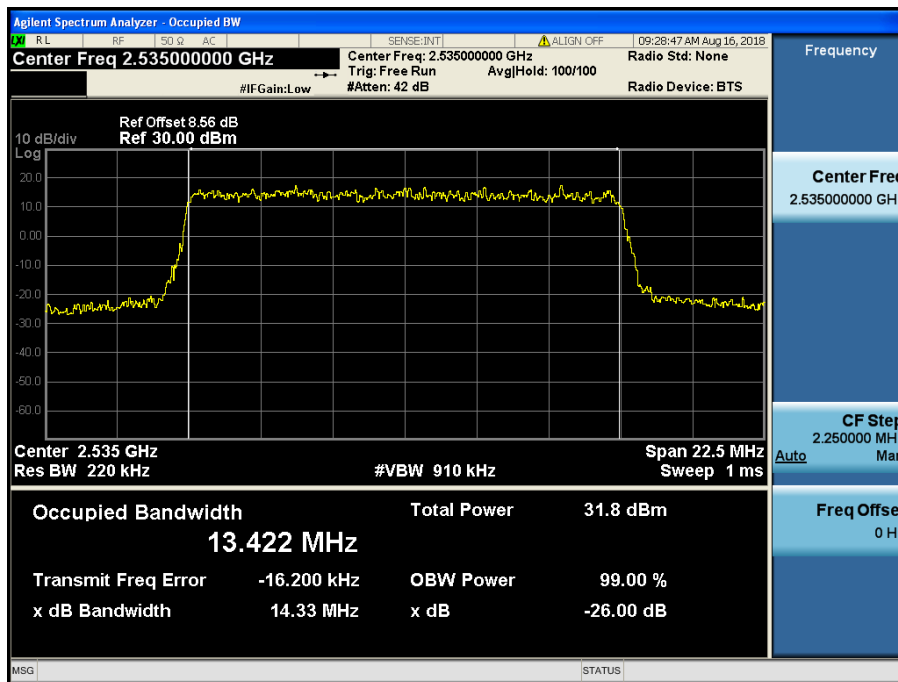

LTE Band 7 / 15 MHz / QPSK - RB Size 75

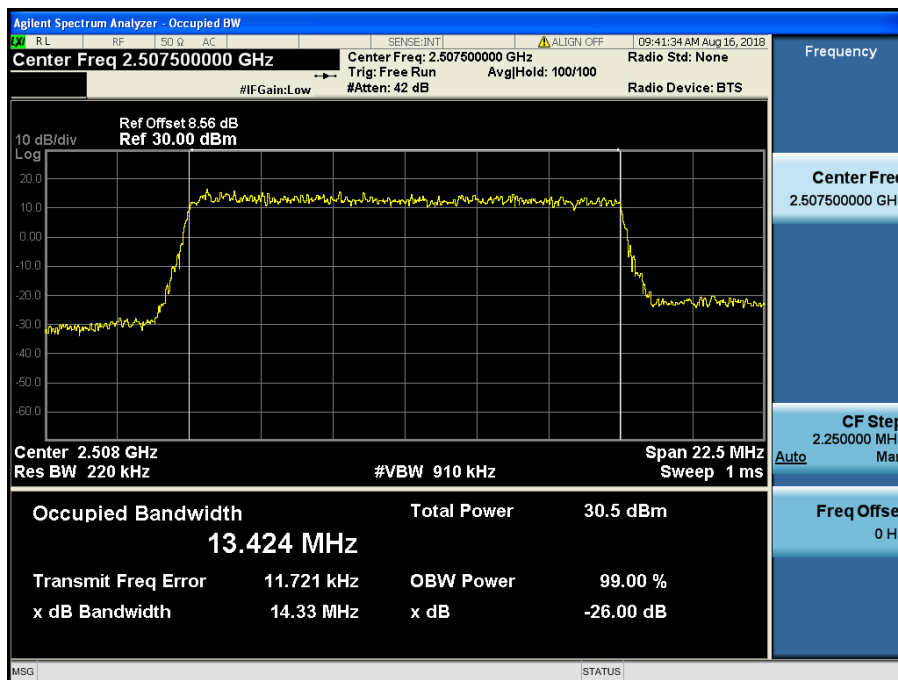

LTE Band 7 / 15 MHz / 16QAM - RB Size 75

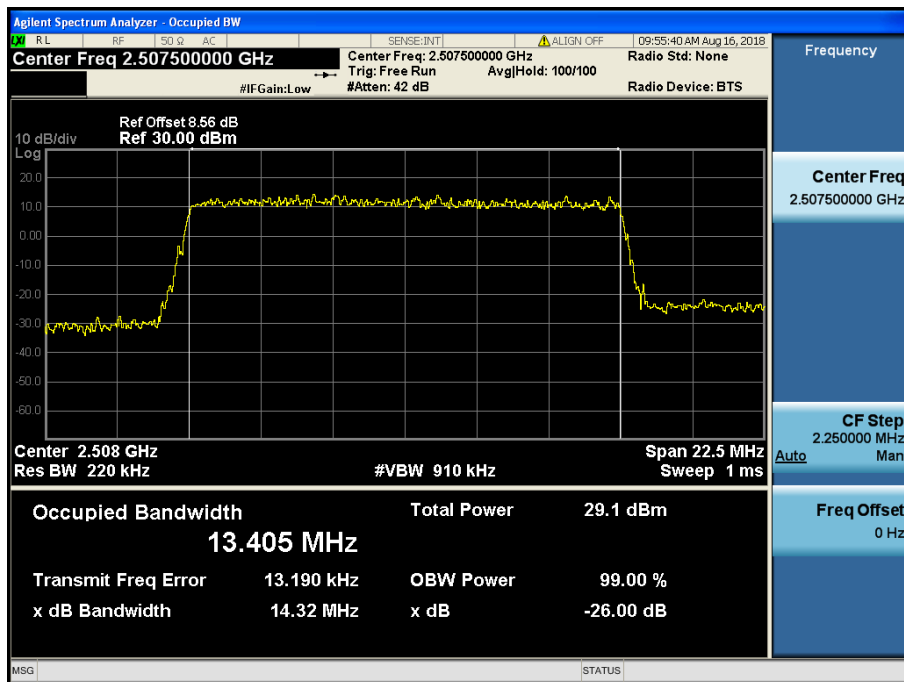

LTE Band 7 / 15 MHz / 64QAM - RB Size 75

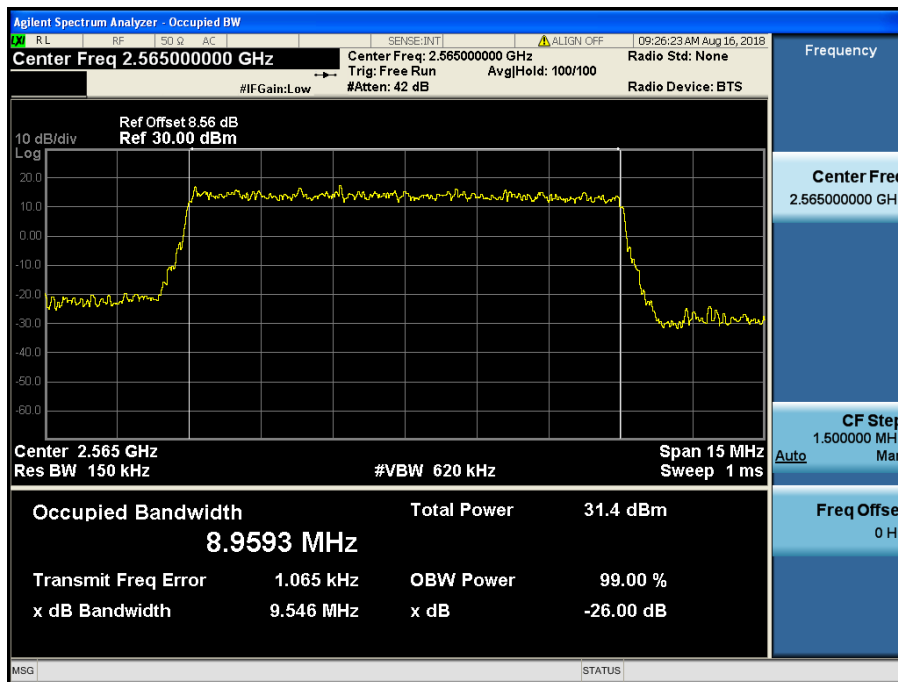

LTE Band 7 / 10 MHz / QPSK - RB Size 50

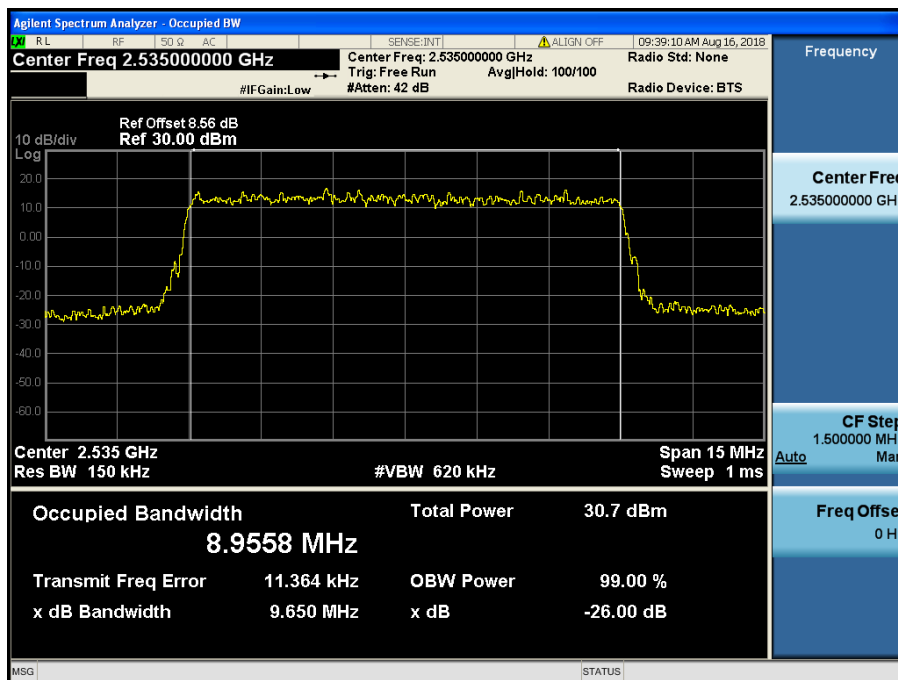

LTE Band 7 / 10 MHz / 16QAM - RB Size 50

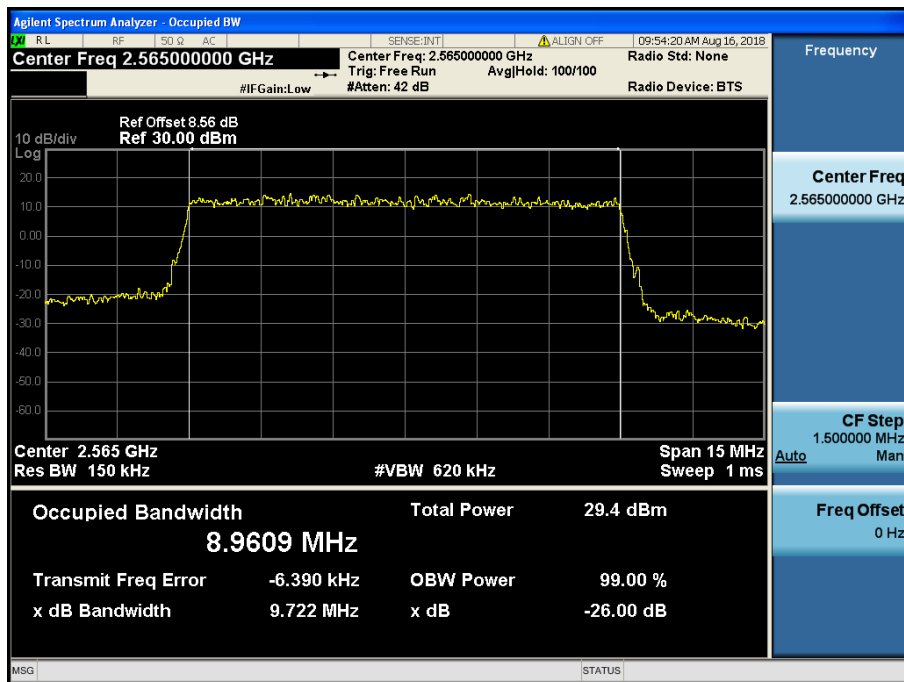

LTE Band 7 / 10 MHz / 64QAM - RB Size 50

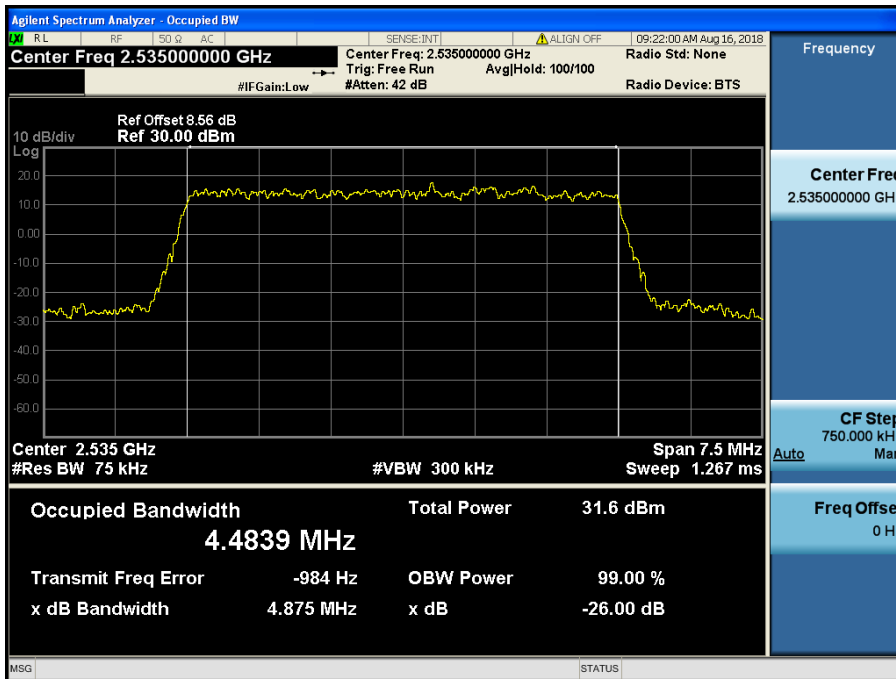

LTE Band 7 / 5 MHz / QPSK - RB Size 25

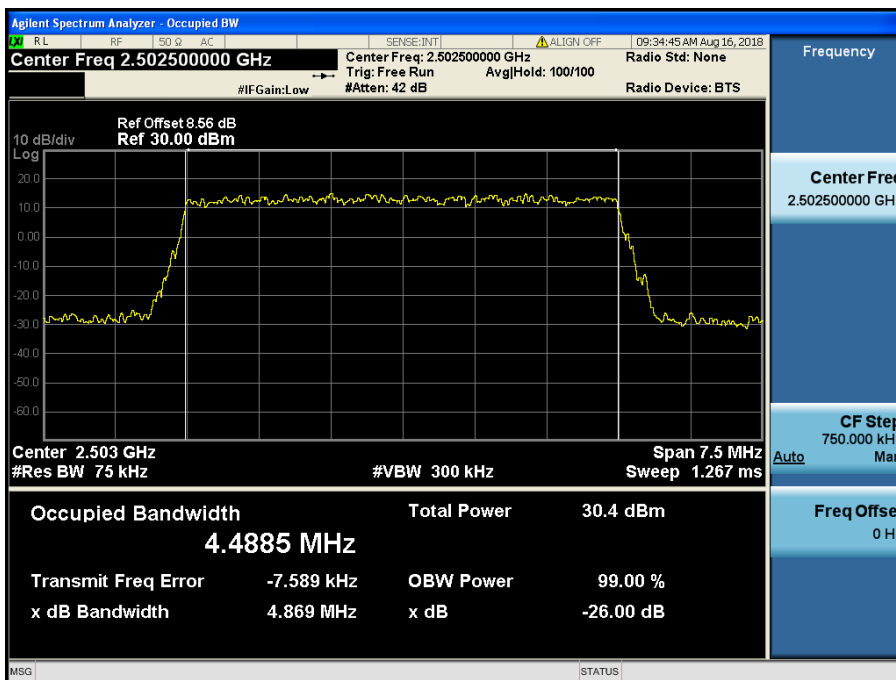

LTE Band 7 / 5 MHz / 16QAM - RB Size 25

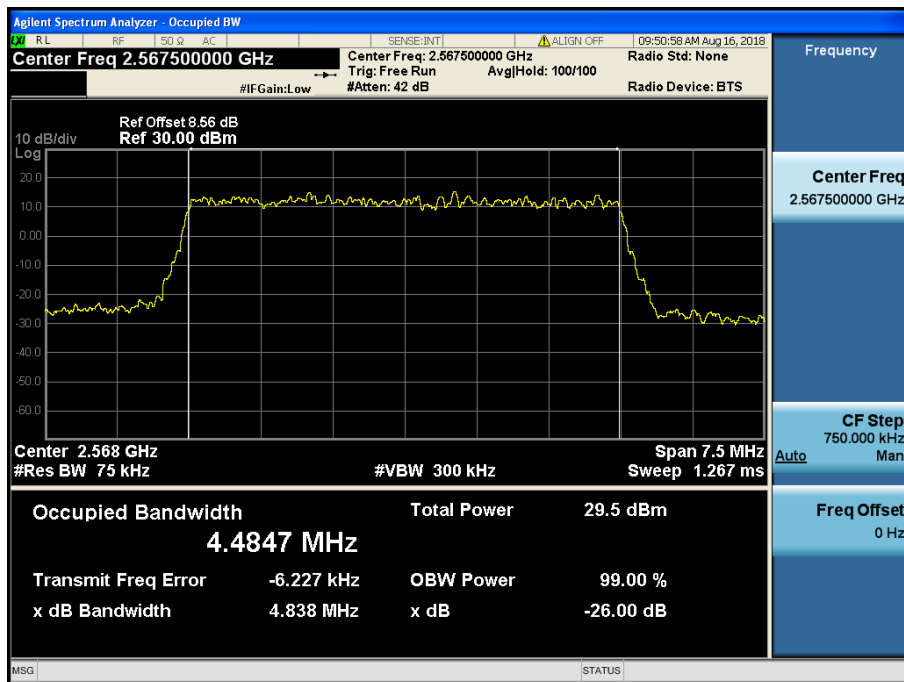

LTE Band 7 / 5 MHz / 64QAM - RB Size 25



## 8.2 PEAK TO AVERAGE RATIO

### 8.2.1 LTE Band 12,17

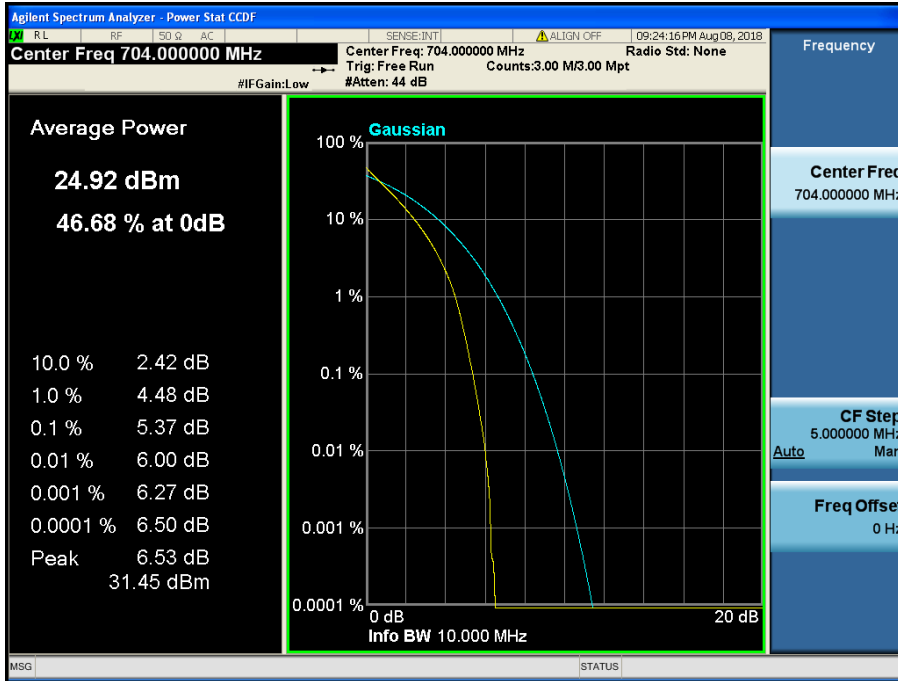

LTE Band 12,17 / 10 MHz / QPSK - RB Size 50

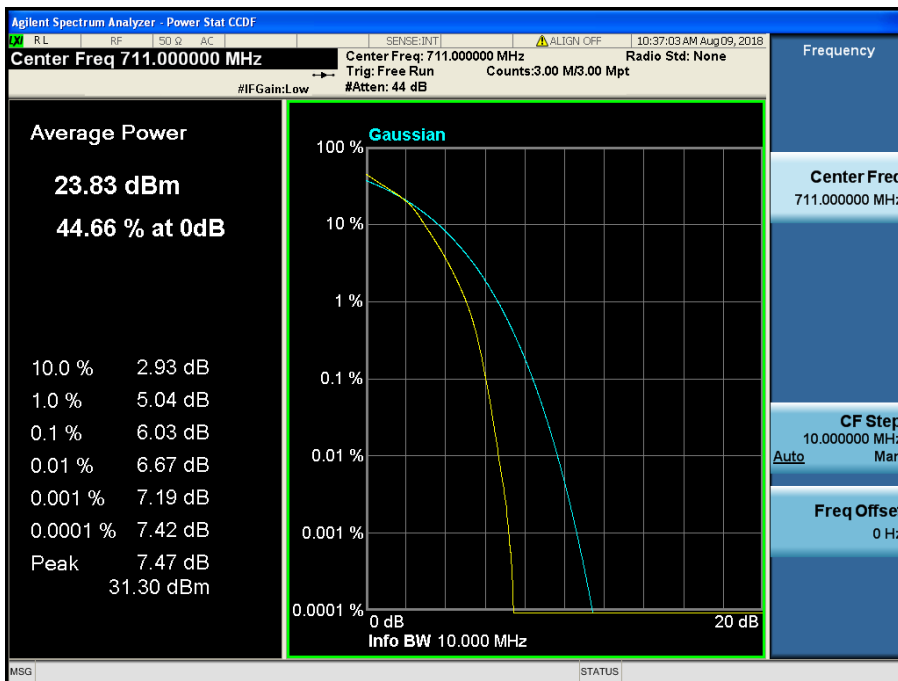

LTE Band 12,17 / 10 MHz / 16QAM - RB Size 50

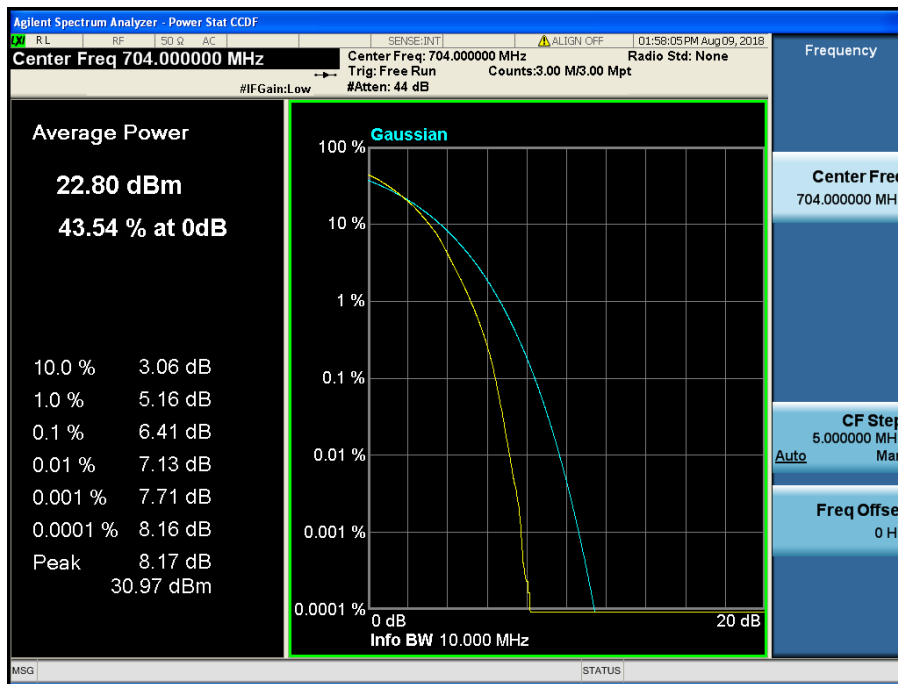

LTE Band 12,17 / 10 MHz / 64QAM - RB Size 50

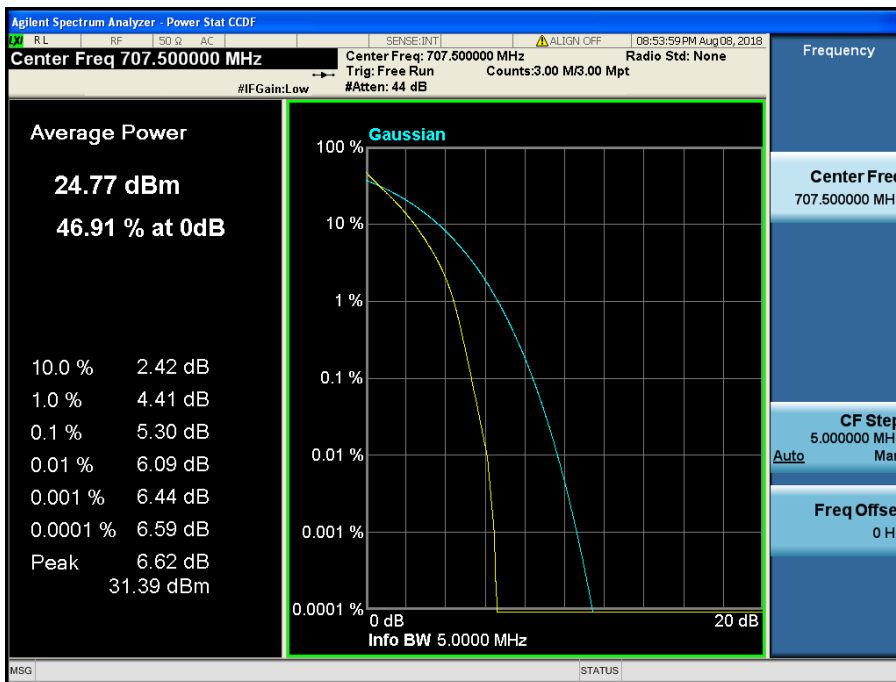

LTE Band 12,17 / 5 MHz / QPSK - RB Size 25

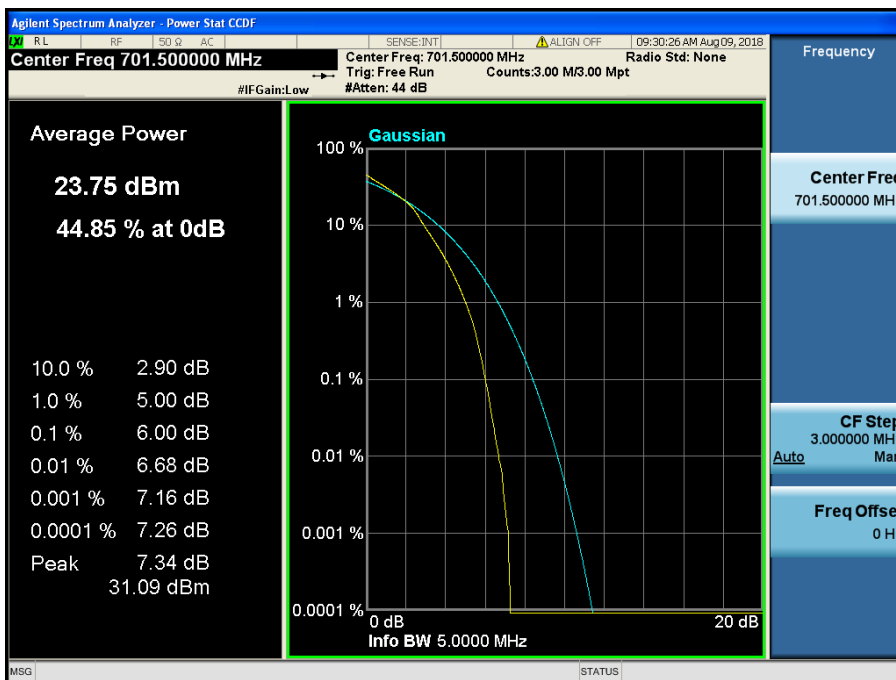

LTE Band 12,17 / 5 MHz / 16QAM - RB Size 25

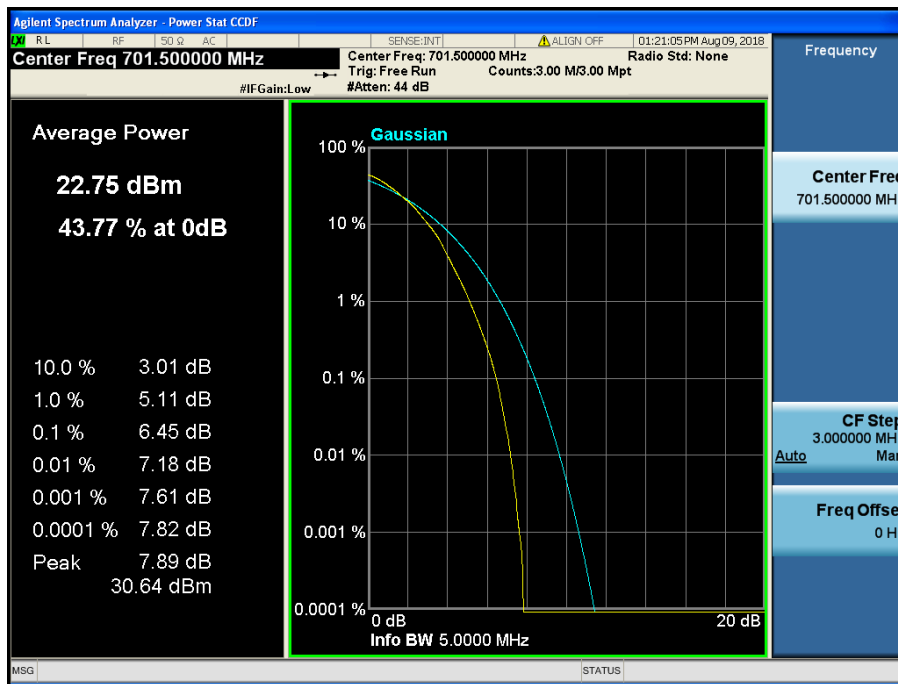

LTE Band 12,17 / 5 MHz / 64QAM - RB Size 25

8.2.2 LTE Band 12

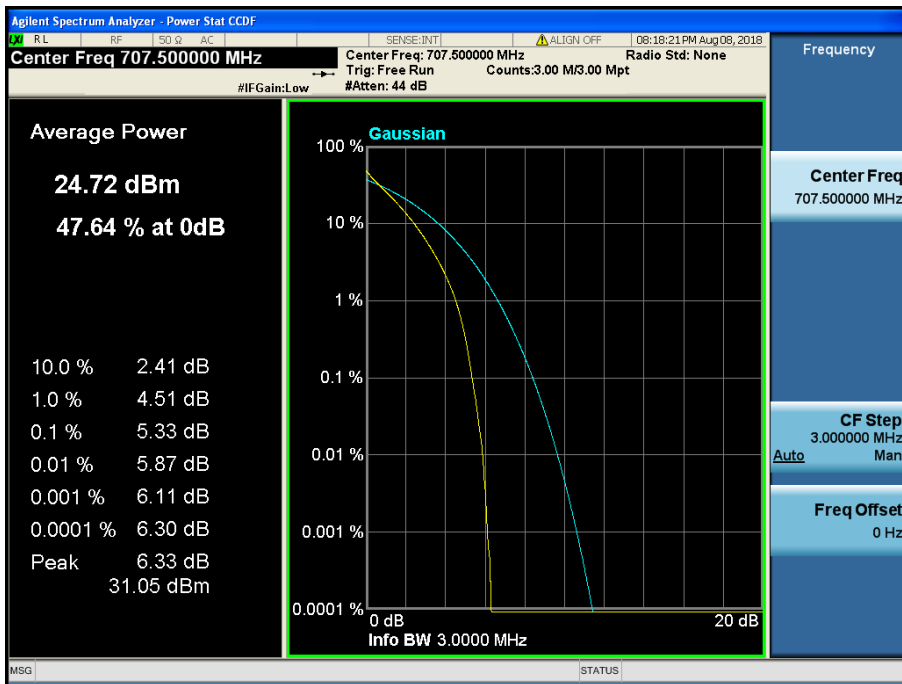

LTE Band 12 / 3 MHz / QPSK - RB Size 15

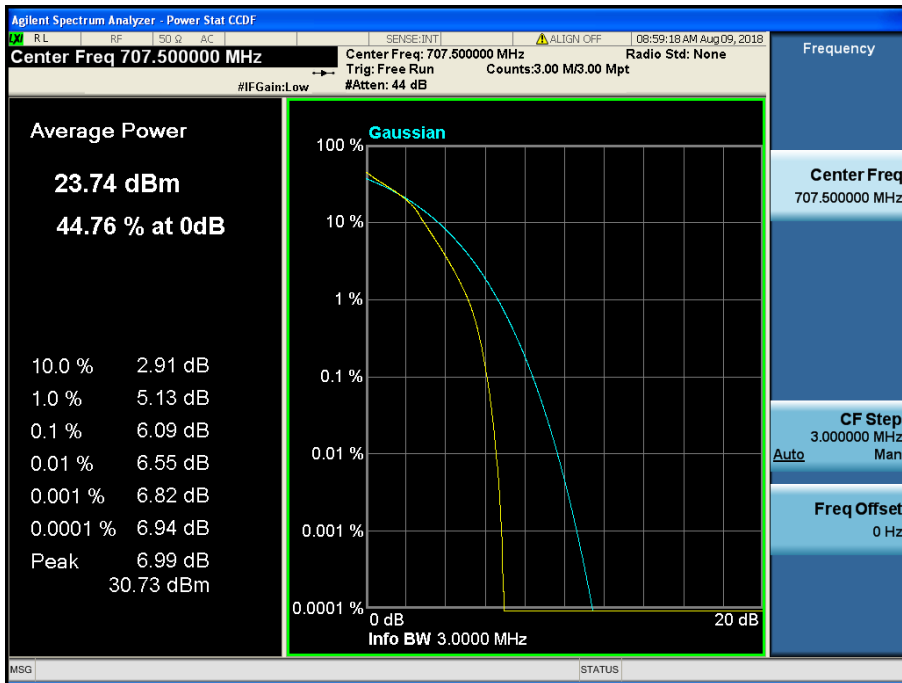

LTE Band 12 / 3 MHz / 16QAM - RB Size 15

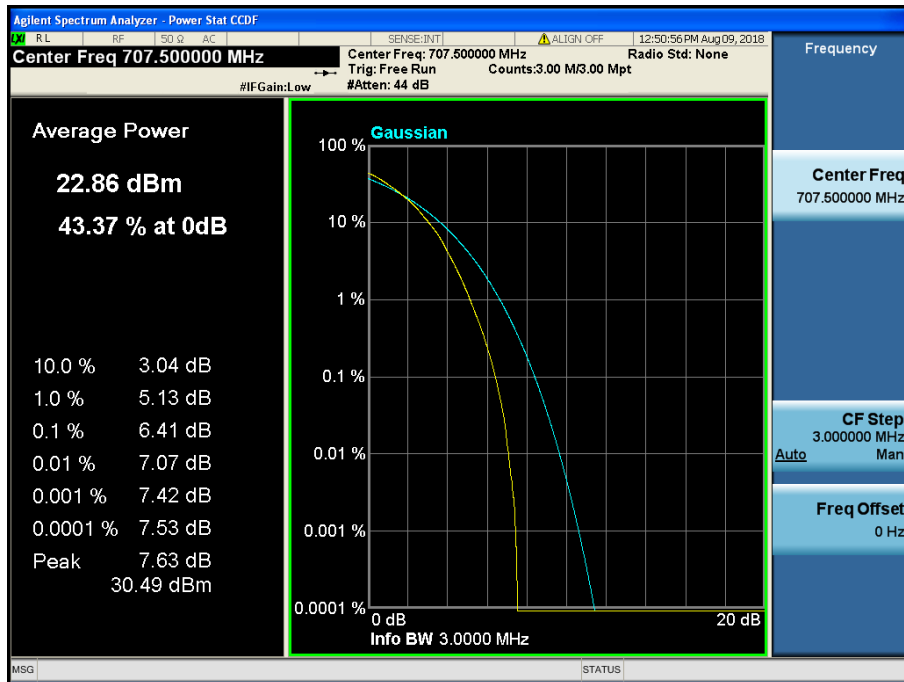

LTE Band 12 / 3 MHz / 64QAM - RB Size 15

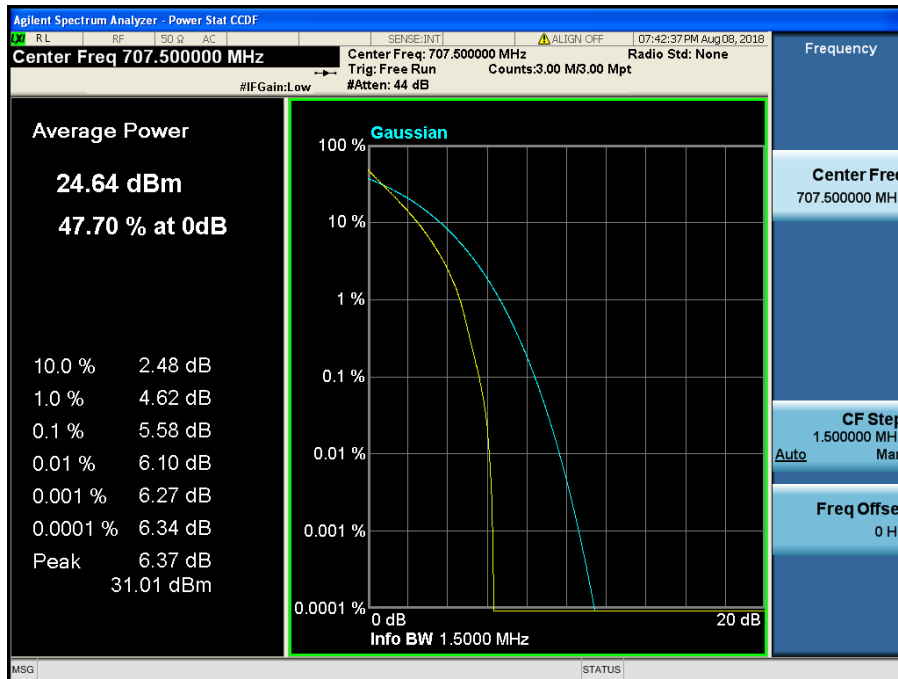

LTE Band 12 / 1.4 MHz / QPSK - RB Size 6



LTE Band 12 / 1.4 MHz / 16QAM - RB Size 6

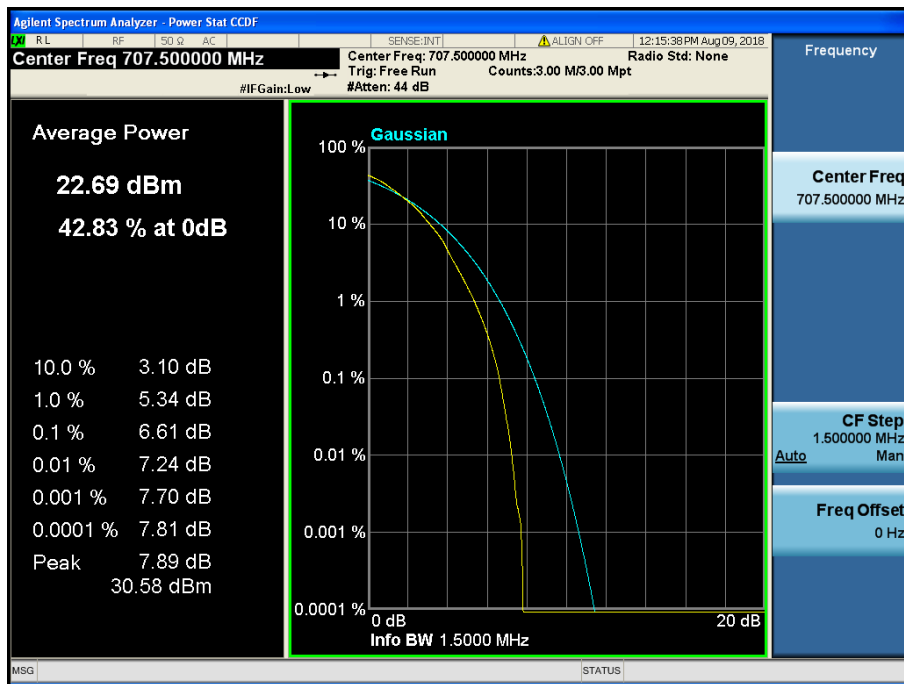

LTE Band 12 / 1.4 MHz / 16QAM - RB Size 6



8.2.3 LTE Band 5

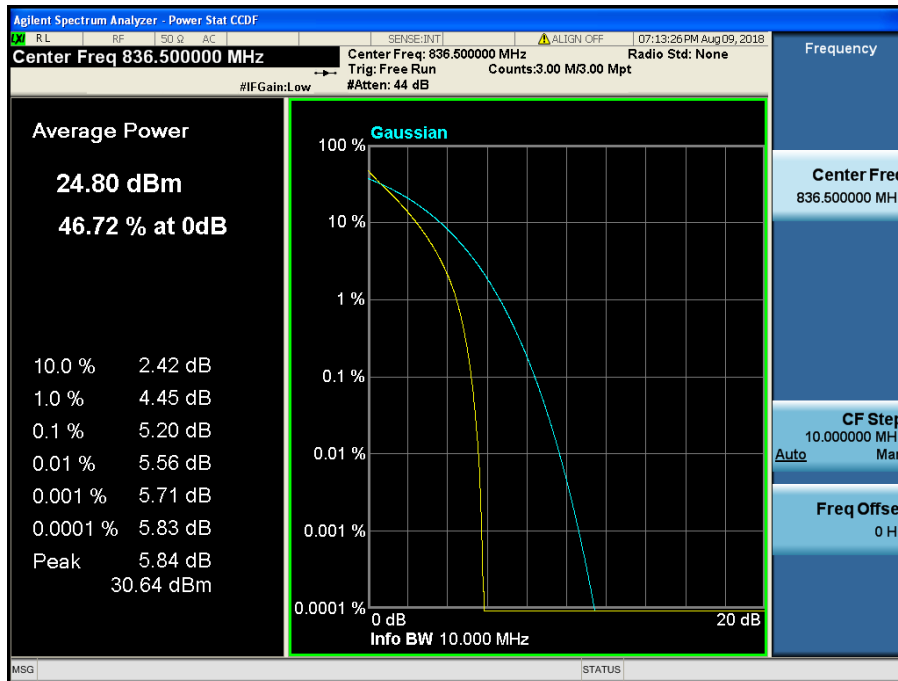

LTE Band 5 / 10 MHz / QPSK - RB Size 50



LTE Band 5 / 10 MHz / 16QAM - RB Size 50

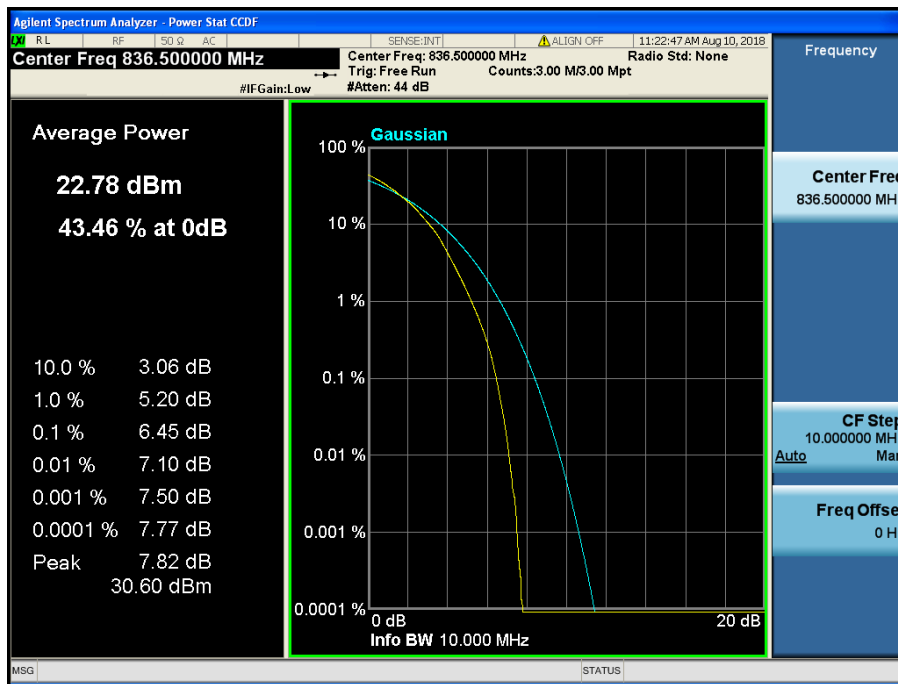

LTE Band 5 / 10 MHz / 64QAM - RB Size 50

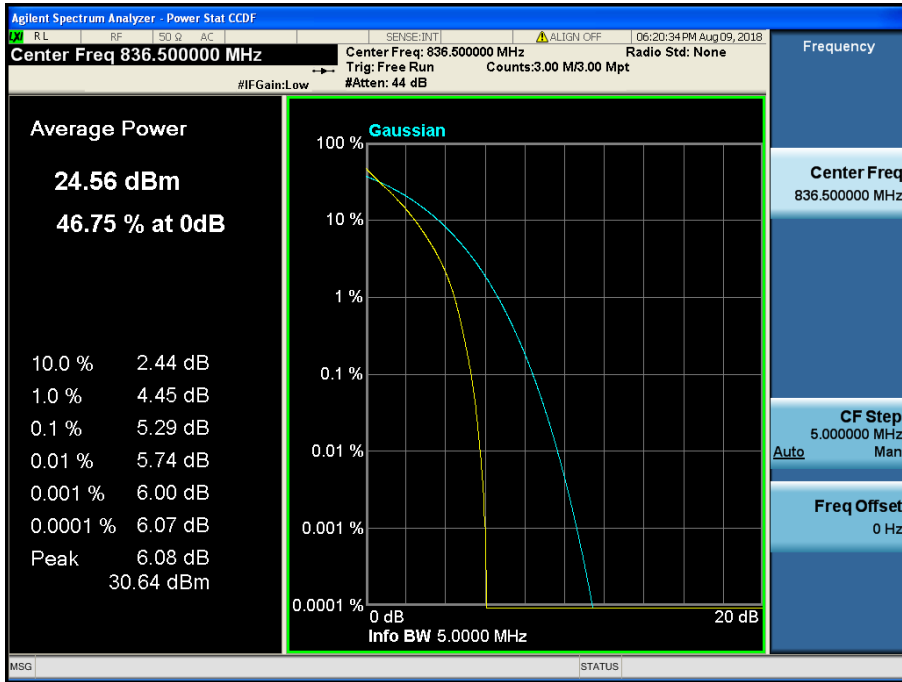

LTE Band 5 / 5 MHz / QPSK - RB Size 25

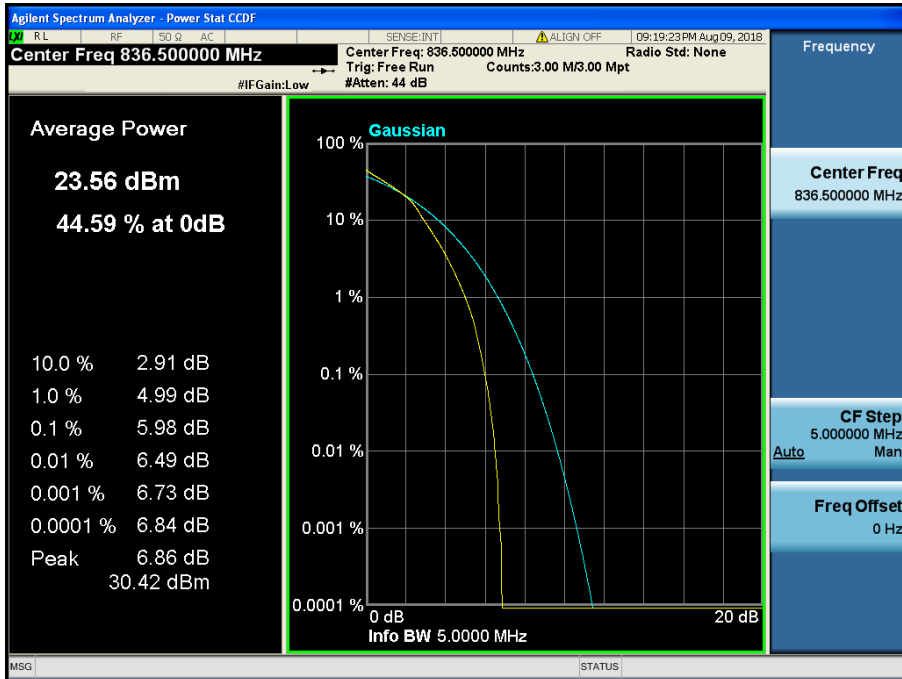

LTE Band 5 / 5 MHz / 16QAM - RB Size 25

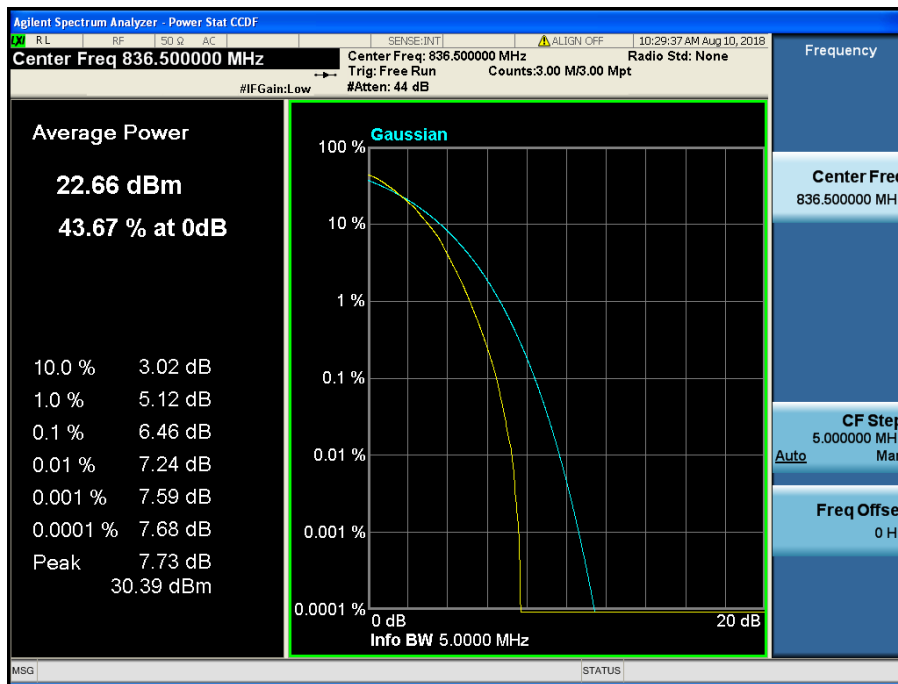

LTE Band 5 / 5 MHz / 64QAM - RB Size 25

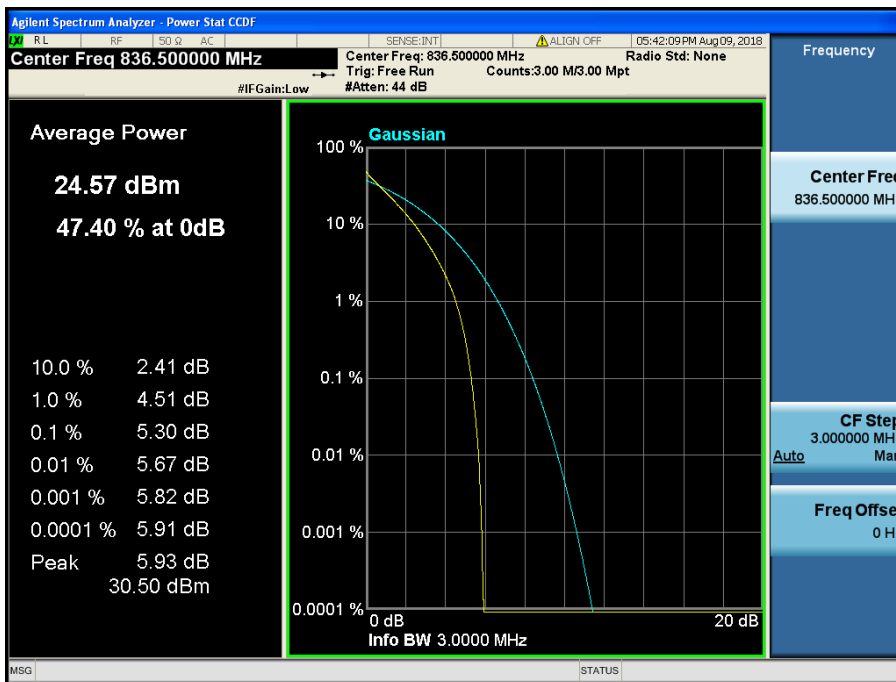

LTE Band 5 / 3 MHz / QPSK - RB Size 15

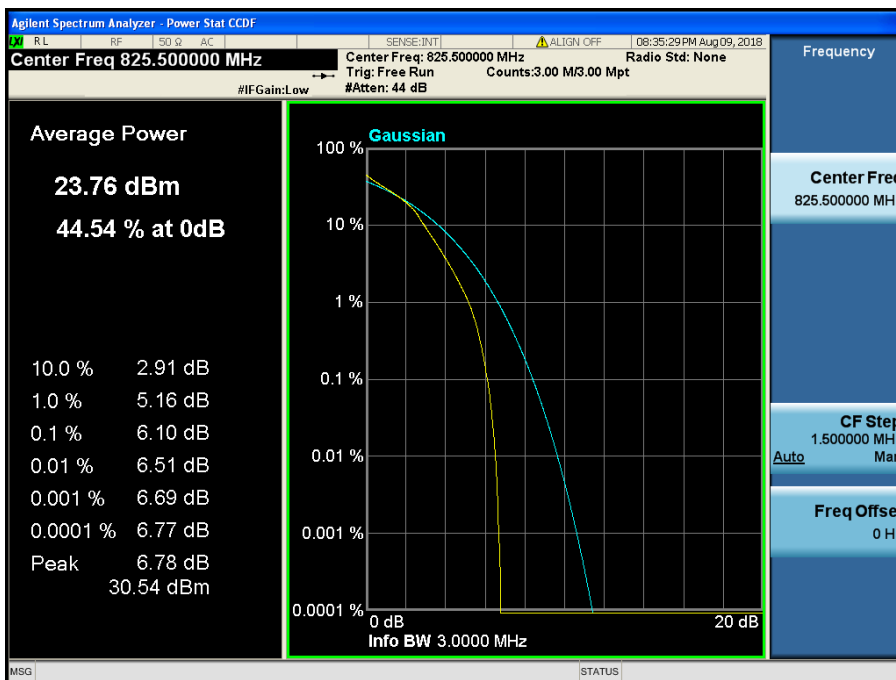

LTE Band 5 / 3 MHz / 16QAM - RB Size 15

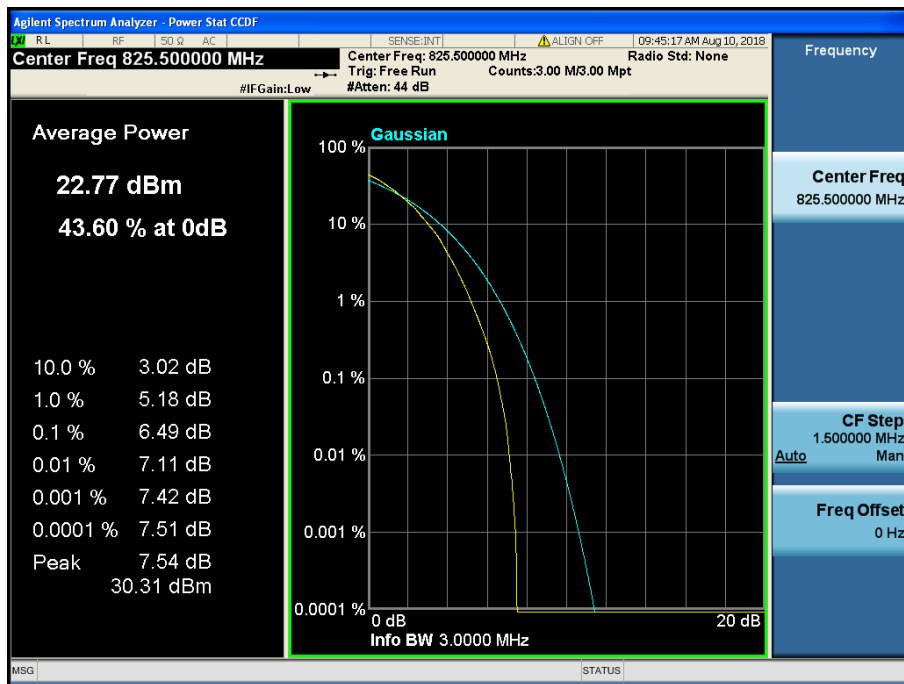

LTE Band 5 / 3 MHz / 64QAM - RB Size 15

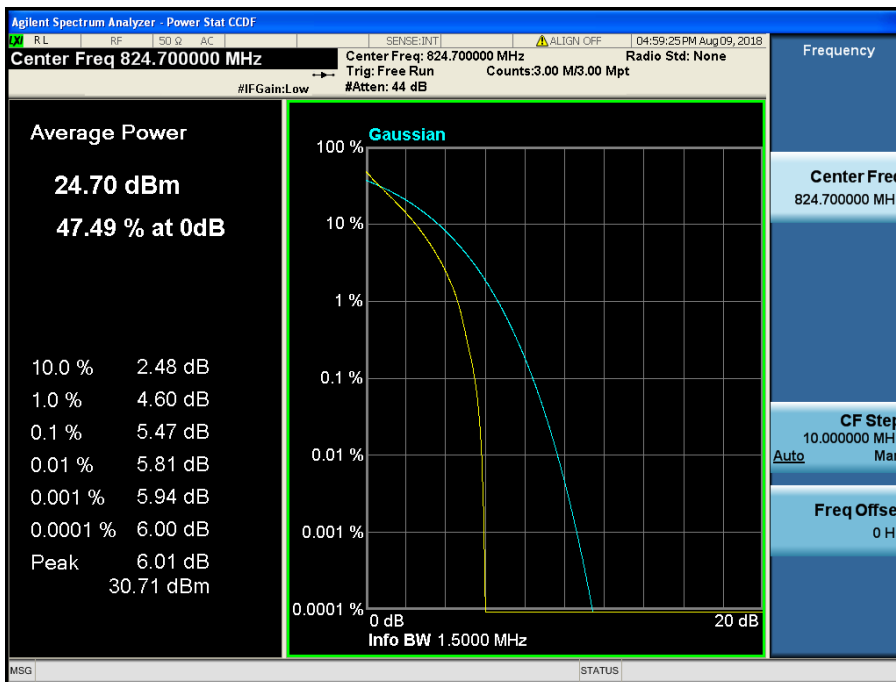

LTE Band 5 / 1.4 MHz / QPSK - RB Size 6

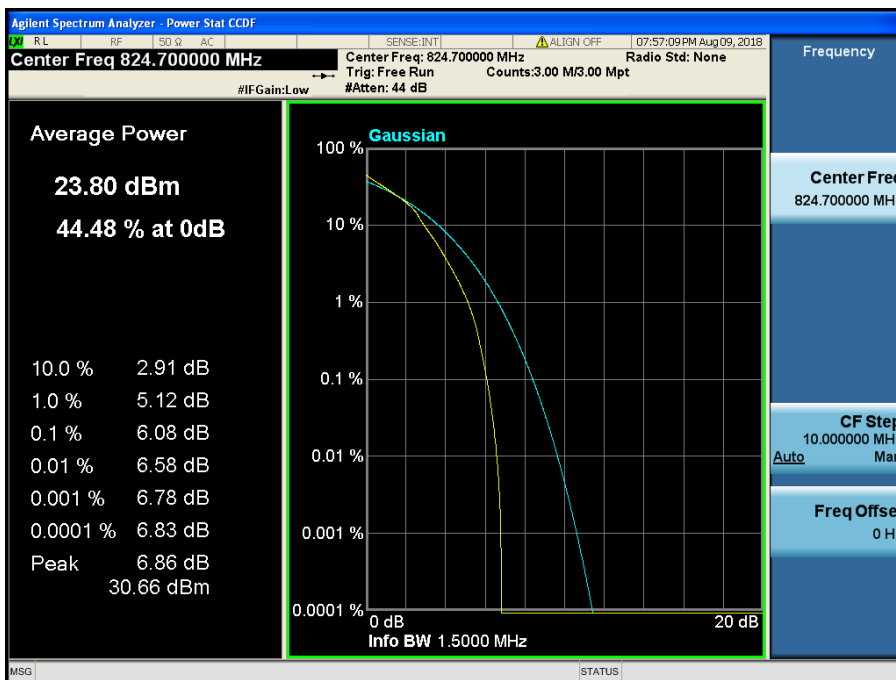

LTE Band 5 / 1.4 MHz / 16QAM - RB Size 6

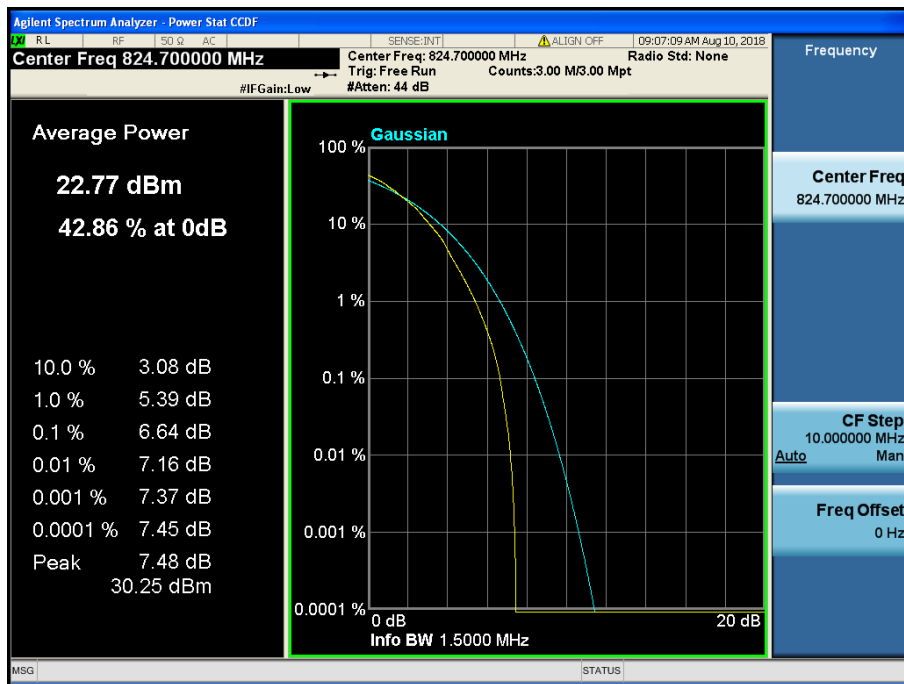

LTE Band 5 / 1.4 MHz / 64QAM - RB Size 6