



TEST REPORT



DT&C Co., Ltd.

42, Yurim-ro, 154Beon-gil, Cheoin-gu, Yongin-si, Gyeonggi-do, Korea, 17042
Tel : 031-321-2664, Fax : 031-321-1664

1. Report No : DRRFCC1804-0045(2)
2. Customer
 - Name : LG Electronics MobileComm USA, Inc.
 - Address : 1000 Sylvan Ave., Englewood Cliffs, New Jersey, United States, 07632
3. Use of Report : FCC Original Grant
4. Product Name / Model Name : Mobile Phone / LM-Q710FA
FCC ID : ZNFQ710FA
5. Test Method Used : IEEE 1528-2013, FCC SAR KDB Publications (Details in test report)
Test Specification : CFR §2.1093
6. Date of Test : 2018.03.19 ~ 2018.04.11, 2018.05.03
7. Testing Environment : Refer to appended test report.
8. Test Result : Refer to attached test report.

Affirmation	Tested by	Reviewed by
	Name : BumJun Park 	Name : HakMin Kim 

The test results presented in this test report are limited only to the sample supplied by applicant and the use of this test report is inhibited other than its purpose. This test report shall not be reproduced except in full, without the written approval of DT&C Co., Ltd.

2018 . 05 . 04 .

DT&C Co., Ltd.

If this report is required to confirmation of authenticity, please contact to report@dtnc.net

Test Report Version

Test Report No.	Date	Description
DRRFCC1804-0045	Apr. 24, 2018	Initial issue
DRRFCC1804-0045(1)	May. 03, 2018	Add LTE DL CA Powers etc.
DRRFCC1804-0045(2)	May. 04, 2018	Revise Section 10.4

Table of Contents

1. DESCRIPTION OF DEVICE	5
1.1 Guidance Applied.....	6
1.2 DUT Antenna Locations.....	6
1.3 SAR Test Exclusions Applied.....	7
1.4 Power Reduction for SAR.....	7
1.5 Device Serial Numbers.....	7
1.6 LTE Information.....	8
2. INTROCUCTION	9
3. DESCRIPTION OF TEST EQUIPMENT	10
3.1 SAR MEASUREMENT SETUP.....	10
3.2 Probe Specification.....	11
3.3 Probe Calibration Process.....	12
3.3.1 E-Probe Calibration.....	12
3.4 Data Extrapolation.....	13
3.5 SAM Twin PHANTOM.....	14
3.6 Device Holder for Transmitters.....	14
3.7 Brain & Muscle Simulation Mixture Characterization.....	15
3.8 SAR TEST EQUIPMENT.....	17
4. TEST SYSTEM SPECIFICATIONS	18
5. SAR MEASUREMENT PROCEDURE	19
5.1 Measurement Procedure.....	19
6. DEFINITION OF REFERENCE POINTS	21
6.1 Ear Reference Point.....	21
6.2 Handset Reference Points.....	21
7. TEST CONFIGURATION POSITIONS FOR HANDSETS	22
7.1 Device Holder.....	22
7.2 Positioning for Cheek/Touch.....	22
7.3 Positioning for Ear / 15 ° Tilt.....	22
7.4 Body-Worn Accessory Configurations.....	23
7.5 Extremity Exposure Configurations.....	23
7.6 Wireless Router Configurations.....	24
8. RF EXPOSURE LIMITS	25
9. FCC MEASUREMENT PROCEDURES	26
9.1 Measured and Reported SAR.....	26
9.2 Procedures Used to Establish RF Signal for SAR.....	26
9.3 SAR Measurement Conditions for WCDMA (UMTS).....	26
9.3.1 Output Power Verification.....	26
9.3.2 Head SAR Measurements for Handsets.....	26
9.3.3 Body SAR Measurements.....	27
9.3.4 Release 5 HSDPA Data Devices.....	27
9.3.5 Release 6 HSUPA Data Devices.....	27
9.3.6 SAR Measurement Conditions for DC-HSDPA.....	28
9.4 SAR Measurement Conditions for LTE.....	28
9.4.1 Spectrum Plots for RB Configurations.....	28
9.4.2 MPR.....	28
9.4.3 A-MPR.....	28
9.4.4 Required RB Size and RB Offsets for SAR Testing.....	29
9.4.5 Downlink Only Carrier Aggregation.....	29
9.4.5.1 Fall 2017 TCB Workshop notes (LTE Carrier Aggregation).....	30

9.5 SAR Testing with 802.11 Transmitters	32
9.5.1 General Device Setup.....	32
9.5.2 Initial Test Position Procedure.....	32
9.5.3 2.4 GHz SAR Test Requirements	32
9.5.4 OFDM Transmission Mode and SAR Test Channel Selection	33
9.5.5 Initial Test Configuration Procedure	33
10. RF CONDUCTED POWERS	34
10.1 GSM Nominal and Maximum Output Power Spec and Conducted Powers	34
10.2 WCDMA Nominal and Maximum Output Power Spec and Conducted Powers	35
10.3 LTE Nominal and Maximum Output Power Spec and Conducted Powers.....	36
10.4 WLAN Nominal and Maximum Output Power Spec and Conducted Powers.....	51
10.5 Bluetooth Conducted Powers	52
11. SYSTEM VERIFICATION	54
11.1 Tissue Verification	54
11.2 Test System Verification	56
12. SAR TEST RESULTS	57
12.1 Head SAR Results.....	57
12.2 Standalone Body-Worn SAR Worn SAR Results.....	62
12.3 Standalone Hotspot SAR Results.....	66
12.4 SAR Test Notes	71
13. FCC MULTI-TX AND ANTENNA SAR CONSIDERATIONS	74
13.1 Introduction	74
13.2 Simultaneous Transmission Procedures.....	74
13.3 Simultaneous Transmission Capabilities	74
13.4 Head SAR Simultaneous Transmission Analysis	76
13.5 Body-Worn Simultaneous Transmission Analysis.....	78
13.6 Hotspot SAR Simultaneous Transmission Analysis	79
13.7 Phablet SAR Simultaneous Transmission Analysis	80
13.8 Simultaneous Transmission Conclusion	80
14. SAR MEASUREMENT VARIABILITY	81
14.1 Measurement Variability	81
15. MEASUREMENT UNCERTAINTIES	82
16. CONCLUSION	94
17. REFERENCES	95
Attachment 1. – Probe Calibration Data	97
Attachment 2. – Dipole Calibration Data.....	136
Attachment 3. – SAR SYSTEM VALIDATION	184

1. DESCRIPTION OF DEVICE

General Information

EUT type	Mobile Phone				
FCC ID	ZNFQ710FA				
Equipment model name	LM-Q710FA				
Equipment add model name	LMQ710FA, Q710FA, LM-Q710RA, LMQ710RA, Q710RA, LM-Q710FM, LMQ710FM, Q710FM, LM-Q710HS, LMQ710HS, Q710HS, LM-Q710HSW, LMQ710HSW, Q710HSW • 15 models are same mechanical, electrical and functional except follows. - LMQ710FA, Q710FA, LM-Q710RA, LMQ710RA, Q710RA, LM-Q710FM, LMQ710FM, Q710FM, LM-Q710HS, LMQ710HS, Q710HS : No differences - LM-Q710HSW, LMQ710HSW, Q710HSW : Dual SIM support(1 RF Path)				
Equipment serial no.	Identical prototype				
Mode(s) of Operation	GSM 850, GSM 1900, WCDMA 850, WCDMA 1700, WCDMA 1900, LTE Band 12, 17, 5, 66, 4, 2, 7, 2.4 G W-LAN (802.11b/g/n-HT20), Bluetooth				
TX Frequency Range	Band	Mode	Operating Modes	Bandwidth	Frequency
	GSM 850	GSM/GPRS/EDGE	Voice/Data	-	824.2 ~ 848.8 MHz
	GSM 1900	GSM/GPRS/EDGE	Voice/Data	-	1850.2 ~ 1909.8 MHz
	WCDMA 850	WCDMA	Voice/Data	-	826.4 ~ 846.6 MHz
	WCDMA 1700	WCDMA	Voice/Data	-	1712.4 ~ 1752.6 MHz
	WCDMA 1900	WCDMA	Voice/Data	-	1852.4 ~ 1907.6 MHz
	LTE Band 12	LTE	Voice/Data	1.4/3/5/10MHz	699.7 ~ 715.3 MHz
	LTE Band 17	LTE	Voice/Data	5/10MHz	706.5 ~ 713.5 MHz
	LTE Band 5	LTE	Voice/Data	1.4/3/5/10MHz	824.7 ~ 848.3 MHz
	LTE Band 66	LTE	Voice/Data	1.4/3/5/10/15/20MHz	1710.7 ~ 1779.3 MHz
	LTE Band 4	LTE	Voice/Data	1.4/3/5/10/15/20MHz	1710.7 ~ 1754.3 MHz
	LTE Band 2	LTE	Voice/Data	1.4/3/5/10/15/20MHz	1850.7 ~ 1909.3 MHz
	LTE Band 7	LTE	Voice/Data	5/10/15/20MHz	2502.5 ~ 2567.5 MHz
	2.4 GHz W-LAN	802.11b/g/n	Voice/Data	HT20/VHT20	2412 ~ 2462 MHz
Bluetooth	-	Data	-	2402 ~ 2480 MHz	
RX Frequency Range	GSM 850	GSM/GPRS/EDGE	Voice/Data	-	869.2 ~ 893.8 MHz
	GSM 1900	GSM/GPRS/EDGE	Voice/Data	-	1930.2 ~ 1989.8 MHz
	WCDMA 850	WCDMA	Voice/Data	-	871.4 ~ 891.6 MHz
	WCDMA 1700	WCDMA	Voice/Data	-	2112.4 ~ 2152.6 MHz
	WCDMA 1900	WCDMA	Voice/Data	-	1932.4 ~ 1987.6 MHz
	LTE Band 12	LTE	Voice/Data	1.4/3/5/10MHz	729.7 ~ 745.3 MHz
	LTE Band 17	LTE	Voice/Data	5/10MHz	736.5 ~ 743.5 MHz
	LTE Band 5	LTE	Voice/Data	1.4/3/5/10MHz	869.7 ~ 893.3 MHz
	LTE Band 66	LTE	Voice/Data	1.4/3/5/10/15/20MHz	2110.7 ~ 2179.3 MHz
	LTE Band 4	LTE	Voice/Data	1.4/3/5/10/15/20MHz	2110.7 ~ 2154.3 MHz
	LTE Band 2	LTE	Voice/Data	1.4/3/5/10/15/20MHz	1930.7 ~ 1989.3 MHz
	LTE Band 7	LTE	Voice/Data	5/10/15/20MHz	2622.5 ~ 2687.5 MHz
	2.4 GHz W-LAN	802.11b/g/n	Voice/Data	HT20/VHT20	2412 ~ 2462 MHz
	Bluetooth	-	Data	-	2402 ~ 2480 MHz
Equipment Class	Band	Reported SAR			
		1g SAR (W/kg)			10g SAR (W/kg)
		Head	Body-Worn	Hotspot	Phablet
PCE	GSM 850	0.12	0.45	-	-
PCE	GPRS 850	0.19	0.68	0.68	-
PCE	GSM 1900	0.14	0.28	-	-
PCE	GPRS 1900	0.22	0.52	1.05	-
PCE	WCDMA 850	0.17	0.69	0.69	-
PCE	WCDMA 1700	< 0.1	0.28	0.45	-
PCE	WCDMA 1900	< 0.1	0.19	0.33	-
PCE	LTE Band 12	0.13	0.56	0.56	-
PCE	LTE Band 17	-	-	-	-
PCE	LTE Band 5	0.16	0.66	0.66	-
PCE	LTE Band 66	< 0.1	0.45	0.83	-
PCE	LTE Band 4	-	-	-	-
PCE	LTE Band 2	< 0.1	0.32	0.56	-
PCE	LTE Band 7	< 0.1	0.36	0.43	-
DTS	2.4 GHz W-LAN	1.08	0.40	0.40	-
DSS	Bluetooth	0.30	< 0.1	< 0.1	-
Simultaneous SAR per KDB 690783 D01v01r03		1.26	1.06	1.06	-
FCC Equipment Class	Licensed Portable Transmitter Held to Ear (PCE) Part 15 Spread Spectrum Transmitter(DSS) Digital Transmission System(DTS)				
Date(s) of Tests	2018.03.19 ~ 2018.04.11, 2018.05.03				
Antenna Type	Internal Antenna				
Functions	<ul style="list-style-type: none"> GSM/GPRS/EDGE (GPRS/EDGE Class: 12) supported. * DTM not supported. No simultaneous transmission between BT & 2.4GHz WLAN VoIP is supported. W-LAN 2.4GHz is supported Hotspot. 				

1.1 Guidance Applied

- IEEE 1528-2013
- FCC KDB Publication 941225 D01v03r01 (3G SAR Procedures)
- FCC KDB Publication 941225 D05v02r05 (SAR for LTE Devices)
- FCC KDB Publication 941225 D05Av01r02 (LTE Rel.10 KDB Inquiry Sheet)
- FCC KDB Publication 941225 D06v02r01 (Hotspot Mode)
- FCC KDB Publication 248227 D01v02r02 (802.11 Wi-Fi SAR)
- FCC KDB Publication 447498 D01v06 (General RF Exposure Guidance)
- FCC KDB Publication 648474 D04v01r03 (Handset SAR)
- FCC KDB Publication 690783 D01v01r03 (SAR Listings on Grants)
- FCC KDB Publication 865664 D01v01r04 (SAR Measurement 100 MHz to 6 GHz)
- FCC KDB Publication 865664 D02v01r02 (RF Exposure Reporting)
- October 2013 TCB Workshop Notes (GPRS testing criteria)
- April 2015 TCB Workshop Notes (Simultaneous transmission summation clarified)
- October 2016 TCB Workshop Notes (Bluetooth Duty Factor)
- April 2018 TCB Workshop Notes (LTE Carrier Aggregation)

1.2 DUT Antenna Locations

The overall dimensions of this device are > 9 x 5 cm. A diagram showing the location of the device of the device antenna can be found in ZNFQ710FA_Antenna Location. Since the diagonal dimension of this device is > 160 mm and < 200 mm. it is considered a "phablet".

Mode	Device Sides for SAR Testing					
	Top	Bottom	Front	Rear	Right	Left
GSM/GPRS/EDGE 850	X	O	O	O	O	O
GSM/GPRS/EDGE 1900	X	O	O	O	X	O
WCDMA 850	X	O	O	O	O	O
WCDMA 1700	X	O	O	O	X	O
WCDMA 1900	X	O	O	O	X	O
LTE Band 12	X	O	O	O	O	O
LTE Band 17	X	O	O	O	O	O
LTE Band 5	X	O	O	O	O	O
LTE Band 66	X	O	O	O	X	O
LTE Band 4	X	O	O	O	X	O
LTE Band 2	X	O	O	O	X	O
LTE Band 7	X	O	O	O	X	O
2.4G W-LAN	O	X	O	O	X	O
Bluetooth	O	X	O	O	X	O

Note 1: Particular DUT edges were not required to be evaluated for Hotspot SAR or Phablet SAR if the edges were greater than 2.5 cm from the transmitting antenna according to FCC KDB Publication 648474 D04v01r03. The antenna document shows the distances between the transmit antennas and the edges of the device.

Note 2: O means test and X means no testing.

1.3 SAR Test Exclusions Applied

(A) Licensed Transmitter(s)

GSM/GPRS/EDGE DTM is not supported for US bands. Therefore, the GSM Voice modes in this report do not transmit simultaneously with GPRS/EDGE Data.

This device support LTE capabilities with overlapping transmission frequency ranges. When the supported frequency range of an LTE Band falls completely within an LTE band with a larger transmission frequency range, both LTE band have the same target power (or the band with the larger transmission frequency range has a higher target power), and both LTE bands share the same transmission path and signal characteristics, SAR was only assessed for the band with the larger transmission frequency range.

1.4 Power Reduction for SAR

There is no power reduction used for any band/mode implemented in this device for SAR purposes.

1.5 Device Serial Numbers

Band & Mode	Head Serial Number	Body Serial Number	Hotspot Serial Number	Phablet Serial Number
GSM/GPRS/EDGE 850	FCC #1	FCC #1	FCC #1	-
GSM/GPRS/EDGE 1900	FCC #1	FCC #1	FCC #1	-
WCDMA 850	FCC #1	FCC #1	FCC #1	-
WCDMA 1700	FCC #1	FCC #1	FCC #1	-
WCDMA 1900	FCC #1	FCC #1	FCC #1	-
LTE Band 12	FCC #1	FCC #1	FCC #1	-
LTE Band 17	FCC #1	FCC #1	FCC #1	-
LTE Band 5	FCC #1	FCC #1	FCC #1	-
LTE Band 66	FCC #1	FCC #1	FCC #1	-
LTE Band 4	FCC #1	FCC #1	FCC #1	-
LTE Band 2	FCC #1	FCC #1	FCC #1	-
LTE Band 7	FCC #1	FCC #1	FCC #1	-
2.4 GHz WLAN	FCC #1	FCC #1	FCC #1	-
Bluetooth	FCC #1	FCC #1	FCC #1	-

1.6 LTE Information

LTE Information					
FCC ID	ZNFQ710FA				
Form Factor	Mobile Phone				
Frequency Range of each LTE transmission Band	LTE Band 12 (699.7 ~ 715.3 MHz) LTE Band 17 (706.5 ~ 713.5 MHz) LTE Band 5 (Cell) (824.7 ~ 848.3 MHz) LTE Band 66 (AWS) (1710.7 ~ 1779.3 MHz) LTE Band 4 (AWS) (1710.7 ~ 1754.3 MHz) LTE Band 2 (PCS) (1850.7 ~ 1909.3 MHz) LTE Band 7 (2502.5 ~ 2567.5 MHz)				
Channel Bandwidths	LTE Band 12 : 1.4 MHz, 3 MHz, 5 MHz, 10 MHz LTE Band 17 : 5 MHz, 10 MHz LTE Band 5 : 1.4 MHz, 3 MHz, 5 MHz, 10 MHz LTE Band 66 : 1.4 MHz, 3 MHz, 5 MHz, 10 MHz, 15 MHz, 20 MHz LTE Band 4 : 1.4 MHz, 3 MHz, 5 MHz, 10 MHz, 15 MHz, 20 MHz LTE Band 2 : 1.4 MHz, 3 MHz, 5 MHz, 10 MHz, 15 MHz, 20 MHz LTE Band 7: 5 MHz, 10 MHz, 15 MHz, 20 MHz				
Channel Number and Frequencies(MHz)	Low	Low-Mid	Mid	Mid-High	High
LTE Band 12: 1.4 MHz	699.7 (23017)	N/A	707.5 (23095)	N/A	715.3 (23173)
LTE Band 12: 3 MHz	700.5 (23025)	N/A	707.5 (23095)	N/A	714.5 (23165)
LTE Band 12: 5 MHz	701.5 (23035)	N/A	707.5 (23095)	N/A	713.5 (23155)
LTE Band 12: 10 MHz	704.0 (23060)	N/A	707.5 (23095)^{Note1}	N/A	711.0 (23130)
LTE Band 17: 5 MHz	706.5(23755)	N/A	710.0(23790)	N/A	713.5(23825)
LTE Band 17: 10 MHz	709.0(23780)	N/A	710.0(23790)	N/A	711.0(23800)
LTE Band 5 (Cell): 1.4 MHz	824.7 (20407)	N/A	836.5 (20525)	N/A	848.3 (20643)
LTE Band 5 (Cell): 3 MHz	825.5 (20415)	N/A	836.5 (20525)	N/A	847.5 (20635)
LTE Band 5 (Cell): 5 MHz	826.5 (20425)	N/A	836.5 (20525)	N/A	846.5 (20625)
LTE Band 5 (Cell): 10 MHz	829.0 (20450)	N/A	836.5 (20525)^{Note2}	N/A	844.0 (20600)
LTE Band 66 (AWS): 1.4 MHz	1710.7 (131979)	N/A	1745.0 (132322)	N/A	1779.3 (132665)
LTE Band 66 (AWS): 3 MHz	1711.5 (131987)	N/A	1745.0 (132322)	N/A	1778.5 (132657)
LTE Band 66 (AWS): 5 MHz	1712.5 (131997)	N/A	1745.0 (132322)	N/A	1777.5 (132647)
LTE Band 66 (AWS): 10 MHz	1715.0 (132022)	N/A	1745.0 (132322)	N/A	1775.0 (132622)
LTE Band 66 (AWS): 15 MHz	1717.5 (132047)	N/A	1745.0 (132322)	N/A	1772.5 (132597)
LTE Band 66 (AWS): 20 MHz	1720.0 (132072)	N/A	1745.0 (132322)	N/A	1770.0 (132572)
LTE Band 4 (AWS): 1.4 MHz	1710.7 (19957)	N/A	1732.5 (20175)	N/A	1754.3 (20393)
LTE Band 4 (AWS): 3 MHz	1711.5 (19965)	N/A	1732.5 (20175)	N/A	1753.5 (20385)
LTE Band 4 (AWS): 5 MHz	1712.5 (19975)	N/A	1732.5 (20175)	N/A	1752.5 (20375)
LTE Band 4 (AWS): 10 MHz	1715.0 (20000)	N/A	1732.5 (20175)	N/A	1750.0 (20350)
LTE Band 4 (AWS): 15 MHz	1717.5 (20025)	N/A	1732.5 (20175)	N/A	1747.5 (20325)
LTE Band 4 (AWS): 20 MHz	1720.0 (20050)	N/A	1732.5 (20175)	N/A	1745.0 (20300)
LTE Band 2 (PCS): 1.4 MHz	1850.7 (18607)	N/A	1880.0 (18900)	N/A	1909.3 (19193)
LTE Band 2 (PCS): 3 MHz	1851.5 (18615)	N/A	1880.0 (18900)	N/A	1908.5 (19185)
LTE Band 2 (PCS): 5 MHz	1852.5 (18625)	N/A	1880.0 (18900)	N/A	1907.5 (19175)
LTE Band 2 (PCS): 10 MHz	1855.0 (18650)	N/A	1880.0 (18900)	N/A	1905.0 (19150)
LTE Band 2 (PCS): 15 MHz	1857.5 (18675)	N/A	1880.0 (18900)	N/A	1902.5 (19125)
LTE Band 2 (PCS): 20 MHz	1860.0 (18700)	N/A	1880.0 (18900)	N/A	1900.0 (19100)
LTE Band 7: 5 MHz	2502.5 (20775)	N/A	2535.0 (21100)	N/A	2567.5 (21425)
LTE Band 7: 10 MHz	2505.0 (20800)	N/A	2535.0 (21100)	N/A	2565.0 (21400)
LTE Band 7: 15 MHz	2507.5 (20825)	N/A	2535.0 (21100)	N/A	2562.5 (21375)
LTE Band 7: 20 MHz	2510.0 (20850)	N/A	2535.0 (21100)	N/A	2560.0 (21350)
UE Category	LTE Rel.10, UE Category 6				
Modulations Supported in UL	QPSK, 16QAM				
LTE MPR Permanently implemented per 3GPP TS 36.101 section 6.2.3~6.2.5? (manufacturer attestation to be provided)	Yes				
A-MPR (Additional MPR) disabled for SAR Testing?	Yes				
Power reduction explanation	This device doesn't implements power reduction.				
LTE Carrier Aggregation Possible Combinations	The technical description includes all the possible carrier aggregation combinations.				
LTE Additional Information	This device does not support CA features on 3GPP Release 10. All uplink communications are identical to the Release 8 Specifications. The following LTE Release 10 Features are not supported: Relay, HetNet, Enhanced MIMO, eICIC, WIFI Offloading, MDH, eMBMS, Cross-Carrier Scheduling, Enhanced SC-FDMA.				

Note(s)

- LTE Band 12 at 10 MHz bandwidth does not support three non-overlapping channels.
Per KDB 941225 D05v02r05, when a device supports overlapping channel assignment in a channel bandwidth configuration, the middle channel of the group of overlapping channels should be selected for testing.
- LTE Band 5 (Cell) at 10 MHz bandwidth does not support three non-overlapping channels.
Per KDB 941225 D05v02r05, when a device supports overlapping channel assignment in a channel bandwidth configuration, the middle channel of the group of overlapping channels should be selected for testing.

2. INTROCUCTION

The FCC and Industry Canada have adopted the guidelines for evaluating the environmental effects of radio frequency (RF) radiation in ET Docket 93-62 on Aug. 6, 1996 and Health Canada Safety Code 6 to protect the public and workers from the potential hazards of RF emissions due to FCC-regulated portable devices.

The FCC has adopted the guidelines for evaluating the environmental effects of radio frequency radiation in ET Docket 93-62 on Aug. 6, 1996 to protect the public and workers from the potential hazards of RF emissions due to FCC-regulated portable devices. The safety limits used for the environmental evaluation measurements are based on the criteria published by the American National Standards Institute (ANSI) for localized specific absorption rate (SAR) in IEEE/ANSI C95.1-1992 Standard for Safety Levels with Respect to Human Exposure to Radio Frequency Electromagnetic Fields, 3 kHz to 300 GHz. The measurement procedure described in IEEE/ANSI C95.3-2002 Recommended Practice for the Measurement of Potentially Hazardous Electromagnetic Fields - RF and Microwave is used for guidance in measuring SAR due to the RF radiation exposure from the Equipment Under Test (EUT). These criteria for SAR evaluation are similar to those recommended by the National Council on Radiation Protection and Measurements (NCRP) in Biological Effects and Exposure Criteria for Radio frequency Electromagnetic Fields," NCRP Report No. 86 NCRP, 1986, Bethesda, MD 20814. SAR is a measure of the rate of energy absorption due to exposure to an RF transmitting source. SAR values have been related to threshold levels for potential biological hazards.

SAR Definition

Specific Absorption Rate (SAR) is defined as the time derivative (rate) of the incremental energy (dU) absorbed by (dissipated in) an incremental mass (dm) contained in a volume element (dV) of a given density (ρ) It is also defined as the rate of RF energy absorption per unit mass at a point in an absorbing body (see Fig. 2.1)

$$SAR = \frac{d}{dt} \left(\frac{dU}{dm} \right) = \frac{d}{dt} \left(\frac{dU}{\rho dv} \right)$$

Fig. 2.1 SAR Mathematical Equation

SAR is expressed in units of Watts per Kilogram (W/kg).

$$SAR = \frac{\sigma \cdot E^2}{\rho}$$

where:

- σ = conductivity of the tissue-simulating material (S/m)
- ρ = mass density of the tissue-simulating material (kg/m³)
- E = Total RMS electric field strength (V/m)

NOTE: The primary factors that control rate of energy absorption were found to be the wavelength of the incident field in relations to the dimensions and geometry of the irradiated organism, the orientation of the organism in relation to the polarity of field vectors, the presence of reflecting surfaces, and whether conductive contact is made by the organism with a ground plane.

3. DESCRIPTION OF TEST EQUIPMENT

3.1 SAR MEASUREMENT SETUP

Measurements are performed using the DASY5 automated dosimetric assessment system. The DASY5 is made by Schmid & Partner Engineering AG (SPEAG) in Zurich, Switzerland and consists of high precision robotics system (Staubli), robot controller, desktop computer, near-field probe, probe alignment sensor, and the generic twin phantom containing the brain equivalent material. The robot is a six-axis industrial robot performing precise movements to position the probe to the location (points) of maximum electromagnetic field (EMF) (see Fig. 3.1).

A cell controller system contains the power supply, robot controller each pendant (Joystick), and a remote control used to drive the robot motors. The PC consists of the Intel Core i7-4770 3.40 GHz desktop computer with Windows 7 system and SAR Measurement Software DASY5, A/D interface card, monitor, mouse, and keyboard. The Staubli Robot is connected to the cell controller to allow software manipulation of the robot. A data acquisition electronic (DAE) circuit that performs the signal amplification, signal multiplexing, AD-conversion, offset measurements, mechanical surface detection, collision detection, etc. is connected to the Electro-optical coupler (EOC). The EOC performs the conversion from the optical into digital electric signal of the DAE and transfers data to the PC plug-in card.

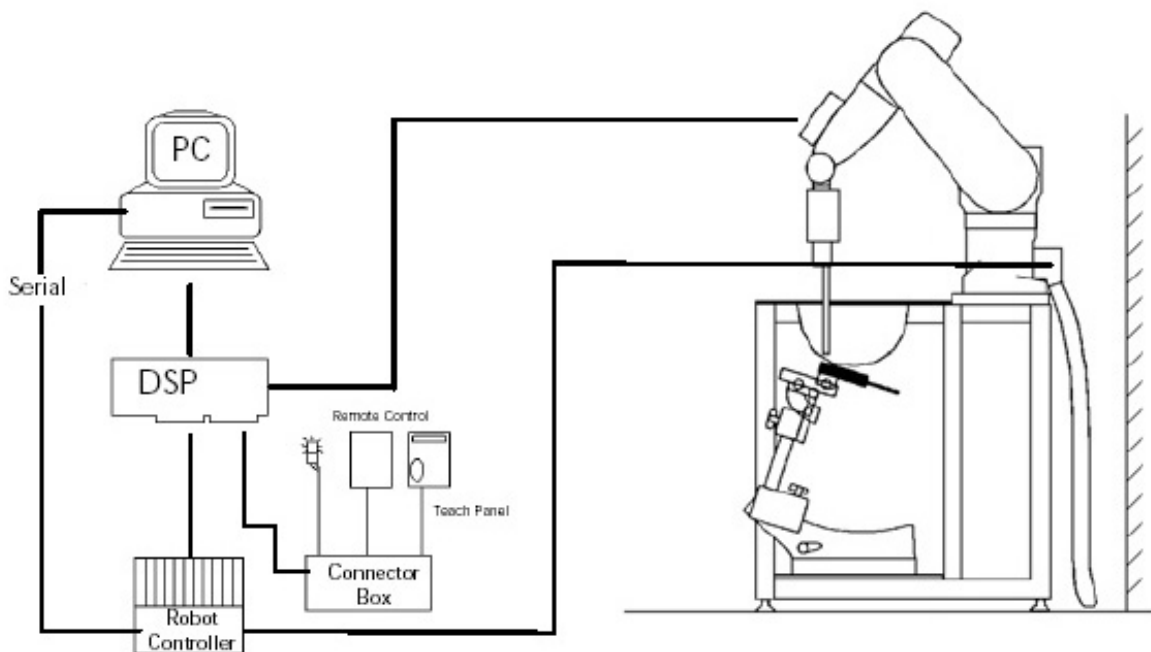

Figure 3.1 SAR Measurement System Setup

The DAE4 consists of a highly sensitive electrometer-grade preamplifier with auto-zeroing, a channel and gain-switching multiplexer, a fast 16 bit AD-converter and a command decoder and control logic unit. Transmission to the PC-card is accomplished through an optical downlink for data and status information and an optical uplink for commands and clock lines. The mechanical probe mounting device includes two different sensor systems for frontal and sidewise probe contacts. They are also used for mechanical surface detection and probe collision detection. The robot uses its own controller with a built in VME-bus computer. The system is described in detail.

3.2 Probe Specification

Calibration	In air from 10 MHz to 6 GHz In brain and muscle simulating tissue at Frequencies of 750 MHz, 835 MHz, 900 MHz, 1750 MHz, 1900 MHz, 2300 MHz, 2450 MHz, 2600 MHz, 3500 MHz, 5200 MHz, 5300 MHz, 5500 MHz, 5600 MHz, 5800 MHz
Frequency	10 MHz to 6 GHz
Linearity	± 0.2 dB(30 MHz to 6 GHz)
Dynamic	10 μW/g to > 100 mW/g
Range	Linearity : ±0.2dB
Dimensions	Overall length : 337 mm
Tip length	20 mm
Body diameter	12 mm
Tip diameter	2.5 mm
Distance from probe tip to sensor center	1.0 mm
Application	SAR Dosimetry Testing Compliance tests of mobile phones

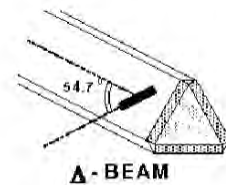

Figure 3.2 Triangular Probe Configurations



Figure 3.3 Probe Thick-Film Technique



DAE System

The SAR measurements were conducted with the dosimetric probe EX3DV4 designed in the classical triangular configuration(see Fig. 3.2) and optimized for dosimetric evaluation. The probe is constructed using the thick film technique; with printed resistive lines on ceramic substrates. The probe is equipped with an optical multitier line ending at the front of the probe tip. It is connected to the EOC box on the robot arm and provides an automatic detection of the phantom surface. Half of the fibers are connected to a pulsed infrared transmitter, the other half to a synchronized receiver. As the probe approaches the surface, the reflection from the surface produces a coupling from the transmitting to the receiving fibers. This reflection increases first during the approach, reaches maximum and then decreases. If the probe is flatly touching the surface, the coupling is zero. The distance of the coupling maximum to the surface is independent of the surface reflectivity and largely independent of the surface to probe angle. The DASY5 software reads the reflection during a software approach and looks for the maximum using a 2nd order fitting. The approach is stopped at reaching the maximum.

3.3 Probe Calibration Process

3.3.1 E-Probe Calibration

Dosimetric Assessment Procedure

Each probe is calibrated according to a dosimetric assessment procedure with accuracy better than +/- 10%. The spherical isotropy was evaluated with the procedure and found to be better than +/-0.25dB. The sensitivity parameters (Norm X, Norm Y, Norm Z), the diode compression parameter (DCP) and the conversion factor (Conv F) of the probe is tested.

Free Space Assessment

The free space E-field from amplified probe outputs is determined in a test chamber. This is performed in a TEM cell for frequencies below 1 GHz, and in a waveguide above 1GHz for free space. For the free space calibration, the probe is placed in the volumetric center of the cavity at the proper orientation with the field. The probe is then rotated 360 degrees.

Temperature Assessment *

E-field temperature correlation calibration is performed in a flat phantom filled with the appropriate simulated brain tissue. The measured free space E-field in the medium, correlates to temperature rise in a dielectric medium. For temperature correlation calibration a RF transparent the remits or based temperature probe is used in conjunction with the E-field probe.

$$SAR = C \frac{\Delta T}{\Delta t}$$

$$SAR = \frac{|E|^2 \cdot \sigma}{\rho}$$

where:

where:

Δt = exposure time (30 seconds),

σ = simulated tissue conductivity,

C = heat capacity of tissue (brain or muscle),

ρ = Tissue density (1.25 g/cm³ for brain tissue)

ΔT = temperature increase due to RF exposure.

SAR is proportional to $\Delta T / \Delta t$, the initial rate of tissue heating, before thermal diffusion takes place. Now it's possible to quantify the electric field in the simulated tissue by equating the thermally derived SAR to the E- field;

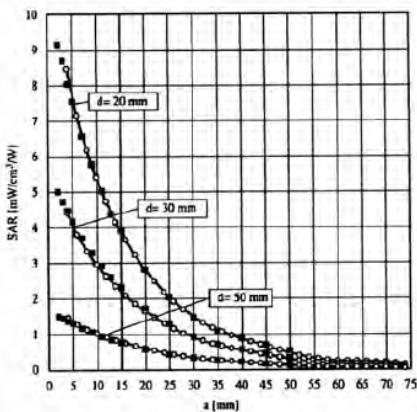

Figure 3.4 E-Field and Temperature Measurements at 900MHz

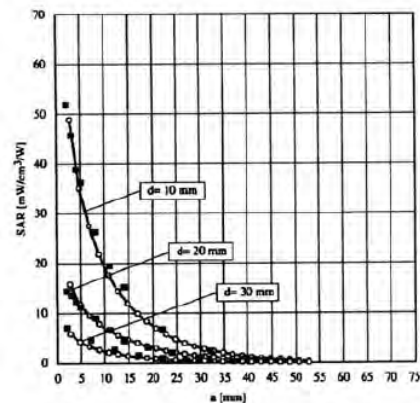

Figure 3.5 E-Field and Temperature Measurements at 1800MHz

3.4 Data Extrapolation

The DASY5 software automatically executes the following procedures to calculate the field units from the microvolt readings at the probe connector. The first step of the evaluation is a linearization of the filtered input signal to account for the compression characteristics of the detector diode. The compensation depends on the input signal, the diode type and the DC-transmission factor from the diode to the evaluation electronics. If the exciting field is pulsed, the crest factor of the signal must be known to correctly compensate for peak power. The formula for each channel can be given like below;

$$V_i = U_i + U_i^2 \cdot \frac{cf}{dcp_i}$$

with V_i = compensated signal of channel i ($i=x,y,z$)
 U_i = input signal of channel i ($i=x,y,z$)
 cf = crest factor of exciting field (DASY parameter)
 dcp_i = diode compression point (DASY parameter)

From the compensated input signals the primary field data for each channel can be evaluated:

E-field probes:

$$E_i = \sqrt{\frac{V_i}{Norm_i \cdot ConvF}}$$

with V_i = compensated signal of channel i ($i = x,y,z$)
 $Norm_i$ = sensor sensitivity of channel i ($i = x,y,z$)
 $\mu V/(V/m)^2$ for E-field probes
 $ConvF$ = sensitivity of enhancement in solution
 E_i = electric field strength of channel i in V/m

The RSS value of the field components gives the total field strength (Hermetian magnitude):

$$E_{tot} = \sqrt{E_x^2 + E_y^2 + E_z^2}$$

The primary field data are used to calculate the derived field units.

$$SAR = E_{tot}^2 \cdot \frac{\sigma}{\rho \cdot 1000}$$

with SAR = local specific absorption rate in W/g
 E_{tot} = total field strength in V/m
 σ = conductivity in [mho/m] or [Siemens/m]
 ρ = equivalent tissue density in g/cm^3

The power flow density is calculated assuming the excitation field to be a free space field.

$$P_{free} = \frac{E_{tot}^2}{3770}$$

with P_{pwe} = equivalent power density of a plane wave in W/cm^2
 E_{tot} = total electric field strength in V/m

3.5 SAM Twin PHANTOM

The SAM Twin Phantom V5.0 is constructed of a fiberglass shell integrated in a wooden table. The shape of the shell is based on data from an anatomical study designed to determine the maximum exposure in at least 90% of all users. It enables the dosimetric evaluation of left and right hand phone usage as well as body mounted usage at the flat phantom region. A cover prevents the evaporation of the liquid.

Reference markings on the Phantom allow the complete setup of all predefined phantom positions and measurement grids by manually teaching three points in the robot. (see Fig. 3.6)



Figure 3.6 SAM Twin Phantom

SAM Twin Phantom Specification:

Construction	The shell corresponds to the specifications of the Specific Anthropomorphic Mannequin (SAM) phantom defined in IEEE 1528 and IEC 62209-1. It enables the dosimetric evaluation of left and right hand phone usage as well as body mounted usage at the flat phantom region. A cover prevents evaporation of the liquid. Reference markings on the phantom allow the complete setup of all predefined phantom positions and measurement grids by teaching three points with the robot. Twin SAM V5.0 has the same shell geometry and is manufactured from the same material as Twin SAM V4.0, but has reinforced top structure.
Shell Thickness	2 ± 0.2 mm
Filling Volume	Approx. 25 liters
Dimensions	Length: 1000 mm Width: 500 mm Height: adjustable feet

Specific Anthropomorphic Mannequin (SAM) Specifications:

The phantom for handset SAR assessment testing is a low-loss dielectric shell, with shape and dimensions derived from the anthropometric data of the 90th percentile adult male head dimensions as tabulated by the US Army. The SAM Twin Phantom shell is bisected along the mid-sagittal plane into right and left halves (see Fig. 3.7). The perimeter sidewalls of each phantom halves are extended to allow filling with liquid to a depth that is sufficient to minimized reflections from the upper surface. The liquid depth is maintained at a minimum depth of 15cm to minimize reflections from the upper surface.

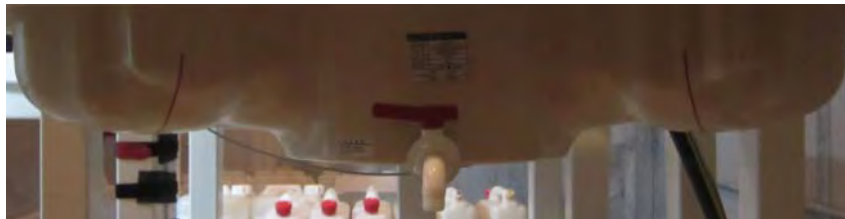

Figure 3.7 Sam Twin Phantom shell

3.6 Device Holder for Transmitters

In combination with the Twin SAM Phantom V4.0/V4.0c, V5.0 or ELI4, the Mounting Device enables the rotation of the mounted transmitter device in spherical coordinates. Rotation point is the ear opening point. Transmitter devices can be easily and accurately positioned according to IEC, IEEE, FCC or other specifications. The device holder can be locked for positioning at different phantom sections (left head, right head, flat).

Note: A simulating human hand is not used due to the complex anatomical and geometrical structure of the hand that may produce infinite number of configurations. To produce the worst-case condition (the hand absorbs antenna output power), the hand is omitted during the tests.



Figure 3.8 Mounting Device

3.7 Brain & Muscle Simulation Mixture Characterization

The brain and muscle mixtures consist of a viscous gel using hydrox-ethylcellulose (HEC) gelling agent and saline solution (see Table 3.1). Preservation with a bactericide is added and visual inspection is made to make sure air bubbles are not trapped during the mixing process. The mixture is calibrated to obtain proper dielectric constant (permittivity) and conductivity of the desired tissue. The mixture characterizations used for the brain and muscle tissue simulating liquids are according to the data by C. Gabriel and G. Harts grove.



Figure 3.9 Simulated Tissue

Table 3.1 Composition of the Tissue Equivalent Matter

Ingredients (% by weight)	Frequency (MHz)							
	835		1900		2450		5200 ~ 5800	
Tissue Type	Head	Body	Head	Body	Head	Body	Head	Body
Water	40.19	50.75	55.24	70.23	71.88	73.40	65.52	80.00
Salt (NaCl)	1.480	0.940	0.310	0.290	0.160	0.060	-	-
Sugar	57.90	48.21	-	-	-	-	-	-
HEC	0.250	-	-	-	-	-	-	-
Bactericide	0.180	0.100	-	-	-	-	-	-
Triton X-100	-	-	-	-	19.97	-	17.24	-
DGBE	-	-	44.45	29.48	7.990	26.54	-	-
Diethylene glycol hexyl ether	-	-	-	-	-	-	17.24	-
Polysorbate (Tween) 80	-	-	-	-	-	-	-	20.00
Target for Dielectric Constant	41.5	55.2	40.0	53.3	39.2	52.7	-	-
Target for Conductivity (S/m)	0.90	0.97	1.40	1.52	1.80	1.95	-	-

Salt:	99 % Pure Sodium Chloride	Sugar:	98 % Pure Sucrose
Water:	De-ionized, 16M resistivity	HEC:	Hydroxyethyl Cellulose
DGBE:	99 % Di(ethylene glycol) butyl ether,[2-(2-butoxyethoxy) ethanol]		
Triton X-100(ultra pure):	Polyethylene glycol mono[4-(1,1,3,3-tetramethylbutyl)phenyl] ether		

Table 3.2 HSL/MSL750 (Head and Body liquids for 700 – 800 MHz)

Item	Head Tissue Simulation Liquids HSL750
	Muscle (body) Tissue Simulation Liquids MSL750
Type No	SL AAH 075, SL AAM 075
Manufacturer	SPEAG
The item is composed of the following ingredients:	
H ² O	Water, 35 – 58%
Sucrose	Sucrose, 40 – 60%
NaCl	Sodium Chloride, 0 – 6%
Hydroxyethyl-cellulose	Medium Viscosity (CAS# 9004-62-0), < 0.3%
Preventol-D7	Preservative: aqueous preparation, (CAS# 55965-84-9), containing 5-chloro-2-methyl-3(2H)-isothiazolone and 2-methyl-3(2H)-isothiazolone, 0.1 – 0.6%

Table 3.3 HSL/MSL1750 (Head and Body liquids for 1700 – 1800 MHz)

Item	Head Tissue Simulation Liquids HSL1750
	Muscle (body) Tissue Simulation Liquids MSL1750
Type No	SL AAH 175, SL AAM 175
Manufacturer	SPEAG
The item is composed of the following ingredients:	
H ² O	Water, 52 – 75%
C ₈ H ₁₈ O ₃	Diethylene glycol monobutyl ether (DGBE), 25 – 48%
NaCl	Sodium Chloride, < 1.0%

3.8 SAR TEST EQUIPMENT

Table 3.4 Test Equipment Calibration

	Type	Manufacturer	Model	Cal.Date	Next.Cal.Date	S/N
<input checked="" type="checkbox"/>	SEMITEC Engineering	SEMITEC	N/A	N/A	N/A	Shield Room
<input checked="" type="checkbox"/>	Robot	SCHMID	TX60L	N/A	N/A	F14/5VR2A1/A/01
<input checked="" type="checkbox"/>	Robot Controller	SCHMID	CS8C	N/A	N/A	F14/5VR2A1/C/01
<input checked="" type="checkbox"/>	Joystick	SCHMID	N/A	N/A	N/A	D21142605A
<input checked="" type="checkbox"/>	Intel Core i7-4770 3.40 GHz Windows 7 Professional	N/A	N/A	N/A	N/A	N/A
<input checked="" type="checkbox"/>	Probe Alignment Unit LB	N/A	N/A	N/A	N/A	SE UKS 030 AA
<input checked="" type="checkbox"/>	Mounting Device	SCHMID	SD000H01KA	N/A	N/A	N/A
<input checked="" type="checkbox"/>	Twin SAM Phantom	SCHMID	TP1220	N/A	N/A	N/A
<input checked="" type="checkbox"/>	Data Acquisition Electronics	SCHMID	DAE4V1	2017-09-19	2018-09-19	1453
<input checked="" type="checkbox"/>	Dosimetric E-Field Probe	SCHMID	EX3DV4	2017-05-31	2018-05-31	3866
<input checked="" type="checkbox"/>	750MHz SAR Dipole	SCHMID	D750V3	2018-01-18	2020-01-18	1049
<input checked="" type="checkbox"/>	835MHz SAR Dipole	SCHMID	D835V2	2017-09-21	2019-09-21	464
<input checked="" type="checkbox"/>	1800MHz SAR Dipole	SCHMID	D1800V2	2017-05-23	2019-05-23	2d047
<input checked="" type="checkbox"/>	1900MHz SAR Dipole	SCHMID	D1800V2	2017-09-20	2019-09-20	5d029
<input checked="" type="checkbox"/>	2450MHz SAR Dipole	SCHMID	D2450V2	2017-09-19	2019-09-19	726
<input checked="" type="checkbox"/>	2600MHz SAR Dipole	SCHMID	D2600V2	2018-02-16	2020-02-16	1103
<input checked="" type="checkbox"/>	Network Analyzer	Agilent	E5071C	2018-02-02	2019-02-02	MY46111534
<input checked="" type="checkbox"/>	Signal Generator	Agilent	E4438C	2017-09-05	2018-09-05	US41461520
<input checked="" type="checkbox"/>	Amplifier	RFBAY.Inc	MPA-40-40	2017-12-28	2018-12-28	21151801
<input checked="" type="checkbox"/>	Amplifier	EMPOWER	BBS3Q7ELU	2017-09-06	2018-09-06	1020
<input checked="" type="checkbox"/>	High Power RF Amplifier	EMPOWER	BBS3Q8CCJ	2017-09-05	2018-09-05	1005
<input checked="" type="checkbox"/>	Power Meter	HP	EPM-442A	2017-12-27	2018-12-27	GB37170267
<input checked="" type="checkbox"/>	Power Meter	HP	EPM-442A	2017-12-27	2018-12-27	GB37170413
<input checked="" type="checkbox"/>	Power Sensor	HP	8481A	2017-12-27	2018-12-27	US37294267
<input checked="" type="checkbox"/>	Power Sensor	HP	8481A	2017-12-27	2018-12-27	3318A96566
<input checked="" type="checkbox"/>	Power Sensor	HP	8481A	2017-12-27	2018-12-27	2702A65976
<input checked="" type="checkbox"/>	Dual Directional Coupler	Agilent	778D-012	2017-12-27	2018-12-27	50228
<input checked="" type="checkbox"/>	Directional Coupler	HP	772D	2017-07-13	2018-07-13	2889A01064
<input checked="" type="checkbox"/>	Low Pass Filter 1GHz	Wainwright Instruments	WLK6-1000-1400-9000-60SS	2017-09-05	2018-09-05	165
<input checked="" type="checkbox"/>	Low Pass Filter 1.5GHz	Micro LAB	LA-15N	2017-12-27	2018-12-27	N/A
<input checked="" type="checkbox"/>	Low Pass Filter 3.0GHz	Micro LAB	LA-30N	2017-09-05	2018-09-05	N/A
<input checked="" type="checkbox"/>	Attenuators(3 dB)	Agilent	8491B	2017-12-27	2018-12-27	MY39260700
<input checked="" type="checkbox"/>	Attenuators(10 dB)	WEINSCHL	23-10-34	2017-12-27	2018-12-27	BP4387
<input checked="" type="checkbox"/>	Dielectric Probe kit	SCHMID	DAK-3.5	2017-11-21	2018-11-21	1092
<input checked="" type="checkbox"/>	Dielectric Probe kit	SCHMID	DAK-3.5	2017-07-18	2018-07-18	1046
<input checked="" type="checkbox"/>	8960 Series 10 Wireless Comms. Test Set	Agilent	E5515C	2017-09-05	2018-09-05	GB41321164
<input checked="" type="checkbox"/>	Wideband Radio Communication Tester	Rohde Schwarz	CMW500	2018-03-07	2019-03-07	162709
<input checked="" type="checkbox"/>	Wideband Radio Communication Tester	Rohde Schwarz	CMW500	2018-02-05	2019-02-05	101414
<input checked="" type="checkbox"/>	Radio Communication Analyzer	KEYSIGHT	E7515A	2017-09-07	2018-09-07	MY55210201
<input checked="" type="checkbox"/>	Radio Communication Analyzer	KEYSIGHT	E7515A	2017-12-27	2018-12-27	MY57270113
<input checked="" type="checkbox"/>	Power Splitter	Anritsu	K241B	2017-12-27	2018-12-27	1301183
<input checked="" type="checkbox"/>	Bluetooth Tester	TESCOM	TC-3000B	2017-12-26	2018-12-26	3000B770243

NOTE: The E-field probe was calibrated by SPEAG, by temperature measurement procedure. Dipole Verification measurement is performed by DT&C before each test. The brain and muscle simulating material are calibrated by DT&C using the dielectric probe system and network analyzer to determine the conductivity and permittivity (dielectric constant) of the brain and muscle-equivalent material. Each equipment item was used solely within its respective calibration period.

4. TEST SYSTEM SPECIFICATIONS

Automated TEST SYSTEM SPECIFICATIONS:

Positioner

Robot	Stäubli Unimation Corp. Robot Model: TX60L
Repeatability	0.02 mm
No. of axis	6

Data Acquisition Electronic (DAE) System

Cell Controller

Processor	Intel Core i7-4770
Clock Speed	3.40 GHz
Operating System	Windows 7 Professional
Data Card	DASY5 PC-Board

Data Converter

Features	Signal, multiplexer, A/D converter. & control logic
Software	DASY5
Connecting Lines	Optical downlink for data and status info Optical uplink for commands and clock

PC Interface Card

Function	24 bit (64 MHz) DSP for real time processing Link to DAE 4 16 bit A/D converter for surface detection system serial link to robot direct emergency stop output for robot
-----------------	--

E-Field Probes

Model	EX3DV4 S/N: 3866
Construction	Triangular core fiber optic detection system
Frequency	10 MHz to 6 GHz
Linearity	± 0.2 dB (30 MHz to 6 GHz)

Phantom

Phantom	SAM Twin Phantom (V5.0)
Shell Material	Composite
Thickness	2.0 ± 0.2 mm



Figure 4.1 DASY5 Test System

5. SAR MEASUREMENT PROCEDURE

5.1 Measurement Procedure

The evaluation was performed using the following procedure compliant to FCC KDB Publication 865664 D01v01r04 and IEEE 1528-2013:

1. The SAR distribution at the exposed side of the head or body was measured at a distance no greater than 5.0 mm from the inner surface of the shell. The area covered the entire dimension of the device-head and body interface and the horizontal grid resolution was determined per FCC KDB Publication 865664 D01v01r04 (See Table 5.1) and IEEE1528-2013.
2. The point SAR measurement was taken at the maximum SAR region determined from Step 1 to enable the monitoring of SAR fluctuations/drifts during the 1g/10g cube evaluation. SAR at this fixed point was measured and used as a reference value.
3. Based on the area scan data, the peak of the region with maximum SAR was determined by spline interpolation. Around this point, a volume was assessed according to the measurement resolution and volume size requirements of FCC KDB Publication 865664 D01v01r04 (See Table 5.1) and IEEE 1528-2013. On the basis of this data set, the spatial peak SAR value was evaluated with the following procedure (see references or the DASY manual online for more details):
 - a. SAR values at the inner surface of the phantom are extrapolated from the measured values along the line away from the surface with spacing no greater than that in Table 5.1. The extrapolation was based on a least-squares algorithm. A polynomial of the fourth order was calculated through the points in the z-axis (normal to the phantom shell).
 - b. After the maximum interpolated values were calculated between the points in the cube, the SAR was averaged over the spatial volume (1g or 10g) using a 3D-Spline interpolation algorithm. The 3D-spline is composed of three one-dimensional splines with the "Not a knot" condition (in x, y, and z directions). The volume was then integrated with the trapezoidal algorithm. One thousand points (10 x 10 x 10) were obtained through interpolation, in order to calculate the averaged SAR.
 - c. All neighboring volumes were evaluated until no neighboring volume with a higher average value was found.
4. The SAR reference value, at the same location as step 2, was re-measured after the zoom scan was complete to calculate the SAR drift. If the drift deviated by more than 5%, the SAR test and drift measurements were repeated.

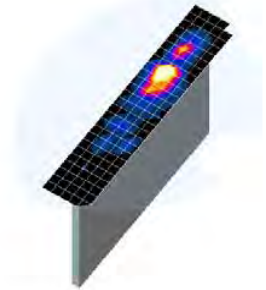

Figure 5.1
Sample SAR Area Scan

		≤ 3 GHz	> 3 GHz
Maximum distance from closest measurement point (geometric center of probe sensors) to phantom surface		$5 \text{ mm} \pm 1 \text{ mm}$	$\frac{1}{2} \cdot \delta \cdot \ln(2) \text{ mm} \pm 0.5 \text{ mm}$
Maximum probe angle from probe axis to phantom surface normal at the measurement location		$30^\circ \pm 1^\circ$	$20^\circ \pm 1^\circ$
Maximum area scan spatial resolution: $\Delta x_{Area}, \Delta y_{Area}$		≤ 2 GHz: $\leq 15 \text{ mm}$ 2 – 3 GHz: $\leq 12 \text{ mm}$	3 – 4 GHz: $\leq 12 \text{ mm}$ 4 – 6 GHz: $\leq 10 \text{ mm}$
		When the x or y dimension of the test device, in the measurement plane orientation, is smaller than the above, the measurement resolution must be \leq the corresponding x or y dimension of the test device with at least one measurement point on the test device.	
Maximum zoom scan spatial resolution: $\Delta x_{Zoom}, \Delta y_{Zoom}$		≤ 2 GHz: $\leq 8 \text{ mm}$ 2 – 3 GHz: $\leq 5 \text{ mm}^*$	3 – 4 GHz: $\leq 5 \text{ mm}^*$ 4 – 6 GHz: $\leq 4 \text{ mm}^*$
Maximum zoom scan spatial resolution, normal to phantom surface	uniform grid: $\Delta z_{Zoom}(n)$	$\leq 5 \text{ mm}$	3 – 4 GHz: $\leq 4 \text{ mm}$ 4 – 5 GHz: $\leq 3 \text{ mm}$ 5 – 6 GHz: $\leq 2 \text{ mm}$
	graded grid	$\Delta z_{Zoom}(1)$: between 1 st two points closest to phantom surface	$\leq 4 \text{ mm}$
		$\Delta z_{Zoom}(n>1)$: between subsequent points	$\leq 1.5 \cdot \Delta z_{Zoom}(n-1) \text{ mm}$
Minimum zoom scan volume	x, y, z	$\geq 30 \text{ mm}$	3 – 4 GHz: $\geq 28 \text{ mm}$ 4 – 5 GHz: $\geq 25 \text{ mm}$ 5 – 6 GHz: $\geq 22 \text{ mm}$
Note: δ is the penetration depth of a plane-wave at normal incidence to the tissue medium; see IEEE Std 1528-2013 for details. * When zoom scan is required and the <i>reported</i> SAR from the <i>area scan based 1-g SAR estimation</i> procedures of KDB Publication 447498 is $\leq 1.4 \text{ W/kg}$, $\leq 8 \text{ mm}$, $\leq 7 \text{ mm}$ and $\leq 5 \text{ mm}$ zoom scan resolution may be applied, respectively, for 2 GHz to 3 GHz, 3 GHz to 4 GHz and 4 GHz to 6 GHz.			

Table 5.1 Area and Zoom Scan Resolutions per FCC KDB Publication 865664 D01v01r04*

6. DEFINITION OF REFERENCE POINTS

6.1 Ear Reference Point

Figure 6.1 shows the front, back and side views of the SAM Twin Phantom. The point “M” is the reference point for the center of the mouth, “LE” is the left ear reference point(ERP), and “RE” is the right ERP. The ERPs are 15mm posterior to the entrance to the Ear canal (EEC) along the B-M line (Back-Mouth), as shown in Figure 6.1. The plane Passing, through the two ear canals and M is defined as the Reference Plane. The line N-F (Neck- Front) is perpendicular to the reference plane and passing through the RE (or LE) is called the Reference Pivoting Line (see Figure 6.1). Line B-M is perpendicular to the N-F line. Both N-F and B-M lines are marked on the external phantom shell to facilitate handset positioning.

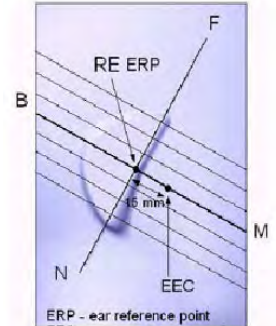

Figure 6.1
Close-up side view of ERP

6.2 Handset Reference Points

Two imaginary lines on the handset were established: the vertical centerline and the horizontal line. The test device was placed in a normal operating position with the “test device reference point” located along the “vertical centerline” on the front of the device aligned to the “ear reference point” (See Fig. 6.3). The “test device reference point” was then located at the same level as the center of the ear reference point. The test device was positioned so that the “vertical centerline” was bisecting the front surface of the handset at its top and bottom edges, positioning the “ear reference point” on the outer surface of the both the left and right head phantoms on the ear reference point.



Figure 6.2 Front, back and side view SAM Twin Phantom

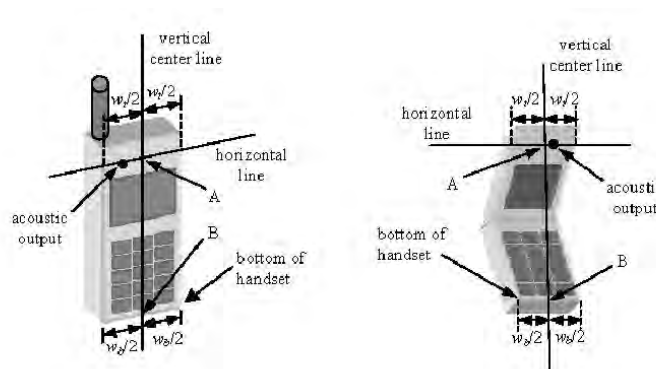

Figure 6.3 Handset Vertical Center & Horizontal Line Reference Points

7. TEST CONFIGURATION POSITIONS FOR HANDSETS

7.1 Device Holder

The device holder is made out of low-loss POM material having the following dielectric parameters: relative permittivity $\epsilon = 3$ and loss tangent $\delta = 0.02$.

7.2 Positioning for Cheek/Touch

1. The test device was positioned with the handset close to the surface of the phantom such that point A is on the (virtual) extension of the line passing through points RE and LE on the phantom (see Figure 7.1), such that the plane defined by the vertical center line and the horizontal line of the phone is approximately parallel to the sagittal plane of the phantom.



Figure 7.1 Front, Side and Top View of Cheek/Touch Position

2. The handset was translated towards the phantom along the line passing through RE & LE until the handset touches the ear.
3. While maintaining the handset in this plane, the handset was rotated around the LE-RE line until the vertical centerline was in the plane normal to MB-NF including the line MB (reference plane).
4. The phone was then rotated around the vertical centerline until the phone (horizontal line) was symmetrical with respect to the line NF.
5. While maintaining the vertical centerline in the reference plane, keeping point A on the line passing through RE and LE, and maintaining the phone contact with the ear, the handset was rotated about the line NF until any point on the handset made contact with a phantom point below the ear (cheek). (See Figure 7.2)

7.3 Positioning for Ear / 15 ° Tilt

With the test device aligned in the “Cheek/Touch Position”:

1. While maintaining the orientation of the phone, the phone was retracted parallel to the reference plane far enough to enable a rotation of the phone by 15 degree.
2. The phone was then rotated around the horizontal line by 15 degree.
3. While maintaining the orientation of the phone, the phone was moved parallel to the reference plane until any part of the phone touches the head. (In this position, point A was located on the line RE-LE). The tilted position is obtained when the contact is on the pinna. If the contact was at any location other than the pinna, the angle of the phone would then be reduced. The tilted position was obtained when any part of the phone was in contact of the ear as well as a second part of the phone was in contact with the head (see Figure 7.3).

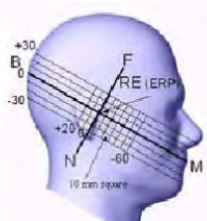

Figure 7.2 Side view w/relevant markings



Figure 7.3 Front, Side and Top View of Ear/15° Position

7.4 Body-Worn Accessory Configurations

Body-worn operating configurations are tested with the belt-clips and holsters attached to the device and positioned against a flat phantom in a normal use configuration (see Figure 7.4). Per FCC KDB Publication 648474 D04v01r03, Body-worn accessory exposure is typically related to voice mode operations when handsets are carried in body-worn accessories. The body-worn accessory procedures in FCC KDB Publication 447498 D01v06 should be used to test for body-worn accessory SAR compliance, without a headset connected to it. This enables the test results for such configuration to be compatible with that required for hotspot mode when the body-worn accessory test separation distance is greater than or equal to that required for hotspot mode, when applicable. When the reported SAR for a body-worn accessory, measured without a headset connected to the handset, is > 1.2 W/kg, the highest reported SAR configuration for that wireless mode and frequency band should be repeated for that body-worn accessory with a headset attached to the handset.

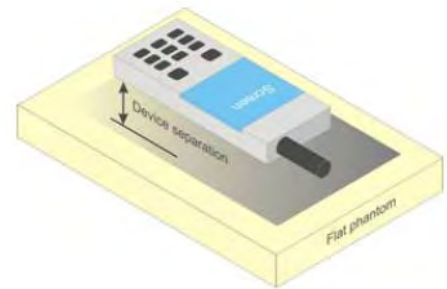

Figure 7.4 Sample Body-Worn Diagram

Accessories for Body-worn operation configurations are divided into two categories: those that do not contain metallic components and those that do contain metallic components. When multiple accessories that do not contain metallic components are supplied with the device, the device is tested with only the accessory that dictates the closest spacing to the body. Then multiple accessories that contain metallic components are tested with the device with each accessory. If multiple accessories share an identical metallic component (i.e. the same metallic belt-clip used with different holsters with no other metallic components) only the accessory that dictates the closest spacing to the body is tested.

Body-worn accessories may not always be supplied or available as options for some devices intended to be authorized for body-worn use. In this case, a test configuration with a separation distance between the back of the device and the flat phantom is used. Test position spacing was documented.

Transmitters that are designed to operate in front of a person's face, as in push-to-talk configurations, are tested for SAR compliance with the front of the device positioned to face the flat phantom in head fluid. For devices that are carried next to the body such as a shoulder, waist or chest-worn transmitters, SAR compliance is tested with the accessories, including headsets and microphones, attached to the device and positioned against a flat phantom in a normal use configuration.

7.5 Extremity Exposure Configurations

Devices that are designed or intended for use on extremities or mainly operated in extremity only exposure conditions; i.e., hands, wrists, feet and ankles, may require extremity SAR evaluation. When the device also operates in close proximity to the user's body, SAR compliance for the body is also required. The 1-g body and 10-g extremity SAR Exclusion Thresholds found in KDB Publication 447498D01v06 should be applied to determine SAR test requirements.

7.6 Wireless Router Configurations

Some battery-operated handsets have the capability to transmit and receive user data through simultaneous transmission of WIFI simultaneously with a separate licensed transmitter. The FCC has provided guidance in FCC KDB Publication 941225 D06v02r01 where SAR test considerations for handsets ($L \times W \geq 9 \text{ cm} \times 5 \text{ cm}$) are based on a composite test separation distance of 10 mm from the front, rear and edges of the device containing transmitting antennas within 2.5 cm of their edges, determined from general mixed use conditions for this type of devices. When the same wireless transmission configuration is used for testing body-worn accessory and hotspot mode SAR, respectively, in voice and data mode, SAR results for the most conservative test separation distance configuration may be used to support both SAR conditions.

When the user enables the personal wireless router functions for the handset, actual operations include simultaneous transmission of both the WIFI transmitter and another licensed transmitter. Both transmitter often do not transmit at the same transmitting frequency and thus cannot be evaluated for SAR under actual use conditions due to the limitations of the SAR assessment probes. Therefore, SAR must be evaluated for each KDB Publication 447498 D01v06 procedures. The "Portable Hotspot" feature on the handset was not activated during SAR assessment, to ensure the SAR measurements were evaluated for a single transmission frequency RF signal at a time.

8. RF EXPOSURE LIMITS

Uncontrolled Environment:

UNCONTROLLED ENVIRONMENTS are defined as locations where there is the exposure of individuals who have no knowledge or control of their exposure. The general population/uncontrolled exposure limits are applicable to situations in which the general public may be exposed or in which persons who are exposed as a consequence of their employment may not be made fully aware of the potential for exposure or cannot exercise control over their exposure. Members of the general public would come under this category when exposure is not employment-related; for example, in the case of a wireless transmitter that exposes persons in its vicinity.

Controlled Environment:

CONTROLLED ENVIRONMENTS are defined as locations where there is exposure that may be incurred by persons who are aware of the potential for exposure, (i.e. as a result of employment or occupation). In general, occupational/controlled exposure limits are employment, who have been made fully aware of the potential for exposure and can exercise control over their exposure. This exposure category is also applicable when the exposure is of a transient nature due to incidental passage through a location where the exposure levels may be higher than the general population/uncontrolled limits, but the exposed person is fully aware of the potential for exposure and can exercise control over his or her exposure by leaving the area or by some other appropriate means.

Table 8.1.SAR Human Exposure Specified in ANSI/IEEE C95.1-1992

	HUMAN EXPOSURE LIMITS	
	General Public Exposure (W/kg) or (mW/g)	Occupational Exposure (W/kg) or (mW/g)
SPATIAL PEAK SAR * (Brain)	1.60	8.00
SPATIAL AVERAGE SAR ** (Whole Body)	0.08	0.40
SPATIAL PEAK SAR *** (Hands / Feet / Ankle / Wrist)	4.00	20.0

1. The Spatial Peak value of the SAR averaged over any 1 gram of tissue (defined as a tissue volume in the shape of a cube) and over the appropriate averaging time.
2. The Spatial Average value of the SAR averaged over the whole body.
3. The Spatial Peak value of the SAR averaged over any 10 grams of tissue (defined as a tissue volume in the shape of a cube) and over the appropriate averaging time.

Uncontrolled Environments are defined as locations where there is the exposure of individuals who have no knowledge or control of their exposure.

Controlled Environments are defined as locations where there is exposure that may be incurred by persons who are aware of the potential for exposure, (i.e.as a result of employment or occupation).

9. FCC MEASUREMENT PROCEDURES

Power measurements were performed using a base station simulator under digital average power.

9.1 Measured and Reported SAR

Per FCC KDB Publication 447498 D01v06, When SAR is not measured at the maximum power level allowed for production units, the results must be scaled to the maximum tune-up tolerance limit according to the power applied to the individual channels tested to determine compliance. For simultaneous transmission, the measured aggregate SAR must be scaled according to the sum of the differences between the maximum tune-up tolerance and actual power used to test each transmitter. When SAR is measured at or scaled to the maximum tune-up tolerance limit, the results are referred to as reported SAR. The highest reported SAR results are identified on the grant of equipment authorization according to procedures in KDB 690783 D01v01r03.

9.2 Procedures Used to Establish RF Signal for SAR

The following procedures are according to FCC KDB Publication 941225 D01v03r01.

The device was placed into a simulated call using a base station simulator in a RF shielded chamber. Establishing connections in this manner ensure a consistent means for testing SAR and are recommended for evaluating SAR [4]. Devices under test were evaluated prior to testing, with a fully charged battery and were configured to operate at maximum output power. In order to verify that the device was tested throughout the SAR test at maximum output power, the SAR measurement system measures a “point SAR” at an arbitrary reference point at the start and end of the 1 gram SAR evaluation, to assess for any power drifts during the evaluation. If the power drift deviated by more than 5%, the SAR test and drift measurements were repeated.

9.3 SAR Measurement Conditions for WCDMA (UMTS)

9.3.1 Output Power Verification

Maximum output power is measured on the High, Middle and Low channels for each applicable transmission band according to the general descriptions in section 5.2 of 3GPP TS 34.121, using the appropriate RMC or AMR with TPC (transmit power control) set to all “1s”.

Maximum output power is verified on the High, Middle and Low channels according to the general, descriptions in section 5.2 of 3GPP TS 34.121 (release 5), using the appropriate RMC with TPC,(transmit power control) set to all “1s” or applying the required inner loop power control procedures to maintain maximum output power while HSUPA is active. Results for all applicable physical channel configurations (DPCCH, DPDCHn and spreading codes, HS-DPCCH etc) are tabulated in this test report. All configurations that are not supported by the DUT or cannot be measured due to technical or equipment limitations are identified.

9.3.2 Head SAR Measurements for Handsets

SAR for head exposure configurations is measured using the 12.2 kbps RMC with TPC bits configured to all “1s”. SAR in AMR configurations is not required when the maximum average output of each RF channel for 12.2 kbps AMR is less than 0.25 dB higher than that measured in 12.2 kbps RMC. Otherwise, SAR is measured on the maximum output channel in 12.2 AMR with a 3.4 kbps SRB (signaling radio bearer) using the exposure configuration that resulted in the highest SAR for that RF channel in the 12.2 kbps RMC mode.

9.3.3 Body SAR Measurements

SAR for body exposure configurations is measured using the 12.2 kbps RMC with the TPC bits all "1s".

9.3.4 Release 5 HSDPA Data Devices

The following procedures are applicable to HSDPA data devices operating under 3GPP Release 5. SAR is required for devices in body-worn accessory and other body exposure conditions, including handsets and data modems operating in various electronic devices. HSDPA operates in conjunction with WCDMA and requires an active DPCCH. The default test configuration is to measure SAR in WCDMA with HSDPA remain inactive, to establish a radio link between the test device and a communication test set using a 12.2 kbps RMC configured in Test Loop Mode 1. SAR for HSDPA is selectively measured using the highest reported SAR configuration in WCDMA, with an FRC in H-set 1 and a 12.2 kbps RMC. SAR is selectively confirmed for other physical channel configurations (DPCCH & DPDCHn) according to exposure conditions, device operating capabilities and maximum output power specified for production units, including tune-up tolerance by applying the 3G SAR test reduction procedures. Maximum output power is verified according to the applicable versions of 3GPP TS 34.121. SAR must be measured based on these maximum output conditions and requirements in KDB Publication 447498, with respect to the UE Categories, and explained in the SAR report. When Maximum Power Reduction (MPR) applies, the implementations must be clearly identified in the SAR report to support test results according to Cubic Metric (CM) and, as appropriate, Enhanced MPR (E-MPR) requirements.

Sub-test	β_c	β_d	β_d (SF)	β_c/β_d	$\beta_{hs}^{(1)}$	CM (dB) ⁽²⁾
1	2/15	15/15	64	2/15	4/15	0.0
2	12/15 ⁽³⁾	15/15 ⁽³⁾	64	12/15 ⁽³⁾	24/15	1.0
3	15/15	8/15	64	15/8	30/15	1.5
4	15/15	4/15	64	15/4	30/15	1.5

Note 1: Δ_{ACK} , Δ_{NACK} and $\Delta_{CQI} = 8 \Leftrightarrow A_{hs} = \beta_{hs}/\beta_c = 30/15 \Leftrightarrow \beta_{hs} = 30/15 * \beta_c$
 Note 2: CM = 1 for $\beta_c/\beta_d = 12/15$, $\beta_{hs}/\beta_c = 24/15$.
 Note 3: For subtest 2 the β_c/β_d ratio of 12/15 for the TFC during the measurement period (TF1, TF0) is achieved by setting the signaled gain factors for the reference TFC (TF1, TF1) to $\beta_c = 11/15$ and $\beta_d = 15/15$.

Figure 9.1 Table 1

9.3.5 Release 6 HSUPA Data Devices

The following procedures are applicable to HSPA (HSUPA/HSDPA) data devices operating under 3GPP Release 6. SAR is required for devices in body-worn accessory and other body exposure conditions, including handsets and data modems operating in various electronic devices. HSUPA operates in conjunction with WCDMA and HSDPA. SAR is initially measured in WCDMA test configurations with HSPA remain inactive. The default test configuration is to establish a radio link between the test device and a communication test set to configure a 12.2 kbps RMC in Test Loop Mode 1. SAR for HSPA is selectively measured with HS-DPCCH, E-DPCCH and E-DPDCH, all enabled, along with a 12.2 kbps RMC using the highest reported SAR configuration in WCDMA with 12.2 kbps RMC only.

An FRC is configured according to HS-DPCCH Sub-test 1 using H-set 1 and QPSK. HSPA is configured according to E-DCH Sub-test 5 requirements. SAR for other HSPA sub-test configurations is confirmed selectively according to exposure conditions, E-DCH UE Category and maximum output power of production units, including tune-up tolerance by applying the 3G SAR test reduction procedure. Maximum output power is verified according to procedures in applicable versions of 3GPP TS 34.121. SAR must be measured based on these maximum output conditions and requirements in KDB Publication 447498, with respect to the UE Categories for HS-DPCCH and HSPA, and explained in the SAR report. When Maximum Power Reduction (MPR) applies, the implementations must be clearly identified in the SAR report to support test results according to Cubic Metric (CM) and, as appropriate, Enhanced MPR (E-MPR) requirements.

Sub-test	β_c	β_d	β_a (SF)	β_c/β_d	$\beta_{hs}^{(1)}$	β_{ec}	β_{ed}	β_{ed} (SF)	β_{ed} (codes)	CM ⁽²⁾ (dB)	MPR (dB)	AG ⁽⁴⁾ Index	E-TFCl
1	11/15 ⁽³⁾	15/15 ⁽³⁾	64	11/15 ⁽³⁾	22/15	209/225	1039/225	4	1	1.0	0.0	20	75
2	6/15	15/15	64	6/15	12/15	12/15	94/75	4	1	3.0	2.0	12	67
3	15/15	9/15	64	15/9	30/15	30/15	$\beta_{ed}: 47/15$ $\beta_{ed}: 47/15$	4	2	2.0	1.0	15	92
4	2/15	15/15	64	2/15	4/15	2/15	56/75	4	1	3.0	2.0	17	71
5	15/15 ⁽⁴⁾	15/15 ⁽⁴⁾	64	15/15 ⁽⁴⁾	30/15	24/15	134/15	4	1	1.0	0.0	21	81

Note 1: Δ_{ACK} , Δ_{NACK} and $\Delta_{CQI} = 8 \Leftrightarrow A_{hs} = \beta_{hs}/\beta_c = 30/15 \Leftrightarrow \beta_{hs} = 30/15 * \beta_c$.
 Note 2: CM = 1 for $\beta_c/\beta_d = 12/15$, $\beta_{hs}/\beta_c = 24/15$. For all other combinations of DPDCH, DPCCCH, HS-DPCCH, E-DPDCH and E-DPCCH the MPR is based on the relative CM difference.
 Note 3: For subtest 1 the β_c/β_d ratio of 11/15 for the TFC during the measurement period (TF1, TF0) is achieved by setting the signaled gain factors for the reference TFC (TF1, TF1) to $\beta_c = 10/15$ and $\beta_d = 15/15$.
 Note 4: For subtest 5 the β_c/β_d ratio of 15/15 for the TFC during the measurement period (TF1, TF0) is achieved by setting the signaled gain factors for the reference TFC (TF1, TF1) to $\beta_c = 14/15$ and $\beta_d = 15/15$.
 Note 5: Testing UE using E-DPDCH Physical Layer category 1 Sub-test 3 is not required according to TS 25.306 Table 5.1g.
 Note 6: β_{ed} cannot be set directly; it is set by Absolute Grant Value.

Figure 9.2 Table 2

9.3.6 SAR Measurement Conditions for DC-HSDPA

In the following DB 941225 D01v03r01 procedures, the mode tested for SAR is referred to as the primary mode. The equivalent modes considered for SAR test reduction are denoted as secondary modes. Both primary and secondary modes must be in the same frequency band. When the maximum output power and tune-up tolerance specified for production units in a secondary mode is $\leq 1/4$ dB higher than the primary mode or when the highest reported SAR of the primary mode is scaled by the ratio of specified maximum output power and tune-up tolerance of secondary to primary mode and the adjusted SAR is ≤ 1.2 W/kg, SAR measurement is not required for the secondary mode. This is referred to as the 3G SAR test reduction procedure in the following SAR test guidance, where the primary mode is identified in the applicable wireless mode test procedures and the secondary mode is wireless mode being considered for SAR test reduction by that procedure. When the 3G SAR test reduction procedure is not satisfied, it is identified as “otherwise” in the applicable procedures; SAR measurement is required for the secondary mode.

SAR is required for Rel. 8 DC-HSDPA when SAR is required for Rel. 5 HSDPA; otherwise, the 3G SAR test reduction procedure is applied to DC-HSDPA with 12.2 kbps RMC as the primary mode. Power is measured for DC-HSDPA according to the H-Set 12, FRC configuration in Table C.8.1.12 of 3GPP TS 34.121-1 to determine SAR test reduction. A primary and a secondary serving HS-DSCH Cell are required to perform the power measurement and for the results to be acceptable.

9.4 SAR Measurement Conditions for LTE

LTE modes were tested according to FCC KDB 941225 D05v02r05 publication. Please see notes after the tabulated SAR data for required test configurations. Establishing connections with base station simulators ensure a consistent means for testing SAR and are recommended for evaluating SAR. The R&S CMW500 was used for LTE output power measurement and SAR testing. Closed loop power control was used so the UE transmits with maximum output power during SAR testing. SAR tests were performed with the same number of RB and RB offsets transmitting on all TTI frames (maximum TTI).

9.4.1 Spectrum Plots for RB Configurations

A properly configured base station simulator was used for SAR tests and power measurements. Therefore, spectrum plots for RB configurations were not required to be included in this report.

9.4.2 MPR

MPR is permanently implemented for this device by the manufacturer. The specific manufacturer target MPR is indicated alongside the SAR results. MPR is enabled for this device, according to 3GPP TS36. 101 Section 6.2.3 – 6.2.5 under Table 6.2.3-1.

9.4.3 A-MPR

A-MPR (Addition MPR) has been disabled for all SAR tests by setting NS=01 on the base station simulator.

9.4.4 Required RB Size and RB Offsets for SAR Testing

According to FCC KDB 941225 D05v02r05:

- a. Per Section 5.2.1, SAR is required for QPSK 1 RB Allocation for the largest bandwidth
 - i. The required channel and offset combination with the highest maximum output power is required for SAR.
 - ii. When the reported SAR is ≤ 0.8 W/kg, testing of the remaining RB offset configurations and required test channel is not required. Otherwise, SAR is required for the remaining required test channels using the RB offset configuration with highest output power for that channel.
 - iii. When the reported SAR for a required test channel is > 1.45 W/kg, SAR is required for all RB offset configurations for that channel.
- b. Per Section 5.2.2, SAR is required for 50% RB allocation using the largest bandwidth following the same procedures outlined in Section 5.2.1.
- c. Per Section 5.2.3, QPSK SAR is not required for the 100% allocation when the highest maximum output power for the 100% allocation is less than the highest maximum output power of the 1 RB and 50% RB allocations and the reported SAR for the 1 RB and 50% RB allocations is < 0.8 W/kg. Otherwise, SAR is measured for the highest output power channel; and if the reported SAR is > 1.45 W/kg, the remaining required test channels must also be tested.
- d. Per Section 5.2.4 and 5.3, SAR tests for higher order modulations and lower bandwidths configurations are not required when the conducted power of the required test configurations determined by Sections 5.2.1 through 5.2.3 is less than or equal to 0.5 dB higher than the equivalent configuration using QPSK modulation and when the QPSK SAR for those configurations is < 1.45 W/kg.

9.4.5 Downlink Only Carrier Aggregation

Conducted power measurements with LTE Carrier Aggregation (CA) (downlink only) active are made in accordance to KDB Publication 941225 D05Av01r02 and Fall 2017 TCB Workshop notes (LTE Carrier Aggregation). The RCC connection is only handled by one cell, the primary component carrier (PCC) for downlink and uplink communications. After making a data connection to the PCC, the UE device adds secondary component carrier(s) (SCC) on the downlink only. All uplink communications and acknowledgements remain identical to specifications when downlink carrier aggregation is inactive on the PCC. For every supported combination of downlink only carrier aggregation, additional conducted output powers are measured with the downlink carrier aggregation active for configuration with highest measured maximum conducted power with downlink carrier aggregation inactive measured among the channel bandwidth, modulation, and RB combinations in each frequency band. Per FCC KDB Publication 941225 D05Av01r02, no SAR measurements are required for carrier aggregation configurations when the average output power with downlink only carrier aggregation active is not more than 0.25 dB higher than the average output power with downlink only carrier aggregation inactive.

9.4.5.1 Fall 2017 TCB Workshop notes (LTE Carrier Aggregation)

DL CA Inter-Band Exclusion

- 1) SAR test exclusion for inter-band DL CA is determined by power measurements according to the number of frequency bands and component carriers (CCs) supported by the product implementation
- 2) When the DL CA configurations are tabulated in separate columns
 - i) For example, CA_2A-5A (0), CA_2A-2A-5A (0), CA_2A-2A-5A-30A (0) and CA_2A-4A-5A-30A (0) would be listed in the columns corresponding to 2 bands/2 CCs, 2 bands/3 CCs, 3 bands/4CCs and 4 bands/4 CCs: and
 - ii) The CA/CC combinations in each columns are sorted so that frequency bands listed in subsequent columns on each row are ascending subsets, as illustrated below; i.e., columns to the right correspond to increasing number of frequency bands and CCs

2 bands / 2 CC	2 bands / 3 CC	3 bands / 4 CC	4 bands / 4 CC
CA_2A-5A (0)	CA_2A-2A-5A (0)	CA_2A-2A-5A-30A (0)	CA_2A-4A-5A-30A (0)
	CA_2A-2A-12A (0)	CA_2A-2A-12A-30A (0)	CA_2A-4A-12A-30A (0)
CA_4A-12B(0)		XXXXXX	
	XXXXX		XXXXX
XXXXX			XXXXX
Fill in the XXXXX according to configurations supported by the product			

- 3) In applying the existing power measurement procedures of KDB 941225 D05A for DL CA SAR test exclusion
 - i) Only the subset with the largest number of combinations of frequency bands and CCs in each row need consideration; i.e., the right most configuration
- 4) When a power measurement configuration does not qualify for SAR test exclusion, power is measured for the previous lower order combination (next left column) for the remaining lower order subsets in the row to qualify for SAR test exclusion and to limit the number of SAR tests
- 5) The configurations require power measurements should be highlighted in reports

DL CA Intra-Band Exclusion

- 1) For intra-band DL CA, contiguous and non-contiguous CA are considered separately by tabulating these in separate columns
 - i) all CA configurations for the same frequency band are grouped together in adjacent rows in each column; for example,
 - ii) CA_41A-41A (0)(1) ... CA_41A-41C (0) for non-contiguous CCs
 - iii) CA_7B (0) ... CA_7C(0)(1)(2) for contiguous CCs
- 2) In applying the power measurement procedures of KDB 941225 D05A for DL CA SAR test exclusion
 - i) Only the CA configuration with the largest aggregated DL CA bandwidth in each frequency band group need consideration
 - a) independently for contiguous and non-contiguous CA
 - ii) When the same frequency band is used for both contiguous and non-contiguous CA, power may be measured using the configuration with the largest aggregated bandwidth “and” maximum output power among the contiguous and non-contiguous CA configurations
 - a) otherwise, these are considered separately
- 8) The existing procedures in KDB 941225 D05A are applied
 - i) For contiguous CA to position additional CCs adjacent to the PCC
 - a) alternatively on either side of the PCC and already added CCs, within the frequency band and
 - b) within the transmission band for channels at the ends of a frequency band
 - ii) for non-contiguous CA to use the largest allowed channel separation to distribute the CCs evenly across the frequency band
- 9) DL PCC channel is determined by the UL channel and UL/DL pairing requirements for FDD
- 10) DL SCC and subsequent CCs should be configured using the channel bandwidth and RB configurations closest to that used for the DL PCC
- 11) When a power measurement configuration does not qualify for SAR test exclusion, power is measured for the next largest aggregated bandwidth to qualify for SAR test exclusion and to limit the number of SAR tests
- 12) The configurations that require power measurements should be highlighted in test reports

9.5 SAR Testing with 802.11 Transmitters

The normal network operating configurations are not suitable for measuring the SAR of 802.11 b/g/n transmitters. Unpredictable fluctuations in network traffic and antenna diversity conditions can introduce undesirable variations in SAR results. The SAR for these devices should be measured using chipset based test mode software to ensure the results are consistent and reliable. See KDB Publication 248227D01v02r02 for more details.

9.5.1 General Device Setup

Chipset based test mode software is hardware dependent and generally varies among manufacturers. The device operating parameters established in test mode for SAR measurements must be identical to those programmed in production units, including output power levels, amplifier gain settings and other RF performance tuning parameters. The test frequencies should correspond to actual channel frequencies defined for domestic use. SAR for devices with switched diversity should be measured with only one antenna transmitting at a time during each SAR measurement, according to a fixed modulation and data rate. The same data pattern should be used for all measurements.

A periodic duty factor is required for current generation SAR systems to measure SAR. When 802.11 frame gaps are accounted for in the transmission, a maximum transmission duty factor of 92-96% is typically achievable in most test mode configurations. A minimum transmission duty factor of 85% is required to avoid certain hardware and device implementation issues related to wide range SAR scaling. The reported SAR is scaled to 100% transmission duty factor to determine compliance at the maximum tune-up tolerance limit.

9.5.2 Initial Test Position Procedure

For exposure conditions with multiple test positions, such as handset operating next to the ear, devices with hotspot mode or UMPC mini-tablet, procedures for initial test position can be applied. Using the transmission mode determined by the DSSS procedure or initial test configuration, area scans are measured for all position in an exposure condition. The test position with the highest extrapolated (peak) SAR is used as the initial test position. When reported SAR for the initial test position is ≤ 0.4 W/kg, no additional testing for the remaining test positions is required. Otherwise, SAR is evaluated at the subsequent highest peak SAR position until the reported SAR result is ≤ 0.8 W/kg or all test position are measured.

9.5.3 2.4 GHz SAR Test Requirements

SAR is measured for 2.4 GHz 802.11b DSSS using either a fixed test position or, when applicable, the initial test position procedure. SAR test reduction is determined according to the following:

- 1) When the reported SAR of the highest measured maximum output power channel for the exposure configuration is ≤ 0.8 W/kg, no further SAR testing is required for 802.11b DSSS in that exposure configuration.
- 2) When the reported SAR is > 0.8 W/kg, SAR is required for that exposure configuration using the next highest measured output power channel. When any reported SAR is > 1.2 W/kg, SAR is required for the third channel; i.e., all channels require testing.

2.4 GHz 802.11 g/n OFDM are additionally evaluated for SAR if the highest reported SAR for 802.11b, adjusted by the ratio of the OFDM to DSSS specified maximum output power is > 1.2 W/kg. When SAR is required for OFDM modes in 2.4 GHz band, the Initial Test Configuration Procedures should be followed.

9.5.4 OFDM Transmission Mode and SAR Test Channel Selection

For the 2.4 GHz bands, when the same maximum output power was specified for multiple OFDM transmission mode configurations in a frequency band or aggregated band, SAR is measured using the configuration with the largest channel bandwidth, lowest order modulation and lowest data rate. When the maximum output power of a channel is the same for equivalent OFDM configurations; for example, 802.11g and 802.11n with the same channel bandwidth, modulation and data rate etc., the lower order 802.11 mode i.e., 802.11g then 802.11n is used for SAR measurement. When the maximum output power were the same for multiple test channels, either according to the default or additional power measurement requirements, SAR is measured using the channel closest to the middle of the frequency band or aggregated band. When there are multiple channels with the same maximum output power, SAR is measured using the higher number channel.

9.5.5 Initial Test Configuration Procedure

For OFDM, in both 2.4 bands, an initial test configuration is determined for each frequency band and aggregated band, according to the transmission mode with the highest maximum output power specified for SAR measurements. When the same maximum output is specified for multiple OFDM transmission mode configurations in a frequency band or aggregated band, SAR is measured using the configuration(s) with the largest channel bandwidth, lowest order modulation, and lowest data rate. The channel of the transmission mode with the highest average RF output conducted power will be the initial test configuration.

When the reported SAR is ≤ 0.8 W/kg, no additional measurements on other test channels are required.

Otherwise, SAR is evaluated using the subsequent highest average RF output channel until the reported SAR result is ≤ 1.2 W/kg or all channels are measured.

10. RF CONDUCTED POWERS

This device operates using the following maximum and nominal output power specifications. SAR values were scaled to the maximum allowed power to determine compliance per KDB Publication 447498 D01v06

10.1 GSM Nominal and Maximum Output Power Spec and Conducted Powers

Band & Mode		Voice[dBm]	Burst Average GMSK [dBm]				Burst Average GMSK [dBm]			
		1 TX Slot	1 TX Slot	2 TX Slot	3 TX Slot	4 TX Slot	1 TX Slot	2 TX Slot	3 TX Slot	4 TX Slot
GSM/GPRS/EDGE 850	Maximum	33.7	33.7	32.7	30.7	29.7	27.2	26.2	24.2	22.7
	Nominal	33.2	33.2	32.2	30.2	29.2	26.7	25.7	23.7	22.2
GSM/GPRS/EDGE 1900	Maximum	30.7	30.7	29.7	27.7	26.7	26.2	24.7	22.7	21.7
	Nominal	30.2	30.2	29.2	27.2	26.2	25.7	24.2	22.2	21.2

Table 10.1.1 GSM Nominal and Maximum Output Power Spec

Band	Channel	Maximum Burst-Averaged Output Power(dBm)								
		Voice	GPRS/EDGE Data (GMSK)				EDGE Data (8-PSK)			
		GSM CS 1 Slot	GPRS 1 TX Slot	GPRS 2 TX Slot	GPRS 3 TX Slot	GPRS 4 TX Slot	EDGE 1 TX Slot	EDGE 2 TX Slot	EDGE 3 TX Slot	EDGE 4 TX Slot
GSM850	128	33.57	33.58	32.68	30.61	29.68	27.19	26.18	24.18	22.68
	190	33.50	33.54	32.65	30.64	29.64	27.17	26.19	24.16	22.69
	251	33.39	33.38	32.59	30.45	29.60	27.13	26.17	24.15	22.65
PCS 1900	512	30.63	30.64	29.66	27.60	26.69	26.18	24.15	22.13	21.18
	661	30.41	30.42	29.53	27.44	26.68	26.17	24.12	22.11	21.15
	810	30.34	30.35	29.46	27.35	26.57	26.11	24.14	22.16	21.19
Band	Channel	Calculated Maximum Frame-Averaged Output Power(dBm)								
		Voice	GPRS/EDGE Data (GMSK)				EDGE Data (8-PSK)			
		GSM CS 1 Slot	GPRS 1 TX Slot	GPRS 2 TX Slot	GPRS 3 TX Slot	GPRS 4 TX Slot	EDGE 1 TX Slot	EDGE 2 TX Slot	EDGE 3 TX Slot	EDGE 4 TX Slot
GSM850	128	24.54	24.55	26.66	26.35	26.67	18.16	20.16	19.92	19.67
	190	24.47	24.51	26.63	26.38	26.63	18.14	20.17	19.90	19.68
	251	24.36	24.35	26.57	26.19	26.59	18.10	20.15	19.89	19.64
PCS 1900	512	21.60	21.61	23.64	23.34	23.68	17.15	18.13	17.87	18.17
	661	21.38	21.39	23.51	23.18	23.67	17.14	18.10	17.85	18.14
	810	21.31	21.32	23.44	23.09	23.56	17.08	18.12	17.90	18.18
GSM850	Frame Avg. Targets:	24.17	24.17	26.18	25.94	26.19	17.67	19.68	19.44	19.19
PCS 1900		21.17	21.17	23.18	22.94	23.19	16.67	18.18	17.94	18.19

Table 10.1.2 GSM Conducted Power

Note:

- Both burst-averaged and calculated frame-averaged powers are included. Frame-averaged power was calculated from the measured burst-averaged power by converting the slot powers into linear units and calculating the energy over 8 timeslots.
- GPRS (GMSK) output powers were measured with coding scheme setting of 1 (CS1) on the base station simulator. CS1 was configured to measure GPRS output power measurements and SAR to ensure GMSK modulation in the signal. Our Investigation has shown that CS1 - CS4 settings do not have any impact on the output levels or modulation in the GPRS modes.
- EDGE (8-PSK) output powers were measured with MCS7 on the base station simulator. MCS7 coding scheme was used to measure the output powers for EDGE since investigation has shown that choosing MCS7 coding scheme will ensure 8-PSK modulation. It has been shown that MCS levels that produce 8PSK modulation do not have an impact on output power.

GPRS Multislot class: 12 (max 4 TX Uplink slots)
EDGE Multislot class: 12 (max 4 TX Uplink slots)
DTM Multislot Class: N/A

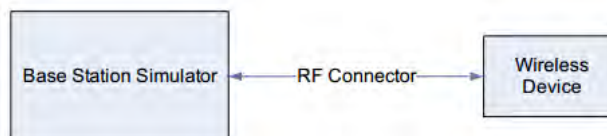

Figure 10.1 Power Measurement Setup

10.2 WCDMA Nominal and Maximum Output Power Spec and Conducted Powers

Band & Mode		Modulated Average [dBm]			
		3GPP WCDMA (Rel.99)	3GPP HSDPA	3GPP HSUPA	3GPP DC-HSDPA
WCDMA 850 (Cell)	Maximum	25.2			
	Nominal	24.7			
WCDMA 1700 (AWS)	Maximum	24.2			
	Nominal	23.7			
WCDMA 1900 (PCS)	Maximum	24.2			
	Nominal	23.7			

Table 10.2.1 WCDMA Nominal and Maximum Output Power Spec

3GPP Release Version	Mode	3GPP 34.121 Subtest	Cellular Band (dBm)			AWS Band (dBm)			PCS Band (dBm)			3GPP MPR (dB)
			4132	4183	4233	1312	1412	1513	9262	9400	9538	
99	WCDMA	12.2 kbps RMC	25.05	25.07	25.19	23.03	23.14	23.13	23.38	23.23	23.29	-
99		12.2 kbps AMR	25.07	25.14	25.14	22.92	23.09	23.06	23.34	23.16	23.28	-
5	HSDPA	Subtest 1	24.09	24.13	24.14	22.21	22.36	22.35	22.33	22.23	22.30	0
5		Subtest 2	24.05	24.10	24.13	22.23	22.25	22.30	22.28	22.21	22.25	0
5		Subtest 3	23.57	23.63	23.70	21.73	21.86	21.84	21.87	21.73	21.79	0.5
5		Subtest 4	23.55	23.58	23.67	21.75	21.78	21.83	21.84	21.71	21.78	0.5
6	HSUPA	Subtest 1	23.23	23.21	23.25	22.24	22.42	22.27	22.39	22.21	22.33	0
6		Subtest 2	22.08	22.13	22.19	20.98	21.07	21.15	21.34	21.18	21.27	2
6		Subtest 3	23.14	23.14	23.21	21.94	22.09	22.12	22.30	22.18	22.25	1
6		Subtest 4	21.59	21.66	21.72	20.58	20.68	20.59	20.84	20.72	20.81	2
6		Subtest 5	23.23	23.21	23.26	22.21	22.35	22.25	22.37	22.24	22.24	0
8	DC-HSDPA	Subtest 1	24.02	24.06	24.10	23.26	23.32	23.25	22.73	22.77	22.75	0
8		Subtest 2	24.01	24.05	24.06	23.23	23.33	23.30	22.74	22.71	22.73	0
8		Subtest 3	23.48	23.59	23.64	22.83	22.94	22.75	22.24	22.27	22.28	0.5
8		Subtest 4	23.50	23.53	23.65	22.74	22.81	22.78	22.27	22.28	22.27	0.5

Table 10.2.2 WCDMA Conducted Power

WCDMA SAR was tested under RMC 12.2 kbps with HSPA Inactive per KDB Publication 941225 D01v03r01. HSPA SAR was not required since the average output power of the HSPA subtests was not more than 0.25 dB higher than the RMC level and SAR was less than 1.2 W/kg.

The manufacturer declares that the HSDPA, HSUPA and DC-HSDPA transmitter's power will not exceed the R99 maximum transmit power in devices based on Mediatek's HSPA chipset solutions.

DC-HSDPA considerations

- 3GPP Specification 34.121-1 Release 8 Ver 8.10.0 was used for DC-HSDPA guidance.
- H-Set 12 (QPSK) was confirmed to be used during DC-HSDPA measurements.
- The DUT supports UE category 24 for HSDPA.

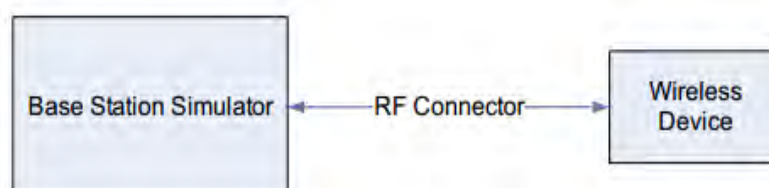

Figure 10.2 Power Measurement Setup

10.3 LTE Nominal and Maximum Output Power Spec and Conducted Powers

Band & Mode	Modulated Average[dBm]	
LTE Band 12	Maximum	25.2
	Nominal	24.7

Table 10.3.1 Nominal and Maximum Output Power Spec

1) LTE Band 12

LTE Band 12 Conducted Power– 10 MHz Bandwidth					
Modulation	RB Size	RB Offset	Mid Channel	MPR Allowed Per 3GPP(dB)	MPR (dB)
			23095 (707.5 MHz)		
			Conducted Power (dBm)		
QPSK	1	0	24.86	0	0
	1	25	24.83		
	1	49	24.89		
	25	0	23.81	0-1	1
	25	12	23.94		
	25	25	23.83		
50	0	23.82	0-1	1	
16QAM	1	0	24.05	0-1	1
	1	25	24.00		
	1	49	24.01		
	25	0	22.84	0-2	2
	25	12	22.95		
	25	25	22.80		
	50	0	22.85		

Table 10.3.2 LTE Conducted Power

Note 1: LTE Band 12 at 10 MHz bandwidth does not support three non-overlapping channels.

Per KDB 941225 D05v02r05, when a device supports overlapping channel assignment in a channel bandwidth configuration, the middle channel of the group of overlapping channels should be selected for testing.

LTE Band 12 Conducted Power– 5 MHz Bandwidth							
Modulation	RB Size	RB Offset	Low Channel	Mid Channel	High Channel	MPR Allowed Per 3GPP(dB)	MPR (dB)
			23035 (701.5 MHz)	23095 (707.5 MHz)	23155 (713.5 MHz)		
			Conducted Power (dBm)				
QPSK	1	0	24.98	24.88	24.91	0	0
	1	12	24.96	24.75	24.99		
	1	24	24.93	24.97	25.05		
	12	0	23.89	23.83	23.85	0-1	1
	12	6	23.94	23.77	23.96		
	12	13	24.00	23.84	23.92		
	25	0	23.99	23.86	23.94	0-1	1
16QAM	1	0	24.13	24.00	24.08	0-1	1
	1	12	24.16	23.86	24.09		
	1	24	24.08	24.12	23.97		
	12	0	22.95	22.85	22.90	0-2	2
	12	6	23.01	22.81	22.99		
	12	13	23.07	22.88	22.97		
	25	0	22.99	22.85	22.93		

Table 10.3.3 LTE Conducted Power

LTE Band 12 Conducted Power– 3 MHz Bandwidth							
Modulation	RB Size	RB Offset	Low Channel	Mid Channel	High Channel	MPR Allowed Per 3GPP(dB)	MPR (dB)
			23025 (700.5 MHz)	23095 (707.5 MHz)	23165 (714.5 MHz)		
			Conducted Power (dBm)				
QPSK	1	0	25.07	24.93	25.02	0	0
	1	7	24.97	24.75	24.95		
	1	14	25.03	24.97	25.11		
	8	0	24.04	23.84	24.02	0-1	1
	8	4	24.00	23.80	24.01		
	8	7	24.03	23.85	24.03		
		15	0	24.05	23.87	24.03	0-1
16QAM	1	0	24.18	24.00	24.14	0-1	1
	1	7	24.15	23.84	23.99		
	1	14	24.18	24.05	23.99		
	8	0	23.11	22.87	23.07	0-2	2
	8	4	23.11	22.87	23.03		
	8	7	23.09	22.90	23.01		
		15	0	23.09	22.91	23.05	0-2

Table 10.3.4 LTE Conducted Power

LTE Band 12 Conducted Power– 1.4 MHz Bandwidth							
Modulation	RB Size	RB Offset	Low Channel	Mid Channel	High Channel	MPR Allowed Per 3GPP(dB)	MPR (dB)
			23017 (699.7 MHz)	23095 (707.5 MHz)	23173 (715.3 MHz)		
			Conducted Power (dBm)				
QPSK	1	0	24.96	24.72	24.90	0	0
	1	2	24.92	24.70	24.91		
	1	5	24.96	24.75	24.99		
	3	0	25.04	24.78	25.02	0	0
	3	2	25.00	24.74	25.01		
	3	3	25.04	24.81	25.06		
		6	0	24.01	23.76	23.99	0-1
16QAM	1	0	24.14	23.87	24.00	0-1	1
	1	2	24.12	23.80	23.96		
	1	5	24.15	23.91	23.97		
	3	0	24.11	23.82	24.00	0-1	1
	3	2	24.17	23.89	24.06		
	3	3	24.15	23.88	24.03		
		6	0	23.11	22.85	23.04	0-2

Table 10.3.5 LTE Conducted Power

Band & Mode		Modulated Average[dBm]
LTE Band 5	Maximum	25.2
	Nominal	24.7

Table 10.3.6 Nominal and Maximum Output Power Spec

2) LTE Band 5 (Cell)

LTE Band 5 (Cell) Conducted Power– 10 MHz Bandwidth					
Modulation	RB Size	RB Offset	Mid Channel	MPR Allowed Per 3GPP(dB)	MPR (dB)
			20525 (836.5 MHz)		
			Conducted Power (dBm)		
QPSK	1	0	24.84	0	0
	1	25	24.81		
	1	49	25.07		
	25	0	23.83	0-1	1
	25	12	23.83		
	25	25	23.84		
50	0	23.87	0-1	1	
16QAM	1	0	24.03	0-1	1
	1	25	23.94		
	1	49	24.15		
	25	0	22.82	0-2	2
	25	12	22.79		
	25	25	22.80		
	50	0	22.82	0-2	2

Table 10.3.7 LTE Conducted Power

Note: LTE Band 5(Cell) at 10 MHz bandwidth does not support three non-overlapping channels.

Per KDB 941225 D05v02r05, when a device supports overlapping channel assignment in a channel bandwidth configuration, the middle channel of the group of overlapping channels should be selected for testing.

LTE Band 5 (Cell) Conducted Power– 5 MHz Bandwidth							
Modulation	RB Size	RB Offset	Low Channel	Mid Channel	High Channel	MPR Allowed Per 3GPP(dB)	MPR (dB)
			20425 (826.5 MHz)	20525 (836.5 MHz)	20625 (846.5 MHz)		
			Conducted Power (dBm)				
QPSK	1	0	24.91	24.81	24.96	0	0
	1	12	24.86	24.76	24.93		
	1	24	24.88	24.92	24.99		
	12	0	23.83	23.77	23.93	0-1	1
	12	6	23.85	23.75	23.91		
	12	13	23.86	23.78	23.88		
25	0	23.88	23.81	23.96	0-1	1	
16QAM	1	0	24.11	24.01	24.14	0-1	1
	1	12	24.04	23.94	24.11		
	1	24	24.07	24.03	24.07		
	12	0	22.86	22.75	22.93	0-2	2
	12	6	22.90	22.77	22.93		
	12	13	22.92	22.78	22.90		
	25	0	22.87	22.76	22.91	0-2	2

Table 10.3.8 LTE Conducted Power

LTE Band 5 (Cell) Conducted Power- 3 MHz Bandwidth							
Modulation	RB Size	RB Offset	Low Channel	Mid Channel	High Channel	MPR Allowed Per 3GPP(dB)	MPR (dB)
			20415 (825.5 MHz)	20525 (836.5 MHz)	20635 (847.5 MHz)		
			Conducted Power (dBm)				
QPSK	1	0	25.01	24.87	25.02	0	0
	1	7	24.89	24.78	24.96		
	1	14	24.94	24.93	25.06		
	8	0	23.97	23.83	24.02	0-1	1
	8	4	23.91	23.79	23.97		
	8	7	23.91	23.82	24.00		
16QAM	15	0	23.95	23.86	24.02	0-1	1
	1	0	24.15	24.04	24.13		
	1	7	24.08	23.93	24.09		
	1	14	24.14	24.00	24.09	0-2	2
	8	0	22.99	22.83	23.01		
	8	4	22.97	22.83	23.00		
	8	7	22.95	22.84	22.98	0-2	2
	15	0	22.97	22.86	23.02		

Table 10.3.9 LTE Conducted Power

LTE Band 5 (Cell) Conducted Power- 1.4 MHz Bandwidth							
Modulation	RB Size	RB Offset	Low Channel	Mid Channel	High Channel	MPR Allowed Per 3GPP(dB)	MPR (dB)
			20407 (824.7 MHz)	20525 (836.5 MHz)	20643 (848.3 MHz)		
			Conducted Power (dBm)				
QPSK	1	0	25.06	24.90	25.05	0	0
	1	2	24.95	24.77	24.95		
	1	5	24.98	24.85	25.00		
	3	0	25.00	24.90	25.06	0	0
	3	2	24.99	24.86	25.03		
	3	3	25.04	24.89	25.03		
16QAM	6	0	24.00	23.87	24.03	0-1	1
	1	0	24.18	23.98	24.07		
	1	2	24.13	23.94	24.04		
	1	5	24.17	23.99	24.09	0-1	1
	3	0	24.06	23.88	24.01		
	3	2	24.09	23.94	24.05		
	3	3	24.07	23.93	24.04	0-2	2
	6	0	23.00	22.83	23.01		

Table 10.3.10 LTE Conducted Power

Band & Mode	Modulated Average[dBm]	
	LTE Band 66	Maximum
	Nominal	23.7

Table 10.3.11 Nominal and Maximum Output Power Spec

3) LTE Band 66

LTE Band 66 (AWS) Conducted Power– 20 MHz Bandwidth							
Modulation	RB Size	RB Offset	Low Channel	Mid Channel	High Channel	MPR Allowed Per 3GPP(dB)	MPR (dB)
			132072 (1720.0 MHz)	132322 (1745.0 MHz)	132572 (1770.0 MHz)		
			Conducted Power (dBm)				
QPSK	1	0	24.14	24.13	24.15	0	0
	1	50	23.74	24.08	24.10		
	1	99	24.15	24.14	24.16		
	50	0	23.08	23.16	23.17	0-1	1
	50	25	22.86	23.12	23.13		
	50	50	23.07	23.15	23.16		
100	0	22.96	23.14	23.15	0-1	1	
16QAM	1	0	23.19	23.12	23.10	0-1	1
	1	50	22.74	22.97	23.02		
	1	99	22.99	23.18	23.04		
	50	0	21.90	22.19	22.18	0-2	2
	50	25	21.98	22.13	22.17		
	50	50	21.90	22.18	22.06		
100	0	21.92	22.11	22.13	0-2	2	

Table 10.3.12 LTE Conducted Power

LTE Band 66 (AWS) Conducted Power– 15 MHz Bandwidth							
Modulation	RB Size	RB Offset	Low Channel	Mid Channel	High Channel	MPR Allowed Per 3GPP(dB)	MPR (dB)
			132047 (1717.5 MHz)	132322 (1745.0 MHz)	132597 (1772.5 MHz)		
			Conducted Power (dBm)				
QPSK	1	0	23.95	23.79	24.08	0	0
	1	36	23.73	23.73	23.84		
	1	74	23.79	23.85	23.98		
	36	0	22.78	22.90	23.19	0-1	1
	36	18	22.70	22.89	23.08		
	36	37	22.73	22.98	23.04		
75	0	22.74	23.00	23.13	0-1	1	
16QAM	1	0	23.10	22.98	23.17	0-1	1
	1	36	22.72	22.86	22.93		
	1	74	22.81	23.02	22.97		
	36	0	21.95	22.05	22.14	0-2	2
	36	18	21.85	22.08	22.11		
	36	37	21.89	22.13	22.06		
75	0	21.86	22.12	22.15	0-2	2	

Table 10.3.13 LTE Conducted Power

LTE Band 66 (AWS) Conducted Power– 10 MHz Bandwidth							
Modulation	RB Size	RB Offset	Low Channel	Mid Channel	High Channel	MPR Allowed Per 3GPP(dB)	MPR (dB)
			132022 (1715.0 MHz)	132322 (1745.0 MHz)	132622 (1775.0 MHz)		
			Conducted Power (dBm)				
QPSK	1	0	24.11	23.95	24.08	0	0
	1	25	23.76	23.88	23.92		
	1	49	23.71	23.96	23.96		
	25	0	22.89	23.04	23.12	0-1	1
	25	12	22.80	23.02	22.96		
	25	25	22.87	23.02	22.89		
50	0	22.92	23.05	23.05	0-1	1	
16QAM	1	0	23.13	22.93	23.07	0-1	1
	1	25	22.71	22.91	22.87		
	1	49	22.74	23.03	22.92		
	25	0	21.94	22.09	22.18	0-2	2
	25	12	21.87	22.08	22.09		
	25	25	21.92	22.08	22.03		
50	0	21.94	22.09	22.12	0-2	2	

Table 10.3.14 LTE Conducted Power

LTE Band 66 (AWS) Conducted Power– 5 MHz Bandwidth							
Modulation	RB Size	RB Offset	Low Channel	Mid Channel	High Channel	MPR Allowed Per 3GPP(dB)	MPR (dB)
			131997 (1712.5 MHz)	132322 (1745.0 MHz)	132647 (1777.5 MHz)		
			Conducted Power (dBm)				
QPSK	1	0	23.99	24.02	23.93	0	0
	1	12	23.79	23.84	23.89		
	1	24	23.78	23.86	23.94		
	12	0	22.88	22.97	23.05	0-1	1
	12	6	22.83	22.98	23.03		
	12	13	22.79	23.00	23.04		
16QAM	25	0	22.86	23.01	23.08	0-1	1
	1	0	23.08	22.88	22.88		
	1	12	22.82	22.94	22.90		
	1	24	22.70	22.97	22.92	0-2	2
	12	0	22.00	22.06	22.07		
	12	6	21.94	22.08	22.08		
	12	13	21.88	22.10	22.07	0-2	2
	25	0	21.93	22.07	22.08		

Table 10.3.15 LTE Conducted Power

LTE Band 66 (AWS) Conducted Power– 3 MHz Bandwidth							
Modulation	RB Size	RB Offset	Low Channel	Mid Channel	High Channel	MPR Allowed Per 3GPP(dB)	MPR (dB)
			131987 (1711.5 MHz)	132322 (1745.0 MHz)	132657 (1778.5 MHz)		
			Conducted Power (dBm)				
QPSK	1	0	24.08	23.91	23.95	0	0
	1	7	23.91	23.87	23.92		
	1	14	23.74	23.93	24.03		
	8	0	23.01	23.02	23.09	0-1	1
	8	4	22.96	23.02	23.08		
	8	7	22.91	23.01	23.10		
16QAM	15	0	22.99	23.05	23.14	0-1	1
	1	0	23.12	22.94	22.93		
	1	7	22.90	22.94	22.94		
	1	14	22.80	23.01	22.96	0-2	2
	8	0	22.17	22.15	22.14		
	8	4	22.13	22.14	22.15		
	8	7	22.06	22.16	22.18	0-2	2
15	0	22.09	22.13	22.17			

Table 10.3.16 LTE Conducted Power

TE Band 66 (AWS) Conducted Power– 1.4 MHz Bandwidth							
Modulation	RB Size	RB Offset	Low Channel	Mid Channel	High Channel	MPR Allowed Per 3GPP(dB)	MPR (dB)
			131979 (1710.7 MHz)	132322 (1745.0 MHz)	132665 (1779.3 MHz)		
			Conducted Power (dBm)				
QPSK	1	0	23.88	23.88	23.83	0	0
	1	2	23.86	23.90	23.85		
	1	5	23.86	23.93	23.88		
	3	0	24.08	23.88	24.01	0	0
	3	2	24.09	23.87	24.00		
	3	3	23.94	23.91	24.03		
	16QAM	6	0	23.00	22.98	23.09	0-1
1		0	22.90	22.87	22.89		
1		2	22.93	22.90	22.81		
1		5	22.89	22.91	22.91	0-1	1
3		0	23.11	23.03	23.13		
3		2	23.11	23.04	23.16		
3		3	23.08	23.10	23.15	0-2	2
6		0	22.11	22.09	22.15		

Table 10.3.17 LTE Conducted Power

Band & Mode	Modulated Average[dBm]	
	LTE Band 4	Maximum
	Nominal	23.7

Table 10.3.18 Nominal and Maximum Output Power Spec

4) LTE Band 4

LTE Band 4 (AWS) Conducted Power-- 20 MHz Bandwidth					
Modulation	RB Size	RB Offset	Mid Channel	MPR Allowed Per 3GPP(dB)	MPR (dB)
			20175 (1732.5 MHz)		
			Conducted Power (dBm)		
QPSK	1	0	24.03	0	0
	1	50	23.80		
	1	99	24.01		
	50	0	23.20	0-1	1
	50	25	22.98		
	50	50	22.89		
16QAM	100	0	23.02	0-1	1
	1	0	23.18		
	1	50	22.87	0-1	1
	1	99	23.11		
	50	0	22.05		
	50	25	21.83	0-2	2
	50	50	21.75		
	100	0	21.92		

Table 10.3.19 LTE Conducted Power

LTE Band 4 (AWS) Conducted Power-- 15 MHz Bandwidth							
Modulation	RB Size	RB Offset	Low Channel	Mid Channel	High Channel	MPR Allowed Per 3GPP(dB)	MPR (dB)
			20025 (1717.5 MHz)	20175 (1732.5 MHz)	20325 (1747.5 MHz)		
			Conducted Power (dBm)				
QPSK	1	0	23.92	23.97	24.07	0	0
	1	36	23.72	23.80	23.92		
	1	74	23.84	23.89	23.97		
	36	0	22.76	23.02	23.09	0-1	1
	36	18	22.75	22.92	23.02		
	36	37	22.84	22.89	23.03		
16QAM	75	0	22.79	22.97	23.05	0-1	1
	1	0	23.06	23.03	23.17		
	1	36	22.76	22.89	23.11	0-1	1
	1	74	22.95	22.99	23.10		
	36	0	21.77	21.88	22.05		
	36	18	21.72	21.81	22.00	0-2	2
	36	37	21.77	21.77	22.03		
	75	0	21.79	21.87	22.04		

Table 10.3.20 LTE Conducted Power

LTE Band 4 (AWS) Conducted Power– 10 MHz Bandwidth							
Modulation	RB Size	RB Offset	Low Channel	Mid Channel	High Channel	MPR Allowed Per 3GPP(dB)	MPR (dB)
			20000 (1715.0 MHz)	20175 (1732.5 MHz)	20350 (1750.0 MHz)		
			Conducted Power (dBm)				
QPSK	1	0	23.83	23.87	24.02	0	0
	1	25	23.79	23.79	23.95		
	1	49	23.74	23.83	23.96		
	25	0	22.76	22.97	23.01	0-1	1
	25	12	22.70	22.89	22.99		
	25	25	22.75	22.83	23.00		
16QAM	50	0	22.77	22.93	23.03	0-1	1
	1	0	22.98	22.94	23.18	0-1	1
	1	25	22.77	22.90	23.13		
	1	49	22.92	22.96	23.11		
	25	0	21.77	21.90	22.07	0-2	2
	25	12	21.70	21.81	22.06		
	25	25	21.74	21.75	22.06		
		50	0	21.77	21.80	22.09	0-2

Table 10.3.21 LTE Conducted Power

LTE Band 4 (AWS) Conducted Power– 5 MHz Bandwidth							
Modulation	RB Size	RB Offset	Low Channel	Mid Channel	High Channel	MPR Allowed Per 3GPP(dB)	MPR (dB)
			19975 (1712.5 MHz)	20175 (1732.5 MHz)	20375 (1752.5 MHz)		
			Conducted Power (dBm)				
QPSK	1	0	23.76	23.83	23.93	0	0
	1	12	23.71	23.84	23.91		
	1	24	23.78	23.84	23.90		
	12	0	22.75	22.87	22.94	0-1	1
	12	6	22.79	22.86	22.98		
	12	13	22.75	22.83	23.00		
16QAM	25	0	22.76	22.87	22.97	0-1	1
	1	0	22.95	22.90	23.06	0-1	1
	1	12	22.89	22.93	23.08		
	1	24	22.80	22.92	23.07		
	12	0	21.84	21.82	22.06	0-2	2
	12	6	21.90	21.85	22.11		
	12	13	21.84	21.82	22.13		
		25	0	21.78	21.80	22.04	0-2

Table 10.3.22 LTE Conducted Power

LTE Band 4 (AWS) Conducted Power– 3 MHz Bandwidth							
Modulation	RB Size	RB Offset	Low Channel	Mid Channel	High Channel	MPR Allowed Per 3GPP(dB)	MPR (dB)
			19965 (1711.5 MHz)	20175 (1732.5 MHz)	20385 (1753.5 MHz)		
			Conducted Power (dBm)				
QPSK	1	0	23.76	23.89	23.98	0	0
	1	7	23.76	23.81	24.01		
	1	14	23.73	23.88	23.97		
	8	0	22.81	22.93	23.04	0-1	1
	8	4	22.79	22.90	23.02		
	8	7	22.78	22.90	23.03		
	15	0	22.81	22.95	23.07	0-1	1
16QAM	1	0	22.91	23.01	23.17	0-1	1
	1	7	22.85	22.94	23.16		
	1	14	22.89	22.98	23.17		
	8	0	21.99	21.95	22.18	0-2	2
	8	4	21.97	21.94	22.14		
	8	7	21.98	21.92	22.17		
	15	0	21.87	21.96	22.19	0-2	2

Table 10.3.23 LTE Conducted Power

TE Band 4 (AWS) Conducted Power– 1.4 MHz Bandwidth							
Modulation	RB Size	RB Offset	Low Channel	Mid Channel	High Channel	MPR Allowed Per 3GPP(dB)	MPR (dB)
			19957 (1710.7 MHz)	20175 (1732.5 MHz)	20393 (1754.3 MHz)		
			Conducted Power (dBm)				
QPSK	1	0	23.99	23.94	24.00	0	0
	1	2	23.98	23.81	24.12		
	1	5	24.13	23.85	24.08		
	3	0	23.95	23.83	23.97	0	0
	3	2	23.94	23.86	23.90		
	3	3	23.87	23.83	23.93		
	6	0	23.04	22.89	22.99	0-1	1
16QAM	1	0	23.18	22.96	23.16	0-1	1
	1	2	23.09	22.94	23.11		
	1	5	23.15	22.98	23.06		
	3	0	23.09	22.94	23.14	0-1	1
	3	2	23.08	23.01	23.08		
	3	3	23.06	22.99	23.07		
	6	0	22.02	21.94	22.17	0-2	2

Table 10.3.24 LTE Conducted Power

Band & Mode	Modulated Average [dBm]	
	LTE Band 2(PCS)	Maximum
	Nominal	23.7

Table 10.3.25 Nominal and Maximum Output Power Spec
5) LTE Band 2 (PCS)

LTE Band 2 (PCS) Conducted Power– 20 MHz Bandwidth							
Modulation	RB Size	RB Offset	Low Channel	Mid Channel	High Channel	MPR Allowed Per 3GPP(dB)	MPR (dB)
			18700 (1860.0 MHz)	18900 (1880.0 MHz)	19100 (1900.0 MHz)		
			Conducted Power (dBm)				
QPSK	1	0	24.14	24.18	24.19	0	0
	1	50	23.90	23.85	23.85		
	1	99	24.02	23.95	24.03		
	50	0	23.13	23.06	23.16	0-1	1
	50	25	22.97	22.91	22.92		
	50	50	23.01	22.84	22.81		
16QAM	100	0	23.03	22.93	22.91	0-1	1
	1	0	23.11	23.19	23.16		
	1	50	23.08	23.01	23.04		
	1	99	23.17	23.11	23.12	0-2	2
	50	0	22.04	21.96	22.05		
	50	25	21.95	21.85	21.89		
	50	50	22.00	21.76	21.77	0-2	2
	100	0	21.99	21.87	21.89		

Table 10.3.26 LTE Conducted Power

LTE Band 2 (PCS) Conducted Power– 15 MHz Bandwidth							
Modulation	RB Size	RB Offset	Low Channel	Mid Channel	High Channel	MPR Allowed Per 3GPP(dB)	MPR (dB)
			18675 (1857.5 MHz)	18900 (1880.0 MHz)	19125 (1902.5 MHz)		
			Conducted Power (dBm)				
QPSK	1	0	24.02	24.04	23.97	0	0
	1	36	23.87	23.83	23.82		
	1	74	23.94	23.88	23.99		
	36	0	23.01	22.96	22.98	0-1	1
	36	18	22.93	22.88	22.89		
	36	37	22.93	22.83	22.82		
16QAM	75	0	22.96	22.88	22.87	0-1	1
	1	0	23.10	23.19	23.17		
	1	36	23.06	23.03	23.00		
	1	74	23.08	23.06	23.18	0-2	2
	36	0	21.94	21.92	21.93		
	36	18	21.89	21.82	21.84		
	36	37	21.91	21.78	21.79	0-2	2
	75	0	21.92	21.87	21.86		

Table 10.3.27 LTE Conducted Power

LTE Band 2 (PCS) Conducted Power– 10 MHz Bandwidth							
Modulation	RB Size	RB Offset	Low Channel	Mid Channel	High Channel	MPR Allowed Per 3GPP(dB)	MPR (dB)
			18650 (1855.0 MHz)	18900 (1880.0 MHz)	19150 (1905.0 MHz)		
			Conducted Power (dBm)				
QPSK	1	0	23.94	23.95	23.90	0	0
	1	25	23.84	23.82	23.83		
	1	49	23.89	23.84	23.91		
	25	0	22.95	22.90	22.92	0-1	1
	25	12	22.89	22.84	22.84		
	25	25	22.83	22.77	22.72		
16QAM	50	0	22.92	22.87	22.85	0-1	1
	1	0	23.04	23.14	23.09		
	1	25	23.01	22.98	23.00		
	1	49	23.06	23.02	23.08	0-2	2
	25	0	21.88	21.90	21.89		
	25	12	21.84	21.83	21.81		
	25	25	21.80	21.75	21.71	0-2	2
	50	0	21.85	21.81	21.81		

Table 10.3.28 LTE Conducted Power

LTE Band 2 (PCS) Conducted Power– 5 MHz Bandwidth							
Modulation	RB Size	RB Offset	Low Channel	Mid Channel	High Channel	MPR Allowed Per 3GPP(dB)	MPR (dB)
			18625 (1852.5 MHz)	18900 (1880.0 MHz)	19175 (1907.5 MHz)		
			Conducted Power (dBm)				
QPSK	1	0	24.13	23.87	23.83	0	0
	1	12	24.11	23.84	23.87		
	1	24	24.06	23.83	23.92		
	12	0	22.84	22.82	22.87	0-1	1
	12	6	22.84	22.82	22.85		
	12	13	22.82	22.80	22.79		
16QAM	25	0	22.85	22.82	22.84	0-1	1
	1	0	22.97	23.05	22.99		
	1	12	23.00	23.01	23.06	0-1	1
	1	24	23.02	23.00	23.10		
	12	0	21.81	21.85	21.87		
	12	6	21.82	21.85	21.88	0-2	2
	12	13	21.83	21.83	21.85		
	25	0	21.77	21.79	21.82		
					0-2	2	

Table 10.3.29 LTE Conducted Power

TE Band 2 (PCS) Conducted Power– 3 MHz Bandwidth							
Modulation	RB Size	RB Offset	Low Channel	Mid Channel	High Channel	MPR Allowed Per 3GPP(dB)	MPR (dB)
			18615 (1851.5 MHz)	18900 (1880.0 MHz)	19185 (1908.5 MHz)		
			Conducted Power (dBm)				
QPSK	1	0	24.16	24.17	24.16	0	0
	1	7	24.10	24.08	24.12		
	1	14	24.16	24.16	24.15		
	8	0	23.16	23.16	23.18	0-1	1
	8	4	23.12	23.14	23.15		
	8	7	23.13	23.15	23.17		
16QAM	15	0	23.16	23.15	23.14	0-1	1
	1	0	23.10	23.20	23.12		
	1	7	22.95	23.11	23.08	0-1	1
	1	14	23.01	23.15	23.16		
	8	0	21.99	22.12	21.99		
	8	4	22.01	21.95	21.99	0-2	2
	8	7	21.99	22.03	22.04		
15	0	22.03	21.96	22.06			
					0-2	2	

Table 10.3.30 LTE Conducted Power

LTE Band 2 (PCS) Conducted Power– 1.4 MHz Bandwidth							
Modulation	RB Size	RB Offset	Low Channel	Mid Channel	High Channel	MPR Allowed Per 3GPP(dB)	MPR (dB)
			18607 (1850.7 MHz)	18900 (1880.0 MHz)	19193 (1909.3 MHz)		
			Conducted Power (dBm)				
QPSK	1	0	23.78	23.78	23.84	0	0
	1	2	23.74	23.74	23.83		
	1	5	23.78	23.80	23.88		
	3	0	23.87	23.86	24.17	0	0
	3	2	23.82	23.83	24.14		
	3	3	23.87	23.86	24.16		
16QAM	6	0	22.85	22.84	23.16	0-1	1
	1	0	22.97	22.98	22.99		
	1	2	22.90	22.88	23.01	0-1	1
	1	5	22.94	22.89	23.06		
	3	0	22.95	23.06	23.07		
	3	2	23.00	23.01	23.14	0-1	1
	3	3	22.99	22.98	23.12		
	6	0	21.91	21.94	22.02		
					0-2	2	

Table 10.3.31 LTE Conducted Power

Band & Mode	Modulated Average [dBm]	
	LTE Band 7	Maximum
	Nominal	22.7

Table 10.3.32 Nominal and Maximum Output Power Spec
6) LTE Band 7

LTE Band 7 Conducted Power– 20 MHz Bandwidth							
Modulation	RB Size	RB Offset	Low Channel	Mid Channel	High Channel	MPR Allowed Per 3GPP(dB)	MPR (dB)
			20850 (2510.0 MHz)	21100 (2535.0 MHz)	21350 (2560.0 MHz)		
			Conducted Power (dBm)				
QPSK	1	0	22.77	22.81	22.80	0	0
	1	50	22.81	22.82	22.81		
	1	99	22.83	22.90	22.82		
	50	0	21.74	21.89	21.85	0-1	1
	50	25	21.73	21.75	21.74		
	50	50	21.70	21.72	21.71		
16QAM	100	0	21.71	21.74	21.73	0-1	1
	1	0	21.96	22.00	22.00		
	1	50	21.91	21.95	21.94	0-1	1
	1	99	22.02	22.05	22.00		
	50	0	20.76	20.76	20.77		
	50	25	20.72	20.69	20.64	0-2	2
	50	50	20.71	20.64	20.60		
	100	0	20.74	20.71	20.63		

Table 10.3.33 LTE Conducted Power

LTE Band 7 Conducted Power– 15 MHz Bandwidth							
Modulation	RB Size	RB Offset	Low Channel	Mid Channel	High Channel	MPR Allowed Per 3GPP(dB)	MPR (dB)
			20825 (2507.5 MHz)	21100 (2535.0 MHz)	21375 (2562.5 MHz)		
			Conducted Power (dBm)				
QPSK	1	0	22.71	22.78	22.82	0	0
	1	36	22.69	22.77	22.71		
	1	74	22.77	22.84	22.77		
	36	0	21.66	21.75	21.78	0-1	1
	36	18	21.65	21.73	21.70		
	36	37	21.64	21.71	21.63		
16QAM	75	0	21.64	21.73	21.70	0-1	1
	1	0	21.90	21.92	21.97		
	1	36	21.85	21.93	21.90	0-1	1
	1	74	21.90	22.03	21.92		
	36	0	20.69	20.74	20.82		
	36	18	20.70	20.74	20.73	0-2	2
	36	37	20.69	20.72	20.68		
	75	0	20.71	20.74	20.75		

Table 10.3.34 LTE Conducted Power

LTE Band 7 Conducted Power– 10 MHz Bandwidth							
Modulation	RB Size	RB Offset	Low Channel	Mid Channel	High Channel	MPR Allowed Per 3GPP(dB)	MPR (dB)
			20800 (2505.0 MHz)	21100 (2535.0 MHz)	21400 (2565.0 MHz)		
			Conducted Power (dBm)				
QPSK	1	0	22.70	22.76	22.76	0	0
	1	25	22.69	22.76	22.69		
	1	49	22.74	22.78	22.71		
	25	0	21.64	21.74	21.71	0-1	1
	25	12	21.65	21.73	21.64		
	25	25	21.64	21.69	21.68		
16QAM	50	0	21.63	21.71	21.65	0-1	1
	1	0	21.89	21.92	21.92	0-1	1
	1	25	21.85	21.92	21.87		
	1	49	21.94	21.93	21.89		
	25	0	20.67	20.75	20.76	0-2	2
	25	12	20.70	20.74	20.70		
	25	25	20.67	20.69	20.64		
		50	0	20.66	20.71	20.68	0-2

Table 10.3.35 LTE Conducted Power

LTE Band 7 Conducted Power– 5 MHz Bandwidth							
Modulation	RB Size	RB Offset	Low Channel	Mid Channel	High Channel	MPR Allowed Per 3GPP(dB)	MPR (dB)
			20775 (2502.5 MHz)	21100 (2535.0 MHz)	21425 (2567.5 MHz)		
			Conducted Power (dBm)				
QPSK	1	0	22.64	22.73	22.66	0	0
	1	12	22.63	22.73	22.65		
	1	24	22.65	22.73	22.67		
	12	0	21.62	21.69	21.65	0-1	1
	12	6	21.63	21.70	21.65		
	12	13	21.66	21.72	21.65		
16QAM	25	0	21.60	21.68	21.65	0-1	1
	1	0	21.83	21.89	21.80	0-1	1
	1	12	21.75	21.92	21.84		
	1	24	21.84	21.88	21.87		
	12	0	20.65	20.72	20.71	0-2	2
	12	6	20.71	20.76	20.73		
	12	13	20.74	20.77	20.73		
		25	0	20.63	20.70	20.65	0-2

Table 10.3.36 LTE Conducted Power

7) LTE DL Carrier Aggregation Conducted Powers

- Below downlink CA configurations were determined based on Manufacturer's information.

Class	CA BW Class		Maximum number of CC
	ATBC		
	N _{RB,agg}	MHz	
A	N ≤ 100	20	1
B	25 < N ≤ 100	20	2
C	100 < N ≤ 200	40	2
D	200 < N ≤ 300	60	3
E	300 < N ≤ 400	80	4
F	400 < N ≤ 500	100	5
I	700 < N ≤ 800	160	8

Table 10.3.37 Inter-band DL CA Configuration

2 bands / 2CC	2 bands / 3CC	2 bands / 4CC
CA_4A-7A (0)(1) Table 10.3.38	N/A	N/A
CA_5A-7A (0)(1) Table 10.3.38	N/A	N/A

CA_4A-7A(1) : BW 40, 13.2

Table 10.3.38 LTE DL Carrier Aggregation Conducted Power for Inter-band DL CA Configuration [CA_4A-17A (0)(1) / CA_5A-7A (0)(1)]

PCC									SCC				Power	
PCC Band	PCC BW (MHz)	PCC (UL) CH.	PCC (UL) Freq. (MHz)	Modulation	PCC UL# RB	PCC UL RB Offset	PCC (DL) CH.	PCC (DL) Freq. (MHz)	SCC Band	SCC BW (MHz)	SCC (DL) CH.	SCC (DL) Freq. (MHz)	LTE Tx. Power with DL CA Enabled (dBm)	LTE Single Carrier Tx. Power (dBm)
LTE B4	20	20175	1732.5	QPSK	1	0	2175	2132.5	LTE B7	20	3100	2655	24.01<	24.03
LTE B4	20	20175	1732.5	QPSK	1	0	2175	2132.5	LTE B7	15	3100	2655	23.99<	24.03
LTE B4	20	20175	1732.5	QPSK	1	0	2175	2132.5	LTE B7	10	3100	2655	23.97<	24.03
LTE B4	20	20175	1732.5	QPSK	1	0	2175	2132.5	LTE B7	5	3100	2655	23.95<	24.03
LTE B5	10	20525	836.5	QPSK	1	0	2525	881.5	LTE B7	20	3100	2655	25.05<	25.07
LTE B5	10	20525	836.5	QPSK	1	0	2525	881.5	LTE B7	15	3100	2655	25.03<	25.07
LTE B5	10	20525	836.5	QPSK	1	0	2525	881.5	LTE B7	10	3100	2655	25.01<	25.07

Table 10.3.39 Intra-band (contiguous) DL CA Configuration

1 bands / 2CC	1 bands / 3CC	1 bands / 4CC
CA_7C (0)(1)(2) Table 10.3.40	N/A	N/A
CA_66B (0)	N/A	N/A
CA_66C (0) Table 10.3.40	N/A	N/A

Table 10.3.40 LTE DL Carrier Aggregation Conducted Power for Intra-band (contiguous) DL CA Configuration [CA_7C (0)(1)(2) / CA_66C (0)]

PCC									SCC				Power	
PCC Band	PCC BW (MHz)	PCC (UL) CH.	PCC (UL) Freq. (MHz)	Modulation	PCC UL# RB	PCC UL RB Offset	PCC (DL) CH.	PCC (DL) Freq. (MHz)	SCC Band	SCC BW (MHz)	SCC (DL) CH.	SCC (DL) Freq. (MHz)	LTE Tx. Power with DL CA Enabled (dBm)	LTE Single Carrier Tx. Power (dBm)
LTE B7	20	21100	2535	QPSK	1	99	3100	2655	LTE B7	20	3298	2674.8	22.87<	22.90
LTE B7	20	21100	2535	QPSK	1	99	3100	2655	LTE B7	15	3271	2672.1	22.85<	22.90
LTE B7	20	21100	2535	QPSK	1	99	3100	2655	LTE B7	10	3244	2669.4	22.83<	22.90
LTE B66	20	132572	1770.0	QPSK	1	99	67036	2170.0	LTE B66	20	66838	2150.2	24.14<	24.16
LTE B66	20	132572	1770.0	QPSK	1	99	67036	2170.0	LTE B66	15	66886	2155.0	24.12<	24.16
LTE B66	20	132572	1770.0	QPSK	1	99	67036	2170.0	LTE B66	10	66936	2160.0	24.10<	24.16
LTE B66	20	132572	1770.0	QPSK	1	99	67036	2170.0	LTE B66	5	66986	2165.0	24.08<	24.16

Table 10.3.41 Intra-band (non-contiguous) DL CA Configuration

1 bands / 2CC	1 bands / 3CC	1 bands / 4CC
CA_66A-66A (0) Table 10.3.42	N/A	N/A

Table 10.3.42 LTE DL Carrier Aggregation Conducted Power for Intra-band (non-contiguous) DL CA Configuration [CA_66A-66A (0)]

PCC									SCC				Power	
PCC Band	PCC BW (MHz)	PCC (UL) CH.	PCC (UL) Freq. (MHz)	Modulation	PCC UL# RB	PCC UL RB Offset	PCC (DL) CH.	PCC (DL) Freq. (MHz)	SCC Band	SCC BW (MHz)	SCC (DL) CH.	SCC (DL) Freq. (MHz)	LTE Tx. Power with DL CA Enabled (dBm)	LTE Single Carrier Tx. Power (dBm)
LTE B66	20	132572	1770.0	QPSK	1	0	67036	2170.0	LTE B66	20	66796	2145.0	24.06<	24.16
LTE B66	20	132572	1770.0	QPSK	1	0	67036	2170.0	LTE B66	15	66786	2145.0	24.04<	24.16
LTE B66	20	132572	1770.0	QPSK	1	0	67036	2170.0	LTE B66	10	66786	2145.0	24.02<	24.16
LTE B66	20	132572	1770.0	QPSK	1	0	67036	2170.0	LTE B66	5	66786	2145.0	24.00<	24.16

Note(s):

- The device only supports downlink Carrier Aggregation. Uplink Carrier Aggregation is not supported. The DL carrier aggregation powers were measured according to the 941225 D05Av01r02. Per FCC KDB Publication 941225 D05Av01r02, no further power measurements and SAR measurements are required for DL carrier aggregation configurations when the average output power with downlink only carrier aggregation active is not more than 0.25 dB higher than the average output power with downlink only carrier aggregation inactive.
- For downlink carrier aggregation combinations, PCC uplink channel was selected based on section C.3)b)ii) of KDB 941225 D05Av01r02.

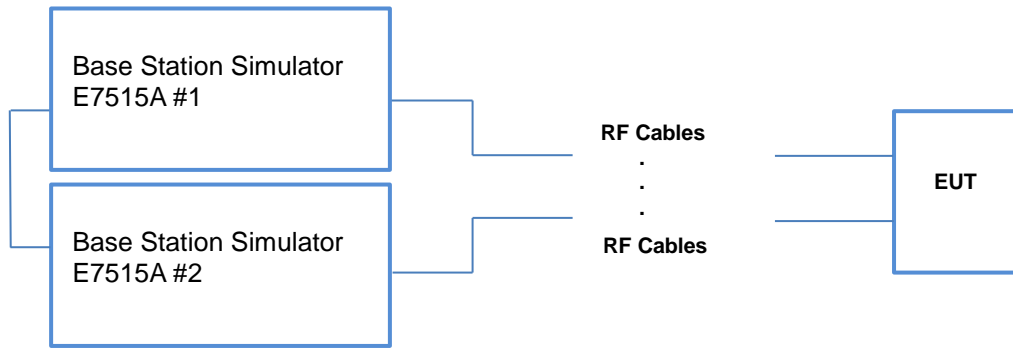

Figure 10.3.1 DL 4CA Power Measurement Setup

10.4 WLAN Nominal and Maximum Output Power Spec and Conducted Powers

Band (GHz)	Mode	Ch	Modulated Average[dBm]	
			Maximum	Nominal
2.4	802.11b	1~11	19.0	18.0
	802.11g (6~36Mbps)	1	14.5	13.5
		2~10	17.5	16.5
		11	14.5	13.5
	802.11g (48~54Mbps)	1	14.0	13.0
		2~10	17.0	16.0
		11	14.0	13.0
	802.11n HT20 (MCS0-MCS4)	1	14.0	13.0
		2~10	16.0	15.0
		11	14.0	13.0
	802.11n HT20 (MCS5-MCS7)	1	13.0	12.0
		2~10	15.0	14.0
11		13.0	12.0	

Table 10.4.1 Nominal and Maximum Output Power Spec

Mode	Freq.	Ch	IEEE 802.11 (2.4 GHz) Conducted Power
	(MHz)		(dBm)
802.11b	2412	1	<u>18.35</u>
	2437	6	<u>18.63</u>
	2462	11	<u>18.14</u>
802.11g	2412	1	14.10
	2437	6	16.80
	2462	11	13.61
802.11n (HT-20)	2412	1	13.38
	2437	6	15.43
	2462	11	13.25

Table 10.4.2 IEEE 802.11 Average RF Power

Justification for reduced test configurations for WIFI channels per KDB Publication 248227 D01v02r02:

- Power measurements were performed for the transmission mode configuration with the highest maximum output power specified for production units.
- For transmission modes with the same maximum output power specification, powers were measured for the largest channel bandwidth, lowest order modulation and lowest data rate.
- For transmission modes with identical maximum specified output power, channel bandwidth, modulation and data rates, power measurements were required for all identical configurations.
- For each transmission mode configuration, powers were measured for the highest and lowest channels; and at the mid-band channel(s) when there were at least 3 channels supported. For configurations with multiple mid-band channels, duo to an even number of channels, both channels were measured.
- Output Power and SAR is not required for 802.11 g/n HT20 channels when the highest reported SAR for DSSS is adjusted by the ratio of OFDM to DSSS specified maximum output power and the adjust SAR is ≤ 1.2 W/kg.
- The underlined data rate and channel above were tested for SAR.

The average output powers of this device were tested by below configuration.

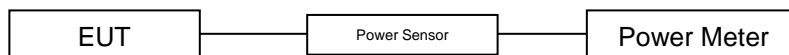

Figure 10.4 Power Measurement Setup

10.5 Bluetooth Conducted Powers

Modulated Average[dBm]		
Bluetooth 1 Mbps	Maximum	11.5
	Nominal	10.5
Bluetooth 2 Mbps	Maximum	9.5
	Nominal	8.5
Bluetooth 3 Mbps	Maximum	9.5
	Nominal	8.5
Bluetooth LE	Maximum	8.0
	Nominal	7.0

Table 10.5.1 Nominal and Maximum Output Power Spec

Channel	Frequency	Burst AVG Output Power (1Mbps)	Frame AVG Output Power (1Mbps)	Burst AVG Output Power (2Mbps)	Frame AVG Output Power (2Mbps)	Burst AVG Output Power (3Mbps)	Frame AVG Output Power (3Mbps)
	(MHz)	(dBm)	(dBm)	(dBm)	(dBm)	(dBm)	(dBm)
Low	2402	9.25	8.10	7.02	5.87	7.02	5.87
Mid	2441	11.30	10.15	8.96	7.81	8.96	7.81
High	2480	10.37	9.22	7.91	6.76	7.92	6.77

Table 10.5.2 Bluetooth Frame Average RF Power

Channel	Frequency	Burst AVG Output Power(LE)	Frame AVG Output Power(LE)
	(MHz)	(dBm)	(dBm)
Low	2402	6.71	4.57
Mid	2440	7.46	5.32
High	2480	7.05	4.91

Table 10.5.3 Bluetooth LE Frame Average RF Power

- Bluetooth Conducted Powers procedures

- Bluetooth (BDR, EDR)

- 1) Enter DUT mode in EUT and operate it.

When it operating, The EUT is transmitting at maximum power level and duty cycle fixed.

- 2) Instruments and EUT were connected like Figure 10.5.1(A).

- 3) The maximum output powers of BDR(1 Mbps), EDR(2, 3 Mbps) and each frequency were set by a Bluetooth Tester.

- 4) Power levels were measured by a Power Meter.

2. Bluetooth (LE)

- 1) Enter LE mode in EUT and operate it.

When it operating, The EUT is transmitting at maximum power level and duty cycle fixed.

- 2) Instruments and EUT were connected like Figure 10.5.1(B).

- 3) The average conducted output powers of LE and each frequency can measurement according to setting program in EUT.

- 4) Power levels were measured by a Power Meter.

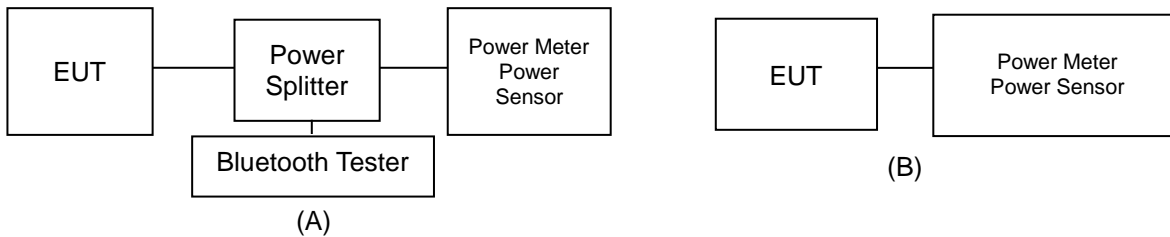

Figure 10.5.1 Average Power Measurement Setup

The average conducted output powers of Bluetooth were measured using above test setup and a wideband gated RF power meter when the EUT is transmitting at its maximum power level.

- Bluetooth Transmission Plot

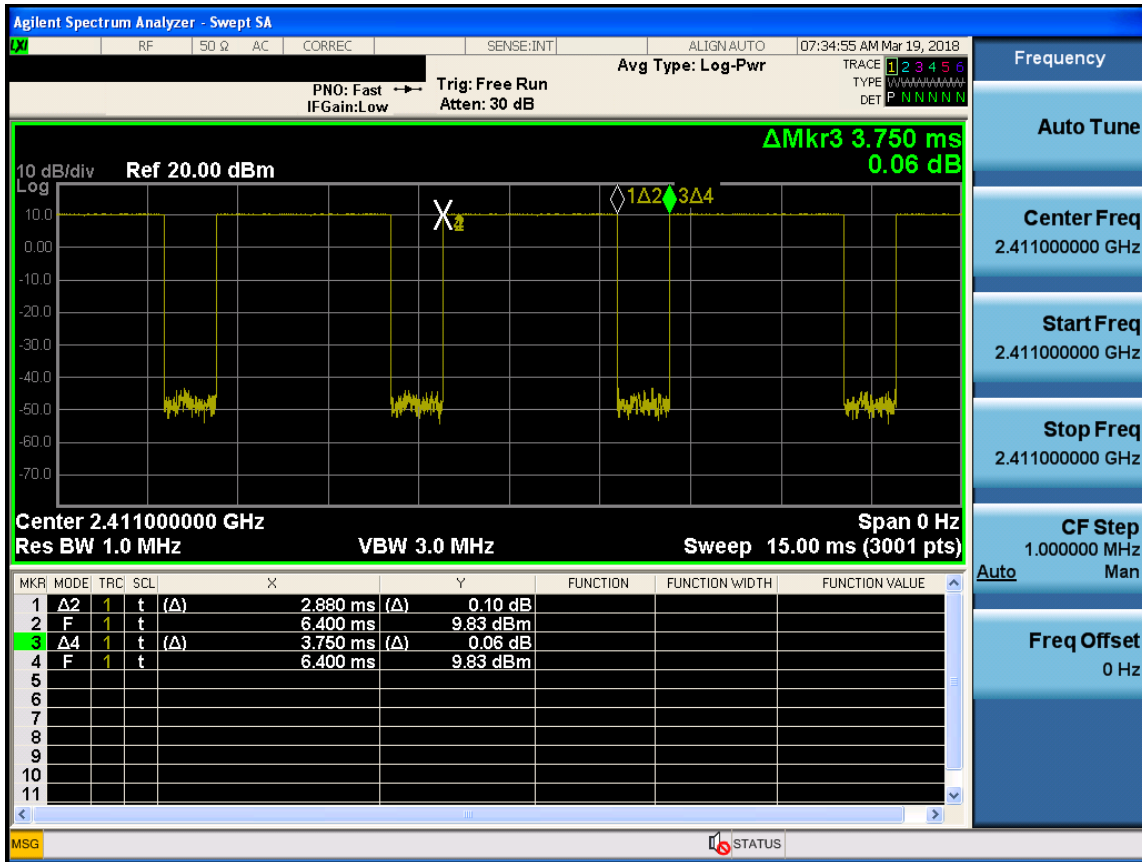

Figure 10.5.2 Bluetooth Transmission Plot

- Bluetooth Duty Cycle Calculation

$$\text{Duty Cycle} = \text{Pulse/Period} * 100\% = (2.880/3.750) * 100 = 76.8\%$$

11. SYSTEM VERIFICATION

11.1 Tissue Verification

MEASURED TISSUE PARAMETERS										
Date(s)	Tissue Type	Ambient Temp.[°C]	Liquid Temp.[°C]	Measured Frequency [MHz]	Target Dielectric Constant, ϵ_r	Target Conductivity, σ (S/m)	Measured Dielectric Constant, ϵ_r	Measured Conductivity, σ (S/m)	ϵ_r Deviation [%]	σ Deviation [%]
Mar. 26. 2018	750 Head	20.9	21.1	707.5	42.129	0.887	41.829	0.874	-0.71	-1.47
				750.0	41.900	0.890	41.489	0.911	-0.98	2.36
Mar. 26. 2018	750 Body	20.9	21.3	707.5	55.699	0.960	54.696	0.950	-1.80	-1.04
				750.0	55.531	0.963	54.350	0.990	-2.13	2.80
Mar. 21. 2018	835 Head	21.1	21.2	824.2	41.552	0.899	42.064	0.877	1.23	-2.45
				835.0	41.500	0.900	41.941	0.886	1.06	-1.56
				836.6	41.500	0.901	41.925	0.888	1.02	-1.44
				848.8	41.500	0.914	41.974	0.898	1.14	-1.75
Mar. 21. 2018	835 Body	21.1	21.0	824.2	55.243	0.969	54.409	0.958	-1.51	-1.14
				835.0	55.200	0.970	54.295	0.970	-1.64	0.00
				836.6	55.197	0.971	54.281	0.972	-1.66	0.10
				848.8	55.160	0.986	54.165	0.985	-1.80	-0.10
Mar. 22. 2018	835 Head	21.0	21.3	826.4	41.542	0.899	42.030	0.878	1.17	-2.34
				835.0	41.500	0.900	41.937	0.885	1.05	-1.67
				836.5	41.500	0.901	41.920	0.887	1.01	-1.55
				836.6	41.500	0.901	41.919	0.887	1.01	-1.55
Mar. 23. 2018	835 Body	21.2	21.0	846.6	41.500	0.912	41.815	0.896	0.76	-1.75
				826.4	55.235	0.969	55.120	0.966	-0.21	-0.31
				835.0	55.200	0.970	55.024	0.977	-0.32	0.72
				836.5	55.197	0.971	55.013	0.978	-0.33	0.72
Apr. 09. 2018	1800 Head	21.3	21.1	836.6	55.197	0.971	55.010	0.979	-0.34	0.82
				846.6	55.166	0.984	54.911	0.990	-0.46	0.61
				1712.4	40.126	1.350	40.624	1.305	1.24	-3.33
				1720.0	40.114	1.354	40.585	1.311	1.17	-3.18
				1732.4	40.097	1.361	40.535	1.322	1.09	-2.87
Apr. 11. 2018	1800 Body	21.4	21.1	1745.0	40.079	1.369	40.489	1.333	1.02	-2.63
				1752.6	40.069	1.373	40.462	1.340	0.98	-2.40
				1770.0	40.043	1.383	40.395	1.353	0.88	-2.17
				1800.0	40.000	1.400	40.258	1.380	0.65	-1.43
				1712.4	53.596	1.464	53.062	1.463	-1.00	-0.07
				1720.0	53.580	1.469	53.027	1.470	-1.03	0.07
Mar. 27. 2018	1900 Head	21.0	20.8	1732.4	53.556	1.477	52.972	1.481	-1.09	0.27
				1745.0	53.530	1.485	52.917	1.491	-1.15	0.40
				1752.6	53.516	1.489	52.883	1.497	-1.18	0.54
				1770.0	53.480	1.501	52.815	1.511	-1.24	0.67
Mar. 27. 2018	1900 Body	21.0	21.4	1800.0	53.300	1.520	52.717	1.535	-1.09	0.99
				1850.2	40.000	1.400	39.982	1.347	-0.05	-3.79
				1880.0	40.000	1.400	39.931	1.376	-0.17	-1.71
				1900.0	40.000	1.400	39.883	1.393	-0.29	-0.50
Apr. 06. 2018	1900 Head	21.0	21.5	1909.8	40.000	1.400	39.857	1.401	-0.36	0.07
				1850.2	53.300	1.520	53.194	1.498	-0.20	-1.45
				1880.0	53.300	1.520	53.091	1.522	-0.39	0.13
				1900.0	53.300	1.520	53.009	1.544	-0.55	1.58
Apr. 10. 2018	1900 Body	21.6	21.9	1909.8	53.300	1.520	52.982	1.555	-0.60	2.30
				1852.4	40.000	1.400	39.908	1.349	-0.23	-3.64
				1860.0	40.000	1.400	39.898	1.358	-0.25	-3.00
				1880.0	40.000	1.400	39.858	1.376	-0.36	-1.71
Apr. 10. 2018	1900 Body	21.6	21.9	1900.0	40.000	1.400	39.818	1.395	-0.46	-0.36
				1907.6	40.000	1.400	39.802	1.403	-0.50	0.21
				1852.4	53.300	1.520	52.988	1.494	-0.59	-1.71
				1860.0	53.300	1.520	52.974	1.500	-0.61	-1.32
Apr. 10. 2018	1900 Body	21.6	21.9	1880.0	53.300	1.520	52.889	1.516	-0.77	-0.26
				1900.0	53.300	1.520	52.809	1.539	-0.92	1.25
Apr. 10. 2018	1900 Body	21.6	21.9	1907.6	53.300	1.520	52.786	1.549	-0.96	1.91

MEASURED TISSUE PARAMETERS										
Date(s)	Tissue Type	Ambient Temp.[°C]	Liquid Temp.[°C]	Measured Frequency [MHz]	Target Dielectric Constant, ϵ_r	Target Conductivity, σ (S/m)	Measured Dielectric Constant, ϵ_r	Measured Conductivity, σ (S/m)	Er Deviation [%]	σ Deviation [%]
Mar. 28. 2018	2450 Head	21.2	21.3	2402.0	39.282	1.757	39.374	1.785	0.23	1.59
				2412.0	39.265	1.766	39.343	1.796	0.20	1.70
				2437.0	39.222	1.788	39.267	1.824	0.11	2.01
				2441.0	39.215	1.792	39.253	1.829	0.10	2.06
				2450.0	39.200	1.800	39.219	1.839	0.05	2.17
				2462.0	39.184	1.813	39.180	1.852	-0.01	2.15
Mar. 28. 2018	2450 Body	21.2	21.0	2402.0	52.764	1.904	51.210	1.853	-2.95	-2.68
				2412.0	52.751	1.914	51.184	1.864	-2.97	-2.61
				2437.0	52.717	1.938	51.123	1.894	-3.02	-2.27
				2441.0	52.712	1.941	51.111	1.899	-3.04	-2.16
				2450.0	52.700	1.950	51.088	1.910	-3.06	-2.05
				2462.0	52.685	1.967	51.063	1.924	-3.08	-2.19
Apr. 05. 2018	2600 Head	21.4	21.2	2510.0	39.120	1.864	38.100	1.920	-2.61	3.00
				2535.0	39.087	1.891	38.018	1.950	-2.73	3.12
				2560.0	39.053	1.917	37.931	1.980	-2.87	3.29
				2600.0	39.000	1.960	37.793	2.027	-3.09	3.42
Apr. 05. 2018	2600 Body	21.4	21.0	2510.0	52.624	2.035	52.544	2.027	-0.15	-0.39
				2535.0	52.592	2.071	52.483	2.057	-0.21	-0.68
				2560.0	52.560	2.106	52.418	2.088	-0.27	-0.85
				2600.0	52.509	2.163	52.322	2.136	-0.36	-1.25
May. 03. 2018	835 Head	22.0	21.7	835.0	41.500	0.900	41.229	0.896	-0.65	-0.44
				836.5	41.500	0.901	41.217	0.898	-0.68	-0.33
May. 03. 2018	835 Body	22.0	21.4	835.0	55.200	0.970	53.204	1.008	-3.62	3.92
				836.5	55.197	0.971	53.190	1.010	-3.64	4.02

The above measured tissue parameters were used in the DASY software. The DASY software was used to perform interpolation to determine the dielectric parameters at the SAR test device frequencies (per KDB 865664 and IEEE 1528-2013 6.6.1.2). The tissue parameters listed in the SAR test plots may slightly differ from the table above due to significant digit rounding in the software.

Measurement Procedure for Tissue verification:

- 1) The network analyzer and probe system was configured and calibrated.
- 2) The probe was immersed in the sample which was placed in a nonmetallic container. Trapped air bubbles beneath the flange were minimized by placing the probe at a slight angle.
- 3) The complex admittance with respect to the probe aperture was measured
- 4) The complex relative permittivity, for example from the below equation (Pournaropoulos and Misra):

$$Y = \frac{j2\omega\epsilon_r\epsilon_0}{[\ln(b/a)]^2} \int_a^b \int_a^b \int_0^\pi \cos\phi' \frac{\exp[-j\omega r'(\mu_0\epsilon_r\epsilon_0)^{1/2}]}{r'} d\phi' d\rho' d\rho$$

where Y is the admittance of the probe in contact with the sample, the primed and unprimed coordinates refer to source and observation points, respectively, $r^2 = \rho^2 + \rho'^2 - 2\rho\rho'\cos\phi'$, ω is the angular frequency, and $j = \sqrt{-1}$.

11.2 Test System Verification

Prior to assessment, the system is verified to the $\pm 10\%$ of the specifications at below listed frequencies by using the SAR Dipole kit(s). (Graphic Plots Attached)

Table 11.2.1 System Verification Results (1g)

SYSTEM DIPOLE VERIFICATION TARGET & MEASURED												
SAR System #	Freq. [MHz]	SAR Dipole kits	Date(s)	Tissue Type	Ambient Temp. [°C]	Liquid Temp. [°C]	Probe S/N	Input Power (mW)	1 W Target SAR _{1g} (W/kg)	Measured SAR _{1g} (W/kg)	1 W Normalized SAR _{1g} (W/kg)	Deviation [%]
B	750	D750V3, SN:1049	Mar. 26. 2018	Head	20.9	21.1	3866	250	8.32	2.12	8.48	1.92
B	750	D750V3, SN:1049	Mar. 26. 2018	Body	20.9	21.3	3866	250	8.70	2.09	8.36	-3.91
B	835	D835V2, SN:464	Mar. 21. 2018	Head	21.1	21.2	3866	250	9.38	2.48	9.92	5.76
B	835	D835V2, SN:464	Mar. 21. 2018	Body	21.1	21.0	3866	250	9.45	2.41	9.64	2.01
B	835	D835V2, SN:464	Mar. 22. 2018	Head	21.0	21.3	3866	250	9.38	2.39	9.56	1.92
B	835	D835V2, SN:464	Mar. 23. 2018	Body	21.2	21.0	3866	250	9.45	2.32	9.28	-1.80
B	1800	D1800V2, SN:2d047	Apr. 09. 2018	Head	21.3	21.1	3866	100	39.9	4.11	41.10	3.01
B	1800	D1800V2, SN:2d047	Apr. 11. 2018	Body	21.4	21.1	3866	100	39.2	4.03	40.30	2.81
B	1900	D1900V2, SN:5d029	Mar. 27. 2018	Head	21.0	20.8	3866	100	39.2	4.08	40.80	4.08
B	1900	D1900V2, SN:5d029	Mar. 27. 2018	Body	21.0	21.4	3866	100	39.6	3.93	39.30	-0.76
B	1900	D1900V2, SN:5d029	Apr. 06. 2018	Head	21.0	21.5	3866	100	39.2	4.02	40.20	2.55
B	1900	D1900V2, SN:5d029	Apr. 10. 2018	Body	21.6	21.9	3866	100	39.6	4.01	40.10	1.26
B	2450	D2450V2, SN: 726	Mar. 28. 2018	Head	21.2	21.3	3866	100	51.9	4.89	48.90	-5.78
B	2450	D2450V2, SN: 726	Mar. 28. 2018	Body	21.2	21.0	3866	100	50.3	4.93	49.30	-1.99
B	2600	D2600V2, SN: 1103	Apr. 05. 2018	Head	21.4	21.2	3866	100	56.4	5.52	55.20	-2.13
B	2600	D2600V2, SN: 1103	Apr. 05. 2018	Body	21.4	21.0	3866	100	55.7	5.48	54.80	-1.62
B	835	D835V2, SN:464	May. 03. 2018	Head	22.0	21.7	3866	250	9.38	2.45	9.80	4.48
B	835	D835V2, SN:464	May. 03. 2018	Body	22.0	21.4	3866	250	9.45	2.39	9.56	1.16

Note1 : System Verification was measured with input 250 mW, 100 mW and normalized to 1W.

Note2 : To confirm the proper SAR liquid depth, the z-axis plots from the system verifications were included since the system verifications were performed using the same liquid, probe and DAE as the SAR tests in the same time period.

Note3: Full system validation status and results can be found in Attachment 3.

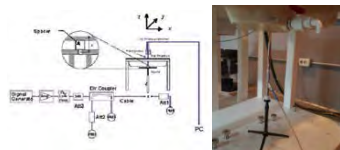

Figure 11.1 Dipole Verification Test Setup Diagram & Photo

12. SAR TEST RESULTS

12.1 Head SAR Results

Table 12.1.1 GSM/GPRS 850 Head SAR

MEASUREMENT RESULTS														
FREQUENCY		Mode/ Band	Service	Maximum Allowed Power [dBm]	Conducted Power [dBm]	Drift Power [dB]	Phantom Position	Device Serial Number	# of Time Slots	Duty Cycle	1g SAR (W/kg)	Scaling Factor	1g Scaled SAR (W/kg)	Plots #
MHz	Ch													
836.6	190	GSM850	GSM	33.70	33.50	0.100	Left Touch	FCC #1	1	1:8.3	0.112	1.047	0.117	A1
836.6	190	GSM850	GSM	33.70	33.50	0.140	Right Touch	FCC #1	1	1:8.3	0.077	1.047	0.081	
836.6	190	GSM850	GSM	33.70	33.50	0.080	Left Tilt	FCC #1	1	1:8.3	0.040	1.047	0.042	
836.6	190	GSM850	GSM	33.70	33.50	0.180	Right Tilt	FCC #1	1	1:8.3	0.047	1.047	0.049	
836.6	190	GSM850	GPRS	29.70	29.64	0.090	Left Touch	FCC #1	4	1:2.075	0.191	1.014	0.194	A2
836.6	190	GSM850	GPRS	29.70	29.64	0.180	Right Touch	FCC #1	4	1:2.075	0.128	1.014	0.130	
836.6	190	GSM850	GPRS	29.70	29.64	-0.170	Left Tilt	FCC #1	4	1:2.075	0.073	1.014	0.074	
836.6	190	GSM850	GPRS	29.70	29.64	-0.190	Right Tilt	FCC #1	4	1:2.075	0.080	1.014	0.081	
ANSI / IEEE C95.1-1992- SAFETY LIMIT Spatial Peak Uncontrolled Exposure/General Population Exposure								Head 1.6 W/kg (mW/g) averaged over 1 gram						

Table 12.1.2 PCS/GPRS 1900 Head SAR

MEASUREMENT RESULTS														
FREQUENCY		Mode/ Band	Service	Maximum Allowed Power [dBm]	Conducted Power [dBm]	Drift Power [dB]	Phantom Position	Device Serial Number	# of Time Slots	Duty Cycle	1g SAR (W/kg)	Scaling Factor	1g Scaled SAR (W/kg)	Plots #
MHz	Ch													
1880.0	661	PCS1900	PCS	30.70	30.41	0.090	Left Touch	FCC #1	1	1:8.3	0.132	1.069	0.141	A3
1880.0	661	PCS1900	PCS	30.70	30.41	0.020	Right Touch	FCC #1	1	1:8.3	0.102	1.069	0.109	
1880.0	661	PCS1900	PCS	30.70	30.41	0.170	Left Tilt	FCC #1	1	1:8.3	0.045	1.069	0.048	
1880.0	661	PCS1900	PCS	30.70	30.41	0.140	Right Tilt	FCC #1	1	1:8.3	0.074	1.069	0.079	
1880.0	661	PCS1900	GPRS	26.70	26.68	0.170	Left Touch	FCC #1	4	1:2.075	0.220	1.005	0.221	A4
1880.0	661	PCS1900	GPRS	26.70	26.68	0.020	Right Touch	FCC #1	4	1:2.075	0.180	1.005	0.181	
1880.0	661	PCS1900	GPRS	26.70	26.68	0.090	Left Tilt	FCC #1	4	1:2.075	0.076	1.005	0.076	
1880.0	661	PCS1900	GPRS	26.70	26.68	-0.130	Right Tilt	FCC #1	4	1:2.075	0.137	1.005	0.138	
ANSI / IEEE C95.1-1992- SAFETY LIMIT Spatial Peak Uncontrolled Exposure/General Population Exposure								Head 1.6 W/kg (mW/g) averaged over 1 gram						

Table 12.1.3 WCDMA 850 Head SAR

MEASUREMENT RESULTS													
FREQUENCY		Mode/ Band	Service	Maximum Allowed Power [dBm]	Conducted Power [dBm]	Drift Power [dB]	Phantom Position	Device Serial Number	Duty Cycle	1g SAR (W/kg)	Scaling Factor	1g Scaled SAR (W/kg)	Plots #
MHz	Ch												
836.6	4183	WCDMA 850	RMC	25.20	25.07	0.030	Left Touch	FCC #1	1:1	0.168	1.030	0.173	A5
836.6	4183	WCDMA 850	RMC	25.20	25.07	0.010	Right Touch	FCC #1	1:1	0.101	1.030	0.104	
836.6	4183	WCDMA 850	RMC	25.20	25.07	-0.060	Left Tilt	FCC #1	1:1	0.069	1.030	0.071	
836.6	4183	WCDMA 850	RMC	25.20	25.07	0.050	Right Tilt	FCC #1	1:1	0.076	1.030	0.078	
ANSI / IEEE C95.1-1992- SAFETY LIMIT Spatial Peak Uncontrolled Exposure/General Population Exposure									Head 1.6 W/kg (mW/g) averaged over 1 gram				

Table 12.1.4 WCDMA 1700 Head SAR

MEASUREMENT RESULTS													
FREQUENCY		Mode/ Band	Service	Maximum Allowed Power [dBm]	Conducted Power [dBm]	Drift Power [dB]	Phantom Position	Device Serial Number	Duty Cycle	1g SAR (W/kg)	Scaling Factor	1g Scaled SAR (W/kg)	Plots #
MHz	Ch												
1732.4	1412	WCDMA 1700	RMC	24.20	23.14	-0.080	Left Touch	FCC #1	1:1	0.043	1.276	0.055	A6
1732.4	1412	WCDMA 1700	RMC	24.20	23.14	0.120	Right Touch	FCC #1	1:1	0.040	1.276	0.051	
1732.4	1412	WCDMA 1700	RMC	24.20	23.14	0.160	Left Tilt	FCC #1	1:1	0.018	1.276	0.023	
1732.4	1412	WCDMA 1700	RMC	24.20	23.14	0.150	Right Tilt	FCC #1	1:1	0.015	1.276	0.019	
ANSI / IEEE C95.1-2005- SAFETY LIMIT Spatial Peak Uncontrolled Exposure/General Population Exposure									Head 1.6 W/kg (mW/g) averaged over 1 gram				

Table 12.1.5 WCDMA 1900 Head SAR

MEASUREMENT RESULTS													
FREQUENCY		Mode/ Band	Service	Maximum Allowed Power [dBm]	Conducted Power [dBm]	Drift Power [dB]	Phantom Position	Device Serial Number	Duty Cycle	1g SAR (W/kg)	Scaling Factor	1g Scaled SAR (W/kg)	Plots #
MHz	Ch												
1880.0	9400	WCDMA 1900	RMC	24.20	23.23	0.040	Left Touch	FCC #1	1:1	0.038	1.250	0.048	A7
1880.0	9400	WCDMA 1900	RMC	24.20	23.23	0.040	Right Touch	FCC #1	1:1	0.025	1.250	0.031	
1880.0	9400	WCDMA 1900	RMC	24.20	23.23	0.010	Left Tilt	FCC #1	1:1	0.019	1.250	0.024	
1880.0	9400	WCDMA 1900	RMC	24.20	23.23	0.120	Right Tilt	FCC #1	1:1	0.010	1.250	0.013	
ANSI / IEEE C95.1-1992- SAFETY LIMIT Spatial Peak Uncontrolled Exposure/General Population Exposure									Head 1.6 W/kg (mW/g) averaged over 1 gram				

Table 12.1.6 LTE Band 12 Head SAR

MEASUREMENT RESULTS																	
FREQUENCY		Mode/ Band	BW [MHz]	Max Allowed Power [dBm]	Cond. PWR [dBm]	Drift Power [dB]	MPR	Position	Device Serial Number	Mod.	RB Size	RB Offs.	Duty Cycle	1g SAR (W/kg)	Scaling Factor	1g Scaled SAR (W/kg)	Plots #
MHz	Ch																
707.5	23095	LTE B12	10	25.20	24.89	0.160	0	Left Touch	FCC #1	QPSK	1	49	1:1	0.125	1.074	0.134	A8
707.5	23095	LTE B12	10	24.20	23.94	0.130	1	Left Touch	FCC #1	QPSK	25	12	1:1	0.095	1.062	0.101	
707.5	23095	LTE B12	10	25.20	24.89	0.100	0	Right Touch	FCC #1	QPSK	1	49	1:1	0.081	1.074	0.087	
707.5	23095	LTE B12	10	24.20	23.94	0.140	1	Right Touch	FCC #1	QPSK	25	12	1:1	0.056	1.062	0.059	
707.5	23095	LTE B12	10	25.20	24.89	-0.050	0	Left Tilt	FCC #1	QPSK	1	49	1:1	0.052	1.074	0.056	
707.5	23095	LTE B12	10	24.20	23.94	0.030	1	Left Tilt	FCC #1	QPSK	25	12	1:1	0.041	1.062	0.044	
707.5	23095	LTE B12	10	25.20	24.89	0.020	0	Right Tilt	FCC #1	QPSK	1	49	1:1	0.052	1.074	0.056	
707.5	23095	LTE B12	10	24.20	23.94	0.130	1	Right Tilt	FCC #1	QPSK	25	12	1:1	0.034	1.062	0.036	
ANSI / IEEE C95.1-1992- SAFETY LIMIT Spatial Peak Uncontrolled Exposure/General Population Exposure										Head 1.6 W/kg (mW/g) averaged over 1 gram							

Table 12.1.7 LTE Band 5 (Cell) Head SAR

MEASUREMENT RESULTS																	
FREQUENCY		Mode/ Band	BW [MHz]	Max Allowed Power [dBm]	Cond. PWR [dBm]	Drift Power [dB]	MPR	Position	Device Serial Number	Mod.	RB Size	RB Offs.	Duty Cycle	1g SAR (W/kg)	Scaling Factor	1g Scaled SAR (W/kg)	Plots #
MHz	Ch																
836.5	20525	LTE B5	10	25.20	25.07	0.110	0	Left Touch	FCC #1	QPSK	1	49	1:1	0.157	1.030	0.162	A9
836.5	20525	LTE B5	10	24.20	23.84	0.110	1	Left Touch	FCC #1	QPSK	25	25	1:1	0.124	1.086	0.135	
836.5	20525	LTE B5	10	24.20	23.87	0.150	1	Left Touch	FCC #1	QPSK	50	0	1:1	0.125	1.079	0.135	
836.5	20525	LTE B5	10	25.20	25.07	-0.180	0	Right Touch	FCC #1	QPSK	1	49	1:1	0.119	1.030	0.123	
836.5	20525	LTE B5	10	24.20	23.84	0.170	1	Right Touch	FCC #1	QPSK	25	25	1:1	0.086	1.086	0.093	
836.5	20525	LTE B5	10	24.20	23.87	-0.020	1	Right Touch	FCC #1	QPSK	50	0	1:1	0.070	1.079	0.076	
836.5	20525	LTE B5	10	25.20	25.07	0.120	0	Left Tilt	FCC #1	QPSK	1	49	1:1	0.063	1.030	0.065	
836.5	20525	LTE B5	10	24.20	23.84	0.110	1	Left Tilt	FCC #1	QPSK	25	25	1:1	0.052	1.086	0.056	
836.5	20525	LTE B5	10	24.20	23.87	0.160	1	Left Tilt	FCC #1	QPSK	50	0	1:1	0.041	1.079	0.044	
836.5	20525	LTE B5	10	25.20	25.07	0.020	0	Right Tilt	FCC #1	QPSK	1	49	1:1	0.080	1.030	0.082	
836.5	20525	LTE B5	10	24.20	23.84	-0.180	1	Right Tilt	FCC #1	QPSK	25	25	1:1	0.059	1.086	0.064	
836.5	20525	LTE B5	10	24.20	23.87	0.070	1	Right Tilt	FCC #1	QPSK	50	0	1:1	0.041	1.079	0.044	
ANSI / IEEE C95.1-1992- SAFETY LIMIT Spatial Peak Uncontrolled Exposure/General Population Exposure										Head 1.6 W/kg (mW/g) averaged over 1 gram							

Table 12.1.8 LTE Band 66 (AWS) Head SAR

MEASUREMENT RESULTS																	
FREQUENCY		Mode/ Band	BW [MHz]	Max Allowed Power [dBm]	Cond. PWR [dBm]	Drift Power [dB]	MPR	Position	Device Serial Number	Mod.	RB Size	RB Offs.	Duty Cycle	1g SAR (W/kg)	Scaling Factor	1g Scaled SAR (W/kg)	Plots #
MHz	Ch																
1770.0	132572	LTE B66	20	24.20	24.16	-0.180	0	Left Touch	FCC #1	QPSK	1	99	1:1	0.086	1.009	0.087	A10
1770.0	132572	LTE B66	20	23.20	23.17	0.190	1	Left Touch	FCC #1	QPSK	50	0	1:1	0.073	1.007	0.074	
1770.0	132572	LTE B66	20	24.20	24.16	0.170	0	Right Touch	FCC #1	QPSK	1	99	1:1	0.077	1.009	0.078	
1770.0	132572	LTE B66	20	23.20	23.17	-0.070	1	Right Touch	FCC #1	QPSK	50	0	1:1	0.054	1.007	0.054	
1770.0	132572	LTE B66	20	24.20	24.16	0.110	0	Left Tilt	FCC #1	QPSK	1	99	1:1	0.036	1.009	0.036	
1770.0	132572	LTE B66	20	23.20	23.17	-0.130	1	Left Tilt	FCC #1	QPSK	50	0	1:1	0.038	1.007	0.038	
1770.0	132572	LTE B66	20	24.20	24.16	0.070	0	Right Tilt	FCC #1	QPSK	1	99	1:1	0.046	1.009	0.046	
1770.0	132572	LTE B66	20	23.20	23.17	-0.120	1	Right Tilt	FCC #1	QPSK	50	0	1:1	0.038	1.007	0.038	
ANSI / IEEE C95.1-1992- SAFETY LIMIT Spatial Peak Uncontrolled Exposure/General Population Exposure										Head 1.6 W/kg (mW/g) averaged over 1 gram							

Table 12.1.9 LTE Band 2 (PCS) Head SAR

MEASUREMENT RESULTS																	
FREQUENCY		Mode/ Band	BW [MHz]	Max Allowed Power [dBm]	Cond. PWR [dBm]	Drift Power [dB]	MPR	Position	Device Serial Number	Mod.	RB Size	RB Offs.	Duty Cycle	1g SAR (W/kg)	Scaling Factor	1g Scaled SAR (W/kg)	Plots #
MHz	Ch																
1900.0	19100	LTE B2	20	24.20	24.19	0.060	0	Left Touch	FCC #1	QPSK	1	0	1:1	0.089	1.002	0.089	A11
1900.0	19100	LTE B2	20	23.20	23.16	0.090	1	Left Touch	FCC #1	QPSK	50	0	1:1	0.072	1.009	0.073	
1900.0	19100	LTE B2	20	24.20	24.19	0.160	0	Right Touch	FCC #1	QPSK	1	0	1:1	0.054	1.002	0.054	
1900.0	19100	LTE B2	20	23.20	23.16	0.140	1	Right Touch	FCC #1	QPSK	50	0	1:1	0.042	1.009	0.042	
1900.0	19100	LTE B2	20	24.20	24.19	0.030	0	Left Tilt	FCC #1	QPSK	1	0	1:1	0.016	1.002	0.016	
1900.0	19100	LTE B2	20	23.20	23.16	-0.090	1	Left Tilt	FCC #1	QPSK	50	0	1:1	0.010	1.009	0.010	
1900.0	19100	LTE B2	20	24.20	24.19	-0.110	0	Right Tilt	FCC #1	QPSK	1	0	1:1	0.033	1.002	0.033	
1900.0	19100	LTE B2	20	23.20	23.16	-0.160	1	Right Tilt	FCC #1	QPSK	50	0	1:1	0.026	1.009	0.026	
ANSI / IEEE C95.1-1992- SAFETY LIMIT Spatial Peak Uncontrolled Exposure/General Population Exposure										Head 1.6 W/kg (mW/g) averaged over 1 gram							

Table 12.1.10 LTE Band 7 Head SAR

MEASUREMENT RESULTS																	
FREQUENCY		Mode/ Band	BW [MHz]	Max Allowed Power [dBm]	Cond. PWR [dBm]	Drift Power [dB]	MPR	Position	Device Serial Number	Mod.	RB Size	RB Offs.	Duty Cycle	1g SAR (W/kg)	Scaling Factor	1g Scaled SAR (W/kg)	Plots #
MHz	Ch																
2535.0	21100	LTE B7	20	23.20	22.90	0.000	0	Left Touch	FCC #1	QPSK	1	99	1:1	0.057	1.072	0.061	
2535.0	21100	LTE B7	20	22.20	21.89	0.000	1	Left Touch	FCC #1	QPSK	50	0	1:1	0.033	1.074	0.035	
2535.0	21100	LTE B7	20	23.20	22.90	0.000	0	Right Touch	FCC #1	QPSK	1	99	1:1	0.065	1.072	0.070	A12
2535.0	21100	LTE B7	20	22.20	21.89	0.000	1	Right Touch	FCC #1	QPSK	50	0	1:1	0.047	1.074	0.050	
2535.0	21100	LTE B7	20	23.20	22.90	0.000	0	Left Tilt	FCC #1	QPSK	1	99	1:1	0.015	1.072	0.016	
2535.0	21100	LTE B7	20	22.20	21.89	0.000	1	Left Tilt	FCC #1	QPSK	50	0	1:1	0.008	1.074	0.009	
2535.0	21100	LTE B7	20	23.20	22.90	-0.050	0	Right Tilt	FCC #1	QPSK	1	99	1:1	0.033	1.072	0.035	
2535.0	21100	LTE B7	20	22.20	21.89	-0.130	1	Right Tilt	FCC #1	QPSK	50	0	1:1	0.026	1.074	0.028	
ANSI / IEEE C95.1-1992- SAFETY LIMIT Spatial Peak Uncontrolled Exposure/General Population Exposure									Head 1.6 W/kg (mW/g) averaged over 1 gram								

Table 12.1.11 DTS Head SAR

MEASUREMENT RESULTS																
FREQUENCY		Mode (Antenna)	Maximum Allowed Power [dBm]	Conducted Power [dBm]	Drift Power [dB]	Phantom Position	Device Serial Number	Peak SAR of Area Scan	Data Rate [Mbps]	Duty Cycle	1g SAR (W/kg)	Scaling Factor	Scaling Factor (Duty Cycle)	1g Scaled SAR (W/kg)	Plots #	
MHz	Ch															
2437.0	6	802.11b	19.00	18.63	-0.070	Left Touch	FCC #1	0.282	1	99.8	0.227	1.089	1.002	0.248		
2412.0	1	802.11b	19.00	18.35	-0.030	Right Touch	FCC #1	0.860	1	99.8	0.802	1.161	1.002	0.933		
2437.0	6	802.11b	19.00	18.63	0.100	Right Touch	FCC #1	0.974	1	99.8	0.892	1.089	1.002	0.973		
2462.0	11	802.11b	19.00	18.14	0.100	Right Touch	FCC #1	0.954	1	99.8	0.884	1.219	1.002	1.080	A13	
2437.0	6	802.11b	19.00	18.63	-0.100	Left Tilt	FCC #1	0.312	1	99.8	0.258	1.089	1.002	0.282		
2412.0	1	802.11b	19.00	18.35	0.010	Right Tilt	FCC #1	0.676	1	99.8	0.682	1.161	1.002	0.793		
2437.0	6	802.11b	19.00	18.63	-0.190	Right Tilt	FCC #1	0.733	1	99.8	0.783	1.089	1.002	0.854		
2462.0	11	802.11b	19.00	18.14	-0.020	Right Tilt	FCC #1	0.698	1	99.8	0.797	1.219	1.002	0.973		
2437.0	6	802.11b	19.00	18.63	0.010	Right Touch	FCC #1	0.963	1	99.8	0.892	1.089	1.002	0.973		
ANSI / IEEE C95.1-1992- SAFETY LIMIT Spatial Peak Uncontrolled Exposure/General Population Exposure									Head 1.6 W/kg (mW/g) averaged over 1 gram							

Note: Blue entries represent variability measurements.

Adjusted SAR results for OFDM SAR

Adjusted SAR results for OFDM SAR												
FREQUENCY		Mode/ Antenna	Service	Maximum Allowed Power [dBm]	1g Scaled SAR (W/kg)	FREQUENCY [MHz]	Mode	Service	Maximum Allowed Power [dBm]	Ratio of OFDM to DSSS	1g Adjusted SAR (W/kg)	Determine OFDM SAR
MHz	Ch											
2462.0	11	802.11b	DSSS	19.0	1.080	2437	802.11g	OFDM	17.5	0.708	0.765	X
2462.0	11	802.11b	DSSS	19.0	1.080	2437	802.11n	OFDM	16.0	0.501	0.541	X
ANSI / IEEE C95.1-1992- SAFETY LIMIT Spatial Peak Uncontrolled Exposure/General Population Exposure									Head 1.6 W/kg (mW/g) averaged over 1 gram			

 Note: SAR is not required for the following 2.4 GHz OFDM conditions. When the highest reported SAR for DSSS is adjusted by the ratio of OFDM to DSSS specified maximum output power and the adjusted SAR is ≤ 1.2 W/kg.

Table 12.1.12 Bluetooth Head SAR

MEASUREMENT RESULTS																
FREQUENCY		Mode	Maximum Allowed Power [dBm]	Conducted Power [dBm]	Drift Power [dB]	Phantom Position	Device Serial Number	Rate [Mbps]	Duty Cycle (%)	1g SAR (W/kg)	Scaling Factor	Scaling Factor (Duty Cycle)	1g Scaled SAR (W/kg)	Plots #		
MHz	Ch															
2441.0	39	Bluetooth	11.50	10.15	0.050	Left Touch	FCC #1	1	76.8	0.043	1.365	1.302	0.076			
2441.0	39	Bluetooth	11.50	10.15	-0.000	Right Touch	FCC #1	1	76.8	0.168	1.365	1.302	0.299	A14		
2441.0	39	Bluetooth	11.50	10.15	0.010	Left Tilt	FCC #1	1	76.8	0.041	1.365	1.302	0.073			
2441.0	39	Bluetooth	11.50	10.15	-0.190	Right Tilt	FCC #1	1	76.8	0.125	1.365	1.302	0.222			
ANSI / IEEE C95.1-1992- SAFETY LIMIT Spatial Peak Uncontrolled Exposure/General Population Exposure									Head 1.6 W/kg (mW/g) averaged over 1 gram							

12.2 Standalone Body-Worn SAR Worn SAR Results

Table 12.2.1 GSM/PCS/GPRS/WCDMA Body-Worn SAR

MEASUREMENT RESULTS														
FREQUENCY		Mode/ Band	Service	Maximum Allowed Power [dBm]	Conducted Power [dBm]	Drift Power [dB]	Spacing [Side]	Device Serial Number	# of Time Slot s	Duty Cycle	1g SAR (W/kg)	Scaling Factor	1g Scaled SAR (W/kg)	Plots #
MHz	Ch													
836.6	190	GSM850	GSM	33.70	33.50	-0.020	10 mm [Front]	FCC #1	1	1:8.3	0.434	1.047	0.454	A15
836.6	190	GSM850	GSM	33.70	33.50	-0.030	10 mm [Rear]	FCC #1	1	1:8.3	0.400	1.047	0.419	
836.6	190	GSM850	GPRS	29.70	29.64	-0.010	10 mm [Front]	FCC #1	4	1:2.075	0.671	1.014	0.680	A16
836.6	190	GSM850	GPRS	29.70	29.64	0.050	10 mm [Rear]	FCC #1	4	1:2.075	0.649	1.014	0.658	
1880.0	661	PCS1900	PCS	30.70	30.41	-0.020	10 mm [Front]	FCC #1	1	1:8.3	0.264	1.069	0.282	A17
1880.0	661	PCS1900	PCS	30.70	30.41	0.050	10 mm [Rear]	FCC #1	1	1:8.3	0.251	1.069	0.268	
1880.0	661	PCS1900	GPRS	26.70	26.68	0.000	10 mm [Front]	FCC #1	4	1:2.075	0.515	1.005	0.518	A18
1880.0	661	PCS1900	GPRS	26.70	26.68	0.010	10 mm [Rear]	FCC #1	4	1:2.075	0.480	1.005	0.482	
836.6	4183	WCDMA 850	RMC	25.20	25.07	-0.080	10 mm [Front]	FCC #1	N/A	1:1	0.668	1.030	0.688	A19
836.6	4183	WCDMA 850	RMC	25.20	25.07	0.000	10 mm [Rear]	FCC #1	N/A	1:1	0.630	1.030	0.649	
1732.4	1412	WCDMA 1700	RMC	24.20	23.14	-0.030	10 mm [Front]	FCC #1	N/A	1:1	0.174	1.276	0.222	
1732.4	1412	WCDMA 1700	RMC	24.20	23.14	-0.040	10 mm [Rear]	FCC #1	N/A	1:1	0.219	1.276	0.279	A20
1880.0	9400	WCDMA 1900	RMC	24.20	23.23	-0.070	10 mm [Front]	FCC #1	N/A	1:1	0.139	1.250	0.174	
1880.0	9400	WCDMA 1900	RMC	24.20	23.23	0.030	10 mm [Rear]	FCC #1	N/A	1:1	0.148	1.250	0.185	A21
ANSI / IEEE C95.1-1992– SAFETY LIMIT Spatial Peak Uncontrolled Exposure/General Population Exposure								Body 1.6 W/kg (mW/g) averaged over 1 gram						

Table 12.2.2 LTE B12, B5, B66 Body-Worn SAR

MEASUREMENT RESULTS

FREQUENCY		Mode/ Band	BW [MHz]	Max Allowed Power [dBm]	Cond. PWR [dBm]	Drift Power [dB]	MPR	Position	Device Serial Number	Mod.	RB Size	RB Offs.	Duty Cycle	1g SAR (W/kg)	Scaling Factor	1g Scaled SAR (W/kg)	Plots #
MHz	Ch																
707.5	23095	LTE B12	10	25.20	24.89	-0.090	0	10 mm [Front]	FCC #1	QPSK	1	49	1:1	0.525	1.074	0.564	A22
707.5	23095	LTE B12	10	24.20	23.94	-0.070	1	10 mm [Front]	FCC #1	QPSK	25	12	1:1	0.401	1.062	0.426	
707.5	23095	LTE B12	10	25.20	24.89	-0.010	0	10 mm [Rear]	FCC #1	QPSK	1	49	1:1	0.459	1.074	0.493	
707.5	23095	LTE B12	10	24.20	23.94	-0.010	1	10 mm [Rear]	FCC #1	QPSK	25	12	1:1	0.349	1.062	0.371	
836.5	20525	LTE B5	10	25.20	25.07	-0.030	0	10 mm [Front]	FCC #1	QPSK	1	49	1:1	0.572	1.030	0.589	
836.5	20525	LTE B5	10	24.20	23.84	-0.020	1	10 mm [Front]	FCC #1	QPSK	25	25	1:1	0.450	1.086	0.489	
836.5	20525	LTE B5	10	24.20	23.87	0.020	1	10 mm [Front]	FCC #1	QPSK	50	0	1:1	0.442	1.079	0.477	
836.5	20525	LTE B5	10	25.20	25.07	0.010	0	10 mm [Rear]	FCC #1	QPSK	1	49	1:1	0.642	1.030	0.661	A23
836.5	20525	LTE B5	10	24.20	23.84	0.010	1	10 mm [Rear]	FCC #1	QPSK	25	25	1:1	0.497	1.086	0.540	
836.5	20525	LTE B5	10	24.20	23.87	0.020	1	10 mm [Rear]	FCC #1	QPSK	50	0	1:1	0.486	1.079	0.524	
1770.0	132572	LTE B66	20	24.20	24.16	0.140	0	10 mm [Front]	FCC #1	QPSK	1	99	1:1	0.384	1.009	0.387	
1770.0	132572	LTE B66	20	23.20	23.17	0.090	1	10 mm [Front]	FCC #1	QPSK	50	0	1:1	0.311	1.007	0.313	
1770.0	132572	LTE B66	20	24.20	24.16	-0.000	0	10 mm [Rear]	FCC #1	QPSK	1	99	1:1	0.444	1.009	0.448	A24
1770.0	132572	LTE B66	20	23.20	23.17	0.000	1	10 mm [Rear]	FCC #1	QPSK	50	0	1:1	0.342	1.007	0.344	
ANSI / IEEE C95.1-1992- SAFETY LIMIT Spatial Peak Uncontrolled Exposure/General Population Exposure									Body 1.6 W/kg (mW/g) averaged over 1 gram								

Table 12.2.3 LTE B2/B7 Body-Worn SAR

MEASUREMENT RESULTS

FREQUENCY		Mode/ Band	BW [MHz]	Max Allowed Power [dBm]	Cond. PWR [dBm]	Drift Power [dB]	MPR	Position	Device Serial Number	Mod.	RB Size	RB Offs.	Duty Cycle	1g SAR (W/kg)	Scaling Factor	1g Scaled SAR (W/kg)	Plots #
MHz	Ch																
1900.0	19100	LTE B2	20	24.20	24.19	0.020	0	10 mm [Front]	FCC #1	QPSK	1	0	1:1	0.320	1.002	0.321	A25
1900.0	19100	LTE B2	20	23.20	23.16	0.030	1	10 mm [Front]	FCC #1	QPSK	50	0	1:1	0.262	1.009	0.264	
1900.0	19100	LTE B2	20	24.20	24.19	0.080	0	10 mm [Rear]	FCC #1	QPSK	1	0	1:1	0.279	1.002	0.280	
1900.0	19100	LTE B2	20	23.20	23.16	-0.010	1	10 mm [Rear]	FCC #1	QPSK	50	0	1:1	0.232	1.009	0.234	
2535.0	21100	LTE B7	20	23.20	22.90	0.060	0	10 mm [Front]	FCC #1	QPSK	1	99	1:1	0.299	1.072	0.321	
2535.0	21100	LTE B7	20	22.20	21.89	-0.030	1	10 mm [Front]	FCC #1	QPSK	50	0	1:1	0.249	1.074	0.267	
2535.0	21100	LTE B7	20	23.20	22.90	0.050	0	10 mm [Rear]	FCC #1	QPSK	1	99	1:1	0.333	1.072	0.357	A26
2535.0	21100	LTE B7	20	22.20	21.89	0.030	1	10 mm [Rear]	FCC #1	QPSK	50	0	1:1	0.264	1.074	0.284	
ANSI / IEEE C95.1-1992- SAFETY LIMIT Spatial Peak Uncontrolled Exposure/General Population Exposure									Body 1.6 W/kg (mW/g) averaged over 1 gram								

Table 12.2.4 DTS Body-Worn SAR

MEASUREMENT RESULTS															
FREQUENCY		Mode	Maximum Allowed Power [dBm]	Conducted Power [dBm]	Drift Power [dB]	Phantom Position	Device Serial Number	Peak SAR of Area Scan	Data Rate [Mbps]	Duty Cycle	1g SAR (W/kg)	Scaling Factor	Scaling Factor (Duty Cycle)	SAR (W/kg)	Plots #
MHz	Ch														
2437.0	6	802.11b	19.00	18.63	-0.080	10 mm [Front]	FCC #1	0.141	1	99.8	0.137	1.089	1.002	0.149	
2437.0	6	802.11b	19.00	18.63	0.190	10 mm [Rear]	FCC #1	0.345	1	99.8	0.364	1.089	1.002	0.397	A27
ANSI / IEEE C95.1-1992- SAFETY LIMIT Spatial Peak Uncontrolled Exposure/General Population Exposure								Body 1.6 W/kg (mW/g) averaged over 1 gram							

Adjusted SAR results for OFDM SAR												
FREQUENCY		Mode/ Antenna	Service	Maximum Allowed Power [dBm]	1g Scaled SAR (W/kg)	FREQUENCY [MHz]	Mode	Service	Maximum Allowed Power [dBm]	Ratio of OFDM to DSSS	1g Adjusted SAR (W/kg)	Determine OFDM SAR
MHz	Ch											
2437.0	6	802.11b	DSSS	19.0	0.397	2437	802.11g	OFDM	17.5	0.708	0.281	X
2437.0	6	802.11b	DSSS	19.0	0.397	2437	802.11n	OFDM	16.0	0.501	0.199	X
ANSI / IEEE C95.1-1992- SAFETY LIMIT Spatial Peak Uncontrolled Exposure/General Population Exposure								Body 1.6 W/kg (mW/g) averaged over 1 gram				

Note: SAR is not required for the following 2.4 GHz OFDM conditions. When the highest reported SAR for DSSS is adjusted by the ratio of OFDM to DSSS specified maximum output power and the adjusted SAR is ≤ 1.2 W/kg.

Table 12.2.5 Bluetooth Body-Worn SAR

MEASUREMENT RESULTS														
FREQUENCY		Mode	Maximum Allowed Power [dBm]	Conducted Power [dBm]	Drift Power [dB]	Phantom Position	Device Serial Number	Rate [Mbps]	Duty Cycle (%)	1g SAR (W/kg)	Scaling Factor	Scaling Factor (Duty Cycle)	1g Scaled SAR (W/kg)	Plots #
MHz	Ch													
2441.0	39	Bluetooth	11.50	10.15	-0.140	10 mm [Front]	FCC #1	1	76.8	0.019	1.365	1.302	0.034	
2441.0	39	Bluetooth	11.50	10.15	0.170	10 mm [Rear]	FCC #1	1	76.8	0.043	1.365	1.302	0.076	A28
ANSI / IEEE C95.1-1992- SAFETY LIMIT Spatial Peak Uncontrolled Exposure/General Population Exposure								Body 1.6 W/kg (mW/g) averaged over 1 gram						

12.3 Standalone Hotspot SAR Results

Table 12.3.1 GPRS/WCDMA Hotspot SAR

MEASUREMENT RESULTS														
FREQUENCY		Mode/ Band	Service	Maximum Allowed Power [dBm]	Conducted Power [dBm]	Drift Power [dB]	Spacing [Side]	Device Serial Number	# of Time Slot s	Duty Cycle	1g SAR (W/kg)	Scaling Factor	1g Scaled SAR (W/kg)	Plots #
MHz	Ch													
836.6	190	GSM850	GPRS	29.70	29.64	0.130	10 mm [Bottom]	FCC #1	4	1:2.075	0.393	1.014	0.399	
836.6	190	GSM850	GPRS	29.70	29.64	-0.010	10 mm [Front]	FCC #1	4	1:2.075	0.671	1.014	0.680	A16
836.6	190	GSM850	GPRS	29.70	29.64	0.050	10 mm [Rear]	FCC #1	4	1:2.075	0.649	1.014	0.658	
836.6	190	GSM850	GPRS	29.70	29.64	-0.140	10 mm [Right]	FCC #1	4	1:2.075	0.106	1.014	0.107	
836.6	190	GSM850	GPRS	29.70	29.64	-0.090	10 mm [Left]	FCC #1	4	1:2.075	0.318	1.014	0.322	
1850.2	512	PCS1900	GPRS	26.70	26.69	-0.070	10 mm [Bottom]	FCC #1	4	1:2.075	1.050	1.002	1.052	A29
1880.0	661	PCS1900	GPRS	26.70	26.68	-0.060	10 mm [Bottom]	FCC #1	4	1:2.075	0.903	1.005	0.908	
1909.8	810	PCS1900	GPRS	26.70	26.57	-0.050	10 mm [Bottom]	FCC #1	4	1:2.075	0.804	1.030	0.828	
1880.0	661	PCS1900	GPRS	26.70	26.68	0.000	10 mm [Front]	FCC #1	4	1:2.075	0.515	1.005	0.518	
1880.0	661	PCS1900	GPRS	26.70	26.68	0.010	10 mm [Rear]	FCC #1	4	1:2.075	0.480	1.005	0.482	
1880.0	661	PCS1900	GPRS	26.70	26.68	0.010	10 mm [Left]	FCC #1	4	1:2.075	0.238	1.005	0.239	
1850.2	512	PCS1900	GPRS	26.70	26.69	-0.100	10 mm [Bottom]	FCC #1	4	1:2.075	1.030	1.002	1.032	
836.6	4183	WCDMA 850	RMC	25.20	25.07	0.170	10 mm [Bottom]	FCC #1	N/A	1:1	0.400	1.030	0.412	
836.6	4183	WCDMA 850	RMC	25.20	25.07	-0.080	10 mm [Front]	FCC #1	N/A	1:1	0.668	1.030	0.688	A19
836.6	4183	WCDMA 850	RMC	25.20	25.07	0.000	10 mm [Rear]	FCC #1	N/A	1:1	0.630	1.030	0.649	
836.6	4183	WCDMA 850	RMC	25.20	25.07	0.130	10 mm [Right]	FCC #1	N/A	1:1	0.119	1.030	0.123	
836.6	4183	WCDMA 850	RMC	25.20	25.07	0.080	10 mm [Left]	FCC #1	N/A	1:1	0.296	1.030	0.305	
1732.4	1412	WCDMA 1700	RMC	24.20	23.14	0.070	10 mm [Bottom]	FCC #1	N/A	1:1	0.355	1.276	0.453	A30
1732.4	1412	WCDMA 1700	RMC	24.20	23.14	-0.030	10 mm [Front]	FCC #1	N/A	1:1	0.174	1.276	0.222	
1732.4	1412	WCDMA 1700	RMC	24.20	23.14	-0.040	10 mm [Rear]	FCC #1	N/A	1:1	0.219	1.276	0.279	
1732.4	1412	WCDMA 1700	RMC	24.20	23.14	0.100	10 mm [Left]	FCC #1	N/A	1:1	0.118	1.276	0.151	
1880.0	9400	WCDMA 1900	RMC	24.20	23.23	0.140	10 mm [Bottom]	FCC #1	N/A	1:1	0.267	1.250	0.334	A31
1880.0	9400	WCDMA 1900	RMC	24.20	23.23	-0.070	10 mm [Front]	FCC #1	N/A	1:1	0.139	1.250	0.174	
1880.0	9400	WCDMA 1900	RMC	24.20	23.23	0.030	10 mm [Rear]	FCC #1	N/A	1:1	0.148	1.250	0.185	
1880.0	9400	WCDMA 1900	RMC	24.20	23.23	-0.100	10 mm [Left]	FCC #1	N/A	1:1	0.080	1.250	0.100	
ANSI / IEEE C95.1-1992– SAFETY LIMIT Spatial Peak Uncontrolled Exposure/General Population Exposure									Body 1.6 W/kg (mW/g) averaged over 1 gram					

Note: Blue entries represent variability measurements.

Table 12.3.2 LTE B12, B5 Hotspot SAR

MEASUREMENT RESULTS

FREQUENCY		Mode/ Band	BW [MHz]	Max Allowed Power [dBm]	Cond. PWR [dBm]	Drift Power [dB]	MPR	Position	Device Serial Number	Mod.	RB Size	RB Offs.	Duty Cycle	1g SAR (W/kg)	Scaling Factor	1g Scaled SAR (W/kg)	Plots #
MHz	Ch																
707.5	23095	LTE B12	10	25.20	24.89	0.020	0	10 mm [Bottom]	FCC #1	QPSK	1	49	1:1	0.378	1.074	0.406	
707.5	23095	LTE B12	10	24.20	23.94	0.040	1	10 mm [Bottom]	FCC #1	QPSK	25	12	1:1	0.276	1.062	0.293	
707.5	23095	LTE B12	10	25.20	24.89	-0.090	0	10 mm [Front]	FCC #1	QPSK	1	49	1:1	0.525	1.074	0.564	A22
707.5	23095	LTE B12	10	24.20	23.94	-0.070	1	10 mm [Front]	FCC #1	QPSK	25	12	1:1	0.401	1.062	0.426	
707.5	23095	LTE B12	10	25.20	24.89	-0.010	0	10 mm [Rear]	FCC #1	QPSK	1	49	1:1	0.459	1.074	0.493	
707.5	23095	LTE B12	10	24.20	23.94	-0.010	1	10 mm [Rear]	FCC #1	QPSK	25	12	1:1	0.349	1.062	0.371	
707.5	23095	LTE B12	10	25.20	24.89	-0.030	1	10 mm [Right]	FCC #1	QPSK	1	49	1:1	0.143	1.074	0.154	
707.5	23095	LTE B12	10	24.20	23.94	-0.050	0	10 mm [Right]	FCC #1	QPSK	25	12	1:1	0.107	1.062	0.114	
707.5	23095	LTE B12	10	25.20	24.89	0.000	0	10 mm [Left]	FCC #1	QPSK	1	49	1:1	0.209	1.074	0.224	
707.5	23095	LTE B12	10	24.20	23.94	-0.060	1	10 mm [Left]	FCC #1	QPSK	25	12	1:1	0.168	1.062	0.178	
836.5	20525	LTE B5	10	25.20	25.07	-0.120	0	10 mm [Bottom]	FCC #1	QPSK	1	49	1:1	0.329	1.030	0.339	
836.5	20525	LTE B5	10	24.20	23.84	-0.150	1	10 mm [Bottom]	FCC #1	QPSK	25	25	1:1	0.254	1.086	0.276	
836.5	20525	LTE B5	10	24.20	23.87	0.110	1	10 mm [Bottom]	FCC #1	QPSK	50	0	1:1	0.236	1.079	0.255	
836.5	20525	LTE B5	10	25.20	25.07	-0.030	0	10 mm [Front]	FCC #1	QPSK	1	49	1:1	0.572	1.030	0.589	
836.5	20525	LTE B5	10	24.20	23.84	-0.020	1	10 mm [Front]	FCC #1	QPSK	25	25	1:1	0.450	1.086	0.489	
836.5	20525	LTE B5	10	24.20	23.87	0.020	1	10 mm [Front]	FCC #1	QPSK	50	0	1:1	0.442	1.079	0.477	
836.5	20525	LTE B5	10	25.20	25.07	0.010	0	10 mm [Rear]	FCC #1	QPSK	1	49	1:1	0.642	1.030	0.661	A23
836.5	20525	LTE B5	10	24.20	23.84	0.010	1	10 mm [Rear]	FCC #1	QPSK	25	25	1:1	0.497	1.086	0.540	
836.5	20525	LTE B5	10	24.20	23.87	0.020	1	10 mm [Rear]	FCC #1	QPSK	50	0	1:1	0.486	1.079	0.524	
836.5	20525	LTE B5	10	25.20	25.07	-0.040	0	10 mm [Right]	FCC #1	QPSK	1	49	1:1	0.102	1.030	0.105	
836.5	20525	LTE B5	10	24.20	23.84	-0.120	1	10 mm [Right]	FCC #1	QPSK	25	25	1:1	0.080	1.086	0.087	
836.5	20525	LTE B5	10	24.20	23.87	-0.090	1	10 mm [Right]	FCC #1	QPSK	50	0	1:1	0.054	1.079	0.058	
836.5	20525	LTE B5	10	25.20	25.07	-0.080	0	10 mm [Left]	FCC #1	QPSK	1	49	1:1	0.308	1.030	0.317	
836.5	20525	LTE B5	10	24.20	23.84	-0.080	1	10 mm [Left]	FCC #1	QPSK	25	25	1:1	0.230	1.086	0.250	
836.5	20525	LTE B5	10	24.20	23.87	-0.030	1	10 mm [Left]	FCC #1	QPSK	50	0	1:1	0.218	1.079	0.235	
ANSI / IEEE C95.1-1992- SAFETY LIMIT Spatial Peak Uncontrolled Exposure/General Population Exposure										Body 1.6 W/kg (mW/g) averaged over 1 gram							

Table 12.3.3 LTE B66 Hotspot SAR

MEASUREMENT RESULTS																	
FREQUENCY		Mode/ Band	BW [MHz]	Max Allowed Power [dBm]	Cond. PWR [dBm]	Drift Power [dB]	MPR	Position	Device Serial Number	Mod.	RB Size	RB Offs.	Duty Cycle	1g SAR (W/kg)	Scaling Factor	1g Scaled SAR (W/kg)	Plots #
MHz	Ch																
1720.0	132072	LTE B66	20	24.20	24.15	0.030	0	10 mm [Bottom]	FCC #1	QPSK	1	99	1:1	0.629	1.012	0.637	
1745.0	132322	LTE B66	20	24.20	24.14	-0.070	0	10 mm [Bottom]	FCC #1	QPSK	1	99	1:1	0.821	1.014	0.832	A32
1770.0	132572	LTE B66	20	24.20	24.16	0.030	0	10 mm [Bottom]	FCC #1	QPSK	1	99	1:1	0.816	1.009	0.823	
1770.0	132572	LTE B66	20	23.20	23.17	-0.050	1	10 mm [Bottom]	FCC #1	QPSK	50	0	1:1	0.702	1.007	0.707	
1770.0	132572	LTE B66	20	23.20	23.15	-0.070	1	10 mm [Bottom]	FCC #1	QPSK	100	0	1:1	0.710	1.012	0.719	
1770.0	132572	LTE B66	20	24.20	24.16	0.140	0	10 mm [Front]	FCC #1	QPSK	1	99	1:1	0.384	1.009	0.387	
1770.0	132572	LTE B66	20	23.20	23.17	0.090	1	10 mm [Front]	FCC #1	QPSK	50	0	1:1	0.311	1.007	0.313	
1770.0	132572	LTE B66	20	24.20	24.16	0.000	0	10 mm [Rear]	FCC #1	QPSK	1	99	1:1	0.444	1.009	0.448	
1770.0	132572	LTE B66	20	23.20	23.17	0.000	1	10 mm [Rear]	FCC #1	QPSK	50	0	1:1	0.342	1.007	0.344	
1770.0	132572	LTE B66	20	24.20	24.16	0.050	0	10 mm [Left]	FCC #1	QPSK	1	99	1:1	0.298	1.009	0.301	
1770.0	132572	LTE B66	20	23.20	23.17	0.298	1	10 mm [Left]	FCC #1	QPSK	50	0	1:1	0.226	1.007	0.228	
1745.0	132322	LTE B66	20	24.20	24.14	-0.060	0	10 mm [Bottom]	FCC #1	QPSK	1	99	1:1	0.820	1.014	0.831	
ANSI / IEEE C95.1-1992- SAFETY LIMIT Spatial Peak Uncontrolled Exposure/General Population Exposure										Body 1.6 W/kg (mW/g) averaged over 1 gram							

Note: Blue entries represent variability measurements.

Table 12.3.4 LTE B2 Hotspot SAR

MEASUREMENT RESULTS																	
FREQUENCY		Mode/ Band	BW [MHz]	Max Allowed Power [dBm]	Cond. PWR [dBm]	Drift Power [dB]	MPR	Position	Device Serial Number	Mod.	RB Size	RB Offs.	Duty Cycle	1g SAR (W/kg)	Scaling Factor	1g Scaled SAR (W/kg)	Plots #
MHz	Ch																
1900.0	19100	LTE B2	20	24.20	24.19	-0.050	0	10 mm [Bottom]	FCC #1	QPSK	1	0	1:1	0.556	1.002	0.557	A33
1900.0	19100	LTE B2	20	23.20	23.16	-0.080	1	10 mm [Bottom]	FCC #1	QPSK	50	0	1:1	0.440	1.009	0.444	
1900.0	19100	LTE B2	20	24.20	24.19	0.020	0	10 mm [Front]	FCC #1	QPSK	1	0	1:1	0.320	1.002	0.321	
1900.0	19100	LTE B2	20	23.20	23.16	0.030	1	10 mm [Front]	FCC #1	QPSK	50	0	1:1	0.262	1.009	0.264	
1900.0	19100	LTE B2	20	24.20	24.19	0.080	0	10 mm [Rear]	FCC #1	QPSK	1	0	1:1	0.279	1.002	0.280	
1900.0	19100	LTE B2	20	23.20	23.16	-0.010	1	10 mm [Rear]	FCC #1	QPSK	50	0	1:1	0.232	1.009	0.234	
1900.0	19100	LTE B2	20	24.20	24.19	-0.190	0	10 mm [Left]	FCC #1	QPSK	1	0	1:1	0.142	1.002	0.142	
1900.0	19100	LTE B2	20	23.20	23.16	-0.170	1	10 mm [Left]	FCC #1	QPSK	50	0	1:1	0.114	1.009	0.115	
ANSI / IEEE C95.1-1992- SAFETY LIMIT Spatial Peak Uncontrolled Exposure/General Population Exposure										Body 1.6 W/kg (mW/g) averaged over 1 gram							

Table 12.3.5 LTE B7 Hotspot SAR

MEASUREMENT RESULTS

FREQUENCY		Mode/ Band	BW [MHz]	Max Allowed Power [dBm]	Cond. PWR [dBm]	Drift Power [dB]	MPR	Position	Device Serial Number	Mod.	RB Size	RB Offs.	Duty Cycle	1g SAR (W/kg)	Scaling Factor	1g Scaled SAR (W/kg)	Plots #
MHz	Ch																
2535.0	21100	LTE B7	20	23.20	22.90	0.030	0	10 mm [Bottom]	FCC #1	QPSK	1	99	1:1	0.399	1.072	0.428	A34
2535.0	21100	LTE B7	20	22.20	21.89	-0.100	1	10 mm [Bottom]	FCC #1	QPSK	50	0	1:1	0.325	1.074	0.349	
2535.0	21100	LTE B7	20	23.20	22.90	0.060	0	10 mm [Front]	FCC #1	QPSK	1	99	1:1	0.299	1.072	0.321	
2535.0	21100	LTE B7	20	22.20	21.89	-0.030	1	10 mm [Front]	FCC #1	QPSK	50	0	1:1	0.249	1.074	0.267	
2535.0	21100	LTE B7	20	23.20	22.90	0.050	0	10 mm [Rear]	FCC #1	QPSK	1	99	1:1	0.333	1.072	0.357	
2535.0	21100	LTE B7	20	22.20	21.89	0.030	1	10 mm [Rear]	FCC #1	QPSK	50	0	1:1	0.264	1.074	0.284	
2535.0	21100	LTE B7	20	23.20	22.90	0.120	0	10 mm [Left]	FCC #1	QPSK	1	99	1:1	0.142	1.072	0.152	
2535.0	21100	LTE B7	20	22.20	21.89	0.160	1	10 mm [Left]	FCC #1	QPSK	50	0	1:1	0.112	1.074	0.120	
ANSI / IEEE C95.1-1992– SAFETY LIMIT Spatial Peak Uncontrolled Exposure/General Population Exposure									Body 1.6 W/kg (mW/g) averaged over 1 gram								

Table 12.3.6 DTS Hotspot SAR

MEASUREMENT RESULTS															
FREQUENCY		Mode	Maximum Allowed Power [dBm]	Conducted Power [dBm]	Drift Power [dB]	Phantom Position	Device Serial Number	Peak SAR of Area Scan	Data Rate [Mbps]	Duty Cycle	1g SAR (W/kg)	Scaling Factor	Scaling Factor (Duty Cycle)	SAR (W/kg)	Plots #
MHz	Ch														
2437.0	6	802.11b	19.00	18.63	-0.170	10 mm [Top]	FCC #1	0.150	1	99.8	0.164	1.089	1.002	0.179	
2437.0	6	802.11b	19.00	18.63	-0.080	10 mm [Front]	FCC #1	0.141	1	99.8	0.137	1.089	1.002	0.149	
2437.0	6	802.11b	19.00	18.63	0.190	10 mm [Rear]	FCC #1	0.345	1	99.8	0.364	1.089	1.002	0.397	
2437.0	6	802.11b	19.00	18.63	-0.160	10 mm [Left]	FCC #1	0.369	1	99.8	0.367	1.089	1.002	0.400	A35
ANSI / IEEE C95.1-1992- SAFETY LIMIT Spatial Peak Uncontrolled Exposure/General Population Exposure								Body 1.6 W/kg (mW/g) averaged over 1 gram							

Adjusted SAR results for OFDM SAR												
FREQUENCY		Mode/ Antenna	Service	Maximum Allowed Power [dBm]	1g Scaled SAR (W/kg)	FREQUENCY [MHz]	Mode	Service	Maximum Allowed Power [dBm]	Ratio of OFDM to DSSS	1g Adjusted SAR (W/kg)	Determine OFDM SAR
MHz	Ch											
2437.0	6	802.11b	DSSS	19.0	0.400	2437	802.11g	OFDM	17.5	0.708	0.283	X
2437.0	6	802.11b	DSSS	19.0	0.400	2437	802.11n	OFDM	16.0	0.501	0.200	X
ANSI / IEEE C95.1-1992- SAFETY LIMIT Spatial Peak Uncontrolled Exposure/General Population Exposure							Body 1.6 W/kg (mW/g) averaged over 1 gram					

Note: SAR is not required for the following 2.4 GHz OFDM conditions. When the highest reported SAR for DSSS is adjusted by the ratio of OFDM to DSSS specified maximum output power and the adjusted SAR is ≤ 1.2 W/kg.

Table 12.3.7 Bluetooth Hotspot SAR

MEASUREMENT RESULTS														
FREQUENCY		Mode	Maximum Allowed Power [dBm]	Conducted Power [dBm]	Drift Power [dB]	Phantom Position	Device Serial Number	Rate [Mbps]	Duty Cycle (%)	1g SAR (W/kg)	Scaling Factor	Scaling Factor (Duty Cycle)	1g Scaled SAR (W/kg)	Plots #
MHz	Ch													
2441.0	39	Bluetooth	11.50	10.15	-0.130	10 mm [Top]	FCC #1	1	76.8	0.021	1.365	1.302	0.037	
2441.0	39	Bluetooth	11.50	10.15	-0.140	10 mm [Front]	FCC #1	1	76.8	0.019	1.365	1.302	0.034	
2441.0	39	Bluetooth	11.50	10.15	0.170	10 mm [Rear]	FCC #1	1	76.8	0.043	1.365	1.302	0.076	
2441.0	39	Bluetooth	11.50	10.15	-0.110	10 mm [Left]	FCC #1	1	76.8	0.050	1.365	1.302	0.089	A36
ANSI / IEEE C95.1-1992- SAFETY LIMIT Spatial Peak Uncontrolled Exposure/General Population Exposure								Body 1.6 W/kg (mW/g) averaged over 1 gram						

12.4 SAR Test Notes

General Notes:

1. The test data reported are the worst-case SAR values according to test procedures specified in IEEE 1528-2013, and FCC KDB Publication 447498 D01v06.
2. Batteries are fully charged at the beginning of the SAR measurements. A standard battery was used for all SAR measurements.
3. Liquid tissue depth was at least 15.0 cm for all frequencies.
4. The manufacturer has confirmed that the device(s) tested have the same physical, mechanical and thermal characteristics and are within operational tolerances expected for production units
5. SAR results were scaled to the maximum allowed power to demonstrate compliance per FCC KDB Publication 447498 D01v06.
6. Device was tested using a fixed spacing for body-worn accessory testing. A separation distance of 10 mm was considered because the manufacturer has determined that there will be body-worn accessories available in the marketplace for users to support this separation distance.
7. Per FCC KDB Publication 648474 D04v01r03, body-worn SAR was evaluated without a headset connected to the device. Since the standalone reported body-worn SAR was not > 1.2 W/kg, no additional body-worn SAR evaluations using a headset cable were performed.
8. During SAR Testing for the Wireless Router conditions per FCC KDB Publication 941225 D06v02r01, the actual Portable Hotspot operation (with actual simultaneous transmission of a transmitter with WIFI) was not activated.
9. SAR measurements were performed using the DASY5 automated system. The procedure for spatial peak SAR evaluation has been implemented according to the IEEE 1528 standard. During a maximum search, global and local maxima searches are automatically performed in 2-D after each area scan measurement. The algorithm will find the global maximum and all local maxima within 2 dB of the global maxima for all SAR distributions. All local maxima within 2 dB of the global maximum were searched and passed for the Zoom Scan measurement.

GSM Notes:

1. Body-Worn accessory testing is typically associated with voice operations. Therefore, GSM voice was evaluated for body-worn SAR.
2. This device supports GSM VOIP in the head and body-worn configurations; therefore GPRS was additionally evaluated for head and body-worn compliance.
3. Justification for reduced test configurations per KDB Publication 941225 D01v03r01 and October 2013 TCB Workshop Notes: The source-based frame-averaged output power was evaluated for all GPRS/EDGE slot configurations. The configuration with the highest target frame averaged output power was evaluated for hotspot SAR.
4. Per FCC KDB Publication 447498 D01v06, if the reported (scaled) SAR measured at the middle channel or highest output power channel for each test configuration is ≤ 0.8 W/kg then testing at the other channels is not required for such test configuration(s). Since the maximum output power variation across the required test channels is not > $\frac{1}{2}$ dB, the middle channel was used for testing.

WCDMA (UMTS) Notes:

1. WCDMA (UMTS) mode in was tested under RMC 12.2 kbps with HSPA Inactive per KDB Publication 941225 D01v03r01. AMR and HSPA SAR was not required since the average output power of the HSPA subtests was not more than 0.25 dB higher than the RMC level and SAR was less than 1.2 W/kg.
2. Per FCC KDB Publication 447498 D01v06, if the reported (scaled) SAR measured at the middle channel or highest output power channel for each test configuration is ≤ 0.8 W/kg then testing at the other channels is not required for such test configuration(s). When the maximum output power variation across the required test channels is $> \frac{1}{2}$ dB, instead of the middle channel, the highest output power channel was used.

LTE Notes:

1. LTE Considerations: LTE test configurations are determined according to SAR Evaluation Considerations for LTE Devices in FCC KDB Publication 941225 D05v02r05. The general test procedures used for testing can be found in Section 5.
2. According to FCC KDB 941225 D05v02r05, when the reported SAR is ≤ 0.8 W/kg, testing of the 100% RB allocation and required test channels is not required.
Otherwise, SAR is required for the remaining required test channels using the 1 RB, 50% RB and 100% RB allocation with highest output power for that channel.
Only one channel, and as reported SAR values for 1 RB allocation and 50% RB allocation were less than 1.45 W/kg only the highest power RB offset for each allocation was required.
3. MPR is permanently implemented for this device by the manufacturer. The specific manufacturer target MPR is indicated alongside the SAR results. MPR is enabled for this device, according to 3GPP TS36. 101 Section 6.2.3 – 6.2.5 under Table 6.2.3-1.
4. A-MPR was disabled for all SAR tests by setting NS=1 on the base station simulator. SAR tests were performed with the same number of RB and RB offsets transmitting on all TTI frames (maximum TTI).
5. Per KDB Publication 941225 D05Av01r02, SAR for LTE CA operations was not needed since the maximum average output power in LTE CA mode was not > 0.25 dB higher than the maximum output power when downlink carrier aggregation was inactive.
6. SAR test reduction is applied using the following criteria:
Start with the largest channel bandwidth and measure SAR for QPSK with 1 RB, and 50% RB allocation, using the RB offset and required test channel combination with the highest maximum output power among RB offsets at the upper edge, middle and lower edge of each required test channel. When the reported SAR is > 0.8 W/kg, testing for other channels is performed at the highest output power level for 1 RB, and 50% RB configuration for that channel. Testing for 100% RB configuration is performed at the highest output power level for 100% RB configuration across the Low, Mid and High channel when the highest reported SAR for 1 RB and 50% RB are > 0.8 W/kg, Testing for the remaining required channels is not needed because the reported SAR for 100% RB Allocation < 1.45 W/kg. Testing for 16QAM modulation is not required because the reported SAR for QPSK is < 1.45 W/kg and its output power is not more than 0.5 dB higher than that a QPSK. Testing for the other channel bandwidths is not required because the reported SAR for the highest channel bandwidth is < 1.45 W/kg and its output power is not more than 0.5 dB higher than that of the highest channel bandwidth.

WLAN Notes:

1. The initial test position procedures were applied. The test position with the highest extrapolated peak SAR will be used as the initial test position. When reported SAR for the initial test position is ≤ 0.4 W/kg, no additional testing for the remaining test positions was required. Otherwise, SAR is evaluated at the subsequent highest peak SAR positions until the reported SAR result is ≤ 0.8 W/kg or all test positions are measured.
2. Justification for test configurations for WLAN per KDB Publication 248227 D01v02r02 for 2.4 GHz WIFI single transmission chain operations, the highest measured maximum output power channel for DSSS was selected for SAR measurement. SAR for OFDM modes (2.4 GHz 802.11g/n) was not required due to the maximum allowed powers and the highest reported DSSS SAR when the highest reported SAR for DSSS is adjusted by the ratio of OFDM to DSSS specified maximum output and the adjusted SAR is ≤ 1.2 W/kg.
3. When the maximum reported 1g averaged SAR ≤ 0.8 W/kg, SAR testing on additional channels was not required. Otherwise, SAR for the next highest output power channel was required until the reported SAR result was ≤ 1.20 W/kg or all test channels were measured.
4. The device was configured to transmit continuously at the required data rate, channel bandwidth and signal modulation, using the highest transmission duty factor to determine compliance.

Bluetooth Notes:

1. Bluetooth SAR was measured with the device connected to a call with hopping disabled with DH5 operation. Per October 2016 TCB Workshop Notes, the reported SAR was scaled to the 100% transmission duty factor to determine compliance. Refer to section 10.5 for the time-domain plot and calculation for the duty factor of the device.

13. FCC MULTI-TX AND ANTENNA SAR CONSIDERATIONS

13.1 Introduction

The following procedures adopted from FCC KDB Publication 447498 D01v06 are applicable to handsets with built-in unlicensed transmitters such as 802.11b/g/n and Bluetooth devices which may simultaneously transmit with the licensed transmitter.

13.2 Simultaneous Transmission Procedures

This device contains transmitters that may operate simultaneously. Therefore simultaneous transmission analysis is required. Per FCC KDB 447498 D01v06 4.3.2 and IEEE 1528-2013 Section 6.3.4.1.2, simultaneous transmission SAR test exclusion may be applied when the sum of the sum 1-g SAR for all the simultaneous transmitting antennas in a specific a physical test configuration is ≤ 1.6 W/kg. The different test position in an exposure condition may be considered collectively to determine SAR test exclusion according to the sum of 1-g or 10-g SAR.

13.3 Simultaneous Transmission Capabilities

According to FCC KDB Publication 447498 D01v06, transmitters are considered to be transmitting simultaneously when there is overlapping transmission, with the exception of transmissions during network hand-offs with maximum hand-off duration less than 30 seconds. Possible transmission paths for the DUT are shown in Figure 13.1 and are color-coded to indicate communication modes which share the same path. Modes which share the same transmission path cannot transmit simultaneously with one another.

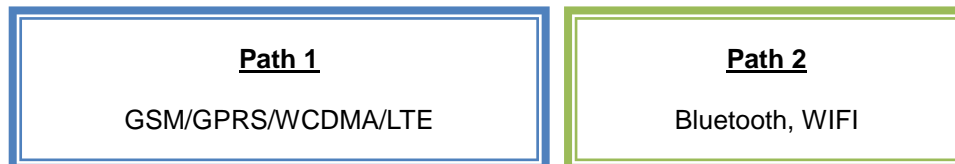

Figure 13.1 Simultaneous Transmission Paths

This device contains multiple transmitters that may operate simultaneously, and therefore requires a simultaneous transmission analysis according to FCC KDB Publication 447498 D01v06.

Table 13.3.1 Simultaneous Transmission Scenarios

No.	Capable TX Configuration	GSM 850/1900 (Voice)	GPRS 850/1900 (Data)	WCDMA B5/B4/B2 (Voice)	WCDMA B5/B4/B2 (Data)	LTE B12/B17/B5/B66/B4/B2/B7	WiFi 2.4GHz 802.11b/g/n	Bluetooth 2.4GHz
1	GSM 850/1900 (Voice)		No	No	No	No	Yes	Yes
2	GPRS 850/1900 (Data)	No		No	No	No	Yes	Yes
3	WCDMA B5/B4/B2 (Voice)	No	No		No	No	Yes	Yes
4	WCDMA B5/B4/B2 (Data)	No	No	No		No	Yes	Yes
5	LTE B12/B17/B5/B66/B4/B2/B7	No	No	No	No		Yes	Yes
6	WiFi 2.4GHz 802.11b/g/n	Yes	Yes	Yes	Yes	Yes		No
7	Bluetooth 2.4GHz	Yes	Yes	Yes	Yes	Yes	No	

Table 13.3.2 Simultaneous SAR Cases

No.	Capable Transmit Configuration	Head SAR	Body-Worn SAR	Hotspot SAR	Note
1	GSM Voice + Wi-Fi 2.4 GHz	Yes	Yes	N/A	
2	GSM Voice + Bluetooth 2.4 GHz	Yes	Yes	N/A	
3	WCDMA + Wi-Fi 2.4 GHz	Yes	Yes	Yes	
4	WCDMA + Bluetooth 2.4 GHz	Yes	Yes	Yes	
5	LTE + Wi-Fi 2.4 GHz	Yes	Yes	Yes	
6	LTE + Bluetooth 2.4 GHz	Yes	Yes	Yes	
7	GPRS/EDGE + Wi-Fi 2.4 GHz	Yes	Yes	Yes	
8	GPRS/EDGE + Bluetooth 2.4 GHz	Yes	Yes	Yes	

Notes:

- WiFi 2.4GHz is supported Hotspot and WiFi-Direct(GO/GC).
- LTE, WCDMA, GPRS/EDGE is supported Hotspot.
- VoIP is supported in LTE, WCDMA, GSM
- Bluetooth and WiFi can not transmit simultaneously at 2.4G band.
- GSM, WCDMA and LTE can not transmit simultaneously since they share the same chip.
- When the user utilizes multiple services in UMTS 3G mode it uses multi-Radio Access Bearer or multi-RAB. The power control is based on a physical control channel (Dedicated Physical Control Channel [DPCC]) and power control will be adjusted to meet the needs of both services. Therefore, the UMTS+WLAN scenario also represents the UMTS Voice/DATA + WLAN Hotspot scenario.
- Per the manufacturer, WiFi Direct is expected to be used in conjunction with a held-to-ear or body-worn accessory voice call. Simultaneous transmission scenarios involving WiFi direct are included in the above table.

13.4 Head SAR Simultaneous Transmission Analysis

Table 13.4.1 Simultaneous Transmission Scenario : 2G/3G/4G + 2.4 GHz W-LAN (Held to Ear)

Exposure Condition	Mode	Configuration	2G/3G/4G SAR (W/kg)	2.4G W-LAN SAR (W/kg)	ΣSAR (W/kg)
			1	2	1+2
Head SAR	GSM 850	Left Touch	0.117	0.248	0.365
		Right Touch	0.081	1.080	1.160
		Left Tilt	0.042	0.282	0.323
		Right Tilt	0.049	0.973	1.022
	GPRS 850	Left Touch	0.194	0.248	0.441
		Right Touch	0.130	1.080	1.210
		Left Tilt	0.074	0.282	0.356
		Right Tilt	0.081	0.973	1.054
	GSM 1900	Left Touch	0.141	0.248	0.389
		Right Touch	0.109	1.080	1.189
		Left Tilt	0.048	0.282	0.330
		Right Tilt	0.079	0.973	1.052
	GPRS 1900	Left Touch	0.221	0.248	0.469
		Right Touch	0.181	1.080	1.261
		Left Tilt	0.076	0.282	0.358
		Right Tilt	0.138	0.973	1.111
	WCDMA 850	Left Touch	0.173	0.248	0.421
		Right Touch	0.104	1.080	1.184
		Left Tilt	0.071	0.282	0.353
		Right Tilt	0.078	0.973	1.051
	WCDMA 1700	Left Touch	0.055	0.248	0.303
		Right Touch	0.051	1.080	1.131
		Left Tilt	0.023	0.282	0.304
		Right Tilt	0.019	0.973	0.992
	WCDMA 1900	Left Touch	0.048	0.248	0.295
		Right Touch	0.031	1.080	1.111
		Left Tilt	0.024	0.282	0.305
		Right Tilt	0.013	0.973	0.986
	LTE Band 12	Left Touch	0.134	0.248	0.382
		Right Touch	0.087	1.080	1.167
		Left Tilt	0.056	0.282	0.337
		Right Tilt	0.056	0.973	1.029
	LTE Band 5	Left Touch	0.162	0.248	0.409
		Right Touch	0.123	1.080	1.202
		Left Tilt	0.065	0.282	0.346
		Right Tilt	0.082	0.973	1.055
	LTE Band 66	Left Touch	0.087	0.248	0.334
		Right Touch	0.078	1.080	1.157
		Left Tilt	0.036	0.282	0.318
		Right Tilt	0.046	0.973	1.019
LTE Band 2	Left Touch	0.089	0.248	0.337	
	Right Touch	0.054	1.080	1.134	
	Left Tilt	0.016	0.282	0.298	
	Right Tilt	0.033	0.973	1.006	
LTE Band 7	Left Touch	0.061	0.248	0.309	
	Right Touch	0.070	1.080	1.150	
	Left Tilt	0.016	0.282	0.298	
	Right Tilt	0.035	0.973	1.008	

Table 13.4.2 Simultaneous Transmission Scenario : 2G/3G/4G + Bluetooth (Held to Ear)

Exposure Condition	Mode	Configuration	2G/3G/4G SAR (W/kg)	Bluetooth SAR (W/kg)	Σ SAR (W/kg)
			1	2	1+2
Head SAR	GSM 850	Left Touch	0.117	0.076	0.193
		Right Touch	0.081	0.299	0.380
		Left Tilt	0.042	0.073	0.115
		Right Tilt	0.049	0.222	0.271
	GPRS 850	Left Touch	0.194	0.076	0.270
		Right Touch	0.130	0.299	0.429
		Left Tilt	0.074	0.073	0.147
		Right Tilt	0.081	0.222	0.303
	GSM 1900	Left Touch	0.141	0.076	0.217
		Right Touch	0.109	0.299	0.408
		Left Tilt	0.048	0.073	0.121
		Right Tilt	0.079	0.222	0.301
	GPRS 1900	Left Touch	0.221	0.076	0.297
		Right Touch	0.181	0.299	0.480
		Left Tilt	0.076	0.073	0.149
		Right Tilt	0.138	0.222	0.360
	WCDMA 850	Left Touch	0.173	0.076	0.249
		Right Touch	0.104	0.299	0.403
		Left Tilt	0.071	0.073	0.144
		Right Tilt	0.078	0.222	0.300
	WCDMA 1700	Left Touch	0.055	0.076	0.131
		Right Touch	0.051	0.299	0.350
		Left Tilt	0.023	0.073	0.096
		Right Tilt	0.019	0.222	0.241
	WCDMA 1900	Left Touch	0.048	0.076	0.124
		Right Touch	0.031	0.299	0.330
		Left Tilt	0.024	0.073	0.097
		Right Tilt	0.013	0.222	0.235
	LTE Band 12	Left Touch	0.134	0.076	0.210
		Right Touch	0.087	0.299	0.386
		Left Tilt	0.056	0.073	0.129
		Right Tilt	0.056	0.222	0.278
	LTE Band 5	Left Touch	0.162	0.076	0.238
		Right Touch	0.123	0.299	0.422
		Left Tilt	0.065	0.073	0.138
		Right Tilt	0.082	0.222	0.304
	LTE Band 66	Left Touch	0.087	0.076	0.163
		Right Touch	0.078	0.299	0.377
		Left Tilt	0.036	0.073	0.109
		Right Tilt	0.046	0.222	0.268
LTE Band 2	Left Touch	0.089	0.076	0.165	
	Right Touch	0.054	0.299	0.353	
	Left Tilt	0.016	0.073	0.089	
	Right Tilt	0.033	0.222	0.255	
LTE Band 7	Left Touch	0.061	0.076	0.137	
	Right Touch	0.070	0.299	0.369	
	Left Tilt	0.016	0.073	0.089	
	Right Tilt	0.035	0.222	0.257	

13.5 Body-Worn Simultaneous Transmission Analysis

Table 13.5.1 Simultaneous Transmission Scenario : 2G/3G/4G + 2.4 GHz W-LAN (Body-Worn at 10 mm)

Exposure Condition	Mode	Configuration	2G/3G/4G SAR (W/kg)	2.4G W-LAN SAR (W/kg)	Σ SAR (W/kg)
			1	2	1+2
Body-Worn SAR	GSM 850	Front	0.454	0.149	0.603
		Rear	0.419	0.397	0.816
	GPRS 850	Front	0.680	0.149	0.829
		Rear	0.658	0.397	1.056
	GSM 1900	Front	0.282	0.149	0.431
		Rear	0.268	0.397	0.665
	GPRS 1900	Front	0.518	0.149	0.667
		Rear	0.482	0.397	0.879
	WCDMA 850	Front	0.688	0.149	0.837
		Rear	0.649	0.397	1.046
	WCDMA 1700	Front	0.222	0.149	0.371
		Rear	0.279	0.397	0.676
	WCDMA 1900	Front	0.174	0.149	0.323
		Rear	0.185	0.397	0.582
	LTE Band 12	Front	0.564	0.149	0.713
		Rear	0.493	0.397	0.890
	LTE Band 5	Front	0.589	0.149	0.738
		Rear	0.661	0.397	1.058
	LTE Band 66	Front	0.387	0.149	0.536
		Rear	0.448	0.397	0.845
LTE Band 2	Front	0.321	0.149	0.470	
	Rear	0.280	0.397	0.677	
LTE Band 7	Front	0.321	0.149	0.470	
	Rear	0.357	0.397	0.754	

Table 13.5.2 Simultaneous Transmission Scenario : 2G/3G/4G + Bluetooth (Body-Worn at 10 mm)

Exposure Condition	Mode	Configuration	2G/3G/4G SAR (W/kg)	Bluetooth SAR (W/kg)	Σ SAR (W/kg)
			1	2	1+2
Body-Worn SAR	GSM 850	Front	0.454	0.034	0.488
		Rear	0.419	0.076	0.495
	GPRS 850	Front	0.680	0.034	0.714
		Rear	0.658	0.076	0.734
	GSM 1900	Front	0.282	0.034	0.316
		Rear	0.268	0.076	0.344
	GPRS 1900	Front	0.518	0.034	0.552
		Rear	0.482	0.076	0.558
	WCDMA 850	Front	0.688	0.034	0.722
		Rear	0.649	0.076	0.725
	WCDMA 1700	Front	0.222	0.034	0.256
		Rear	0.279	0.076	0.355
	WCDMA 1900	Front	0.174	0.034	0.208
		Rear	0.185	0.076	0.261
	LTE Band 12	Front	0.564	0.034	0.598
		Rear	0.493	0.076	0.569
	LTE Band 5	Front	0.589	0.034	0.623
		Rear	0.661	0.076	0.737
	LTE Band 66	Front	0.387	0.034	0.421
		Rear	0.448	0.076	0.524
LTE Band 2	Front	0.321	0.034	0.355	
	Rear	0.280	0.076	0.356	
LTE Band 7	Front	0.321	0.034	0.355	
	Rear	0.357	0.076	0.433	

13.6 Hotspot SAR Simultaneous Transmission Analysis

Per FCC KDB Publication 941225 D06v02r01, the device edges with antennas more than 2.5 cm from edge are not required to be evaluated for SAR ("").

Table 13.6.1 Simultaneous Transmission Scenario : 2G/3G/4G + 2.4 GHz W-LAN (Hotspot at 10 mm)

Exposure Condition	Mode	Configuration	2G/3G/4G SAR (W/kg)	2.4G W-LAN SAR (W/kg)	ΣSAR (W/kg)
			1	2	1+2
Hotspot SAR	GPRS 850	Top	-	0.179	0.179
		Bottom	0.399	-	0.399
		Front	0.680	0.149	0.830
		Rear	0.658	0.397	1.055
		Right	0.107	-	0.107
		Left	0.322	0.400	0.722
	GPRS 1900	Top	-	0.179	0.179
		Bottom	1.052	-	1.052
		Front	0.518	0.149	0.667
		Rear	0.482	0.397	0.879
		Right	0.113	-	0.113
		Left	0.239	0.400	0.639
	WCDMA 850	Top	-	0.179	0.179
		Bottom	0.412	-	0.412
		Front	0.688	0.149	0.837
		Rear	0.649	0.397	1.046
		Right	0.123	-	0.123
	WCDMA 1700	Left	0.305	0.400	0.705
		Top	-	0.179	0.179
		Bottom	0.453	-	0.453
		Front	0.222	0.149	0.371
		Rear	0.279	0.397	0.676
	WCDMA 1900	Right	0.048	-	0.048
		Left	0.151	0.400	0.551
		Top	-	0.179	0.179
		Bottom	0.334	-	0.334
		Front	0.174	0.149	0.323
	LTE Band 12	Rear	0.185	0.397	0.582
		Right	0.043	-	0.043
		Left	0.100	0.400	0.500
		Top	-	0.179	0.179
		Bottom	0.406	-	0.406
	LTE Band 5	Front	0.564	0.149	0.713
		Rear	0.493	0.397	0.890
		Right	0.154	-	0.154
		Left	0.224	0.400	0.624
		Top	-	0.179	0.179
	LTE Band 66	Bottom	0.339	-	0.339
		Front	0.589	0.149	0.738
		Rear	0.661	0.397	1.058
		Right	0.105	-	0.105
		Left	0.317	0.400	0.717
	LTE Band 66	Top	-	0.179	0.179
		Bottom	0.832	-	0.832
		Front	0.387	0.149	0.536
		Rear	0.448	0.397	0.845
		Right	0.091	-	0.091
	LTE Band 2	Left	0.301	0.400	0.701
Top		-	0.179	0.179	
Bottom		0.557	-	0.557	
Front		0.321	0.149	0.470	
Rear		0.280	0.397	0.677	
LTE Band 7	Right	0.068	-	0.068	
	Left	0.142	0.400	0.542	
	Top	-	0.179	0.179	
	Bottom	0.428	-	0.428	
	Front	0.321	0.149	0.470	
LTE Band 7	Rear	0.357	0.397	0.754	
	Right	0.041	-	0.041	
	Left	0.152	0.400	0.552	
	Top	-	0.179	0.179	
	Bottom	0.428	-	0.428	

Table 13.6.14 Simultaneous Transmission Scenario : 2G/3G/4G + Bluetooth (Hotspot at 10 mm)

Exposure Condition	Mode	Configuration	2G/3G/4G SAR (W/kg)	Bluetooth SAR (W/kg)	Σ SAR (W/kg)
			1	2	1+2
Hotspot SAR	GPRS 850	Top	-	0.037	0.037
		Bottom	0.399	-	0.399
		Front	0.680	0.034	0.714
		Rear	0.658	0.076	0.734
		Right	0.107	-	0.107
		Left	0.322	0.089	0.411
	GPRS 1900	Top	-	0.037	0.037
		Bottom	1.052	-	1.052
		Front	0.518	0.034	0.552
		Rear	0.482	0.076	0.558
		Right	0.113	-	0.113
		Left	0.239	0.089	0.328
	WCDMA 850	Top	-	0.037	0.037
		Bottom	0.412	-	0.412
		Front	0.688	0.034	0.722
		Rear	0.649	0.076	0.725
		Right	0.123	-	0.123
		Left	0.305	0.089	0.394
	WCDMA 1700	Top	-	0.037	0.037
		Bottom	0.453	-	0.453
		Front	0.222	0.034	0.256
		Rear	0.279	0.076	0.355
		Right	0.048	-	0.048
		Left	0.151	0.089	0.240
	WCDMA 1900	Top	-	0.037	0.037
		Bottom	0.334	-	0.334
		Front	0.174	0.034	0.208
		Rear	0.185	0.076	0.261
		Right	0.043	-	0.043
		Left	0.100	0.089	0.189
	LTE Band 12	Top	-	0.037	0.037
		Bottom	0.406	-	0.406
		Front	0.564	0.034	0.598
		Rear	0.493	0.076	0.569
		Right	0.154	-	0.154
		Left	0.224	0.089	0.313
	LTE Band 5	Top	-	0.037	0.037
		Bottom	0.339	-	0.339
		Front	0.589	0.034	0.623
		Rear	0.661	0.076	0.737
		Right	0.105	-	0.105
		Left	0.317	0.089	0.406
	LTE Band 66	Top	-	0.037	0.037
		Bottom	0.832	-	0.832
		Front	0.387	0.034	0.421
		Rear	0.448	0.076	0.524
		Right	0.091	-	0.091
		Left	0.301	0.089	0.390
	LTE Band 2	Top	-	0.037	0.037
		Bottom	0.557	-	0.557
Front		0.321	0.034	0.355	
Rear		0.280	0.076	0.356	
Right		0.068	-	0.068	
Left		0.142	0.089	0.231	
LTE Band 7	Top	-	0.037	0.037	
	Bottom	0.428	-	0.428	
	Front	0.321	0.034	0.355	
	Rear	0.357	0.076	0.433	
	Right	0.041	-	0.041	
	Left	0.152	0.089	0.241	

13.7 Phablet SAR Simultaneous Transmission Analysis

Per FCC KDB Publication 648474 D04 Handset SAR, Phablet SAR tests were not required of Hotspot 1g SAR (scaled to maximum output power, including tolerance) < 1.2 W/kg. Therefore no further analysis was required to for Phablet Simultaneous Transmission Analysis.

13.8 Simultaneous Transmission Conclusion

The above numerical summed SAR results for all the worst-case simultaneous transmission conditions were below the SAR limit. Therefore, the above analysis is sufficient to determine that simultaneous transmission cases will not exceed the SAR limit and therefore no measured volumetric simultaneous SAR summation is required per FCC KDB Publication 447498 D01v06 and IEEE 1528-2013 Section 6.3.4.1.2.

14. SAR MEASUREMENT VARIABILITY

14.1 Measurement Variability

Per FCC KDB Publication 865664 D01v01r04, SAR measurement variability was assessed for each frequency band, which was determined by the SAR probe calibration point and tissue-equivalent medium used for the device measurements. When both head and body tissue-equivalent media were required for SAR measurements in a frequency band, the variability measurement procedures were applied to the tissue medium with the highest measured SAR, using the highest measured SAR configuration for that tissue-equivalent medium. These additional measurements were repeated after the completion of all measurements requiring the same head or body tissue-equivalent medium in a frequency band. The test device was returned to ambient conditions (normal room temperature) with the battery fully charged before it was re-mounted on the device holder for the repeated measurement(s) to minimize any unexpected variations in the repeated results.

SAR Measurement Variability was assessed using the following procedures for each frequency band:

1. When the original highest measured SAR is ≥ 0.80 W/kg, the measurement was repeated once.
2. A second repeated measurement was performed only if the ratio of largest to smallest SAR for the original and first repeated measurements was > 1.20 or when the original or repeated measurement was ≥ 1.45 W/kg (~ 10% from the 1-g SAR limit).
3. A third repeated measurement was performed only if the original, first or second repeated measurement was ≥ 1.5 W/kg and the ratio of largest to smallest SAR for the original, first and second repeated measurements is > 1.20 .
4. Repeated measurements are not required when the original highest measured SAR is < 0.80 W/kg
5. The same procedures should be adapted for measurements according to extremity exposure limits by applying a factor of 2.5 for extremity exposure to the corresponding SAR thresholds.

Table 14.1 Head SAR Measurement Variability Results

Frequency		Mode	Service	# of Time Slots	Spacing [Side]	Measured SAR (1g)	1st Repeated SAR(1g)	Ratio	2nd Repeated SAR(1g)	Ratio	3rd Repeated SAR(1g)	Ratio
MHz	Ch.					(W/kg)	(W/kg)		(W/kg)		(W/kg)	
2437.0	6	802.11b	-	-	Right Touch	0.892	0.892	1.00	-	-	-	-
ANSI / IEEE C95.1-1992– SAFETY LIMIT Spatial Peak Uncontrolled Exposure/General Population Exposure						Head 1.6 W/kg (mW/g) averaged over 1 gram						

Table 14.2 Hotspot SAR Measurement Variability Results

Frequency		Mode	Service	# of Time Slots	Spacing [Side]	Measured SAR (1g)	1st Repeated SAR(1g)	Ratio	2nd Repeated SAR(1g)	Ratio	3rd Repeated SAR(1g)	Ratio
MHz	Ch.					(W/kg)	(W/kg)		(W/kg)		(W/kg)	
1850.2	512	PCS1900	GPRS	4	10 mm [Bottom]	1.050	1.030	1.02	-	-	-	-
1745.0	132322	LTE B66	-	-	10 mm [Bottom]	0.821	0.820	1.00	-	-	-	-
ANSI / IEEE C95.1-1992– SAFETY LIMIT Spatial Peak Uncontrolled Exposure/General Population Exposure						Body 1.6 W/kg (mW/g) averaged over 1 gram						

15. MEASUREMENT UNCERTAINTIES

750 MHz Head

Error Description	Uncertainty value $\pm\%$	Probability Distribution	Divisor	(Ci) 1g	Standard (1g)	vi 2 or Veff
Measurement System						
Probe calibration	± 6.0	Normal	1	1	$\pm 6.0 \%$	∞
Axial isotropy	± 4.7	Rectangular	$\sqrt{3}$	1	$\pm 2.7 \%$	∞
Hemispherical isotropy	± 9.6	Rectangular	$\sqrt{3}$	1	$\pm 5.5 \%$	∞
Boundary Effects	± 0.8	Rectangular	$\sqrt{3}$	1	$\pm 0.46 \%$	∞
Probe Linearity	± 4.7	Rectangular	$\sqrt{3}$	1	$\pm 2.7 \%$	∞
Probe modulation response	± 2.4	Rectangular	$\sqrt{3}$	1	$\pm 1.4 \%$	∞
Detection limits	± 0.25	Rectangular	$\sqrt{3}$	1	$\pm 0.14 \%$	∞
Readout Electronics	± 1.0	Normal	1	1	$\pm 1.0 \%$	∞
Response time	± 0.8	Rectangular	$\sqrt{3}$	1	$\pm 0.46 \%$	∞
Integration time	± 2.6	Rectangular	$\sqrt{3}$	1	$\pm 1.5 \%$	∞
RF Ambient Conditions – Noise	± 3.0	Rectangular	$\sqrt{3}$	1	$\pm 1.7 \%$	∞
RF Ambient Conditions – Reflections	± 3.0	Rectangular	$\sqrt{3}$	1	$\pm 1.7 \%$	∞
Probe Positioner	± 0.4	Rectangular	$\sqrt{3}$	1	$\pm 0.23 \%$	∞
Probe Positioning	± 2.9	Rectangular	$\sqrt{3}$	1	$\pm 1.7 \%$	∞
Algorithms for Max. SAR Eval.	± 1.0	Rectangular	$\sqrt{3}$	1	$\pm 0.58 \%$	∞
Test Sample Related						
Device Positioning	± 2.9	Normal	1	1	$\pm 2.9 \%$	145
Device Holder	± 3.6	Normal	1	1	$\pm 3.6 \%$	5
Power Drift	± 5.0	Rectangular	$\sqrt{3}$	1	$\pm 2.9 \%$	∞
SAR Scaling	± 2.0	Rectangular	$\sqrt{3}$	1	$\pm 1.2 \%$	∞
Physical Parameters						
Phantom Shell	± 4.0	Rectangular	$\sqrt{3}$	1	$\pm 2.3 \%$	∞
Liquid conductivity (Target)	± 5.0	Rectangular	$\sqrt{3}$	0.64	$\pm 2.9 \%$	∞
Liquid conductivity (Meas.)	± 4.2	Normal	1	0.64	$\pm 4.2 \%$	10
Liquid permittivity (Target)	± 5.0	Rectangular	$\sqrt{3}$	0.6	$\pm 2.9 \%$	∞
Liquid permittivity (Meas.)	± 4.1	Normal	1	0.6	$\pm 4.1 \%$	10
Temp. unc. - Conductivity	± 1.9	Rectangular	$\sqrt{3}$	0.78	$\pm 1.1 \%$	∞
Temp. unc. - Permittivity	± 2.0	Rectangular	$\sqrt{3}$	0.23	$\pm 1.2 \%$	∞
Combined Standard Uncertainty					$\pm 12 \%$	330
Expanded Uncertainty (k=2)					$\pm 24 \%$	

The above measurement uncertainties are according to IEEE Std 1528

750 MHz Body

Error Description	Uncertainty value $\pm\%$	Probability Distribution	Divisor	(Ci) 1g	Standard (1g)	vi 2 or Veff
Measurement System						
Probe calibration	± 6.0	Normal	1	1	$\pm 6.0 \%$	∞
Axial isotropy	± 4.7	Rectangular	$\sqrt{3}$	1	$\pm 2.7 \%$	∞
Hemispherical isotropy	± 9.6	Rectangular	$\sqrt{3}$	1	$\pm 5.5 \%$	∞
Boundary Effects	± 0.8	Rectangular	$\sqrt{3}$	1	$\pm 0.46 \%$	∞
Probe Linearity	± 4.7	Rectangular	$\sqrt{3}$	1	$\pm 2.7 \%$	∞
Probe modulation response	± 2.4	Rectangular	$\sqrt{3}$	1	$\pm 1.4 \%$	∞
Detection limits	± 0.25	Rectangular	$\sqrt{3}$	1	$\pm 0.14 \%$	∞
Readout Electronics	± 1.0	Normal	1	1	$\pm 1.0 \%$	∞
Response time	± 0.8	Rectangular	$\sqrt{3}$	1	$\pm 0.46 \%$	∞
Integration time	± 2.6	Rectangular	$\sqrt{3}$	1	$\pm 1.5 \%$	∞
RF Ambient Conditions – Noise	± 3.0	Rectangular	$\sqrt{3}$	1	$\pm 1.7 \%$	∞
RF Ambient Conditions – Reflections	± 3.0	Rectangular	$\sqrt{3}$	1	$\pm 1.7 \%$	∞
Probe Positioner	± 0.4	Rectangular	$\sqrt{3}$	1	$\pm 0.23 \%$	∞
Probe Positioning	± 2.9	Rectangular	$\sqrt{3}$	1	$\pm 1.7 \%$	∞
Algorithms for Max. SAR Eval.	± 1.0	Rectangular	$\sqrt{3}$	1	$\pm 0.58 \%$	∞
Test Sample Related						
Device Positioning	± 2.9	Normal	1	1	$\pm 2.9 \%$	145
Device Holder	± 3.6	Normal	1	1	$\pm 3.6 \%$	5
Power Drift	± 5.0	Rectangular	$\sqrt{3}$	1	$\pm 2.9 \%$	∞
SAR Scaling	± 2.0	Rectangular	$\sqrt{3}$	1	$\pm 1.2 \%$	∞
Physical Parameters						
Phantom Shell	± 4.0	Rectangular	$\sqrt{3}$	1	$\pm 2.3 \%$	∞
Liquid conductivity (Target)	± 5.0	Rectangular	$\sqrt{3}$	0.64	$\pm 2.9 \%$	∞
Liquid conductivity (Meas.)	± 4.3	Normal	1	0.64	$\pm 4.3 \%$	10
Liquid permittivity (Target)	± 5.0	Rectangular	$\sqrt{3}$	0.6	$\pm 2.9 \%$	∞
Liquid permittivity (Meas.)	± 4.0	Normal	1	0.6	$\pm 4.0 \%$	10
Temp. unc. - Conductivity	± 1.9	Rectangular	$\sqrt{3}$	0.78	$\pm 1.1 \%$	∞
Temp. unc. - Permittivity	± 1.9	Rectangular	$\sqrt{3}$	0.23	$\pm 1.1 \%$	∞
Combined Standard Uncertainty					$\pm 12 \%$	330
Expanded Uncertainty (k=2)					$\pm 24 \%$	

The above measurement uncertainties are according to IEEE Std 1528

835 MHz Head

Error Description	Uncertainty value $\pm\%$	Probability Distribution	Divisor	(Ci) 1g	Standard (1g)	vi 2 or Veff
Measurement System						
Probe calibration	± 6.0	Normal	1	1	$\pm 6.0 \%$	∞
Axial isotropy	± 4.7	Rectangular	$\sqrt{3}$	1	$\pm 2.7 \%$	∞
Hemispherical isotropy	± 9.6	Rectangular	$\sqrt{3}$	1	$\pm 5.5 \%$	∞
Boundary Effects	± 0.8	Rectangular	$\sqrt{3}$	1	$\pm 0.46 \%$	∞
Probe Linearity	± 4.7	Rectangular	$\sqrt{3}$	1	$\pm 2.7 \%$	∞
Probe modulation response	± 2.4	Rectangular	$\sqrt{3}$	1	$\pm 1.4 \%$	∞
Detection limits	± 0.25	Rectangular	$\sqrt{3}$	1	$\pm 0.14 \%$	∞
Readout Electronics	± 1.0	Normal	1	1	$\pm 1.0 \%$	∞
Response time	± 0.8	Rectangular	$\sqrt{3}$	1	$\pm 0.46 \%$	∞
Integration time	± 2.6	Rectangular	$\sqrt{3}$	1	$\pm 1.5 \%$	∞
RF Ambient Conditions – Noise	± 3.0	Rectangular	$\sqrt{3}$	1	$\pm 1.7 \%$	∞
RF Ambient Conditions – Reflections	± 3.0	Rectangular	$\sqrt{3}$	1	$\pm 1.7 \%$	∞
Probe Positioner	± 0.4	Rectangular	$\sqrt{3}$	1	$\pm 0.23 \%$	∞
Probe Positioning	± 2.9	Rectangular	$\sqrt{3}$	1	$\pm 1.7 \%$	∞
Algorithms for Max. SAR Eval.	± 1.0	Rectangular	$\sqrt{3}$	1	$\pm 0.58 \%$	∞
Test Sample Related						
Device Positioning	± 2.9	Normal	1	1	$\pm 2.9 \%$	145
Device Holder	± 3.6	Normal	1	1	$\pm 3.6 \%$	5
Power Drift	± 5.0	Rectangular	$\sqrt{3}$	1	$\pm 2.9 \%$	∞
SAR Scaling	± 2.0	Rectangular	$\sqrt{3}$	1	$\pm 1.2 \%$	∞
Physical Parameters						
Phantom Shell	± 4.0	Rectangular	$\sqrt{3}$	1	$\pm 2.3 \%$	∞
Liquid conductivity (Target)	± 5.0	Rectangular	$\sqrt{3}$	0.64	$\pm 2.9 \%$	∞
Liquid conductivity (Meas.)	± 3.8	Normal	1	0.64	$\pm 3.8 \%$	10
Liquid permittivity (Target)	± 5.0	Rectangular	$\sqrt{3}$	0.6	$\pm 2.9 \%$	∞
Liquid permittivity (Meas.)	± 4.0	Normal	1	0.6	$\pm 4.0 \%$	10
Temp. unc. - Conductivity	± 1.8	Rectangular	$\sqrt{3}$	0.78	$\pm 1.0 \%$	∞
Temp. unc. - Permittivity	± 1.9	Rectangular	$\sqrt{3}$	0.23	$\pm 1.1 \%$	∞
Combined Standard Uncertainty					$\pm 12 \%$	330
Expanded Uncertainty (k=2)					$\pm 24 \%$	

The above measurement uncertainties are according to IEEE Std 1528

835 MHz Body

Error Description	Uncertainty value $\pm\%$	Probability Distribution	Divisor	(Ci) 1g	Standard (1g)	vi 2 or Veff
Measurement System						
Probe calibration	± 6.0	Normal	1	1	$\pm 6.0 \%$	∞
Axial isotropy	± 4.7	Rectangular	$\sqrt{3}$	1	$\pm 2.7 \%$	∞
Hemispherical isotropy	± 9.6	Rectangular	$\sqrt{3}$	1	$\pm 5.5 \%$	∞
Boundary Effects	± 0.8	Rectangular	$\sqrt{3}$	1	$\pm 0.46 \%$	∞
Probe Linearity	± 4.7	Rectangular	$\sqrt{3}$	1	$\pm 2.7 \%$	∞
Probe modulation response	± 2.4	Rectangular	$\sqrt{3}$	1	$\pm 1.4 \%$	∞
Detection limits	± 0.25	Rectangular	$\sqrt{3}$	1	$\pm 0.14 \%$	∞
Readout Electronics	± 1.0	Normal	1	1	$\pm 1.0 \%$	∞
Response time	± 0.8	Rectangular	$\sqrt{3}$	1	$\pm 0.46 \%$	∞
Integration time	± 2.6	Rectangular	$\sqrt{3}$	1	$\pm 1.5 \%$	∞
RF Ambient Conditions – Noise	± 3.0	Rectangular	$\sqrt{3}$	1	$\pm 1.7 \%$	∞
RF Ambient Conditions – Reflections	± 3.0	Rectangular	$\sqrt{3}$	1	$\pm 1.7 \%$	∞
Probe Positioner	± 0.4	Rectangular	$\sqrt{3}$	1	$\pm 0.23 \%$	∞
Probe Positioning	± 2.9	Rectangular	$\sqrt{3}$	1	$\pm 1.7 \%$	∞
Algorithms for Max. SAR Eval.	± 1.0	Rectangular	$\sqrt{3}$	1	$\pm 0.58 \%$	∞
Test Sample Related						
Device Positioning	± 2.9	Normal	1	1	$\pm 2.9 \%$	145
Device Holder	± 3.6	Normal	1	1	$\pm 3.6 \%$	5
Power Drift	± 5.0	Rectangular	$\sqrt{3}$	1	$\pm 2.9 \%$	∞
SAR Scaling	± 2.0	Rectangular	$\sqrt{3}$	1	$\pm 1.2 \%$	∞
Physical Parameters						
Phantom Shell	± 4.0	Rectangular	$\sqrt{3}$	1	$\pm 2.3 \%$	∞
Liquid conductivity (Target)	± 5.0	Rectangular	$\sqrt{3}$	0.64	$\pm 2.9 \%$	∞
Liquid conductivity (Meas.)	± 4.1	Normal	1	0.64	$\pm 4.1 \%$	10
Liquid permittivity (Target)	± 5.0	Rectangular	$\sqrt{3}$	0.6	$\pm 2.9 \%$	∞
Liquid permittivity (Meas.)	± 4.0	Normal	1	0.6	$\pm 4.0 \%$	10
Temp. unc. - Conductivity	± 1.7	Rectangular	$\sqrt{3}$	0.78	$\pm 1.0 \%$	∞
Temp. unc. - Permittivity	± 1.9	Rectangular	$\sqrt{3}$	0.23	$\pm 1.1 \%$	∞
Combined Standard Uncertainty					$\pm 12 \%$	330
Expanded Uncertainty (k=2)					$\pm 24 \%$	

The above measurement uncertainties are according to IEEE Std 1528

1800 MHz Head

Error Description	Uncertainty value $\pm\%$	Probability Distribution	Divisor	(Ci) 1g	Standard (1g)	vi 2 or Veff
Measurement System						
Probe calibration	± 6.0	Normal	1	1	$\pm 6.0 \%$	∞
Axial isotropy	± 4.7	Rectangular	$\sqrt{3}$	1	$\pm 2.7 \%$	∞
Hemispherical isotropy	± 9.6	Rectangular	$\sqrt{3}$	1	$\pm 5.5 \%$	∞
Boundary Effects	± 0.8	Rectangular	$\sqrt{3}$	1	$\pm 0.46 \%$	∞
Probe Linearity	± 4.7	Rectangular	$\sqrt{3}$	1	$\pm 2.7 \%$	∞
Probe modulation response	± 2.4	Rectangular	$\sqrt{3}$	1	$\pm 1.4 \%$	∞
Detection limits	± 0.25	Rectangular	$\sqrt{3}$	1	$\pm 0.14 \%$	∞
Readout Electronics	± 1.0	Normal	1	1	$\pm 1.0 \%$	∞
Response time	± 0.8	Rectangular	$\sqrt{3}$	1	$\pm 0.46 \%$	∞
Integration time	± 2.6	Rectangular	$\sqrt{3}$	1	$\pm 1.5 \%$	∞
RF Ambient Conditions – Noise	± 3.0	Rectangular	$\sqrt{3}$	1	$\pm 1.7 \%$	∞
RF Ambient Conditions – Reflections	± 3.0	Rectangular	$\sqrt{3}$	1	$\pm 1.7 \%$	∞
Probe Positioner	± 0.4	Rectangular	$\sqrt{3}$	1	$\pm 0.23 \%$	∞
Probe Positioning	± 2.9	Rectangular	$\sqrt{3}$	1	$\pm 1.7 \%$	∞
Algorithms for Max. SAR Eval.	± 1.0	Rectangular	$\sqrt{3}$	1	$\pm 0.58 \%$	∞
Test Sample Related						
Device Positioning	± 2.9	Normal	1	1	$\pm 2.9 \%$	145
Device Holder	± 3.6	Normal	1	1	$\pm 3.6 \%$	5
Power Drift	± 5.0	Rectangular	$\sqrt{3}$	1	$\pm 2.9 \%$	∞
SAR Scaling	± 2.0	Rectangular	$\sqrt{3}$	1	$\pm 1.2 \%$	∞
Physical Parameters						
Phantom Shell	± 4.0	Rectangular	$\sqrt{3}$	1	$\pm 2.3 \%$	∞
Liquid conductivity (Target)	± 5.0	Rectangular	$\sqrt{3}$	0.64	$\pm 2.9 \%$	∞
Liquid conductivity (Meas.)	± 4.1	Normal	1	0.64	$\pm 4.1 \%$	10
Liquid permittivity (Target)	± 5.0	Rectangular	$\sqrt{3}$	0.6	$\pm 2.9 \%$	∞
Liquid permittivity (Meas.)	± 3.8	Normal	1	0.6	$\pm 3.8 \%$	10
Temp. unc. - Conductivity	± 1.9	Rectangular	$\sqrt{3}$	0.78	$\pm 1.1 \%$	∞
Temp. unc. - Permittivity	± 1.9	Rectangular	$\sqrt{3}$	0.23	$\pm 1.1 \%$	∞
Combined Standard Uncertainty					$\pm 12 \%$	330
Expanded Uncertainty (k=2)					$\pm 24 \%$	

The above measurement uncertainties are according to IEEE Std 1528

1800 MHz Body

Error Description	Uncertainty value $\pm\%$	Probability Distribution	Divisor	(Ci) 1g	Standard (1g)	vi 2 or Veff
Measurement System						
Probe calibration	± 6.0	Normal	1	1	$\pm 6.0 \%$	∞
Axial isotropy	± 4.7	Rectangular	$\sqrt{3}$	1	$\pm 2.7 \%$	∞
Hemispherical isotropy	± 9.6	Rectangular	$\sqrt{3}$	1	$\pm 5.5 \%$	∞
Boundary Effects	± 0.8	Rectangular	$\sqrt{3}$	1	$\pm 0.46 \%$	∞
Probe Linearity	± 4.7	Rectangular	$\sqrt{3}$	1	$\pm 2.7 \%$	∞
Probe modulation response	± 2.4	Rectangular	$\sqrt{3}$	1	$\pm 1.4 \%$	∞
Detection limits	± 0.25	Rectangular	$\sqrt{3}$	1	$\pm 0.14 \%$	∞
Readout Electronics	± 1.0	Normal	1	1	$\pm 1.0 \%$	∞
Response time	± 0.8	Rectangular	$\sqrt{3}$	1	$\pm 0.46 \%$	∞
Integration time	± 2.6	Rectangular	$\sqrt{3}$	1	$\pm 1.5 \%$	∞
RF Ambient Conditions – Noise	± 3.0	Rectangular	$\sqrt{3}$	1	$\pm 1.7 \%$	∞
RF Ambient Conditions – Reflections	± 3.0	Rectangular	$\sqrt{3}$	1	$\pm 1.7 \%$	∞
Probe Positioner	± 0.4	Rectangular	$\sqrt{3}$	1	$\pm 0.23 \%$	∞
Probe Positioning	± 2.9	Rectangular	$\sqrt{3}$	1	$\pm 1.7 \%$	∞
Algorithms for Max. SAR Eval.	± 1.0	Rectangular	$\sqrt{3}$	1	$\pm 0.58 \%$	∞
Test Sample Related						
Device Positioning	± 2.9	Normal	1	1	$\pm 2.9 \%$	145
Device Holder	± 3.6	Normal	1	1	$\pm 3.6 \%$	5
Power Drift	± 5.0	Rectangular	$\sqrt{3}$	1	$\pm 2.9 \%$	∞
SAR Scaling	± 2.0	Rectangular	$\sqrt{3}$	1	$\pm 1.2 \%$	∞
Physical Parameters						
Phantom Shell	± 4.0	Rectangular	$\sqrt{3}$	1	$\pm 2.3 \%$	∞
Liquid conductivity (Target)	± 5.0	Rectangular	$\sqrt{3}$	0.64	$\pm 2.9 \%$	∞
Liquid conductivity (Meas.)	± 4.2	Normal	1	0.64	$\pm 4.2 \%$	10
Liquid permittivity (Target)	± 5.0	Rectangular	$\sqrt{3}$	0.6	$\pm 2.9 \%$	∞
Liquid permittivity (Meas.)	± 4.0	Normal	1	0.6	$\pm 4.0 \%$	10
Temp. unc. - Conductivity	± 1.9	Rectangular	$\sqrt{3}$	0.78	$\pm 1.1 \%$	∞
Temp. unc. - Permittivity	± 1.9	Rectangular	$\sqrt{3}$	0.23	$\pm 1.1 \%$	∞
Combined Standard Uncertainty					$\pm 12 \%$	330
Expanded Uncertainty (k=2)					$\pm 24 \%$	

The above measurement uncertainties are according to IEEE Std 1528

1900 MHz Head

Error Description	Uncertainty value $\pm\%$	Probability Distribution	Divisor	(Ci) 1g	Standard (1g)	vi 2 or Veff
Measurement System						
Probe calibration	± 6.0	Normal	1	1	$\pm 6.0 \%$	∞
Axial isotropy	± 4.7	Rectangular	$\sqrt{3}$	1	$\pm 2.7 \%$	∞
Hemispherical isotropy	± 9.6	Rectangular	$\sqrt{3}$	1	$\pm 5.5 \%$	∞
Boundary Effects	± 0.8	Rectangular	$\sqrt{3}$	1	$\pm 0.46 \%$	∞
Probe Linearity	± 4.7	Rectangular	$\sqrt{3}$	1	$\pm 2.7 \%$	∞
Probe modulation response	± 2.4	Rectangular	$\sqrt{3}$	1	$\pm 1.4 \%$	∞
Detection limits	± 0.25	Rectangular	$\sqrt{3}$	1	$\pm 0.14 \%$	∞
Readout Electronics	± 1.0	Normal	1	1	$\pm 1.0 \%$	∞
Response time	± 0.8	Rectangular	$\sqrt{3}$	1	$\pm 0.46 \%$	∞
Integration time	± 2.6	Rectangular	$\sqrt{3}$	1	$\pm 1.5 \%$	∞
RF Ambient Conditions – Noise	± 3.0	Rectangular	$\sqrt{3}$	1	$\pm 1.7 \%$	∞
RF Ambient Conditions – Reflections	± 3.0	Rectangular	$\sqrt{3}$	1	$\pm 1.7 \%$	∞
Probe Positioner	± 0.4	Rectangular	$\sqrt{3}$	1	$\pm 0.23 \%$	∞
Probe Positioning	± 2.9	Rectangular	$\sqrt{3}$	1	$\pm 1.7 \%$	∞
Algorithms for Max. SAR Eval.	± 1.0	Rectangular	$\sqrt{3}$	1	$\pm 0.58 \%$	∞
Test Sample Related						
Device Positioning	± 2.9	Normal	1	1	$\pm 2.9 \%$	145
Device Holder	± 3.6	Normal	1	1	$\pm 3.6 \%$	5
Power Drift	± 5.0	Rectangular	$\sqrt{3}$	1	$\pm 2.9 \%$	∞
SAR Scaling	± 2.0	Rectangular	$\sqrt{3}$	1	$\pm 1.2 \%$	∞
Physical Parameters						
Phantom Shell	± 4.0	Rectangular	$\sqrt{3}$	1	$\pm 2.3 \%$	∞
Liquid conductivity (Target)	± 5.0	Rectangular	$\sqrt{3}$	0.64	$\pm 2.9 \%$	∞
Liquid conductivity (Meas.)	± 3.7	Normal	1	0.64	$\pm 3.7 \%$	10
Liquid permittivity (Target)	± 5.0	Rectangular	$\sqrt{3}$	0.6	$\pm 2.9 \%$	∞
Liquid permittivity (Meas.)	± 4.3	Normal	1	0.6	$\pm 4.3 \%$	10
Temp. unc. - Conductivity	± 1.7	Rectangular	$\sqrt{3}$	0.78	$\pm 1.0 \%$	∞
Temp. unc. - Permittivity	± 1.9	Rectangular	$\sqrt{3}$	0.23	$\pm 1.1 \%$	∞
Combined Standard Uncertainty					$\pm 12 \%$	330
Expanded Uncertainty (k=2)					$\pm 24 \%$	

The above measurement uncertainties are according to IEEE Std 1528

1900 MHz Body

Error Description	Uncertainty value $\pm\%$	Probability Distribution	Divisor	(Ci) 1g	Standard (1g)	vi 2 or Veff
Measurement System						
Probe calibration	± 6.0	Normal	1	1	$\pm 6.0 \%$	∞
Axial isotropy	± 4.7	Rectangular	$\sqrt{3}$	1	$\pm 2.7 \%$	∞
Hemispherical isotropy	± 9.6	Rectangular	$\sqrt{3}$	1	$\pm 5.5 \%$	∞
Boundary Effects	± 0.8	Rectangular	$\sqrt{3}$	1	$\pm 0.46 \%$	∞
Probe Linearity	± 4.7	Rectangular	$\sqrt{3}$	1	$\pm 2.7 \%$	∞
Probe modulation response	± 2.4	Rectangular	$\sqrt{3}$	1	$\pm 1.4 \%$	∞
Detection limits	± 0.25	Rectangular	$\sqrt{3}$	1	$\pm 0.14 \%$	∞
Readout Electronics	± 1.0	Normal	1	1	$\pm 1.0 \%$	∞
Response time	± 0.8	Rectangular	$\sqrt{3}$	1	$\pm 0.46 \%$	∞
Integration time	± 2.6	Rectangular	$\sqrt{3}$	1	$\pm 1.5 \%$	∞
RF Ambient Conditions – Noise	± 3.0	Rectangular	$\sqrt{3}$	1	$\pm 1.7 \%$	∞
RF Ambient Conditions – Reflections	± 3.0	Rectangular	$\sqrt{3}$	1	$\pm 1.7 \%$	∞
Probe Positioner	± 0.4	Rectangular	$\sqrt{3}$	1	$\pm 0.23 \%$	∞
Probe Positioning	± 2.9	Rectangular	$\sqrt{3}$	1	$\pm 1.7 \%$	∞
Algorithms for Max. SAR Eval.	± 1.0	Rectangular	$\sqrt{3}$	1	$\pm 0.58 \%$	∞
Test Sample Related						
Device Positioning	± 2.9	Normal	1	1	$\pm 2.9 \%$	145
Device Holder	± 3.6	Normal	1	1	$\pm 3.6 \%$	5
Power Drift	± 5.0	Rectangular	$\sqrt{3}$	1	$\pm 2.9 \%$	∞
SAR Scaling	± 2.0	Rectangular	$\sqrt{3}$	1	$\pm 1.2 \%$	∞
Physical Parameters						
Phantom Shell	± 4.0	Rectangular	$\sqrt{3}$	1	$\pm 2.3 \%$	∞
Liquid conductivity (Target)	± 5.0	Rectangular	$\sqrt{3}$	0.64	$\pm 2.9 \%$	∞
Liquid conductivity (Meas.)	± 4.1	Normal	1	0.64	$\pm 4.1 \%$	10
Liquid permittivity (Target)	± 5.0	Rectangular	$\sqrt{3}$	0.6	$\pm 2.9 \%$	∞
Liquid permittivity (Meas.)	± 3.9	Normal	1	0.6	$\pm 3.9 \%$	10
Temp. unc. - Conductivity	± 1.9	Rectangular	$\sqrt{3}$	0.78	$\pm 1.1 \%$	∞
Temp. unc. - Permittivity	± 1.8	Rectangular	$\sqrt{3}$	0.23	$\pm 1.0 \%$	∞
Combined Standard Uncertainty					$\pm 12 \%$	330
Expanded Uncertainty (k=2)					$\pm 24 \%$	

The above measurement uncertainties are according to IEEE Std 1528

2450 MHz Head

Error Description	Uncertainty value $\pm\%$	Probability Distribution	Divisor	(Ci) 1g	Standard (1g)	vi 2 or Veff
Measurement System						
Probe calibration	± 6.0	Normal	1	1	$\pm 6.0 \%$	∞
Axial isotropy	± 4.7	Rectangular	$\sqrt{3}$	1	$\pm 2.7 \%$	∞
Hemispherical isotropy	± 9.6	Rectangular	$\sqrt{3}$	1	$\pm 5.5 \%$	∞
Boundary Effects	± 0.8	Rectangular	$\sqrt{3}$	1	$\pm 0.46 \%$	∞
Probe Linearity	± 4.7	Rectangular	$\sqrt{3}$	1	$\pm 2.7 \%$	∞
Probe modulation response	± 2.4	Rectangular	$\sqrt{3}$	1	$\pm 1.4 \%$	∞
Detection limits	± 0.25	Rectangular	$\sqrt{3}$	1	$\pm 0.14 \%$	∞
Readout Electronics	± 1.0	Normal	1	1	$\pm 1.0 \%$	∞
Response time	± 0.8	Rectangular	$\sqrt{3}$	1	$\pm 0.46 \%$	∞
Integration time	± 2.6	Rectangular	$\sqrt{3}$	1	$\pm 1.5 \%$	∞
RF Ambient Conditions – Noise	± 3.0	Rectangular	$\sqrt{3}$	1	$\pm 1.7 \%$	∞
RF Ambient Conditions – Reflections	± 3.0	Rectangular	$\sqrt{3}$	1	$\pm 1.7 \%$	∞
Probe Positioner	± 0.4	Rectangular	$\sqrt{3}$	1	$\pm 0.23 \%$	∞
Probe Positioning	± 2.9	Rectangular	$\sqrt{3}$	1	$\pm 1.7 \%$	∞
Algorithms for Max. SAR Eval.	± 1.0	Rectangular	$\sqrt{3}$	1	$\pm 0.58 \%$	∞
Test Sample Related						
Device Positioning	± 2.9	Normal	1	1	$\pm 2.9 \%$	145
Device Holder	± 3.6	Normal	1	1	$\pm 3.6 \%$	5
Power Drift	± 5.0	Rectangular	$\sqrt{3}$	1	$\pm 2.9 \%$	∞
SAR Scaling	± 2.0	Rectangular	$\sqrt{3}$	1	$\pm 1.2 \%$	∞
Physical Parameters						
Phantom Shell	± 4.0	Rectangular	$\sqrt{3}$	1	$\pm 2.3 \%$	∞
Liquid conductivity (Target)	± 5.0	Rectangular	$\sqrt{3}$	0.64	$\pm 2.9 \%$	∞
Liquid conductivity (Meas.)	± 3.8	Normal	1	0.64	$\pm 3.8 \%$	10
Liquid permittivity (Target)	± 5.0	Rectangular	$\sqrt{3}$	0.6	$\pm 2.9 \%$	∞
Liquid permittivity (Meas.)	± 4.0	Normal	1	0.6	$\pm 4.0 \%$	10
Temp. unc. - Conductivity	± 1.8	Rectangular	$\sqrt{3}$	0.78	$\pm 1.0 \%$	∞
Temp. unc. - Permittivity	± 1.9	Rectangular	$\sqrt{3}$	0.23	$\pm 1.1 \%$	∞
Combined Standard Uncertainty					$\pm 12 \%$	330
Expanded Uncertainty (k=2)					$\pm 24 \%$	

The above measurement uncertainties are according to IEEE Std 1528

2450 MHz Body

Error Description	Uncertainty value $\pm\%$	Probability Distribution	Divisor	(Ci) 1g	Standard (1g)	vi 2 or Veff
Measurement System						
Probe calibration	± 6.0	Normal	1	1	$\pm 6.0 \%$	∞
Axial isotropy	± 4.7	Rectangular	$\sqrt{3}$	1	$\pm 2.7 \%$	∞
Hemispherical isotropy	± 9.6	Rectangular	$\sqrt{3}$	1	$\pm 5.5 \%$	∞
Boundary Effects	± 0.8	Rectangular	$\sqrt{3}$	1	$\pm 0.46 \%$	∞
Probe Linearity	± 4.7	Rectangular	$\sqrt{3}$	1	$\pm 2.7 \%$	∞
Probe modulation response	± 2.4	Rectangular	$\sqrt{3}$	1	$\pm 1.4 \%$	∞
Detection limits	± 0.25	Rectangular	$\sqrt{3}$	1	$\pm 0.14 \%$	∞
Readout Electronics	± 1.0	Normal	1	1	$\pm 1.0 \%$	∞
Response time	± 0.8	Rectangular	$\sqrt{3}$	1	$\pm 0.46 \%$	∞
Integration time	± 2.6	Rectangular	$\sqrt{3}$	1	$\pm 1.5 \%$	∞
RF Ambient Conditions – Noise	± 3.0	Rectangular	$\sqrt{3}$	1	$\pm 1.7 \%$	∞
RF Ambient Conditions – Reflections	± 3.0	Rectangular	$\sqrt{3}$	1	$\pm 1.7 \%$	∞
Probe Positioner	± 0.4	Rectangular	$\sqrt{3}$	1	$\pm 0.23 \%$	∞
Probe Positioning	± 2.9	Rectangular	$\sqrt{3}$	1	$\pm 1.7 \%$	∞
Algorithms for Max. SAR Eval.	± 1.0	Rectangular	$\sqrt{3}$	1	$\pm 0.58 \%$	∞
Test Sample Related						
Device Positioning	± 2.9	Normal	1	1	$\pm 2.9 \%$	145
Device Holder	± 3.6	Normal	1	1	$\pm 3.6 \%$	5
Power Drift	± 5.0	Rectangular	$\sqrt{3}$	1	$\pm 2.9 \%$	∞
SAR Scaling	± 2.0	Rectangular	$\sqrt{3}$	1	$\pm 1.2 \%$	∞
Physical Parameters						
Phantom Shell	± 4.0	Rectangular	$\sqrt{3}$	1	$\pm 2.3 \%$	∞
Liquid conductivity (Target)	± 5.0	Rectangular	$\sqrt{3}$	0.64	$\pm 2.9 \%$	∞
Liquid conductivity (Meas.)	± 4.1	Normal	1	0.64	$\pm 4.1 \%$	10
Liquid permittivity (Target)	± 5.0	Rectangular	$\sqrt{3}$	0.6	$\pm 2.9 \%$	∞
Liquid permittivity (Meas.)	± 4.2	Normal	1	0.6	$\pm 4.2 \%$	10
Temp. unc. - Conductivity	± 1.8	Rectangular	$\sqrt{3}$	0.78	$\pm 1.0 \%$	∞
Temp. unc. - Permittivity	± 1.8	Rectangular	$\sqrt{3}$	0.23	$\pm 1.0 \%$	∞
Combined Standard Uncertainty					$\pm 12 \%$	330
Expanded Uncertainty (k=2)					$\pm 24 \%$	

The above measurement uncertainties are according to IEEE Std 1528

2600 MHz Head

Error Description	Uncertainty value $\pm\%$	Probability Distribution	Divisor	(Ci) 1g	Standard (1g)	vi 2 or Veff
Measurement System						
Probe calibration	± 6.0	Normal	1	1	$\pm 6.0 \%$	∞
Axial isotropy	± 4.7	Rectangular	$\sqrt{3}$	1	$\pm 2.7 \%$	∞
Hemispherical isotropy	± 9.6	Rectangular	$\sqrt{3}$	1	$\pm 5.5 \%$	∞
Boundary Effects	± 0.8	Rectangular	$\sqrt{3}$	1	$\pm 0.46 \%$	∞
Probe Linearity	± 4.7	Rectangular	$\sqrt{3}$	1	$\pm 2.7 \%$	∞
Probe modulation response	± 2.4	Rectangular	$\sqrt{3}$	1	$\pm 1.4 \%$	∞
Detection limits	± 0.25	Rectangular	$\sqrt{3}$	1	$\pm 0.14 \%$	∞
Readout Electronics	± 1.0	Normal	1	1	$\pm 1.0 \%$	∞
Response time	± 0.8	Rectangular	$\sqrt{3}$	1	$\pm 0.46 \%$	∞
Integration time	± 2.6	Rectangular	$\sqrt{3}$	1	$\pm 1.5 \%$	∞
RF Ambient Conditions – Noise	± 3.0	Rectangular	$\sqrt{3}$	1	$\pm 1.7 \%$	∞
RF Ambient Conditions – Reflections	± 3.0	Rectangular	$\sqrt{3}$	1	$\pm 1.7 \%$	∞
Probe Positioner	± 0.4	Rectangular	$\sqrt{3}$	1	$\pm 0.23 \%$	∞
Probe Positioning	± 2.9	Rectangular	$\sqrt{3}$	1	$\pm 1.7 \%$	∞
Algorithms for Max. SAR Eval.	± 1.0	Rectangular	$\sqrt{3}$	1	$\pm 0.58 \%$	∞
Test Sample Related						
Device Positioning	± 2.9	Normal	1	1	$\pm 2.9 \%$	145
Device Holder	± 3.6	Normal	1	1	$\pm 3.6 \%$	5
Power Drift	± 5.0	Rectangular	$\sqrt{3}$	1	$\pm 2.9 \%$	∞
SAR Scaling	± 2.0	Rectangular	$\sqrt{3}$	1	$\pm 1.2 \%$	∞
Physical Parameters						
Phantom Shell	± 4.0	Rectangular	$\sqrt{3}$	1	$\pm 2.3 \%$	∞
Liquid conductivity (Target)	± 5.0	Rectangular	$\sqrt{3}$	0.64	$\pm 2.9 \%$	∞
Liquid conductivity (Meas.)	± 4.1	Normal	1	0.64	$\pm 4.1 \%$	10
Liquid permittivity (Target)	± 5.0	Rectangular	$\sqrt{3}$	0.6	$\pm 2.9 \%$	∞
Liquid permittivity (Meas.)	± 4.3	Normal	1	0.6	$\pm 4.3 \%$	10
Temp. unc. - Conductivity	± 1.9	Rectangular	$\sqrt{3}$	0.78	$\pm 1.1 \%$	∞
Temp. unc. - Permittivity	± 1.8	Rectangular	$\sqrt{3}$	0.23	$\pm 1.0 \%$	∞
Combined Standard Uncertainty					$\pm 12 \%$	330
Expanded Uncertainty (k=2)					$\pm 24 \%$	

The above measurement uncertainties are according to IEEE Std 1528

2600 MHz Body

Error Description	Uncertainty value $\pm\%$	Probability Distribution	Divisor	(Ci) 1g	Standard (1g)	vi 2 or Veff
Measurement System						
Probe calibration	± 6.0	Normal	1	1	$\pm 6.0 \%$	∞
Axial isotropy	± 4.7	Rectangular	$\sqrt{3}$	1	$\pm 2.7 \%$	∞
Hemispherical isotropy	± 9.6	Rectangular	$\sqrt{3}$	1	$\pm 5.5 \%$	∞
Boundary Effects	± 0.8	Rectangular	$\sqrt{3}$	1	$\pm 0.46 \%$	∞
Probe Linearity	± 4.7	Rectangular	$\sqrt{3}$	1	$\pm 2.7 \%$	∞
Probe modulation response	± 2.4	Rectangular	$\sqrt{3}$	1	$\pm 1.4 \%$	∞
Detection limits	± 0.25	Rectangular	$\sqrt{3}$	1	$\pm 0.14 \%$	∞
Readout Electronics	± 1.0	Normal	1	1	$\pm 1.0 \%$	∞
Response time	± 0.8	Rectangular	$\sqrt{3}$	1	$\pm 0.46 \%$	∞
Integration time	± 2.6	Rectangular	$\sqrt{3}$	1	$\pm 1.5 \%$	∞
RF Ambient Conditions – Noise	± 3.0	Rectangular	$\sqrt{3}$	1	$\pm 1.7 \%$	∞
RF Ambient Conditions – Reflections	± 3.0	Rectangular	$\sqrt{3}$	1	$\pm 1.7 \%$	∞
Probe Positioner	± 0.4	Rectangular	$\sqrt{3}$	1	$\pm 0.23 \%$	∞
Probe Positioning	± 2.9	Rectangular	$\sqrt{3}$	1	$\pm 1.7 \%$	∞
Algorithms for Max. SAR Eval.	± 1.0	Rectangular	$\sqrt{3}$	1	$\pm 0.58 \%$	∞
Test Sample Related						
Device Positioning	± 2.9	Normal	1	1	$\pm 2.9 \%$	145
Device Holder	± 3.6	Normal	1	1	$\pm 3.6 \%$	5
Power Drift	± 5.0	Rectangular	$\sqrt{3}$	1	$\pm 2.9 \%$	∞
SAR Scaling	± 2.0	Rectangular	$\sqrt{3}$	1	$\pm 1.2 \%$	∞
Physical Parameters						
Phantom Shell	± 4.0	Rectangular	$\sqrt{3}$	1	$\pm 2.3 \%$	∞
Liquid conductivity (Target)	± 5.0	Rectangular	$\sqrt{3}$	0.64	$\pm 2.9 \%$	∞
Liquid conductivity (Meas.)	± 3.7	Normal	1	0.64	$\pm 3.7 \%$	10
Liquid permittivity (Target)	± 5.0	Rectangular	$\sqrt{3}$	0.6	$\pm 2.9 \%$	∞
Liquid permittivity (Meas.)	± 3.9	Normal	1	0.6	$\pm 3.9 \%$	10
Temp. unc. - Conductivity	± 1.8	Rectangular	$\sqrt{3}$	0.78	$\pm 1.0 \%$	∞
Temp. unc. - Permittivity	± 2.0	Rectangular	$\sqrt{3}$	0.23	$\pm 1.2 \%$	∞
Combined Standard Uncertainty					$\pm 12 \%$	330
Expanded Uncertainty (k=2)					$\pm 24 \%$	

The above measurement uncertainties are according to IEEE Std 1528

16. CONCLUSION

Measurement Conclusion

The SAR measurement indicates that the EUT complies with the RF radiation exposure limits of the FCC. These measurements are taken to simulate the RF effects exposure under the worst-case conditions. Precise laboratory measures were taken to assure repeatability of the tests. The tested device complies with the requirements in respect to all parameters subject to the test. The test results and statements relate only to the item(s) tested.

Please note that the absorption and distribution of electromagnetic energy in the body are every complex phenomena that depend on the mass, shape, and size of the body, the orientation of the body with respect to the field vectors, and the electrical properties of both the body and the environment. Other variables that may play a substantial role impossible biological effect are those that characterize the environment (e.g. ambient temperature, air velocity, relative humidity, and body insulation) and those that characterize the individual (e.g. age, gender, activity level, debilitation, or disease).

Because innumerable factors may interact to determine the specific biological outcome of an exposure to electromagnetic fields, any protection guide shall consider maximal amplification of biological effects as a result of field-body interactions, environmental conditions, and physiological variables.

17. REFERENCES

- [1] Federal Communications Commission, ET Docket 93-62, Guidelines for Evaluating the Environmental Effects of Radiofrequency Radiation, Aug. 1996.
- [2] ANSI/IEEE C95.1-2005, American National Standard safety levels with respect to human exposure to radiofrequency electromagnetic fields, 3kHz to 300GHz, New York: IEEE, 2006.
- [3] ANSI/IEEE C95.1-1992, American National Standard safety levels with respect to human exposure to radiofrequency electromagnetic fields, 3kHz to 300GHz, New York: IEEE, Sept. 1992.
- [4] ANSI/IEEE C95.3-2002, IEEE Recommended Practice for the Measurement of Potentially Hazardous Electromagnetic Fields - RF and Microwave, New York: IEEE, December 2002.
- [5] IEEE Standards Coordinating Committee 39 –Standards Coordinating Committee 34 – IEEE Std. 1528-2003, Recommended Practice for Determining the Peak Spatial-Average Specific Absorption Rate (SAR) in the Human Body Due to Wireless Communications Devices.
- [6] NCRP, National Council on Radiation Protection and Measurements, Biological Effects and Exposure Criteria for Radio Frequency Electromagnetic Fields, NCRP Report No. 86, 1986. Reprinted Feb. 1995.
- [7] T. Schmid, O. Egger, N. Kuster, Automated E-field scanning system for dosimetric assessments, IEEE Transaction on Microwave Theory and Techniques, vol. 44, Jan. 1996, pp. 105-113.
- [8] K. Pokovic, T. Schmid, N. Kuster, Robust setup for precise calibration of E-field probes in tissue simulating liquids at mobile communications frequencies, ICECOM97, Oct. 1997, pp. -124.
- [9] K. Pokovic, T. Schmid, and N. Kuster, E-field Probe with improved isotropy in brain simulating liquids, Proceedings of the ELMAR, Zadar, Croatia, June 23-25, 1996, pp. 172-175.
- [10] Schmid & Partner Engineering AG, Application Note: Data Storage and Evaluation, June 1998, p2.
- [11] V. Hombach, K. Meier, M. Burkhardt, E. Kuhn, N. Kuster, The Dependence of EM Energy Absorption upon Human Modeling at 900 MHz, IEEE Transaction on Microwave Theory and Techniques, vol. 44 no. 10, Oct. 1996, pp. 1865-1873.
- [12] N. Kuster and Q. Balzano, Energy absorption mechanism by biological bodies in the near field of dipole antennas above 300MHz, IEEE Transaction on Vehicular Technology, vol. 41, no. 1, Feb. 1992, pp. 17-23.
- [13] G. Hartsgrrove, A. Kraszewski, A. Surowiec, Simulated Biological Materials for Electromagnetic Radiation Absorption Studies, University of Ottawa, Bio electromagnetics, Canada: 1987, pp. 29-36.
- [14] Q. Balzano, O. Garay, T. Manning Jr., Electromagnetic Energy Exposure of Simulated Users of Portable Cellular Telephones, IEEE Transactions on Vehicular Technology, vol. 44, no.3, Aug. 1995.
- [15] W. Gander, Computer mathematick, Birkhaeuser, Basel, 1992.
- [16] W.H. Press, S.A. Teukolsky, W.T. Vetterling, and B.P. Flannery, Numerical Recipes in C, The Art of Scientific Computing, Second edition, Cambridge University Press, 1992.
- [17] N. Kuster, R. Kastle, T. Schmid, Dosimetric evaluation of mobile communications equipment with known precision, IEEE Transaction on Communications, vol. E80-B, no. 5, May 1997, pp. 645-652.
- [18] CENELEC CLC/SC111B, European Prestandard (prENV 50166-2), Human Exposure to Electromagnetic Fields High-frequency: 10kHz-300GHz, Jan. 1995.
- [19] Prof. Dr. Niels Kuster, ETH, Eidgenössische Technische Hochschule Zürich, Dosimetric Evaluation of the Cellular Phone.

- [20] IEC 62209-1, Human exposure to radio frequency fields from hand-held and body-mounted wireless communication devices - Human models, instrumentation, and procedures - Part 1: Procedure to determine the specific absorption rate (SAR) for hand-held devices used in close proximity to the ear (frequency range of 300MHz to 3 GHz), Feb. 2005.
- [21] Industry Canada RSS-102 Radio Frequency Exposure Compliance of Radio communication Apparatus (All Frequency Bands) Issue 5, March 2015.
- [22] Health Canada Safety Code 6 Limits of Human Exposure to Radio Frequency Electromagnetic Fields in the Frequency Range from 3 kHz – 300 GHz, 2009
- [23] FCC SAR Test Procedures for 2G-3G Devices, Mobile Hotspot and UMPC Devices KDB Publications 941225,D01-D07
- [24] SAR Measurement procedures for IEEE 802.11a/b/g KDB Publication 248227 D01v02
- [25] FCC SAR Considerations for Handsets with Multiple Transmitters and Antennas, KDB Publications 648474D02-D04
- [26] FCC SAR Evaluation Considerations for Laptop, Notebook, Netbook and Tablet Computers, FCC KDB Publication 616217 D04
- [27] FCC SAR Measurement and Reporting Requirements for 100MHz – 6 GHz, KDB Publications 865664 D01-D02
- [28] FCC General RF Exposure Guidance and SAR Procedures for Dongles, KDB Publication 447498, D01-D02
- [29] 615223 D01 802 16e WI-Max SAR Guidance v01, Nov. 13, 2009
- [30] Anexo à Resolução No. 533, de 10 de September de 2009.
- [31] IEC 62209-2, Human exposure to radio frequency fields from hand-held and body-mounted wireless communication devices - Human models, instrumentation, and procedures - Part 2: Procedure to determine the specific absorption rate (SAR) for wireless communication devices used in close proximity to the human body(frequency range of 30 MHz to 6 GHz), Mar. 2010.