



# TEST REPORT



**DT&C Co., Ltd.**

42, Yurim-ro, 154Beon-gil, Cheoin-gu, Yongin-si, Gyeonggi-do, Korea, 17042  
Tel : 031-321-2664, Fax : 031-321-1664

1. Report No : DRTFCC1804-0097
2. Customer
  - Name : LG Electronics MobileComm USA, Inc.
  - Address : 1000 Sylvan Ave., Englewood Cliffs, New Jersey, United States, 07632
3. Use of Report : FCC Original Grant
4. Product Name / Model Name : Mobile Phone / LM-Q710FA  
FCC ID : ZNFQ710FA
5. Test Method Used : KDB971168 D01v03r01, ANSI/TIA-603-E-2016, ANSI C63.26-2015  
Test Specification : §2, §22, §24(E), §27
6. Date of Test : 2018.03.13 ~ 2018.04.20
7. Testing Environment : Refer to appended test report.
8. Test Result : Refer to the attached test result.

Affirmation	Tested by	Reviewed by
	Name : JaeHyeok Bang 	Name : Geunki Son  (Signature)

The test results presented in this test report are limited only to the sample supplied by applicant and the use of this test report is inhibited other than its purpose. This test report shall not be reproduced except in full, without the written approval of DT&C Co., Ltd.

2018 . 04 . 25 .

**DT&C Co., Ltd.**

If this report is required to confirmation of authenticity, please contact to [report@dtnc.net](mailto:report@dtnc.net)

## Test Report Version

Test Report No.	Date	Description
DRTFCC1804-0097	Apr. 25 2018	Initial issue

# Table of Contents

<b>1. GENERAL INFORMATION .....</b>	<b>5</b>
<b>2. INTRODUCTION .....</b>	<b>7</b>
2.1 EUT DESCRIPTION .....	7
2.2. EUT CAPABILITIES.....	7
2.3. TESTING ENVIRONMENT.....	7
2.4 MEASURING INSTRUMENT CALIBRATION.....	7
2.5. MEASUREMENT UNCERTAINTY .....	7
2.6. TEST FACILITY.....	7
<b>3. DESCRIPTION OF TESTS.....</b>	<b>8</b>
3.1 ERP & EIRP (Effective Radiated Power & Equivalent Isotropic Radiated Power) .....	8
3.2 PEAK TO AVERAGE RATIO .....	10
3.3 OCCUPIED BANDWIDTH.....	11
3.4 BAND EDGE EMISSIONS AT ANTENNA TERMINAL.....	12
3.5 SPURIOUS AND HARMONIC EMISSIONS AT ANTENNA TERMINAL .....	13
3.6 UNDESIRABLE EMISSIONS.....	14
3.7 FREQUENCY STABILITY .....	15
<b>4. LIST OF TEST EQUIPMENT.....</b>	<b>16</b>
<b>5. SUMMARY OF TEST RESULTS.....</b>	<b>17</b>
<b>6. SAMPLE CALCULATION .....</b>	<b>18</b>
<b>7. TEST DATA .....</b>	<b>21</b>
7.1 OCCUPIED BANDWIDTH.....	21
7.2 PEAK TO AVERAGE RATIO .....	21
7.3 BAND EDEG EMISSIONS (Conducted).....	21
7.4 SPURIOUS AND HARMONICS EMISSIONS (Conducted).....	21
7.5 ERP & EIRP .....	22
7.5.1 LTE Band 12.....	22
7.5.2 LTE Band 17.....	23
7.5.3 LTE Band 5.....	24
7.5.4 LTE Band 4.....	25
7.5.5 LTE Band 66.....	26
7.5.6 LTE Band 2.....	27
7.5.7 LTE Band 7.....	28
7.6 UNDESIRABLE EMISSIONS (Radiated) .....	29
7.6.1 LTE Band 12.....	29
7.6.2 LTE Band 17.....	31
7.6.3 LTE Band 5.....	32
7.6.4 LTE Band 4.....	33
7.6.5 LTE Band 66.....	34
7.6.6 LTE Band 2.....	35

7.6.7 LTE Band 7.....	36
<b>7.7 FREQUENCY STABILITY .....</b>	<b>37</b>
7.7.1 LTE Band 12.....	37
7.7.2 LTE Band 17.....	38
7.7.3 LTE Band 5.....	39
7.7.4 LTE Band 4.....	40
7.7.5 LTE Band 66.....	41
7.7.6 LTE Band 2.....	42
7.7.7 LTE Band 7.....	43
<b>8. TEST PLOTS.....</b>	<b>44</b>
<b>8.1 OCCUPIED BANDWIDTH.....</b>	<b>44</b>
8.1.1 LTE Band 12.....	44
8.1.2 LTE Band 17.....	48
8.1.3 LTE Band 5.....	50
8.1.4 LTE Band 4.....	54
8.1.5 LTE Band 66.....	60
8.1.6 LTE Band 2.....	66
8.1.7 LTE Band 7.....	72
<b>8.2 PEAK TO AVERAGE RATIO .....</b>	<b>76</b>
8.2.1 LTE Band 12.....	76
8.2.2 LTE Band 17.....	80
8.2.3 LTE Band 5.....	82
8.2.4 LTE Band 4.....	86
8.2.5 LTE Band 66.....	92
8.2.6 LTE Band 2.....	98
8.2.7 LTE Band 7.....	104
<b>8.3 BAND EDGE EMISSIONS(Conducted).....</b>	<b>108</b>
8.3.1 LTE Band 12.....	108
8.3.2 LTE Band 17.....	116
8.3.3 LTE Band 5.....	120
8.3.4 LTE Band 4.....	128
8.3.5 LTE Band 66.....	140
8.3.6 LTE Band 2.....	152
8.3.7 LTE Band 7.....	164
<b>8.4 SPURIOUS AND HARMONICS EMISSIONS(Conducted).....</b>	<b>170</b>
8.4.1 LTE Band 12.....	170
8.4.2 LTE Band 17.....	176
8.4.3 LTE Band 5.....	179
8.4.4 LTE Band 4.....	185
8.4.5 LTE Band 66.....	203
8.4.6 LTE Band 2.....	221
8.4.7 LTE Band 7.....	239

## 1. GENERAL INFORMATION

**Applicant Name** : LG Electronics MobileComm USA, Inc.  
**Address** : 1000 Sylvan Ave., Englewood Cliffs, New Jersey, United States, 07632  
**FCC ID** : ZNFQ710FA  
**FCC Classification** : PCS Licensed Transmitter held to ear (PCE)  
**EUT Type** : Mobile Phone  
**Model Name** : LM-Q710FA  
**Add Model Name** : LMQ710FA, Q710FA, LM-Q710RA, LMQ710RA, Q710RA, LM-Q710FM, LMQ710FM, Q710FM, LM-Q710HS, LMQ710HS, Q710HS, LM-Q710HSW, LMQ710HSW, Q710HSW  
**Supplying power** : DC 3.85 V  
**Antenna Information** : PIFA Antenna

Mode	TX Frequency (MHz)	Emission Designator	Modulation	ERP	
				Max power (dBm)	Max power (W)
LTE Band 12	704 ~ 711	8M97G7D	QPSK	19.89	0.097
LTE Band 12	704 ~ 711	8M98W7D	16QAM	18.79	0.076
LTE Band 12	701.5 ~ 713.5	4M49G7D	QPSK	18.76	0.075
LTE Band 12	701.5 ~ 713.5	4M51W7D	16QAM	17.65	0.058
LTE Band 12	700.5 ~ 714.5	2M70G7D	QPSK	18.87	0.077
LTE Band 12	700.5 ~ 714.5	2M70W7D	16QAM	18.00	0.063
LTE Band 12	699.7 ~ 715.3	1M10G7D	QPSK	18.30	0.068
LTE Band 12	699.7 ~ 715.3	1M09W7D	16QAM	17.43	0.055
LTE Band 17	709 ~ 711	9M00G7D	QPSK	19.72	0.094
LTE Band 17	709 ~ 711	8M99W7D	16QAM	19.08	0.081
LTE Band 17	706.5 ~ 713.5	4M49G7D	QPSK	18.84	0.077
LTE Band 17	706.5 ~ 713.5	4M50W7D	16QAM	17.61	0.058
LTE Band 5	829 ~ 844	8M96G7D	QPSK	21.43	0.139
LTE Band 5	829 ~ 844	8M96W7D	16QAM	20.64	0.116
LTE Band 5	826.5 ~ 846.5	4M50G7D	QPSK	21.43	0.139
LTE Band 5	826.5 ~ 846.5	4M51W7D	16QAM	20.37	0.109
LTE Band 5	825.5 ~ 847.5	2M71G7D	QPSK	20.88	0.122
LTE Band 5	825.5 ~ 847.5	2M69W7D	16QAM	19.88	0.097
LTE Band 5	824.7 ~ 848.3	1M09G7D	QPSK	20.22	0.105
LTE Band 5	824.7 ~ 848.3	1M09W7D	16QAM	19.39	0.087

Mode	TX Frequency (MHz)	Emission Designator	Modulation	EIRP	
				Max power(dBm)	Max power(W)
LTE Band 4	1720 ~ 1745	18M0G7D	QPSK	18.86	0.077
LTE Band 4	1720 ~ 1745	17M9W7D	16QAM	18.24	0.067
LTE Band 4	1717.5 ~ 1747.5	13M4G7D	QPSK	18.93	0.078
LTE Band 4	1717.5 ~ 1747.5	13M4W7D	16QAM	18.12	0.065
LTE Band 4	1715 ~ 1750	9M01G7D	QPSK	19.61	0.091
LTE Band 4	1715 ~ 1750	8M98W7D	16QAM	18.70	0.074
LTE Band 4	1712.5 ~ 1752.5	4M50G7D	QPSK	19.35	0.086
LTE Band 4	1712.5 ~ 1752.5	4M49W7D	16QAM	18.40	0.069
LTE Band 4	1711.5 ~ 1753.5	2M70G7D	QPSK	18.90	0.078
LTE Band 4	1711.5 ~ 1753.5	2M69W7D	16QAM	18.57	0.072
LTE Band 4	1710.7 ~ 1754.3	1M09G7D	QPSK	19.51	0.089
LTE Band 4	1710.7 ~ 1754.3	1M09W7D	16QAM	18.74	0.075
LTE Band 66	1720 ~ 1770	17M9G7D	QPSK	19.16	0.082
LTE Band 66	1720 ~ 1770	17M9W7D	16QAM	18.07	0.064
LTE Band 66	1717.5 ~ 1772.5	13M4G7D	QPSK	18.28	0.067
LTE Band 66	1717.5 ~ 1772.5	13M5W7D	16QAM	17.55	0.057
LTE Band 66	1715 ~ 1775	8M98G7D	QPSK	18.55	0.072
LTE Band 66	1715 ~ 1775	8M98W7D	16QAM	18.00	0.063
LTE Band 66	1712.5 ~ 1777.5	4M50G7D	QPSK	18.62	0.073
LTE Band 66	1712.5 ~ 1777.5	4M49W7D	16QAM	18.23	0.067
LTE Band 66	1711.5 ~ 1778.5	2M70G7D	QPSK	18.57	0.072
LTE Band 66	1711.5 ~ 1778.5	2M70W7D	16QAM	17.80	0.060
LTE Band 66	1710.7 ~ 1779.3	1M09G7D	QPSK	18.41	0.069
LTE Band 66	1710.7 ~ 1779.3	1M09W7D	16QAM	17.92	0.062
LTE Band 2	1860 ~ 1900	17M9G7D	QPSK	20.03	0.101
LTE Band 2	1860 ~ 1900	17M9W7D	16QAM	19.10	0.081
LTE Band 2	1857.5 ~ 1902.5	13M4G7D	QPSK	19.68	0.093
LTE Band 2	1857.5 ~ 1902.5	13M4W7D	16QAM	18.92	0.078
LTE Band 2	1855 ~ 1905	8M95G7D	QPSK	19.11	0.081
LTE Band 2	1855 ~ 1905	8M99W7D	16QAM	18.85	0.077
LTE Band 2	1852.5 ~ 1907.5	4M49G7D	QPSK	19.47	0.089
LTE Band 2	1852.5 ~ 1907.5	4M49W7D	16QAM	18.44	0.070
LTE Band 2	1851.5 ~ 1908.5	2M70G7D	QPSK	19.20	0.083
LTE Band 2	1851.5 ~ 1908.5	2M70W7D	16QAM	18.72	0.074
LTE Band 2	1850.7 ~ 1909.3	1M09G7D	QPSK	19.92	0.098
LTE Band 2	1850.7 ~ 1909.3	1M09W7D	16QAM	19.00	0.079
LTE Band 7	2510 ~ 2560	17M9G7D	QPSK	18.62	0.073
LTE Band 7	2510 ~ 2560	18M0W7D	16QAM	17.98	0.063
LTE Band 7	2507.5 ~ 2562.5	13M4G7D	QPSK	18.71	0.074
LTE Band 7	2507.5 ~ 2562.5	13M4W7D	16QAM	17.48	0.056
LTE Band 7	2505 ~ 2565	8M99G7D	QPSK	18.00	0.063
LTE Band 7	2505 ~ 2565	8M98W7D	16QAM	16.83	0.048
LTE Band 7	2502.5 ~ 2567.5	4M49G7D	QPSK	17.71	0.059
LTE Band 7	2502.5 ~ 2567.5	4M49W7D	16QAM	16.70	0.047

## 2. INTRODUCTION

### 2.1 EUT DESCRIPTION

The Equipment Under Test (EUT) supports GSM/WCDMA/LTE Phone with Bluetooth, WLAN.

### 2.2. EUT CAPABILITIES

This EUT contains the following capabilities:

850/1900 GSM/EDGE, 850/1700/1900 WCDMA/HSUPA, Multi-band LTE, 802.11b/g/n WLAN(2.4GHz), Bluetooth(BDR, EDR, LE).

### 2.3. TESTING ENVIRONMENT

Ambient Condition	
▪ Temperature	+20 °C ~ +25 °C
▪ Relative Humidity	41 % ~ 45 %

### 2.4 MEASURING INSTRUMENT CALIBRATION

The measuring equipment, which was utilized in performing the tests documented herein, has been calibrated in accordance with the manufacturer's recommendations for utilizing calibration equipment, which is traceable to recognized national standards.

### 2.5. MEASUREMENT UNCERTAINTY

The measurement uncertainties shown below were calculated in accordance with requirements of ANSI C 63.4-2014. All measurement uncertainty values are shown with a coverage factor of  $k = 2$  to indicate a 95 % level of confidence.

Parameter	Measurement uncertainty
Radiated Disturbance (Below 1 GHz)	5.1 dB (The confidence level is about 95 %, $k = 2$ )
Radiated Disturbance (1 GHz ~ 18 GHz)	5.4 dB (The confidence level is about 95 %, $k = 2$ )
Radiated Disturbance (Above 18 GHz)	5.3 dB (The confidence level is about 95 %, $k = 2$ )

### 2.6. TEST FACILITY

<b>DT&amp;C Co., Ltd.</b>		
The 3 m test site and conducted measurement facility used to collect the radiated data are located at the 42, Yurim-ro, 154beon-gil, Cheoin-gu, Yongin-si, Gyeonggi-do, Korea 17042. The test site comply with the requirements of § 2.948 according to ANSI 63.4-2014.		
<b>- FCC MRA Accredited Test Firm No. : KR0034</b>		
<a href="http://www.dtnc.net">www.dtnc.net</a>		
Telephone	:	+ 82-31-321-2664
FAX	:	+ 82-31-321-1664

### 3. DESCRIPTION OF TESTS

#### 3.1 ERP & EIRP (Effective Radiated Power & Equivalent Isotropic Radiated Power)

##### Test Set-up

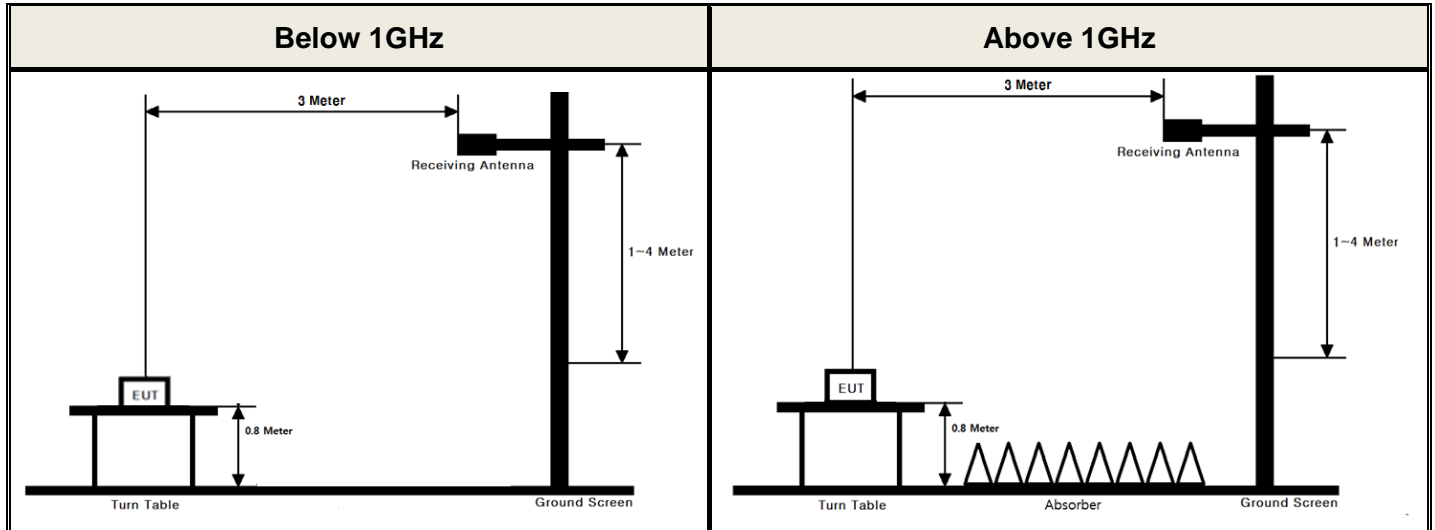

These measurements were performed at 3 m test site. The equipment under test is placed on a non-conductive table 0.8-meters above a turntable which is flush with the ground plane and 3 meters from the receive antenna. For measurements above 1GHz absorbers are placed on the floor between the turn table and the antenna mast in such a way so as to maximize the reduction of reflections. For measurements below 1 GHz, the absorbers are removed.

##### Test Procedure

- ANSI/TIA-603-E-2016 - Section 2.2.17
- KDB971168 D01v03r01 - Section 5.2.2
- ANSI C63.26-2015 – Section 5.2.4.4.1

##### Test setting

1. Set span to 2 x to 3 x the OBW.
2. Set RBW = 1% to 5% of the OBW.
3. Set VBW  $\geq$  3 x RBW.
4. Set number of points in sweep  $\geq$  2 x span / RBW.
5. Sweep time:
  - 1) Set = auto-couple, or
  - 2) Set  $\geq$  [10 x (number of points in sweep) x (transmission period)] for single sweep (automation-compatible) measurement. Transmission period is the on and off time of the transmitter.
6. Detector = power averaging (rms).
7. If the EUT can be configured to transmit continuously, then set the trigger to free run.
8. If the EUT cannot be configured to transmit continuously, then use a sweep trigger with the level set to enable triggering only on full power bursts and configure the EUT to transmit at full power for the entire duration of each sweep. Verify that the sweep time is less than or equal to the transmission burst duration. Time gating can also be used under similar constraints (i.e., configured such that measurement data is collected only during active full-power transmissions).
9. Trace average at least 100 traces in power averaging (rms) mode if sweep is set to auto-couple. To accurately determine the average power over multiple symbols, it can be necessary to increase the number of traces to be averaged above 100 or, if using a manually configured sweep time, increase the sweep time.



10. Compute the power by integrating the spectrum across the OBW of the signal using the instrument's band or channel power measurement function, with the band/channel limits set equal to the OBW band edges. If the instrument does not have a band or channel power function, then sum the spectrum levels (in linear power units) at intervals equal to the RBW extending across the entire OBW of the spectrum.

The receiver antenna height and turntable rotations were adjusted for the highest reading on the receive spectrum analyzer.

A half-wave dipole was substituted in place of the EUT. This dipole antenna was driven by a signal generator and the level of the signal generator was adjusted to obtain the same receive spectrum analyzer reading. The conducted power at the terminal of the substitute antenna is measured.

The ERP/EIRP is calculated using the following formula:

**ERP/EIRP = The conducted power at the substitute antenna's terminal [dBm] + Substitute Antenna gain [dBd for ERP , dBi for EIRP]**

For readings above 1 GHz, the above procedure is repeated using horn antennas and the difference between the gain of the horn antenna and an isotropic antenna are taken into consideration.

## 3.2 PEAK TO AVERAGE RATIO

### Test set-up

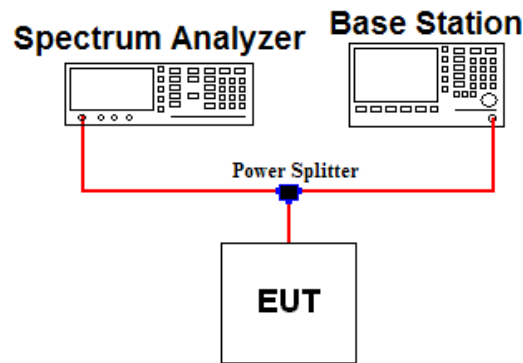

### Test Procedure

- KDB971168 D01v03r01 - Section 5.7.2
- ANSI C63.26-2015 – Section 5.2.3.4

A peak to average ratio measurement is performed at the conducted port of the EUT.

The spectrum analyzers Complementary Cumulative Distribution Function (CCDF) measurement profile is used to determine the largest deviation between the average and the peak power of the EUT in a given bandwidth. The CCDF curve shows how much time the peak waveform spends at or above a given average power level. The present of time the signal spends at or above the level defines the probability for that particular power level.

### Test setting

The spectrum Analyzer's CCDF measurement function is enabled.

1. Set resolution/measurement bandwidth  $\geq$  OBW or specified reference bandwidth.
2. Set the number of counts to a value that stabilizes the measured CCDF curve.
3. Set the measurement interval as follows:
  - 1) For continuous transmissions, set to the greater of  $[10 \times (\text{number of points in sweep}) \times (\text{transmission symbol period})]$  or 1 ms.
  - 2) For burst transmissions, employ an external trigger that is synchronized with the EUT burst timing sequence, or use the internal burst trigger with a trigger level that allows the burst to stabilize. Set the measurement interval to a time that is less than or equal to the burst duration.
  - 3) If there are several carriers in a single antenna port, the peak power shall be determined for each individual carrier (by disabling the other carriers while measuring the required carrier) and the total peak power calculated from the sum of the individual carrier peak powers.
4. Record the maximum PAPR level associated with a probability of 0.1%.
5. The peak power level is calculated from the sum of the PAPR value from step d) to the measured average power.

### 3.3 OCCUPIED BANDWIDTH.

#### Test set-up

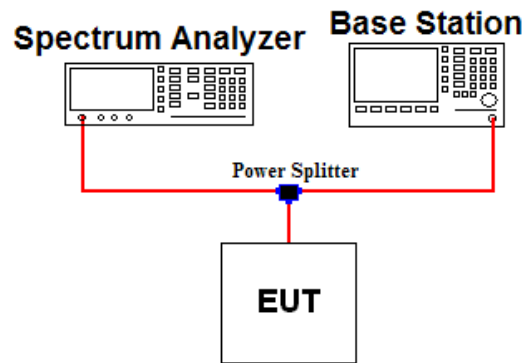

#### Test Procedure

- KDB971168 D01v03r01 - Section 4.3
- ANSI C63.26-2015 – Section 5.4.4

The occupied bandwidth, that is the frequency bandwidth such that, below its lower and above its upper frequency limits, the mean powers radiated are each equal to 0.5 percent of the total mean power of a given emission.

#### Test setting

1. The signal analyzer's automatic bandwidth measurement capability was used to perform the 99 % occupied bandwidth and the 26 dB bandwidth. The bandwidth measurement was not influenced by any intermediate power nulls in the fundamental emission.
2.  $RBW = 1 \sim 5 \%$  of the expected OBW &  $VBW \geq 3 \times RBW$
3. Detector = Peak
4. Trance mode = Max hold
5. Sweep = Auto couple
6. The trace was allowed to stabilize
7. If necessary, step 2 ~ 6 were repeated after changing the RBW such that it would be within 1 ~ 5 % of the 99 % occupied bandwidth observed in step 6.

### 3.4 BAND EDGE EMISSIONS AT ANTENNA TERMINAL

#### Test set-up

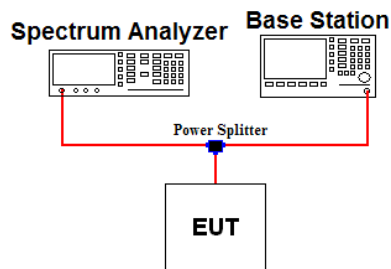

#### Test Procedure

- KDB971168 D01v03r01 - Section 6
- ANSI C63.26-2015 – Section 5.7

All out of band emissions are measured by means of a calibrated spectrum analyzer. The EUT was setup to maximum output power at its lowest and highest channel with all bandwidths, modulations and RB configurations.

The power of any spurious emission shall be attenuated below the transmitter power (P) by at least  $43 + 10 \log(P)$  dB.

#### Test setting

1. Start and stop frequency were set such that the band edge would be placed in the center of the plot
2. Span was set large enough so as to capture all out of band emissions near the band edge
3. RBW  $\geq 1\%$  of the emission bandwidth
4. VBW  $\geq 3 \times$  RBW
5. Detector = RMS & Trace mode = Max hold
6. Sweep time = Auto couple or 1 s for band edge
7. Number of sweep point  $\geq 2 \times$  span / RBW
8. The trace was allowed to stabilize

Note 1: Per Part 22.917(b)(1) / 24.238(b) / 27.53(h) in the 1 MHz bands immediately outside and adjacent to the frequency block a resolution bandwidth of at least one percent of the emission bandwidth of the fundamental emission of the transmitter may be employed to demonstrate compliance with the out-of-band emissions limit.

The emission bandwidth is defined as the width of the signal between two points, one below the carrier center frequency and one above the carrier center frequency, outside of which all emission are attenuated at least 26 dB below the transmitter power.

Note 2: Per Part 27(g) for operations in the 600 MHz band and the 698-746 MHz band, compliance with this provision is based on the use of measurement instrumentation employing a resolution bandwidth of 100 kilohertz or greater. However, in the 100 kilohertz bands immediately outside and adjacent to a licensee's frequency block, a resolution bandwidth of at least 30 kHz may be employed.

Note 3: For part 27.53(m)(4) the attenuation factor shall be not less than  $40 + 10 \log(P)$  dB on all frequencies between the channel edge and 5 megahertz from the channel edge,  $43 + 10 \log(P)$  dB on all frequencies between 5 megahertz and X megahertz from the channel edge, and  $55 + 10 \log(P)$  dB on all frequencies more than X megahertz from the channel edge, where X is the greater of 6 megahertz or the actual emission bandwidth as defined in paragraph (m)(6) of this section. In addition, the attenuation factor shall not be less than  $43 + 10 \log(P)$  dB on all frequencies between 2490.5 MHz and 2496 MHz and  $55 + 10 \log(P)$  dB at or below 2490.5 MHz.

Note 4: Per part 27.53(m)(6) in the 1 MHz bands immediately outside and adjacent to the frequency block a resolution bandwidth of at least two percent may be employed, except when the 1 MHz band is 2495-2496 MHz, in which case a resolution bandwidth of at least one percent may be employed.

### 3.5 SPURIOUS AND HARMONIC EMISSIONS AT ANTENNA TERMINAL

#### Test set-up

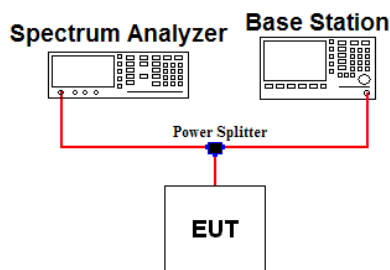

#### Test Procedure

- KDB971168 D01v03r01 - Section 6
- ANSI C63.26-2015 – Section 5.7

The level of the carrier and the various conducted spurious and harmonic frequencies is measured by means of a calibrated spectrum analyzer. The EUT was setup to maximum output power at its low, middle, high channel with all bandwidths, modulations and RB configurations. The spectrum is scanned from 9 kHz up to a frequency including its 10<sup>th</sup> harmonic.

The power of any spurious emission shall be attenuated below the transmitter power (P) by at least  $43 + 10 \log(P)$  dB.

#### Test setting

1. RBW = 100 kHz (Below 1 GHz) or 1 MHz (Above 1 GHz) & VBW  $\geq 3 \times$  RBW ( Refer to Note 1)
2. Detector = RMS & Trace mode = Max hold
3. Sweep time = Auto couple
4. Number of sweep point  $\geq 2 \times$  span / RBW
5. The trace was allowed to stabilize

Note 1: Compliance with these provisions is based on the use of measurement instrumentation employing a resolution bandwidth of 100 kHz or greater for frequencies less than 1GHz and 1MHz or greater for frequencies greater than 1GHz.

### 3.6 UNDESIRABLE EMISSIONS

#### Test Set-up

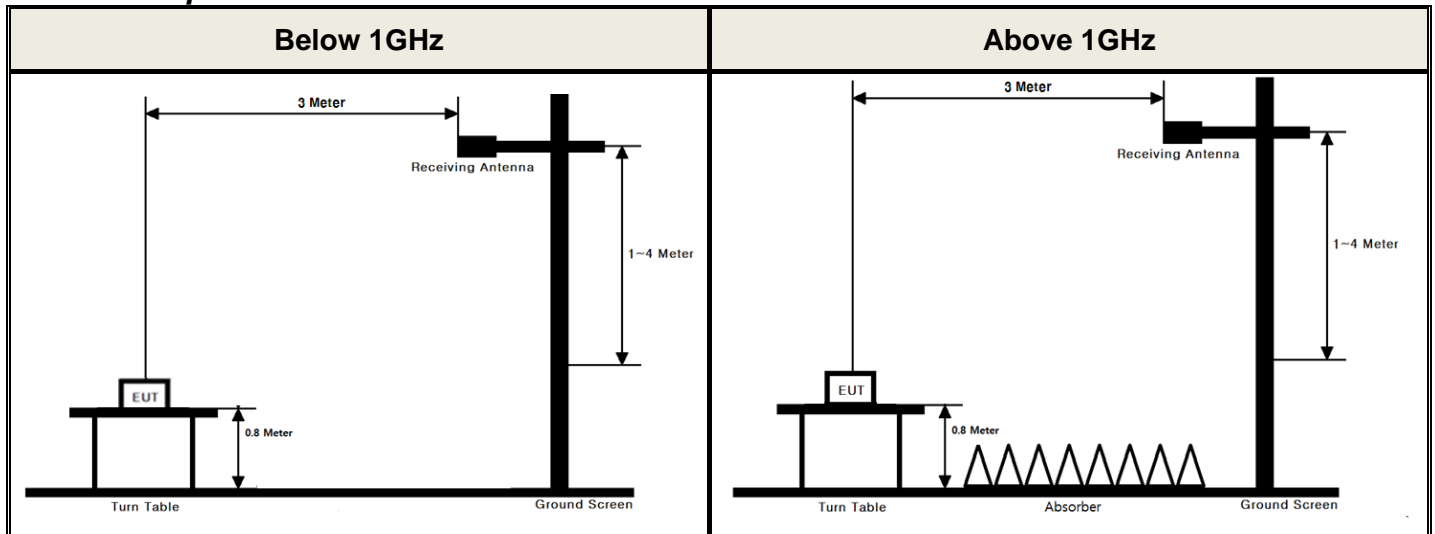

These measurements were performed at 3 test site. The equipment under test is placed on a non-conductive table 0.8-meters above a turntable which is flush with the ground plane and 3 meters from the receive antenna. For measurements above 1GHz absorbers are placed on the floor between the turn table and the antenna mast in such a way so as to maximize the reduction of reflections. For measurements below 1 GHz, the absorbers are removed.

#### Test Procedure

- ANSI/TIA-603-E-2016 - Section 2.2.12
- KDB971168 D01v03r01 - Section 5.8
- ANSI C63.26-2015 – Section 5.5

#### Test setting

1. RBW = 100 kHz for below 1 GHz and 1 MHz for above 1 GHz / VBW  $\geq$  3 X RBW
2. Detector = RMS & Trace mode = Max hold
3. Sweep time = Auto couple
4. Number of sweep point  $\geq$  2 X span / RBW
5. The trace was allowed to stabilize

The receive antenna height and turntable rotations were adjusted for the highest reading on the receive spectrum analyzer.

For radiated power measurements below 1 GHz, a half-wave dipole was substituted in place of the EUT. This dipole antenna was driven by a signal generator and the level of the signal generator was adjusted to obtain the same spectrum analyzer reading.

For radiated power measurements above 1 GHz, a Horn antenna was substituted in place of the EUT. This Horn antenna was driven by a signal generator and the level of the signal generator was adjusted to obtain the same spectrum analyzer reading. The difference between the gain of the horn and an isotropic antenna are taken into consideration.

This measurement was performed with the EUT oriented in 3 orthogonal axis.

### 3.7 FREQUENCY STABILITY

#### Test Set-up

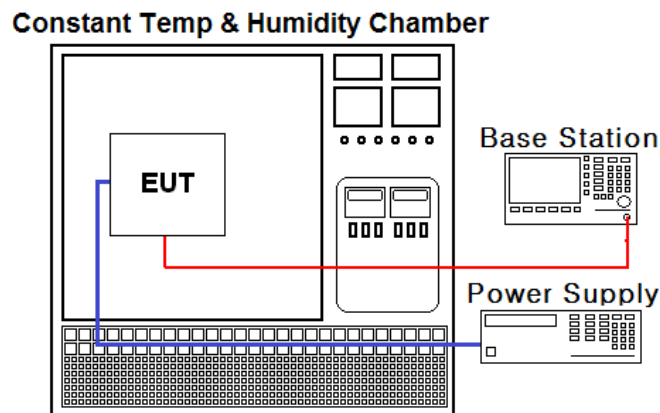

#### Test Procedure

- ANSI/TIA-603-E-2016
- KDB971168 D01v03r01 - Section 9

The frequency stability of the transmitter is measured by:

a.) **Temperature:**

The temperature is varied from - 30 °C to + 50 °C using an environmental chamber.

b.) **Primary Supply Voltage:**

The primary supply voltage is varied from 85 % to 115 % of the nominal value for non hand-carried battery and AC powered equipment. For hand-carried, battery-powered equipment, primary supply voltage is reduced to the battery operating end point which shall be specified by the manufacturer.

#### Specification:

The frequency stability shall be sufficient to ensure that the fundamental emission stays within the authorized frequency block for Part 24, 27. The frequency stability of the transmitter shall be maintained within  $\pm 0.00025\%$  ( $\pm 2.5$  ppm) of the center frequency for Part 22.

#### Time Period and Procedure:

1. The carrier frequency of the transmitter is measured at room temperature.  
(20 °C to provide a reference)
2. The equipment is turned on in a "standby" condition for one minute before applying power to the transmitter. Measurement of the carrier frequency of the transmitter is made within one minute after applying power to the transmitter.
3. Frequency measurements are made at 10 °C intervals ranging from -30 °C to +50 °C.  
A period of at least one half-hour is provided to allow stabilization of the equipment at each temperature level.

#### 4. LIST OF TEST EQUIPMENT

Type	Manufacturer	Model	Cal.Date (yy/mm/dd)	Next.Cal. Date (yy/mm/dd)	S/N
Spectrum Analyzer	Agilent Technologies	N9020A	17/09/05	18/09/05	MY46471251
Spectrum Analyzer	Agilent Technologies	N9020A	17/12/26	18/12/26	MY50200828
DC Power Supply	Agilent Technologies	66332A	17/09/05	18/09/05	GB42110550
Multimeter	FLUKE	17B	17/12/26	18/12/26	26030065WS
Power Splitter	Anritsu	K241B	17/12/27	18/12/27	016681
Temp & Humi Test Chamber	SJ Science	SJ-TH-S50	17/12/28	18/12/28	SJ-TH-S50120203
Thermohyrometer	BODYCOM	BJ5478	18/01/03	19/01/03	120612-2
Radio Communication Analyzer	Anritsu	MT8820C	17/09/07	19/09/07	6201127429
Signal Generator	R&S	SMBV100A	17/12/28	18/12/28	255571
Signal Generator	R&S	SMF100A	17/12/27	18/12/27	102341
Loop Antenna	Schwarzbeck	FMZB1513	18/01/30	20/01/30	1513-128
Bilog Antenna	Schwarzbeck	VULB9160	16/08/05	18/08/05	9160-3362
Dipole Antenna	Schwarzbeck	VHA9103	17/03/14	19/03/14	2116
Dipole Antenna	Schwarzbeck	VHA9103	16/04/15	18/04/15	2117
			18/04/13	18/04/13	
Dipole Antenna	Schwarzbeck	UHA9105	17/03/14	19/03/14	2261
Dipole Antenna	Schwarzbeck	UHA9105	16/04/15	18/04/15	2262
			18/04/13	18/04/13	
HORN ANT	ETS	3117	16/05/13	18/05/13	00140394
HORN ANT	ETS	3117	17/08/02	19/08/02	00154312
HORN ANT	A.H.Systems	SAS-574	17/04/25	19/04/25	154
HORN ANT	A.H.Systems	SAS-574	17/07/31	19/07/31	155
PreAmplifier	RFBAY.Inc	MPA-40-40	17/12/28	18/12/28	21151801
PreAmplifier	EMPOWER	BBS3Q7ELU	17/09/06	18/09/06	1020
PreAmplifier	TSJ	MLA-010K01-B01- 27	18/03/05	19/03/05	1844539
Amplifier	Agilent	8449B	17/09/05	18/09/05	3008A02108
High-pass filter	Wainwright	WHKX12-935-1000- 15000-40SS	17/09/05	18/09/05	7
High-pass filter	Wainwright	WHKX12-2580- 3000-18000-80SS	17/09/05	18/09/05	3
High-pass filter	Wainwright	WHNX8.0/26.5-6SS	17/12/26	18/12/26	3
CABLE	DTNC	CABLE	NA	NA	C-016-4
CABLE	DTNC	CABLE	NA	NA	RF-81
CABLE	Radiall	TESTPRO3	NA	NA	RF-74
CABLE	DTNC	CABLE-RF	NA	NA	RF-76
CABLE	DTNC	CABLE-RF	NA	NA	RF-54
CABLE	DTNC	CABLE-RF	NA	NA	RF-32
CABLE	Radiall	TESTPRO3	NA	NA	RF-66
CABLE	HUBER+SUHNER	SUCOFLEX103	NA	NA	RF-75

Note: The measurement antennas were calibrated in accordance to the requirements of ANSI C63.5-2017.



## 5. SUMMARY OF TEST RESULTS

FCC Part Section(s)	Test Description	Test Limit	Test Condition	Status Note 1
2.1046	Conducted Output Power	N/A	Conducted	<b>C</b> Note2
2.1049	Occupied Bandwidth	N/A		<b>C</b>
24.232(d) 27.50(d.5)	Peak to Average Ratio	< 13 dB		<b>C</b>
2.1051 22.917(a) 24.238(a) 27.53(g) 27.53(h)	Band Edge / Conducted Spurious Emissions	> 43 + 10log <sub>10</sub> (P) dB at Band edge and for all out-of-band emissions		<b>C</b>
27.53(m)	Band Edge / Conducted Spurious Emissions	> 40 + 10log <sub>10</sub> (P) dB at channel edge and 5 MHz from the channel edge > 43 + 10log <sub>10</sub> (P) dB at 5 MHz and X MHz from the channel edge > 55 + 10log <sub>10</sub> (P) dB at all frequencies more than X MHz from the channel edge		<b>C</b>
2.1055 22.355 24.235 27.54	Frequency Stability	< 2.5 ppm (Part 22) Fundamental emissions must stay within Authorized frequency block (Part 24, 27)		<b>C</b>
27.50(c.10)	Radiated Output Power (B12, 17)	< 3 Watts max. ERP		Radiated
22.913(a.5)	Radiated Output Power (B5)	< 7 Watts max. ERP	<b>C</b>	
27.50(d.4)	Radiated Output Power (B4, 66)	< 1 Watts max. EIRP	<b>C</b>	
24.232(c) 27.50(h.2)	Radiated Output Power(B2, 7)	< 2 Watts max. EIRP	<b>C</b>	
2.1053 22.917(a) 24.238(a) 27.53(g) 27.53(h)	Undesirable Emissions	> 43 + 10log <sub>10</sub> (P) dB for all out-of-band emissions	<b>C</b>	
27.53(m)	Undesirable Emissions(B7)	> 55 + 10log <sub>10</sub> (P) dB for all out-of-band emissions	<b>C</b>	
Note 1: <b>C</b> =Comply <b>NC</b> =Not Comply <b>NT</b> =Not Tested <b>NA</b> =Not Applicable Note 2: Refer to RF Exposure Report (Test Report SAR)				

## 6. SAMPLE CALCULATION

### A. Emission Designator

#### LTE Band 12(QPSK)

Emission Designator = **8M97G7D**  
LTE OBW = 8.971 MHz  
G = Phase Modulation  
7 = Quantized/Digital Info  
D = Data Transmission

#### LTE Band 17(QPSK)

Emission Designator = **9M00G7D**  
LTE OBW = 9.000 MHz  
G = Phase Modulation  
7 = Quantized/Digital Info  
D = Data Transmission

#### LTE Band 5(QPSK)

Emission Designator = **8M96G7D**  
LTE OBW = 8.963 MHz  
G = Phase Modulation  
7 = Quantized/Digital Info  
D = Data Transmission

#### LTE Band 4(QPSK)

Emission Designator = **18M0G7D**  
LTE OBW = 17.955 MHz  
G = Phase Modulation  
7 = Quantized/Digital Info  
D = Data Transmission

#### LTE Band 66(QPSK)

Emission Designator = **17M9G7D**  
LTE OBW = 17.912 MHz  
G = Phase Modulation  
7 = Quantized/Digital Info  
D = Data Transmission

#### LTE Band 12(16QAM)

Emission Designator = **8M98W7D**  
LTE OBW = 8.980 MHz  
W = Amplitude/Angle Modulated  
7 = Quantized/Digital Info  
D = Data Transmission

#### LTE Band 17(16QAM)

Emission Designator = **8M99W7D**  
LTE OBW = 8.988 MHz  
W = Amplitude/Angle Modulated  
7 = Quantized/Digital Info  
D = Data Transmission

#### LTE Band 5(16QAM)

Emission Designator = **8M96W7D**  
LTE OBW = 8.959 MHz  
W = Amplitude/Angle Modulated  
7 = Quantized/Digital Info  
D = Data Transmission

#### LTE Band 4(16QAM)

Emission Designator = **17M9W7D**  
LTE OBW = 17.927 MHz  
W = Amplitude/Angle Modulated  
7 = Quantized/Digital Info  
D = Data Transmission

#### LTE Band 66(16QAM)

Emission Designator = **17M9W7D**  
LTE OBW = 17.915 MHz  
W = Amplitude/Angle Modulated  
7 = Quantized/Digital Info  
D = Data Transmission

**LTE Band 2(QPSK)**

Emission Designator = **17M9G7D**  
LTE OBW = 17.930 MHz  
G = Phase Modulation  
7 = Quantized/Digital Info  
D = Data Transmission

**LTE Band 7(QPSK)**

Emission Designator = **17M9G7D**  
LTE OBW = 17.891 MHz  
G = Phase Modulation  
7 = Quantized/Digital Info  
D = Data Transmission

**LTE Band 2(16QAM)**

Emission Designator = **17M9W7D**  
LTE OBW = 17.924 MHz  
W = Amplitude/Angle Modulated  
7 = Quantized/Digital Info  
D = Data Transmission

**LTE Band 7(16QAM)**

Emission Designator = **18M0W7D**  
LTE OBW = 17.957 MHz  
W = Amplitude/Angle Modulated  
7 = Quantized/Digital Info  
D = Data Transmission

## B. For substitution method

Channel Bandwidth (MHz)	Test Frequency (MHz)	Test Mode	RB Size/ Offset	Spectrum Reading Value(dBm)	EUT Axis	Ant Pol (H/V)	Level(dBm) @ Ant Terminal	TX Ant Gain (dBd)	ERP (dBm)	ERP (W)
10	829	QPSK	1/0	-15.18	X	H	20.20	1.23	21.43	0.139

### ERP or EIRP = Level @ Ant Terminal LEVEL(dBm) + Tx Ant. Gain

- 1) The EUT mounted on a non-conductive turntable is 0.8 meter above test site ground level.
- 2) During the test, the turn table is rotated until the maximum signal is found.
- 3) Record the field strength meter's level.
- 4) Replace the EUT with dipole/Horn antenna that is connected to a calibrated signal generator.
- 5) Increase the signal generator output till the field strength meter's level is equal to the item (3).
- 6) The signal generator output level with substituted antenna gain is the rating of ERP, EIRP or Radiated spurious emission.

## 7. TEST DATA

### 7.1 OCCUPIED BANDWIDTH

- Plots of the EUT's Occupied Bandwidth are shown in Clause 8.1

### 7.2 PEAK TO AVERAGE RATIO

- Plots of the EUT's Peak- to- Average Ratio are shown in Clause 8.2

### 7.3 BAND EDGE EMISSIONS (Conducted)

- Plots of the EUT's Band Edge Emissions are shown in Clause 8.3

### 7.4 SPURIOUS AND HARMONICS EMISSIONS (Conducted)

- Plots of the EUT's Spurious Emissions are shown in Clause 8.4

## 7.5 ERP & EIRP

### 7.5.1 LTE Band 12

Channel Bandwidth (MHz)	Test Frequency (MHz)	Test Mode	RB Size/Offset	Ant Pol (H/V)	Level(dBm) @ Ant Terminal	TX Ant Gain (dBd)	ERP (dBm)	ERP (W)
10	704	QPSK	1/0	H	17.16	1.28	18.44	0.070
		16QAM	1/0	H	16.30	1.28	17.58	0.057
	711	QPSK	1/49	H	18.61	1.28	19.89	0.097
		16QAM	1/49	H	17.51	1.28	18.79	0.076
5	701.5	QPSK	1/0	H	17.07	1.28	18.35	0.068
		16QAM	1/0	H	16.06	1.28	17.34	0.054
	707.5	QPSK	1/24	H	17.48	1.28	18.76	0.075
		16QAM	1/24	H	16.37	1.28	17.65	0.058
	713.5	QPSK	1/24	H	17.25	1.28	18.53	0.071
		16QAM	1/24	H	16.34	1.28	17.62	0.058
3	700.5	QPSK	1/0	H	17.10	1.28	18.38	0.069
		16QAM	1/0	H	16.03	1.28	17.31	0.054
	707.5	QPSK	1/14	H	17.12	1.28	18.40	0.069
		16QAM	1/14	H	16.45	1.28	17.73	0.059
	714.5	QPSK	1/14	H	17.59	1.28	18.87	0.077
		16QAM	1/14	H	16.72	1.28	18.00	0.063
1.4	699.7	QPSK	1/5	H	17.02	1.28	18.30	0.068
		16QAM	1/5	H	16.06	1.28	17.34	0.054
	707.5	QPSK	1/5	H	16.97	1.28	18.25	0.067
		16QAM	1/5	H	16.15	1.28	17.43	0.055
	715.3	QPSK	1/0	H	16.43	1.28	17.71	0.059
		16QAM	1/0	H	15.93	1.28	17.21	0.053

Note: This device was tested under all bandwidths, modulations and RB configurations and the worst case data are reported in the table above.

### 7.5.2 LTE Band 17

Channel Bandwidth (MHz)	Test Frequency (MHz)	Test Mode	RB Size/ Offset	Ant Pol (H/V)	Level(dBm) @ Ant Terminal	TX Ant Gain (dBd)	ERP (dBm)	ERP (W)
10	709	QPSK	1/49	H	18.43	1.28	19.71	0.094
		16QAM	1/49	H	17.59	1.28	18.87	0.077
	711	QPSK	1/49	H	18.44	1.28	19.72	0.094
		16QAM	1/49	H	17.80	1.28	19.08	0.081
5	706.5	QPSK	1/0	H	17.10	1.28	18.38	0.069
		16QAM	1/0	H	16.32	1.28	17.60	0.058
	710	QPSK	1/24	H	17.56	1.28	18.84	0.077
		16QAM	1/24	H	16.33	1.28	17.61	0.058
	713.5	QPSK	1/24	H	16.49	1.28	17.77	0.060
		16QAM	1/24	H	15.43	1.28	16.71	0.047

Note: This device was tested under all bandwidths, modulations and RB configurations and the worst case data are reported in the table above.

### 7.5.3 LTE Band 5

Channel Bandwidth (MHz)	Test Frequency (MHz)	Test Mode	RB Size/Offset	Ant Pol (H/V)	Level(dBm) @ Ant Terminal	TX Ant Gain (dBd)	ERP (dBm)	ERP (W)
10	829	QPSK	1/0	H	20.20	1.23	21.43	0.139
		16QAM	1/0	H	19.41	1.23	20.64	0.116
	836.5	QPSK	1/49	H	18.97	1.22	20.19	0.104
		16QAM	1/49	H	17.84	1.22	19.06	0.081
	844	QPSK	1/49	H	18.53	1.21	19.74	0.094
		16QAM	1/49	H	17.51	1.21	18.72	0.074
5	826.5	QPSK	1/0	H	20.20	1.23	21.43	0.139
		16QAM	1/0	H	19.14	1.23	20.37	0.109
	836.5	QPSK	1/24	H	18.09	1.22	19.31	0.085
		16QAM	1/24	H	17.39	1.22	18.61	0.073
	846.5	QPSK	1/0	H	19.69	1.21	20.90	0.123
		16QAM	1/0	H	18.53	1.21	19.74	0.094
3	825.5	QPSK	1/0	H	19.65	1.23	20.88	0.122
		16QAM	1/0	H	18.65	1.23	19.88	0.097
	836.5	QPSK	1/0	H	18.34	1.22	19.56	0.090
		16QAM	1/0	H	17.19	1.22	18.41	0.069
	847.5	QPSK	1/0	H	19.41	1.21	20.62	0.115
		16QAM	1/0	H	18.35	1.21	19.56	0.090
1.4	824.7	QPSK	1/0	H	18.99	1.23	20.22	0.105
		16QAM	1/0	H	18.16	1.23	19.39	0.087
	836.5	QPSK	1/5	H	17.93	1.22	19.15	0.082
		16QAM	1/5	H	17.04	1.22	18.26	0.067
	848.3	QPSK	1/5	H	18.72	1.21	19.93	0.098
		16QAM	1/5	H	17.80	1.21	19.01	0.080

Note: This device was tested under all bandwidths, modulations and RB configurations and the worst case data are reported in the table above.



**7.5.4 LTE Band 4**

Channel Bandwidth (MHz)	Test Frequency (MHz)	Test Mode	RB Size/ Offset	Ant Pol (H/V)	Level(dBm) @ Ant Terminal	TX Ant Gain (dBi)	EIRP (dBm)	EIRP (W)
20	1720	QPSK	1/0	H	12.16	5.82	17.98	0.063
		16QAM	1/0	H	11.38	5.82	17.20	0.052
	1732.5	QPSK	1/0	H	12.13	5.75	17.88	0.061
		16QAM	1/0	H	11.58	5.75	17.33	0.054
	1745	QPSK	1/0	H	13.19	5.67	18.86	0.077
		16QAM	1/0	H	12.57	5.67	18.24	0.067
15	1717.5	QPSK	1/0	H	12.05	5.84	17.89	0.062
		16QAM	1/0	H	11.42	5.84	17.26	0.053
	1732.5	QPSK	1/0	H	12.72	5.75	18.47	0.070
		16QAM	1/0	H	11.96	5.75	17.71	0.059
	1747.5	QPSK	1/0	H	13.27	5.66	18.93	0.078
		16QAM	1/0	H	12.46	5.66	18.12	0.065
10	1715	QPSK	1/0	H	12.60	5.85	18.45	0.070
		16QAM	1/0	H	12.06	5.85	17.91	0.062
	1732.5	QPSK	1/0	H	13.86	5.75	19.61	0.091
		16QAM	1/0	H	12.92	5.75	18.67	0.074
	1750	QPSK	1/0	H	13.70	5.64	19.34	0.086
		16QAM	1/0	H	13.06	5.64	18.70	0.074
5	1712.5	QPSK	1/0	H	12.25	5.87	18.12	0.065
		16QAM	1/0	H	11.50	5.87	17.37	0.055
	1732.5	QPSK	1/0	H	13.36	5.75	19.11	0.081
		16QAM	1/0	H	12.54	5.75	18.29	0.067
	1752.5	QPSK	1/0	H	13.72	5.63	19.35	0.086
		16QAM	1/0	H	12.77	5.63	18.40	0.069
3	1711.5	QPSK	1/0	H	12.03	5.87	17.90	0.062
		16QAM	1/0	H	11.21	5.87	17.08	0.051
	1732.5	QPSK	1/0	H	13.15	5.75	18.90	0.078
		16QAM	1/0	H	12.62	5.75	18.37	0.069
	1753.5	QPSK	1/0	H	13.25	5.62	18.87	0.077
		16QAM	1/0	H	12.95	5.62	18.57	0.072
1.4	1710.7	QPSK	1/0	H	11.53	5.88	17.41	0.055
		16QAM	1/0	H	10.80	5.88	16.68	0.047
	1732.5	QPSK	1/0	H	12.88	5.75	18.63	0.073
		16QAM	1/0	H	12.41	5.75	18.16	0.065
	1754.3	QPSK	1/5	H	13.90	5.61	19.51	0.089
		16QAM	1/5	H	13.13	5.61	18.74	0.075

Note: This device was tested under all bandwidths, modulations and RB configurations and the worst case data are reported in the table above.

**7.5.5 LTE Band 66**

Channel Bandwidth (MHz)	Test Frequency (MHz)	Test Mode	RB Size/ Offset	Ant Pol (H/V)	Level(dBm) @ Ant Terminal	TX Ant Gain (dBi)	EIRP (dBm)	EIRP (W)
20	1720	QPSK	1/0	H	13.01	5.82	18.83	0.076
		16QAM	1/0	H	12.25	5.82	18.07	0.064
	1745	QPSK	1/0	H	13.49	5.67	19.16	0.082
		16QAM	1/0	H	12.26	5.67	17.93	0.062
	1770	QPSK	1/0	H	12.41	5.52	17.93	0.062
		16QAM	1/0	H	11.96	5.52	17.48	0.056
15	1717.5	QPSK	1/0	H	12.02	5.84	17.86	0.061
		16QAM	1/0	H	10.83	5.84	16.67	0.046
	1745	QPSK	1/74	H	11.71	5.67	17.38	0.055
		16QAM	1/74	H	11.26	5.67	16.93	0.049
	1772.5	QPSK	1/0	H	12.77	5.51	18.28	0.067
		16QAM	1/0	H	12.04	5.51	17.55	0.057
10	1715	QPSK	1/0	H	11.13	5.85	16.98	0.050
		16QAM	1/0	H	10.61	5.85	16.46	0.044
	1745	QPSK	1/49	H	11.66	5.67	17.33	0.054
		16QAM	1/49	H	11.12	5.67	16.79	0.048
	1775	QPSK	1/0	H	13.06	5.49	18.55	0.072
		16QAM	1/0	H	12.51	5.49	18.00	0.063
5	1712.5	QPSK	1/0	H	11.31	5.87	17.18	0.052
		16QAM	1/0	H	10.73	5.87	16.60	0.046
	1745	QPSK	1/0	H	11.94	5.67	17.61	0.058
		16QAM	1/0	H	11.12	5.67	16.79	0.048
	1777.5	QPSK	1/24	H	13.14	5.48	18.62	0.073
		16QAM	1/24	H	12.75	5.48	18.23	0.067
3	1711.5	QPSK	1/0	H	11.39	5.87	17.26	0.053
		16QAM	1/0	H	10.44	5.87	16.31	0.043
	1745	QPSK	1/14	H	11.78	5.67	17.45	0.056
		16QAM	1/14	H	11.16	5.67	16.83	0.048
	1778.5	QPSK	1/14	H	13.10	5.47	18.57	0.072
		16QAM	1/14	H	12.33	5.47	17.80	0.060
1.4	1710.7	QPSK	1/2	H	11.04	5.88	16.92	0.049
		16QAM	1/2	H	10.40	5.88	16.28	0.042
	1745	QPSK	1/5	H	12.43	5.67	18.10	0.065
		16QAM	1/5	H	11.82	5.67	17.49	0.056
	1779.3	QPSK	1/5	H	12.95	5.46	18.41	0.069
		16QAM	1/5	H	12.46	5.46	17.92	0.062

Note: This device was tested under all bandwidths, modulations and RB configurations and the worst case data are reported in the table above.

### 7.5.6 LTE Band 2

Channel Bandwidth (MHz)	Test Frequency (MHz)	Test Mode	RB Size/ Offset	Ant Pol (H/V)	Level(dBm) @ Ant Terminal	TX Ant Gain (dBi)	EIRP (dBm)	EIRP (W)
20	1860	QPSK	1/0	H	15.01	5.02	20.03	0.101
		16QAM	1/0	H	14.08	5.02	19.10	0.081
	1880	QPSK	1/0	H	13.99	4.91	18.90	0.078
		16QAM	1/0	H	13.43	4.91	18.34	0.068
	1900	QPSK	1/0	H	13.86	4.81	18.67	0.074
		16QAM	1/0	H	12.83	4.81	17.64	0.058
15	1857.5	QPSK	1/0	H	14.65	5.03	19.68	0.093
		16QAM	1/0	H	13.89	5.03	18.92	0.078
	1880	QPSK	1/0	H	13.94	4.91	18.85	0.077
		16QAM	1/0	H	13.26	4.91	18.17	0.066
	1902.5	QPSK	1/0	H	14.58	4.80	19.38	0.087
		16QAM	1/0	H	13.60	4.80	18.40	0.069
10	1855	QPSK	1/0	H	13.53	5.05	18.58	0.072
		16QAM	1/0	H	13.80	5.05	18.85	0.077
	1880	QPSK	1/0	H	14.07	4.91	18.98	0.079
		16QAM	1/0	H	13.00	4.91	17.91	0.062
	1905	QPSK	1/0	H	14.32	4.79	19.11	0.081
		16QAM	1/0	H	13.33	4.79	18.12	0.065
5	1852.5	QPSK	1/0	H	14.41	5.06	19.47	0.089
		16QAM	1/0	H	13.38	5.06	18.44	0.070
	1880	QPSK	1/0	H	13.37	4.91	18.28	0.067
		16QAM	1/0	H	12.69	4.91	17.60	0.058
	1907.5	QPSK	1/0	H	13.79	4.77	18.56	0.072
		16QAM	1/0	H	12.61	4.77	17.38	0.055
3	1851.5	QPSK	1/0	H	14.14	5.06	19.20	0.083
		16QAM	1/0	H	13.66	5.06	18.72	0.074
	1880	QPSK	1/0	H	13.75	4.91	18.66	0.073
		16QAM	1/0	H	12.90	4.91	17.81	0.060
	1908.5	QPSK	1/0	H	14.09	4.77	18.86	0.077
		16QAM	1/0	H	13.13	4.77	17.90	0.062
1.4	1850.7	QPSK	1/0	H	14.85	5.07	19.92	0.098
		16QAM	1/0	H	13.93	5.07	19.00	0.079
	1880	QPSK	1/5	H	13.56	4.91	18.47	0.070
		16QAM	1/5	H	12.94	4.91	17.85	0.061
	1909.3	QPSK	1/0	H	14.01	4.76	18.77	0.075
		16QAM	1/0	H	12.87	4.76	17.63	0.058

Note: This device was tested under all bandwidths, modulations and RB configurations and the worst case data are reported in the table above.

### 7.5.7 LTE Band 7

Channel Bandwidth (MHz)	Test Frequency (MHz)	Test Mode	RB Size/ Offset	Ant Pol (H/V)	Level(dBm) @ Ant Terminal	TX Ant Gain (dBi)	EIRP (dBm)	EIRP (W)
20	2506	QPSK	1/99	H	10.92	6.19	17.11	0.051
		16QAM	1/99	H	10.86	6.19	17.05	0.051
	2593	QPSK	1/99	H	12.11	6.21	18.32	0.068
		16QAM	1/99	H	11.77	6.21	17.98	0.063
	2680	QPSK	1/0	H	12.41	6.21	18.62	0.073
		16QAM	1/0	H	11.27	6.21	17.48	0.056
15	2503.5	QPSK	1/0	H	10.50	6.19	16.69	0.047
		16QAM	1/0	H	10.35	6.19	16.54	0.045
	2593	QPSK	1/0	H	12.50	6.21	18.71	0.074
		16QAM	1/0	H	11.27	6.21	17.48	0.056
	2682.5	QPSK	1/0	H	11.82	6.21	18.03	0.064
		16QAM	1/0	H	10.96	6.21	17.17	0.052
10	2501	QPSK	1/0	H	10.77	6.19	16.96	0.050
		16QAM	1/0	H	10.14	6.19	16.33	0.043
	2593	QPSK	1/49	H	11.11	6.21	17.32	0.054
		16QAM	1/49	H	9.84	6.21	16.05	0.040
	2685	QPSK	1/0	H	11.78	6.22	18.00	0.063
		16QAM	1/0	H	10.61	6.22	16.83	0.048
5	2498.5	QPSK	1/0	H	10.83	6.19	17.02	0.050
		16QAM	1/0	H	9.80	6.19	15.99	0.040
	2593	QPSK	1/24	H	11.50	6.21	17.71	0.059
		16QAM	1/24	H	10.49	6.21	16.70	0.047
	2687.5	QPSK	1/0	H	11.47	6.22	17.69	0.059
		16QAM	1/0	H	10.36	6.22	16.58	0.045

Note: This device was tested under all bandwidths, modulations and RB configurations and the worst case data are reported in the table above.

## 7.6 UNDESIRABLE EMISSIONS (Radiated)

### 7.6.1 LTE Band 12

B.W (MHz)	Test Freq. (MHz)	RB Size/ Offset	Test Mode	Freq.(MHz)	Ant Pol (H/V)	Level(dBm) @ Ant Terminal	TX Ant Gain(dBd)	Result		Limit (dBc)
								(dBm)	(dBc)	
10	704	1/0	QPSK	1399.37	V	-51.89	2.89	-49.00	67.44	31.44
				2098.65	H	-53.73	2.42	-51.31	69.75	
			16QAM	1399.46	V	-52.22	2.89	-49.33	66.91	30.58
				2098.76	H	-54.55	2.42	-52.13	69.71	
	711	1/49	QPSK	1430.87	V	-51.38	3.09	-48.29	68.18	32.89
				2146.48	H	-51.92	2.84	-49.08	68.97	
			16QAM	1430.91	V	-52.01	3.09	-48.92	67.71	31.79
				2146.48	H	-51.92	2.84	-49.08	67.87	
5	701.5	1/0	QPSK	1398.77	V	-51.85	2.89	-48.96	67.31	31.35
				2098.12	H	-52.98	2.42	-50.56	68.91	
			16QAM	1398.54	V	-52.11	2.88	-49.23	66.57	30.34
				2097.69	H	-53.77	2.41	-51.36	68.70	
	707.5	1/24	QPSK	1419.42	V	-49.72	3.02	-46.70	65.46	31.76
				2128.94	H	-53.00	2.68	-50.32	69.08	
			16QAM	1419.24	V	-50.68	3.02	-47.66	65.31	30.65
				2129.17	H	-53.11	2.69	-50.42	68.07	
	713.5	1/24	QPSK	1431.28	V	-50.68	3.09	-47.59	66.12	31.53
				2147.08	H	-52.53	2.85	-49.68	68.21	
			16QAM	1431.28	V	-50.68	3.09	-47.59	65.21	30.62
				2147.07	H	-52.66	2.85	-49.81	67.43	

B.W (MHz)	Test Freq. (MHz)	RB Size/Offset	Test Mode	Freq.(MHz)	Ant Pol (H/V)	Level(dBm) @ Ant Terminal	TX Ant Gain(dBd)	Result		Limit (dBc)		
								(dBm)	(dBc)			
3	700.5	1/0	QPSK	1398.30	V	-51.62	2.88	-48.74	67.12	31.38		
				2097.85	H	-53.25	2.42	-50.83	69.21			
			16QAM	1398.62	V	-52.38	2.88	-49.50	66.81	30.31		
				2097.60	H	-53.98	2.41	-51.57	68.88			
	707.5	1/14	QPSK	1417.51	V	-49.70	3.01	-46.69	65.09	31.40		
				2126.47	H	-53.28	2.66	-50.62	69.02			
			16QAM	1417.45	V	-49.78	3.00	-46.78	64.51	30.73		
				2126.14	H	-53.72	2.66	-51.06	68.79			
			714.5	1/14	QPSK	1431.71	V	-50.82	3.09	-47.73	66.60	31.87
						2147.32	H	-53.06	2.85	-50.21	69.08	
	16QAM	1431.49			V	-51.19	3.09	-48.10	66.10	31.00		
		2147.32			H	-53.56	2.85	-50.71	68.71			
1.4	699.7	1/5	QPSK	1400.36	V	-51.88	2.90	-48.98	67.28	31.30		
				2100.56	H	-52.86	2.43	-50.43	68.73			
			16QAM	1400.06	V	-51.96	2.90	-49.06	66.40	30.34		
				2100.73	H	-53.37	2.43	-50.94	68.28			
	707.5	1/5	QPSK	1416.04	V	-49.46	3.00	-46.46	64.71	31.25		
				2124.22	H	-53.26	2.64	-50.62	68.87			
			16QAM	1415.97	V	-50.14	3.00	-47.14	64.57	30.43		
				2123.65	H	-53.80	2.64	-51.16	68.59			
	715.3	1/0	QPSK	1429.88	V	-52.10	3.08	-49.02	66.73	30.71		
				2147.27	H	-52.87	2.85	-50.02	67.73			
			16QAM	1429.60	V	-53.16	3.08	-50.08	67.29	30.21		
				2147.59	H	-53.87	2.85	-51.02	68.23			

Note 1: Limit Calculation =  $43 + 10\log_{10}(P[\text{Watts}])$

Note 2: This device was tested under all bandwidths, modulations and RB configurations and the worst case data are reported in the table above.

Note 3: The frequency spectrum is examined from 9 kHz to the 10th harmonic of the fundamental frequency of the transmitter. No other spurious and harmonic emissions were reported greater than listed emissions above table.

**7.6.2 LTE Band 17**

B.W (MHz)	Test Freq. (MHz)	RB Size/ Offset	Test Mode	Freq.(MHz)	Ant Pol (H/V)	Level(dBm) @ Ant Terminal	TX Ant Gain(dBd)	Result		Limit (dBc)
								(dBm)	(dBc)	
10	709	1/49	QPSK	1426.78	V	-53.04	3.06	-49.98	69.69	32.71
				2140.27	H	-50.65	2.79	-47.86	67.57	
			16QAM	1426.89	V	-53.68	3.06	-50.62	69.49	31.87
				2139.98	H	-51.26	2.78	-48.48	67.35	
	711	1/49	QPSK	1430.74	V	-50.69	3.08	-47.61	67.33	32.72
				2146.32	H	-51.94	2.84	-49.10	68.82	
			16QAM	1431.03	V	-50.97	3.09	-47.88	66.96	32.08
				2146.32	H	-52.01	2.84	-49.17	68.25	
5	706.5	1/0	QPSK	1408.70	V	-53.93	2.95	-50.98	69.36	31.38
				2113.19	H	-51.28	2.54	-48.74	67.12	
			16QAM	1408.54	V	-54.40	2.95	-51.45	69.05	30.60
				2113.27	H	-51.59	2.54	-49.05	66.65	
	710	1/24	QPSK	1424.29	V	-50.71	3.05	-47.66	66.50	31.84
				2136.60	H	-50.90	2.75	-48.15	66.99	
			16QAM	1424.42	V	-51.50	3.05	-48.45	66.06	30.61
				2136.59	H	-52.03	2.75	-49.28	66.89	
	713.5	1/24	QPSK	1431.51	V	-51.39	3.09	-48.30	66.07	30.77
				2147.01	H	-50.58	2.85	-47.73	65.50	
			16QAM	1431.35	V	-51.57	3.09	-48.48	65.19	29.71
				2146.93	H	-51.60	2.85	-48.75	65.46	

Note 1: Limit Calculation =  $43 + 10\log_{10}(P[\text{Watts}])$

Note 2: This device was tested under all bandwidths, modulations and RB configurations and the worst case data are reported in the table above.

Note 3: The frequency spectrum is examined from 9 kHz to the 10th harmonic of the fundamental frequency of the transmitter. No other spurious and harmonic emissions were reported greater than listed emissions above table.

### 7.6.3 LTE Band 5

B.W (MHz)	Test Freq. (MHz)	RB Size/ Offset	Test Mode	Freq.(MHz)	Ant Pol (H/V)	Level(dBm) @ Ant Terminal	TX Ant Gain(dBd)	Result		Limit (dBc)
								(dBm)	(dBc)	
10	829	1/0	QPSK	1649.87	H	-58.19	3.77	-54.42	75.85	34.43
			16QAM	1649.17	H	-58.71	3.77	-54.94	75.58	33.64
	836.5	1/49	QPSK	1681.56	H	-57.02	3.78	-53.24	73.43	33.19
			16QAM	1682.01	H	-57.18	3.78	-53.40	72.46	32.06
	844	1/49	QPSK	1696.84	H	-57.97	3.79	-54.18	73.92	32.74
			16QAM	1697.28	H	-58.14	3.79	-54.35	73.07	31.72
5	826.5	1/0	QPSK	1648.52	H	-58.04	3.77	-54.27	75.70	34.43
			16QAM	1648.28	H	-58.99	3.77	-55.22	75.59	33.37
	836.5	1/24	QPSK	1677.30	H	-57.05	3.78	-53.27	72.58	32.31
			16QAM	1677.60	H	-57.36	3.78	-53.58	72.19	31.61
	846.5	1/0	QPSK	1690.26	H	-57.49	3.79	-53.70	74.60	33.90
			16QAM	1690.99	H	-58.58	3.79	-54.79	74.53	32.74
3	825.5	1/0	QPSK	1648.43	H	-58.26	3.77	-54.49	75.37	33.88
			16QAM	1648.60	H	-58.53	3.77	-54.76	74.64	32.88
	836.5	1/0	QPSK	1670.42	H	-57.52	3.78	-53.74	73.30	32.56
			16QAM	1670.45	H	-57.61	3.78	-53.83	72.24	31.41
	847.5	1/0	QPSK	1692.40	H	-58.21	3.79	-54.42	75.04	33.62
			16QAM	1692.26	H	-58.77	3.79	-54.98	74.54	32.56
1.4	824.7	1/0	QPSK	1648.91	H	-58.68	3.77	-54.91	75.13	33.22
			16QAM	1648.76	H	-58.74	3.77	-54.97	74.36	32.39
	836.5	1/5	QPSK	1673.72	H	-57.27	3.78	-53.49	72.64	32.15
			16QAM	1674.43	H	-57.68	3.78	-53.90	72.16	31.26
	848.3	1/5	QPSK	1697.55	H	-56.96	3.79	-53.17	73.10	32.93
			16QAM	1697.51	H	-57.57	3.79	-53.78	72.79	32.01

Note 1: Limit Calculation =  $43 + 10\log_{10}(P[\text{Watts}])$

Note 2: This device was tested under all bandwidths, modulations and RB configurations and the worst case data are reported in the table above.

Note 3: The frequency spectrum is examined from 9 kHz to the 10th harmonic of the fundamental frequency of the transmitter. No other spurious and harmonic emissions were reported greater than listed emissions above table.



**7.6.4 LTE Band 4**

B.W (MHz)	Test Freq. (MHz)	RB Size/Offset	Test Mode	Freq.(MHz)	Ant Pol (H/V)	Level(dBm) @ Ant Terminal	TX Ant Gain(dBi)	Result		Limit (dBc)
								(dBm)	(dBc)	
20	1720	1/0	QPSK	3421.25	H	-54.60	8.23	-46.37	64.35	30.98
			16QAM	3419.07	H	-55.59	8.23	-47.36	64.56	30.20
	1732.5	1/0	QPSK	3442.30	H	-55.73	8.31	-47.42	65.30	30.88
			16QAM	3443.71	H	-55.23	8.31	-46.92	64.25	30.33
	1745	1/0	QPSK	3473.07	H	-55.31	8.42	-46.89	65.75	31.86
			16QAM	3473.07	H	-56.27	8.42	-47.85	66.09	31.24
15	1717.5	1/0	QPSK	3418.34	H	-55.47	8.22	-47.25	65.14	30.89
			16QAM	3418.38	H	-56.14	8.22	-47.92	65.18	30.26
	1732.5	1/0	QPSK	3449.15	H	-55.20	8.33	-46.87	65.34	31.47
			16QAM	3449.00	H	-56.64	8.33	-48.31	66.02	30.71
	1747.5	1/0	QPSK	3481.12	H	-55.47	8.44	-47.03	65.96	31.93
			16QAM	3481.02	H	-56.31	8.44	-47.87	65.99	31.12
10	1715	1/0	QPSK	3420.63	H	-55.58	8.23	-47.35	65.80	31.45
			16QAM	3420.72	H	-57.15	8.23	-48.92	66.83	30.91
	1732.5	1/0	QPSK	3456.10	H	-56.44	8.36	-48.08	67.69	32.61
			16QAM	3456.15	H	-57.36	8.36	-49.00	67.67	31.67
	1750	1/0	QPSK	3489.80	H	-54.12	8.47	-45.65	64.99	32.34
			16QAM	3489.84	H	-56.08	8.47	-47.61	66.31	31.70
5	1712.5	1/0	QPSK	3418.59	H	-55.18	8.23	-46.95	65.07	31.12
			16QAM	3418.59	H	-57.11	8.23	-48.88	66.25	30.37
	1732.5	1/0	QPSK	3460.68	H	-55.95	8.37	-47.58	66.69	32.11
			16QAM	3460.69	H	-56.90	8.37	-48.53	66.82	31.29
	1752.5	1/0	QPSK	3501.13	H	-55.48	8.51	-46.97	66.32	32.35
			16QAM	3501.14	H	-57.45	8.51	-48.94	67.34	31.40
3	1711.5	1/0	QPSK	3421.54	H	-55.57	8.24	-47.33	65.23	30.90
			16QAM	3421.46	H	-56.36	8.24	-48.12	65.20	30.08
	1732.5	1/0	QPSK	3460.55	H	-54.83	8.37	-46.46	65.36	31.90
			16QAM	3460.61	H	-55.90	8.37	-47.53	65.90	31.37
	1753.5	1/0	QPSK	3504.19	H	-55.31	8.51	-46.80	65.67	31.87
			16QAM	3504.43	H	-56.89	8.51	-48.38	66.95	31.57
1.4	1710.7	1/0	QPSK	3420.58	H	-55.69	8.23	-47.46	64.87	30.41
			16QAM	3420.61	H	-56.45	8.23	-48.22	64.90	29.68
	1732.5	1/0	QPSK	3465.50	H	-55.18	8.39	-46.79	65.42	31.63
			16QAM	3465.47	H	-57.74	8.39	-49.35	67.51	31.16
	1754.3	1/5	QPSK	3511.21	H	-55.91	8.52	-47.39	66.90	32.51
			16QAM	3511.15	H	-56.83	8.52	-48.31	67.05	31.74

Note 1: Limit Calculation =  $43 + 10\log_{10}(P[\text{Watts}])$

Note 2: This device was tested under all bandwidths, modulations and RB configurations and the worst case data are reported in the table above.

Note 3: The frequency spectrum is examined from 9 kHz to the 10th harmonic of the fundamental frequency of the transmitter. No other spurious and harmonic emissions were reported greater than listed emissions above table.

**7.6.5 LTE Band 66**

B.W (MHz)	Test Freq. (MHz)	RB Size/ Offset	Test Mode	Freq.(MHz)	Ant Pol (H/V)	Level(dBm) @ Ant Terminal	TX Ant Gain(dBi)	Result		Limit (dBc)
								(dBm)	(dBc)	
20	1720	1/0	QPSK	3420.90	H	-54.66	8.23	-46.43	65.26	31.83
			16QAM	3421.01	H	-55.84	8.23	-47.61	65.68	31.07
	1745	1/0	QPSK	3471.88	H	-56.22	8.41	-47.81	66.97	32.16
			16QAM	3471.95	H	-56.73	8.41	-48.32	66.25	30.93
	1770	1/0	QPSK	3521.65	H	-55.49	8.52	-46.97	64.90	30.93
			16QAM	3521.57	H	-56.71	8.52	-48.19	65.67	30.48
15	1717.5	1/0	QPSK	3422.34	H	-55.21	8.24	-46.97	64.83	30.86
			16QAM	3422.40	H	-56.24	8.24	-48.00	64.67	29.67
	1745	1/74	QPSK	3493.48	H	-55.96	8.49	-47.47	64.85	30.38
			16QAM	3494.58	H	-57.02	8.49	-48.53	65.46	29.93
	1772.5	1/0	QPSK	3543.31	H	-55.72	8.53	-47.19	65.47	31.28
			16QAM	3543.26	H	-57.61	8.53	-49.08	66.63	30.55
10	1715	1/0	QPSK	3421.68	H	-55.66	8.24	-47.42	64.40	29.98
			16QAM	3421.69	H	-56.18	8.24	-47.94	64.40	29.46
	1745	1/49	QPSK	3504.31	H	-55.86	8.51	-47.35	64.68	30.33
			16QAM	3504.32	H	-56.43	8.51	-47.92	64.71	29.79
	1775	1/0	QPSK	3538.73	H	-56.25	8.53	-47.72	66.27	31.55
			16QAM	3538.76	H	-57.85	8.53	-49.32	67.32	31.00
5	1712.5	1/0	QPSK	3419.22	H	-55.38	8.23	-47.15	64.33	30.18
			16QAM	3419.25	H	-57.45	8.23	-49.22	65.82	29.60
	1745	1/0	QPSK	3483.22	H	-55.10	8.45	-46.65	64.26	30.61
			16QAM	3483.00	H	-56.27	8.45	-47.82	64.61	29.79
	1777.5	1/24	QPSK	3561.26	H	-55.54	8.54	-47.00	65.62	31.62
			16QAM	3561.23	H	-56.35	8.54	-47.81	66.04	31.23
3	1711.5	1/0	QPSK	3420.45	H	-56.29	8.23	-48.06	65.32	30.26
			16QAM	3420.49	H	-57.89	8.23	-49.66	65.97	29.31
	1745	1/14	QPSK	3493.53	H	-55.60	8.49	-47.11	64.56	30.45
			16QAM	3494.51	H	-57.09	8.49	-48.60	65.43	29.83
	1778.5	1/14	QPSK	3562.61	H	-55.06	8.54	-46.52	65.09	31.57
			16QAM	3562.61	H	-57.41	8.54	-48.87	66.67	30.80
1.4	1710.7	1/2	QPSK	3421.69	H	-55.25	8.24	-47.01	63.93	29.92
			16QAM	3422.99	H	-55.57	8.24	-47.33	63.61	29.28
	1745	1/5	QPSK	3492.22	H	-55.08	8.48	-46.60	64.70	31.10
			16QAM	3492.34	H	-56.43	8.48	-47.95	65.44	30.49
	1779.3	1/5	QPSK	3561.58	H	-56.20	8.54	-47.66	66.07	31.41
			16QAM	3561.52	H	-57.63	8.54	-49.09	67.01	30.92

Note 1: Limit Calculation =  $43 + 10\log_{10}(P[\text{Watts}])$

Note 2: This device was tested under all bandwidths, modulations and RB configurations and the worst case data are reported in the table above.

Note 3: The frequency spectrum is examined from 9 kHz to the 10th harmonic of the fundamental frequency of the transmitter. No other spurious and harmonic emissions were reported greater than listed emissions above table.

**7.6.6 LTE Band 2**

B.W (MHz)	Test Freq. (MHz)	RB Size/ Offset	Test Mode	Freq.(MHz)	Ant Pol (H/V)	Level(dBm) @ Ant Terminal	TX Ant Gain(dBi)	Result		Limit (dBc)
								(dBm)	(dBc)	
20	1860	1/0	QPSK	3703.05	V	-53.64	8.49	-45.15	65.18	33.03
			16QAM	3703.17	V	-54.20	8.49	-45.71	64.81	32.10
	1880	1/0	QPSK	3734.30	V	-53.91	8.50	-45.41	64.31	31.90
			16QAM	3734.11	V	-55.04	8.50	-46.54	64.88	31.34
	1900	1/0	QPSK	3777.52	V	-53.71	8.52	-45.19	63.86	31.67
			16QAM	3775.17	V	-54.02	8.52	-45.50	63.14	30.64
15	1857.5	1/0	QPSK	3697.85	V	-53.43	8.49	-44.94	64.62	32.68
			16QAM	3697.72	V	-55.16	8.49	-46.67	65.59	31.92
	1880	1/0	QPSK	3747.41	V	-54.59	8.51	-46.08	64.93	31.85
			16QAM	3747.41	V	-55.72	8.51	-47.21	65.38	31.17
	1902.5	1/0	QPSK	3789.54	V	-54.97	8.53	-46.44	65.82	32.38
			16QAM	3789.57	V	-56.88	8.53	-48.35	66.75	31.40
10	1855	1/0	QPSK	3700.55	V	-54.06	8.49	-45.57	64.15	31.58
			16QAM	3700.44	V	-56.40	8.49	-47.91	66.76	31.85
	1880	1/0	QPSK	3750.39	V	-54.14	8.51	-45.63	64.61	31.98
			16QAM	3750.41	V	-55.72	8.51	-47.21	65.12	30.91
	1905	1/0	QPSK	3803.21	V	-53.77	8.53	-45.24	64.35	32.11
			16QAM	3803.22	V	-55.69	8.53	-47.16	65.28	31.12
5	1852.5	1/0	QPSK	3703.24	V	-53.98	8.49	-45.49	64.96	32.47
			16QAM	3703.24	V	-55.33	8.49	-46.84	65.28	31.44
	1880	1/0	QPSK	3756.50	V	-54.14	8.51	-45.63	63.91	31.28
			16QAM	3756.54	V	-55.14	8.51	-46.63	64.23	30.60
	1907.5	1/0	QPSK	3811.45	V	-54.50	8.54	-45.96	64.52	31.56
			16QAM	3811.51	V	-55.68	8.54	-47.14	64.52	30.38
3	1851.5	1/0	QPSK	3669.79	V	-53.48	8.51	-44.97	64.17	32.20
			16QAM	3699.80	V	-55.23	8.49	-46.74	65.46	31.72
	1880	1/0	QPSK	3757.30	V	-54.86	8.51	-46.35	65.01	31.66
			16QAM	3757.30	V	-55.48	8.51	-46.97	64.78	30.81
	1908.5	1/0	QPSK	3814.47	V	-54.27	8.55	-45.72	64.58	31.86
			16QAM	3814.47	V	-55.39	8.55	-46.84	64.74	30.90
1.4	1850.7	1/5	QPSK	3702.48	V	-53.50	8.49	-45.01	64.93	32.92
			16QAM	3702.48	V	-54.84	8.49	-46.35	65.35	32.00
	1880	1/5	QPSK	3761.07	V	-54.54	8.51	-46.03	64.50	31.47
			16QAM	3761.07	V	-56.74	8.51	-48.23	66.08	30.85
	1909.3	1/0	QPSK	3817.23	V	-53.41	8.55	-44.86	63.63	31.77
			16QAM	3817.24	V	-55.07	8.55	-46.52	64.15	30.63

Note 1: Limit Calculation =  $43 + 10\log_{10}(P[\text{Watts}])$

Note 2: This device was tested under all bandwidths, modulations and RB configurations and the worst case data are reported in the table above.

Note 3: The frequency spectrum is examined from 9 kHz to the 10th harmonic of the fundamental frequency of the transmitter. No other spurious and harmonic emissions were reported greater than listed emissions above table.

**7.6.7 LTE Band 7**

B.W (MHz)	Test Freq. (MHz)	RB Size/Offset	Test Mode	Freq.(MHz)	Ant Pol (H/V)	Level(dBm) @ Ant Terminal	TX Ant Gain(dBi)	Result		Limit (dBc)
								(dBm)	(dBc)	
20	2510	1/99	QPSK	5039.26	H	-53.56	10.18	-43.38	60.49	42.11
			16QAM	5039.25	H	-54.88	10.18	-44.70	61.75	42.05
	2535	1/99	QPSK	5092.71	H	-53.97	10.27	-43.70	62.02	43.32
			16QAM	5092.81	H	-55.35	10.27	-45.08	63.06	42.98
	2560	1/0	QPSK	5095.39	H	-54.40	10.27	-44.13	62.75	43.62
			16QAM	5095.40	H	-56.36	10.27	-46.09	63.57	42.48
15	2507.5	1/0	QPSK	5000.20	H	-52.08	10.11	-41.97	58.66	41.69
			16QAM	5000.11	H	-52.87	10.11	-42.76	59.30	41.54
	2535	1/0	QPSK	5053.96	H	-51.98	10.20	-41.78	60.49	43.71
			16QAM	5054.05	H	-54.00	10.20	-43.80	61.28	42.48
	2562.5	1/0	QPSK	5110.92	H	-53.72	10.30	-43.42	61.45	43.03
			16QAM	5110.93	H	-55.39	10.30	-45.09	62.26	42.17
10	2505	1/0	QPSK	4998.33	H	-52.63	10.11	-42.52	59.48	41.96
			16QAM	4998.33	H	-53.36	10.11	-43.25	59.58	41.33
	2535	1/49	QPSK	5082.72	H	-53.64	10.25	-43.39	60.71	42.32
			16QAM	5082.81	H	-55.23	10.25	-44.98	61.03	41.05
	2565	1/0	QPSK	5121.05	H	-53.10	10.32	-42.78	60.78	43.00
			16QAM	5121.04	H	-56.58	10.32	-46.26	63.09	41.83
5	2502.5	1/0	QPSK	4999.66	H	-52.59	10.11	-42.48	59.50	42.02
			16QAM	4999.71	H	-54.45	10.11	-44.34	60.33	40.99
	2535	1/24	QPSK	5072.32	H	-52.43	10.23	-42.20	59.91	42.71
			16QAM	5072.28	H	-53.66	10.23	-43.43	60.13	41.70
	2567.5	1/0	QPSK	5129.98	H	-53.22	10.33	-42.89	60.58	42.69
			16QAM	5129.98	H	-54.11	10.33	-43.78	60.36	41.58

Note 1: Limit Calculation =  $55 + 10\log_{10}(P[\text{Watts}])$

Note 2: This device was tested under all bandwidths, modulations and RB configurations and the worst case data are reported in the table above.

Note 3: The frequency spectrum is examined from 9 kHz to the 10<sup>th</sup> harmonic of the fundamental frequency of the transmitter. No other spurious and harmonic emissions were reported greater than listed emissions above table.

## 7.7 FREQUENCY STABILITY

### 7.7.1 LTE Band 12

OPERATING FREQUENCY : 707.5 MHz

REFERENCE VOLTAGE : 3.85 VDC

LIMIT : The frequency stability shall be sufficient to ensure that the fundamental emission stays within the authorized frequency block.

VOLTAGE (%)	POWER (V DC)	TEMP (°C)	FREQUENCY (Hz)	FREQ.Dev (Hz)	Deviation	
					(ppm)	(%)
100%	3.85	+20(Ref)	707,500,006	+6	0.0085	0.000000848
100%		-30	707,500,007	+7	0.0099	0.000000989
100%		-20	707,499,998	-2	-0.0028	-0.000000283
100%		-10	707,500,005	+5	0.0071	0.000000707
100%		0	707,500,005	+5	0.0071	0.000000707
100%		+10	707,499,998	-2	-0.0028	-0.000000283
100%		+20	707,500,006	+6	0.0085	0.000000848
100%		+30	707,499,994	-6	-0.0085	-0.000000848
100%		+40	707,499,996	-4	-0.0057	-0.000000565
100%		+50	707,499,995	-5	-0.0071	-0.000000707
115%	4.43	+20	707,500,003	+3	0.0042	0.000000424
BATT.ENDPOINT	2.85	+20	707,500,006	+6	0.0085	0.000000848

**Note.** Based on the results of the frequency stability test at the center channel the frequency deviation results measured are very small. as such it is determined that the channels at the band edge would remain inband when the maximum measured frequency deviation noted during the frequency stability tests is applied. therefore the device is determined to remain operating in band over the temperature and voltage range as tested.

**7.7.2 LTE Band 17**

OPERATING FREQUENCY : 710 MHz  
 REFERENCE VOLTAGE : 3.85 VDC  
 LIMIT : The frequency stability shall be sufficient to ensure that the fundamental emission stays within the authorized frequency block.

VOLTAGE (%)	POWER (V DC)	TEMP (°C)	FREQUENCY (Hz)	FREQ.Dev (Hz)	Deviation	
					(ppm)	(%)
100%	3.85	+20(Ref)	709,999,996	-4	-0.0056	-0.000000563
100%		-30	709,999,995	-5	-0.0070	-0.000000704
100%		-20	710,000,002	+2	0.0028	0.000000282
100%		-10	709,999,996	-4	-0.0056	-0.000000563
100%		0	709,999,995	-5	-0.0070	-0.000000704
100%		+10	709,999,998	-2	-0.0028	-0.000000282
100%		+20	709,999,996	-4	-0.0056	-0.000000563
100%		+30	710,000,003	+3	0.0042	0.000000423
100%		+40	710,000,005	+5	0.0070	0.000000704
100%		+50	709,999,996	-4	-0.0056	-0.000000563
115%		4.43	+20	709,999,998	-2	-0.0028
BATT.ENDPOINT	2.85	+20	710,000,005	+5	0.0070	0.000000704

**Note.** Based on the results of the frequency stability test at the center channel the frequency deviation results measured are very small. as such it is determined that the channels at the band edge would remain inband when the maximum measured frequency deviation noted during the frequency stability tests is applied. therefore the device is determined to remain operating in band over the temperature and voltage range as tested.

**7.7.3 LTE Band 5**

OPERATING FREQUENCY : 836.5 MHz  
 REFERENCE VOLTAGE : 3.85 VDC  
 DEVIATION LIMIT :  $\pm 0.00025\%$  or 2.5 ppm

VOLTAGE (%)	POWER (V DC)	TEMP (°C)	FREQUENCY (Hz)	FREQ.Dev (Hz)	Deviation	
					(ppm)	(%)
100%	3.85	+20(Ref)	836,500,005	+5	0.0060	0.000000598
100%		-30	836,500,003	+3	0.0036	0.000000359
100%		-20	836,500,004	+4	0.0048	0.000000478
100%		-10	836,500,005	+5	0.0060	0.000000598
100%		0	836,500,005	+5	0.0060	0.000000598
100%		+10	836,500,003	+3	0.0036	0.000000359
100%		+20	836,500,005	+5	0.0060	0.000000598
100%		+30	836,500,002	+2	0.0024	0.000000239
100%		+40	836,499,996	-4	-0.0048	-0.000000478
100%		+50	836,500,006	+6	0.0072	0.000000717
115%		4.43	+20	836,500,005	+5	0.0060
BATT.ENDPOINT	2.85	+20	836,499,997	-3	-0.0036	-0.000000359

**7.7.4 LTE Band 4**

OPERATING FREQUENCY : 1732.5 MHz  
 REFERENCE VOLTAGE : 3.85 VDC  
 LIMIT : The frequency stability shall be sufficient to ensure that the fundamental emission stays within the authorized frequency block.

VOLTAGE (%)	POWER (V DC)	TEMP (°C)	FREQUENCY (Hz)	FREQ.Dev (Hz)	Deviation	
					(ppm)	(%)
100%	3.85	+20(Ref)	1,732,499,995	-5	-0.0029	-0.000000289
100%		-30	1,732,499,993	-7	-0.0040	-0.000000404
100%		-20	1,732,500,003	+3	0.0017	0.000000173
100%		-10	1,732,500,005	+5	0.0029	0.000000289
100%		0	1,732,499,998	-2	-0.0012	-0.000000115
100%		+10	1,732,499,996	-4	-0.0023	-0.000000231
100%		+20	1,732,499,995	-5	-0.0029	-0.000000289
100%		+30	1,732,500,006	+6	0.0035	0.000000346
100%		+40	1,732,500,004	+4	0.0023	0.000000231
100%		+50	1,732,499,995	-5	-0.0029	-0.000000289
115%	4.43	+20	1,732,499,996	-4	-0.0023	-0.000000231
BATT.ENDPOINT	2.85	+20	1,732,499,998	-2	-0.0012	-0.000000115

**Note.** Based on the results of the frequency stability test at the center channel the frequency deviation results measured are very small. as such it is determined that the channels at the band edge would remain inband when the maximum measured frequency deviation noted during the frequency stability tests is applied. therefore the device is determined to remain operating in band over the temperature and voltage range as tested.



**7.7.5 LTE Band 66**

OPERATING FREQUENCY : 1745 MHz  
 REFERENCE VOLTAGE : 3.85 VDC  
 LIMIT : The frequency stability shall be sufficient to ensure that the fundamental emission stays within the authorized frequency block.

VOLTAGE (%)	POWER (V DC)	TEMP (°C)	FREQUENCY (Hz)	FREQ.Dev (Hz)	Deviation	
					(ppm)	(%)
100%	3.85	+20(Ref)	1,744,999,997	-3	-0.0017	-0.000000172
100%		-30	1,745,000,005	+5	0.0029	0.000000287
100%		-20	1,744,999,998	-2	-0.0011	-0.000000115
100%		-10	1,744,999,998	-2	-0.0011	-0.000000115
100%		0	1,744,999,994	-6	-0.0034	-0.000000344
100%		+10	1,744,999,995	-5	-0.0029	-0.000000287
100%		+20	1,744,999,997	-3	-0.0017	-0.000000172
100%		+30	1,744,999,994	-6	-0.0034	-0.000000344
100%		+40	1,744,999,995	-5	-0.0029	-0.000000287
100%		+50	1,744,999,994	-6	-0.0034	-0.000000344
115%	4.43	+20	1,745,000,002	+2	0.0011	0.000000115
BATT.ENDPOINT	2.85	+20	1,745,000,003	+3	0.0017	0.000000172

**Note.** Based on the results of the frequency stability test at the center channel the frequency deviation results measured are very small. as such it is determined that the channels at the band edge would remain inband when the maximum measured frequency deviation noted during the frequency stability tests is applied. therefore the device is determined to remain operating in band over the temperature and voltage range as tested.

### 7.7.6 LTE Band 2

OPERATING FREQUENCY : 1880 MHz  
 REFERENCE VOLTAGE : 3.85 VDC  
 LIMIT : The frequency stability shall be sufficient to ensure that the fundamental emission stays within the authorized frequency block.

VOLTAGE (%)	POWER (V DC)	TEMP (°C)	FREQUENCY (Hz)	FREQ.Dev (Hz)	Deviation	
					(ppm)	(%)
100%	3.85	+20(Ref)	1,879,999,996	-4	-0.0021	-0.000000213
100%		-30	1,879,999,994	-6	-0.0032	-0.000000319
100%		-20	1,880,000,006	+6	0.0032	0.000000319
100%		-10	1,879,999,995	-5	-0.0027	-0.000000266
100%		0	1,879,999,997	-3	-0.0016	-0.000000160
100%		+10	1,879,999,997	-3	-0.0016	-0.000000160
100%		+20	1,879,999,996	-4	-0.0021	-0.000000213
100%		+30	1,879,999,994	-6	-0.0032	-0.000000319
100%		+40	1,880,000,008	+8	0.0043	0.000000426
100%		+50	1,880,000,005	+5	0.0027	0.000000266
115%		4.43	+20	1,880,000,005	+5	0.0027
BATT.ENDPOINT	2.85	+20	1,880,000,002	+2	0.0011	0.000000106

**Note.** Based on the results of the frequency stability test at the center channel the frequency deviation results measured are very small. as such it is determined that the channels at the band edge would remain inband when the maximum measured frequency deviation noted during the frequency stability tests is applied. therefore the device is determined to remain operating in band over the temperature and voltage range as tested.

### 7.7.7 LTE Band 7

OPERATING FREQUENCY : 2535 MHz  
 REFERENCE VOLTAGE : 3.85 VDC  
 LIMIT : The frequency stability shall be sufficient to ensure that the fundamental emission stays within the authorized frequency block.

VOLTAGE (%)	POWER (V DC)	TEMP (°C)	FREQUENCY (Hz)	FREQ.Dev (Hz)	Deviation	
					(ppm)	(%)
100%	3.85	+20(Ref)	2,534,999,996	-4	-0.0016	-0.000000158
100%		-30	2,534,999,994	-6	-0.0024	-0.000000237
100%		-20	2,534,999,992	-8	-0.0032	-0.000000316
100%		-10	2,534,999,993	-7	-0.0028	-0.000000276
100%		0	2,535,000,003	+3	0.0012	0.000000118
100%		+10	2,534,999,990	-10	-0.0039	-0.000000394
100%		+20	2,534,999,996	-4	-0.0016	-0.000000158
100%		+30	2,534,999,995	-5	-0.0020	-0.000000197
100%		+40	2,534,999,996	-4	-0.0016	-0.000000158
100%		+50	2,535,000,003	+3	0.0012	0.000000118
115%		4.43	+20	2,534,999,990	-10	-0.0039
BATT.ENDPOINT	2.85	+20	2,535,000,003	+3	0.0012	0.000000118

**Note.** Based on the results of the frequency stability test at the center channel the frequency deviation results measured are very small. as such it is determined that the channels at the band edge would remain inband when the maximum measured frequency deviation noted during the frequency stability tests is applied. therefore the device is determined to remain operating in band over the temperature and voltage range as tested.

## 8. TEST PLOTS

Note: All bandwidths, RB configurations, and modulations were investigated.  
The worst case test results are reported.

### 8.1 OCCUPIED BANDWIDTH

#### 8.1.1 LTE Band 12

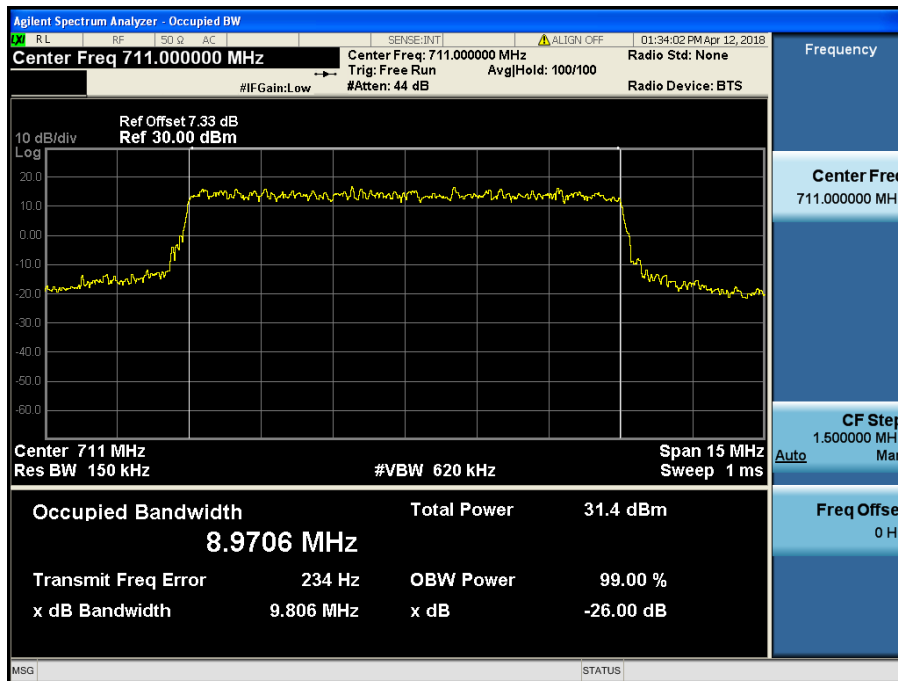

LTE Band 12 / 10 MHz / QPSK - RB Size 50

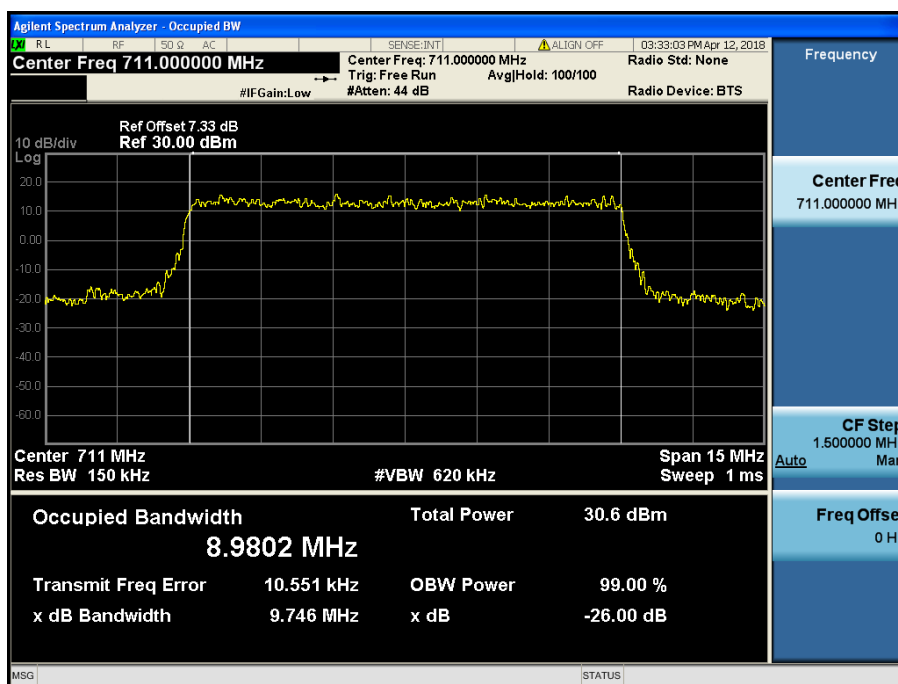

LTE Band 12 / 10 MHz / 16QAM - RB Size 50

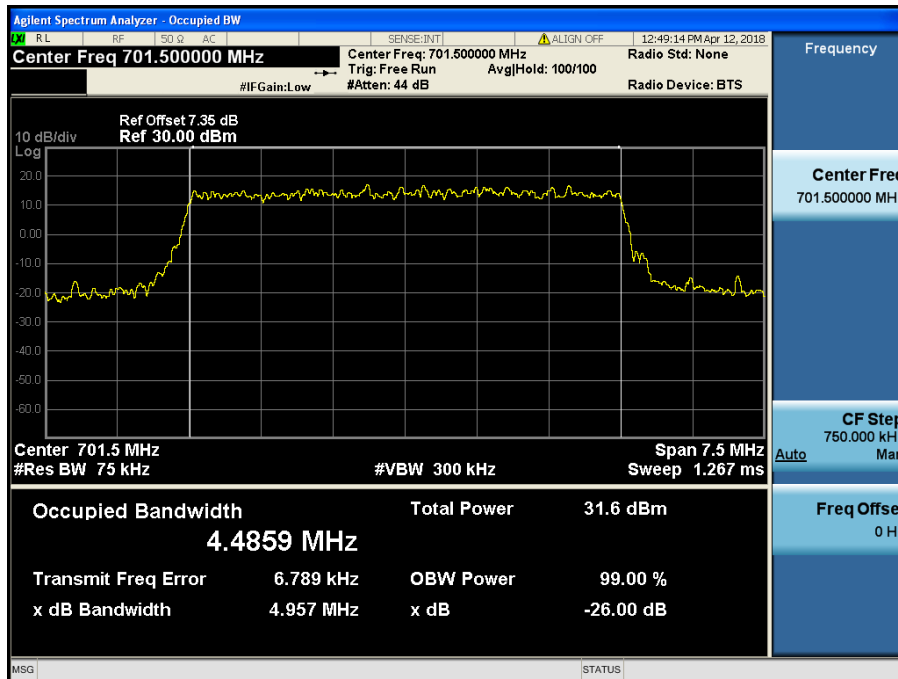

LTE Band 12 / 5 MHz / QPSK - RB Size 25

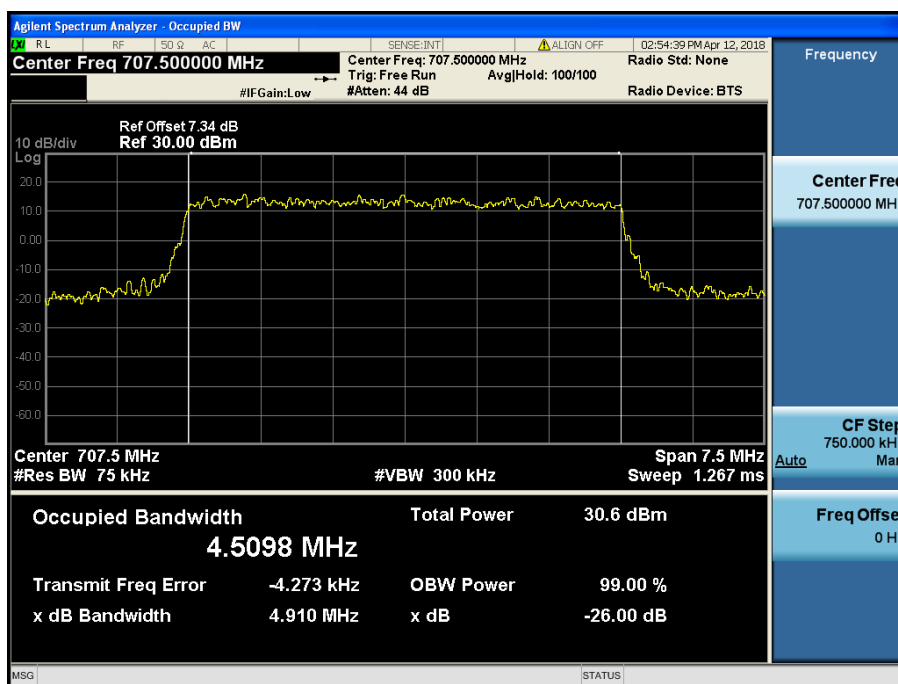

LTE Band 12 / 5 MHz / 16QAM - RB Size 25

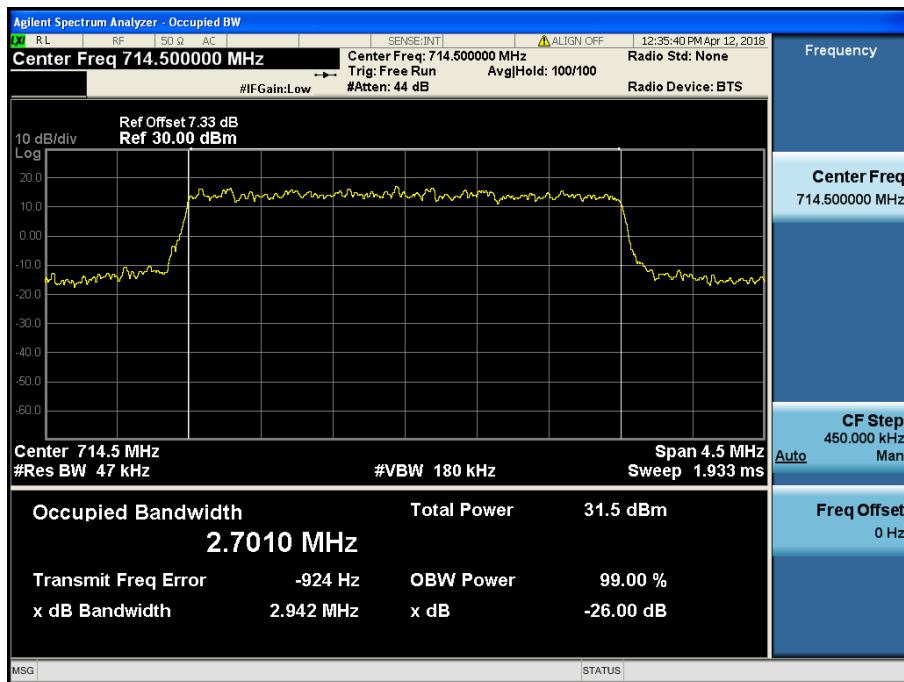

LTE Band 12 / 3 MHz / QPSK - RB Size 15

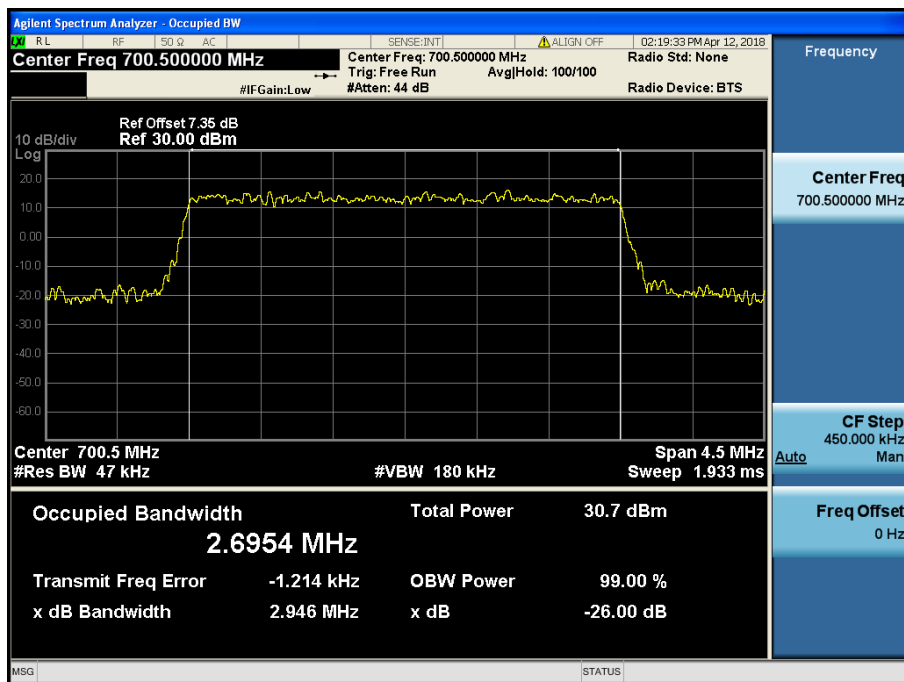

LTE Band 12 / 3 MHz / 16QAM - RB Size 15

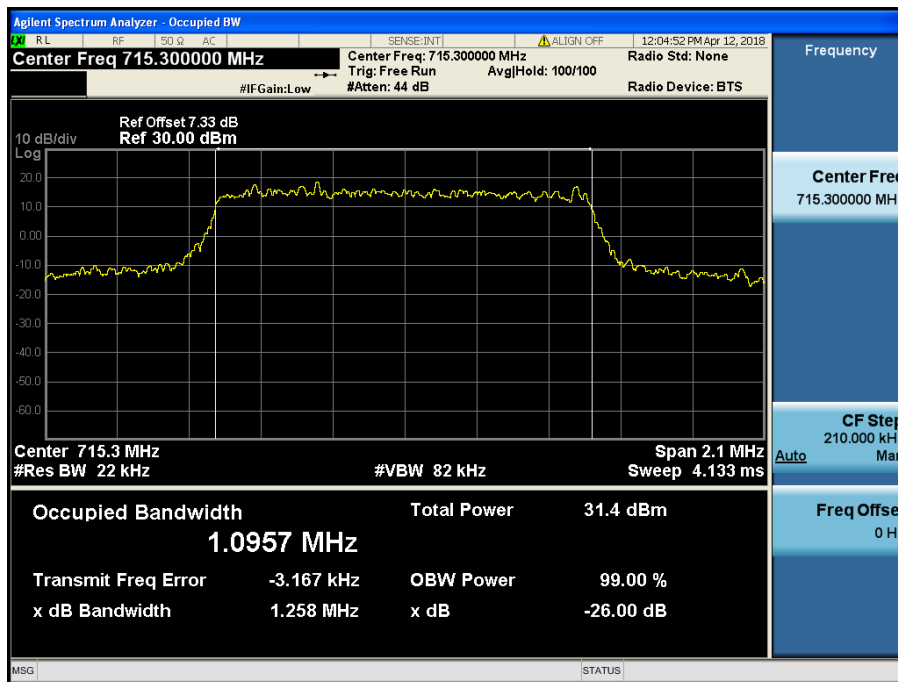

LTE Band 12 / 1.4 MHz / QPSK - RB Size 6

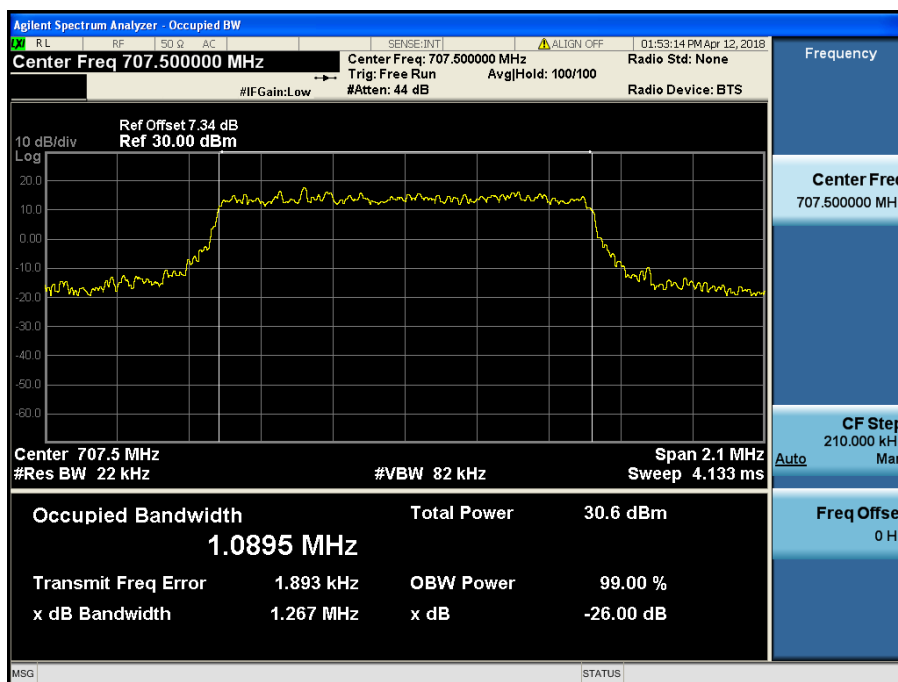

LTE Band 12 / 1.4 MHz / 16QAM - RB Size 6

8.1.2 LTE Band 17

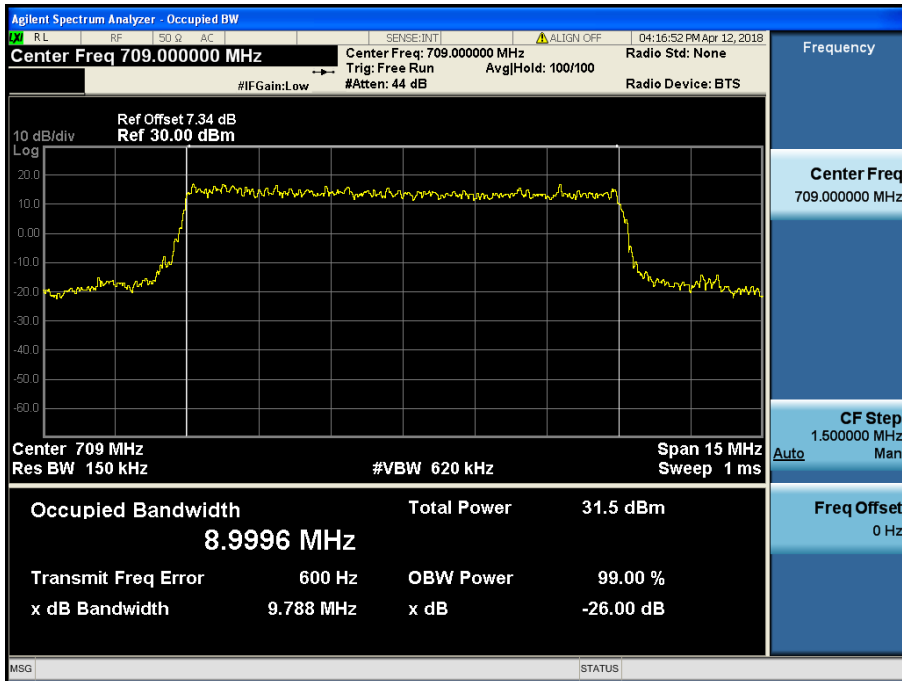

LTE Band 17 / 10 MHz / QPSK - RB Size 50

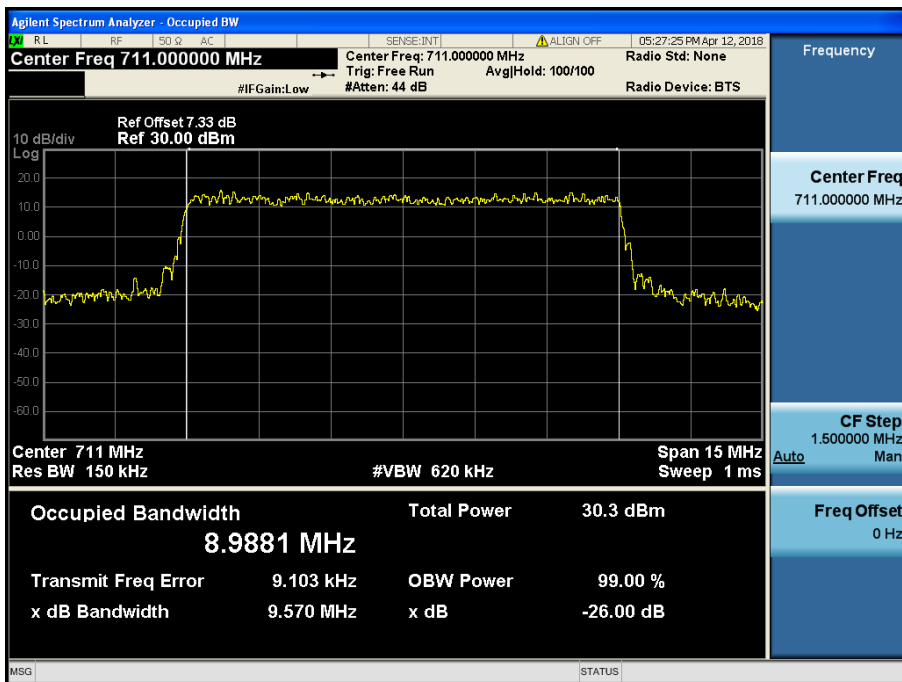

LTE Band 17 / 10 MHz / 16QAM - RB Size 50



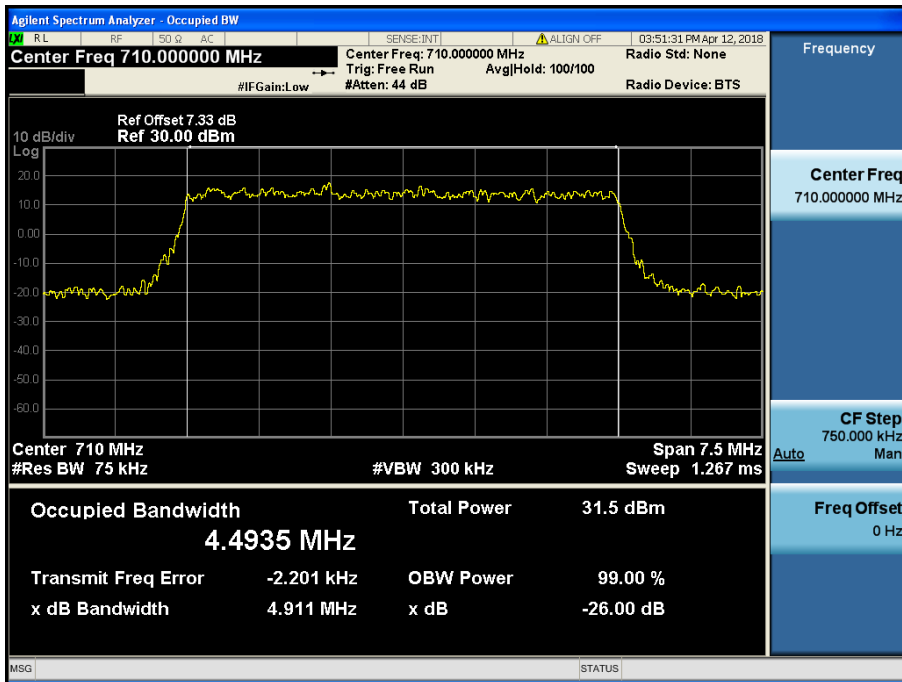

LTE Band 17 / 5 MHz / QPSK - RB Size 25

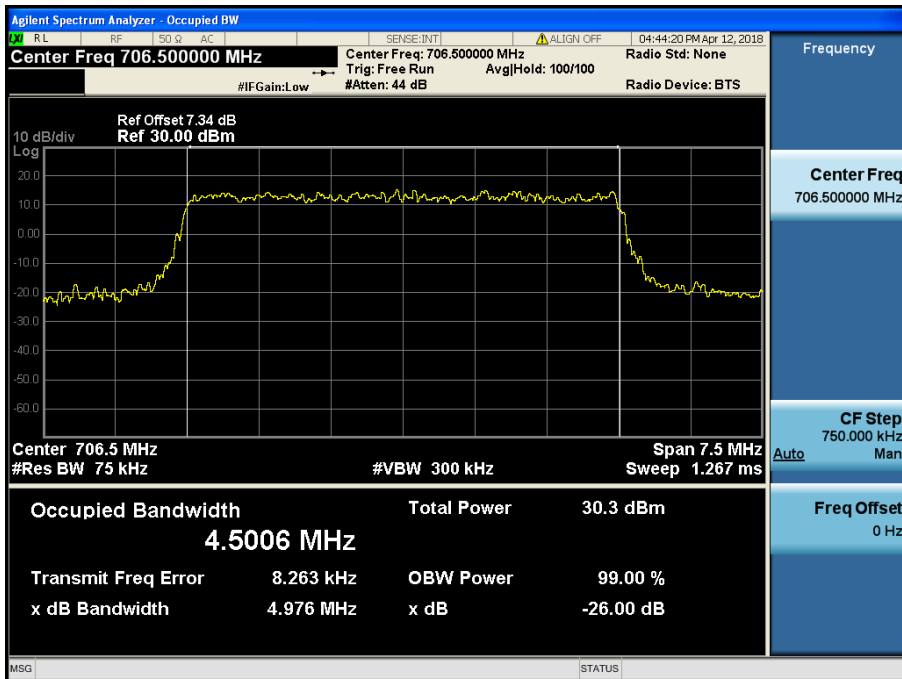

LTE Band 17 / 5 MHz / 16QAM - RB Size 25

8.1.3 LTE Band 5

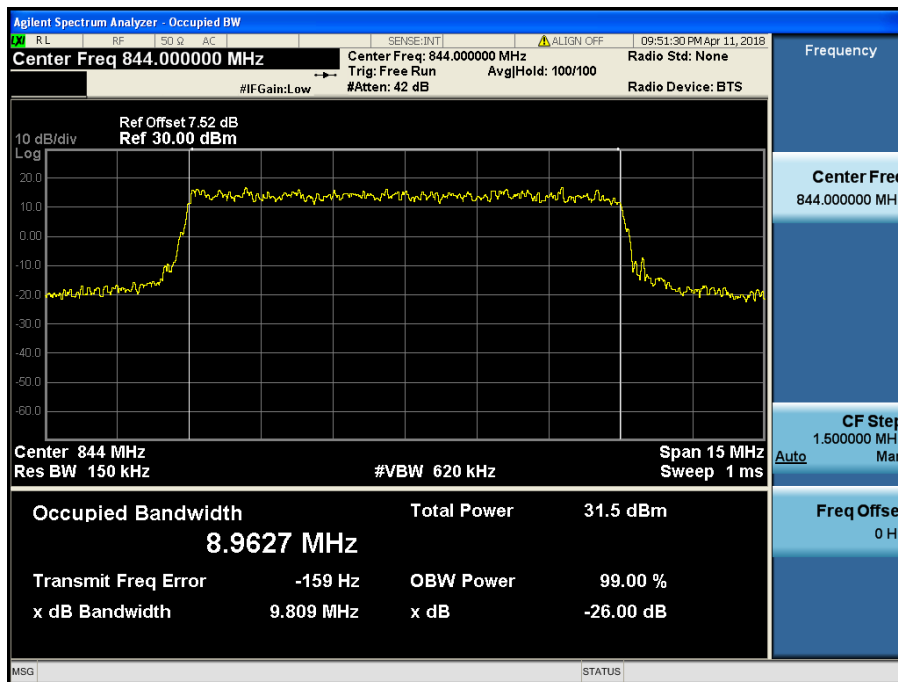

LTE Band 5 / 10 MHz / QPSK - RB Size 50

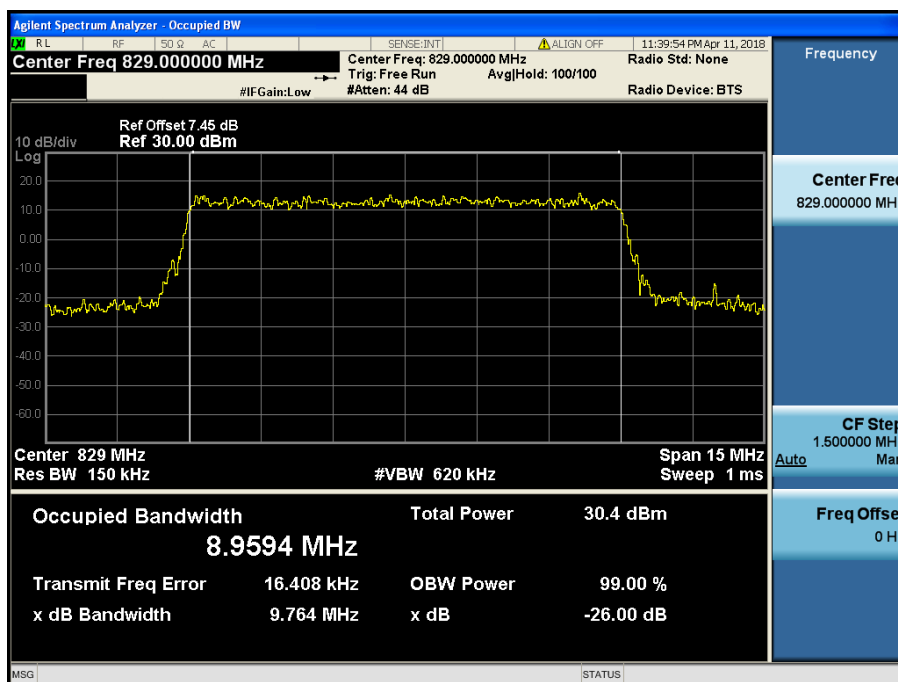

LTE Band 5 / 10 MHz / 16QAM - RB Size 50

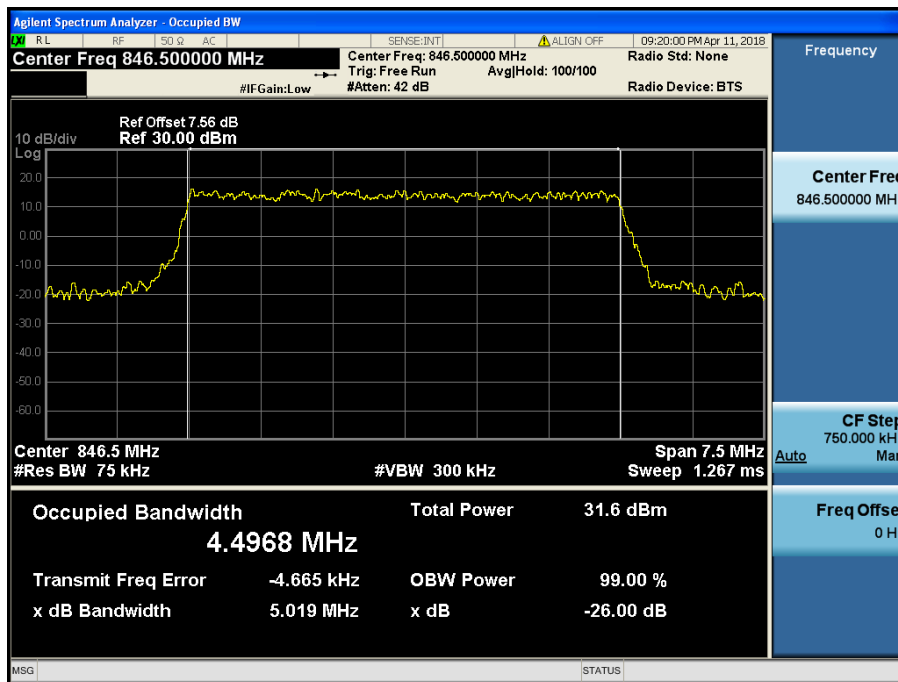

LTE Band 5 / 5 MHz / QPSK - RB Size 25

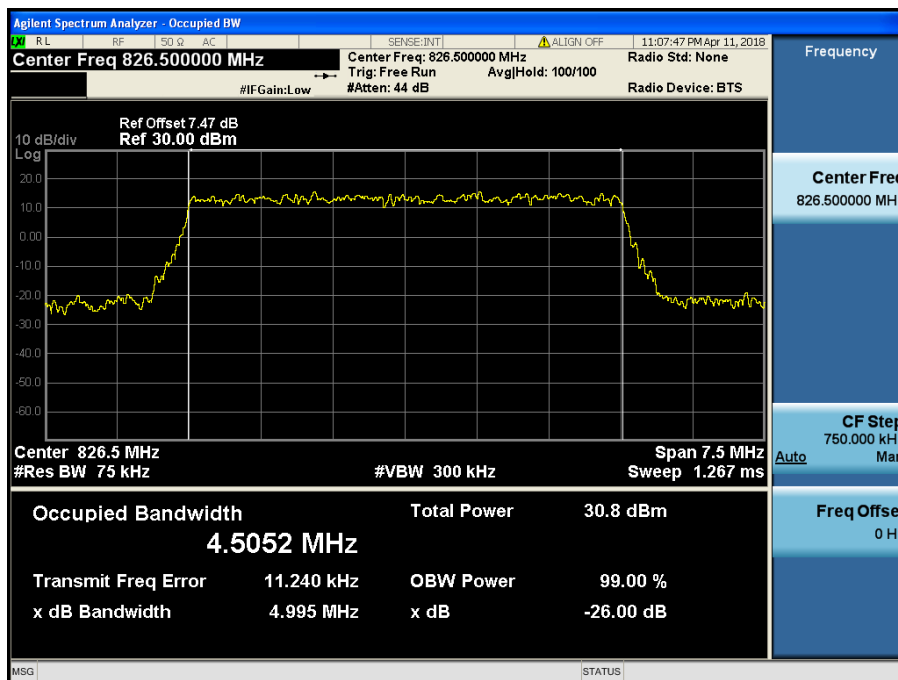

LTE Band 5 / 5 MHz / 16QAM - RB Size 25

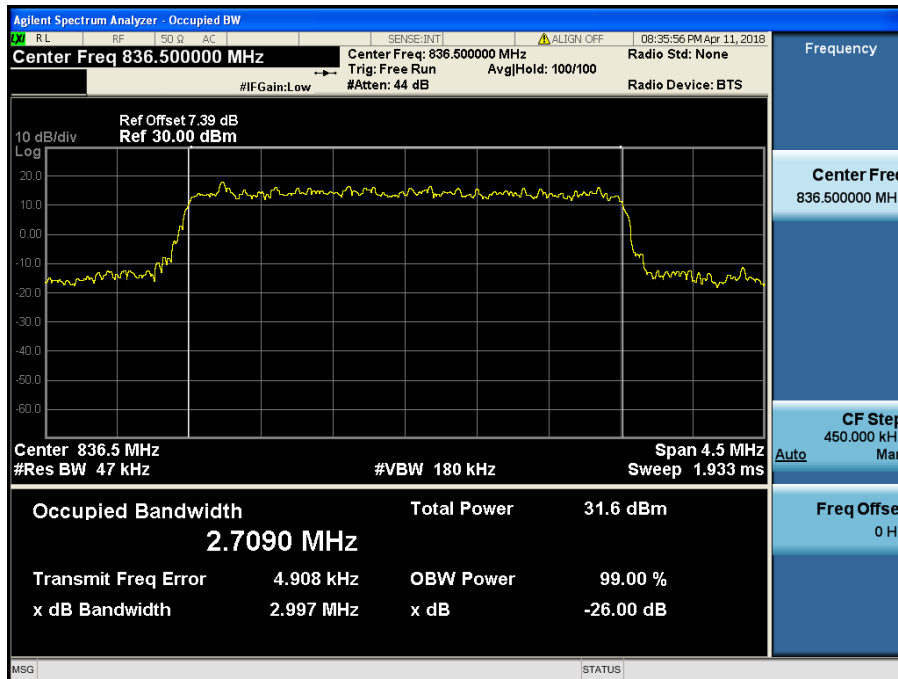

LTE Band 5 / 3 MHz / QPSK - RB Size 15

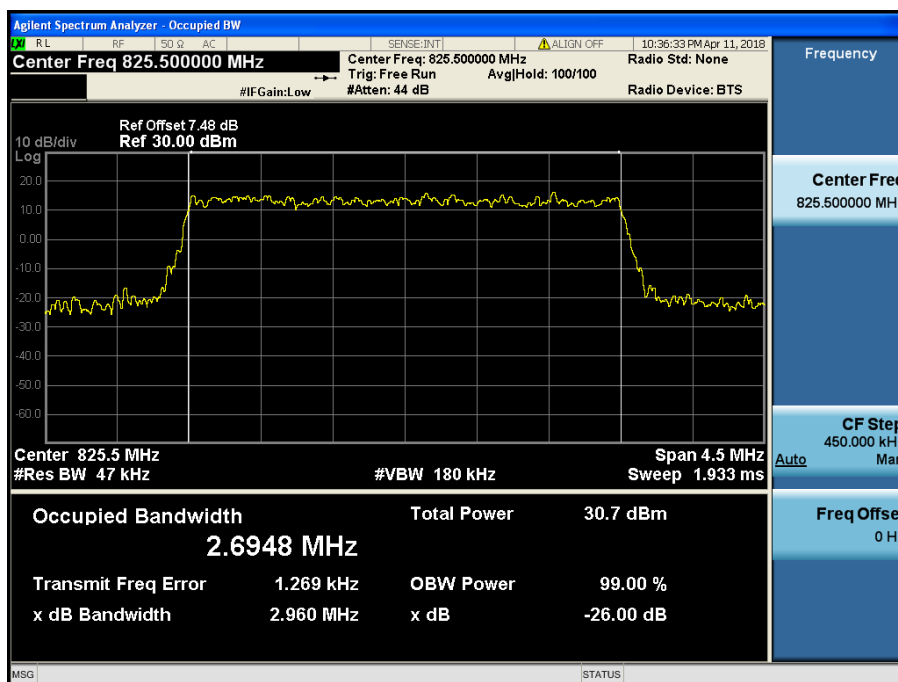

LTE Band 5 / 3 MHz / 16QAM - RB Size 15



LTE Band 5 / 1.4 MHz / QPSK - RB Size 6

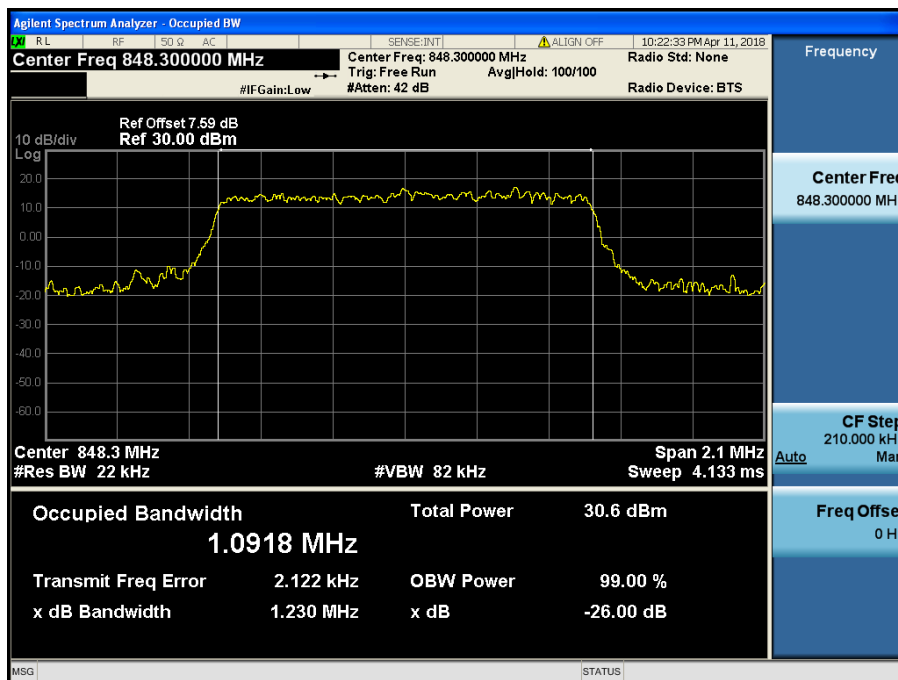

LTE Band 5 / 1.4 MHz / 16QAM - RB Size 6

8.1.4 LTE Band 4

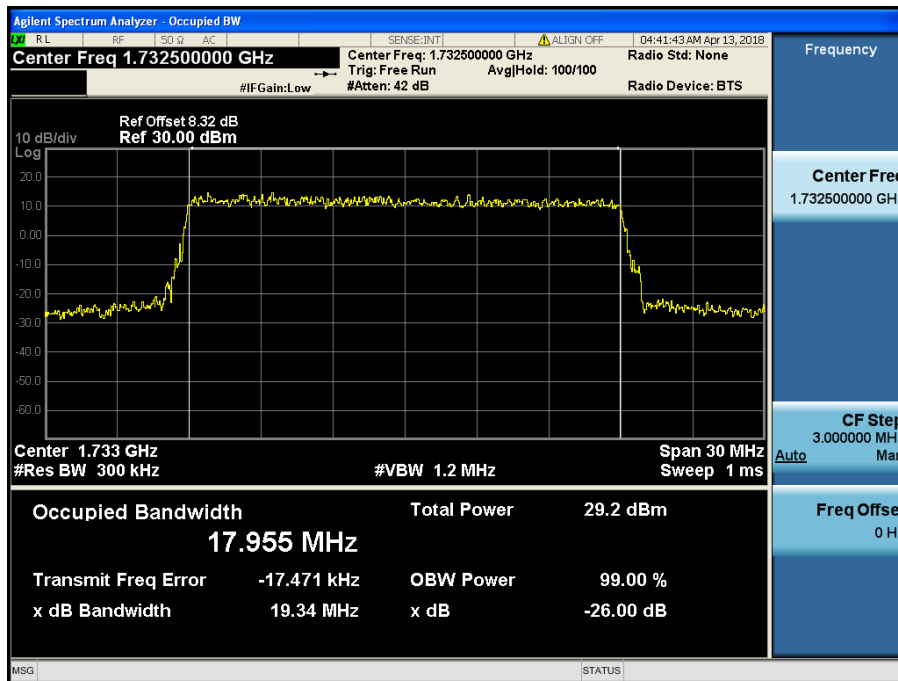

LTE Band 4 / 20 MHz / QPSK - RB Size 100

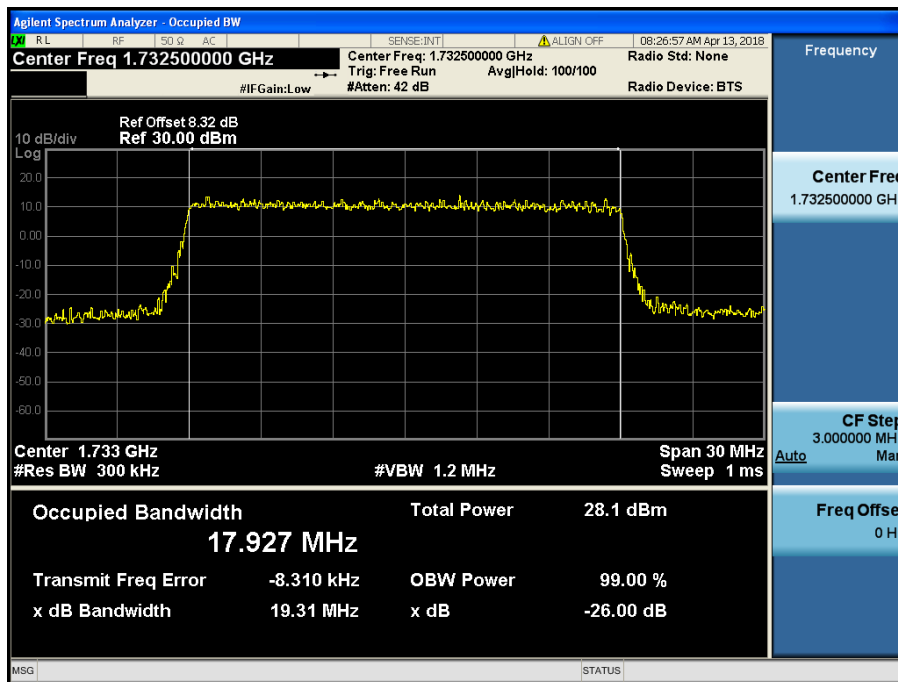

LTE Band 4 / 20 MHz / 16QAM - RB Size 100

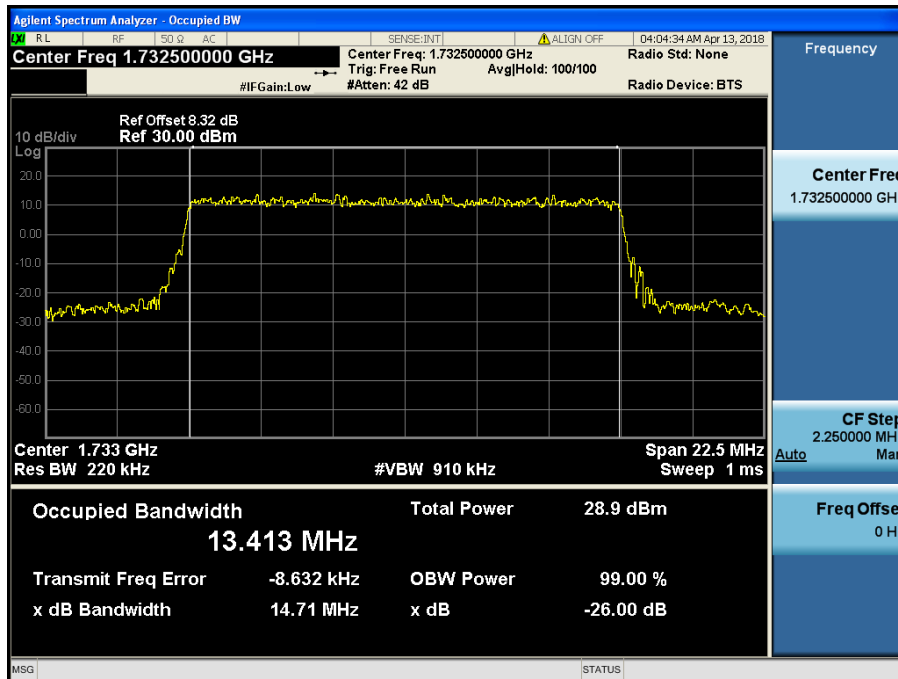

LTE Band 4 / 15 MHz / QPSK - RB Size 75

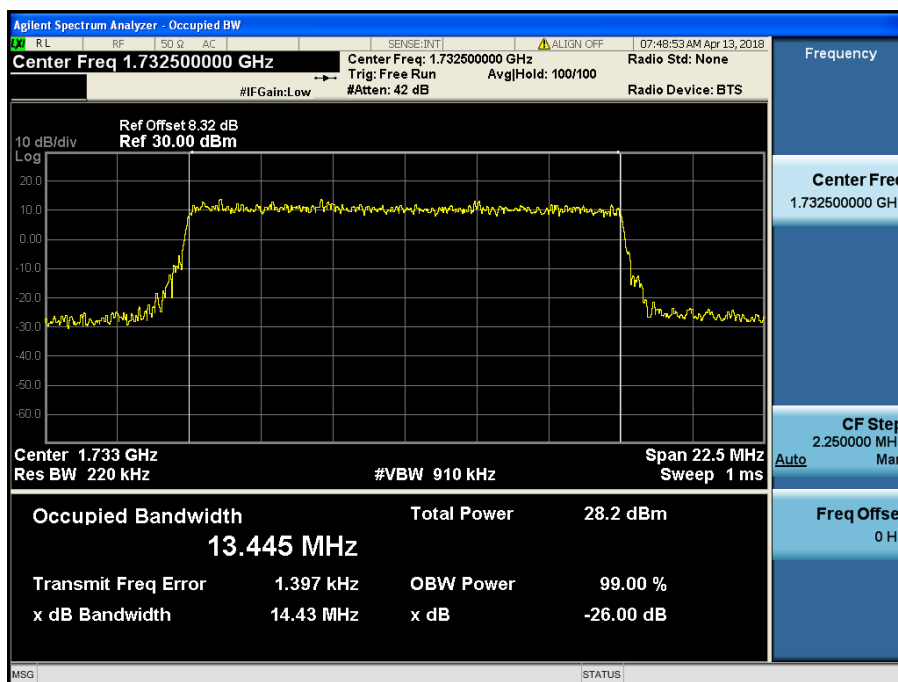

LTE Band 4 / 15 MHz / 16QAM - RB Size 75

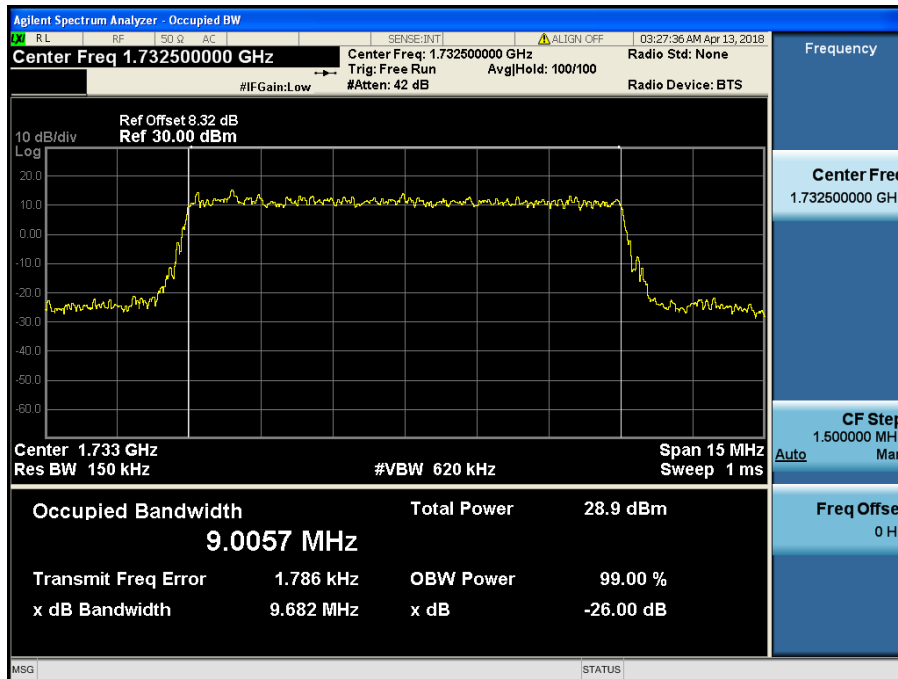

LTE Band 4 / 10 MHz / QPSK - RB Size 50

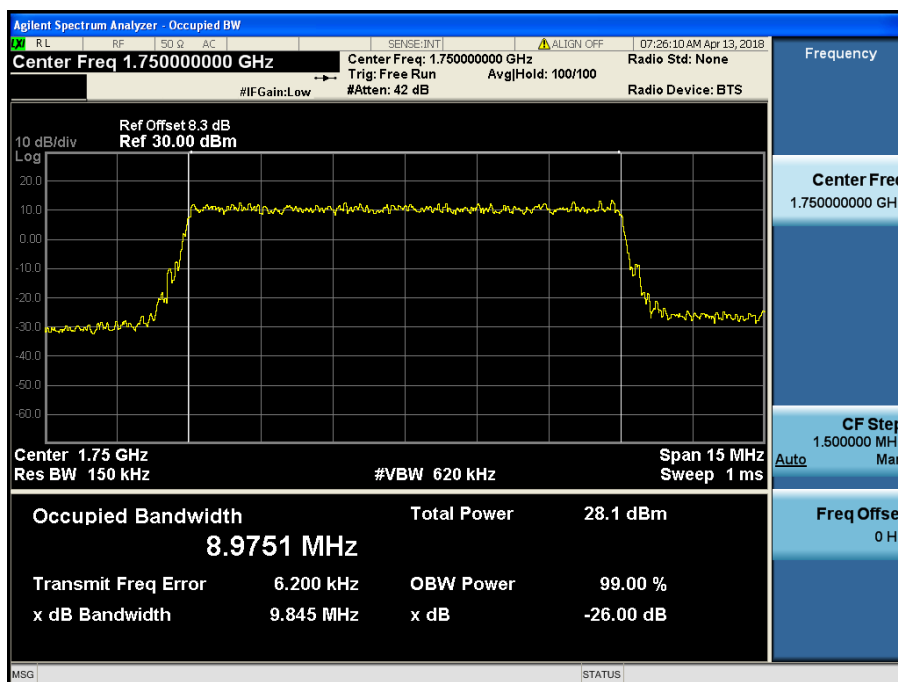

LTE Band 4 / 10 MHz / 16QAM - RB Size 50



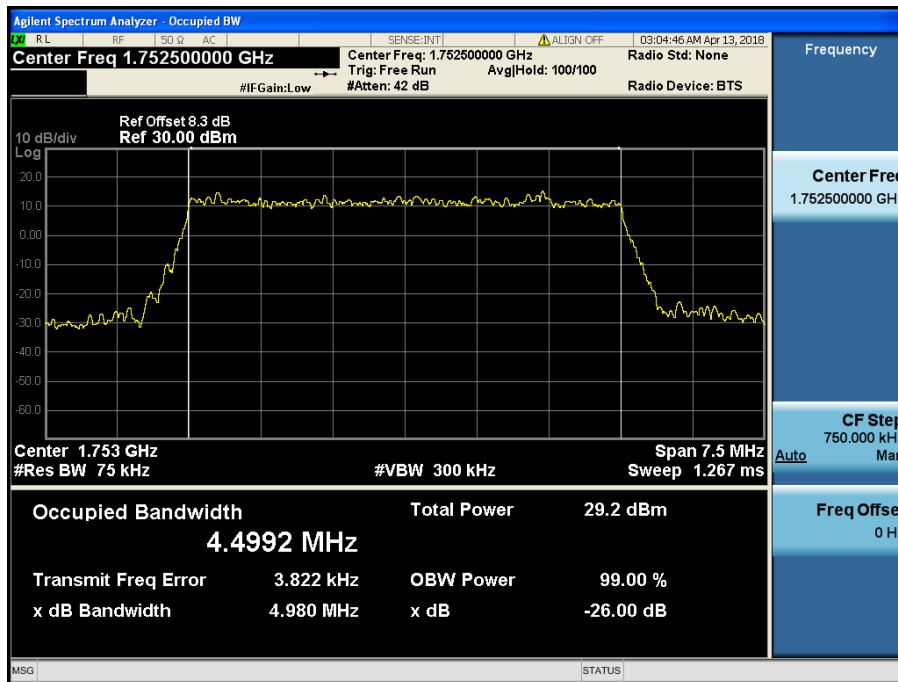

LTE Band 4 / 5 MHz / QPSK - RB Size 25

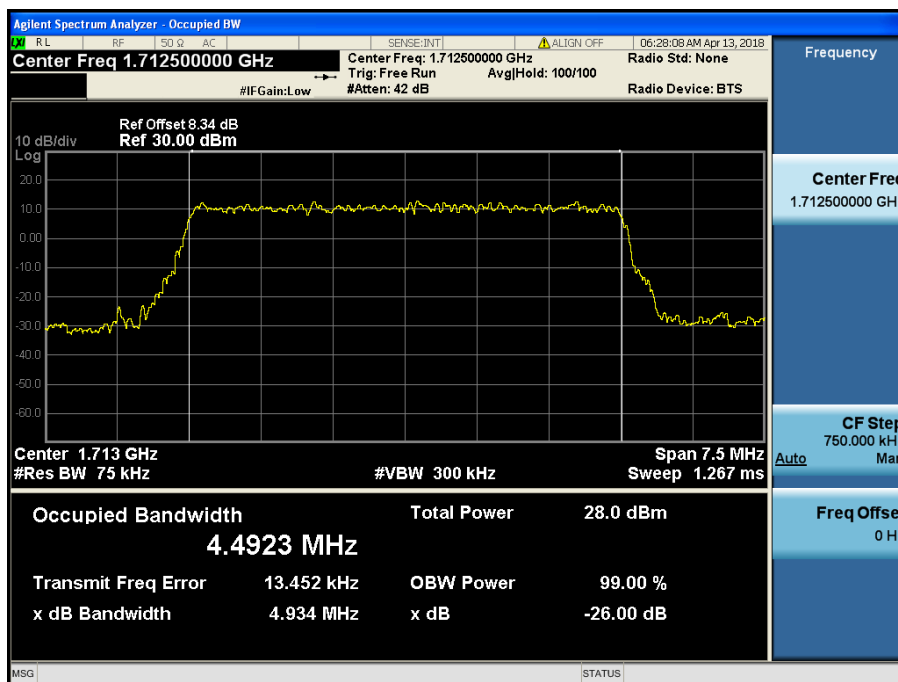

LTE Band 4 / 5 MHz / 16QAM - RB Size 25

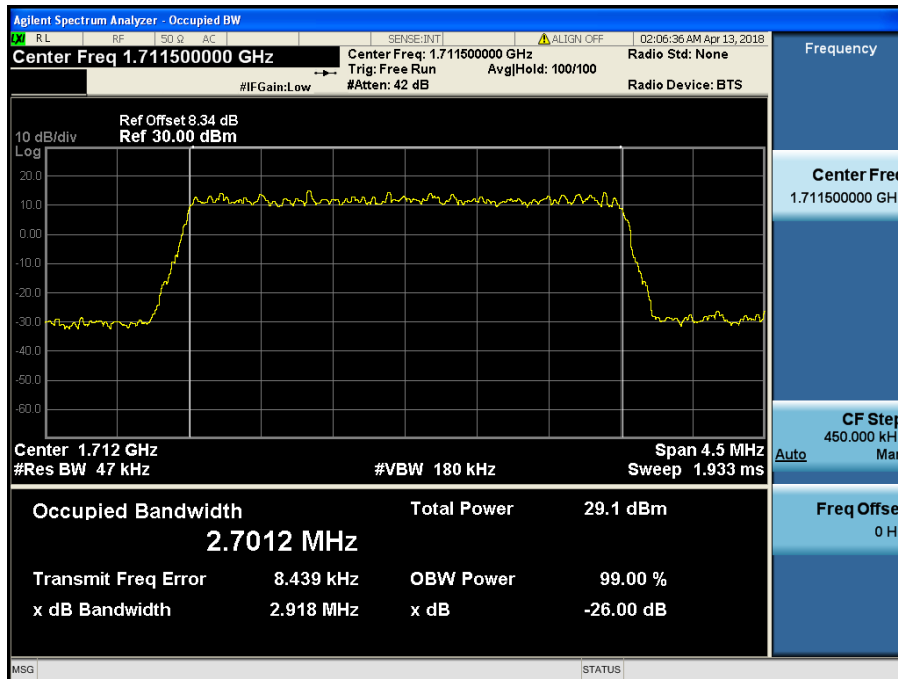

LTE Band 4 / 3 MHz / QPSK - RB Size 15

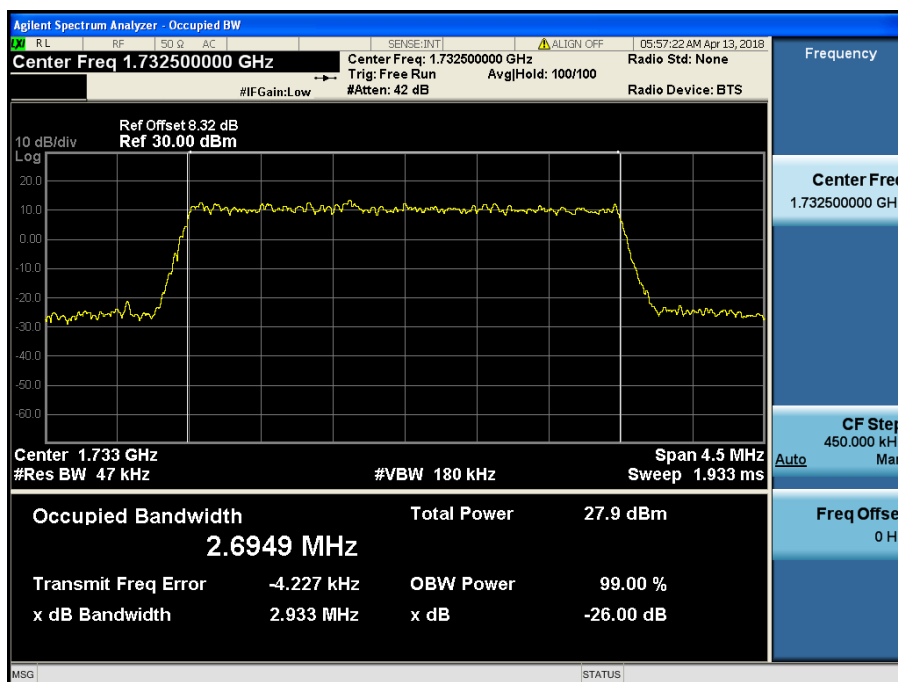

LTE Band 4 / 3 MHz / 16QAM - RB Size 15

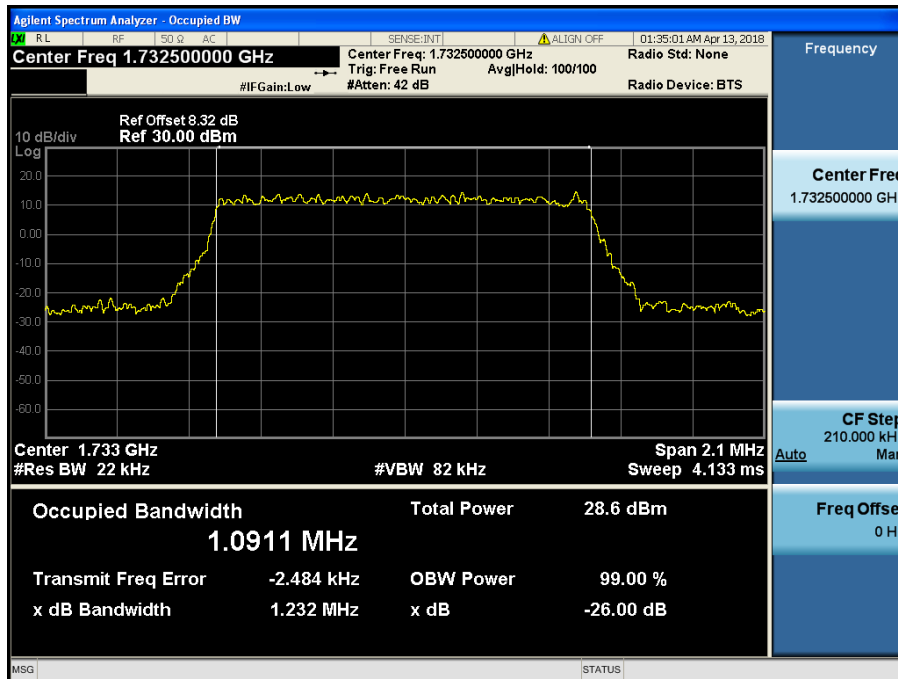

LTE Band 4 / 1.4 MHz / QPSK - RB Size 6

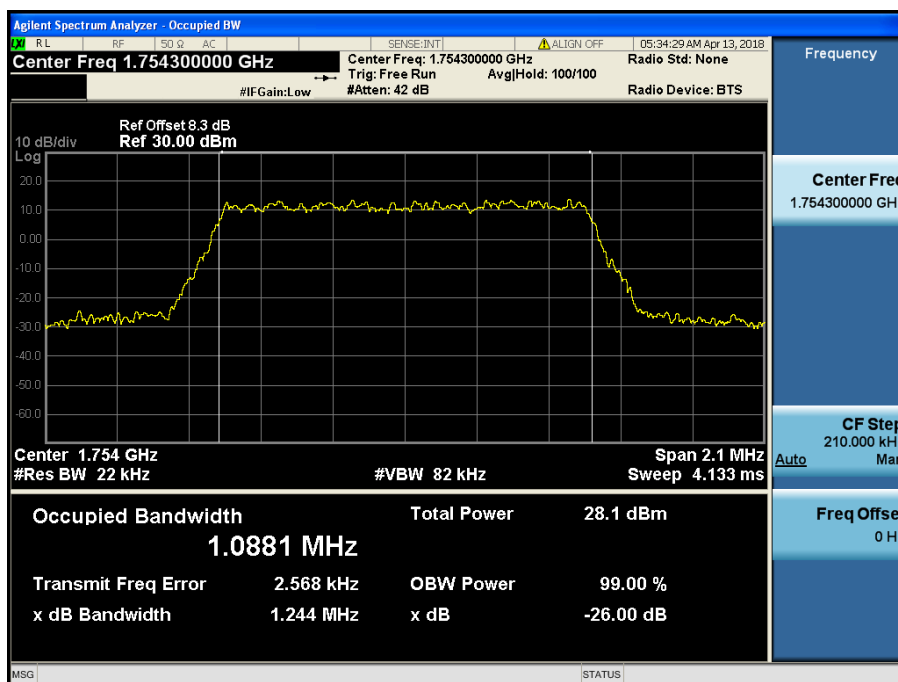

LTE Band 4 / 1.4 MHz / 16QAM - RB Size 6

8.1.5 LTE Band 66

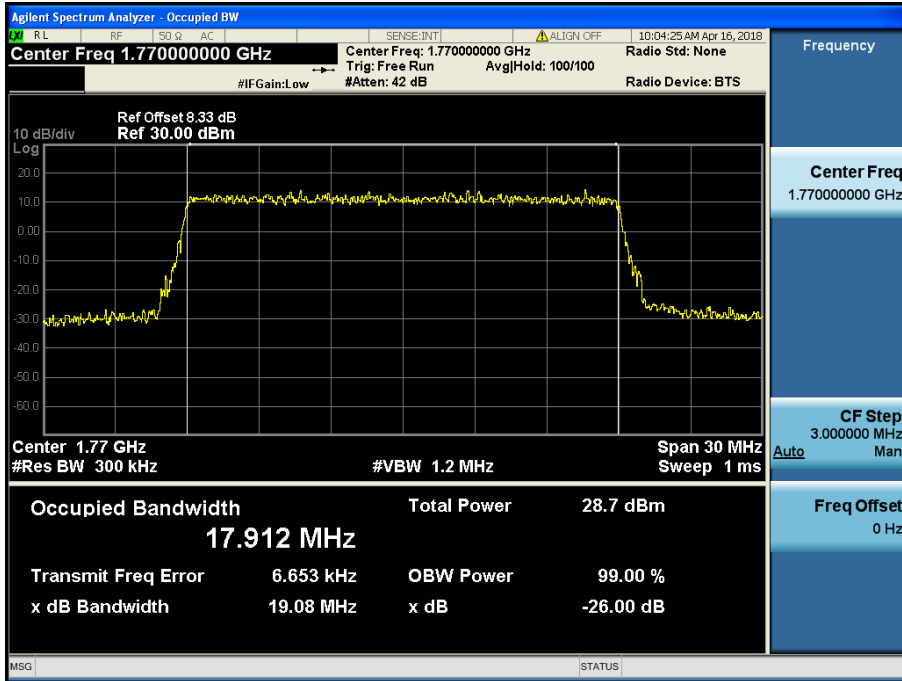

LTE Band 66 / 20 MHz / QPSK - RB Size 100

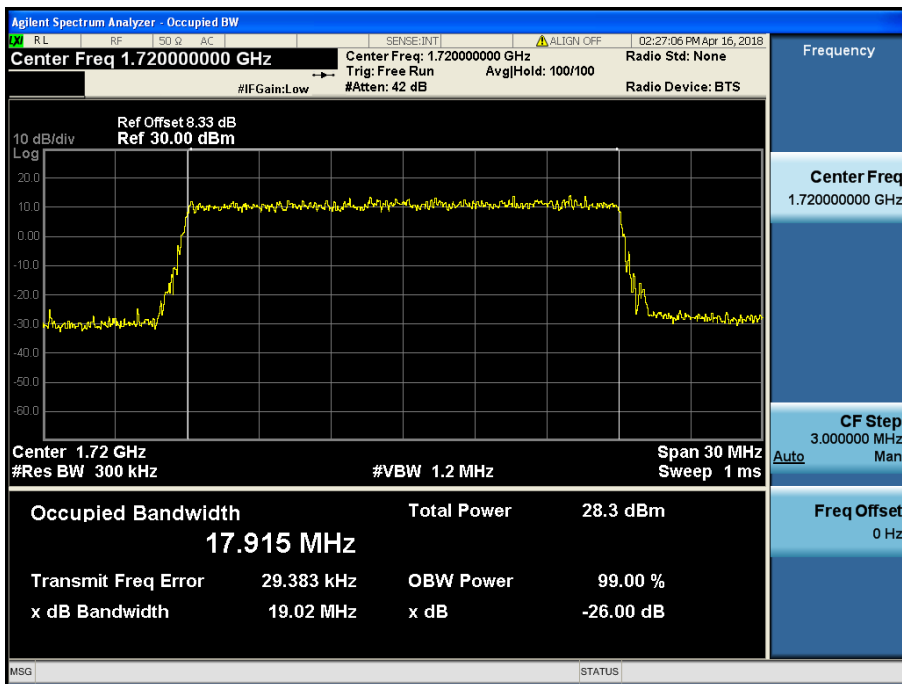

LTE Band 66 / 20 MHz / 16QAM - RB Size 100

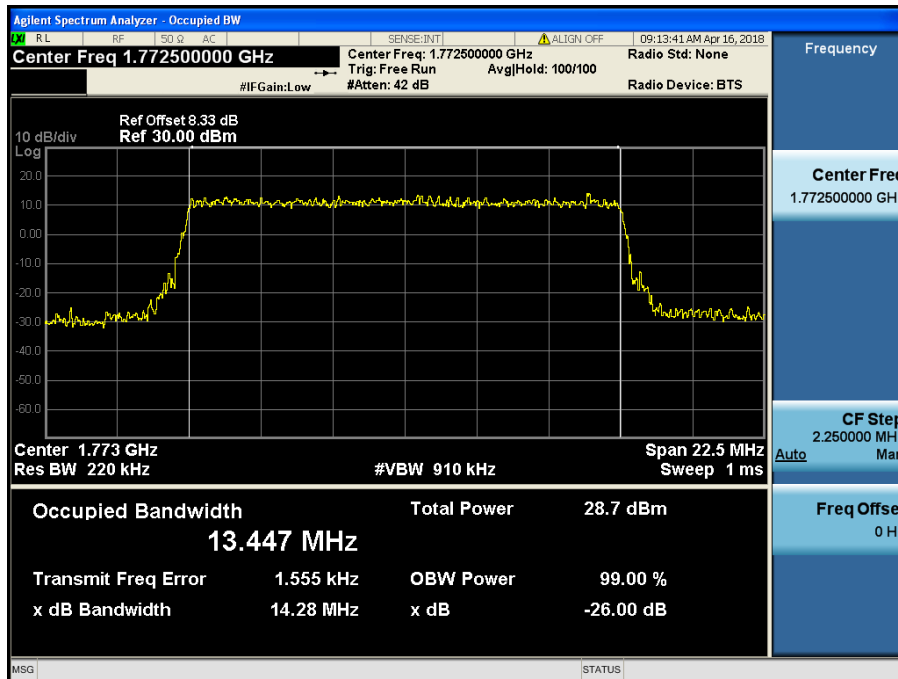

LTE Band 66 / 15 MHz / QPSK - RB Size 75

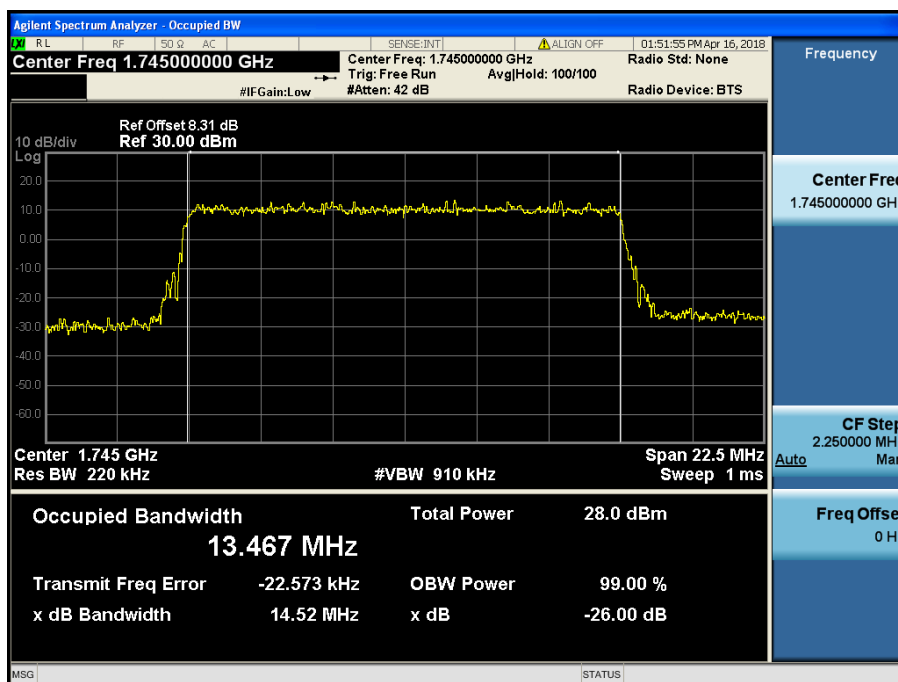

LTE Band 66 / 15 MHz / 16QAM - RB Size 75

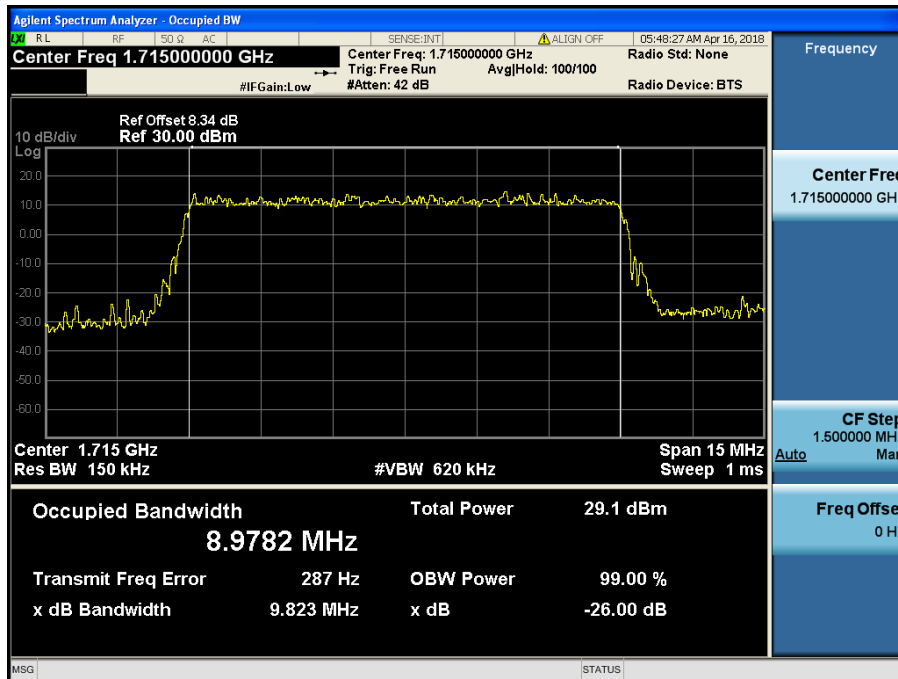

LTE Band 66 / 10 MHz / QPSK - RB Size 50

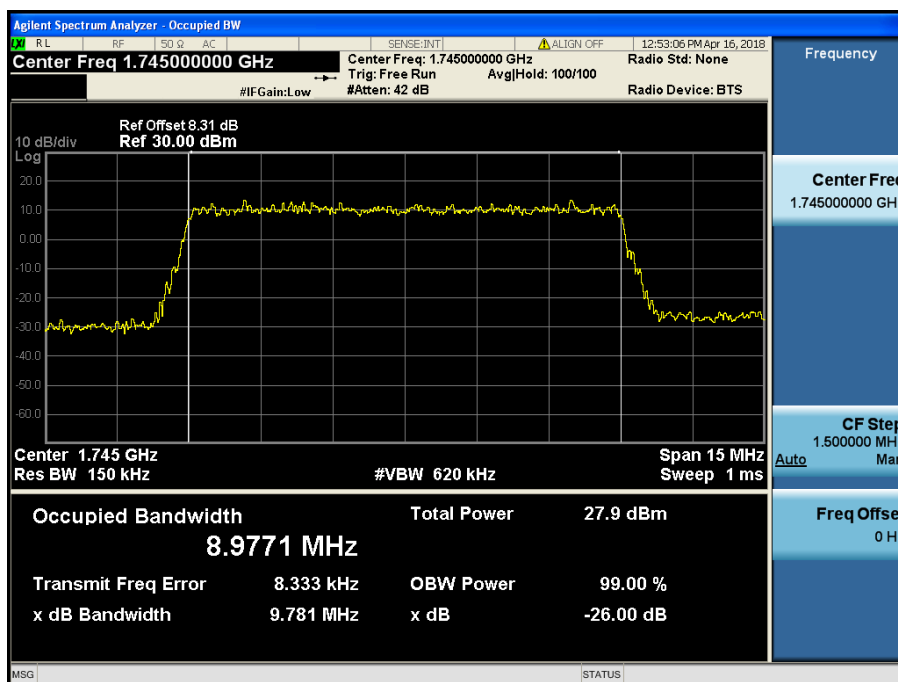

LTE Band 66 / 10 MHz / 16QAM - RB Size 50

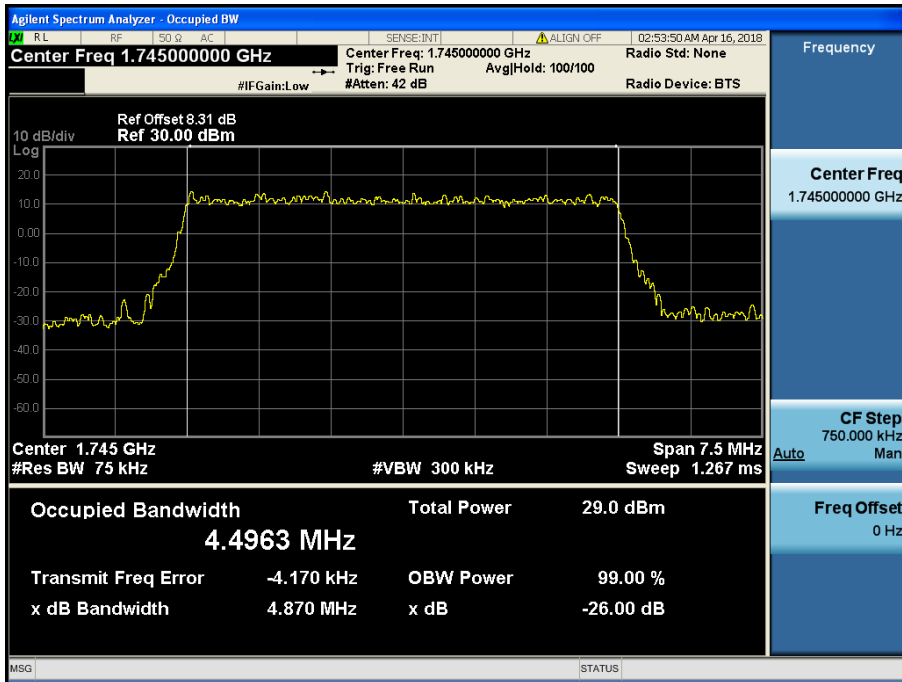

LTE Band 66 / 5 MHz / QPSK - RB Size 25

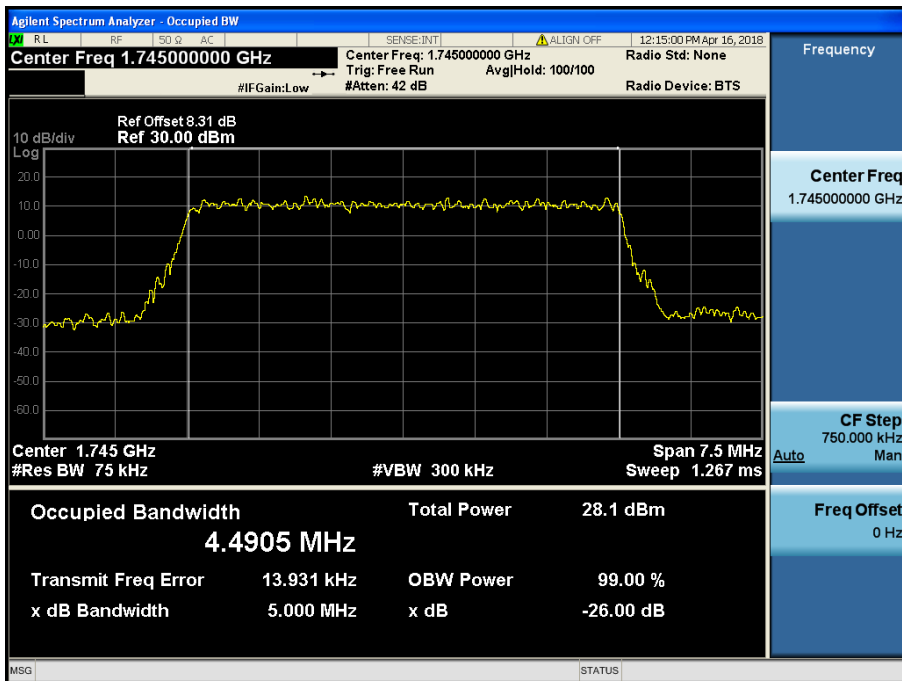

LTE Band 66 / 5 MHz / 16QAM - RB Size 25

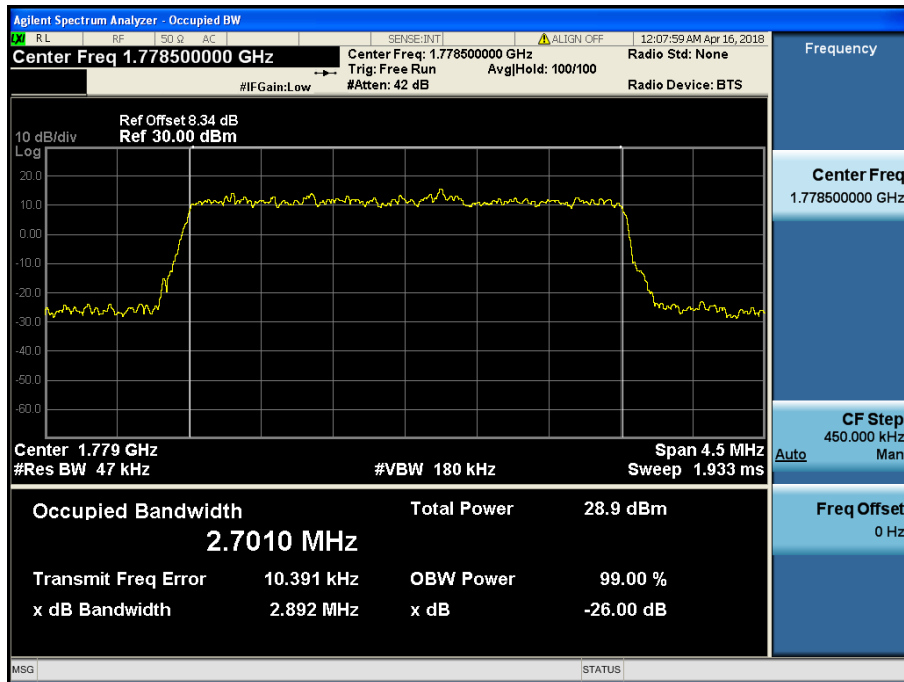

LTE Band 66 / 3 MHz / QPSK - RB Size 15

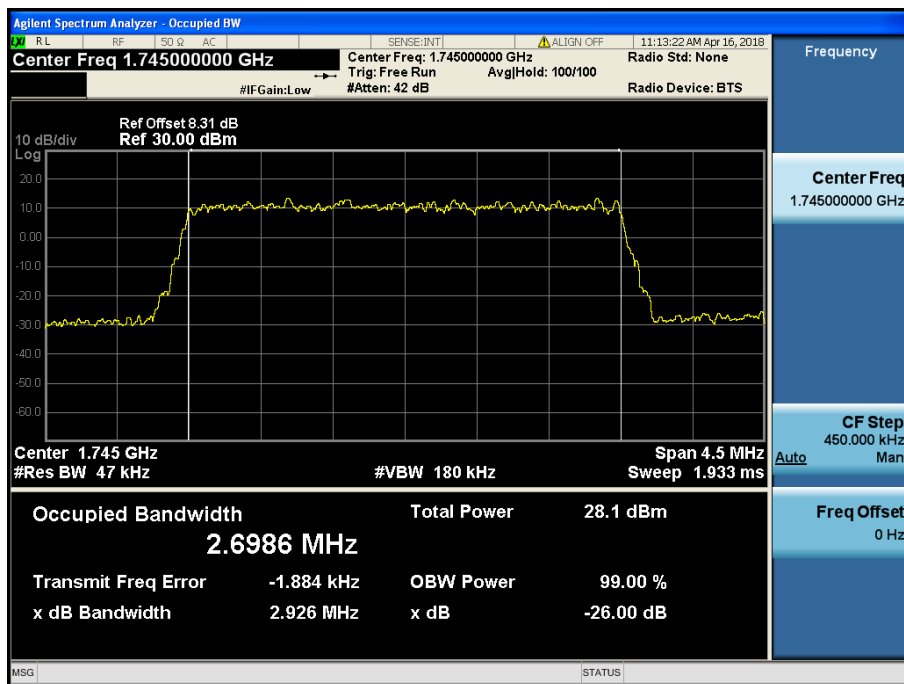

LTE Band 66 / 3 MHz / 16QAM - RB Size 15



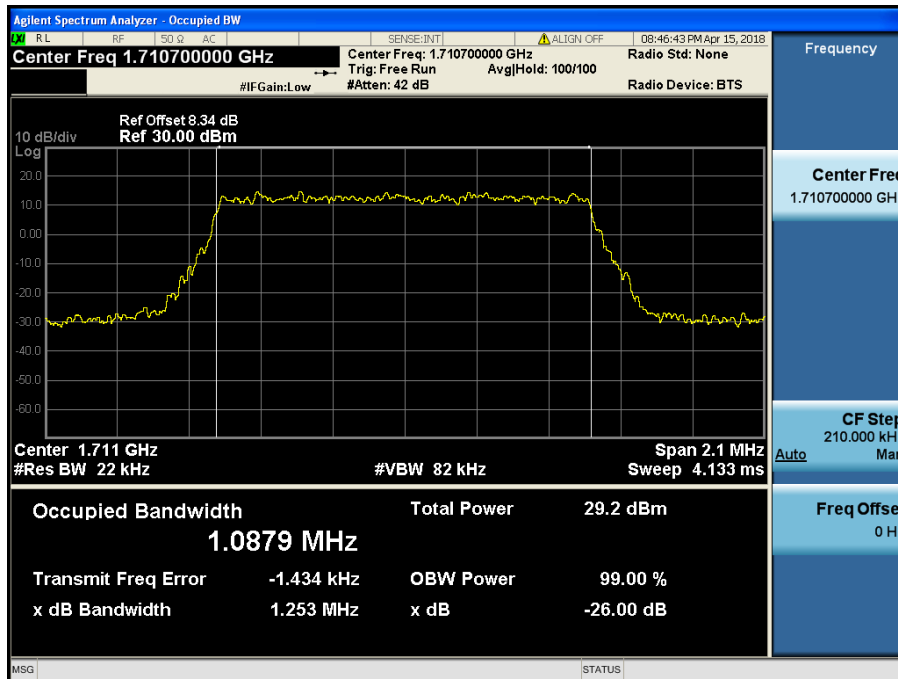

LTE Band 66 / 1.4 MHz / QPSK - RB Size 6

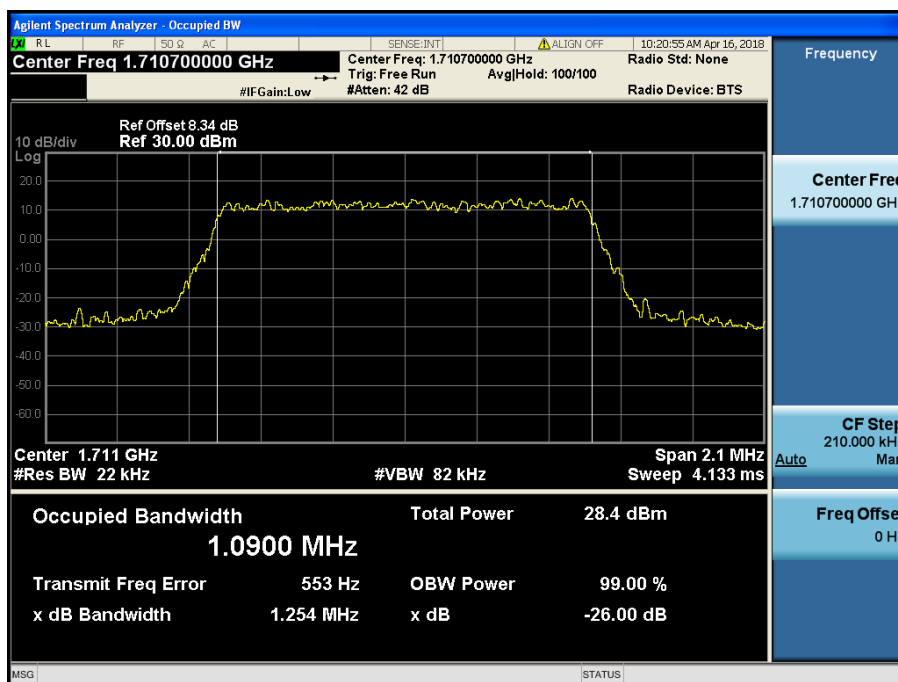

LTE Band 66 / 1.4 MHz / 16QAM - RB Size 6

8.1.6 LTE Band 2

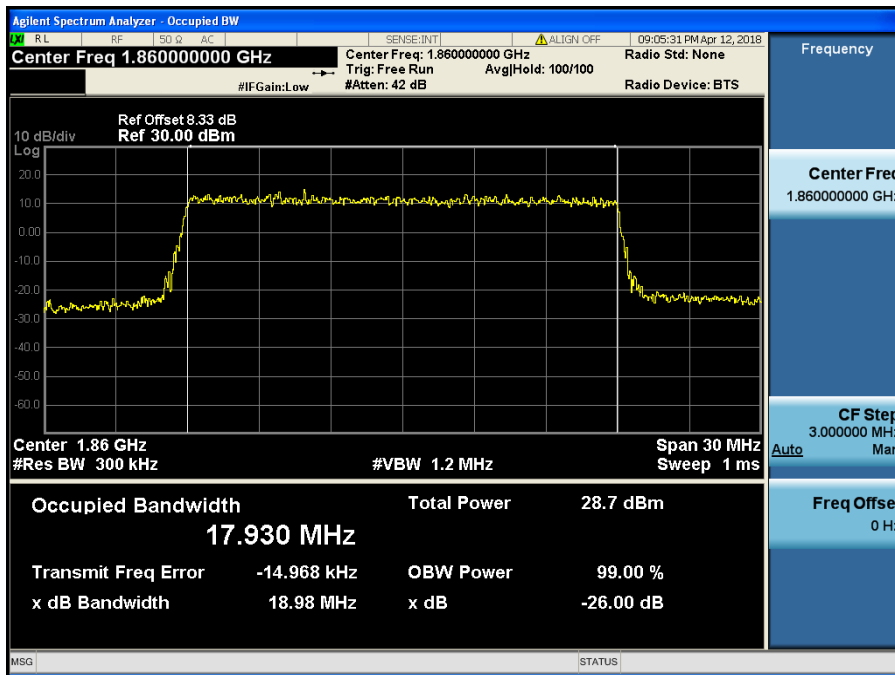

LTE Band 2 / 20 MHz / QPSK - RB Size 100

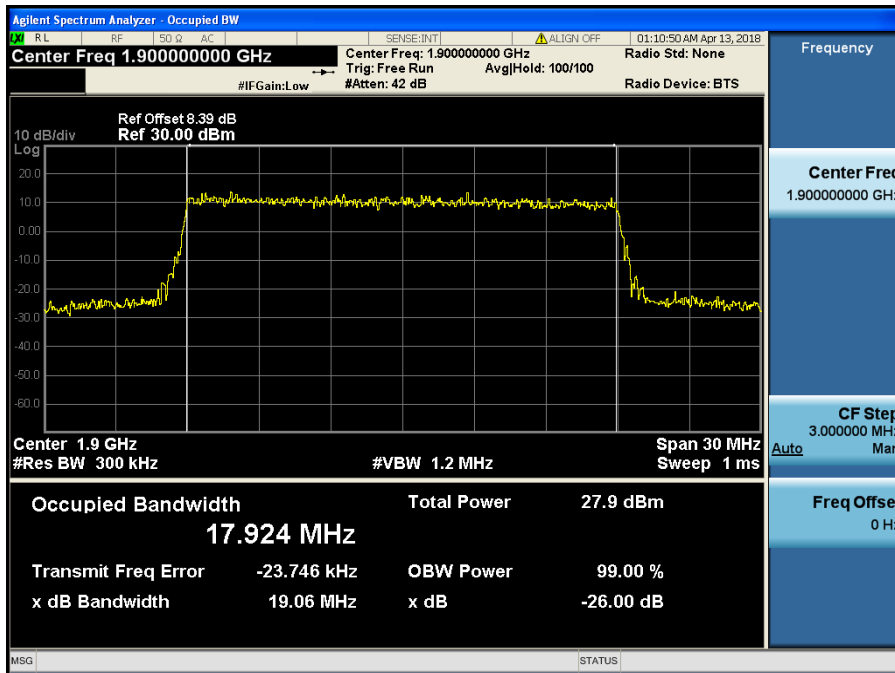

LTE Band 2 / 20 MHz / 16QAM - RB Size 100

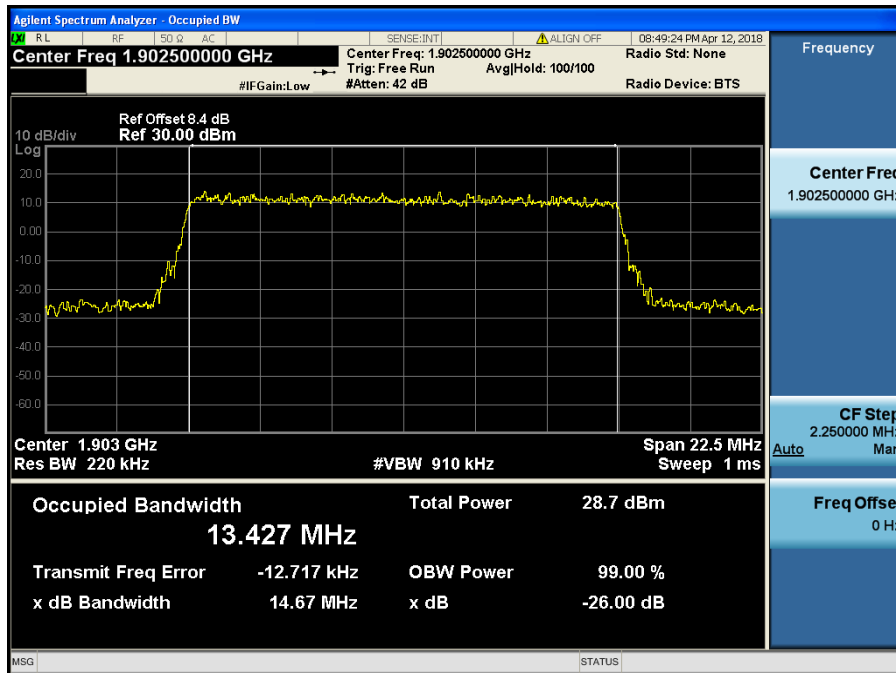

LTE Band 2 / 15 MHz / QPSK - RB Size 75

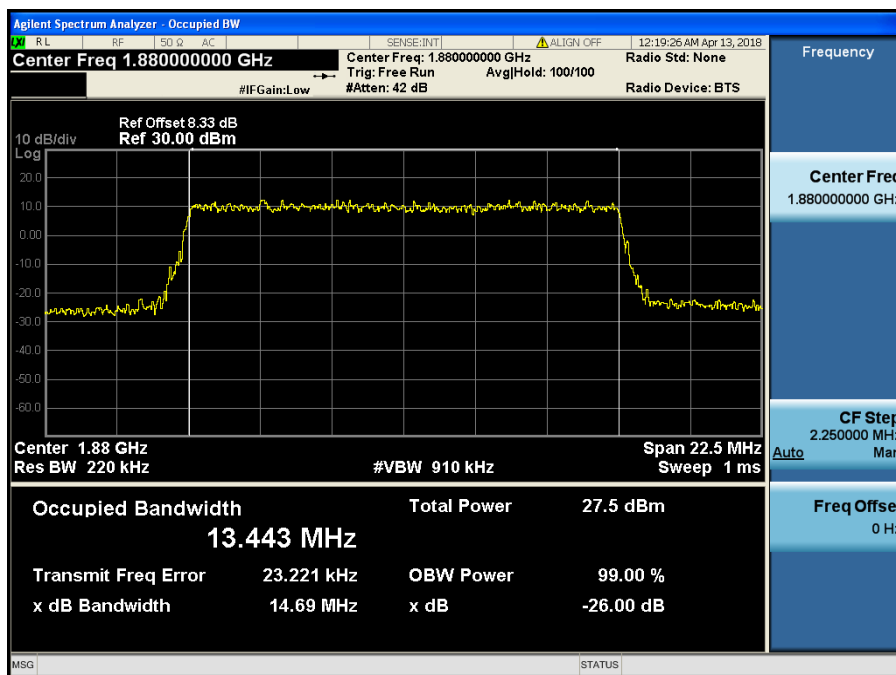

LTE Band 2 / 15 MHz / 16QAM - RB Size 75

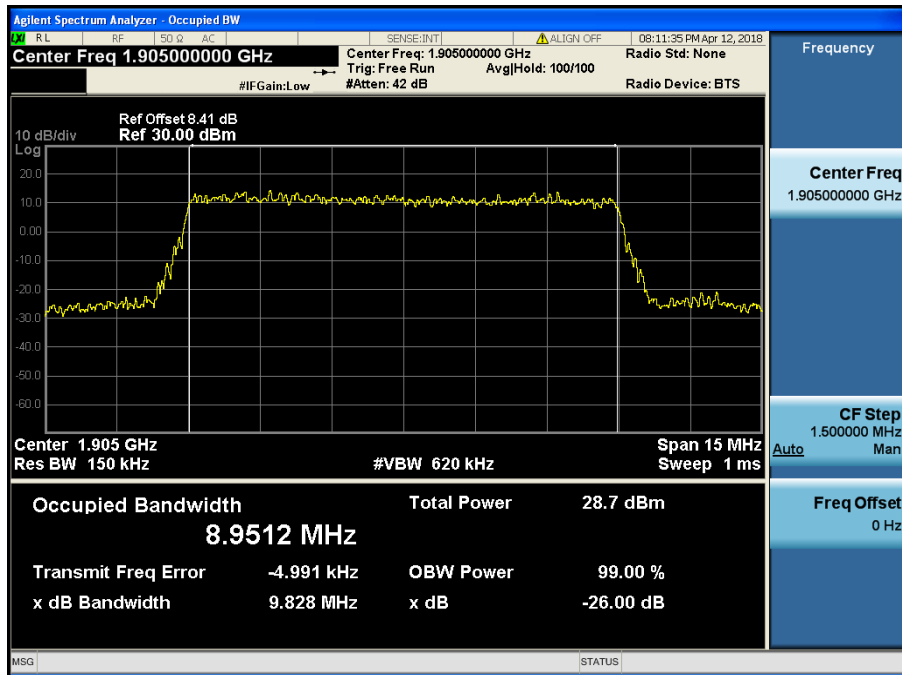

LTE Band 2 / 10 MHz / QPSK - RB Size 50

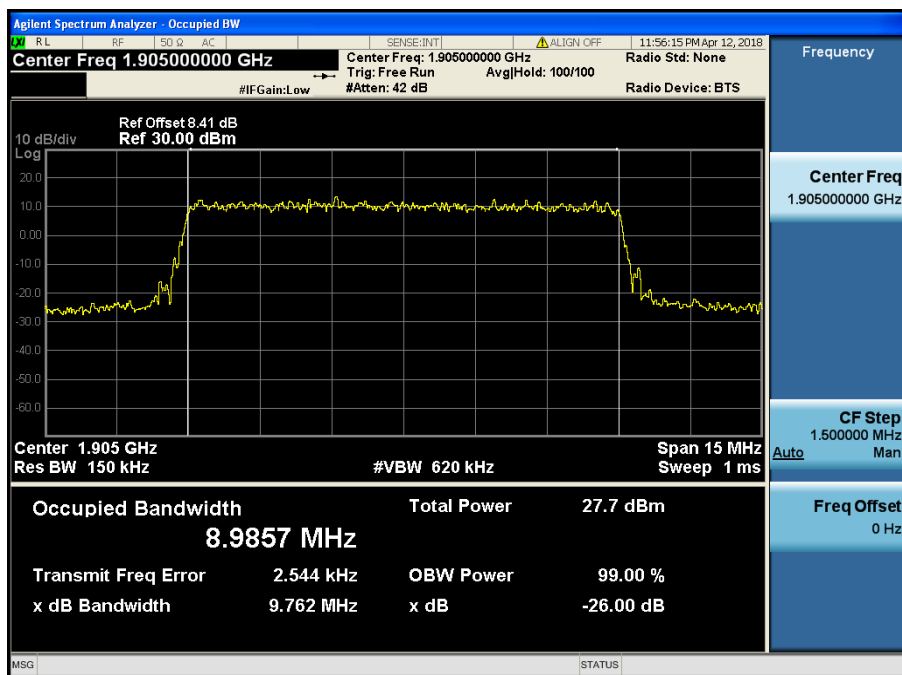

LTE Band 2 / 10 MHz / 16QAM - RB Size 50

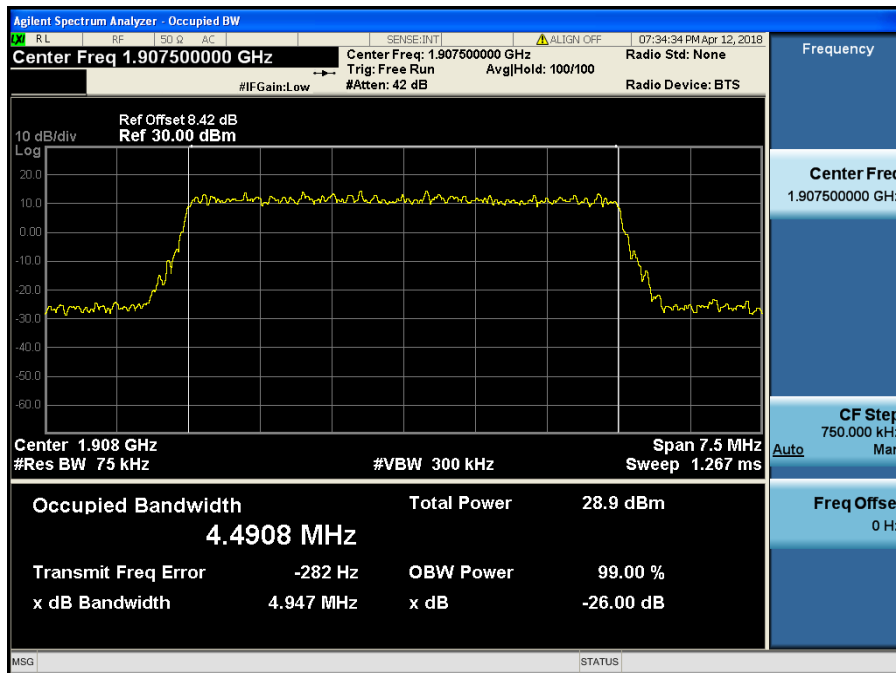

LTE Band 2 / 5 MHz / QPSK - RB Size 25

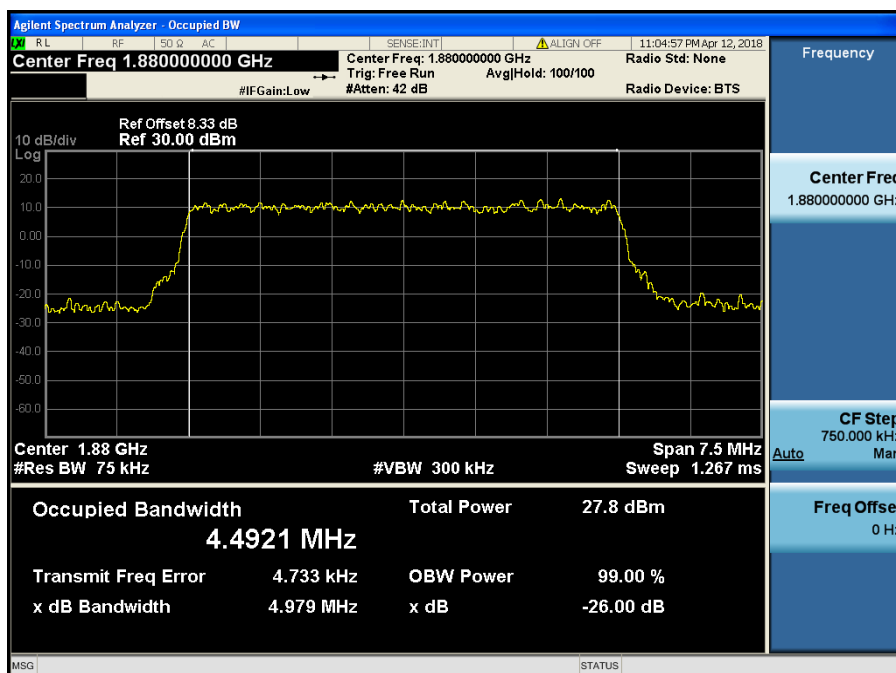

LTE Band 2 / 5 MHz / 16QAM - RB Size 25

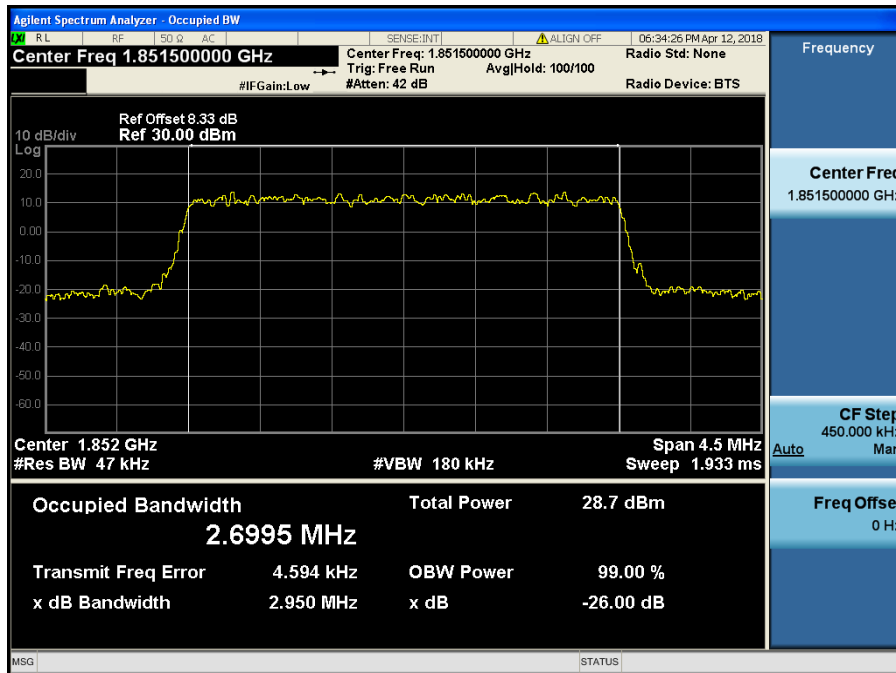

LTE Band 2 / 3 MHz / QPSK - RB Size 15

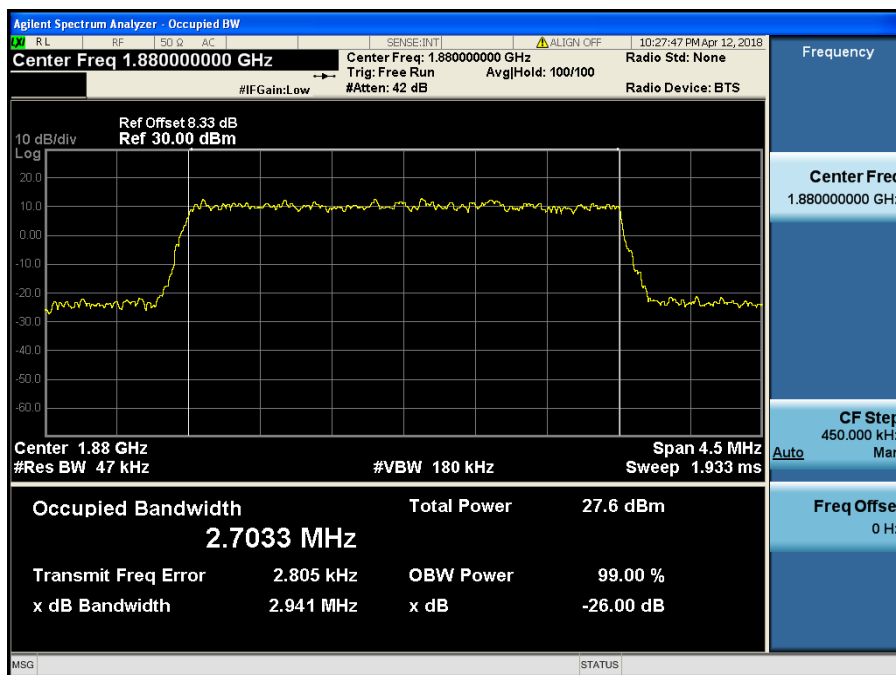

LTE Band 2 / 3 MHz / 16QAM - RB Size 15

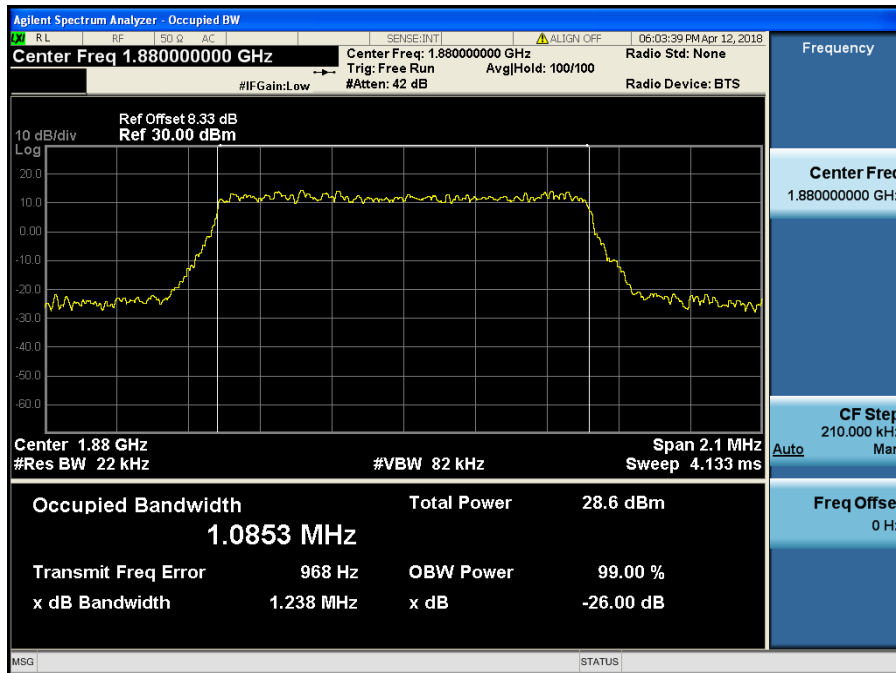

LTE Band 2 / 1.4 MHz / QPSK - RB Size 6

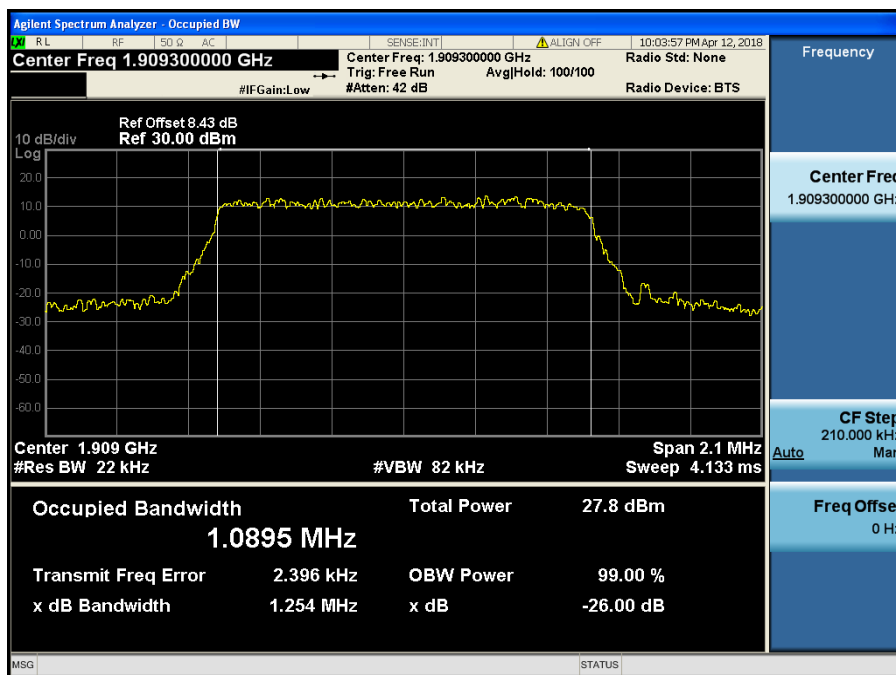

LTE Band 2 / 1.4 MHz / 16QAM - RB Size 6

8.1.7 LTE Band 7

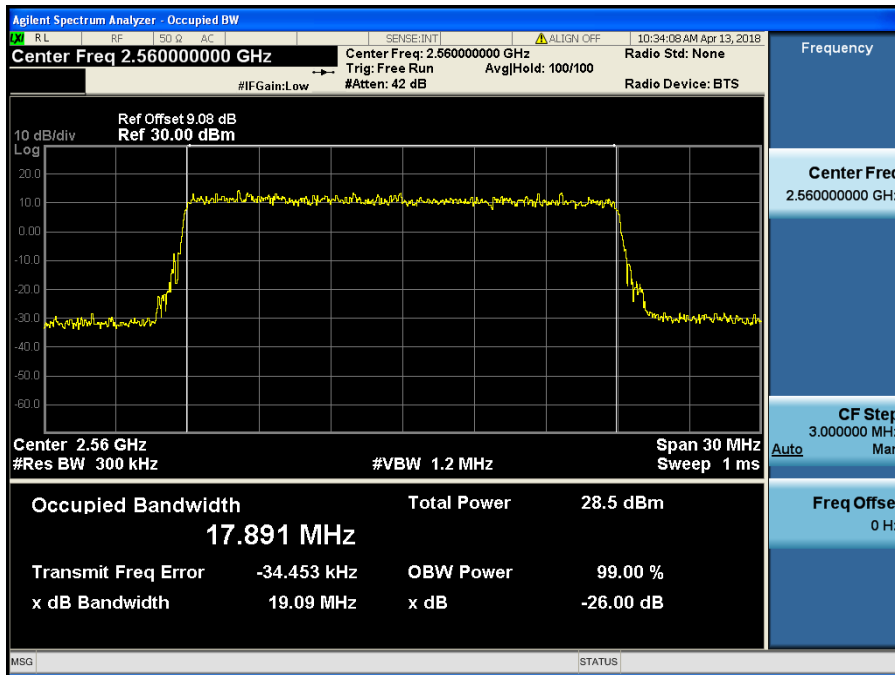

LTE Band 7 / 20 MHz / QPSK - RB Size 100

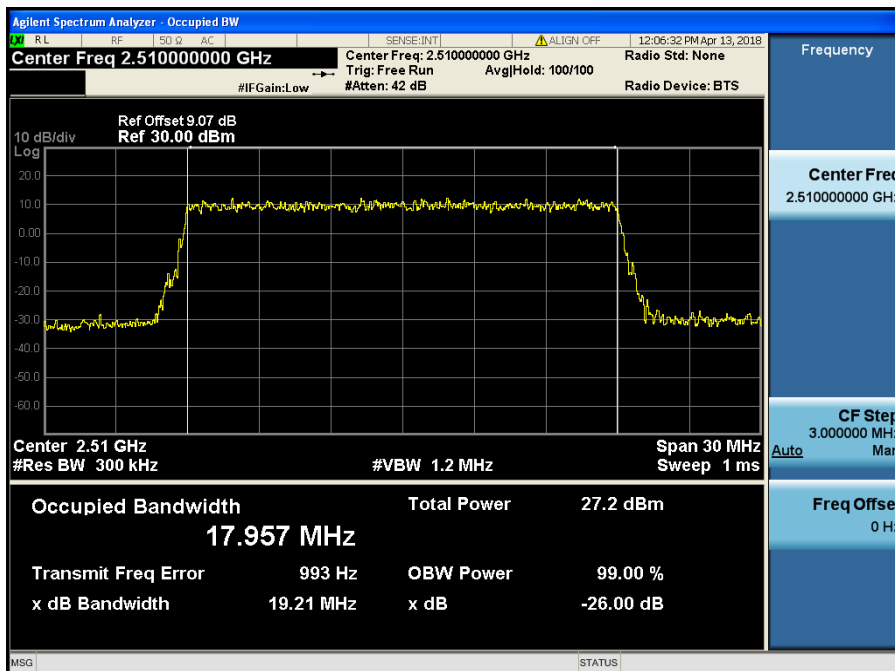

LTE Band 7 / 20 MHz / 16QAM - RB Size 100



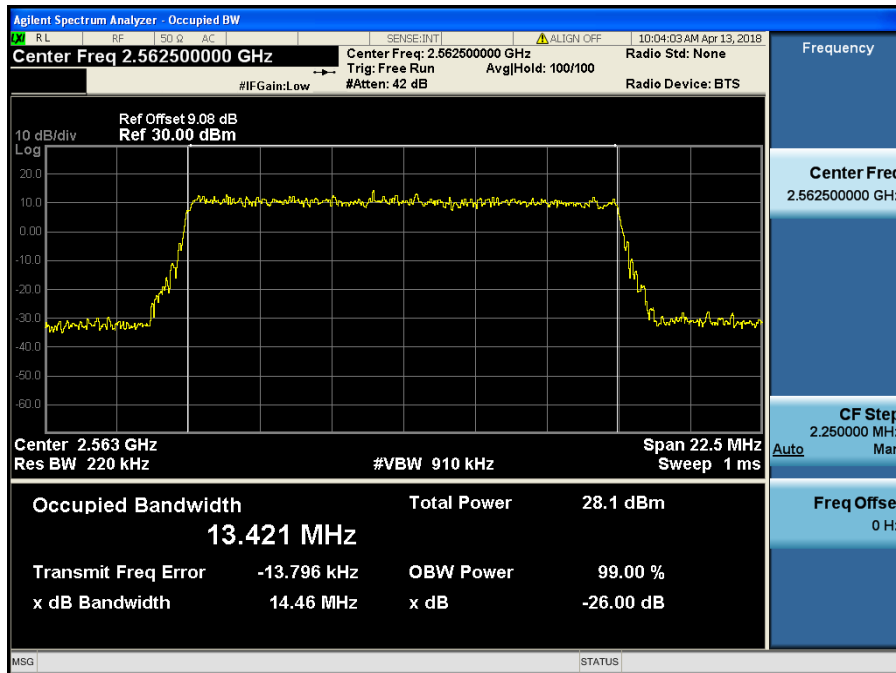

LTE Band 7 / 15 MHz / QPSK - RB Size 75

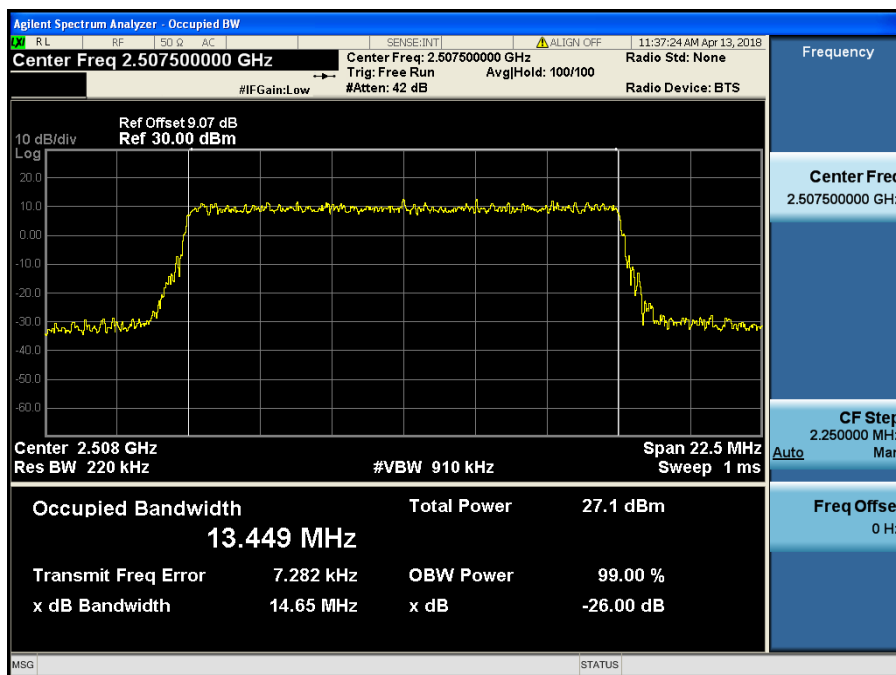

LTE Band 7 / 15 MHz / 16QAM - RB Size 75

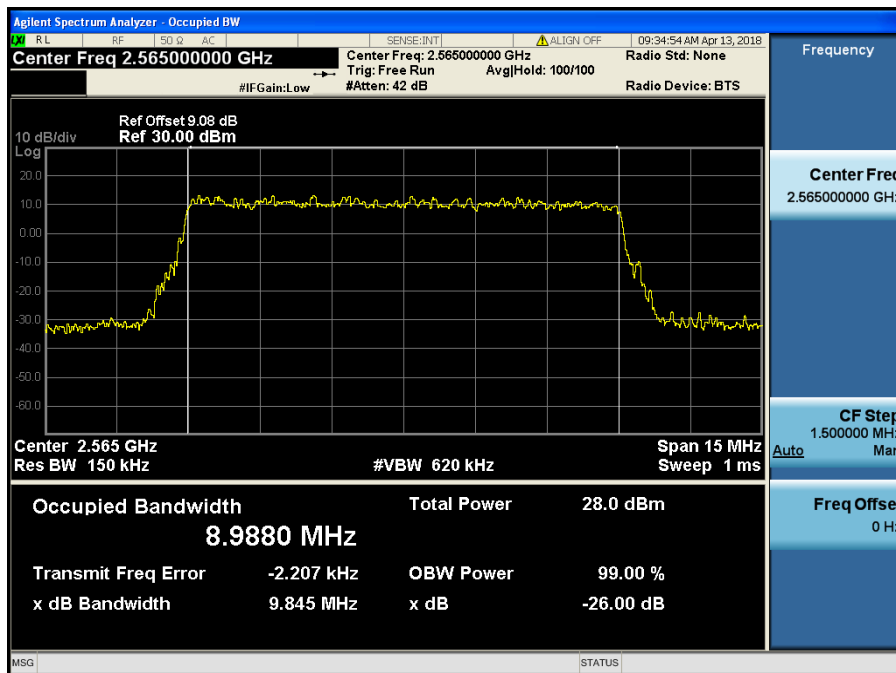

LTE Band 7 / 10 MHz / QPSK - RB Size 50

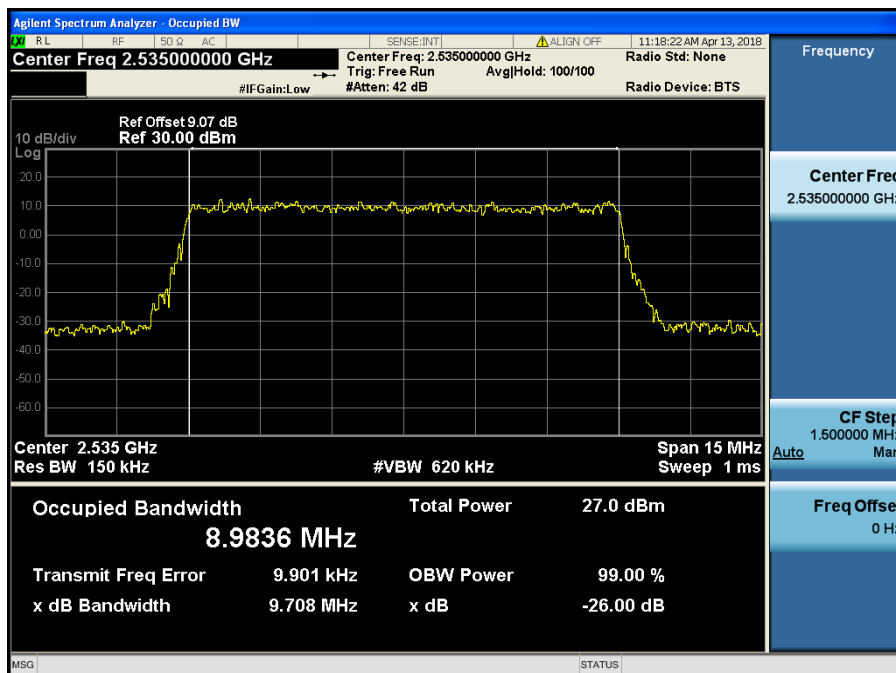

LTE Band 7 / 10 MHz / 16QAM - RB Size 50

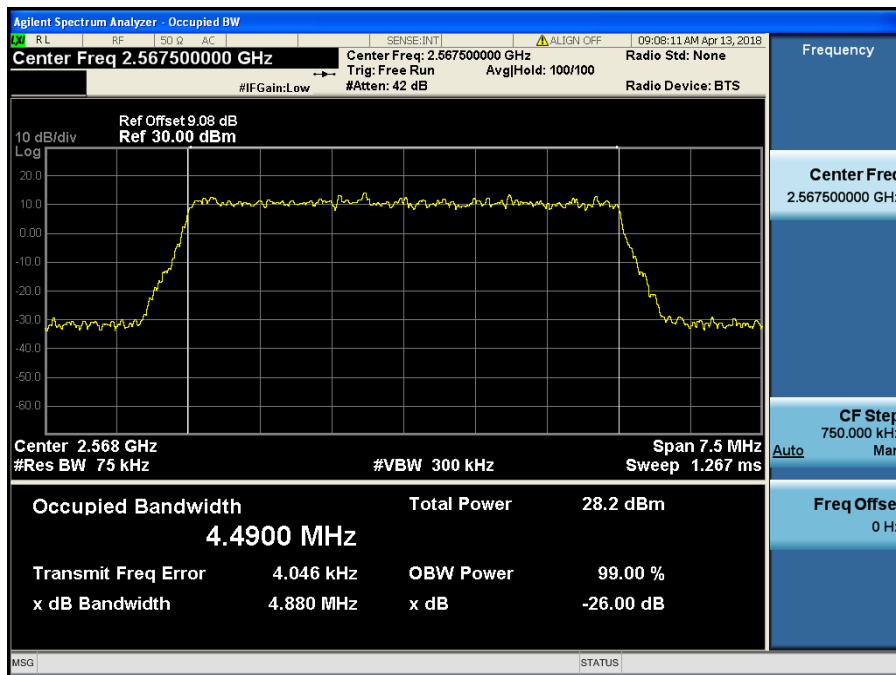

LTE Band 7 / 5 MHz / QPSK - RB Size 25

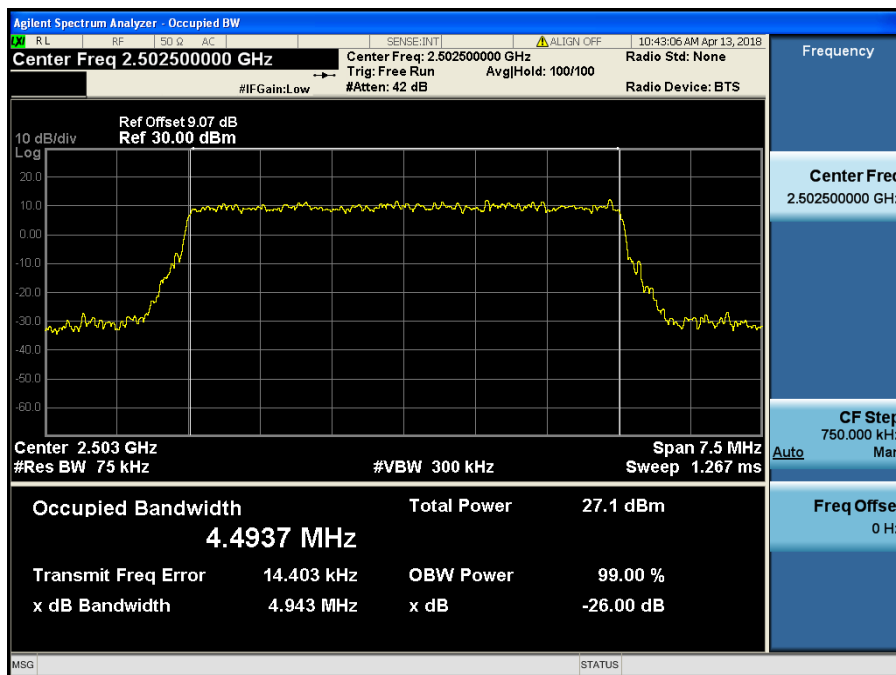

LTE Band 7 / 5 MHz / 16QAM - RB Size 25

## 8.2 PEAK TO AVERAGE RATIO

### 8.2.1 LTE Band 12

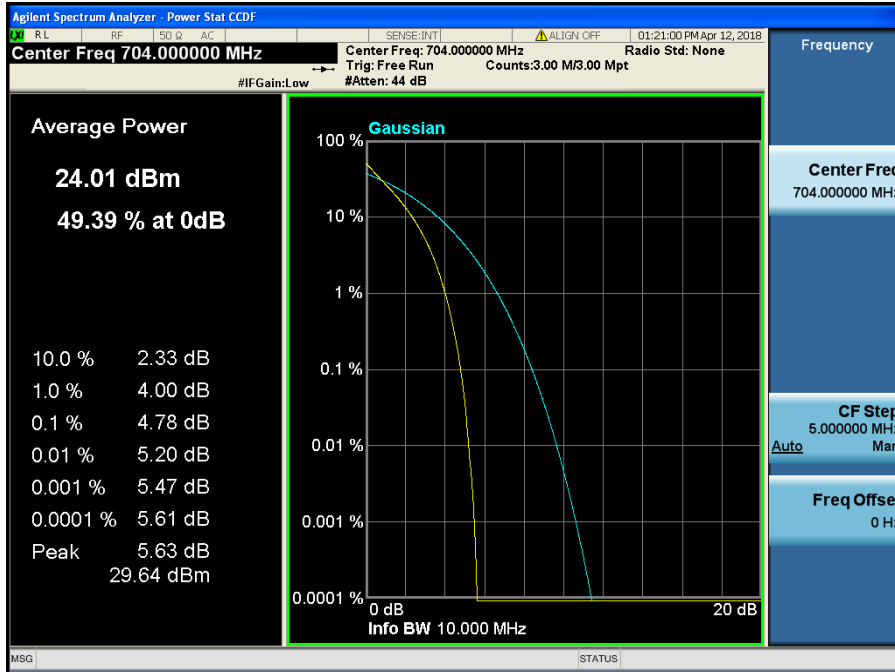

LTE Band 12 / 10 MHz / QPSK - RB Size 50

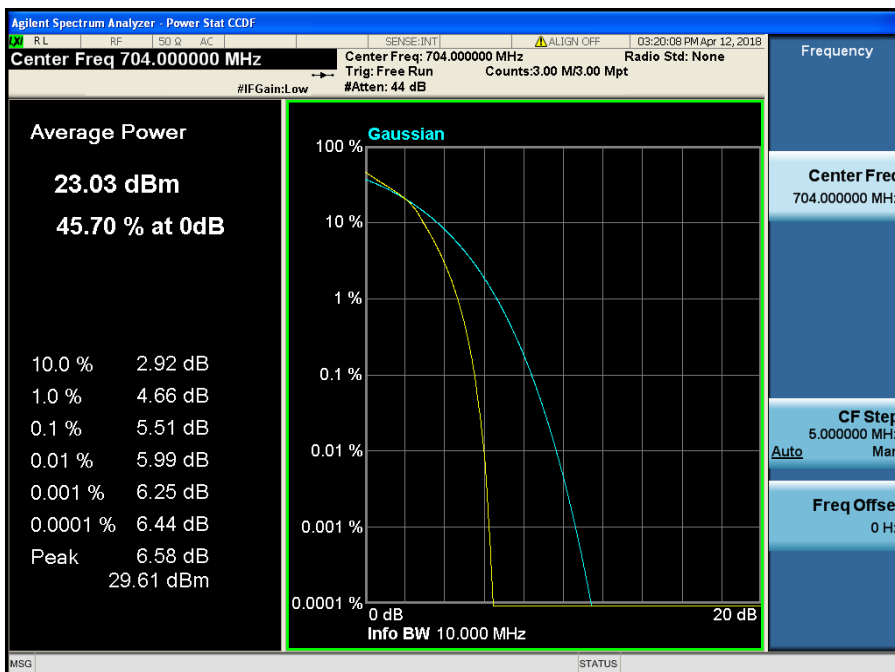

LTE Band 12 / 10 MHz / 16QAM - RB Size 50

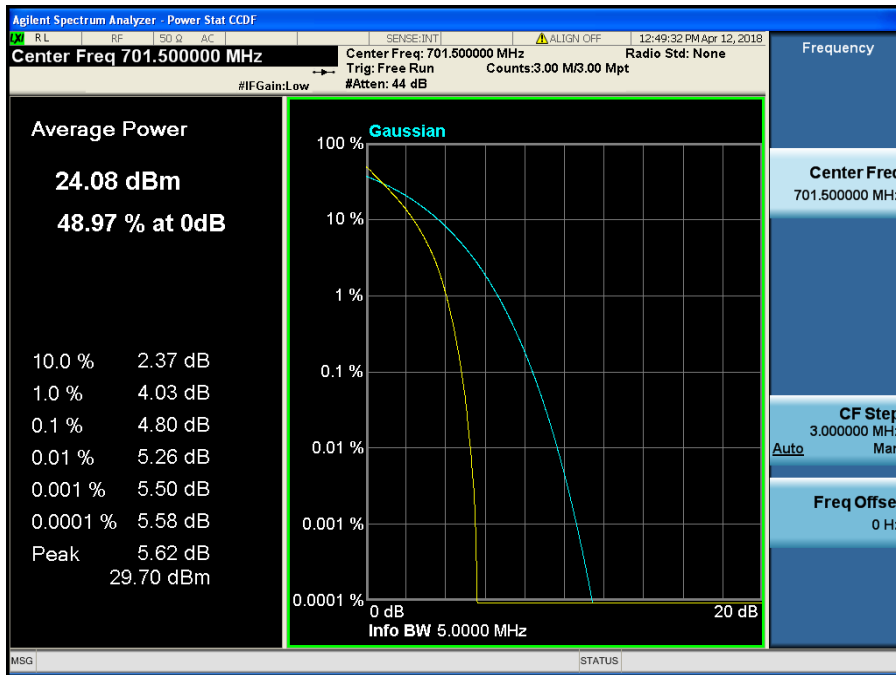

LTE Band 12 / 5 MHz / QPSK - RB Size 25

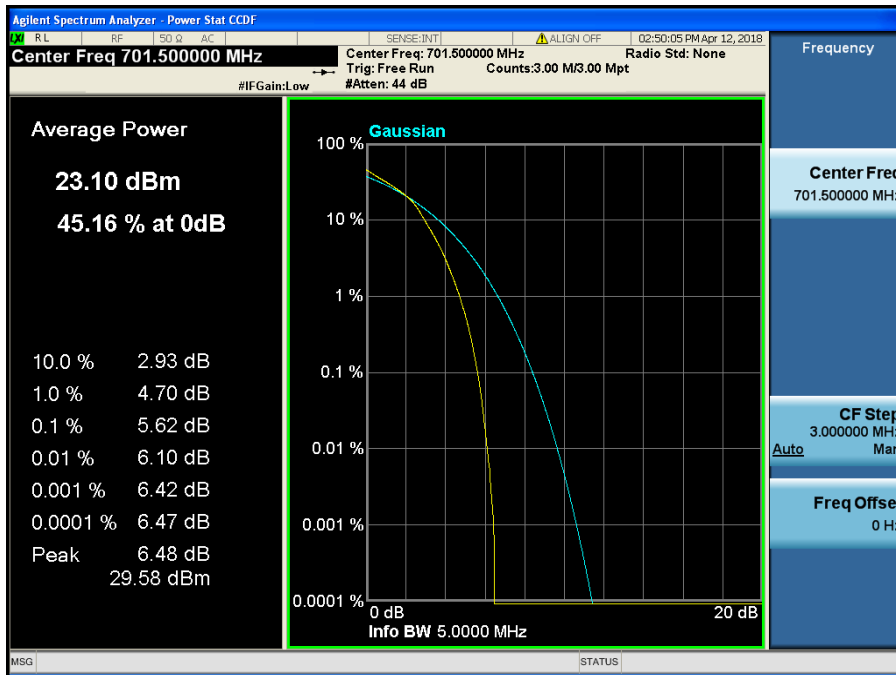

LTE Band 12 / 5 MHz / 16QAM - RB Size 25

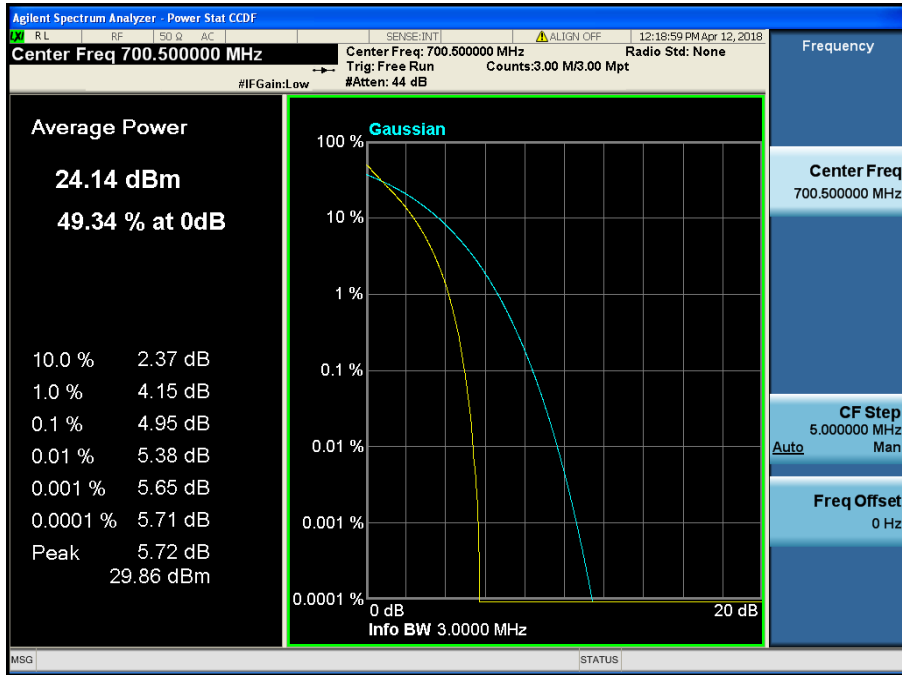

LTE Band 12 / 3 MHz / QPSK - RB Size 15

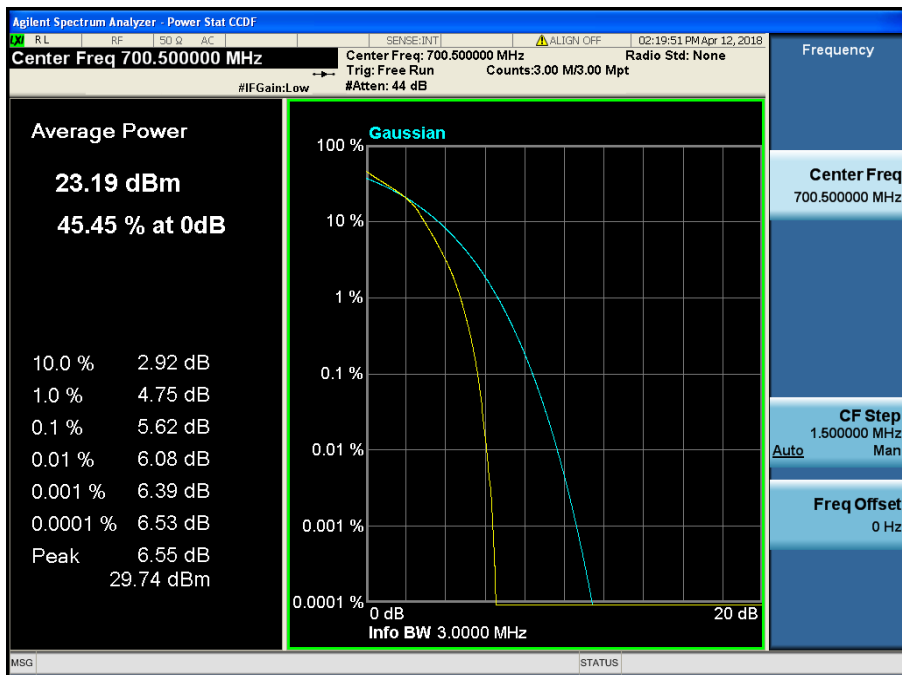

LTE Band 12 / 3 MHz / 16QAM - RB Size 15

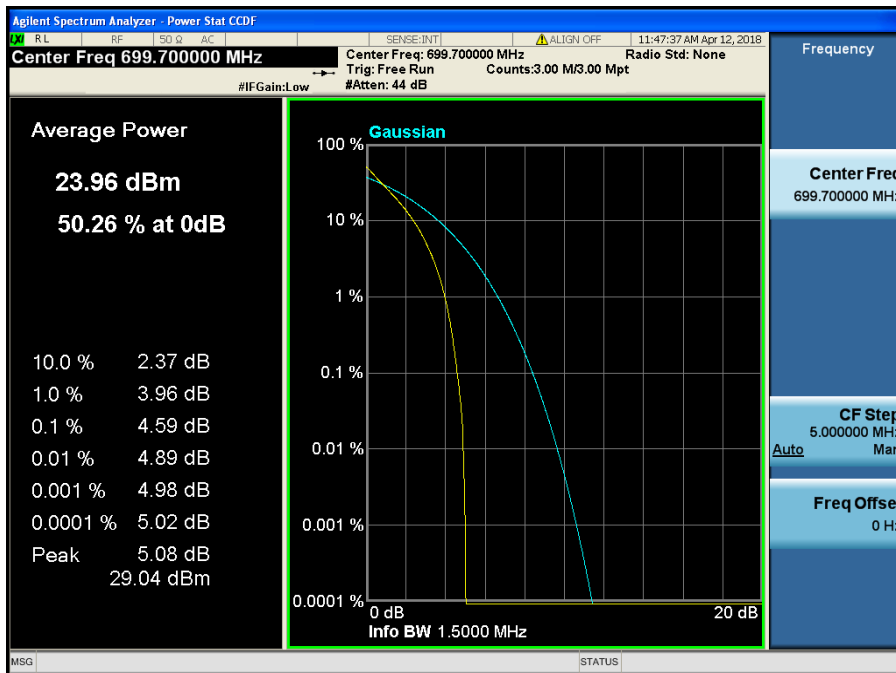

LTE Band 12 / 1.4 MHz / QPSK - RB Size 6

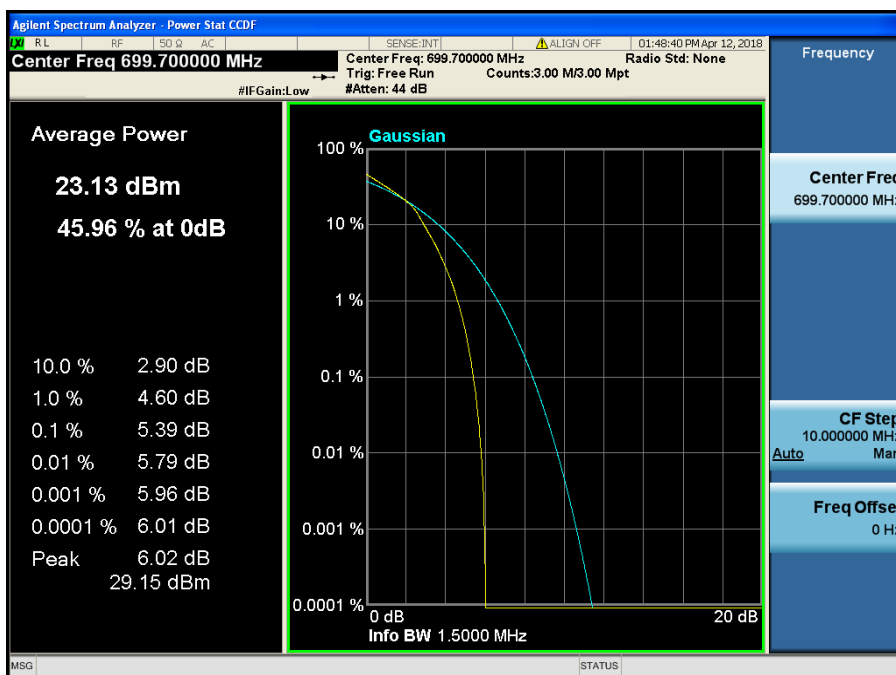

LTE Band 12 / 1.4 MHz / 16QAM - RB Size 6

8.2.2 LTE Band 17

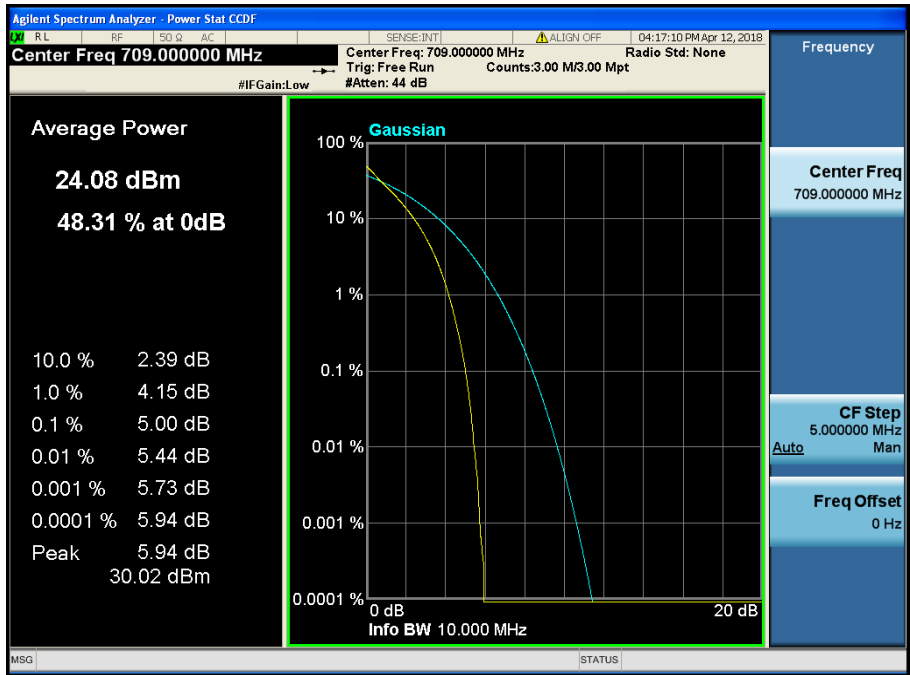

LTE Band 17 / 10 MHz / QPSK - RB Size 50

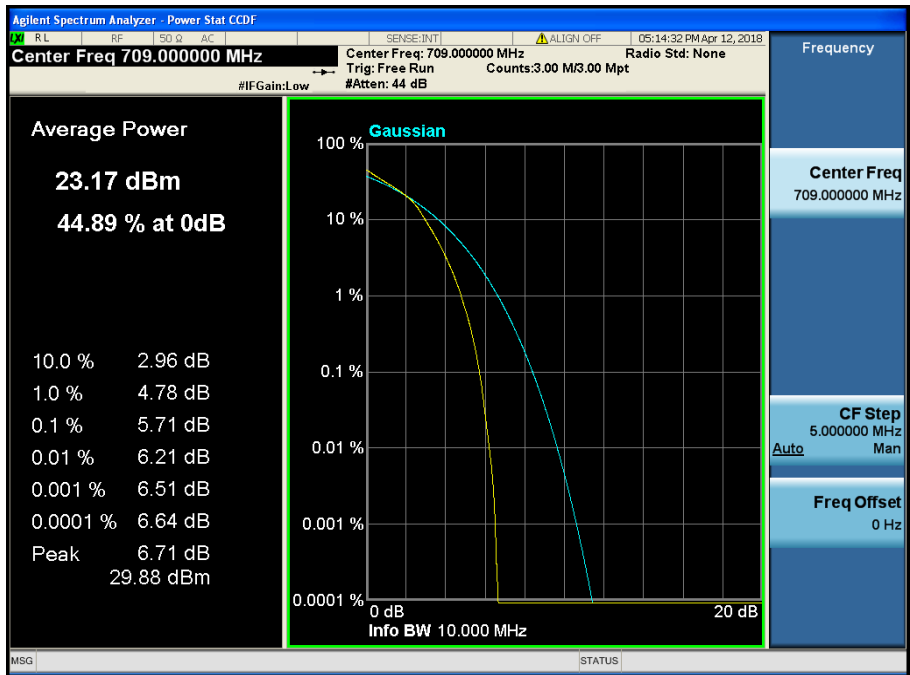

LTE Band 17 / 10 MHz / 16QAM - RB Size 50



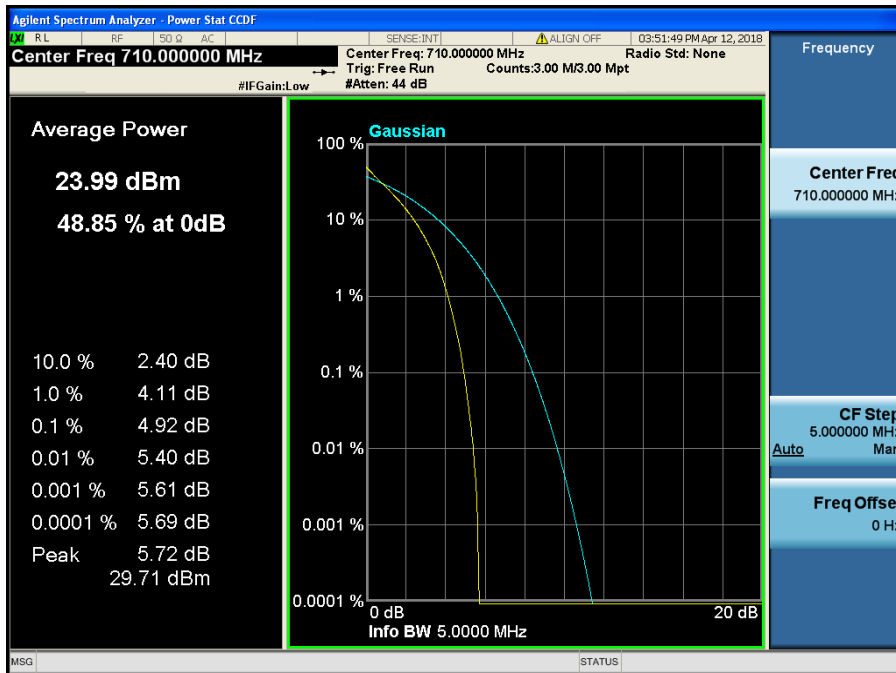

LTE Band 17 / 5 MHz / QPSK - RB Size 25



LTE Band 17 / 5 MHz / 16QAM - RB Size 25

8.2.3 LTE Band 5

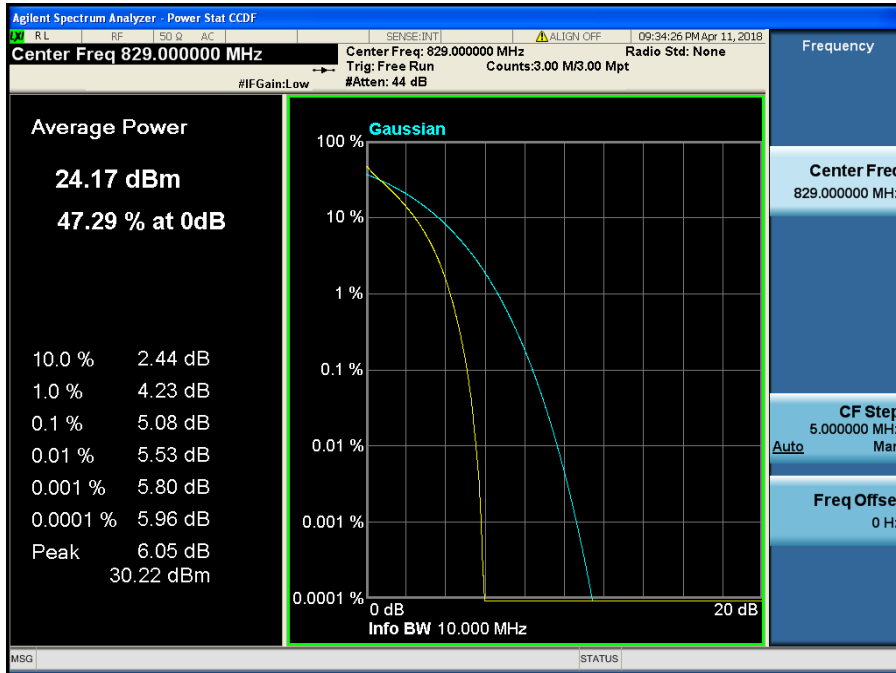

LTE Band 5 / 10 MHz / QPSK - RB Size 50

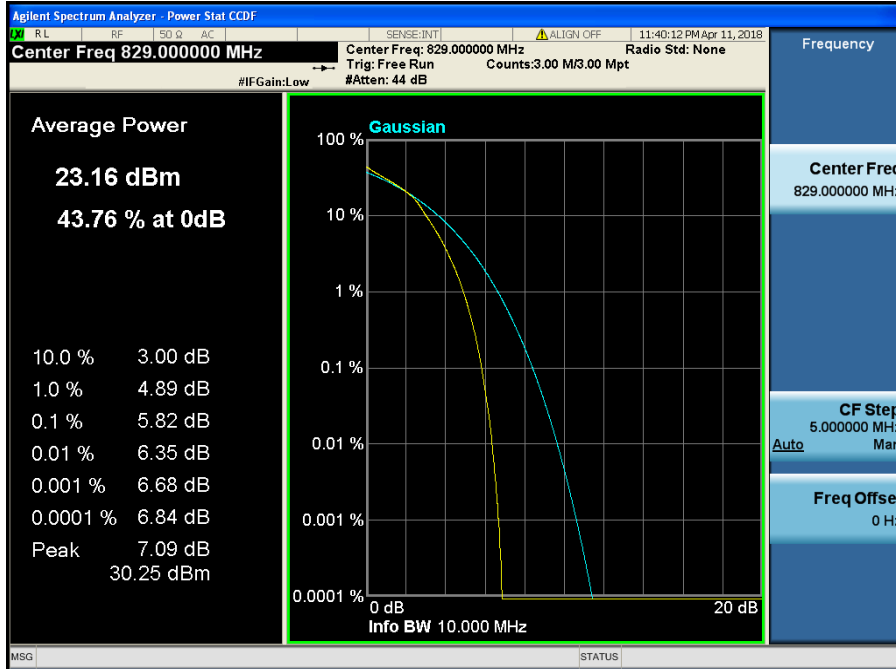

LTE Band 5 / 10 MHz / 16QAM - RB Size 50

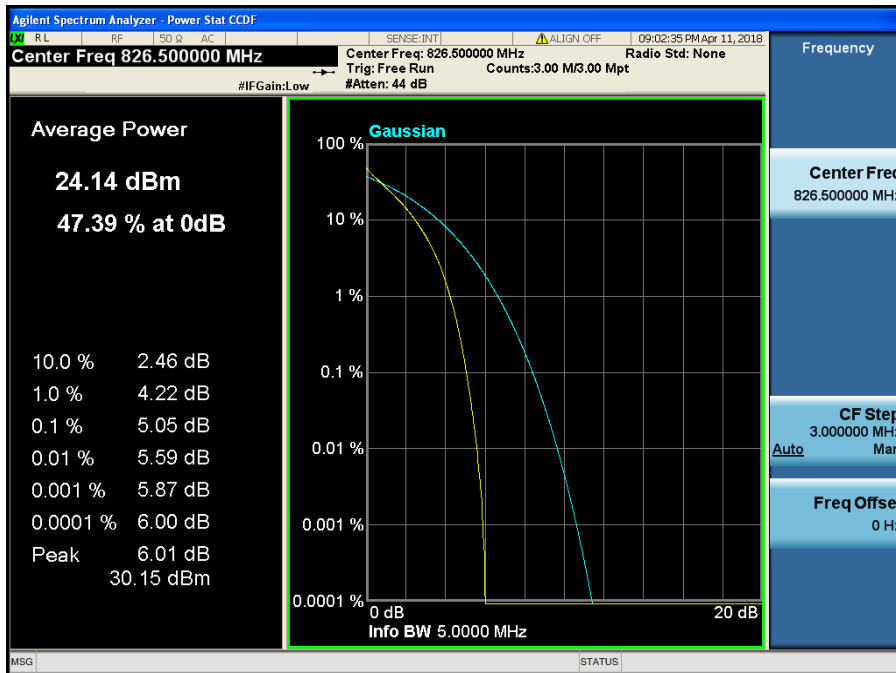

LTE Band 5 / 5 MHz / QPSK - RB Size 25

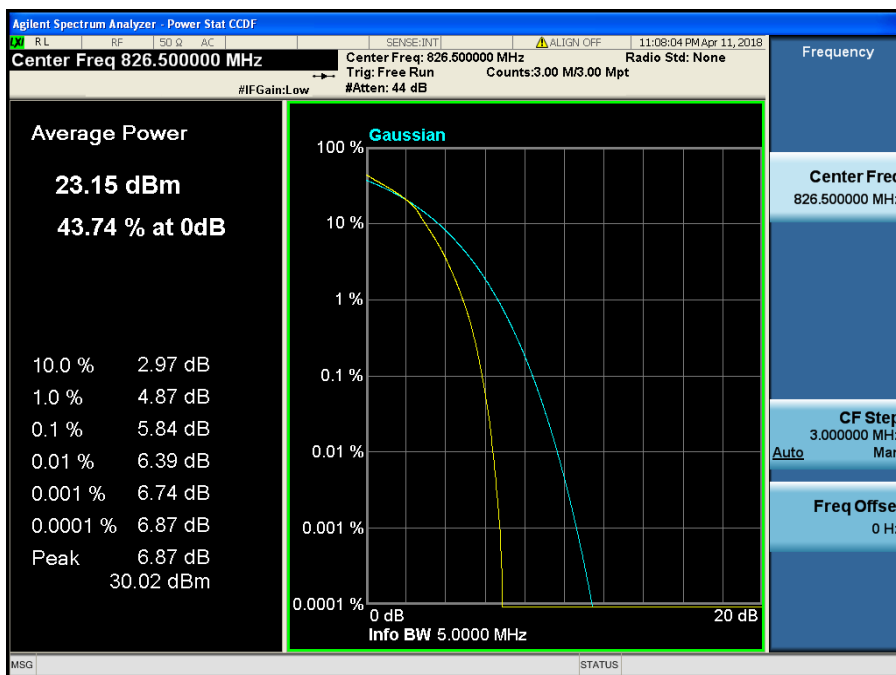

LTE Band 5 / 5 MHz / 16QAM - RB Size 25



LTE Band 5 / 3 MHz / QPSK - RB Size 15



LTE Band 5 / 3 MHz / 16QAM - RB Size 15

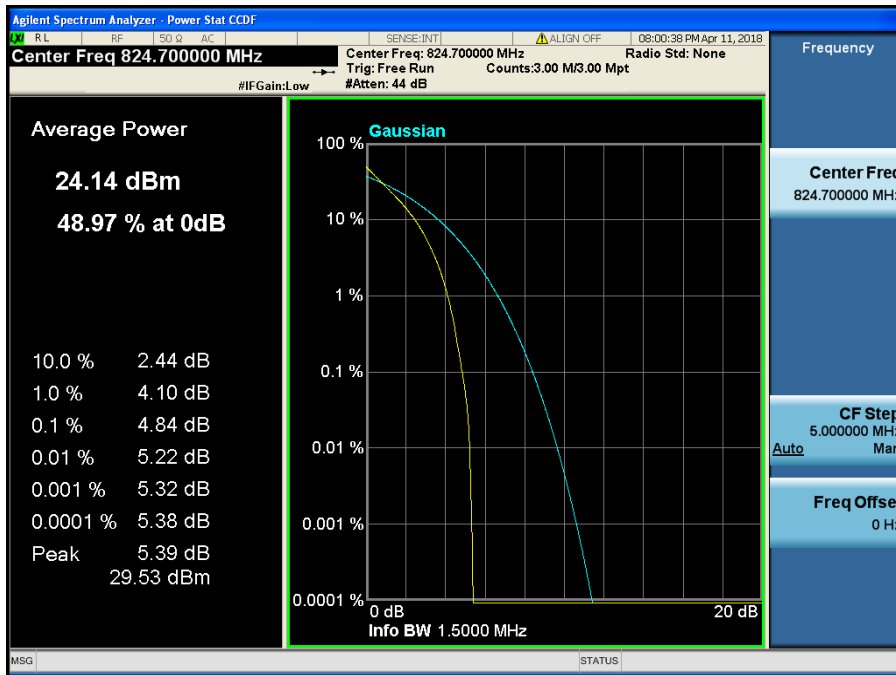

LTE Band 5 / 1.4 MHz / QPSK - RB Size 6

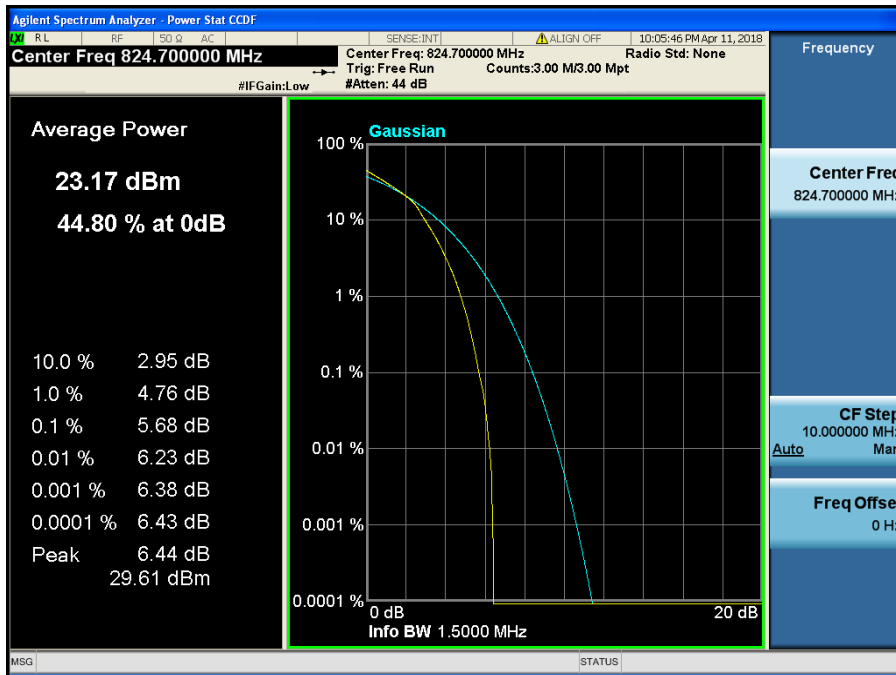

LTE Band 5 / 1.4 MHz / 16QAM - RB Size 6

8.2.4 LTE Band 4

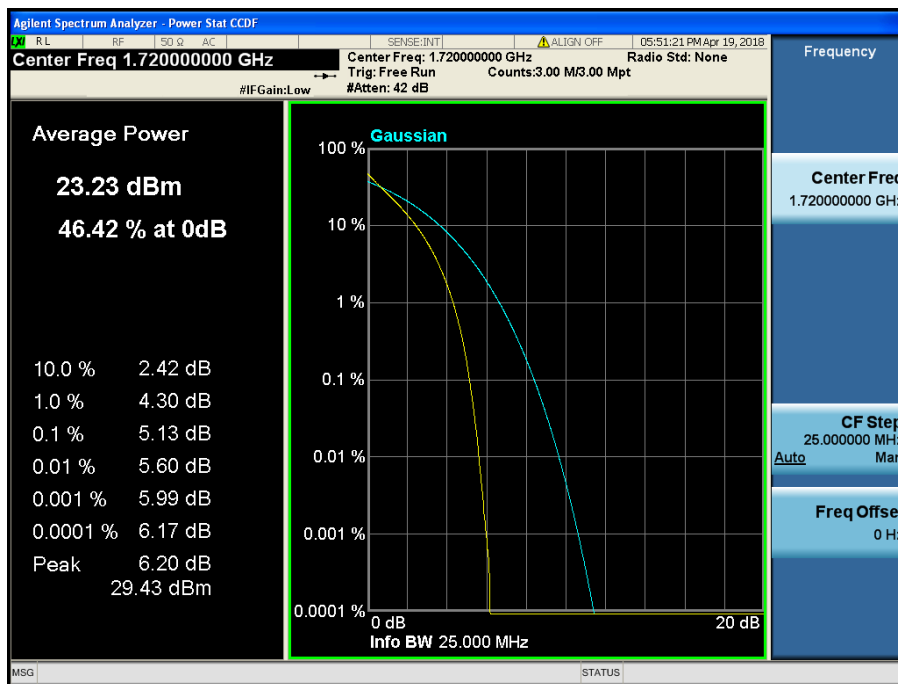

LTE Band 4 / 20 MHz / QPSK - RB Size 100

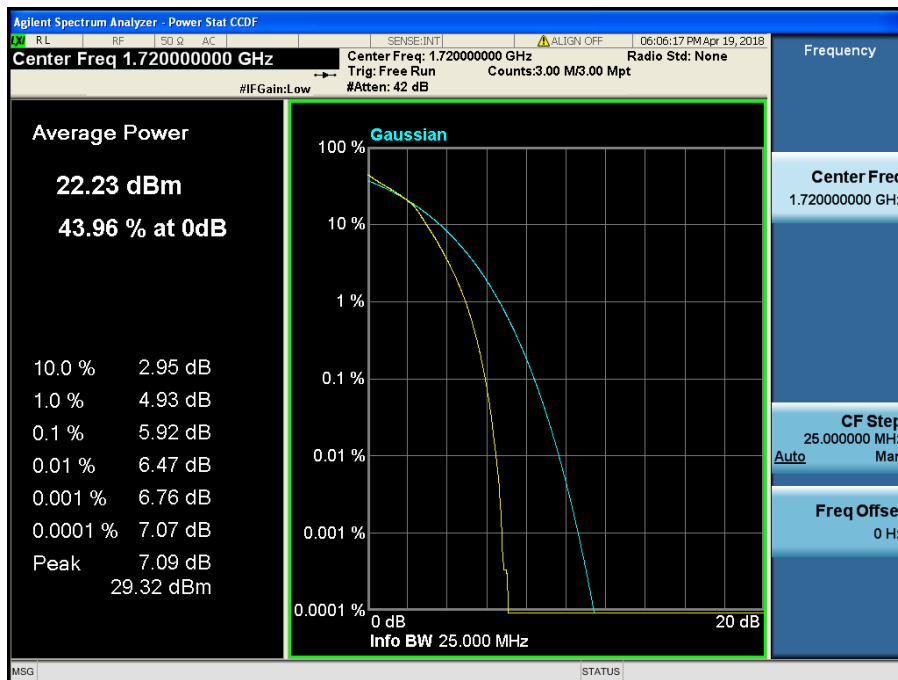

LTE Band 4 / 20 MHz / 16QAM - RB Size 100

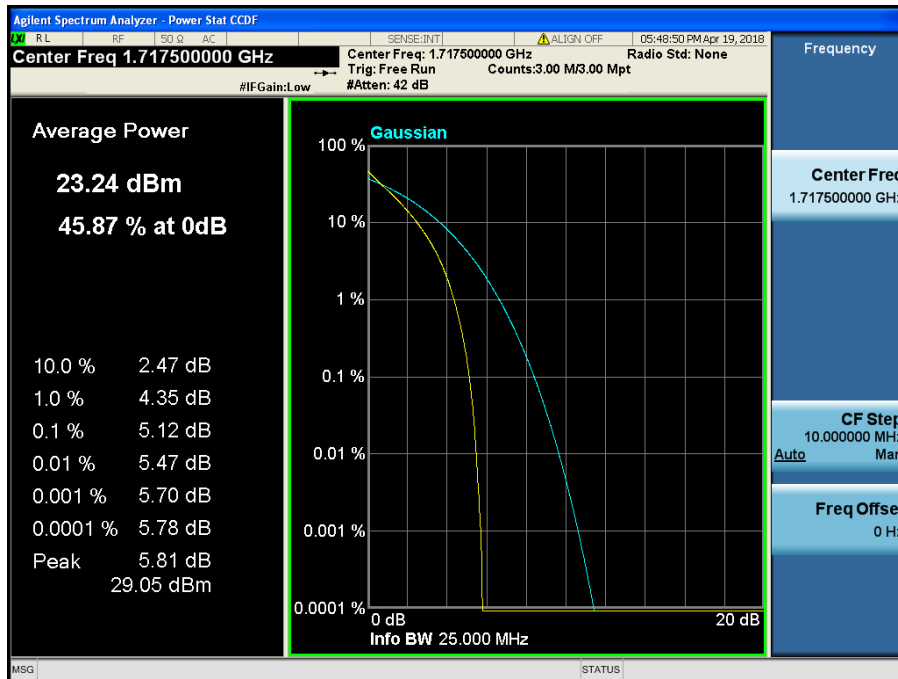

LTE Band 4 / 15 MHz / QPSK - RB Size 75

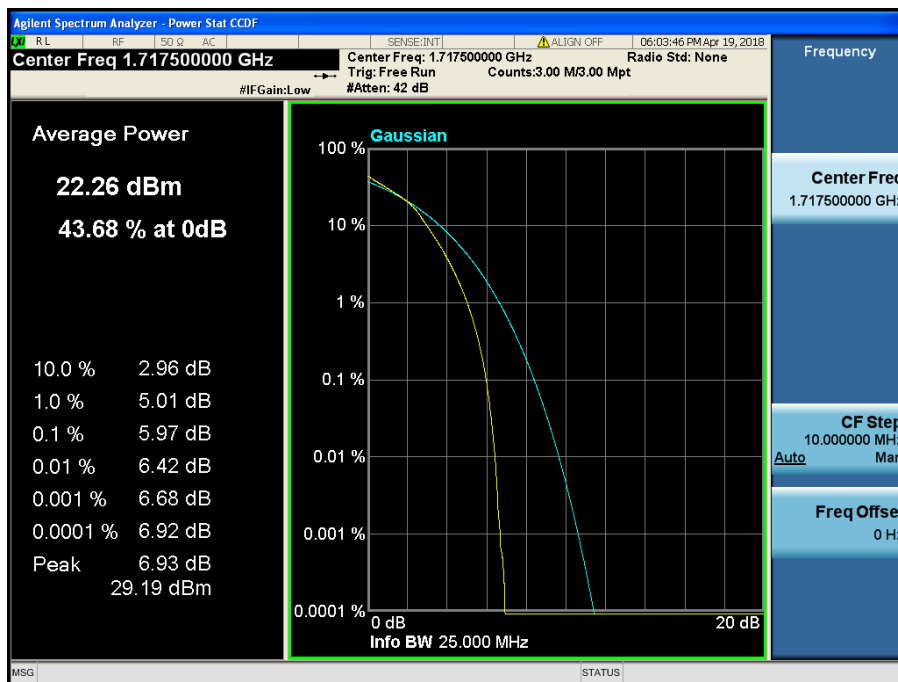

LTE Band 4 / 15 MHz / 16QAM - RB Size 75

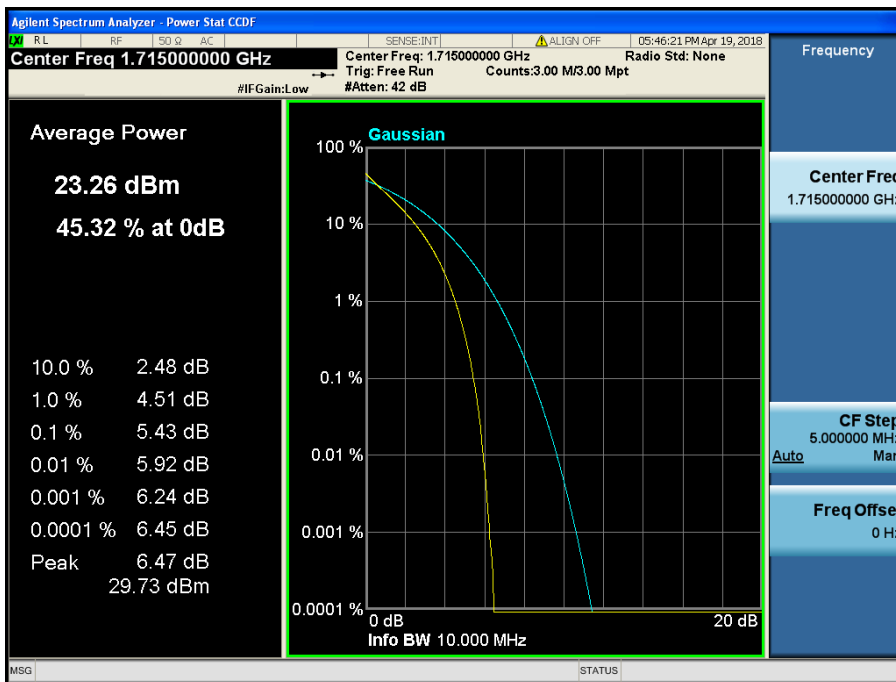

LTE Band 4 / 10 MHz / QPSK - RB Size 50

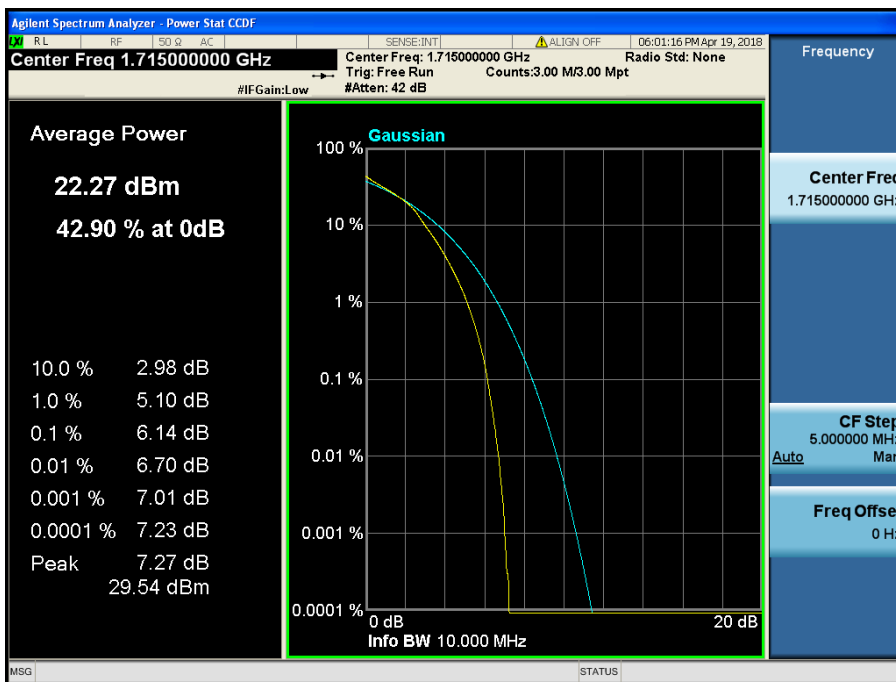

LTE Band 4 / 10 MHz / 16QAM - RB Size 50



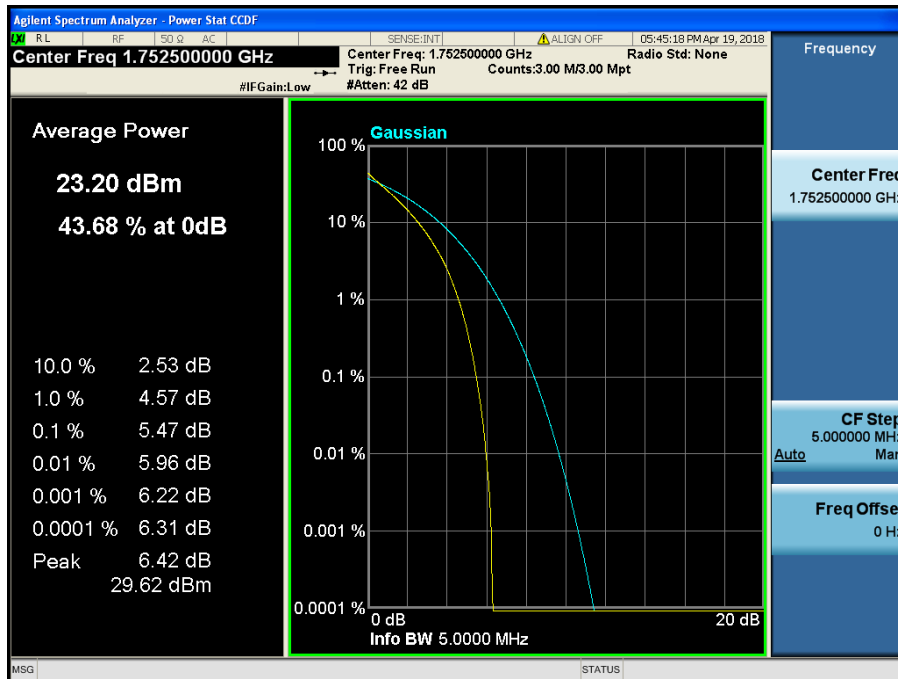

LTE Band 4 / 5 MHz / QPSK - RB Size 25

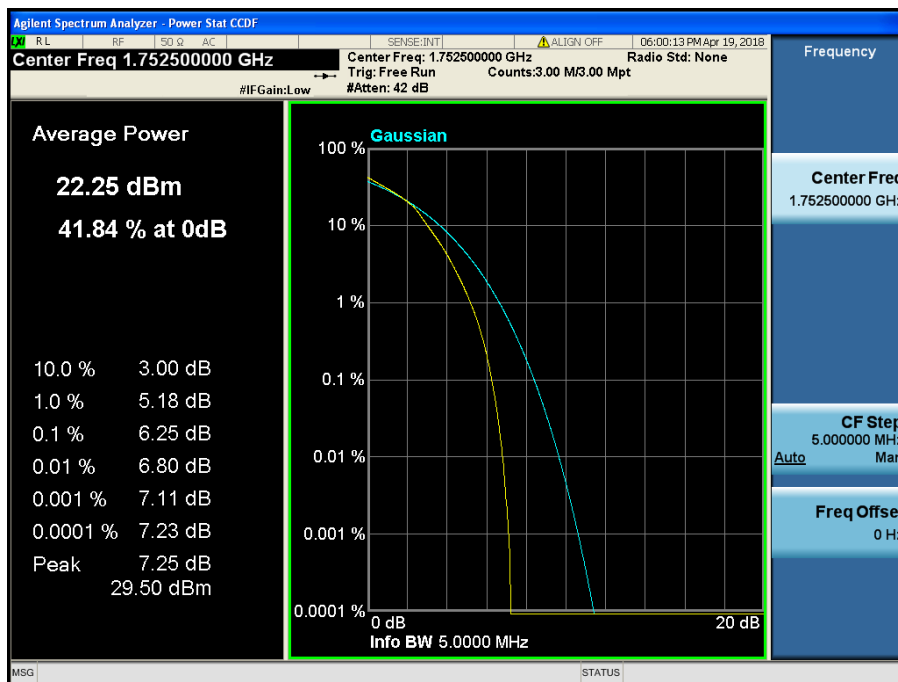

LTE Band 4 / 5 MHz / 16QAM - RB Size 25

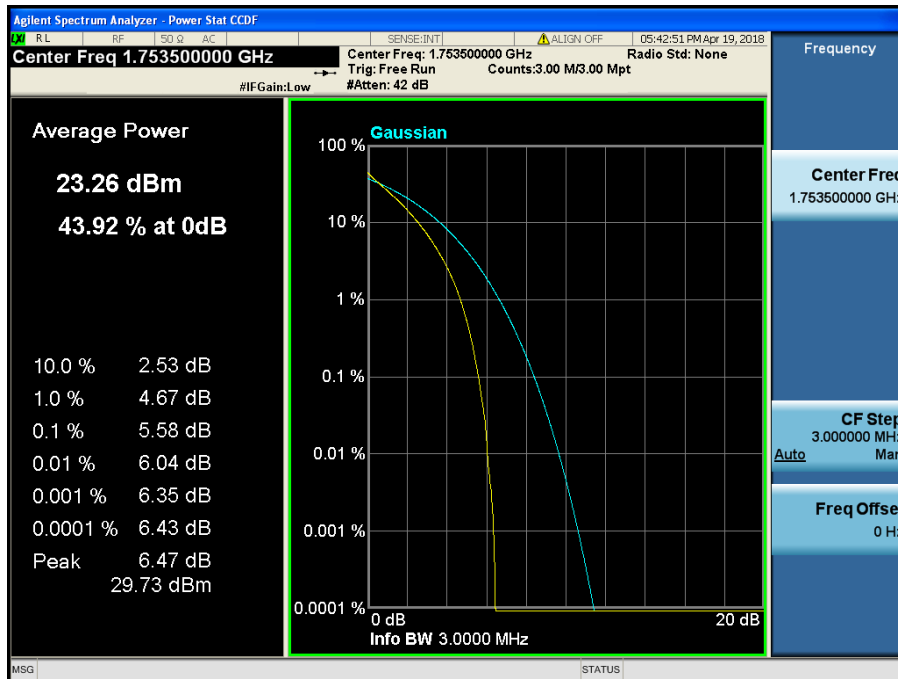

LTE Band 4 / 3 MHz / QPSK - RB Size 15

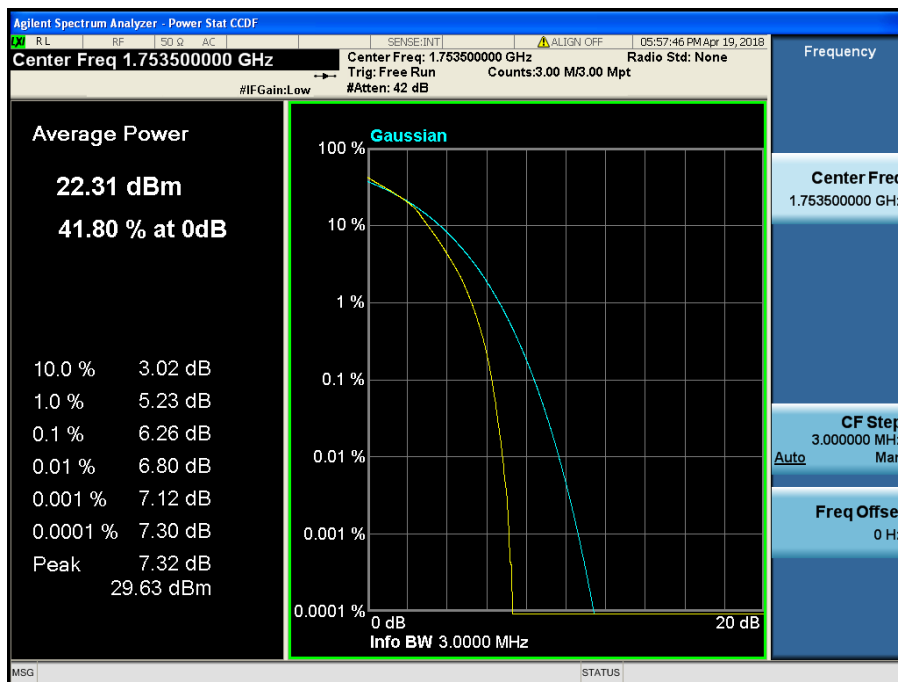

LTE Band 4 / 3 MHz / 16QAM - RB Size 15

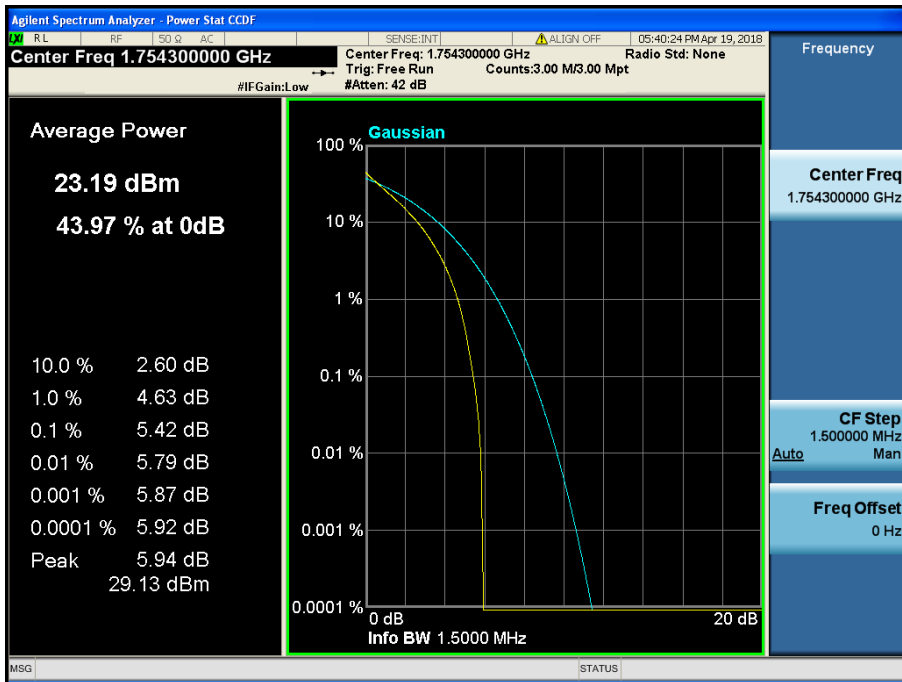

LTE Band 4 / 1.4 MHz / QPSK - RB Size 6

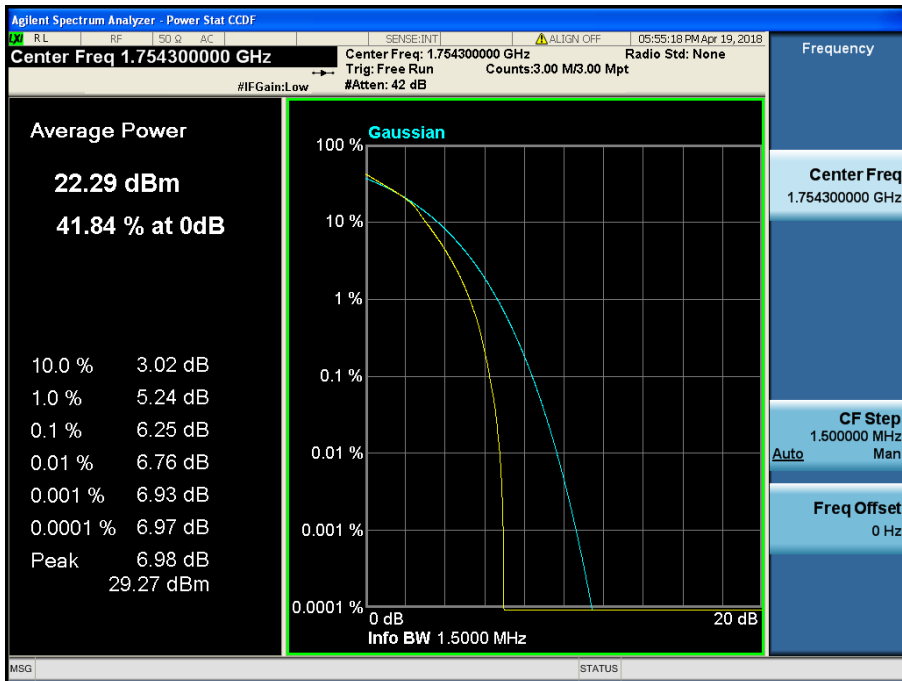

LTE Band 4 / 1.4 MHz / 16QAM - RB Size 6

8.2.5 LTE Band 66

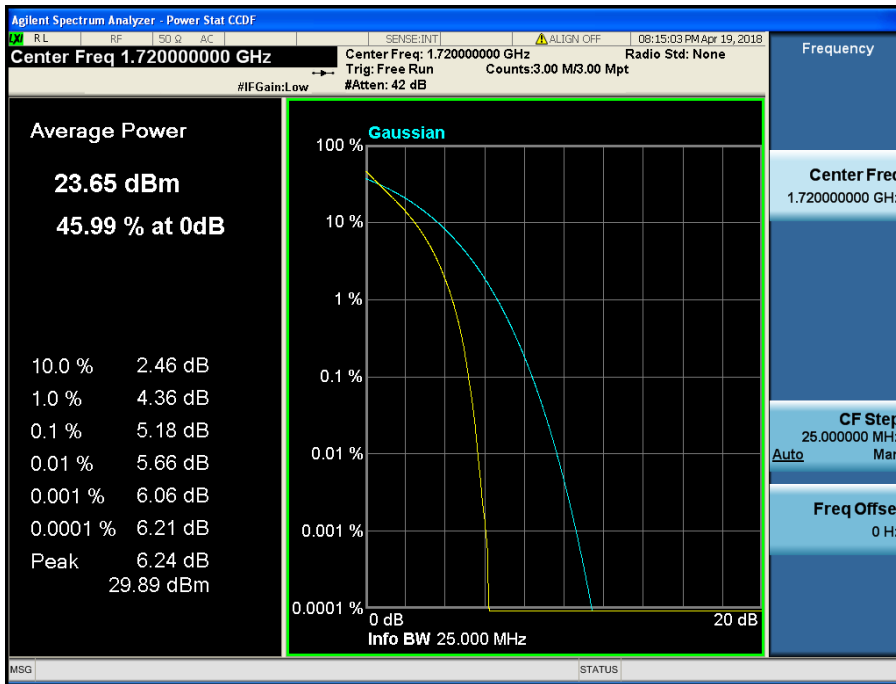

LTE Band 66 / 20 MHz / QPSK - RB Size 100

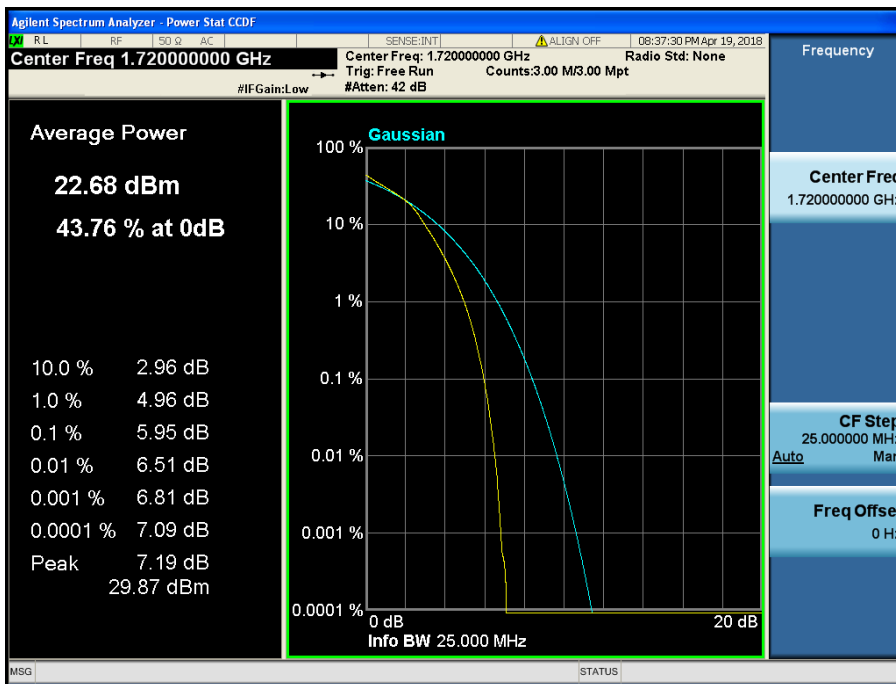

LTE Band 66 / 20 MHz / 16QAM - RB Size 100

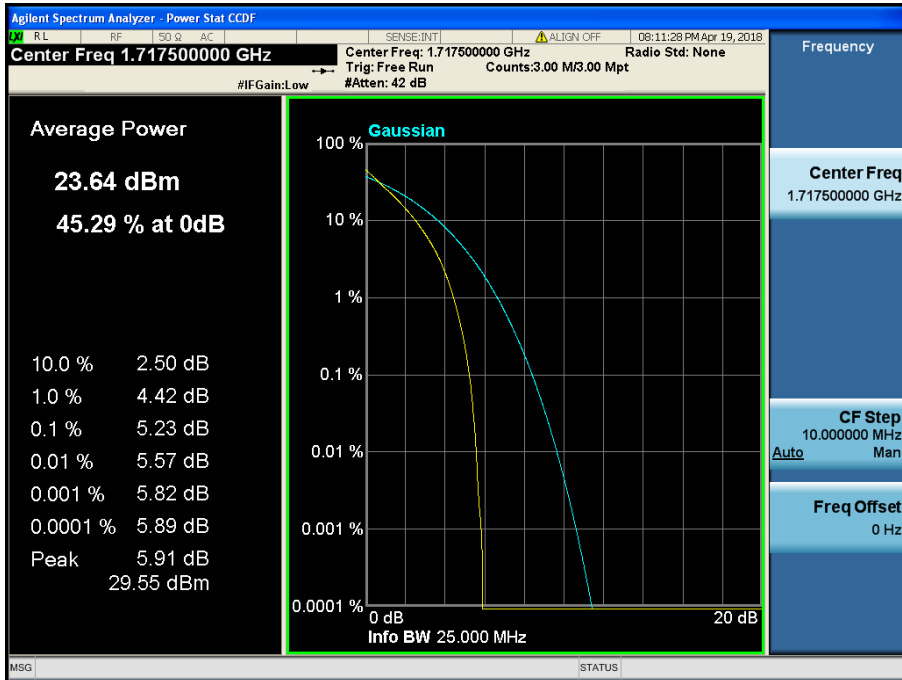

LTE Band 66 / 15 MHz / QPSK - RB Size 75

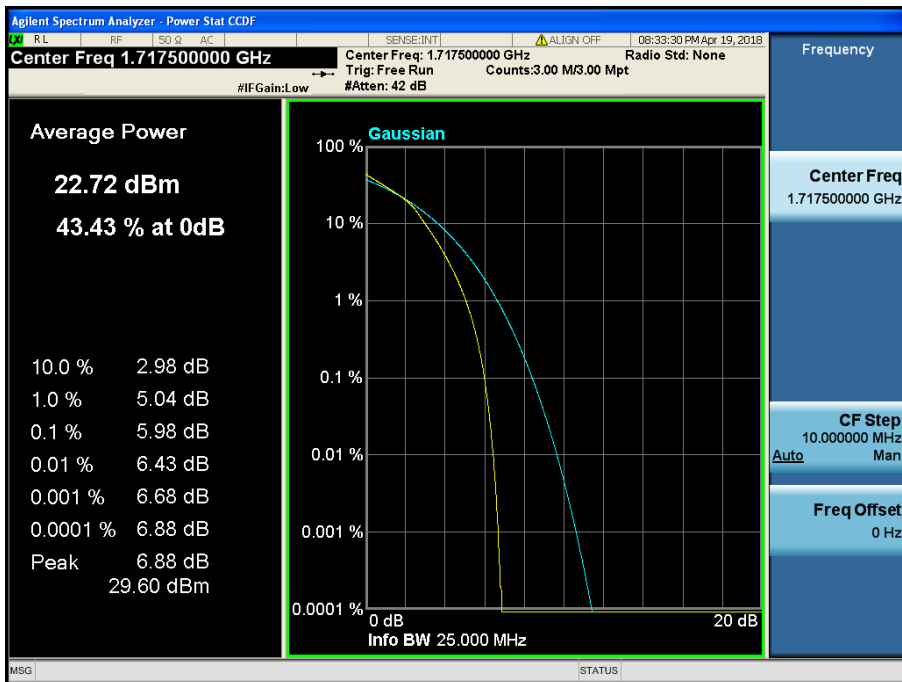

LTE Band 66 / 15 MHz / 16QAM - RB Size 75

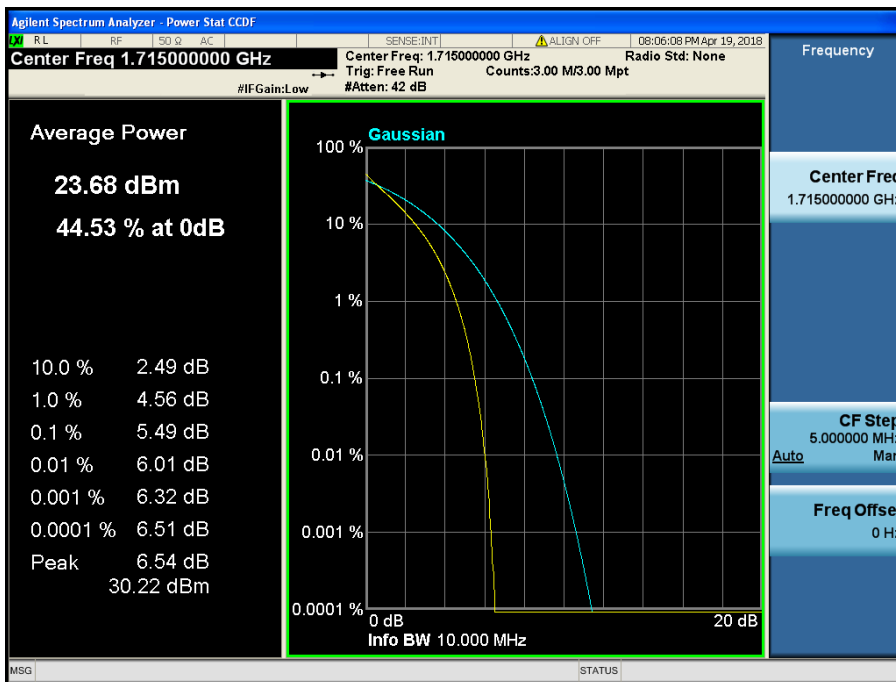

LTE Band 66 / 10 MHz / QPSK - RB Size 50

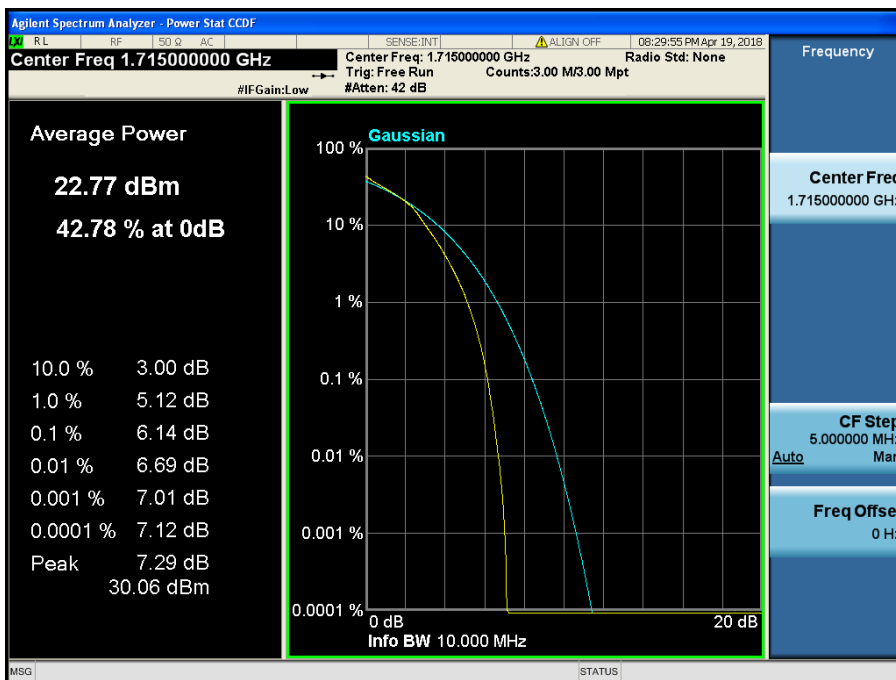

LTE Band 66 / 10 MHz / 16QAM - RB Size 50

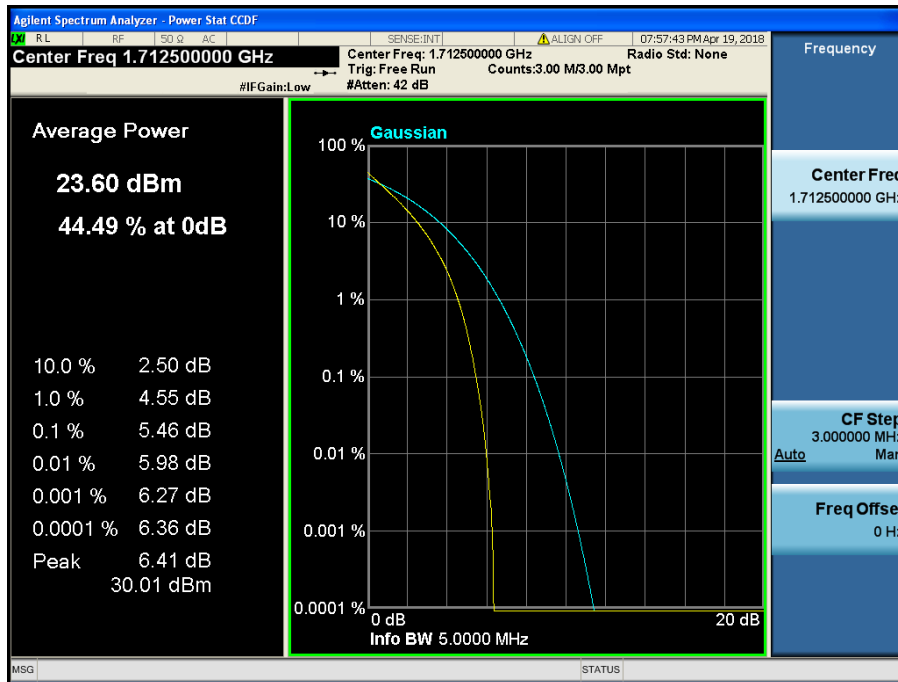

LTE Band 66 / 5 MHz / QPSK - RB Size 25



LTE Band 66 / 5 MHz / 16QAM - RB Size 25

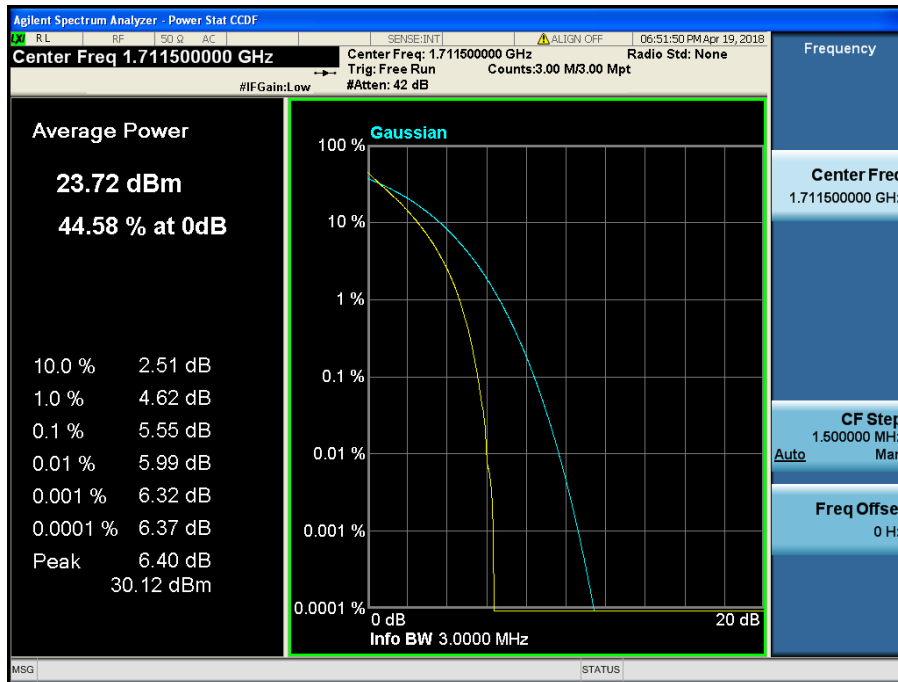

LTE Band 66 / 3 MHz / QPSK - RB Size 15

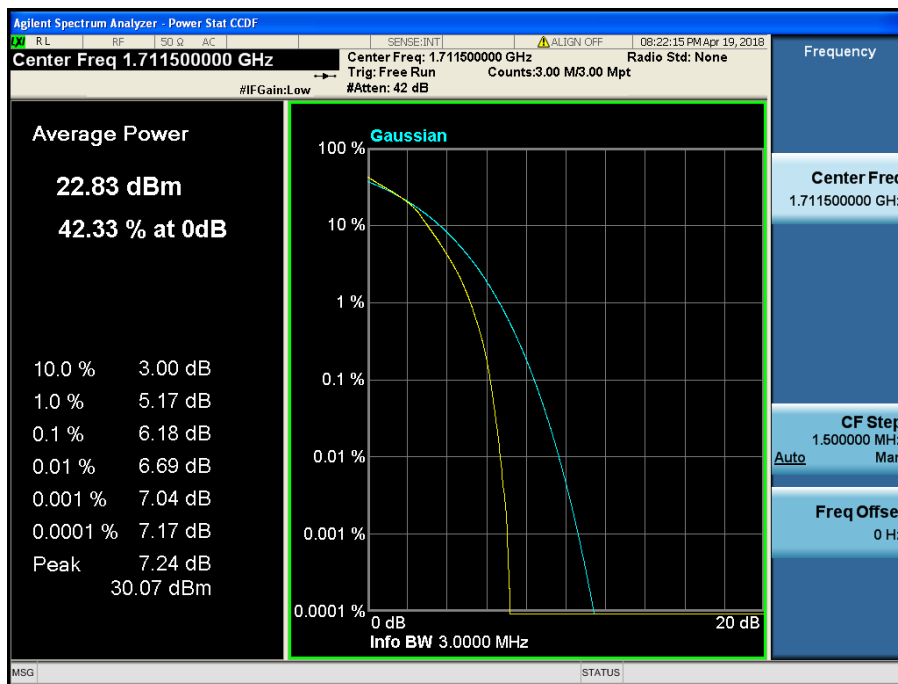

LTE Band 66 / 3 MHz / 16QAM - RB Size 15



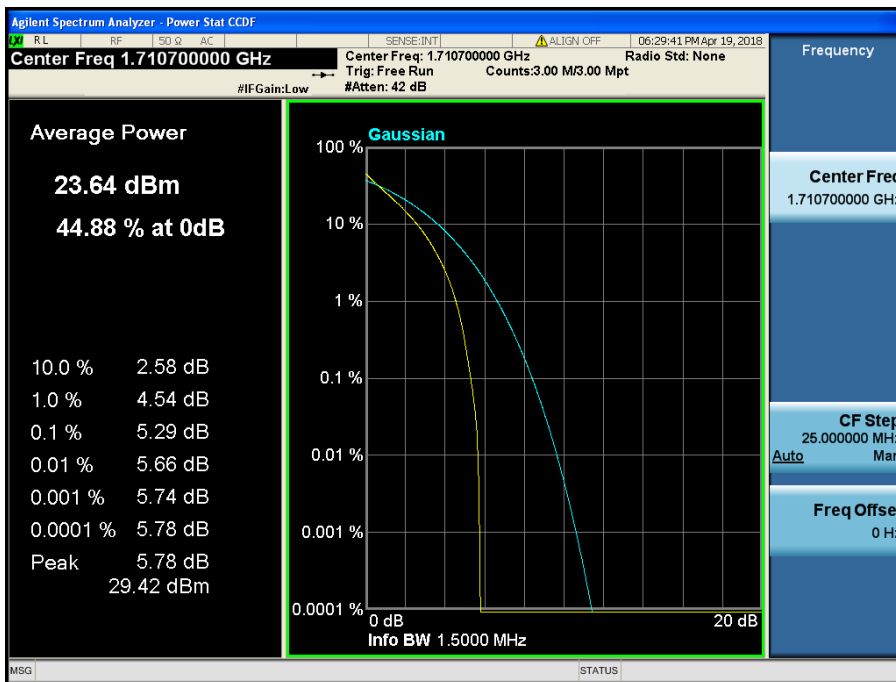

LTE Band 66 / 1.4 MHz / QPSK - RB Size 6

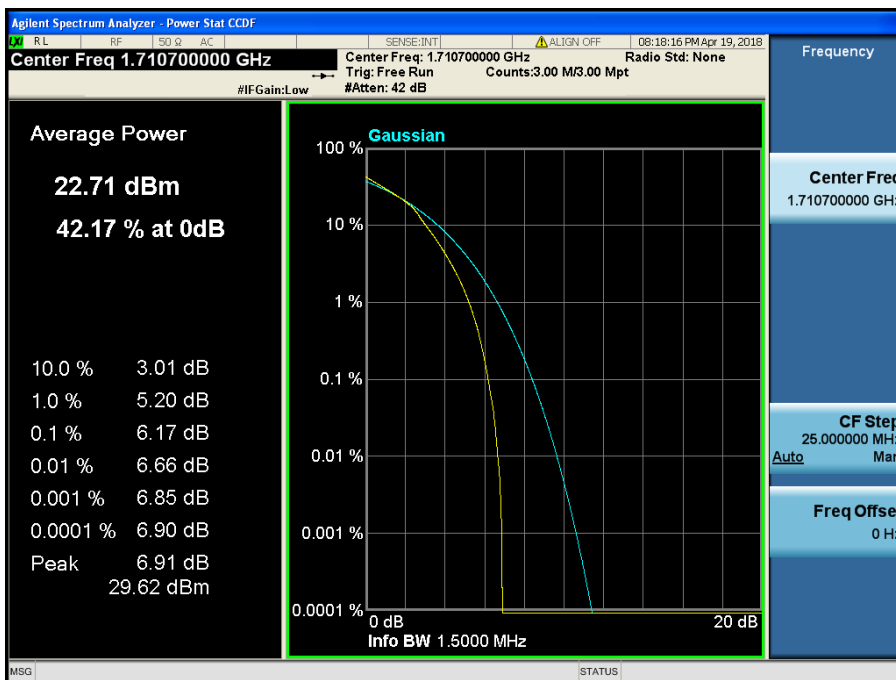

LTE Band 66 / 1.4 MHz / 16QAM - RB Size 6

8.2.6 LTE Band 2

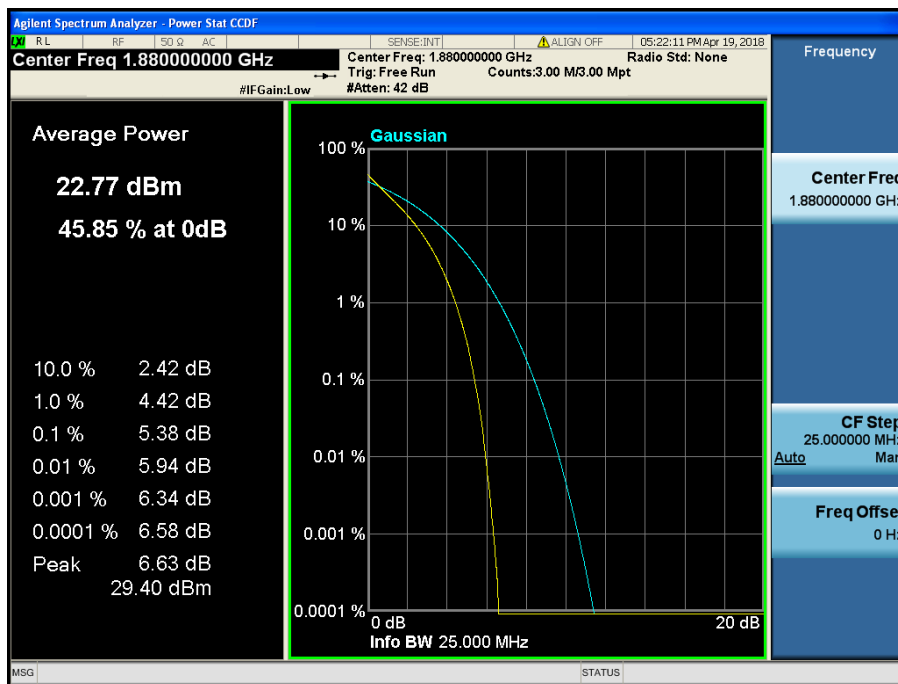

LTE Band 2 / 20 MHz / QPSK - RB Size 100

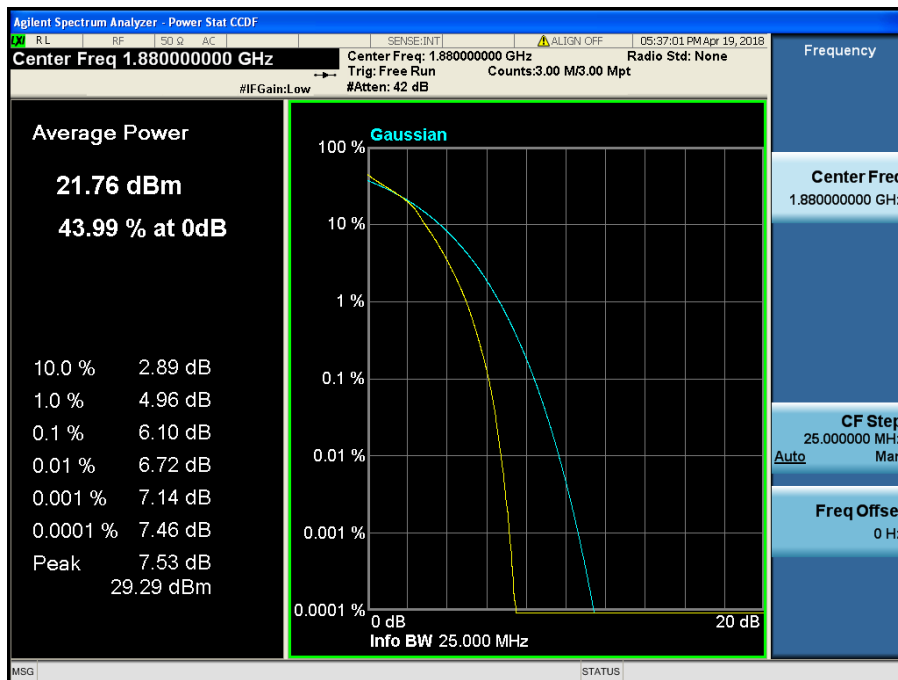

LTE Band 2 / 20 MHz / 16QAM - RB Size 100